

Re Rdall

WIRELESS WORLD

AND

RADIO REVIEW

No. 164. [No. 1. VOL. XI.]

7th OCTOBER, 1922.

Registered at the G.P.O. as a Weekly Newspaper.

A New Condenser for Wireless Receivers THE DUBILIER TYPE 600 MICA CONDENSER

The illustrations show two types of this new condenser for wireless receiving circuits. These condensers have the same perfect mica insulation, the same high efficiency and the same permanence of capacity as the larger Dubilier Mica Condensers used in wireless transmitters. Distortion when receiving telephony is often due to bad design of the components of the receiver—therefore use efficient Dubilier Condensers in your receiver to obtain the best out of your set.

With Clips for Grid Leak.

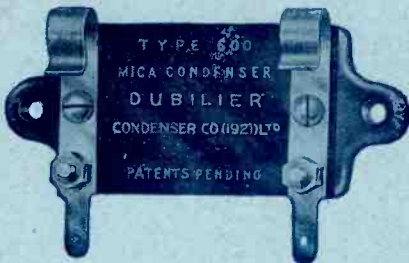

Without Clips for Grid Leak.

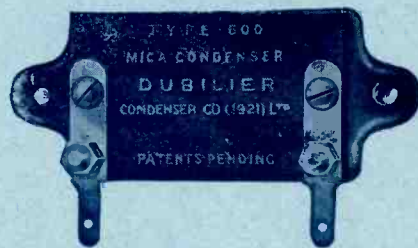

PRICES

Capacities between 0'0001 and 0'0009 mfd.	2/6 each
" 0'001 " 0'005 " inclusive	3/6 "
Condensers complete with Grid Leaks	7/6 "

TRADE TERMS ON APPLICATION.

Both types of condenser (with or without clips for a grid leak) are fitted with screw terminals as well as tags for making soldered connections.

DUBILIER

THE DUBILIER CONDENSER CO. (1921), LTD.,

DUCON WORKS, Goldhawk Road, Shepherd's Bush, London, W.12

Telephone—Hammersmith 1084

Telegrams—Hiveltcon, Phone, London.

Code—Marconi International

Visit our Stand No. 36. All-British Wireless Exhibition, Horticultural Hall, September 30th to October 7th.



STERLING No. 1 CRYSTAL W/T RECEIVING SET

Specially designed for use in connection with the Wireless Telephony Broadcasting Scheme, and is suitable for a range of about 25 miles.

PRICE £7-12-6

Visit our stand No. 34. All-British Wireless Exhibition, Horticultural Hall, September 30th to October 7th.

STERLING TELEPHONE & ELECTRIC CO., LTD.

210-212, Tottenham Court Road,
LONDON : : : W.1

Telephone No. : 4144 Museum (7 lines)
Telegrams : "Cucumis, Wesdo, London."

Works : "DAGENHAM, ESSEX.

BRANCHES :

NEWCASTLE-ON-TYNE : 9, Clavering Place.
CARDIFF : 8, Park Place.

IMMEDIATE DELIVERY

"Wireless for all"

Before you decide on the construction of your set. It will pay you to have particulars of—

Condensite Celoron

For PANELS and OTHER PARTS.

This material is waterproof, immune to atmospheric and climatic conditions, will not warp, has high surface and volume resistivity, high di-electric strength, low specific gravity.

LET US QUOTE YOU

SEND PARTICULARS OF YOUR EXACT REQUIREMENTS TO
THE MANUFACTURERS

DIAMOND FIBRE CO. LTD.
DIAMOND-FIBRE WORKS HIGH ROAD SOUTH TOTTENHAM, N.15.

JUST PUBLISHED!

RADIO PRESS WIRELESS DIRECTORY

An absolutely up-to-date list of wireless call signs of all kinds of stations throughout the world.

High-power Stations — Coastal Stations — Ship Stations — and British Amateur and Experimental Wireless Stations.

If You Had a Telephone

could you do without a telephone directory? No, of course not. Nor can you do without this Wireless Directory, which is the first of its kind, is published at a reasonable price, and is a complete guide—brought absolutely up to date—of all the commercial and amateur stations of the world. Can you afford to be ignorant of where your music, speech, and messages come from? Your hobby will be twice as interesting when you have bought this book.

Contains the largest list of Amateur Stations yet published

**Every Reader of the "Wireless World"
should purchase a copy immediately**

A THOROUGHLY AUTHORITATIVE DIRECTORY

PRICE 2/6 NET

(Post Free 2/8)

Radio Press Ltd.

**DEVEREUX BUILDINGS,
DEVEREUX COURT,
STRAND, LONDON, W.C.2**

Visit our Stand No. 27, All-British Wireless Exhibition, Horticultural Hall, September 30th to October 7th.

*IN consequence of re-organisa-
tion and enlargement of our
works, all business will be
conducted in future from our
works address:—*

**THE “K.B.” RADIO
EQUIPMENT COMPANY**

17 and 19, Lonsdale Road, KILBURN, N.W.6

Telephone—WILLESDEN 3021

BURNDEPT

WIRELESS APPARATUS

LONDON OFFICE & SHOWROOMS
15, Bedford Street, Strand, W.C.2.

All **BURNDEPT** Valve Apparatus is duly licensed under Marconi Patents for Amateur use in Great Britain.

An Announcement

OUR new illustrated catalogue, giving full particulars and much interesting information about our apparatus, can now be obtained.

The catalogue is printed in two colours on good paper, and is profusely illustrated. It is bound in a cover of tasteful design, and contains two sections, Amateur Wireless Receiving equipment and Broadcasting equipment; a further section will be ready on October 30th, dealing with transmitting equipment, which will be posted to all holders of the catalogue in due course.

Everyone interested in Wireless ought to write for one.

Price **1/-** post free

Which amount will be returned with first order.

BURNDEPT, LTD., *Manufacturers of Wireless Apparatus*
AERIAL & EASTNOR WORKS, BLACKHEATH, S.E.3

"WESTERN COUNTIES" ACCUMULATORS			
Write for Complete Price List.		FOR WIRELESS USE	
Write for Complete Price List.		Write for Complete Price List.	
The most Reliable and Moderate Priced Accumulator on the Market.			
4 Volts.		6 Volts.	
80 amphours	£1 8 6	60 amphours	£1 17 6
120 "	1 17 6	90 "	2 5 0
150 "	2 5 6	120 "	2 12 6
180 "	2 19 6		
Sole Agents for Messrs. BURNDEPT LTD., for South-Midland and South-Western Counties.		The Western Counties Electrical & Engineering Company, Midland Bank Chambers, Yeovil. Telephone— "Electron, Yeovil" Yeovil	

AUCKLAND'S

HIGH CLASS SLAB INDUCTANCES



Uni-Wave wound, self-supporting; entirely different from the mass of wax now being offered. Our Catalogue gives inductive value of each coil.

Range.....8 Coils
300—30,000 m.

PRICE PER SET:
12/6

CONDENSER
DIALS ENGRAVED
TO 180°
3/9



A Standard Dial, Bevelled Edge and fitted with Brass Bush and Fluted Knob.

MARCONI
OSRAM
VALVES



17/6

We have large stocks of Valves. Each Valve is tested and bears a guarantee, but is sent at the purchaser's risk, by post.

TABLE STANDS FOR DUO-COILS

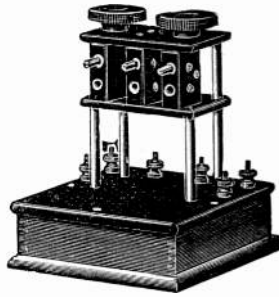

Regd. No. 688454.

For Three Coils ... **21/-**
" Two " ... **18/-**

SPECIAL
PANEL TYPE HOLDER
For Three Coils **12/6**

TELEPHONE TRANSFORMERS

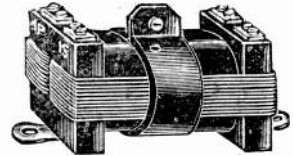

Correct Design and Workmanship. For use with L.R. Phones as used in "Auckland" Sets. Over 3,000 of these Transformers are now in use.

PRICE :
13/6

Mounted in Polished Box
17/6

FILAMENT RESISTANCES



FOR PANEL MOUNTING

HIGHEST STANDARD
AT A LOW PRICE

Fitted with Brass Bush and Pointer, exact as illustration.

3/9

CALL AND INSPECT

THE STAND IS No. 46

at which large and varied stocks of everything wireless will be on view, and can be purchased.

**STAND NO.
46**

G. Z. AUCKLAND & SON, 395, St. John Street, E.C.1

Factories—ISLINGTON, N.

MANUFACTURERS OF WIRELESS APPARATUS.

LONDON OFFICES:

Phone—CLERKENWELL 1172.

AUCKLAND'S

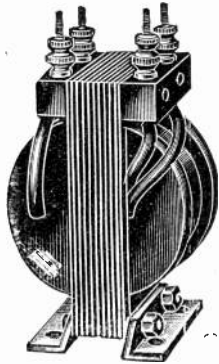

AUCKLAND'S INTERVALVE TRANSFORMERS

are guaranteed to give Maximum L.F. Amplification (giving no distortion of speech or parasitic noises), by reason of their careful design and manufacture.

The coil is layer wound and spaced, and the Stalloy Core is faced with Insulation on one side of each Lamination, to obtain the Maximum Magnetic Field.

Like all "Auckland Products" they are Unsurpassed.

PRICE **20/-** EACH.

Liberal Discount to Trade.

Deliveries from Stock.

MADE BY INSTRUMENT MAKERS FOR INSTRUMENT USERS.

AUCKLAND CONDENSERS

Specification.

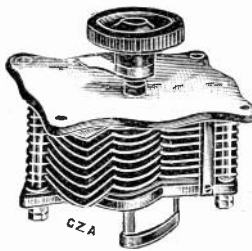

Our orders for these condensers required the whole output.

Having increased our factory space and improved the method of

manufacture, we can now offer from stock for panel mounting.

1. Vanes are of hard Aluminium.
2. Spacing of plates '072".
3. Top plate die cast and fitted with Ebonite bush with brass centre as bearing.
4. Bottom plate $\frac{1}{8}$ " Aluminium and fitted as per No. 3.
5. Centre contact maintained by phosphor bronze strip.

Built to a universal standard.

TYPICAL AGAIN OF "AUCKLAND'S."

·0002 mfd.	15/-
·0003 "	16/-
·0005 "	18/-
·001 "	24/-

WATCH for future adverts. of Complete Sets and Amplifiers, manufactured under licence of Marconi patents.

G. Z. AUCKLAND & SON, 395, St. John Street, E.C.1

Factories—ISLINGTON, N.

MANUFACTURERS OF WIRELESS APPARATUS.

LONDON OFFICES:

Phone—CLERKENWELL 3173.

McGRUER

HOLLOW MASTS

are simple to fix on either roof or ground. They have the least wave-disturbing mass consistent with rigidity.

Our 30' Mast with folding joint weighs only 16 lbs. It is supplied complete with Truck, Sheave, Insulators, Stays, Strainers and Anchors.

We specialise in light masts and spreaders.

Masts of any height supplied.

Write stating your particular requirements and we will quote you by return.

McGruer Hollow Spar Co. Ltd.

Commercial Road, Lambeth, S.E.1.

Telephone: Hop 718. Telegrams: Ollosparsh, Watloo London.

SOMETHING NEW !!

"SEMAPHORE" REPLACEABLE DRY BATTERIES for WIRELESS RECEIVING SETS.



See it and other Smart Ideas at Stand 5, Horticultural Hall, Sept. 30 to Oct. 7

ADVANTAGES—About 5 times life of ordinary batteries. Any 2 cells can be replaced at cost of 1/-. Tappings at every 3 volts by means of Wander Plugs. 12 Cells (18 volts) complete with Connectors and Plugs 7/6 each. 24 (36) " " " " 18/9 " For Higher Voltages place additional "Boxes" together.

SEMAPHORE, Ltd., DRY BATTERY SPECIALISTS
28, John Street, Bedford Row, London, W.C.1
Telephones - - MUSEUM 5422 and 5423
Telegrams - - ARWELIDITE, HOLB. LONDON



TRADE MARK

**The WHITECROSS
COMPANY, LIMITED
:: WARRINGTON ::**

Manufacturers of All Descriptions of
**WIRE ROPES
AND WIRES**

The most reliable and efficient
Batteries for Wireless Work are

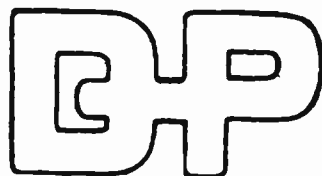

**STORAGE
BATTERIES**

D.P. Batteries are made to fit almost any size of box. The output of our Works runs to hundreds of thousands of plates yearly.

Write us for particulars

The D. P. BATTERY CO., Ltd.
BAKEWELL — DERBYSHIRE
& 11 Victoria St., London, S.W.

If you want advice as to the books on Wireless Telegraphy and Telephony best suited to your requirements write to :

**The Radio Expert,
The Wireless Press, Ltd., 12-13, Henrietta Street, London, W.C.2.
THE PIONEER HOUSE FOR WIRELESS PUBLICATIONS.**

THE WIRELESS WORLD AND RADIO REVIEW

THE OFFICIAL ORGAN OF THE WIRELESS SOCIETY OF LONDON
A MAGAZINE DEVOTED TO WIRELESS TELEGRAPHY AND TELEPHONY

CONTENTS

Dr. J. A. Fleming, F.R.S.	- - - - -	1
Electrons, Electric Waves, and Wireless Telephony. By Dr. J. A. Fleming, F.R.S.	- - - - -	2
The All-British Wireless Exhibition	- - - - -	8
Automatic Wireless Reception. By W. D. Owen, A.M.I.E.E.	- - - - -	24

Contents continued on next page.

The discerning Amateurs and Experimenters require apparatus and parts of the highest quality and efficiency. These can be obtained only from :

Radio Supplies (Established 1920) 236, High Holborn, London, W.C.1.

The firm with a long-standing reputation for Superior Wireless Apparatus.

NOW IS THE TIME to acquire a sound theoretical and practical knowledge of **THREE ELECTRODE VALVES**, (as applied to C.W. Radio-telegraphy and Radio-telephony), by means of my **POSTAL INSTRUCTION COURSE**.
Perfectly Simple
May I Send you Particulars?

2/Lt. E. REDPATH,
19, Niger St., BARROW-IN-FURNESS

CONTENTS *(Continued)*

Experimental Licences	- - - - -	26
Notes	- - - - -	27
Wireless Society of London	- - - - -	28
Calendar of Current Events	- - - - -	28
Wireless Club Reports	- - - - -	29
Questions and Answers	- - - - -	33
Share Market Report	- - - - -	38

THE WIRELESS WORLD AND RADIO REVIEW is published weekly on Saturdays.

All correspondence relating to contributions should be addressed to THE EDITOR, THE WIRELESS WORLD AND RADIO REVIEW, 12-13, Henrietta Street, Strand, London, W.C.2.

No responsibility can be taken for MSS. or photographs sent without stamps to defray cost of return postage.

Editorial and Publishing Offices, 12-13, Henrietta Street, Strand, London, W.C.2.

Telegraphic Address: "Radionic, Rand, London." Telephone No.: Gerrard 2807.

Advertisement Managers, Bertram Day & Co., Ltd., 9 and 10, Charing Cross, S.W.1.

Telephone No.: Gerrard 8063 and 8064

SUBSCRIPTION RATES.—

28s. per annum, post free. Single Copies 6d., or post free 7d.

Registered at the G.P.O. for transmission by Magazine Post to Canada and Newfoundland.

MAKE YOUR OWN SETS.—As an advertisement and until withdrawn, we offer the complete parts for making 1 Valve to 7 Valve Receivers together with full instructions at specially reduced prices.

Complete Parts for 1 Valve Set £6 6 0	Including Ebonite Panel and Terminals, Polished Wood Box, Filament Resistance(s), Vernier Condenser, Grid Leak and Condenser, Tuning Coils, 4000 ohm Telephones, H.T. Battery, 4 volt Accumulator, Aerial Wire Insulators, etc.
Complete Parts for 2 Valve Set 8 0 0	
Complete Parts for 3 Valve Set 15 0 0	
Complete Parts for 4 Valve Set 18 0 0	

If you wish to enlarge your present set, write stating parts you have, when we will quote you for parts required and full instructions.

OUR PROFESSIONAL SERVICES ARE AT YOUR DISPOSAL.
 Cash with Order—Delivery in Rotation, Carriage Paid.

WIRELESS COLLEGE, Amateur Supplies Dept., COLWYN BAY

VALVES

DELIVERY FROM STOCK.

RECEIVING.



Type.	Filament Voltage.	Anode Voltage.	PRICE.
R	4	60	£0 17 6
R4B	4	50	1 10 0
V24	5.2	36	1 4 0
Q	5.2	50	1 4 0
		(150 as amplifier)	
QX	5.2	50	1 4 0

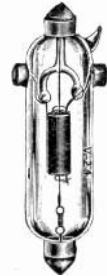

SPECIAL LOW TEMPERATURE VALVES.



Type.	Filament Voltage.	Filament Current.	Anode Voltage.	PRICE.
L.T.1	1.8	.4	36-50	£2 10 0
L.T.3	1.8	.11	„	„

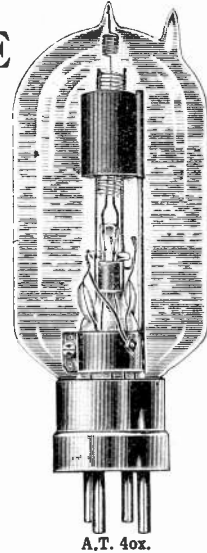

TRANSMITTING.

Type	Filament Voltage.	Anode Voltage.	PRICE.
A.T.25	5.5	UP TO 1,000	£1 10 0
A.T.40X	7	„ 1,000	2 15 0

Visit our Stand No. 32. All-British Wireless Exhibition, Horticultural Hall, September 30th to October 7th

THE
MARCONI SCIENTIFIC INSTRUMENT CO., LTD.

40 DEAN STREET, SOHO, W.1

TELEGRAMS: THEMASINCO, WESTCENT
 TELEPHONE: GERRARD 774

WATES

SPECIALITIES INCLUDE THE RELIABLE—

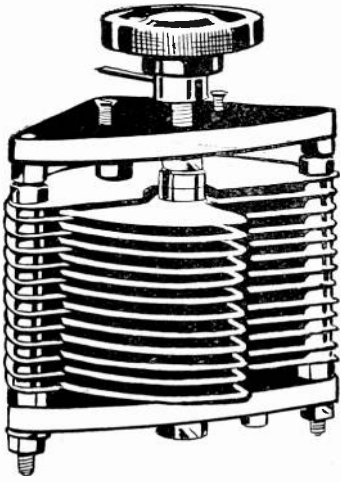

Panel Mounting Condenser

A first-class condenser exceptionally smooth in adjustment and manufactured with precision.

Capacity.	Panel Mounting.	In Mahog. Case.
0003 ..	15/-	20/-
0005 ..	17/6	22/-
00075 ..	20/-	24/-

Visit our Stand No. 15. All-British Wireless Exhibition, Horticultural Hall, Westminster, Sept. 30th to Oct. 7th.

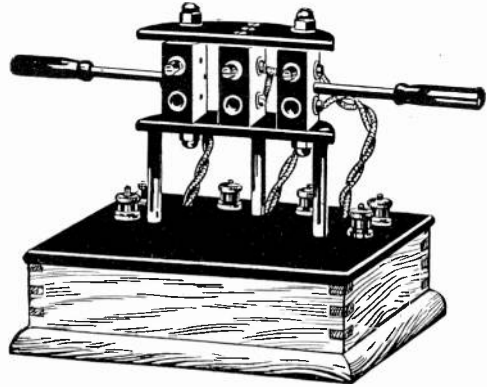

Triple Coil Holder.

Reaction is not allowed except on a tuned aerial circuit. This handsome triple coil holder is all you require to conform to the regulations. Price each £1. Coils for all wavelengths in stock.

Send 3 Stamps for Wireless list.

A FEW PROVINCIAL AGENCIES STILL AVAILABLE.

WATES Bros., 13/14, Gt. Queen St., Kingsway, W.C.2

Manufacturers of First-class Wireless Apparatus

W. & M. CRYSTAL DETECTOR

Specially designed to withstand vibration

Delicate Contact and Fine Adjustment.

Price **6/6**
Post Free.

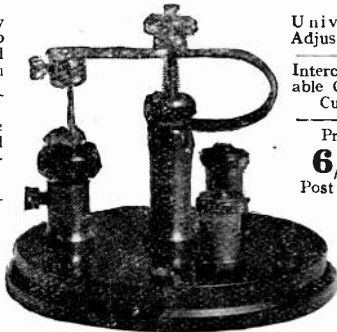

Universal Adjustment.

Interchangeable Crystal Cups.

Price **6/6**
Post Free.

Registered Design No. 692248.

Trade Terms and Discounts on Application.

MANUFACTURED SOLELY BY THE

Wainwright Manufacturing Co., Ltd.,
25, VICTORIA STREET, S.W.1.

Works: WALTHAMSTOW, Essex, and BIRMINGHAM.

Telegrams: "NOMINATUS, VIC, LONDON."
Telephone: VICTORIA 4319.

EBONITE AND VULCANITE

TUBES—RODS—SHEETS

LARGE STOCKS

BRITANNIA RUBBER AND KAMPTULICON CO., LTD.

7, NEWGATE ST., LONDON, E.C.1

Telephone : 2168 Central

Telegrams : Britannia, London

THE WIRELESS WORLD AND RADIO REVIEW

THE OFFICIAL ORGAN OF THE WIRELESS SOCIETY OF LONDON

No. 164 [No. 1.
VOL. XI.]

OCTOBER 7TH, 1922.

WEEKLY

Dr. J. A. Fleming, F.R.S.

AUTHOR OF "ELECTRONS, ELECTRIC WAVES, AND WIRELESS TELEPHONY," COMMENCING IN THIS ISSUE.

IN this issue it is our privilege to publish the first of a series of articles contributed by Dr. J. A. Fleming, F.R.S., whose portrait appears on this page. In our issue of September 16th, we announced that the second half-yearly volume, which commences with this issue, would contain the commencing instalment of these contributions.

The appearance of these articles under the title of "Electrons, Electric Waves, and Wireless Telephony," at the present moment is extremely opportune, since it coincides with the official announcements that Broadcasting is to start at once.

With the introduction of Broadcasting, there will be thousands who will be seeking for information as to what Broadcasting is and how it is done.

These articles by Dr. Fleming will exactly answer these questions. Dr. Fleming will explain in not too technical language exactly what wireless telephony is and how it is produced.

This knowledge will add enormously to

the interest which those new to wireless will have in the new science, which, through the introduction of Broadcasting, is to have so great a future. Perhaps these articles will afford an even greater fascination for those acquainted with wireless,

who will thereby be able to appreciate more fully the arguments put forward by Dr. Fleming and the experiments with which he illustrates them.

There have been many contributions to wireless literature dealing with the subject of wireless telephony, but never before, we feel convinced, has the subject been treated in a manner so well calculated to absorb the attention and interest of every class of reader.

Those who have read Dr. Fleming's recent book "Fifty Years of Electricity," are in a position

to form some estimate of the interest which these articles will arouse. There are indeed few who have been in a position to watch the growth of wireless and contribute so largely to its development as Dr. Fleming.

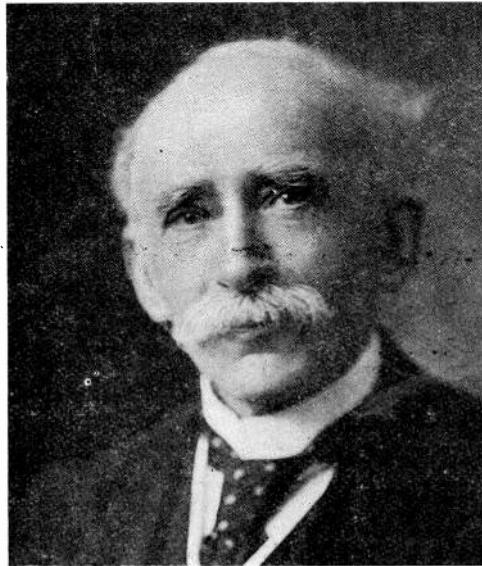

DR. J. A. FLEMING, F.R.S.

Electrons, Electric Waves, and Wireless Telephony—I.

By Dr. J. A. FLEMING, F.R.S.

The series of articles by Dr. J. A. Fleming, F.R.S., which will appear under the above title, are a reproduction with some additions of the Christmas Lectures on Electric Waves and Wireless Telephony he gave at the Royal Institution, London, in December and January, 1921-1922. These lectures attracted very large audiences and were brilliantly illustrated by experiments and demonstrations. Over 400 applications for admission to these lectures had to be refused by the Managers owing to the sitting space in the theatre being insufficient to accommodate all who wished to attend. The Wireless Press, Ltd., has been able to secure the serial rights of publication, and any subsequent republication. The articles are therefore copyright, and rights of translation and reproduction are strictly reserved.

It is hardly necessary to remind the readers of "The Wireless World and Radio Review" that Dr. Fleming has been closely and practically connected with the development of wireless telegraphy and telephony from the very beginning, and was last year awarded by The Royal Society of Arts their very highest distinction, the Gold Albert Medal, for his electrical discoveries and researches, and especially for the epoch-making invention of the Thermionic Valve, which in its later developments is the foundation of all modern radiotelephony.

I.—WAVES AND WAVE PRODUCTION.

NOW that the wonderful art of wireless telephony has reached a point in its development at which it is rapidly becoming a popular pastime in place of an exceptional feat by experts, there is naturally a demand for expositions of the scientific principles underlying it, which shall be capable of being understood by the general reader.

This is not adequately supplied either by the highly technical journals or by the bulk of the popular wireless literature being poured out from the Press. Mere pictures or even semi-technical explanations of the mysteries of receiving circuits or the mode of employing thermionic valves or crystals for "listening in," do not entirely meet the public requirements.

This remarkable achievement of applied science is the outcome of the great advances which have taken place in the last quarter of a century in our knowledge concerning atoms, electrons, electric waves and electrical physics generally.

An intelligent comprehension of the *modus operandi* of the technical appliances used in wireless telephony necessitates, then, some slight acquaintance with modern scientific views concerning the nature of matter and electricity, and the possible relations of these to the more fundamental conceptions of æther, space, time and energy.

Probably the chief gain which will result from a keen popular interest in wireless telephony will be an increased public attention to

the progress of electrical science. In view of recent important advances in pure science, most of our text-books on electricity as used in "Schools and Colleges" require to be rewritten.

It is now seen that we have to put on the scrap-heap much of the electrical theory and many explanations of physical phenomena formerly deemed satisfactory, and start with fresh ideas.

In the following articles an attempt will be made to give in outline an account of some of these modern ideas, and advances in recent physics, as far as they bear on the evolution of wireless telephony. The highly technical details of wireless apparatus and its expert management will not so much concern us, and, in any case, is provided for in other publications and books.

When anyone not in the least acquainted with the facts of electrical physics, asks a wireless operator to explain the nature of his operations and appliances he is generally informed it is accomplished by the use of "electric waves." But any attempt to progress beyond the stage of mere phrases generally places the expert and the enquirer in difficulties.

To answer this question at all efficiently renders it necessary to build up from a deeper foundation and consider in detail what is meant in scientific language by the term *wave*. It is essential therefore to start from a consideration of familiar physical effects which can be seen with the bodily eyes, and to make

of these stepping-stones by which we may be enabled to understand something of analogous processes which can only be appreciated with the eyes of the mind.

I. SURFACE WAVES ON LIQUIDS.

The easiest avenue of approach to the study of waves in general is to discuss some of the properties and the nature of the visible surface waves in liquids. We are all acquainted with the appearance of the sea surface when it is traversed by and tossed up into waves, and also with the effects produced on the surface of still water when it has ripples created upon it by the splash of a stone thrown in. In common language we apply the term "wave" to the splashing water thrown up on the beach or rocks at the seaside (Fig. 1). This, however,

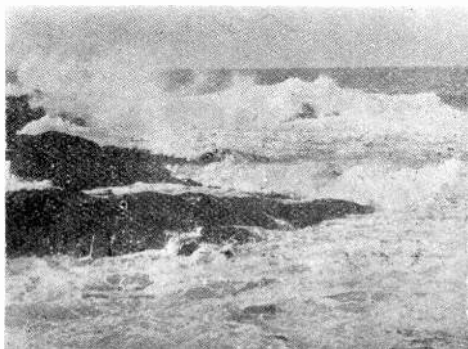

Fig. 1. Sea Waves breaking on the Rocks and Beach

is merely the result of the break-up or end of a wave, and in a scientific sense of the word it is not more properly called a wave than a house in the act of falling down could be described as a "desirable residence."

To understand what is meant by a surface wave in scientific terminology we must go out a little distance from the coast over deep sea water on some breezy day. We shall then see what appear to be rounded elevations or hummocks on the water, which move forward. To the inexperienced eye it seems as if the surface water, as a whole, was in motion in one direction.

If, however, we fasten attention upon some floating object, such as a patch of seaweed or a seagull sitting on the water, we see that as each wave passes under it the floating object is merely lifted up, pushed forward a little, then let down and drawn back, and, in short,

never moves far from one position. A little thought makes it evident we have to distinguish between the motion of the water particles *per se*, and the motion or change in position of the elevations and depressions in the water surface.

We can watch with the eye the progress of a certain hump or ridge on the surface, but that hummock does not consist of the same particles of water for two successive instants.

At any one spot the actual extent of the displacement of individual particles of water may be small, and the progressive movement is merely the apparent change in place from instant to instant of the locality at which this displacement or motion is a maximum or minimum. A simple illustration of the effect may be obtained by laying transversely upon a long horizontal board a cardboard cylinder about the same length as the width of the board. To this cylinder is attached a string by which it can be pulled along parallel to itself. Over the cylinder is laid a strip of green cloth which must be taken to represent the sea surface. A small piece of paper cut out in the shape of a seagull or a small stuffed bird may then be pinned to the cloth (see Fig. 2). If, then, the card roller is pulled along under the cloth each point of the latter will be successively raised and lowered. A moving elevation of the cloth in the form of a ridge or hummock will travel along the cloth and initiate by its action on the model bird the behaviour of the water at one point and at various points in the path of the wave.

2. DEFINITION OF WAVE MOTION.

We are then able to give a definition of wave-motion as follows:—

If the particles of any material or parts of any construction perform successively,

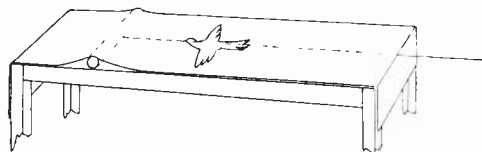

Fig. 2. A Model to explain the progression of a surface wave on water.

meaning by that one after the other and not all at once, any kind of movement or displacement in which they start from and come back

to a given point, this constitutes a *wave motion*. We can see this process illustrated when a gust of wind blows over a field of ripe corn. Each ear or row of ears along a certain region bows down under the pressure of the wind, and then springs up again. Row upon row of the corn-stalks successively, make their obeisance in this fashion to Hermes, and the result is that a sort of shadow sweeps over the field, very beautiful to behold, which constitutes a kind of wave.

A wave does not necessarily involve motion. It may consist in any kind of cyclical change repeated from point to point along a certain line. Thus, suppose we have a very long row of incandescent electric lamps, which by some contrivance can be switched on one at a time for a moment, and then off again. If each lamp in turn, one after the other, progressively along the row, is thus illuminated for an instant, we shall see a wave of illumination propagated along the series of lamps.

If at each point in the series the motion or change is only performed once, we have a so-called *solitary wave*. If at each point it is repeated at regular intervals we shall have produced a *train of waves*.

We can provide an illustration of a progressive wave train in the following way. Wind a length of stiff wire round a pencil or other circular sectioned rod in open turns, like a corkscrew. Fix this spiral in a frame (see Fig. 3) so that it can be rotated. Throw the shadow of it on a screen by means of an optical lantern or else the sunlight, and rotate

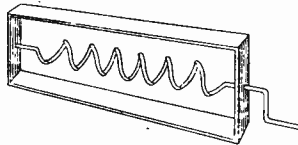

Fig. 3. A Spiral wire, the shadow of which when the wire is rotated imitates a series of progressive waves.

the screw. The shadow will present the appearance of a series of waves travelling along. If a little bit of sealing wax is put on the screw at one point its shadow will merely move up and down on the screen, thus enabling us to distinguish between the cyclical motion at each point in the system, and the apparent motion of the wave.

When dealing with trains of waves there are four terms very frequently in use which it will be convenient to define at this stage.

At any one point in the wave region the material or medium executes a certain regularly repeated motion, or else some cycle of operations. The number of times this cycle is repeated per second or per unit of time, is called the *wave frequency*. The greatest extent of this displacement or motion, or other change from its zero position, is called the *wave amplitude*.

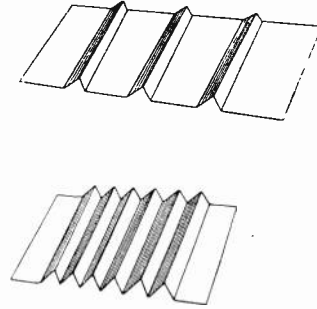

Fig. 4. Pleated paper models to illustrate the difference between "long" and "short" surface waves on water.

The shortest distance measured across from one wave hump or maximum to the next adjacent one is called the *wavelength*. It is important for the general reader to notice that the term "a long wave" does not mean a wave which is long in the direction of the crest, ridge, hump or elevation, but it means that distance between the waves is relatively large. Thus, for instance, if we pleat a sheet of paper so that the folds or ridges are close together, we might take this as an illustration of what is meant by "short" waves. If, however, the ridges or pleats are relatively far apart, they would be called "long" waves (see Fig. 4).

The terms "long" and "short" are, however, relative, and what would be a very long wave for certain purposes might be a very short one for others.

Then, in the next place, every wave moves forward parallel to itself with a certain speed called the *wave velocity*. We may, for instance, imagine a bird to fly along over the sea surface in the same direction in which the waves are travelling and to keep himself always poised above the same crest or hump. The speed with which the bird flies is then the same as the wave velocity.

In all cases of wave motion there is a connection between the wave velocity, the wave

frequency and wavelength, as follows:— The wave velocity is numerically equal to the product of the wavelength and wave frequency when using the same units of length and time. Thus, if the water at any place rises and falls ten times a minute, and if the shortest distance from crest to crest or the wavelength is 20 ft., then the wave velocity is $10 \times 20 = 200$ ft. per minute.

Algebraically, the rule is expressed in the formula $W = n\lambda$, where W is the wave velocity, n the frequency, and λ the wavelength.

In many cases the velocity of the wave is quite independent of the wavelength, that is, long and short waves travel at the same speed. This is the case with wireless waves, and those similar waves which constitute light. On the other hand, it is not the case with surface waves on liquids. On the deep sea surface long waves travel faster than short waves.

Approximately speaking, in the case of deep sea waves the wave velocity is about equal to the square root of $2\frac{1}{4}$ times the wavelength. Thus, waves on the Atlantic Ocean which are spaced apart 300 ft. from crest to crest, or have a wavelength of 100 yards, travel at about 26 miles an hour, or roughly at the speed of a slow railway train. Hence, they catch up a not very quick-moving ship and passing under it, cause the ship to pitch.

3. PRODUCTION OF A WAVE.

We must next consider a little more carefully how a wave is produced, and why it travels along when once started.

In order that a true self-propagating wave may be produced on or in a material, the latter must possess two special properties.

First, it must have elasticity of some kind; that is, it must *resist* some kind of change in it, for example, compression, twisting, stretching, or rotation, and must spring back when released.

Secondly, it must *persist* in motion or have mass or inertia, or some quality equivalent to it which causes it to store up energy when moving, or as the displacement is changing. In short, the medium must possess the power of storing up energy in two ways, viz., as potential energy in the form of some strain, or displacement, and as kinetic energy in the form of some motion, or other change not purely mechanical but equivalent to motion or release of strain.

At any one point the energy is being transformed periodically from potential to kinetic

form and back again. In a wave motion in which the motion or displacement follows a simple harmonic law the average of the varying potential energy during one complete period is equal to the average of the varying kinetic energy during the same period.

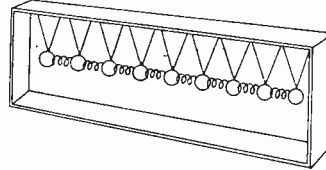

Fig. 5. A Model made with golf balls and spiral springs to illustrate the nature of a longitudinal wave.

The mode of production of a compressional wave can be studied by means of a simple model made with a number of golf balls suspended from a frame by strings so as to hang in a row, each ball being about two inches apart. The balls are inter-connected by spiral springs of brass wire, which resist compression or extension (see Fig. 5). If then the end ball is given a sudden blow with a piece of wood in the direction of the row of balls, it is set in motion and its kinetic energy expended in compressing the spring between it and the second ball. Owing to the mass or inertia of the balls the compression is not transmitted instantly to all the springs, but the spring between the balls 1 and 2 after being compressed expands again and brings ball 1 to rest and starts ball 2 in motion. This again compresses the spring between ball 2 and ball 3, and the same process is repeated from ball to ball. The movement and compression is thus handed on and finally reaches the end spring and ball, which latter flies off freely.

It is easy to watch the rather slow propagation of this wave of compression along the row of balls. As an illustration of another kind of wave called a distortional wave, a model of the following description can be made.

Stretch in a long frame a pair of parallel steel wires about half an inch apart. Thread on these wires long slips of wood or metal (see Fig. 6). The steel wires, and therefore the bars threaded on them, resist being twisted relatively to each other. Hence if we give the end bar a transverse pull so as to twist the wires between the bar 1 and bar 2, that twist will then tend to bring bar 1 back to its original place; but, having mass, it overshoots the mark and then the reverse twist applied pulls back

bar 2. Each bar then continues to vibrate, but the vibrations of each bar are a little out of step with those of its neighbours on either side. The vibratory motion is passed on from bar to bar with a certain delay in phase, as it is called, and hence we have a wave of distortion transmitted along the collection of bars strung on the steel wires.

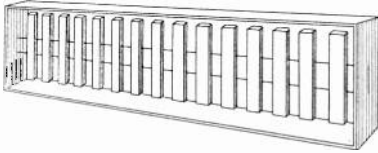

Fig. 6. A Model made with wooden bars and steel wires to illustrate the nature of a distortional wave.

There can be as many different types of wave as there are kinds of elastic resistance, and in a solid elastic substance it is possible to have two types of wave produced, one called a compressional wave in virtue of the fact that the solid resists compression and the other called distortional, in consequence of the fact that a solid resists change of shape. We have these two kinds of waves produced in the earth's crust during earthquakes.

4. WAVES ON WATER.

In the light of these explanations we can then consider the familiar facts connected with the production of waves when a stone, for instance, is thrown upon still water in a lake.

We know that a free water surface is a level surface and that the water resists being

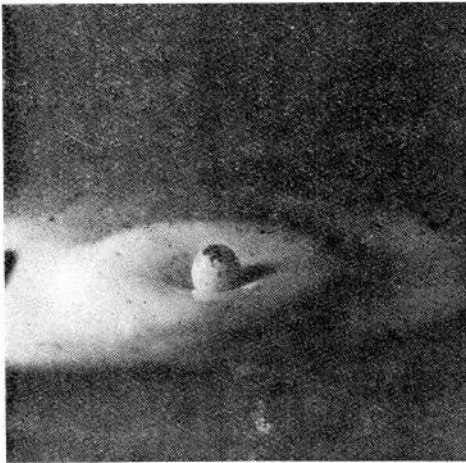

Fig. 7. An instantaneous photograph of a ball dropping into water and creating a circular wave of elevation on it.

made unlevel, and if it is momentarily heaped up or depressed at any place the force of gravitation at once restores the level.

When a stone is thrown on water and plunges downward through the surface, it creates a temporary depression or cavity in the water. Since water is nearly incompressible, it follows that if the surface is depressed at one place it must be heaped up in some adjacent place. Therefore the plunging stone not only creates a cavity, it also heaps up the water in a circular ridge or hummock all round the depression (see Fig. 7). But this state of the water

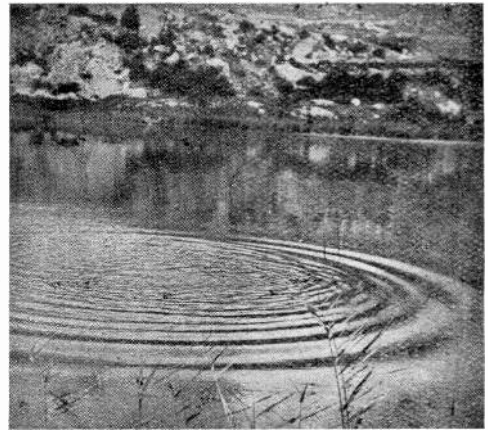

Fig. 8. A train of expanding circular ripples on water created by throwing a stone into a pond.

cannot continue if left to itself. The water rushes in to fill up the central cavity and its inertia carries it up into a column or hump. This involves the production of a ring-shaped depression or trough around the elevation and the first-formed annular ridge or elevation is pushed farther out. The water at the splash point thus bounces up and down, say half a dozen times before it comes to rest, and this creates as many concentric ring-shaped ridges and troughs on the surrounding surface, which then expand outwards as a family of wavelets or ripples (see Fig. 8).

There is one curious fact connected with this ripple band which few persons out of the thousands who throw stones into water have ever noticed. On looking carefully at the ever-expanding band of ripples it will be noticed that on the inner edge little wavelets are continually being produced and others die away at the outer edge. In other words, the waves travel through the band of wavelets faster than the group of waves moves as a whole.

This establishes an important distinction between the velocity of a wave and the velocity of a *group* of waves.

In the case of wireless waves there is no difference between the wave velocity and the group velocity, but for sea waves or the surface of deep water the group velocity is half the velocity of the single wave.

The waves on a water surface produced by throwing in a stone or other object, or by the wind, as in the case of sea waves, are called *gravitation waves* because the elastic resistance called into play is that due to the effort of the water surface to remain level under the action of gravitation.

5. CAPILLARY SURFACE WAVES.

We can, however, produce another type of wave on a water surface called a *capillary wave*, which depends upon the resistance of the water surface to stretching.

The surface of every liquid is in a state in which the surface particles draw each other together or cling more closely than those in the interior. Hence a certain effort or force is necessary to break through the surface film or to stretch it, and this surface layer endeavours always to contract or shrink up to the smallest area consistent with the boundary conditions. This is called the *surface tension* of the liquid or the *capillarity*. This last term is derived from the Latin word for a hair, because the ascent of liquids in very fine tubes such as the sap in a tree up the fine tubular tissues is due to this same action. The ascent of a liquid up a fine tube is dependent upon the condition that the liquid must wet the walls of the tube.

The existence of this surface film upon liquids and its resistance to stretching gives the explanation of the fact that small bodies made of material intrinsically heavier than water can yet float upon it. If a little very clean water is put into a clean saucer, a fine clean steel sewing needle can be dropped upon the surface if held in a horizontal position close over it and released, and it will then be seen to float on the water. The needle is not heavy enough to break through the surface film but makes a little depression in it, in which the needle lies like a baby in its cradle. It is for this reason that small dust particles can lie on water and little insects can run over the surface without risking death by drowning.

We can produce capillary waves on water by holding vertically and half immersed in it a straight stiff fine wire and pushing the wire

quickly forward across the surface. Round the point of immersion of the wire will be seen a group of very small waves or ripples which become of shorter wavelength in proportion as the wire is more quickly moved forward.

Again, when drops of water such as rain-drops fall on the surface of pools of water, each drop as it strikes the surface creates a rapidly expanding ring-shaped ripple, which is a capillary wave. These are instances of waves on water which depend not upon gravitation but upon capillarity for their formation.

The fact that a liquid film is in a state of tension and tries to contract as much as possible is easily proved by experiments with soap bubbles. If a soap bubble is blown on the end of a glass tube and the mouth then removed from the blowing end, the bubble begins at once to shrink up, exactly as a thin indiarubber balloon would do if inflated with air and then left to itself. Another similar experimental proof is as follows:—Make a wire ring about 2 ins. in diameter, having a long wire handle, and tie across the ring a fine thread, which is not drawn quite tight. Fill the ring with a soap film by immersing it in a soap solution in such fashion that the loose thread is entirely wetted by and included in the film. Then break through the film on one side of the thread, and the liquid film tension on the other side will at once contract and pull the thread tight into the form of a curve, which then forms one boundary of the film. We see by this experiment that a liquid film is in a state of stretch or tension, and will always contract so as to make its surface area as small as is consistent with the boundary conditions. Hence it resists stretching and in virtue of this can have capillary or surface tension waves formed on it. There is one distinction between these two types of surface water wave which should be noted.

We have already explained that on deep water long gravitation waves travel faster than short ones. On the other hand, short capillary waves move faster than long ones. There is, therefore, a certain wavelength for surface waves on water, about two-thirds of an inch in length, at which surface waves travel at the slowest rate, viz., about 9 ins. a second.

This wave may be considered to lie on the boundary between true gravitation waves, which are longer, and true capillary waves, which are shorter than this critical length.

(To be continued)

The All-British Wireless Exhibition

OPENING OF THE EXHIBITION AND FURTHER DESCRIPTION OF THE EXHIBITS.

ON Saturday, September 30th, the All-British Wireless Exhibition at the Horticultural Hall, Westminster, was opened by Sir Henry Norman, M.P.

At the opening ceremony Sir Henry Norman spoke warmly of the Exhibition and congratulated all those responsible for its organisation. He emphasised that the Exhibition was calculated to make a very strong popular appeal, yet, at the same time, there was a vast amount which would absorb the interest of the expert.

Referring to the introduction of broadcasting he said that all the difficulties between the companies engaged in the formation of the Broadcasting Company, and the Postmaster-General had now happily been overcome and that nothing beyond a few preliminaries now stood in the way of the introduction of broadcasting. Broadcasting in London would be speedily followed by broadcasting from the Manchester centre, and thereafter from the other six centres into which the country is to be divided.

Speaking later at a luncheon given by the organisers of the Exhibition, Sir Henry Norman, after again congratulating the organisers and community on the excellent work conducted by the Wireless Society of London, said that there were still those who thought that wireless broadcasting was only a passing craze like ping-pong or "put and take," which, given time, would soon die out. These views were not shared by himself. He believed that broadcasting was destined to become as integral a part of our everyday life as the ordinary telephone is to-day. Broadcasting, he said, was no passing craze. For a month or two it would be the general topic of conversation, but in a year or so it would have become so commonplace a necessity that it would cease to be mentioned.

Sir Henry Norman then referred to the misleading statement which had appeared in the daily press regarding the negotiations between the Postmaster-General and the committee of the Broadcasting Company. He thought that in reality the arrangements had been carried through with the most surprising speed, taking into consideration

the very many questions which had had to be settled. An admirable scheme had now been devised, and thanks to the energy and care which had been shown by those engaged in the work, the Broadcasting Company had been formed, and the Articles of Association approved by the Postmaster-General.

Sir Henry Norman then referred to the absolute necessity of a first-class broadcasting programme being arranged. He referred to the speech by H.R.H. the Prince of Wales to be broadcasted next Saturday, and concluded with the hope that the final triumph of broadcasting would come when the King addressed the Parliaments of the Empire by such means.

The success of the opening day of the Exhibition might be described as exceeding all expectations. Throughout the day every part of the building was crowded with an enthusiastic attendance. The telephony broadcast transmissions received in the centre of the hall were made audible throughout the building and the quality of the transmissions left little to be desired. This Exhibition will, indeed, be an excellent send-off for broadcasting, and will give to the public the opportunity of an appreciative understanding of broadcasting possibilities.

Below we continue the description of some of the exhibits, accounts of a number of which appeared in the issue of September 30th.

The Ever-Ready Company (Great Britain) Ltd. (Stand No. 11.).

This firm is showing a large assortment of their famous batteries applicable to all wireless purposes. All kinds of various lighting devices are also exhibited, and space does not allow justice to be done to so great a variety of useful exhibits. In particular, however, may be mentioned the type of cell known as U.W.I., which is here illustrated. This type of cell is specially applicable to the building up of H.T. units for wireless purposes.



A U.W.I. Cell.

S. G. Brown, Ltd. (Stand No. 43).

The exhibits of Messrs. S. G. Brown, Ltd., consist of radio telephones, loud speakers and microphone amplifiers.

There are three types of telephones. Firstly, the Type "A," which is so well known, and is claimed by the makers to be the most sensitive wireless phone in the world, and which has adjustable magnets. Secondly, the Type "D," a flat disc type of telephone, which is excellent for all-round work, and gives remarkably clear articulation. Lastly, the newly devised Type "F" telephone, which instrument is a cheaper form, and has some novel features in that the case and straps are constructed of aluminium and duralumin, highly polished and with a fine finish, and it has a special form of magnet which gives great efficiency. The total weight is only 6 ozs., and it may be considered the lightest telephone on the market.

The Microphone Amplifier is of great value when used in conjunction with a loud speaker to give increased volume of sound to fill a room.

Two types of loud speaker are exhibited, the large Type H.1. and the small Type H.2. These loud speakers with the improved curved horns are now well known, and their excellent acoustical qualities.

A special Loud Speaking Telephone Set is also being exhibited, consisting of a loud speaker with a trumpet seven feet in length and a special transmitter. These instruments will allow a person to project his voice to a considerable distance, and would enable an orator to address a huge audience in the open air under conditions where his own voice would be almost inaudible. It is claimed that this loud speaking set is the clearest and loudest yet made. The loud speaker is approximately eight times more powerful than the "Brown" Type H.1. Loud Speaker.

General Radio Company (Stand No. 26).

The General Radio Company are exhibiting wireless receiving apparatus of various descriptions, ranging from the small portable crystal sets to multi-valve receivers.

A model of a drawing-room receiver enclosed in a cabinet of period design is exhibited.

This includes a loud speaker. Tuning is accomplished by rotating a single calibrated dial. To operate the apparatus, it is only necessary to press a button which controls all five valves, loud speaker, batteries and accumulators.

All parts are enclosed and mounted in cabinets, and all dials for making adjustments are clearly marked to indicate their purpose. The entire assembly of each set is secured to the ebonite panel so that, if desired, it can easily be removed from the cabinet.

The Peto-Scott Co. (Stand No. 16).

The apparatus exhibited on this stand includes a three-valve set built up in unit system from "Peto-Scott" units. The unit parts for building apparatus are supplied complete with full instructions for building and wiring so that the sets may be completed at home. These parts are carefully packed in special boxes.

A little booklet has been prepared by this company explaining the construction of various sets from the parts they supply.

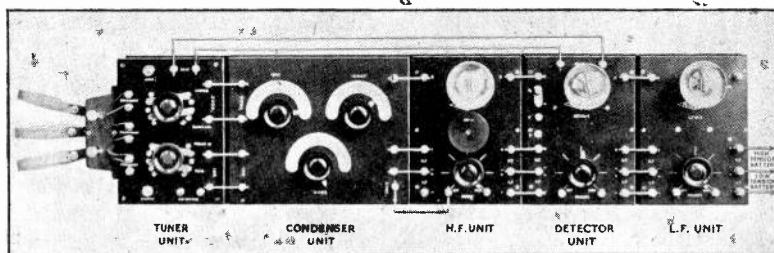

Peto-Scott's Unit Sets.

G. Z. Auckland & Son (Stand No. 46).

This firm exhibits a large and varied selection of component parts, including their well-known Intervalve Transformers, which are wound in layers and spaced to give maximum efficiency, the cores being of Stalloy iron.

The variable condensers shown are of a type built upon aluminium top and bottom plates, thereby making them rigid, with no possibility of becoming loose. The spacing of the vanes is 0.072 and the condensers are made in four sizes, viz., 0.0002, 0.0003, 0.0005, and 0.001 mfd.

Among other parts exhibited are Duo-lateral Coils and several types of coil holders, both table and panel, telephone transformers, knobs, dials, detectors, etc.

Complete sets, Receivers, Amplifiers (2- and 3-valve) and Power Amplifiers are also exhibited.

Messrs. Alfred Graham & Co. (Stand No. 44).

On this stand several new products of this firm, including various forms of the "Amplion" loud speaker, are exhibited.

The "Amplion" is specially designed to be suitable for musical and vocal effects. Types for table and wall fixing are shown and will work in conjunction with any good amplifier. The G-R power amplifier constructed by the firm for this use is also on exhibition, and is adapted to operate on all plate voltages up to 300 volts.



The "Amplion" Loud Speaker.

Two wireless cabinets embodying wireless receiving sets of Marconi manufacture, and also "Algraphone" mechanisms constructed by Messrs. Graham are shown. These are so arranged that the horns or sound amplifiers are employed alternatively, either for the reproduction of gramophone records, or for wireless reception, several interesting features being present in these machines.

Both these cabinets operate with a loop or frame aerial. One of them is arranged with "Electravox" equipment, for the electrical

reproduction of music either locally or at a distance. In this instrument, sounds set up by means of reproducers are not directly emitted by a horn or trumpet, but affect a microphonic transmitter of improved type.



Headgear by Alfred Graham & Co.

This is connected with a suitable transformer, and one or more loud speakers, which latter are adapted also for wireless reception.

Additional apparatus in evidence are, intervalve and step-down transformers, and the "Graham" improved headgears which are capable of fine adjustment and are extremely sensitive. Each earpiece in these instruments is adapted to be readily removed from the headband, and may be used independently.

The Automatic Telephone Manufacturing Co., Ltd. (Stand No. 52).

The Automatic Telephone Manufacturing Co., Ltd., of Liverpool, exhibit a full range of practical and well made accessories. Among these are A.T.M. head telephones, which have been designed to meet broadcasting requirements. The method of securing the telephones to the headbands is worthy of note. This permits of instantaneous adjustment, and combined with the absence of weight makes the set extremely comfortable to wear. A.T.M. loud speakers are made in two sizes, the smaller being suitable for ordinary use, and the larger for demonstrations, etc., where greater volume is required. In

designing these loud speakers the object has been to secure reproduction of perfect articulation rather than mere volume of sound plus distortion. Variable and vernier condensers, fixed condensers, intervalve,



Telephone Receivers of High Efficiency, by the Automatic Telephone Manufacturing Co.

valve telephone and high frequency transformers, wavemeters, buzzers, coil-holders and duolateral coils are included in the exhibit.

A wide range of "Radiak" products, manufactured by Ashley Wireless Telephone Co., Ltd., of Liverpool, are also displayed on this stand, including wireless receiving apparatus. The "Radiak," 1 to 5-valve unit system, will make a great appeal on account of its simplicity and the easy way in which it is possible to add a unit at a time similar in the way one would add to a sectional bookcase. The "Radiak" 5-valve complete unit will be found attractive because of its easy method of operation and adjustment.

Burndept, Limited (Stand No. 12a).

Messrs. Burndept, Limited, are showing a comprehensive range of apparatus finished in high-class style. The well-known Burndept Ultra IV is shown in combination with a tuning panel, which gives every possible variety of circuit by operating three small key switches. An interesting exhibit is the Burndept IV, with a plate-glass back, so that the internal construction may be studied. The well-made components and heavy former bent bare copper wiring are illustrative of the best commercial practices.

A laboratory receiving station is shown, consisting of a Tuning Panel, a Two-Valve Panel (one H.F., one Detector), containing the well-known "Rejector Circuit," described

by Mr. Frank Phillips before the Wireless Society of London (see our issue of April 8th, 1922); and a two-valve low frequency amplifier. The three polished mahogany cabinets connected together by short strapping wires are models of luxury.

There is also a Burndept Transmitter in which a single valve, with grid modulation, is used. This apparatus shows signs of careful design in that a plate variometer is provided in order that the output impedance of the valve may be adjusted to the input impedance of the aerial circuit.

Messrs. Burndept are also exhibiting four newly designed types of Broadcast Receivers.

The "Ethophone" Junior is a simple type of crystal receiver controlled by a single dial. Signals with this little instrument



Automatic Telephone Co.'s new type Loud Speaker.

are said to be loud and clear on a 50-ft. aerial 25 miles from 2 LO. The Burndept Valve Broadcast Receivers are known by the names of Ethophones II and III respectively, being two and three-valve sets, built into desk-shaped cases, having a sloping ebonite instrument board. The valves and also the high tension batteries are contained inside the cabinets out of harm's way.

A useful feature is the provision of separate terminals for loud speaker and head telephones, together with a switch to bring either into operation at will. Low resistance telephones

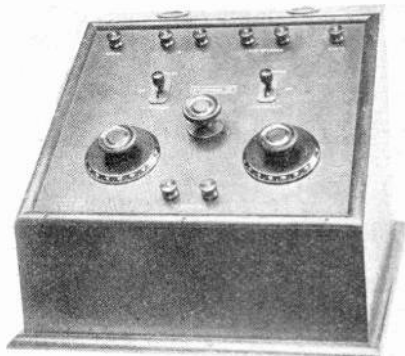

The Burndeft Ethophone II.

and loud speakers are used and a telephone transformer is embodied in each receiver.

Ethophone III is provided with a switch

We learn that everything shown by Messrs. Burndeft, with the exception of telephones, batteries and valves, is made throughout at their factories in Blackheath, where some 300 persons are employed.

Gambrell Brothers, Ltd. (Stand No. 47).

A range of patented inductances possessing many original features are exhibited by Messrs. Gambrell Brothers, Ltd., for which are claimed the following advantages: Low effective resistance, low self capacity, the coils for broadcast reception having a capacity of 4 cms., greater range of wavelength for given variation of capacity, great mechanical strength and uniformity in size.

A double circuit tuner fitted with two variable condensers and series parallel switch for aerial condenser is an interesting exhibit. The tuner incorporates a patented coil holder

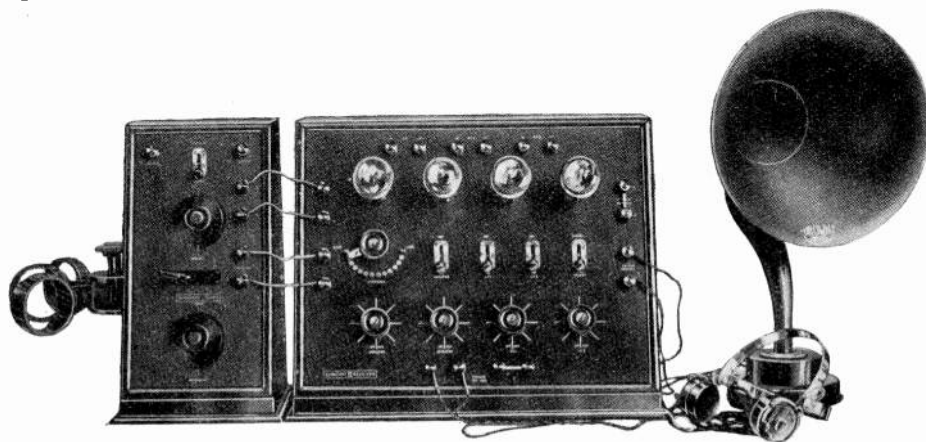

Burndeft "Ultra IV" with Loud Speaker.

marked "High Power" and "Low Power," which serves to bring a third valve into operation when louder signals are required.

The "Ethophonola" is the Burndeft Broadcast Receiver De Luxe, and consists of a four-valve receiver built into a cabinet gramophone case. There are no head receivers, as all sound issues through the doors of a sound chamber. All batteries are self-contained, and it is necessary to connect only to earth and to a short aerial wire.

Many excellent accessories are shown in addition by Messrs. Burndeft, such as variable condensers, with and without a single plate vernier controlled by a long handle, interval telephone transformers, rheostats, valve sockets, etc.



The Burndeft Ethophone Junior.

by means of which the coupling between coils can be reduced to zero and even to a negative value. The adjusting handles for the coils are conveniently placed in the front of the instrument and the coils being at the rear, interference caused by the proximity of the hand is obviated. The condensers are also shielded so that the tuning is facilitated.

Another tuner embodying the same features is described as a Type A and is fitted in a sloping cabinet. It is fitted with three variable condensers. The aerial and closed circuit condensers each have a vernier adjustment. The coil holder is conveniently mounted on the top of the instrument. Two switches are provided, one series parallel for aerial condenser and one for single or double circuit working.

A range of amplifiers are exhibited, both high frequency and low frequency, also a low

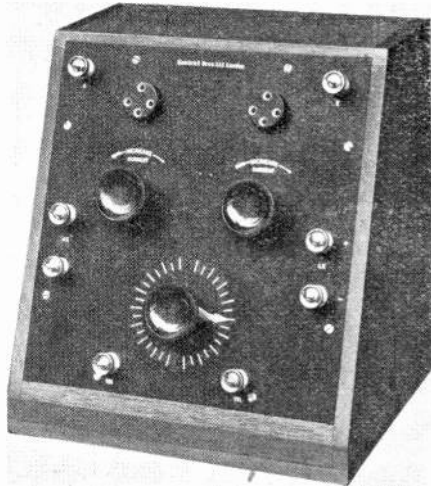

Detector-Amplifier by Gambrell, Bros. Ltd.

frequency amplifier for attachment to a crystal receiver and a power amplifier for loud speaker.

Receivers are shown for broadcast reception, including a crystal set. A two-valve set in a sloping cabinet, complete with tuner, and a three-valve cabinet containing tuner, amplifier, loud speaker and all necessary batteries.

Hambling Clapp & Company (Stand No. 12.)

A number of wireless accessories are shown here which will appeal to the amateur who wishes to construct and experiment with his own receiver.

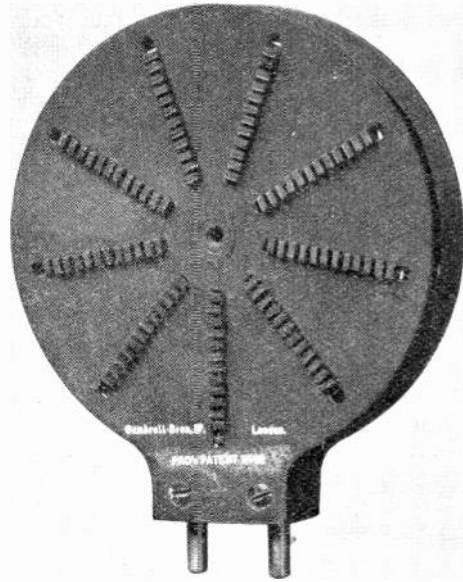

The Gambrell Inductance, a type having very low self capacity.

One or two types of valve panels, including H.F. and L.F., are shown.

The single valve L.F. panel is of interest as many experimenters require one stage of note magnification that can be easily placed in circuit, with no alteration to the existing panels.

The two-valve L.F. amplifier is fitted with a special switching device that enables the user to employ either one or two valves, or the detecting valve only, without disconnecting the telephone leads and transferring them to the detector panel

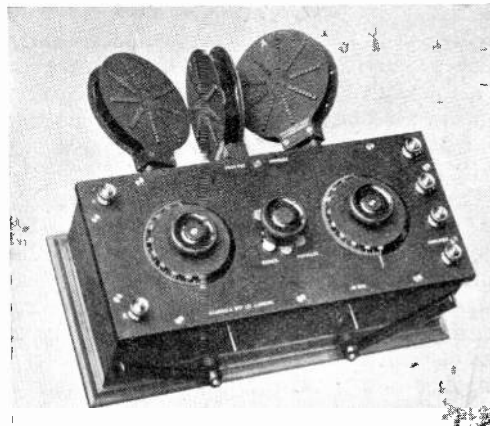

Gambrell Tuner.

A three-valve experimental panel is also shown which provides the experimenter with a panel applicable to any type of circuit; either H.F. or L.F. couplings can be quickly brought into circuit. This panel consists of a mahogany base-board fitted with three ebonite panels containing the necessary terminals for aerial, earth, coils, telephones and batteries.

Amongst other accessories are a new type of valve socket, a new type of valve holder with terminals, and a type of coil holder is designed with a view of reducing the effects of hand capacity while operating. Variable condensers of all types and capacities, H.F. transformers and L.F. transformers are also exhibited.

An exhibit of interest on this stand is a five-electrode valve due to Mr. Pragnell, which was described in the issue of this Journal for June 24th, 1922, page 377.

Various designs of crystal sets known as the O.K. Crystal Sets, are shown and these include one specially intended for the use of scouts.

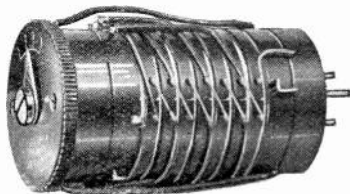

High-frequency Transformer for use over a wide range of wavelengths (L. McMichael).

L. McMichael, Ltd. (Stand No. 38).

This stand is replete with good things for the amateur, experimenter and members of the trade. Among the pieces of apparatus which deserve special attention were the "M.H. type" sets. These sets are of exceptionally fine finish and of compact design. They range from a simple one-valve panel to a four-valve set complete with condensers, filament rheostats, and switching arrangements, so that one, two, three or four valves are available at option.

The "MH₃" and "MH₄" valve sets are arranged so that both high and low frequency amplification are available. The high frequency is obtained by means of special plug-in transformers. The high frequency transformers are available in two types, one of which is the usual circular disc type plugging into a valve holder socket, eight of these being necessary for a complete set for all wavelengths. As an alternative to this, Messrs.

McMichael, Ltd., have recently brought out an improved high frequency transformer unit with switching arrangement so that four ranges are embodied in one piece of apparatus, thus obviating the trouble of constantly pulling in and out the small high frequency transformers when wavelength changes are made. With these new type high frequency "plug-in" units two pieces of apparatus

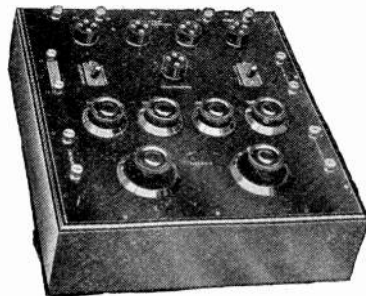

Four-valve Receiver, Type M.H.4.

only are required to cover all wavelengths from 300 metres to 25,000 metres, each piece of apparatus having four stud switches of unique design.

It might be mentioned that these sets are manufactured at the new works at Slough, which have recently been taken over in association with Messrs. B. Hesketh, Ltd.

A feature of the stand is a specially compact and well finished set of "Radio Blocks," these being an adaptation of the unit system.

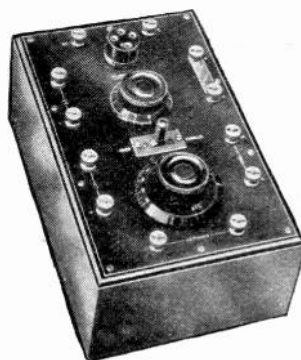

Detector Receiver Panel, Type M.H.1.

For appearance and general finish they leave nothing to be desired and we understand that for efficiency they are ahead of anything yet tested out in this line. The block itself consists of a simple machined aluminium box with ebonite top and terminals, and

whether the unit be one for a high frequency, a rheostat, a detector or one for low frequency, the design, size and general appearance remains precisely the same. Any combination of valves up to even 8 or 9 can be made in a few moments and there is a special system of connecting the blocks which has hitherto not been used and which is thoroughly

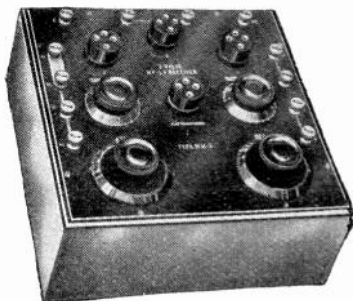

Detector-Amplifier, Type M.H.3.

protected. It is claimed that for absence of noise when using a number of valves, these radio blocks are unequalled. A loud speaker connected to seven of these radio blocks, three high frequency, one detector and three low frequency, gives exceptionally fine and loud signals, but when no signals are coming through there is a quietness and absence of extraneous noises which is unparalleled.

Messrs. McMichael, Ltd., have been well known for a considerable time past for their very large stocks of ex-Government goods and it goes without saying that these were

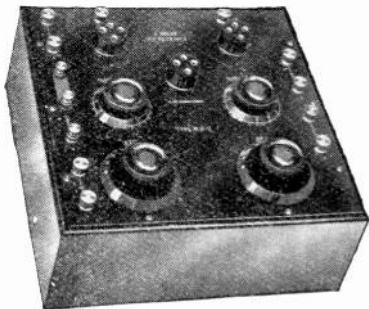

Two-Valve Receiver, Type M.H.2.

well represented on their stand. The high-class workmanship put into ex-Government wireless apparatus needs no comment, and before these stocks are exhausted all experimenters would be well advised to avail themselves of the low prices ruling to obtain such

useful instruments as the Mark III crystal tuner complete with head telephones (new), and aerial wire; the Townsend Wavemeter ranging from 300 to 4,000 metres; C Mark III amplifier, 50-watt Trench Set, which is both a spark transmitter and receiver, and the B Mark II receiver amplifier, which, as readers will already be aware, is the subject of a very interesting competition for amateurs. Messrs. McMichael, Ltd., are offering a prize of £50 and various consolation prizes of smaller sums for the best and generally most efficient conversion of this set, which is at present designed for short waves, so that normal wavelengths may be used. There is an opportunity for those who are interested to show their ingenuity and recoup themselves handsomely.

Brown's telephones were strongly in evidence, and the experimenter will be well advised to purchase this sensitive headgear at the price at which they are offered. Although a very large number were disposed of by the

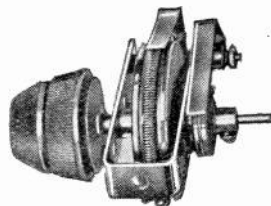

*New type of Variable Filament Resistance
(L. McMichael).*

Government and have been retailed, this supply is gradually coming to an end. It should be pointed out that two kinds are available. Messrs. L. McMichael are making a special feature of those which have been actually reconditioned by the makers, Messrs. S. G. Brown, Ltd. They hold the entire supply of these and it is obvious that telephones which have been through the makers' hands for readjustment and fitting with new diaphragms are the most desirable for the amateur to purchase.

Of general apparatus and accessories space does not permit a full description, but it would appear that everything without exception which is of use or interest to the amateur and experimenter, is available on this stand. One filament rheostat particularly stands out far beyond the average. This is of unique design and provides for vernier adjustment by a very simple method. The experimenter who knows will not need to be reminded of the importance

of the fine adjustment of his filaments. The C.W. Mk III 2-valve receiver amplifier, suitable for all wavelengths from 300 to 3,000 metres, is one of the many ex-Government sets particularly useful for telephony reception on short wavelengths.

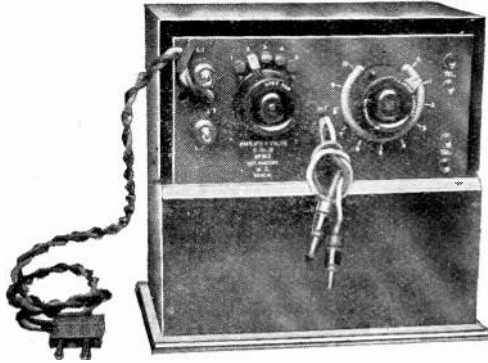

Specimen of Ex-Government Apparatus shown on Stand No. 38.

Metropolitan-Vickers Electrical Co., Ltd. (Stand No. 33).

The "Cosmos" Radiophone Crystal Set and the "Cosmos" Radiophone Valve Set are shown on this stand. These sets are designed for the reception of broadcasted telephony. The aim has been to produce the most efficient sets possible for this particular purpose, free from all unnecessary complications, and as a result, the sets are exceptionally compact and simple,

and no technical knowledge is required for their operation.

The Crystal Set is applicable for broadcasted speech or music within distances of 10 miles of a broadcasting station, or considerably further under favourable conditions.

The Valve Set is suitable for longer distances up to 50 miles or more, and by the addition of

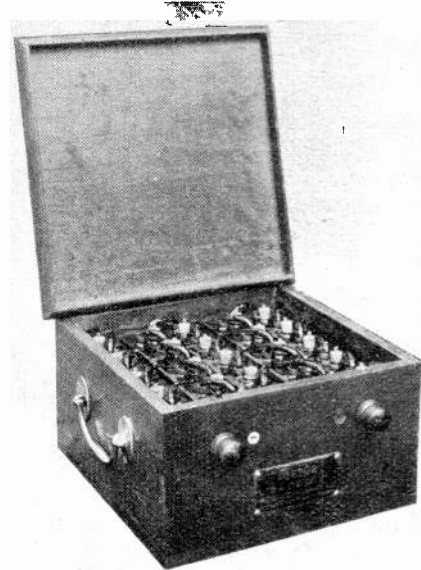

Chloride 25-Cell, 50-volt. R.G. Type H.T. Battery.



A Metropolitan Vickers Crystal Receiver.

a note-amplifying attachment the range may be increased to 200 miles with head-telephones, or a loud speaking telephone may be used at distances up to 50 to 100 miles. An attachment is also shown by means of which the current required for the filaments and plate circuits of the valves may be derived from the electric lighting supply wherever a D.C. supply is available, thus dispensing with the use of batteries.

A feature of the exhibit is a scale model of the proposed transmitting aerial at the Company's Trafford Park Works, and of the adjoining research buildings

and laboratories in which wireless experimental work is carried on.

The Chloride Electrical Storage Company, Ltd. (Stand No. 30).

Exide Batteries made by this well-known firm are the principal exhibit of this stand.

A range of types of batteries for every wireless purpose are to be seen. A large series of low voltage Exide Batteries in celluloid



Chloride 30-Cell 60-volt AYGI type batteries.

boxes, also various high voltage sets of Exide Batteries. These comprise complete 24, 30, 50 and 60-volt sets, compactly fitted in wooden trays.

Examples of individual H.T. cells are shown in ebonite, glass, and celluloid containers.

Exhibits of special interest include 6 volt 40 ampere hour and 2 volt 40 ampere hour celluloid accumulator sets, which are of an unspillable type.

The special H.T. battery, the long thin plates of which are contained in a number of glass test tubes mounted on a wooden framework, is also an exhibit of interest.

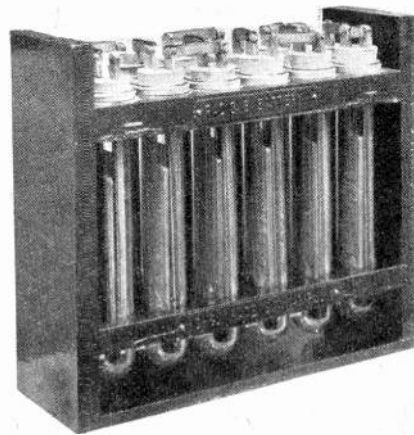

Chloride 12-Volt. H.T. Battery with strong glass Test Tube Containers.

The Telephone Manufacturing Co., Ltd., (Stand No. 20).

A "De Luxe" cabinet set is exhibited by this firm, which has been specially designed to meet the requirements of efficiency and simplicity of control. The set is self-contained in the cabinet which is designed to harmonise with other prices of furniture.

The instrument comprises a valve and crystal set, so arranged that, by the manipulation of

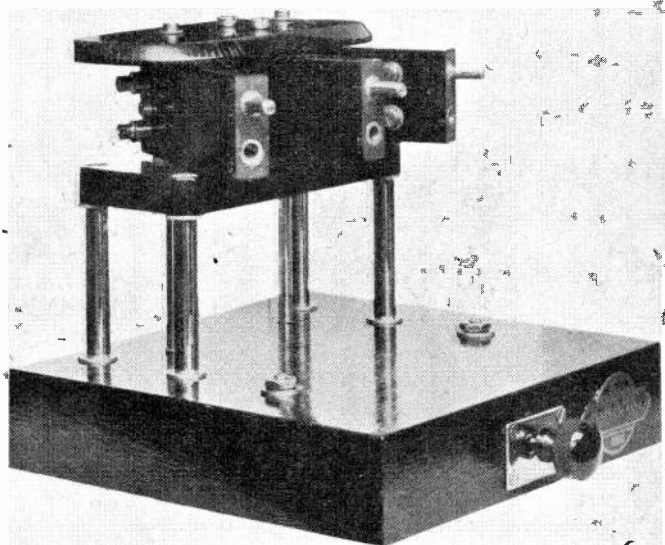

Igranite "Micro-Adjuster" coil holder with Vernier Adjustment.

a switch, either can be brought into operation as may be desired. Two stages of audio-frequency amplification are provided. A crystal detector of cartridge pattern is fitted in duplicate.

The loud speaker and requisite batteries are mounted in the cabinet.

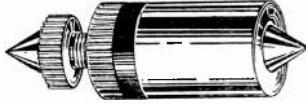

"T.M.C." Cartridge Crystal Detector.

Mullard Radio Valve Co. (Stand No. 41).

The Mullard Radio Valve Co., Ltd., are well-known in wireless circles as the manufacturers of the famous "Ora" valve. The name "Ora" is derived from the unique properties of this valve as an oscillator, rectifier and amplifier. This triple function enables the one type of valve to be used for the three different purposes on any valve set, thus saving cost and eliminating the difficulty in replacements.



An "Ora" Valve.

Apart from the "Ora" valve, many other Mullard valves are showing on stand No. 41. Transmitting valves, rectifying valves and receiving valves in large and small sizes,

including the high power silica valve manufactured under licence from the Admiralty, are all shown and cover the whole range of wireless valve manufactures.

One specially interesting feature of the Mullard valve display is the range of valves with low temperature filaments. These are a new development which should arouse very considerable interest in view of their great advantages for all valve purposes. These valves have been successfully made by a new patented process whereby a high electron emission is obtained with a low temperature filament. The two great advantages are: (a) Low filament current consumption, this being approximately half the power required for a similar high temperature filament valve. The L.F. 0/100 type takes about 18-20 watts filament consumption—the normal high temperature filament valve of this type taking 36 to 40 watts. (b) Long life, which follows from the low temperature of the filament.

Other Mullard products comprising valve sockets and bases, condensers, grid leaks, anode resistances, telephone head-sets, H.F. and L.F. transformers, etc., are on view. Some of these are well known to the wireless public, others are being introduced as the latest products of the new Mullard factory.

The Marconi Scientific Instrument Co., Ltd. (Stand No. 32).

This Company display a comprehensive selection of their manufactures both for the amateur and commercial markets.

The apparatus and equipment represents a high standard of design and workmanship.

A special feature of the exhibit is the well-known Marconi Scientific Unit System, which has been modified to conform with the recent regulations made by the Post Office authorities.

The modifications are confined to the high-frequency stages (Unit 3) and constitute the use of tuned anode circuits which give the maximum of amplification possible throughout the full range of wavelengths in general use. Reaction is secured by means of a magnetic coupling which links the detector plate circuit to the plate circuit of the first high-frequency stage.

Special advantages are claimed for this arrangement compared with the usual closed circuit and its reaction arrangement. These include:—

1. Easy manipulation.
2. The tuned anode coils are calibrated for all wavelengths; thus the instrument

serves the additional purpose of a wavemeter.

3. There is a minimum transference of energy to the aerial when autodyne reception is being employed.

4. The receiver is extremely silent in working, and is affected to a remarkably small degree by atmospherics.

A novel feature included in a receiver is provided by the type M.42 Rotary Tuner with unified control of reaction and tuning, which includes an automatic wavelength indicator.

Many types of receivers and amplifiers are also shown; one of interest being an

apparatus, and it should represent a sound investment for wireless societies and others possessing transmitting licences.

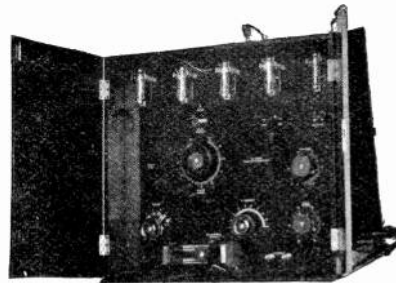

An Exhibit on Stand No. 30.

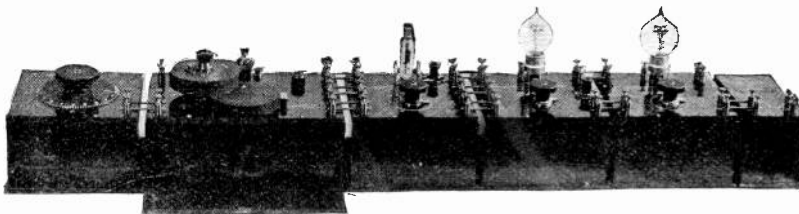

A "Marconi Scientific" Unit Set.

eight-valve receiver attached to a small loop aerial for reception of broadcasted concerts and amateur transmissions.

Two transmitters are shown, each being suitable for telephony, C.W. and I.C.W. telegraphy.

Both these transmitters employ the "choke control" method of modulation. Type No. 1 derives the high tension supply to the valve plates from a battery of secondary cells, and is normally rated at 10 watts. Type No. 2 is operative with input powers between 10 and 50 watts; the plate supply being derived from a Rotary Transformer giving 1,000 volts and 75 milliamps, running off a 12-volt accumulator battery.

The following ranges are claimed for working over average country:—Speech, 50 miles; C.W. Telegraphy, 120 miles; I.C.W. Telegraphy, 70 miles; based on the assumption that a three-valve receiver with one stage of high frequency amplification is used for reception at these ranges.

An Independent Oscillation Generator and Heterodyne Wavemeter combined, having a wave range of 300 to 600 metres, is exhibited. This little instrument may be used for the calibration of both transmitting and receiving

Another interesting piece of apparatus is a wavemeter, having a range of 100 to 20,000 metres, and these wavemeters of this type carry the National Physical Laboratory certificate.

Other phases of the Company's activities in the commercial telegraph and submarine cable worlds are indicated. The process of

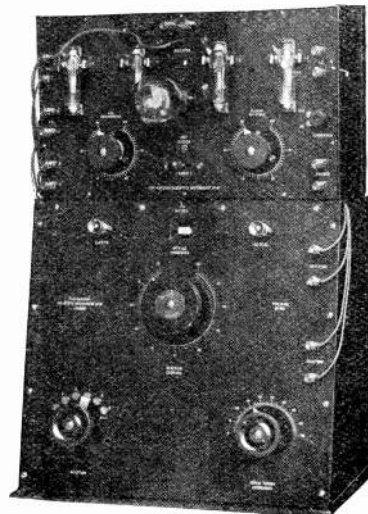

"M.42" Type Rotary Tuner.

Wheatstone strip perforation with the Marconi-Gell Perforator is shown in operation. One of the most interesting features in this section is the Marconi Undulator, which is used for high speed reception on the transoceanic circuits.

The "Aristophone" Loud Speaker is shown in a separate mahogany case for drawing-room use with "Aristophone" panels.

To those who prefer greater scope for trying alternative methods of connection, and who wish to construct their own sets without



Metropolitan-Vickers Valve Receiver.

Radio Communication Company, Ltd. (Stand No. 45).

Exhibits which hint at activities outside "Broadcasting" are shown on this stand. These include a complete ship's equipment as fitted by the Radio Communication Co. An idea may be gained of the dimensions of Elwell land stations by a comparison of some large insulators with those used on aerials for receiving broadcasting.

A type of receiver exhibited is that known as the "Panel-type Aristophone," in which all the advantages of the "Aristophone" are obtained without costly cabinet work of the latter instrument, and which may, moreover, be purchased in several units as required. The first unit is a complete crystal receiver, and subsequent panels add valve amplification. These panels are of high grade design and finish.

Panels for a large number of purposes are standardised.

going into an unnecessary amount of bench work, the "Radiocraft" exhibits will appeal.

Accessories deserving of attention are the Elwell amplifying unit, bull-dog grip fittings for telephone cords, plugs, and



"Polar" Receivers, Types 32 and 35.

jacks specially designed for wireless purposes ; an adaptor for making use of a gramophone as a loud speaker ; air-space coils and a moulded ball for variable couplings.

Western Electric Company Ltd. (Stand No. 39).

A feature of the valve apparatus shown on this stand is that all valves used are enclosed in the sets, and thus protection is assured against accidents and against dust, while the main feature of the apparatus is the simplicity of adjustment and operation. No filament adjustment is necessary at any time, and a key switch is provided in each set to control the filaments.

All valve receiving apparatus is mounted in polished mahogany cases, and the fittings are of oxidised brass.

A Single-valve Detector and Tuner is shown contained in a mahogany case, in which there is also provision for the inclusion of double head receivers. The valve filament can be seen through a mica window and a ventilation disc is provided to ventilate the interior of the case. At one end of the case there is fitted a small card with particulars of the various wavelengths, together with the respective condenser settings, and above and below are the variable condenser handles. The lower handle is set to the given wavelength of the transmitting station it is wished to receive and the upper handle is used for the finer adjustment. Thus the set is simplified by the use of only one handle for fine tuning. The valves used in this detector are made specially to Western Electric specifications.



"Polar" Cabinet Set.

The voltage on the filament is 4 volts, with a current consumption of 0.7 of an ampere, while the voltage on the plate is 30 volts with a current consumption of one-half of a milli-ampere.

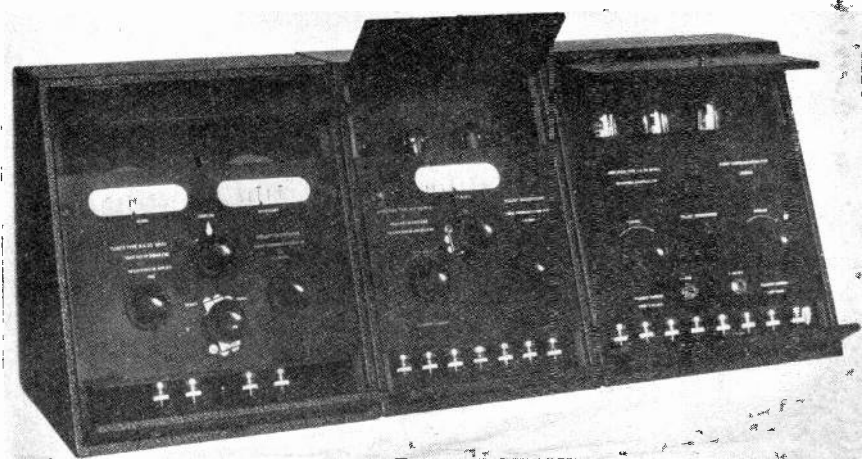

A Combined Receiver shown on Stand 45.

The range of wavelengths of this receiver is approximately 300 to 500 metres with an aerial 30 ft. high and 100 ft. long. Two tuned circuits are employed.

Low frequency amplifiers are shown in two patterns. The first contains a one-stage amplifier with a switching key which enables the input to be switched directly to the output without passing through the amplifier. This is a convenience when desiring to reduce amplification without altering connections. The second contains two stages of amplification, and a switching key which enables one or two to be used as required without change of connections. The key, in its central position, disconnects the valves in both cases.

The Western Electric Loud Speaking Equipment consists of the Western Electric No. 44002 Loud Speaking Receiver and Amplifier, these two components being known, and supplied together, as the Loud Speaking Equipment.

The Amplifier is specially designed for use in conjunction with the Loud Speaking Receiver and is contained in a similar box to that of the amplifier previously described. A separate key controls the filaments and is situated at one end of the case, together with a five-stop switch for the adjustment of the volume of sound.

The valves used in this amplifier are Western Electric Type Valves No. 216A.

The Western Electric Cabinet Set, Model 1 Cabinet Receiving Set, is shown, which is on

Chippendale lines, 4 ft. 6 ins. wide and 3 ft. 2 ins. high.

This cabinet contains the complete equipment for the reception of wireless broadcasting, and the only connection necessary is the earth lead.

There are three divisions in the cabinet. The centre compartment contains a frame aerial, which can be rotated through 350 degs. by means of a small handle beneath the cabinet, and a loud speaking receiver is installed inside the frame aerial with the horn concealed. The left-hand compartment contains the receiving set, a single stage low frequency amplifier, and the loud speaking amplifier. The right-hand compartment contains the

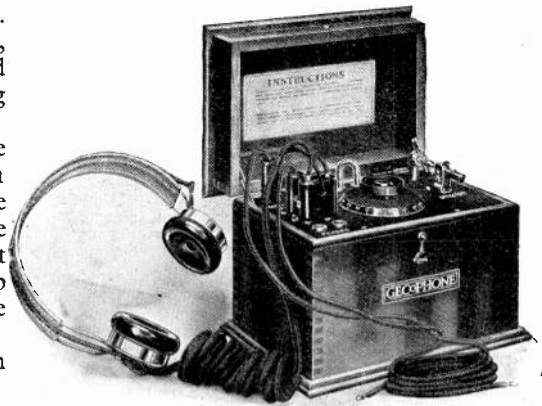

"Gecophone," Crystal Set, No. 1.

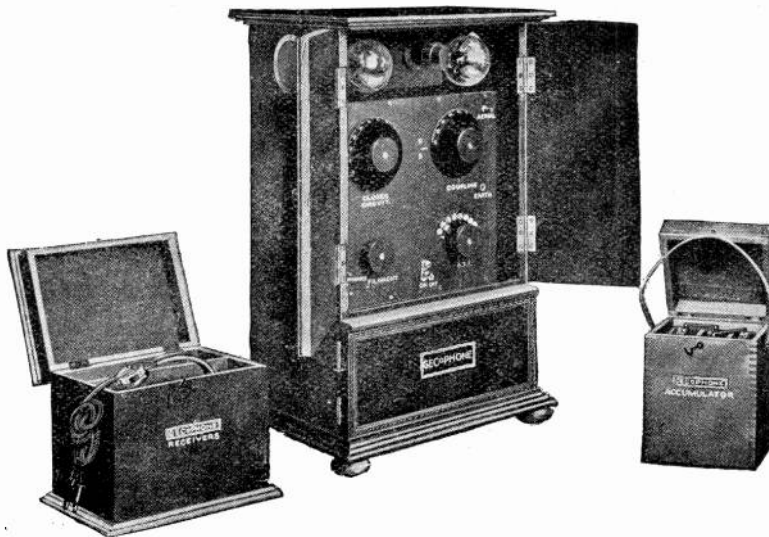

General Electric Co.'s Complete Two-Valve Receiver.

batteries and accumulator.

The Western Electric Model No. 2 is another finely constructed instrument.

The upper compartment contains a loud speaking receiver. The lower left-hand compartment contains a single-valve detector and tuner, a single stage low frequency amplifier and loud speaking equipment.

This cabinet is for an external aerial and external batteries, and has a terminal block for external connections.

The M.O. Valve Co. Ltd. (Stand No. 28).

This company is exhibiting a comprehensive series of all types of their transmitting, receiving, rectifying and amplifying valves, ranging from the familiar V.24 type receiving valve to the latest type of high power transmitter.

Transmitting valves for the amateur are also a feature.

In conjunction with this firm the General Electric Co., Ltd., of Magnet House, Kingsway, are showing on the same stand their latest and most efficient wireless receiving apparatus, embodying two types of crystal receiving sets for the reception of broadcasting programmes, with an approximate range of 15 miles respectively, and an exceedingly high-class and well designed two-valve set for the reception of signals within a range of approximately 100 miles. This set is fitted with sockets for the addition of a coil for any other wavelengths for which broadcasting may ultimately be allowed. The whole set

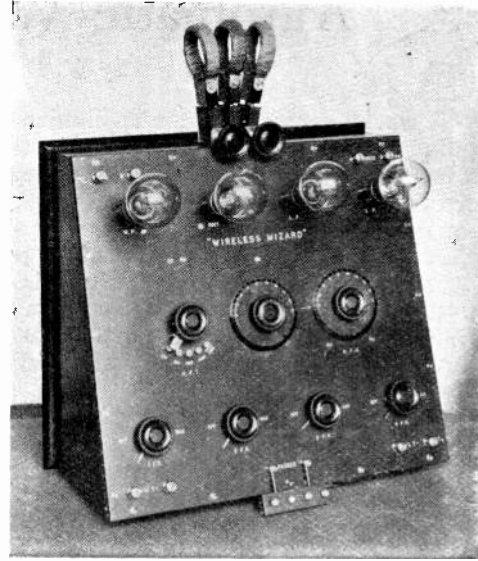

Tuner-Amplifier shown on Stand No. 54.

four-valve sets, termed the "Wireless Wonder" and "Wireless Wizard" respectively, are the two principle exhibits.

Mitchell's Electrical and Wireless, Ltd. (Stand No. 21).

For some time back this firm has specialised in high tension generators and manufacture several sizes from 50 to 750 watts, and 300 up to 2,000 volts. All sizes are made either self or separately exciting.

A new coil-holder and mounting for "Lokap" coils is exhibited, so that amateurs who wish to make up their own coils on the "Lokap" machine will have no difficulty in arranging an excellent three-coil tuner.

A speciality of cabinet receiving sets of both crystal and valve types are shown, complete with telephones, in polished mahogany cabinets, and the only terminals are the aerial, earth and batteries.

In addition to the above the manufactures of this firm include valve apparatus on the unit system for experimental work, and a special tuner for broadcasting wavelengths arranged so that telephony can be received with the greatest efficiency.

c

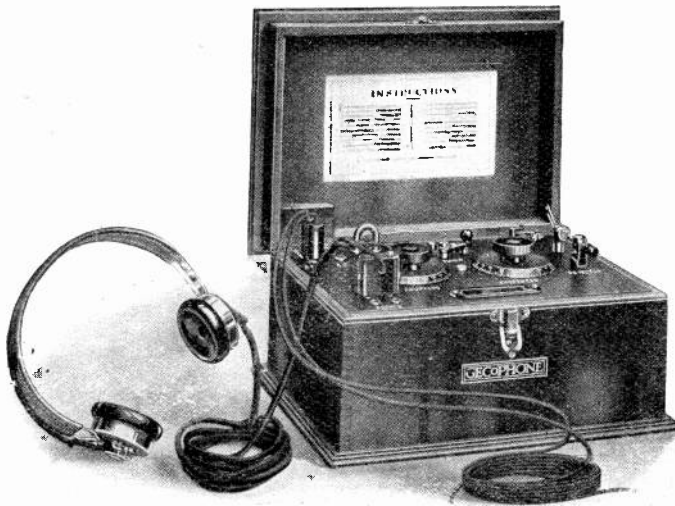

"Gecophone" Crystal Set, No. 2.

is supplied complete with the necessary batteries and phones. A series of panels, aerial fittings and sundries will also be shown.

Stanley Prince and Co. (Stand No. 54).

Apparatus known by the trade name of "King Radio" is shown on this stand. There is a two-valve receiver of attractive design. A crystal set and a one-valve set are also shown, each set being available complete with all the accessories necessary. Three and

Automatic Wireless Reception

By W. D. OWEN, A.M.I.E.E.

IT would appear that the application of time switches to wireless reception is a logical step in the development of automatic electrical apparatus; yet, so far as the writer is aware, no mention of such application has hitherto appeared in the technical or lay press.

A receiver that is entirely automatic in operation must have many uses apart from the obvious one of enabling time signals to be taken by anyone unacquainted with wireless.

meteorological report (1930 G.M.T.) announces itself, and on each occasion the apparatus obligingly switches itself off at the termination of the message and remains inoperative until the next one comes along, when the switch automatically closes and the valves light up, whether there be an audience or not.

It is but a simple step from the reception of broadcasted time signals to the reception of broadcasted telephony; and it is probable

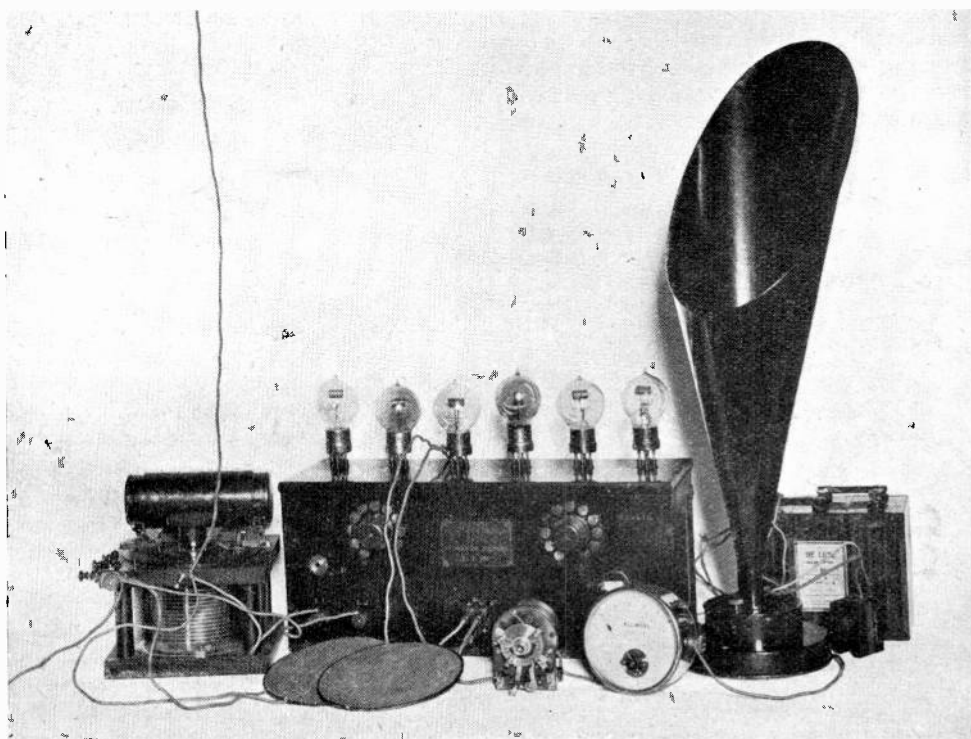

The apparatus described in this article grouped together for the purpose of illustration.

The following description of an automatic installation that has been in successful operation for several months may, therefore, be of general interest, as it may prove to be the first of its type.

It commences its day's work at 9.15 a.m. with the 0815 meteorological report from Eiffel Tower. Then, at 11.40 a.m., the morning time signal at 1044 G.M.T. comes in. Again, at 8.30 p.m., the French and Belgian

that, by the time these lines appear in print, the English and Dutch concerts may be similarly received. There is no technical reason why this is not already an accomplished fact; but it involves the duplication of apparatus to an extent which prudence has hitherto forbidden.

The results of the writer's experiments show that it is possible to devise wireless receiving apparatus which—when once set up, tuned and

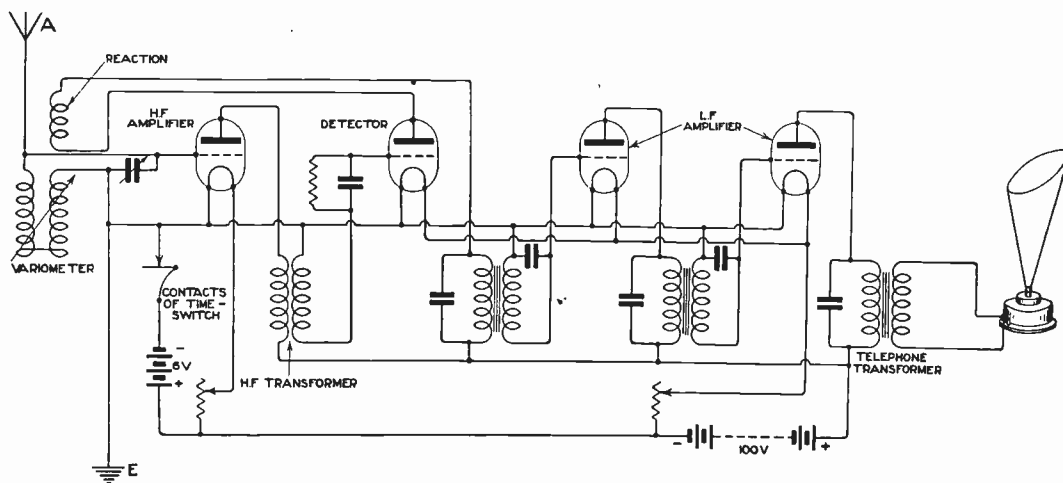

The circuit used, which is a modified French Amplifier.

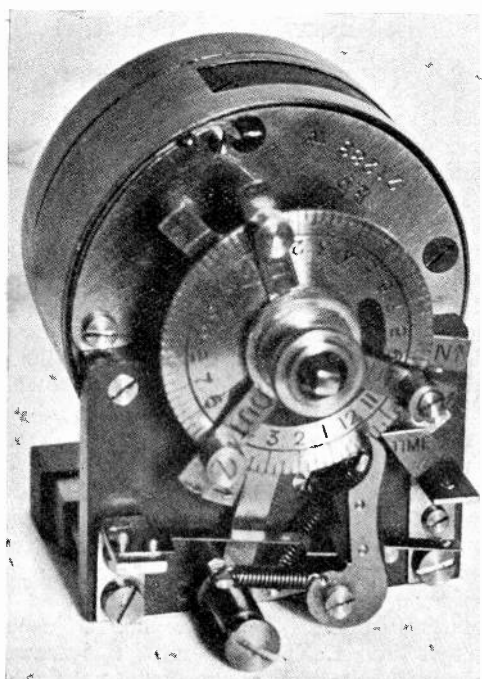

The Venner Time Switch.

adjusted—requires no attention whatever, beyond winding up the spring of the time switch and changing the accumulators, say, once a fortnight.

The apparatus used in these experiments consists of a simple tuner adjusted to a fixed wavelength of 2,600 metres for the reception of Paris spark signals, a multi-valve amplifier, Brown's loud speaker, and a special Venner time switch illustrated on this page.

The aerial loading inductances are arranged on the variometer principle and are adjusted to receive FL with the minimum value of shunted capacity. The detector-amplifier is a modified French military model LI which, since the photograph was taken, has had two high-frequency stages removed to accommodate the time switch inside the case. This leaves four valves, one for high-frequency amplification, one for detection and two for note magnification. The circuit is given above.

The signal strength with this arrangement (and reaction almost to the point of oscillation) is such that it is a sore trial to the ears of any but a wireless enthusiast to be in the room when the set is in operation—Paris being about 700 miles distant. The aerial is a single wire of regulation dimensions, directional as regards Paris.

The time switch illustrated was specially made for the writer by Venner's, Ltd. Its function is to close the filament circuit for a predetermined time interval at certain times of the day, both the time interval and the times being subject to control. The switch illustrated completes the cycle of operations three times every twenty-four hours.

The Experimental Licence

THE POST OFFICE POINT OF VIEW STATED AT THE MEETING OF THE WIRELESS SOCIETY OF LONDON.

AS previously announced in this Journal, the matters which were due for discussion at the meeting of the Wireless Society of London, held on Wednesday, September 27th, included, in particular, broadcasting and the position with regard to the issue of experimental and broadcasting licences by the Post Office authorities. Whilst the discussion at that meeting will be fully reported in a subsequent issue of this Journal, it may be of interest here to give briefly the salient points brought out in a speech made by Mr. E. M. Shaughnessy of the General Post Office. Mr. Shaughnessy emphasised the necessity for the Post Office to exercise control over the issue of licences in order to safeguard the broadcasting scheme from the chaos which might result from the careless use by totally inexperienced amateurs of receivers capable of oscillating the aerial and thereby causing interference. With this object in view it has been decided that "experimental" licences will only be issued to serious experimenters and the Post Office authorities responsible for the issuing of licences will endeavour to discriminate between those who are "proper persons" to be granted licences to conduct experiments and those who are merely interested in reception of the broadcasting to whom broadcasting licences will be issued.

Mr. Shaughnessy assured the meeting that the Post Office was in no way antagonistic towards the activities of amateurs and that the issue of experimental licences would be made on as generous a scale as was compatible with safeguarding the use of the aether for the general public. Whereas it had recently been proposed by the Post Office to restrict the experimenter as regards the type of circuit which he should employ, it is now decided that the experimenter will be free to use various types of circuit for all wavelengths except the wavelengths allotted for broadcasting and over this band it is stipulated that no circuit capable of oscillating is to be employed.

We feel sure that the attitude of the Post Office will be accepted as a very reasonable one, provided, of course, that the issue of "Experimental" licences is granted on a

very generous scale. If, however, the stipulation is to be made that the would-be experimenter must first have had considerable experience in wireless, it is difficult to see how this will be received by the large number of future experimenters who up till now have not had the opportunity to acquire any practical experience. Perhaps, however—and this is put forward as a suggestion—the good behaviour and also the tuition of would-be experimenters, if guaranteed by a wireless society or responsible individual, might be accepted as meeting the requirements of the Post Office in their very natural and desirable efforts to maintain order in the aether.

H.S.P.

The Wireless Society of London

AN IMPORTANT ANNOUNCEMENT.

THE advent of broadcasting has introduced with it certain necessary changes in the legislation which will affect to a greater or lesser degree every user of wireless telegraphy.

In particular, the effect of the new Post Office Regulations will be to make a distinction between the broadcaster and the experimenter. Hitherto all amateurs have been classed by the Post Office as experimenters, but in future there is to be an additional class, termed the broadcast licence holder, who will be granted a licence which will not give authority to experiment.

In connection with the broadcast user of wireless an important announcement is about to be made by the Wireless Society of London. Broadcast licence holders will be specially catered for by the Society and special lectures and instruction will be given to those who may desire to acquire sufficient knowledge of the subject to entitle them to obtain an experimental licence. The details of this arrangement will be published shortly. In the meantime, it would be furthering the cause of amateur wireless to make it public that the Wireless Society of London and the affiliated Societies will welcome "broadcast" licencees, and will do all that is possible to assist them wherever the desire exists to go further and join the ranks of the experimenter.

Notes

Successful Railway Experiments.

Research scientists have been conducting experiments in America with a view to establishing a system of telephonic communication with moving trains on a scale much larger than any previous scheme. Although the developments are still in the experimental stage it is now said by the railway executives that there is little doubt as to the ultimate success. The chief difficulty is interference, but many of the larger companies are sufficiently satisfied to introduce on their fast trains a wireless telephone service as an auxiliary system. Plans are now being made, and it is expected that when experiments are complete the system will be introduced on all the more important fast trains throughout the country.

Canadian Train Receiving Set.

An indication of the development of the installation of radio on trains is revealed by the fact that the annual livestock exhibit train which tours Manitoba for the benefit of farmers has now on board a receiving set for the purpose of distributing news. Enthusiasm among amateurs is growing in Canada, and considerable quantities of apparatus are being sold.

Successful Demonstration at Dereham.

At a Y.M.C.A. fête at East Dereham, Mr. H. Jewson, in whose grounds the function was held, was mainly responsible for a successful wireless demonstration. Messrs. Hobbies, Ltd., whose works are at Dereham, produced a pair of 70-ft. lattice wood masts, and erected a receiving station with apparatus in a summer house. During the afternoon parties of people were admitted to listen to time signals, messages from ships, coded messages, amateur transmissions and concerts.

The Greenwich Wireless Society.

Hon. Secretary, Mr. W. G. Kimber, 39, Bargery Road, Catford, S.E.6.

Owing to the kindness of Messrs Burndept, Ltd., the above Society will now hold the first meeting of the session at "Eastnor House," Tranquil Vale, Blackheath (Burndept Ltd.), on Saturday, October 7th, 1922 and not on Tuesday, October 3rd, as stated in a previous issue of *The Wireless World and Radio Review*.

All members and intending members are specially asked to attend, as several matters of importance are to be discussed.

Death of Mr. L. H. Walter.

Mr. L. H. Walter, who died a few days ago, was keenly interested in the scientific development of wireless telegraphy. During the Great War he translated a number of books dealing with the subject for the Air Ministry. He was the editor of "Science Abstracts" for many years and published a number of papers on electrical matters in the proceedings of the Royal Society and other journals.

Mr. Walter, who was the younger son of the late Mr. D. H. Walter, was educated in Hanover and at Trinity College, Cambridge. He took honours in the Natural Science Tripos, worked in the

laboratory of Sir Alfred Ewing, and was experimental assistant to Sir Hiram Maxim. He was a member of the staff of the Institution of Electrical Engineers.

Use of Coils as H. F. Transformers.

A correspondent, Mr. A. S. D. Kennard, A.C.G.I., points out that he finds it very satisfactory to use Burndept or other similar type of coils as H.F. transformers. He uses a two-coil holder and the usual condenser. If a three-coil holder is used, then the reaction coil may be coupled to the H.F. coils, thus decreasing risk of radiation and causing interference.

Weather Reports from Greenland.

Investigations are being made by Danish authorities as the result of which it is hoped to establish a wireless weather station in Greenland. In the compiling of weather reports information from Greenland is much desired, and if the new station comes into being data of the highest value in forecasting will be available.

Marconi Concession in Austria Ratified.

The Reparations Commission having ratified the Austrian Government's concession to Marconi's Wireless Telegraph Company, the final documents relating to that concession have been signed and are now in London.

By this concession the Marconi Company is given the sole right to erect, and to work for 30 years, wireless stations for public traffic between Austria and all other countries.

Demonstration at Brighthouse.

Members of the Brighthouse Wireless Society gave a demonstration at the exhibition of students' work which was held at the Brighthouse (Yorks) Technical Schools.

Direction Finder Demonstrated.

Capt. H. de A. Donisthorpe, of the Marconi International Marine Communication Company, conducted a private demonstration of the direction finder at the Central Station Hotel, Newcastle.

A number of shipowners and others present were highly interested.

The value of the marine direction finder as an aid to navigation has been well proved, and that value is now growing rapidly, especially since the chief maritime countries have commenced erecting special wireless "beacon" stations. These stations, situated at selected points, operate their transmitting gear during fog for the special purpose that ships fitted with direction finders may be able to take bearings on them.

Highgate Society Public Demonstration.

On Saturday, Oct. 7th, the Wireless Society, of Highgate, will give a public demonstration. Boy Scouts in uniform will be admitted free to hear the Prince of Wales' broadcasted speech.

Dissolution of Partnership.

Mr. Jas. Griffin, of the Star Delta Wireless Supply Company, points out that although he has dissolved partnership with Mr. Nicholl he is carrying on business alone under the same name.

The Wireless Society of London.

The fiftieth Ordinary General Meeting was held on Wednesday, September 27th, at 6 p.m., at the Institution of Electrical Engineers, Victoria Embankment, London.

After the minutes of the previous meeting had been read and confirmed, the President expressed regret that, owing to indisposition, Signore Marconi, who had hoped to be present to address the meeting, was unable to attend. The President then referred to various matters of business which formed the subject for subsequent discussion at the meeting. The subjects dealt with included in particular the question of broadcasting and the effect of recent regulations of the Post Office Authorities on the granting of amateur and experimental licences. (For a full report of the discussion at this meeting, see a subsequent issue of this journal.)

At the conclusion of the discussion the President announced that the following had been duly elected to membership of the Society:—

Members: Albert G. Foster, Douglas Neill-Keith, Eric E. Hart, Frank A. Greene, F. N. Nichols, William Monro Smith, Horace Freeman, Herbert W. Tomlinson, Philips Keston Turner, Arthur C. Chatwin, Lawrence L. Sims, William H. Taylor, Maurice C. J. Lloyd, Charles Cooper, Bernard J. Axten, Robert J. Sawbridge, William J. Rickets, Walter Mossop, Horace A. Thomas, Alexander C. Dixon, Oscar F. Brown, Norman F. Edwards, Cyril Midworth, N. Pensabene Perez.

Associate Members: John M. Skelhorn, Herbert Wright, Arthur J. Jacob, Stanley T. Taylor, William B. Irvin, Viscomte J. de Sibour, Trevor J. Pavey.

Foreign Member: J. Roussel.

The following Societies were accepted for affiliation:

Wembley Wireless Society.
 Ilkley and District Wireless Society.
 Middlesbrough and District Wireless Society.
 Ilford and District Radio Society.
 Shrewsbury and District Radio Society.
 Ramsgate, Broadstairs and District Wireless Society.
 Redhill and Reigate Wireless Society.
 Durham City and District Wireless Club.
 Smethwick Wireless Society.
 Bishop's Stortford Wireless Society.
 Radio Club de Brussels, Belgium.
 Malta Radio Society.
 The meeting adjourned at 7.35 p.m.

Calendar of Current Events

Friday, October 6th.

BELVEDERE AND DISTRICT RADIO AND SCIENTIFIC SOCIETY.

Lecture on "Construction of Society's Apparatus" (third lecture of series), by Mr. S. Burman.

Saturday, October 7th.

GREENWICH WIRELESS SOCIETY.

First meeting of session. At Eastner House, Tranquil Vale, Blackheath.

SUNDERLAND WIRELESS AND SCIENTIFIC ASSOCIATION.

At 7.30 p.m. at Technical College. Annual Meeting and Presidential Address.

Sunday, October 8th.

Daily Mail Concert from the Hague, PCGG, 8 to 9 p.m. B.S.T., on 1,085 metres.

Monday, October 9th.

ILKLEY AND DISTRICT WIRELESS SOCIETY.

At 7.30 p.m. At Regent Café. General Meeting, followed by lecture on "Capacity and Condensers," by Mr. E. Stanley Dobson.

WIRELESS SOCIETY OF HULL.

Lecture on "Calculation of Inductances," by Mr. Hy. Strong.

BOROUGH OF TYNEMOUTH Y.M.C.A. RADIO AND SCIENTIFIC SOCIETY.

7.30 p.m., Buzzer Practice. 8 p.m., lecture on "Short Wave Receivers," by Mr. W. G. Dixon.

IPSWICH AND DISTRICT WIRELESS SOCIETY.

At 8 p.m. At 55, Fonnereau Road. Lecture on "Matter and Energy," by Mr. R. Stanley Lewis.

Tuesday, October 10th.

Transmission of telephony at 8 p.m. on 400 metres by 2 MT Writtle.

Wednesday, October 11th.

REDHILL AND DISTRICT Y.M.C.A. WIRELESS SOCIETY.

At 111, Station Road, Redhill. Lecture on "Condensers," by Mr. Edwards.

PORTSMOUTH AND DISTRICT WIRELESS ASSOCIATION.

Lecture on "Charging Accumulators by the Noden Valve off A.C. Mains," by Mr. R. Cole.

STOCKTON AND DISTRICT WIRELESS SOCIETY.

At 7 p.m. General Meeting.

Thursday, October 12th.

Daily Mail Concert as above.

RADIO EXPERIMENTAL ASSOCIATION.

(NOTTINGHAM AND DISTRICT.)

First Meeting in new headquarters.

Friday, October 13th.

WEST LONDON WIRELESS AND EXPERIMENTAL ASSOCIATION.

At Stamford Brook Lodge, Ravenscourt Park, W.6. A popular lecture and demonstration of latest apparatus made by Messrs. Burndept, Ltd., by Mr. A. O. Gibbons.

BELVEDERE AND DISTRICT RADIO AND SCIENTIFIC SOCIETY.

Lectures on "Crystal Circuits," by Mr. C. E. Morrison, and "Telephones and Microphones," by Mr. S. G. Meadows.

Sunday, October 15th.

Daily Mail Concert as above.

Monday, October 16th.

FINCHLEY AND DISTRICT WIRELESS SOCIETY.
 Social Evening.

IPSWICH AND DISTRICT WIRELESS SOCIETY.

At 8 p.m. At 55, Fonnereau Road. Lecture on "Armstrong Circuit Experiences," by Mr. Dyer.

Tuesday, October 17th.

Telephony by 2 MT Writtle as above.

Thursday, October 19th.

Daily Mail Concert as above.

Wireless Club Reports

NOTE.—Under this heading the Editor will be pleased to give publication to reports of the meetings of Wireless Clubs and Societies. Such reports should be submitted without covering letter in the exact form in which they are to appear and as concise as possible, the Editor reserving the right to edit and curtail the reports if necessary. The Editor will be pleased to consider for publication papers read before Societies. An Asterisk denotes affiliation with the Wireless Society of London.

Leeds and District Amateur Wireless Society.*

Hon. Secretary, Mr. D. E. Pettigrew, 37, Mexborough Avenue, Chapeltown Road, Leeds.

The second annual general meeting was held on September 22nd at 8 p.m., at the Leeds University. Mr. A. M. Bage (Vice-President) was elected chairman. The chairman called upon the Hon. Secretary to read the Minutes of the first annual meeting, which were accepted as correct. The Hon. Secretary then presented the report of the Committee, who had pleasure in recording a year of steady progress and success. An Exhibition of Apparatus and Demonstration of Wireless Telephony inaugurated the first complete session of the Society. Eighteen general meetings have been held, twenty-one papers, etc., having been read. Two informal meetings were also held. Most of the meetings have been held at the Leeds University. The thanks of the Committee are due to Mr. H. F. Yardley, A.M.I.R.E., of the British Wireless Supply Co., for having kindly placed rooms at the Society's disposal on several occasions. The Society was represented by letter at the Third Annual Conference of Affiliated Wireless Societies. The junior members of the Society were invited to attend a course of lectures under the direction of Mr. T. Brown Thomson of Messrs. Burndept, Ltd. (then Burnham & Co.). At the commencement of the session the membership of the Society was 47 and is now 103. The report of the Hon. Treasurer was then called for, and approved as being satisfactory in all respects. The chairman then announced the resignation of all officers, and invited any of the members present to pass any remarks on the administration of the Society during the past session. Mr. D. E. Pettigrew paid tribute to the help certain members had given him in enabling the programme of the Society to be carried out to the best degree. It was resolved to present Mr. D. E. Pettigrew with a pair of Brown's phones suitably inscribed as a recognition of his work during the session.

The election of officers followed, Mr. A. M. Bage being elected President; Vice Presidents, Capt. F. A. Whitaker, R.E., Mr. G. P. Kendall, B.Sc.; Hon. Secretary, Mr. D. E. Pettigrew; Hon. Treasurer, Mr. R. E. Timms; Committee Members, Messrs. Yardley, Croysdale, S. Kniveton, O'Donohoe, Thomson, H. J. Wray and Marshall.

It was resolved that the annual subscription and entrance fees be altered to 7s. 6d. and 4s. respectively, for members over 18 years of age, and 5s. and 2s. 6d. respectively under 18 years of age. Meetings will be held weekly, formal or general meetings and informal or instructional meetings to be held alternately on Fridays. It was resolved to take steps to acquire transmitting and receiving apparatus and a sub-committee was appointed to work with the ordinary committee in dealing with the question. Accommodation for the 1922-23

session has not been completely arranged, but it is hoped to make a definite announcement almost immediately. Certain rules were then altered, following other business. After a hearty vote of thanks had been accorded to the chairman for his excellent management of the meeting, the meeting adjourned.

The Wireless Society of Hull and District.*

Hon. Secretary, Mr. H. Nightscales, 16, Portobello Street, Hull.

On September 11th, before a fair attendance of members, Mr. J. Nicholson gave a lecture on "Aerials." In the first place, the lecturer laid particular emphasis on the necessity of knowing what one intended to do before commencing work. He then proceeded by gradual steps to detail the preparation of a mast and the fittings required. In order to make the lecture more interesting, he then gave a demonstration on making guys, splicing of same, etc. In concluding he showed the gathering the method of erection and fixing of the mast and aerials. The lecture was particularly instructive to the new members, although the older members no doubt gained some useful hints. The lecturer knows his subject well, and can express himself.

On the motion of Mr. C. B. Snowden, and seconded by Major F. Holman, Mr. Nicholson was accorded a hearty vote of thanks for his interesting lecture. One new member was elected.

On Monday, October 9th, Mr. Hy. Strong is due to give a paper on "Calculation of Inductances." This is the second of a series of lectures arranged specially for the benefit of the new members, and a good attendance is looked for on this occasion.

Stoke-on-Trent Wireless and Experimental Society*

Hon. Secretary, Mr. F. T. Jones, 360, Cobridge Road, Hanley.

At a meeting of this Society at the Y.M.C.A., Hanley, on Thursday, September 21st, there was a much larger attendance than there has been during the last few weeks.

The outside aerial has now been erected, and requires a little tuning up before the best results can be achieved. The Society has not yet received a reception licence from the Post Office, but there is every indication of this being granted in the near future. When this comes along, the practical work of the Society will be able to progress unimpeded.

Through the kindness of two of the members, a blackboard and easel will be provided to facilitate the giving of lectures.

Wireless and Experimental Association.*

Hon. Secretary, Mr. Geo. Sutton, 18, Melford Road, S.E. 22.

The Association meeting at the Central Hall,

Peckham, on Wednesday, September 20th, was very successful.

The members had been despondent over the persistent rumours of the threats to their liberties. They were now overjoyed to think that the situation was so much improved.

They paid a special tribute to their Secretary for the prompt and able way in which he had called public attention to the danger which had threatened them.

They were also rejoiced to hear that Sir Frederick Hall, M.P., K.B.E., had acceded to their request and had honoured them by becoming the Vice-President of the Association.

Wolverhampton and District Wireless Society.*
Secretary, Mr. J. A. H. Devey, 232, Great Brickkiln Street, Wolverhampton.

A meeting of the above Society was held at headquarters, 26, King Street, Wolverhampton, on Wednesday, September 13th, when a very interesting and instructive lecture was given by Mr. H. Taylor (2 KQ) on "Hints and Tips on Receiving."

The lecture was chiefly for beginners, and commencing with the correct method of using a single valve set, the lecturer (by means of diagrams) illustrated the importance of correct circuits.

Mr. Taylor laid great stress on the fact of having a good and permanent grid leak of correct value, and also the advantages of grid batteries and their effect upon the circuit.

Many questions were addressed to the lecturer, whose extensive experience proved exceedingly beneficial and opportune to all present. One of the chief items of discussion was the question of grid batteries, and various opinions were expressed as to their importance, permanency and correct method of coupling.

The East London Radio Society.*

Hon. Secretary, Mr. L. E. Lubbock, King George's Hall, East India Dock Road, Poplar.

On Tuesday, September 12th, 1922, the usual meeting of the above Society was held at the Lecture Hall, Woodstock Road, E.14.

The attendance was quite as good as usual and after 2 MT (Writtle) had finished his excellent transmission the members settled down to the first of Mr. J. Keen's series of lectures, "How the Valve Works."

Mr. J. Keen is a lecturer of very considerable ability and his extensive knowledge of all matters wireless enables him to deal with his subjects in a manner which is not too simple for those of experience and not too intricate for the beginner. He traced the history of the valve from the initial conception of the idea, and the original formation of the electron theory. After dealing very fully with the valve in all its aspects, Mr. J. Keen invited questions. The keenness of the questioning was ample proof of the attentiveness of the audience, and of the interest created by the lecture. But all questions, whether coming from senior or junior members, were ably dealt with.

Votes of thanks to both chairman and lecturer were carried and the meeting closed at 10.15 p.m.

On Friday, September 18th, 1922, the Society's buzzer class was well attended. Listening-in did not commence until 9.15 p.m. and after various interesting experiments the meeting closed at 10.20 p.m.

Mr. J. Keen also lectured on Tuesday, September 22nd, on the "Application of Valves to Receiving Circuits." All who are interested are heartily invited to attend any future lecture held under the auspices of this Society.

Southwark Wireless Telephony Association.

Hon. Secretary, Mr. W. Helps, Headquarters, King's Hall, London Road, S.E.1.

This Association held its second meeting of the month on Sunday, September 17th. The crystal set competition was carried out, and the judges, Messrs. A. O. Gibbons, A.M.I.E.E., and Winston, awarded the gold and silver medal, presented by W. F. Hurndall, Esq., after keen competition, to Mr. Fitcher, he having secured the highest number of points. The Secretary announced that the future programme was full of very good things. For the next meeting, Mr. A. O. Gibbons, had promised to give an "Elementary Lecture on Wireless," with lantern slide illustrations. Also that entrance fee would be 1s. 6d. in future, and subscriptions 1s. per month instead of 6d. Visitors would be admitted to lectures on the payment of 6d. A vote of thanks to the judges concluded the business.

Beckenham and District Radio Society.

Hon. Secretary, Mr. J. F. Butterfield, 10, The Close, Elmers End, Beckenham.

On Thursday, September 14th, the general meeting of the Beckenham and District Radio Society was held for the purpose of confirming proposed rules.

Every encouragement is given to novice members, the general programme being that each week a certain part of a crystal set is thoroughly explained with a view to instructing those anxious to make their own sets.

Up to the present the progress of the Society has surprised its founders. A few weeks ago eight persons met to formally found the Society; since then new members have joined each week. There are now 40 members, including juniors. A number already possess receiving sets, and it is interesting to record that one junior member won the first prize in Selfridge's home-made set competition. He constructed a first-class crystal set, on which Writtle can be heard.

On Thursday, September 21st, the study of component parts of apparatus was continued, the condenser being chosen for the subject at this meeting, the Vice-President being in the chair.

The Hon. Secretary continued his lecture and ably explained the construction, approximate cost and use of the condenser. A number of questions were asked and answered.

It was decided to have a question box to enable members to put in written enquiries, which would be replied to on the following Thursday immediately preceding the chief item of the agenda.

On September 28th, a variable condenser was assembled from the parts by way of practical instruction, and this condenser is being used on a receiving set, which is being made up for the Society. It is proposed to obtain a loud speaker.

Enquiries will be welcomed by the Hon. Secretary, and prospective members are asked to attend the weekly meetings held at 114, High Street, Beckenham, each Thursday at 8.15 p.m.

The Present Wireless Boom

has given an enormous impetus to the manufacture of wireless apparatus. The tendency has been to sacrifice quality to quantity in endeavouring to keep pace with the demands. Throughout this period of increasing wireless activity S. G. BROWN, LTD., have wisely refused to lower their high standard of quality even at the expense of occasional delay in fulfilling orders. As a result they have more than maintained their enviable reputation as RELIABLE wireless manufacturers, and to-day it continues to be recognised by amateur and professional alike that wireless instruments and parts manufactured by and bearing the name "BROWN" can be bought with absolute confidence in their quality, value and efficiency.



"A" TYPE.
Low Resistance, 58.-
High Resistance, 62- to 66-
"D" TYPE.
Low Resistance, 48.-
High Resistance, 52.-

(All above prices include cords).

The "Brown" Super-sensitive Telephones

These Telephones are unquestionably the clearest and most sensitive made, and, consequently, increase the distance over which wireless can be heard.

BROWN'S are recognised as the most comfortable to wear, due to their extreme lightness in weight and adaptable adjustment.

There are no wireless headphones in the world to compare with BROWN'S.

IMPORTANT NOTICE—When purchasing BROWN'S you should see that the name BROWN is stamped on the back of each ear piece. This is the *hall-mark and proof* of their *genuineness, excellence of finish and highest efficiency.*

In Universal Use. As supplied to British, Allied and Foreign Governments.

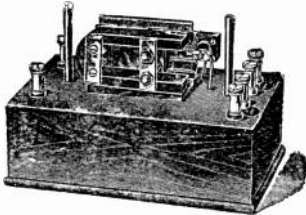

The "Brown" Microphone Amplifier

This Amplifier magnifies signals, speech, or music, without distortion, and is of considerable interest to amateurs and scientific investigators. The magnification is much greater than that obtained from a two-valve amplifier. In construction, this instrument is much more robust than other relays. *This instrument satisfies the urgent demand for a reliable inexpensive amplifier, which the most inexperienced amateur can use, and which the most experienced requires.* The necessary transformers are included in the base.

The "Brown" Loud Speakers with new improved Curved Horns

The requisites of a Loud Speaker are pure tone, clear articulation, and good volume of sound. The "BROWN" Loud Speaker possesses these qualities and they are enhanced by the new improved curved horn.

AMATEURS do not always need the full sized Loud Speaker (H.1) as used in Lecture Halls, and a small type (H.2) has been designed to meet their more modest home requirements *both as to volume of sound and price.*

THE NEW HORN of dull blacked aluminium used with both H.1 and H.2 is constructed on the logarithmic law of increasing openings and is acoustically perfect.

NOTE THIS.—The strength and clearness of all music, speech and Morse heard by one person wearing headphones is broadcasted to a whole room full of people when a Brown Amplifier and Loud Speaker are used with your set.

The most popular and perfect loud speakers ever offered to the public.

Thousands already in use in all parts of the world.

CATALOGUE POST FREE.

Visit Our London Showrooms: 19, MORTIMER STREET, W.1.

Visit our Stand No. 43 at the All-British Wireless Exhibition, Horticultural Hall, Sept. 30th to Oct. 7th.

SOLE MANUFACTURERS—



PRICES:
H. 1 (Large) Low Resistance, 120 ohms Height 21", £6 : 5 : 0 (High resistance 2/6 to 5/- extra).
H. 2 (Small) Low Resistance, 120 ohms Height 12", £3 : 0 : 0 (High Resistances 2/6 to 5/- extra).

Telegrams—
"Sidbrownix. London."
Telephone—
Chiswick 1469.

Sole Agent for the Argentine—
Horacio D. Guerrero,
Las Heras 2480, Buenos Aires



Head Office and Works:
VICTORIA ROAD, NORTH ACTON,
LONDON, W.3

London Showrooms:
19, MORTIMER STREET,
LONDON, W.1.

SIEMENS H.T. DRY BATTERIES

Two Announcements Worthy of Attention

REDUCED PRICES NOW IN FORCE

Size 643	15 volts	-	3/9	each	
„ 789	15 „	-	6/3	„	
„ 826	30 „	-	7/6	„	} Removable } plug } terminals } if required } 1/- per pair } extra
„ 827	36 „	-	9/-	„	
„ 828	50 „	-	12/-	„	
„ 829	60 „	-	15/-	„	
„ 830	90 „	-	22/6	„	
„ 831	100 „	-	24/-	„	

FLAT STRIP TERMINALS ABOLISHED

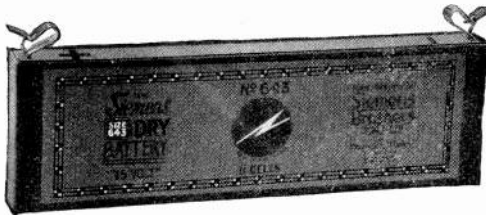

An improved form of terminal for the standard 15-volt battery has been designed by us, and as soon as existing stocks are disposed of we shall supply these batteries fitted with two **Spring Clip Terminals** as shown in the above illustration.

With the Spring Clips no soldering will be required, a short piece of copper wire being all that is necessary to connect adjacent units.- The contact is perfectly sound and cannot shake loose.

Strip terminals will be supplied if specially asked for.

Pamphlets on application to the Manufacturers :

Siemens Brothers & Co. Ltd.
WOOLWICH, LONDON, S.E.18

Telegrams : SIEMENS, WOOLWICH Telephone : CITY 6400 (7 lines)

and at Belfast, Birmingham, Bristol, Cardiff, Glasgow, Leeds, Manchester, Newcastle, Sheffield, Southampton.

Visit our Stand No. 48. All-British Wireless Exhibition, Horticultural Hall, September 30th to October 7th

THE HALL MARK of EFFICIENCY

Prices
on
Application



•0005
•0003
•0005
•001 mfd.

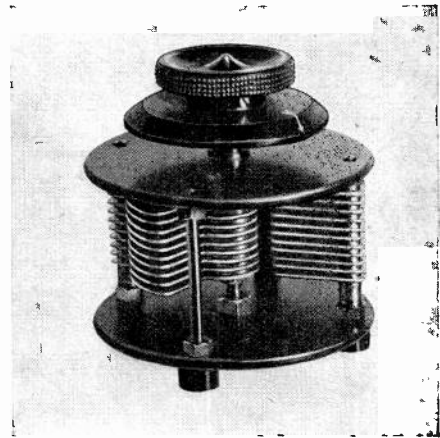

J. BURNS, LIMITED
Wangye Works, Chadwell Heath, Essex

Distinctive Wireless Apparatus

SUPER VII★ RECEIVERS

Price
£4 2s. 6d. less Valve.

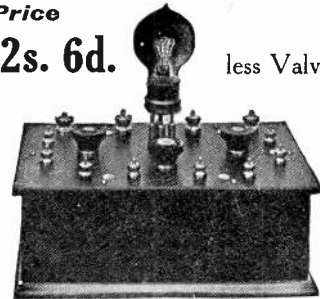

Cannot be Bettered for Results,
Workmanship and Finish

Manufactured under Marconi License.

Write for Illustrated List, Post Free 4d.
Complete Stations, from one to six valves Cabinet
Instruments also "Castaphone" Crystal Receivers,
and Patent Tuners and Accessories.

Sole
Manufacturers : **GORDON CASTAGNOLI**
BRAINTREE, ESSEX

Barnes, Mortlake and Richmond Wireless Society.

(Temporary name.)

Hon. Secretary, Mr. E. A. Rogers, 17, Leinster Avenue, East Sheen.

An inaugural meeting of the above Society took place at East Sheen, and over 40 people attended.

Mr. F. Hope-Jones, M.I.E.E. (Chairman of the Wireless Society of London), kindly consented to take the chair, and in his opening speech gave some very good reasons why we should form such a Society.

Mr. Rogers explained what had been done so far, and apologised that Mr. Blake was unavoidably absent, and read his letter to the meeting.

It was decided that the name of the Society should be postponed until the next meeting for further discussion.

The following gentlemen were duly elected by the meeting for the coming year, which it was decided should start on October 1st:—

President, Mr. G. G. Blake, M.I.E.E., 10, Onslow Road, Richmond; Hon. Secretary, Mr. E. A. Rogers, 17, Leinster Avenue, East Sheen; Hon. Treasurer, Mr. K. L. Davy, 11, Sheen Gate Gardens, East Sheen.

The following were elected to the Committee:—

Messrs. Swain, Lloyd, Driver, Appleton-Smith, Poole and Wootton. They were empowered to draw up the rules for confirmation at the next meeting.

The subscription was fixed by the meeting at 10s. 6d. per annum, payable in advance.

Over 30 visitors signed the membership form before leaving, and many more promised to send theirs along.

Many gentlemen with aeriels known to the Society were not at the meeting, and it is hoped that they will turn up at subsequent meetings.

Several ladies were present, and the members hope to see many more.

Mr. Hope-Jones, on behalf of the meeting, thanked Mr. and Mrs. Davy for allowing the use of their room, and a hearty vote of thanks to Mr. Hope-Jones for taking the chair and being the first hon. member, terminated a most successful evening.

Full particulars of the Society will be gladly sent by the Hon. Secretary from the above address.

Swinton and District Amateur Radio Society.

Hon. Secretary, Mr. Geo. T. Bultitude, The Slade, Swinton.

At the weekly meeting of the above Society Mr. F. Finn, of Swinton, gave a lecture on "A Three-Valve Panel and its Circuit." Mr. Finn illustrated by the blackboard each valve and its connections, and then reviewed the whole circuit in detail. Later Mr. Finn gave "Points on Aerial Erection," which proved very instructive. Mr. Finn was thanked for his address.

The Society passed a resolution "That the membership be open to either sex," and new members will be welcomed every Thursday.

The Fulham and Putney Radio Society.

Hon. Secretary, Mr. J. Wright Dewhurst, 52, North End Road, West Kensington, London, W.14.

The above Society held a meeting on Friday, September 22nd, which was well attended and several new members were made.

After the buzzer class a large variety of apparatus and components were shown by the members and a variety of interesting discussions took place regarding the various parts.

Mr. Calver presented the Society with a large number of basket coils, a large tuner coil, and also a basket-coil winding former. Mr. Hart Smith presented a book for the library and also a number of Morse code instruction leaflets.

Mr. S. W. Martin presented a piece of apparatus which, after alteration, will make an efficient practice key.

A vote of thanks was accorded to the above members, and the meeting closed at 10 o'clock, leaving some of the members listening in on Mr. E. V. Barker's multiple valve set.

Otley and District Wireless Society.

Hon. Secretary, Mr. N. Weston, Student I.E.E., 24, Guycroft, Otley.

A lecture was given by the Hon. Secretary on "Secondary Cells," describing their construction, care and maintenance, at the meeting on September 22nd. Fausé and Planté cells were dealt with, and characteristic curves showing voltage, specific gravity and discharge during charge were drawn on the blackboard of main types of prominent makers' cells. Mr. H. Johnson exhibited a novel three-valve set with combined crystal, incorporating "Dewar" switches, so that Mark III tuning coils, and duolateral coils could be used for short and long wave tuning; also one, two or all valves could be switched in circuit, or crystal only used. The set reflected great credit on the maker, and good results were obtained. A further set of lectures will be given on elementary wireless telegraphy, and it is hoped that rapid progress will be made in order to pave the way for more advanced lectures.

A fourth lady member was enrolled. Until further notice meetings will be held every Tuesday at 7.30 p.m. for Morse practice, and general meetings, and lectures every Friday, at 8 p.m.

Southport Wireless Society.

Hon. Secretary and Treasurer, Mr. R. W. Brown, 71, Norwood Crescent, Southport.

A series of very interesting lectures have been held during September by the above Society at their headquarters, Queen's Hotel, Promenade, Southport.

On Monday the 11th, Captain F. C. Poulton, O.B.E., gave a lecture on "Electrical Measuring Instruments," describing in detail the construction and working of voltmeters and amperemeters. The lecture was very instructive to all present, and was highly appreciated.

On Monday the 18th, a lecture was given by Mr. E. Lomas on "Automatic Telephones." This lecture was also very much enjoyed by all the members present.

On Monday the 25th, Mr. E. R. W. Field explained and demonstrated a new "Rejector Circuit" set.

The lectures in question have all brought full attendances, and a further series are in contemplation. Amateurs interested in the above Society can obtain full particulars upon application to the Hon. Secretary.

Streatham Radio Society.

Hon. Secretary, Mr. S. C. Newton, "Compton," Pendenis Road, Streatham, S.W.

A meeting of the above Society was held on Wednesday evening, September 13th, at the headquarters, 35, Streatham Hill, S.W. Mr. Bevan Swift as Chairman presided.

This is the sixth general meeting since the formation of the Society, and it was attended by the majority of the members and several visitors.

The Treasurer arranged for a photograph to be taken of the members, and several new members were proposed and seconded.

A demonstration was given by Mr. Smith, who used a four-valve set, very kindly lent for the occasion by Mr. Travers, of the Radio Appliances, Ltd., Streatham.

Sir William Lane Mitchell, President of the Society, whom it was hoped would have been able to turn up, sent a letter to the Secretary, expressing his regret at his non-attendance, and wishing the Society every success. The Treasurer reported on the satisfactory state of the funds of the Society, and the Secretary stated that negotiations were now taking place for affiliation to the Wireless Society of London. He also reported that application had been made to the Postmaster-General for a receiving licence. Several members promised to read papers, and a committee meeting was arranged to discuss and arrange a programme for the winter session. The meeting closed at 10 p.m., with the usual vote of thanks to those responsible for the demonstration.

The membership of this Society is growing rapidly; it is now nearly 40, and a very interesting programme is being arranged, so that members may receive instructions, advice, and spend an enjoyable evening together.

The Secretary will be pleased to receive applications from wireless enthusiasts resident in the district.

Ilford and District Radio Society.

Hon. Secretary, Mr. A. E. Gregory, 77, Khedive Road, Forest Gate, E.7.

On Thursday, September 14th, at an informal meeting, the Society again had the pleasure of a lecture delivered by Mr. Gregory, the Secretary. The subject, "The Elementary Principles of the Valve," is generally admitted to be a difficult one to speak on, but this was not the case with Mr. Gregory.

The lecturer began with the electron theory, and gradually advanced to the two and three-electrode valves. The working of the two-electrode valve was fully explained, showing how the valve acted as a relay. It was then shown how, by the insertion of the third electrode, the grid, the flow of electrons between filament and plate could be controlled. The practical method of plotting the "curve" of a valve was explained with the aid of diagrams and an imaginary curve was plotted. From this curve the correct point on which to work was explained.

As usual, at the end of the lecture questions were invited, but none were forthcoming, probably owing to the excellent and lucid way the lecture was given.

This was undoubtedly the best lecture the Society has had, and Mr. Gregory is to be heartily congratulated on the results of his efforts.

Owing to the fact that it was an "informal" meeting, the attendance was not as good as one

might desire. Mr. Gregory has kindly consented to deliver the lecture again at a "formal" meeting in the near future.

The meeting closed with a vote of thanks to the lecturer.

Membership is increasing. Applications should be addressed to the Secretary.

Rhyl and District Amateur Wireless Society.

Hon. Secretary, Mr. C. Mitchell, 24, East Parade.

A demonstration was given on Wednesday last on a two-valve receiving set. The Society's new headquarters, Arcville College, Russell Road, proved an excellent place for reception of wireless messages. Of great interest to the members was the instruction as to how to put a small receiving set together for practical use. Each part was shown in detail and advice given on every point possible.

On Wednesday, September 27th, a lecture was given by Mr. D. T. Jones on "Accumulators."

Stockton and District Amateur Wireless Society.

Hon. Secretary, Mr. William F. Wood, 4, Birkley Square, Norton, Stockton-on-Tees.

The monthly meeting of this Society was held on Thursday, September 14th, 1922, in the Concert Hall of the Malleable Workmen's Institute, Norton-on-Tees.

The chair was taken by the Vice-President, Mr. S. G. Marston.

At the conclusion of the business a lecture entitled "The Romance of Wireless" was given by Mr. Norman Whiteley, of the Bradford Wireless Society, and profusely illustrated with slides specially prepared by the lecturer.

The progress of this particular branch of electrical science was aptly illustrated and explained, and a large and appreciative audience spent a most interesting and enjoyable evening.

At the conclusion of the meeting hearty votes of thanks were accorded to the lecturer and lanternist.

The next general meeting is fixed for October 11th.

Arrangements are in hand for holding classes during the winter season, commencing in October.

Fulham and Chelsea Amateur Radio and Social Society.

Hon. Secretary, Mr. R. S. V. Wood, 48, Hamble Street, Fulham, S.W.6.

The above Society have obtained permission to hold their headquarters at the Chelsea Polytechnic, Manresa Road, Chelsea, where all meetings will now be held every Tuesday evening from 8 to 10 p.m.

Mount Pleasant Radio Society.

Hon. Secretary, Mr. W. R. Fleming, 156, Upton Park Road, Forest Gate, E.7.

The inaugural meeting of the above Society was held on Friday, September 22nd, when rules were formed and officers elected.

For the present it was agreed to limit the membership to civil servants.

A hearty invitation is given to all civil servants to join the Society and the Secretary will be pleased to forward particulars.

MAGNAVOX

THE WORLD'S FINEST

LOUD SPEAKER

RADIO
brings it
MAGNAVOX
tells it.

*Broadcasting faithfully reproduced
with marvellous clarity and volume*

IMMEDIATE DELIVERY.

Visit our Stand No. 34. All-British Wireless Exhibition,
Horticultural Hall, September 30th to October 7th.

Manufacturers & Sole Licensees for Europe

Sterling Telephone & Electric Co., Ltd.

TELEPHONE HOUSE,

210/212, Tottenham Court Road, London, W.1

Telephone No.: 4144 Museum (7 lines). Telegrams: "Cucumis, Wesdo, London."

Works: DAGENHAM, ESSEX.

BRANCHES: NEWCASTLE-ON-TYNE: 9, Clavering Place.

CARDIFF: 8, Park Place.

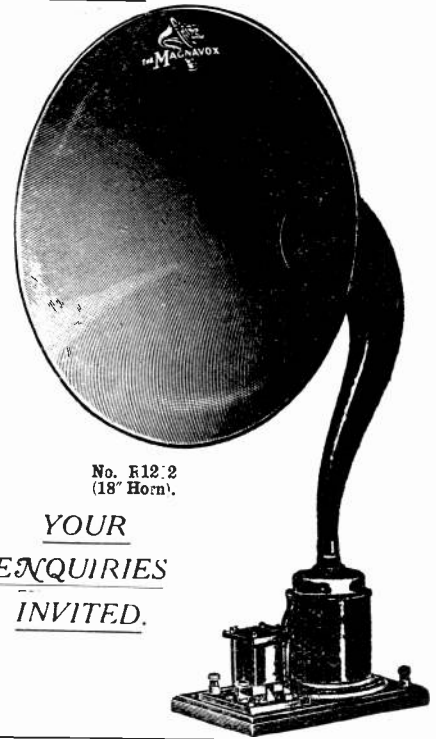

No. R12.2
(18" Horn).

YOUR
ENQUIRIES
INVITED.

YOUR WIRELESS SET IS ONLY AS EFFICIENT
AS YOUR BATTERY IS RELIABLE,
THEREFORE ALWAYS USE

HART BATTERIES

SUITABLE FOR
HIGH AND LOW TENSION CIRCUITS.

IMMEDIATE DESPATCH FROM STOCK OF FOLLOWING TYPES:—

TYPE	Voltage	AMPERE HOUR CAPACITY		APPROXIMATE OVERALL DIMENSIONS			TYPE OF BOX	NET PRICE EACH	
		Contin-uous	Inter-mittent	WIDTH	LENGTH	HEIGHT		Cash with Order.	Carriage Paid
							St-gly		For Two or more
P.L. 3	2	1	2	27/32"	2 1/4"	3"	CELLULOID	3s. 0d.	2s. 6d.
"	2	1	2	1 5/32"	2 11/16"	3 1/2"	EBONITE	6s. 0d.	5s. 8d.
"	2	1	2	1 1/2"	1 1/2"	4 1/2"	GLASS	5s. 6d.	5s. 0d.
E 5	2	5	10	1 1/2"	1 1/2"	6"	GLASS	6s. 8d.	6s. 2d.
A.P. 7	2	11	22	1 1/2"	1 1/2"	6 1/2"	EBONITE	6s. 0d.	5s. 9d.

THESE CELLS CAN BE SUPPLIED MADE UP IN BATTERIES OF ANY REQUIRED VOLTAGE. SPECIAL PRICES FOR SUCH BATTERIES WILL BE QUOTED ON APPLICATION.

Visit our Stand No. 17. All-British Wireless Exhibition, Horticultural Hall, September 30th to October 7th.

HART ACCUMULATOR CO., LTD.
STRATFORD, LONDON, E.15

BRANCHES:
BELFAST 41, CHICHESTER STREET
BIRMINGHAM 174, CORPORATION STREET
BRISTOL 37, VICTORIA STREET
GLASGOW 107, WELLINGTON STREET
LONDON 36, VICTORIA STREET, S.W.1
MANCHESTER 4, VICTORIA BRIDGE
YORK—6, BRIDGE STREET

ELECTRICAL DISPOSALS SYNDICATE

RETAIL
BUSINESS

GOVERNMENT SURPLUS

WHOLESALE
PRICES

FURTHER SELECTIONS FROM OUR STOCK

Condensers.—Two on ebonite base, mica and foil, .0003 mfd., 5/- pair; .002 mfd., 6/- pair.

Separators.—Containing cabinet $5\frac{1}{2}'' \times 7'' \times 6''$, hinged hollow lid, 200 ohm choke coil with $\frac{1}{2}$ lb. 36 S.W.G. D.S.C. wire, one 2 mfd. and two $\frac{1}{2}$ mfd. mansbridge condensers, 1 D.P. plug and flex, 6 fuses and holders, 6 lightning arresters, several sheets, 1" polished ebonite, terminals, etc. Only a few now left, 12/6.

Battery Boxes.— $12\frac{1}{2}'' \times 6'' \times 6\frac{1}{2}''$ each 1/6
Lucas, $7'' \times 8'' \times 5\frac{1}{2}''$ each 1/6
 $8\frac{1}{2}'' \times 8\frac{1}{2}'' \times 3\frac{1}{2}''$ each 2/6
All painted wood with hinged lid and fittings.

Nuts.—Per doz. 0 B.A. $\times \frac{1}{4}''$, 4d.; 2B.A. terminals, 1/-; 4B.A. hex., 3d.; 6B.A. hex., 3d.; 8B.A. hex., 3d., etc.

Table Telephones with Solid Back Microphones. 5/- each.

Telephone Receivers, G.P.O. Type. 3/6 each.

Plug and Jack, complete with Cord. 3/6 each.

Leads.—Red and Black twin twisted flex approx. 2' long, 4d. each.

Eraiding.—Red or green for telephone cords, 1d. per yard

Power Transformers.—Prices on application.

Steam Engine with 100 volt. 10 amp. dynamo D.C., never been run, £25 each.

6-Volt 20 actual Amp. Hr. Accumulators.—New in glass jars. Very special line. Perfect for 3-valve work, £1 17s. 6d.

Transmitting Valves.—Marconi A.T. 40. A very limited number, £1 12s. 6d.

Screws.—0B.A. $\times \frac{1}{4}''$ grub (steel), 4B.A. $\times \frac{1}{4}''$ grub, 6B.A. $\times \frac{3}{16}''$ grub (brass), 2d. doz.

6B.A. $\times \frac{1}{4}''$ cheese, 6B.A. $\times \frac{1}{4}''$ C/sk, 4B.A. grub, 2B.A. $\times \frac{1}{4}''$ grub (all brass), 3d. doz.

0B.A. $\times \frac{3}{8}''$ R. lead, 4B.A. $\times \frac{1}{4}''$, 6B.A. $\times \frac{1}{4}''$ (brass tinned), 4d. doz.

2B.A. $\times \frac{3}{8}''$ cheese, 4B.A. $\times 1''$ (collar), 6B.A. $\times \frac{3}{4}''$ C/sk (brass), 5d. doz.

2B.A. $\times \frac{1}{2}''$ C/sk, 1B.A. $\times \frac{1}{2}''$ terminal, 3B.A. $\times \frac{1}{2}''$ terminal (brass or brass tinned), 6d. doz.

0B.A. $\times 1\frac{1}{16}''$ cheese, 0B.A. $\times 1\frac{1}{4}''$ C/sk., 2B.A. $\times 1\frac{1}{2}''$ C/sk (brass or brass tinned), 9d. doz..

Etc., etc., etc.

If what you require is not on the list

'PHONE : MUSEUM 643.

WRITE : 6, MARKET PLACE, W.1.

CALL : 84, GLENGALL ROAD, PECKHAM.

TECHNICAL ADVICE FREE.

BRITISH EBONITE TO GOVERNMENT SPECIFICATION FOR BRITISH WIRELESS.

MANUFACTURED BY:

THE BRITISH EBONITE CO., LTD.

HANWELL

LONDON, W.7

APPLY FOR LIST "W."

SPECIAL QUALITY RODS, TUBES,
and SHEETS FOR WIRELESS.
ALL USUAL SIZES KEPT IN STOCK.
Grained Ebonite is a Speciality.

TELEGRAMS : "Ebonital, Han, London."
PHONE : Ealing 1689.

WHOLESALE
ONLY.

Questions and Answers

NOTE.—This section of the magazine is placed at the disposal of all readers who wish to receive advice and information on matters pertaining to both the technical and non-technical sides of wireless work. Readers should comply with the following rules:—(1) Each question should be numbered and written on a separate sheet on one side of the paper, and addressed "Questions and Answers," Editor, THE WIRELESS WORLD AND RADIO REVIEW, 12/13, Henrietta Street, London, W.C.2. Queries should be clear and concise. (2) Before sending in their questions readers are advised to search recent numbers to see whether the same queries have not been dealt with before. (3) Each communication sent in to be accompanied by the "Questions and Answers" coupon to be found in the advertisement columns of the issue current at the time of forwarding the questions. (4) The name and address of the querist, which is for reference and not for publication, to appear at the top of every sheet or sheets, and unless typewritten, this should be in block capitals. Queries will be answered under the initials and town of the correspondent, or, if so desired, under a "nom de plume." (5) In view of the fact that a large proportion of the circuits and apparatus described in these answers are covered by patents, readers are advised before making use of them, to satisfy themselves that they would not be infringing patents. (6) Where a reply through the post is required, every question sent in must be accompanied by a postal order for the amount of 1s., or 3s. 6d. for a maximum of four questions. (7) Four questions is the maximum which may be sent in at one time.

In view of the serious interference which an oscillating receiver can cause to other receivers in its neighbourhood, it is understood that for broadcast wavelengths, certainly, and possibly for all wavelengths, the Postmaster-General will in future allow no type of circuit which is capable of oscillating and so energising the aerial.

The necessary consequence of this restriction is that if reaction of the type commonly used in the past is still employed, it must be in such a way that the oscillation point cannot be reached over the wavelength range of the receiver, however tightly the reaction coil is coupled, and with whatever values of filament voltage or plate voltage the set is worked.

In order to comply with this requirement, it is essential that the reaction coil should be sufficiently loosely coupled to the aerial inductances as not to set up oscillations, or alternatively the reaction might be arranged between the grid and plate circuits of a high frequency amplifier as shown on p. 715 of the issue of September 2nd, and p. 867 September 30th, 1922.

We strongly urge readers who are making or using sets of the usual reacting type to either reduce the amount of reaction which they can employ to such an extent that they are perfectly satisfied that the set can never oscillate, or to cut out their reaction entirely.

"J.W.C." (Streatham) submits a blueprint showing the construction and connections of a detector panel, which is provided with terminals for aerial and reaction circuits, and asks for method of connecting up two slide inductances to this apparatus.

Wired as shown, it is not possible to make use of a two-slide inductance with this panel, excepting of course, by using the valve as a detector only, and not producing reaction effects. To do this, connect the aerial to one end of the inductance coil and one slider to earth. Short circuit the terminals marked "reaction" and connect the one marked "G" to the aerial, and that marked "F" to the other slider. What you really require is a loose-coupled inductance. Your panel should be arranged as shown in the diagram on page 456 of July 8th issue, excepting that the variable condenser may be connected across the grid leak for use as a variable grid condenser. You might read the article referred to and follow up the constructional details given in that and subsequent issues.

"K. A. T." (Broadstairs).—Your questions do not tell us what single unit set you are referring to. However, the diagram (Fig. 1) will show you a typical set for the results described. A set as shown in this diagram may be used independently of any other apparatus. Two or more of these units may be coupled together in various ways, and it is, of course, possible to use coupled circuits and valves without using units of this type.

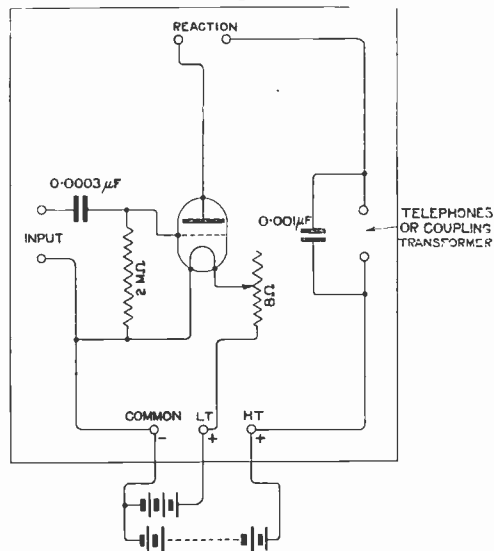

Fig. 1.

"H.W.C." (N.15) is unable to erect an aerial of greater length than 30 ft., and asks whether we would recommend under the circumstances the use of a three-wire aerial.

Yes, but endeavour to space your wires as far apart as possible, say at least 5 ft., whilst at the same time the spreaders must not be too heavy or the increased sagging may counteract any advantage you may gain by putting up the extra wire. The three-wire aerial will have increased capacity, and consequently when tuning with a variable condenser the adjustments will be less critical, as the proportion of variation in capacity will be less.

"ENGINEER BEGINNER" (London) wishes to receive Dutch concerts and other telephony on a frame, and asks (1) Winding for suitable frame to be used with the two or three-valve set. (2) If the circuit shown on page 554, July 29th issue, would be suitable.

(1) It is difficult to receive PCGG in London with a three-valve set and frame aerial. At least six will be required, the circuit being on the lines of Fig. 2, of the issue referred to. For PCGG the aerial might have sides of 5', with about 10 turns, spaced $\frac{1}{4}$ " apart. More turns might be added if desired for FL and similar stations.

ary should be taken to H.T. plus and L.T. minus. (3) We do not recommend the use of the ordinary pattern telephone jack on the high frequency side of the amplifier. There is, however, a special variety of break-jack on the market which can be adopted without fear of detrimental effects. We do not understand why your reaction coil has to be reversed when altering the number of L.F. volts in circuit, as no change is made in the detector valve plate circuit however many valves are switched in or out. We can quite understand, however, that a reversal may be necessary when switching from one to two H.F. valves, and this is

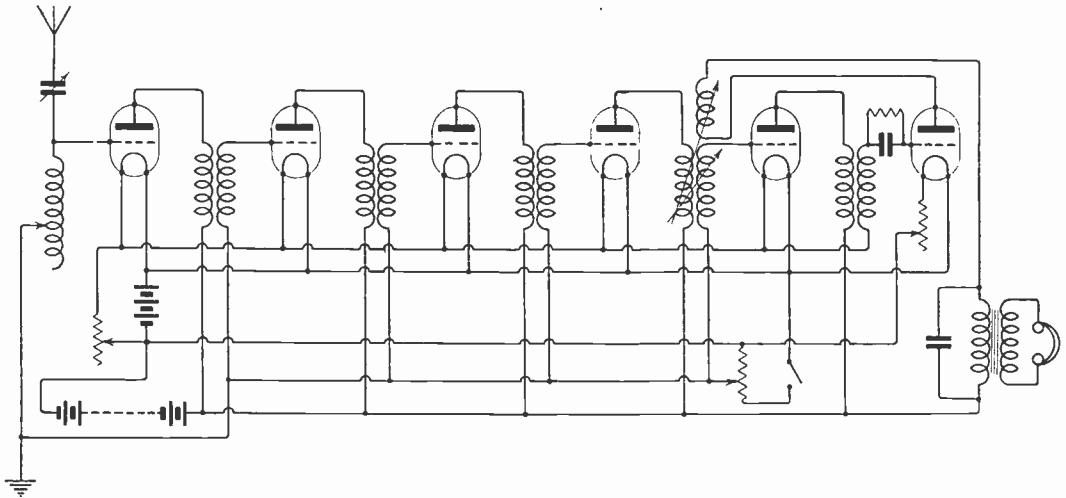

Fig. 2.

"T.K." (Runcorn) has constructed a 5-valve amplifier as shown on page 117 of "Wireless Telegraphy and Telephony," by E. Redpath, and is not obtaining satisfactory results, and asks (1) The directions of windings for the transformers. (2) Suitable windings for H.F. transformers. (3) Suitability of telephone jacks and cords for receiving circuits, and (4) Whether the set is suitable for the reception of telephony with a loud speaker.

(1) H.T. plus is taken to I.P., plate to O.P., grid to I.S., L.T. minus to O.S. (2) You will have to determine the exact windings of the transformers by experiment, but as a guide you must bear in mind that two single layers of 300 turns each on a 2 $\frac{1}{4}$ " ebonite former, insulated from one another by a single layer of empire cloth, will produce a transformer suitable for operations on wavelengths from 500/750 metres. If you adopt the type of transformer of which the windings are placed in a groove, we can, working on this basis, roughly calculate the number of turns required, bearing in mind that the concentration of the turns into a smaller space will increase the value of inductance. When winding in a groove, make both windings in the same direction, taking the leads which come out between the two windings to plate and grid, and the leads that pass from the inside of the primary and the outside of the second-

due to a reversal in the connections of one of the H.F. transformers. You must test your transformers out separately, and obtain identical results from each. When using two stages of H.F. amplification, the two intervalve transformers must be of identical value, otherwise one will filter out wavelength for which the other is arranged to give good amplification. (4) Yes, on a good aerial.

"RADIO" (Norway) asks questions about the Armstrong super-regenerative circuit.

(1) This circuit is not suitable to cover a range of 120/10,000 metres. It is probably intended as a short wave circuit. In any case wavelengths of the oscillating circuits must be several times the wavelengths of the tuning circuits. We do not advise this circuit for reception much above 1,000 metres. (2) Pancakes to tune to 10,000 metres become very unwieldy in size. For this purpose we should recommend small pancakes placed side by side with ebonite spacing washers between them about $\frac{1}{8}$ " thick. We should suggest about 10 pancakes with 80 turns on each, and a mean diameter of 3" as suitable.

"A.G.C." (London) asks (1) To what wavelength a coil 11" x 6" wound with No. 26 will tune a 100 ft. aerial, 6 ft. high. (2) Whether a potentiometer is needed with zincite-bornite crystal.

(1) Approximately 2,500 metres. (2) No.

T.M.C. Wireless

DE LUXE

ALL-BRITISH WIRELESS EXHIBITION AND CONVENTION
HORTICULTURAL HALL, WESTMINSTER, S.W.
SEPTEMBER 30TH TO OCTOBER 7TH, 1922

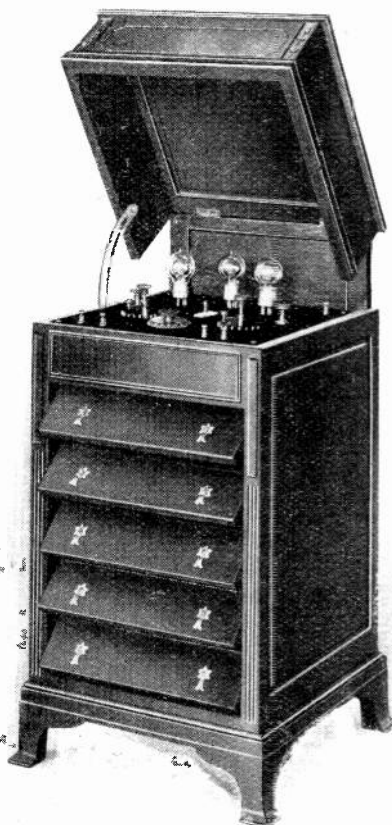

STAND
No. 20

STAND
No. 20

THE TELEPHONE MANUFACTURING CO. LTD
HOLLINGSWORTH WORKS, WEST DULWICH, S.E.21
TELEPHONE : SYDENHAM 2460-1 TELEGRAMS : BUBASTIS DULCROX

ORA

The Valve for perfect reception

For receiving vocal and instrumental items you must have Mullard "ORA" Valves to get the best results.

Oscillates—Rectifies—Amplifies

Specially recommended where good detection and amplification are required.

15/- each



IMPORTANT NOTICE.—The great demand for Mullard ORA valves and other accessories has compelled us to open much larger works.

Mullard Radio Valve Co. Ltd.

45, Nightingale Lane, S.W.12.

Contractors to H.M. Admiralty.
War Office, Royal Air Force & Post Office.

Telephone: Codes: Telegrams:
Hammersmith 312 ABC(Ed) Radio Valve Mullard Lond



Glasgow Depot: 15, Woodside Terrace, Newcastle Depot: 17, Sandhill,

Please send me part free

Quantity	Description and Price
.....	Telephone Head Sets 30/- per set
.....	ORA Valves 15/- each
.....	Grid A Resistances 5/- each
.....	Grid A or B Resistances 5/- each
.....	BA Condensers 0000 mfd. 2/6 each
.....	Combination Resistances and Condensers 7/6 each
.....	Valve Bases with Terminals 5/- each
.....	Valve Sockets 1/8 each
.....	Terminal Clips 9/- per pair

Name and Address
To the MULLARD RADIO VALVE CO., LTD.,
45, Nightingale Lane,
London, S.W.12

Name of usual Wireless Dealer:

I enclose (cheque) Money
Order. P.O. value

to cover the cost.

SEND THIS TO-DAY

"A.F." (Wimbledon Park) asks (1) Whether it is possible to operate a relay for his present set with, say, the addition of one or two note magnifying valves. (2) What type of relay we would recommend him to use, and (3) a suitable circuit.

Yes, this can be done, and depends entirely upon the efficiency of the relay adopted. You should connect in circuit between the secondary of the last low frequency amplifier and the relay a perikon crystal. (2) The relay to which you refer can be thoroughly recommended, or alternatively, you might try the large pattern Siemens type relay, which you can obtain from many dealers in ex-Government apparatus. (3) The whole matter of recording has been dealt with very fully by the Wireless Society of London, and a copy of their discussion on the subject, together with many useful and well-tried circuits, can be obtained on application to the Secretary.

"E.H.B." (Somerset) submits a circuit diagram and asks for criticism.

For the reception of telephony, particularly on short wavelengths, you are recommended to tune your aerial and reaction coils with air dielectric variable condensers. The grid condenser should be bridged with a leak of about 2 megohms; otherwise your circuit is quite correct. As your present coil seems to tune to rather long wavelengths, you might try making up two coils as shown on page 328 of the June 10th issue, connecting one in the aerial circuit and the other in the reaction circuit, and laying them over one another to produce the necessary coupling.

"E.B." (South Croydon) asks (1) Whether capacity reaction is as efficient as magnetic reaction in the circuits usually adopted by amateurs, and (2) Whether the use of a loose coupled aerial circuit is recommended in the construction of receiver on the lines described on page 37, April 8th issue, and whether reaction effects will be obtained, seeing that the grid is giving a positive potential.

(1) Tuned magnetic reaction is to be preferred to the capacity arrangement, as it is easier to manipulate, and produces constant effect on all wavelengths, whilst the efficiency of capacity reaction varies with wavelength and degree of amplification. It is not advised for use with very short wavelengths. (2) In the particular circuit to which you refer, you will find it an advantage to work with three coils—that is, a loose-coupled aerial circuit, closed circuit with tuning condenser, and tuned plate circuit. The positive potential which is applied to the grid of the oscillator and detector valves should be adopted with this circuit, but in the usual reaction circuit it is now becoming common practice to connect the filament resistance in the negative lead, joining the lead which gives the grid its potential, to the negative leg of the filament.

"RUPERT" (Tottenham).—(1) Circuit as shown is quite O.K., except that a parallel condenser is not needed at 1,000 metres. A one-valve set with slab coils will not give satisfactory results on PCGG in London. (2) The only way to appreciably improve this set is to add further valves. (3) The loud speaker suggested will not give much results from a single valve set, except possibly from 2 LO. It should be used with a L.F. amplifier and with an ordinary telephone transformer. (4) There are

many ways of adding a second valve. See Fig. 5, page 437, July 1st issue.

"W.H.G." (London).—The usual method of using a three coil tuner is as shown in, say, Fig. 2, page 705, August 26th issue, although this method is not likely to be allowed very much longer. Particulars regarding types of transformers, etc., will be found in these columns in various recent issues. We regret that we have not sufficient space to collect these here into one reply. You can also find many constructional details in articles on special sets, as, for instance, the four-valve station described in the July 15th and following issues. See also Fig. 3, below.

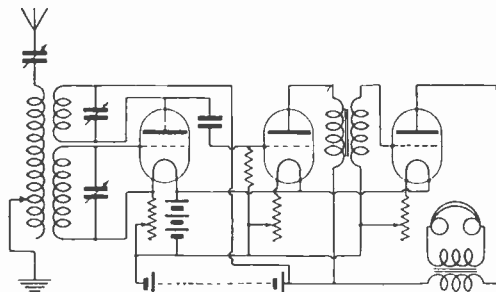

Fig. 3.

"C.B." (Ealing) asks (1) If a circuit will be suitable for reception of telephony. (2) Maximum wavelength to be obtained with a coil $4\frac{1}{2}'' \times 10\frac{1}{2}''$, of No. 24 enamelled wire. (3) If a reaction coil is necessary for the reception of telephony.

(1) Yes, except that parallel A.T.C. is not necessary for short wavelengths, and for such wavelengths grid condenser should be about 0.0003 mfd. (2) Without a parallel A.T.C. this coil would tune to about 2,200 metres. This might perhaps be brought up to 3,500 metres with parallel condenser without serious inefficiency. (3) No, although additional range can be obtained by its use.

"GRANDSIRE" (Ilkley).—For 20,000 metres your coils should have up to 1,200 turns. (2) Yes, but probably not very sensitive.

"ELECTRON" (Whitby Bay) asks (1) If we consider a certain circuit good for telephony. (2) If it will be infringing any patent. (3) If the circuit will pass P.M.G. for licence. (4) What is the best transformer arrangement in the H.F. circuit to cover 300/20,000 metres.

(1) Quite good. We presume, however, the last interval transformer, as well as the telephone transformer, is intended to be iron cored. If so, the primary of the former should have a condenser across it. (2) Yes, particularly in regard to reaction and the grid condenser and leak. (3) Almost certainly not. (4) We should recommend interchangeable plug-in transformers, of which about five would be required with variable condenser across one winding of each.

"J.L.S." (St. Annes) asks (1) *If any improvements can be made in a circuit submitted.* (2) *Reasons for variable results with this set.* (3) *For a better circuit.* (4) *For a diagram showing how to add two valves H.F. to this set.*

(1) The circuit shown is of quite good type. You might add a switch to enable you to connect in series the A.T.C. for short wavelengths. It is unlikely that reaction of this type will be allowed in the future. (2) As you do not give us any clue to the nature of the variations we cannot help you much. Your aerial insulation may be defective, or the earth variable and poor. Carefully built up, your circuit should give as good results as most others given in these columns. (4) Set might become approximately that as shown in Fig. 4, page 706, August 26th issue.

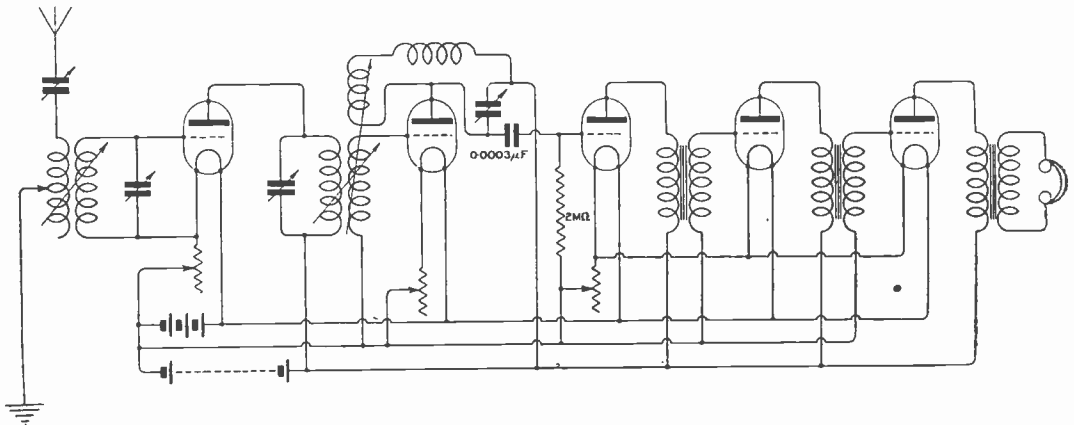

Fig. 4.

"TUNER" (Bembridge) asks (1) *Suitable dimensions for A.T.I. to tune 200/30,000 metres.* (2) *Suitable tappings for this inductance.* (3) *What capacity to use with it.* (4) *Formula for calculating the wavelength of a tuner.*

(1) and (2) About the only satisfactory way to cover such a range is to use a set of interchangeable honeycomb coils as listed by many of our advertisers. (3) 0.0005 mfd. for short wavelengths and up to 0.0015 mfd. for long. (4)

$$\lambda = 1885 \sqrt{\frac{L}{C}}$$

metres mhs. mfd.

"H.S." (Macclesfield) asks (1) *For a loose coupler to tune from 200 to 1,100 meters.* (2) *Which of three arrangements of A.T.I. and A.T.C. is the most efficient.* (3) *Whether a certain set is as efficient as a certain type of instrument.*

(1) 6" x 4" of No. 22, secondary 5" x 3" of No. 26. (2) The arrangement of your Fig. 3 is the best for these wavelengths. (3) The circuit referred to is of the type suggested as an alternative.

"W.T.R." (Cheltenham) asks (1) *Which is to be preferred—one detector followed by two note magnifiers, or one high frequency amplifier, detector and low frequency amplifier.* (2) *Whether a four-wire aerial would give better results than a two-wire as he is limited as to length.* (3) *Whether 25 ft. of earth lead is too much, and* (4) *For the most serviceable*

combination of H.F. and L.F. amplification for embodying in a five-valve set, for use under unfavourable conditions.

(1) If great range is required, it is advisable to make use of at least one high frequency amplifier, for although low frequency amplification gives greater signal strength, it will at times not bring in signals which a high frequency amplifier would render audible, though perhaps of poor strength. A combination of H.F. and L.F. is recommended, and in order to prevent re-radiation, reaction can be arranged between the plate circuit of the second valve and the high frequency intervalve transformer, as shown in the circuit on page 615 of August 12th issue. (2) The two-wire aerial would be satisfactory, but if you can conveniently arrange the four wires without undue sagging due to the wide

and heavy spreaders, it would give you better results. You should, if possible, erect a small mast on the roof top to get the aerial higher than the house. Read the article on "Aerial Construction" on page 259 of May 27th issue. (3) Your earth lead is rather long, and may have detrimental effects when receiving on short wavelengths. If it is possible to well insulate it to the point of earthing, it may be an advantage. (4) For demonstration purposes you will need to use at least three L.F. valves and a receiver; making use of one H.F., one detector and three L.F., should give the results you require, though always endeavour to erect the usual suspended wire aerial for reception instead of a frame.

"C.V.T." (Headcorn) asks for the correct method of operating his receiving set.

As you do not say the exact type of receiver which you have purchased, we regret we cannot give you explicit details for manipulation. There is no book that would give you in brief the exact method for operating the outfit. We would recommend you to obtain a knowledge of the theory of wireless telegraphy by reading "The Elementary Principles of Wireless Telegraphy," by R. D. Bangay, followed by the "Oscillation Valve," by H. E. Penrose (Wireless Press, Ltd.). Why not write to the manufacturers of your apparatus and ask them for the information you require.

*Marconi's Wireless
Telegraph Co., Ltd.*

ARE EXHIBITING AT THE

FIRST ALL-BRITISH
WIRELESS EXHIBITION

AT THE HORTICULTURAL HALL, WESTMINSTER.

FROM SEPT. 30th. TO OCT. 7th.

*They are showing their
latest pattern Marconiphones,
together with apparatus
representative of other
branches of their industry*

**DO NOT FAIL TO VISIT
STAND 24.**

MARCONI'S WIRELESS
TELEGRAPH CO., LTD.
MARCONI HOUSE, STRAND, LONDON.

TOMLINSON

LONDON, LIMITED.

3 FINCHLEY RD., ST. JOHN'S WOOD

HAS LARGE STOCK OF WIRELESS

Goods at Lowest Prices

HAMPSTEAD 1844

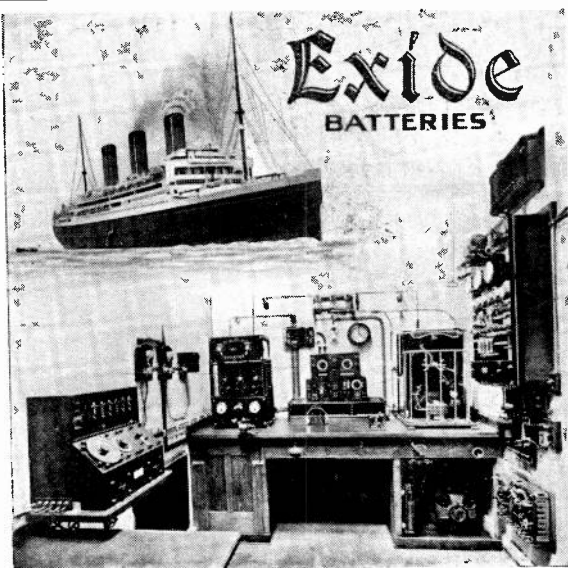

THE LARGEST SHIP IN THE WORLD

— the White Star Liner
"Majestic" — uses Exide
batteries for her wireless
installation.

No finer testimony to the
general reliability of Exides,
and their particular suitability
for wireless work, could be given

Visit our Stand No. 30. All-British
Wireless Exhibition, Horticultural
Hall, September 30 to October 7

THE **Chloride** ELECTRICAL STORAGE
COMPANY LIMITED.

Prices and Particulars on Application

HEAD OFFICE:

Clifton Junction, Nr. Manchester

LONDON SHOWROOMS:

219/229, Shaftesbury Ave., London, W.C.2

"PATIENCE" (Redhill) (1) *Submits a circuit of a three-valve receiver, and asks for criticism.* (2) *Why it is difficult to eliminate carrier wave in telephony, and whether we recommend the enclosing of the high frequency transformer in an iron box.* (3) *Whether his apparatus is liable to re-radiate,* and (4) *Whether we consider it suitable for operating a loud speaker on signals from PCGG, FL, 2 MT, etc.*

(1) Your aerial switching arrangement is not quite correct. You should arrange to connect the aerial tuning condenser in series or parallel with the aerial inductance only, whilst the closed circuit should have its own tuning condenser. The primary of the first low frequency transformer should be bridged with a condenser of capacity of 0.001 mfd. The condenser across the 4,000 ohm telephones is unnecessary. They should merely be connected in series with the primary of the last transformer, and arranged with a switch for disconnecting or short-circuiting when not in use. You will probably find it better to connect your low resistance telephones in series. The detector valve should be one specially selected to give good rectification, such as "Q" or "R.4b." We do not think you will find it necessary to arrange such a variety of tapings on your high tension battery, but on the other hand, the H.T. leads from each valve should be brought along separately to the battery and plugged in to suit the particular requirements of the variety of valve. (2) This depends upon the extent of modulation. Well modulated telephony produces considerably damped signals, and although much easier to receive free from howling noises, the damping, by broadening the band of wavelengths, somewhat decreases the transmitting range. Very critical adjustment of the reaction circuit is essential to eliminate the trouble, which is due more to the design of the apparatus at the transmitter than at the receiver. (3) Yes. To reduce re-radiation you might arrange to couple a reaction coil to the intervalve high frequency transformer, or at least to an inductance placed in series with the secondary. (4) For operating a loud speaker, you should add two note magnifying valves, and even then it is doubtful if you will get satisfactory results, stationed so far away and using such limited power.

"R.C.B." (Glasgow) *submits a circuit and asks for criticism.*

The circuit is quite in order and should give good results, but we would recommend you to tune the primary of the intervalve oscillation transformer with a small variable condenser having a maximum capacity of about 0.0001. The second valve should be arranged as a detector with grid condenser and leak, and be of a type to give good rectification, and you might substitute for the resistance capacity arrangement a low frequency intervalve transformer. This will give you considerably greater signal strength. The reaction coil should be connected in the plate circuit of the second valve. Your circuit exactly as submitted should give satisfactory results, but where amplification is desired, at least one stage low frequency should be made use of. We are unacquainted with the merits of the particular type of valve to which you refer, as you do not state the type number, and there are several varieties of German valve available.

"W.H.S.W." (Cookham) *is constructing the tuner panel described on page 471 of July 15th issue, and asks (1) Whether it is necessary to construct the special high frequency detector set described by the author of that article, or whether he might use it in connection with the panel described on page 455, July 8th. (2) Whether he could add a particular five-valve outfit to this set, and (3) Whether we recommend as an alternative arrangement the set described on page 554, July 29th.*

(1), (2) and (3) For a start we would strongly recommend you to make up the tuning panel for these three coils to the description to which you refer, and use this in conjunction with the single valve panel. This will bring in signals and will indicate to you the lines upon which progress should be made to produce greater amplification. The five-valve set is quite a good outfit, but in actual construction it is somewhat complicated particularly with regard to wiring up the various jacks, and if not very carefully arranged would give rise to a good deal of howling. The complete outfit as described by the author of the tuner can be recommended for general use. When you have got your single valve set working, you might add one note magnifier, and then later one high frequency valve to any design you may prefer, and advice on the construction of the various components will be given as time goes on, under the heading of "Experimental Station Design." If you are desirous of rendering telephony audible from a loud speaker, you will need at least a five-valve set, consisting of three valves as arranged for use in conjunction with the tuning unit, followed by two low frequency magnifiers.

"F. T. S." (Bromley) *points out a slip in a reply to "Radio 3 UC," on page 603, in August 5th issue, in the last line of which a statement appears that—*

$$n = \frac{1,116}{48} = 23.$$

He suggests that this might lead to a serious inconvenience to amateurs possessing little electrical knowledge.

We much regret the error, which is obviously a compositor's slip. This should read—

$$n = \frac{111.6}{48} = 2.3.$$

We think that any amateur would realise the nature of the error at a glance, and not be seriously worried by it. He also asks whether certain windings would be suitable for intervalve transformers. The windings suggested would not be efficient owing to their low impedance. We should much prefer windings of 1 oz. and 3 ozs. of No. 44 DWS. The core suggested would be satisfactory, and if the wires are long enough they may be twisted round outside the windings so as to give an almost closed iron circuit.

"L. P. E." (Sutton) *asks (1) Whether the switching arrangements of a three-valve set are correct to enable any combination of the valves to be used.*

Yes, except that provision should be made for switching off the filament from the first valve when it is not in use. If this precaution is omitted there will be a considerable leakage of potential through the grid and filament of the first valve.

"T.A.J." (Chingford) asks how to connect up a three-coil holder and coils as a single valve set. Coils may be connected up as in Fig. 1, page 465, July 8th issue, in which the middle coil of the diagram is the fixed coil of the tuner. Two variable condensers are necessary, used as shown in the diagram.

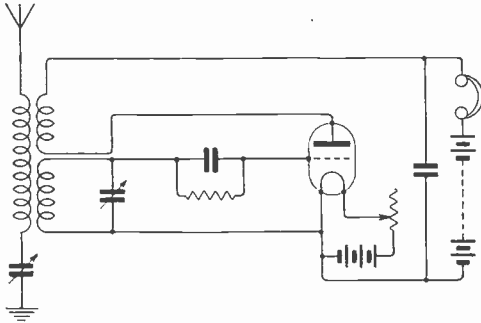

Fig. 5.

"WINDY" (Maida Hill) asks (1) If an aerial for crystal reception erected parallel to, but 6' below his aerial, is likely to give trouble or to be an advantage to both. (2) What H.T. voltage is required for "Ora" valves. (3) The relative merits of "Ora" and "R" type valves.

(1) There is not likely to be any serious trouble with 6' between the aerials, but if the distance had been less, each station would notice a considerable falling off in strength when the other station came into tune with it. (2) About 40 volts. (3) Without discussing the merits of any particular make of valve, a broad distinction between the two types indicated is that the cylindrical type is electrically somewhat more efficient, and the bulb type mechanically a much sounder proposition.

"AUDIBILITY" (Thornton Heath) asks questions about the Armstrong super-regenerative circuit.

(1) The tuning coils should be arranged in the normal way, and not as in the Reinartz tuner. (2) and (3) Gauges of wire, capacities, etc., are fairly optional, subject to the fact that the tuning circuits should be suitable for the short wavelengths to be received, and the oscillating circuits for 5,000/10,000 metres. (4) These valves may be used.

"J.A.F." (Tor-Point) asks (1) The effect on sets which he is likely to hear by moving a crystal set from Plymouth to a point a little south of Ayr. (2) If it is better to separate the crystals, or wire and crystal, when shutting down for the night.

(1) FL instead of loud will probably be very weak, and the number of ships you will hear will probably be considerably reduced. (2) This is not as a rule necessary. The fact that a point which appears sensitive overnight is found insensitive in the morning does not necessarily indicate that the crystals have been injured in any way.

"AMPLIFIER" (Arundel) refers to the L.F. amplifier on page 457, of July 8th issue, and asks (1) Where to connect four terminals shown to. (2) The object of the 18-volt, 6-volt and 4.5 volt batteries. (3) If the radio-frequency chokes are suitable for all wavelengths. (4) Why the centre of the secondary in the telephone transformer is earthed.

(1) We regret that we have no further information as to the exact circuit this amplifier was intended to be used with. (2) The 6-volt battery is for filament lighting for all valves. The 18-volt battery is probably intended for the grid potential of the first valve. The 4.5 volt battery applies negative potential to the grids of the last three valves for the purpose of decreasing distortion. (3) The radio-frequency chokes would only be effective on short wavelengths, but would probably be unnecessary at long. We consider these chokes to be rather an ultra-refinement. (4) This is a common device to prevent howling, and to give increased stability of working.

"L.B.C." (Harrogate) sends a diagram of a tuner and asks (1) Best value of condensers. (2) If certain Vernier condensers will be an advantage. (3) Values for Vernier condensers. (4) Any suggestions for improvements.

(1) 1, 0.001 mfd. 2, 0.0005 mfd. 3, 0.0005 mfd., but not really necessary. (2) Yes. (3) 0.00005 to 0.0001 mfd. (4) You might split the aerial inductance into two coils, using only one, the smaller of the two, for coupling to the closed circuit.

"CRYSTOPHONE" (Wolverhampton).—

(1) The circuit shown is quite correct, as are the values of the condensers employed, except that it is useless to put a reaction coil in the anode circuit of a L.F. valve—it should be in the anode circuit of the detector. (2) There are various ways of adding another valve, most of which you will be able to get from examination of circuits recently given. (3) It is most unlikely that PCGG will be heard plainly by you on a two-valve set. It is doubtful whether you will get very satisfactory results with four. (4) Coils suggested might be wound with No. 26 wire. The reaction directly on to the aerial in the way suggested is almost certain to be prohibited in the future.

SHARE MARKET REPORT.

Prices as we go to press on September 29th are:—

Marconi Ordinary	£2	6	0
.. Preference	2	1	3
.. Inter. Marine	1	7	1½
.. Canadian	10	0	

Radio Corporation of America:—

Ordinary	19	4½
Preference	13	6

EXPERIENCE



The Cabinet Set de Luxe

This is a complete and self-contained cabinet model. No aerial or earth leads are required, or external wires of any description. It is as completely portable as any ordinary piece of furniture. A powerful loud speaker of one of the best standard makes, particularly clear tone, is incorporated in the design, while high and low tension batteries are accommodated in a special compartment.

VALVE SYSTEM. Seven valves are employed. The first three are connected to specially designed high-frequency intervalve transformers, fitted with tapping points on the windings and controlled by a coupled switch for simultaneous operation. The fourth valve acts as a detector. The last three valves are coupled through audio-frequency transformers which are free from distortion.

SIMPLICITY IN OPERATION. A most important feature is the utmost simplicity in operation which has been achieved. To receive the broadcast programme it is only necessary to open the lid of the instrument, switch on the valves and swing the frame aerial into the best position. Neither special knowledge nor technical skill are required.

COMPLETELY SELF-CONTAINED. This model will operate equally well in any room of the house, out on the lawn or wherever the broadcasting concert is required. For use in flats, hotels, apartments and other places where the erection of an outdoor aerial is impossible, this self-contained model will be particularly welcomed.

HIGH GRADE CABINET. The cabinet itself is a really fine piece of workmanship. It can be supplied in any period or other design required.

CONSTRUCTIONAL DETAILS. The highest quality fittings and apparatus are exclusively employed. They are of our own manufacture and design and fully guaranteed.

This model represents both in design and detailed construction the finest wireless receiving set now available. Already it is receiving very interested and favourable comment and will undoubtedly go far to enhance the reputation of British radio engineers the world over.

During the All-British Wireless Exhibition three models will be displayed on our stand No. 37, and we invite you to inspect them.

PRICES AND OTHER PARTICULARS ON APPLICATION.

OTHER R.I. PRODUCTS:—CRYSTAL SETS, VALVE SETS, LOUD SPEAKERS, PRECISION AIR CONDENSERS, HIGH RESISTANCE TELEPHONES, FIXED CONDENSERS, SERIES PARALLEL SWITCHES, ETC., ETC.

RADIO INSTRUMENTS, LTD.,

Managing Director: J. Joseph, M.I.E.E., late Manager to Mr. H. W. Sullivan.
Chief Designer: W. A. Appleton, M.B.E., M.I.R.E., late Admiralty Technical Research Officer.

ONLY ADDRESS. Works, Offices, Showrooms: 12a, Hyde St., NEW OXFORD ST., W.C.1
Telephone: Regent 1908. 'Grams: "Instradio, London."

We have the largest wireless works in Central London.
We are wireless engineers of established reputation.

Our name on wireless apparatus is a guarantee of satisfaction.

Visit our Stand No. 37. All-British Wireless Exhibition, Horticultural Hall, September 30th to October 7th.

1912—1922

TEN years ago we started to manufacture and sell wireless apparatus, and though our activities were diverted into other spheres during the War, we are still the leading provincial wireless supply house.

To-day we describe some of the instruments we manufacture, and ask you not to forget to give us a call at **STAND 42**.

All our apparatus conforms to the Postmaster-General's Regulations, and is licensed for amateur use in Great Britain under Marconi's Wireless Telegraph Co's patents. You are therefore perfectly safe in purchasing our apparatus.

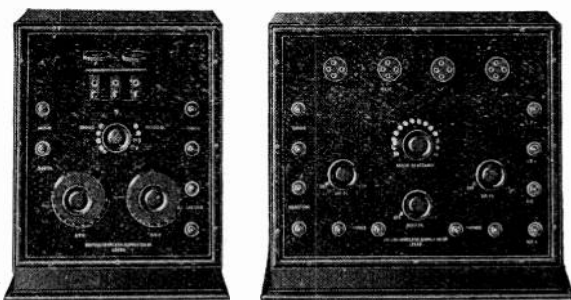

BRITWIRE Mk. III Receiver (three valve), for use on all wave-lengths. Will receive telephony or telegraphy on all waves from 100 to 20,000 metres without loss of efficiency.

BRITWIRE Mk. I Tuner. Three circuit, with series parallel switch, aerial cannot radiate.

Price—Receiver .. **£12 10 0**
 ,, Tuner .. **7 0 0**

BRITWIRE Mk. IV Receiver (four valve), with two note magnifying valves. By using this receiver telephony can be made audible over a large hall.

Price **£16 10 0**



BRITWIRE Single Valve Note Magnifier. By using this on your crystal or valve set an astonishing increase in signal strength is obtained

Price **£3 0 0**

BRITWIRE Two Valve Note Magnifier. Price .. **£5 5 0**

BRITWIRE Three Valve Note Magnifier. Price .. **£7 10 0**



All the above valve apparatus licensed under Marconi patents for amateur use in Great Britain.

BRITISH WIRELESS SUPPLY CO., LTD.

6, BLENHEIM TERRACE, LEEDS.

Tel : 26926.

18, ELDON SQUARE NEWCASTLE-ON-TYNE.

Tel : 380 CITY.

33, HIGH STREET, SOUTHAMPTON.

Tel : 403.

11, CHURCH STREET, WEST HARTLEPOOL.

Tel : 373.

WORKS : LEEDS.

Visit our Stand No. **42**. All-British Wireless Exhibition, Horticultural Hall, Sept. 30th to Oct. 7th.

ZINCITE EX STOCK

Lumps - - - - - **72/- lb**
 Cut (any size, no dust) from **99/- lb**

A. HINDERLICH,
 Central Hall, Southall.

OUR SPECIAL LINE

Only
 1/6 doz.
 Postage extra



Complete
 Illustrated lists
 Two Stamps

ELECTRICAL SUPPLY STORES
 5, ALBERT TERRACE, KING CROSS, HALIFAX

WIRELESS

Crystal Sets	from	£3
Phones, 4,000w. (Double headgear)		27/-
Valve Holders	1/- and	1/6
Switch Arms, laminated brush, laquered		2/-
Grid Condensers (ebonite with terminals)		2/3
Aluminium Pulleys for Aerials		1/-
Contact Studs	per doz.	1/-
Terminals	from 2/- per	doz.
Filament Resistances, for under panel mounting		3/6
Nickel-plated Ericsson Microphones		5/-
Microphones, with replaceable insets		2/6
Variable Condenser in Cabinet (21 plates)		18/6
Intervalve Transformers (wound with silk wire, ratio 5:1)		21/-
Condenser Plates (aluminium)	per doz. pairs	2/-
Reel Insulators, 1 1/2" diameter		3d.
Mk. III Crystals in Cups, Zincite and Bornite	each	6d.
Ebonite Knobs, and knobs with 2 b.a. bush	each	6d.
H.T. Batteries, 15v.		3/-
H.T. Battery Boxes, 10" x 5" x 8" with Switch and Fuses		6/6
Mahogany Instrument Cases, 13" x 8" x 6", with carrying, lock and key		8/6
Wilson Transmitters, complete with interrupter, as new	£6 10s.	
Ex-Government Telephones, 1,500 w. (double headgear)		10/6
Ivorine Scale 0°-180°		9d.
Egg Insulators		6d.
One only, Weston relay		£2
Sliders and Rod		1/4

ALL GOODS GUARANTEED.

Carriage paid on orders of £1 and over.

C. S. SWAN,
191, Bishopsgate

Phone, Bishopsgate 1155. (next to Brandons, Tailors)

Everything for Wireless

Visit us here at our Showrooms and Listen-in
 on the

Multum-in-Parvo Crystal Sets

with all equipment including 4000 ohm Phones in
 Attache Case and Mahogany Cabinets, also Colonial
 Models, at **£5 15s. 0d.** complete.

(All Registered Designs.)

Send for our List of Spare Parts, Phones, Loud Speakers and Valve Sets

Consolidated Trading & Mfg. Co., Ltd.

Phone : Southend 817

Associated with

Chancery 7054

J. Bridge & Sons

Works :
 Nelson Street, Southend-on-Sea

Office and Showrooms :
 Cromwell House, Fulwell Place, Holborn
 (Next to Chancery Lane Tube Station)

The "Broadway" Radio Works,
Devonshire Road, Bexleyheath, Kent.

WE HAVE A LARGE STOCK OF
FILAMENT RESISTANCES
GUARANTEED.

Fitted with Pointer and Knob, 4/- each, postage 4d.
Fitted with Bevelled Ebonite Dial and Knob, 5/9, postage 5d.

CONDENSERS
ALL TYPES AND VALUES.
EVERY ARTICLE GUARANTEED.
FINEST WORKMANSHIP
AND FINISH.
BRASS WORK
POLISHED AND LACQUERED.

Value in M.F.	Panel Mounting in Parts	Panel Mounting Assembled	Cabinet Mounting in Parts	Cabinet Mounting Assembled	Cabinet Mounting Assembled in Cabinet	Polished Mahogany Cabinet
·0015 ..	23/-	25/6	24/-	26/6	33/-	6/3
·001 ..	16/9	19/6	17/9	21/-	26/-	5/6
·00075 ..	13/6	16/3	14/6	16/6	22/-	5/6
·0005 ..	10/6	13/-	11/9	13/9	18/-	4/6
·0004 ..	10/-	12/6	11/-	13/3	17/6	4/6
·0003 ..	9/-	11/6	10/-	12/-	16/-	4/-
·0002 ..	7/-	9/-	8/-	9/6	13/6	4/-
·0001 ..	6/-	8/-	7/-	8/6	12/6	4/-
Vernier..	—	4/6	—	5/-	9/-	3/6

Fitted with Bevelled Ebonite Dial 1/9 extra.
Special Sizes Made to Order. Price list on request.
ALL SUNDRIES AND COMPONENTS IN STOCK.
ORDERS OVER 20/- CARRIAGE PAID.

J. B. BOWER & CO., LTD

Manufacturing Electricians and Wireless Experts

15, Kingston Road, Wimbledon, S.W.19

TELEPHONE : Wimbledon 1030

WORKS : Merton

We are offering while the stock lasts—5,000 Complete Wireless Sets made in our own works, each set consisting of—

COMPLETE CRYSTAL RECEIVING SET

with a wavelength of 2,700 metres maximum, and 300 metres minimum.

1 Pair of 4,000 ohms Headphones

1 Hank 7/22 Aerial Wire (100ft.)

2 Reel Insulators

The whole Set for the sum of **£3 15s. 0d.**
Cash with order. Packed and despatched carriage paid.

This is the cheapest and most efficient Receiving Set on the market, and is guaranteed by us. You have no further expense. Just erect your aerial, and you are ready to listen-in.

Send for our complete Illustrated List of Wireless Parts

We are exhibiting at the All-British Wireless Exhibition, at the Horticultural Hall. Come and see us.

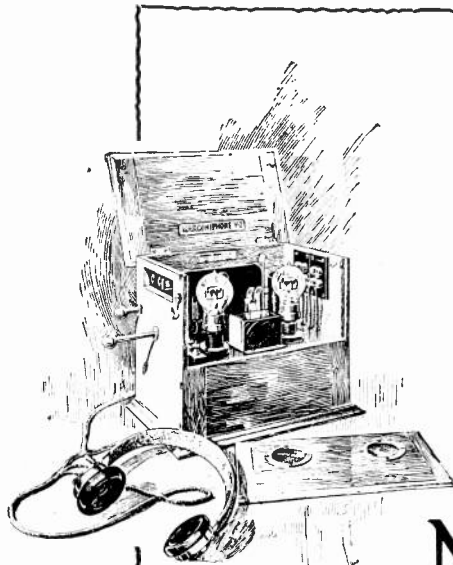

*The Marconiophone
V2 Model.*

COMPLETE sets of Wireless Apparatus in stock ready for immediate delivery; also Amplifiers, Tuners, Loud Speakers and all components.

WE place our experience at your disposal—send us your enquiries, or call—we will gladly give you expert advice.

NEGRETTI & ZAMBRA
RADIO DEPT.,
38, HOLBORN VIADUCT, E.C.1
LONDON

VALVE AMPLIFIERS FOR CRYSTAL SETS

If you have a good crystal set, the most efficient and economical method of increasing your range is to build an H.F. amplifier from our set of parts.

A set constructed on these lines receives telephony up to 100 miles, and Morse from medium power coastal stations up to 300 or 400 miles. It is quite equal to many two-valve sets.

Everything necessary is supplied, including panel drilled and engraved, polished walnut cabinet, variable condenser, etc., etc. Nothing to make, and only requires assembling. Complete instructions and diagrams are included. Valve and Batteries extra.

Price **45/-** carr. paid.

Call or write for full particulars and free list "W."

The OMNIPHONE WIRELESS Co.,
24 Warwick St., Regent St., London, W.1

20 yards from Regent St., between Maison Lewis and Robinson & Cleavers. Phone: Regent 3335.

JUST PUBLISHED! SIMPLIFIED WIRELESS

By JOHN SCOTT-TAGGART, F.Inst.P.

Author of

"Wireless for All," "Wireless Valves Simply Explained," etc., etc.

An entirely new book for the beginner.

IT TELLS YOU

- (1) All about elementary electricity.
- (2) What the different parts of wireless circuits are for.
- (3) How to erect your aerial.
- (4) How to make inductances, variable condensers, fixed condensers, crystal detectors, etc.
- (5) How to make several types of complete receivers out of the simplest materials.

WHY NOT MAKE YOUR OWN SET? THIS BOOK TELLS YOU HOW!

PRICE **1/-**, postage 1½d.

GET YOUR COPY TO-DAY.

From all Booksellers, or by return post from:—

Radio Press Limited,

Devereux Buildings, Devereux Court, Strand, W.C.2 (Opposite the Law Courts).

Our Stand at the Exhibition is No. 27. Pay us a Visit!

HIGH FREQUENCY COUPLING

Use **HONEYCOMB** Duolateral **COILS** for **LOOSE COUPLING** with **HIGH FREQUENCY AMPLIFICATION** as the simplest alternative to Direct Coupled Reaction, which is prohibited by the **POSTMASTER-GENERAL**. But be sure they are genuine **IGRANIC** Manufacture (De Forest Patent).



HONEYCOMB COIL.
(De Forest Patent.)

TRADE ONLY SUPPLIED.

COILS RHEOSTATS TRANSFORMERS

SEE OUR STAND No. 4
All - British Wireless Exhibition
Coils being wound on Patent Leeson Winding Machines. The most interesting Stand at the Exhibition

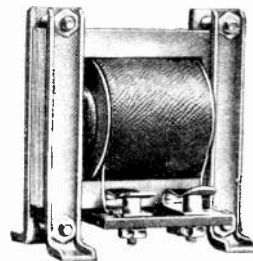

INTERVALVE TRANSFORMER

GLASGOW - - 50, Wellington St.
MANCHESTER 30, Cross Street.
BRADFORD - - 8, Woodview Terr.
Manningham.

149, QUEEN VICTORIA ST., LONDON



BIRMINGHAM - 73/74, Exchange Buildings.
CARDIFF - - - Western Mail Chambers.
NEWCASTLE - 90, Pilgrim Street,
WORKS - - BEDFORD

MORGAN & TAYLORS RADIO ELECTRIC LTD.

Telephone No. 1239

The Pioneers of "Wireless" in South Wales

We can give prompt deliveries of the following—

LOW RESISTANCE PHONES, new and fully guaranteed ..	25/-
Crystal Detectors	6/6
Switch Arms	2/6
Contact Studs doz.	1/6
Coil Stands (3 plug)	21/-
Condenser Dials	3/9
Filament Rheostats	3/9
L.F. Transformers	20/-
Variable Condensers, .001 ..	37/6
" " .001 for panel mounts	24/-
" " .0005 " "	18/-
" " .0003 " "	16/-
" " .0002 " "	15/6

Postage extra.

Crystal Sets, Ebonite Sheet, Ebonite Rod, Brass Rod and all other Wireless accessories in stock. Send for Catalogue

10a, SNEYD STREET, CATHEDRAL ROAD, CARDIFF
Sole agents for S. Wales & Mon. for G. Z. AUCKLAND & SONS
TRADE TERMS ON APPLICATION

" BINGLECT "

Radio

We have purchased large quantities of these Strainers in various sizes ranging from 3" to 7" overall length when closed.

No other strainer manufactured can compare for strength and length of extension.

Price 1/9 each

POST FREE.

The trade are invited to write for special terms.



THE BINGLEY ELECTRICAL CO.

PARK RD., BINGLEY

Telephone 249.

THE " BROADCASTER "

is a Complete Amplifying Unit, combined with extra Sound Magnifier, £4 17 6

BUILT on the latest scientific principles, the "Broadcaster" is designed to give the greatest amount of amplification, and is specially adapted for receiving Broadcasting, while the price is well within the reach of the modest purse.

The "Broadcaster" is fitted with terminals from which it can be instantly connected with any receiving set on the market, either Valve or Crystal.

A receiving set *without* the "Broadcaster" is, comparatively speaking, only a twentieth of what the same set is *with* the "Broadcaster."

The "Broadcaster" must not be confused with so-called Loud Speakers; the extra Amplifying Unit which it contains supplies the initial extra power required for the loud speaking device.

Owing to the unprecedented demand for the "Broadcaster" the public are advised to order immediately, either from their local dealer, or direct from the Manufacturers. Orders will be dealt with in strict rotation.

PRICE: less Valve (only until a certain quantity which the manufacturers have decided upon have been disposed of) **£4 17 6**

Thenceforth the full price £6 10 0 will be fixed. With all orders received before November 20th, one R.Type Valve will be included free with each "Broadcaster."

The "Broadcaster" is protected by patent, and any infringement will be dealt with summarily.

MANUFACTURERS:

British Wireless Co.

Incorporating

Midland Radiophone Co.

Hearsall Works, Coventry.

SUPPLIED BY THE LEADING WIRELESS DEPÔTS.

DRY BATTERIES

for WIRELESS SETS

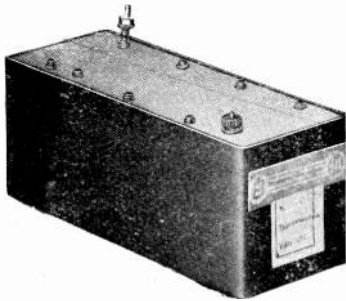

No. 4 W.

No. 4 W. Rectangular. 36 volts, 1 screw terminal and 8 plug holes with wander plug. Size 6 3/4" x 2 1/2" x 2 1/2"

PRICE - - 7/- EACH
(Carriage Paid)

All BRITISH MADE and Prices quoted are for Carriage Paid.

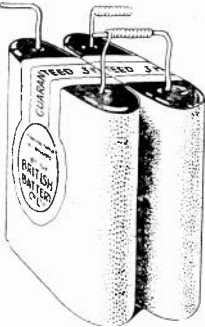

No. 1 W.

Connect as Illustration. (Patent applied for).

No. 1 W. Standard Pocket-lamp size, 4 1/2 volts (as illustration), with patent spiral wire terminals for connecting in series.

Insert straight terminal in spiral of next battery and bend same, no soldering required.

PRICE 7/- Per doz. (Carriage Paid)

NOTE.—(1 doz. = 54 volts).

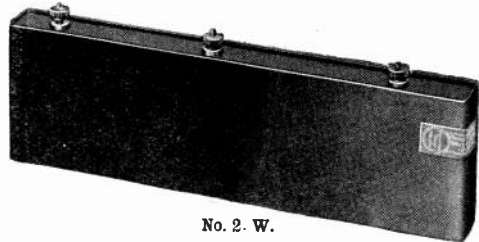

No. 2 W.

No. 2 W. SLAB. 15 volts (11 cells), 3 screw terminals, size 9" x 1 1/2" x 2 1/4" high.

PRICE - - 3/- EACH
(Carriage Paid)

No. 3 W. Rectangular. 15 volts, 2 screw terminals.

Size 3 1/2" x 2 1/8" x 2 3/8" high

PRICE - - 3/- EACH
(Carriage Paid)

Manufactured by **THE BRITISH BATTERY Co., Ltd.**
(Telephone : Watford 617) Clarendon Road, WATFORD, HERTS.

You cannot get Results ?

USE

M.C.C. CONDENSERS

and your troubles will be over.

Capacity.	Panel Mounting.	Fitted in Mahogany Box with Ebonite Scale.	Fitted with Micrometer Attachment.
.0025	27/6	37/6	52/6
.001	15/-	21/-	36/-
.0005	10/6	16/6	31/6
.0003	9/6	15/6	30/6
.00015	8/6	14/6	29/6
.00008	7/6	13/6	28/6
.00005	5/6	11/6	26/6

Blocking Condensers, all capacities	2/6
Switch Arms	2/6
Set of .001 Spindles, with nuts	1/6
Set of .0005 Spindles, with nuts	1/3
Large Spacers	doz. 5d.
Small Spacers	doz. 3 1/2d.
Vanes	doz. pair 1/9
Knob, drilled and tapped, 2B.A.	6d.

HART'S ACCUMULATORS

4-Volt 80 amps	35/-
6 Volt 60 amps	40/-

Mahogany Cabinets made to your own specification. Special terms for all above parts to trade.

Amateurs supplied with all parts at—

M.C.C. Wireless Components,
1a, Grandsen Avenue, Hackney, London, E.8

TO THE TRADE

Good range of accurate Fixed Condensers ready to assemble or complete. Best graded Ruby Mica and Ebonite

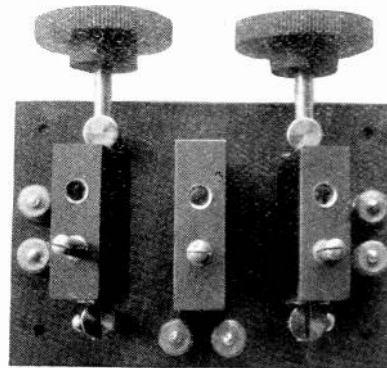
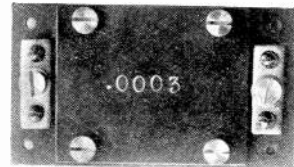

Tuning Stands of best Ebonite. Lacquered Brass Fittings. Instrument finish. No flexible leads to work loose, fray out or short circuit.

Value in Accuracy, Finish, and Price.

J. E. DAWSON, Manufacturing Electrician
20, West Street, Boston, Lincs.

THE ZODEL COIL WINDER

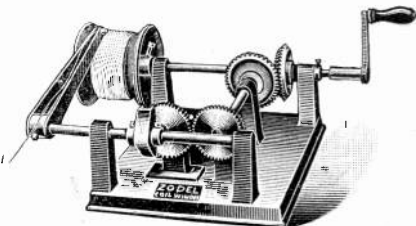

FOR DUO-LATERAL FORM COILS.

Why pay high prices for coils when you can produce the best Duo-Lateral formation type for the mere cost of the Wire?

The Zodel Machine is designed on scientific lines. Built by engineers. So simple that a child can use it. Winds Duo-Lateral Coils in a couple of minutes on any former, from 3/16" to 1" wide. The Coils produced have been proved to have the lowest distributed capacity.

CASH PRICE **£2 : 0 : 0** POST PAID

Obtainable from all Wireless Stores or direct from—

WALLACE HEATON, Ltd., RADIO EXPERTS
84, HIGH STREET, SHEFFIELD.

SEA, LAND and AIR

THE AUSTRALIAN
MONTHLY JOURNAL
of Aviation, Radio-Tele-
graphy & Radio-Telephony

Price
1/9
Post Free

Annual
Subscription
21/-

THE WIRELESS PRESS LIMITED
12/13, Henrietta St., London, W.C.2

THE MARK OF



RELIABILITY

1 to 12 volts.

1 to 35 amps.

VOLT & AMMETER

Combined Dead Beat Pocket Type. New and not German.
Splendid Instrument in Nickel Plated Case.
Ideal for Testing Cells and Filament Current.

POST PAID **5/6** NUMBER LIMITED

OTHER EXCEPTIONAL VALUES.

Aerial Wire. Enamelled Hard Drawn, 7/22's Copper, 5/- per 100'.
Aerial Wire. Bright Hard Drawn, 7/22's Copper, 4/- per 100'.
Aerial Insulators. Shell type, 2" x 2 1/4", green, 1/2 each.
Aerial Insulators. Reel type, 2" diameter, brown, 3d. each.
Filament Resistances. For panel mounting, 2/6 each.
H.F. Transformers, plug in type, 300 and 700 metres, 4/- each.
H.F. Transformers, plug in type, 1,000 m. 4/6; 2,600 m. 5/6 each.
H.F. Transformers. Formers only, with pins, 3/- each.
Tangent H.F. Transformers. All ranges, 6/8 each.
Switch Arms. Complete fitted with knob, 1/- and 2/6 each.
Dewar Switches. D.P. Change over, panel type, 2/- each.
Lightning Arresters. Carbon block type, 1/6 each.
Valve Holders. Flanged "A" type, 1/- Ebonite with 8 nuts, 1/5 each.
Ebonite Panel, fitted with 3 Valve Holders, complete, 4/-.
Ebonite Panel, fitted with 2 Valve Holders, complete, 2/3.
Valve Sockets, per set of 4 with 8 nuts, 7d.
Transformer Holder. With 4 terminals and wired, 3/6 each.
High Note Buzzer (Army Type), worth treble, 2/6 each.
Telephone Transformers (Army Type), 9/- each.
Wireless Jacks, with plug, as illus., page 733, 1/- the pair.
Brown's Type "A" Headphones. Guaranteed new and unused. 8,000 ohms, 49/6; 120 ohms, 42/6. With cords, 51/6 and 44/6.
Ever Ready Batteries (all sizes), 16 Volt, 3/6 each.
Mica. Clear Ruby, .002" thick, 3" x 2", 1/- doz. pieces.
Inductance Slider Rod, 1/2" square, 13" long, drilled, 6d. each.
Slider, complete with plunger for 1/2" rod, 6d. each.
Contact Studs. Fitted with nut and washer, 1/3 doz.
Condenser Vanes. Best Aluminium, 3 1/2", 1/6 doz. pairs.
Condenser Spacing Washers. Small, 3d., large 6d. doz.
Condenser Screwed Rod, Brass 22" long, 1/2" 4d., 3/16" 6d.
Insulating Tubing. Assorted colours, 6d. per yard.
Sheet Ebonite, 1" to 3/4" thick, 4/6 per lb.
Terminals. Mark 3 N. Plated, 4B.A., 2/6 doz.
Terminals. Small pattern, 9d. doz.
Dubilier Condensers. All capacities at prices advertised.
Grid Leaks. All resistances, 2- and 5- each.
Vernier Condenser. Panel type .00005, 5-
Radio Instrument L.F. Transformers, 25/- each.
Tangent L.F. Transformers, 22/6 each.
Ivory Scales. 0-180, good quality, 8d. each.
Ivory Tablets. Set of seven, 1/-
Skinderviken Microphone Buttons, 5/- each.
Burnded and De Forest Coils in stock. Advertised prices.
Potentiometer 300 ohms. Panel type on ebonite, 4/6 each.
Condenser, 5-Plate. Panel type on ebonite, 5/6 each.
Complete Illustrated Catalogue, post free 4d., allowed for off first order. Orders under 5/6 add 6d. for postage.

J. H. TAYLOR & CO.,
ELECTRICAL AND RADIO ENGINEERS,
Maoulay St., HUDDERSFIELD.
Telephone, 341. Telegrams: "Thorough, Huddersfield."

Radcom Rheostats

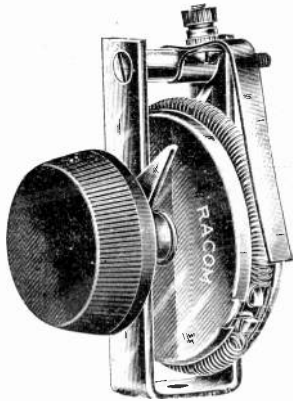

*Control
Protect
Improve*

FEATURES :

Panel Mounting
 $\frac{1}{8}$ " to $\frac{1}{2}$ "

Positive Stops at
zero and full resist-
ance

Single Turn
Control

Smooth and Quiet
Guaranteed

PLAIN TYPE

PLAIN TYPE for Amplifying Valves - 5/-

VERNIER TYPE for Detector Valves - 7/6

Radio COMPONENTS LTD.

12/13, HENRIETTA ST., LONDON, W.C.2

Telephone :
GERRARD 792.

Telegrams :
RADPONENT, RAND, LONDON

(E.P.S. 2)

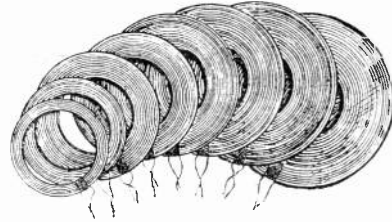

"OOJAH" Slab Inductances (set of 8), 300-30,000
metres 10 - Postage 9d.

"OOJAH" Curves (set of 8 each, 7" x 6", and
circuits) 1 6 Postage 2d.

"OOJAH" Basket Inductances (set of 7), 300-5,000
metres 7,- Postage 6d.

Trade and Factors' enquiries Invited.

NOTICE.

"OOJAH" Slabs are the inductances which have gained so much favour in the past with the Wireless Experimenter. Many imitations are now appearing upon the market, and to ensure procuring the genuine article, not only specify "OOJAH" brand in your orders but see that the packet is secured with the "OOJAH" Seal, bearing the Registered Trade Mark.



ALL "OOJAH" INDUCTANCES ARE ENCLOSED IN A TRANSPARENT COVERING AS THEY BEAR INSPECTION

GREENSLADE & BROWN

LANSDOWNE ROAD, CLAPHAM, S.W. 9.

Telephones { Brixton 639.
 { Brixton 3251.

AGENTS WANTED

**STAND
10**

HORTICULTURAL HALL,
Sept. 30th—Oct. 17th.

Sole Agencies for the Radio Productions
of FELLOWS MAGNETO Co., LTD.

Agencies will be granted to one
firm in each of the principal towns.

Address applications to :

WIRELESS MANAGER,
FELLOWS MAGNETO Co., LTD
CUMBERLAND AVENUE, PARK ROYAL, N.W.10

*Phones : WILLESDEN 1560, 1561.

*Grams : "QUIRMAG, PHONE, LONDON."

(E.P.S.) 4

Western Electric

MAKERS OF OVER
HALF THE WORLD'S TELEPHONES

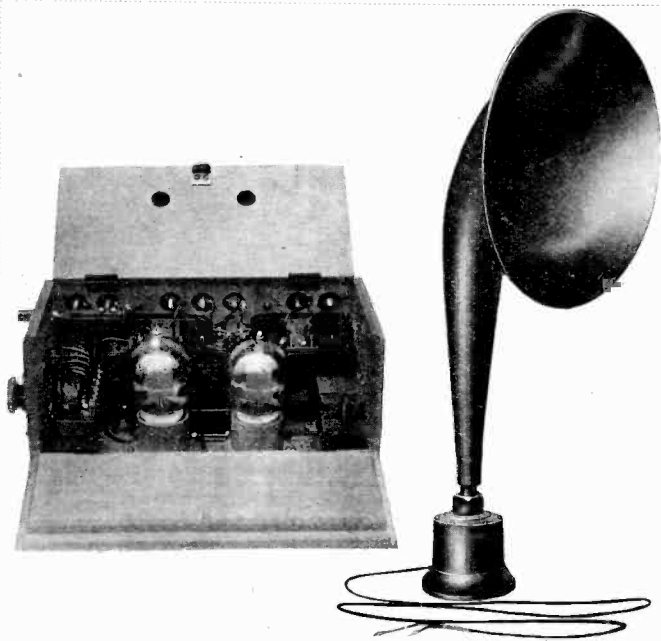

Western Electric
LOUD SPEAKING EQUIPMENT

The Western Electric Loud Speaking Equipment is used in conjunction with any good type of Valve Detector Set for amplifying radio telephony speech or music, and consists of a Loud Speaking Amplifier and a Loud Speaking Receiver.

A great deal of engineering development work has been carried on in connection with this Equipment, and it is accepted that there is no apparatus in existence to-day which approaches it in efficiency and general reliability. Both Amplifier and Loud Speaking Receiver are so designed as to provide clear and true reproduction over the entire musical range, that is, the Equipment will receive clearly the low notes of a pipe organ and the high notes of a Violin or Soprano. The Amplifier is specially designed and is contained complete in a polished mahogany case, together with a five-step Switch. For the adjustment of the Volume of sound Ventilation Discs and a Window for inspecting the filament without opening the case are provided.

The Valves used in this Amplifier are special Western Electric type Valves, and the Transformers are also designed expressly to reduce noise to the utmost and to eliminate distortion.

Western Electric Company Limited.

62, Finsbury Pavement, E.C.2

Works : North Woolwich, E.16

Branches: Birmingham, Leeds, Cardiff, Newcastle, Manchester, Glasgow.

Visit our Stand No. 39. All-British Wireless Exhibition, Horticultural Hall, Sept. 30th to Oct. 7th.



Build your own Valve Set

THIS Booklet shows you how, with P.S. standardised Radio parts, you can easily build a highly efficient Set with a screw-driver and a pair of pliers—and without previous electrical knowledge.

It explains how the P.S. Unit System permits you to add further Valves at any time at minimum cost.

Thousands of home constructed Peto Scott Sets are already giving splendid results all over the country.

6d.

Post free

Our big 32 page illustrated catalogue sent free with every Booklet.

Don't miss our Stand No. 16 at the Wireless Exhibition.

SEND TO-DAY

Showrooms and Offices :
FEATHERSTONE HOUSE,
64, HIGH HOLBORN, W.C.1.

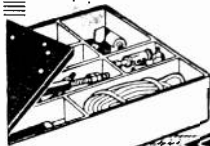

M.A.S. 3

ACCUMULATORS

Highest Quality. Lowest Prices.
ABSOLUTELY GUARANTEED.

IN CELLULOID CASES

4v. 40 amps.	each 18/6	6v. 40 amps.	each 26/3
4v. 100 amps.	" 30/-	6v. 100 amps.	" 41/6
All Sizes in Stock. Packing Free.			

Special Prices to the Trade.

AN ASTOUNDING OFFER, QUITE GENUINE.

400 only, 4v. 60 amp., in Celluloid Cases.

AT 17/6 EACH.

These will not be sold before September 28th. This price cannot be repeated when the 400 are sold. And they are subject to Trade Discount.

SPECIAL LINE.

WIRELESS HEADPHONES. 4,000 Ohms. Double Head-band, each Receiver detachable instantaneously. Highly Efficient. Complete with Flexible and Cord.

OUR PRICE 22/6.

SPECIAL PRICES TO THE TRADE.

WRITE FOR OUR WIRELESS LISTS.

VARIABLE CONDENSERS.

FIXED CONDENSERS.

COIL HOLDERS.

CONDENSER PLATES, ETC.

F. YATES & Son, Ltd

WHOLESALE ELECTRICIANS.

144, Church St., Kensington, London, W.8
One Min. from Notting Hill Gate Sta. Phone—Park 4276.

To the Trade Only

We are able to deliver the following **FROM STOCK**

R.M.C. Liquid Grid Leaks (Prov. Patent 12270).

Filament Resistances.

Aerial and Lead-in Insulators.

Switch Arms.

Set of Parts for Valve Panel.

L.F. Amplifiers, etc.

Please give Trade References with application for list.

Radio Manufacturing Co.,
100, DALE END, BIRMINGHAM.

The London Telegraph Training College, Ltd.

Telephone
WESTERN 2696.

Morse House, Earl's Court, S.W.

ESTABLISHED
25 YEARS.

OFFICIALLY RECOGNISED BY THE WAR OFFICE AND POST OFFICE AUTHORITIES

CABLE AND WIRELESS TELEGRAPHY.

PARENTS desirous of placing their sons in either of the above Services and of affording them the best training facilities should apply for particulars of Courses and the methods of instruction which place this Institution in the first rank. **Cable Telegraphy** offers at the present time excellent prospects to youths from 15 years of age and upwards, and **the College has exclusive facilities** for obtaining posts for qualified students in the leading Cable Companies at **commencing salaries** of £150 to £300 per annum, with yearly increments of £12 to £25, and ultimate possibilities of obtaining positions as Supervisors, Assistant Superintendents, Managers, etc.

In the Wireless Telegraph Service the commencing remuneration at the present time is approximately £150 per annum, and Operators, when qualified by obtaining the Postmaster-General's Certificate of Proficiency, are nominated by the College for appointments.

No Correspondence Classes or Branches.

DAY AND EVENING CLASSES.

Prospectus containing all information will be forwarded on application to

THE SECRETARY (Dept. H.), 262, Earl's Court Road, Earl's Court, London, S.W.5

Sole Proprietors of the "Scott" Training Disc, which contains useful formulæ and other information for Wireless Telegraph Operators and is invaluable to Army Signalling Officers for range finding, etc.

Price, complete with instructions for use, 1/-. Postage 2d.

Telephone—
GERRARD
6785

W.E.L.^{TD}

Telegrams—
"WIRELOQUIP,
WESTCENT,
LONDON."

UNIT "A"

Broadcast Receiver

for All Wavelengths

Write for our Illustrated
LIST "B"

Post Free 3d.

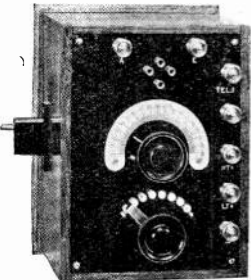

ADAPTED FOR
PLUG-IN COILS.

FITTED WITH
AERIAL SERIES
CONDENSER.

WIRELESS EQUIPMENT LIMITED,

90, Charing Cross Road, W.C.2.

Visit our Stand No. 14.
All-British Wireless Exhibition, Horticultural Hall, September 30th — October 7th.

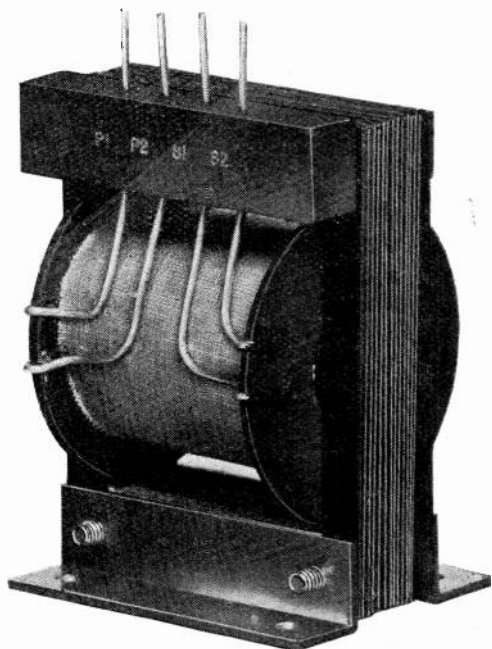

INTERVALVE TRANSFORMERS

Windings of best enamelled pure copper wire.

Primary wound to possess correct impedance when connected in plate circuit of average "hard" receiving valve.

Secondary Designed to deliver maximum voltage.

Insulation Each layer insulated by finest paraffined paper and guaranteed not to break down when correctly used.

PRICE **23/6** POST FREE.

*Immediate Delivery from Stock.
Attractive Discounts to the Trade.*

THE ASHLEY WIRELESS TELEPHONE CO. LTD.
DEPT. W.
69, RENSHAW ST., LIVERPOOL.

PATENT RADIO INSULATORS

(GOVERNMENT TESTED).

ABSOLUTELY WATER & WEATHER PROOF.

No Soldering of Aerial Joints Required.

Atmospherics and Statics Eliminated.

Universally adopted by the British, American, French and Italian Naval, Military and Aerial Services.

**1/6
EACH**

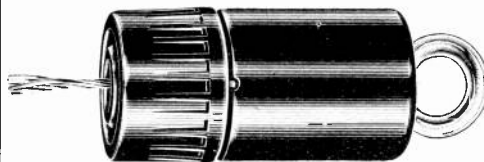

Registered Patent.

GUARANTEE.

We guarantee these insulators to have a higher consistent insulation capacity than any other form of insulation at present adopted for Radio Transmission and Reception.

Generous Terms to the Trade.

ECON MANUFACTURING CO., LIMITED,

6, Holborn Viaduct, London, E.C. 1.

Factory: Paris Garden, Blackfriars, S.E.1. Phone: City 4148
Hop 2000.

**All-British Wireless Exhibition,
STAND No. 50 (Annexe).**

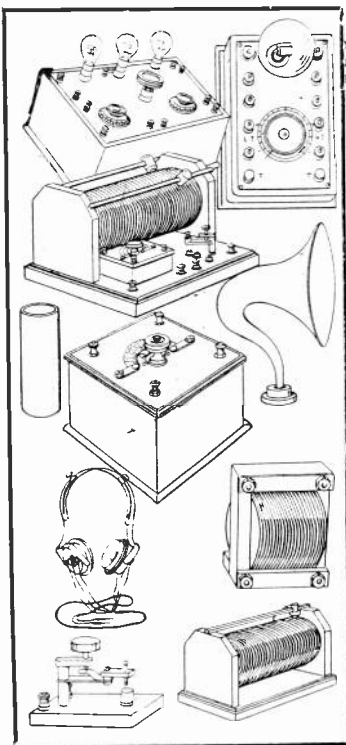

HIGH GRADE
(Valve and Crystal)
WIRELESS RECEIVING SETS
and all
ACCESSORIES

WE ARE Actual Manufacturers, and give prompt deliveries at competitive prices.

TRADE ONLY
Our "SPECIAL NET TRADE LIST" will be forwarded post free on receipt of Trade Card or Memo.

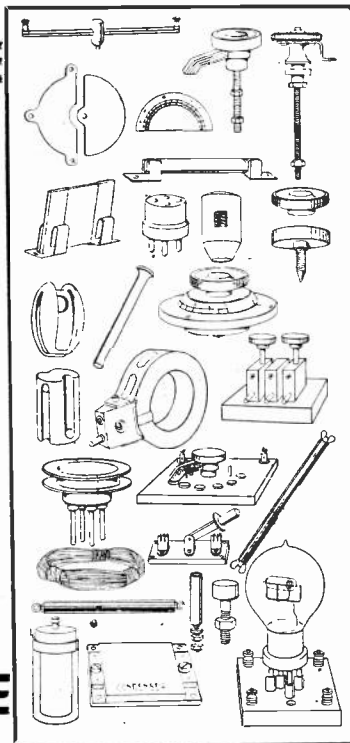

BIRMINGHAM WIRELESS INSTRUMENT and COMPONENTS CO.
71 Broad Street, BIRMINGHAM

EBONITE PARTS -

- Knobs.** Highly finished, mat or polished. 3½d., 4½d. 5½d.
- Condenser Dials.** Complete with knob, polished and engraved, 3/- each. Without knob, 2/3 each.
- Filament Resistances.** Best quality, 2 8 each.
- Valve Holders.** Best quality, 1/- each. Special make and mat finish, 2/- each.
- Grid Leak and Condenser.** The best make on the market. 2 -.
- Variable Condensers.** A really high class instrument, .001, 15/-; .0003, 9/6; .0005, 11/6.
- Vernier Condenser.** 3/9 each.
- Coil Holders,** 1/6 each. Coil plugs, 1/6 each.
- Laminated Switch Arms.** Best quality, complete, 1 6.
- Ebonite Coil Stands.** With three coil holders, suitable for new circuit, 15/6. Beautifully made.
- Brass Terminals.** 2B.A. x 2½", 2½d. each. 3B.A. x 1½", 2½d. each. 3B.A. x 1¼", 2d. each.
- Complete Set of Parts for making up a .0003 Condenser,** 4/6; .0003 condenser, 6/6; a .001, 8 6.

All orders served in rotation, and customers immediately advised as to the date of delivery if same cannot be executed by return.

- Prices on application for Intervals. Telephone Transformers, also H.F. Transformers.
- Inductively coupled Tuning Inductances.** £2 each.
- Plain Single Slider Inductance,** 15/- each.
- Plain Double Slider Inductance,** 16/- each.
- One-valve Detector Panels in Beautiful Cabinet,** 20/- each.
- Western Electric Head 'Phones, 4,000 ohms,** 30/- each.
- SINGLE VALVE COMPLETE RECEIVING SET,** fitted with ebonite coil stand for three coils, a most efficient and elegant instrument, less valve battery aerial and 'phones, £4 10s.
- Two-valve Sets,** as above, in larger cabinet, £6 10s.
- Three-valve Sets,** as above, £8 10s.

Special Notice should be taken in regard to the complete sets as they are far and away the best value offered to-day to the public.

Build your own Amplifier!



Low Frequency Intervalve Transformers

Built up of Stalloy insulated laminations, silk covered windings, terminals mounted on ebonite block. Tested 1,000 volts.

Ratio of windings 1 : 3.

A guaranteed article offered by a firm with many years' experience in High Tension Transformer construction.

PRICE **30/-**

SPECIAL TERMS TO TRADE.

Order now and secure prompt delivery.

MEDICAL SUPPLY ASSOCIATION
167/185, Gray's Inn Road, London, W.C.1.

RADIO INSULATION

AS SPECIFIED AND USED BY THE BRITISH ADMIRALTY

BRITISH MADE

PAXOLIN

BRITISH MADE

TUBES DISCS PLATES, &c.

MANUFACTURED IN ALL FORMS, SIZES AND THICKNESSES

BY

THE MICANITE & INSULATORS CO. LTD.

EMPIRE WORKS

WALTHAMSTOW

LONDON, E.17

TELEGRAMS:—"MYTILITE, PHONE, LONDON."

TELEPHONES:—WALTHAMSTOW 738, 739

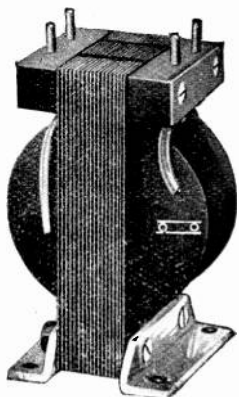

L.F. Transformer.

GENTS' MAKE FITMENTS

**LARGE STOCKS!
PROMPT DELIVERY**

OF L.F. TRANSFORMERS

AND

"DISCOL" H.F. TRANSFORMER

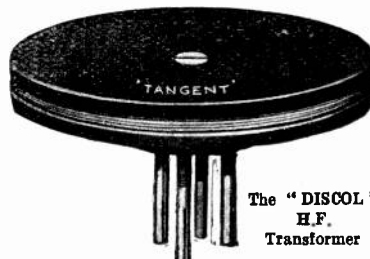

The "DISCOL"
H.F.
Transformer

SEND FOR SUNDRIES PAMPHLET "LD66."

May we quote for your requirements?

GENT & Co. Ltd., FARADAY WORKS, LEICESTER.

LONDON: - 25 VICTORIA ST., S.W.1.

NEWCASTLE-ON-TYNE:—"TANGENT HOUSE," 52 BLACKETT ST.

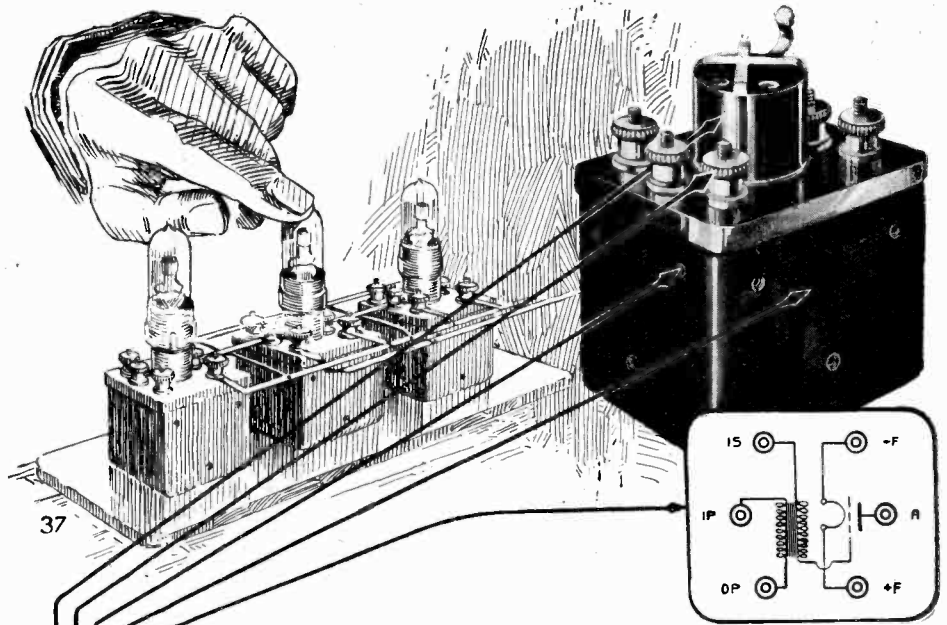
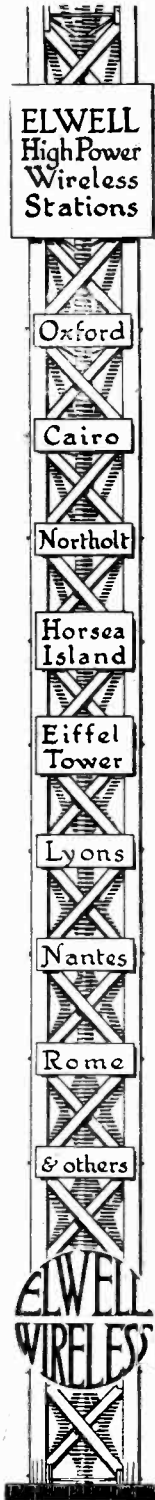

No need to spend time making these connections. The Elwell note magnifier contains them ready made.

The interval transformer is contained in an iron case, allowing units to be placed close together without howling.

Tapped holes in two sides and base make fixing easy. The unit will also stand alone.

All connections are embedded in compound and brought out to terminals. No soldering necessary. The perfect insulation of the grid connection ensures silent operation.

The valve holder has specially long leakage paths and an earth clip.

This patented amplifying unit, when provided with a valve and connected as marked on the terminals, is all that is necessary to give one stage of note magnification to your existing set.

Two, three or more units may be coupled as shown, to give as many stages of note magnification as required.

AMPLIFYING MADE EASY

When building a valve set, do not buy interval transformers. Use Elwell Amplifying Units. They save time, money and trouble.

When buying a valve set, select one using these units. They enable the manufacturer to give you a better job at a lower cost.

The unit featured is a note magnifier.

A similar design of unit is available as an oscillation amplifier and a third design as a rectifying unit.

WRITE US OR CALL.

C. F. ELWELL, LTD., *Radio Engineers,*
CRAVEN HOUSE, KINGSWAY, LONDON, W.C. 2
 Telephone: REGENT 421.

Visit our Stand No. 45. All-British Wireless Exhibition, Horticultural Hall, September 30th to October 7th.

FOLLOW THE CROWD
TO
STAND NO. 1.

AT THE
**ALL BRITISH
WIRELESS EXHIBITION
AND INSPECT
THE
Crystone
REGISTERED
COMPLETE OUTFITS**

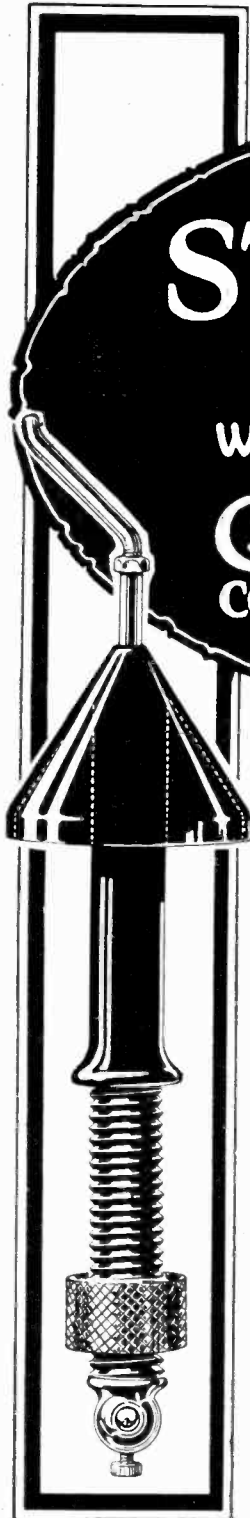

All Crystone Receivers
will be fitted with the

Lattikone Tuner

(lattice wound cone coil, patent pending)

which combines in itself the func-
tions of a variometer and a variable
condenser, while yet possessing the
body and strength of a direct coup-
led inductance, and which will be

THE UNIVERSAL TUNER

:: OF THE FUTURE ::

*Demonstrations of all Types
from 10 a.m. to 10 p.m.*

Visit our Stand No. 1, All-British Wireless Exhibi-
tion, Horticultural Hall, Sept. 30th to Oct. 7th.

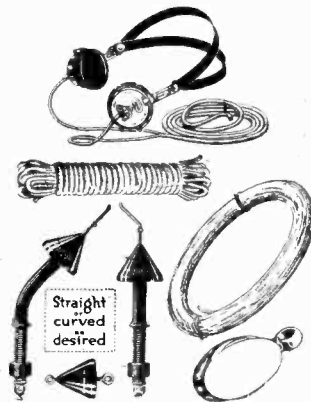

**CALL AND INSPECT OUR
COMPLETE OUTFITS**

Outfit No. 1. Crystone Receiver
Type 20 T.T., Crystor Aerial Outfit, a
pair of Sterling Headphones, 4,000 ohms,
packed in suitable case - £7 : 12 : 6

Outfit No. 3. Crystone "Scout"
Receiver, Crystor Aerial Outfit, a pair of
British Headphones, 4,000 ohms, packed
in suitable box - - - £5 : 12 : 6

WIRELESS SUPPLIES CO.,
64, Mortimer Street, London, W.1.

THAT'S BETTER



WE were confident that when our friends were assured of the genuineness of our special offer of Phones we should be assailed with orders. We have already received very many repeat orders and orders emanating from the same districts, from which we may conclude that they are the result of recommendation. The full 1,000 have not been sold at the time of going to press so that when this advertisement appears we shall still supply at our special prices below.

140 ohms
23/6
4,000 ohms
25/-
8,000 ohms
27/6

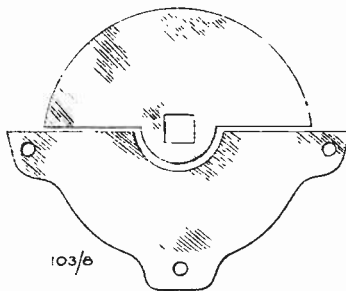

Will those of our customers who have already received price lists please note that our Condenser Valves are reduced to 9d. per dozen fixed or moving, and our Valve Holders to 1/- each. Price lists 3d. post free.

Watch for the name of our nearest agent.

BURY—BENNETT & CO.,
12, Union Square.

BOLTON—J. S. McLEOD,
189, Blackburn Road.

AGENTS WANTED

J. L. CARTWRIGHT & CO.,

The Actual Manufacturers,

130-132, LONDON ROAD, MANCHESTER.

Telephone: 4209 Central. Works: BERRY STREET. Telegrams: "Pladuram" Manchester

Enormous Stocks of Ex-W.D. WIRELESS GEAR AT ABSURDLY LOW PRICES



INTERVAL
TRANSFORMER.

Fitted with panel fixing plate and earthing wire for iron core.

Fully tested;
Ratio 5:1

PRICE **15/-**
Postage 9d. extra

Call and inspect our enormous stock or write for particulars and prices of your requirements.

Brass terminals, Wheatstone Bridges, Marconi Type 16 Crystal Sets, Model L receiving sets, Shell insulators, Wavemeters, etc., etc.

J. LIPOWSKY Electrical and
Wireless Engineer

614, OLD FORD ROAD, BOW, LONDON, E.3

Telephone: East 3:45

Near Old Ford Station.

Nos. 8 or 39 'Bus

Everything Guaranteed

THE POPULAR VARIABLE CONDENSER, Guaranteed, silent in action, and the finest value ever offered.

Mfd.	Mounted in Cabinet.	Panel Mounting.	Sets of Parts.
0003	14/6	11/-	5/-
0005	17/6	14/-	7/-
001	22/6	19/-	11/-

The sets of parts include ebonite drilled, ready for fitting. Cabinets, 3/6 extra.

THE SCIENTIFIC WET BATTERY, in walnut finished case. Nest of 50 cells, 74 volts, 22/6, post 3/6. Nest of 25 cells, 37 volts, 13/6, post 1/6.

L.F. AMPLIFYING UNITS, for adding to crystal, valve sets, and panels for loud speakers, etc., mounted into walnut cabinet, 6" x 8", 1 valve, 37/6, 2 valves, £3 3s., post 1/-.

BLACK INDICATION TABLETS, engraved white, Aerial, Earth, Phones, React., Prim., Sec., A.T.L., A.T.C., + LT-, +HT-, per set of 10 2/6.

TUNING STAND for Honeycomb and Duo-Lateral Coils, 2-Coil Stand, 10/6; 3-Coil Stand, 15/6. Post, 8d. Coil holders, 1/3 each, 13/6 per doz. Standard pattern.

SENSITONE CRYSTAL.—The perfect mineral detector, 1/- per specimen, post free.

KNIFE SWITCHES ON EBONITE, D.P.D.T., 2/3; S.P.D.T., 1/6; S.T.D.P. 1/6.

FILAMENT RESISTANCES for Panel mounting, 3/6, post 4d.

MARK III TERMINALS, with nuts, 2/3 per doz., post 5d.

SLAB INDUCTANCES, per set of 8, 10/6, post 9d.

BASKET INDUCTANCES, per set of 7, 7/-, post 4d.

SCIENTIFIC SUPPLY STORES,

8, Newington Causeway, London, S.E.1.

'Phone, Hop. 4177.

STAND No. 25

THE TINGEY UNIT SYSTEM

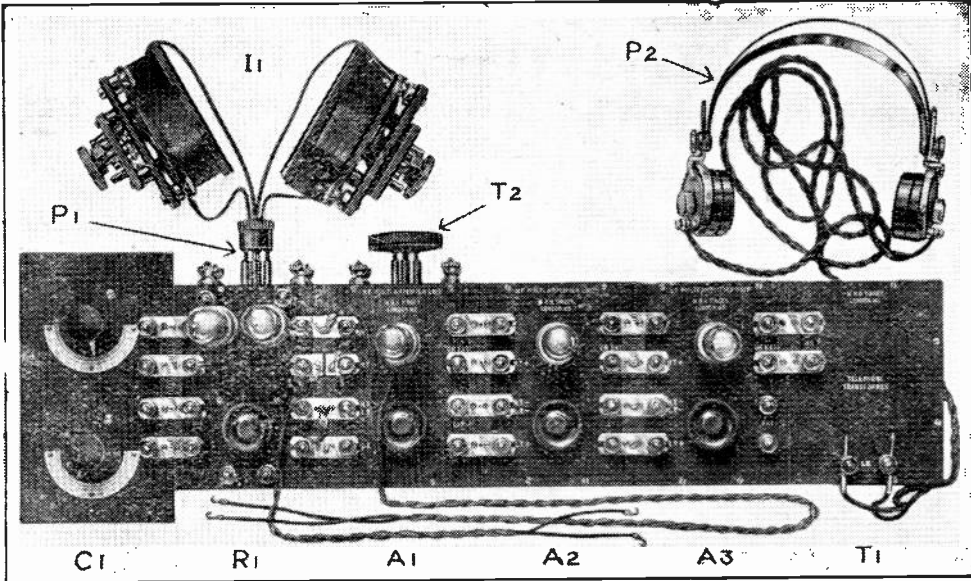

<table border="0" style="width: 100%;"> <tr> <td>C1.</td> <td>CONDENSERS. One pair mounted in case..</td> <td style="text-align: right;">£ 5 0 0</td> </tr> <tr> <td>R*.</td> <td>RECEIVER (for R. Valves) ..</td> <td style="text-align: right;">4 17 6</td> </tr> <tr> <td>R1*.</td> <td>RECEIVERS (for Mullard Valves) ..</td> <td style="text-align: right;">4 7 6</td> </tr> <tr> <td>R.S.</td> <td>SINGLE VALVE RECEIVER ..</td> <td style="text-align: right;">3 10 0</td> </tr> <tr> <td>R.V.</td> <td>UNIT H.F. to follow R.S. Unit ..</td> <td style="text-align: right;">2 0 0</td> </tr> <tr> <td>A.2.</td> <td>MULTI H.F. AMPLIFIER UNIT, Choke and resistance type ..</td> <td style="text-align: right;">3 15 0</td> </tr> <tr> <td>A.3.</td> <td>MULTI L.F. AMPLIFIER UNIT ..</td> <td style="text-align: right;">3 15 0</td> </tr> <tr> <td>A.4.</td> <td>MULTI H.F. AMPLIFIER UNIT, without inductances or variable condenser ..</td> <td style="text-align: right;">2 10 0</td> </tr> <tr> <td>A24.</td> <td>COMBINED UNIT, tuned or stand-by position ..</td> <td style="text-align: right;">3 15 0</td> </tr> <tr> <td>T.1.</td> <td>MULTI TELEPHONE TRANSFORMER UNIT ..</td> <td style="text-align: right;">2 0 0</td> </tr> <tr> <td>11.</td> <td>INDUCTANCES. A. Coil—200-1,600 metres with approximate calibration. Price ..</td> <td style="text-align: right;">1 5 0</td> </tr> </table>	C1.	CONDENSERS. One pair mounted in case..	£ 5 0 0	R*.	RECEIVER (for R. Valves) ..	4 17 6	R1*.	RECEIVERS (for Mullard Valves) ..	4 7 6	R.S.	SINGLE VALVE RECEIVER ..	3 10 0	R.V.	UNIT H.F. to follow R.S. Unit ..	2 0 0	A.2.	MULTI H.F. AMPLIFIER UNIT, Choke and resistance type ..	3 15 0	A.3.	MULTI L.F. AMPLIFIER UNIT ..	3 15 0	A.4.	MULTI H.F. AMPLIFIER UNIT, without inductances or variable condenser ..	2 10 0	A24.	COMBINED UNIT, tuned or stand-by position ..	3 15 0	T.1.	MULTI TELEPHONE TRANSFORMER UNIT ..	2 0 0	11.	INDUCTANCES. A. Coil—200-1,600 metres with approximate calibration. Price ..	1 5 0	<table border="0" style="width: 100%;"> <tr> <td>1.1.</td> <td>INDUCTANCES. B. Coil—1,000-8,500 metres with approximate calibration ..</td> <td style="text-align: right;">£ 1 17 6</td> </tr> <tr> <td>1.1.</td> <td>INDUCTANCES. C. Coil—5,000-24,000 metres with approximate calibration ..</td> <td style="text-align: right;">3 2 6</td> </tr> <tr> <td>J.1.</td> <td>JUNCTION BRACKETS (8 styles)-from 3 - to ..</td> <td style="text-align: right;">6 6 each</td> </tr> <tr> <td>P.2.</td> <td>BROWN'S PHONES (D Type), 120 w. Per pair ..</td> <td style="text-align: right;">2 8 6</td> </tr> <tr> <td></td> <td>BROWN'S RELAY UNIT (mounted in case), for rapid attachment to Tingeey Units. No loose connections (2,000 ohms input) ..</td> <td style="text-align: right;">6 15 0</td> </tr> <tr> <td></td> <td>BROWN'S RELAY (without Tingeey adaptation) ..</td> <td style="text-align: right;">6 2 6</td> </tr> <tr> <td></td> <td>"ORA" MULLARD'S VALVES ..</td> <td style="text-align: right;">each 0 15 0</td> </tr> <tr> <td>P.1.</td> <td>INDUCTANCE PLUGS ..</td> <td style="text-align: right;">0 4 0</td> </tr> <tr> <td>T.2.</td> <td>INTERCHANGEABLE TRANSFORMERS (300 to 24,000 metres) ..</td> <td style="text-align: right;">each 6 - to 12 -</td> </tr> <tr> <td></td> <td>TINGEY (3-Valve) RECEIVER, 1 valve H.F., 1 Rect. 1 L.F. (without valves) ..</td> <td style="text-align: right;">8 10 0</td> </tr> </table>	1.1.	INDUCTANCES. B. Coil—1,000-8,500 metres with approximate calibration ..	£ 1 17 6	1.1.	INDUCTANCES. C. Coil—5,000-24,000 metres with approximate calibration ..	3 2 6	J.1.	JUNCTION BRACKETS (8 styles)-from 3 - to ..	6 6 each	P.2.	BROWN'S PHONES (D Type), 120 w. Per pair ..	2 8 6		BROWN'S RELAY UNIT (mounted in case), for rapid attachment to Tingeey Units. No loose connections (2,000 ohms input) ..	6 15 0		BROWN'S RELAY (without Tingeey adaptation) ..	6 2 6		"ORA" MULLARD'S VALVES ..	each 0 15 0	P.1.	INDUCTANCE PLUGS ..	0 4 0	T.2.	INTERCHANGEABLE TRANSFORMERS (300 to 24,000 metres) ..	each 6 - to 12 -		TINGEY (3-Valve) RECEIVER, 1 valve H.F., 1 Rect. 1 L.F. (without valves) ..	8 10 0
C1.	CONDENSERS. One pair mounted in case..	£ 5 0 0																																																														
R*.	RECEIVER (for R. Valves) ..	4 17 6																																																														
R1*.	RECEIVERS (for Mullard Valves) ..	4 7 6																																																														
R.S.	SINGLE VALVE RECEIVER ..	3 10 0																																																														
R.V.	UNIT H.F. to follow R.S. Unit ..	2 0 0																																																														
A.2.	MULTI H.F. AMPLIFIER UNIT, Choke and resistance type ..	3 15 0																																																														
A.3.	MULTI L.F. AMPLIFIER UNIT ..	3 15 0																																																														
A.4.	MULTI H.F. AMPLIFIER UNIT, without inductances or variable condenser ..	2 10 0																																																														
A24.	COMBINED UNIT, tuned or stand-by position ..	3 15 0																																																														
T.1.	MULTI TELEPHONE TRANSFORMER UNIT ..	2 0 0																																																														
11.	INDUCTANCES. A. Coil—200-1,600 metres with approximate calibration. Price ..	1 5 0																																																														
1.1.	INDUCTANCES. B. Coil—1,000-8,500 metres with approximate calibration ..	£ 1 17 6																																																														
1.1.	INDUCTANCES. C. Coil—5,000-24,000 metres with approximate calibration ..	3 2 6																																																														
J.1.	JUNCTION BRACKETS (8 styles)-from 3 - to ..	6 6 each																																																														
P.2.	BROWN'S PHONES (D Type), 120 w. Per pair ..	2 8 6																																																														
	BROWN'S RELAY UNIT (mounted in case), for rapid attachment to Tingeey Units. No loose connections (2,000 ohms input) ..	6 15 0																																																														
	BROWN'S RELAY (without Tingeey adaptation) ..	6 2 6																																																														
	"ORA" MULLARD'S VALVES ..	each 0 15 0																																																														
P.1.	INDUCTANCE PLUGS ..	0 4 0																																																														
T.2.	INTERCHANGEABLE TRANSFORMERS (300 to 24,000 metres) ..	each 6 - to 12 -																																																														
	TINGEY (3-Valve) RECEIVER, 1 valve H.F., 1 Rect. 1 L.F. (without valves) ..	8 10 0																																																														

COMPLETE RECEIVING SETS (VALVE) From £14.

All "Tingeey" Valve Apparatus is duly licensed under Marconi Patents for Amateur use in Great Britain.

TINGEY FOR COMPONENT PARTS

<table border="0" style="width: 100%;"> <tr> <td colspan="2">EBONITE, cut to size—</td> <td style="text-align: right;">£ s. d.</td> </tr> <tr> <td>12 x 12 x 1/2</td> <td>.. .. .</td> <td style="text-align: right;">0 5 3</td> </tr> <tr> <td>12 x 9 x 1</td> <td>.. .. .</td> <td style="text-align: right;">0 4 0</td> </tr> <tr> <td>12 x 6 x 1</td> <td>.. .. .</td> <td style="text-align: right;">0 2 8</td> </tr> <tr> <td>10 x 10 x 1/2</td> <td>.. .. .</td> <td style="text-align: right;">0 4 0</td> </tr> <tr> <td>10 x 8 x 1/2</td> <td>.. .. .</td> <td style="text-align: right;">0 3 3</td> </tr> <tr> <td>12 x 3 x 1/2</td> <td>.. .. .</td> <td style="text-align: right;">0 1 4</td> </tr> <tr> <td>6 x 6 x 1/2</td> <td>.. .. .</td> <td style="text-align: right;">0 1 4</td> </tr> <tr> <td>GRID LEAKS, 1 to 5 megohms ..</td> <td style="text-align: right;">each</td> <td style="text-align: right;">0 2 6</td> </tr> <tr> <td>ANODE RESISTANCES, any resistance ..</td> <td style="text-align: right;">each</td> <td style="text-align: right;">0 2 6</td> </tr> <tr> <td>VARIOMETER OR REACTANCE FORMS ..</td> <td style="text-align: right;">each</td> <td style="text-align: right;">0 7 6</td> </tr> <tr> <td>CONDENSER SCALES, Ivorine ..</td> <td style="text-align: right;">each</td> <td style="text-align: right;">0 1 6</td> </tr> <tr> <td>LAMINATED SWITCH ARMS ..</td> <td style="text-align: right;">each</td> <td style="text-align: right;">0 2 9</td> </tr> </table>	EBONITE, cut to size—		£ s. d.	12 x 12 x 1/2	0 5 3	12 x 9 x 1	0 4 0	12 x 6 x 1	0 2 8	10 x 10 x 1/2	0 4 0	10 x 8 x 1/2	0 3 3	12 x 3 x 1/2	0 1 4	6 x 6 x 1/2	0 1 4	GRID LEAKS, 1 to 5 megohms ..	each	0 2 6	ANODE RESISTANCES, any resistance ..	each	0 2 6	VARIOMETER OR REACTANCE FORMS ..	each	0 7 6	CONDENSER SCALES, Ivorine ..	each	0 1 6	LAMINATED SWITCH ARMS ..	each	0 2 9	<table border="0" style="width: 100%;"> <tr> <td>FILAMENT RESISTANCE, Unmounted ..</td> <td style="text-align: right;">each</td> <td style="text-align: right;">0 4 0</td> </tr> <tr> <td>FILAMENT RESISTANCE, Mounted ..</td> <td style="text-align: right;">each</td> <td style="text-align: right;">0 8 6</td> </tr> <tr> <td>FILAMENT RESISTANCE and Valve Holder ..</td> <td style="text-align: right;">each</td> <td style="text-align: right;">0 15 6</td> </tr> <tr> <td>SWITCHES, 5 point ..</td> <td style="text-align: right;">each</td> <td style="text-align: right;">0 5 0</td> </tr> <tr> <td>SWITCHES, 10 point ..</td> <td style="text-align: right;">each</td> <td style="text-align: right;">0 7 6</td> </tr> <tr> <td>SWITCHES, 19 point ..</td> <td style="text-align: right;">each</td> <td style="text-align: right;">0 10 0</td> </tr> <tr> <td>EXPERIMENTAL VALVE PANEL ..</td> <td style="text-align: right;">each</td> <td style="text-align: right;">1 15 0</td> </tr> <tr> <td>THREE-VALVE PANELS ..</td> <td style="text-align: right;">each</td> <td style="text-align: right;">0 4 6</td> </tr> <tr> <td>CONTACT STUDS, small, cleaned and lacquered, doz. ..</td> <td style="text-align: right;">doz.</td> <td style="text-align: right;">0 1 3</td> </tr> <tr> <td>CONTACT STOPS ..</td> <td style="text-align: right;">doz.</td> <td style="text-align: right;">0 1 6</td> </tr> <tr> <td>VALVE LEGS ..</td> <td style="text-align: right;">doz.</td> <td style="text-align: right;">0 2 6</td> </tr> <tr> <td>VALVE PINS ..</td> <td style="text-align: right;">doz.</td> <td style="text-align: right;">0 2 6</td> </tr> <tr> <td colspan="3" style="text-align: center;">Various other component parts.</td> </tr> </table>	FILAMENT RESISTANCE, Unmounted ..	each	0 4 0	FILAMENT RESISTANCE, Mounted ..	each	0 8 6	FILAMENT RESISTANCE and Valve Holder ..	each	0 15 6	SWITCHES, 5 point ..	each	0 5 0	SWITCHES, 10 point ..	each	0 7 6	SWITCHES, 19 point ..	each	0 10 0	EXPERIMENTAL VALVE PANEL ..	each	1 15 0	THREE-VALVE PANELS ..	each	0 4 6	CONTACT STUDS, small, cleaned and lacquered, doz. ..	doz.	0 1 3	CONTACT STOPS ..	doz.	0 1 6	VALVE LEGS ..	doz.	0 2 6	VALVE PINS ..	doz.	0 2 6	Various other component parts.		
EBONITE, cut to size—		£ s. d.																																																																													
12 x 12 x 1/2	0 5 3																																																																													
12 x 9 x 1	0 4 0																																																																													
12 x 6 x 1	0 2 8																																																																													
10 x 10 x 1/2	0 4 0																																																																													
10 x 8 x 1/2	0 3 3																																																																													
12 x 3 x 1/2	0 1 4																																																																													
6 x 6 x 1/2	0 1 4																																																																													
GRID LEAKS, 1 to 5 megohms ..	each	0 2 6																																																																													
ANODE RESISTANCES, any resistance ..	each	0 2 6																																																																													
VARIOMETER OR REACTANCE FORMS ..	each	0 7 6																																																																													
CONDENSER SCALES, Ivorine ..	each	0 1 6																																																																													
LAMINATED SWITCH ARMS ..	each	0 2 9																																																																													
FILAMENT RESISTANCE, Unmounted ..	each	0 4 0																																																																													
FILAMENT RESISTANCE, Mounted ..	each	0 8 6																																																																													
FILAMENT RESISTANCE and Valve Holder ..	each	0 15 6																																																																													
SWITCHES, 5 point ..	each	0 5 0																																																																													
SWITCHES, 10 point ..	each	0 7 6																																																																													
SWITCHES, 19 point ..	each	0 10 0																																																																													
EXPERIMENTAL VALVE PANEL ..	each	1 15 0																																																																													
THREE-VALVE PANELS ..	each	0 4 6																																																																													
CONTACT STUDS, small, cleaned and lacquered, doz. ..	doz.	0 1 3																																																																													
CONTACT STOPS ..	doz.	0 1 6																																																																													
VALVE LEGS ..	doz.	0 2 6																																																																													
VALVE PINS ..	doz.	0 2 6																																																																													
Various other component parts.																																																																															

Offices & Works

Phone
HAMMERSMITH 1916
Telegs.
TINGO DAR LONDON

W.R.H. TINGEY.

SPECIALIST IN WIRELESS

Offices & Showrooms

92 Queen St.
Hammersmith,
London, W. 6.

EBONITE

**SHEETS, RODS, TUBES, MOULDINGS, PANELS
TONS OF SHEETS**

in London Stock suitable for all requirements of the Wireless Trade.

ENQUIRIES INVITED.

RADION

This is the latest product of our Factories—a superior insulating material for high grade sets, which in grain and colour closely resembles mahogany. Manufacturers looking for something distinctive are invited to write us for further particulars.

AMERICAN HARD RUBBER Co. (Britain) Ltd.

13a, FORE STREET, LONDON, E.C.2

TELEPHONE—12754 CENTRAL.

LESLIE Mc MICHAEL LTD.

PROVIDENCE PLACE, WEST END LANE, KILBURN, N.W.6

Bus Services 1, 8, 16, 28, 51 all pass West End Lane

Telephone: HAMPSTEAD 1261 Nearest Tube Station: KILBURN PARK (BAKERLOO)

Our customers at our stand No. 38 at the All-British Exhibition this week have given us further abundant proof of the success of our M.H. sets in use throughout the country.

3-Valve Detector Amplifier Type M.H.3

This instrument is a Three-Valve Receiver Unit, giving the range and clarity of reception characterised by M.H.2. with the additional amplification provided by an Audio Frequency stage of Amplification.

By a rearrangement of the linking strap (Top left of Panel) the latter stage can be cut out, the set then being identical with the M.H.2.

The extraordinary popularity of this set is sufficient proof of its capabilities, and it is strongly recommended for general purposes where range and strength of reception, with great clarity and freedom from noise is required.

Price - - - **£14 14 0**

Accessories for this set to make COMPLETE STATION about £12 0 0.

Ask for our Booklet showing M.H. sets from 1 valve to 5 valve and full list of accessories in each case.

We are prepared to appoint further Agents and Representatives who will guarantee to STOCK and DEMONSTRATE our apparatus. BOURNEMOUTH (Hants) and DISTRICT is now covered by our having appointed Messrs. J. E. Beale Ltd., of Bournemouth.

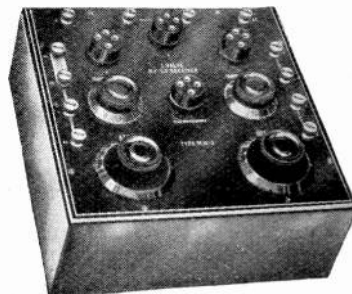

BUTLER'S RELIABLE MANUFACTURES

H.F. TRANSFORMERS to fit Valve Sockets

No.	Range		No.	Range	
0	150	5/6	5	2500	8/3
1	300	6/-	6	6000	9/9
2	600	6/3	7	8000	12/-
3	1200	6/9	8	24000	14/3
4	1800	7/6	8	24000	14/3

There is a good latitude on these coils for higher & lower ranges

H.B. COIL HOLDER

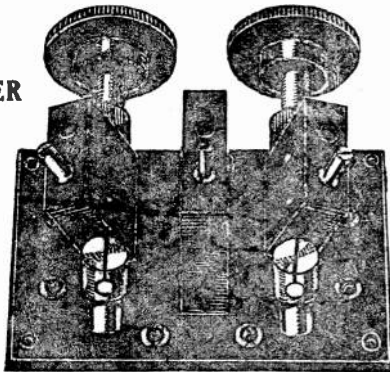

Standard fitting suitable for our "H.B." or any de Forest pattern coil. To take 3 coils £1 1 0
 " " 2 " 17 6

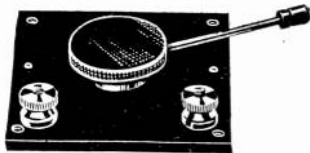

Vernier Condenser suitable for fine tuning of inductance on plating across primary of H.F. transformer. Best workmanship throughout 6/-, postage 6d.

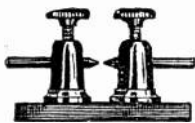

Lightning Arrester mounted on ebonite panel varying adjustment 2 6 postage 3d.



Best quality Laminated Switch complete 3/- postage 3d.



Well-finished Crystal Set, enclosed in Mahogany Cabinet. Wavelength range to 3000 metres approximately.

£2 10 0

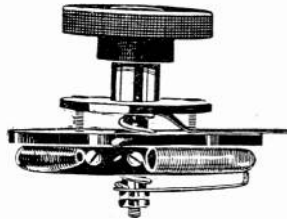

Best workmanship. ebonite throughout. filament resistance. For 1 to 3 valves. 6 - If mounted on panel with 2 terminals 10 -



First-class finish. Cut out of the solid rod. Complete with fixing screw 1/6 Postage 3d.

A HIGH-CLASS NICKEL PLATED SWITCH.

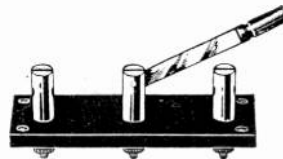

WILL CARRY UP TO 20 AMPS.

" BUTTLO " SWITCH (Registered) ON EBONITE BASE.

Single pole	single throw	2/6
Double	"	4/-
Single	double	3/6
Double	"	5/6

H.T. BATTERIES (Fully Guaranteed)

15 Volt strip connection	3/6	post 6d.	36 Volt Wander plug 3-volt Variation	7/6	post 1/-
15 " 3-terminal type	3/6	" 6d.	60 " " "	14/6	" 1/-
15 " Wander plug 3-volt Variation	4/-	" 6d.	108 " " "	22/6	" 1/3

Terms cash with order.

Fully illustrated list post free 4d.

H. D. BUTLER & Co. Ltd.,

Telephone—Hop 3029 Works, North 1838.

Office & Showrooms:—
 Bank Buildings, 222, Gt. Dover Street, Borough, S.E.1
 Works: Canonbury, London, N.1
 Telegrams—"Ingenuity Phone, London."



---CQ Std bi for ERICSSON PHONES

WHEN you install your wireless set—crystal or valve —you'll get maximum results if you fit Ericsson Phones—clarity, sensitivity, strength of signals and absence of "click." Specially suited to telephony. Ericsson Phones embody the accumulated experience of telephone manufacture for a generation. Easy to the head, light and comfortable. The magnets never lose their strength and "shorts" are non-existent.

Write for Particulars.

The BRITISH L. M. ERICSSON MANUFACTURING Co., Ltd.

Head Office:
60, Lincoln's Inn Fields, E.C.2



SKINDERVIKEN BUTTON.
A Supersensitive Microphone.
Known all over the world and patented in every civilised country. Over 60,000 sold. ENGLISH Manufacture.
Make up your own Loud Speaker.
Transmit your GRAMOPHONE music to any room in your house.

The only practical Microphone for use in Detectiphone Sets.
Price 5/- each

Special Low Resistance Receivers (for use with Skinderviken Buttons) 10/- each
Special Gramophone Attachments 1/- "

Write for 16 page BOOKLET fully illustrated and containing much useful information for all interested in Electrical Sound Transmission. 6d. Post free.

Sole Proprietors:
MIKRO LTD., 274/6, Pentonville Rd., London, N.1
(Opp. King's Cross (Met.) Rly Station).



EFFICIENT—WELL FINISHED—
MAXIMUM CAPACITY—LOW PRICES.

Send for Complete Lists.

THE ESSEX ACCUMULATOR CO., LTD.
499, Grove Green Road, Leytonstone, E.11.
Telephone: Wanstead 749.

VARIABLE CONDENSERS



Best instrument finish, complete with scales.

Capacity .001 19/6
" .0005 15/-
" .0003 12/6

Cash with order, post free.

Trade inquiries invited.

CLARKE BROS.,
Manufacturers,
Allerton Road Works,
Mossley Hill, Liverpool.



For Maximum Amplification of Speech and Music without Distortion you need this

INTERVALVE TRANSFORMER
17/6 post free.

GUARANTEED reliable and efficient. Money refunded in full if not satisfied.

WOODMASON COLCHESTER

" EIFFEL TOWER TYPE."

MASTS

STRONG. LIGHT.
WOOD LATTICE. EASY TO ERECT.
ROT AND WATER PROOF.

20 to 50 feet - - - 1/- per foot
 55 " 100 " - - - 1/6 " "

FROM STOCK. CASH WITH ORDER.

WILKINSON, Lonsdale Road, Kilburn, N.W.6
 Same Address since 1900. Trade Supplied.
 Bankers—LONDON CITY AND MIDLAND, KILBURN, N.W.6.

LISTEN - IN — on the

A complete Installation at a low cost



"AEROWAVE" RECEIVER

Price
£6 : 6 : 0
 with complete Equipment

HENRY J. BREWSTER & CO.
 11, Queen Victoria Street, LONDON, E.C.4

SPEARS and COMPANY
 FOR

TERMINALS

SCREWS, NUTS, WASHERS, PLUGS and SOCKETS, CONTACT STUDS, BUSHES, VALVE LEGS, CONDENSER VANES and TURNED and PRESSED PARTS OF EVERY DESCRIPTION.
 Actual Manufacturers to TRADE ONLY

We regret we cannot supply small lots to Amateurs.
 Write for Illustrated List.

CAPSTAN REPETITION WORKS,
PARK ROAD, HOCKLEY, BIRMINGHAM
 Telephone : 3265 Central. Telegrams : " Firettes," Birmingham

THE
PARAGON RUBBER MANUFACTURING CO.
SCULCOATES, HULL.

E BONITE Sheet, Rod & Tube ELECTRICAL MOULDINGS	WIRELESS KNOBS V A L V E S SLIDERS, Etc.
--	---

Wholesale only.

London Office : **PERCY W. C. TRICK,**
 20, LITTLE PORTLAND STREET, W.1
 Telephone : MUSEUM 2043.

SINGLE VALVE RECEIVING SETS—Comprising Tuner 100/1,300 m., Variable Condenser, Valve Panel with Filament Resistance, etc., £5.

TWO-VALVE SET—1 H.F. Valve, 1 Rectifier, Tuner, etc., as above, £7 10s.

THREE-VALVE SET—1 H.F. Valve, 1 Rectifier and 1 L.F. ditto. Tuner, etc., as above, £9 10s. For use with L.S.

Headphones (Double), 8,000 ohms, 24/6 4,000 ohms, 22/6.
 Accumulators, 4v. 40a., 21/-.
 H.T. Batteries, 50v., 12/6.
 L.F. Transformers 21/-.
 H.F. Transformers. Plug in type, for various wavelengths, 6/-, 12/-.
 'Phone Transformers, 15/-.
 Valves—ORA, 15/-, Dutch, 11/-.
 Valve legs with two nuts and washers, 2d. each.
 Valve Holders, complete with nuts, 1/3 each.
 Filament Resistance, complete with knob for panel mounting, 3/9 each.
 Filament Resistance, ebonite former, complete with screws, 1/3 each.
 High Res. Wire, per yard, 2d.
 Condensers, Variable, for panel mounting, .0001, 7/-, .001, 19/-, intermediate sizes pro rata.
 Condenser Vanes, fixed and variable, 1/- per doz.
 Condenser Washers, small, 3d. per doz., large, 5d. per doz
 2BA Screwed Rod for assembling, 6d. per ft.
 Ebonite Knobs, 1½" diameter, screwed 2 or 4BA. 6d. each.
 Grid Condenser and Leak. on ebonite base, 1/6 each.
 Ivory Scales, 0 degs.-180 degs., 7d. each.
 Ivory Tablets marked Aerial, Earth, etc., 1½d. each.
 Hollow Steel Aerial Masts, complete with guys, etc., from 30/-.
 Mica, Ebonite (Sheet, rod, tube), Brass Rod, Insulating Tubing, Paraffin Wax, Foil, Aerial Wire, Copper Wire, Insulators, Terminals, Nuts and Screws, etc., etc., at lowest prices.

HESTIA ENGINEERING CO.,
 32, Palmerston Road, Acton, London, W.3

E BONITE

EQUIPMENT

FOR

WIRELESS SETS

SHEETS, KNOBS, COIL
 HOLDERS, VALVE HOLDERS,
 ENGRAVED DIALS, SOLID
 E BONITE HORNS FOR
 LOUD SPEAKERS, PANELS

FROM STOCK

HIGHTENSITE LTD.
 Normandy St., Custom House, E. 16
 'Phone : EAST 3153.

THE WIRELESS WORLD EXCHANGE AND MART

TARIFF. Advertisements are accepted for this Section at the rate of twopence per word, with a minimum charge of two shillings. The advertiser's name and address will be charged for, and single letters and single figures will be counted as words. Compound words will be counted as two words.

DEPOSITS. All advertisements must be prepaid in the form of Postal Orders, the remittance being forwarded to Messrs. Bertram Day & Co., Ltd., 9 & 10, Charing Cross, S.W.1.

Intending purchasers may deposit the purchase money of any article advertised or sold by advertisers with Messrs. Bertram Day & Co., Ltd., who will acknowledge its receipt to the vendor and the depositor, the full addresses of whom should be given. Subject to special agreement between the parties, it is understood that all goods are sent on approval each party paying carriage one way in the event of the goods being returned. The deposit will be retained until due advice of the completion of the purchase has been given or until the articles have been retained and accepted. In order to cover postage, etc., a fee of 6d. in respect of sums of £1 and under and 1s. for sums in excess of £1, must be paid at the same time as the deposit. For persons not resident in the United Kingdom these fees are doubled. We cannot undertake to receive any deposit less than 2s. 6d.

FOR SALE.

Cast Iron Boxes for low frequency transformers, 1/3, aluminium condenser vanes 7 1/2 doz., Stalloy telephone diaphragms, 3d. By return of post. Postage extra.—SWINGLEHURST & Co., Electricians, 145, Gisburn Road, Barrowford, Lancs.

Sayers for Satisfaction.—Three-valve set. Needs slight adjustment with H.R. telephones, valves, 60-volt battery, 2 variable condensers, loose coupler, double aerial, £11. 35v. 7 amp. dynamo, complete, ready for winding, solid built up commutation and bush gear fitted, a bargain, £3 10s. Tuning inductances, 12" x 4", wound No. 24, 10s. extra sliders 2s. 6d. All above carriage paid.—H. SAYER, Kirkby Stephen, Westmorland.

For Sale, Complete Cabinet Type Four-valve Receiver, H.F. and L.F., complete with Brown's telephones, valves, H.T. batteries, two accumulators, price £20.—Box S.2, BERTRAM DAY'S ADVERTISING OFFICES, 9 and 10, Charing Cross, S.W.1.

Crystal Receivers, 300 to 1,500 metres, 30s. Valve detector panel, complete, 21s. Aerial, 7/22 100 ft., 4s. 6d. Ebonite, 4s. 6d. lb. Enquiries for wireless apparatus invited. Cash with order. Postage extra.—DOWLE & HOBBS, 38, Elm Street, Cardiff.

Cox Spark Coil, 1 1/2", entirely enclosed mahogany. Reinforced break. Perfect condition. What offers?—CARDEN, 100, Woodvale, S.E.23.

Two-Valve Receiver.—Receives telephony from Writtle, Hague, Croydon, Paris. Polished mahogany case, £6. Three-valve detector amplifier, splendid for all telephony. Handsome mahogany case, £10.—FRAIN, Snainton, Yorks.

Adams 2 1/2 centre precision bench lathe with countershaft, nearly new, cost £21, take half. Also three-valve amplifier, C. Mark III, guaranteed perfect, £4.—SPENCER, Botolphs Corner, Sevenoaks

Three-Valve Telephony Receiver.—High-class with pickled valves. Telephones and Variable H.T. in mahogany case, £20. Seen any evening.—63, Ringford Road, Wandsworth, S.W.

Single-Valve Set, comprising panel with two condensers, filament resistance valve, high and low tension batteries, tuners, telephones, cheap, £6 15s.—37 Chancellor Road, W. Dulwich, S.E.21.

Mark II Transmuting Condenser, plug-in 25-1600 jars complete. What offers?—9 Marion Road, Southsea.

Wireless Enthusiasts! Charge your own accumulators with the "Derek" D.C. Charging Board. Rate of charge = 0.5 amperes. The most efficient and cheapest outfit on the market to-day. Limited number only. Complete with simple instructions, £2.—F. HOLME, Electrical Engineer, Dane Road, Sale.

Two-Valve Receiver, 40s. Transformers (two), 25s. each. Variable condenser, 15s. and 5s. Telephone, 10s. Three-valve Panel, 10s. Valve, 9s. Condenser, 1s. 6d. and other parts.—COOPER, 80, Royal Hospital Road, S.W.3.

Wireless Masts.—Improved Girder Type, Light and strong. 30 to 50 ft. at 1s. ft., 50 to 100 ft. at 1s. 6d. ft. Cash with order, carriage forward.—F. ARMSTRONG, Weybridge.

Loud Speaker Horns.—Guaranteed acoustically perfect. All sizes from 3s. 6d. Usual trade terms.—COVENTRY TANKERS, LTD. Hearsall Works, Coventry.

The Hestia Engineering Co. supply everything for wireless, see page xxxi.—32, Palmerston Road, Acton, London, W.3.

Valves! Valves! Valves! Thirty excellent receiving valves, to be cleared at 12s. each, worth double this price.—ROBBERS, 369 Hither Green Lane, S.E.

Agate Cylinders, etc., for loud speaking apparatus from JAMES R. GREGORY & Co., Mineralogists, 139, Fulham Road, S.W.3.

For Sale.—Four Fuller block 6 volt 45 amp accumulators, fully charged, almost new, cost £3 13s. 6d. each. will accept £2 10s. each.—FORWOOD, Limsfield, Surrey.

C. Mark III Three-Valve Amplifier, new and tested. £8.—Best, 98, Caversham Avenue, Palmers Green, N.13.

For Wireless Cabinets

SEND TO
J. A. JONES & CO., LTD.,
CABINET CASE MAKERS,
Progress Works, Park Road,
Aston, BIRMINGHAM.
Phone—EAST 234.

Send us your enquiries for
BOXES, CABINETS,
SPREADERS, CONDENSERS and parts, LEAD-IN-TUBES, and all accessories, to the Trade.

COMPETITIVE PRICES
PROMPT DELIVERIES
The Central Aircraft Co.
179 High Rd., Kilburn, N.W.6
Phone—Hampstead 4403-4 8018.

CONNOLLY BROTHERS,

Wireless Apparatus Manufacturers,
LOBSTOCK RD., URMSTON, MANCHESTER
Spares and Complete Components at Trade Prices.
Examples: 50' x 6' Double Wire Aerial, 40' Lead in, ready for fixing, 17/6. 7/22 Stranded Wire, 1/4d. per ft. 2" Reel Insulators, 4 1/2d. each. 4" x 12" Wound Inductance Coil, 4/9. 28's Enamelled Wire, 1/1b., 2/-, 1lb. 3/6. Carriage paid on orders over £2.

KEYSTONE WIRELESS SUPPLIES

WHOLESALE ONLY.
Ebonite, cabinet work, engraving, expert designers in amplifiers. Slab inductances, basket coils, etc. Switch arms, contacts, Terminals, Scales.
Low Prices Offices: High Finish.
33, Trinity Road, TOOTING, S.W.

HEATH & Co., Ltd.

Instrument Works, New Eltham, S.E.9 are prepared to undertake in their fully equipped works—Wireless Apparatus and Parts for the trade. Quotations given to Blue Prints. Immediate attention.
Phone—Lee Green 301. Wire—Polaris, London.

EBONITE "A" TYPE 4 PRONG VALVE HOLDERS

1/- each, post free.
WILKINSON,
LONSDALE RD., KILBURN, N.W.6
TRADE SUPPLIED. Established 1900

TRADE Grelco MARK

UNIQUE ALLE D

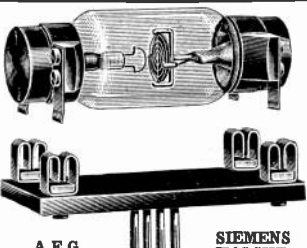

FOR PURITY

A.E.G. SIEMENS HALSKE.

Valves for Radio Reception. Best make and finish. Fil. current 3/4 volts. Plate, 60 volts. PRICE, 7/6. POSTAGE, 4d.
Adaptor A.G. as illustrated, to fit "R" Type holders.

PRICE, 3/-.
Postage 2d.



FILAMENT RHEOSTAT. THE RESULT OF MANY EXPERIMENTS TO PRODUCE AN ARTICLE WHICH WILL GIVE EVERY SATISFACTION. PHOSPHOR BRONZE ARM, WILL NOT WORK LOOSE, EASY TO FIX TO PANEL.
PRICE, 4/-.
Postage, 6d.

We supply every wireless accessory at the right price and welcome every prospective customer. You will not be pressed to buy. Illustrated Catalogue in preparation.

Grafton Electric Company
Showrooms—54, GRAFTON STREET,
TOTTENHAM COURT ROAD,
LONDON, W.1. Telephone—Museum 241.

THE WIRELESS WORLD EXCHANGE AND MART

ONE OF OUR SPECIALITIES

"SIDLEY"

High-Frequency Transformers.

Double-Grooved.	Highest Efficiency.
No. 1 - 300/530	} Postage 31. Extra. Complete Set of Five Post Free.
„ 2 - 500/920	
„ 3 - 900/1500	
„ 4 - 1450/2600	
„ 5 - 2400/4000	

We also manufacture in-between sizes 1a, 2a, 3a at same prices.

G. R. MARSON, LTD.

Electrical and Radio Engineers,
HALES STREET, COVENTRY.

CROWDER and READ

INSTRUMENT MAKERS

33, HUGHENDEN ROAD, HIGH WYCOMBE, BUCKS.

"Telespark" Receiving Set for Spark or Telephony, Complete, 400-4,500 metres. Double Slide Inductance, nickel plated, dust-proof. Crystal Detector 2,000 ohm Phones. Polished mahogany base, Aerial, Insulators. First-class finish. Send for particulars and photograph. Tested before dispatch. Price, £5 15s.

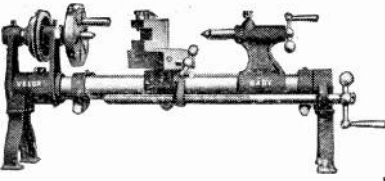

TOO CHEAP to be GOOD, yet the above is used in the manufacture of Electrical Instruments, Typewriter and Clock Parts. If good enough for these, WHY NOT YOURS?

Complete as illustrated ... £4 18 6
.. without Slide-rest £2 7 6

Stamp for Letter:

255, Westgate Road, Newcastle-on-Tyne.

WIRELESS WOODWORK.

(Wholesale only.)

WIRELESS CABINETS, CRYSTAL RECEIVING SETS, CONDENSER CASES, BATTERY CASES.

ALLIANCE ACCESSORY CO.,
4, Woburn Buildings, Upper Woburn Pl., W.C.1

We can quote low prices, combined with high-class finish and quality.—PROMPT DELIVERY.

BOOKS.

Technical Books.—Second-hand and New Books on every conceivable subject. Catalogue free. State wants. Books sent on approval. Books bought.—FOYLE, 121, 125, Charing Cross Road, London.

Radio Magazines, all the latest, "Radio World," 10d.; "Popular Radio," 10d.; "Radio Broadcast," 1s. 6d.; "Radio News," 1s. 6d.; "Science and Invention," 1s. 9d.; "Scientific American," 2s. 6d. Post free.—INTERNATIONAL NEWS COMPANY, LTD., 15, Bream's Buildings, London, E.C.4.

Radio Chart.—"Care and Maintenance of Accumulators," 1s. Post free.—Publishing Branch, G. D. HINKS, Hardington, Yeovil.

FOR SALE—continued.

Surplus.—Three-valve amplifier boxes with holders, resistance, battery box, etc. 7s. 6d. Valve holders, 10d. Telephone transformers, 6s. 6d. Transformer coils, 1s. H.T. Batteries, 36-volt, in polished case, terminals on ebonite, 9s. 6d. Crystal sets with telephones, 59s. Valve panel with resistance, 10s. 6d. .005 Condensers in polished case, 16s. Large terminals, 2s. 3d. doz.—SAUNDERS, Morland Road, Croydon.

Red-Seal High Tension Batteries are Guaranteed. 15v. Standard size. Sample, 2s. 11d., three for 7s. 6d.—LITCHFIELD Co., 12, Great Castle Street, W.1.

Steel Tubular Masts, 10 ft. 15s.; 20 ft., 25s.; 30 ft., 35s. Painted, galvanised guy wires, pulley, base plate. Also fixing irons supplied.—ABBEY ENGINEERING WORKS, Walton, Norfolk.

TRADE ENQUIRIES.

Manufacturers Lists and Terms—agencies, considered.—BROCK & Co., Tavistock Road Plymouth.

Work Wanted in the manufacture of wireless parts and accessories. Quotations to the trade from blue prints, prompt attention.—C. F. HART & Co., 23, Bateman's Row, Shoreditch, E.C.2.

To Wireless Firms and Amateurs.—Complete designs of wireless sets supplied, with blue prints if desired. Motors, generators, etc., all types and sizes designed and windings calculated. Send for quotations for your designs. Sound Technical advice given.—Write O. S. PUCKLE, Buckhurst Hill, Essex.

Manufacturers List and Trade Terms required.—COOK'S WIRELESS DEPOT, 9, Bedford Street, Ipswich.

WANTED.—Calibrated scales for Townsend wavemeters, also any other parts for same.—RIDGWAY RADIO, Wimbledon.

Wireless Dealers are advised to stock parts for making radio apparatus, as so many amateurs prefer to make their own instruments. There is also the additional profit in making your own sets from stock parts. Raw materials and partly machined parts can be had direct from the factory at the right price.—THE "NEWTONIA" WIRELESS FACTORY, 13/15, Whitcomb Street, London, W.C.2. Regent 643 and 5469.

SITUATIONS WANTED.

Advertiser (34), desires change, thorough business training and first class experience in the wireless trade. Would organise new business, or take any position where abilities would be appreciated.—Box P.5, BERTRAM DAY'S ADVERTISING OFFICES, 9 and 10, Charing Cross, S.W.1.

Energetic Young Man requires situation, London district, salesman demonstrator. Experience multi valves. Capable, lucid instruction radio.—84, Bruce Road, Welling, Kent.

SITUATIONS VACANT.

Manufacturer of High-class Wireless Apparatus and equipment, desires representatives on commission basis. Live men only—work could be handled with other lines. Give full details of territory covered, commission desired, etc., in confidence to G.W.M., Box P.6, BERTRAM DAY'S ADVERTISING OFFICES, 9 and 10, Charing Cross, S.W.1.

Wireless Designer required at once by large electrical engineering firm. Must have had sound electrical training and experience in the practical design of wireless apparatus. Apply stating full particulars with training experience and salary expected, to Box P.7, BERTRAM DAY'S ADVERTISING OFFICES, 9 and 10, Charing Cross, S.W.1.

MISCELLANEOUS

Great Success.—Morse Receiving easily mastered with the "Little Brick" (Prov. Pat. 13846). Sends any message any speed, and only costs a shilling to make. Full instructions and drawings, 2s. Instrument on ebonite, complete with instructions, 6s. post free. Further particulars stamped envelope. Satisfaction guaranteed.—GRIMSHAW (Dept. W.), Leigh Street, Golborne, Lancs.

Radio Accessories

High Class Aerial Insulators. Following best High Tension Electrical Practice. High insulation under all conditions. Drip Ring: 3 1/2" diam., weight 5 1/2 ozs., breaking load 860 lbs. Price 2/- each, postage extra. Ordinary barrel type, ditto, length 2 1/2", diameter 1 1/2", weight 4 1/4 ozs., 1/- each, postage extra.

Aerial Wire. Bare copper.
Size 3/20, 4/- per 100', post free.
Size 7/22, 5/- per 100', post free.
Size 7/20, 7/- per 100', post free.

Galvanised Steel Stay Wire.
Size, 3/16, 2/6 per 100', weight 7lbs. Carriage extra.

Galvanised Malleable Pulley Blocks.
Size 1 1/2" .. post free 1/2
Size 2" .. post free 1/8
Size 2 1/2" .. post free 3/-

LIGHT STEEL MASTS.

Any height, made of aircraft quality steel. Sound engineering structures at competitive prices. Full specification and prices on request.

Trade inquiries invited.
H. LONGTON, Radio Engineer,
43, Johnson Street, Westminster, S.W.1.

RADIOPHONE TUNERS,

200-1,400 ms. .. 38/-
Valve Panels for above .. 21/-
0005 Variable Condensers .. 18/6

Above 3 make an Ideal Receiver.

Broadcast Concert Coils, pair 2/-
Grid Leaks and Condensers .. 3/6
Fixed Condensers .. 2/6
5-Plate Condensers .. 6/6
2-Valve H.F. Amplifier Panels 32/-

Get our New Bargain List.

AMATEUR SUPPLIES,

134, COTEFORD STREET,
TOOTING, LONDON, S.W.

RESULTS

Whether as a source of practical information for the Amateur or as a valuable medium for every Advertiser, the best results are invariably obtained "Wireless World" through the

For full particulars and advertising rates apply to
BERTRAM DAY & CO., LTD.
Complete Advertising Service,
9 and 10 CHARING CROSS, S.W.1

Questions and Answers

COUPON

To accompany Questions sent in during the week commencing October 7th, 1922.

VOL. XI. NO. 1.

See Conditions on Page 33.

THE WIRELESS WORLD EXCHANGE AND MART

Your Case Work

Let us quote you for your wireless casework. We are specialists in this class of work and feel sure our workmanship and prices will interest you.

Phone L.W. 2720.

CARRINGTON & NEWBERY LTD.,
18/20, Normans Buildings, Old Street, E.C.

TO Electrical Firms ESTABLISHING Wireless Dept.

ENERGETIC Young Ex-operator and Officer. Possessing good technical knowledge and seven years' commercial experience. With proved organising ability. Having accurate knowledge of amateur requirements, desires position with a "live wire" firm. Excellent references. Will interview in London by appointment. Address, Box H 4, BERTRAM DAY'S ADVERTISING OFFICES, 9 and 10, CHARING CROSS.

THE A.B.C. OF WIRELESS.

By PERCY W. HARRIS.

64 Pages. Well Illustrated.
Price 6d. net. Post free 8d.

THE CONSTRUCTION OF AMATEUR VALVE STATIONS.

By A. L. M. DOUGLAS.

78 Pages. 55 Diagrams, etc.
Price 1 6 net. Post free 1/8.

THE RADIO EXPERIMENTERS HANDBOOK.

By P. R. COURSEY, B.Sc. (Eng.).

113 Pages. 99 Diagrams.
Price 3 6. Post Free 4/-.

MAGNETISM AND ELECTRICITY FOR HOME STUDY.

By H. E. PENROSE.

515 Pages. 224 Diagrams.
Price 6 - net. Post free 6/6.

ELEMENTARY PRINCIPLES OF WIRELESS TELEGRAPHY.

By R. D. BANGAY. Parts 1 and 2.

Price 4 - each. Post free 4/5.
Parts combined in one volume.
Price 7, 6 net. Post free 8/3.

THE WIRELESS PRESS LTD.,

12/13, Henrietta St., London, W.C.2

With Good Apparatus you
can Get Good Results

The "W.P." Morse Practice Key

Well Made—Well Finished
Thoroughly Reliable

Price 7/6 Post Free

THE WIRELESS PRESS, LTD.,
12/13, Henrietta St., London, W.C.2

GOVERNMENT SURPLUS.

200 Pairs of Government Headphones, Re-conditioned as new, guaranteed perfect, 6,000 and 8,000 ohms, 2/6 pair. A limited quantity of Variable Condensers, .0002, 8/- each. .0005, 11/6 each. .001, 15/- each (for Cabinet Mt., 1/- each extra). DOUBLE SLIDE TUNING COILS EBONITE ENDS, 12/- each. Sheet Ebonite, 3/9 lb. Valve Holders, best quality, 1/- each. 3-Coil Holders on Ebonite, 11/- each. Postage extra.—W. H. SALT, 161, YORK ROAD, BATTERSEA, S.W.11.

DON'T WORK in the Dark

If you have a Wireless Set and know but little of the principles of its working, you are missing a great amount of the interest and pleasure which the man obtains who has this knowledge.

It is nice to get good results but where is the satisfaction if you know not how they are obtained?

The Elementary Principles of WIRELESS TELEGRAPHY BY R. D. BANGAY

tells in the simplest possible manner, the theory and practice of wireless.

The Author makes the subject intelligible to persons who do not possess much technical knowledge, and at the same time it is brief and accurate.

The book is so arranged as to be useful as a reference book for students and amateurs. It is published in two parts

PRICE **4/-** EACH (post free 4/5)

or combined in one volume

PRICE **7/6** NETT (post free 8/3)

THE WIRELESS PRESS, LIMITED, DEPT. W.W., 12-13, HENRIETTA ST., STRAND, LONDON, W.C.2

FIVE

NEW WIRELESS PRESS BOOKS

Now Ready & On Sale at our
STAND No. 40

THE PERRY AUTO-TIME MORSE SYSTEM

An aid to the rapid acquirement of speed in the transmission and reception of the Morse Code. *16 pages.*

By F. W. PERRY.

6d. Net. Post Free, 7d.

THE WIRELESS TELEPHONE

WHAT IT IS & HOW IT WORKS

Including directions for building a Simple Valve Receiver for Wireless Telephone Broadcast.

128 Pages. Cr. 8 vo.

78 Diagrams and Illustrations.

By PHILIP R. COURSEY, B.Sc. (Eng.), A.M.I.E.E.

2/6 Net. Post Free, 2/10

MAST & AERIAL CONSTRUCTION FOR AMATEURS

Setting forth clearly all that the experimenting amateur requires.

88 pages.

Over 70 Diagrams and Illustrations.

By F. J. AINSLEY, A.M.I.C.E.

1/6 Net. Post Free, 1/8

CRYSTAL RECEIVERS FOR BROADCAST RECEPTION

Which includes directions for constructing a simple Crystal Receiver for Wireless Telephone Broadcast.

80 pages. Cr. 8 vo.

Over 70 Photographs and Diagrams.

By PERCY W. HARRIS.

1/6 Net. Post Free, 1/8

DIRECTION AND POSITION FINDING BY WIRELESS

A book which supplies a long-felt want.

376 pages. Demy 8 vo.

250 Illustrations.

By R. KEEN, B.Eng. (Hons.), A.M.I.E.E.

9/- Net. Post Free, 9/9

THE WIRELESS PRESS LIMITED

DEPT. W.W.

12-13, HENRIETTA STREET, STRAND, LONDON, W.C.2

JUST RECEIVED!**AMERICA'S LATEST PUBLICATIONS
FOR THE WIRELESS EXPERIMENTER.****HOW TO MAKE COMMERCIAL TYPE RADIO APPARATUS**

By M. B. SLEEPER. Price 4/- net (post free 4/3).
Size 7½" x 5" 159 pages, 96 Diagrams and Illustrations.

**CONSTRUCTION OF RADIO PHONE AND TELEGRAPH
RECEIVERS FOR BEGINNERS**

By M. B. SLEEPER. Price 4/- net (post free 4/3).
Size 7½" x 5" 142 pages, 74 Diagrams and Illustrations.

RADIO EXPERIMENTER'S HANDBOOK

By M. B. SLEEPER. Price 5/- net (post free 5/3).
Size 6½" x 4" 148 pages, 82 Diagrams and Illustrations.

THE ABC OF VACUUM TUBES USED IN RADIO RECEPTION

By E. H. LEWIS. Price 6/- (post free 6/5).
Size 7½" x 5" 132 pages, 48 Diagrams and Illustrations. "Written Especially for the Beginner."

**CONSTRUCTION OF NEW TYPE TRANS-ATLANTIC
RECEIVING SETS**

By M. B. SLEEPER. Price 4/- net (post free 4/3).
Size 7½" x 5" 113 pages, 47 Diagrams and Illustrations.

**THE WIRELESS PRESS, LTD., Dept. W.W.
12-13, HENRIETTA STREET, STRAND, LONDON, W.C.2**

Visit our Stand No. 40. All-British Wireless Exhibition, Horticultural Hall, Sept. 30th to Oct. 7th

Revised and Enlarged Edition

AMATEURS This is just
what you want

THE VEST POCKET
DICTIONARY

OF

TECHNICAL TERMS

USED IN

WIRELESS WORK

By Harold Ward

Over 1500 definitions

Price **2/6** net. Post free **2/9**

The Wireless Press, Limited

Dept. W.W.

12-13, Henrietta Street, Strand, London, W.C.2

**RADIO & MODEL
ENGINEERING**

Edited by

M. B. SLEEPER.

Price **7d.** monthly. Post free **8d.**

Subscription **7/-** per annum.

An American magazine of good quality devoted exclusively to the Construction of Radio Apparatus which can be built at home.

Each article is illustrated with excellent photographs and diagrams.

Several Receiving Circuits are given in every issue.

Sole European Agents:—

**The Wireless Press Ltd.,
12/13 Henrietta St., London, W.C.2**

WIRELESS BROADCASTING

③ Good receivers



Fellocryst

A simple and reliable crystal receiver for all wavelengths from 300 to 1500 metres. Complete with one pair 4000 ohms double headphones, 100 ft. aerial and insulators.

£3 : 7 : 6 (Postage: 1/6 extra)

Fellocryst Super

For fine tuning for all broadcasting wavelengths from 300-500 metres. Mounted in oak cabinet and highly finished, complete with one pair 4000 ohms double headphones, 100 ft. aerial and insulators.

£4 : 7 : 6 (postage 2/- extra)

Fellophone

2 VALVE RECEIVING CABINET For all broadcasting wavelengths from 300-500 metres. In solid oak cabinet complete with H.T. battery, 6 volt accumulator, 4000 ohms double headphones, 100 ft. aerial and insulators, but without valves.

£9 : 0 : 0 (carriage 2/- extra)

2 Mullard "ORA" valves for Fellophone - - - 30/- extra
Extra headphones complete, 30/- per pair.

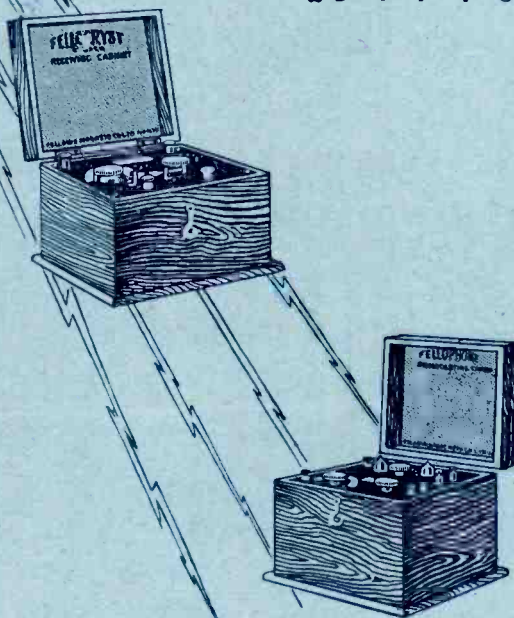

"for they are jolly good Fellows"

FELLOWS MAGNETO CO., LTD.

Telephone: Willersden 560-1.

LONDON, N.W.10.

Telegrams: Quixmag, Phone. London.

Visit our Stand No. 10.

All-British Wireless Exhibition, Horticultural Hall, Sept. 30 to Oct. 7th.

(E.P.S. 3)

SULLIVAN INSTRUMENTS

TO ALL WHOM IT MAY CONCERN

In order to better cope with the demand for "BROADCASTING" and other "WIRELESS" Sets and Components, I have arranged to form my business into a Limited Liability Company now in course of incorporation, under the title of

H. W. SULLIVAN (LTD.)

of which I am Chairman.

My Co-Directors are : Lieut. W. G. BISHOP, O.B.E., R.N. (retd.) (Late Chief Wireless Inspector, H.M. Signal School, Portsmouth), and S. R. DAVIE, Esq.

Secretary : J. H. DUNDAS.

Solicitors : Messrs. FIELD, ROSCOE & Co., 36, Lincoln's Inn Fields, W.C.2.

Pending removal to larger and more commodious Works under one roof, the manufacture throughout of all apparatus will continue to be carried on at Liverpool House, Middlesex Street, E.1, and Drayton Park, N.5. The Head Office is Winchester House, Old Broad St., E.C.2, as heretofore.

NOW READY.—Working Diagrams of Valve Amplifying Receiver Circuits, new and enlarged edition (No. 4). A number of further and extremely useful diagrams have been included in this edition.

All Instruments covered by the Marconi Company's Patents are made under licence from that Company.

Crystal Receiver Sets for Broadcasting Reception (Patents pending) Valve Amplifiers for increasing the range and sound volume of the above, as also for simultaneous reception by a number of listeners.

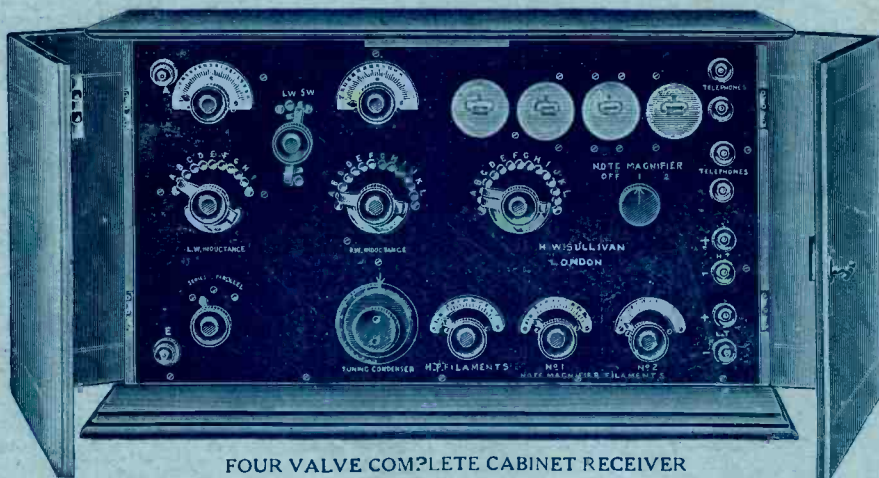

FOUR VALVE COMPLETE CABINET RECEIVER

Single and Multi-Valve Receivers, Amplifiers, Telephone Receivers (highly sensitive and distortionless) and every other description of the highest class Wireless Apparatus.

DEMONSTRATION AND SHOWROOMS : Liverpool House, Middlesex Street, E.1

(Two minutes walk from Liverpool Street and Broad Street Stations.)

TRADE TERMS ON APPLICATION.

Visit our Stand No. 49. All-British Wireless Exhibition, Horticultural Hall, September 30th to October 7th.

<p><i>Works.</i> "LIVERPOOL HOUSE" MIDDLESEX ST., LONDON, E.1 Phone: Avenue 4871</p>	<h1>HW SULLIVAN</h1> <p>TELEGRAMS: "DEADBEAT, STOCK, LONDON."</p>	<p><i>Offices.</i> WINCHESTER HOUSE LONDON, E.C.2., ENGLAND Phone: London Wall 3518</p>
--	---	---

WIRELESS WORLD

AND

RADIO REVIEW

No. 165. [No. 2.
VOL. XI.]

14th OCTOBER, 1922.

Registered at the G.P.O.
as a Weekly Newspaper.

The Tingey Self-Contained Cabinet Set

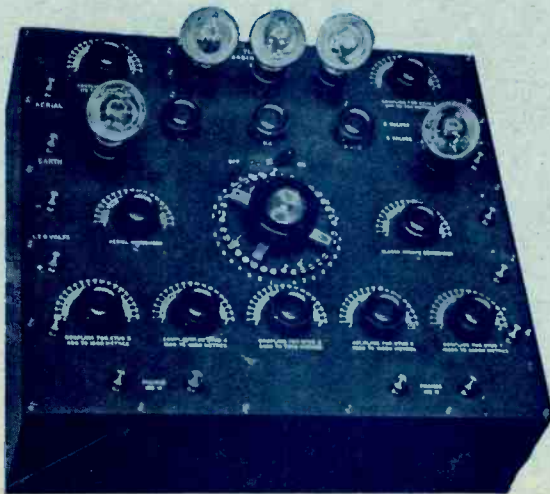

(REGISTERED DESIGN)

**This is the last word
in Self-Contained Sets.**

It is only necessary to attach Earth, Aerial, 6-volt Accumulator and Telephones or Loud Speaker to obtain loud clear signals or speech, on any wavelength. No Inductances are Tapped, entirely separate coils employed for each range of wavelengths, thus making the set particularly efficient on short waves.

IMPORTANT NOTICE

This Set conforms to all requirements
of the Postmaster-General.

*All Tingey Valve Apparatus is duly licensed under
Marconi Patents for Amateur use in Great Britain.*

W. R. H. TINGEY

Telephone—HAMMERSMITH 1916.

SPECIALIST IN WIRELESS,

92 Queen St., Hammersmith, London, W.6

Telegrams—"TINGO'DAR. LONDON."

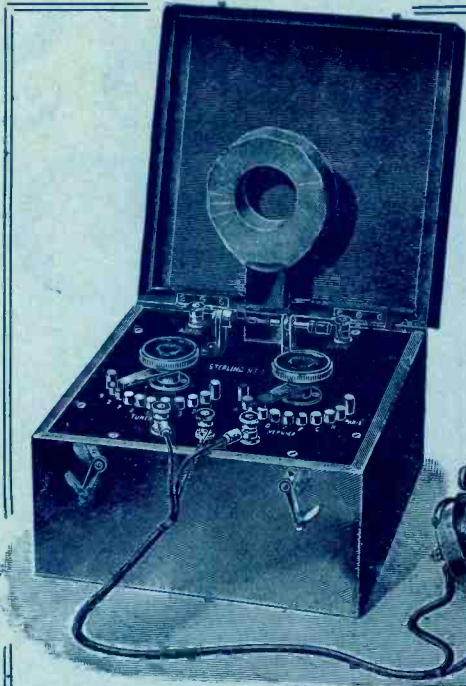

STERLING No. 1 CRYSTAL W/T RECEIVING SET

Specially designed for use in connection with the Wireless Telephony Broadcasting Scheme, and is suitable for a range of about 25 miles.

PRICE £7-12-6

**STERLING TELEPHONE
& ELECTRIC CO., LTD.**

210-212, Tottenham Court Road,
LONDON : : : W.1

Telephone No. : 4144 Museum (7 lines)
Telegrams : "Cucumis, Wesdo, London."

Works : DAGENHAM, ESSEX.

BRANCHES :

NEWCASTLE-ON-TYNE : 9, Clavering Place.
CARDIFF : 8, Park Place.

IMMEDIATE DELIVERY

DON'T WORK in the Dark

If you have a Wireless Set and know but little of the principles of its working, you are missing a great amount of the interest and pleasure which the man obtains who has this knowledge.

It is nice to get good results but where is the satisfaction if you know not how they are obtained?

The Elementary Principles of WIRELESS TELEGRAPHY ^{BY} R. D. BANGAY

tells in the simplest possible manner, the theory and practice of wireless.

The Author makes the subject intelligible to persons who do not possess much technical knowledge, and at the same time it is brief and accurate.

The book is so arranged as to be useful as a reference book for students and amateurs. It is published in two parts

PRICE **4/-** EACH (post free 4/5)

or combined in one volume

PRICE **7/6** NETT (post free 8/3)

THE WIRELESS PRESS, LIMITED, DEPT. W.W., 12-13, HENRIETTA ST., STRAND, LONDON, W.C.2

GAMAGES

LEAD IN AMATEUR WIRELESS
FIRST IN 1908—FOREMOST TO-DAY

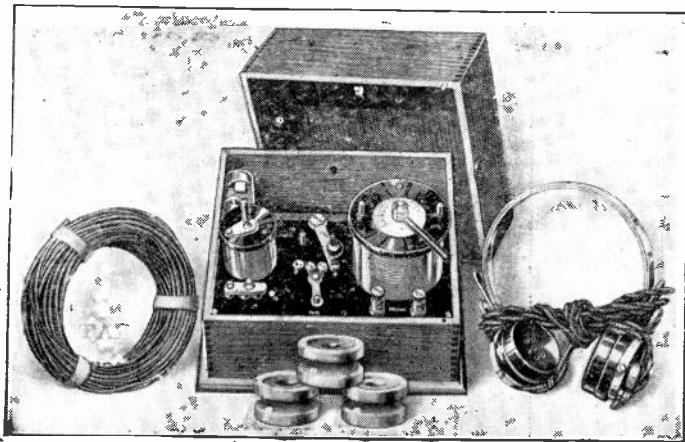

Gamage's Crystal Receiving Set

An efficient set designed to meet the requirements of the Postmaster-General with regard to wavelength. The tuning coil is wound with best quality wire and is tapped in four places. This, when used in conjunction with the Variable Condenser, which is of the best possible workmanship, gives a good variation of tuning. The crystal detector, designed to prevent dust from deteriorating the sensitivity of the crystal, contains our famous "Permanite" Crystal, which has given such excellent results. The task of finding a sensitive spot on the crystal is minimised by means of a buzzer. Will receive telephony for 30 miles and signals from Spark Stations using a wavelength of 300 500 metres for 150 to 200 miles. Complete in polished mahogany cabinet, with instruments mounted on polished ebonite, 'Phones, Aerial Wire and insulators ready for use

£5 : 5s.

GAMAGE'S WIRELESS CATALOGUE is full of interest to all Experimenters. Well illustrated and supplying full details, prices, etc. You can have a copy free for the asking at our Exhibition Stand (31), or at Holborn, or a card will bring it by post

"Sonus" Model A Combination

With these instruments, as illustration, it is possible for the serious experimenter to obtain really excellent results. The combination employed is perhaps the best-known of any, namely, 1 High Frequency Amplifying, 1 Detecting and 1 Low Frequency Amplifying valve. Long distance work becomes a pleasure when this combination is employed, for in the construction of the panels the greatest care has been exercised in the selection of Transformers, etc., so that the familiar "howls" frequently met with may be eliminated as far as possible. The design of these panels is such that either a plain detector, 1 H.F., 1 Detecting—1 Detecting, 1 L.F.—or all three together may be used simply by strapping the panels together by means of brass strips. The workmanship, efficiency and finish of these instruments cannot be surpassed, and satisfaction is assured. This set, when complete

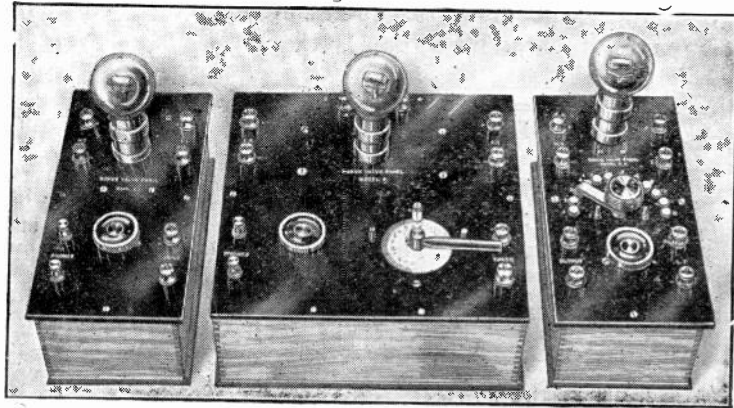

with H.T. battery, L.T. battery, 'phones, Aerial wire, insulators, etc., can be purchased at the extremely low cost of

£22 : 15s.

A. W. GAMAGE, LTD., HOLBORN, LONDON, E.C. 1

THE
W & M
Crystal
Detector

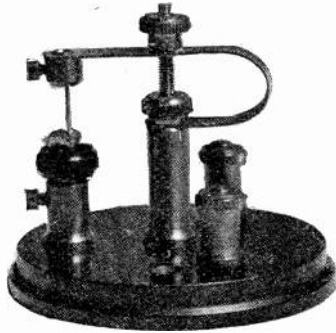

Registered Design No. 692248.
UNIVERSAL ADJUSTMENT.
INTERCHANGEABLE CRYSTAL HOLDERS.

Price 6/6 net, post free

FITTED WITH SILICON CRYSTAL.

Extra Crystal Cups 6d. each.

Absolutely the most efficient Crystal Detector yet produced, and the only one that will stand a considerable amount of vibration without requiring adjustment.

THE
W & M
Variable
Condenser

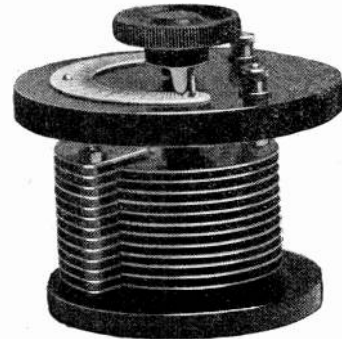

COMPACT, NEAT AND ACCURATE.
Only .025" Air space between each pair of Vanes.

MADE IN TWO SIZES.

.0005 mfd **18/6** each net

.001 mfd **24/6** each net

Post free

State whether for panel mounting or as separate unit.

Ebonite Tube Covers 1/6 & 2/- each extra

WE WILL SEND ON APPROVAL

and on the distinct understanding that if the buyer is in any degree dissatisfied with his purchase, he can return same within 24 hours and money will be immediately refunded.

ALL OUR APPARATUS is produced under the personal supervision of our Technical Director, Mr. Henry A. Machen, A.M.I.E.E. (late of Siemens Bros. and Co., Ltd.), whose experience in the design and manufacture of Wireless Apparatus extends over a period of Fifteen years. CATALOGUES FREE.

TRADE TERMS AND DISCOUNTS ON APPLICATION.

Manufactured solely by—

The Wainwright Manufacturing Co., Ltd.,
25, VICTORIA STREET, S.W.1.

Works: WALTHAMSTOW, Essex, and BIRMINGHAM.

Telegrams: Nominatus Vic London.

Telephone: Victoria 4319.

BURNDEPT
WIRELESS APPARATUS

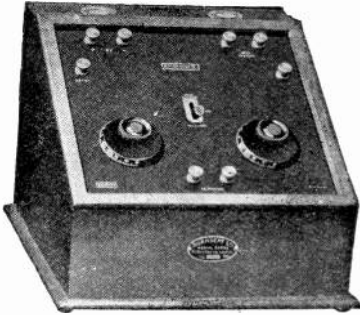

Ethophone II

REGISTERED TRADE MARK
 (2 Valve Receiver)

For Broadcast Reception.

Range 80-100 Miles.

The Last Word in Efficiency and Simplicity.

THE Ethophone II has a wavelength range of 300 to 500 metres. It is capable of receiving music, speeches, lectures, etc., transmitted from British Broadcast Stations over a distance of 80 to 100 miles and will actuate a loud speaker at 30-40 miles

The Ethophone II is supplied in a polished walnut cabinet with ebonite instrument board arranged desk style. Valves and H.T. Battery are inside cabinet away from harm. Separate terminals are supplied for headphones and for loud speaker with a switch to select. This instrument presents a very compact, well finished appearance, and is exceptionally efficient and silent in action. The circuits have been approved by the P.M.G. and make full use of reaction to increase range and signal strength.

Licensed under Marconi Patents.

PRICE, including Valves and H.T. Batteries **£28 0 0**

BURNDEPT, LTD. London Office & Showrooms: 15, Bedford St., Strand, W.C. 2
 AERIAL & EASTNOR WORKS: BLACKHEATH, S.E.3

W. A. C. SMITH
 236, Argyle Street,
GLASGOW,

are Sole Scottish Agents for the
Famous Burndept Receivers

MANCHESTER

61, BRIDGE STREET.

Phone : City 6192.

LIVERPOOL

10, SOUTH JOHN STREET.

Phone : Bank 4611.

FOR BURNDEPT APPARATUS

W. C. BARRACLOUGH

Sole North Western Agent.

*IN consequence of re-organisa-
tion and enlargement of our
works, all business will be
conducted in future from our
works address:—*

**THE “K.B.” RADIO
EQUIPMENT COMPANY**

17 and 19, Lonsdale Road, KILBURN, N.W.6

Telephone—WILLESDEN 3021

DUBILIER

A New Condenser for Wireless Receivers

THE DUBILIER TYPE 600 MICA CONDENSER

The illustrations show two patterns of this new condenser for wireless receiving circuits. The condensers have the same perfect mica insulation, the same high efficiency and the same permanence of capacity as the larger Dubilier Mica Condensers used in wireless transmitters. Distortion when receiving telephony is often due to bad design of the components of the receiver—therefore use efficient Dubilier Condensers in your receiver to obtain the best out of your set.

PRICES:

- Capacity below 0.001 microfarad - 2/6 each
- " " 0.001 & 0.005 " - 3/- ,,
- (inclusive)
- Condensers complete with Grid Leaks - 7/6 ,,

TRADE TERMS ON APPLICATION.

With Clips for Grid Leak.

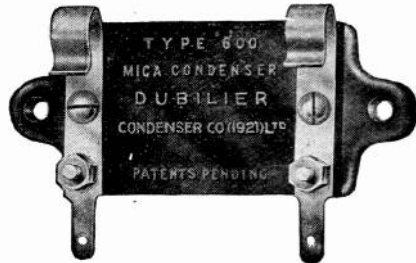

Without Clips for Grid Leak.

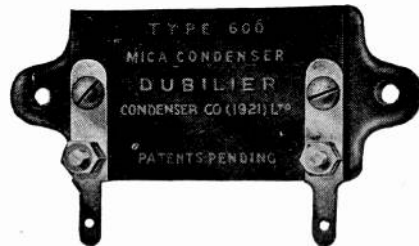

THE WAY TO DUBILIERS.

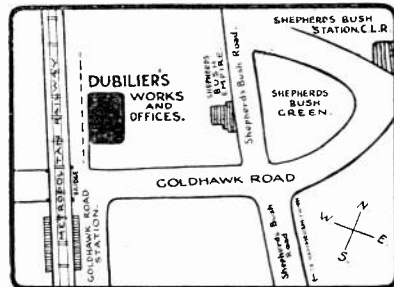

THE DUBILIER CONDENSER CO. (1921), LTD.,
DUCON WORKS, Goldhawk Road, Shepherd's Bush, London, W.12

Telephone—Hammersmith 1084.

Telegrams—Hivoltcon, Phone, London.

Code—Marconi International.

McGRUER

HOLLOW MASTS

are simple to fix on either roof or ground. They have the least wave-disturbing mass consistent with rigidity.

Our 30' Mast with folding joint weighs only 16 lbs. It is supplied complete with Truck, Sheave, Insulators, Stays, Strainers and Anchors.

We specialise in light masts and spreaders.

Masts of any height supplied.

Write stating your particular requirements and we will quote you by return

McGruer Hollow Spar Co. Ltd.

Commercial Road, Lambeth, S.E.1.

Telephone: Hop 718. Telegrams: Ollosparsh, Watloo. London.



**GENUINE
HELLESEN
DRY BATTERIES**



HIGH TENSION WIRELESS BATTERIES.

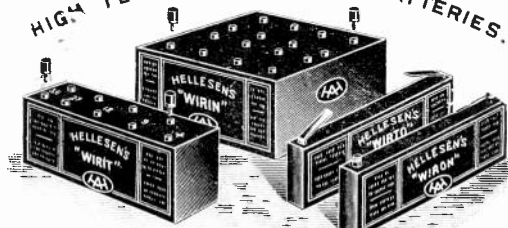

SPECIAL TRADE AND WHOLESALE TERMS

Code word.	Volts.	Details.	Price.
"WIRON"	15	Screw terminals	4/- each
"WIRTO"	15	Strip "	4/- "
"WIRIT"	36	2 insulated wander plugs	8/6 "
"WIRIN"	60	" "	14/- "

Wander Plugs and Terminals are included in the price of the Battery and are NOT AN EXTRA.

**KNOWN THE WORLD OVER AS
THE BEST.**

ALL LISTS FREE ON APPLICATION.

A. H. HUNT, LTD.

H.A.H. Works, Tunstall Rd., Croydon, Surrey.

"OOJAH" BASKET INDUCTANCES

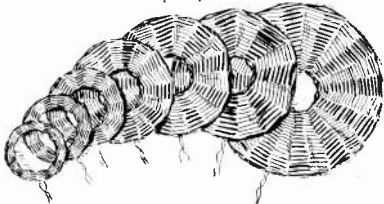

Set of 7, giving an approximate wavelength range of 150m to 4500m in conjunction with a .001mf. condenser.

PRICE **7/-** PER SET

POST FREE.

LIBERAL DISCOUNT TO FACTORS.

All "OOJAH" Inductances are wrapped in a transparent covering and sealed with the Registered Trade Mark "OOJAH."

The Seal is a guarantee of quality.

None are genuine without.

"OOJAH" Basket and Slab Inductances are being extensively copied, as most good things are, and purchasers are advised to not only specify "OOJAH" Brand in their orders, but to see that the seal is intact.

GREENSLADE & BROWN
LANSDOWNE ROAD, CLAPHAM, S.W.9

Telephones—BRIXTON 639 & 3251.

The most reliable and efficient
Batteries for Wireless Work are

D.P.

STORAGE BATTERIES

D.P. Batteries are made to fit almost any size of box. The output of our Works runs to hundreds of thousands of plates yearly.

Write us for particulars

The D. P. BATTERY CO., LTD.,
BAKEWELL — DERBYSHIRE
& 11 Victoria St., London, S.W.

AFA "DUROS" CELLS

The only accumulator supplied in a charged state. They retain their charge for very long periods.
Stocked by all leading dealers in "Wireless Supplies."

E. G. LIND & CO., 58a, BUCKINGHAM PALACE ROAD, WESTMINSTER, S.W.1

THE WIRELESS WORLD AND RADIO REVIEW

THE OFFICIAL ORGAN OF THE WIRELESS SOCIETY OF LONDON
A MAGAZINE DEVOTED TO WIRELESS TELEGRAPHY AND TELEPHONY

CONTENTS

The All-British Wireless Exhibition	- - - - -	39
Electrons, Electric Waves, and Wireless Telephony. By Dr. J. A. Fleming, F.R.S.	- - - - -	41
(continued)	- - - - -	
Meteorological Wireless Codes. By W. G. W. Mitchell, B.Sc., F.R.A.S., F.R.Met.S.	- - - - -	47

Contents continued on next page.

BRITISH EBONITE TO GOVERNMENT SPECIFICATION FOR BRITISH WIRELESS.

MANUFACTURED BY:

THE BRITISH EBONITE CO., LTD.

HANWELL

LONDON, W.7

APPLY FOR LIST "W."

SPECIAL QUALITY RODS, TUBES,
and SHEETS FOR WIRELESS.
ALL USUAL SIZES KEPT IN STOCK.
Grained Ebonite is a Speciality.

TELEGRAMS: "Ebonitical, Han, London."
PHONE: Ealing 1639.

WHOLESALE ONLY.

MEN IN THE WIRELESS SERVICES DESIRING RAPID ADVANCEMENT
 should train in spare time with the College which ensures this.
 "U.E.C." (Regent's Park, London, N.W.1) has in Twelve Years secured hundreds of successes by
 Individual Postal Training for Engineering Examinations and Professional Work.
 State YOUR ambition in confidence, to—SECRETARY'S DEPT. (Desk W.).
UNIVERSITY ENGINEERING COLLEGE, WESTGATE-ON-SEA, KENT,
 and expert advice with the New prospectus, No. 8, will be sent you without obligation.

CONTENTS *(Continued)*

Experimental Station Design. By F.H.H. <i>(continued)</i>	- - - - -	52
Exhibition Notices	- - - - -	55
Wireless Society of London	- - - - -	58
Notes	- - - - -	64
Correspondence	- - - - -	65
Calendar of Current Events	- - - - -	65
Wireless Club Reports	- - - - -	66
Questions and Answers	- - - - -	71
Share Market Report	- - - - -	78

THE WIRELESS WORLD AND RADIO REVIEW is published weekly on Saturdays.
 All correspondence relating to contributions should be addressed to THE EDITOR,
 THE WIRELESS WORLD AND RADIO REVIEW, 12-13, Henrietta Street, London, W.C.2.
 No responsibility can be taken for MSS. or photographs sent without stamps to defray
 cost of return postage.
 Editorial and Publishing Offices 12-13, Henrietta Street, Strand, London, W.C.2.
 Telegraphic Address: Radionic, Rand, London." Telephone No.: Gerrard 2807.
 Advertisement Managers, Bertram Day & Co., Ltd., 9 and 10, Charing Cross, S.W.1.
 Telephone No.: Gerrard 8063 and 8064

SUBSCRIPTION RATES.—

28s. per annum, post free. Single Copies 6d., or post free 7d.

Registered at the G.P.O. for transmission by Magazine Post to Canada and Newfoundland.

No Waiting. Delivery from Stock
Perry Head Phones
 4,000 Ohms **21/-** per pair
 Specially designed for Wireless Telephony, Receivers arranged in series, mounted in Aluminium Cases and fitted with extremely light and efficient Head Bands, and Twin Connecting Cords.
The JEARY Electrical Co., Ltd.
 8, LAMBETH HILL & 97, Queen Victoria St., London, E.C.4

" EIFFEL TOWER TYPE."
MASTS
 STRONG. LIGHT.
 WOOD LATTICE. EASY TO ERECT.
 ROT AND WATER PROOF.
 20 to 50 feet - - - 1/- per foot
 55 " 100 " - - - 1/6 " "
 FROM STOCK. CASH WITH ORDER.
WILKINSON, Lonsdale Road, Kilburn, N.W.6
 Same Address since 1900. Trade Supplied.
 Bankers—LONDON CITY AND MIDLAND, KILBURN, N.W.6.

VALVES

DELIVERY FROM STOCK.

RECEIVING.

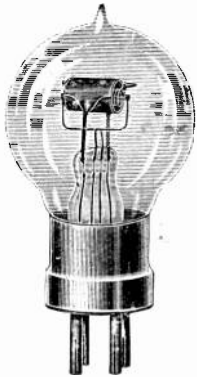

Type.	Filament Voltage.	Anode Voltage.	PRICE.
R	4	60	£0 17 6
R ₄ B	4	50	1 10 0
V ₂₄	5.2	36	1 4 0
Q	5.2	50	1 4 0
		(150 as amplifier)	
QX	5.2	50	1 4 0

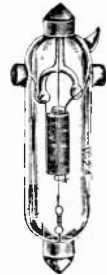

SPECIAL LOW TEMPERATURE VALVES.



Type.	Filament Voltage.	Filament Current.	Anode Voltage.	PRICE.
L.T.1	1.8	.4	36-50	£2 10 0
L.T.3	1.8	.11	„	„

TRANSMITTING.

L.T. 1.

Type	Filament Voltage.	Anode Voltage.	PRICE.
A.T.25	5.5	UP TO 1,000	£1 10 0
A.T.40X	7	„ 1,000	2 15 0

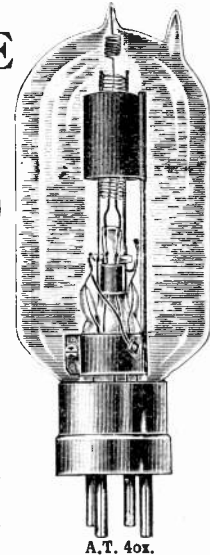

A.T. 40x.

THE
MARCONI SCIENTIFIC INSTRUMENT CO., LTD.

40 DEAN STREET, SOHO, W.1

TELEGRAMS: THEMASINCO, WESTCENT
 TELEPHONE: GERRARD 774

WATES

SPECIALITIES INCLUDE THE RELIABLE—

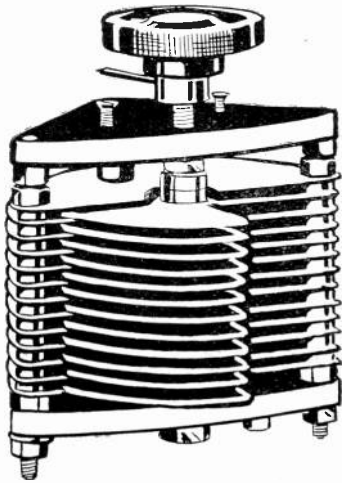

Panel Mounting Condenser

A first-class condenser exceptionally smooth in adjustment and manufactured with precision.

Capacity.	Panel Mounting.	In Mahog. Case.
*0003	15/-	20/-
*0005	17/6	22/-
*00075	20/-	24/-

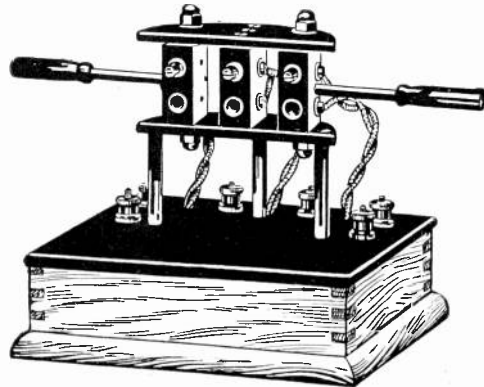

Triple Coil Holder.

Reaction is not allowed except on a tuned aerial circuit. This handsome triple coil holder is all you require to conform to the regulations. Price each **£1.** Coils for all wavelengths in stock.

Send 3 Stamps for Wireless list.

A FEW PROVINCIAL AGENCIES STILL AVAILABLE.

WATES Bros., 13/14, Gt. Queen St., Kingsway, W.C.2

Manufacturers of First-class Wireless Apparatus

ECONOMIC ELECTRIC LIMITED

ESTAB. 1896

Telephone: MUSEUM 1055.



PRICE 15/-

THE NEW THREE ELECTRODE VALVE

The "XTRAUDION"

is the latest development of the Thermionic Triode and gives exceptionally fine results.

Oscillates—Rectifies—Amplifies.

Filament consumption 5 amps at 4volts; Anode potential 50 volts. Standard Fitting, High Amplification, Characteristic, Silent Working.



Obtainable from the patentees
Economic Electric Ltd.

Wholesale Agent
Mr. H. S. TYLER,
23b Balham Hill, London, S.W.11

DAVIS & TIMMINS, LIMITED.

34a, York Road, King's Cross, N.1



SCREWS & TERMINALS FOR WIRELESS SETS.

Illustrated Lists sent Free on Request.

Tele. No.: NORTH 580.

Telegrams: CONDUCTIVITY, LONDON.

THE WIRELESS WORLD AND RADIO REVIEW

THE OFFICIAL ORGAN OF THE WIRELESS SOCIETY OF LONDON

No. 165 [VOL. XI.] OCTOBER 14TH, 1922.

WEEKLY

The Wireless Exhibition.

THE first All-British Wireless Exhibition has now closed, but the effect which it has produced yet remains as a permanent record of the advent of British

ance being far beyond anything anticipated. As already reported, the Exhibition was opened by Sir Henry Norman, M.P., and the accompanying photograph was taken after the



A Photograph taken just after the opening of the Exhibition.

Broadcasting, and the first real introduction of wireless telephony to the general public. The popularity which the Exhibition received was an excellent indication of public interest in wireless telephony, the attend-

Exhibition had been declared open. Among those present will be seen on the left Sir Henry Norman, M.P., Mr. L. F. Fogarty, Mr. L. McMichael, Mr. A. A. Campbell Swinton, Admiral of the Fleet Sir Henry B. Jackson,

Mr. F. Hope-Jones and Mr. Bertram Day, and, on the other side of the receiver, Mr. E. H. Shaughnessy and Captain Mullard.

A photograph shown on this page was taken during a visit to the Exhibition of the Maharajah of Baroda on October 3rd.

concerts gave the public an opportunity of becoming acquainted with the attainments of wireless telephony as applicable to broadcasting, and must have contributed considerably to the large amount of business transacted by the exhibiting companies.



A General View showing some of the Stands.

The receiving apparatus seen in the centre which was fitted with a frame aerial in its base, was used for rendering wireless concerts audible

It is gratifying to think that so successful an Exhibition, and so well attended, can be held in the field of Wireless, and it must only be



Distinguished Visitors at the Exhibition.

throughout the hall, and admirably demonstrated what can be achieved in the home by the installation of a receiver. The half-hour

regarded as a forerunner of exhibitions to be held in the future under the auspices of the Wireless Society of London.

Electrons, Electric Waves, and Wireless Telephony—II.

By Dr. J. A. FLEMING, F.R.S.

The articles appearing under the above title are a reproduction with some additions of the Christmas Lectures on Electric Waves and Wireless Telephony given by Dr. J. A. Fleming, F.R.S., at the Royal Institution, London, in December and January 1921-1922. The Wireless Press, Ltd., has been able to secure the serial rights of publication, and any subsequent re-publication. The articles are therefore copyright, and rights of publication and reproduction are strictly reserved.

6. EXPERIMENTAL ILLUSTRATIONS OF WAVE PHENOMENA.

It is possible with a certain type of apparatus to exhibit many interesting experiments with capillary waves on water which illustrate the properties of waves in general. As arranged by the author for lecture purposes this apparatus is as follows:—A circular shallow trough is constructed, having a plate-glass bottom and an exit tap. The trough may be about 8 ins. in diameter, and should be fitted with an overflow tube so as to keep a constant depth of about $\frac{1}{2}$ or $\frac{3}{4}$ of an inch of water in it. This trough is placed on the stage of a vertical

projection electric lantern so that light is sent through it and an image of any object on the surface of the water is focussed on the lantern screen. The trough is provided with a pair of fine supply tubes, by means of which drops of water coming from an elevated tank can be allowed to drop at regular interval on the water surface in the shallow tanks. As each drop falls on the water it will start a ring-shaped capillary ripple, but this ripple flits outwards so rapidly the eye cannot follow it. We can, however, render it visible as follows. In front of the lantern objective we place a metal disc with 4 or 6 holes in it. The disc must be caused to rotate by a pulley and

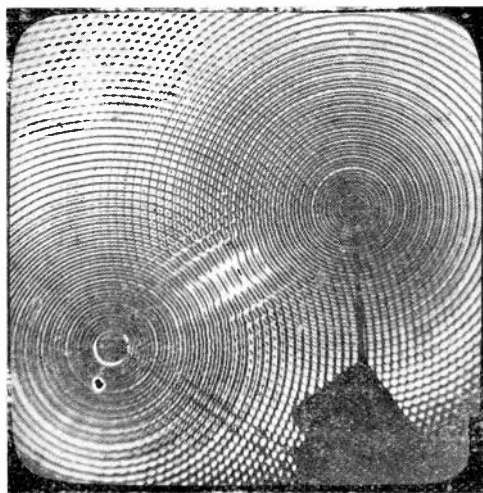
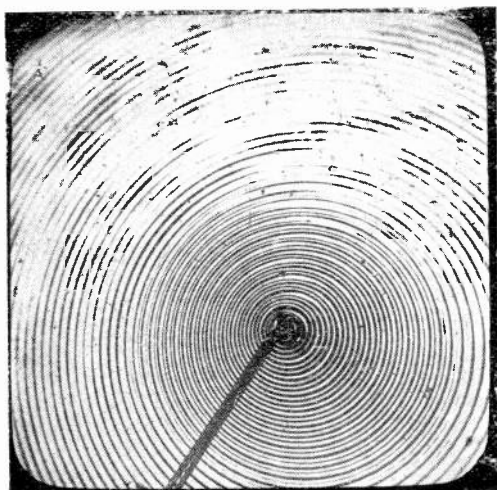

Fig. 9. The shadows of capillary ripples created on water by drops of water falling on to the surface at regular intervals of time.

belt so that as it revolves it periodically eclipses and allows the light from the lantern to pass as in a cinema projector lantern. The result is that the image on the screen is seen intermittently. If, now, the rate at which the water drops fall on the water surface is so adjusted that the interval between two drops falling is equal to the interval between the passage of two holes in the disc in front of the lantern objective lens, we shall see on the screen an image of a set of concentric annular ripples, which will appear to be stationary or can be made to expand slowly outwards by properly adjusting the speed of the stroboscopic disc (see Fig. 9).

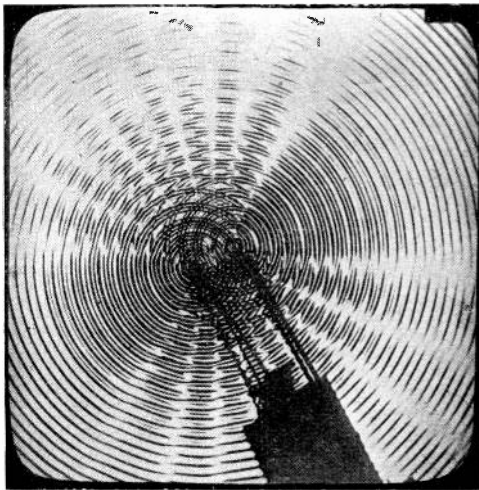

Fig. 10. The interference of two sets of circular capillary ripples or wavelets. The white portions in the diagram are the places in which the two sets of waves have interfered and destroyed each other.

With this apparatus we can show a number of instructive experiments. If we arrange two dropping tubes so as to drop water at places an inch or two apart in the tank and adjust the drops so that they fall simultaneously, then we shall see on the screen a complex pattern of ripples. Each set of drops makes its own concentric set of annular wavelets. It will then be clear that at certain places the humps of one set of waves will coincide with the humps of the other set, and the elevation of the water at those places will be increased. In the same way the hollows or depressions of one set will be in coincidence

with those of the other, and will increase the depression. On the other hand there will be some places lying along certain lines at which the humps or crests of one set of waves will coincide with the hollows or troughs of the other set, and hence at these places the waves will extinguish or nullify each other. This effect is called the *interference* of waves, and is of great importance in wave phenomena in general (see Fig. 10). In fact, whenever we can obtain evidence of interference we can say with almost complete certainty that we are dealing with a case of wave motion. In our lantern tank experiment the lines along which interference is taking place from waves diverging from two centres are lines which are parts of curves called hyperbolas, because it is a property of such a curve that the difference of the distance of any point on the curve from two fixed points called the foci is constant. The condition of interference is that the distance of the point at which it takes place from the two wave sources must be a certain odd multiple of half a wavelength, and, moreover, the waves must start in the same phase at the same instant from the two sources.

Another effect well shown by this ripple apparatus is the reflection of a wave. For this purpose we put into the shallow trough a little flat wall of metal which stands up above the water a little. The dropping point is arranged at a little distance from this wall so that the miniature waves strike against it like sea waves on the coast striking a sea wall. We then see on the screen a double set of ripples, one set approaching the wall and another set moving away from it. This second set appear to diverge from a point as far

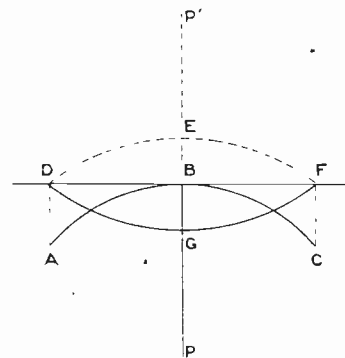

Fig. 11.

behind the wall as the actual source point is in front of it. The reason for this will be evident on looking at the diagram in Fig. 11.

Let P be the origin from which the waves diverge and let ABC represent the crest of one annular wave just reaching the wall DBF . If the wall did not exist that wave would move onwards and an instant later would be found in the position DEF , which is part of a circle whose centre is at P . Since, however, all parts of the wave ABC are turned back or reversed in motion on striking the wall, the actual reflected wave is found at DGF . It is obvious that this is part of a circle whose centre is at P' , which is a point as far behind the wall DBF as the actual origin P is in front of it. The actual process of reflection of the wave is as follows:—

Consider one circular crest ABC (see Fig. 12), which is advancing to the wall DF .

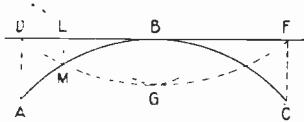

Fig. 12.

As each point on that wave reaches the wall it will create a vibration in the water, which causes a secondary wave to diverge in circles from that point. Thus, when the front of the wave touches the wall at B , a circular wave begins to diverge from B . A little later a point M on the wave reaches the wall at L , and from that point another secondary disturbance originates. Similarly, when a point A on the original wave reaches the wall at D , it gives rise to a secondary wave diverging from that point. The wave originating at B gets the start over that originating at L and that at L over the wave starting from D .

The line DGF (dotted) which touches all these secondary waves at any instant is called their *envelope* and is the resultant reflected wave. Everyone knows that in the case of a reflected image in a looking glass, the image of the object appears to be as far behind the mirror as the real object is in front of it. This is simply a consequence of the fact that the reflected image is caused by light which diverges in spherical waves of a certain kind from every point on the object, and the observer into whose eyes these reflected rays enter sees the image as a collection of radiant points,

each of which appears to be as far behind the mirror as the corresponding radiant point in the object is in front of it.

Many optical illusions and conjurors' tricks depend upon this principle. Thus, for instance, we can easily create the illusion of a candle appearing to burn inside a decanter of water as follows:—

Set up vertically on a table a very clean sheet of clear plate-glass and place a lighted candle at a place near it. The candle can be shaded by a little screen so as not to be seen directly but only as a reflected image in the glass surface. This image appears to be behind the glass. At that point place a large glass decanter full of water and when looked at from a certain direction, the illusion will be complete of a candle appearing to burn inside a bottle of water. (Fig. 13.)

Another important property of surface waves and of waves in general can be demonstrated by the same apparatus, viz., the refraction of waves.

If we have a set of parallel plane or straight waves which are moving in one material or medium and advancing in an inclined direction to a straight boundary between that medium

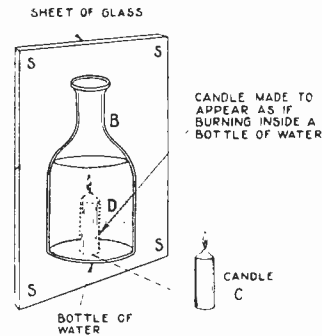

Fig. 13.

and one in which the waves move with a different velocity, then on crossing the boundary the direction in which the waves are advancing is changed. Thus, let AB be the crest line of a straight wave advancing parallel to itself towards a boundary line DF between two media 1 and 2. Let us suppose that the waves travel more slowly in medium 2 than in medium 1. Then when the left-hand end A of the wave AB passes the boundary it will proceed more slowly (Fig. 14.) Hence it will only have reached a point C and travelled

a distance AC in the time that the right-hand end B will have travelled over a greater distance BD and reached the point B . Therefore the line of the wave front, viz., AB , will be slewed round into CD on crossing the boundary into the position DC . This is called the *refraction* or bending of a wave.

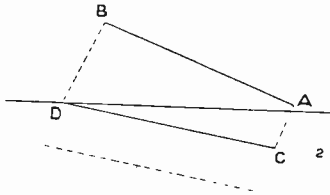

Fig. 14. A diagram illustrating the refraction of a wave.

It is this bending of the wave front when passing across the boundary of two media in which the wave has different velocities which determines so many familiar optical phenomena such as the apparent bending of a stick when placed half immersed in an inclined position in the water.

The refraction of ripples can be shown with the above described lantern apparatus as follows:—

A semi-circular thick sheet of glass is provided which fits into the lantern tank and

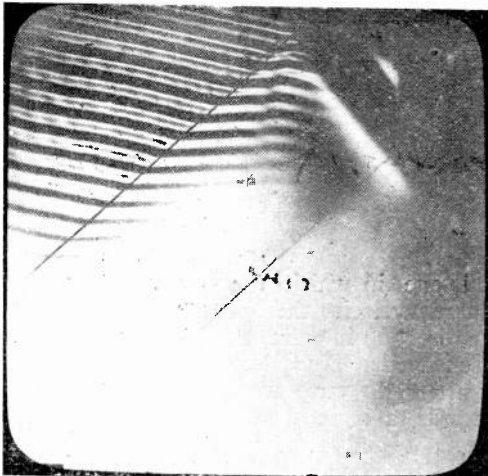

Fig. 15. A diagram showing the refraction or bending of waves in passing over from one medium to another in which they have a different velocity of propagation.

makes one half of it more shallow than the other. One dropping tube is arranged so as to send out ripples from a point in the deeper part of the tank. These ripples spread out in circular rings. If the water level is adjusted so that over the shallow part of the tank it has a very slight depth, not more than a millimetre or so, then over this part the ripples will travel more slowly than over the deeper portion. Hence, when the ripples pass over the boundary line it will be seen, on regulating the speed of the stroboscopic disc as above described, that there is a discontinuity or change of direction of the expanding annular ripples. On the

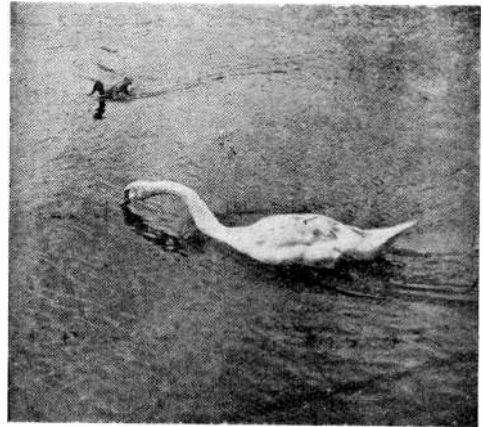

Fig. 16. Echelon waves on water produced by the motion of a swan.

shallow part the form and curvature of the ripples is such that they appear to diverge, not from the actual dropping point, but from another point situated a little way from it (see Fig. 15).

7. WAVES PRODUCED BY SHIPS.

In concluding this part of our subject, attention may be directed to a very important class of surface waves on water, viz., those made by ships, boats, and aquatic animals in moving over the surface.

If we look at any swan or duck, swimming on a pond, especially if the bird is moving quickly, we shall see a set of ripples on either side of it, each comprising a number of wavelets set one behind the other and all included between two lines, starting from the bird's breast, which are inclined to one another at an angle of $38^{\circ} 56'$. These little wavelets overlap

and are said to be arranged "in echelon," a term derived from the French word *échelle*, for steps like a ladder (see Fig. 16).

They are probably best seen when a boy's model ship is sailing over smooth water on a pond, and it will then be noticed that in addition to the echelon waves, which start from the bows, there is another set of transverse waves behind the ship. In fact, the echelon waves and transverse waves all form part of one complete system of ship waves (see Fig. 17).

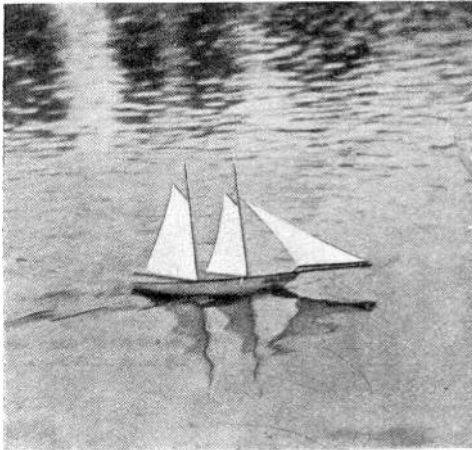

Fig. 17. Echelon waves on water produced by the motion of a boy's model ship.

This system of waves above mentioned is all included between two inclined lines, which start from the ship's bows. A construction which gives this angle is as follows:—Describe a circle and draw through its centre *C* a diameter *AB*. Produce this line *AB* to a point *S*, such that the length *BS* is equal to *AB*. Then from the point *S* draw two lines, called tangents, to touch the circle at points *D* and *E*. Then the angles *DSB*, *ESB*, are each $19^{\circ} 28'$, and the angle *DSE* is $38^{\circ} 56'$ (see Fig. 18).

Let us consider for a moment how these waves are formed. When the ship moves forward through the water it gives a push to the water which creates an elevation and starts a wave. This push being continually repeated as the ship progresses creates a group or family of waves. One of these waves may be considered to be attached to the ship's bows, and to move forward with it. It has already been pointed out that in the case of surface waves on water the velocity of a group of

waves is half that of a single wave. Hence, if when the ship is at *A* it starts a group of waves, the middle point of this group will have travelled only as far as *B* by the time that the ship itself, carrying one wave with it, has travelled double that distance and arrived at *S*. Hence we see that a ship moving over the water is followed by an ever lengthening train of waves, the group velocity of which is half that of the ship.

The subject of wave production by ships is of enormous practical importance, because the creation of waves absorbs or requires, an expenditure of energy. In the case of a steam, petrol or electric ship that energy is derived from the coal, petrol or other source of driving power. Hence, other things being equal, the less the ship makes waves the less the dissipation of energy. Great attention has therefore been given to the design of ship's hulls with the object of determining what form has the least wave-making quality.

All the power taken up in wave-making travels away from the ship and is wasted, and hence to obtain the greatest speed for the least expenditure of propelling power, the form of the ship must be such as to create surface waves as little as possible.

In addition to the power absorption in wave-making there is also an expenditure in making eddies or little vortices in the water, and at low speeds the chief source of energy waste is in overcoming frictional resistance between the water and the hull of the ship.

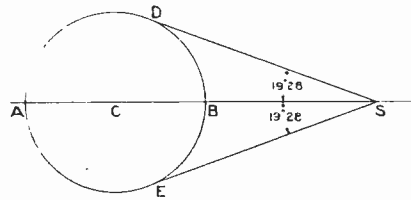

Fig. 18.

This last can be reduced by making the hull smooth, and also free from projecting studs or rivet heads, all of which also tend to create eddies in the water and increase the skin resistance and therefore energy loss. It is now the custom to predetermine the effects of any proposed form or design of ship hull, on the power required to drive it through the water at a given speed by means of experiments made on large scale models dragged through the water in a very long tank called a testing tank. The models are made to scale in paraffin

wax, as this material can easily be shaped to any required form and then melted down and used over again.

The model is then dragged through the water in tank at a given speed, and by means of a sensitive recording dynamometer the power exerted is exactly measured.

As the subject of ship design is not one with which we are here concerned the mode of conducting these tank experiments need not be discussed. The reader who desires more information may be referred to the author's book, "Waves and Ripples in Water, Air, and Aether" (published by the S.P.C.K.), or to Lord Kelvin's "Popular Lectures and Addresses," Vol III (Macmillan & Co.), see the "Lecture on Ship Waves."

8.—ROTATIONAL AND IRROTATIONAL FLUID MOTION.

There is one point in connection with the motion of liquids to which it may not be amiss to make a brief reference. A liquid is capable of motion in two ways, one of which is called *irrotational* motion and the other *vortex* motion.

In the irrotational motion every particle of the liquid moves without rotation. If we imagine any small spherical portion of the liquid to become solidified, and that we could make a mark on this little solid sphere, and watch it as it moves with all the rest of the liquid, we should find the marked spherule moving so as always to keep its marked end pointing in one constant direction. In other words, although it may possess a progressive motion, it is not revolving in any way, or has no rotational motion. On the other hand, if the motion of the liquid is such that the selected spherule turns round continually so as to face in different directions as it progresses, and as the moon does in revolving round the earth, then the motion is called rotational. If the liquid particles rotate so as always to face towards a certain line called a vortex line, then this motion is called vortical.

We can see a vortex of water formed every time we pull up the waste-plug of a bath or wash-hand basin full of water. The water swirls round, forming what is called a whirlpool or eddy, or vortex, in which a certain part of it is revolving round an axis rotationally. A vortex in a liquid must either have its two free ends on the liquid surface or else it must form an endless vortex or vortex ring.

We can see the former type of vortex formed by drawing a teaspoon, with the bowl half immersed, quickly through a cup of tea. On the edge of the spoon will be noticed two little whirlpools of liquid which move with the spoon. These are the ends of a vortex which extends from one whirlpool to the other round the edge of the immersed part of the spoon.

On the other hand, we see an endless vortex produced in those smoke rings which many cigarette smokers can blow from the mouth or end of the cigarette.

In this case the smoky air is revolving round a circular or closed line in such fashion that the motion on the inside of the ring is in the direction in which the ring as a whole is moving forward.

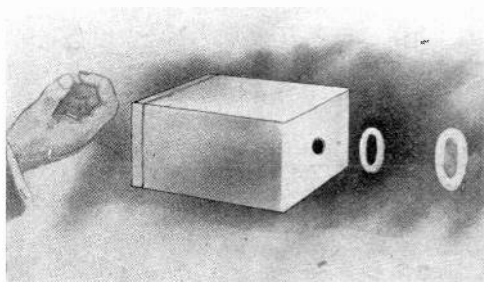

Fig. 19. Smoke rings or circular vortex rings produced by tapping the back of a paper box filled with smoke and making their exit out of a hole in the front.

They can better be made as follows:— Make a little cubical paper box of rather stiff paper, the side of which may be 3 or 4 ins. in length. Cut a circular hole about 1 or $1\frac{1}{2}$ ins. in diameter in the centre of one side (Fig. 19). Fill the box with tobacco smoke by puffing a cigarette into it. Then give a smart tap on the side of the box opposite to the hole. A smoke ring will emerge and fly through the air. A careful examination of the ring as it moves will reveal the peculiar kind of rotary motion which is taking place in the ring. The smoke merely makes evident the air motion, but the vortex ring is produced and exists when the box is tapped, whether it is full of smoke or not. We have such vortex rings produced whenever a jet of gas or liquid moves through an undisturbed mass of gas or liquid.

(To be continued.)

How to Prepare a Synoptic Weather Chart

By W. G. W. MITCHELL, B.Sc., F.R.A.S., F.R.Met.S.

THE synoptic chart gives a "bird s-eye" view of the weather conditions at a certain instant of time over a large area. Such charts, showing barometric pressure and the more important elements of weather, appear in several of the daily newspapers, but, as previously pointed out in these articles, the

on this subject (pp. 819-822, *Wireless World and Radio Review*, September 23rd) in conjunction with the additional specifications given below are all that is required for this purpose. After a few weeks' practice, when the amateur becomes familiar with the code, the translating of the coded message to the map may be done very quickly.

We will take, as an example, the synoptic data message issued by the Air Ministry on August 20th last at 1900 G.M.T. The message, as sent out on 4,100 metres C.W., was as follows:—

01.	12622.	30055.	01178.	84356.	94279.
11.	17824.	21157.	01287.	06196.	01629.
93.	37532.	21211.	12067.		
44.	20021.	30165.	00068.	00009.	00690.
10.	17424.	41256.	00177.	43289.	0047-
92.	40820.	11113.	00186.		
15.	17724.	11163.	00277.	69696.	00070.
61.	21124.	10164.	91077.	00000.	00680.
91.	53422.	63411.	00558.	06194.	
07.	15804.	20156.	02088.	82246.	00080.
78.	20304.	30166.	51186.	00009.	00380.
94.	35200.	05508.	00670.		
03.	13224.	31054.	00268.	09053.	00260.
95.	36918.	45108.	31668.	75600.	



Fig. 1. Code No. 1. Cirrus (ci).—Mares' tails with tufted ends (Cirrus-uncinus), often at about 30,000 ft.

information contained therein is several hours "old" by the time it appears in print. It is our intention in the present article to deal with the decoding and plotting of a synoptic data message. For ordinary purposes, we plot only the essential elements of barometric pressure, wind, weather, temperature and barometric tendency. The codes given in the last article

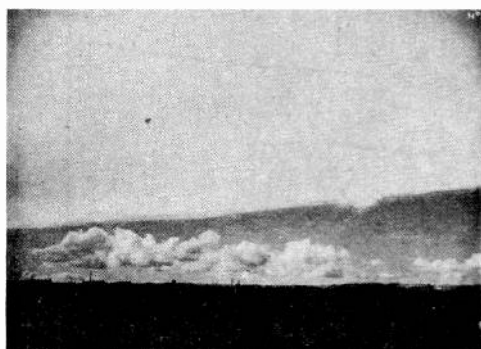

Fig. 2. Code Nos. 2 and 8.—At top, Cirro-Stratus (Ci.-St.). Uniform sheet of very high cloud, 30,000 ft. About 25,000 ft. beneath is, at bottom, Fracto-cumulus (Fr.-Cu.). A string of rugged cumulus at about 6,000 ft.

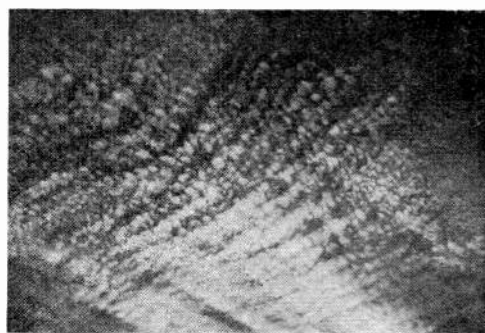
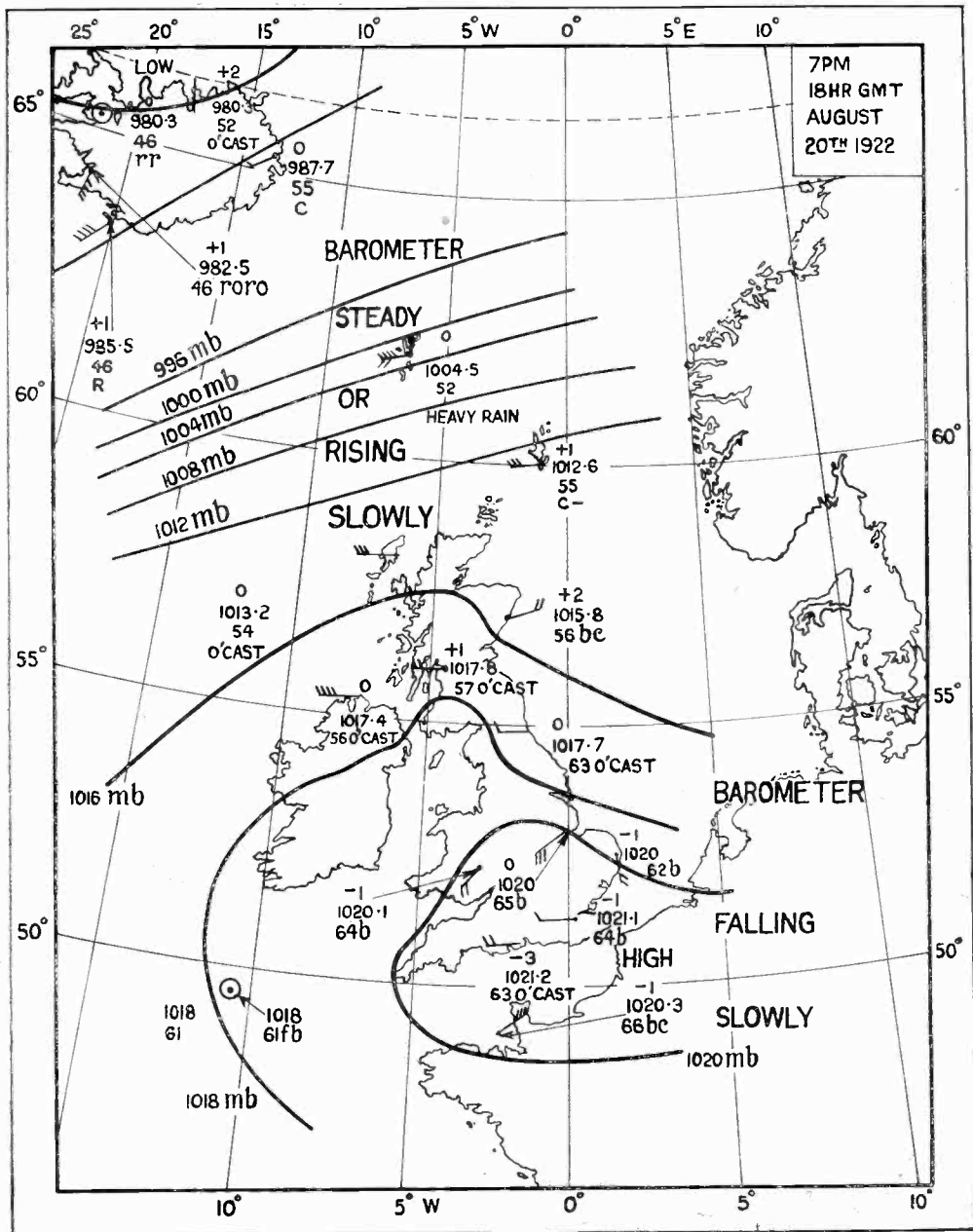

Fig. 3. Code No. 3 (Ci.-Cu.).—The Mackerel Sky. The highest form of cloudlets in waves, 20,000 to 25,000 ft.

45.	20016.	30062.	51068.	82826.	00060.
96.	39120.	63508.	31599.		
54.	20120.	20064.	61077.	81816.	00690.
74.	21222.	21063.	53275.	69694.	00070.
Pilot.	32.	23214.	32120.		
	74.	12603.			
Ships.	14960.	01023.	18009.	08176.	12137.
	50106.	44884.	aaa	14959.	01157.
	28167.	12182.	61614.	69005.	73998.



GENERAL INFERENCE TO BE DERIVED FROM ABOVE SYNOPTIC CHART.

The main Icelandic depression now lies beyond the Arctic circle, and an anticyclone is situated over the English Channel. In the north, fair to cloudy weather, with local showers, is likely, and in the south a fair and rather warm day after early morning mist, and probably local drizzle.



Fig. 4. Code No. 4.—Alto-Cumulus (A.-Cu.). Layer of large cloudlets in waves at middle height.



Fig. 5. Code No. 5.—Alto-Stratus (A.-St.). Sheet at middle height, between 10,000 and 25,000 ft.

The symbolic form of the first part of the message down to the word "pilot" is :—
l_nl_n BBDD FwwTT cbWVH ALaNH
RRMMr (or RRSV_rr), and for ships QLLLx₁
llllx₂ BBDDx₃ Fvkdx₄ wwGGx₅ TTtx₆
CNwr_x y₁y₂y₃y₄z.

Concerning ourselves only with the symbols underlined, which embrace all that can be conveniently plotted on the map without overcrowding, the translation becomes :—first line (first group) station Lerwick—see key-map in last article ; (second group) barometric pressure 1012.6 mb., wind from W.-S.W. ; (third group) wind force 3, cloud increasing, temperature 55° F. ; (fourth group) positive barometric tendency amounting to 1 mb. during preceding 3 hours, past weather cloudy ; (fifth group) N=5/10th of sky covered with cloud. Second line (first group), station Renfrew, etc., etc.

drizzle." The letters have the following meanings :—

- b=fine.
- bc=fair.
- c=cloudy.
- d=drizzle.
- f=fog.
- h=hail.
- i=intermittent (occasional).
- j=adjacent (i.e., in vicinity of station.)
- KQ=line squall.
- l=lightning.
- o=overcast.
- p=passing showers.
- r=rain.
- s=snow.
- t=thunder.
- tlr=thunderstorm.
- ⊕=halo.
- ψ=gale.

The following additional letters are sometimes used in maps :—

- e=wet air without rain falling.
- g=gloomy.
- m=mist.
- q=squally.
- u=ugly, threatening.
- v=extreme visibility.
- w=dew

Present Weather Code (ww).

First Fig.	0	1	2	3	4	5	6	7	8	9	
Second figure.	0	bc—	bc	bc+	bcjp	bc⊕	bc/f	bc/r	bc/s(h)	bctl	bc/tlr
	1	co—	co	co+	cojp	co⊕	co/f	co/r	co/s(h)	cotl	co/tlr
	2	fb	fo	ifb.	ifo	fb—	fo—	ffb	ffo	fb+	fo+
	3	pr ₀	ph ₀	prs ₀	ps ₀	PR—	PR	PR+	PH	PRS	PS
	4	d ₀	d ₀ d ₀	d ₀ +	d—	d	dd	d+	D—	D	DD
	5	r ₀	r ₀ r ₀	r ₀ +	r—	r	rr	r+	R—	R	RR
	6	s ₀	s ₀ s ₀	s ₀ +	s—	s	ss	s+	S—	S	SS
	7	rs ₀	rs ₀ rs ₀	rs ₀ +	rs—	rs	rsrs	rs+	RS—	RS	RSRS
	8	h ₀ (r ₀)	rh ₀ rh ₀	h ₀ (r ₀)+	h(r)—	h(r)	hrh	h(r)+	H(R)—	H(R)	RHRH
	9	tlr ₀	tlrh ₀	tlr	tlrh	TLR	TLRH	TLRψ	TLRHψ	KQ	KQH

A solidus (/) such as occurs in the combination "bc/r" separates weather at the time of observation from the preceding weather ; bc/r thus indicates "fine or fair after rain or

x=hoar frost.
 y=dry air (humidity below 60 per cent.).
 z=haze.
 Continuity is indicated by repetition of

letters. Thus rr=continuous rain. Intensity is indicated by employing capitals; thus R=heavy rain, and RR=continuous heavy rain. A suffix ₀ means "slight"; thus rs₀= slight sleet. + means increasing, and - diminishing, in intensity or amount. KQ= line squall (*i.e.*, very heavy squalls with change of wind direction and fall of temperature).

Precipitation. $\left\{ \begin{array}{l} 5 = \text{Passing showers.} \\ 6 = \text{Rain or drizzle.} \\ 7 = \text{Snow or sleet.} \\ 8 = \text{Hail or rain and hail.} \\ 9 = \text{Thunderstorm.} \end{array} \right.$

Code figure.	Quarter of Globe (Q).		
	Latitude	Longitude	
1	N.	W.	} Barometer in millibars.
2	N.	E.	
3	S.	W.	
4	S.	E.	
5	N.	W.	} Barometers millimetric.
6	N.	E.	
7	S.	W.	
8	S.	E.	



Fig. 6. Code No. 6.—Strato-Cumulus (St.-Cu.) Layer of clouds in irregular order below 7,000 ft.

Characteristic of Barometric Tendency during the three hours preceding the time of observation (c). Code figure.

0 = 0 or +	.. Steady or rising.	} The barometer is now higher than or the same as three hours ago.
1 = + 0	.. Rising, then steady.	
2 = + -	.. Rising, then falling.	
3 = - + or 0 +	Falling or steady, then rising.	
4 = unsteady +	Unsteady, but rising.	} The barometer is now lower than three hours ago.
5 = - Falling.	
6 = - 0	.. Falling, then steady.	
7 = - +	.. Falling, then rising.	
8 = 0 - or + -	Steady or rising, then falling.	
9 = unsteady -	Unsteady, but falling.	

Past Weather in interval since last report (W). Code figure.

Without precipitation.	}	0 = Fair or fine.
		1 = Cloudy.
		2 = Overcast continuously.
		3 = Fog or mist.
		4 = Thick fog.

The weather elements underlined should be transferred direct to the map. First insert an arrow with the appropriate number of flèches to denote wind direction and force respectively. Then write against the station the barometric pressure in mb., above this the barometric tendency and amount in half mb., using red ink for positive and black ink for negative tendencies. Below the pressure, write the temperature in degrees F, and beside this the appropriate symbol for weather. It is sometimes necessary to combine ww, W and N, to arrive at a symbol for indicating the general character of the weather. Reports from the Færoes and Iceland give barometric pressure in mm., and temperature in degrees C. The equation for conversion to mb. and degrees F are:—

(1) $x \text{ mm} = \frac{4}{3} x \text{ millibars.}$
e.g. $760 \text{ mm.} = \frac{4 \times 760}{3} \text{ mb.} = 1013.3 \text{ mb.}$
 (2) $y \text{ degrees C} = \left(\frac{9}{5} y + 32 \right) \text{ degrees F.}$
e.g., $11^\circ \text{ C.} = \left(\frac{9 \times 11}{5} + 32 \right)^\circ \text{F} = 19.8 + 32 \text{ degrees F.} = 51.8^\circ \text{F.}$



Fig. 7. Code No. 7.—Nimbus (Nb.). Shapeless cloud base at 7,000 ft., rain falling.



Fig. 8. Code No. 8.—Fracto-Cumulus (Fr.-Cu.).
Rugged cumulus in drifting groups (4,000 to 6,000 ft.).

Finally isobars should be drawn in on the map*, the centres of high and low pressure marked, and a general indication of the behaviour of the barometer printed over a large area. Some little care will be necessary

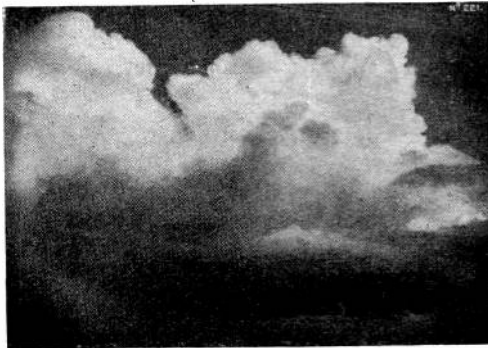

Fig. 9. Code No. 9.—Cumulo-Nimbus (Cu.-Nb.).
Mountainous mass reaching from about 10,000 to
25,000 ft.

at first to give the correct direction and spacing for isobars. Buys' Ballot's law is sometimes helpful in this connection, but

[* Suitable blank maps for use as synoptic charts may be obtained from The Stationery Office, Kingsway. Price 2s. 3d. per hundred, postage 8d. extra.]

absolute reliance should not be placed upon this law. It is usual to draw in isobars at intervals of 2 mb., and for even values, those for 1,014 mb. and over being marked in red (or drawn thick).

The amateur is thus enabled to have a synoptic chart before him within a lapse of $1\frac{1}{2}$ hours from the actual time of the observations. He is then in a position to become his own local weather forecaster.



Fig. 10. Code No. 10.—Fracto-Stratus (Fr.-St.).
Rugged stratus; drifting masses of low cloud.

Beginning on October 15th, meteorological observations taken on board the s.s. "Maud," of the Amundsen polar expedition, will be included in the "International Collective Report," issued daily from the Eiffel Tower at 11.30 G.M.T. The code used will be the same as for American stations in the same meteor and in addition the latitude and longitude of the ship will be given. It is expected that these observations will be continued for two years or more.

These codes and the "International Collective Report" will be dealt with in an article in the next instalment of this series.

The illustrations of cloud formations used in illustration of this article are reproduced by kind permission of the Controller of H.M. Stationery Office, from the Meteorological Observer's Handbook (M.O.233).

LIST OF AMATEUR AND EXPERIMENTAL CALL SIGNS

The Editor wishes to thank all those who have kindly checked the proofs submitted of the particulars of their stations.

Those particulars which arrived too late for inclusion in the list just issued will be included in subsequent issues of this Journal.

Experimental Station Design

(Continued from page 869, September 30th issue.)

These articles, which appear in alternate issues, are intended not only to be a complete guide to those new to wireless, but to give explicit details on the construction of all the components of the Experimental Station. Actual designs will of necessity in some instances be somewhat crude, in order that they can be made up without elaborate workshop equipment. Practical working instructions are given where necessary for the help of those unacquainted with the more simple processes of instrument making. Of course, where good workshop facilities exist, the designs may be readily modified.

Economy is made an essential feature, bearing in mind always that where low-priced component parts can be obtained their use has been embodied in the designs. For those who do not desire to make their own apparatus, the descriptions will assist them in selecting the equipment for their stations.

The information contained in the first few articles under this heading is to help those new to wireless and whose first aim is to build a simple set capable of receiving broadcasted telephony, and consequently may cover ground already familiar to many readers. The succeeding instalments, however, advance by easy stages, and in the course of the series the construction of an elaborate station will be evolved.

XIV.—PILE WINDING.

ONE of the most satisfactory methods of winding an inductance of comparatively high value and occupying small space is achieved by building up a number of layers.

In order to minimise the detrimental effects of self-capacity, it is necessary that only successive turns are allowed to lie side by side, and consequently it is not possible to wind a single layer of many turns, and then to return over this winding with a second layer. The second layer must be piled on to the first layer as it is wound on, and the capacity evenly distributed along the whole inductance. Such a winding, consisting of two layers, is described as a "two-pile winding." Pile winding may, however, consist of several layers, five being usually the limit, five-pile winding requiring considerable skill and patience.

For those unaccustomed to the winding of single layer inductances, it might be mentioned that when winding by hand, wires between 20 and 36 S.W.G. can usually be neatly arranged, providing the diameter of the former does not exceed five inches.

Large diameter formers are difficult to wind, as the turns have a tendency to run slack.

If the former is of cardboard, it must be thoroughly dried out before winding, or otherwise subsequent drying will cause contraction sufficient to make the turns loop over one another, and particularly is this the case with large diameters. To prevent absorption of moisture and subsequent deterioration of insulation, the former, after drying, should be well impregnated, both inside and out, with shellac varnish and baked in a moderately warm oven. Even when a lathe is available, it is usually better, if only one or two inductances have to be wound, to put on the wire by hand, and the method of terminating the ends of a single layer winding is shown in a previous article.*

The size of wire for pile winding should not be finer than 30 S.W.G., for it is difficult to make fine wire take the neces-

sary kinks required for holding it in position. The heaviest gauge wire that can be conveniently pile wound is No. 20, as thicker wires

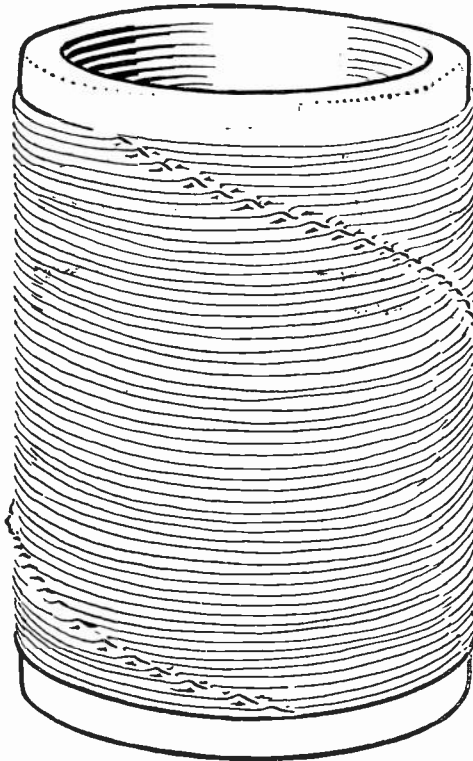

A Pile-Wound Inductance.

* Fig. 4, p. 866. Sept. 30, 1922.

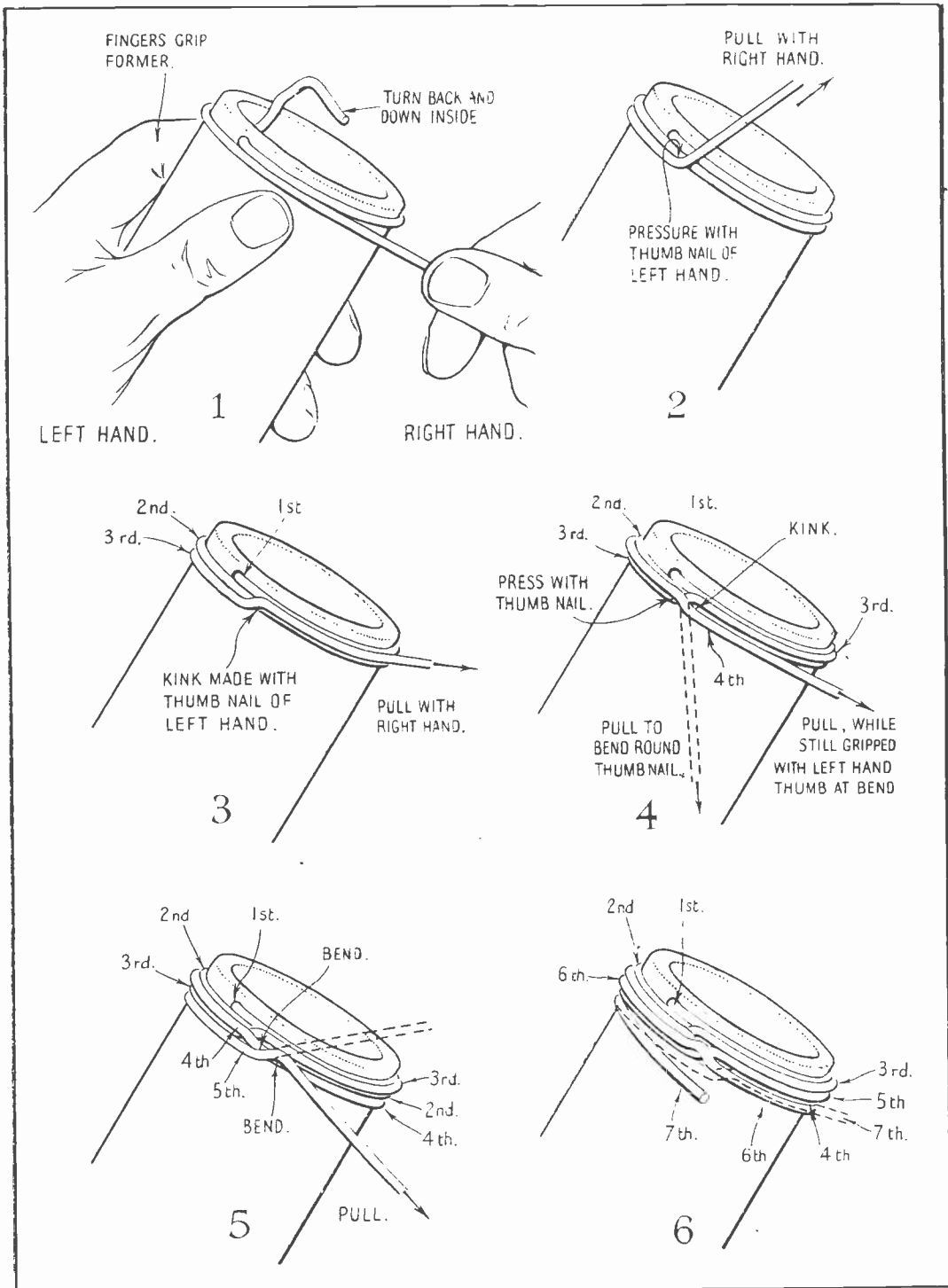

Method of making of a Two-Pile Winding.

are rather difficult to bend with the thumbnail; sizes 22, 24, 26 and 28 single or double cotton or double silk covered, being particularly convenient for two-pile winding.

Two-pile winding is shown step by step on the adjoining page. In order to avoid complication when learning the method, it is better to terminate the end of the wire through a hole in the former, and Fig. 1 shows the first turn and a half completed. Two complete turns are wound on, holding and rotating the former with the left hand, while the thumb of the right hand maintains the tension on the wire. On the completion of the second turn, the wire is firmly held down with the left-hand thumbnail pressed hard on to it, and a pull in an upward direction on the wire with the right hand will make the necessary kink (Fig. 2). Then by slightly reducing the pull, the thumbnail may be slid just a little way along the wire to a point midway between the first and second turns, and the wire pulled down in line with the other turns, making a second kink and allowing the wire to lie in the dip between the first and second turns. (Fig. 3).

The turn is then continued round by revolving the former, pulling tightly all the time, and if the first two turns have been put on tightly, there will be no tendency for this turn to squeeze them apart. The first two turns of course must lie closely together, and if necessary may be pressed together with the thumbnail. On reaching the point of bending of the third turn, a cross-over must be made, as indicated in Fig. 4. The thumbnail is first of all pressed against the wire at a point just behind the cross-over, and the wire pulled downwards as indicated by the dotted lines. The thumbnail is then transferred to the other side of the cross-over and a slight upward kink made, after which the wire is continued round in contact with the former. On again reaching the point of cross-over, the wire is given a smart bend upwards, as shown in Figs. 2 and 5, and this time a little further on, say a quarter of an inch beyond the point of kinking of the third turn. The kink this time facilitates the building up of the wire into the groove provided by the previous turn. It is continued round, and when the cross-over of the fifth turn is reached, kinks are made as

indicated in Fig. 4, to permit of the wire again coming down in contact with the former (Fig. 6), and removing any tendency the previous turn may have to fall out of position.

This process is continued, the points of cross-over always being an even distance beyond the previous ones, so that a uniform effect is obtained, and the kinks appear as a spiral around the wiring. After a little practice, pile-winding can be carried out quite quickly, the bends being made by a quick motion of the thumb of the left hand.

Two-pile winding is particularly useful where it is desirable to arrange a number of turns of low resistance in a small space, in order to provide tight coupling with another inductance. If it is desired to concentrate a larger number of turns into the small winding space, three, four, or five-pile winding may be attempted. For three-pile winding, three turns should be wound on side by side, and then, as shown in Fig. 2, the fourth turn should be wound between the second and third, whilst the fifth must be wound between the first and second. The sixth is wound over the top and between the fourth and fifth, and must pass on to these windings just in front of the point of cross-over. Having completed the sixth, which is at a distance of three layers out from the former, the kink is made this time in front of the point of cross-over, and the wire drops down to form the seventh turn in contact with the former and alongside the third. As soon as the point is reached where the wire crosses down from the top, that is the end of the sixth turn to the beginning of the seventh, a little pressure with the thumbnail, giving a bent back kink, will assist the ninth turn in lying firmly in position almost on top of the eighth turn. Another turn, and the winding is again three layers out from the former, after which a kink is made to facilitate the drop of the wire down into contact with the former. The process is carefully repeated, pulling the wire tightly all the time, and keeping the turns pressed closely together. The beginner should not attempt three-pile winding with finer gauges than No. 28. The methods of four and five-pile windings are easily apparent from the foregoing instructions.

F.H.H.

The All-British Wireless Exhibition

Description of Exhibits continued from p. 23, October 7th, 1922.

Anode Wireless and Scientific Instruments, Ltd., (Stand No. 2).

A receiving set of table design was exhibited, particularly suitable for use in a drawing-room, as it will harmonise with other furniture in the room. The wireless set itself is totally enclosed but is readily accessible by a falling panel on the side, and a loud speaker is incorporated. Articles on the table need not be disturbed when bringing the receiving set into operation. An instrument of special interest was the small variable condenser of simple construction, consisting of two metal plates with mica dielectric; one plate being moved by means of a

patented screw arrangement. This condenser is beautifully finished, and occupies very little space.

The screw mechanism is accurately made, and gives a smooth movement. Tuners, detectors, H.F., and L.F. amplifiers were to be seen. The full range of instruments designed on the unit principle were particularly attractive and possessed remarkably good finish.



A Table Set by Anode Wireless and Scientific Instruments, Ltd.

Unit 1 tuner employs the anode variometer system. Its range is 350-500 metres. Unit 2 is a one-valve amplifier. Unit 3 is an amplifying valve detector incorporating a combined rheostat and potentiometer. Unit 4a is a L.F. amplifier. Unit 5 is a telephone transformer.

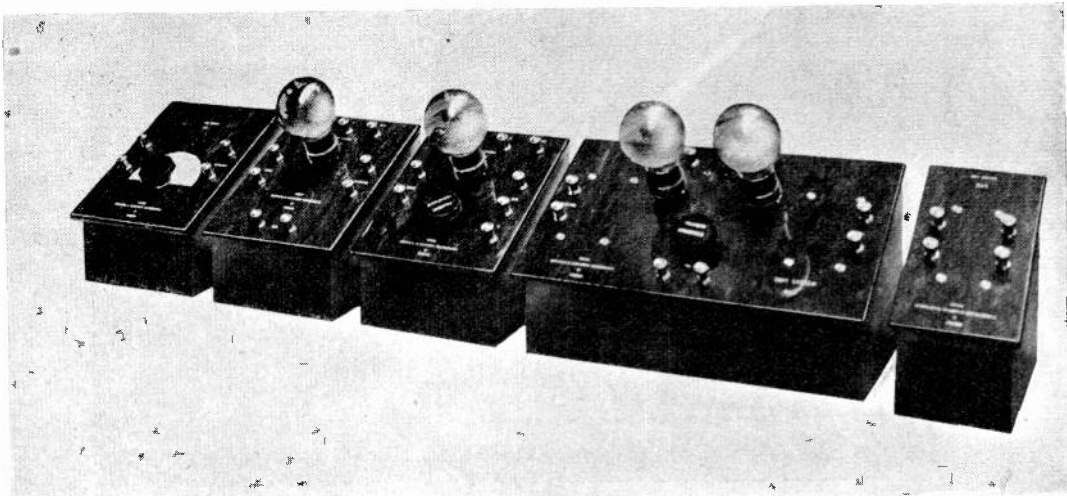

Anode Units.

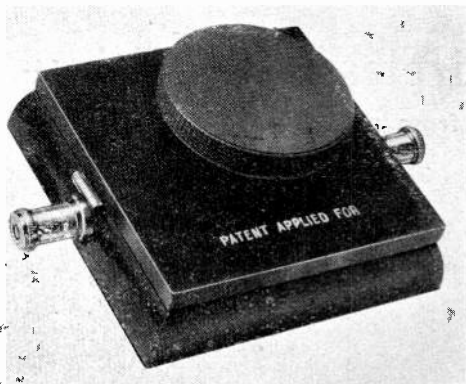

"Anode" Variable Condenser.

Fellows Magneto Company (Stand No 10).

On this stand was to be found a full range of receiving apparatus of reliable design, and many useful component parts. A five-valve panel set attracted a good deal of attention. The number of valves in circuit is varied by inserting the telephone plug in various jacks arranged along the base of the receiver panel, and any combination of high and low frequency can be effected. The set is provided with doors which close completely over the panel.

General Radio Company. (Stand No. 26).

The apparatus exhibited on this stand included short wave receiving sets and amplifiers specially arranged for easy manipulation. The finish of these instruments was very attractive, particularly the condenser and variometer scales, which were of nickelled metal and slightly raised. An efficient type of variometer of low self-capacity was to be seen, and was much appreciated by experimenters. It was built on a wooden frame, and had a maximum coupling between its two windings, thus providing a tuning adjustment over a wide range.

A special feature was a very beautiful multivalve cabinet receiving set. The pressing of a button provided on the front of the panel put the set into operation. To the wireless enthusiasts it was as beautiful inside as it was out.

A number of components, in particular high frequency and low frequency intervalve transformers, were shown, of unique design.

Wates Brothers (Stand No. 15).

This Company is well known as suppliers of component parts, which were displayed in great variety on their Stand. A very attractive cabinet set with loud speaker was on view, incorporating apparatus of standard design.

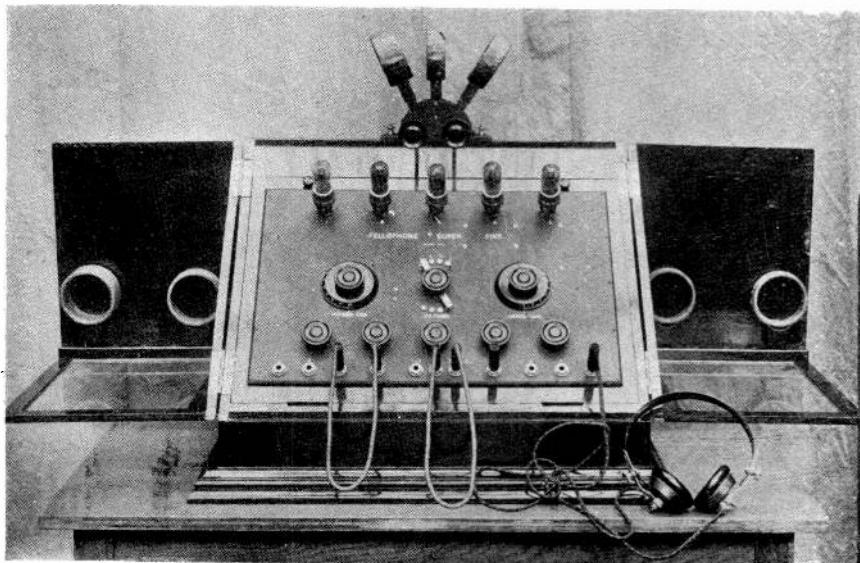

The "Fellophone Super-Five."

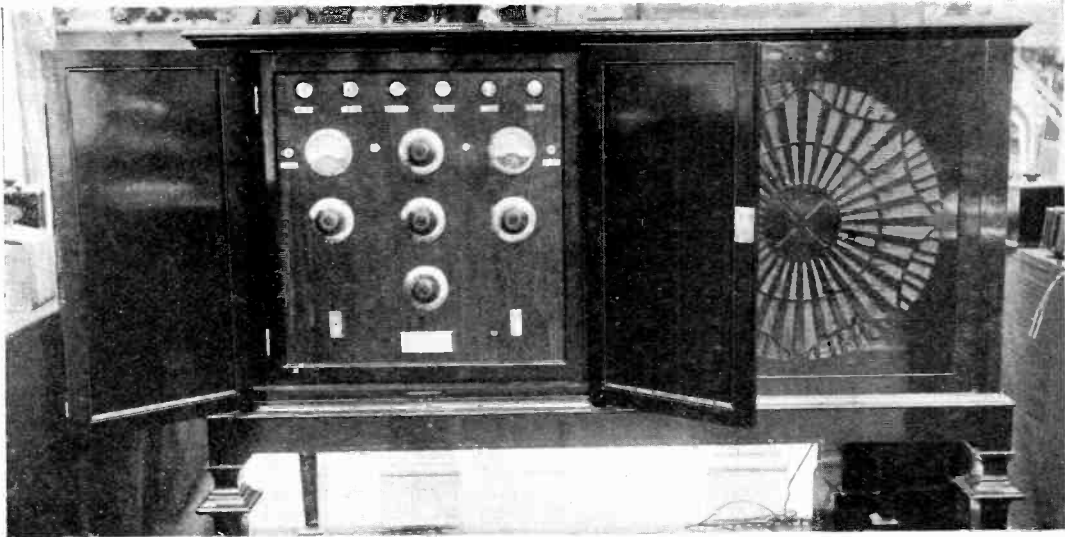

The General Radio Co.'s Cabinet Receiving Set.

**“K.B.” Radio Equipment Co.
(Stand No. 8).**

At stand No. 8 there was a selection of apparatus ranging from small parts to complete five or seven-valve sets. Of most interest was

previously made. This system is also supplied in parts, ready for the amateur to assemble in his own workshop. Other items of interest were two-valve sets, L.F. transformers, grid leaks, coil holders and all the small apparatus and parts constantly required by the amateur who builds his own set.



*View of Interior of Cabinet Set
(General Radio Co.)*

the “K.B.” Unit System, by means of which a set containing any number of valves can be built up one panel at a time, without altering or throwing away any purchases



Cabinet Set exhibited by Wites Bros.

The Wireless Society of London

REPORT OF DISCUSSION HELD AT THE ORDINARY GENERAL MEETING, SEPTEMBER 27th, 1922

The President, Admiral of the Fleet Sir Henry B. Jackson, opening the meeting, said :—

Ladies and Gentlemen, our official organ, the *Wireless World and Radio Review*, in its number of September 16th, indicated the matters which would be brought to the notice of this meeting, which is the first meeting of the winter session. The most important item in that list was that we hoped Senatore Marconi would be able to give us a technical lecture. I have had some correspondence with him, and he wrote at the beginning of the month advising me that on his return from France he had received my letter, and it would give him the greatest pleasure to be present at the opening meeting of the Wireless Society of London, and to say a few words. He said he was then leaving for Italy, and that it was not certain when he could get back, but that if he could get back he would be here.

Well, Senatore Marconi has returned, but I am very sorry to say that he is not well. His doctors have said that he must not come here this evening, so we are very grievously disappointed in that particular. I think I may say on behalf of the Society that it expresses its regret for the cause of his inability to attend, and wishes him a speedy recovery, and hopes that his lecture is only postponed. May I take it for granted that you all agree to that. Senatore Marconi thanks you very much for the invitation.

This disappointment rather changes our proceedings for to-night, but still, as the *Wireless World and Radio Review* indicated, there are a good many points that I think can very well be discussed here. In fact, I think this is the first meeting of the Wireless Society since I have joined it at which members only have been present for the discussion of domestic affairs, because at the Annual General Meeting in January we have affiliated societies represented, and we cannot confine our attention to our own affairs. But to-night, as we have no technical lecture, we have the evening before us to consider various matters and to discuss them.

I am just going to run through some of the points I am to bring before your notice, and will ask you to give them careful consideration before those which require your definite approval are brought before the Annual Meeting next January.

One minor point is to remind you that several members of your Committee retire at the end of the year automatically by the rules of the Society. Now, the selection of those who will replace them is a matter that rests entirely in your hands, in the hands of the members of the Society, if they choose to take that action. If they do not do so, the selection of the proposed members will naturally fall on the Committee, and they may or may not choose people you would like. You may or may not like a change in the general type of those serving on the Committee to which you entrust your interests, and who, in my opinion, serve them very diligently and very well. It rests with you, and if

you do not exercise your rights and privileges now, do not, some months hence, complain that you have a Committee which does not really represent the views of the majority of the members of the Society.

There may be amongst you some members who would like to serve on the Committee whom we do not know. If there are, I hope they will present themselves. Very often people are modest and do not like to press their claims.

The next point is the progress in the affiliation scheme of the Provincial and Suburban Societies—that is the best way of putting it—with the London Society which was initiated three years ago and has worked so well.

It has been slowly but surely forced on the minds of the Committee that the London branch cannot really be unpopular and moribund, though some rumours that this view is sometimes held in the provinces have reached me.

Our Chairman very recently, in the *Wireless World and Radio Review*, gives a very good argument why such societies as this exist at all, and why those interested in radio work should join this Society. I would only add on general principle that an organised body, even though it is small, can look after its own interests better than a large body which is unorganised, and that is one of the reasons why we suggest that members should join the Wireless Society of London. Compared with many of the societies interested in technical sciences, the Wireless Society of London is comparatively young, and, judging by its very rapid growth, it has hardly reached its manhood. This is not its own fault, as practical wireless was only born about a generation ago. It is therefore still struggling against some difficulties, but it is a live and going concern, and it is recognised by the Government authorities as such. Though mainly composed of amateur workers, it represents the most go-ahead of technical sciences, and we members may feel a certain pride in belonging to it, and may now legitimately ask our confrères in the other wireless societies (of which the greater number are already affiliated to us) whether they will not bind themselves to us still closer and form one Society, which may be a Society which represents the whole of Great Britain. Perhaps at some future date it might become an Empire society. I only put this forward as a personal view.

Briefly our proposal is that we might better be called the "Radio Society of Great Britain" than the "Wireless Society of London," the affiliated societies calling themselves by the same name, but adding the name of their branch.

Perhaps the word "radio" may not appeal to conservative minds, but it is really a more correct term than "wireless," if one considers the enormous amount of wire that is used in radio communications. Personally I always have been of a conservative mind, especially in regard to honourable names and traditions such as ours, but I think I can also claim to be one of the first practical workers in

Great Britain in this work, and yet I am now in entire agreement with the change. I really think that the fact that one of the earliest workers, of conservative mind, does not mind changing the name of the Society of which he has the honour to be President, might give the lead to others who might be rather unwilling to accept it. We have decided in the Committee that unless strong and reasonable opposition is put forward by those now belonging to or associated with this Society, that this change of title will take effect next year. In the meantime the necessary changes (which really are very small) in the existing rules of the Society and the affiliated societies can be carefully considered. I will not take up your time this evening in enlarging on the small alterations necessary. Later on we will ask the Treasurer to give his opinions on this matter, and I will ask others to talk about it later.

Another point I wish to bring forward is that in future, lecturers are requested to prepare the material of the lectures and send it in beforehand, so that the lectures can be printed in advance for distribution to those who are attending the lectures. It is a great convenience to those who wish to take any part in the discussions, and it enables publication in our official organ to take place much sooner than would otherwise be the case. I hope those who are preparing lectures for us will not omit sending them in about a fortnight beforehand.

The next point with which we have to deal is that on Thursday last the Secretary of the General Post Office, on behalf of the Postmaster-General, with Captain Loring, Mr. Brown, and Mr. Shaughnessy in attendance, received very courteously, and at very short notice, a deputation consisting of myself as President, Messrs. Campbell Swinton (Past - President), Hope - Jones (Chairman), McMichael (Hon. Secretary), and Scott-Taggart, as representatives of the experimental amateurs in this country.

We felt some anxiety as to the future of amateur experimenters and the licences which they would receive in view of the introduction of broadcasting. We had a long, amicable and straightforward discussion on the whole subject, and whilst strongly holding that our past and present rights must be fully considered, we were much impressed by the great difficulties the Post Office authorities have in attempting to satisfy all parties concerned with impartiality and justice. We gave our opinions and suggestions, and Captain Loring and Mr. Shaughnessy are here this evening to let you know at first hand what their difficulties are. I hope they will also be able to state whether any decisions have been arrived at. We must express our thanks to them and to the Postmaster-General for receiving us, and to the former for coming to us this evening.

The next point is the forthcoming Wireless Exhibition and Convention, which is to be opened next Saturday by our Honorary Vice-President, Sir Henry Norman, M.P., and which is to be held under our auspices. I think this is the first wireless exhibition to be held in this country on such a large scale. I hope everybody here will visit it, besides many others, and I think I may, in the name of this Society, wish it and its promoters every success. I shall be present at the opening, as will also Mr. Campbell Swinton, and I think we may take it that we all wish it every success.

The next point is the arrangements for the

transmissions in the forthcoming Atlantic tests which are being considered by a small sub-committee and which are making good progress. The arrangements are hardly definite enough for me to set them before you this evening, so beyond wishing success to this important and difficult test of what the amateurs of Great Britain can do in return for what those in the U.S.A. did for us with such success last winter, I will not deal with the matter further now, but I think Major Hamilton, who is very interested in helping in this matter, may be able to say a few more words about it this evening.

Another point I am going to bring before you is that in July last an international gathering of representative men interested in many branches of science assembled at Brussels at the invitation of the Belgian Government to co-ordinate research work in several branches of chemistry and physics. The Union Radiotélégraphique Scientifique Internationale was one of these bodies. This Union was formed before the war, and has shown practically that it is a going concern by sending out the U.R.S.I. signals from Nantes. At this Radio Union, representatives from Belgium, France, Italy, Great Britain, Norway, the United States, and the Japanese, who also came in a short time ago, spent a whole week in serious discussion and in arranging an organisation for future work and its analysis on an international basis.

To effect this four Commissions have been formed to deal respectively with instrumental standards for radio measurements, measurement of received signals both in strength and direction, atmospherics, and collection of results obtained, and ideas from outside bodies and persons. Each country also has its National Committee, who will assist in the work of the Commissions through the representatives of each country. I may remark that I am at present the Secretary of the British National Committee, and Sir Richard Glazebrook is the Chairman and also one of the representatives of the Standards Commission. Mr. Dye, of the N.P.L., and also, I believe, Dr. Erskine Murray, are members. Dr. Howe and Mr. F. E. Smith are on the Measurements Commission, and Dr. Eccles is the President of the Atmospherics Commission, but I have not heard from Brussels definitely who are the other members. General Ferrié is President of the Union.

You may notice that a good many of these names are on the printed list of those who are officers of the Wireless Society of London. It is of the fourth, or, as it is termed, the "Liaison" Commission, that I shall speak to-night. This has been formed with the sole object of bringing into closer touch with the scientific side of the work individuals not claiming to be research workers or mathematicians, who are interested, and personally work at practical radio communication, such as operators, amateurs, designers and manufacturers of wireless apparatus. The object is to help to probe into, and we hope eventually eliminate, the many difficulties that workers experience in practical radio communication. I will give an example of how many of us might assist in this work. With a view of finding out how great an area any "click" from an atmospheric may cover, General Ferrié suggests to such observers as will take part in this that the time signals emitted by numerous stations all over the world should be the period when these particular

observations are made, since they will give very accurate records of the time of observation, especially in the case of rhythmic dots emitted periodically. The atmospheric clicks should be noted very accurately during these signals, and the results would be sent to a central office for analysis. If, say, 20 observers on any one day record simultaneously during these few minutes all atmospherics, and if some of these are evident on two or more records, a good idea of the area affected will be obtained, and will be of much more scientific value than a thousand clicks observed by one individual on different days. Dr. Austin gave an instance of this which proved that in the Pacific Ocean it was evident that some clicks affected several different stations, each of which was over 2,000 miles away from the other station. That was a very striking example.

Another point is the rapid fading away of signals at or near sunrise. It is often noticed, and systematic observation carried out carefully for a few days with regard to the sunset period, would also be of use. I think there are many members of this Society who could help in this, and when I mention the name of the British representative of this, the "Liaison" Commission, who was unanimously elected to the post in Brussels, I feel sure that those who can will help him in this work. It is our Past-President, Mr. Campbell Swinton, and I will ask him to supplement my remarks later, and to put my name down as the first on his list. Perhaps he will now make some remarks on what I have been saying.

Mr. A. A. Campbell Swinton.

I should like first of all to say something with regard to the proposed change of name. Though I, personally, have a sort of sentimental liking for the old name of "Wireless," I think "Radio" would be a much more scientific name, and if we are going to change we had better adopt the word "radio." But apart from that I am wholly in accord with what was said with regard to the advantage of changing the name of the Society from the "Society of London" to the "Society" or "Association of Great Britain." I think that with all our affiliated societies (there are something like a hundred of them now) it is the only logical course to take. The question will not be decided until the Annual General Meeting, and I hope that members will support the idea of the Committee that it would be advisable to make his change.

As regards the Commission of Liaison, in connection with the Conference that has recently taken place at Brussels, I must confess personally that I am a little overwhelmed at the idea that I am to represent this country, and apparently to collect every kind of suitable wireless information from all operators and manufacturers and experimenters of this country, and, I suppose, communicate this to Brussels. It seems rather a large order, particularly for a person who is so very much occupied as I am by commercial and other affairs. But I feel it a great honour to have been selected at Brussels for this purpose, and I have accepted the position, and will do my best to carry it out. I shall have to ask all you gentlemen to help me, because it is people like you who have to do the work which I have to collect, and I hope later on, when things

are a little more advanced, I shall be able to tell you more about it. At the moment I am rather in the dark as to just what it is I have to do, but you may be sure I will do all I can, and I shall ask you to assist me. I am very glad to accept the kind offer of our President, one of the earliest workers in wireless telegraphy, and will put his name first on the list.

Mr. F. Hope-Jones.

Mr. President, Ladies and Gentlemen:—If I may refer first to what the last speaker has been saying, may I remark that I rather envy him his job, and I do not think it will be a very serious one, thanks to the co-operation he will get from all amateur radio-telegraphists, not only of this Society but the provincial societies as well. May I remind him and the President that one of the first serious pieces of work which the Wireless Society of London undertook was an attempt to do the same thing. In the year 1913 I distinctly recollect how, in company, I believe, with Professor Howe, Dr. Eccles, Mr. Coursey, and several of those who were such earnest and hard workers in those days, we went up to see Professor Fleming with draft forms that we were going to discuss with him. The forms were carefully ruled out—rather elaborately so. They were to be circulated to all those amateurs with receiving licences then known in order to observe atmospherics, and the great point was that they had to be very careful to get their time exact, or otherwise their records would not have been much use. That was the obvious difficulty. Their progress was spoilt, like many other things, by the outbreak of war, but I doubt whether those efforts would have been of very much use now.

The President.

These observations were in Dr. Eccles' hands, and they have been sent to Brussels, so they will not be lost.

Mr. F. Hope-Jones.

I am glad to hear they were not lost, but quite obviously they cannot be as valuable as those proposed by General Ferrié, based on observations where the rhythmic signals are to be made use of: and I am sure the new efforts will be a great success.

I do not know, Mr. President, what other matters you think it would be appropriate for me to deal with. May I mention one little domestic detail. Thanks to our official organ, *The Wireless World and Radio Review*, coming out every week now, we feel that the republication of the Proceedings of the Society in the form of the Journal becomes simply a matter for the library. We want the proceedings in the permanent form for our library bookshelves, and that is the only purpose which the Society Journal now fulfils. It is now suggested on that account that these proceedings shall be reprinted from our official organ only once every six months, or possibly twelve months, and posted to our members in one volume.

There again you will observe the tendency which is to fall into line with the great institutions in all such matters.

Very little mention was made by the President regarding the Exhibition, simply because he had so many things to talk about and not because it

is a matter of small importance, either in his mind or in yours. We know this Exhibition is going to be a real success, and the Wireless Society of London from the very first decided that it would assist it in every way in its power, and I think we have taken responsibility for the social side of the Exhibition. We are to provide the lecturers, and I understand there will be lectures every evening in the little room upstairs, and perhaps in the afternoon as well. I ought to add that Mr. Bertram Day is a little indisposed (I take it he has been overworking) or he would have been here himself as the official organiser responsible for the Exhibition: but he has a representative here, Mr. Freeman, who will answer any questions.

There is a little matter I can mention now, as it might otherwise get forgotten, and that is that there is to be a big Convention of the Boy Scouts at Alexandra Palace on Saturday, October 7th. The Prince of Wales will be present, and on his return to York House at 7 o'clock, he is going to broadcast a message to the scouts of the Empire, or at any rate in the British Isles. He will transmit on the broadcasting wave through Marconi's, and our Secretary, with his usual promptness, the moment he was informed of this (and I think very wisely too), sent a special circular letter by that night's post to our affiliated societies suggesting that they should put themselves into communication with the local Boy Scout organisations in every town. We in London propose to do the same thing. Fifty tickets have been sent to the Boy Scouts headquarters so that they may hear His Royal Highness's message.

With regard to the change in name. It fell to me, as Chairman of the last Conference, to mention the proposed change of name. I was then only voicing opinions that were more felt than heard, and I was asked what the general idea was. I said that it was because we were doing national work. Whenever it became necessary to negotiate with the representatives of the Post Office, it fell to us to carry out such negotiations. If we do national work I think we would do that work better if we had a national title. I happen to have been privileged by the Treasurer to look through the draft of a memorandum, showing how it would affect our constitution and the nature of the alterations that would be made—mere mechanical alterations caused by the change of name—and I could see that these alterations would be very trivial. It seems to me that the framers of the constitution of the Wireless Society of London as it stands to-day might very well have had a national organisation in view, the changes required being so small. The details of the changes would, of course, be handled by an expert Committee accustomed to such questions, and the whole matter would be thoroughly gone into in good time before the Annual Meeting and before the Conference, and I take it that the change would not be effective until the Conference, when we have the advantage of the full discussion by the members and delegates of Provincial societies.

The President.

Would Mr. Freeman like to make any remarks regarding the Exhibition?

Mr. Freeman.

The only way in which I can assist is to invite

questions, which I will do my very best to answer—any questions at all regarding organising the actual work to be done towards publicity. I cannot speak as to the design of the instruments and other matters of that description, but as regards publicity and the actual work of organisation I can give you any information you desire.

The President.

These questions might perhaps be left till later on in the evening, so that we can get through our own business first.

Dr. Howe, would you care to make any remarks?
Dr. G. W. O. Howe.

I think the proposed change of name would be wise. I have felt for some time that the "Wireless Society of London" hardly described the functions of the Society. That has been my opinion for some time, and I am entirely in favour of the change, although I cannot say that I quite agree with the reason which our President gave for changing, since although much wire is used in connection with the instruments, the transmission is wireless, and one cannot say that transmission is not wireless simply because a lot of iron and steel is used at each end. But this is a detail. The greatest disadvantage of the word "wireless" is that it has to be translated in every language into another word, whereas the word "radio" is international. That, to my mind, is the greatest reason for the change, and I am whole-heartedly in favour of substituting the word "radio" for "wireless" in all cases.

The President.

I think the next subject we had better handle is the question of those licences. Mr. Shaughnessy and Captain Loring are here, and I will ask if Mr. Shaughnessy will give us his views.

Mr. E. H. Shaughnessy.

Mr. Chairman, Ladies and Gentlemen:—The Post Office has granted licences freely in the past to all serious experimenters. There is no reason for it to change its mind now. There is some difficulty, I think you will appreciate, in distinguishing the experimenter—the real experimenter—from those people who simply want broadcasting. The question of broadcasting also involves very serious consideration. If the present state of affairs amongst those very skilled amateurs who already possess licences were to be extended, then broadcasting would be a failure. Only last night I listened to Writtle at home for a part of the time. For most of the time those experimenters who hold licences stating that they must not interfere with other stations; that they must not use a valve which will oscillate the aerial; those very earnest experimenters, were causing my apparatus to whistle almost incessantly. Now it is to avoid that evil being made greater than it is at present—and I think you will all agree that it is bad enough now—it is to avoid that, that we have to deal with the technical aspect of the case very carefully. With regard to broadcasting apparatus, we are going to see that this thing does not happen. We are going to test every type of apparatus that is sold for broadcasting purposes. We are going to issue licences which will enable people only to buy harmless apparatus. You can get harmless apparatus that can be very efficient. In the case of broadcasting apparatus we are stipulating that there shall be no oscillation of the aerial, that there shall

be no radiation whatever. The wavelength band on which broadcasting will take place is very limited. The wavelength band on which amateurs work has been unlimited. We think that it is only fair to the large manufacturing firms who are interested in broadcasting, as well as fair to those firms who are also making broadcasting and amateur apparatus, that protection, technical protection, should be afforded for the broadcast band. In the past there has always been a stipulation on the licences that where a valve is used the circuit must be arranged so as not to cause interference with other stations. That condition, which we have trusted the possessors of the licences would honestly endeavour to fulfil, is very seldom fulfilled. We have complaints, and I personally have for the last few months listened in the evening to see how far the conditions of our licences are carried out. In future we are going to stipulate that during the broadcasting hours, and between a wavelength of 300 to 500 metres, no valve with adjustable reaction on to the aerial shall be used. I think you will all agree that it is only fair that we must ask the amateurs (who are really bound honestly by their licences) to see that they do not cause any oscillation on the aerial thereby interfering with each other and interfering with the broadcasting people. If we impose—there is no “if” about it, I am prepared to assert that we shall impose that condition—and if it is loyally observed by those people who get the licences, experimental licences, then we shall not be inclined to say that no reaction whatever may be used on any wavelength. We shall not stipulate that you must not have a reacting valve at all. Naturally we want to conserve the ether for useful work, and we also want to give serious experimenters every opportunity of experimenting with a view to improving existing conditions. That again leads to the difficulty of defining an “experimenter.” Sets of apparatus are sold which go from 150 metres to 25,000 metres range in wavelength. A card is supplied; you turn the handle to such and such a stop, and you get the Eiffel Tower, or one of Leaffield’s harmonics.

The man who owns that set probably has never seen the inside of it. He usually buys it out of sheer curiosity to listen to signals. It is very difficult to assume that he is an experimenter. A man buys a set which he just adjusts to some particular wavelength, usually it is on the regenerative principle, and he listens in. It does not matter to him what station he hears, it may be North Foreland, but so long as it makes a noise, it does not matter what it is.

Even in a case like that I think we may be inclined to be generous in our interpretation of the term “experimenter,” so long as we can be assured that such apparatus is not used for the wavelength band of 300 to 500 metres.

Recently we have been stipulating in our licences that reaction must be on to a secondary circuit coupled to the aerial. We had hoped that when we asked people to send in a diagram of the apparatus that would be used that we should then have no trouble in distinguishing the experimenter. Most of them said they proposed to use Mr. So-and-so’s set. Some of the diagrams sent in were real works of art, but nothing to do with wireless telegraphy, so that did not ease our troubles. Seeing that we are being inundated with applica-

tions for licences just now, mostly as a result of broadcasting, it is very difficult to deal with them on the basis of a diagram. There is not the slightest doubt that most of the applications are simply because broadcasting is mooted.

To get back to the point of reaction being on the secondary coil. We are prepared to waive that condition, because we find that unless it is very carefully used, it is no better than going straight back on to the aerial. If it is very badly used it may be worse. We are, I think you will agree, compelled to examine carefully the applications for licences. But our attitude is not one of opposition to the experimenter. We always have taken a very generous view of applications for receiving licences, and there has been no change whatever in the attitude of the Post Office in that direction. As a matter of fact, personally I feel that those who are engaged in the art of wireless telegraphy, earning bread and butter by it, generally are so hard worked that they have no time to trouble about the inventive side of the question. It is frequently, very frequently, the man who has leisure and takes up any art or science as a hobby, who will pursue some particular point that may lead to very valuable results. We are fully alive to this.

It seems that all along we have been very generous in our interpretation of the term “experimenter.”

I do not think there is any other point with regard to licensing, but if anyone desires to ask questions, and the Chairman considers they are in order, I will do my best to answer them.

The President.

Captain Loring, would you like to supplement these remarks?

Captain Loring.

There is very little I can say in addition to the most excellent speech of Mr. Shaughnessy. Mr. Shaughnessy has put the whole case of the Post Office so very clearly that I cannot do anything more than just to tell you at the present moment we are not giving a decision.

We are not in a position to say that any decision like to support what Mr. Shaughnessy said with regard to the fact that I can assure the members there is no intention on the part of the Post Office to put any obstacle in the way of the issue of experimental licences to the proper people.

I know there has been a certain amount of comment regarding the withholding of licences—you see it in the Press—and people are wondering what is happening, but we must realise that this broadcasting question has only arisen very recently and very suddenly, and has increased the number of licensees or applicants for licences tenfold and even more, and also with the increase in the number of licensees, it is essential to adopt a definite policy, and therefore it is only wise, in the interest of all of us, that the Post Office, who is responsible for the future policy, should go as slowly as possible, and as far as may be consult the interests of all concerned, as we did only a few days ago when your representatives came to see us.

I do not think that any of you can say that during the last two or three years the amateur movement has not received very great consideration and sympathy from the Post Office Department, which is supposed to be one which is entirely devoid of these sentiments very often, and the

Post Office only desires to see the experimenter on the one hand get everything he wants in order to pursue his investigations, and on the other hand, to see the broadcasting industry, which is going to be a very considerable one, established on a proper basis, which will enable its extension without having to revise the conditions and cause friction all round by having to make new regulations. I would just like to say, as regards the word "Radio" for the Wireless Society of London, I think it is a great improvement on the word "Wireless."

There is one other little point which I should like to mention to the Society, and that is the use of this new word "broadcaster," which has recently been so freely adopted. To my mind it is a horrible word.

Mr. C. F. Phillips.

Mr. Chairman, Ladies and Gentlemen:—First of all, I think we owe a very hearty vote of thanks to the Post Office, especially to Mr. Shaughnessy and Captain Loring for their remarks this evening. I think that the Post Office is very old and very wise. They won't give too much, and they won't give it too readily. They give us little by little, but I have come to the conclusion that what they do give they give with a good grace. I think as regards "no reaction during broadcast hours," it is the wisest possible decision: that the user of an experimental set who listens to broadcast should be put on his honour, not to use a limited amount of reaction, but to use no reaction whatsoever, to take such steps as are necessary to ensure that his friends by assisting him in the manipulation of his apparatus they cannot unwittingly offend through lack of knowledge. I think it is a wise step, and I do not think it is a hard restriction, specially in view of the fact that generally the experimenter has at his disposal several valves and a very high class station to listen to. You will notice that in the broadcast band the wavelength covers the amateur wavelength of 440 metres for transmission. You might think that it is a hardship to be thus prevented from listening to your friends during the hours of broadcasting, but I think you would find in practice that if you attempted to listen to a 10-watt transmission made on 440 metres whilst a broadcasting station is transmitting on a kilowatt and a half that you would not have much chance.

Now as regards the position of the Broadcasting Company—the company that is about to be formed—I have had the honour of sitting on the Committee forming that Company, and I have taken it upon myself to urge the point of view of the amateur. At the meeting this afternoon I told the members of that Company that I proposed to say a few words this evening, and what I say I say with their consent. I want to take away one idea that may exist in the minds of some of you here, and in the minds of some who may not be here, that this proposed Broadcasting Company is in any way a monopoly. The Broadcasting Company is not a monopoly in any sense of the word.

For broadcasting to be a success somebody has to do it. In a little place like England it is quite impossible for an unlimited number of people to be allowed to broadcast, and therefore the actual broadcasting must be in the hands of a few. Also it is very necessary that the transmissions should be co-ordinated, and again we possess

great advantages in one organisation if that co-ordination becomes automatic.

Now as regards the no-monopoly point. If the Broadcast Company were going to give all the transmissions and also sell all the apparatus, there would be a monopoly, but in their wisdom the Post Office authorities would not countenance such a thing as that. Anybody is perfectly free to join the Broadcast Company and to make apparatus, and he cannot be refused. That immediately destroys any question of monopoly. He has only to ask and he may join, and he may then become a member of the Company. The real object of the Broadcasting Company is to provide that the apparatus used for broadcasting in this country shall be of British manufacture. The industry is likely to be a very large one, and if it is a large industry it will employ a large number of people, and at this time, when unemployment is such a serious question. It is essential that the condition should be fulfilled that the apparatus shall be British, and that can only be done by banding together the manufacturers of this apparatus, who will have to give guarantees that their apparatus will be British.

Now as regards the amateur position. The amateur has had a free hand hitherto, and we have the assurance of the Post Office that he will have a free hand in the future. Soon there is going to be provided for him, to listen into on high power, something that he can make a loud noise with without very expensive apparatus.

He may tell the Post Office that he wants his experimenter's licence solely to listen to North Foreland, but in practice it is perfectly certain that he will at some time listen to broadcasting. The Post Office was approached with that in mind to see what can be done in order to ensure that the amateur shall pay some trifling sum in exchange for this programme. It is quite likely, and I know that this Society has recommended, that the amateur licence fee shall be slightly increased. Do not think that this is an additional tax which the Post Office requires. But when you are given an experimental licence now, you are virtually getting in addition a free ticket for the music hall.

If you are asked to pay a few shillings a year it won't be a large sum. Just put it down to the programme, for that is all it is.

One more thing I might add to what I have said. People are always asking when broadcasting is going to start. I think it will start pretty soon. In fact, I know it will start very soon indeed. There will be official broadcasting starting on September 30th to October 7th from the Horticultural Hall, for the Exhibition, at the hours of 11, 3, 6 and 8, except on Sunday. These transmissions will be made in order that people visiting the Exhibition may know what they may expect to hear when they purchase their broadcasting sets. Each transmission will be received at the Exhibition, and when once that broadcasting has been started I should not be at all surprised if it continues.

The Broadcast Committee wish me to state that never at any time have they seriously desired to limit any rights and privileges given amateurs by the Post Office in the past which they know the Post Office intend shall continue to exist that they can be quite certain they would not for their part endeavour to restrict them.

(To be concluded.)

C 2

The Wireless Society of London. HOW THE BROADCAST LICENSEE MAY JOIN.

THE non-commercial user of wireless telegraphy has hitherto been confined to the class known as the amateur and experimenter, but the introduction of broadcasting has necessitated the adoption of a new name to define those non-technical users, who are nevertheless interested in wireless to the extent of listening in for the broadcast transmissions. A very large proportion of these recruits to the science will undoubtedly later on attain a knowledge of the technical side of the subject and will join the ranks of the amateur proper and the experimenter.

The Postmaster-General has recognised that the introduction of broadcasting creates a new class of user of wireless, and this class is to be accommodated with the special form of license known as the Broadcast License.

The Wireless Society of London, equally appreciative of the fact that a new factor has

arisen, and that the new class of user should be specially catered for, has taken action as already indicated in the note which appeared on page 26 of the issue of this Journal for October 7th, and in taking this step the Society looks for the support of all affiliated societies.

Broadcast licensees, or those who have applied for broadcast licences, will be accommodated in the Society as Associates, and no technical qualifications will be expected of them. Those who desire to become experimenters will be given every assistance through the Society to acquire the requisite knowledge, through the medium of lectures and demonstrations to be specially provided.

The subscription for Associates is 5s. per annum, without entrance fee. Applications may be made at once to the Hon. Secretary, Mr. L. McMichael, 32, Quex Road, W. Hampstead, N.W.6.

Notes

Death of Prof. F. T. Trouton, F.R.S.

Professor F. T. Trouton, whose death took place a few days ago, will be remembered in wireless circles as one of the first experimenters in radio science in this country. He was Emeritus Professor of Physics in the University of London, and was assistant to Professor Fitzgerald of Trinity College, Dublin, for many years. His connection with the Theory of Relativity has recently been a means of bringing his name before the scientific world. Prof. Trouton took an active part in the affairs of the Royal Society, of which he was a fellow.

Lecture at Selfridge's.

Capt. H. de A. Donisthorpe gave a lecture at Selfridge's Stores on October 3rd. Experiments were carried out, and a number of interesting photographs of land and ship wireless installations were shown. At the close of the lecture music was successfully received.

Concerts at Croydon.

Croydon Public Library was used for demonstrating the reception of wireless concerts a few days ago.

A Kingston Club.

We are informed by Mr. R. J. T. Norton (2 NQ), of 14, Woodside Road, Kingston-on-Thames, that he, together with other amateurs in the Kingston district, anticipate forming a club. Those interested and who might become members are invited to communicate with Mr. Norton.

A Change of Wavelength.

An Air Ministry notice to airmen states that with effect from October 1st, 1922, the British Meteorological Synoptic message issued at 0200 G.M.T. will be transmitted on 4,100 metres C.W. instead of on 1,400 metres C.W.

A Knightsbridge Radio Club.

Mr. R. H. Davis, the secretary of the newly formed Knightsbridge Radio Club, informs us that headquarters for the members have been acquired. Communications should be sent direct to the Secretary's address, 1, Kinnerton Place, South Knightsbridge. He will gladly furnish full particulars as to membership to anyone in the district.

Halifax Exhibition.

Members of the Halifax Wireless Club are demonstrating, and selling their surplus apparatus at an exhibition to be held at their headquarters, Clare Hall, Prescott Street, Halifax, on October 20th and 21st. Apparatus by leading makers will be exhibited. Special transmissions of music are being arranged.

Amateur Call Sign 2 FC.

Our list of Experimental Stations contains an error. The particulars relating to 2 FC should be cancelled.

The Armstrong Circuit.

In our next issue will appear a full constructional article on the Armstrong Super-Regenerative Receiver, written by Mr. P. W. Harris, a frequent contributor to this Journal. The receiver to be described makes use of a circuit not previously published in this country and admirable results are being obtained.

A Luncheon.

On Saturday, October 7th, a lunch was given to those responsible for the transmission and reception of the concerts in connection with the Exhibition to express personal appreciation of their work. The lunch was promoted by Mr. Duveer, of Messrs. Burndept, Ltd., and the Wireless Society of London, was also represented.

Correspondence

To the Editor of THE WIRELESS WORLD AND RADIO REVIEW.

SIR,—I was interested to read in the issue of September 16th a letter addressed to you by Mr. L. M. Baker (2FN), whose transmissions of music, incidentally, I very much enjoy.

We can all understand, I think, the manner in which Mr. Skeet, of Leicester, made his mistake.

When I got one of my early attempts to work, the first speech I heard was, "Hello 2PF, 2FN calling."

Since the publication of Mr. Skeet's letter, the gentleman who I believed to be "2PF" has given out his call sign in what you no doubt will agree all amateurs should use—the "lingo" of signalling, 2 pip esses. When Writtle transmits there is no mistaking the call sign of 2 emma toc.

GERALD HARRISON.

Nottingham.

ON HETERODYNES.

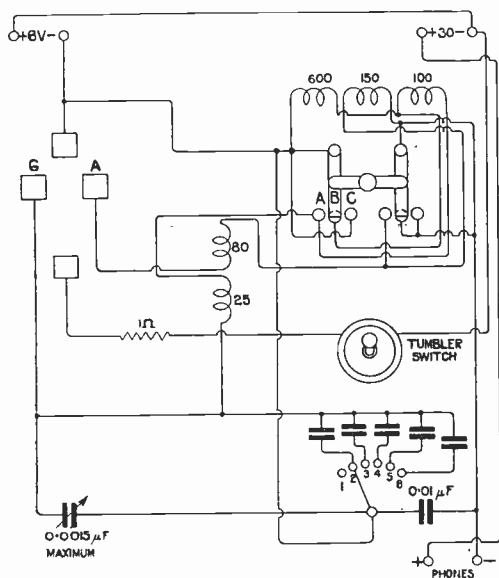

It is regretted that an omission was made from the circuit diagram given in Fig. 20, page 852. The corrected diagram is here given.

Calendar of Current Events

Friday, October 13th.

WEST LONDON WIRELESS AND EXPERIMENTAL ASSOCIATION.

At Stamford Brook Lodge, Ravenscourt Park, W.6. A popular lecture and demonstration of latest apparatus made by Messrs. Burndept, Ltd., by Mr. A. O. Gibbons.

BELVEDERE AND DISTRICT RADIO AND SCIENTIFIC SOCIETY.

Lectures on "Crystal Circuits," by Mr. C. E. Morrison, and "Telephones and Microphones," by Mr. S. G. Meadows.

RADIO SCIENTIFIC SOCIETY.

7 p.m. At The Grotto Café, Todd Street, Manchester. Annual General Meeting.

Sunday, October 15th.

Daily Mail Concert from the Hague, PGGG, 8 to 9 p.m. G.M.T., on 1,085 metres.

Monday, October 16th.

FINCHLEY AND DISTRICT WIRELESS SOCIETY.

Social Evening. (Postponed to October 30th).

IPSWICH AND DISTRICT WIRELESS SOCIETY.

At 8 p.m. At 55, Fonnereau Road. Lecture on "Armstrong Circuit Experiences," by Mr. Dyer.

Tuesday, October 17th.

Transmissions of telephony at 8 p.m. on 400 metres by 2 MT Writtle.

Wednesday, October 18th.

THE INSTITUTE OF PHYSICS.

At 6 p.m. At Institution of Electrical Engineers. Lecture on "Physics and the Physicist," by Mr. Clifford C. Paterson. (Third lecture of series.)

At 5-5.30; 6-6.30 p.m. Concert in aid of the Gravesend Disabled Soldiers' and Sailors' Fund. (P.M.G. permitting.)

Thursday, October 19th.

Daily Mail Concert as above.

DERBY WIRELESS CLUB.

Informal meeting.

Friday, October 20th.

POWISLAND RADIO AND SCIENTIFIC SOCIETY.

First meeting and lecture by Viscount Chine on "The Elementary Principles of Wireless."

WAKEFIELD AND DISTRICT WIRELESS SOCIETY.

At 8 p.m. At the Y.M.C.A. Lecture on "A Four-Valve Receiver," by Mr. Swale.

HALIFAX WIRELESS CLUB.

At 6.30 p.m. At Clare Hall, Prescott Street, Halifax, and also the following day from 2.30 p.m. Exhibition of Wireless Apparatus by all the leading makers. Demonstrations and sale of members surplus apparatus.

Sunday, October 22nd.

Daily Mail Concert as above.

Tuesday, October 24th.

Telephony by 2 MT Writtle as above.

Wednesday, October 25th.

REDHILL & DISTRICT Y.M.C.A. WIRELESS SOCIETY.

At 111, Station Road, Redhill. Lecture on "Inductances," by Mr. Pescett.

Thursday, October 26th.

Daily Mail Concert as above.

DERBY WIRELESS CLUB.

At 7.30 p.m. At The Court, Alvaston. Lecture on "Amplification," by Mr. E. V. R. Martin.

Friday, October 27th.

WAKEFIELD AND DISTRICT WIRELESS SOCIETY.

Lecture on "The Relation of Inductance and Capacity to Electro Magnet Waves in Receiving and Transmitting Circuits," by Mr. Watson.

Saturday, October 28th.

WORKING MEN'S WIRELESS CLUB.

At Crowndale Road, N.W.1. Exhibition and demonstration at 1 p.m., also exhibition of X-Ray apparatus.

Wireless Club Reports

NOTE.—Under this heading the Editor will be pleased to give publication to reports of the meetings of Wireless Clubs and Societies. Such reports should be submitted without covering letter in the exact form in which they are to appear and as concise as possible, the Editor reserving the right to edit and curtail the reports if necessary. The Editor will be pleased to consider for publication papers read before Societies. An Asterisk denotes affiliation with the Wireless Society of London.

North Middlesex Wireless Club.*

Hon. Secretary, Mr. E. M. Savage, "Nithsdale," Eversley Park Road, Winchmore Hill, N.21.

A meeting of the Club was held on September 20th at headquarters, Shaftesbury Hall, Bowes Park. This meeting, following close on the fête held at Palmer's Green in aid of the local hospitals, at which the Club assisted, it was thought that it would interest new members to hear how the speech received on that occasion was transmitted. The Chairman accordingly called on Mr. L. C. Holton to lecture on "The Transmission of Wireless Telephony."

Mr. Holton began by explaining the action of a simple "spark" transmitter, and showed how a group of waves finally produced a single movement of the telephone receiver. He said that the human ear could distinguish frequencies from 34 up to about 16,000 to 20,000 per second as a musical note, and went on to explain what difficulties had to be overcome before speech could be transmitted by wireless when the transmitting system employed "damped waves." He said these difficulties were easily overcome when a "continuous wave" system was used, and drew a number of circuits showing how a valve could be made to generate the necessary waves, and explained how a microphone, when connected in a suitable part of the circuit, had the effect of modulating the waves radiated, and produced speech in the receiver at the other end.

Mr. Holton then gave particulars of a more powerful circuit using one valve (the power valve) for generating the waves, and a second valve (the control valve) for impressing speech on the wave. He then exhibited the transmission panel of his set, which was well on the way to completion, and which had been made to his design by Mr. G. W. Evans. This is a particularly fine piece of work which made all those present feel envious.

After a vote of thanks to Mr. Holton, the Secretary read a letter from the Marconi Co., thanking the Club for its assistance at the fête mentioned above, when music was transmitted from 2 LO, and received at Palmer's Green on the Marconi Co.'s instruments by their operator. It is expected that one result of the fête will be a large influx of members to the Club, particulars of which may be had on application to the Hon. Secretary.

East London Radio Society.*

Hon. Secretary, The Lecture Hall, Woodstock Road, Poplar, E.14.

A successful meeting was held at the Lecture Hall, Woodstock Road, E.14, on September 19th, with Mr. A. J. Alexander in the chair.

Informal discussion preceded the actual opening of the meeting. These short open discussions are proving of great value to the Society, and most new members' difficulties are satisfactorily disposed of by the more experienced and competent experimenters. The Society's set was then set in opera-

tion, and members listened with great interest to 2 MT. Mr. J. Keens then delivered the second lecture of the present series, the subject being "The Application of the Thermionic Valve to Receiving Circuits." Those who knew little of the subject were agreeably surprised to find what was to them a difficult matter, ably brought within their comprehension. Those who knew a great deal of the subject were equally surprised to listen to the matter being so simply explained.

The meeting closed with votes of thanks to the Chairman and Lecturer.

On September 22nd a further meeting was held. On September 26th a lecture was given on "Inductance Coils," with some remarks upon crystal sets.

The Secretary will be pleased to hear from any East London amateur desirous of joining the Society.

Durham City and District Wireless Club.*

Hon. Secretary, Mr. Geo. Barnard, 3, Sowerby Street, Sacriston, Durham.

The first public lecture and demonstration organised by the above Club took place on Friday, September 22nd. The hall was packed to the limit. To suit the requirements of the majority there, Capt. H. de A. Donisthorpe did not make his address of too technical a nature.

As is always usual, some of the experiments did not come off; however, there were some very interesting demonstrations which proved most entertaining to the crowded house.

The lantern slides were shown admirably by Mr. Bertram, who is a member of the Club. At the conclusion of the lecture, Lt.-Col. Cluff, on behalf of the meeting, thanked Capt. Donisthorpe, and asked for appreciation to be shown in the usual way.

A large percentage of those present remained behind to inspect the apparatus, which included a loud speaker, a seven-valve Marconi receiver, Seismograph, and a fine compact three-valve audio frequency amplifier belonging to Mr. D. Bromwell.

Wireless and Experimental Association.*

Hon. Secretary, Mr. Geo. Sutton, 18, Melford Road, S.E.22.

At the Central Hall, Peckham, on September 27th, the members carried out buzzer practice under Mr. Sam Middleton. The Chairman, Mr. Knight, lectured on series and parallel connections of batteries, and also different systems of electric light wiring. Mr. Bird, the newly-appointed Secretary for foreign members, read correspondence from a member stationed at Cairo.

Mr. Middleton then gave useful tips on surfacing and working ebonite, which were much appreciated.

Wakefield and District Wireless Society.*

Hon. Secretary, Mr. Ed. Swale, 11, Thornes Road, Wakefield.

A meeting of the above was held in the Y.M.C.A., Grove Road, on Friday, September 22nd, at 8 p.m. Chairman, Mr. H. H. T. Burbury (President).

The minutes were read and signed, after which Mr. Burbury called upon his son to give his lecture on the "Two-valve, High Frequency Amplifier, with a view to Maximum Amplification," a continuation from the meeting of September 1st.

Messrs. Bateman and Wrigley figured in discussion with the speaker, who explained every detail to a most appreciative audience.

All were glad to see the return of the President after his two months business vacation.

Buzzer practices are now in vogue for half-an-hour prior to each meeting.

Newcastle and District Amateur Wireless Association.*

Hon. Secretary, Mr. Colin Bain, 51, Grainger Street, Newcastle-on-Tyne.

A meeting of the above Association was held at Headquarters, Wireless School, Eldon Square, Newcastle-on-Tyne, on Monday, August 28th, at which a demonstration was given by the representative of The Sterling Telephone Co., Ltd., of the large 18-in. Magnavox loud speaker, with an amplifier. Tremendously loud signals were received.

At the following weekly meeting on Monday, September 4th, seven new members were proposed and approved of by the Committee, bringing the membership up to 81.

In view of the now rapidly increasing number of members it has become necessary to find a larger club-room, and all members were requested to endeavour to find a suitable club-room for the future use of the Association.

Letters from the P.M.G. to members applying for experimental licences were then read, and after a short discussion Mr. Burdis recommended all new members to apply for a simple non-radiating circuit at first, then after having gained experience, to apply for permission to use a more complete installation.

A very interesting discussion upon short wave inductances finished the business of the evening.

Leicestershire Radio and Scientific Society.*

Hon. Secretary, Mr. J. R. Crawley, 269, Mere Road, Leicester.

The Society held their bi-monthly meeting on September 25th, at headquarters, Mercury Office, 8, Chatham Street.

The President, Mr. Cyril T. Atkinson, being the lecturer, Mr. H. E. Dyson, Vice-President, took the chair.

There was a large gathering, many new members being in evidence. The preliminary business was short, consisting mainly of a small amount of correspondence, together with discussion of a special scheme of lectures suitable for beginners, this latter item being left for the consideration of the Committee.

The Chairman then called upon the President to deliver his lecture on "Wavemeters."

Mr. Atkinson opened up with the elementary principles of wavemeter design, passing by easy stages to the consideration of one or two sound commercial instruments as follows: First the Marconi crystal type, second a Telefunken instru-

ment, and thirdly the Townsend pattern. Each of these types received a very detailed analysis, special reference being given to the latter owing to its suitability for home construction, which was next touched upon, detailed instruction being given of a similar instrument having a simple range of from 140 to 240 metres. The lecture was concluded with an explanation of a method of calibration suitable for wavemeters of a comparatively short maximum wavelength, viz., the Lecher wire. A discussion followed, Mr. Atkinson making suitable replies to the sundry questioners. The meeting then concluded by a very hearty vote of thanks from the assembly for the interesting and useful lecture, this being proposed by the Chairman and seconded by Messrs. J. W. Pallett and D. Morton.

The next meeting of the Society took place on October 9th, the title of the lecture being "The Construction of Wireless Apparatus," by Mr. S. Skeet.

All communications regarding the Society to be addressed to the Hon. Secretary.

Stoke-on-Trent Wireless and Experimental Society.*

Hon. Secretary, Mr. F. T. Jones, 360, Cobridge Road, Hanley.

At a meeting at the Y.M.C.A., Hanley, on September 28th, it was announced that a temporary permit had been received from the G.P.O. pending the issue of the experimental receiving licence. The Society is now in a position to carry on its practical work unimpeded.

Arrangements were made to entertain local boy scouts on the occasion of the Prince of Wales' address to scouts from York House, broadcasted from Marconi House on October 7th.

Wallasey Wireless and Experimental Society.*

Hon. Secretary, Mr. C. D. M. Hamilton, 24, Vaughan Road, Wallasey.

On September 6th a lecture and demonstration were conducted by Messrs. Cowan and Hamilton.

A four-valve receiver was used, a detector panel and low frequency unit constructed by Mr. Hamilton, and a two-valve L.F. unit made by Mr. Cowan.

The Society's indoor aerial not being as efficient as could be wished, the results were perhaps open to criticism, but signals were received from several continental stations, and telephony from the dock board and bar ship was made audible to the members through a "Brown" loud speaker.

A field meeting was held on September 9th, excellent results being obtained on two valves. Telephony was received from several local amateurs.

Liverpool Wireless Society.*

Hon. Secretary, Mr. C. L. Lyons, 76, Old Hall Street, Liverpool (telephone 4641 Central).

A meeting was held on September 28th at the Royal Institution, Colquhoun Street, Liverpool. Mr. E. B. Grindrod was in the chair.

Questions were dealt with by Mr. S. Lowey, who gave blackboard diagrams. (Mr. Lowey's station was described in *The Wireless World and Radio Review* some few issues back.)

One of the series of short lectures which is proceeding in conjunction with the Society's apparatus was then delivered. At the last meeting the C. Mark III three-valve amplifier was fully described. On this occasion the Mark III. tuner was described in detail by Mr. N. D. B. Hyde, in

more or less non-technical manner, blackboard diagrams being used. The receiving panel proper was taken from its case and passed round for inspection. Questions were again invited and dealt with by Mr. Hyde.

The winter session of the Society opened on October 12th, when the President, Professor E. W. Marchant, D.Sc., delivered an interesting address. All local amateurs and enthusiasts are invited to join the Society. During September over twelve new members were enrolled.

Sunderland Wireless and Scientific Association.*

Hon. Secretary, Mr. H. G. Mac Coll, 1, North Elms, Sunderland.

The last General Meeting of the session was held at the Technical College on Saturday, September 23rd. Nominations having been received for the Officers and Committee for the ensuing year, Mr. R. Sutherland Allan opened a discussion on the programme for the next session. He informed the meeting that a suite of rooms had been obtained for the Association at Westfield House, consisting of a reading room, experimental and lecture room, Secretary's office, and cloak room. These rooms are to be open daily for the use of members.

He then explained that the Committee had arranged to run a number of courses of lectures jointly with the Sunderland Y.M.C.A. Radio Society. The following courses have been arranged:—

(1) Course of 24 Wireless lectures. (2) Course of 12 lectures on Elementary Magnetism and Electricity (before Christmas), followed by 12 Elementary Wireless Lectures. (3) Course of Elementary Wireless Lectures for Beginners. (4) Lectures on other scientific subjects, lectures, debates, etc. (5) Four Public Popular Lectures. (6) Courses of Senior and Junior Buzzer Practice. A discussion then ensued, after which the meeting was declared informal. The Association is holding a wireless and scientific exhibition in connection with the Sunderland Housing and Health Exhibition at the Whitehall Rink from October 3rd to 14th. The present membership is 131.

Whitley and Monkseaton Y.M.C.A. Wireless Society.

Hon. Secretary, Mr. R. J. Oliver, 12, Waverley Avenue, Monkseaton, Northumberland.

This Society, recently formed, has 30 members.

The officers for the ensuing year are—President, Mr. H. B. Saint; Vice-Presidents, Mr. H. Kitchen, M.I.E.E., and Mr. H. F. White, M.I.R.E.; Chairman, Mr. Fred Morley; Secretary and Treasurer, Mr. R. J. Oliver. Messrs. Fred Kaye, G. M. Daniels and T. W. Stewart, were elected to serve on the Committee.

Applications for membership should be sent to the Hon. Secretary.

Eastern Enfield Wireless and Experimental Society.

Hon. Secretary, Mr. Arthur I. Dabbs, 315, High Road, Ponders End, N.

The inaugural meeting of the above Society was held on September 28th at the "Falcon Inn," South Street, Ponders End, when a very satisfactory attendance was recorded. Mr. J. Kent was elected Chairman, Mr. Balfour, Treasurer, and Mr. A. Dabbs, Hon. Secretary. A Committee was elected consisting of the Chairman, Secretary, and Messrs. A. Rich, Gill and Brackenbury.

The Chairman announced that Mr. Balfour had very kindly offered the use of the room for meetings, and, moreover, was presenting the Society with a complete three-valve receiving set with loud speaker and aerial for the use of the members at the meeting room. A hearty vote of thanks was accorded Mr. Balfour, and arrangements were made for the application for the licence immediately.

The subscription decided upon is 10s. 6d. per year, the objects of the Society being to assist everybody in the district who is in any way interested in wireless either from an experimental or "broadcasting" point of view. Meetings are held every Thursday at 8 p.m. at the "Falcon Inn," and the Secretary will be very pleased to give prospective members any information if they will write him or attend the meetings. The Society has had an enthusiastic commencement, and has prospects of being very well equipped, and it is hoped that everybody in the district interested will recognise the advantages of the Society.

Bromley Radio and Experimental Society.

Hon. Secretary, Mr. J. Fergusson-Croome, "Gowrie," Wendover Road, Bromley, Kent.

The inaugural meeting was held on September 25th, at 8 p.m., at 14, College Road, Bromley. A good number of amateurs attended.

Enthusiasts in the Bromley district are invited to communicate with the Hon. Secretary.

Middlesbrough and District Wireless Society.

Hon. Secretary, Mr. Cleveland Hood, Nunthorpe, S.O., Yorks.

A meeting of this Society was held on September 18th, when Mr. Frank King delivered his paper on the "Armstrong Regenerative Circuit," after which a keen discussion took place.

It was resolved that the circuit should be applied to the Society's apparatus in order to discover what disadvantages Armstrong's new invention carries with it.

The Society has a full programme until December.

Ipswich and District Wireless Society.

Hon. Secretary, Mr. F. T. G. Townsend, 46, Grove Lane, Ipswich.

A very successful sale and exchange of members' spare apparatus was carried through under the auspices of the above Society at its headquarters, 55, Fonnereau Road, on September 25th. The stipulation was made that 10 per cent. of all sales should be given to the general fund of the Society. It was pleasing to note the presence of the Society's representatives from Felixstowe and Bury St. Edmunds. The Annual General Meeting is being held shortly, and any resolutions or suggestions should be submitted to the Committee at once.

Wolverhampton and District Wireless Society.

Hon. Secretary, Mr. J. A. H. Devey, 232, Great Brickkiln Street, Wolverhampton.

At a meeting of the above Society held at headquarters, 26, King Street, Wolverhampton, on September 27th, a most instructive and unique lecture was given by Mr. F. G. Redhead on "Psychic Phenomena and Wireless."

The subject proved an exceedingly attractive one, the lecturer endeavouring to prove that a similar action took place with the human brain as that of wireless telegraphy, the various organs acting on each other by induction, and the nerves and fibres being the conducting bodies. This was

due to the electric forces of the brain. Telepathy, as he expressed it, was really a human wireless.

The lecturer went on to say that the human brain is not only a transmitting and receiving machine for electric waves, but the human body is a complete electric generating station.

A very animated and vivacious discussion followed, the subject being gone into thoroughly, Messrs. Harvey-Marston, A. A. Devey, Rushton, Jones and Court, taking part.

Fulham and Chelsea Amateur Radio and Social Society.

Hon. Secretary, Mr. R. S. V. Wood, 48, Hamble Street, Fulham, S.W.6.

The minutes of the previous meeting being read and accepted, one new member was presented to the meeting and accepted for enrolment. Total membership, 72.

During the evening Mr. Skutt gave an interesting and simple analogy of the fixed condenser, and Mr. Hawthorne dealt with the functions of the valve in answer to a junior.

Mr. Gauntlet also gave his experience on reception on a gas-pipe aerial and water-pipe earth.

The Society's headquarters are Chelsea Polytechnic, Manresa Road, Chelsea.

All communications to be addressed to the Hon. Secretary.

Clapham Park Wireless Society.

Hon. Secretary, Mr. J. C. Elvy, 12, Tavistock Street, Strand, W.C.

The second, third, fourth and fifth general meetings of the above were held at Headquarters, Studios, 67, Balham High Road, on August 9th, 23rd, September 6th and 20th, 1922, and the Society can now be regarded as a real live institution. Its headquarters being located on the 'bus and tram routes proves decidedly advantageous to members on outskirts of Streatham Hill, Balham, Clapham, Tooting, Battersea and Wandsworth. Applications for membership have been received from Wimbledon and Merton.

An aerial gratuitously provided by one of the members, Mr. F. Race, has been erected by Mr. M. P. Prout, the Hon. Treasurer, at the headquarters, and Mr. A. L. Beadle has loaned Morse apparatus for the usual "buzzer practice."

Mr. H. J. Howard gave a lecture on "The A.B.C. of Wireless," at the September 6th meeting, which provoked a healthy and instructive discussion, followed by a demonstration with a H.P.R. three-valve set, provided by Mr. Race for the evening's "listening in," necessary permission having been obtained from P.M.G.

The Hon. Treasurer has provided printed stationery for the initial stages of the Society's proceedings.

Mr. A. L. Beadle is experimenting on a device for drawing attention of passers-by to the effect that those interested in wireless should walk inside to gain information and advice.

The last meeting was noteworthy by reason of one of the new members, Mr. J. A. Daniels, giving an impromptu and most interesting discourse on wireless in general and amplification in particular, which provoked a healthy discussion, the lecturer readily adapting himself to the general satisfaction of all present.

Affiliation with the Wireless Society of London was discussed, of which more will be heard later.

The Hon. Secretary suggested a device for overcoming electrical troubles which Mr. A. L. Beadle is contending with in connection with his Morse signalling device for welcoming visitors inside Headquarters when Society is conducting its affairs.

Mr. J. A. Daniels promised to bring a five-valve set and Magnavox loud speaker for demonstrational purposes at the meeting on October 4th. Meetings will be held at 7.30 p.m. every Wednesday for the next six months. Visitors are welcomed. New members are being admitted at every meeting.

Owing to the rapid growth of the membership roll it has become necessary to bring into action the Hon. Secretary's scheme of organisation, namely, a representative for each section of the geographical area embraced by the Society. Those contemplating entering the Society are now able to call or communicate with the representative for the section in which they are resident, the representative being elected on the Committee, viz.:—
Battersea: Chas. D. Richardson, Esq., 64, Sarsfield Road, Balham, S.W.12; Streatham Hill: K. S. Burch, Esq., "Shirley," 15, Woodfield Avenue, Streatham Hill, S.W.16; Tooting: A. L. Beadle, Esq., 118, Gassiot Road, S.W.17; Clapham: W. Brierley, Esq., 2, Gauden Road, Clapham, S.W.4; Balham: R. H. J. McCue, Esq., 50, Cloudesdale Road, Balham, S.W.17; J. Gray, Esq., 20, Elmbourne Road, Balham, S.W.17; Wandsworth Common: Mr. H. Austin, 60 Kyrle Road, Wandsworth Common.

Hon. Secretary, Mr. J. C. Elvy, A.M.I.E.E., 3, Fontenoy Road, Bedford Hill, S.W.12.

Working Men's College Wireless Club.

Hon. Secretary, Mr. A. Fryatt, Working Men's College, Crowndale Road, N.W.1.

The above Club is holding an exhibition on October 28th at 7 p.m., and it extends a hearty welcome to all interested in wireless.

It is hoped to arrange concerts with various broadcasters, and also to gain permission for the working of an indoor transmitter which, to amateurs who, so far, have only been acquainted with a receiving set, should prove extremely interesting.

In addition to the above, the members are exhibiting their own apparatus, the construction of which in many cases is very unique.

An X-ray exhibition is also being held in conjunction with the Wireless Club.

Belvedere and District Radio and Scientific Society.

Hon. Secretary, Mr. S. G. Meadows, 1, Kentish Road, Belvedere, Kent.

The fourth meeting of the above Society was held on Friday, September 22nd. The President in the chair. The Society is fortunate in having such an enthusiastic gentleman at its head.

Mr. S. Burman, during a lecture on "Construction of the Society's Apparatus," explained very clearly the principle of the rectifying panel, and at the same time considerably helped the amateur who was puzzled with the functioning of certain parts of the circuit.

Mr. S. C. Meadows followed with a lecture on the "Wireless Wave." Forthcoming lectures are as follows:—Friday, October 6th, "Construction

of Society's Apparatus," third lecture of series, by Mr. S. Burnam. Friday, October 13th, "Crystal Circuits," by Mr. C. E. Morriss; "Telephones and Microphones," by Mr. S. G. Meadows.

Barnsley Amateur Wireless Association.

Corresponding Secretary, Mr. G. Wigglesworth, Y.M.C.A. Buildings, Barnsley.

The headquarters of the above Association have been finally established at the local Y.M.C.A. buildings. The members of the recently formed Wireless Section of the Y.M.C.A. have amalgamated with the Association, making it a strong and enthusiastic body of between 40 and 60 members to date.

A general meeting was convened for September 27th, to elect a President and Vice-Presidents, and also for the purpose of determining the future programme and policy of the Association.

Following are the Association's officers:—Chairman, Mr. C. Pickering; Corresponding Secretary, Mr. G. Wigglesworth; Financial Secretary, Mr. Kelly; Treasurer, Mr. J. A. T. Carr.

Intending members should communicate with the Secretary.

Sale, Altrincham and District Proposed Society.

A Society is being formed for the Sale and Altrincham district. Those interested, especially ladies, are invited to communicate with Mr. P. Newton Clough, Stanley House, Sale.

Borough of Tynemouth Y.M.C.A. Radio and Scientific Society.

Hon. Secretary, Mr. Geo. J. S. Littlefield, 37, Borough Road, North Shields.

The third Annual General Meeting of the above Society was held on Monday, September 18th, in the Y.M.C.A. buildings, Bedford Street, North Shields. Councillor A. E. Hill presided, and there was a good attendance of both old and prospective members. There were also present Mr. R. Lishman, J.P., and Mr. J. C. Burnett, B.Sc., Vice-Presidents of the Society.

Mr. Littlefield read the Secretary's report of the last year's work, which showed considerable progress, the outstanding features being the exhibition and the dinner, both of which were highly successful. During the summer months two field days were held, one at Holywell Dene and the other at Newbiggin. At the latter place, transmission tests were carried out under the guidance of Mr. Forsyth and Mr. Boutland, of Ashington. A transmitting licence for the Society is now being applied for.

The Treasurer, in his report, stated that although there had been a considerable expenditure this past year, particularly on the Club installation, the financial position of the Society was extremely good.

Mr. Thomas Hunter was cordially thanked for his services in auditing the accounts.

These reports were followed by the election of officers, the result being as follows:—Patron, the Mayor of Tynemouth (re-elected); President, Mr. J. E. Burnett, F.R.Met.Soc. (re-elected); Vice-Presidents, Mr. S. Todd, Mr. W. Hall, Councillor A. E. Hill, Mr. R. Lishman, J.P., Mr. E. E. Triggs, Mr. E. W. Heaton, F.R.G.S., Mr. J. C. Burnett B.Sc., Mr. T. Blackburn (all re-elected); Hon. Secretary, Mr. Geo. J. S. Littlefield; Hon. Assistant Secretary, Mr. D. G. Scott; Hon.

Treasurer, Mr. J. E. Emery (re-elected); Hon. Auditor, Mr. Thomas Hunter, A.C.A. (re-elected); Committee, Dr. J. A. Hislop, Mr. R. Morley, Mr. H. Hutchinson, Mr. W. J. Potts, Mr. L. L. Sims (re-elected).

A vote of thanks to last year's officers was proposed by Mr. Hutchinson and carried with acclamation. Mr. Littlefield then said a few words about this winter's syllabus of lectures which was well in hand, and included a number of practical demonstrations. It is hoped to hold a three-days' exhibition in December. Items of a minor nature were then dealt with, and it was stated that the Society's apparatus would be available for the use of members on meeting nights, Tuesdays and Fridays. It was also decided that a dinner should be held at the close of the winter session. The Secretary asked all members possessing receiving apparatus to send him reports of their reception of the Chase Radio Telephony Station—5BA. Detailed reports of the general reception in the North Shields district could then be compiled and sent in, the information being invaluable to the gentlemen operating the station.

This concluded the business of the meeting and after a hearty vote of thanks was proposed to Councillor A. E. Hill for so kindly taking the chair at extremely short notice, the meeting closed. Afterwards several new members were enrolled. Full particulars of the Society will be gladly sent to anyone interested on application to the Hon. Secretary.

Finchley and District Wireless Society.

Hon. Secretary, Mr. A. E. Field, 28, Holmwood Gardens, Church End, Finchley, N.3.

The fourth meeting of the Society was held at the Wright-Kingsford Home, Granvill Road, when it was decided that future meetings should be held on Monday evenings, at 8 o'clock, and that a social evening should be held on October 16th. A demonstration was given on a four-valve set, kindly lent by Mr. Bishop. The membership is now over 40, and the Society is anxious to increase its numbers still further. A buzzer class is held at the close of each meeting, and is conducted by Mr. Nicholls. The subscription has been fixed at 12s. per annum for senior members, and 6s. per annum for juniors.

It is hoped to become affiliated to the London Wireless Society in the near future.

The Hon. Secretary invites enquiries from all interested amateurs in the district.

Cambridge and District Wireless Society.

Hon. Secretary, Mr. J. J. Butterfield, 107, King Street, Cambridge.

Sir G. Douglas Newton, K.B.E., M.P., J.P., has kindly consented to become patron of the Society.

Meetings for the winter session commenced on Tuesday, October 3rd, and will be held on each alternate Tuesday. It is hoped to publish further particulars later.

Knightsbridge Radio Club.

Hon. Secretary, Mr. R. H. Davis, 1, Kinnerton Place South, Knightsbridge, S.W.

A wireless club has been formed at Knightsbridge. Ideal headquarters have been obtained at St. Paul's Men's Club, Wilton Crescent Mews. The membership at present is nearly 30, and is gradually increasing. The Secretary will be pleased to hear from intending members.

Questions and Answers

NOTE.—This section of the magazine is placed at the disposal of all readers who wish to receive advice and information on matters pertaining to both the technical and non-technical sides of wireless work. Readers should comply with the following rules—(1) Each question should be numbered and written on a separate sheet on one side of the paper, and addressed "Questions and Answers," Editor, THE WIRELESS WORLD AND RADIO REVIEW, 12, 13, Henrietta Street, London, W.C.2. Queries should be clear and concise. (2) Before sending in their questions readers are advised to search recent numbers to see whether the same queries have not been dealt with before. (3) Each communication sent in to be accompanied by the "Questions and Answers" coupon to be found in the advertisement columns of the issue current at the time of forwarding the questions. (4) The name and address of the querist, which is for reference and not for publication, to appear at the top of every sheet or sheets, and unless typewritten, this should be in block capitals. Queries will be answered under the initials or town of the correspondent, or, if so desired, under a "nom de plume." (5) In view of the fact that a large proportion of the circuits and apparatus described in these answers are covered by patents, readers are advised before making use of them, to satisfy themselves that they would not be infringing patents. (6) Where a reply through the post is required every question sent in must be accompanied by a postal order for the amount of 1s., or 3s. 6d. for a maximum of four questions. (7) Four questions is the maximum which may be sent in at one time.

In view of the serious interference which an oscillating receiver can cause to other receivers in its neighbourhood, it is understood that for broadcast wavelengths certainly, and possibly for all wavelengths, the Postmaster-General will in future allow no type of circuit which is capable of oscillating and so energising the aerial, either directly or through any circuit coupled to it.

The necessary consequence of this restriction is that if reaction of the type commonly used in the past is still employed, it must be in such a way that the oscillation point cannot be reached over the wavelength range of the receiver, however tightly the reaction coil is coupled, and with whatever values of filament voltage or plate voltage the set is worked.

In order to comply with this requirement, it is essential that the reaction coil should be sufficiently loosely coupled to the aerial inductances as not to set up oscillations, or alternatively the reaction might be arranged between the grid and plate circuits of a high frequency amplifier as shown on p. 715 of the issue of September 2nd.

We strongly urge readers who are making or using sets of the usual reacting type to either reduce the amount of reaction which they can employ to such an extent that they are perfectly satisfied that the set can never oscillate or to cut out their reaction entirely.

"J.J.B." (Leith).—The present regulations of the Postmaster-General specify that the reaction inductance may be coupled back to the secondary of the loose-coupled aerial tuning system. This being the case, the use of a switch providing for a stand-by position is no longer required. The arrangement of the three-coils is consequently of importance. The secondary circuit should be the middle coil and the reaction one of the outside coils. The tuner and stand-by switch may be abandoned.

"J.B." (N.16).—When licences are issued to experimenters permitting them to receive wireless telegraphy signals, it is stipulated that they shall make no use of any information that may come to their knowledge by the use of their apparatus. The Postmaster-General undertakes the reception and delivery of telegrams handled by wireless, and we cannot think that he would authorise you to organise any such service for yourself.

"R.G.D." (Sydenham).—A diagram is given in Fig. 1 of a three-valve receiver comprising H.F. valve, detector, and L.F. magnifier, arranged to suit the requirements of the Postmaster-General. It is at present stated that the use of the three-coil aerial circuit is permitted, which is made use of in the circuit. Should the circuit not be approved by the time you submit your application, you must embody the arrangement shown in the article on an H.F. amplifier in our issue of September 30th (see Fig. 1.)

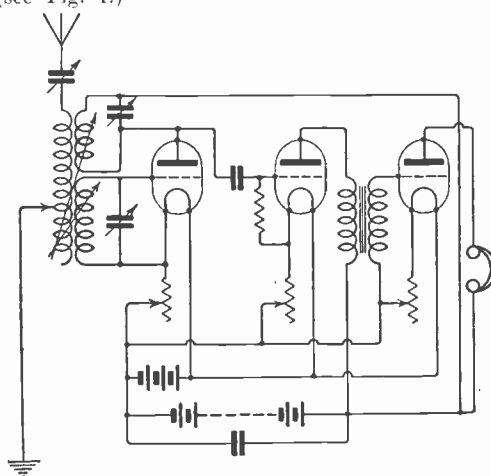

Fig. 1.

"W.D.L." (N.12).—There are many multivalve circuits given in back numbers of this journal suitable for operating a loud speaker. It is difficult to arrange H.F. amplification to cover such a wide range of wavelengths, and we suggest interchangeable high frequency transformers up to 2,000 metres, after which resistance capacity coupling is substituted. The method of doing this is shown on page 741 of September 2nd issue, where also are shown switches for throwing H.F. and L.F. valves in and out of circuit. We would also refer you to the diagram, Fig. 9, on page 743 of the September 2nd issue; also Fig. 2 and the explanatory text concerning it on page 705 of August 26th issue as a good guide.

"R.A.H." (Accrington) mentions experiments carried out in America for using the electric light wires of a house as an aerial by means of a special fitting, and asks (1) Our opinion of this innovation. (2) Whether it is possible to buy the necessary apparatus in England.

(1) The suggested scheme can certainly be worked and gives quite satisfactory results in many cases for short distances. See page 695, August 26th issue. (2) A suitable fitting is now marketed by the Dubilier Condenser Co.

"W.E.S." (Maidstone) submits a circuit and asks how it is that a certain coil improves the strength of signals.

We should say that this is due to the action of this coil in conjunction with the grid condenser, forming an "acceptor" circuit for the required frequency, allowing the transference of greater potentials to the grid of the valve.

"E.C.D." (Kent) asks (1) For wiring diagram using two H.F., one detector and one L.F. valves and plug-in transformers, with reaction. (2) Would three-valve set, one H.F., one detector and one L.F. receive telephony from Manchester. (3) Capacities of condensers to use in the set and (4) Are high resistance telephones better for these circuits than low resistance with transformer.

(1) and (3) See Fig. 2. (2) Yes. (4) No, a correctly designed valve to telephone transformer with L.R. telephones is the better arrangement, although if it is necessary to economise there is no harm in putting the H.R. telephones directly in the plate circuit.

but if your transformer consists of separate sections not connected together except by the external leads shown, your scheme will be quite satisfactory.

"B.C.O." (Earlsfield).—(1) Both of the circuits which you show are capable of causing radiation when connected to an outside aerial. We believe, however, that at the moment the Postmaster-General is prepared to authorise the use of the upper circuit, though he states that it is to be operated in such a way as not to cause radiation. The lower circuit, which consists of heterodyne oscillator coupled to an inductance which in turn is coupled to the aerial circuit, does, of course, radiate, though the use of a separate oscillator of this sort is, we believe, still approved by the Postmaster-General. (2) The relationship between the coils A and B depends entirely upon the amount of inductance included in the aerial circuit. Instead of joining additional inductance in series with the secondary of the aerial circuit oscillation transformer, you might simply provide a coil, placed near the secondary inductance, which is connected in series with the plate circuit inductance of the oscillator. (3) This depends entirely upon the dimensions of the frame aerial. Would probably bring in ships and Paris, other spark stations and telephony from high power broadcasting stations up to a distance of 50 miles when connected to a frame aerial having sides each of 4'. (4) It is very difficult to receive PCGG on a frame aerial, and we would recommend you to use one having sides of at least 6', arranging very careful tuning for high frequency transformers.

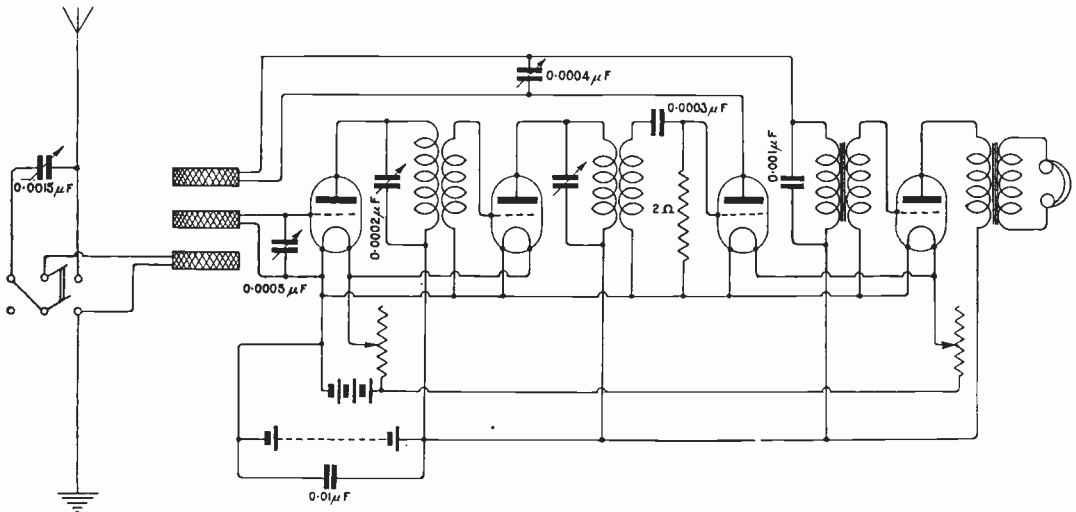

Fig. 2.

"W.B." (Cardiff) asks (1) What windings to put on bobbins of a certain size for an L.F. transformer. (2) Whether the connections of a H.F. transformer shown are correct.

(1) Core B will be better. You should wind it full of No. 44 wire, preferably DWS, using half as many turns again for the secondary winding as for the primary. (2) Your diagram is not very clear,

"W.F.S." (Kent) asks (1) For three-valve circuit with switches making use of components he possesses. (2) Particulars of aerial inductance. (3) Advice on set for concerts. (4) If fuses are useful in L.T. circuit.

(1) See Fig. 2 and switching arrangements shown in September 30th issue. (2) You may add coils to the aerial and closed circuits. We

The Present Wireless Boom

has given an enormous impetus to the manufacture of wireless apparatus. The tendency has been to sacrifice quality to quantity in endeavouring to keep pace with the demands. Throughout this period of increasing wireless activity S. G. BROWN, LTD., have wisely refused to lower their high standard of quality even at the expense of occasional delay in fulfilling orders. As a result they have more than maintained their enviable reputation as RELIABLE wireless manufacturers, and to-day it continues to be recognised by amateur and professional alike that wireless instruments and parts manufactured by and bearing the name "BROWN" can be bought with absolute confidence in their quality, value and efficiency.



"A" TYPE.
Low Resistance, 58/-
High Resistance, 62/- to 66/-
"D" TYPE.
Low Resistance, 48/-
High Resistance, 52/-

(All above prices include cords.)

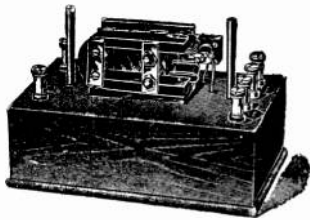

PRICES :

Low Resistance (120 ohms) input, £6
High Resistance (2,000 ohms) input, 2/6 extra.



PRICES :
H. 1 (Large) Low Resistance, 120 ohms Height 21", £6 : 5 : 0 (High resistance 2/6 to 5/- extra).
H. 2 (Small) Low Resistance, 120 ohms Height 12", £3 : 0 : 0 (High Resistances 2/6 to 5/- extra).

The "Brown" Super-sensitive Telephones

These Telephones are unquestionably the clearest and most sensitive made, and, consequently, increase the distance over which wireless can be heard.

BROWN'S are recognised as the most comfortable to wear, due to their extreme lightness in weight and adaptable adjustment.

There are no wireless headphones in the world to compare with BROWN'S.

IMPORTANT NOTICE—When purchasing BROWN'S you should see that the name BROWN is stamped on the back of each ear piece. This is the *hall-mark and proof* of their *genuineness, excellence of finish and highest efficiency.*

In Universal Use. As supplied to British, Allied and Foreign Governments.

The "Brown" Microphone Amplifier

This Amplifier magnifies signals, speech, or music, without distortion, and is of considerable interest to amateurs and scientific investigators. The magnification is much greater than that obtained from a two-valve amplifier. In construction, this instrument is much more robust than other relays. *This instrument satisfies the urgent demand for a reliable inexpensive amplifier, which the most inexperienced amateur can use, and which the most experienced requires.* The necessary transformers are included in the base.

The "Brown" Loud Speakers with new improved Curved Horns

The requisites of a Loud Speaker are pure tone, clear articulation, and good volume of sound. The "BROWN" Loud Speaker possesses these qualities and they are enhanced by the new improved curved horn.

AMATEURS do not always need the full sized Loud Speaker (H.1) as used in Lecture Halls, and a small type (H.2) has been designed to meet their more modest home requirements *both as to volume of sound and price.*

THE NEW HORN of dull blacked aluminium used with both H.1 and H.2 is constructed on the logarithmic law of increasing openings and is acoustically perfect.

NOTE THIS.—The strength and clearness of all music, speech and Morse heard by one person wearing headphones is broadcasted to a whole room full of people when a Brown Amplifier and Loud Speaker are used with your set.

The most popular and perfect loud speakers ever offered to the public.

Thousands already in use in all parts of the world.

CATALOGUE POST FREE.

Visit Our London Showrooms : 19, MORTIMER STREET, W.1.

SOLE MANUFACTURERS—



Sole Agent for the Argentine—

Horacio D. Guerrero,
Las Heras 2480, Buenos Aires

Telegrams—
"Siddbrownix, London."

Telephone—
Chiswick 1469.

Head Office and Works :
VICTORIA ROAD, NORTH
ACTON, LONDON, W.3

London Showrooms :
19, MORTIMER STREET,
LONDON, W.1.

EXPERIENCE

**DISTORTIONLESS AUDIO FREQUENCY
INTERVALVE
TRANSFORMER**

DESIGNED AND BUILT ON SCIENTIFIC LINES

25/-
Telephone Transformer - - **20/-**

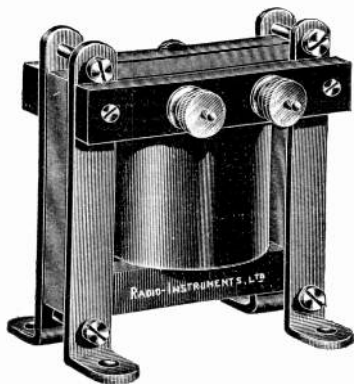

Many testimonials received from satisfied customers (originals of which can be seen at our works) prove this transformer to be considerably in advance of anything previously designed for audio frequency amplification. It is the ideal transformer for amplification with a crystal set.

WINDING AND INSULATION is by a patented process, every individual turn being specially insulated from adjacent turns as well as between layers. Tested at 1,000 volts.

DIMENSIONS are reduced to the smallest limit consistent with absolute reliability: 3 1/4" wide, 2 1/4" over feet, 3 3/8" deep. The unusually heavy wire eliminates a common weakness in other designs where efficiency and reliability are sacrificed to space.

CONSTRUCTION is on exactly similar lines to power transformers. The closed core is built up from best quality Stalloy iron laminae.

IMMUNITY FROM BREAKDOWN is assured by scientific design and careful construction, coupled with high insulation, large gauge wire, and efficient dimensions. Comparative tests confirm the superiority of our designs.

Order at Once to secure Immediate Delivery.

TELEPHONE TRANSFORMERS at 20 - each. Why pay more for imported articles of less efficiency? Get wireless equipment of latest improved designs made by British radio engineers of established reputation.

NEW BOOK OF DIAGRAMS, indispensable to the experimenter and all seriously interested in wireless. 21 working diagrams. Price 1-

THE R.I. CATALOGUE of Wireless Apparatus and components. Complete but concise. 24 pages. Price 6d.

Early application invited.

Radio Instruments Limited

Managing Director: J. Joseph, M.I.E.E., late Manager to Mr. H. W. Sullivan. Chief Designer: W. A. Appleton, M.B.E., M.I.R.E., late Admiralty Technical Research Officer.

ONLY ADDRESS. Works, Offices & Showrooms
12a, Hyde Street,

NEW OXFORD ST., W.C.1

Telephone: Regent 1908. Telegrams: Instradio, London.

(E.P.S.)2.

THE HALL MARK of EFFICIENCY

Prices
on
Application



'00005
'0003
'0005
'001 mfd.

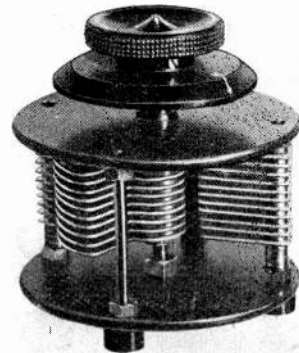

J. BURNS, LIMITED
Wangye Works, Chadwell Heath, Essex

**HIGH - CLASS
RADIO COMPONENTS**

- AERIAL WIRE. Best Stranded Copper per 100 feet . . . 3/6
- DOUBLE HEADPHONES. Best British make 4,000ohms. . . 25/-
- CONDENSER VANES. Aluminium, true to 1-1,000 per doz . . . 9d.
- FIXED CONDENSERS, mounted in ebonite with 2 brass terminals . . . 2/-
- VALVE HOLDERS. One grade only, the best, in turned ebonite . . . 1/9
- IVORINE PLATES. 2 holes for fixing. Engraved H.T., Aerial, Condenser, Telephones, Earth. Set of Six . . . 1/-
- VALVES. The Mullard "Ora," one of the most reliable for Broadcasting. Will rectify, oscillate and amplify . . . 15/-
- GRID LEAKS. The Mullard patent . . . 5/-
- GRID LEAKS. With Mica and tinfoil condenser, in ebonite case, complete with clips and terminals . . . 7/6
- SWITCH ARMS. First grade, made of ebonite, brass and phosphor bronze . . . 3/6
- IVORINE SCALES. Engraved 0-90 and 0-180 . . . 9d.
- CONDENSER EBONITE TOP. Highly finished with graduated Scale . . . 1/9
- VALVE LEGS. Set of four with Nuts, Brass . . . 6d.
- FILAMENT RESISTANCES, guaranteed efficient and made right . . . 4/6
- EBONITE KNOBS. Best quality Ebonite, knurled and polished . . . 4d.
- HIGH FREQUENCY TRANSFORMER BOBBINS, fitted with pin contacts for standard valve . . . 3/-

We guarantee the above goods to give satisfaction and every article carries our "money back" guarantee, therefore send to one of the oldest firms in the trade. Complete valve sets in stock from £10 10s. Crystal Sets complete from £3 5s. Other prices upon application.

RELIANCE RADIO SERVICE

283, St. John Street, Clerkenwell, London, E.C.1
'Phore: Clerkenwell 429). 'Grams: Remagco, Smith, London.

cannot usefully give winding details because we have no knowledge of your aerial, condensers, or wavelength range of your variometers. (3) Use 1 H.F. in preference to another L.F. valve. (4) No.

"C.B." (Madrid).—(1) and (3) As you are desirous of using your Mark III tuner for long wave reception, you would be well advised to dismantle it and make use of the components, particularly as you wish to couple it to a valve receiver. We should recommend you to obtain a three-coil holder and set of coils, and tune your inductance with the condensers removed from the Mark III; and you might arrange for two stages of H.F.

and is entirely due to the design of the intervalve transformers, and the method in which they are connected up. It may be very difficult to eliminate it, and you might try reversing the connections to the transformers, and the cores might be bridged across and joined to the H.T. plus. Alternatively, you might try separating the transformers out, and keeping the cores carefully insulated from one another. We would recommend you to substitute one stage of L.F. amplification by H.F. to the arrangement which is given in our issue of September 30th, under the heading "Experimental Station Design."

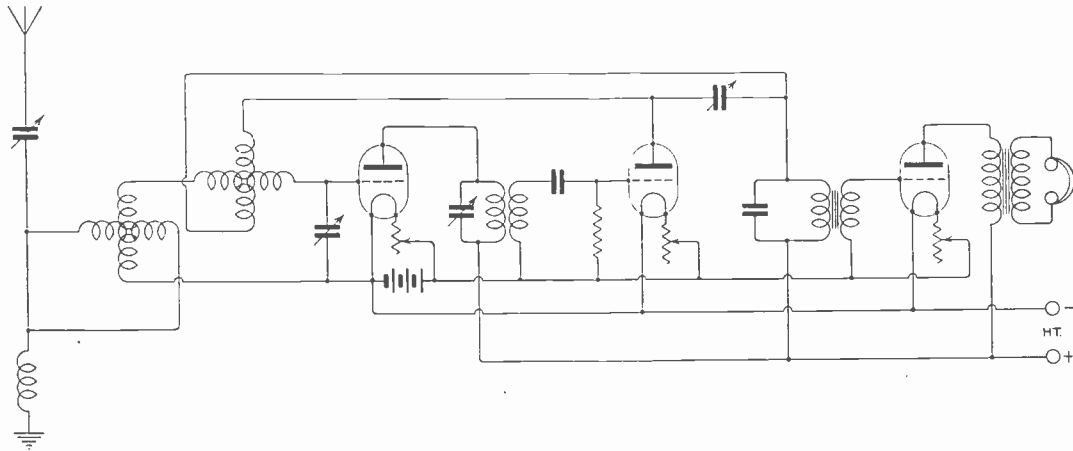

Fig. 3.

amplification followed by one L.F. amplifier. You might find it rather difficult to manipulate four stages of H.F. amplification. Numerous circuits making use of this arrangement have been given in the recent issues of this journal under the "Questions and Answers" section; in particular, Fig. 10, page 743; Fig. 6, page 741; Fig. 5, page 740; Fig. 2, page 705; Fig. 4, page 706, etc. (2) Yes; you will obtain fairly good results with the arrangement you propose, though we always advocate the use of an outdoor aerial whenever possible. (4) Usually 0.0013 and 0.00045 mds., though one plate a little out of position may somewhat increase these values.

"A.C." (Kilburn).—Although you state that the switches shown on your set are of the Dewar type, you do not say the number of contacts to which they are fitted, and consequently we cannot work them into a circuit. However, the equipment with which your panel is provided is entirely suitable for building up the set described on page 677 of August 26th issue, and continued in the issue of September 2nd, with the exception, of course, that you have one additional valve, and an additional transformer, which can easily be arranged to provide another stage of note magnification. We think the article to which we have referred you gives you all the information you will need, and far more than we could attempt to give you here.

"———" (Blackheath).—The trouble which you are experiencing is quite a common one,

"G.H." (Goteburg) asks (1) *If a resistance coupled four-valve circuit should be as good as a similarly coupled transformer circuit between 1,000 and 15,000 metres.* (2) *Diagram for such a circuit.* (3) *If certain apparatus could be used in the tuner.* (4) *What is a loading coil.*

(1) Probably somewhat better. (2) Diagram of Fig. 9, page 673, August 19th issue, will be quite satisfactory if the anode resistances are substituted for the three anode tuned circuits shown. (3) All the apparatus suggested is desirable, except the variable condenser across the reaction coil, which is hardly necessary. (4) Any inductance coil used to raise the wavelength of a circuit.

"———" (Aycocks Green) asks (1) *If an antenna or aerial plug is any good for a crystal set.* (2) *If an antenna is more efficient with a crystal set.* (3) *If it is equal to an aerial.*

(1) (2) and (3) We do not understand what you mean by the term "antenna plug." We should imagine this to mean an arrangement for connecting an aerial to a receiver by means of a plug and socket, which is quite a satisfactory way of making connection. This, however, does not fit in with your questions. We should be pleased to give you further advice if you will explain exactly what you mean by this term. The terms "antenna" and "aerial" as generally used are synonymous. Perhaps the reply to "R.A.H." (Accrington) on the previous page will help you.

"F.W." (Birmingham).—You will require, we should say, at least three interchangeable

reaction coils to cover the range you require. A more convenient arrangement is to vary the amount of added inductance connected in series with this coil. As you have not yet constructed your H.F. unit, we would recommend you to study carefully the description given of one making use of the tuned anode arrangement, which appears in our issue of September 30th.

"H.B." (Birmingham).—(1) The type of inductance to which you refer is quite suitable for connecting in the plate circuit of the H.F. valve. For reception on 300 metres one coil with 44 turns is suitable, whilst two coils will tune between 500 and 700 metres. Beyond this range you must find out the number required by experiment, as the inductive value depends so much upon the closeness of the coils when assembled. You should space each coil with a piece of waxed paper when building up your inductances. You will probably need from 15 to 20 coils. The coupling of the reaction coil connected in the plate circuit of the second valve to the inductance of the rejector circuit is a very satisfactory arrangement, and gives good amplification, though tight coupling is necessary. An article describing the construction of such a set is given in the issue of September 30th. You will need exactly the same number of coils in reactance and rejector circuits. You might bind the required number up into units, placing one set over the other.

"E.R.S." (Bredbury).—(1) It is rather beyond the scope of this department to give you all the necessary details for constructing a complete three-valve receiver, but all the details you require will be found in the article entitled "A Broadcast Receiver," in our issue of August 26th, and continued in the issue of September 2nd. In order to comply with the requirements of the Post Office it is necessary that the reaction inductance shall be coupled to the secondary of the loose coupled aerial circuit oscillation transformer. (2) We cannot give the precise windings for the construction of honeycomb coils to cover the range 180/3,000 metres. It is really much easier to buy coils having definite values specified by the manufacturers. The inductive value of a honeycomb coil depends very considerably upon the precise method of winding the wire. Useful information can be obtained from the "Radio Experimenter's Handbook," by Coursey. (3) A loud-speaker constructed by adding a trumpet to the telephone earpieces is not very satisfactory. The efficiency of a loud-speaker depends essentially upon the fitting of the base of the trumpet to the earpiece and the critical dimensions of the air column contained between the base of the trumpet and the diaphragm, and the length of the air column in the trumpet. The range of the reception depends entirely upon the power of the transmitter, and the set to which we refer you would probably be capable of reception of amateur telephony over a distance of 50 miles, and high power broadcasted telephony over a very much greater range. Range depends also on the efficiency and dimensions of your aerial. (4) Primary batteries are not very satisfactory for filament heating, as during discharge the potential across the terminals steadily falls, and it will be necessary to continually adjust the filament resistance. It is not impossible to charge an accumulator from cells of the type you mention,

but we do not recommend it. You will probably find large bichromate cells most suitable for the purpose of charging your accumulator.

"J.L.C." (Forest Hill).—We at present understand that the Postmaster-General is prepared to authorise the use of a reaction coil which is coupled back to the secondary of a loose-coupled oscillation transformer connected in the aerial circuit, as indicated on your diagram A, which is returned. Alternatively you might arrange an inductance in the plate circuit of your second valve, and couple it back to the tuned anode circuit, and the design of an instrument making use of this arrangement was given in our issue of September 30th.

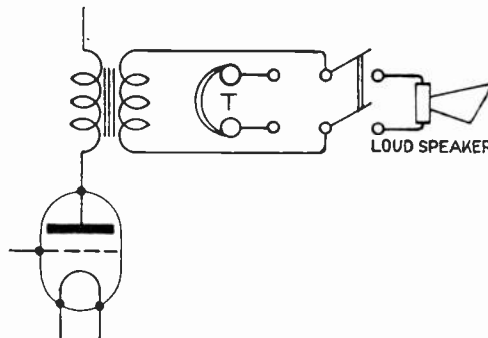

Fig. 4.

"J.D." (Huddersfield) asks (1) A diagram of a four-valve set, one H.F., one rectifying, two L.F., to comply with certain conditions. (2) and (3) Questions about re-radiation and (4) Questions about generator noises.

(1) See diagrams on page 879, September 30th issue, and Fig. 4. (2) and (3) If you are reacting into the closed circuit and the set is oscillating you will be causing a slight disturbance. The set must not oscillate to receive telephony. Your local society should be able to help you. (4) The generator noise you hear is due to the small voltage ripple superimposed on the direct current generated by the machine.

"H.A.B." (Birmingham).—The use of a grid condenser and leak as shown in your diagram is essential when using resistance capacity coupling, or the form of coupling which you have shown connected in the circuit. The grid condensers being left permanently in circuit will not have a detrimental effect provided they have a suitable value, which, for short wave working, is 0.0003 mfd. You should use valves specially designed to function as H.F. amplifiers, such as "R" or "V24." We notice that you have not provided reaction in your circuit, but when using grid condensers of the values suggested, it is not probable that rectification will be so complete that the reaction coil cannot be connected in series with the plate circuit of the detector valve.

"P.M." (E.C.1.).—The "Burndept 200" coil will cover a range of 300-600 metres when bridged with a variable condenser having a maximum value of 0.00035 mfd. You will obviously need a number of coils to cover a wavelength range of 300 to 2,000.

MAGNAVOX

THE WORLD'S FINEST

LOUD SPEAKER

RADIO
brings it
MAGNAVOX
tells it.

*Broadcasting faithfully reproduced
with marvellous clarity and volume*

IMMEDIATE DELIVERY.

Manufacturers & Sole Licensees for Europe

Sterling Telephone & Electric Co., Ltd.

TELEPHONE HOUSE.

210/212, Tottenham Court Road, London, W.1
Telephone No.: 4144 Museum (7 lines). Telegrams: "Cucumis, Wesde, London."

Works: DAGENHAM, ESSEX.

BRANCHES: **NEWCASTLE-ON-TYNE**: 9, Clavering Place.
CARDIFF: 8, Park Place.

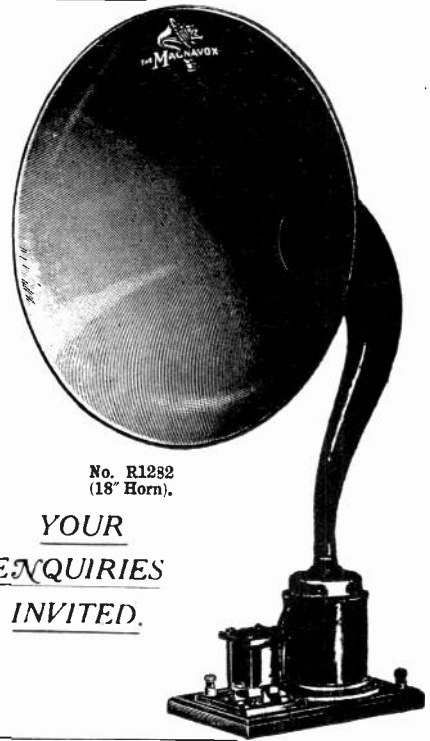

No. R1282
(18" Horn).

*YOUR
ENQUIRIES
INVITED.*

TOMLINSON

LONDON, LIMITED.

3, FINCHLEY RD., ST. JOHN'S WOOD

Hampstead 1844

WIRELESS DEMONSTRATIONS DAILY

VALVE HOLDERS

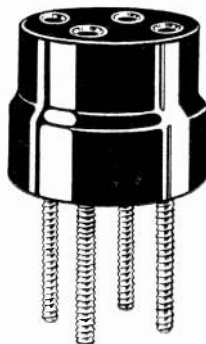

PRICE 1/-
(Post 2d.)

T.M.C. Wireless

DE LUXE

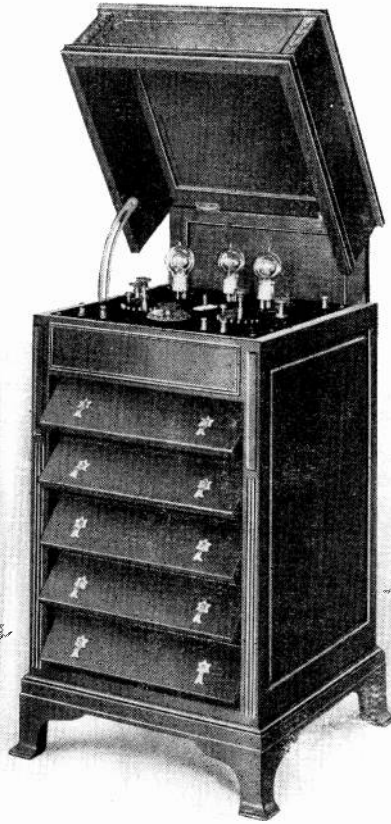

THE TELEPHONE MANUFACTURING CO. LTD
HOLLINGSWORTH WORKS, WEST DULWICH, S.E.21
TELEPHONE : SYDENHAM 2460-1 TELEGRAMS : BUBASTIS DULCROX

"T.S." (Wolverton).—(1) Your set is correctly wired, and the cause of obtaining poor results is very probably due to the design of the H.F. transformer. Poor results in receiving circuits are practically always due to the use of inefficient transformers or unsuitable valves. The first valve should be one designed to amplify high frequency oscillations such as "R" or "V.24." The second should be an efficient rectifier such as "R4B," whilst the third for use as a note magnifier should be "R" or "R4B." The windings of the inductances are suitable for operating for a limited wavelength range. The reaction coil might be bridged with a variable condenser having a maximum value of 0.0004 mfd. to facilitate adjustment, and to bring the range of tuning within that of the aerial circuit. The condenser in the aerial circuit might be provided with a switch for connecting either in series or parallel across the aerial inductance. (2) We do not advocate the use of H.F. transformers for use on wavelengths of over 2,000 metres. For wavelengths above 2,000 metres the resistance capacity method of intervalve coupling will give results nearly equal to inductively wound transformers, and has the advantage that no tuning adjustments are required. The number of turns required for various wavelengths depends essentially upon the tightness of winding, and it is very difficult to give precise windings for transformers of the type you show. You do not state the mean diameter of the bobbin, but assuming it to be 2", you will require approximately 600 turns each for primary and secondary. Put the two windings on separately, using a fine wire such as No. 38 to 44 S.S.C.

"T.W." (Darwen).—(1) Your circuit diagram is quite in order, though, of course, we cannot recommend the use of a filament resistance having a resistance of only about 10 ohms for use as a potentiometer. It will certainly produce potential variations intermediate between the plus and minus potentials of the battery, but will consume a considerable amount of current. A suitable resistance for potentiometer is 200 to 700 ohms. If Osram "R" valves are used for H.F. amplification, the use of a potentiometer is not essential. (2) The circuit will probably operate successfully with "Ora" valves, but best results are usually obtained by employing valves specially designed to function as H.F. amplifiers, rectifying and L.F. valves. The grid condenser should have a value of 0.0003 mfd., and the grid leak a value between 1.5 and 2.5 megohms. You have stated the values of your aerial tuning condenser and closed circuit tuning condenser as being each 0.005. We presume you mean 0.0005, as a condenser having air dielectric and the value you state would be extraordinarily large. You might arrange to connect the aerial tuning condenser in series or parallel across the inductance. It is convenient also to bridge the reaction inductance with a variable condenser having a maximum value of about 0.0005. The efficiency of the outfit will depend to a large extent upon the design of the intervalve transformers, in particular those used in the high frequency circuits. The transformers should be tested out individually on a two-valve set, in order to prove that they will give quite good amplification before being assembled into the five-valve outfit.

"F.C.G." (Bury St. Edmunds).—Your circuit is, of course, quite in order, and it is one that can be thoroughly recommended for reception on short wavelengths. It is difficult to suggest why changes in the value of the aerial tuning inductance should not make any difference to the tuning, and without examining the set in the hope of finding a fault, we cannot suggest the cause of the defect. All of the values you have adopted seem to be correct and the windings of the inductances suitable for short wave reception. It may be absurd to suggest it, but is the lead from your L.T. minus to the earth and lower end of aerial tuning inductance connected up? You do not say what type of valves you are using. The first should be one designed to efficiently amplify oscillations without rectifying, such as an "R" or "V24," whilst the second should be an efficient rectifier, such as an "R4B." It is a distinct advantage to add at least one note magnifying valve, though, of course, it is not much good considering this until your set is functioning correctly. An article on the arrangement of reaction you have adopted is given in the issue of September 30th and probably contains information that may be helpful to you. It is always very difficult to suggest faults in receiving circuits from brief descriptions. Usually a glance at the instrument itself will rapidly disclose the trouble.

"R.R." (Birkdale).—If you are unacquainted with the meanings of the conventional signs used in wireless circuits, it is rather beyond the scope of this department to give you all the information you will need to build up a five-valve receiver on the unit system. The most complete description of a receiver that we have published is that given on page 678 of August 26th issue, and continued in the issue of September 2nd. This is not on the unit system, but in making it up you will gain a good deal of experience in the construction and manipulation of wireless apparatus. An article on the unit system was given on page 760 of our issue of September 9th last, and this can be arranged to incorporate as many high frequency and low frequency valves as is desired. You might obtain a good deal of helpful information from the "Radio Experimenter's Handbook," by Coursey (Wireless Press, Ltd., price 3s. 6d.). We presume you are in possession of an experimenter's licence, and if you will send to us the diagram which you furnished when making application for your permit, we shall be pleased to add to it any details we may think helpful in the making-up of the set.

"V.J." (Gainsborough).—We recommend you to adopt the winding given in the article to which you refer, where a little experimental work may be necessary in order to get the precise values necessary, as the tightness of winding very considerably alters the wavelength range. For wavelengths beyond those for which the H.F. transformer is designed, we would recommend you to use resistance capacity intervalve coupling.

"M.A.H." (Croydon).—The circuit to which you refer, on page 445 of the July 8th issue, would probably not be approved by the Post Office; and we recommend you to either adopt the circuit shown on page 771, September 9th issue, or preferably, that given in the article on "Experimental Station Design," in the issue of September 30th.

"H.S." (Stretford).—We have scrutinised the blue-print diagram which accompanied your query of the 18th inst., and which appears to be in every way correct. The circuit is quite a popular one, and can be relied upon to give good results. One connection is perhaps strange, and that is that in the secondary of the high frequency transformer you have connected a condenser in the lead to the grid of the next valve. This is quite in order, but it makes the use of a grid condenser and leak between those of the grid and filament minus quite unnecessary. For short wave working you may find that a tuned plate circuit as used in the construction of the broadcast receiver described on page 768 of August 26th issue would be preferable to the intervalve transformer which you show. You do not show the aerial tuning condenser, but we presume you intend to use one externally to the instrument.

"G.S.P." (Beckenham).—The terminals on your panel are for use with a circuit in which the aerial inductance is coupled to the reaction coil. Such an arrangement is liable to cause serious interference, and we understand that the Post Office is prepared to authorise the use of three coils arranged, one in the aerial circuit, the middle one in a secondary circuit, and the other in the plate circuit. We would recommend, however, in order to entirely eliminate radiation, the use of the high frequency amplifying device given in our issue of September 30th.

"NOVICE" (Salop) has loose coupled tuner, variable condenser 0.0003 and H.R. telephones and asks (1) For circuit. (2) Range of tuning. (3) Method of adding one stage H.F.

(1) See Fig. 5. You will need an additional inductance if you desire to receive C.W. signals. Read carefully all articles on "Experimental Station Design" in back numbers. (2) About 3,200 metres. (3) See article on H.F. unit amplifier with reaction in issue of September 30th, 1922.

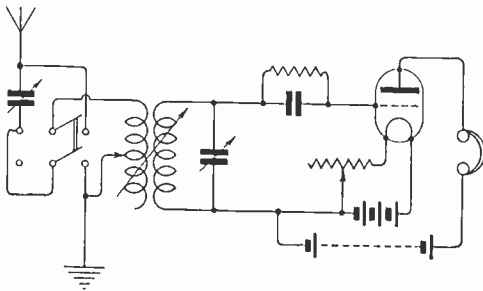

Fig. 5.

"L.R.C." (Goodmayes).—(1) An elementary book is "Heat, Light and Sound" (Jones). (2) "Electricity in the Service of Man" (Millineux Warnsley), Parts I and II. (3) A discourse on the Heavyside theory is rather beyond the scope of this section. The last volume of the *Radio Review* contained information on this subject. (4) Because the wavelength and hence the critical angle of reflection is different.

"C.F.D." (Whitby) has difficulty in reception of PCGG and asks (1) For criticism of circuit.

(2) For advice in getting set to oscillate on short wave-lengths. (3) What changes are necessary to extend range of Reinartz tuner to 450 metres. (4) Criticism of aerial system.

(1) You will need to add one stage H.F. You might construct the unit H.F. amplifier given in issue of September 30th, 1922. (2) The arrangement of your coils probably does not provide for sufficient coupling, also tune reaction coil with variable condenser and of course, use loose coupled aerial circuit. (3) Include a few more turns when constructing inductance. (4) Read article on aerial construction on page 259, May 27th, 1922.

"MUSIC" (Lowerby) asks (1) For values of condensers and H.F. transformers shown in Fig. 10, September 2nd issue. (2) For a diagram of a four-valve set to cover 150 to 2,000 metres, using two H.F., one detector and one L.F. stages, with values and particulars of construction of H.F. transformers. (3) Values of condensers and grid leak shown in diagram Fig. 8, September 2nd issue.

(1) and (3) Aerial tuning condenser maximum 0.0015 mfd., closed circuit condenser maximum 0.0005 mfd., H.F. transformer tuning condenser maximum 0.0002 mfd., L.F. transformer by-pass condenser 0.001 mfd., grid condenser 0.0003 mfd., grid leak 2 megohms, reaction tuning condenser maximum 0.0004 mfd., battery by-pass condenser from 0.001 mfd. to 0.5 mfd. (2) The diagram, Fig. 4, September 23rd, 1922, issue which meets your requirements and can be thoroughly recommended. Anode tuning condensers should have a maximum value not exceeding 0.0002 mfd. Should you wish to experiment with H.F. transformers, we suggest you commence with those described in the article on "Experimental Station Design," September 2nd issue.

"F.L.C." (E.C.1).—(1) Your proposed test by means of copper and silver coins for the sensitiveness of telephone receivers is satisfactory, and a fairly loud click should be obtained. (2) You do not state the dimensions of the frame aerial you propose to use, but we should, with the system of reception you propose to adopt, advise the use of one having sides at least 4 feet in length. The leads from the frame are bridged with a variable condenser across which is connected the crystal and primary of an intervalve transformer, which is bridged with a condenser having a value of 0.001 mfd. The secondary of the transformer is connected to the usual arrangement of two note magnifying valves, circuits for which are frequently given in this journal. (3) The specimens of wire you enclose are No. 44 S.W.G. One is single silk covered, and the other we believe has a covering of a single layer of cotton. Without knowing the dimensions of the pole pieces of your telephones, we cannot advise you as to their resistance, but the wire is suitable for winding telephone receivers of a fairly high resistance.

"V.T.B." (E.8).—It is rather beyond the scope of this section to give you a full description of the construction of a three-valve receiving set, but all the information you require can be obtained from an article entitled "A Broadcast Receiver," in our issues of August 26th and September 2nd.

"G.E.W." (Kent).—Your diagram is correct, although we prefer a telephone transformer. You might find it helpful to tune the reaction coil.



MARCONI
GIVES
UNRIVALLED
WIRELESS
SERVICE

THE MARCONI INTERNATIONAL
MARINE COMMUNICATION CO. LTD.
MARCONI HOUSE, STRAND, LONDON

"BRITWIRE" APPARATUS

Ask any visitor to the Exhibition which stand they visited first *and* last, and ten to one the answer will be the "BRITWIRE" Stand. Because, as hundreds actually told us, the finish and price of our instruments and accessories left nothing to be desired.



"BRITWIRE" Mk. III Receiver, one H.F., one Rectifying, one L.F. valve, efficient for telephony and morse on all wavelengths.

Price - - - **£12 10 0**

"BRITWIRE" Mk. IV Receiver as above, but with two note magnifying valves.

Price - - - **£16 10 0**

"BRITWIRE" Tuner as illustrated, with series parallel switch

Price - - - - - **£7 10 0**



"BRITWIRE" Note Magnifiers.

Single Valve - - **£3 0 0**

Two Valve - - **£5 5 0**

Three Valve - - **£7 10 0**



Send for Illustrated List - - Post Free 3d.

Agents required in all large Towns.

All the above valve apparatus licensed under Marconi patents for amateur use in Gt. Britain.

POST ORDERS TO

BRITISH WIRELESS SUPPLY CO., LTD.

6, BLENHEIM TERRACE, LEEDS.

Tel : 28926.

18, ELDON SQUARE, NEWCASTLE-ON-TYNE.

Tel : 360 CITY.

33, HIGH STREET, SOUTHAMPTON.

Tel : 403.

11, CHURCH STREET, WEST HARTLEPOOL.

Tel : 373.

WORKS : LEEDS.

"J.E.C." (Brockley) asks (1) Winding for A.T.I. and reaction coil to tune in 200-2,000 metres. (2) Diagram of three-valve set.

(1) For short wavelengths make up an inductance according to the instructions given in "Experimental Station Design," page 328, June 10th issue. For longer wavelengths, make up cylindrical coils with 5 or 6 taps, 6" x 6" full of No. 26 D.C.C. for A.T.I., and 4½" x 4" full of No. 28 D.C.C. for closed circuit. For reaction you had better react into the H.F. transformer. See Figs. 8 and 9, pages 742 and 743, September 2nd issue, Fig. 1, page 771, September 9th issue, and page 791, September 16th issue. We do not think you will gain any advantage by using separate batteries.

"H.Y." (Belgium) asks (1) For criticism of his five-valve set. (2) Wavelength of his aerial. (3) If French valves marked "S.I.B." are suitable, and their operating values. (4) The difference between slab and basket coils.

(1) You will find a switch to connect your aerial tuning condenser in series or parallel with the aerial tuning inductance helpful. Connect the reaction coil in the plate circuit of the third valve, and couple it with the closed circuit inductance. You should join a 0.001 mfd. condenser across the primary of the first L.F. transformer. Your switching arrangement is not very good. See the diagram on page 883, September 30th issue. r_1 and r_2 have rather high values. We prefer a telephone transformer. (2) Roughly 190 metres. (3) We cannot say, as we have no particulars of these valves. We suggest you enquire of the makers. (4) Inductance coils are fully explained in "The Radio Experimenter's Handbook," by Coursey.

"CURIOSITY" (Islington) requires diagram of two-valve set using plug-in type H.F. transformers.

(1) See Figs. 6 and 7, page 707, August 26th issue. You will gain a good deal of useful information by reading the articles on "Experimental Station Design" appearing in alternate issues. See in particular the article in September 16th issue. (2) Range 50-100 miles.

"F.A.P." (Bucks) asks (1), (2) and (3) Questions about his aerial. (4) Are Mullard "Ora" valves suitable for use in a four-valve set.

(1) The highest mast the chimney will support depends upon the construction and condition of the chimney. About 12' long would be reasonable. (2) Halfway between A and B. (3) About 6'. You will find the article on "Experimental Station Design" in May 27th issue, which deals with aeriels, very instructive. (4) It is always better to use the valves for which the set was designed, and in this case the valves which the author of the article employs are quite satisfactory.

"D.A." (Hampton) asks how to add two valves to his set.

We cannot help you much as you do not give us a wiring diagram of your set. We think you will have no difficulty if you look through several recent issues.

"R.A.H." (Clapham Junction).—The diagram is not correct as you have drawn it. See

diagram Fig. 1, page 805, September 16th issue. The telephones may be connected directly in the plate circuit, but the use of a telephone transformer is preferable. Notice the marking on the telephones and join them up accordingly.

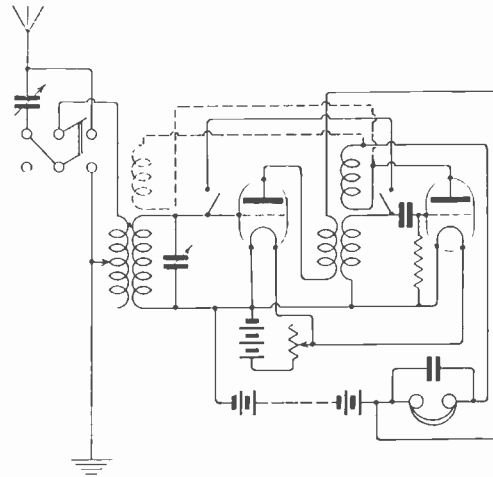

Fig. 6.

"E.H.W.B." (Bourville).—(1) Has a single-valve panel with three coil holders, and wishes to know how to arrange reaction when on "Stand-by." (2) Asks questions about his set. (3) For a two-valve diagram with switches to cut out either valve.

(1) With a single-valve set you cannot use reaction when on "stand-by," as the Post Office will not permit reacting directly into the aerial coil. When receiving on "tune" position you can react into the closed circuit coil, which should be the centre coil of the three. With a two-valve set you may react into the H.F. transformer as explained in recent issues, and then it will not matter whether you are receiving on "Tune" or "Stand-by." (2) No. A grid leak and condenser is better. If you want to try a potentiometer, connect it up as shown in the H.F. amplifier panel, Fig. 6, page 809, September 16th issue. If no reaction is employed you will receive everything except pure C.W. telegraphy, although, of course, reaction, when judiciously used, greatly improves signals. (3) See Fig. 6.

"NOVICE" (Runcorn).—(1) Your questions are not very clear. Use 40-50 volts H.T. and put 0.001 mfd. condenser across telephones and H.T. battery. For tuning to short wavelengths connect your tuning condenser in series with the aerial coil. (2) The circuit, Fig. 1, page 771, September 9th issue, will probably suit you, also see September 30th issue. (3) The noise which you hear is probably due to induction. (4) The purpose of reaction is to transfer some of the energy in the plate circuit back to the grid circuit, where it is amplified again. It acts to reduce the resistance of the input circuit to oscillations set up by the incoming signals.

"S.A.X." (Preston).—(1) Enquires whether the circuit given on page 608, Fig. 5, August 5th issue, comes under the heading of those capable of energising the aerial, if so, for a rearranged

circuit using the same components, but cutting out reaction altogether. (2) Windings for tuner to use with this circuit to tune up to 6,000 metres. (3) Number of plates for variable condenser of 0.001 mfd., and 0.00035 mfd. diameter of moving plates 3" and spacing 3/32". (4) H.T. and L.T. voltages.

(1) A circuit of this type will radiate and will therefore not be permitted by the Postmaster-General. To cut out reaction altogether, remove the reaction coil and tuning condenser, and connect the plate of the detecting valve to the intervalve transformer. Should you wish to experiment with reaction later on you cannot do better than to use one of the methods explained in "Experimental Station Design," September 2nd and 30th issues. (2) You do not give us any particulars of your aerial. Using the full P.M.G. aerial and 0.001 mfd. tuning condenser, you might use two coils, 3" x 3" full of 22 D.S.C. for short waves, and 8" x 10" full of 26 D.S.C. for the longer waves. (3) and (4) Use 6 volts L.T. and about 60 volts H.T. with "R" valves.

"D.S." (Wilts).—With regard to the use of interchangeable transformer and resistance capacity coupling you may gain some useful information from the article on page 760, September 9th issue, also Fig. 6, page 741, September 2nd issue. We understand at present that the Postmaster-General has no objection to reacting into the closed circuit. Potentiometer control is not necessary with "R" valves but it may be useful with your valves. We anticipate your reaction trouble will disappear when further H.F. valves are used. See also article in September 30th issue.

"SIGNALMAN" (Lancs).—We do not recommend this set. Why not make the Broadcast receiver described in the August 26th and September 2nd issues?

"AFICIONADO" (Leeds) asks (1) Whether in the formula, $wavelength = 1885 \sqrt{LC}$, the capacity and inductance are in parallel, and how to use this formula if the capacity and inductance are in series. (2) The dimensions of slab coils, wound with 36 gauge wire, which will tune up to 30,000 metres with a 0.001 mfd. condenser. (3) How to cut out disturbances caused by the tramway system. (4) Criticism of his set.

(1) The formula is applied to a circuit with capacity and inductance in parallel. The total capacity is the capacity of the condenser added to the self-capacity of the coil. If you have two condensers in series work out their resultant

capacity first, $\frac{1}{C} = \frac{1}{c_1} + \frac{1}{c_2}$, etc., and then use

the wavelength formula. (2) You do not give sufficient particulars, and we suggest you wind a number of coils and mount them side by side, bringing out the connections to a switch. (3) You will find it a very difficult matter to cut out the disturbances as you are so close to the tramway system. Add valves to your set and use a frame aerial. (4) The circuit as shown is of little value and would not be authorised by the Post Office. See Fig. 4, page 840, September 23rd issue.

"S.A.X." (Preston) enquires (1) Whether the circuit given on page 608, Fig. 5, August 5th issue, comes under the heading of those capable of energising the aerial; if so, for a rearranged circuit using same

components, but cutting out reaction altogether. (2) Windings for tuner to use with this circuit to tune up to 6,000 metres and (3) Number of plates for variable condenser of 0.001 and 0.00035 mfd. diameter of moving plates 3" and spacing 3/32". (4) Values of H.T. and L.T. batteries.

(1) A circuit of this type will radiate, and as such would not be permitted by the Postmaster-General. To cut out reaction altogether, remove the reaction coil and variable condenser, and connect the plate of the oscillating valve to the intervalve transformer. You could, of course, react into the H.F. transformer as described in "Experimental Station Design," September 2nd issue. (2) You do not state what range of wavelengths you wish to cover or the size of your aerial. (3) Roughly 22 fixed and 21 moving plates for 0.001 mfd.; 7 fixed and 6 moving plates for 0.00035 mfd., though number of plates, of course, depends upon their thickness, for a given size of spacing washer. (4) Depends essentially upon type of valve used, but 45 to 70 volts is a usual H.T. potential and 4 to 6 volts for L.T.

"E.A.M.G." (N.21) (1) Has added 1 H.F. valve to his single valve set and signals are weaker, and asks for cause of trouble. (2) When set is oscillating is it interfering with other receiving sets near-by. (3) Does the Post Office allow reaction, if not how to receive C.W. (4) Have curves, showing number of turns of wire in honeycomb coils, plotted against wavelength been published.

(1) From the data you give us it appears that your secondary circuit will not cover the same range of wavelengths as the primary circuit, and the H.F. transformer probably does not tune to the wavelengths you wish to receive. The reaction coil shown in your sketch should couple with the closed circuit coil, and not the aerial coil. (2) When the set is oscillating it will be a source of annoyance to other amateurs in your district. (3) At present the Post Office regulations permit reaction coupled to the closed circuit, for the reception of C.W. A good method is to couple the reaction coil to an H.F. transformer as described in "Experimental Station Design," page 715, September 2nd issue, and page 791, September 16th issue. You cannot do better than adopt the circuit given on page 867, September 30th. (4) The inductance depends upon the exact method of winding, spacing, etc. You will find a number of useful curves in "Prepared Radio Measurements," by Batcher, also see page 487, July 15th, and page 320, June 10th, 1922.

SHARE MARKET REPORT.

Prices as we go to press on October 6th are:—

Marconi Ordinary	£2	7	0
.. Preference	2	3	3
.. Inter. Marine	1	7	3
.. Canadian	10	7	½

Radio Corporation of America:—

Ordinary	1	0	3
Preference	14	7	½

Build your own set with Mullard Accessories



22/23

The wireless components with a world-wide reputation of many years standing. They will ensure your getting a set which looks well, works well and "speaks" well.

For receiving vocal and instrumental items you must have the **MULLARD "ORA" Valves**

Oscillates—Rectifies—Amplifies

Specially recommended where good amplification is required.

15/- each

IMPORTANT NOTICE

The great demand for Mullard "ORA" Valves and other accessories has compelled us to open much larger works. A greatly increased output is now available.

The MULLARD "R" Valve is now reduced in price from 22/6 to 17/6

Mullard Radio Valve Co. Ltd.

45, Nightingale Lane, S.W.12.

Contractors to H.M. Admiralty,
War Office, Royal Air Force & Post Office.
Telephone: Codes: Telegrams:
Battersea 1068 ARC(5 Ed.) "Radiovalve Hammer" Lond.
Bentley's



Please send the post free

Quantity	Description and Price
.....	Telephone Head Sets 30 .. 15/- per set
.....	ORA Valves .. 5/- each
.....	Grid A Resistances .. 5/- each
.....	Anode A or B Resistances .. 2/6 each
.....	BA Condensers 0000 mfd. and Resistances with Condensers .. 7/6 each
.....	Valve Bases .. 5/- each
.....	Valve Sockets .. 1/3 each
.....	Terminal Clips .. 91. per pair

I enclose (Cheque, Money Order, P.O.) value
to cover the cost.

Name and Address
To the MULLARD RADIO VALVE CO., LTD.,
45, Nightingale Lane,
London, S.W.12

Name of usual Wireless Dealer

SEND THIS TO-DAY

SINGLE VALVE RECEIVING SETS—Comprising Tuner 100/1,300 m., Variable Condenser, Valve Panel with Filament Resistance, etc., £5.
TWO-VALVE SET—1 H.F. Valve, 1 Rectifier, Tuner, etc., as above, £7 10s.
THREE-VALVE SET—1 H.F. Valve, 1 Rectifier and 1 L.F. ditto. Tuner, etc., as above, £9 10s. For use with L.S.
 Headphones (Double), 8,000 ohms, 24/6 4,000 ohms, 22/6.
 Accumulators, 4v. 40a., 21/-.
 H.T. Batteries, 50v., 12/6.
 L.F. Transformers 21/-.
 H.F. Transformers. Plug in type, for various wavelengths, 6/-, 12/-.
 *Phone Transformers, 15/-.
 Valves—ORA, 15/-, Dutch, 11/-.
 Valve legs with two nuts and washers, 2d. each.
 Valve Holders, complete with nuts, 1/3 each.
 Filament Resistance, complete with knob for panel mounting, 3/9 each.
 Filament Resistance, ebonite former, complete with screws, 1/3 each.
 High Res. Wire, per yard, 2d.
 Condensers, Variable, for panel mounting, .0001, 7/-, .001, 19/-, intermediate sizes pro rata.
 Condenser Vanes, fixed and variable, 1/- per doz.
 Condenser Washers, small, 3d. per doz., large, 5d. per doz.
 2BA Screwed Rod for assembling, 6d. per ft.
 Ebonite Knobs, 1½" diameter, screwed 2 or 4BA, 6d. each.
 Grid Condenser and Leak, on ebonite base, 1/6 each.
 Ivorine Scales, 0 degs.-180 degs., 7½d. each.
 Ivorine Tablets marked Aerial, Earth, etc., 1½d. each.
 Hollow Steel Aerial Masts, complete with guys, etc., from 30/-.
 Mica, Ebonite (Sheet, rod, tube), Brass Rod, Insulating Tubing, Paraffin Wax, Foil, Aerial Wire, Copper Wire, Insulators, Terminals, Nuts and Screws, etc., etc., at lowest prices.
HESTIA ENGINEERING CO.,
 32, Palmerston Road, Acton, London, W.3

EBONITE EQUIPMENT

FOR WIRELESS SETS

SHEETS, KNOBS, COIL HOLDERS, VALVE HOLDERS, ENGRAVED DIALS, SOLID EBONITE HORNS FOR LOUD SPEAKERS, PANELS

FROM STOCK

HIGHTENSITE LTD.
 Normandy St., Custom House, E. 16

*Phone: EAST 3153.

THE "BROADWAY" RADIO WORKS, DEVONSHIRE ROAD, BEXLEYHEATH, KENT.

WE HAVE A LARGE STOCK OF
FILAMENT RESISTANCES
 GUARANTEED.

Fitted with Pointer and Knob, 4/- each, postage 4d.
 Fitted with Bevelled Ebonite Dial and Knob, 5/9, postage 5d.

CONDENSERS

ALL TYPES AND VALUES.
 EVERY ARTICLE GUARANTEED.
FINEST WORKMANSHIP
 AND FINISH.
 BRASS WORK
 POLISHED AND LACQUERED.

Value in M.F.	Panel Mounting in Parts	Panel Mounting Assembled	Cabinet Mounting in Parts	Cabinet Mounting Assembled	Cabinet Mounting Assembled in Cabinet	Polished Mahogany Cabinet
.0015 ..	23/-	25/6	24/-	26/6	33/-	6/3
.001 ..	16/9	19/6	17/9	21/-	26/-	5/6
.00075 ..	13/6	16/3	14/6	16/6	22/-	5/6
.0005 ..	10/6	13/-	11/9	13/9	18/-	4/6
.0004 ..	10/-	12/6	11/-	13/3	17/6	4/6
.0003 ..	9/-	11/6	10/-	12/-	16/-	4/-
.0002 ..	7/-	9/-	8/-	9/6	13/6	4/-
.0001 ..	6/-	8/-	7/-	8/6	12/6	4/-
Vernier ..	—	4/6	—	5/-	9/-	3/6

Fitted with Bevelled Ebonite Dial 1/9 extra.
 Special Sizes Made to Order. Price list on request.
ALL SUNDRIES AND COMPONENTS IN STOCK.
ORDERS OVER 20/- CARRIAGE PAID.

A Crystal Receiver

is the **ONLY** Receiver
 that gives **PERFECT CLARITY**
 on Telephony

THEREFORE we are now offering a beautifully finished and thoroughly reliable Crystal Set having a range of 200 to 3000 metres fitted in a solid mahogany cabinet french polished, with lid,

Price £4 - 0 - 0

with pair of high resistance telephones,
£5 - 10 - 0

Range of telephony : 25 to 30 miles.
 Range of telegraphy : Paris, etc.

Prompt delivery of all orders.

“ THE BROADCASTER ”

is a Complete Amplifying Unit, combined with extra Sound Magnifier, £4 17 6

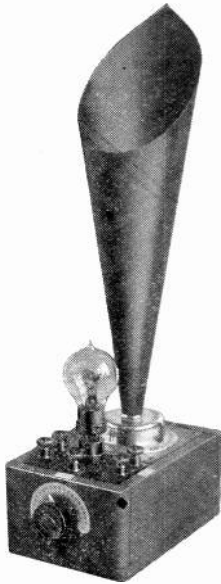

Built on the latest scientific principles, the “Broadcaster” is designed to give the greatest amount of amplification, and is specially adapted for receiving Broadcasting, while the price is well within the reach of the modern purse.

The “Broadcaster” is fitted with terminals from which it can be instantly connected with any receiving set on the market, either Valve or Crystal.

A receiving set *without* the “Broadcaster” is, comparatively speaking, only a twentieth of what the same set is *with* the “Broadcaster.”

The “Broadcaster” must not be confused with so-called Loud Speakers; the extra Amplifying Unit which it contains supplies the initial extra power required for the loud speaking device.

Owing to the unprecedented demand for the “Broadcaster” the public are advised to order immediately, either from their local dealer, or direct from the Manufacturers. Orders will be dealt with in strict rotation.

PRICE: less Valve (only until a certain quantity which the manufacturers have decided upon) £4.17.6

Thenceforth the full price £6 10 0 will be fixed. With all orders received before November 20th, one R.Type Valve will be included free with each “Broadcaster.”

The “Broadcaster” is protected by prov. patent, and any infringement will be dealt with summarily.

MANUFACTURERS:
British Wireless Co.
Incorporating
Midland Radiophone Co.
Hearsall Works, Coventry.

SUPPLIED BY THE LEADING
WIRELESS DEPÔTS.

FILAMENT RHEOSTATS

**CONTROL, PROTECT
AND ASSIST YOUR
VALVES BY USING
IGRANIC FILAMENT
RHEOSTATS.**

Type No. 11601.H-1.

Has Vernier adjustment which obtains the maximum detector action by interposing a graduated stepless resistance between each turn of the main resistance, thus adjusting the detector filament voltage to millivolts.

Type No. 11601.H-2.

Without Vernier for use with amplifying valves.

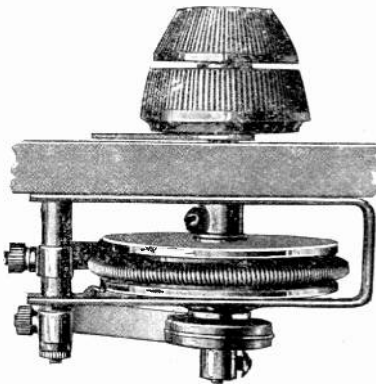

Type No. 11601.H-1.

**Standard Features
of Design are:**

- Panel mounting.
- Positive travel stops.
- Multi-step control.
- “Off” position.
- Coned knurled handles.
- Complete voltage range.
- Pointer indicating.
- Single turn contacts.
- Adjustable contact fingers.
- Knurled terminals.
- Smooth acting mechanism.

**IGRANIC
FILAMENT RHEOSTATS
built by
Rheostat Manufacturers.**

GLASGOW - - 50, Wellington Street.

MANCHESTER 30, Cross Street.

BRADFORD - 18, Woodview Terr.
Manningham.

149 QUEEN VICTORIA ST., LONDON, E.C.4



BIRMINGHAM - 73/74, Exchange Buildings.

CARDIFF - - - Western Mail Chambers.

NEWCASTLE - - 90, Pilgrim St.

WORKS - - - BEDFORD.

THE ZODEL COIL WINDER

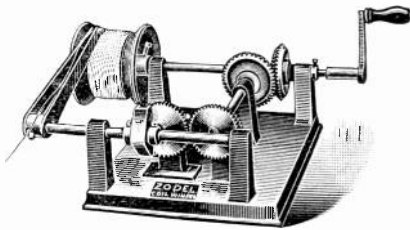

FOR DUO-LATERAL FORM COILS.

Why pay high prices for coils when you can produce the best Duo-Lateral formation type for the mere cost of the Wire?

The Zodel Machine is designed on scientific lines. Built by engineers. So simple that a child can use it. Winds Duo-Lateral Coils in a couple of minutes on any former, from 3/16" to 1" wide. The Coils produced have been proved to have the lowest distributed capacity.

CASH PRICE **£2 : 0 : 0** POST PAID

Obtainable from all Wireless Stores or direct from—

WALLACE HEATON, Ltd., RADIO EXPERTS
84, HIGH STREET, SHEFFIELD.

A NEW TYPE OF VARIABLE CONDENSER

A very compact form of Condenser, using a film of mercury as one element up to .0004 mfd. mounted on ebonite base **10/6**

BASKET COILS AND TUNING STAND

Coils mounted on ebonite formers and fitted with sockets for plug mounting. Set of five for use up to 1,200 metres **7/6**
Separate coils, 1/6, 1/9 & 2/- each.

Special Tuning Stand on ebonite base for use with these coils ... **12/-**

TELEPHONE TRANSFORMERS

For use with 120 ohm Telephones, unmounted **12/6**
Ditto, in wooden case, with Terminals **16/-**

Accessories, Panels, etc. Special apparatus made to customers' requirements.

REYNOLDS & BRADWELL,
41, CHURCH STREET, BIRMINGHAM

ACCUMULATORS

Highest Quality. Lowest Prices.
ABSOLUTELY GUARANTEED.

IN CELLULOID CASES

4v. 40 amps. ... each 18/6 6v. 40 amps. ... each 26/3
4v. 100 amps. ... " 30/- 6v. 100 amps. ... " 41/6
All Sizes in Stock. Packing Free.

Special Prices to the Trade.

AN ASTOUNDING OFFER, QUITE GENUINE.

400 only, 4v. 60 amp., in Celluloid Cases.

AT 17/6 EACH.

These will not be sold before September 28th. This price cannot be repeated when the 400 are sold. And they are subject to Trade Discount.

SPECIAL LINE.

WIRELESS HEADPHONES. 4,000 Ohms. Double Headband, each Receiver detachable instantaneously. Highly Efficient. Complete with Flexible and Cord.
OUR PRICE 22/6.

SPECIAL PRICES TO THE TRADE.

WRITE FOR OUR WIRELESS LISTS.

VARIABLE CONDENSERS.

FIXED CONDENSERS.

COIL HOLDERS.

CONDENSER PLATES, ETC.

F. YATES & Son, Ltd

WHOLESALE ELECTRICIANS.

144, Church St., Kensington, London, W.8
One Min. from Notting Hill Gate Sta. Phone—Park 4276.

Everything Guaranteed

THE POPULAR VARIABLE CONDENSER, Guaranteed, silent in action, and the finest value ever offered.

Mfd.	Mounted in Cabinet.	Panel Mounting.	Sets of Paris.
.0003	14/6	11/-	5/-
.0005	17/6	14/-	7/-
.001	22/6	19/-	11/-

The sets of parts include ebonite drilled, ready for fitting. Cabinets, 3/6 extra.

THE SCIENTIFIC WET BATTERY, in walnut finished case. Nest of 50 cells, 74 volts, 22/6, post 3/6. Nest of 25 cells, 37 volts, 13/6, post 1/6.

L.F. AMPLIFYING UNITS, for adding to crystal, valve sets, and panels for loud speakers, etc., mounted into walnut cabinet, 8" x 8", 1 valve, 37/6, 2 valves, £3 3s., post 1/-.

BLACK INDICATION TABLETS, engraving white, Aerial, Earth, Phones, React., Prim., Sec., A.T.I., A.T.C., + LT-, + HT-, per set of 10 2/6.

TUNING STAND for Honeycomb and Duo-Lateral Coils, 2-Coil Stand, 10/6; 3-Coil Stand, 15/6. Post, 8d. Coil holders, 1/3 each, 13/6 per doz. Standard pattern.

SENSITONE CRYSTAL.—The perfect mineral detector, 1/- per specimen, post free.

KNIFE SWITCHES ON EBONITE, D.P.D.T., 2/3; S.P.D.T., 1/6; S.T.D.P. 1/6.

FILAMENT RESISTANCES for Panel mounting, 3/6, post 4d.

MARK III TERMINALS, with nuts, 2/3 per doz., post 5d.

SLAB INDUCTANCES, per set of 8, 10/6, post 9d.

BASKET INDUCTANCES, per set of 7, 7/-, post 4d.

SCIENTIFIC SUPPLY STORES,

8, Newington Causeway, London, S.E.1.

'Phone, Hop 4177.

“CASTAPHONE”

(REG. TRADE MARK)

CRYSTAL W/T RECEIVING SET

Price **65/-**

Complete with 'Phones, Aerial Wire, etc., **90/-**

VALVES

“ORA,” “XTRAUDION,”

“R.M.R.”

Post free **15/-** each

H.T. BATTERIES, tapped :—

15 volts, 4/- 36 volts, 8/- 60 volt, 14/6

30 „ 7 9 50 „ 13/- 75 „ 16/6

VALVEHOLDERS, 1/6, 1/9, & 2/3

“HERTZITE”

Simple to use. No Battery Required.

Price **2/6** post free

Mounted in our Patent Detector, **5/9** post free

RUSSELL AND SHAW,
38, Great James St., Bedford Row, W.C.1

To the Trade Only

We are able to deliver the following FROM STOCK

R.M.C. Liquid Grid Leaks (Prov. Patent 12270).

Filament Resistances.

Aerial and Lead-in Insulators.

Switch Arms.

Set of Parts for Valve Panel.

L.F. Amplifiers, etc.

Please give Trade References with application for list.

Radio Manufacturing Co.,
100, DALE END, BIRMINGHAM.

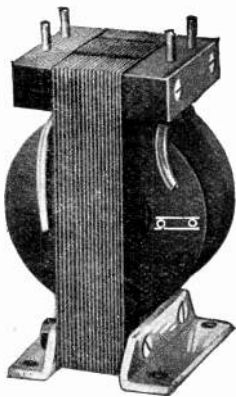

L.F. Transformer.

GENTS' MAKE FITMENTS

LARGE STOCKS AND PROMPT DELIVERY OF

L.F. TRANSFORMERS

AND

“DISCOL” H.F. TRANSFORMERS

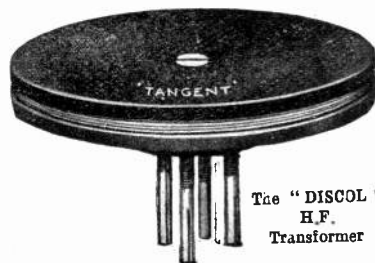

The “DISCOL” H.F. Transformer

SEND FOR OUR SUNDRIES PAMPHLET “LD66.”

May we quote for your requirements?

GENT & Co. Ltd., FARADAY WORKS, LEICESTER.

LONDON :—25 VICTORIA ST., S.W.1.

NEWCASTLE-ON-TYNE :—“TANGENT HOUSE,” 52 BLACKETT ST.

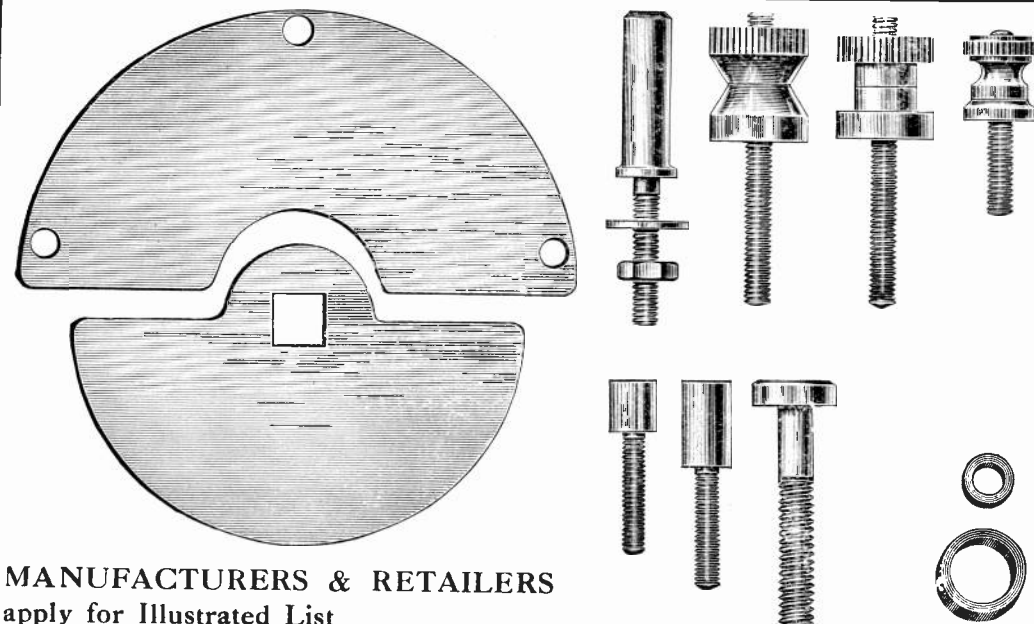

MANUFACTURERS & RETAILERS
 apply for Illustrated List
 and TRADE TERMS. KEEN PRICES. PROMPT DELIVERY.

Phone—
 Holborn 1812 **ORMOND ENGINEERING CO., 199, Pentonville Rd., King's Cross, N.1.**

TEC

HIGH TENSION DRY BATTERIES
 for WIRELESS SETS

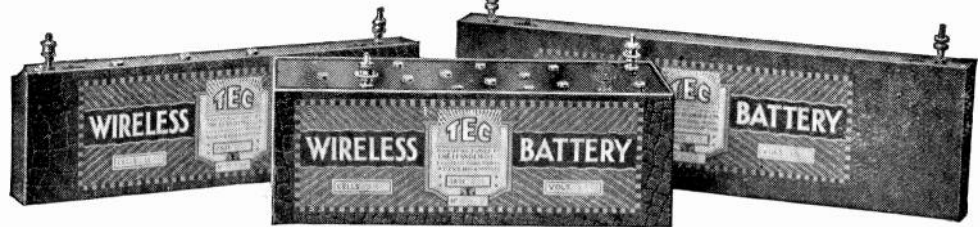

NORMAL SIZE, No. W 70 V, 15 Volts Price 5/-	W 72 V, 50 Volts Price 15/-	GIANT SIZE, No. W 75, 15 Volts Price 6/6
--	--------------------------------	---

SUPPLIED IN TWO SIZES FOR 15, 50 or 60 VOLTS
 and with Tappings in 3 Volt Steps.

ALL BATTERIES FITTED WITH PLUG SOCKETS AND MOVABLE TERMINALS.

Complete Illustrated Price List on Application.

**THE EFANDEM CO., LTD., FALLINGS PARK WORKS,
 DRY BATTERY MANUFACTURERS WOLVERHAMPTON**

MAKE YOUR OWN SETS.

- 1 Valve to 7 Valve Receivers together with
- Complete Parts for 1 Valve Set **£6 6 0**
- Complete Parts for 2 Valve Set **8 0 0**
- Complete Parts for 3 Valve Set **15 0 0**
- Complete Parts for 4 Valve Set **18 0 0**

As an advertisement and until withdrawn, we offer the complete parts for making full instructions at specially reduced prices.

Including Ebonite Panel and Terminals, Polished Wood Box, Filament Resistance(s), Vernier Condenser, Grid Leak and Condenser, Tuning Coils, 4000 ohm Telephones, H.T. Battery, 4 volt Accumulator, Aerial Wire Insulators, etc.

If you wish to enlarge your present set, write stating parts you have, when we will quote you for parts required and full instructions.

OUR PROFESSIONAL SERVICES ARE AT YOUR DISPOSAL.

Cash with Order—Delivery in Rotation, Carriage Paid.

WIRELESS COLLEGE, Amateur Supplies Dept., COLWYN BAY



SKINDERVIKEN BUTTON.

A Supersensitive Microphone. Known all over the world and patented in every civilised country. Over 80,000 sold. ENGLISH Manufacture.

Make up your own Loud Speaker. Transmit your GRAMOPHONE music to any room in your house.

The only practical Microphone for use in Detectophone Sets. **Price 5/- each**

Special Low Resistance Receivers (for use with Skinderviken Buttons) 10/- each
Special Gramophone Attachments 1/- "

Write for 16 page BOOKLET fully illustrated and containing much useful information for all interested in Electrical Sound Transmission. 8d. Post free.

Sole Proprietors:

MIKRO LTD., 274/6, Pentonville Rd., London, N.1
(Opp. King's Cross (Met.) Rly Station).

THE PARAGON RUBBER MANUFACTURING CO. SCULCOATES, HULL.

E B O N I T E	W I R E L E S S
Sheet, Rod & Tube	K N O B S
E L E C T R I C A L	V A L V E S
M O U L D I N G S	S L I D E R S, E t c.

Wholesale only.

London Office: **PERCY W. C. TRICK,**
20, LITTLE PORTLAND STREET, W.1
Telephone: MUSEUM 2043.

F. WIGGINS & SONS

MICA

Telephone :
Avenue 2248

Largest Stock
in the World.

FOR CONDENSERS AND ALL PURPOSES.

102, 103 & 104, Minories, London, E.1



**TUBE, SHEET,
WIRE, STRIP,
ROD & CASTINGS**

IN

PHOSPHOR BRONZE,

COPPER, BRASS, &c., &c.

**CHARLES CLIFFORD & SON, LTD.,
BIRMINGHAM.**

IF IT'S ABOUT WIRELESS —ASK US—

We hold a complete stock of everything wireless and can usually supply by return post

Send to-day for complete lists

Electrical Supply Stores

5, Albert Terrace, King Cross,
Halifax, Eng.

SPEARS and COMPANY FOR

TERMINALS

SCREWS, NUTS, WASHERS, PLUGS and SOCKETS, CONTACT STUDS, BUSHES, VALVE LEGS, CONDENSER VANES and TURNED and PRESSED PARTS OF EVERY DESCRIPTION.

Actual Manufacturers to TRADE ONLY

We regret we cannot supply small lots to Amateurs.

Write for Illustrated List.

**CAPSTAN REPETITION WORKS,
PARK ROAD, HOCKLEY, BIRMINGHAM**
Telephone: 3265 Central. Telegrams: "Firettes," Birmingham



Western Electric No. 44011.

DOUBLE HEAD RECEIVERS

have been designed to give maximum efficiency coupled with a low cost of production. The regular characteristics of the windings have been fitted to the physical dimensions of the Receivers in a manner to ensure that the efficiency is practically uniform over the whole audible range of frequencies. This characteristic is in marked contrast to that of Receivers which employ the feature of resonance in order to obtain sensitiveness.

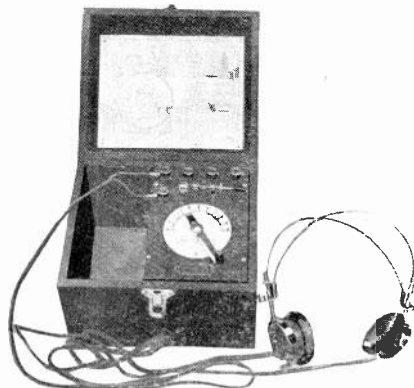

Western Electric No. 44000

CRYSTAL SET

is contained in a small polished mahogany box closed by a hinged lid. A partition is included which holds the double head receivers. The set is supplied complete with two spare crystals, and is capable of receiving within quite a large radius of a transmitting station.

Western
MAKERS
HALF THE WOR

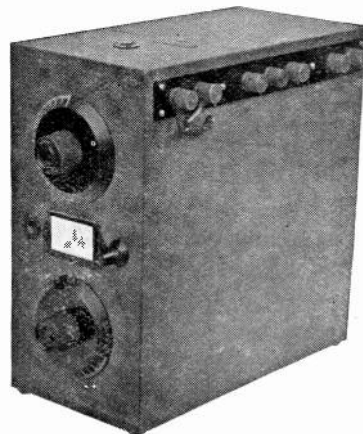

Western Electric

VALVE DETECTOR and TUNER

is contained in a polished mahogany case and provides for the inclusion of Double Head Receivers, while a spring button is fitted on the top of the case to open the receiver compartments. The Valve filaments can be seen through a specially designed mica window, and ventilation discs are provided to fully ventilate the interior of the case. At one end of the case a small card is fitted which gives particulars of various wavelengths. The set is simplified by the use of only one handle for fine tuning, and the filament key is conveniently placed on the right hand side of the wavelength index. The valves used are specially made to Western Electric specification, and the whole set is built to give the greatest possible efficiency.

Western Electric

62, Finsbury Pave-

Works - - - - - North
Branches - - - - - Newcastle,
Glasgow,

Electric

OF OVER
LD'S TELEPHONES

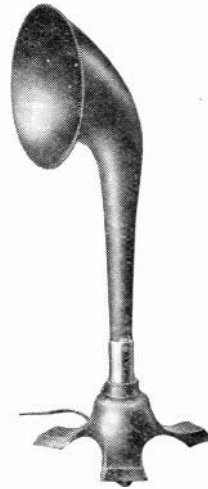
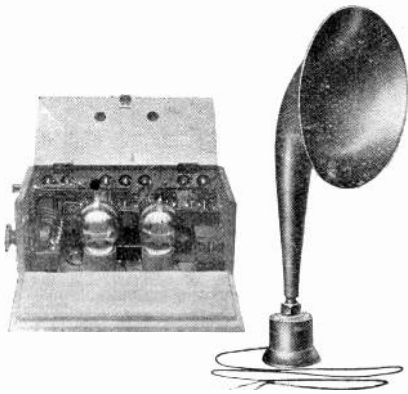

Western Electric No. 44003
LOUD SPEAKING RECEIVER

eliminates the necessity of wearing Head Receivers over the ears and can be utilised in all cases where speech or music is received in sufficient volume to be really loud on head receivers. It can be used with the valve detector alone or in conjunction with either the one stage or two stage low frequency amplifier. It has the advantage of the Head Receivers in allowing a number of people to listen-in at the same time. The Loud Speaking Receiver is supplied in three standard resistances, *i.e.*, 70, 2,000 or 4,000 ohms.

Western Electric

LOUD SPEAKING EQUIPMENT

consists of a specially designed Loud Speaking Amplifier and a Loud Speaking Receiver. Both Amplifier and Loud Speaking Receiver are so designed as to provide clear and true production over the entire musical range, *i.e.*, the outfit will receive clearly the low notes of a pipe organ and the high notes of a violin or soprano. The equipment is the result of many years research work, and there is no equipment in existence to-day which approaches it in efficiency and general reliability.

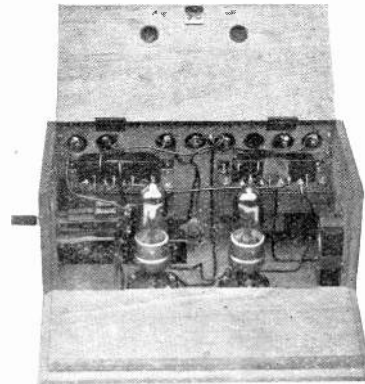

Western Electric
LOW FREQUENCY AMPLIFIER

is supplied in either one or two stages and is contained complete in a polished mahogany case. At one end of the case a key is fitted to control the stages of amplification. It is designed and constructed on the most simple lines, and the valves used are specially made to Western Electric specification. A window is inserted in the mahogany case through which the filament can be inspected, and a ventilation disc is also inserted to control the temperature of the compartment.

Company Limited.

ment, London, E.C. 2

Woolwich, London, E. 16

Birmingham, Cardiff,

Leeds, Manchester.

As quick as Writing

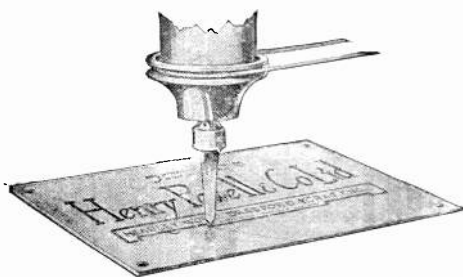

Cutter at work.

The Taylor-Hobson Engraving Machine reduces engraving to a speedy mechanical process.

It does high-class work, either sunk or in relief, on hard or soft surfaces at a fraction of the old cost.

It is used all over the world for work on metals.

We have just issued a New Catalogue. Send for it.

TAYLOR, TAYLOR & HOBSON, LTD.

74a, Newman Street, London, W.1

Works: LEICESTER.

STAMPINGS FOR RADIO INSTRUMENTS

TRANSFORMER CORE LAMINATIONS AND
DIAPHRAGMS FOR HEAD-PHONES

(IN OUR PATENT HIGH RESISTANCE MATERIAL)

“STALLOY.”

STALLOY WIRE FOR TRANSFORMER CORES.

ALUMINIUM CONDENSER VANES.

TRADE ENQUIRIES SOLICITED

JOSEPH SANKEY & SONS, Ltd., BILSTON

Representative: Robert Jenkins, 168, Regent St., London, W.1

**OOJAH
HIGH FREQUENCY TRANSFORMERS.**

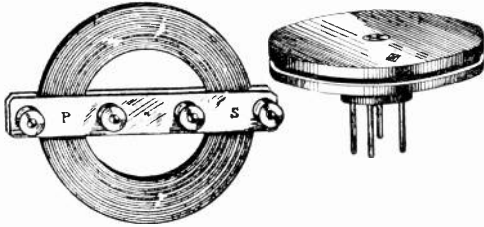

FIG. 1.

FIG. 2.

Patent pending Rd. No. 685488

These H.F. Transformers have been designed to meet the growing demand of the Wireless Experimenter for a cheap and efficient H.F. Transformer.

They were used successfully in the recent Transatlantic Tests. All Transformers are wound with D.S.C. paraffin-waxed copper wire (affording the highest degree of insulation) of a gauge far thicker than transformers now upon the market; the H.F. resistance being extremely low.

No. 3 is recommended for the reception of the Dutch Concert and general telephony.

No.		Min. W/L.		Un-mounted	Fig. 1	Fig. 2
		300 to 800	1,400 to 5,000			
No. 1	..	300 to 800	1,400 to 5,000	1/3	3/9	4/6
No. 2	..	600 to 1,400	1,400 to 5,000	1/6	4/-	4/6
No. 3	..	900 to 1,900	1,400 to 5,000	2/6	5/-	5/6
No. 4	..	1,800 to 4,000	1,400 to 5,000	3/-	5/6	6/-
No. 5	..	3,000 to 5,000	1,400 to 5,000	4/-	6/8	7/-

Postage extra.

GREENSLADE & BROWN
LANSDOWNE ROAD, CLAPHAM, S.W. 9.

Telephones { Brixton 639.
Brixton 3251.

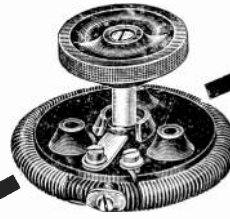

Regd. Design
No. 691772.

**4/6 Buys the Famous
ASHDOWN
Filament Resistance**

The ASHDOWN is an example of superior design and workmanship. Experts say it is the finest value in the Trade and decidedly the best resistance.

**If it's good enough for Experts
it's good enough for YOU**

Type A for 1 and 2 valves.
Type B for 3 valves (same price)

H. E. Ashdown (Birmingham) Ltd.
Perry Barr — Birmingham.

Phone: Northern 859.
Tel.: Segment

Stocks held by London Rep.:
Mr. J. O. MADDOCK,
11 Bayham Rd., Bedford Pk., W.



**---CQ Std bi
for ERICSSON PHONES**

WHEN you install your wireless set—crystal or valve—you'll get maximum results if you fit Ericsson Phones—clarity, sensitivity, strength of signals and absence of "click." Specially suited to telephony.

Ericsson Phones embody the accumulated experience of telephone manufacture for a generation. Easy to the head, light and comfortable. The magnets never lose their strength and "shorts" are non-existent.

Write for Particulars.

The BRITISH L. M. ERICSSON
MANUFACTURING Co., Ltd.

Head Office:
60, Lincoln's Inn Fields, E.C.2

Ericsson
TELEPHONES

RADIO INSULATION

AS SPECIFIED AND USED BY THE BRITISH ADMIRALTY

BRITISH MADE

PAXOLIN

BRITISH MADE

TUBES DISCS PLATES, &c.

MANUFACTURED IN ALL FORMS, SIZES AND THICKNESSES

BY

THE MICANITE & INSULATORS Co. LTD.

EMPIRE WORKS

WALTHAMSTOW

LONDON, E.17

TELEGRAMS.—"MYTILITE, PHONE LONDON."

TELEPHONES.—WALTHAMSTOW 738, 739

"For they are jolly good Fellows"

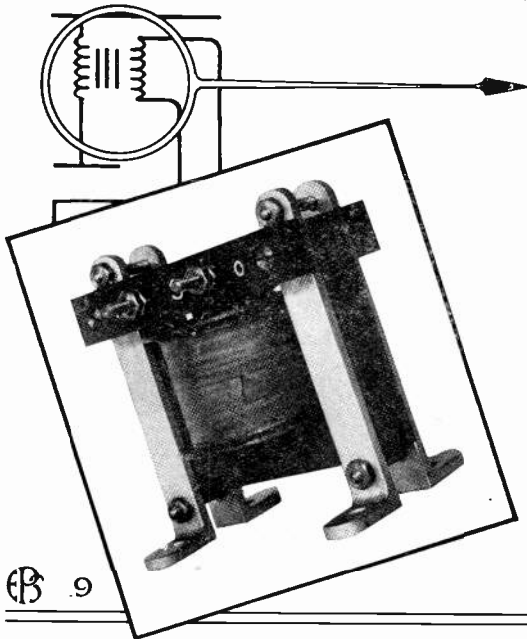

INTERVALVE TRANSFORMERS

Use Fellows Intervalve Transformers, and secure maximum amplification with freedom from distortion and extraneous noises.

British made throughout and guaranteed.

PRICE **22/6** (POSTAGE **6d.**)

FELLOWS MAGNETO CO., LTD.
LONDON, N.W.10.

Telephone :
Willesden 1560-1.

Telegrams :
Quixmag, Phone, London

ACCESSORIES FOR PRIVATE WIRELESS INSTALLATIONS



**TELEPHONE HEAD SETS
AERIAL WIRE & INSULATORS
PROTECTORS FOR
AERIAL & BATTERY
EARTHING DEVICES
JACKS & PLUGS
H.T. BATTERIES,
ETC. ETC.**

Descriptive pamphlet and prices on application to

THE MANUFACTURERS:
SIEMENS BROTHERS & CO., LTD.
WOOLWICH, LONDON, S.E. 18

Telegrams: **SIEMENS, WOOLWICH.**

Telephone: **CITY 6400**

and at

Be'ast, Birmingham, Bristol, Cardiff, Glasgow,
Leeds, Manchester, Newcastle, Sheffield, Southampton.

BATTERIES OF MERIT.

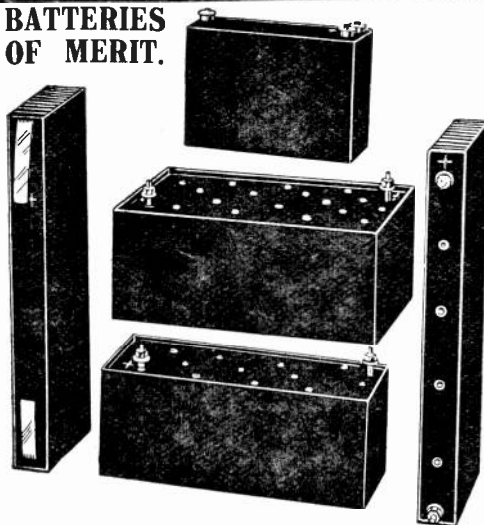

15 Volt Strip Connection	3/6, postage 6d.
15 " 3-terminal type, 7½ or 15 volts . . .	3/6 " 6d.
15 " Wander Plug, 3 volt variation . . .	4/- " 6d.
38 " " " " " " " " " " " " " " "	7/6 " 1/-
60 " " " " " " " " " " " " " " "	14/6 " 1/-

Fully Illustrated List of Wireless Goods, post free, 4d.

H. D. BUTLER & CO., LTD

Office: BANK BUILDINGS, 222, GT. DOVER ST., S.E.1
(Opposite Borough Tube Station)
Works: CANONBURY, LONDON, N.1
Telephone: Hop. 3029. Teleg.: "Ingenuity, Phone, London."

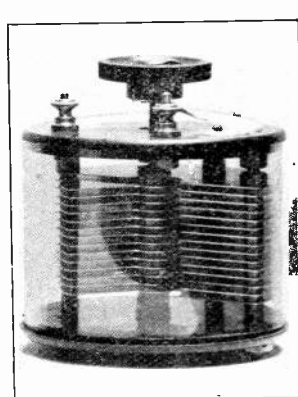

**IMPROVED TYPE
CONDENSERS.**
Dust Proof Celluloid
Case—
-001, each 24/-
-0005, each 17/6
-0003, each 15/-
Vernier . . . 12/6
(3 or 5 plate)
**VARIABLE AIR
CONDENSERS.**
Panel Type with
Knob—
-001, each 19/-
-0005, each 12/6
-0003, each 10/-
Vernier, each 5/-
(3 or 5 plate).
Bevelled Scales, 3/6
extra.
Ivory Scales, 9d.
each.
Condenser Knobs, 3/-
each. Bushed
2B.A.

Condenser Vanes, 7d. doz. Fixed or moving.
Large Spacing Washers, 3½d. doz.
Small Spacing Washers, 2½d. doz.
Screwed Rod, 3½d. per ft. length, 2B.A.
Filament Resistances, 3/6. Slightly damaged, 2/-.
Laminated Switch Arms, 1/9.
Valve Holders, with nuts, 1/-.
Complete sets of parts to make up valve panels, engraved, from
£1.
H.F. Amplifier Panels, complete from 30/-.
High F. Transformers, from 2/6.
L.F. from £1.
Mark III Type Terminals, 2d. each, 1/10 doz.
Insulating Sleeving, 5d. yard, 4/6 doz. all colours.
Plug in Coils and Coil Holders.

B. L. HOUSTON, 65, Endell St., W.C.2
Phone: Regent 4911.

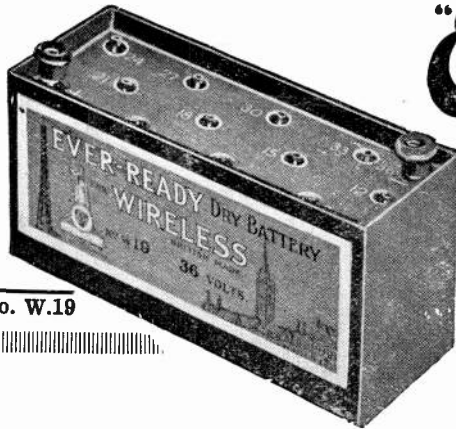

No. W.19

"Ever-Ready"
British Made

DRY CELLS and BATTERIES for High & Low Tension

THE STANDARD OF QUALITY



U.W.1

HIGH TENSION BATTERIES

Any size or voltage with any tappings or sockets at 3 or 6 volt intervals for use with Wander Plugs can be supplied to order

With 13 sockets as illustrated.

No. W.19, 36 volts, 24 cells, 8/6 each. Size $6\frac{1}{2} \times 2\frac{1}{2} \times 3\frac{1}{2}$.
Weight 2 lb. 8 ozs.

Wander Plugs 1/- per pair. With 2 Spring Contacts.
No. W.11, 15 volts, 11 cells, 3/6 each. Size $9\frac{1}{2} \times \frac{1}{2} \times 2\frac{1}{2}$.
Weight 1 lb. 2 ozs.

THE UNIT DRY CELL

"Build up your batteries as you build up your Marconi Sets."

Unlimited flexibility in size, voltage and intermediate tappings. Each cell is fitted with brass screw terminal and looped wire, and they are efficiently insulated to prevent current leak.

No. U.W. 1, 7/6 per dozen. E.M.F. $1\frac{1}{2}$ volts.
Weight $3\frac{1}{4}$ ozs. Dimensions $2\frac{1}{2} \times 1\frac{1}{16}$ diam.

Art Catalogue of Standard Sizes and Voltages and list of Accumulators for Valve Filament Supply sent on request. Dept. D.L.

THE EVER-READY WORKS, Hercules Place, Holloway, N. 7.

JUST RECEIVED!

AMERICA'S LATEST PUBLICATIONS FOR THE WIRELESS EXPERIMENTER.

HOW TO MAKE COMMERCIAL TYPE RADIO APPARATUS

By M. B. SLEEPER. Price 4/- net (post free 4/3).
Size $7\frac{1}{2} \times 5$ " 159 pages, 96 Diagrams and Illustrations.

CONSTRUCTION OF RADIO PHONE AND TELEGRAPH RECEIVERS FOR BEGINNERS

By M. B. SLEEPER. Price 4/- net (post free 4/3).
Size $7\frac{1}{2} \times 5$ " 142 pages, 74 Diagrams and Illustrations.

RADIO EXPERIMENTER'S HANDBOOK

By M. B. SLEEPER. Price 5/- net (post free 5/3).
Size $6\frac{1}{4} \times 4$ " 148 pages, 82 Diagrams and Illustrations.

THE ABC OF VACUUM TUBES USED IN RADIO RECEPTION

By E. H. LEWIS. Price 6/- (post free 6/5).
Size $7\frac{1}{2} \times 5$ " 152 pages. 48 Diagrams and Illustrations. "Written Especially for the Beginner."

CONSTRUCTION OF NEW TYPE TRANS-ATLANTIC RECEIVING SETS

By M. B. SLEEPER. Price 4/- net (post free 4/3).
Size $7\frac{1}{2} \times 5$ " 113 pages, 47 Diagrams and Illustrations.

**THE WIRELESS PRESS, LTD., Dept. W.W.
12-13, HENRIETTA STREET, STRAND, LONDON, W.C.2**

THE IONOPHONE

The new Ideal Broadcasting Receiving Sets.

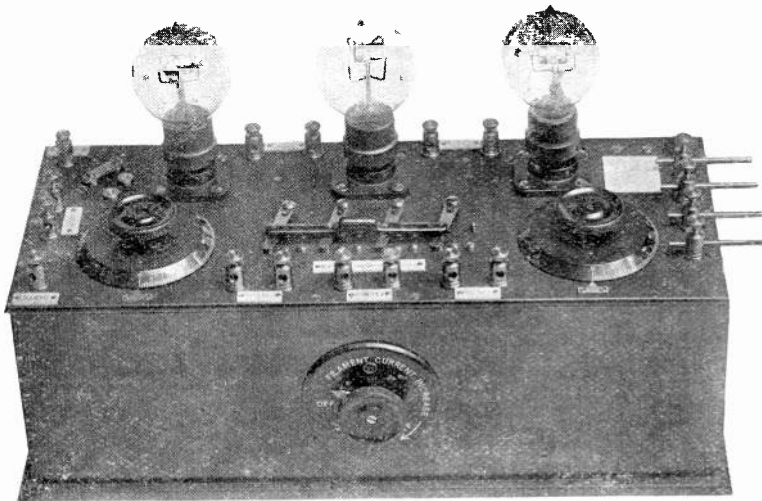

THE IONOPHONE RECEIVING SET.

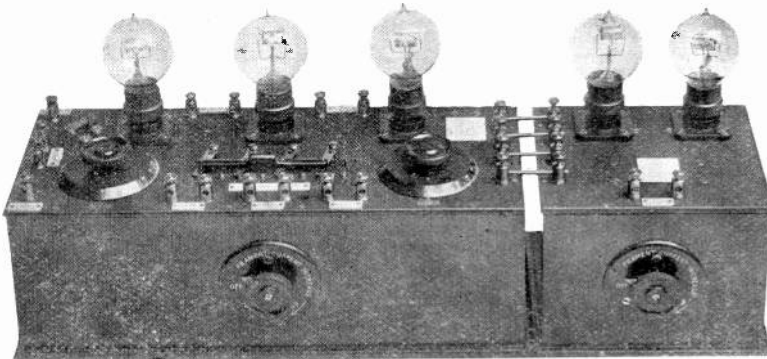

THE IONOPHONE connected with AMPLIFIER.

THE "IONOPHONE" SETS & ACCESSORIES met with a splendid reception at the All-British Wireless Exhibition.

ILLUSTRATED BOOKLET (W) with full details of all we manufacture will be sent Post Free upon receipt of stamp.

J. A. COOMES & CO., LTD.

London Showrooms—41, NEW OXFORD ST., W.C.1

Works—2 and 4, East Avenue, Manor Park, E.12

IMPORTANT— —NOTICE

A. C. COSSOR, Limited, hereby give notice that the order of Mr. Justice Russell of the 1st March, 1922, continually advertised by the Marconi Co., was an order ARRIVED AT BY CONSENT.

Being engaged at the time in the production of an improved and different type of valve, A. C. COSSOR, Limited, did not consider the patents in question of sufficient importance to warrant the expense of litigation.

A. C. COSSOR, Limited, respectfully leave the public and the Trade to judge whether the constant repetition of the notification of the judgment referred to is necessary or expedient in the circumstances.

A. C. COSSOR, LIMITED

Aberdeen Works, Aberdeen Lane,
Highbury Grove, N.5

Enormous Stocks of Ex-W.D. WIRELESS GEAR AT ABSURDLY LOW PRICES

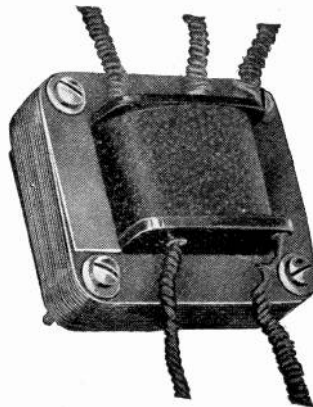

INTERVALVE
TRANSFORMER.
(New Goods)

Fitted with panel fixing plate and earthing wire for iron core.

Fully tested;
Ratio 5:1

PRICE **15/-**
Postage 9d. extra

Call and inspect our enormous stock or write for particulars and prices of your requirements.

Brass terminals, Wheatstone Bridges, Marconi Type 16 Crystal Sets, Model L receiving sets, Shell insulators, Wavemeters, etc., etc., etc.

J. LIPOWSKY Electrical and
Wireless Engineer
614, OLD FORD ROAD, BOW, LONDON, E.3

Telephone: East 3345

Near Old Ford Station.

Nos. 8 or 39 'Bus

"MAKURONE" WIRELESS APPARATUS



We have received the following order:—"Dear Sirs, Please forward 1 lb. of No. 24 Enamelled Wire. I see you mention that you wind wire free, if so please also send me an inductance tube 12" x 4 1/2" with wire wound on tube. If you do not wind wire on to tube free, then please send on shellac instead of tube."

We know our prices are absolutely the keenest on the market but we cannot undertake to supply a valve free of charge with every holder. We cover all goods with the guarantee "money back if not entirely satisfied."

Our special offer of the first 1000 phones at prices below is still open at the time of going to press, so that we shall still supply at these prices when this advert appears.

Extracts from our Price Lists (3d. post free).

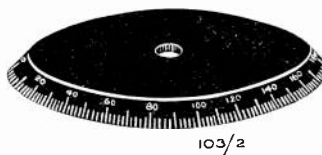

103/2

3" Engraved Dials 1/9 each

The last word in Condenser Parts.
Drilled ready for assembling.

·001	17/-	·00075	13/-
·0005	10/-	·0002	7/-

Scale and Pointer 1/- extra.
Ebonite Dial 1/9 extra.

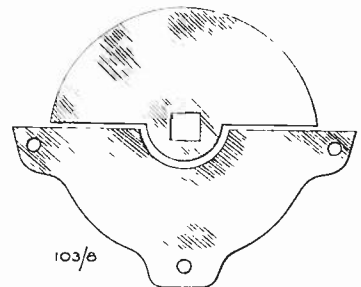

103/6

Condenser Vanes reduced to 9d.
per doz. fixed or moving.

A new illustration is being made, this illustration not being a true representation of the swivel—a remarkable feature of our phones.

140 ohm	-	-	23/6
4000 ohm	-	-	25/-
8000 ohm	-	-	27/6

Postage 9d.

J. L. CARTWRIGHT & CO.,

Phone: 4209 Central.

Manufacturing Electrical
Engineers,

'Grams: "Pladuram" Manchester.

BOLTON: J. S. McLeod, 189, Blackburn Road,
WARRINGTON: Economic Electric Co., 64 & 66, Sankey Street.

BURY: Bennett & Co., 12 Union Square.
AGENTS WANTED.

Please Note—NEW OFFICES & SHOWROOMS:
24, London Rd., MANCHESTER

Works: BERRY STREET

The FELLOCRYST SUPER

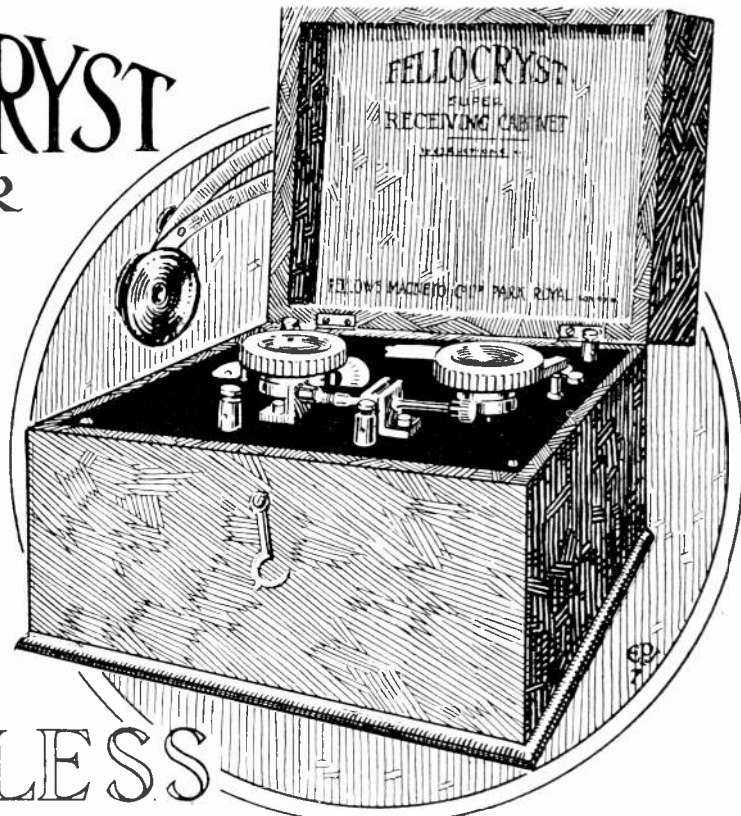

WIRELESS BROADCASTING

This is a high grade crystal detector especially designed for receiving broadcasting, and complies with all regulations. Beautiful pure clear speech and music are received, and as many as 3 pairs of Fellows 4,000 ohms double headphones can be simultaneously used. The "Fellocryst Super" is mounted in a highly polished oak cabinet and is sent out complete with 100 ft. coil of 7/22 stranded copper aerial wire, two shell insulators and one 4,000 ohms double headphone, and is **British Made Throughout.**

PRICE COMPLETE **£4 : 7 : 6**
POSTAGE 2 - EACH.

EXTRA 4,000 OHMS DOUBLE HEADPHONES **30/-**
POSTAGE 1/-

FELLOWS MAGNETO Co., Ltd.
LONDON, N.W.10.

Telephone: Willesden 1560-1.

Telegrams: Quismag, Phone, London.

For they are jolly good Fellows

Genuine Radcom Duolateral Inductance Coils "DE FOREST PATENT"



These coils are designed to reduce the self capacity of a receiving inductance to a minimum.

PRICES

Mounted complete..
from 5/-

RADCOM
Rheostats, Tuners, Transformers
ACCUMULATORS

Orders value £2, not exceeding 11-lbs. weight
CARRIAGE PAID.

Radio

COMPONENTS LTD.

12/13, HENRIETTA ST., LONDON, W.C.2
Telephone: GERRARD 792
grams: RADFONENTS, RAND, LONDON

(E.P.S. 3)

VARIABLE CONDENSERS

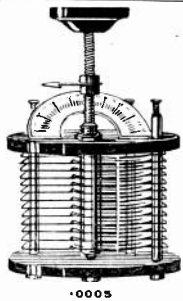

Best instrument finish,
complete with scales.

Capacity .001 19/6
" .0005 15/-
" .0003 12/6

Cash with order, post free.

Trade inquiries invited.

CLARKE BROS.,
Manufacturers,
Allerton Road Works,
Mossley Hill, Liverpool.

Questions and Answers COUPON

To accompany Questions
sent in during the week
commencing Oct. 14th, 1922.

VOL. XI, NO. 2.

See Conditions on Page 71.



Why buy when you can build your own?

No need to buy expensive ready built Sets when you can build your own at a fraction of the cost. The Peto-Scott System of standardised Radio sets in parts permits you to build, on your kitchen table, with a

screwdriver and a pair of pliers, a highly efficient multi-valve Set, which will be a constant source of enjoyment to you.

SEND

6d.

to day for an interesting, well illustrated Booklet describing the whole system.

A free copy of our big illustrated Catalogue enclosed if you mention "Wireless World."

Sets of Parts.

No. 3 Unit (H.F.) 13/6
No. 4 Unit
(Detector) ... 17/6
No. 5 Unit (L.F.) 33/6
Mahogany Cabinets
to fit ... 3/6

Condensers:
.0002 ... 7/-
.0003 ... 9/-
.0005 ... 11/-
.001 ... 18/-

Cabinets extra.
All parts standardised
throughout, guaranteed
packed in boxes, complete
with all working instructions.

Featherstone - House,
64, High Holborn, W.C.1

THE PETO-SCOTT CO.

POST FREE

OFFICIAL

POST FREE

8d.
POST FREE

CATALOGUE

8d.
POST FREE

of the

First All-British
WIRELESS
EXHIBITION
AND CONVENTION

1922

POST FREE

OFFICIAL

POST FREE

8d.
POST FREE

CATALOGUE

8d.
POST FREE

Apply to THE ORGANISERS,
BERTRAM DAY & CO., LTD.
9 & 10, Charing Cross, S.W.1
(Wireless Advertising Specialists)

HOLLOW STEEL MASTS

Are light, strong, made in sections, easily erected, and will last a lifetime. Each mast is complete with baseplate, finial, rope cleat, pulley, gey clips, steel gey ropes, strainers, painted one coat ready for erection.

Prompt delivery. Prices F.O.R. for cash with order. 25 ft. £4/5/0, 30 ft. £5/5/0, 40 ft. £7, 45 ft. £7/15/0 50 ft. £10/10/0 60 ft. £15/10/0. Other lengths supplied at equally low prices. Trade inquiries invited.

The Wireless Steel Mast & Accessory Co., Lombard St. West, West Bromwich.
Telephone No. : 447. Telegrams : "Wireless Westbromwich."

7 ft. BAMBOO SPREADERS }
BRASSBOUND EYELET ENDS } 5/6

PULLEYS 1/6 EYEBOLTS -/9
ROPE CLEATS 1/- ROPE GRIPS -/6
GUY CLIPS 1/9 ADJUSTABLE
WIRE STRAINERS 2/0 GUYELIPS 2/9
PORCELAIN INSULATORS EGG TYPE -/9
" " SHELL TYPE 1/9
VULCANITE TUBULAR INSULATORS 1/9
" " LEAD IN " 5/-

BEST WHITE COTTON HALYARD ROPE.
TINNED STEEL CABLE, AERIAL WIRES.

POST FREE.
TRADE SUPPLIED.

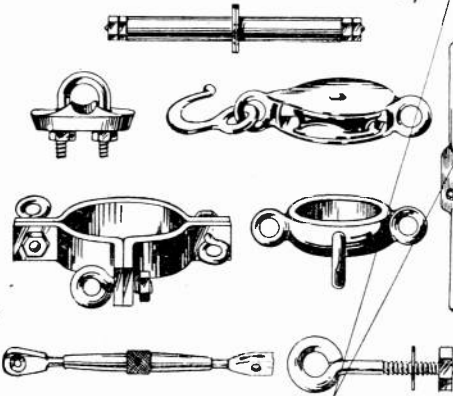

VARIABLE H.T. BATTERIES

DISTANT LOW POWER TELEPHONY can only be received by using correct H.T. Voltage, the value of which varies with the type of valve and filament voltage. The W.A.S. VARIABLE H.T. BATTERIES will increase the efficiency of your set and give you undistorted speech and music.

These batteries being made from a special formula have a longer life than any that are on the market and are perfectly SILENT in working.

If a cell gives out it can be quickly "shorted" with only the loss of 3 Volts. In any other makes the whole unit would have to be thrown away. Any number of these units can be connected in series.

Price 7/- post free.

(Send your dealer's name and address.)

AGENTS WANTED.



WRITE FOR FREE BOOKLET.

W. A. SAXBY & CO., 3, Gayford Road, LONDON, W.12.

Telephone :
HAMMERSMITH 443

LESLIE Mc MICHAEL LTD.

PROVIDENCE PLACE, WEST END LANE, KILBURN, N.W.6

Bus Services 1, 8, 16, 28, 31 all pass West End Lane

Telephone: HAMPSTEAD 1261 Nearest Tube Station: KILBURN PARK (BAKERLOO)

The M.H.4.R. Detector Amplifier & Tuner Panel M.H./L.C.

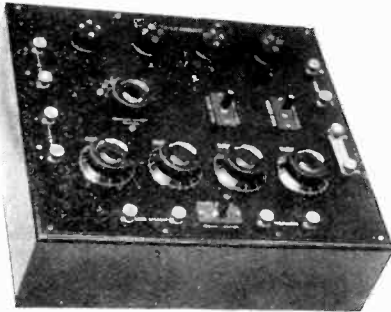

4-VALVE DETECTOR AMPLIFIER

Type M.H.4.R.

This instrument is a complete amplifier of extraordinary power having incorporated in it a High Frequency Amplifying device working on the Reactance principle. By means of this device very high efficiency is obtained at all wavelengths between 300 and 10,000 M. without any H.F. Tuning Condenser.

Key Switches are provided enabling 2, 3 or 4 Valves to be used at will.

This is only **one of the many** high class and efficient M.H. Sets illustrated and described in our new booklet.

The instrument will work with any normal type of Tuner, but the special Tuner (Type M.H./L.C.) is strongly recommended.

Price - - £25 0 0

(VALVES EXTRA)



TUNER PANEL M.H./L.C.

The instrument illustrated above is a complete tuner, consisting of Aerial and Closed Circuits, both of which utilise the standard coils of Duo-Lateral type.

A special holder of distinctive design permits of any degree of coupling being used between the two circuits.

The closed circuit is provided internally with magnetic reaction so that only two "plug in" coils are used at one time.

Particular attention is directed to this instrument in view of the restriction imposed by the P.M.G. on directly coupled circuits which may, when oscillating, interfere with commercial and other reception. By using a loosely coupled circuit, not only is interference with other stations eliminated or reduced to negligible proportions, but extraneous noises are largely eliminated and a degree of selectivity attained which is impossible on the alternative system.

Price - - £8 8 0

(COILS EXTRA)

ACCESSORIES.

Tuning Coils, say 150 to 3,000 metres	£2 7 3
High Tension Battery (72 volts)	15 0
Low " " (6 volts 40 amp.)	1 10 0
Aerial, 100ft.	6 6
Insulators (4)	4 0
Head 'Phones, 8,000 ohms (Brown's)	2 15 0
Valves each	17 6

Illustrated Catalogue and M.H. Type Booklet 6d. Post Free.

JUST PUBLISHED!

RADIO PRESS WIRELESS DIRECTORY

PRICE **2/6** (post free 2/8)

A complete list of wireless call signs of all kinds of stations throughout the world.
HIGH-POWER STATIONS. COASTAL STATIONS.
SHIP STATIONS AND BRITISH AMATEUR STATIONS.

An Absolute Necessity to the Real Experimenter.

Every "Wireless World" reader should purchase a copy immediately.

PRACTICAL WIRELESS VALVE CIRCUITS

By JOHN SCOTT-TAGGART, F.Inst.P.

Author of "Elementary Text-book on Wireless Vacuum Tubes,"
"Thermionic Tubes in Radio Telegraphy and Telephony."

A companion volume to the author's text-books on Valves.

Contains 70 beautifully produced circuit diagrams with full notes on each. Special non-radiating circuits are given, and other circuits complying with the Postmaster-General's latest instructions. For the first time, a full criticism of available circuits is given, with advice as to which to use in a given set of circumstances.

Every reader of any of the author's books on Valves should order a copy immediately.

PRICE **2/6** NET. (post free 2/8)

Have you read "Simplified Wireless," our new shilling book which deals with the elementary theory of wireless and gives full instructions for making Broadcast Receivers? Buy it at your bookstall.

Radio Press Ltd.

DEVEREUX BUILDINGS,
DEVEREUX COURT,
STRAND, LONDON, W.C.2
Opposite the Law Courts.

£25 IN PRIZES

The Radio Press offer the following prizes to amateurs for *original* constructional articles. Each article should give full instructional details with sketches (which may be pencilled sketches). The articles should describe actual working sets, the simpler the better, which have given good results. The Radio Press reserve the right of publication, but will pay generously for any articles accepted for publication whether they win a prize or not. The circuits employed should preferably be similar to one or other of those contained in "Practical Wireless Valve Circuits" (Price 2s. 6d., Radio Press), but this is not an essential condition.

COMPETITION "A"

An article on the construction of a broadcast receiver using two or more valves. There should be no reaction on aerial or closed receiving circuit.

	£	s.	d.
1st Prize	3	10	0
2nd ,,	2	0	0
3rd ,,	1	10	0
4th ,,	1	0	0
5th ,,	15	0	
6th ,,	10	0	

COMPETITION "B"

An article on the construction of a receiver for wavelengths above the broadcast wavelengths:

	£	s.	d.
1st Prize	5	0	0
2nd ,,	3	0	0
3rd ,,	2	0	0
4th ,,	1	10	0
5th ,,	1	0	0
6th ,,	15	0	

COMPETITION "C"

An article on the construction of some compound part of a wireless receiver, e.g., crystal detector, valve panel, grid leak, etc. 5 prizes of 10s. each.

The Radio Press takes this opportunity of stating that they are at all times ready to consider articles or books on wireless subjects whether of an instructional or constructional nature and to pay for them on publication. The future plans of Radio Press, Limited, are such that we shall be able to publish large numbers of original articles. If you have a set or piece of apparatus which you have found successful, write a description of it and send it to us; we will pay you well for accepted contributions. A good description of, say, an efficient receiver, is more important than style.

ALL ENTRIES (including manuscript) FOR THESE COMPETITIONS MUST BE SENT TO RADIO PRESS, LTD., DEVEREUX COURT, STRAND, W.C.2, NOT LATER THAN NOVEMBER 7th. ARTICLES MAY BE SENT IN AT ANY TIME.

THE WIRELESS WORLD EXCHANGE AND MART

TARIFF. Advertisements are accepted for this Section at the rate of twopence per word, with a minimum charge of two shillings. The advertiser's name and address will be charged, for and single letters and single figures will be counted as words. Compound words will be counted as two words.

DEPOSITS. All advertisements must be prepaid in the form of Postal Orders, the remittance being forwarded to Messrs. Bertram Day & Co., Ltd., 9 & 10, Charing Cross, S.W.1.

Intending purchasers may deposit the purchase money of any article advertised or sold by advertisers with Messrs. Bertram Day & Co., Ltd., who will acknowledge its receipt to the vendor and the depositor, the full addresses of whom should be given. Subject to special agreement between the parties, it is understood that all goods are sent on approval, each party paying carriage one way in the event of the goods being returned. The deposit will be retained until due advice of the completion of the purchase has been given or until the articles have been retained and accepted. In order to cover postage, etc., a fee of 6d. in respect of sums of £1 and under, and 1s. for sums in excess of £1, must be paid at the same time as the deposit. For persons not resident in the United Kingdom these fees are doubled. We cannot undertake to receive any deposit less than 2s. 6d.

FOR SALE.

Two-Valve Receiver, B Mk. II, complete with variable condenser. £6.—BOWEN, Whitesgreen Cottage, Charlwood, Surrey.

Three-Valve Receiver, with valves, tuner (20,000 metres), condenser, telephones, etc. £12.—SLOAN, Windsor Avenue, Lurgan.

Three-Valve Amplifiers.—L.F. C. Mk. 111. Brand new. A beautiful panel, four transformers, three intervals, one telephone. A limited quantity only. £5 15s. each.—GEO. AXE, 52-4, Ben Johnson Road, Stepney, E.1.

Locally Superior Three-Valve H.F. Transformer coupled receiver, complete, six Siemens 65v. H.T. leclanche units, few unmounted duo coils ex-Government H.T. coil generator.—COOPER, 16, Wentworth Road, York.

Morse Practice.—You cannot get full enjoyment from your wireless set unless acquainted with Morse code. I supply apparatus for practising. Key, 4s. 6d. post free, or key and sounder, 14s. 6d. post free. These can be used with wire as in ordinary telegraphy.—H. R. N., 27, Wingate Road, Hammersmith, W.6.

Phones! Phones! Phones! to be Cleared. New single 'phones, 4,000 ohms 6 ft. lead, 10s. 6d. post free. Double 'phones, 4,000 ohms, 6 ft tinsel cord, soft leather headstraps, 18s. 6d. post free. Approval against cash willingly. Every phone guaranteed. Wonderful value.—CHITTENDEN & SIMMONS, Malvern Road, Thornton Heath.

"Hart" 4-Volt ex-Government Accumulators. Unused, complete in metal case with handle, 12s. 6d. each.—ST. GEORGE'S MOTORS, 16, Fulham Road, South Kensington, London, S.W.3.

Films! Films!—500 for sale. Catalogue free.—LOGAN, 29, Minford Gardens, West Kensington.

Our Speciality, Crystal Detectors, Vertical Type on Ebonite Bases. Complete with cup and terminals. Polished and lacquered or nickel plated, 4s. Actual manufacturers.—H. AVLES, 15, Harringay Road, Harringay, N.15.

What About It! Complete crystal set, 3,000 metres, £3 15s. Gamage L.F. amplifier, 30s. Loose coupler, 10,000 metres, £2 5s. Magnephone loud speaker, 37s. 6d.—G. BOOTHROYD, 44, Leyland Road, Southport.

Marconi Four-Valve Receiver, £6 15s. Bargain.—SCARBOROUGH, 21, George Street, Hull.

Three-Valve Detector Amplifier Type M.H.3, maker McMichael. New last month. Perfect. £12 12s.—STANNARD, Buckden, Huntingdon.

Mark III* Tuner, complete, splendid condition, £9. Stamp reply.—BOX Q.4, BERTRAM DAY'S ADVERTISING OFFICES, 9 and 10, Charing Cross, S.W.1.

High-Class Switches mounted on ebonite. Six-point, 5s. 6d.; 12-point, 7s. 6d.; 30-point, 11s. 6d.—WIRELESS, 14, Alexandra Road, Great Crosby, Liverpool.

Three-Valve Wireless Station, complete, £13.—Particulars, 57, Great Thorton Street, Hull.

Giving up Wireless—Miscellaneous Instruments, Accessories, etc., for disposal. Cheap. Addressed envelope for list.—CARR, 6, Norwood Avenue, Southport.

Cozwhy Filament Fuses will protect your valves from Burn-outs. $\frac{1}{2}$ or $\frac{3}{4}$ amp., 10d. each, 8s. doz. Polished ebonite fuse-holders, plated ph.br. springs, 2s. 6d. each, 11s. set of five. Post free. Cash with order.—BESWINNING'S, 49, Cowley Road, Ilford.

Two-Valve Receiver.—Receives telephony from Writtle, Hague, Croydon, Paris. Polished mahogany case, £6. Three-valve detector amplifier, splendid for all telephony. Handsome mahogany case, £10.—FRAIN, Snainton, Yorks.

Wireless Masts.—Improved Girder Type. Light and strong, 30 to 50 ft. at 1s. ft., 50 to 100 ft. at 1s. 6d. ft. Cash with order, carriage forward.—F. ARMSTRONG, Weybridge.

The Hestia Engineering Co. supply everything for wireless, see page xx.—32, Palmerston Road, Acton, London, W.3.

B.A. Screws, Nuts and Washers, ass rted gross 2s., lists 2d.—J. H. BENNETT, Station Road, Willesd n Junction.

For Wireless Cabinets

SEND TO
J. A. JONES & CO., LTD.,
CABINET CASE MAKERS,
Progress Works, Park Road,
Aston, BIRMINGHAM.
Phone—EAST 234.

Send us your enquiries for
BOXES, CABINETS,
SPREADERS, CONDENSERS and parts, LEAD-IN-TUBES, and all accessories, to the Trade.

COMPETITIVE PRICES
PROMPT DELIVERIES
The Central Aircraft Co.
179 High Rd., Kilburn, N.W.6
Phone—Hamstead 4403-4 8018.

I Buy Wireless Gear of every description.
Send your particulars to:
WILKINSON,
Lonsdale Rd., Kilburn, N.W.6
SAME ADDRESS SINCE 1900.

A.S.A. Guaranteed Wireless Products

Best Filament Resistances	3-
15v. H.T. Batteries—The Best	3-
Grid Leaks and Condensers	2/6
Fixed Condensers, .002	2-
Laminated Switch Arms and Bush	2-
Condenser Vanes, the best	doz. 1/-
Vernier Condensers, .0001	4/6
Variable Condensers in Cabinet, .0005	18/6
100' 7/22 Aerial Wire	4-
40.0 ohm Headphones (good)	25/-
Crystal Receiving Sets	25-
Sets of Parts for 2-Valve H.F. Amplifier	30/-
2-Valve L.F. Amplifier	40-
3-Valve H.F. and L.F. Amplifier	60/-
Cabinets, 10" x 6" x 4", polished	5/-
Condenser Boxes, polished	2/6
3-Coil Honeycomb Holders	16/6
H.F. Transformers, for Broadcast	3/6
Honeycomb Coils from	1/6
Concert Coils	per pair 2-
Coil Holders, for same	5-

Our List Beats Them All.
Amateur Supplies Association
134 Coteford Street, Tooting.
Works : 196, High Street, Merton.



UNIQUE

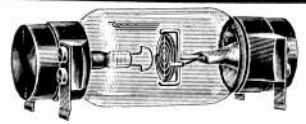

FOR PURCHASE



A.E.G.



SIEMENS HALSKE.

Valves for Radio Reception. Best make and finish. Fil. current 3/4 volts. Plate, 60 volts. PRICE, 7/6. POSTAGE, 4d.

Adaptor A.G. as illustrated, to fit "R" Type holders.

PRICE, 3/-.
Postage 2d.



FILAMENT RHEOSTAT. THE RESULT OF MANY EXPERIMENTS TO PRODUCE AN ARTICLE WHICH WILL GIVE EVERY SATISFACTION. PHOSPHOR.

BRONZE ARM. WILL NOT WORK LOOSE, EASY TO FIX TO PANEL.
PRICE, 4/-.
Postage, 3d.

We supply every wireless accessory at the right price and welcome every prospective customer. You will not be pressed to buy. Illustrated Catalogue in preparation.

Grafton Electric Company

Show rooms—54, GRAFTON STREET, TOTTENHAM COURT ROAD, LONDON, W.1. Telephone—Museum 247.

THE WIRELESS WORLD EXCHANGE AND MART

ENGRAVING

for every style of instrument on any material.

F. OSBORNE & CO., LTD.
27, Eastcastle St., Oxford St., London, W.1
Est. 1874. Museum 2264

RENO ROTARY VANE Variable Condensers

.001 mfd.

- MODEL A. Polished Ebonite Case Ivorine Scale - 13/6
- MODEL B. Panel Model, Complete with Screws and Scale - - - 11/6

Stamp for Illustrated Leaflet.

Reno Scientific Instrument Co.
5, Poole Road, BOURNEMOUTH.

FOR SALE.

"OSBORNE" RADIO SUPPLY.

A Selection from our list. Keenest prices yet.

Condensers, complete .001, 8/-
set of parts ready to .0005, 5/6
assemble, no trouble. .0003, 5/-
.0002, 4/6

Ver., 2/6 (post extra)

Very highly finished, ready to use, built of best quality parts, .0005, 16/-. etc.

Filament Resistance (very efficient) . . . 3/8

Laminated Switch Arms 1/10

Small Rheostat Switches 1/-

Highly Finished Knobs 5d.

Large spacers per doz. 5d.

Small spacers per doz. 3d.

4B.A. Terminals, best per doz. 1/9

Contact Studs per doz. 1/-

Condenser Vanes, "accurate," per pair 1 1/4d.

Etc.

Orders despatched within 6 hours of receipt of order. TRY US.

146, Millfields Road, Clapton, London, E.5.

EASY TERMS OR CASH.

TWO VALVE MODEL B, 7 1/2 Gns. ; SINGLE VALVE MODEL A, 5 1/2 Gns.

MODEL B comprise; Polished Cabinet, Ebonite Panel, 2-way Coil Holder, Honeycomb Coils, 2 Mullard Ora Valves, L.F. Transformer, Variable Condenser '0005, Filament Resistance, Grid Leak and Condenser, 1 pair Mullard Double Head Phones 4000 ohms, H. I. Battery, Accumulator 4 volts, 100 ft. Aerial Wire, Leading In Tube, Insulators and Terminals (for 2 Phones).

This Advertisement Offer is open to Readers of the "Wireless World" for 14 days only. Satisfaction or Money returned. Stamped envelope for full particulars and terms.

G. BUSH, 119, SUTHERLAND AVENUE, LONDON, W.9

SITUATIONS WANTED.

Ex-Naval Wireless Instructor, twelve years practical experience, seeks wireless situation. —JAMES BACON, Aveley, Essex.

Enthusiastic Wireless Operator, age 22, three years' experience, seeks position as salesman or demonstrator, etc. First Class Certificate, good technical knowledge, excellent references, South England preferred.—"ALLOA," Bungalow Estate, Swanage.

TRADE INQUIRIES.

Wireless Dealers are advised to stock parts for making radio apparatus, as so many amateurs prefer to make their own instruments. There is also the additional profit in making your own sets from stock parts. Raw materials and partly machined parts can be had direct from the factory at the right price.—THE "NEWTONIA" WIRELESS FACTORY, 13/15, Whitcomb Street, London, W.C.2. Regent 643 and 5469.

BOOKS.

Radio Magazines, all the latest, "Radio World," 10 1/4d.; "Popular Radio," 10 1/4d.; "Radio Broadcast," 1s. 6d.; "Radio News," 1s. 6d.; "Science and Invention," 1s. 9d.; "Scientific American," 2s. 6d. Post free.—INTERNATIONAL NEWS COMPANY, LTD., 15, Bream's Buildings, London, E.C.4.

Bamboo Poles for Aerials

AND BAMBOO OF EVERY DESCRIPTION

:: FROM TWIGS TO YACHT MASTS ::

Large Stocks always on hand.

A. E. DAVIES & CO. (Importers),
164, LEVER ST., CITY RD., LONDON, E.C.1

Cheapest house in the Trade for



Wireless Supplies

Equipment

(Wholesale only)

4, Little Titchfield Street,
Oxford Circus,
LONDON, W.1

ASK FOR
OUR LIST

HIGH TENSION BATTERIES AND "UNIT" CELLS.

As supplied to Admiralty, War Office, etc., new and direct from factory. Long life and large capacity. 60 volts 44 cells arranged in neat case, fitted with wander plugs and sockets for 3-volt variations. Weight, 5 lbs. 16/8, postage 1/8.

"UNIT" Cells—each fitted with brass screw terminal to carbon, insulated connecting wire to zinc looped for attaching to carbon terminal of adjoining cell. Larger than generally used in High-Tension Batteries, greater capacity and longer life. E.M.F. 1 1/2 volts. 7/6 per dozen cells, postage 1/8.

WIRELESS BATTERY SUPPLIES,
19, UPPER KENT ROAD, MANCHESTER.

RAPID WIRELESS TRAINING

DAY AND EVENING CLASSES; Correspondence Classes with Instrument work at School if desired. **Postal Course on Valves.** Classes for Amateurs and Experimenters.

CABLE AND INLAND TELEGRAPHY. Send for Prospectus.

Amateur Supplies List A, from **JAMES FRASER & CO.** (same address).

Phone: North 1036.

ELECTRICAL TRAINING COLLEGE, Radio House, Manor Gdns., Holloway, London, N.

If you want advice as to the books on Wireless Telegraphy and Telephony best suited to your requirements write to:

The Radio Expert,

The Wireless Press, Ltd., 12-13, Henrietta Street, London, W.C.2.—
THE PIONEER HOUSE FOR WIRELESS PUBLICATIONS.

FIRST ALL-BRITISH WIRELESS EXHIBITION AND CONVENTION 1922

A Record Success

Although at the time of going to press this Exhibition is not yet over there is already overwhelming evidence to prove that it has been in all respects an unqualified success. Results have exceeded all expectations. The records available up to midday, Friday, show an average public attendance of nearly 5,000 daily, with a daily sale of 1,500 catalogues. On Wednesday approximately 6,000 people paid for admission, which is believed to constitute a record attendance for any Exhibition ever held at the Horticultural Hall.

Enthusiastic reports are available from the Standholders as to the volume of business that has been carried out. In a number of cases sufficient orders have been placed to provide work for months ahead, in addition to numerous enquiries waiting to receive attention. To cite only one example of the impetus to Wireless Trade provided by this Exhibition—a prominent provincial firm has found it necessary to arrange immediate accommodation for a London Depot.

At a preliminary and fully representative Meeting of Standholders a unanimous resolution was passed to the effect that the Exhibition had been organised and conducted in a perfectly satisfactory and successful manner.

Among the distinguished visitors to the Exhibition must be mentioned His Highness the Gaekwar of Baroda and Madame Tetrassini, the famous Prima Donna. The latter had the novel experience of listening-in to one of her own songs broadcasted from a gramophone record and received at the Demonstration Stand.

A limited number of Catalogues have been reserved for supply to those who will not have an opportunity of visiting the Exhibition. This Catalogue, comprising some 144 pages and containing a great deal of information regarding "Wireless" and kindred subjects, is being sold at the nominal price of 6d. each and will be sent for 8d. post free on application to

The Organisers :

BERTRAM DAY & CO., LTD.,

9 and 10, CHARING CROSS, S.W.1

Gerrard 8063/4

AUCKLAND'S



Liberal Discount to Trade.
Deliveries from Stock.

AUCKLAND'S INTERVALVE TRANSFORMERS

are guaranteed to give Maximum L.F. Amplification (giving no distortion of speech or parasitic noises), by reason of their careful design and manufacture.

The coil is layer wound and spaced, and the Stalloy Core is faced with Insulation on one side of each Lamination, to obtain the Maximum Magnetic Field.

Like all "Auckland Products" they are Unsurpassed.

PRICE 20/- EACH.

MADE BY INSTRUMENT MAKERS FOR INSTRUMENT USERS.
THOUSANDS HAVE NOW BEEN SOLD.

AUCKLAND CONDENSERS

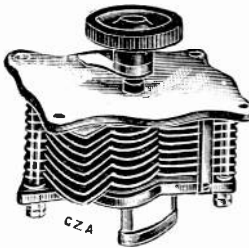

Our orders for these condensers required the whole output. Having increased our factory space and improved the method of manufacture, we can now offer from stock for panel mounting.

·0002 mfd.	15/-
·0003 "	16/-
·0005 "	18/-
·001 "	24/-



L.F. AMPLIFIERS

3 Valve	£5 10 0
2 "	£3 17 6

COMPLETE 4 VALVE RECEIVERS

with set of Duo Coils, Valves, H.T. and L.T. Batteries ... £35 0 0
Call and hear demonstrations.

G. Z. AUCKLAND & SON, 395, St. John Street, E.C.1

LONDON OFFICES:

Factories—ISLINGTON, N.

MANUFACTURERS OF WIRELESS APPARATUS.

'Phone—CLERKENWELL 3173.

WARNING.

MARCONI'S WIRELESS TELEGRAPH CO., LTD.,

v.

A. C. COSSOR, LTD.

Marconi's Wireless Telegraph Company, Limited, **GIVE NOTICE** that an **ORDER** was made in the High Court of Justice, Chancery Division, by Mr. Justice Russell on the 1st March, 1922, restraining Messrs. A. C. Cossor, Ltd. from infringing the Marconi Company's Letters Patent Nos. 28413 of 1913 and 126658, except so far as Messrs. A. C. Cossor, Ltd. manufacture for H.M. Government.

Messrs. A. C. Cossor, Ltd., were further **ORDERED** upon oath to **DESTROY** all articles and apparatus (other than those constructed to the order of H.M. Government) made or used by them in **INFRINGEMENT** of these patents, and **TO PAY THE MARCONI COMPANY DAMAGES AND COSTS.**

The M-O Valve Company, Limited, of Osram Works, Brook Green, Hammersmith, London, W.6, is the only firm in this country licensed to manufacture thermionic valves under the patents belonging to the Marconi Company.

Any valve similar to those generally known as the "French type" constitutes an infringement of the above patents whether manufactured in this country or imported from abroad. Marconi House, Strand, London, W.C. 2.

The Construction of Amateur Valve Stations

By ALAN L. M. DOUGLAS

78 pages. 55 Diagrams and Illustrations.

PRICE **1/6** NETT.
(Postage 2d.)

The aim of the author in compiling this volume has been to place within the reach of the amateur who is interested in Wireless Telegraphy and Telephony a Handbook which will enable him to obtain data that he has otherwise difficulty in acquiring, in order that he may construct for himself apparatus which he desires to make, but does not quite know how to design correctly.

The Wireless Press Ltd.,
12/13 Henrietta St., London, W.C.2

NEW SUPPLY JUST RECEIVED FROM
THE PRINTERS.

THE RADIO EXPERIMENTER'S HANDBOOK

By PHILLIP R. COURSEY,
B.Sc. (Eng.), F. Inst. P.

113 pages. 99 Diagrams and Illustrations.

PRICE **3/6** NETT.
(Postage 6d.)

CONTENTS—

General Considerations—Components of Wireless Installation—The Aerial Circuit—Receiving Tuners—Receivers, including detailed instructions on the making of the many types of inductances and useful Mark III tuner modifications, Amplifiers and Valve Detectors with circuits of high-frequency, low-frequency and resistance—Capacity Coupled Amplifiers—Heterodynes, giving working instructions for making up a long range heterodyne wavemeter—Appendix: High Frequency Measurements and Calculations with valuable data and tables.

The Wireless Press, Ltd.

Dept. W.W.

12-13, Henrietta St., Strand, London, W.C.2

Revised and Enlarged Edition

AMATEURS This is just what you want

THE VEST POCKET
DICTIONARY

OF

TECHNICAL TERMS

USED IN

WIRELESS WORK

By Harold Ward

Over 1500 definitions

Price **2/6** net. Post free **2/9**

The Wireless Press, Limited

Dept. W.W.

12-13, Henrietta Street, Strand, London, W.C.2

**DON'T BE CAUGHT!!!
FROM FACTORY TO YOU**

NO WE are really actual manufacturers,
Deal direct
And don't waste money. Why pay
middlemen's profits?
Reap the benefit yourself.

Particularly note our sets
Are guaranteed absolutely complete. Don't
Rush and buy a supposed cheap set and find
your extras exceed your original cost
Take our advice, buy from Factory
Sure saving of money

**WE GUARANTEE ALL PARTS
NEW, NO WAR STOCK USED.**

We sell Complete Sets.

1	"LACLAND" Valve Set	£12 0 0
2	" " " "	£16 10 0
3	" " " "	£19 10 0
4	" " " "	£22 5 0
	Carriage Paid	Immediate Delivery

Arrangements can be made for our experts to erect your sets
and place same in best position for reception and broadcasting.

Agents Wanted for (parts of) following Counties—Kent,
Surrey, Essex, Herts, Bucks and Middlesex.

**LACLAND ELECTRICAL MANUFACTURING AGENCY (Dept. B.),
68, Great Queen Street, Kingsway, London, W.C.2.**

GERRARD 5341.

(HOLBORN END.)

THE GOODS!!!

**HAVE YOU A GRAMOPHONE?
THEN GET A
GRAMAPHIX LOUD SPEAKER**

**THE GRAMAPHIX multiplies sound!
THE GRAMAPHIX fits any gramophone!
HAVE YOU HEARD THE GRAMAPHIX?**

IT produces full volume of sound without distortion and
makes your gramophone a **RADIO LOUD SPEAKER**.
The Gramaphix is the result of considerable time and
expense which has enabled us to offer a **LOUD SPEAKER**,
with exclusive features **AT A PRICE WITHIN THE
REACH OF ALL**.

The Gramaphix utilizes the scientifically designed tone amplifier
of the gramophone to secure mellow ss and **BEAUTY OF
TONE**, therefore doing away with all that metallic sound,
scratching and "ring" associated with other loud speakers.

The Gramaphix is the talk of the wireless world.
ADJUSTED IN A MINUTE by a child.

LATEST AND LOUDEST.

Why pay pounds when a better **10/6** **IMMEDIATE
instrument can be secured for DELIVERY.**

**WITH GOOD APPARATUS YOU
CAN GET GOOD RESULTS.**

THE
**"W.P." Morse
Practice Key**

**WELL MADE—WELL FINISHED
THOROUGHLY RELIABLE.**

Price **7/6** Post Free.

**The Wireless Press, Ltd.,
12/13, HENRIETTA ST., LONDON, W.C.2**

BARGAINS

EX-ARMY T.M.B. BUZZER MARK 235, Comprising a special
type of BUZZER, TRANSFORMER, TAPPING KEY, and
SINGLE EARPIECE HEADPHONE. All connected and
mounted in Walnut Cabinet ... 9/-, post 1/-

THE POPULAR VARIABLE CONDENSER, Guaranteed,
silent in action, and the finest value ever offered—

Mfd.	Mounted in Cabinet.	Panel Mounting.	Sets of Parts.
-0003	14/6	11/-	5/-
-0005	17/6	14/-	7/-
-001	22/6	19/-	11/-

The sets of parts include ebonite drilled, ready for fitting.
Cabinets 3/6 extra, and must not be confused with the other
rubbish offered.

L.F. AMPLIFYING UNITS, for adding to crystal, valve sets
and panels for Loud Speakers, etc., mounted into Walnut
Cabinet, 6" x 8", 1 valve 37/6, 2 valves £3 3s. Post 1/-.

BLACK INDICATION TABLETS, engraved white, Aerial,
Earth, Phones, React., Prim., Sec., A.T.L., A.T.C., +LT—,
+HT—, per set of 10 ... 2/6

SENSITONE CRYSTAL, The perfect mineral Detector. Per
specimen ... post free 1/-

KNIFE SWITCHES ON EBONITE, D.P.D.T., 2/3; S.P.D.T., 1/6;
S.T.D.P., 1/6; Triple Pole D.T., 3/6. Post 3d.

FILAMENT RESISTANCES for Panel Mounting, 3/6, post 4d.

MARK III TERMINALS, with nuts, 2/3 per doz., post 5d.

BASKET INDUCTANCES, per set of 7, 7/-, post 5d.

THE POPULAR LOUD SPEAKER, 4,000 ohms, £2 5s., post 1/6.

RADIO, ELECTRICAL & MECHANICAL SUPPLIES.

SCIENTIFIC SUPPLY STORES

8, NEWINGTON CAUSEWAY,
LONDON, SE1.

PHONE
HUP-477.

GECOPHONE

RECEIVING SETS & AERIAL EQUIPMENT



for
**WIRELESS
BROADCASTING**

An illustrated descriptive booklet, No. B.C. 2815, the most complete and comprehensive of its kind yet published, containing full particulars of Gecophone Wireless Apparatus, together with details and diagrams for erection of aerials, etc., will be forwarded post free on application to—THE GENERAL ELECTRIC CO., LTD., Dept. W/T, Magnet House, Kingsway, London, W.C.2.



"GECOPHONE" Receiving Sets are obtainable from Electrical Contractors, Stores & Ironmongers.
MANUFACTURERS & WHOLESALE ONLY

THE GENERAL ELECTRIC CO., LTD., Magnet House, Kingsway, London, W.C.2

FIVE EXHIBITION SUCCESSES

THE PERRY AUTO-TIME MORSE SYSTEM

An aid to the rapid acquirement of speed in the transmission and reception of the Morse Code. 16 pages.

By F. W. PERRY.

6d. Net. Post Free, 7d.

THE WIRELESS TELEPHONE WHAT IT IS & HOW IT WORKS

Including directions for building a Simple Valve Receiver for Wireless Telephone Broadcast. 78 Diagrams and Illustrations.
128 Pages. Cr. 8vo.

By PHILIP R. COURSEY, B.Sc. (Eng.), A.M.I.E.E.

2/6 Net. Post Free, 2/10

MAST & AERIAL CONSTRUCTION FOR AMATEURS

Setting forth clearly all that the experimenting amateur requires. Over 70 Diagrams and Illustrations.
88 pages.

By F. J. AINSLEY, A.M.I.C.E.

1/6 Net. Post Free, 1/8

CRYSTAL RECEIVERS FOR BROADCAST RECEPTION

Which includes directions for constructing a simple Crystal Receiver for Wireless Telephone Broadcast. Over 70 Photographs and Diagrams.
80 pages. Cr. 8vo.

By PERCY W. HARRIS.

1/6 Net. Post Free, 1/8

DIRECTION AND POSITION FINDING BY WIRELESS

A book which supplies a long-felt want. 250 Illustrations.
376 pages. Demy 8vo.

By R. KEEN, B.Eng. (Hons.), A.M.I.E.E.

9/- Net. Post Free, 9/9

THE WIRELESS PRESS LIMITED

DEPT. W.W.

12-13, HENRIETTA STREET, STRAND, LONDON, W.C.2

The OHMER INSULATION TESTING SET (COX'S PATENT)

This is the lightest, cheapest and best instrument of its kind on the market. It consists of an Ohmeter and Generator mounted in one case. The Ohmeter is of the Electrostatic type, giving extreme lightness. Absolutely unaffected by external fields. It reads directly in Megohms and is independent of the voltage or speed of the generator.

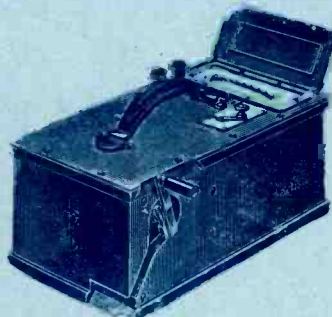

NALDER BROS. & THOMPSON, LTD.,
97a, DALSTON LANE, LONDON, E.S.

The YEAR BOOK of WIRELESS Telegraphy and Telephony 1922

1476 Pages.

Price 15/- Nett.

Demy 8vo.

Postage Inland 1/-.

Abroad 1/4.

CONTENTS :-

Record of the Development of Wireless Telegraphy—National and International Wireless Laws and Regulations—Directory of the World's Land and Ship Wireless Stations—International Allocation of Call Letters—Alphabetical List of Call Letters—Meteorological Section—International Time and Weather Signals—National Résumés of Progress in Wireless Telegraphy—Particulars of Wireless Telegraph Patents, 1921—Aviation Section—Tabular List of Aviation Stations—Useful Data Section—Wireless Terminology—Conventional Signs used in Wireless Diagrams—Companies Engaged in the Commercial Development of Wireless Telegraphy—Biographical Section—Literature on Wireless Telegraphy and Telephony—Directory of the World's Wireless Societies—Directory of Wireless Colleges and Schools—List of Licensed Amateur Transmitting Stations—Code Section—Special Articles on "The Earthing Resistance of Antennæ," by Dr. Miessner—"The Recording of Wireless Signals," by Dr. Abraham—"The Birth and History of Long Distance Wireless Telegraphy"—"The Rectification Effect in its Reaction to the Composition and Structure of Crystals."

A valuable feature of the present issue is the specially drawn map, which gives, for the first time, a simple means of finding the distance and true direction of Wireless Stations in all parts of the World, from London as the centre.

THE WIRELESS PRESS, LIMITED,

DEPT. W.W., 12-13 HENRIETTA ST., STRAND, LONDON, W.C.2

Registered "NIPHAN" Trade Mark.

WATER-TIGHT PLUGS and CABLE COUPLINGS
TO MEET HOME OFFICE REQUIREMENTS



COUPLING CONNECTING CABLES

Phones :
2603 Gerrard 12061 Central.

Telegrams :
"Niphan, London."
Patented in England and Abroad.

As used by H.M. War Office, Electric Supply Companies, Railway Companies, Marconi's Wireless Telegraph Company
SIMMONDS BROS., LTD.
4, 6 & 8, NEWTON STREET, HOLBORN, W.C.



SIX WAY TEE CONNECTORS

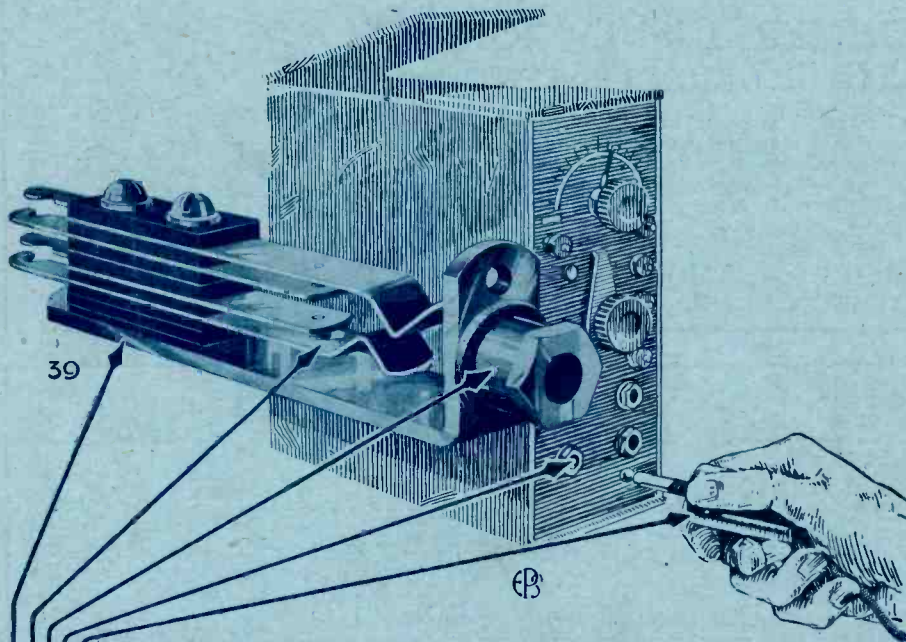

GET THE BEST OUT OF YOUR SET BY USING

THE ELWELL JACK SYSTEM

Once connected up on the Elwell Jack System your receiving set becomes far more convenient to use both for broadcast reception and for experimental purposes. The following operations become quite automatic:—

1. Filaments switched on.
2. Telephones or loud speaker put across any desired number of valves.
3. Interval transformers disconnected at point of insertion so ensuring maximum efficiency.
4. Only the required number of valves light up. The remainder stay out of circuit.
5. Removing Plug completely switches off set. No errors can afterwards be made in connections or switching. Loose contacts and broken leads are permanently prevented. Comparative tests of telephones and loud speakers can be made with ease and accuracy.

(a) Any standard telephone plug can be used but preferably the special spiral Elwell plugs which are fitted with self-tightening connection grips.

(b) The Jacks fit neatly on the panel and being heavily nickel plated add considerably to its appearance.

(c) They are easily fixed to any panel up to $\frac{1}{8}$ " thick. No fixing screws are required.

(d) Five types of jack are available from a simple telephone jack to one controlling telephone, transformer and filament battery.

(e) Insulation tested to 1000 volts.

Write for descriptive leaflets.

C. F. ELWELL, LTD., *Radio Engineers,*
CRAVEN HOUSE, KINGSWAY, LONDON, W.C.2

Telephone: REGENT 421.

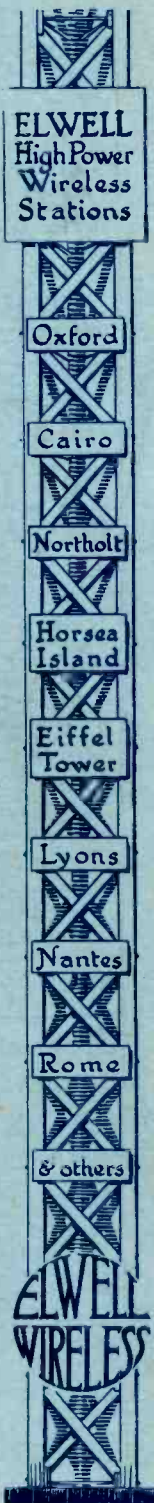

21st OCTOBER, 1922.

THE

PRICE 6D. NET.

WIRELESS WORLD

AND

RADIO REVIEW

Es Kdare

No. 166. [No. 3.
VOL. XI.]

21st OCTOBER, 1922.

Registered at the G.P.O.
as a Weekly Newspaper.



A FULL RANGE

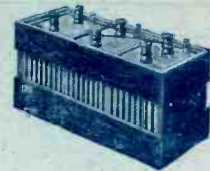

OF

HART

HIGH AND LOW TENSION

BATTERIES

INCLUDING VARIOUS NEW TYPES SUITABLE FOR

WIRELESS SYSTEMS



HART ACCUMULATOR CO., LTD.,
STRATFORD LONDON, E.15

BRANCHES { BELFAST, BIRMINGHAM, BRISTOL, GLASGOW,
MANCHESTER, WESTMINSTER & YORK.

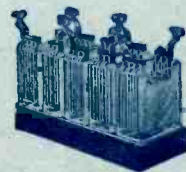



STERLING No. 1 CRYSTAL W/T RECEIVING SET

Specially designed for use in connection with the Wireless Telephony Broadcasting Scheme, and is suitable for a range of about 25 miles.

PRICE £7-12-6

TO BE OBTAINED FROM ALL DEALERS OR DIRECT FROM:-

STERLING TELEPHONE & ELECTRIC CO., LTD.

210-212, Tottenham Court Road,
LONDON W.1

Telephone No. : 4144 Museum (7 lines)
Telegrams : "Cucumis, Wesdo, London."

Works : DAGENHAM, ESSEX.

BRANCHES :

NEWCASTLE-ON-TYNE : 9, Clavering Place.
CARDIFF : 8, Park Place.

IMMEDIATE DELIVERY

"Wireless for all"

Before you decide on the construction of your set. It will pay you to have particulars of—

Condensite Celoron

For PANELS and OTHER PARTS.

This material is waterproof, immune to atmospheric and climatic conditions, will not warp, has high surface and volume restivity, high di-electric strength, low specific gravity.

LET US QUOTE YOU

SEND PARTICULARS OF YOUR EXACT REQUIREMENTS TO
THE MANUFACTURERS

DIAMOND FIBRE CO. LTD.

DIAMOND-FIBRE WORKS HIGH ROAD SOUTH TOTTENHAM, N.15.

W. MACKIE & CO.

(ESTABLISHED 1882.)

Works: THE PALACE ENGINEERING WORKS,
129, 131, 133, Lambeth Road, London, S.E.1.

Central Office: Sardinia House, Kingsway, London, W.C.2.

Telephone Nos.: Works—Hop 182.

Central Office—Holborn 2125.

Manufacturers of Wireless Generators to the
Admiralty, War Office, and Air Force,
Marconi's Wireless Telegraph Co., Ltd., &c.

HAVE just placed on the market the latest machine for Wireless users. Specially constructed for silence in Wireless Transmission.

80^{Watt} Rotary Transformer

L.T. 11 Volts 13·9 Amps.

H.T. 1150 Volts ·073 Amps.

SUITABLE FOR ALL WIRELESS ENGINEERS.

INSPECTION INVITED.

ENQUIRIES SOLICITED.

THE Tingey Self-Contained Cabinet Set

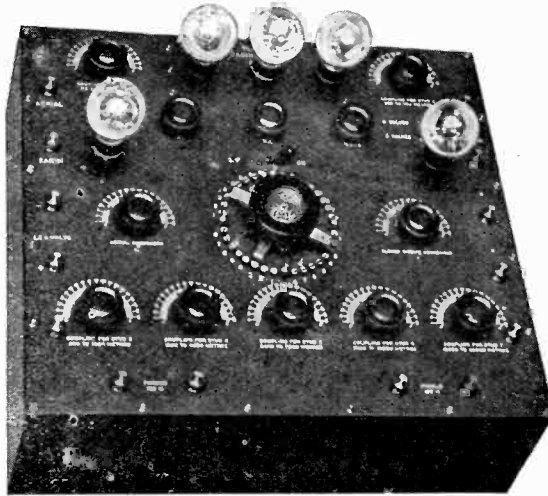

(REGISTERED DESIGN)

**This is the last word
in Self-Contained Sets.**

It is only necessary to attach Earth, Aerial, 6-volt Accumulator and Telephones or Loud Speaker to obtain loud clear signals or speech, on any wavelength. No Inductances are Tapped, entirely separate coils employed for each range of wavelengths, thus making the set particularly efficient on short waves.

The design of this Set makes it extremely suitable for fitting into gramophone cabinets.

IMPORTANT NOTICE.—This Set conforms to all requirements of the Postmaster-General.

We are also showing a **FOUR-VALVE BROADCASTING SET** specially constructed and designed to meet the requirements of the Postmaster-General as for Broadcast Reception only. Range 100-500 metres.

All Tingey Valve Apparatus is duly licensed under Marconi Patents for Amateur use in Great Britain.

TWO INSTRUCTIVE PRACTICAL PAMPHLETS

of great use to all desiring sound information on the erection and maintenance of home Wireless Stations.

Aerial and Earth. Fault Finding.

PRICE **8d.** EACH. POST PAID.

The above can only be purchased from the Author, **W. R. H. TINGEY**
(Capt. Royal Corps of Signals, T.F.), M.I.R.E.

W. R. H. TINGEY *SPECIALIST IN WIRELESS,*
92 Queen St., Hammersmith, London,
Telephone—HAMMERSMITH 1916. Telegrams—"TINGOIDAR, LONDON." **W.8**

BURNDEPT

WIRELESS APPARATUS

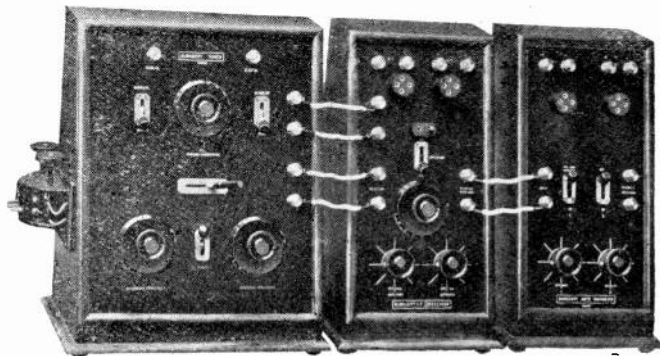

No. 124S.

No. 106S.

No. 114S.

Laboratory Station

For the Serious Experimenter

The Burndept Tuner Mk. IV allows of optional single or double circuit working with switches to operate both Primary and Secondary condensers in series or parallel as required. It is in every sense a Laboratory instrument built on sound lines.

The Burndept H.F. I Receiver consists of a radio frequency amplifier and detector. Tuned reactance capacity coupling is used in accordance with Mr. Frank Phillips' specifications given in the "Wireless World" of 8th April, 1922, but with the addition of a switch to cut out the H.F. Amplifier when not required, and a Burndept Stabilizer which prevents exceptionally sharp resonance on short waves.

The Note Magnifier Mk. IV is provided with a switch and is so arranged that it may be left connected to the Valve panel permanently, and the telephones permanently connected to the Note Magnifier output. In one position of the switch both Note Magnifier valves are "OFF," but the output of the valve panel is connected "THROUGH" to the telephone terminals of the Note Magnifier, in the other positions both Note Magnifier valves are "ON."

All Burndept wireless apparatus is manufactured under ideal conditions in model factories at Blackheath.

*All **BURNDEPT** Valve Apparatus is duly licensed under Marconi Patents for Amateur use in Great Britain.*

Write for further information and our Illustrated Catalogue, Price 1/-

No. 124S.	Tuner, Mark IV	- - - - -	£16 10 0
106S.	H.F. I. Receiver	- - - - -	15 0 0
114S.	Note Magnifier, Mark IV	- - - - -	14 0 0

BURNDEPT, Ltd., London Office & Showrooms, 15, BEDFORD ST., STRAND, W.C.2
Aerial and Eastnor Works, BLACKHEATH, S.E.3

DUBILIER

Radio Music from every Electric Lampholder

Every electric lampholder can now be used with safety for picking up radio signals, "Broadcasting," etc. The "DUCON" forms a perfect attachment between the radio receiver and the electric light wires.

Every "DUCON" is tested at 2000 volts A.C., and has the highest possible insulation resistance. Shocks and short-circuits are thus rendered impossible.

The "DUCON" fits directly into any standard B.C. electric lampholder, and is provided with terminals for connections to the radio receiver.

Simplicity with Perfect Safety is the Keynote of the "Ducon."

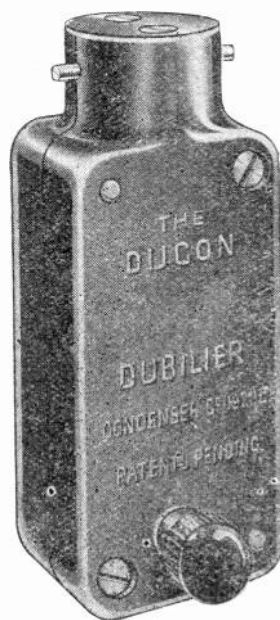

Price 10/- each

DUBILIER VARIABLE CONDENSERS FOR ALL PURPOSES

**THE DUBILIER CONDENSER CO. (1921), LTD.,
DUCON WORKS, Goldhawk Road, Shepherd's Bush, London, W.12**

Telephone—Hammersmith 1034.

Telegrams—Hivoltcon, Phone, London.

Collo—Marconi International.

DUBILIER

Dubilier Grid Leaks
 are like Dubilier Condensers—
the best



We have now got into full swing on the mass production of grid leaks, and in consequence have greatly reduced the manufacturing cost. We have, as usual, decided to reduce our price accordingly, and in future the Dubilier Grid Leaks will be sold at 2/6 each.

Dealers holding stocks of Dubilier Grid Leaks will be credited in full if they return their stocks to us.

Dubilier Grid Leaks are Accurate, Constant, Guaranteed.

THE DUBILIER CONDENSER CO. (1921), LTD.,
DUCON WORKS, Goldhawk Road, Shepherd's Bush, London, W.12

Telephone—Hammersmith 1084. Telegrams—Hivolcon, Phone, London. Code—Marconi International.

THE WAY TO DUBILIERS.

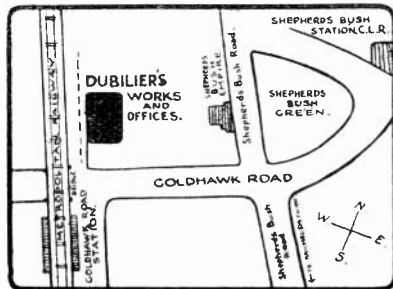

15/-

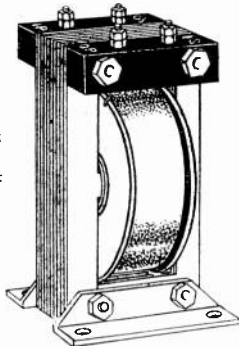

INTERVALVE TRANSFORMERS 2XX TYPE

TRADE QUOTED

EAST HAM WIRELESS SUPPLY CO.
429 Barking Road, East Ham, E.6.



TRADE MARK

The WHITECROSS COMPANY, LIMITED :: WARRINGTON ::

Manufacturers of All Descriptions of

WIRE ROPES AND WIRES

SIEMENS H.T. DRY BATTERIES

Two Announcements Worthy of Attention

REDUCED PRICES NOW IN FORCE

Size 643	15 volts	-	3/9	each	
" 789	15 "	-	6/3	"	
" 826	30 "	-	7/6	"	} Removable plug terminals if required 1/- per pair extra
" 827	36 "	-	9/-	"	
" 828	50 "	-	12/-	"	
" 829	60 "	-	15/-	"	
" 830	90 "	-	22/6	"	
" 831	100 "	-	24/-	"	

FLAT STRIP TERMINALS ABOLISHED

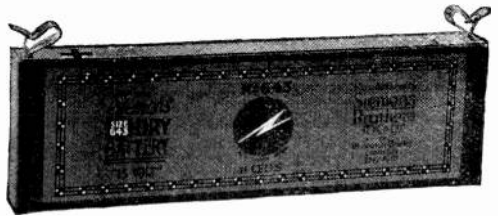

An improved form of terminal for the standard 15-volt battery has been designed by us, and as soon as existing stocks are disposed of we shall supply these batteries fitted with two **Spring Clip Terminals** as shown in the above illustration.

With the Spring Clips no soldering will be required, a short piece of copper wire being all that is necessary to connect adjacent units. The contact is perfectly sound and cannot shake loose.

Strip terminals will be supplied if specially asked for.

Pamphlets on application to the Manufacturers

Siemens Brothers & Co. Ltd.
WOOLWICH, LONDON, S.E.18

Telegram: SIEMENS, WOOLWICH

Telephone: CITY 6400 (7 lines)

and at Belfast, Birmingham, Bristol, Cardiff, Glasgow,
Leeds, Manchester, Newcastle, Sheffield, Southampton.

WIRELESS EQUIPMENT LTD.

Tel: GERRARD 6785. RADIO ENGINEERS AND MANUFACTURERS. Apparatus and Spares. Write for our illustrated lists of sets and component parts, 3d. post free. Head Office: 90, CHARING CROSS ROAD, LONDON, W.C.2

Telegrams: WIREQUIP WESTCENT LONDON

THE WIRELESS WORLD AND RADIO REVIEW

THE OFFICIAL ORGAN OF THE WIRELESS SOCIETY OF LONDON
A MAGAZINE DEVOTED TO WIRELESS TELEGRAPHY AND TELEPHONY

CONTENTS

The Armstrong Super-Regenerative Receiver. By Percy W. Harris	- - - - -	79
Electrons, Electric Waves, and Wireless Telephony. By Dr. J. A. Fleming, F.R.S.	- - - - -	83
(continued)	- - - - -	
"Jammed!" By H. R. Taunton	- - - - -	92

Contents continued on next page.

RADIO INSULATION

AS SPECIFIED AND USED BY THE BRITISH ADMIRALTY

BRITISH MADE **PAXOLIN** BRITISH MADE

TUBES DISCS PLATES, &c.

MANUFACTURED IN ALL FORMS, SIZES AND THICKNESSES

BY

THE MICANITE & INSULATORS Co. LTD.

EMPIRE WORKS

WALTHAMSTOW

LONDON, E.17

TELEGRAMS.—"MYTILITE, PHONE, LONDON." TELEPHONES.—WALTHAMSTOW 738, 739

NOW IS THE TIME to acquire a sound theoretical and practical knowledge of **THREE ELECTRODE VALVES**, (as applied to C.W. Radio-telegraphy and Radio-telephony), by means of my **POSTAL INSTRUCTION COURSE.**

Perfectly Simple

May I Send you Particulars?

2/Lt. E. REDPATH,
19 Niger St., **BARROW-IN-FURNESS**

CONTENTS *(Continued)*

The Wireless Society of London	- - - - -	97
Notes	- - - - -	99
Correspondence	- - - - -	102
Calendar of Current Events	- - - - -	102
Wireless Club Reports	- - - - -	103
Questions and Answers	- - - - -	109
Share Market Report	- - - - -	116

THE WIRELESS WORLD AND RADIO REVIEW is published weekly on Saturdays.

All correspondence relating to contributions should be addressed to THE EDITOR, THE WIRELESS WORLD AND RADIO REVIEW, 12-13, Henrietta Street, Strand, London, W.C.2.

No responsibility can be taken for MSS. or photographs sent without stamps to defray cost of return postage

Editorial and Publishing Offices 12-13, Henrietta Street, Strand, London, W.C.2.

Telegraphic Address: 'Radionic, Rand, London.' Telephone No.: Gerrard 2807.

Advertisement Managers, Bertram Day & Co., Ltd., 9 and 10, Charing Cross, S.W.1.

Telephone No.: Gerrard 8063 and 8064

SUBSCRIPTION RATES.—

28s. per annum, post free. Single Copies 6d., or post free 7d.

Registered at the G.P.O. for transmission by Magazine Post to Canada and Newfoundland.

EUREKA!! DRUDGERY
BANISHED!

THE

"TURNEY"

AUTOMATIC MORSE BUZZER

PROV. PATENT 28766.

Transmits in a fascinating manner suitable signals quickly training the ear to instinctively read the code as heard in the 'phones.

You MUST Learn Morse.

DON'T WASTE YOUR TIME.

SEND AT ONCE.

PRICE COMPLETE **30/-** POST FREE

W. PRESTON TURNBULL 26, Cowper St.
Leeds.

WOODWORK
AT LOW CUT PRICES

PROMPT DELIVERY. ENQUIRIES
FOR QUOTATIONS SOLICITED.

THE HOBRO MANF'G CO.
56a, Church Rd., Manor Park, London, E.12

VALVES

DELIVERY FROM STOCK.

RECEIVING.

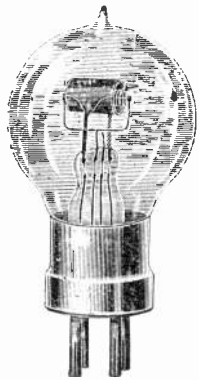

Type.	Filament Voltage.	Anode Voltage.	PRICE.
R	4	60	£0 17 6
R ₄ B	4	50	1 10 0
V ₂₄	5.2	36	1 4 0
Q	5.2	50	1 4 0
		(150 as amplifier)	
QX	5.2	50	1 4 0

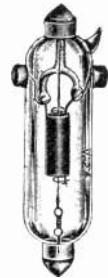

SPECIAL LOW TEMPERATURE VALVES.



Type.	Filament Voltage.	Filament Current.	Anode Voltage.	PRICE.
L.T. 1	1.8	.4	36-50	£2 10 0
L.T. 3	1.8	.11	„	„

TRANSMITTING.

Type	Filament Voltage.	Anode Voltage.	PRICE.
A.T. 25	5.5	UP TO 1,000	£1 10 0
A.T. 40X	7	„ 1,000	2 15 0

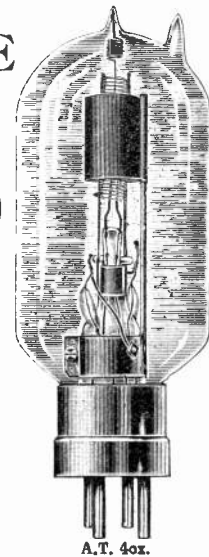

A.T. 40x.

THE
MARCONI SCIENTIFIC INSTRUMENT CO., LTD.

40 DEAN STREET, SOHO, W.1

TELEGRAMS: THOMAS MARCONI CO. WESTCHAMPT
 TELEPHONE: GERRARD 774

Showrooms that will interest you!

FREE DEMONSTRATIONS AND ADVICE

Visit our well-equipped Showrooms, and ask our experts anything you want to know; they will be happy to give you any advice, and a demonstration if necessary, and tell you which set will best suit your pocket. In addition to Complete Receiving Sets of the best quality, we also manufacture and supply all component parts.

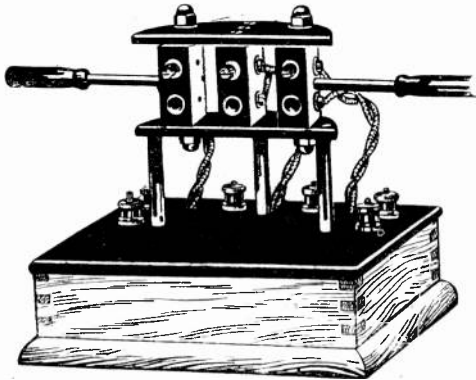

Send 3d. Stamps for our Illustrated Catalogue.

"Ideal" Valve Accumulator, 6 volt, 50 amp.
25/- per set. Carriage 3/-

"Ideal" Valve Accumulator, 4 volt, 50 amp.
24/- per set. Carriage 2/-

Filament Resistances, 5/- each.

Variable Condensers (of various capacities),
from 6/-

Fixed Condensers, from 2/6

H.T. Battery Case, 15/-

H.T. Battery Case, with 60 volt Battery, 29/-

The illustration is that of our Three Coil Holder Complete Unit for use with any standard coils, mounted on mahogany base, with ebonite top and well lacquered brass parts. The levers at the side make possible the most critical adjustment with the very minimum of friction.

Price **20/-** each

List of H.T. Batteries or Accumulators free.

WATES BROS.

13/14, Great Queen Street,
KINGSWAY, W.C.2.

NOTICE

RADIO SUPPLIES have to announce that their Showrooms and Offices are now situated at 234, High Holborn, London, W.C.1 (two doors nearer, Kingsway than before), where customers are invited to inspect their greatly increased stock, and to compare it with any other makes on the market. Complete apparatus will be demonstrated to all who wish it.

EBONITE AND VULCANITE

TUBES—RODS—SHEETS

LARGE
STOCKS

BRITANNIA RUBBER AND
KAMPTULICON CO., LTD.
7, NEWGATE ST., LONDON, E.C.1

Telephone :
2168 Central

Telegrams :
Britannia, London

THE WIRELESS WORLD AND RADIO REVIEW

THE OFFICIAL ORGAN OF THE WIRELESS SOCIETY OF LONDON

No. 166 [No. 2.
VOL. XI.]

OCTOBER 21ST, 1922.

WEEKLY

The Armstrong Super-Regenerative Receiver

PRACTICAL DETAILS OF A BRITISH-BUILT INSTRUMENT.

By PERCY W. HARRIS.

THE principles of the new Armstrong Super-Regenerative Receiver, and many of the theoretical circuits used with it, are already known to readers of this journal. There seems, however, a great lack of practical

2 LO is stronger on two valves than on an ordinary set with three and an outside aerial 50 ft. long. If the directions here given are followed, any amateur with quite ordinary skill in instrument assembling can build the

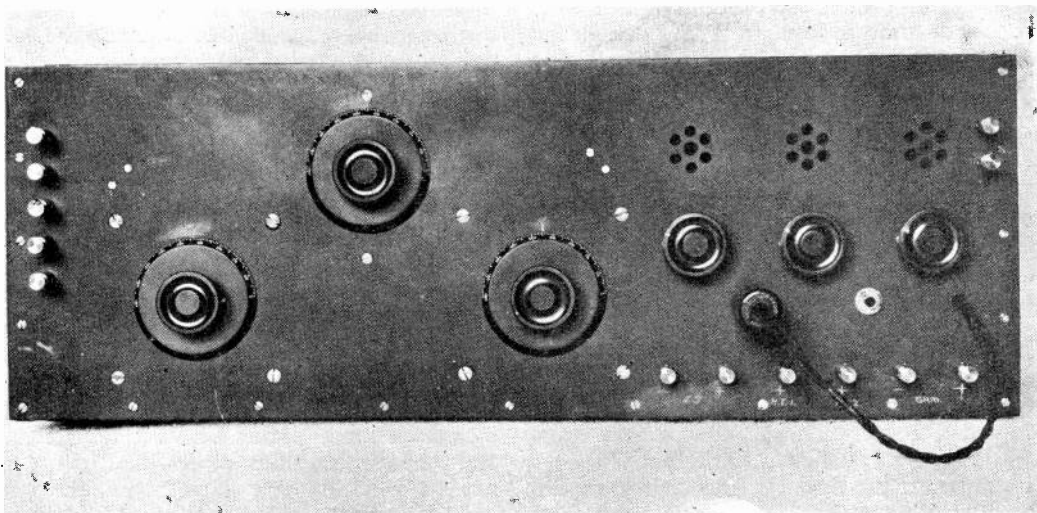

Fig. 1. A Photograph of the Armstrong Super-Regenerative Receiver showing the Completed Instrument.

data, and for this reason the writer ventures to publish the following description of his own "Armstrong Super," which fulfils the most sanguine expectations in regard to signal strength. With "R" valves and a 2-ft. loop,

receiver, and if care is taken in details, the result of the work will be a handsome and fascinating addition to the wireless room.

Before beginning, let us refresh our minds regarding principles.

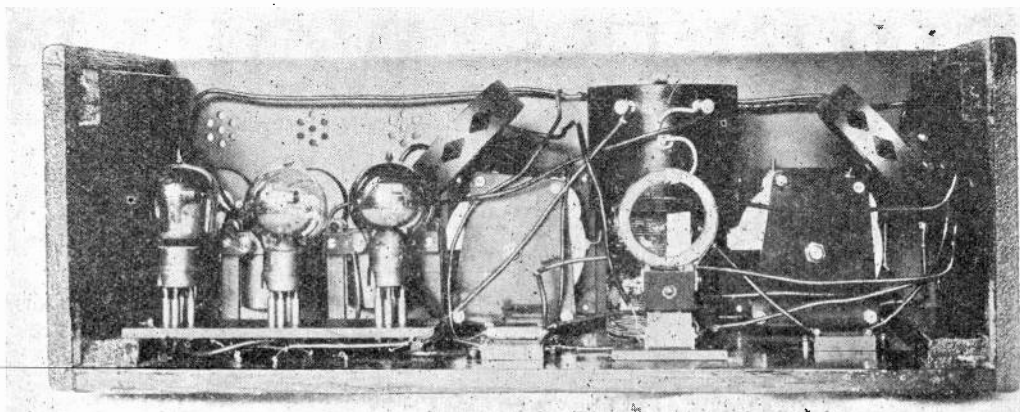

Fig. 2. A View of the back of the Armstrong Super-Regenerative Receiver with part of the case removed.

In essence, the basis of the Armstrong Super-regenerator is an ordinary regenerative receiver in which the reaction coupling is so tight that the first incoming signal sends the circuit into oscillation. This builds up rapidly and regularly until the limit of current-carrying capacity is reached. If nothing were done to it the circuit would continue to oscillate at uniform strength as long as high and low tension supply lasted, and further incoming signals would make no additional impression. It must be remembered that from the first impulse of the wave to the maximum oscillation of the valve a definite interval of time elapses, the oscillation building up by stages. At the end of a measured interval the amplitude of the oscillation built up from the impulse of a weak signal is less than the corresponding amplitude set up by a strong signal in the same period; in fact, at the end of regular periods of time (supposing the oscillation to be stopped periodically) the value of the oscillations is strictly in proportion to the strength of each original impulse. This statement may seem a little involved at first reading, but it should be grasped if the reader wishes to understand the basic principles.

In his circuits Armstrong uses a special oscillating valve circuit which periodically stops the oscillations of the valve in the regenerative circuit by making its grid positive at regular intervals, or by some other equally effective method. The most popular circuits use three valves, one for detecting and regeneration, one

for oscillating, and one for note-magnification. The incoming signals set the regenerative valve oscillating, and the current goes on building up by regeneration until, after a definite interval of time, the oscillation is stopped by the quenching effect of the oscillator valve circuit. The result is that incoming signals are enormously magnified, distortion being avoided by stopping the valve oscillating at regular and very short intervals.

If we consider for a moment we shall see that the amplification is limited by more than one factor. First of all, the longer the period we can allow the valve to oscillate before quenching it, the greater will be the building up effect. If, however, we make the period too long the quenching oscillations will descend to audible frequency and interfere with reception. Secondly, we are limited by the current carrying capacity of the valves used, for which reason the maximum effect is obtained by using transmitter valves.

Some of the new Armstrong receivers include a filter circuit between the detector and the note magnifier, so designed that it will not allow oscillations above about 3,000 per second to pass. This keeps out the whistle of the quenching frequency (if this is low), while allowing voice and music frequencies, as well as suitable heterodyne notes to pass. A filter adds considerably to the complication of the circuit, and the necessary resistances and chokes are not easily obtainable.

The present writer experimented with

several of the circuits described in these pages, but, like many others, was unsuccessful. Considerable study of American technical publications revealed the fact that nine out of every ten would-be users of the instrument were failing similarly. The reason seemed to be that not only the circuit, but the disposition of the parts must be correct. Then, by good chance, he found in one of the newer and very well edited American wireless publications, *Popular Radio*, an article by Mr. L. M. Cockaday describing a circuit and arrangement which dispensed with many of the complications. This circuit and instrument was also described in the following issue of *Q. S. T.*, certain improvements being added in the article in the latter publication. The instrument to be described is largely based upon Mr. Cockaday's description, and the writer takes this opportunity of acknowledging his indebtedness to Mr. Cockaday, *Popular Radio*, and *Q. S. T.*

terminals on the left are for connection to different loops, the particular terminals used depending on the size of the loop and the number of turns of wire. Once found, the adjustment here remains constant for a given loop. The two terminals on the right are for telephones or loud speaker, and the six below (counting from the left) are L.T. negative, L.T. positive (the H.T. negative is also connected to this terminal), H.T. positive for first two valves, H.T. positive for no.e magnifying valve, oscillator valve grid bias positive, oscillator valve grid bias negative. Normally these last two are short circuited, as the instrument works satisfactorily without any bias here.

Of the dials, that on the left belongs to the tuning condenser for signals, the upper dial controls a variometer for reaction, and the third dial on the right controls the condenser for regulating the frequency of the oscillating and quenching valve.

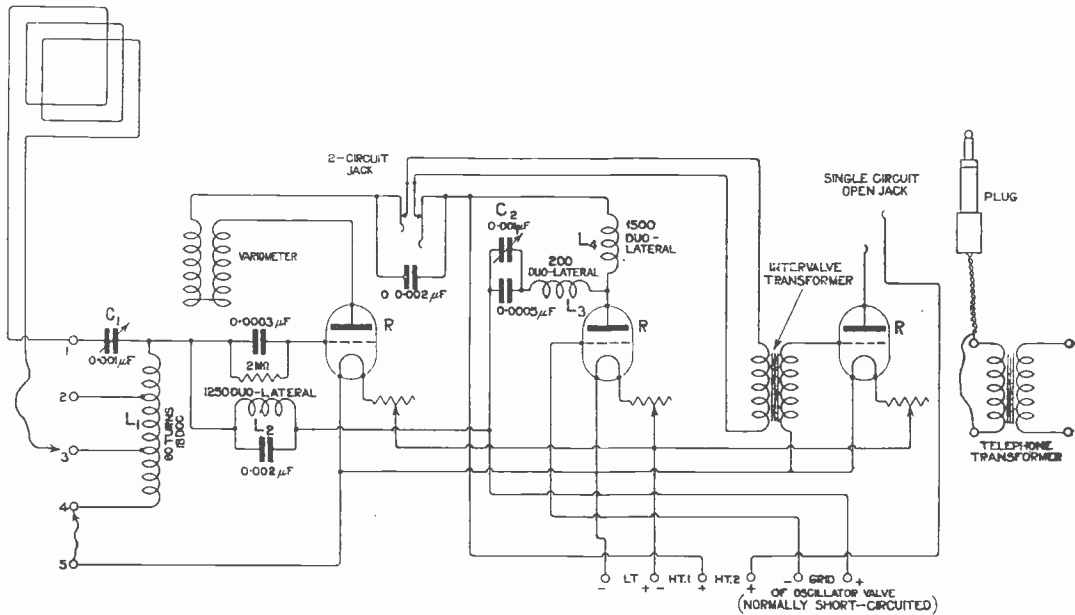

Fig. 3. The circuit used in constructing the Armstrong Super-Regenerative Receiver.

Constructionally the instrument has been modified in several ways, and these will be referred to as the article proceeds.

The photograph on the first page of this article shows the front of the completed instrument. It will be noticed that there are very few controls and variables. The five

The valves are enclosed within the instrument case, thus following a current American practice which has much to recommend it. Three sets of holes act as windows to show that all is well within. A separate filament resistance controls each valve, the knobs of these resistances being shown on the right.

Below the resistances are two jacks, into which a plug can be inserted for using either two or three valves at will. Signal strength is so great that the addition of the note magnifier is often painful.

The circuit used is illustrated in Fig. 3, and a second photograph shows the back of the instrument with portion of the case removed. In Mr. Cockaday's instrument everything is mounted on the back of the panel. The writer has adopted a slightly different method which facilitated construction and makes wiring easier.

In the instrument illustrated the panel was first prepared and drilled, and after certain portions had been mounted on it, it was fixed to the base and two uprights of the case. With this done certain other portions were mounted on the base and wiring carried out in comfort. This arrangement makes for a good disposition of the parts. Two other modifications are of interest. Firstly, the 200, 1,250 and 1,500 coils are mounted on plugs and fit into sockets, thus allowing them to be removed in a moment for other work. Secondly, instead of connecting the telephone to a plug and plugging them into one or the other of the jacks, a telephone transformer is built into the instrument, its secondary being connected by a flexible lead to the plug and its primary to the two telephone terminals of the instrument. This is, of course, a much more satisfactory arrangement than placing the telephones directly in circuit, particularly when we consider that 150 to 200 volts are used on the plate of the last valve.

In the second part of this article detailed constructional details will be given. Meanwhile, here is a list of the components required:

Ebonite panel, 24 ins. by $8\frac{3}{4}$ ins. by $\frac{1}{4}$ in. ($\frac{3}{8}$ in. would be better but makes the panel expensive.)

2 0.001 mfd. variable condensers. (If possible these should *not* have short circuiting contacts.)

1,500-turn duolateral coil (mounted).

1,250-turn duolateral coil (mounted).

200-turn duolateral coil (mounted).

3-plug sockets for above.

2 fixed condensers (Dubilier 600 pattern), 0.002 mfd.

2 fixed condensers (Dubilier 600 pattern), 0.0005 mfd.

1 fixed condenser (Dubilier 600 pattern), 0.0003 mfd., combined with 2 megohm grid leak.

1 ebonite tube, 4 ins. by 3 ins., wound full with No. 18 D.C.C wire with 3 equally spaced taps (four connections in all).

1 American pattern variometer with high maximum and low minimum. (Mine was purchased from an advertiser in *The Wireless World and Radio Review*. Certain British firms are now manufacturing them also.)

3 filament rheostats for panel mounting.

1 double circuit jack.

1 single circuit jack.

1 plug for same.

1 L.F. intervalve transformer. (This *must* be of good quality. The cheap ones, and many expensive kinds too, will burn out. Ask for an instrument which has been tested on high voltages. Certain of those on the market are tested with 1,000 volts between windings.)

1 telephone transformer. (The above remark also applies here.)

3 good hard "R" valves. Better still, small transmitting valves such as the M.O. "A.T.25."

1 tapped high tension battery which will give up to 200 volts.

1 6-volt accumulator.

13 terminals.

Quantity 4 and 6 B.A. metal screws, with suitable nuts, for fixing components in place.

3 sets valve sockets, as shown in the photograph, but preferably valve bases with terminals on the upper part. These latter will facilitate wiring.

Quantity No. 18 tinned copper wire (bare).

Quantity No. 22 or 24 tinned copper wire (bare).

About 8 yds. insulating tubing for thick wire.

8 ft. of "9-in" planed deal, $\frac{5}{8}$ in. thick. (This will actually be about $8\frac{3}{4}$ ins. wide.)

Strip of ebonite about $1\frac{1}{2}$ ins. wide and long enough to take three valves. (Note.—If valve bases with terminals are used, this strip will not be required. The strip method with separate valve sockets is cheapest, but is a nuisance to wire.)

Quantity solder, wood screws, glue, etc.

Small loop aerial suitable for concert wavelengths. The writer uses a loop 2 ft. square wound with 12 turns of single electric light flex.

About 18 ins. silk-covered double flex.

If the above components are purchased new for the work, and are of good quality, the cost will be in the neighbourhood of £16 or £17. Many amateurs, however, will have some of the components already in hand, or can make several of them instead of buying them. With the possible exception of the variometer, all the parts are readily procurable.

(To be concluded.)

Electrons, Electric Waves, and Wireless Telephony. III.

By Dr. J. A. FLEMING, F.R.S.

The articles appearing under the above title are a reproduction with some additions of the Christmas Lectures on Electric Waves and Wireless Telephony given by Dr. J. A. Fleming, F.R.S., at the Royal Institution, London, in December and January 1921-1922. The Wireless Press, Ltd., has been able to secure the serial rights of publication, and any subsequent re-publication. The articles are therefore copyright, and rights of publication and reproduction are strictly reserved.

II.—COMPRESSIONAL WAVES IN AIR.

We have in the next place to explain the nature of a wave which is created *in* a material, and not simply *on* the surface of a medium. To follow this explanation necessitates some effort of the power of mental vision because objective perception is more difficult or impossible.

As already mentioned, there are two types of wave which can thus be produced, viz., compressional and distortional waves, depending upon the two kinds of elastic resistance which can be offered.

A *solid* is defined as a material which offers resistance to change of shape as well as to change of bulk or size. An elastic solid is one which when slightly changed in shape or size returns exactly to its original shape or size when the deforming force is removed.

A *liquid* or *gas* is matter in a physical state in which it offers elastic resistance to change of bulk or volume, but little or no resistance to change of shape.

The elastic resistance to change of volume is called volume elasticity; and the substance is said to have compressional elasticity or compressibility. The resistance to change of shape is called rigidity, and a substance which possesses elastic resistance to change of shape is said to have distortional elasticity.

In scientific language any change of size or shape in a substance is called a *strain*, and the corresponding force causing it is called a *stress*. Elasticity is numerically measured by the ratio of stress to strain in appropriate units. Hence in scientific language a substance is called highly elastic if it requires a relatively large stress or force to make a given small strain. In common language we generally

say that a substance, for example, indiarubber, is very elastic if it stretches a great deal under a small pull; but in scientific usage we call a substance such as steel highly elastic because it requires a very large stress or force to create a relatively small strain, or stretches very little under a pull. The strain is always measured by the ratio of the change in volume or length to the original volume or length.

The two types of elasticity with which we are concerned in wave propagation, are the volume elasticity and the simple rigidity or shape elasticity.

Before discussing the way in which these qualities affect the speed of wave propagation it may be well to consider in detail the process of producing a space wave or wave *in* an elastic medium such as air.

Suppose a very sudden expansion of the air is made at one place by a little explosion or by an electric spark, the effect is to compress suddenly the air in a small spherical shell lying around that point. Owing to the inertia and compressibility of the air this compression does not make itself felt at once at any great distance. When the explosion is over, this shell of compressed air immediately around the place of explosion expands again, and in so doing compresses the air in a spherical shell just outside the first layer. This again, in turn, releases itself and so the compression is handed on from layer to layer. If we picture to ourselves the region round the original centre of explosion as divided into concentric shells like the coats of an onion, we can say that each shell in turn becomes compressed and then expanded again, passing from within outwards. This gradual transference of the compression from layer to layer constitutes a

wave of compression, and in air at the temperature of melting point of ice (0° Centigrade), it travels at the rate of 1,090 ft. per second or nearly 700 miles per hour.

It can be proved by mathematical reasoning, though the proof is not given here since it is somewhat difficult to follow, that the speed at which a wave travels in an elastic medium is numerically equal to the square root of the quotient of the elasticity by the density using the appropriate units.

In a gas such as air the decrease in volume produced by an increase in pressure is such that if the pressure is applied slowly the product of volume and pressure remains constant.

Let V be the original volume and let v be a small reduction in volume produced by an increase in pressure from P to $P+p$. Then by the above rule (Boyle's Law) we have—

$$(V - v)(P + p) = VP \text{ or}$$

$$P = \frac{V - v}{v} p = \frac{v}{v/V} p$$

provided v is small compared with V . But $\frac{p}{v/V}$

is the ratio of increase in pressure to decrease in volume expressed as a fraction of original volume. This is therefore the compressional elasticity. Accordingly this last is numerically equal to the pressure of the gas at standard temperature 0° Centigrade. But the law of Boyle only holds good for changes of pressure so slowly applied that no change of temperature takes place.

In the case of the compression produced in air waves, the pressure is suddenly applied and it can be shown that the elasticity with which we are then concerned is measured, not by the pressure P but by 1.41 times P .

To render the above explanations clearer we may consider a numerical example.

The pressure of the air at normal barometric height, viz., 760 mm. = 30 inches and 0° Centigrade is about 2116.4 pounds per square foot. But the so-called weight of 1 lb. is 32.2 absolute units of force in British foot, pound, second units; because a mass of 1 lb. acquires under gravity a velocity of 32.2 feet per second per second, whereas the unit force imparts a velocity of only 1 foot per second. Hence the pressure per square foot in absolute units of force is $2116.4 \times 32.2 = 68,148$. If we multiply this number by 1.41 we obtain the product 96088.68, which is the numerical value of the elasticity of air at 0° Centigrade and 760 mm. for suddenly applied pressure. The

density of air at the same pressure and temperature is such that one cubic foot of air weighs 0.0807 pounds. Hence if we divide the number 96088.68 by 0.0807 and take the square root of the quotient, we arrive at a number close to 1,090, which is therefore the velocity of a compressional wave in air at the above standard pressure and temperature in feet per second. In the case of water the ratio of elasticity to density is nearly 17 or 18 times that for air and the velocity of a compressional wave in water is therefore rather more than four times its velocity in air.

Although we cannot see these compressional waves in air they can nevertheless be photographed by an ingenious process which may be explained as follows:—

If we look at a shallow pool of water on a bright sunny day when there is a slight wind producing ripples on the surface of the pool, we shall see a series of bright lines on the bottom of the pool, which move with the wavelets. The curved surface of the wave makes the water act like a lens and concentrates the sun's light on certain lines, corresponding to these waves.

A wave in air is a region of condensation followed generally by one of rarefaction and the compressed air acts to some extent like a lens on rays of light. Suppose, then, that we create a very sudden sound by means of the snap of an electric spark. This starts a sound wave which consists of a single region of compression followed by a region of expansion. This air wave can be allowed to flit across a sensitive photographic plate in a dark room. It moves at the rate of 13,200 inches or so per second and therefore occupies about $1/2,000$ th part of a second in moving a distance of 6 inches.

Suppose a second electric spark is made at a distance from the plate, but so that its light falls on the plate. If the interval of time between the sound-creating spark and the light-creating spark is properly adjusted, the latter will impress on the photographic plate an image of the sound wave as it flits across the plate.

Some very successful experiments in photographing sound waves in this manner were carried out as far back as 1899 by Prof. R. W. Wood, and described by him in the *Philosophical Magazine* for August, 1899. He followed a method first used by Toepler, but with many improvements.

The light-giving spark was formed by the discharge of a small Leyden jar between two pieces of magnesium ribbon, clamped between two glass plates. An optical image of this spark was formed by a large lens, and the image nearly covered by a horizontal metal plate. Behind this was placed another lens which formed a faint image of the first lens on a photographic plate, which was thus uniformly illuminated. If, then, a sound wave produced by another electric spark, which takes place about one ten-thousandth part of a second before the light-giving spark is allowed to flit across the first lens, an image of the compressional wave in the form of a bright line appears upon the photographic plate when developed. We then see the compressional

length lies within certain limits, viz., about 30 ft. and 2 or 3 ins.

These waves excite in our ears the sensation of sound. In the human being the external organ we commonly call the ear, is merely a wave collecting shell or sound catcher, and in animals such as horses, dogs, cats, etc., it assumes the form of a curved flap or ear trumpet capable of being turned in various directions.

The true ear or actual organ of hearing is set deeply in the skull, and in mankind may be likened to a sort of house with two rooms and an entrance hall. The entrance hall is the tube opening into the external air. This is closed at the bottom by a delicate membrane like the wing of a fly, which is called the drum

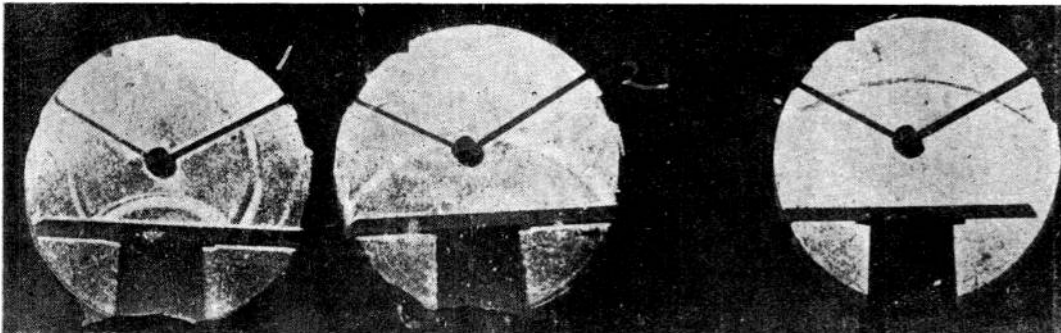

Fig. 20. Photographs of sound waves produced by an electric spark between balls. The central black dots are the balls and the inclined lines the wires leading to the two balls. The sound wave is shown reflected from a table and the three views (left to right) show the various stages of the direct and reflected waves.

wave made by this spark as a circular ring-shaped image on the plate. If we allow the sound wave to impinge upon a reflecting surface we can see the reflected wave (see Fig. 20). We can in this way objectively inspect what takes place when compressional air waves are reflected or refracted in various ways.

Professor Wood was thus able to photograph air waves in the act of being reflected by plane surfaces or refracted by being transmitted through boxes, prisms or lenses of thin collodion, filled with gases such as hydrogen or carbon dioxide, in which compressional waves travel more quickly or more slowly than in air.

Although we cannot see these air waves with our eyes, we are provided with a pair of organs, our ears, which are extraordinarily sensitive to compressional waves in air, either solitary or in trains, provided their wave-

or tympanum. The first room of the ear, called the middle ear, is a cavity which is bounded on one side by the first tympanum and has on the other side two other inner tympana or drums. This cavity communicates with the back of the mouth by a canal called the Eustachian tube, which admits air to the middle ear (Fig. 21). The inner and outer tympana are connected by a little chain of bones called the ossicles. When a compressional wave from the outer air enters the external tube and strikes the ear-drum, it presses it in, and if the waves continue to arrive the tympanum will be set in sympathetic vibration.

These motions of the outer drum are communicated across the middle ear by the chain of bones, and act on the inner tympanum. Behind this middle chamber and deeply buried in the bony framework of the skull lies the real organ of hearing, in and by which

the mere mechanical motions of the tympana are translated into sensations of sound. This inner ear contains an organ called Corti's organ in which are spread out a vast number of nerve fibres which are extensions of the auditory nerve. It is in this inner chamber, the secrets of which physiologists have not yet been fully able to explore, that the transmutation takes place of physical motions into physiological perceptions, or sensations. The ear has a marvellous power of appreciating the frequency of the air waves which enter

gether. These regions of compression and rarefaction are propagated or travel through the air, but the actual motion to and fro of the air molecules themselves at any one place which gives rise to these compressions or rarefactions is very small.

The late Lord Rayleigh (third Baron) made experiments in 1877 in the open air on a calm day with a whistle giving out a sound or air wave having a frequency of 2,730. He found that such a whistle could be heard by a normal ear at a distance of 820 metres. The whistle

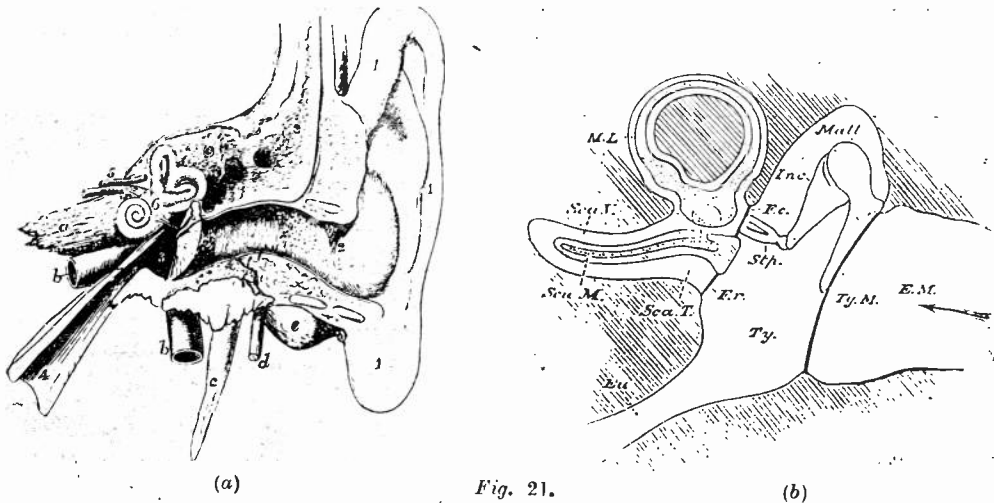

Fig. 21. A sectional diagram of the human ear. 1. The external lobe. 2. The entrance channel. 3. The Tympanum and middle ear. 4. The Eustachian tube. The chain of bones or ossicles connecting the tympana of the outer and inner ear cavities are shown in diagram b.

the outer ear, and also their amplitude, and in addition it detects that which is called their *wave form* or the degree of an admixture of waves of different frequency and amplitude. The difficult questions of physiology and psychology involved in the explanation of the functions of the ear in hearing do not concern us here, but it is important to understand clearly the differences between the motions in the air itself which give rise respectively to sensations corresponding to musical sounds, to mere noises, and to articulate speech.

In an air wave there is a place or places at which the air is slightly compressed, due to the air molecules being a little crowded together, and other adjacent places where it is rarified or the molecules less crowded to-

gether. These regions of compression and rarefaction are propagated or travel through the air, but the actual motion to and fro of the air particles in the sound wave at the above distance from the whistle was only 0.8 of one millionth of a millimetre. This is less than one twenty-five millionths of an inch. Yet the human ear is able to appreciate the extremely slight changes in air pressure due to the motion.

Lord Rayleigh also experimented in 1894 on the amplitude of the least audible sound waves given out by a tuning fork vibrating 256 times a second, and found it to be about 1.27 millionths of a millimetre.

It will be evident from these figures that the expenditure of energy necessary just to excite

a sensation of sound in the ear is extremely small. Measurements made of the energy necessary just able to excite a sensation of light when entering the eye, show that the human eye and ear are about equally sensitive to radiant energy.

In order that an air wave may be produced it is therefore necessary for some solid body or else some puff of air to strike the stationary air very suddenly.

When, for instance, we strike a gong with a drumstick, the disc of metal is pressed in at the centre by the blow, and this produces a sudden local compression of the air on the opposite side which starts an air wave. The actual extent of motion of the wave-producing device may be invisibly small. Thus, for example, if we strike the prongs of a tuning fork and so set them in vibration, the motion is not visible to the eye. If, however, we hold near to the prongs a little pith ball suspended by a silk thread the rapid bouncing to and fro of the ball reveals the minute vibratory motion of the prongs. In the same way, although we cannot see the motions of the disc of the sound-box of a gramophone when it is playing, we can feel that it is in motion by holding the finger very gently just in contact with the disc. Even in the case of loud sound the amplitude of the motion in the gramophone diaphragm scarcely exceeds a few thousandths of an inch.

I. SOUND WAVES.

The next question which must be answered is as to the nature of the motion of the air particles which takes place in sound waves. We have seen that it is an extremely minute motion to and fro in the direction in which the air wave is travelling.

If we suspend a weight from the end of a very long string, say 2 or 3 yards long, fixed at the upper end, and set the weight swinging, we have an arrangement called a simple pendulum. The motion of the bob backwards and forwards exactly resembles that of the end of a tuning fork emitting a pure musical sound, and it is called a simple harmonic motion. Let the bob of the pendulum be formed of a cannister having a small hole in the bottom and let the cannister be filled with fine sand. As the pendulum vibrates the sand will run out of the hole in a fine stream. Let it fall on a long sheet of card (see Fig. 22). If the card is not moved the sand will be merely distributed in a long straight ridge. If,

however, we move the card steadily and uniformly in a direction at right angles to that of the line of vibration of the bob the sand will be distributed in the form of a smooth wavy curve, called a simple harmonic curve (see Fig. 23).

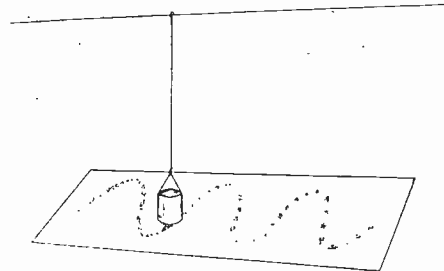

Fig. 22. A pendulum having a bob delivering a stream of sand which marks a simple harmonic curve on a transversely moving strip of paper.

We can imitate this curve in the following way. Procure a cardboard tube having a circular cross section and cut off the end

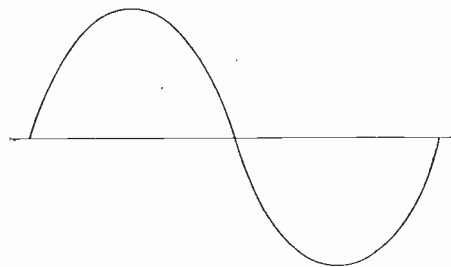

Fig. 23. A simple harmonic or sine curve.

obliquely with a sharp knife so that the slanting end will touch everywhere a flat surface applied to it. Then fold a sheet of paper several times round the tube, and with

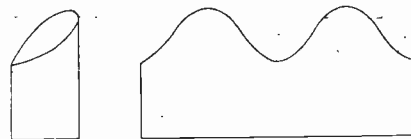

Fig. 24. Method of forming a simple harmonic curve by a sheet of paper cut to fit round a cylinder with oblique end.

scissors cut the edge of the paper to match the sloping end of the tube. Then unfold the paper and its edge will be found cut into the form of a simple harmonic curve (see Fig. 24).

Obtain if possible four tubes respectively of diameters, 3 ins., $1\frac{1}{2}$ ins., 1 in., $\frac{3}{4}$ in. and prepare in the above manner from them four sheets of paper with their edges each cut in wavy curves of the above kind, but the distances from crest to crest of the humps will be in the ratio of 1, $\frac{1}{2}$, $\frac{1}{3}$, $\frac{1}{4}$. By placing these templates, as they are called, on a sheet of paper and passing a pencil

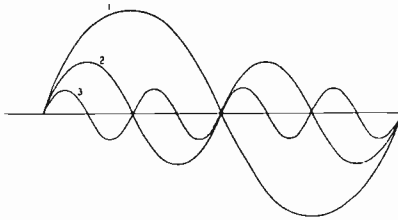

Fig. 25. Simple harmonic curves with wavelengths in ratio of $1 : \frac{1}{2} : \frac{1}{4}$.

round the curved edges, we can draw on the paper four simple harmonic curves which are said to have wavelengths in the ratio of $1 : \frac{1}{2} : \frac{1}{3} : \frac{1}{4}$ (see Fig. 25).

If we describe in this way, say, two superimposed simple harmonic curves with wavelengths in the ratio of 1 to $\frac{1}{2}$, we can then add together the heights of these two curves above

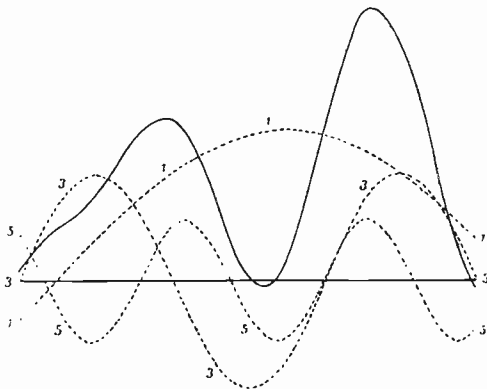

Fig. 26. A diagram illustrating Fourier's Theorem. The black firm line is a periodic curve and the dotted lines its harmonic constituents with wavelengths in ratios $1 : \frac{1}{2} : \frac{1}{3}$.

the mean line and obtain a third periodic curve which is said to be the sum of the other two. This third curve will be more irregular but will repeat itself (see Fig. 26).

In this way we can add together or sum a number of simple harmonic curves whose wavelengths are in the ratio $1 : \frac{1}{2} : \frac{1}{3}$, etc. and obtain very complex periodic curves which, however, repeat themselves in shape. Such curves are called complex periodic curves.

It is quite an easy thing to add together in this manner any number of simple harmonic curves of different wavelengths and amplitudes, and in any relative difference of phase; that means to say, shifted relatively to one another, but with the mean or centre lines of all the curves coincident, and thus obtain a complex curve.

2.—FOURIER'S THEOREM.

Strange to say, it is possible to perform the reverse operation, and if we are given a complex periodic curve which repeats itself regularly, we can find out what are the simple harmonic curves out of which it is built up. The fact that this can be done for certain periodic curves was discovered by a great French mathematician, Fourier, and it is in consequence called Fourier's theorem.

The importance of this fact in connection with sound and music is very great, because it shows us that simple musical sounds, such as those of a tuning fork or open organ pipe, when combined together, can produce air waves in which the to and fro motion of the air particles is very complicated and can only be represented by the varying height of a complex curve corresponding to various distances along its mean line taken as an axis of time. Also Fourier's theorem shows us that such sounds can be analysed into a number of pure musical sounds represented by simple harmonic curves.

Before proceeding further it will, however, be an advantage to explain the manner in which we can determine the nature of the motion of the air particles in air waves given out by various sound producing sources. This is accomplished by means of an instrument called a Phoneidoscope, which is a word meaning "sound forms rendered visible."

It will perhaps be new to some readers to learn that every sound has a certain shape of wave form.

We recognise that there is a great difference between a mere noise and a musical sound, and also that there is a remarkable difference between the quality of the sound given by various musical instruments, even when playing the same note. Also we know that in articulate speech there are great differences between the various vowel sounds, even when pronounced in the same tone and loudness.

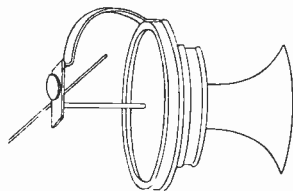
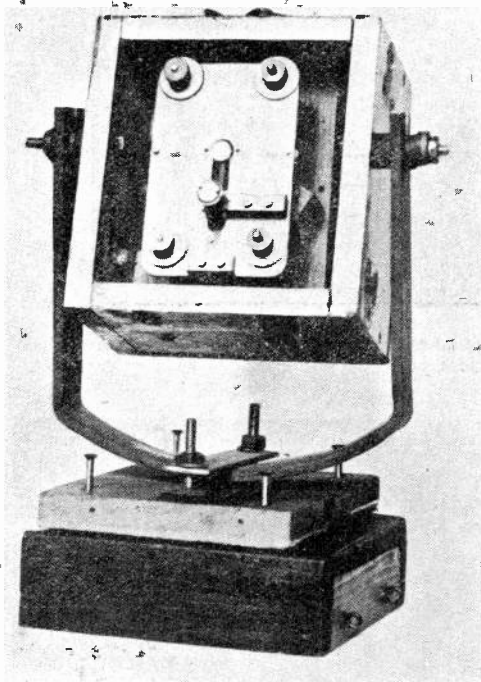

Fig. 27. The Phoneidoscope. (The lower diagram shows the mouthpiece, diaphragm and tilting mirror.)

The phoneidoscope enables us to ascertain the external or physical differences which correspond to these various kinds of sounds considered as sensations. It is constructed in the following manner (see Fig. 27):—

A metal ring has clamped to it a circular disc of very thin glass or transparent mica.

This disc is best made about $2\frac{1}{2}$ in. in diameter, and the ring may be fixed at the narrow end of a wooden trumpet, like a gramophone horn. When an aerial wave enters this horn it presses the disc or diaphragm as it is called, slightly outwards, and if aerial condensational waves continue to arrive, the disc is set in sympathetic vibration. To the centre of this disc is attached a small aluminium pin, cut with a chisel-shaped edge. This chisel presses on the underneath side of a small piece of celluloid, which is pivoted by a wire passed through its centre, and on the other side of the centre is a steel spring, which presses the celluloid up in the same direction as the pressure of the aluminium chisel. The little bit of celluloid has a small circular silvered glass mirror cemented to it. It will then be seen that if the mica disc moves to and fro or vibrates it will cause the little mirror to rock on its axis and the movements of this mirror will copy exactly the movements of the centre of the diaphragm. A ray of light is allowed to fall on this mirror and is reflected on to another steadily revolving mirror. The axis of revolution of this last mirror is so placed that if the diaphragm at rest, the spot of light is carried horizontally across a screen, and in virtue of the persistence

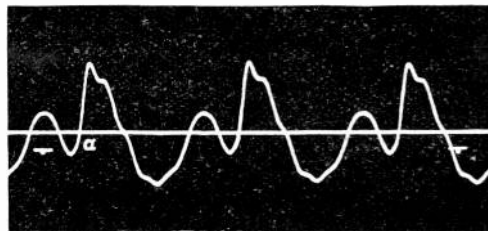

Fig. 28. Wave form of a musical sound as rendered visible by the Phoneidoscope.

of vision, appears as a narrow line of light. If, however, vibrations of the mica diaphragm take place, the spot of light is caused to move up or down and the line of light becomes a more or less regular wavy line of light (see Fig. 28). With this apparatus we can try the following experiments.

If we make near the horn any pure musical sound, we see the line of light thrown into a wavy line of simple harmonic wave form. If the sound is loud, the amplitude or height of these waves is large; but if the sound is feeble, the height is small.

Again, if we sound various notes from organ pipes or pitch-pipes, we find that if the sound is a low or bass note, the wavelength of the

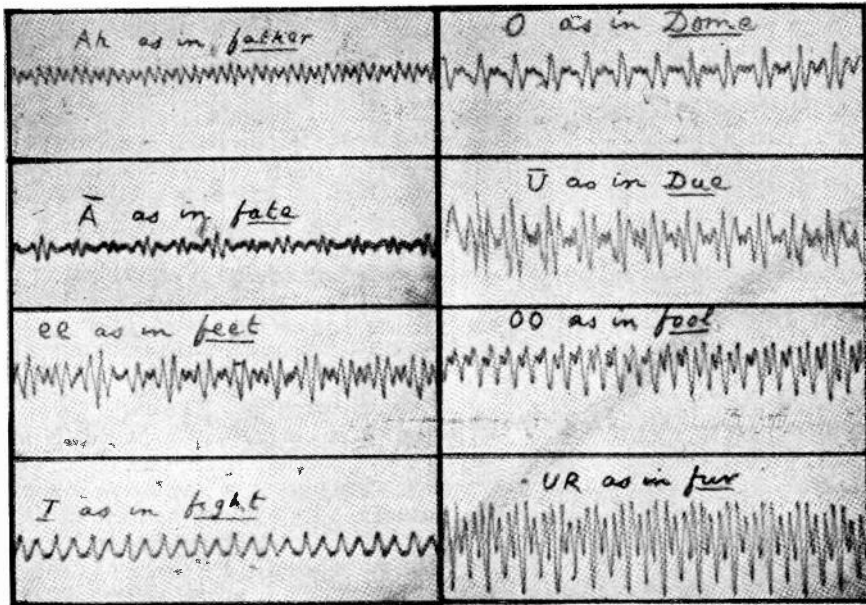

Fig. 29. The Wave forms or shapes of various vowel sounds as photographed by the Fleming Phoneidoscope.

light line waves is large, but if the sound note is high or shrill, then the wavelength is small.

If we sing to the mica diaphragm various vowel sounds, Ah, Ee, Ay, etc., we find that the shape or wave form of the light line is different in every case. If we speak to the diaphragm or recite, the line is thrown into an irregular shape (see Fig. 29).

We see, therefore, that since the amplitude or extent of motion of the mica disc is a measure of that of the air particles which beat against it, we may conclude :

- (i) that the amplitude of motion of the air particles determines the loudness of the sound.
- (ii) that the frequency of their vibration or what comes to the same thing, the aerial wavelength determines the pitch of the sound, and
- (iii) that the wave form or sound shape of the aerial vibrations determines the quality of the sound.

A musical sound results from regularly repeated aerial vibrations, of a certain wave form. A mere noise results from irregular aerial vibrations, and articulate speech results from aerial vibrations of certain specialised forms.

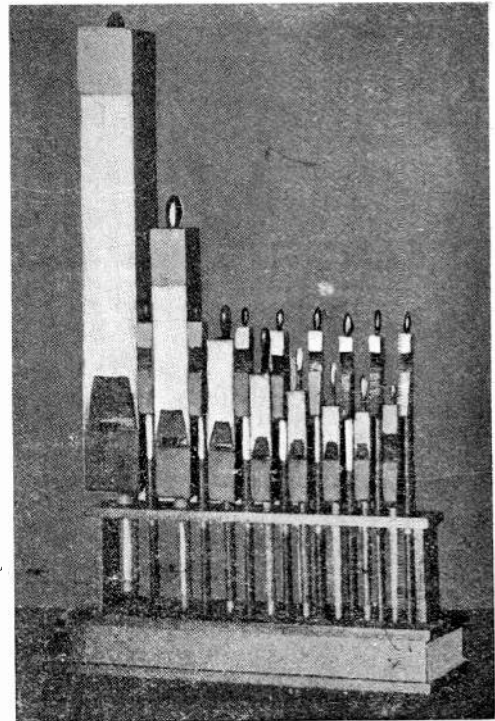

Fig. 30. A collection of organ pipes which when sounded together emit the vowel sound Ah.

Since the complex wave form of vowel sounds can be analysed into the sum of a number of simple or pure musical tones, it is possible to arrange a certain number of organ pipes to

certain selected notes, such that when sounded together, they give out the vowel sounds *Ah* or *Oh* (see Figs. 29 and 30).
(To be continued).

More Transatlantic Tests for Amateurs.

By PHILIP R. COURSEY, B.Sc., F.Inst.P., A.M.I.E.E.

AS most of the readers of this magazine are probably aware, American Radio amateurs, organised by the American Radio Relay League, conducted a series of signalling tests across the Atlantic in December last. The signals sent out by many of those American amateur stations were picked up in many parts of this country. Another series of similar tests is being arranged to take place towards the close of this year, when it is hoped that not only will it again prove possible to pick up signals from our American friends, but also that by means of two or three specially equipped stations in this country it may be possible to reply to them.

The tests on this occasion will embrace not only England and America but France, Belgium, Holland and probably Italy as well. No definite dates for these tests have yet been decided upon; they will probably take place on a number of days during December.

As far as arrangements have been made at present, it is proposed that during the first few days of the test American and Canadian amateurs will transmit signals for reception in England and other European countries. The best American transmitters as determined from these tests will be selected to broadcast the results of the reception of signals transmitted from this side of the Atlantic.

As on the last occasion, preliminary tests are being made in America to determine those transmitters which are best suited to take part in the final test, but on this occasion a rather stiffer condition is being imposed, viz., that in order to qualify for participation in the final tests the American transmitting stations must secure evidence of having transmitted messages for at least 1,200 miles over land.

These preliminary transmission tests have been arranged to commence on October 26th and to continue for ten days until November 4th inclusive.

Every British radio amateur who anticipates being able to listen in for American signals

during the final tests is urged also to listen in during the periods of these preliminary tests, as it should prove possible to intercept some of the signals. The schedule of transmission times during these preliminary tests is set out in the table below, all times being given in G.M.T. The numbers in the columns represent the numbers of the American "Inspection Districts," these numbers being the initial numbers in the call signs of stations transmitting during these periods; C represents Canadian amateurs.

Time G.M.T.	Oct.						Nov.			
	26	27	28	29	30	31	1	2	3	4
0330-0345 ..	C	1	2	3	4	5	6	7	8	9
0345-0400 ..	1	2	3	4	5	6	7	8	9	C
0400-0415 ..	2	3	4	5	6	7	8	9	C	1
0415-0430 ..	3	4	5	6	7	8	9	C	1	2
0430-0445 ..	4	5	6	7	8	9	C	1	2	3
0445-0500 ..	5	6	7	8	9	C	1	2	3	4
0500-0515 ..	6	7	8	9	C	1	2	3	4	5
0515-0530 ..	7	8	9	C	1	2	3	4	5	6
0530-0545 ..	8	9	C	1	2	3	4	5	6	7
0545-0600 ..	9	C	1	2	3	4	5	6	7	8

In order to co-ordinate as far as possible the work of British amateurs during these tests the arrangements on this side have been placed in the hands of the Wireless Society of London by the American Radio Relay League, and a sub-committee of that Society has been formed to deal with the necessary arrangements. The members of this sub-committee are Major N. Hamilton, Captain N. Lea, and Messrs. C. F. Phillips, G. G. Blake, and P. R. Coursey.

Anyone intercepting signals which are apparently of American origin during the periods of these preliminary tests as tabulated above, is requested to communicate the report of his reception to the writer of this note, who is acting as secretary of the sub-committee on behalf of the Wireless Society of London. All such communications should be addressed to 138, Muswell Hill Road, London, N.10.

“JAMMED.”

An Impression of the Exhibition.

By H. R. TAUNTON.

WE went on Wednesday afternoon. Our kindly thought was: “We’ll help this Show along. Five of us—that’ll boost up the receipts!” It was something of a shock, therefore, on turning the corner of Vincent Square, to run into the end of a queue. Apparently the Show was getting along pretty well without us. Having set out to patronise it, however, we were not easily to be thwarted; and in somewhat chastened mood we took our places in the procession.

We found a certain consolation in pointing out to the Cynic how utterly wrong he had been in his estimate of the popularity of the Show. “We told you so!” And by the time we had percolated as far as the entrance we had convinced ourselves we *had*. We were not the only ones the queue surprised. As we waited, a handsome Vauxhall dashed up and deposited a silk-hatted plutocrat, who, like ourselves, had evidently come with the idea of giving the Wireless Industry a “leg up.” His face fell with a thud as his eye took in the waiting throng. Across his features chased disgust, dismay, doubt, and, at last, decision—like a sportsman he toddled down to his place in the distant perspective!

The gentleman who took the cash was, I think, partly answerable for the length of the queue. He was no lightning calculator.

Perhaps he had mislaid his slide-rule; or fifteen pence was a larger sum than he was accustomed to handle.

I share with the criminal classes a dislike to coppers; so I gave him three, and a florin. That absolutely floored him. When presently I suggested a shilling change, bewilderment changed to suspicion. Sternly he pushed back the odd threepence, and, now on familiar ground, gave me change for the two-shilling piece—in coppers!

Once through the barrier, with the stored-up energy of the crowd behind us, we shot like a stream of electrons across the building, and “positively charged” into stand 12a. Here we were badly “jammed”; and had ample leisure to observe that the adjoining stands were 12 and 14, and to admire the persistence of our ancestral superstitions in the scientific soul of the radio specialist.

For five minutes we gazed enthralled on the backs of a six-deep crowd, who gazed enthralled on the backs of a small mob of favoured individuals inside the red rope, who gazed enthralled on a “Plus IV” receiver labelled as sold to a famous prima donna. But wild excitement is ever followed by reaction, and with the passing of time we began to get bored.

Luckily, the band struck up a lively tune, and we found pleasurable distraction in successfully persuading the Innocent that he was listening-in to 2 LO. But when he saw the blue coats of the operators in the balcony he swung to the opposite pole of incredulity; so that, when at three o’clock the real concert began, we could not convince him that the gentleman who “featured” Pagliacci was not concealed in the depths of the loud speaker.

Eventually, by kicking the ankles of those nearest us, we managed to break away from 12a, and, under the guidance of the Expert, who is nothing if he is not methodical, headed for stand number 1. The idea was to pass on to number 2, and so, thoroughly and systematically, round to number 55. We should then all be experts, even as he. But we had omitted to consult the million odd other enthusiasts, who had foolish ideas of their own on the subject, and persisted outrageously in blocking up our gangways.



The Queue outside the Horticultural Hall awaiting entrance to the Exhibition.

We started well. We sent the Expert on ahead—he is broad in the beam—and followed in single file in the vacuum caused by his transit through the serried mass. Thanks to this manoeuvre we hurtled along, at something less than 186,200 miles a second, as far as stand 12. At this point, unfortunately, we were caught in an alternating current of humanity, and thereafter drifted helplessly whither it took us.

We lost the Cynic very early—lost him in the Enthusiast. He was last seen at the Radio Company's stand, bargaining for an antique lacquered cabinet with a seventeen-valve receiver—"but I must have those nice big valves I've just seen on the M.O. stand!"

The Expert was the next to go, as we swung into the straight by McMichael's stand. Here the capacity of the gangway was severely strained. I "grid-leaked" by tripping lightly o'er the solid carpet of feet. But the Expert weighs sixteen stone; and when he attempted to follow he vanished in a haze of "atmospherics." We never saw him again; probably he was "tuned out."

The Innocent, of course, was soon lost in a maze of technicalities. We left him there, stuttering feebly in Morse. Knowing his habits, we thought to find him later in the bun-and-milk department. But we couldn't find *that*. And after an hour in the scum, it was "O, for a draught of vintage!" and never mind the Innocent! But apparently the only thirst catered for at the Show was that for Knowledge.

I was left with the Buyer. I clung to him tenaciously. He was most useful. On business bent, he was collecting catalogues. I saw to it that he collected those I wanted—and carried them. And papers. And books. (My carrying capacity is very small—I suppose about 0'0001 microfarads.) I managed, too, to hang my umbrella on him; but he jibbed at my suit-case—asked if I thought he was a (highly coloured) "carrier wave!"

An enterprising man, our Buyer. The bright notion struck him to ask for samples. Get enough samples for the Firm, and he would be able to build a four-valve receiver for himself. He succeeded up to a point. He got a square inch of ebonite, and a couple of pounds of enamelled wire (in foot lengths); but the scheme broke down when he tried to persuade them to let him have a "Magna-vox."

I tried to do a little buying myself. I

wanted a small condenser. I fought savagely for a place at my chosen stand; but in vain.



Stand 40 before the crowd came.

In the end I was reduced to scribbling my order on a five-pound note, and tossing it over the heads of the crowd to one of the attendants. I think—I hope—it reached him; but up to date neither the condenser nor the change have reached me. I listen-in eagerly for the postman, but I can't tune him in. Don't seem to get his wavelength somehow.

Unfortunately, my intended note of the stand number was interrupted by an earnest young man in a clerical collar. His face was pale, his brow was moist, his tortoiseshell spectacles glistened with ill-suppressed emotion. It was evident he had the wireless craze badly. He clutched my arm, and asked me—me, an entire stranger!—if I would mind giving him a rudimentary exposition of the electron theory. I smote him heavily on the occiput, and withdrew.

We—the Buyer and I—next drifted to the Marconi stand. There we were exasperated to the point of madness by a scorbatic youth playing with the V2 broadcasting model, pushing the rheostat in and out to make the

valve glow. It was nearly ten minutes before I could shove him away and experiment with it myself. Then the Buyer wanted a turn; but as that would have involved his transferring the catalogues, books, and umbrella to me, I led him gently but firmly away to the Metrovick stand to look at the model broadcasting station—which he could do with his hands full.

I left him for a moment to buy a certain book. The salesman was a flatterer. "I'm afraid you'll find it very elementary, sir," he said. I was, I confess, gratified. A discriminating young man! "Oh, I'm only buying it for one of our Directors," I murmured off-handedly. He smiled, as one who understands; and turned to another purchaser of the same book, a sallow youth, barely in his teens. "I'm afraid you'll find it very elementary, sir," he said. Bah! The base huckster!

I went back to add the book to the Buyer's load. I found him, good-natured soul, in converse with the inevitable Dear Old Lady.

"But what," I heard, as I hung discreetly in the offing, "what are those little glass bottles for?"

"Those, ma'am, are valves. They're full of vacuum—"

"Vacuum?" queried she. "Did you say vacuum? Dear me! Now, I always thought that was a large empty place where the Pope lived!"

"No, no. Vacuum is—er—the stuff, you know, they use for cleaning carpets. They fill those glass tubes with it, and oscillate them till they howl; and then they tune the noise, and you hear it at the other end."

(The Buyer prides himself on his firm grasp of principles. A little weak on details, perhaps—he doesn't pretend to be a technical man—but on the general theory, the rock-bottom facts, he's sound, sir, sound. And though he says it, he *has* got the knack of lucid exposition!)

His hearer nodded brightly. "Wonderful!"

"Talking, singing, anything you like!" he went on. "Listen to that ma'am. (A piano rectial.) Every note distinct! Marvelous when you think of it! There they are at Marconi House, oscillating a valve; and here we are, a hundred miles away (sic) listening to a piano, without wires.

"You don't say so!" exclaimed the Dear Old Lady. "A piano without wires! I declare! What will they think of next!"

I crept quietly away, musing fondly on this last boon of Science. A wireless piano! How gladly would I give one to the young woman in the flat below, plodding *fortissimo* up Clementi's Gradus! . . . A pleasant daydream.

It lasted till I found myself strap-hanging in the crowded Tube; and so was reminded of the Show, and my four lost friends. Them I hope, not too confidently, to see again (particularly the Buyer—he's got my umbrella). And I hope to see the Show again; but in some more spacious venue, with larger stands and twelve-foot gangways; somewhere where it will be possible to see and to buy in comparative comfort. The Show was obviously successful in everything that counts as success in a Show. But in the one particular of attendance it was too, too, successful!

THE PRINCE'S AUTOGRAPH.

Following the broadcasting by His Royal Highness The Prince of Wales of an address to the Boy Scouts of Great Britain on Saturday evening, October 7th, Mr. Arthur R. Burrows, Chief of the Demonstration Department of Marconi's Wireless Telegraph Company, who was responsible for the wireless arrangements in connection with this event, has been the honoured recipient of an autographed copy of the preamble in which he announced His Royal Highness.

HIS ROYAL HIGHNESS THE PRINCE OF WALES, CHIEF SCOUT FOR

WALES, WILL NOW SPEAK TO BOY SCOUTS, WHEREVER THEY MAY BE:—

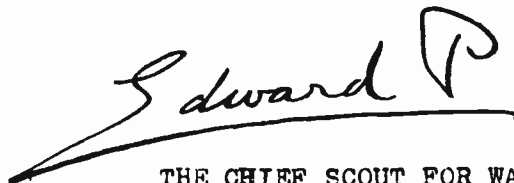

THE CHIEF SCOUT FOR WALES.

The Postmaster-General on Broadcasting.

NO WAVELENGTH LIMIT FOR RECEIVERS.

AT the Annual Meeting of the Bedford Divisional Liberal Association, Women's Group, held at the Liberal Club, Bedford, Mr. Kellaway, the Postmaster-General, made a speech in which he referred to the progress in broadcasting arrangements. Mr. Kellaway said that he was glad to be able to state that there was a reasonable prospect of broadcasting services commencing in the course of the next week or two. The delay had been disappointing in some respects; but if they succeeded in starting this new form of communication in this country on really sound lines, no one would regret the delay. He thought events would show that the Post Office and the Broadcasting Company had been well advised in not being in too much of a hurry.

He had made it a condition in his discussions with the Broadcasting Company that there must be nothing in the nature of monopoly in regard to the selling of receiving sets. Every firm in the country capable of producing cheap and efficient receiving sets must be allowed to become a member of the Broadcasting Company on reasonable terms.

Those who demanded that foreign instruments should be licensed for broadcasting were in effect demanding that British capital should provide the service whilst foreign manufacturers secured the benefit. He had never had any doubt that the decision he had taken was the right one in the circumstances, and he was glad to know that he was supported by the principal wireless societies and by the overwhelming majority of the people and Press of the country.

An agreement had been come to under which receiving sets would not be limited in respect of wavelength. The result of this would be that the owners of receiving sets would be able to receive not only the programmes sent out by the Broadcasting Company, but matter broadcasted from any other centre. This would add immensely to the value of the receiving sets.

Some anxiety had been expressed by the Press as to whether the Broadcasting Company would be allowed to broadcast news. He had recently told a deputation that before permission was given to the Broadcasting Com-

pany to broadcast news, he would arrange for a meeting between these interests and the Broadcasting Company in the hope that they would be able to come to a friendly arrangement. It was obvious that the Broadcasting Company could not be allowed to take the property of the Press and the Press agencies, and he would see that these interests were properly protected in any arrangement made by the Broadcasting Company.

He was very glad to find that these important agencies took a long-sighted view. They realised, as he did, that they could not put a Chinese wall around this new form of communication and say that it should not under any circumstances be allowed to broadcast news. Such an attitude as that would be comparable to the short-sighted attitude of the men who opposed the use of machinery. If they were to make the fullest use of broadcasting it must not unreasonably be circumscribed or shackled. He had every hope that a meeting between the Broadcasting Company and the Press interests would arrive at a settlement which was just to the Press and was in the interest of this new form of communication.

The British Broadcasting Company has issued the following conditions which are to be fulfilled by Broadcast Receivers in order to obtain Post Office approval:—

1. That all types of Broadcast Receivers may be constructed for the reception of signals of any wavelengths.
2. That the apparatus shall be so constructed that it is difficult to change the arrangement of the circuits embodied in the design by means of external connections.
3. The following units, each of which must consist of apparatus assembled, connected and mounted in a single container, shall be approved:—
 - (a) Combined Tuner and Rectifier.
 - (b) Combined Tuner, High Frequency Amplifier and Rectifier.
 - (c) Audio Frequency Amplifier (of Valve or other type.)

Any combination of two or three of the above separate units (a), (b) and (c) will be allowed.

4. No receiving apparatus for general broadcast purposes shall contain a valve or valves so connected as to be capable of causing the Aerial to oscillate.
5. Where reaction is used on to the first receiving circuit it must not be adjustable, but must be fixed and incapable of causing oscillation.
6. Where reaction is used between a second or subsequent valve on to the Anode Circuit of a valve connected to the aerial, and there is no specific coupling provided between the first receiving circuit and the first anode circuit the reaction may be adjustable.
7. Tests of sets will be made on two aerials, one 30 ft. long and the other 100 ft. long.
8. The sets will be tested for the production of oscillations in the aerial and for interference properties with a factor of safety, *i.e.*, increasing the High Tension battery by about 30 per cent., changing valves, etc., but not by altering any soldered connections
9. The Postmaster-General must be satisfied that sets containing reaction can be reasonably repeated with consistent conditions.
10. After approval the type will be given a Post Office registered number and makers must see that the sets fulfil the non-interfering conditions before they are sold. All sets sold under the Broadcast licence shall bear the registered trade mark of the Broadcasting Company and the Post Office registered number.
11. The unit or set approved as the pattern instrument of a type shall be retained without alteration by the maker. The Postmaster-General shall have the right at any time to select any set of an approved type for test to see that the set is reasonably similar to the approved pattern. In the case of sets of an approved type employing reaction being found to oscillate the aerial the Post Office may cancel the authorisation of the future sale of that type. No change in the design of any set or unit may be made after approval without the previous sanction of the Postmaster-General.

BROADCASTING.

MARCONI HOUSE,
STRAND, W.C.2.

October 13th, 1922.

A General Meeting of Manufacturers interested in the manufacturing of broadcasting apparatus will be held at the Institution of Electrical Engineers, Victoria Embankment, London, on October 18th at 3 o'clock in the afternoon, to receive a report from the Broadcasting Company Committee on the present position.

GEO. PELLIS,
Secretary (pro tem).

NOVEL PLUG-IN CONNECTOR.

AN interesting type of connector making smooth and reliable contact has been designed by Mr. E. E. Bramall.

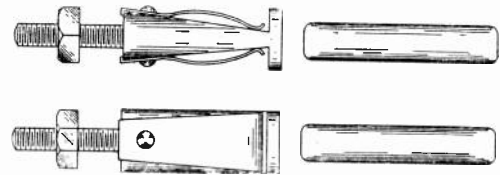

It consists of a brass tube having opposite sides cut away and fitted with hard brass spring contacts. The end to which leads are joined may take the form of a lug, tag or screwed stem.

Experimenters will find this type of connector particularly useful for effecting changes in the circuit arrangements of receiving apparatus, such as interchanging inductances, altering number of valves in action, and making telephone connections at various points in the circuit and tapping out H.T. battery potential. For small transmitters, where the usual type of switch cannot be safely used for varying the inductance valve, owing to the nearness of the contact studs, plug connectors are particularly useful, and this type does not hamper rapid adjustment owing to the small amount of friction and grip upon the plug. To the experimenter who endeavours to make as much of his own apparatus as possible, it is immediately apparent that here is a useful fitment of easy construction. Not a great deal of work is required to make a number of sockets from valve legs. The centre hole is drilled out to about $\frac{3}{16}$ in. and the opposite sides filed away to expose the hole. A hole to take No. 18 brass wire or a small rivet is made to hold the brass spring pieces.

The Wireless Society of London.

REPORT OF DISCUSSION HELD AT THE ORDINARY GENERAL MEETING, SEPTEMBER 27th, 1922—conclusion

After Mr. C. F. Phillips had spoken on the subject of the Broadcasting Company the discussion was continued.

The President.

I do not know whether anybody else wishes to speak on this subject. We still have some other points to deal with. I think the remarks that have been made have been very clear, and will be of great value when they are published.

Mr. Hesketh.

May I ask whether any alterations have been made in the wavelength originally allotted to licensees by the Post Office. You will remember that when this question was first raised official publication was given, through our organ, *The Wireless World and Radio Review*, to the effect that the Post Office had given sympathetic consideration to a petition made through this Society. Is it to be understood from this that the wavelengths originally referred to on the licence forms have been changed, or that the changes will take place in the future.

Mr. E. H. Shaughnessy.

That is all correct. The changes have come into force, and this was the answer to your petition.

Mr. Hesketh.

Then the 1,000 metre wave has been withdrawn.

Mr. E. H. Shaughnessy.

We have not cancelled any licences, but I think the point raised is the phraseology of the Post Office reply to the petition.

Capt. Loring.

I understand the speaker was referring to the reply of the Post Office. The Post Office has approved the change, but unfortunately it had not been officially circulated.

Mr. E. H. Shaughnessy.

The point at issue is that people had licences to transmit on 1,000 metres. The Society requested that that wavelength should be changed to 440 metres. The Post Office agreed to the wavelength being changed to 440 metres, and consequently the use of the 1,000 metre wavelength is now illegal.

Mr. Hesketh.

I take it I must blame the Post Office for not having sent a notification to licensees to this effect.

The President.

I think there has been a slight misunderstanding. The position is that any amateur transmitting licence holder can use a 440 metres wavelength, but they may no longer use 1,000 metres.

Mr. H. S. Walker.

There are one or two points in Mr. Shaughnessy's speech and Mr. Phillips's speech to which I would like to refer. I am very glad to know that reaction is prohibited on the broadcast wavelength, but I should like to ask also what steps, if any, are being taken to stop interference from certain stations. I have the misfortune to live within 14 miles of one of the large stations, and when that station is working it is impossible to receive on any wavelength

from 400 to 700, because of the terrible noise created by the arc. It is just possible that when broadcasting is in progress it will not be possible to receive this either. It occurs to me that perhaps Mr. Shaughnessy can say a few words about that particular station. I believe it is Northolt, and I think most of the amateurs in the vicinity of London are troubled with it. I use special rejecting circuits, but on 440 metres Northolt is impossible to get rid of. I have tried all sorts of means with my station, and there is nothing to remedy it.

The other point is with regard to Mr. Phillips's speech, and his reference to amateur stations transmitting on 440 metres. Mr. Phillips said when broadcasting is in progress the amateur would not be able to receive anything on the 440 wavelength. With that remark I quite agree, and I should like to ask what steps are being taken to protect amateur transmitting stations on 440, because I understand that broadcasting is to take place from 3 in the afternoon until 10 at night, and most amateurs work during that period. Is the amateur to be stopped altogether from working on that particular wavelength during the period that broadcasting is in operation, for it seems quite probable that that is what it may mean. There is another point which may assist the answer to that question, and that is the transmission on shorter wavelengths still. May I ask why it is that the broadcast stations have been given a band of wavelengths from 360 to 425 metres, and yet the amateur station is tied down to 440 metres? Now, if we are to take the strict letter of the law of our licences and stick to 440 metres exactly, then only one transmitting station within a vicinity of 10 miles round London would be working at one time.

Now I understand that there are only going to be eight broadcasting stations in the vicinity of Great Britain. That being so, why should they require a band of wavelengths from the limits mentioned by Mr. Shaughnessy, because I do not think it will be possible for two of these stations to be working together. If three or more work together in the same locality I tremble to think of the consequences. Just these few points could, I hope, be answered this evening.

Mr. E. H. Shaughnessy.

I do not think I can give any hope. With regard to the Northolt Station, I can assure the speaker that we are working on this problem, and we have very considerably reduced the ordinary noise you get from this powerful station. We have an arrangement there which completely removes all the trouble we were getting with certain other stations. With regard to the wavelength band 350 to 425 metres, I do not anticipate the slightest difficulties in getting the broadcasting working at the same time as the serious experimenter. The wavelength band was chosen on a scientific basis, and provides a proper difference between the

wavelengths in order that the difficulty of interference shall be overcome. The reason that that wavelength was used was because all the other waves are occupied. The ether is absolutely choked full, and we had to limit the broadcast people to this band because there were no more available. I think it is a very excellent opportunity for the experimenter, and it will enable him to produce highly selective apparatus.

The President.

I think we must pass on to the Transatlantic tests; I think Major Hamilton and Mr. Coursey might say something.

Major Hamilton.

Our Committee has met on three occasions, and we decided that we would like to use the amateur wavelength of 440 metres for these tests. We are going to ask the Post Office for the necessary permission, and I would like to take this opportunity of asking Captain Loring for his assistance in obtaining this. Through the kindness of several members of the Society who have offered the loan of various pieces of apparatus, I hope soon to be able to call upon you to listen out for our first efforts, in order that we can obtain some idea of the signal strength, constancy of wavelength and freedom from ripple. I saw Mr. E. H. Armstrong yesterday, and he has very kindly consented to listen out specially, both for our tests and for the actual trial. I do not know whether anybody here may have got any ideas on the subject. If so, I think they might be very useful to us.

Mr. P. R. Coursey.

I do not think the time is opportune to say much about the Transatlantic Tests, except that the matter is in the hands of the sub-Committee of the Society, who intend to carry out and to organise tests in both directions across the Atlantic. I might perhaps also mention that the American Radio Relay League have been already in communication with other Societies in other countries with regard to effecting communication with these countries during the forthcoming tests, and it is hoped that we may be able to arrange a programme to include transmissions between America and the various European countries.

Mr. H. H. T. Burbury.

The only remark I would like to make is that if an oscillating aerial is prohibited altogether on the broadcasting wave, which is perfectly reasonable, it seems to me quite obvious that nobody having a transmitting licence for 440 metres can use it during broadcasting hours at all; therefore there is no question of being able to listen between two amateurs, one sending on 440 metres, because you are not allowed to transmit on it.

May I ask Mr. Coursey one question: Can he give us any idea of the time that these tests will take place.

Mr. P. R. Coursey.

Probably in the course of a few weeks, when the arrangements are further advanced, we may be able to give some more definite information and details of the programmes.

Mr. L. F. Fogarty (Hon. Treasurer).

Mr. President, Ladies and Gentlemen:—The proposal to change the title of this Society has met so much support that I do not think it necessary to urge the matter still further. I should, however,

like to give you one or two more details so as to place you in a position to give this matter careful consideration, against the time when it will be put before you as an official resolution.

I should like to say that the idea is not a new one, and that the Committee has had the matter under consideration for several months. The necessity of altering the title and constitution of the present Wireless Society of London suggested itself to me as the outcome of experience derived from an extensive correspondence with members and with affiliated societies, and because I have noticed that some of our affiliated bodies are inclined to initiate important matters, and to follow them up by dealing with the authorities individually rather than by adopting the more satisfactory method of collective co-operation through this Society, which apart from being the oldest, is, I think, the best equipped to handle all such negotiations.

With a view to obtaining as much information as possible, I took advantage of the Signor Umberto Bianchi's presence amongst us last summer to enquire into the working of the Radio Club of Italy. Signor Bianchi, as President of the Radio Club of Italy, was in possession of first hand knowledge of extremely valuable nature, as the constitution of their Society had to be modified almost immediately after the original formation of their Club.

I also took an opportunity of discussing the working of a similar association with the President and Committee of the Société Française d'Etude de Télégraphie et Téléphonie sans fils, on the occasion of a visit to Paris in the early part of this year. The above-mentioned Society covers the whole of France and the French Colonies, and is the central body representing a very large number of smaller societies, situated throughout the French territory. I should also like to take this opportunity of placing on record my appreciation of the honour accorded to me by the above-mentioned Society, in electing me a member, for which purpose they modified their constitution so as to admit a British subject into a society which hitherto had only been open to French nationals.

I should propose, therefore, that the new title should be "The Radio Association of Great Britain," or, alternatively, "The Amateur Radio Association of Great Britain," and that all affiliated societies be free to adopt the same title, adding thereafter some distinctive sub-title, such as Liverpool, Glasgow, or Birmingham branch.

The adoption of some such scheme will, of course, necessitate a modification in the constitution of this Society, and probably also in that of affiliated bodies, who would necessarily have to adopt a standard set of rules governing their relationship to us. For instance, it will be necessary to clearly define that each branch would be entirely responsible for its own finance, and that its annual subscription to the parent body would be on the basis of numbers, larger societies contributing more in proportion to the smaller. I also suggest that the existing rule 32, defining the officers of the Society, should be modified, and should read approximately as follows:—

"The officers of the Association shall be a President, two acting Vice-Presidents, two Vice-Chairmen, the President and Secretary of all

affiliated branches, and the Secretary and Treasurer of the parent association."

In place of rule 33, governing the management of the Society, I suggest the following:—

"The management of the Association shall be vested in a Committee consisting of the President and the officers mentioned in new rule 32, together with the first Past President of the former Wireless Society of London, A. A. Campbell Swinton, Esq., F.R.S., and any other Past President, to the number of three, at the invitation of the governing body, and in addition ten elected members of the Association."

I think it is desirable that consideration should be given to these details, so that a satisfactory scheme may be brought forward in the near future.
The President.

I would point out that Mr. Fogarty's remarks have not been discussed by the Committee. They are what he puts forward, and not put forward by us, because we have not gone into them. Does any other gentleman care to make any other remarks on the subjects we have been dealing with to-night before closing the meeting?

Mr. Evans.

When Capt. Loring a few moments ago referred to the word "broadcaster," I was hoping that he would also mention another point, and that is that the term "broadcast" or "broadcasting" seems to be used as referring to the reception. To cast is to throw out, but we hear of broadcasting apparatus when I believe the speakers refer, not to the sending, but to the receiving apparatus. Cannot something be done to prevent the term "broadcaster" being used in the sense of the receiver.

Mr. C. F. Phillips.

I would like to say that it was once reported in the daily press that our station had been broad-

casting the Dutch concerts, but what it turned out to be was that we had merely made it audible to an audience by means of the loud speaker, and there was no question of transmission at all.

Mr. Ward.

As a representative of the Wireless Society of Greenwich, I should like to suggest that Mr. Shaughnessy's speech dealing with the issue of licences should be distributed immediately to all the provincial societies, as I am sure they are very eager to receive any information that will be of use to them.

The President.

It will be published in our official organ very shortly.

Mr. F. Hope-Jones.

I do not think we can manage to get it distributed before it goes into *The Wireless World and Radio Review*, and I think we can hardly get our Secretary to write it out. I should think it would be out in about a fortnight.

The President.

We have certainly had an interesting discussion, and in spite of not having a technical lecture we have managed to fill up the evening, and have introduced a good many subjects. I must say I have a little sympathy with amateurs on 440 metres. I think they will have to change their hours and get up earlier in the morning. I do not see any other way out. Of course there is the 200 metre wavelength; it is a good thing to go down to that.

Mr. E. H. Shaughnessy.

Mr. Chairman, I would just like to draw your attention to the lower band of wavelengths which is allowed to amateur transmitters—150 to 200. There is a whole band there, and a very large band. It is very efficient if you take the trouble to design your apparatus suitably.

Notes

Demonstration at Canonbury.

Harecourt Literary and Musical Society are holding a wireless demonstration on October 31st, at 8 p.m., at Harecourt Hall, St. Paul's Road, Canonbury, N.1, assisted by the Marconi Company.

Coming Glasgow Exhibition.

Preparations are being made in Glasgow for a public exhibition and demonstration to be held on November 4th. Under the auspices of the Glasgow and District Radio Club, the function is expected to be very popular. An opportunity will be afforded for every amateur in the Glasgow and surrounding districts to see displayed at the McLellan Galleries Hall, Sauchiehall Street, not only the apparatus made by other amateurs, but instruments and accessories by trade makers. A large trade show of all the latest apparatus is expected, beside which the Committee hope to have a collection of ancient and modern apparatus on view.

Two aerials will be erected for the day, and arrangements have been made for a special transmission of telephony from Eiffel Tower.

Mr. W. Yuill, the Hon. Secretary of the Glasgow and District Radio Club, is dealing with enquiries. His address is 93, Holm Street, Glasgow.

Measurement by Wireless.

Professor Richard Whiddington, M.A., D.Sc., lectured at the first meeting of the session of the Royal Philosophical Society of Glasgow on October 4th. His subject was "Measurement by Wireless." The lecturer referred to the development of wireless telegraphy and telephony during the war, and especially the thermionic valve, used in conjunction with the ordinary wireless circuits. The lecturer gave an account of a new apparatus devised by him two or three years ago, intended to measure minute length changes. Until the apparatus was devised the most sensitive arrangement was the so-called interferometer, which was, however, limited in its sensitiveness by the fact that light itself had a stricture—being, as everyone knew, a form of wave motion. Such an apparatus in fact, was only capable of indicating changes in length of the same order as the wavelength of light.

The new apparatus, he said, was not limited in this manner, and had been made to indicate changes many hundreds of times less. It was not very difficult, in fact, to measure changes in length so small as one two-hundred millionth of an inch, a distance of about the same magnitude as the diameter of a hydrogen atom. Experiments were

shown with a rough form of the apparatus, only capable of indicating one ten-millionth part of an inch or so.

Wireless Telephony for Blinded Soldiers.

Among the many thousands of people who listened-in to the Prince of Wales's broadcast speech to the Boy Scouts of the nation were the blind soldiers of St. Dunstan's.

Capt. Ian Fraser, the blind Chairman of St. Dunstan's, has been an ardent wireless experimenter for two years past and in the course of a short address following the transmission he stated that

wireless telephony was opening a new world for the blind. A blind man's hobbies were limited, but wireless was one of those which he could pursue just as well as anyone else. In listening-in he was at no disadvantage to those who could see.

Broadcasting March.

We are pleased to hear, through the organisers of the All-British Wireless Exhibition, Messrs. Bertram Day & Co., Ltd., that the march entitled "Broadcaster," composed specially for the Exhibition by Mr. Percival H. Osborne, and which was played daily with so much success by his Blue Electra Orchestra, has been dedicated to Senatore Marconi.

The British Wireless Company.

In our October 7th issue an illustration was inadvertently omitted by the printers from the British Wireless Company's advertisement headed "The Broadcaster." Would readers kindly refer to the October 14th issue, in which the same illustration appears.

Farthest North Station.

Mr. R. F. Inkster, of King Harold Street, Lerwick, Shetland, informs us that the photograph shown on this page represents the farthest north wireless receiving set in the British Isles, and it has just been erected in a crofter's house in Delting, in the very centre of the Shetland Islands. The thatched roofs of the dwelling-house and buildings, and the open door of the garage on the right, give a striking combination of the ancient and modern.

In the town of Lerwick there are three amateur wireless receiving sets, and news broadcasted from Germany has been distinctly heard (with five and six valves).

Captain Donisthorpe on Romance.

At the opening of the winter session of the Redhill Literary Institute, Captain de A. Donisthorpe gave a lecture on "The Romance of Wireless."



Blind Soldiers at St. Dunstan's being entertained by Capt. Ian Fraser to a concert on his wireless set.



Farthest North Station.

Scouts Hear the Prince.



Scouts and their friends visited the works of Messrs. J. Burns, Ltd., Chadwell Heath, to hear the Prince of Wales' broadcasted message. From the photograph will be seen with what interest the boys listened-in.

Exhibited at the Horticultural Hall.

Although the All-British Wireless Exhibition was so fully represented in these pages, there was one item which failed to find space. Messrs. Siemens' Brothers & Co., Ltd., exhibited vacuum protectors, which possess a number of advantages over the carbon block type. The opposing conductors being enclosed in a partial vacuum causes them to break down reliably at about 300 volts. An insulation resistance of about 3,000 megohms is maintained right up to the point of breakdown. A damaged arrester can be immediately replaced. Being contained in an hermetically sealed vacuum chamber the protector, besides being highly sensitive is also dust, damp, and insect-proof.

Fuses were shown for protecting the filament accumulators and batteries in the event of a short circuit.

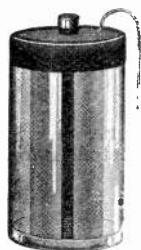

HT 1.

Siemens' Sealed Type Leclanche cells.



HT 3.

Jacks, enabling a number of head sets to be used simultaneously, were also included, and these, when used with multi-valve sets, the number of valves in circuit at any one time can be varied, the connections being established automatically.

A standard switch for panel mounting was exhibited, and this is useful for many switching operations in wireless reception work.

A large number of ebonite accessories were shown, including dials, formers, valve holders, knobs,

coil holder plugs, ebonite panels with tin-foil surfaces, earcaps, etc., etc., all of the Company's usual high quality material.

A full range of sizes of high voltage dry batteries and "inert" batteries were to be seen on Siemens' stand; also 30-volt and 60-volt batteries of Fluid Leclanche Cells, small sack type, contained in suitable boxes with plug sockets to obtain tappings at various voltages.

Correspondence

To the Editor of THE WIRELESS WORLD AND RADIO REVIEW.

Sir.—Being a keen reader of this excellent magazine for over a year. I have read numerous letters published in the correspondence columns concerning reception of amateur transmissions on a limited number of valves. I should like to state that the following amateurs have been heard on a single valve reaction circuit, the set being of my own construction, using a two-wire aerial 50 ft. long and 25 ft. high, badly screened by houses. They are 2 LZ (telephony), 2 IF (telephony), 2 AN (telephony), 2 OM (telephony), 2 ON (telephony), 2 FQ (telephony), 2 DX (Morse), 5 CV (Morse), 2 DF, 2 SZ, 2 KT, 2 TO, and lastly a station whose call I have not yet discovered, 2 PW. The last mentioned called 2 JX at 1300 G.M.T. on October 8th. 2 MT, 2 LO, FL are received well, and PCGG is generally quite good. All the above telephony is received off the oscillation joint. On high wave WSO and WQK are readable.

F. STRAFFORD.

3, Lee Road,
Dovercourt,
Essex.

At Chadwell Heath.

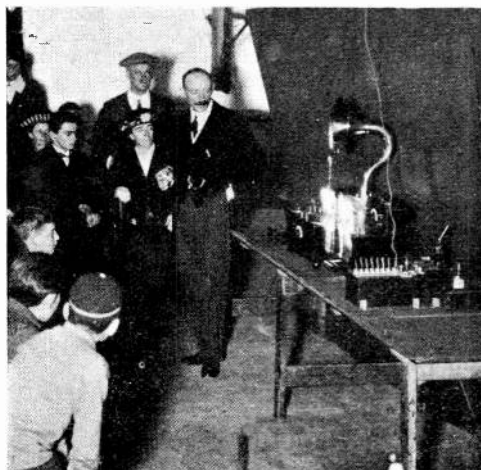

The instrument used at Messrs. J. Burns' works on the occasion of the Prince of Wales's broadcasted speech was one of their standard three-valve sets seen above.

Calendar of Current Events

Friday, October 20th.

At 8.—8.30 p.m., on 350 metres. Concert.

POWISLAND RADIO AND SCIENTIFIC SOCIETY.
First meeting and lecture by Viscount Chine on "The Elementary Principles of Wireless."

WAKEFIELD AND DISTRICT WIRELESS SOCIETY.
At 8 p.m. At the Y.M.C.A. Lecture on "A Four-Valve Receiver," by Mr. Swale.

HALIFAX WIRELESS CLUB.

At 6.30 p.m. At Clare Hall, Prescott Street, Halifax, and also the following day from 2.30 p.m. Exhibition of Wireless Apparatus by all the leading makers. Demonstrations and sale of members' surplus apparatus.

BRADFORD WIRELESS SOCIETY.

At 5, Rendallwell Street, Bradford, Lecture on "Telephony" by Mr. J. Bever.

BELVEDERE AND DISTRICT RADIO AND SCIENTIFIC SOCIETY.

Lecture on "Various Types of Receiving Circuits," by Mr. A. H. Norman.

LEEDS AND DISTRICT AMATEUR WIRELESS SOCIETY.
At 8 p.m. Lecture on "Inductances for all Wavelengths," by Mr. D. E. Pettigrew.

RADIO SOCIETY OF HIGHGATE.

At 7.45 p.m. At the 1919 Club, South Grove, Highgate, N. 6. Lecture on "The Armstrong Super-regenerative Circuit," by Mr. H. Andrews, B.Sc.

Saturday, October 21st.

At 7.30.—8 p.m., on 350 metres. Concert.

Monday, October 23rd.

ILKLEY AND DISTRICT WIRELESS SOCIETY.

At 7.30 p.m. At Regent Café. Lecture on "Electro-Magnetic Induction," by Mr. L. E. Overington.

Tuesday, October 24th.

Transmission of Telephony at 8 p.m. on 400 metres by 2 MT Writtle.

LOWESTOFT AND DISTRICT WIRELESS SOCIETY.
Lecture on "Land Line Telephony," by Mr. R. C. Giles.

Wednesday, October 25th.

REDHILL & DISTRICT Y.M.C.A. WIRELESS SOCIETY.
At 111, Station Road, Redhill. Lecture on "Inductances," by Mr. Pescett.

Thursday, October 26th.

DERBY WIRELESS CLUB.

At 7.30 p.m. At the Court, Alvaston. Lecture on "Amplification," by Mr. E. V. R. Martin.

LUTON WIRELESS SOCIETY.

At 8 p.m. At Hitchin Road, Boys' School. Practical Work and Experiments.

Friday, October 27th.

WAKEFIELD AND DISTRICT WIRELESS SOCIETY.
Lecture on "The Relation of Inductance and Capacity to Electro Magnet Waves in Receiving and Transmitting Circuits," by Mr. Watson.

BELVEDERE AND DISTRICT RADIO AND SCIENTIFIC SOCIETY.

Lecture on "The Detector Unit," by Mr. S. Burman.

LEEDS AND DISTRICT AMATEUR WIRELESS SOCIETY.
At 8 p.m. Demonstration of "Britwire" Apparatus, by Mr. H. F. Yardley, A.M.I.R.E.

RADIO SOCIETY OF HIGHGATE.

At 7.45 p.m. At the 1919 Club, South Grove, Highgate, N. 6. Lecture by Mr. Grimstead.

Saturday, October 28th.

WORKING MEN'S WIRELESS CLUB.

At Crowndale Road, N.W.1. Exhibition and demonstration at 1 p.m., also exhibition of X-Ray apparatus.

Monday, October 30th.

FINCHLEY AND DISTRICT WIRELESS SOCIETY.
Social Evening.

IPSWICH AND DISTRICT WIRELESS SOCIETY.

At 8 p.m., at 55, Fonnereau Road, Lecture on "Accumulators—Their Care and Use," by Mr. F. Boddey.

Tuesday, October 31st.

Transmissions of Telephony by 2MT, Writtle, as above.

Wednesday, November 1st.

EDINBURGH AND DISTRICT RADIO SOCIETY.
At 8 p.m. Business Meeting.

LUTON WIRELESS SOCIETY.

At 8 p.m. At Hitchin Road Boys' School, Lecture on "H.F. Coupling and Transformers," by Mr. C. S. Dunham.

Thursday, November 2nd.

DERBY WIRELESS SOCIETY.

At 7.30 p.m. At The Court, Alvaston. Informal Meeting.

Friday, November 3rd.

RADIO SOCIETY OF HIGHGATE.

At 7.45 p.m., at the 1919 Club, South Grove, Highgate, N.6. Lecture on "Construction of H.F. Amplifiers," by Mr. G. W. Sutton, B.Sc.

BRADFORD WIRELESS SOCIETY.

At 5, Rendallwell Street, Bradford. Debate on "The Prevention of Self-Oscillation."

Saturday, November 4th.

GLASGOW AND DISTRICT RADIO CLUB.

From 12 to 9 o'clock. At the McLellan Galleries Hall, Sauchiehall Street. Exhibition and Demonstration.

Wireless Club Reports

NOTE.—Under this heading the Editor will be pleased to give publication to reports of the meetings of Wireless Clubs and Societies. Such reports should be submitted without covering letter in the exact form in which they are to appear and as concise as possible, the Editor reserving the right to edit and curtail the reports if necessary. The Editor will be pleased to consider for publication papers read before Societies. An Asterisk denotes affiliation with the Wireless Society of London.

West London Wireless and Experimental Association.

Hon. Secretary, Mr. Horace W. Cotton, 19, Bushey Road, Harlington, Middlesex.

A meeting was held on September 22nd, for the first time, at the new headquarters, Stamford Brook Lodge, Ravenscourt Park, W.6. A very large number of members attended. Mr. F. E. Studt interpreted Clause 7. "Aerials," of the new conditions respecting the issue of licences by the Postmaster-General. Mr. Studt was accorded a hearty vote of thanks.

On September 29th Mr. Studt gave a very interesting paper on "A Three-Circuit Variometer Tuner." He explained its many interesting uses, and the various methods of obtaining results in connection with amateur experiments. He gave the detailed data for constructing members' own circuits. Mr. Studt was heartily thanked. A letter from the Wireless Society of London in regard to the Prince of Wales's Address to Boy Scouts was read. The Secretary appealed to all members with receiving apparatus to assist the Wireless Society of London in their programme for this special event.

Several more new members enrolled at both meetings.

Particulars will be sent by the Secretary by return of post to inquirers.

Wakefield and District Wireless Society.*

Hon. Secretary, Mr. Ed. Swale, 11, Thomes Road, Wakefield.

A meeting of the above was held in the Y.M.C.A., Grove Road, on September 29th. Mr. Wrigley in the chair.

The meeting was thrown open for questions on individual troubles. The questions were answered by specialist members.

The Wireless Society of Highgate.*

Hon. Secretary, Mr. J. F. Stanley, B.Sc., 49, Cholmeley Park, Highgate, N.6.

On Friday, September 22nd, at the Highgate Literary and Scientific Institute, Mr. J. F. Stanley gave a demonstration of the Marconiphone V2. He gave a very clear and interesting description of the unusual circuit adopted in this set, which makes use of simultaneous high and low frequency amplification, and finally connected it up to the Society's aerial. Some excellent telephony, both from Marconi House and amateur stations, was picked up, and the simplicity of the tuning adjustments was demonstrated.

After one or two questions had been put to Mr. Stanley, and answered, Mr. F. L. Hogg gave an interesting and simple way of rapidly converting an ordinary two-valve circuit into an Armstrong super-regenerative circuit.

The second Annual General Meeting of the Society was held on September 29th, at the new headquarters, the 1919 Club, South Grove, Highgate,

Mr. P. R. Coursey, B.Sc., the President, in the chair. The following officers were elected for the forthcoming session:—Chairman, Mr. H. Andrews, B.Sc.; Vice-Chairman, Mr. L. Grinstead; Secretary, Mr. J. F. Stanley, B.Sc.; Assist. Secretary, Mr. L. R. Rowlands; Treasurer, Mr. D. H. Eade; Librarian, Mr. P. H. Youngman; Committee: Messrs. S. Croneen, F. B. Ford and T. Russel.

The annual report and statement of accounts were adopted unanimously.

Mr. Coursey then gave his Presidential address. He dealt with the question of Broadcasting and its effect on the experimenter, and he explained the latest decisions of the Post Office with regard to the use of reaction. After dealing briefly with the forthcoming Transatlantic Tests, and the proposed change of name of the Wireless Society of London, Mr. Coursey replied to several questions put to him by members.

A motion was carried to the effect that the Society shall in future be called the Radio Society of Highgate, the word "Radio" now being recognised as more suitable than "Wireless." Mr. Stanley, the new Secretary, outlined briefly the future policy of the Society, mentioning in particular that the Society proposes to give a Radio Dance on Friday, November 17th, 1922. Further details will be announced shortly.

Ilkley and District Wireless Society.*

Hon. Secretary, Mr. E. Stanley Dobson, "Lorne House," Richmond Place, Ilkley.

On October 2nd the fifth General Meeting was held at the headquarters, the "Regent Café," Ilkley, the President, Dr. J. B. Whitfield, occupying the chair.

The Secretary read the report of the Committee appointed to design and draw up the estimates for the Society's receiving set, which was adopted. The Committee will now assemble a single valve receiver and tuner built on the unit system, so as to facilitate future extensions and rearrangement of circuits for demonstration purposes.

The rules of the Society were then officially formulated, and it was resolved that a technical library be instituted, with Mr. C. D. Marshall as Hon. Librarian.

Mr. E. Stanley Dobson then gave his lecture on "Capacity and Condensers."

The theory of electrically charged bodies was first explained, with its application to the action of the condenser. The units and measurement of capacity were dealt with, and the calculation of the capacity of condensers connected in series and parallel.

The various types of condensers were next described in detail, samples of each being exhibited. The function and suitable values of all the condensers in a simple single valve receiver were given, and the lecture concluded with a few hints on the

use of vernier devices for tuning in short wave telephony.

A vote of thanks was accorded to the lecturer, and before the meeting closed the announcement was made that the Society's affiliation with the Wireless Society of London had become an accomplished fact.

Edinburgh and District Wireless Society.*

Hon. Secretary, Mr. W. Winkler, 9, Ettrick Road, Edinburgh.

On October 4th, the Winter Session was opened with a lecture by Major A. W. Jayne, Controller of Telegraphs, General Post Office, Edinburgh, on "Line Telegraphy."

Sir J. Alfred Ewing, K.C.B., the Hon. President of the Society, was in the chair. He remarked on the interest which he had in the work carried out, and the pleasure which it gave him to occupy the position of President.

Major Jayne gave a general résumé of the original systems employed in telegraphy, and then described in detail the working of the more efficient machines in use nowadays. Multiflex working was fully explained in a very clear manner, and the organisation of Post Office telegraph working in all its multifarious organisations gave his audience an idea of the work which the Post Office has to cope with in busy "rush hours."

Interesting slides were used showing the work of the "signals" men in France in 1914-18.

Three elementary lectures on "Wireless" were announced to take place on 11th, 18th and 25th October, in the headquarters, 117, George Street.

A motion was approved:—"That a Research Committee should be formed to undertake work on a definite line on the second and fourth Monday of each month. That this Committee should be chosen by the Council. That the work should be in connection with the Armstrong super-regenerative circuit. That application be made to the Keith Fund for financial assistance in this work, and that short descriptions of the work done should be given at subsequent meetings of the Society."

The Hon. Secretary then made due apology for the errata appearing on the syllabus, as time did not permit the printer to issue proofs.

Bristol and District Wireless Association.*

Hon. Secretary, Mr. L. F. White, 10, Priory Road, Knowle, Bristol.

A meeting of the Association was held in the Physics Lecture Theatre of the University of Bristol at 7 p.m. on September 29th. Owing to the unavoidable absence of the Chairman, Mr. A. E. Mitchell, the Rev. H. W. Jukes was elected to fill the vacancy for the evening.

Discussion took place between the members regarding the proposed Association receiving set, and it was eventually agreed that to adopt the unit system would prove most satisfactory for experimental purposes, and that no difficulty should be experienced in making the receiver portable should occasion arise.

It was decided that no practical work in this direction could be undertaken until the Association is in possession of a workshop.

Mr. L. W. J. Silcocks was thanked for his kind offer to allow members to use his workshop in constructing the receiver until one was acquired by the Association.

The remainder of the evening was taken up by the exhibition of a 5-valve receiver brought by Messrs. Silcocks and Hobbs, which, in conjunction with a Magnavox loud speaker, produced very powerful signals on a good range of wavelengths.

New members elected brings the total up to 72.

The Secretary will be glad to give full particulars of the Association upon application.

Glasgow and District Radio Club.*

Hon. Secretary, Mr. W. Yuill, 93, Holm Street, Glasgow.

A meeting of the above Club was held in the Club Room. There was a very large attendance. The Hon. President, M. W. K. Dewar, presided after the usual preliminaries. The Chairman called on the convener of the Club Apparatus Committee to explain the building of the club set, which his Committee had been working on during the close season. It was originally intended to build the set on the unit principle, but, through certain difficulties, this was not found possible, and a three-valve set, viz., one valve time anode method of H.F. amplification, one detector and one L.F., the usual tuning condensers being included in a separate panel, but permanently fastened to valve panel, and having a three-coil holder for taking standard makes of honeycomb or other type coil to tune over all wavelengths.

As there was a large number of new and prospective members present, the Chairman asked Mr. McLellan to give a short lecture on the general principle of wireless. This he accomplished in a very satisfactory manner, his simple explanation of technical terms being much appreciated. A hearty vote of thanks was asked, and enthusiastically given both gentlemen.

A short discussion followed on several points regarding the working and welfare of the Club.

Wireless and Experimental Association.*

Hon. Secretary, Mr. Geo. Sutton, A.M.I.E.E., 18, Melford Road, S.E.22.

This Association, at the Central Hall, Peckham, on October 4th held the deferred "Gadget" Competition, and many members brought examples of their ingenuity. The result of the judging was: Mr. Voigt, first prize for clip to fasten into headgear telephone leads to prevent accidents by dragging delicate valve gear from the table to the floor. It provided a "weak link" in the chain, which parted easily should the cord be pulled by accident. Honourable mention was accorded to Mr. S. J. Prior, who exhibited a well-made and workable potentiometer, made up from odd scraps of material.

The meeting opened with buzzer practice under Mr. Sam. Middleton. New members are making considerable progress.

Cowes and District Radio Society.*

Hon. Secretary, Mr. L. Ingram, 1, Mill Hill Road, Cowes.

The first annual meeting of the Society was held at the headquarters, East Cowes, on September 27th, 1922. There was a good attendance, and a representative gathering included one Vice-President, namely, Mr. H. S. Benzie.

The proceedings were opened by the Chairman Mr. A. Taylor, who summarised the objects of the Society, and briefly outlined the programme arranged for the coming session.

The annual report was read and adopted.

The financial position of the Society was discussed, and the balance sheet accepted.

The election ballot resulted as follows: Chairman, Mr. E. P. Bartlett; Vice-Chairman, Mr. J. V. Ellis; Hon. Secretary, Mr. L. Ingram; Committee, Mr. E. Hartridge, Mr. C. Mugliston, and Mr. W. Sherratt.

Mr. W. T. Davies, M.B.E., paid a tribute to the excellent work performed throughout the year by the retiring Chairman, Mr. A. Taylor, and proposed that he be elected Honorary Vice-President. Mr. Mugliston seconded, and the proposition was carried unanimously.

The rules of the Society, having been redrafted, were passed after minor alterations had been made.

It was decided that Mr. S. E. Saunders, O.B.E., should be asked to continue as President of the Society, also that Lt.-Col. A. T. C. Vesey, Mr. H. S. Benzie, Mr. H. S. Saunders, and Mr. G. Newman, should be asked to continue as Vice-Presidents. It was also decided to invite Capt. W. Matthews, the Hon. A. G. Guinness, Capt. Frogbrook, Canon Judkins, and Mr. J. Phillips to become Vice-Presidents.

The number of new members who attended the meeting was encouraging, and, as the Chairman remarked in his opening speech, when calling upon the present members to bring along more new members, all who are interested in wireless are cordially invited.

After a short discussion upon matters of general interest a most successful meeting closed at 9.30 p.m.

Radio Society of Highgate.*

Hon. Secretary, Mr. J. F. Stanley, 49, Cholmeley Park, Highgate, N.6..

A debate was held on October 6th, on "That in the Opinion of this House High Frequency Amplification is more suitable than Low Frequency Amplification for Amateur Experimental Purposes." Messrs. Stanley and Eade proposed the motion, which was opposed by Messrs. Hogg and Rowlands. Although the attendance was small, the majority of those present took part in the debate. Some very astonishing results were claimed on both sides, and on the division of the House opinion seemed to be fairly evenly divided, the motion being carried by 8 votes to 7. Five members present did not vote.

On October 7th a very interesting demonstration was given at the Society's headquarters at the 1919 Club, South Grove, Highgate. The presence of large crowds who had collected along the route to see the Prince of Wales drive to and from the Scout's Rally at the Alexandra Palace, was taken advantage of for a thorough and novel publicity campaign, and a "House Full" resulted.

The chief items on the programme were the concert from 2 LO and the message to Scouts by H.R.H. the Prince of Wales, which was clearly heard, thanks to the Magnavox loud speaker. Amateur tests were picked up at random, some excellent speech and music being obtained. The demonstration was thoroughly appreciated by a large audience which included several scouts, the latter being admitted free of charge.

Full particulars of the Society and of the forthcoming Radio Dance may be obtained from the Hon. Secretary.

Stoke-on-Trent Wireless and Experimental Society.*

Hon. Secretary: Mr. F. T. Jones, 360, Cobridge Road, Hanley.

At a meeting at the Y.M.C.A., Hanley, on October 5th, Mr. Walley (member), exhibited his three-valve set, with the aid of which members clearly heard items of the Hague concert, as well as Morse signals from British and continental stations. Mr. Walley has entirely constructed this set himself during the last seven days.

Mr. A. H. Wilson was appointed delegate to represent the Society at the forthcoming conference of the Midland Wireless Societies at Birmingham, in order to arrange the interchange of lectures.

Bradford Wireless Society.*

Hon. Secretary, Mr. J. Bever, 85, Emm Lane, Heaton, Bradford.

The opening meeting of the session was held on October 6th, a number of new members being present. After the business of the meeting, Mr. Whiteley gave a historical survey of wireless, with special reference to the mercantile marine. Special reference was made to the excellent performances of the Radio Communication Company's commercial apparatus, and the whole lecture was illustrated by lantern slides specially prepared by the lecturer. At the conclusion, a hearty vote of thanks was passed.

Mr. Liardet then exhibited a Reinartz tuner with one stage of H.F. amplification, as recently described in *The Wireless World and Radio Review*. An ordinary Reinartz tuner was also shown, and both were much admired.

Meetings will continue to be held throughout the session at the Society's rooms at 5, Rendellwall Street, Bradford. A few of the dates are:—October 20th, Mr. J. Bever, subject, "Telephony"; November 3rd, Debate, "The Prevention of Self-Oscillation"; November 17th, Cinema display (details later); December 1st, Mr. A. Liardet (title later); December 15th Mr. S. Davies, Dewsbury (particulars later); December 29th, Annual general meeting.

South Woodford Radio Society.

Hon. Secretary, Mr. L. R. Gaywood, 190, Hermon Hill, South Woodford.

The first meeting of the 1922-23 season was held at Holy Trinity Parish Hall, South Woodford, on October 3rd, 17 members being present.

The following officers were elected: President, Dr. J. Craig Crawford; Vice-President, Mr. E. Janes; Secretary, Mr. L. R. Gaywood; Treasurer, Mr. Manders; and Committee, Messrs. Cormacy, Carr, and Cameron.

It was decided to meet weekly at Holy Trinity Hall at 8 p.m. on Tuesdays.

The entrance fee was fixed at 2s. 6d., and annual subscription 5s. Particulars can be obtained from the Secretary.

Finchley and District Wireless Society.

Hon. Secretary, Mr. A. E. Field, 28, Holmwood Gardens, N.3.

The fifth meeting of the above Society was held at the club room, Wright-Kingsford House, Granville Road, N.12, on Monday, October 2nd. Mr. Macdonald Brown kindly brought up four crystal sets of various makes for inspection. Parti-

cular interest was centred on a German one. It was decided to postpone the grand social evening until October 30th. Mr. Trussler gave a description of rays and waves as applied to wireless, and explained the atom, molecule and electron. Two new members were elected. The Secretary invites inquiries.

Nottingham Y.M.C.A. Wireless Club for Boys.

Hon. Secretary, Mr. R. Weston, 3, Harcourt Road, Nottingham.

A wireless club for boys between the age of 14 and 18 has been formed in Nottingham at the Y.M.C.A. Boys' Club, King Edward Street, where a two-valve receiving set has been installed.

The following gentlemen were elected officials at the inaugural meeting: Mr. A. Househam, President; Mr. Perkins, Vice-President; Mr. H. A. Carpenter, Chairman of the Committee and Lecturer.

New members are being enrolled, and a successful winter season is anticipated. Mr. Carpenter is giving a series of lectures on "Wireless Telegraphy and Elementary Electricity," and demonstrations take place every Thursday night.

Portsmouth and District Amateur Wireless Society.

Secretary, Mr. R. G. H. Cole, 34, Bradford Road, Southsea.

A meeting of the above Society took place at the John Pile Memorial Rooms, Portsmouth, on October 4th. The buzzer class is making rapid progress. At 8 p.m. the fortnightly business meeting took place. Various matters were discussed. After the meeting Mr. Donkin gave his lecture on "My Portable Crystal Receiving Set," telling of his exploits when he first took an interest in wireless. Mr. Donkin explained that he made a cycling tour, taking his set with him, and his adventures with regard to aërials and other items were both instructive and amusing. A hearty vote of thanks was given Mr. Donkin. After the lecture a short address of great interest was given by Mr. Harrold on his impressions of the London Wireless Exhibition. The President and Council of the Society are anxious to extend the membership, and any amateurs in the locality who are interested are invited to write to the Secretary.

Huddersfield Radio Society.

Hon. Secretary, Mr. C. Dyson, 14, John William Street, Huddersfield.

At a meeting on October 4th there were about 100 persons present. Mr. T. Brooke was Chairman.

A lecture was given on "The Latest Developments in Wireless Telephony" by Mr. P. Denison, of Halifax.

Mr. Denison opened by explaining, in a popular manner, various transmitting circuits used in the past and at the present time, illustrating his remarks by numerous diagrams. A number of lantern slides were used. The lecturer described the functions of the various parts of the apparatus shown, and gave interesting details of the development of his own experimental station (2 KD) at Halifax.

At the conclusion of the lecture Mr. Denison answered questions and was accorded a vote of thanks.

Eastern Enfield Wireless and Experimental Society.

Hon. Secretary, Mr. Arthur J. Dabbs, 315, High Road, Ponders End.

The second meeting of the above Society was held at headquarters, The Falcon Inn, South Street, Ponders End, on October 5th. There was a good attendance. The Chairman stated that it was hoped to receive the licence for the Society's set in the course of a few days.

A set of rules presented by the Committee was, after discussion, passed. A programme for future meetings was also arranged.

It was decided to purchase certain books to form the nucleus of the Society's library, and these will be on loan to all members. Various apparatus will also be purchased by the Society, which can be borrowed by the members for home use.

The subscription is 10s. 6d. per annum, and a good financial position is already attained. Three new members were enrolled. Applicants for membership will be welcomed at any of the Thursday meetings, and the Secretary will be pleased to give particulars to any intending member.

Hexham and District Amateur Wireless Association.

Hon. Secretary, Mr. H. D. Lees, 8, Elvaston Road, Hexham.

The inaugural meeting of this Association took place on October 2nd. Mr. G. S. Douthwaite gave a few explanatory remarks outlining the objects of a Wireless Association, it was then unanimously decided that an Association should be formed under the above name. The meeting proceeded to the election of officers and committee.

On the completion of business Mr. Douthwaite gave a demonstration on his four-valve set with a Magnavox, which was listened to with great interest, signals being audible in all parts of the hall.

Bishop's Stortford and District Amateur Wireless Association.

Hon. Secretary, Mr. J. Cooper, Halfacres, Bishop's Stortford.

The monthly meeting at the Institute on October 6th, was well attended. Mr. L. Wright, of the North Essex Wireless Society delivered a lecture on "Elementary Principles of Valve Reception," presenting his subject in a lucid and interesting manner. Illustrations and diagrams were given, and the various methods of rectification explained in detail. On the proposal of Councillor E. F. Cooper, Vice-President, seconded by Mr. W. S. Filby, a vote of thanks was heartily given. Mr. W. A. Field, the President, occupied the chair.

On October 4th, 5th and 6th, members of the Association gave public demonstrations at the Shakespearean Bazaar held at the Great Hall, Bishop's Stortford. Large numbers queued up for every occasion and listened with interest to the Marconi concerts, etc.

On Saturday, October 7th, an invitation was given to all Boy Scouts and Cubs to attend and hear the Prince of Wales's broadcasted message. A number of Scouts from various troops were present. Reception was very clear, and rendered audible by a "Magnavox," kindly loaned by Mr. C. Randall, of the "Close," Bishop's Stortford.

Communications should be addressed to the Hon. Secretary.

Malvern Wireless Society.

Hon. Secretary, Mr. N. H. Gwynn Jones, Burford House, Great Malvern.

At a meeting of this Society at the Public Library, Mr. Percy Scott Russell, presiding, remarked that they hoped to be affiliated to the London Society, and that Mr. Dyson Perrins had kindly consented to be President.

Officials provisionally elected were Mr. Percy Scott Russell, Chairman; Mr. A. Harrison, Hon. Treasurer; Mr. N. H. Gwynn Jones, Hon. Secretary; Committee, Messrs. Jeynes, L. Mansell, Musgrave, Nadaud, Symonds, Rothwell, H. J. B. Martin, and Green.

The Society has over forty members.

The membership fee is half-a-guinea a year. Meetings are held on Wednesdays.

Hoylake, West Kirby and District Wireless Association.

Hon. Secretary, Mr. Roper Brattan, 14, Kirby Park, West Kirby.

The first General Meeting of the Association was held at Boustead's Café, Market St., Hoylake, on Monday, September 4th, 1922. Mr. T. C. Welding was appointed Chairman. The following were elected officers for the ensuing session:—Hon. Secretary and Treasurer, Mr. Roper Brattan; Hon. Assist. Secretary, Mr. S. H. Cocks; Hon. Technical Adviser, Mr. S. Evans; Committee: Messrs. T. C. Welding, J. D. Wood, P. Boustead and C. E. Price.

The subscription was fixed at 7s. 6d. per session. Sixteen applications for membership were handed to the Secretary during the meeting. A Committee meeting was held at Boustead's Café on September 11th. Mr. T. C. Welding was elected Chairman of Committee for the session.

Many important matters were discussed, it being decided amongst other things to have a question box for the general use of members.

The second General Meeting was fixed for Monday, September 18th, with a Committee meeting beforehand to transact any business.

At the General Meeting on September 18th, which was held again at Boustead's Café, Mr. S. Evans gave an address on "Hints to Beginners." Mr. Evans treated in a very able manner the matter in hand, starting with the procedure in obtaining a receiving licence from the P.M.G., next going on to show the members how to make and fix an aerial, by giving drawings on a blackboard, finishing his address with hints on earth connections.

Many interesting questions were then asked and answered, after which a very hearty vote of thanks was given to Mr. Evans. The meeting was a great success.

The third General meeting was held on Monday, October 2nd, at the Green Lodge Hotel, Hoylake, with the usual Committee meeting beforehand. This General Meeting was held in a private room in the Hotel. Mr. Corlett, of the Green Lodge Hotel, has very kindly offered the use of this room, together with the use of his three-valve set, to the Association. Needless to say this generous offer has been cordially accepted.

The Hon. Secretary, Mr. R. Brattan, gave a lecture on tuning and detecting radio signals, followed by a demonstration on connecting up and operating a simple single valve receiving set.

After several questions on the subject had been answered, a vote of thanks was given to Mr. Brattan for his lecture.

The membership is now 22, and there is every indication of a very successful session.

Beckenham and District Radio Society.

Hon. Secretary, Mr. J. Butterfield, 10, The Close, Elmers End.

On September 28th a 0.001 microfarad condenser was made up, after which a successful reception took place.

The President, Mr. Graves, brought his new four-valve set, connected up, and in a few minutes was able to get results. The Hague and Marconi House concerts were heard. Amateur transmitters were afterwards tuned in, music being received from Brentford, Blackheath and Forest Hill. A loud speaker was used.

Arrangements were made for a two days' demonstration at the Sale of Work in aid of the Church funds at All Saints', Beckenham, on October 4th and 5th.

It was hoped to arrange for the Beckenham Cubs to listen in to the Prince of Wales's address to Boy Scouts on October 7th.

Tottenham Wireless Society.

Hon. Secretary, Mr. R. A. Barker, 22, Broadwater Road, Bruce Grove, N.17.

The inaugural meeting was held on September 21st at 10, Bruce Grove, and the evening was spent in a general discussion regarding the future of the Society.

The second meeting was held on September 28th at the same address, when Mr. Fred Bourne was elected Chairman, Mr. R. A. Barker, Secretary, and Mr. Baker, Treasurer. The first half-hour was spent in buzzer practice, after which the Chairman opened a discussion on "Wireless" in general. Business was discussed and several new members enrolled.

The Chairman is drawing up a syllabus of lectures, demonstrations, etc.

Meetings will be held every week on Thursdays, 8 p.m. sharp, at 10, Bruce Grove (temporary headquarters), and the Secretary will be pleased to welcome prospective members of either sex.

Wanstead Wireless Society.

Hon. Secretary, Mr. A. B. Firman, 18, Clavering Road, Wanstead Park, E.12.

The first weekly meeting of the Society was held on Friday, September 22nd, 1922, at St. Gabriel's Church Hall, Aldersbrook Road, E.12.

After an interesting listening-in on a two-valve set temporarily installed, the President gave a lecture on the "History of Wireless," and different types of apparatus, including the coherer, magnetic detector and valves, together with a brief explanation of the electron theory. The lecture was greatly appreciated.

Mr. Chapman, a member of the Committee, pointed out that great care should be exercised in the purchase of wireless sets, as there were so many second-rate firms selling unreliable apparatus.

It is hoped very shortly to have an up-to-date four-valve receiving set installed for experimental and demonstration purposes. It is also hoped to arrange an interesting series of lectures through the coming season by the President and other prominent men of the profession.

The Brighton Radio Society.

Hon. Secretary, Mr. D. F. Underwood, 68, Southdown Avenue, Brighton.

A meeting of this Society was held at Mr. Volk's workshop, Russell Crescent, on Thursday, September 21st. Seven new members were elected, making the total 70. A motion was entertained from the Sussex Wireless Research Society to become amalgamated with the Brighton Radio Society. It was unanimously decided to adopt the recommendations of the Executive Committee, and a special Committee was formed to effect the fusion.

It was stated that certain gentlemen had promised to give lectures during the coming session.

Any gentlemen interested in Radio in Sussex are invited to communicate with the Hon. Secretary.

Amateurs in the district are invited to listen in on Friday evenings from 7 till 9 p.m. when 2 KA, the Secretary's transmitting station, usually carries out tests.

Fulham and Putney Radio Society.*

Hon. Secretary, Mr. J. Wright Dewhurst, 52, North End Road, West Kensington, London, W.14.

At a well attended meeting held at headquarters on Friday, October 6th, after the buzzer class, Messrs. Houstoun and Calver described and explained some interesting and unique circuits which were much appreciated.

The membership is still increasing, and arrangements are being made to provide interesting and instructive meetings.

Belvedere and District Radio and Scientific Society.

Hon. Secretary, Mr. S. G. Meadows, 1, Kentish Road, Belvedere, Kent.

The fifth General Meeting of the above Society was held on Friday, September 29th. Improvement was shown at the buzzer practice.

Mr. S. Burman continued his lecture on "The Construction of the Society's Apparatus," dealing with the principles underlying the low frequency magnifying panel.

The Secretary briefly outlined the method of producing an alternating current, and followed with the principle of heterodyne or beat reception.

Discussion followed, especially on the different types of circuits which were thought would meet with the Postmaster-General's approval.

The sixth General Meeting of the above Society was held at the Erith Technical Institute, on October 6th.

Satisfactory progress was made at the buzzer practice from 7.30 to 8 p.m.

Mr. S. Burman gave the third of a series of lectures on "The Construction of the Society's Apparatus," in which he dealt with the high frequency amplifying unit. He outlined the three methods of high frequency amplification coupling it was decided to adopt, viz: Resistance capacity reactance capacity, and interchangeable transformers. He explained, in more or less simple language, the way in which the amplified oscillations of the high frequency valves were handed on to the detector valve in each of the three methods. This lecture concludes the theoretical part; the next being on the practical side is intended to show how the various parts were made, set out and assembled.

A discussion took place on general subjects, which brought out some interesting points about earths and aeriars. Opinions seemed to be divided as to the efficiency of insulated wire being used as aeriars against enamelled wire. Two members declared that they had found an insulated wire aerial to be far more efficient than the orthodox plain wire. Another member suggested that a kind of hysteresis might be set up in the insulations surrounding the wire by the high frequency signal oscillations which would tend towards making such an aerial decidedly inefficient. This, however, seemed to be contrary to the experience of the two former speakers.

Bromley Radio and Experimental Society.

Hon. Secretary, Mr. J. Fergusson-Croome, Gowrie, Wendover Road, Bromley, Kent.

A meeting of the above Society was arranged to have taken place at 14, College Road, on October 2nd, but owing to the sudden growth of the Society the meeting was held at the White Hart Hotel.

The Chairman, Mr. L. Stopes, put before the twenty-nine gentlemen present the objects of the Society. He mentioned that several wireless lectures and demonstrations had been fixed, and visits to Croydon Aerodrome and other places of wireless interest would be arranged, also that application for affiliation to the Wireless Society of London had been made. The Chairman then called upon the Secretary to read the rules.

The Treasurer made a strong appeal for new members.

Another successful meeting was held at the White Hart Hotel on Monday, October 9th, when a wireless demonstration was given.

A temporary indoor aerial was erected and connected to a four-valve receiver equipped with a loud speaker; signals were received from many ship and Continental stations as well as music and speech from several amateur transmitting stations.

Excellent results were also obtained by utilising instead of the usual aerial the electric light circuit connected through a very simple device to another four-valve receiver.

As a result of the meeting several new members were enrolled, thus bringing the total membership to well over 40.

Applications for membership should be made to the Hon. Secretary.

Fulham and Chelsea Amateur Radio and Social Society.

Hon. Secretary, Mr. R. S. V. Wood, 48, Hamble Street, Fulham, S.W.6.

Mr. Patterson proposed five new members at a meeting of this Society, and was seconded by Mr. Scutt.

Mr. Scutt introduced a visitor, Mr. Gunning, who gave a lecture on "The Leclanche Cell, its Construction, Chemical Action, and Deterioration." The lecturer was heartily applauded for the able way in which he gave his lecture, and was accorded a vote of thanks. Attendance at the meeting was 55. There is now a total membership of 79. Nine new members have been enrolled, and three visitors attended.

WE OFFER TO THE AMATEUR AND THE TRADE

The Benefit of an Exceptionally Favourable Purchase of a limited number of
FINEST QUALITY VARIABLE CONDENSERS
 at considerably below cost price.—Each Condenser is **ACCURATELY ASSEMBLED AND FITTED** with Ebonite top and bottom plates, polished knob and pointer, and Ivorine Scale.
All Aluminium Vanes. For panel or cabinet mounting.

APPROX. CAP.							VERNIER
IN MFDS	'001	'00075	'0005	'0003	'0002	'0001	'00005
NO. OF PLATES.	57	43	29	19	13	7	3
STOCK	1200	1150	700	960	400	1050	1500
Price:	9/6	7/9	6/6	5/9	5/-	4/-	2/9

CARRIAGE PAID **CASH WITH ORDER.** **ORDERS IN STRICT ROTATION**
 THESE CONDENSERS ARE NEW AND GUARANTEED PERFECT AND CARRY OUR MONEY BACK GUARANTEE. ALL REMITTANCES RECEIVED AFTER THIS OFFER IS EXHAUSTED WILL BE IMMEDIATELY RETURNED.

A DISCOUNT OF 10% WILL BE ALLOWED ON ORDERS OVER £10 BEYOND WHICH NO FURTHER REDUCTION CAN BE GIVEN FOR ANY QUANTITY.

Wire or post your order immediately—
 This stock will obviously soon be cleared at these prices and cannot be repeated

The British Radiophone Company, SALES DEPT., Bulwell (Notts).

Telegram—BRITISH RADIOPHONE BULWELL.

BRITISH EBONITE TO GOVERNMENT SPECIFICATION FOR BRITISH WIRELESS.

MANUFACTURED BY:

THE BRITISH EBONITE CO., LTD.

HANWELL LONDON, W.7.

APPLY FOR LIST "W."

SPECIAL QUALITY RODS, TUBES, and SHEETS FOR WIRELESS. ALL USUAL SIZES KEPT IN STOCK. Grained Ebonite is a Speciality.

TELEGRAMS: "Ebonitical, Han, London."
PHONE: Ealing 1689.

WHOLESALE ONLY.

An Important Announcement

The most up-to-date Catalogue of Wireless Equipment



2nd Edition Now Ready

Our new catalogue covers practically everything required in wireless, whether it is for experimental work or for broadcasting.

Only up-to-date apparatus is described, which is of our own design and manufacture throughout.

Much useful information is given on the functions of the different instruments.

Post free 6d., which will be returned on receipt of first order. Write to-day.

We have the most comprehensive display of wireless apparatus in London. Everything used in wireless is on view.

Call and see our Showrooms.

WORKING DIAGRAMS OF VALVE RECEIVING CIRCUITS.

We have prepared a book of working diagrams for Wireless receiving circuits. This is of the utmost value to the serious experimenter and to the man who wishes to make the most of his resources in time apparatus and money. Over twenty different circuits.

Price 1/- post free.

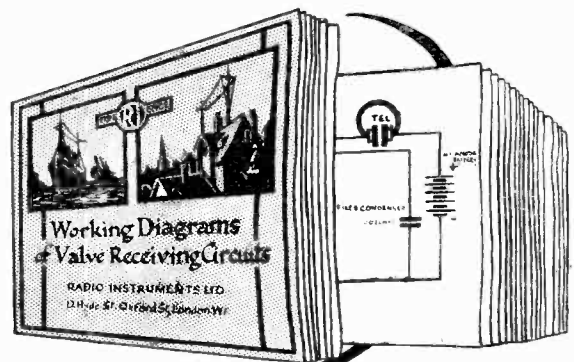

RADIO INSTRUMENTS, LTD.

12a, Hyde Street, New Oxford Street, W.C.1

Managing Director : J. Joseph, M.I.E.E., late Manager to Mr. H.W. Sullivan.
Chief Designer : W. A. Appleton, M.B.E., M.I.R.E., late Admiralty Technical Research Officer.
Telephone : Regent 1908 Telegrams : "Instradio, London."

Questions and Answers

NOTE.—This section of the magazine is placed at the disposal of all readers who wish to receive advice and information on matters pertaining to both the technical and non-technical sides of wireless work. Readers should comply with the following rules:—(1) Each question should be numbered and written on a separate sheet on one side of the paper, and addressed "Questions and Answers," Editor, THE WIRELESS WORLD AND RADIO REVIEW, 12/13, Henrietta Street, London, W.C.2. Queries should be clear and concise. (2) Before sending in their questions readers are advised to search recent numbers to see whether the same queries have not been dealt with before. (3) Each communication sent in to be accompanied by the "Questions and Answers" coupon to be found in the advertisement columns of the issue current at the time of forwarding the questions. (4) The name and address of the querist, which is for reference and not for publication, to appear at the top of every sheet or sheets, and unless typewritten, this should be in block capitals. Queries will be answered under the initials and town of the correspondent, or, if so desired, under a "nom de plume." (5) In view of the fact that a large proportion of the circuits and apparatus described in these answers are covered by patents, readers are advised before making use of them, to satisfy themselves that they would not be infringing patents. (6) Where a reply through the post is required every question sent in must be accompanied by a postal order for the amount of 1s., or 3s. 6d. for a maximum of four questions. (7) Four questions is the maximum which may be sent in at one time.

In view of the serious interference which an oscillating receiver can cause to other receivers in its neighbourhood, it is understood that for broadcast wavelengths, certainly, and possibly for all wavelengths, the Postmaster-General will in future allow no type of circuit which is capable of oscillating and so energising the aerial, either directly or through any circuit coupled to it.

The necessary consequence of this restriction is that if reaction of the type commonly used in the past is still employed, it must be in such a way that the oscillation point cannot be reached over the wavelength range of the receiver, however tightly the reaction coil is coupled, and with whatever values of filament voltage or plate voltage the set is worked.

In order to comply with this requirement, it is essential that the reaction coil should be sufficiently loosely coupled to the aerial inductances as not to set up oscillations, or alternatively the reaction might be arranged between the grid and plate circuits of a high frequency amplifier as shown on p. 715 of the issue of September 2nd and p. 867 September 30th, 1922.

We strongly urge readers who are making or using sets of the usual reacting type to either reduce the amount of reaction which they can employ to such an extent that they are perfectly satisfied that the set can never oscillate or to cut out their reaction entirely.

"H.W.L." (Hove).—(1) It is not possible to give precise windings of H.F. transformers for use on various wavelengths. The wavelengths given by particular windings depend so much on the tightness of winding, and the way in which the wire is wound on. For a range of 180 to 2,600 metres, you will probably need five transformers. You should wind on primary and secondary separately, placing a piece of insulating paper between the two windings. Put on the windings in opposite directions, and the two leads coming out between the windings are taken to grid and plate. 310 turns each is approximately suitable for 600 metres, but you will need to find the other values by experiment, which can easily be done with a two-valve circuit. Try using the tuned anode arrangement, for wavelengths from 180 to 1,500 metres, beyond which you may find it convenient to use resistance capacity inter-valve coupling. (2) Connect up one H.F. transformer followed by a detector valve, to your

usual aerial tuning circuit. The wavemeter may be coupled to the aerial circuit and varied until the loudest signals are heard, adjusting your aerial tuning arrangement to suit the wavelength. If you are making several sets of H.F. transformers, test out those designed to give similar wavelengths in this circuit, in order that they may all be precisely similar. (3) The reaction coil, which must slide closely to the transformer, may consist of approximately 100 turns, and additional turns can be connected in series externally to the coil by means of a studded switch. (4) One detector and one L.F. should bring in 2 LO quite loudly.

"A.C.D." (Leeds).—(1) See Fig. 1. (2) 0.001 mfd. for aerial circuit and 0.0005 mfd. for closed circuit. (3) Not necessary.

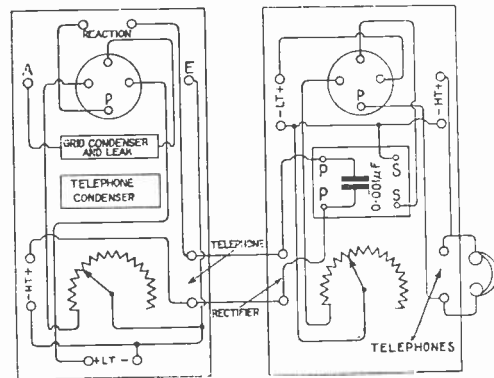

Fig. 1.

"F.O.P." (Wolverhampton).—The Weston Relay which you have purchased is suitable for recording at slow speeds. We suggest you join the relay in series with the perikon detector, and work the arrangement from the last L.F. transformer of your L.F. amplifier. If you wish to experiment with relays, we suggest you read the articles on "Some Methods of Recording Wireless Signals," which appeared in the issues of October 29th and November 12th and 26th, 1921. Unfortunately, you do not give any particulars of items 3 and 5, therefore we are unable to advise you.

"F.C.B." (Northwich).—We have carefully examined your diagrams. They appear to be correct. We suggest you put a condenser of from 0.001 mfd. to 0.5 mfd. across the H.T. battery, using another condenser of 0.001 mfd. across the telephones. We consider it advisable for you to well space the L.F. transformers to prevent interaction. We assume you have made sure the grid leak and grid condenser are O.K., and the H.F. anode reactance is suitable for the wavelength range you wish to receive. If you construct the five-valve set, using 2 H.F., 1 detector and 2 L.F. and loud speaker, you will probably hear the signals all over your room.

(2) It is not possible to give precisely the number of turns required in an aerial inductance to tune to a given wavelength, as it depends so much on the precise capacity and inductance values of the aerial. (3) When using a two-wire aerial comprising 170 ft. of wire, 40 to 60 turns of mean diameter of $2\frac{1}{2}$ " is usually required to tune to a wavelength of 380 metres, but here again the inductive values depend very much on the precise spacing between the turns. (4) Provided a special type of valve such as "Q" or "R4 B" is used as a rectifier, there is nothing gained in making use of a crystal.

"E.A.G." (Birmingham).—(1) The choke

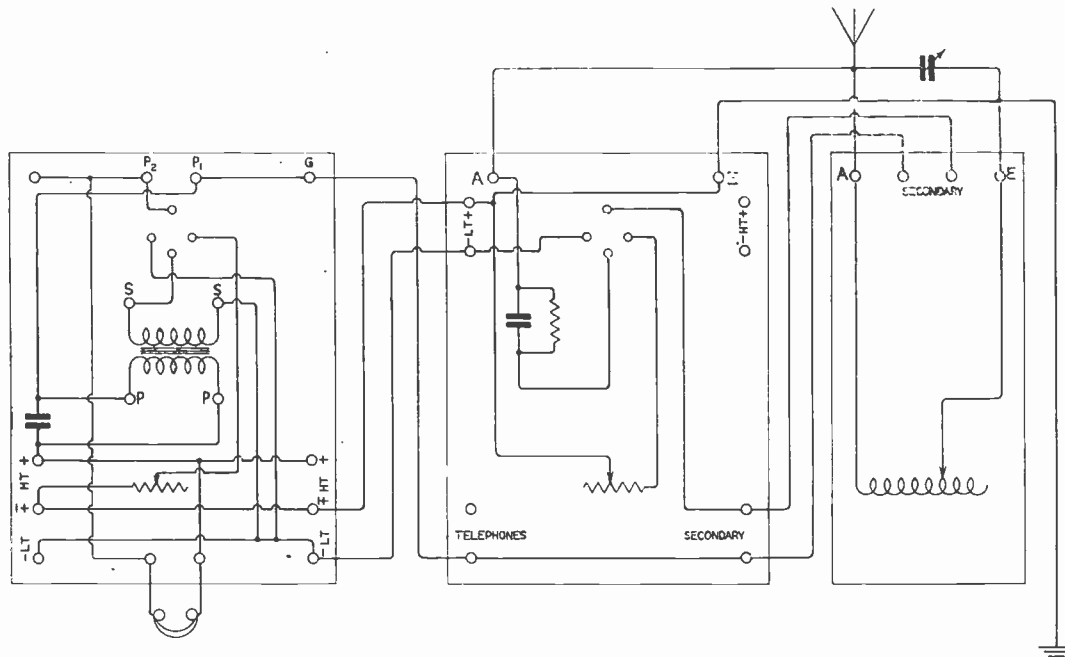

Fig. 2.

"H.F." (Towcester) asks (1) For correct connections of his tuner panel, detector panel, and low frequency amplifier. (2) Whether his variable condenser marked 0.000762 is suitable for use in the set.

(3) Why he is unable to receive PCGG although 2 LO, 2 MT, etc., come in well and (4) Who is 2 BF.

(1) See Fig. 2. (2) Yes. (3) You will need the addition of one H.F. valve for reception of PCGG. (4) No information.

"K.K." (Stansted).—(1) Critical tuning, giving increased signal strength, may be obtained by placing in the hand or other semi-earthed conductor near the tuning inductances, is an effect frequently obtained when receiving short wavelength telephony. A very small change in the capacity in the tuning circuit may give rise to a small change in the wavelength, but of just such a critical value as to give greatly improved results. Although you point out that at the time of making the test you were apparently well insulated from earth, you must regard yourself as forming one plate of a condenser and the insulating material acting as a dielectric between yourself and the earth proper.

coil, as you suggest, may consist of 10,000 turns No. 42 S.W.G. enamelled wire, wound on the coil of an intervalve transformer. Place a layer of thin paper over every few layers of wire, as enamelled wire must not bewound too tightly. (2) An air core choke coil of 5 millihenries may be constructed by winding a three-pile winding of No. 26 S.S.C. wire on a tube 3" diameter and $3\frac{1}{2}$ " long. The winding itself is 2" in length. If you have plenty of room, a single layer coil, 5" diameter, $5\frac{1}{2}$ " long, wound full of No. 26 S.S.C., will provide 5 millihenries of inductance. (3) We advise you not to make a variable condenser of 0.005 mfd. A condenser of this capacity, using plates of the size of your sample, would require a very large number of plates. The value is not critical, and once the adjustment is made, there will be no need to change it. We suggest you make a number of fixed condensers and switch them in parallel, until the desired result is obtained. (4) A filament resistance is quite useless as a potentiometer, which should have a resistance of at least 400 ohms, while the resistance of your filament rheostat is probably 8 ohms.

MAGNAVOX

THE WORLD'S FINEST

LOUD SPEAKER

RADIO
brings it
MAGNAVOX
tells it.

*Broadcasting faithfully reproduced
with marvellous clarity and volume*

IMMEDIATE DELIVERY.

To be obtained from all dealers or direct from the
Manufacturers & Sole Licensees for Europe

Sterling Telephone & Electric Co., Ltd.

TELEPHONE HOUSE.

210/212, Tottenham Court Road, London, W.1
Telephone No.: 4144 Museum (7 lines). Telegrams: "Cucumis. Wesde. London."

Works: DAGENHAM, ESSEX.

BRANCHES: NEWCASTLE-ON-TYNE: 9, Clavering Place.
CARDIFF 8, Park Place.

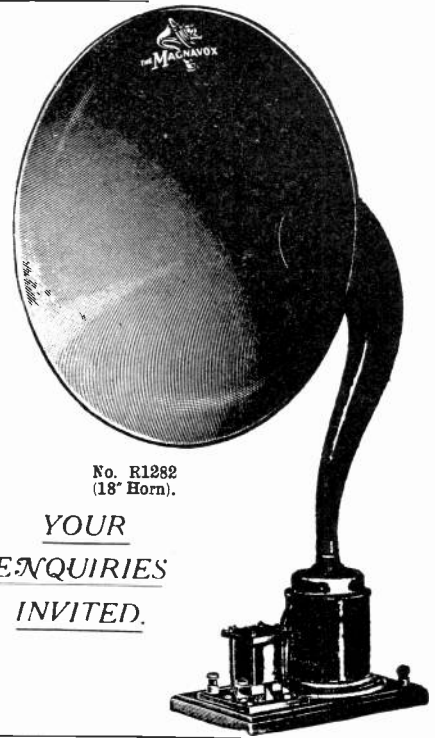

No. R1282
(18" Horn).

YOUR
ENQUIRIES
INVITED.

TOMLINSON

LONDON, LIMITED.

ONE OF OUR WIRELESS COMPONENTS.



4/6

(POSTAGE 3d)

3 FINCHLEY ROAD,
ST. JOHN'S WOOD, N.W.8

HAMPSTEAD
8144.

T.M.C. Wireless

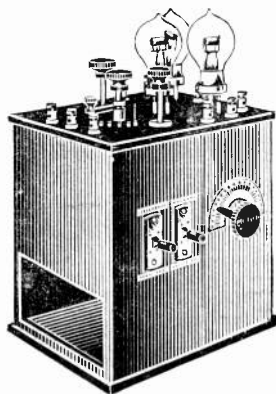

T.M.C. 3-VALVE BROADCASTING SET

A Revelation in Wireless Sets employing one-valve detector, two valves for low frequency amplification. Apparatus mounted includes Variable Filament Resistance, three Valve Sockets, Grid Leak and Condenser, two highly efficient Transformers, Grid Potential Blocking Condenser, Variable Condenser, Series Parallel Switch, Switch for using Loud Speaker or Headphones, Tuner and Reactance. Complete with Three Valves, Loud Speaker and set of "De-Luxe" Headphones. Mounted in polished Walnut. Size $9\frac{1}{2} \times 7 \times 10\frac{1}{2}$ inches high.

**THE MARVELLOUS 3-VALVE SET THAT WAS
THE FEATURE OF THE EXHIBITION.**

THE TELEPHONE MANUFACTURING CO. LTD
HOLLINGSWORTH WORKS, WEST DULWICH, S.E.21
TELEPHONE: SYDENHAM 2460-1 TELEGRAMS: BUBASTIS DULCROX

"S.K.F." (Newcastle-on-Tyne).—We have carefully examined your diagram, and it is correct. Unfortunately you omitted to indicate the values of the components, therefore we cannot advise you whether they are suitable for PCGG. However, as you have received PCGG, we think there can be nothing wrong. You might connect a 0.001 mfd. condenser across the winding of the L.F. transformer in the detector valve plate circuit. We understand that this station increased its power about June 4th. Recently it may have been reduced, and we think you might add another H.F. valve to your set. The diagram (Fig. 3) shows the connections using 2 H.F., 1 detector, and 1 L.F. note magnifier.

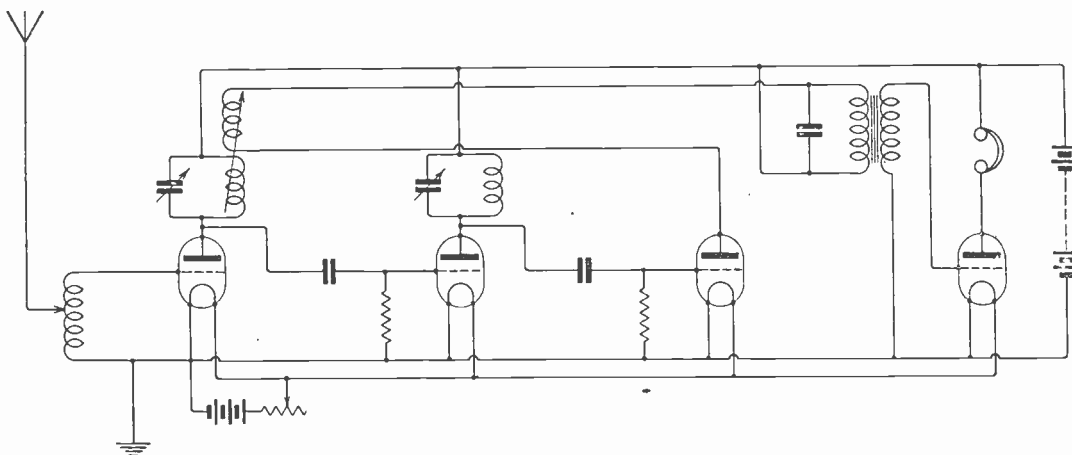

Fig. 3.

"J. McV." (Belfast).—(1) We regret the grid condenser and grid leak values were omitted from our reply, but these are generally very well known. Usual values are 0.0003 mfd. and 2 megohms, although slightly different values may be usefully employed. (2) The tuned anode method of H.F. amplification is very efficient and is to be recommended. It is generally not necessary to use more than three H.F. valves, and we suggest you make up a three-arm switch to vary the number of sections in the anode inductances simultaneously. Above about 2,000 metres a set arranged for resistance capacity H.F. amplification requires less adjusting, but does not give quite the same degree of amplification. (3) The inductance of each anode coil should be approximately the same, and the condensers should also have values very similar. The tuned anodes are, of course, tuned to the wavelength of the signals.

"C.W.A." (S.W.18.).—The choke should be made on an iron core 5' long, $\frac{3}{8}$ " diameter, wind $\frac{3}{4}$ lb. No. 22 D.C.C. wire. You will find it convenient if a number of equally spaced taps are taken off and brought to sockets, or a row of terminals. About 6 taps are useful.

"D.G.B." (S.W.15.).—Unfortunately you do not give us particulars of your aerial, or the dimensions of the tuning inductances, therefore we are afraid we cannot help you. We shall be pleased to reply to your question if you will supply us with these particulars.

"N.M.O.H.S." (Surrey).—(1) We presume you propose to use the two windings in series with a variometer in the plate circuit of the H.F. valve. With the particular type of formers to which you refer, you will not obtain the range you desire—viz., 150/1,100 metres. If you wind each former with 55 turns of No. 28 D.S.C., you will obtain a tuning range of probably about 300 to 850 metres. (2) A tapped single layer will probably be a better arrangement for use in the tuned anode circuit with your parallel tuning condenser of 0.0002 microfarads maximum. The $4\frac{1}{4}$ " former should be wound for a distance of 5" with No. 26 D.C.C., and provided with about

eight tappings at increasing intervals. A V.24 valve is quite suitable as an H.F. magnifier. (3) The best arrangement for three-valve H.F. amplifier is one arranged with tuned anode in intervalve coupling. As one end of each coil is connected to the H.T. plus, you might make a switch carrying three arms at 120 degrees to each other, moving over studs which are tappings from each coil, in order to adjust three intervalve inductances simultaneously. Each winding, of course, will need to be bridged with a variable condenser. (4) Your circuit is quite a good one. The suggested lead between the earth and the L.T. minus is not essential, though there is no harm in providing it.

"W.S.S." (Wembley).—Making use of the 6" diameter cylindrical former in your possession, 55 turns of No. 20 D.C.C. wire, will, with the 0.0005 mfd. series condenser, tune to 450 metres. Take tappings at the 20th, 30th, 42nd and 55th turns. The lowest wavelength you will be able to tune in is approximately 220 metres.

"F.B." (Bayswater).—The most economical method of charging your accumulators is to connect them in series with an electric heater, or carbon filament lamps. A $\frac{1}{2}$ -kw. electric heater on a 200-volt supply will allow 2.5 amperes to pass through the battery; while four carbon lamps of 32 candle power each, connected in parallel, will pass about 2 amperes. It will be found that regular charging at the above rates will keep the accumulators in good condition.

"W.G.H." (Birmingham).—A three-valve circuit is shown in Fig. 4, making use of one H.F., one detector and one low frequency magnifier, to comply with the present Post Office regulations. The use of a loose coupled aerial circuit is permitted, as shown in the diagram, but we would recommend you to couple the reaction coil to the windings of the high frequency transformer or tuned anode circuit, as indicated in our issue of the 30th September, under the heading of "Experimental Station Design."

"G.R.A." (Aldershot).—It is a difficult matter to calculate the number of turns of wire required in honeycomb coils. The inductance of such coils depends very largely upon the method of winding, spacing, etc. Unfortunately you do not give us the capacity of your closed circuit condenser, and we think the best you can do is to use the next larger coil for the closed circuit coil, and the next smaller for the reaction coil, you will then determine by experiment whether the wavelength range of the aerial circuit corresponds with

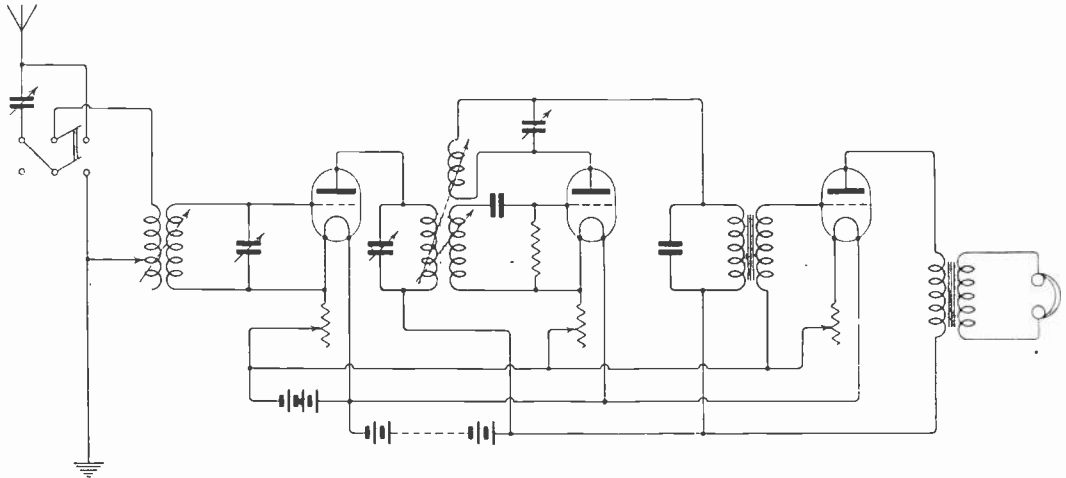

Fig. 4.

"TUNER" (Bembridge).—(1) We do not understand your question; full particulars of a broadcast receiver are given in the issues of August 26th and September 2nd. (2) We do not know what telephones you refer to, so we cannot say. (3) You should consult the local authorities, although we believe there is generally no objection provided the wire is over 30 feet above the ground.

"J.K.W." (Liverpool).—It is reasonable to expect that the Postmaster-General will not authorise you to use the circuit you propose, but we understood that although this circuit is capable of causing re-radiation, the Post Office were prepared to authorise its use by the experimenter. You do not say whether you are applying for a licence for the reception only of Broadcast telephony, or a licence permitting you to conduct experiments, and we now believe that provided the Postmaster-General is satisfied as to your ability to conduct experiments he will entrust you to use any apparatus you desire, providing you undertake not to cause interference. The circuit shown on page 867, September 30th issue, is recommended.

"W.S." (Guildford).—As you give us no particulars of the telephone jacks you propose using, we regret we cannot give you a circuit showing how to connect them. If you will send us particulars of the jacks, we shall be very pleased to help you.

that of the closed circuit; if not, you will be easily able to change the number of turns in the coil.

"W.C.B." (Bradford).—(1) The diagram you send us is correct, but we suggest a series parallel switch to connect the A.T.C. in series or parallel with the A.T.I. The basket-coil arrangement you suggest is satisfactory, and you should mount them all side by side, with about $\frac{1}{4}$ " spacing between them. (2) We consider transformer coupling to be better up to 2,000 metres, and above that wavelength resistance capacity. A diagram showing socket connections, with resistance and transformer connected plugs is given on page 705, August 26th issue. (3) We think you should find a three-coil holder useful, making use of plug-in honeycomb coils. Less space will then be required for the tuner.

"O.B." (Glasgow).—We regret we are unable to advise you on the process to adopt in obtaining a post as wireless engineer or inspector in the General Post Office or other Government Department. Posts of this kind, both at home and abroad, are announced in this and other journals from time to time. We think you cannot do better than reply to one of these advertisements to which your qualifications appear to make you specially suitable. Why are you so desirous of restricting your employment to a Government Department, when really skilled wireless engineers are at present in such great demand by commercial companies?

The Present Wireless Boom

has given an enormous impetus to the manufacture of wireless apparatus. The tendency has been to sacrifice quality to quantity in endeavouring to keep pace with the demands. Throughout this period of increasing wireless activity S. G. BROWN, LTD., have wisely refused to lower their high standard of quality even at the expense of occasional delay in fulfilling orders. As a result they have more than maintained their enviable reputation as RELIABLE wireless manufacturers, and to-day it continues to be recognised by amateur and professional alike that wireless instruments and parts manufactured by and bearing the name "BROWN" can be bought with absolute confidence in their quality, value and efficiency.



"A" TYPE.
Low Resistance,
58/-

High Resistance,
62 - to 66 -

"D" TYPE.
Low Resistance,
48 -

High Resistance,
52 -

(All above prices
include cords).

The "Brown" Super-sensitive Telephones

These Telephones are unquestionably the clearest and most sensitive made, and, consequently, increase the distance over which wireless can be heard.

BROWN'S are recognised as the most comfortable to wear, due to their extreme lightness in weight and adaptable adjustment.

There are no wireless headphones in the world to compare with BROWN'S.

IMPORTANT NOTICE—When purchasing BROWN'S you should see that the name BROWN is stamped on the back of each ear piece. This is the *hall-mark and proof of their genuineness, excellence of finish and highest efficiency.*

In Universal Use. As supplied to British, Allied and Foreign Governments.

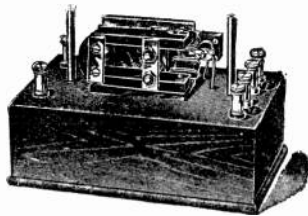

The "Brown" Microphone Amplifier

This Amplifier magnifies signals, speech, or music, without distortion, and is of considerable interest to amateurs and scientific investigators. The magnification is much greater than that obtained from a two-valve amplifier. In construction, this instrument is much more robust than other relays. *This instrument satisfies the urgent demand for a reliable inexpensive amplifier, which the most inexperienced amateur can use, and which the most experienced requires.* The necessary transformers are included in the base.

The "Brown" Loud Speakers with new improved Curved Horns

The requisites of a Loud Speaker are pure tone, clear articulation, and good volume of sound. The "BROWN" Loud Speaker possesses these qualities and they are enhanced by the new improved curved horn.

AMATEURS do not always need the full sized Loud Speaker (H.1) as used in Lecture Halls, and a small type (H.2) has been designed to meet their more modest home requirements both as to volume of sound and price.

THE NEW HORN of dull blacked aluminium used with both H.1 and H.2 is constructed on the logarithmic law of increasing openings and is acoustically perfect.

NOTE THIS.—The strength and clearness of all music, speech and Morse heard by one person wearing headphones is broadcasted to a whole room full of people when a Brown Amplifier and Loud Speaker are used with your set.

The most popular and perfect loud speakers ever offered to the public.

Thousands already in use in all parts of the world.

CATALOGUE POST FREE.

Visit Our London Showrooms: 19, MORTIMER STREET, W.1.



PRICES:
H. 1 (Large) Low
Resistance, 120 ohms
Height 21",
£6 : 5 : 0
(High resistance
2/6 to 5/- extra).

H. 2 (Small) Low
Resistance, 120 ohms
Height 12",
£3 : 0 : 0
(High Resistances
2/6 to 5/- extra).

SOLE MANUFACTURERS—



Telegrams—
"Sibbrownix, London."

Telephone—
Chiswick 1469.

Sole Agent for the Argentine—

Horacio D. Guerrero,
Las Heras 2480, Buenos Aires

Head Office and Works:
VICTORIA ROAD, NORTH
ACTON, LONDON, W.3

London Showrooms:
19, MORTIMER STREET,
LONDON, W.1.

A MAGNIFICENT RECEIVER AT A KNOCKDOWN PRICE

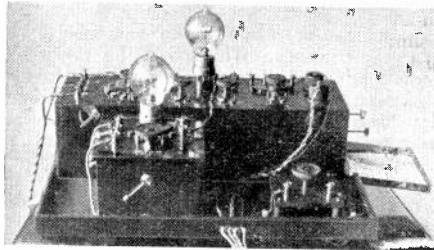

H.P.R. RECEIVER

with special Tuning gauge for 300 to 30,000 metres, including 1 Valve Amplifier for broadcasting (300-500 metres) and 1 Variable Resistance.

Mounted complete on tray for convenience in handling. Also German Army type 4 Valve Amplifier and full instructions. A magnificent instrument finished in the finest style, exactly as photograph.

COST £48

What Offers ?

May be seen at—

ED. J. BURROW & CO., LTD.
93, KINGSWAY, LONDON.

Prices
on
Application.



Trade
Enquiries
Solicited.

Single Valve Panel

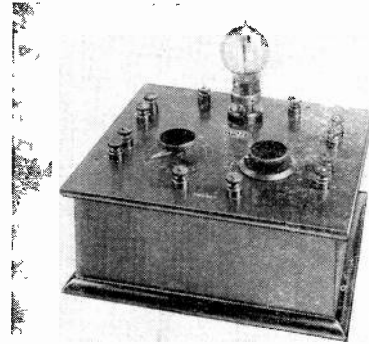

J. BURNS LIMITED
Wangey Works, Chadwell Heath, Essex.

ALL GUARANTEED WIRELESS

2 mf. Condensers	1/6
Grid Condensers, .0033 and .0065	2/6
1 1/2 Reel Insulators, per doz	2/3
Filament Rheostats with Pointer for Panel Mounting, 3/- and 3/9	4/6
120w. Watch Type Receivers	4/6
Lacquered Switch Arms	2/-
Valve Holders with Fixing Screw	10d.
Intervalve Transformers (Silk Wire)	£1
Mark III Crystals, in cups per pair	1/-
Mark III* Crystals, in cups per pair	1/3
Ebonite Knobs (not rubbish), 1 1/2"	5d.
Microphones, with replaceable insets	2/6
H.T. and L.T. Red and Black Leads, ex-Government	4d.
4,000w. Double Headphones	27/-
Dutch Concert Coils per pair	4/6
Well made Crystal Sets	£3
Resistance Coils, wound on china bobbins, 2,880w.	1/-
Loud Speakers, 2,000w., adjustable	50/-
Ex-Government Power Buzzer Cases, mahogany	5/-
Power Buzzers only	6/6
4 volt 50 amp. Accumulators	25/-

WIRELESS ACCESSORIES of all kinds in stock. Send for requirements.

C. S. SWAN,
191, Bishopsgate, E.C.2

Under Brandon's, Tailors, and 65, Windsor Road, Leyton, E.10.

Broadcasting

IS NOW ASSURED

Get Your Installation before the Rush

How to Build the Finest Receiving Station, Expanding by Instalments.

To Receive Signals You Must Have—

Aerial Wire, 150 ft. Silicon Bronze, 4/6
Insulators from 4d. each. Tuning Stand
(3 coils) 30/-, Coils from 1/3, according to
W.L., Detector Unit (Valve) 37/6, Phones
from 24/-, Condensers Variable. 5/- to 36/-,
H.T. and L.T. Batteries, *see our list.*

*To increase range you require 1 H.F. Unit
37/6, and so that your friends can hear
add 1 L.F. Unit 45/-.*

*Illustrated Catalogue, including List of Stations,
useful books, etc., we can supply. 6d. Post free.*

EONS WIRELESS
SUPPLY CO.
115, FLEET STREET, E.C.4.

“W.E.C.” (Putney).—Until very recently, we believe that the Postmaster-General was prepared to authorise the use of a circuit of the type which you suggest, but in our opinion it is just as liable to cause radiation as a direct coupled aerial circuit. If you have an experimenter's licence, we presume that the Postmaster-General is satisfied as to your ability to conduct experiments in wireless telegraphy, and we believe he will leave it to your discretion as to the type of circuit to adopt, but we would recommend you to use a circuit with reaction coupling, if necessary, as shown on page 867, September 30th issue.

use plug-in coils for both the anode and reaction circuit and couple them together. The anode reaction coils are described by Bull on page 678, August 26th issue.

“W.T.A.” (Birmingham).—(1) You may purchase an intervalve transformer from any manufacturer of wireless gear, but if you require one similar to that described in the article of August 26th, it would be better to take the scale drawing with you for reference. (2) The receiver as described will meet the requirements of the Post Office if you leave the reaction coil terminals short-circuited. We suggest you see the articles

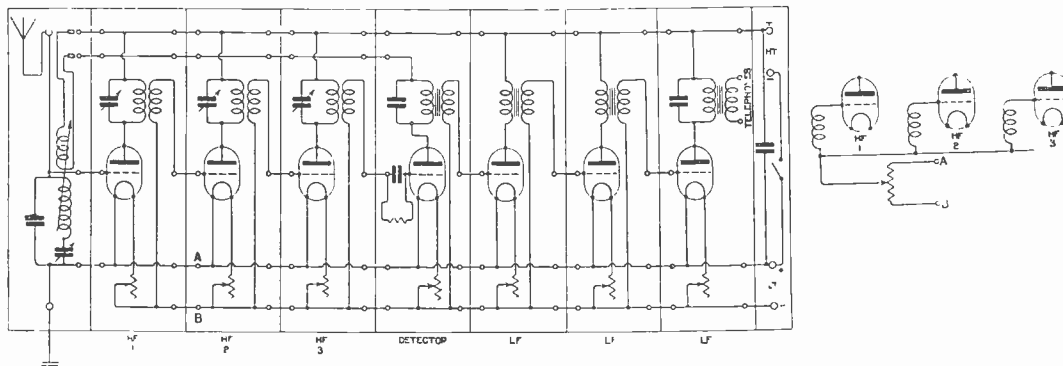

Fig. 5.

“W.H.S.” (West Dulwich).—(1) A wiring diagram using 3 H.F., 1 detector and 3 L.F. valves is given in Fig. 5. We do not recommend joining the last two valves in parallel for the loud speaker, as it is often difficult to get two valves in parallel working properly. However, if you would like to try connecting them in parallel, make up a valve unit and join its plate to the plate of the last valve, and the same with the grids and filaments. (2) As space is not a consideration you may use a variable condenser in place of the fixed condenser as you suggest, although this will give you another adjustment to make each time you tune in. The arrangement using the fixed condenser works very well. Perhaps we may suggest you use a series or parallel with the A.T.C., omitting the fixed condenser. (3) The lower diagram shows how the potentiometer is arranged to control the potentials of the grids of the H.F. valves. The grid leads are connected together and taken to the sliding contact of the potentiometer. The terminals of the potentiometer bridge the L.F. battery. Potentiometer control of the H.F. valves gives a very useful method of controlling the grid potential, and finer adjustment thereby is possible.

“F.W.” (Manchester).—Unfortunately the circuit sketched does not comply with the Post Office regulations. It is never advisable to react back directly into the aerial circuit. We suggest you add another valve, and then couple the reaction coil to the H.F. transformer as shown in the articles on “Experimental Station Design,” pages 715, 791 and 865, September 2nd, 16th and 30th issues. Also see the article on page 26, October 7th issue.

“F.W.” (Birmingham).—We suggest you

on “Experimental Station Design,” September 2nd, 16th and 30th issues, and make arrangements in your set to secure reaction by coupling the reaction coil to the tuned reactance anode coil.

“T.C.O.” (Southport) asks (1) *The gauge of samples of wire submitted.* (2) *Windings for H.F. transformers.* (3) *Particulars for making tuning coils 350-400 metres.*

- (1) No. 1 diameter 0.0124" = No. 30 S.S.C.
- No. 2 " 0.0076" = No. 36 D.S.C.
- No. 3 " 0.0076" = No. 36 S.S.C.
- No. 4 " 0.0076" = No. 36 D.C.C.
- No. 5 " 0.0124" = No. 30 S.S.C.
- No. 6 " 0.0076" = No. 36 D.C.C.

(2) To tune from 350 to 400 metres, we suggest a winding of 130 turns each for primary and secondary in the 1.3/8" diameter former, using the No. 44 D.S.C. wire in your possession. For an optimum wavelength of 1,000 metres wind 350 turns each for primary and secondary in the 1 1/2" diameter former. It is generally not possible to give the number of turns accurately, and some experimental adjustments will probably have to be made. You will be able to wind 20 turns (of the wire submitted) per inch length of former. For the primary use the 3 1/4" former and wind for a length of 4", taking 9 tappings. For the secondary wind 4" of No. 22 D.C.C. on a 3" former, and take 4 tappings. The reaction coil may consist of 3" of No. 28 wound on your 3" diameter former.

(3) We cannot give exact dimensions, because you have not given us particulars of your tuning condensers. We suggest you use a series A.T.C. of maximum value of 0.001 mfd., and a closed circuit tuning condenser of maximum value 0.0005 mfd.

"H.R.S." (Exeter).—(1) A separate heterodyne will only be of use when C.W. signals are to be received. It would be difficult to use it to take the place of reaction, that is, to diminish the effective resistance of the tuner circuits to H.F. currents. To heterodyne an incoming C.W. signal, the heterodyne wavemeter is coupled to the tuner, or preferably, to the plate circuit reaction coil. Of course the reaction coil in Mr. Harris's set may be coupled to the anode coil, and you would find this arrangement satisfactory. (2) Unfortunately you do not give us any particulars of the switches you propose using, so we cannot give you a wiring diagram showing how they are connected. A simple change-over switch is all that is required for the reaction coil.

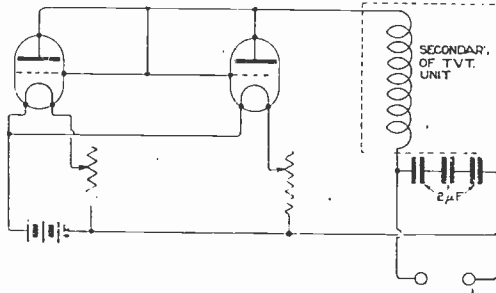

Fig. 6.

"W.G.M." (Salisbury).—It is quite a simple matter to rectify the voltage obtained from your T.V.T. unit. Join two valves in parallel, the grid and plate of each being connected. It is better to use a filament resistance for each valve. The diagram (Fig. 6) shows the arrangement, and you will notice the rectifier filaments are at high potential.

"L.B." (Cambridge).—We cannot give you the precise values necessary to set up oscillations for audio frequency of 400 per second, as the frequency produced by the neon tube depends largely upon the extent of exhaustion. If you connect in series with the source of H.T. supply a resistance having a value between 1 and 1.5 megohms, and bridge the tube with a variable condenser having a maximum value of 0.002, you will obtain a good variation of note frequencies, whilst a condenser having a value of 1 mfd., used in conjunction with the same resistance, will usually give a frequency of about one per second. These particulars apply to Osram neon lamps with resistances moved from sockets.

"G.H.S." (Ilford).—As you do not give any particulars of your tuning condenser, we cannot calculate the size of coil required. We suggest you use single layer coils for short wavelengths, and for longer wavelengths make up a set of honeycomb coils. For the lower wavelength wind a coil 4" in diameter and 6" long with No. 22 wire, taking off, say, six taps. You will require a set of about eight honeycomb coils to tune up to 10,000 metres, winding the honeycomb coils with No. 28 D.C.C. on a former 2" in diameter for 1½". Four layers up to fifteen layers will be required to cover the whole range.

"T.R.A." (Beverley).—(1) and (2) The circuit you give is a fairly satisfactory one, but you will obtain much better results if you use a tuned inductance in the plate circuit of the first valve instead of an H.F. transformer. The constructional details of such an inductance are given in the issue of September 30th. A variable condenser having a maximum value of 0.0002 is suitable for tuning the anode inductance. (3) The circuit you show would not be suitable for reception of PCGG when followed by one L.F. magnifier, and in fact your diagram is not quite correct, as you apply the potential obtained across the ends of the inductance between grid and plate. This is perhaps permitted if you provide a bypass condenser across the telephone receivers, but then of course self-oscillation may occur, and consequently radiation. (4) The coupling of a reaction coil to an intervalve transformer is fully described in our issue of September 2nd, page 715. The necessary components are not on the market at present, but if you are an experimenter, we do not think you should have very much difficulty in constructing the arrangement shown on pages 718 or 792, yourself.

"G.W." (Bradford).—Before erecting a mast or making aerial fixtures to property, it is necessary to obtain the permission of the owner. The approval of a tenant should not be taken as sufficient, because it must be admitted that damage may accidentally occur to the property. Even to be privileged by the owner to make attachment to property is not always satisfactory, for after having perhaps taken great pains to erect a good aerial, the owner may desire its removal at any time. When seeking permission it is advisable to arrange to pay a nominal rent, with, if possible, an agreement for a stated period, and with an undertaking to make good any damage directly attributable to the fixing of the aerial.

"A.C.B." (West Ham).—The diagram given on page 807 is quite correct, but it does not matter usually whether low frequency choke coils are inserted in the positive or negative lead, or both. The reason why the chokes are only connected in one lead, and that the negative, is because experimenters following that diagram may be working with an auto-coupled power transformer, in which case the positive lead from the rectifier valves may be earthed, and as the H.T. positive may also be earthed, any chokes connected along this lead would in effect be short-circuited. In wiring up to the diagram given, you may let your positive leads be at almost earth potential, whilst the negative lead and the battery which heats the filaments of the transmitter valves must be well insulated.

"A.C.W." (Walthamstow) asks (1) If his diagram of connections is correct. (2) Range of wavelengths covered by set.

(1) Your diagram is quite wrong. See Fig. 7, August 12th issue. Beyond this we cannot help you much, as unfortunately you omit to give the values of the components of your set. (2) Range of wavelengths covered from 200 metres to 2,000 metres, assuming you are using a 0.001 mfd. aerial tuning condenser.



MARCONI
GIVES
UNRIVALLED
WIRELESS
SERVICE

The MARCONI INTERNATIONAL
MARINE COMMUNICATION CO. LTD.
MARCONI HOUSE, STRAND, LONDON.

THROUGH THEIR EFFICIENCY, THESE TRANSFORMERS, HIGH AND LOW, HAVE EARNED A REPUTATION FOR THEMSELVES, AND ARE NOW IN LARGE DEMAND BY EVERY CLASS OF USER—

ASK YOUR DEALER FOR—

GENTS' "TANGENT"

L.F.

TRANSFORMER AND

GENTS' "DISCOL"

H.F. TRANSFORMER.

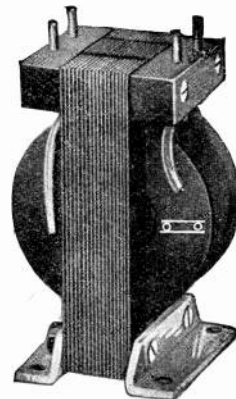

The "TANGENT" L.F. Transformer.

PRICE 22/6 each.

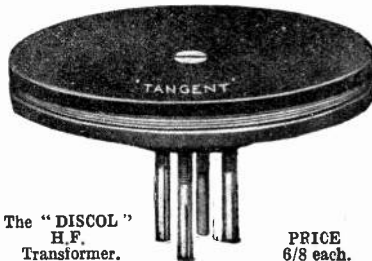

The "DISCOL" H.F. Transformer.

PRICE 6/8 each.

GENT & Co. Ltd., FARADAY WORKS, LEICESTER.

LONDON:—25 VICTORIA ST., S.W.1.
NEWCASTLE-ON-YNE:—"TANGENT HOUSE," BLACKETT ST.

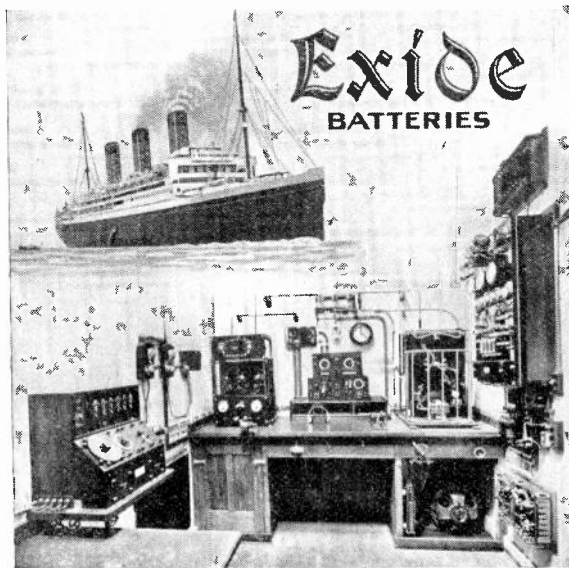

Exide
BATTERIES

THE LARGEST SHIP IN THE WORLD

— the White Star Liner "Majestic" — uses Exide batteries for her wireless installation.

No finer testimony to the general reliability of Exides, and their particular suitability for wireless work, could be given

THE Chloride ELECTRICAL STORAGE COMPANY LIMITED.

Prices and Particulars on Application

HEAD OFFICE:

Clifton Junction, Nr. Manchester

LONDON SHOWROOMS:

219/229, Shaftesbury Ave., London, W.C.2

"C.B." (Lewes).—(1) The diagram of connections of your set is unfortunately not correct. We suggest you use a closed circuit coupled to the aerial circuit, and use a series parallel switch in the aerial circuit to join the A.T.C. in series or parallel with the A.T.I. A large condenser in parallel with the A.T.I. is useless when receiving short waves. Probably 6 volts and a filament resistance for each valve would help you to secure better results. (2) It is always better to use a telephone transformer. The telephones are then less liable to damage. We cannot say why your telephones have burnt out, but you may, of course, have some faulty apparatus in your set, of which we have no particulars. (3) The tuned anode method of H.F. amplification is the best arrangement to use, and we can only suggest the anode coils are incorrect valves. A large number of suitable values have been given in recent issues. The maximum value of the anode tuning condenser should be 0.0002 mfd.

"S.W." (Stoke-on-Trent).—(1) It is quite easy to couple the reaction coil to a Sullivan H.F. transformer. We suggest you wind 100 turns of No. 38 S.S.C. wire on an ebonite former a little smaller than the H.F. transformer, and arrange it to move quite close to the face of the H.F. transformer. For higher wavelengths you will be able to add coils external to the moving reaction coil, as shown in our sketch (1). (2) We regret we have no particulars of the Marconi Tuner you have purchased. We suggest you write to the Marconi Company asking them for a diagram. Without a diagram, we are afraid we cannot advise you how to convert the set. You can try connecting the grid and filament of the first valve across the crystal leads (removing the crystal, of course), and short-circuiting the telephone terminals on the tuner.

"J.B." (Gt. Yarmouth).—The correct method of joining up transformers is as you suggest. I.P. of course is the beginning end of the primary, and I.S. the beginning end of the secondary, both windings being wound on in the same direction. In joining the transformers up in this manner, the maximum voltage is impressed between grid and filament.

"H.E.N." (Oakham).—We are sorry your letter is not very clear. You say you have two L.F. valves in your three-valve set now. You therefore have already a note-magnifying valve. If you wish to add another L.F. valve, you will require one L.F. intervalve transformer, one valve socket, and filament resistance. Use a valve of the same type as that already in use in the L.F. portion of your set. We suggest you consult the advertising pages of our journal. You should have no difficulty in choosing an L.F. intervalve transformer; obviously we cannot recommend any particular manufacturer's product.

"ELECTRIC" (Sunderland) asks (1) *The correct way to connect up L.F. transformers and H.F. transformers.* (2) *The size of former, size of wire and number of turns for a H.F. transformer to tune from 360 to 440 metres.*

(1) If the two windings of the L.F. transformer are wound on in the same direction, the primary winding being put on first, the beginnings of the windings are labelled I.P. and I.S., and the ends of the windings are labelled O.P. and O.S. I.P. is connected to +H.T.; O.P. is connected to Plate; I.S. is connected to Grid; O.S. is connected to

—L.T. If the H.F. transformer consists of a tube upon which one layer of wire is wound for the primary and a layer of wire is wound over the primary for the secondary in the same direction, the ends are taken thus:—I.P. is connected to +H.T.; O.P. is connected to Plate; I.S. is connected to —L.T.; O.S. is connected to Grid. If the H.F. transformer is of the usual plug-in type construction, and the two windings are wound on in the same direction in the groove, the ends are connected thus:—I.P. is connected to +H.T.; O.P. is connected to Plate; I.S. is connected to Grid; O.S. is connected to —L.T. The connecting up of transformers is important, in order that the capacity of the winding of the transformer shall assist as far as possible the electromagnetic transformer action, to provide maximum potential variations between the grid and filament of succeeding valves. (2) The former may be a piece of ebonite 1.1/8" diameter, on which is wound a primary and secondary winding of 450 turns each. The wire may be No. 36 to No. 42 S.S.C. upper.

CORRECTIONS.

Mr. G. Breit, author of "Amplitude of Electrical Oscillations, generated by Electron Tubes," which appeared in the issue of July 22nd, 1922, notifies us that the following corrections should be made:—

Page 519, line 8: Omit period after (II).

Page 519, Equation (V), should be:

$$\frac{(\dot{v}_1 - av_1)^a}{(\dot{v}_1 - \dot{a}v_1)^a} = \frac{(\dot{v}_0 - av_0)^a}{(\dot{v}_0 - \dot{a}v_0)^a}$$

First line below Equation (V) should read:

"This means that $\frac{(\dot{v} - av)^a}{(\dot{v} - \dot{a}v)^a}$, etc."

Page 520, second line of Equation (5) should begin with $\beta \log v$ and not $\beta \log \dot{v}$.

Page 520, line 4 bottom: "is the value of v "—"f" omitted in "of".

Page 520, (Equation (7) should be:

$$y_A - y_{A_1} = \beta \log \frac{v_{A_1}}{v_A} \quad \text{Bar omitted in } y_A.$$

Page 521, line 2 top: "Therefore, if

$v_P = v_A \epsilon^{(y_A - y_P)/\beta}$, etc.,"—first y omitted in exponent.

Page 521, line 19, bottom: "Now clearly for an infinite"—*infinitive* is inserted instead of "infinite."

Page 522, line 9, bottom: " $v = V - \frac{E - a\delta}{1 + \delta}$ "

fraction line is omitted in $\frac{a\delta}{b}$.

Page 523, line 2, in "Illustration." Fraction line omitted in $\frac{\dot{v}}{v}$.

SHARE MARKET REPORT.

Prices as we go to press on October 13th are:—

Marconi Ordinary	£2	10	0
" Preference	2	5	7½
" Inter. Marine	1	8	0
" Canadian	11	0	

Radio Corporation of America:—

Ordinary	1	0	10½
Preference	15	0	

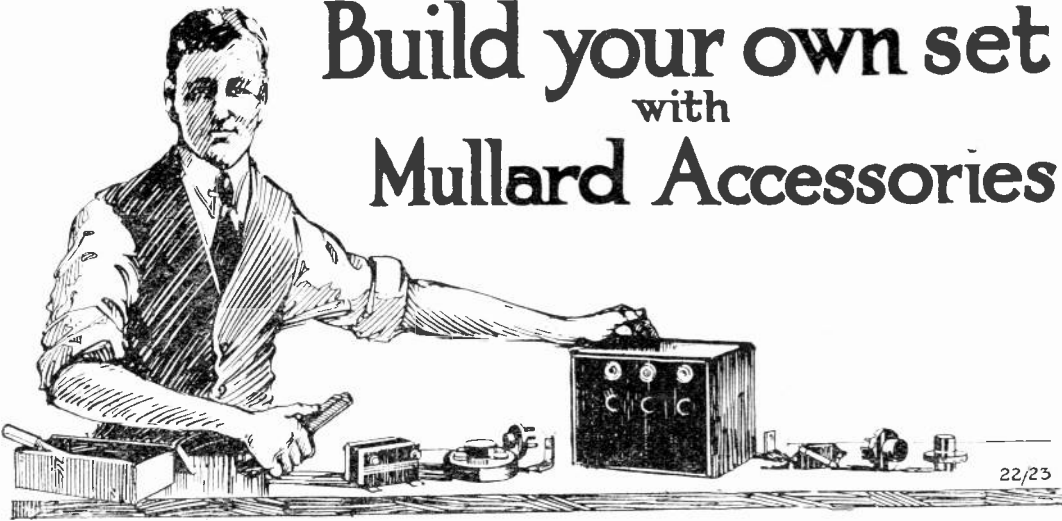

22/23

Build your own set with Mullard Accessories

The wireless components with a world-wide reputation of many years' standing. They will ensure your getting a set which looks well, works well and "speaks" well.

For receiving vocal and instrumental items you must have the **MULLARD "ORA" Valves** to get the best results.

Oscillates—Rectifies—Amplifies
Specially recommended where good amplification is required.

15/- each

IMPORTANT NOTICE

The great demand for Mullard "ORA" Valves and other accessories has compelled us to open much larger works. A greatly increased output is now available.

The MULLARD "R" Valve is now reduced in price from 22/6 to 17/6

Mullard Radio Valve Co. Ltd.

45, Nightingale Lane, S.W.12.

Contractors to H.M. Admiralty,
War Office, Royal Air Force & Post Office.

Telephone: Codes: Telegrams:
Battersea 1908 ABC(S Ed) "Radiovalve, Hammer" Lond.
Bentley's



Please send me just for...

Quantity	Description and Price
.....	Telephone Head Sets 90/- per set
.....	ORA Valves .. 15/- each
.....	Grid A Resistances .. 5/- each
.....	Anode A or B Resistances 5/- each
.....	EA Condensers 0003 mfd. 2/6 each
.....	Combined Resistances 7/6 each
.....	Valve Bases .. 7/6 each
.....	Valve Sockets .. 5/- each
.....	Terminal Clips .. 1/8 each
..... 8/- per pair

I enclose (Cheque, Money Order, P.O.) value
to cover the cost.

Name of your Wireless Dealer:

SEND THIS TO-DAY

Glasgow Depot: 15, Woodside Terrace

Newcastle Depot: 17, Sandhill.



4000 OHMS
IN SERIES
EVERY SET TESTED
AND GUARANTEED

27/6

Complete
[with
Flexible

SPECIAL TERMS
TO THE TRADE

THE "SENSIFONE"

THESE HEADPHONES ARE SO NAMED BECAUSE THEY ARE SO HIGHLY SENSITIVE TO EVEN THE WEAKEST SIGNALS. "SENSIFONES" ARE ALL THAT MODERN SKILL CAN MAKE THEM. YOU MAY GET A MORE EXPENSIVE SET, BUT YOU WILL NOT GET A BETTER. THEY ARE MADE RIGHT.

SOLE MAKERS:

TOWNSHEND'S LD. ERNEST STREET
BIRMINGHAM

Agents and Showrooms:

LONDON: COWARD & CO., 81, CHARLOTTE STREET, W.1.

MANCHESTER: COULSTON & CO., 5, CROSS STREET.

NEWCASTLE: R. F. SUNDERLAND, MILBURN HOUSE.

GLASGOW: CLARKSON HOOD & CO., 45, HOPE STREET.

"For they are jolly good Fellows"

Precision Air Condensers

For series of parallel tuning use Fellows Precision Air Condensers. They are equally suitable for separate use or panel mounting. Made in four standard sizes.

·0002 mfd. - - Price 16/- (postage 6d.)

·0003 mfd. - - Price 17/6 (postage 6d.)

·0005 mfd. - - Price 22/6 (postage 6d.)

·00005 mfd. vernier Price 8/6 (postage 6d.)

All Fellows radio components are British Made throughout and fully guaranteed

FELLOWS MAGNETO Co., Ltd.

LONDON, N.W.10.

Telephone—Willesden 1560-1.

Telegrams—Quixmag, Phon London.

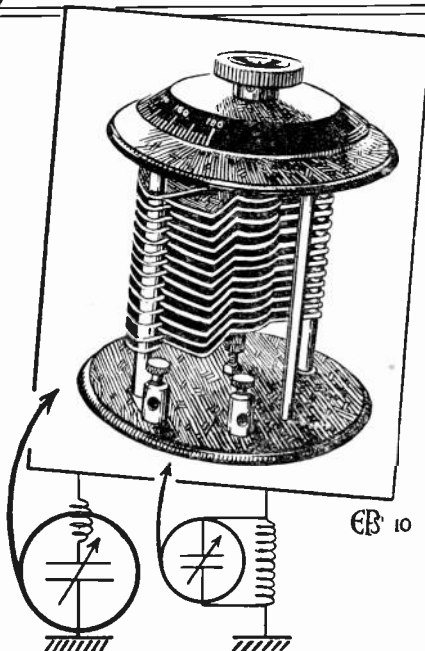

"BRITWIRE" APPARATUS

Ask any visitor to the Exhibition which stand they visited first *and* last, and ten to one the answer will be the "BRITWIRE" Stand. Because, as hundreds actually told us, the finish and price of our instruments and accessories left nothing to be desired.

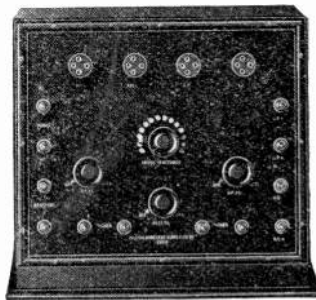

"BRITWIRE" Mk. III Receiver, one H.F., one Rectifying, one L.F. valve, efficient for telephony and morse on all wavelengths.

Price - - - **£12 10 0**

"BRITWIRE" Mk. IV Receiver as above, but with two note magnifying valves.

Price - - - **£16 10 0**

"BRITWIRE" Tuner as illustrated, with series parallel switch

Price - - - - - **£7 10 0**



"BRITWIRE" Note Magnifiers.

Single Valve	- -	£3 0 0
Two Valve	- -	£5 5 0
Three Valve	- -	£7 10 0



Send for Illustrated List - - Post Free 3d.

Agents required in all large Towns.

All the above valve apparatus licensed under Marconi patents for amateur use in Gt. Britain.

POST ORDERS TO

BRITISH WIRELESS SUPPLY CO., LTD.

6, BLENHEIM TERRACE, LEEDS.

Tel : 28926.

18, ELDON SQUARE, NEWCASTLE-ON-TYNE.

Tel : 360 CITY.

33, HIGH STREET, SOUTHAMPTON.

Tel : 403.

11, CHURCH STREET, WEST HARTLEPOOL.

Tel : 873.

WORKS : LEEDS.

The London Telegraph Training College, Ltd.

Telephone
WESTERN 2696.

Morse House, Earl's Court, S.W.

ESTABLISHED
25 YEARS.

OFFICIALLY RECOGNISED BY THE WAR OFFICE AND POST OFFICE AUTHORITIES

CABLE AND WIRELESS TELEGRAPHY.

PARENTS desirous of placing their sons in either of the above Services and of affording them the best training facilities should apply for particulars of Courses and the methods of instruction which place this Institution in the first rank. **Cable Telegraphy** offers at the present time excellent prospects to youths from 15 years of age and upwards, and the **College has exclusive facilities** for obtaining posts for qualified students in the leading Cable Companies at **commencing salaries** of £150 to £300 per annum, with yearly increments of £12 to £25, and ultimate possibilities of obtaining positions as Supervisors, Assistant Superintendents, Managers, etc.

In the Wireless Telegraph Service the commencing remuneration at the present time is approximately £150 per annum, and Operators, when qualified by obtaining the Postmaster-General's Certificate of Proficiency, are nominated by the College for appointments.

No Correspondence Classes or Branches.

DAY AND EVENING CLASSES.

Prospectus containing all information will be forwarded on application to

THE SECRETARY (Dept. H.), 262, Earl's Court Road, Earl's Court, London, S.W.5

Sole Proprietors of the "Scott" Training Disc, which contains useful formulæ and other information for Wireless Telegraph Operators and is invaluable to Army Signalling Officers for range finding, etc.

Price, complete with instructions for use, 1/-. Postage 2d.

DIRECT FROM MANUFACTURERS.

TTW



WIRELESS HEADPHONES	}	4,000 ohms £1 0 0 each.
POLISHED & NICKEL PLATED		
DURALUMIN HEADBANDS		
ALUMINIUM CUPS		
REAL EBONITE EARPIECES		
DOUBLE PLATE MAGNETS	}	8,000 " £1 10 0. "
REPLACEABLE COILS		

Postage 1/-

A Triumph of British Manufacture.

Single ear-	2,000 ohms.	7s. 6d each, postage 6d.
phones as	3,000 "	10s. " "
above	4,000 "	12s. 6d. " "
Spare Coils	1,000 "	2s. " "
	1,500 "	3s. " "
	2,000 "	4s. " "

All fully tested and guaranteed.

Variable condensers 43 Plate '001 M.F. Moving dial. Mounted in polished teak case 14s. each, postage 9d.

2 Valve Set. Treble tuning device. Double Condenser. Separate Filament resistances. H.F. Panel and Detector Panel in polished teak case, £5 10s. 0d.

3 Valve Set as above with L.F. Amplifier	£7 0 0
4 " " 2 L.F.	£8 10 0
5 " " 3 L.F.	£10 0 0

Valves, Coils and Phones extra.

Goods sent to your nearest wireless dealer on approval.

Turnocks Telephone Works, Aston, Birmingham.

I MAKE MY DÉBUT

I am the "HESTAVOX" Broadcast Receiver

LOOK AT MY PHOTOGRAPH—READ MY GUARANTEES

Manufactured under licence from Marconi's Wireless Telegraph Co. Ltd.

My makers deliver me FROM STOCK

My Price (exclusive of accessories) is:

£4:17:6

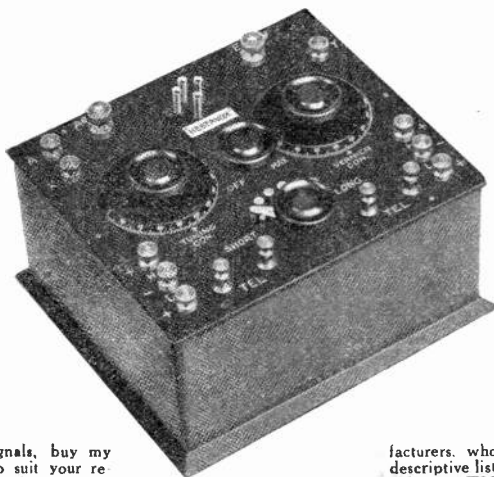

Fully approved by H.M. Postmaster-General for Broadcast Reception.

My makers deliver me FROM STOCK

My Price (inclusive of all accessories) is:

£8:18:6

If you wish to amplify my signals, buy my brothers, the "Hestia" Units, to suit your requirements. Below is the address of my manu-

facturers, who will send, post free on request, descriptive lists of myself and my Unit Brothers, either to THE TRADE or to individuals.

THE HESTIA ENGINEERING COMPANY, (Dept.W.)

Telephone: CHISWICK 586.

32, Palmerston Road, Acton, London, W.3.

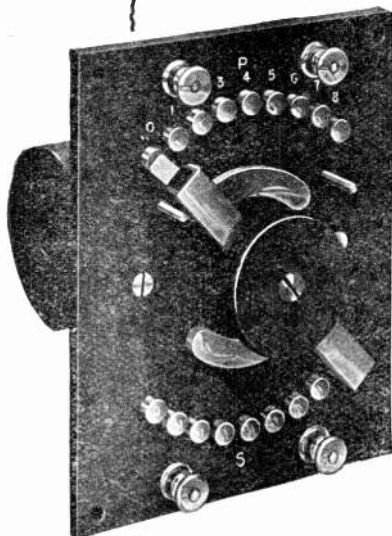

9 stage H.F. Transformer, tapped primary and secondary. Range 150-25,000 metres.

COMPLETE sets of Wireless Apparatus in stock ready for immediate delivery; also Amplifiers, Tuners, Loud Speakers and all components.

WE place our experience at your disposal—send your enquiries, or call—we will gladly give you expert advice.

NEGRETTI & ZAMBRA

RADIO DEPT.,

38, HOLBORN VIADUCT, E.C.1

LONDON

SHEET, ROD AND TUBE stocked in qualities suitable for all Wireless work.
KNOB (Moulded), various patterns stocked
CONDENSER DIAL AND KNOB.
 3" and 4" dia.—0°—100°

*Watch this Advert.
 for new mouldings.*

EBONITE
 (HARD RUBBER)

Enquiries Solicited.

WHOLESALE ONLY.

AMERICAN HARD RUBBER CO.

(BRITAIN) LIMITED

13a, FORE STREET, LONDON, E.C. 2
 Teleg. "Eboniseth, Ave., London." Phone: Central 12754

THE ZODEL COIL WINDER

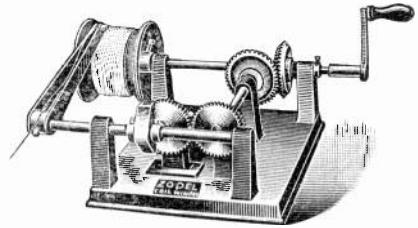

FOR DUO-LATERAL FORM COILS.

Why pay high prices for coils when you can produce the best Duo-Lateral formation type for the mere cost of the Wire?

The Zodel Machine is designed on scientific lines. Built by engineers. So simple that a child can use it. Winds Duo-Lateral Coils in a couple of minutes on any former, from 3/16" to 1" wide. The Coils produced have been proved to have the lowest distributed capacity.

CASH PRICE **£2 : 0 : 0** POST PAID

Obtainable from all Wireless Stores or direct from—

WALLACE HEATON, Ltd., RADIO EXPERTS
 84, HIGH STREET, SHEFFIELD.

SEA, LAND and AIR

THE AUSTRALIAN MONTHLY JOURNAL of Aviation, Radio-Telegraphy & Radio-Telephony

Price **1/9**
 Post Free

Annual Subscription **21/-**

THE WIRELESS PRESS LIMITED
 12/13, Henrietta St., London, W.C.2

BUTLER'S RELIABLE MANUFACTURES

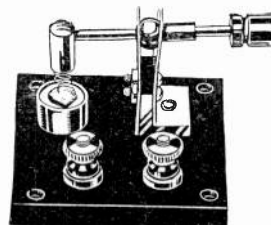

Crystal Detector. Super-sensitive contact, ebonite base, fully lacquered. 4/9 each. Postage 6d.

Well finished brass valve socket, centre of thread bored for soldering. 3d. each. Postage extra.

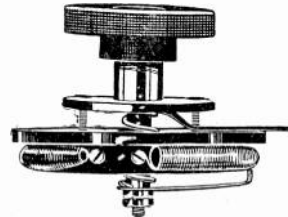
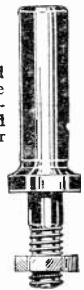

Best workmanship, ebonite throughout, filament resistance. For 1 to 3 valves, 5/8. If mounted on panel with 2 terminals 7/6



First-class finish, Cut out of the solid rod. Complete with fixing screw . . . 1/4 Postage 3d.

Terms cash with order. Fully illustrated list post free 3d.

H. D. BUTLER & CO., LTD

Office & Showrooms:
 Bank Buildings, 222, Gt. Dover Street, Borough, S.E.1
 Telephone: Hop 3029. Works: Canonbury, London, N.1.
 Works North 1838. Telegrams: "Ingenuity Phone, London."

P. ORMISTON & SONS
 (P. H. ORMISTON) :: ESTABLISHED 1793
 79 Clerkenwell Rd., London, E.C.1
 "Ormiston, London." :: :: 13259 Central.

Silk and Cotton Covered H.C. Copper Wire, Resistance Wires, Fuse Wire, Binding Wires, Charcoal Iron Core Wire, Asbestos Covered Wire, Braided and Twisted Wires, Bare Copper Strand and Flexibles of any Construction, Wire Ropes, and Cords (fine sizes) in Galvanized Steel, Phosphor Bronze, &c.

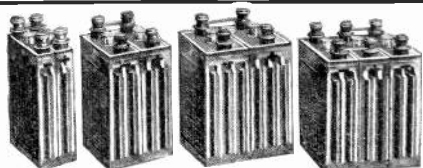

**EFFICIENT—WELL FINISHED—
 MAXIMUM CAPACITY—LOW PRICES.**

Send for Complete Lists.

THE ESSEX ACCUMULATOR CO., LTD.
 499, Grove Green Road, Leytonstone, E.11.
 Telephone: Wanstead 749.



SKINDERVIKEN BUTTON.

A Supersensitive Microphone.

Known all over the world and patented in every civilized country. Over 60,000 sold. **ENGLISH** Manufacture.

Make up your own Loud Speaker.

Transmit your **GRAMOPHONE** music to any room in your house.

The only practical Microphone for use in Detectophone Sets.

Price 5/- each

Special Low Resistance Receivers (for use with Skinderviken Buttons) 10/- each

Special Gramophone Attachments 1/- "

Write for 16 page **BOOKLET** fully illustrated and containing much useful information for all interested in Electrical Sound Transmission. 6d. Post free.

Sole Proprietors:

MIKRO LTD., 274/6, Pentonville Rd., London, N.1
 (Opp. King's Cross (Met.) Rly. Station).

OUR SPECIAL LINE

Only
 1/6 doz.
 Postage extra



49/1

Complete
 Illustrated lists
 Two Stamps

ELECTRICAL SUPPLY STORES
 5, ALBERT TERRACE, KING CROSS, HALIFAX

SPEARS and COMPANY
 FOR

TERMINALS

SCREWS, NUTS, WASHERS, PLUGS and SOCKETS, CONTACT STUDS, BUSHES, VALVE LEGS, CONDENSER VANES and TURNED and PRESSED PARTS OF EVERY DESCRIPTION.

Actual Manufacturers to **TRADE ONLY**

We regret we cannot supply small lots to Amateurs.

Write for Illustrated List.

CAPSTAN REPETITION WORKS,
PARK ROAD, HOCKLEY, BIRMINGHAM
 Telephone: 3265 Central. Telegrams: "Firettes, Birmingham"

THE
PARAGON RUBBER MANUFACTURING CO.
SCULCOATES, HULL. LTD.

E B O N I T E
 Sheet, Rod & Tube
ELECTRICAL
MOULDINGS

W I R E L E S S
KNOBS, LOUD
S P E A K E R S
SLIDERS, Etc.

Wholesale only.

London Office: **PERCY W. C. TRICK,**
 20, LITTLE PORTLAND STREET, W.1
 Telephone: MUSEUM 2043.

" EIFFEL TOWER TYPE."

MASTS

STRONG. LIGHT.
WOOD LATTICE. EASY TO ERECT.
ROT AND WATER PROOF.

20 to 50 feet - - - 1/3 per foot
 55 " 100 " - - - 1/9 " "

FROM STOCK. CASH WITH ORDER.

WILKINSON, Lonsdale Road, Kilburn, N.W.6

Same Address since 1900. Trade Supplied.
 Bankers—LONDON CITY AND MIDLAND, KILBURN, N.W.6.

**WIRE-
 LESS**

FOR PROFESSION OR BROADCAST.

DAY AND EVENING CLASSES: Correspondence Classes with Instrument work at School if desired. Postal Course on Valves. Classes for Amateurs and Experimenters.

CABLE AND INLAND TELEGRAPHY. Send for Pros. Radio supplies, List A, from **JAS. FRASER & CO.**

Telephone:
 No-th 1036

ELECTRICAL TRAINING COLLEGE,

**Radio House, Manor Gardens,
 Holloway, London, N.7.**

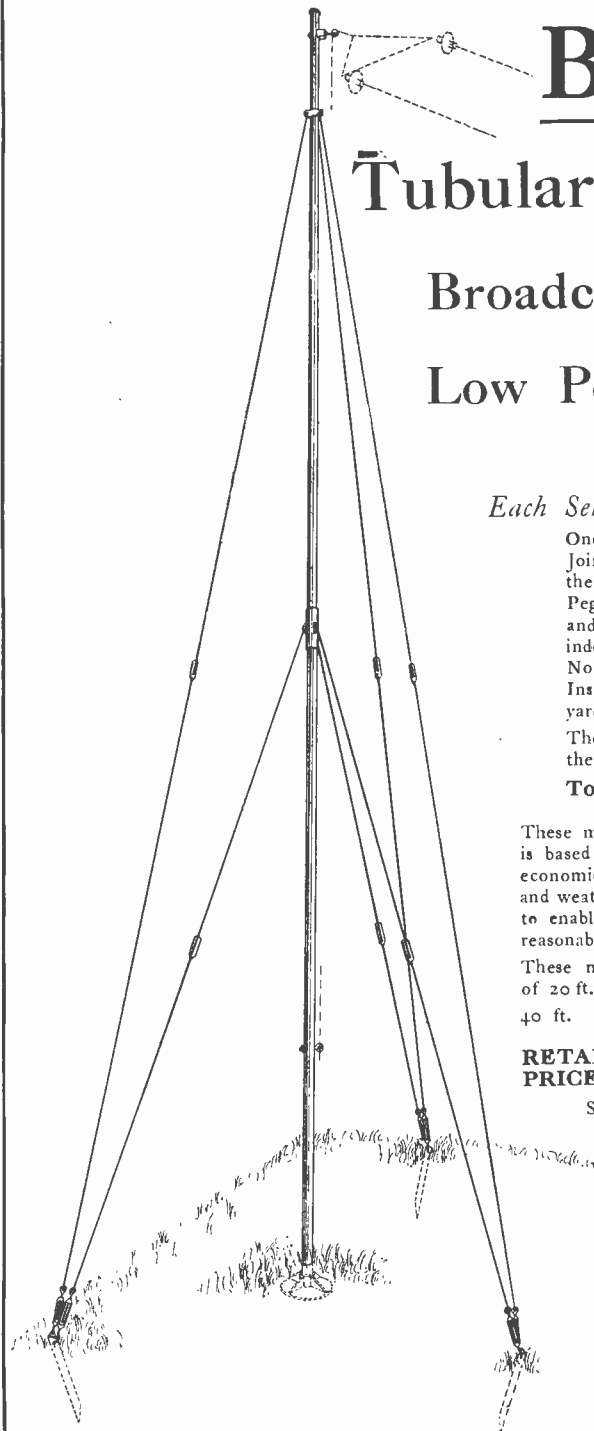

BULLERS'

Tubular Steel Mast Sets

for

Broadcasting Reception

and

Low Power Transmission

HEIGHT 35' 0"

Each Set consists of :

One Top Tube, one Bottom Tube with Shoe and Joint Socket, Six Double Swivels for adjusting the Stay Wires. One 3-Way Stay Clip. Three Stay Pegs of Angle Iron, 2 ft. long pointed at one end and provided with a hole in each flange for independent adjustment of Stays. 180 ft. of No. 12 Flexible Steel Wire Rope. Six Guy Insulators, Patt. E.A. 8760. One Aerial Halyard Pulley and Eye Bolt for securing Halyard. The whole of the Metalwork is galvanized except the Stay Pegs, which are oiled.

Total weight of Tubes & Socket 59 lbs.

These masts are light, strong, and the general arrangement is based on sound engineering practice. The design is as economical as is possible, consistent with necessary strength and weathering capabilities; sufficient stay wire is provided to enable the erector to vary the staying points within a reasonable margin.

These masts can conveniently be erected on a base of 20 ft. diameter.

40 ft. masts can be supplied at slight extra cost.

RETAIL PRICE : £3 : 15 : 0 per set complete.

SPECIAL TERMS TO THE TRADE.

BULLERS, Ltd.

**6, Laurence Pountney Hill,
London, E.C.4.**

Phone:
CITY 985/6.

Works :
HANLEY, } STAFFS.
TIPTON, }
MILTON, }

BULLERS' WIRELESS INSULATORS

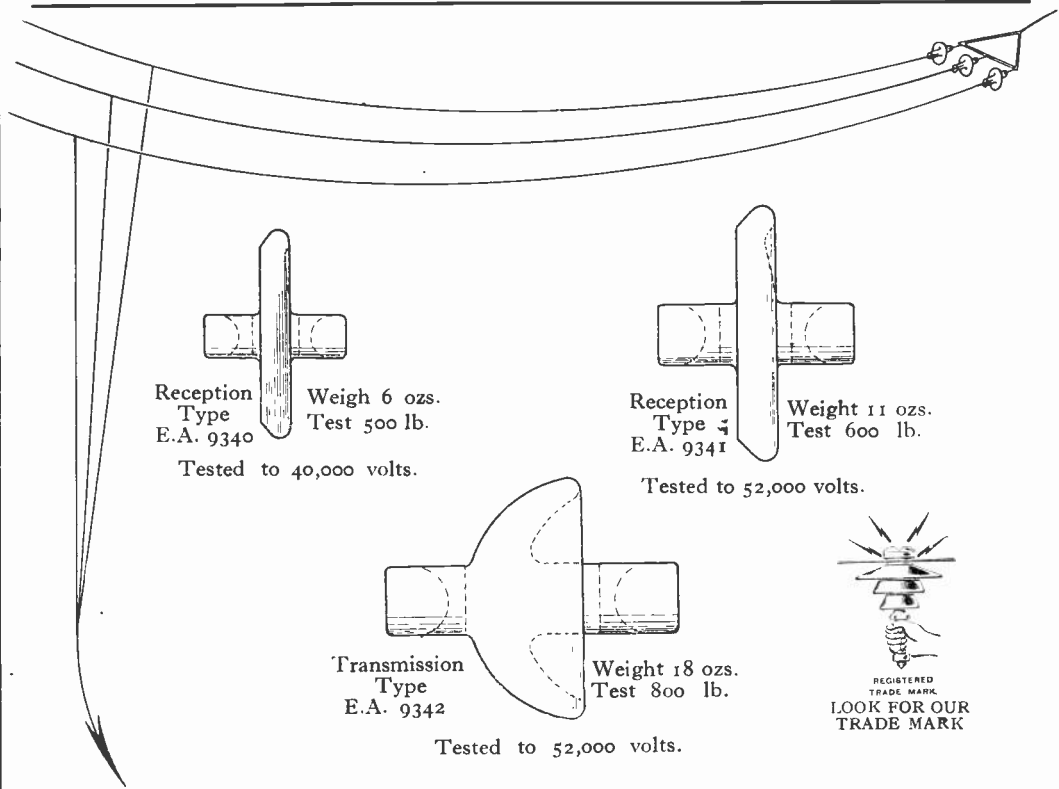

Reception Type E.A. 9340
Weigh 6 ozs.
Test 500 lb.
Tested to 40,000 volts.

Reception Type E.A. 9341
Weight 11 ozs.
Test 600 lb.
Tested to 52,000 volts.

Transmission Type E.A. 9342
Weight 18 ozs.
Test 800 lb.
Tested to 52,000 volts.

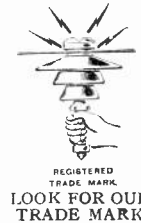

These insulators, of which we are the originators, have been specially designed by us for Broadcasting reception, and Low Power Telegraphic and Telephonic Transmission.

Advantages over other types:—

- I. Very Low Capacity.
- II. Instant Shedding of Rain.
- III. Negligible Weight.
- IV. Highest Insulation Possible.
- V. Great Tensile Strength.
- VI. Easy to attach to Aerial or Halyard.

Trade Enquiries Solicited.

BULLERS L^{TD.} 6, Laurence Pountney Hill, LONDON

Phone : City 985/6

Works : TIPTON, HANLEY, MILTON, STAFFS

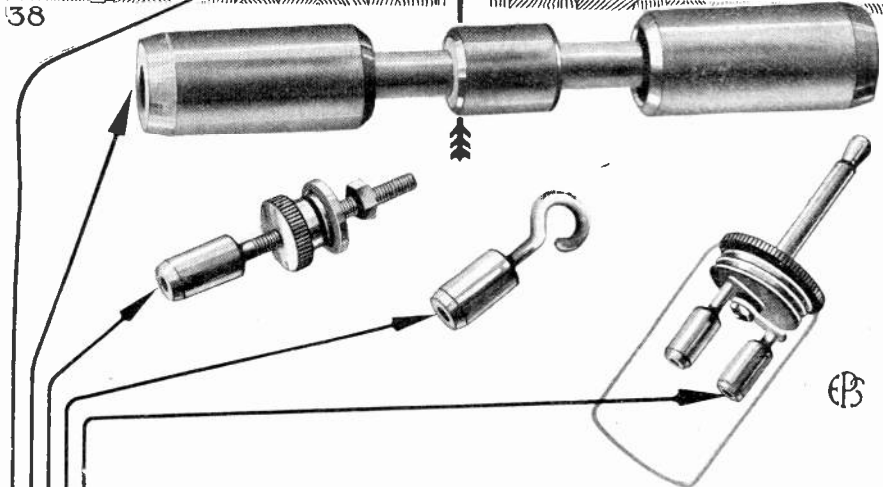
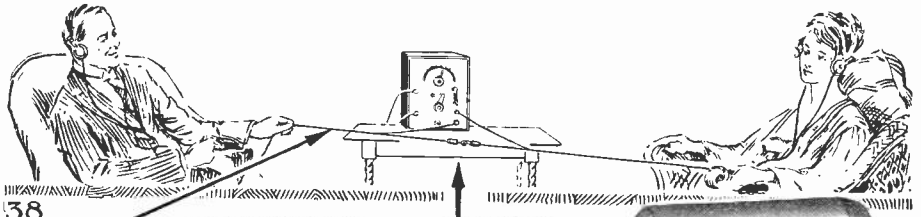

(1) The self-tightening bull-dog grip fitted to the Elwell plug enables telephones or loud speaker connections to be changed in a moment.

(2) By the terminal adaptor, the bull-dog grip connector can be added to any existing terminals.

(3) For fitting to the face of a panel this pattern is recommended. It combines a standard terminal for fixed connections with a bull dog fitting for connections which you require to change.

(4) A series connector with a bull-dog grip at each end. Invaluable for connecting telephones in series.

(5) The series connector in use. Telephones can be connected in series in an instant. No amount of pulling can break the connection. It thus avoids those annoying interruptions caused by involuntary movements.

BULL DOG GRIP CONNECTORS

Elwell patented self-tightening grip fittings are a big convenience. Without soldering, tightening of nuts or screws or the use of any tools whatever, electrical connections can be made, broken or changed in a moment.

Moreover, the connections when made are electrically perfect and self-tightening. **The more you pull them the tighter they grip.** But they can be released in a moment when desired.

Ask to see them at your wireless dealer or write for descriptive leaflet.

C. F. ELWELL, LTD., *Radio Engineers,*
CRAVEN HOUSE, KINGSWAY, LONDON, W.C.2

Telephone: REGENT 421.

LESLIE McMICHAEL LTD.

PROVIDENCE PLACE, WEST END LANE, KILBURN, N.W.6

Bus Services 1, 8, 16, 28, 31 all pass West End Lane

Telephone: HAMPSTEAD 1261 Nearest Tube Station: KILBURN PARK (BAKERLOO)

**M.H. 3
SET
£14 14**

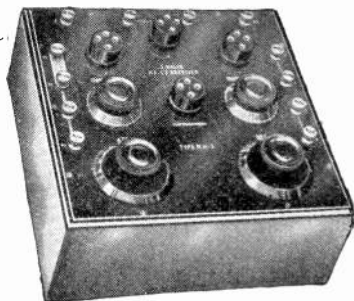
**Accessories**

necessary to make this set into a complete station including aerial, insulators, accumulators, high tension battery, head telephones, Valves, etc., etc.

About £12

A THREE-VALVE SET making use of high and low frequency with highly polished ebonite panel and mahogany box

FOR APPEARANCE *Our* **M.H. SETS**
FOR DESIGN **—** (1 Valve to 5 Valve) are
FOR PERFORMANCE **UNEQUALLED**

THE AMATEUR who, without previous experience, desires to hear **Paris and Berlin** time signals, and music, the weather reports and speech from **Croydon** and other air stations, the **Marconi, Writtle, and Dutch Concerts**, will find the **M.H.3** an ideal instrument—easy to manipulate and as ornamental as it is efficient.

All the above Valve Apparatus licensed under
Marconi patents for amateur use in Great Britain

THE TRADE will find the handling of these **M.H. Sets** and accessories highly profitable—satisfied customers mean recommendations and increased business. Our experience and advice is always at their service. We have scores of satisfied users of these sets all over the country.

Send for full Price List (illustrated) of M.H. Sets and Accessories.

Astounding Value.

OOJAH BASKET INDUCTANCES, 300-3,000 metres, set of 7, 5/-, post 4d.

EX-GOVERNMENT SINGLE EAR PIECE HEADPHONES, wound to approx. 4,000 ohms, 9/6 each, post 6d., guaranteed.

SEMITONE CRYSTAL. The perfect Mineral Detector, 1/-, post free.

KNIFE SWITCHES ON EBONITE, D.P.D.T., 2/3. S.P.D.T., 1/6. S.T.D.P., 1/6. Post 3d.

BLACK INDICATION TABLETS, engraved white, per set of 10, 2/6.

FILAMENT RESISTANCES for Panel Mounting, 3/6, post 4d.

MARK III TERMINALS, with nuts, 2/3 per doz., post 5d.

TUNING STAND for Honeycomb or Duo-Lateral Coils, 2-Coil Stand, 10/6; 3-Coil Stand, 15/6; post 8d. Coil Holders, 1/3 each, 13/6 per doz., standard pattern.

L.F. AMPLIFYING UNITS for adding to crystal, valve sets and panels for Loud Speakers, etc., mounted into Walnut Cabinet, 6" x 8", 1 valve, 37/6; 2 valves, £3 3s. Post 1/-.

THE POPULAR VARIABLE CONDENSER. Guaranteed, silent in action and the finest value ever offered—

Mfd.	Mounted in Cabinet.	Panel Mounting.	Sets of Parts.
.0003	14/6	11/-	5/6
.0005	17/6	14/-	7/6
.001	22/6	19/-	11/6

The sets of parts include Ebonite drilled ready for fitting. Cabinets 3/- extra. Engraved dials with panel mounting type. Postage 9d. extra.

RADIO, ELECTRICAL & MECHANICAL SUPPLIES.

SCIENTIFIC SUPPLY STORES

8, NEWINGTON CAUSEWAY,
LONDON, SE1.

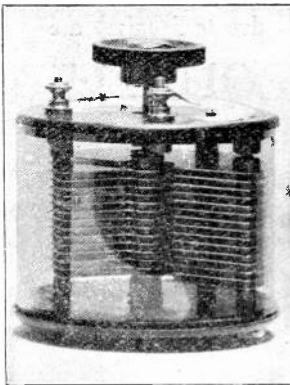

IMPROVED TYPE

CONDENSERS.

Dust Proof Celluloid

Case—

.001, each 24/-

.0005, each 17/6

.0003, each 15/-

Vernier ... 12/6

(3 or 5 plate).

VARIABLE AIR

CONDENSERS.

Panel Type with

Knob—

.001, each 19/-

.0005, each 12/6

.0003, each 10/-

Vernier, each 5/-

(3 or 5 plate).

Bevelled Scales, 3/6

extra.

Ivory Scales, 9d.

each.

Condenser Knobs, 3d.

each. Bushed

2B.A.

Condenser Vanes, 7d. doz. Fixed or moving.

Large Spacing Washers, 3½d. doz.

Small Spacing Washers, 2½d. doz.

Screwed Rod, 3½d. per ft. length, 2B.A.

Filament Resistances, 3/6. Slightly damaged, 2/-.

Laminated Switch Arms, 1/9.

Valve Holders, with nuts, 1/-.

Complete sets of parts to make up valve panels, engraved, from

£1.

H.F. Amplifier Panels, complete from 30/-.

High F. Transformers, from 2/6.

L.F. from £1.

Mark III Type Terminals, 2d. each, 1/10 doz.

Insulating Sleeving, 5d. yard, 4/6 doz. all colours.

Plug in Coils and Coil Holders.

B. L. HOUSTOUN, 65, Endell St., W.C.2

Phone: Regent 4911.

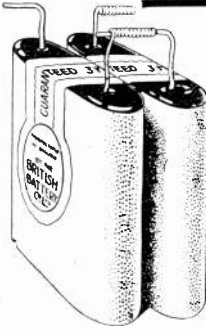

Dry Batteries for Wireless Sets

No. 1 W. Standard Pocket-lamp size, 4½ volts (as illustration), with patent spiral wire terminals for connecting in series.

Insert straight terminal in spiral of next battery and bend same, no soldering required.

PRICE 7/- Per doz.

(Carriage Paid)

No. 1 W.

Connect as Illustration.

(Patent applied for).

NOTE.—(1 doz. = 54 volts).

No. 2 W. Slab. 15 volts (11 cells), 3 screw terminals, size 9" x 7" x 2½" high.

PRICE - - - 3/- EACH

(Carriage Paid)

No. 4 W. Rectangular. 36 volts, 1 screw terminal and 8 plug holes with wander plug. Size 6½" x 2½" x 2½".

All BRITISH MADE PRICE 7/- EACH
and Prices quoted are
for Carriage Paid. (Carriage Paid)

Manufactured by—

THE BRITISH BATTERY Co., Ltd.
Clarendon Rd., WATFORD, HERTS.

(Telephone: Watford 617.)

ACCUMULATORS

100 Only Left. 4 volt, 60 amp.
at 17/6 each.

Packing Free.

Carriage Forward.

Our usual High Quality.

Subject to Trade Discount.

Three hundred sold last week, no more than six can be sold to any one customer, this will allow everyone to have a fair chance to obtain one of the above BARGAINS.

ORDERS taken in Rotation. We apologise for delay. Offered subject to being unsold when this advert. appears.;

4 Volt 24 Amp. at 11/9 each. Postage 1/-.

2 Volt 16 Amp. (in ebonite case), at 3/9 each. Post free.

2-Volt Pocket Lamp, flat type, in celluloid, 12/- per dozen.

4 Volt 40 Amp. .. 18/6 6 Volt 40 Amp. .. 26/3

4 Volt 80 Amp. .. 28/2 8 Volt 60 Amp. .. 31/9

4 Volt 100 Amp. .. 30/- 8 Volt 80 Amp. .. 37/3

6 Volt 100 Amp. .. 41/6

WIRELESS ACCESSORIES.

WRITE FOR LISTS.

TRADE ENQUIRIES SOLICITED.

F. YATES & Son, Ltd

WHOLESALE ELECTRICIANS,

144, Church St., Kensington, London, W.8

One Minute from Notting Hill Gate Station,
Central London and Metropolitan Railways.

Phone—
Park 4276.

The "Broadway" Radio Works
DEVONSHIRE ROAD, BEKLEYHEATH, KENT.

We are now offering TWO types of CRYSTAL SETS, one with a range of 200 to 3000 metres at £4 0 0 and another which is specially designed to give maximum efficiency on the Broadcasting Wavelength at £3 15 0. Both sets are fitted in a beautifully finished Solid Mahogany French Polished Cabinet with lid.

High Resistance Phones £1 10 0 to suit Sets.

CONDENSERS

Value in M.F.	Panel Mounting in Parts	Panel Mounting Assembled	Cabinet Mounting in Parts	Cabinet Mounting Assembled	Cabinet Mounting Assembled in Cabinet	Polished Mahogany Cabinet
.0015 ..	23/-	25/6	24/-	26/6	33/-	6/3
.001 ..	16/9	19/6	17/9	21/-	26/-	5/6
.00075 ..	13/6	16/3	14/6	16/6	22/-	5/6
.0005 ..	10/6	13/-	11/9	13/9	18/-	4/6
.0004 ..	10/-	12/6	11/-	13/3	17/6	4/6
.0003 ..	9/-	11/6	10/-	12/-	16/-	4/-
.0002 ..	7/-	9/-	8/-	9/6	13/6	4/-
.0001 ..	6/-	8/-	7/-	8/6	12/6	4/-
Vernier ..	—	4/6	—	5/-	9/-	3/6

Fitted with Bevelled Ebonite Dial 1/9 extra.

Special Sizes Made to Order. Price list on request.
ALL SUNDRIES AND COMPONENTS IN STOCK.
ORDERS OVER 20/- CARRIAGE PAID.
Trade Enquiries Invited.

Do You Own a Small Engineering Business ?

Why not convert it into a Company, become a Director, and enjoy limited liability ?

Do You Hold a Patent ?

Why not form a Limited Company, and take Cash and Shares for your invention ?

Charge for preparing all official documents, including supplying Registers, Share Certificates, Seal and Minute Book.

£8 : 8 : 0

Plus Stamp Fees and Duties.

Registrations in strict confidence effected by qualified staff holding undeniable credentials

Send Stamp for particulars to

Harold V. Steele, F.C.I.S.,

Chartered Secretary,

93, Maybury Road, WOKING, SURREY.

THE MARK OF



RELIABILITY

1 to 12 volts.

1 to 35 amps.

VOLT & AMMETER

Combined Dead Beat Pocket Type. New and not German. Splendid Instrument in Nickel Plated Case. Ideal for Testing Cells and Filament Current.

POST PAID **5/6** NUMBER LIMITED

OTHER EXCEPTIONAL VALUES.

- Aerial Wire. Enamelled Hard Drawn, 7/22's Copper, 5/- per 100'.
- Aerial Wire. Bright Hard Drawn, 7/22's Copper, 3/6 per 100'.
- Aerial Insulators. Shell type, 2" x 2 1/2", 9d. each.
- Aerial Insulators. Reel type, 2" diameter, brown, 3d. each.
- Filament Resistances. For panel mounting, 2/6 each.
- H.F. Transformers, plug in type, 300 and 700 metres, 4/- each.
- H.F. Transformers, plug in type, 1,000 m. 4/6; 2,600 m. 5/6 each.
- H.F. Transformers. Formers only, with pins, 3/- each.
- Tangent H.F. Transformers. All ranges, 6/8 each.
- Switch Arms. Complete fit ed with knob, 1/- and 2/6 each.
- Dewar Switches. D.P. Change over, panel type, 2/- each.
- Lightning Arresters. Carbon block type, 1/6 each.
- Valve Holders. Flanged "A" type, 1/- Ebonite with 8 nuts, 1/3 each.
- Ebonite Panel, fitted with 3 Valve Holders, complete, 3/2.
- Ebonite Panel, fitted with 2 Valve Holders, complete, 2/3.
- Valve Sockets, per set of 4 with 8 nuts, 7d.
- Transformer Holder. With 4 terminals and wired, 3/6 each.
- High Note Buzzer (Army Type), worth trouble, 3/- each.
- Telephone Transformers (Army Type), 9/- each.
- Wireless Jacks, with plug, as illus., page 733, 1/- the pair.
- Brown's Type "A" Headphones. Guaranteed new and unused, 8,000 ohms, 49/6; 120 ohms, 42/6. With cords, 51/6 and 44/6.
- Ever Ready Batteries (all sizes). 16 Volt, 3/6 each.
- Mica. Clear Ruby, .002" thick, 3" x 2", 1/- doz. pieces.
- Inductance Slider Rod, 1/2" square, 13" long, drilled, 6d. each.
- Slider, complete with plunger for 1/2" rod, 6d. each.
- Contact Studs. Fitted with nut and washer, 1/3 doz.
- Condenser Vanes. Best Aluminium, 3 1/2", 1/6 doz. pairs.
- Condenser Spacing Washers. Small, 3d., large 6d. doz.
- Condenser Screwed Rod, Brass 12" long, 3" 4d., 3/16" 6d.
- Insulating Tubing. Assorted colours, 6d. per yard.
- Sheet Ebonite, 1/4" to 1/2" thick, 4/6 per lb.
- Terminals. Mark 3 N. Plated, 4B.A., 2/6 doz.
- Terminals. Small pattern, 9d. doz.
- Dubblier Condensers. All capacities at prices advertised.
- Grid Leaks. All resistances, 2/- and 5/- each.
- Radio Instrument L.F. Transformers, 25/- each.
- Tangent L.F. Transformers, 22/6 each.
- Ivory Scales. 0-180, good quality, 6d. each.
- Ivoryine Tablets. Set of seven, 7d. and 1/-.
- Skinderviken Microphone Buttons, 5/- each.
- Burndept and De Forest Coils in stock. Advertised prices.
- Potentiometer 300 ohms. Panel type on ebonite, 4/6 each.
- Condenser, 5-Plate. Panel type on ebonite, 4/- each.

Write for Complete Supplementary Price List of Exceptional Values, sent Post Free.

All goods sent CARRIAGE PAID but with orders under 5/6 add 6d. for postage.

J. H. TAYLOR & CO.,
ELECTRICAL AND RADIO ENGINEERS.

Macaulay St., HUDDERSFIELD.
Telephone, 341. Telegrams : "Thorough, Huddersfield."

"THE BROADCASTER"

is a Complete Amplifying Unit, combined with extra Sound Magnifier, £4 17 6

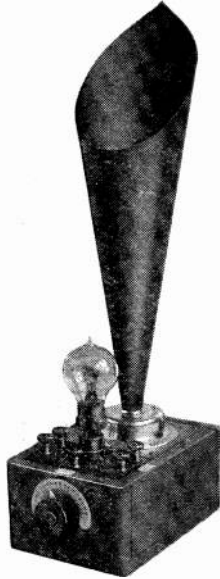

Built on the latest scientific principles, the "Broadcaster" is designed to give the greatest amount of amplification, and is specially adapted for receiving Broadcasting, while the price is well within the reach of the modern purse.

The "Broadcaster" is fitted with terminals from which it can be instantly connected with any receiving set on the market, either Valve or Crystal.

A receiving set *without* the "Broadcaster" is, comparatively speaking, only a twentieth of what the same set is *with* the "Broadcaster."

The "Broadcaster" must not be confused with so-called Loud Speakers; the extra Amplifying Unit which it contains supplies the initial extra power required for the loud speaking device.

Owing to the unprecedented demand for the "Broadcaster" the public are advised to order immediately, either from their local dealer, or direct from the Manufacturers. Orders will be dealt with in strict rotation.

PRICE: less Valve (only until a certain quantity which the manufacturers have decided upon) £4.17.6

Thenceforth the full price £6 10 0 will be fixed. With all orders received before November 20th, one R.Type Valve will be included free with each "Broadcaster."

The "Broadcaster" is protected by prov. patent, and any infringement will be dealt with summarily.

MANUFACTURERS:

British Wireless Co.

Incorporating

Midland Radiophone Co.

Hearsall Works, Coventry.

SUPPLIED BY THE LEADING
WIRELESS DEPÔTS.

VERNIER
TYPE.

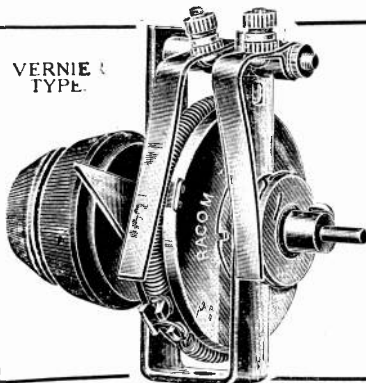

RADCOM Filament RHEOSTATS

Control.

Protect.

Improve.

Features: PANEL MOUNTING $\frac{1}{8}$ " to $\frac{1}{2}$ "

Positive Stops at Zero and full resistance.

Single Turn Control.

Smooth and Quiet.

Guaranteed.

PLAIN TYPE 5/- VERNIER TYPE for Detector Valves 7/6

RADCOM COILS, TUNERS, ACCUMULATORS.

Radio
COMPONENTS LTD.

12/13, Henrietta St.,
LONDON, W.C.2

Telephone: Gerrard 792.
Telegrams: Radponent.
Rand, London.

WIRELESS TRAINING COLLEGES, LTD.

MARKET BUILDINGS, CARDIFF, & ALBERT RD., BOURNEMOUTH

The above Colleges are amongst the Most Successful in existence. We are NOT A BOOM FIRM but have 10 years reputation for not only Passing our students, but what is most vital, GETTING THEM BERTHS WHEN QUALIFIED. This past three months we have placed over 30 Youths in Permanent Berths. We instruct on Valves, and $1\frac{1}{2}$ kW. Marconi Sets. We have NOT a Qualified Student out of berth to-day. Also Wholesale Distributing Superintendent for Messrs. Stuart Wireless Telephone Co., the Valve Set which NEVER FAILS YOU. Agents Wanted. Wholesale Only.

Principal: HON. LT. COMMANDER J. R. SCHOFIELD, M.B.E., R.N.V.R. (C).

P.S.—Students taken individually, so can enter any day suitable.

Series No. 3.

Western Electric

MAKERS OF OVER

HALF THE WORLD'S TELEPHONES

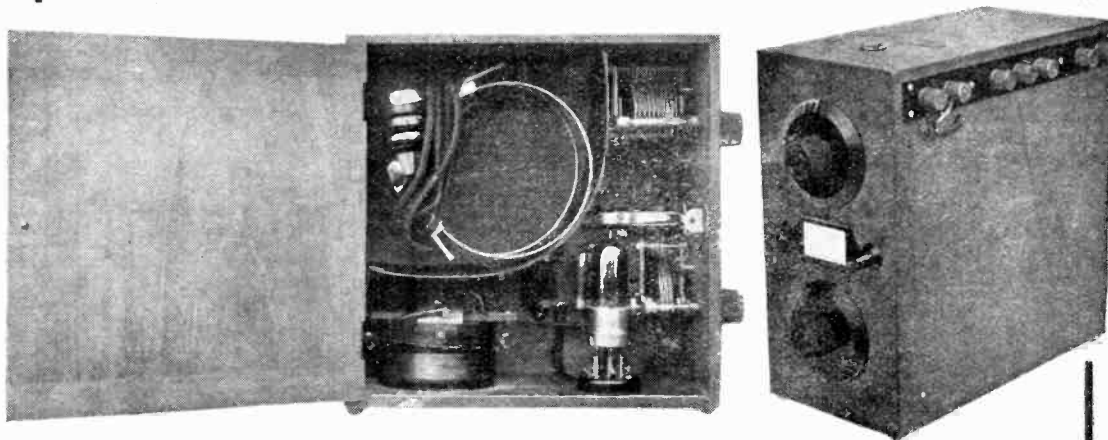

Western Electric

VALVE DETECTOR AND TUNER

is contained in a polished mahogany case and provides for the inclusion of Double Head Receivers, while a spring button is fitted on the top of the case to open the receiver compartments. The valve filaments can be seen through a specially designed mica window, and ventilation discs are provided to fully ventilate the interior of the case. At one end of the case a small card is fitted which gives particulars of various wavelengths together with the respective condenser settings, and above and below are the Variable Condenser Handles. The set is simplified by the use of only one handle for fine tuning, and the filament key is conveniently placed on the right-hand side of the wavelength index. The valves used are specially made to Western Electric specification, and the whole set is built to give the greatest possible efficiency.

Western Electric Company Limited.

62, Finsbury Pavement, London, E.C.2

Telephone—London Wall 7608

WORKS:—

North Woolwich,

London, E.16

Telephone—East 3840 (10 lines)

Also at BEXLEYHEATH, KENT, and NEW SOUTHGATE, N.11

Birmingham—Grenville Buildings, 12, Cherry St.

Leeds—Standard Buildings, City Square

Cardiff—Motor House Chambers, 1, Wood St.

Manchester—Northern Assurance Buildings

Newcastle—20 Saville Row

Glasgow—49, West Campbell Street

We are Actual Manufacturers of Component Parts

OUR PRICES ARE COMPETITIVE. For instance, our Condenser Vanes, made from .022 gauge, hard drawn Aluminium, are 9d. per doz. Sliders, complete with plungers, are 6d. each. Splendid Laminated Switch arms are 2/- each. Etc., etc.

Get Our Price Lists, 3d. post free, and save pounds. We have too many lines to advertise in these columns.



BRITISH MADE. High Conductivity Copper Wires. Best Quality Coverings.

		PER LB.				
S.W.G. per lb.	Yds. per 1,000 yds.	Ohms. per 1,000 yds.	S.C.C.	D.C.C.	S.S.C.	D.S.C. Enam.
12	10	2.9	1/10	1/11	3/0	4/0 1/8
14	18	4.8	1/11	2/0	3/2	4/2 1/9
16	26	7.5	2/0	2/1	3/4	4/4 1/10
18	48	13.3	2/1	2/2	3/8	4/6 1/11
20	84	24	2/2	2/3	4/0	5/6 2/4
22	140	39	2/6	2/11	4/6	6/0 2/6
24	230	63	3/0	3/6	5/0	6/6 2/8
26	340	95	3/7	4/1	5/4	8/0 3/2
28	530	140	4/4	4/8	5/8	9/0 3/6
30	716	200	5/0	5/6	6/8	10/0 3/6
32	950	282	6/0	7/3	8/0	12/6 4/2
34	1,300	382	7/0	8/3	10/0	13/6 4/4
36	2,000	530	8/8	10/0	13/0	15/6 4/8
38	3,000	850	11/3	13/0	16/0	19/0 5/3
40	4,800	1,300	15/0	17/6	20/0	22/8 7/6
		PER OZ.				
42	7,000	—	1/0	1/4	1/9	2/0 8d.
44	11,000	—	—	—	3/0	3/6 1/0
47	27,000	—	—	—	6/0	7/6 2/6
Pro Rata.		Allow for Spools 3d. extra.				

Sole Manufacturers of "MAKURONE" Wireless Apparatus:

J. L. CARTWRIGHT & CO.,
Phone: 4209 Central.

Note—NEW OFFICES & SHOWROOMS
'Grams: "Pladuram" Manchester.

24, London Rd., MANCHESTER
Works: BERRY STREET

BOLTON: J. S. McLeod, 189, Blackburn Road.
WARRINGTON: Economic Electric Co., 64 & 66, Sankey Street.

BURY: Bennett & Co., 12 Union Square.
AGENTS WANTED.

THE LARGEST STOCK
of 4 B.A. TERMINALS IN ENGLAND.

Price, 2/6 per dozen, plated, 3/- brass; 2 B.A. Single, 9d. per dozen, And Ex W.D. Stock at knock-out prices. Wave Metres, Wheatstone Bridges

Leading-in Tube, ebonite, R.A.F. pattern with brass rod and fittings	PRICE	3/6
Aerial Real Insulators, tested to 25,000 volts	PRICE	2 1/2d.
Accumulator Charging Resistances	PRICE	25/-
Universal Tuners. These tuners have been designed to tune in Marconi concerts, broadcasting, and Dutch Concerts, so that a baby can use them. Wavelength range, 300-1,500 metres, with .0005 m.f. condenser.	PRICE	7/-
4,000 ohm 'phones, new patent 3-magnet type, fitted cords and tags, complete with nickel plated head bands	PRICE	85/-
Transmitting Keys, G.P.O. pattern, fitted platinum contacts	PRICE	5/-
Valve Holders, fitted in solid ebonite, fixing case drilled, fitted with valve earthing clip	PRICE	1/6

Condensers of all types, Marconi, Sullivan and all leading makes.

New intervalve transformer Ratio 5-1 all fully tested. PRICE 15/-
Postage extra on all the above prices.
The trade supplied. Enquiries solicited.

J. LIPOWSKY, 614, OLD FORD RD.
LONDON, E.3 'Phone: East 3345

IMPORTANT NOTICE

A. C. COSSOR, Limited, hereby give notice that the order of Mr. Justice Russell of the 1st March, 1922, continually advertised by the Marconi Co., was an order ARRIVED AT BY CONSENT.

Being engaged at the time in the production of an improved and different type of valve, A. C. COSSOR, Limited, did not consider the patents in question of sufficient importance to warrant the expense of litigation.

A. C. COSSOR, Limited, respectfully leave the public and the Trade to judge whether the constant repetition of the notification of the judgment referred to is necessary or expedient in the circumstances.

A. C. COSSOR, LIMITED
Aberdeen Works, Aberdeen Lane,
Highbury Grove, N.5

WARNING.

MARCONI'S WIRELESS TELEGRAPH CO., LTD.,

v.

A. C. COSSOR, LTD.

Marconi's Wireless Telegraph Company, Limited, GIVE NOTICE that an ORDER was made in the High Court of Justice, Chancery Division, by Mr. Justice Russell on the 1st March, 1922, restraining Messrs. A. C. Cossor, Ltd., from infringing the Marconi Company's Letters Patent Nos. 28413 of 1913 and 126658, except so far as Messrs. A. C. Cossor, Ltd. manufacture for H.M. Government.

Messrs. A. C. Cossor, Ltd., were further ORDERED upon oath to DESTROY all articles and apparatus (other than those constructed to the order of H.M. Government) made or used by them in INFRINGEMENT of these patents, and TO PAY THE MARCONI COMPANY DAMAGES AND COSTS.

The M-O Valve Company, Limited, of Osram Works, Brook Green, Hammersmith, London, W.6, is the only firm in this country licensed to manufacture thermionic valves under the patents belonging to the Marconi Company.

Any valve similar to those generally known as the "French type" constitutes an infringement of the above patents whether manufactured in this country or imported from abroad. Marconi House, Strand, London, W.C. 2.

THERE IS MONEY IN WIRELESS

Big Incomes for Those Who Start Now.

Learn at home all about this fascinating science and earn from £5 to £10 weekly.

There is big money to be made in Wireless Telephony for those who step in now, when thousands upon thousands of amateurs are buying Wireless Sets which will need constant attention and repair.

IN YOUR SPARE TIME

you can learn all about Wireless Telephony by following the simple complete and intensely interesting McGrath course. You can enjoy the wonders of this modern marvel yourself, and under the guidance of our Wireless experts, make a big income out of others.

The McGrath Course starts you in the new, not overcrowded, profitable profession of a Wireless expert. We teach you how to install and correctly tune any set to proper wavelengths, to alter and replace parts, or make your own outfits. Think of the enjoyment you get, and think of the money you can earn, when, as Lord Northcliffe said, "A Wireless Set will become indispensable in every home."

Be among the first in the new profession, you should earn easily from £5 to £10 weekly. The McGrath course teaches you how to earn whilst you learn. Pupils are amazed at their rapid success.

Let us send you particulars of MONEY-MAKING WIRELESS FREE.

It costs you nothing to know all about this simple, fascinating course. The knowledge we give will make you independent. Write now and enrol while the business is in its infancy. All applications should be addressed to the Secretary, WIRELESS DEPT., No. 36 McGRATH INSTITUTE, 2., Southampton Street, Holborn, W.C.1

"OOJAH" BASKET INDUCTANCES

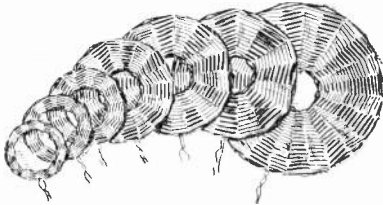

We have pleasure in announcing that owing to the reduction in the price of wire and greatly increased output we are able to lower the price of OOJAH BASKET INDUCTANCES to

PER 5/- SET

Postage 4d.

LIBERAL DISCOUNT TO FACTORS.

All "OOJAH" Inductances are wrapped in a transparent covering and sealed with the Registered Trade Mark "OOJAH."

The Seal is a guarantee of quality. None are genuine without.

"OOJAH" Basket and Slab Inductances are being extensively copied, as most good things are, and purchasers are advised to not only specify "OOJAH" Brand in their orders, but to see that the seal is intact.

GREENSLADE & BROWN
LANSDOWNE ROAD, CLAPHAM, S.W.9

Telephones - BRIXTON 639 & 3211.

No Waiting. Delivery from Stock

Perry Head Phones

4,000 Ohms 21/- per pair

Specially designed for Wireless Telephony, Receivers arranged in series, mounted in Aluminium Cases and fitted with extremely light and efficient Head Bands, and Twin Connecting Cords.

The JEARY Electrical Co., Ltd.

8, LAMBETH HILL & 97, Queen Victoria St., London E.C.4

Questions and Answers COUPON

To accompany Questions sent in during the week commencing Oct. 21st, 1922.

VOL. XI, NO. 3.

See Conditions on Page 109.



Why buy when you can build your own?

YOU will miss half the enjoyment of Radio if you buy a ready-made Set. Besides, you can save quite a lot of money by building up your own. This little Book explains the whole system of Peto Scott Standardised Radio Units in sets of parts. It shows you how easy it is

Price List of Units (IN SETS OF PARTS).

No. 4. Valve Detector Panel	17 6
No. 5. Low Freq. Amplifying Panel	33 6
No. 3. High Freq. Amplifying Panel	13 6
Mahogany Cabinets to fit	3 6

All neatly boxed with full instructions.

Postage 9d. per panel extra, but paid on all orders of £2 and over.

for the inexperienced amateur to build one up on his kitchen table with only a screw-driver and a pair of pliers. *Send for it to-day.*

Post **6^{d.}** Free

Big 32pp. Catalogue free with every Booklet if you mention *Wireless World*.

Featherstone House, 64, High Holborn, W.C.1.



BRITISH MANNESMANN WELDLESS STEEL TUBULAR

MASTS

FOR

Wireless Aerials.

UNRIVALLED IN STABILITY AND EFFICIENCY, UNSURPASSED FOR NEATNESS OF OUTLINE AND APPEARANCE, ECONOMICAL IN COST

THE BRITISH MANNESMANN
TUBE COMPANY, LIMITED
NEWPORT (Mon) & LANDORE, S. WALES.

LONDON OFFICE—67, Queen Victoria Street, E.C.4
BRANCH OFFICES—Birmingham, Glasgow, Leeds, Manchester, Newcastle.

Econ Manufacturing Company, Ltd.

HAVE REMOVED TO THEIR NEW FACTORY
63a, Paris Garden, Stamford Street,
BLACKFRIARS, S.E.1 Phone Hop 2000

1/6 AERIAL INSULATORS 1/6

EACH Set of 4, 5/6 (postage 1/- extra) EACH

Universally acknowledged at the All-British Wireless Exhibition to be one of the most outstanding exhibits, and to be the most perfect form of Radio Aerial insulator in the world. Adopted by the principal wireless companies. No soldering required. No surface leakage.

Absolutely Weather proof. Can be fixed up in one minute

ECON SINGLE LORGETTE PHONES,
120, 2,000 or 4,000 ohms - 21/- each

Messrs. Whale & Co., of
201 Powis St., Woolwich,
wish to announce they are opening

Temporary Office and Demonstration Rooms
at

321 Vauxhall Bridge Rd., Victoria

as

The Whale Wireless Co.

ALL types of valve sets and component parts will be obtainable and all sets will be efficiently demonstrated by expert Radio Engineers.

JUST PUBLISHED! *SOME OPINIONS.*

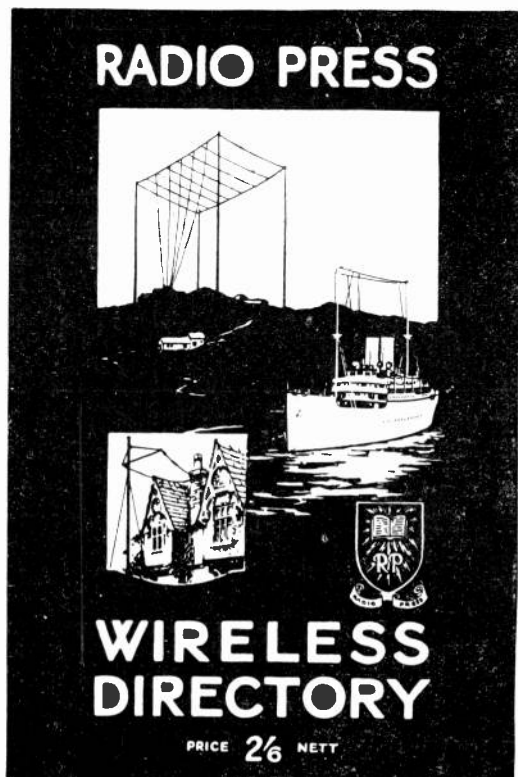

A complete list of the call signs of every Ship and Land Wireless Station in the World and a completely revised list of all amateur call signs.

**AN ABSOLUTE NECESSITY
To All Real Experimenters.**

from

Radio Press Ltd.

Publishers of Authoritative Wireless Literature.

"Many thanks for Wireless Directory, which supplies a long felt want and should be in the hands of every amateur."

"G," *Highbury, N.5.*

"It is an excellent book which satisfies a long felt want. I am recommending it to all amateurs of my acquaintance."

"S," *Holland Park, W.11.*

"It appears to be just the thing we all want and will be in constant use here."

"L," *Sonning, Berks.*

"It is certainly a most comprehensive and useful book."

"M," *Derby.*

Dozens of these testimonials are being received. The book is very handsomely produced with a very attractive two-colour cover. The contents are absolutely up-to-date. Like all our books, it is authoritative.

Order Your Copy Now

from your newsagent, book-seller or wireless dealer or direct (post free) **2/8**

**DEVEREUX BUILDINGS,
DEVEREUX COURT,
STRAND, LONDON, W.C.2**

Opposite the Law Courts.

AUCKLAND'S

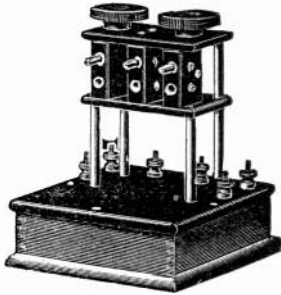
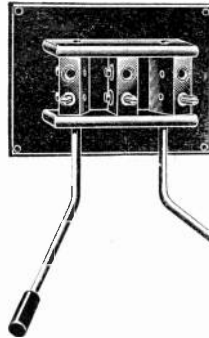

TABLE STAND FOR COILS

Registered Design 688454.
Exact as illustrated.

Price **21/-** each.
2-Way - - 18/-



PANEL TYPE COIL HOLDERS.

Made of Solid Ebonite throughout, and finished in workmanlike manner. Fitted with extended handles as shown to avoid Capacity Effects.

Price **13/6** each.

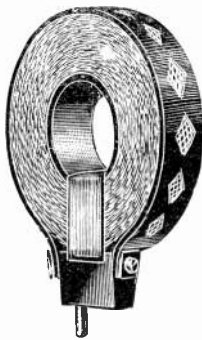

DUO LATERAL COILS

Made under De Forest Patents.
Supplied Mounted only.

Prices from **5/-** each.

INTERVALVE TRANSFORMERS.

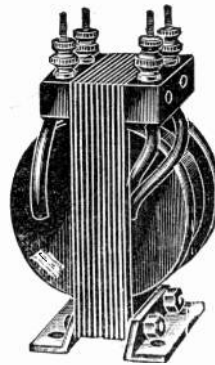

Layer Wound and Spaced.
Stalloy Cores, most efficient.

20/-

From Stock.

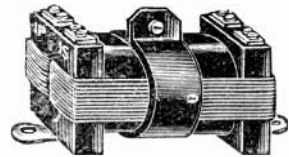

TELEPHONE TRANSFORMERS

Unmounted (as illustration)
suitable for 120 w. Phones.

Price **13/6** each.



CONDENSER DIALS.

Fitted with Knob and Bush,
Engraved to 180°

3/9 each.

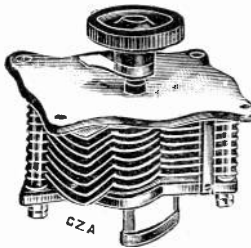

VARIABLE CONDENSERS,

For which we are specially noted.
Top plate; Die cast and fitted
with ebonite bush.

Bottom plate; Die cast and fitted
with ebonite bush.

Vane spacing '072.

Centre contact made by P.B. strip.

'0002	'0003	'0005	'001
15/-	16/-	18/-	24/-

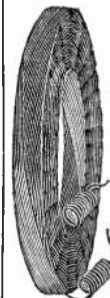

THE NEW UNI-WAVE INDUCTANCES.

Duo Wound.

Range from
300-30,000 m.

Inductive Values
are to be found in
Catalogue.

Price per set of 8,
12/6

G. Z. AUCKLAND & SON, 395, St. John Street, E.C.1
Factories—ISLINGTON, N. WIRELESS INSTRUMENT MAKERS. 'Phone - - 3173 CLERKENWELL

LONDON OFFICES:

32/- per Pair
4000 ohms.

All Resistances in stock.



---CQ Std bi

for ERICSSON PHONES

WHEN you install your wireless set—crystal or valve—you'll get maximum results if you fit Ericsson Phones—clarity, sensitivity, strength of signals and absence of "click." Specially suited to telephony, Ericsson Phones embody the accumulated experience of telephone manufacture for a generation. Easy to the head, light and comfortable. The magnets never lose their strength and "shorts" are non-existent.

Write for Particulars

The BRITISH L. M. ERICSSON MANUFACTURING Co., Ltd.

Head Office:
60, Lincoln's Inn Fields, E.C.2



THE ABC OF WIRELESS

By PERCY W. HARRIS

THE Book for the "Man in the Street."

Price **6d.** nett. Post free **8d.**

What is Wireless? How Does it Work?
THE "ABC" WILL TELL YOU.

THE WIRELESS PRESS, LTD.
12-13, HENRIETTA ST., LONDON, W.C.2

THE RADIO EXPERIMENTER'S HANDBOOK

By PHILIP R. COURSEY,

B.Sc. (Eng.), F.Inst.P.

113 pages. 99 Diagrams and Illustrations.

PRICE **3/6** NETT.

(Postage 6d.)

THE WIRELESS PRESS, LIMITED,
Dept. W.W., 12/13, Henrietta St., Strand, London, W.C.2

RADIO & MODEL ENGINEERING

Edited by M. B. SLEEPER.

Price **7d.** monthly. Post free **8d.**

Subscription **7s.** per annum.

THE WIRELESS PRESS, LTD.,
12-13 HENRIETTA ST., LONDON, W.C.2

NEW DIRECTORY OF AMATEUR & EXPERIMENTAL TRANSMITTING STATIONS

Price **6^d** post free.

THE WIRELESS PRESS, LTD., Dept. W.W.
12-13, Henrietta Street, London, W.C.2

THE WIRELESS WORLD EXCHANGE AND MART

TRADE Grelco MARK



Dewar Switches. Multiple Contact. 4, 6 and 8 way. Price 4/6. Postage 4d.



Aerial Aluminium Pulleys, Bronze Bush Price 1/6. Post 2d. Complete with hemp cord, spliced. Price 2/- Post 2d.

The Original Green Egg Insulator, Highest Insulation. Price 6d. Post 1 1/2d.



Ebonite Leading-in Insulators. Terminals each end as shown. 6" Price 1/6, postage 2d. 9" Price 1/9, postage 3d. 12" Price 2/6, postage 3d.

VALVE SOCKETS WITH NUT & WASHER.  **PRICE Per 1/6 doz. Post 2d.**

We supply every article for Wireless at the very lowest prices. A visit will convince you. Fully Illustrated Catalogue in preparation.

Grafton Electric Company
Showrooms—54, GRAFTON STREET, TOTTENHAM COURT ROAD, LONDON, W1 Telephone—Museum 241. Works—Slough.

A.S.A. Reliable Products

.0005 Variable Condensers	9/6
Vernier Variable Condensers	4/6
Fixed Condensers, .0003, .002	1/6
Filament Resistance	3/0
3-Valve Holders on Ebonite	4/6
Valve Holders	9d.
Laminated Switch Arms	2/-
L.F. Intervale Transformers	17/6
Best French 'Phones, 4,000 ohms, Aluminium	21/-
"Ubique" Crystal Receiving Sets	15/-
100 7/25 Aerial Wire	3/6
Condenser Vanes	per doz. 9d.
2-Valve Receivers—Complete Set of Parts	
—Variable Condenser, Coils, sloping cabinet	80/-
2-Valve H.F. Amplifiers	35/-
3-Coil Holders, on stand	15/-
Honeycomb Plugs	1/6

OUR LIST BEATS THEM ALL.

Amateur Suppliers Association
 134, Coteford Street, Tooting, S.W.
 Works: 198, High Street, Merton, S.W.

FOR SALE.

Loud Speaker Horns.—Guaranteed perfect acoustics. All sizes from 4s. 6d., complete with polished aluminium receiver base. Usual trade terms.—MIDLAND RADIOPHONE CO., Hearsall Works, Coventry.

Spark Coil, 3 ins., oerfect. £2 10s.—MACKINTOSH, 6, Onslow Gardens, S.W.7.

Wireless High Tension Battery Cabinet. Simple economic. Well finished. Seven tappings, 20 to 80 volts.—Particulars, ROWCELL, 28, Rendezvous Street, Folkestone, Kent.

Four-valve Receiving Set, 1 H.F. Detector, 2 L.F. Transformer Coupled. Switches for any combination of valves. In polished oak sloping cabinet. Also .0015 variable condenser, and .003 variable for H.F. transformer. Price, £20.—ADDEY, White Knowle Road, Buxton.

Accumulators.—Two 20-ampere 4 volts, new, uncharged, 15s. each. Also a P. and R., 50 ampere 6 volts, nearly new, 35s.—10, Parsifal Road, Hampstead, N.W.

For Sale.—Single-valve receiver, including condenser and tuner, but without valve or telephones, new, £5.—Apply GRIEF, 40, Manor Park Road, Harlesden, London.

Amateurs.—Loose couplers for crystal receiving sets, tune up to 1,000 metres. Highly finished, price 35s. each. Post free.—WATSON, 708, Coventry Road, Small Heath, Birmingham.

Three-Valve Receiving Station, complete, £11. Bargain. Appointment, owner.—11, Hermitage Road, N.4.

Revolution Counters, by Harding, Richardson, Rhodes & Co., with reciprocating motion, suitable for counting coil turns up to 100,000 and repeat, shop soiled, easily coupled to lathe, special low price, 1 guinea each.—ST. GEORGE'S MOTORS, 16, Fulham Road, South Kensington, S.W.3.

Gentleman must sell New Loud Speaker, one L.R. one H.R. 20 in. Horn, adjustable diaphragm. Marvellous volume, no distortion, accept 50s., post free. Cost double. First remittance secures.—SLENNETT, 34, Willow Grove, E.13.

Mark III Star Tuner. Never used. Condition as new, £7 10s.—CARTER, Gleneagle, Mansions Streatham, London.

Three-Coil Tuning Stands, 17s. Filament resistances, 3s. Condenser plates, 9d. doz. Ebonite tops and bottoms, 1s. 2d. per set. Ebonite knobs, 5d. Send for free list. Postal only.—LAWSON, 15, Hobart Place, Victoria.

Three-valve Amplifier with Transformers, £4 10s. Duolateral tuner, two condensers, vernier and coils, £4 10s.—"Woodside" Cottage, Hill Road, Dursley.

'Phones.—W.D. Single L.R., 4s. each. Sullivan's 120 double, 15s. 6d. pair. New French double, 4,000, 21s. 6d. pair. All perfect. Approval—JAGO, Chertsey.

Crystal Set, working order, £3. Loud speaker, £2. Low resistance Sullivan Telephones, 15s. pair, microphone in case, 25s. Heterodyne wavemeter, 35s. Telephone leads, 1s. each. Crystal detectors, etc.—GIBSON, 32, Tressillian Road, Brockley.

Wireless Masts.—Improved Girder Type, Light and strong, 30 to 50 ft. at 1s. ft., 50 to 100 ft. at 1s. 6d. ft. Cash with order, carriage forward.—F. ARMSTRONG, Weybridge.

B.A. Screws, Nuts and Washers, assorted gross 2s., lists 2d.—J. H. BENNETT, Station Road, Willesden Junction.

Agate Cylinders, etc., for loud speaking apparatus from JAMES R. GREGORY & Co., Mineralogists, 139, Fulham Road, S.W.3.

Cozwhy Filament Fuses will protect your valves from Burn-outs. 1/2 or 1 amp., 10d. each, 8s. doz. Polished ebonite fuse-holders, plated ph.br. springs, 2s. 6d. each, 11s. set of five. Post free. Cash with order.—BESWINNING'S, 49, Cowley Road, Ilford.

Three-Valve Amplifiers.—L.F. C. Mk. III Brand new. A beautiful panel, four transformers, three intervalve, one telephone. A limited quantity only. £5 15s. each.—GEO. AXE, 52-4, Ben Jonson Road, Stepney, E.1.

Send us your enquiries for

BOXES, CABINETS, SPREADERS, CONDENSERS and parts, LEAD-IN-TUBES, and all accessories, to the Trade.

COMPETITIVE PRICES PROMPT DELIVERIES

The Central Aircraft Co.
 179 High Rd., Kilburn, N.W.6
 Phone—Hampstead 4403-4 8018.

ENGRAVING

for every style of instrument on any material.

F. OSBORNE & CO., LTD.
 27, Eastcastle St., Oxford St., London, W.1
 Est. 1874. Museum 2264

For Wireless Cabinets

SEND TO

J. A. JONES & CO., LTD.
 CABINET CASE MAKERS,
 Progress Works, Park Road,
 Aston, BIRMINGHAM.
 Phone—EAST 234.

AMATEUR HAS FOR SALE—

Two single valve panels in mahogany cabinets, Price, £3 each.

Complete Single-valve receiver, comprising panel, and tuner in sloping cabinet, consisting .0006 mf. condenser, Vernier in parallel, series-parallel switch, standard coil holder with long coupling handle, new £12, or sell separately.

3-Valve set complete, in mahogany cabinet, £12 12s.

C.Mk. IV 3-Valve amplifier £5
 H.P.R., complete, single-valve receiver, range 300-30,000 m., in cabinet £15
 5 Pairs Sullivan 120 w. 'phones 10/- each
 4 telephone transformers each 10/-
 12" Spark Coil, by Butt, perfect, cost £125, take £25

Brown Loud Speaker, new £4
 2-Valve L.F. amplifier £3 10s.
 Can be seen by appointment, 'phone Putney 131, after 1 p.m.

J. V. MULHOLLAND, 73, UPPER RICHMOND ROAD, PUTNEY, S.W.

HEATH & Co., Ltd.

Instrument Works, New Eitham, S.E.9

are prepared to undertake in their fully equipped works—**Wireless Apparatus and Parts** for the trade. Quotations given to Blue Prints. Immediate attention.

Phone—Lee Green 301. Wire—Polaris, London.

THE WIRELESS WORLD EXCHANGE AND MART

Electradix Radios

Marconi 'Phones in stock, 2,000 ohms, 49/-; 4,000 ohms, 50/-; 8,000 ohms, 57/-; per pair. Complete with cord and tags. Sullivan's L.R. head 'phones, with cords, 15/- per pair. Ex-Govt. L.R. set of head 'phones, 12/- per pair with cords. No. 7 1,500 ohms, 2 1/2/- per pair. Single receivers, 4/6 each. Large stocks of ammeters and voltmeters, milliamm and hot wire 10/- to 60/-



Mark 2B, two-valve, in polished mahogany case, new and guaranteed, £7 5s. Crystal Sets, variable condenser, detector and fixed inductance, mahogany case, 45/-. Pole Testers, 6d. Single Plug and socket, large, 1/6 per pair. G.P.O. Galvos, Q. and I., 10 6, with shunt switch, 15/-. Buzzers, 2/6, 3/6 and 5/-.

PLUG SOCKETS and cord of all kinds, solo, 1/- pair; twin, 1/6; four-way, 2/-.

TERMINALS. Dozen 2/6 and 3/-.

CONDENSERS. 2 M.F., 1'6; 4 M.F., 5/- Variable for panel, 4/9, 10/- and 11/6. .001 Cabinet, 32 6. Murdoch rheos. for panels, 7/3, with Vernier extra lever, 8/- Our make, 3/9. Valve legs, 1d. each.

Panel Potentiometers, in case with switch, 12/6 each.

Aerials, 7 22, stranded copper, enamelled wire, 6/- per 100'.

Lightning Arrester parts, brass, 6d.

Rubber Aerial Cords, 35/40, copper, 12 yds., 1/6.

Earth Clips, 6d. each. Earth Mats, 10/- each.

Switches, Aerial to earth, 2/9 each. Dewar flush type three-way lever switches for panel, 3/6. Eight-way Lever, for A.T.I., 8/- 30 amp. D.P., 16/-.

Switch Arms, 1/9 each. Studs, 1/6 dozen.

Transformers. Telephone, 15/-; Intervalve, 20/-; for panel mounting.

Connecting up wire, 23'40's, rubber covered, 1d. per yard.

R.A.F. light weight ebonite insulators, 4d. each.

H.T. Battery Units, 4 1/2 volts, 6d. each.

One-valve accumulators, £1.

The handiest depot for City Buyers. Near Aldgate Station, Metropolitan Railway. First on left in Minories. LESLIE DIXON & CO., 9, Colonial Avenue, Minories, E.1.

EASY TERMS OR CASH.

Mullard 'Phones, 4,000 ohms, 30/-; 4 Valves, 15/-; Variable Condensers, assembled, .0005, 17/6; .001, 22 6, fixed capacity condensers, .001 to .005, 3/- each. Grid Leak and Condenser, 4/6. 'Phone Transformers, 13/6 and 17/6. L.F. and Intervalve Transformers, 21/-; Accumulator 4-Volt, 18/-; H.T. Battery, 30-volt, 7/6. Three Coil Holder, 17/6; 2 ditto, 13/6. Coils at list prices, 100' Aerial Wire 7/22 stranded copper, 4/6. Valveholders, 1/-; 1/6. Switch Arms, 2/6. Terminals, etc. G. BUSH, 119, Sutherland Av., London, W.9.

SITUATIONS WANTED.

Ex-Lieut. R.E., thorough theoretical and practical training in all radio matters, and over ten years experience in same in army, navy, and commercial life, expert lecturer and demonstrator, desires position of responsibility with well established firm. Prepared invest small capital.—Apply 1, Oatlands Drive, Weybridge.

Young Man (27), First-class P.M.G. Certificate, desires position, Fitting, erecting, salesman, demonstrator or any other position. Thorough knowledge of wireless. Spark, valves, C.W. experience.—"T," 35, Park Street, Abercynon, Glam.

Advertiser, Ten Years' Experience Wireless, requires post offering scope ability; first-class wireless certificate, expert instrument designer, many years business experience. Sound knowledge steam, internal combustion, electrical, engineering. Fully abreast modern developments. Offers.—"2.K.G.," 14, College Street, Aberdeen.

Educated Man (28) seeks position, home or abroad. Technical and practical knowledge W/T, P.M.G. Cert. What offers.—Box D.6, BERTRAM DAY'S ADVERTISING OFFICES, 9 and 10, Charing Cross, S.W.1.

Advertiser (24), desires post. Thorough knowledge of radio technology, three years' technical training, A.M.I.E.E. and final City and Guilds exams, commercial abilities.—Box L.5, BERTRAM DAY'S ADVERTISING OFFICES, 9 and 10, Charing Cross, S.W.1.

Advertiser (27), seeks permanent settled position, first-class P.M.G., seven years wireless, experienced. C.W. also engineering experience in telephone and cables.—Box B.5, BERTRAM DAY'S ADVERTISING OFFICES, 9 and 10, Charing Cross, S.W.1.

Wireless Operator (24), First-class P.M.G. desires position. Fitting, erecting or salesman demonstrator. Spark, Valve, C.W. experience, late in charge of C.W. station.—"Radio," 120, Sheldon Road, Edmonton, N.18.

SITUATIONS VACANT.

Wanted, capable mechanic, with good all-round knowledge of the making of wireless apparatus. State experience and wages required.—S.S. WIRELESS Co., Spon End Works, Coventry.

Exceptional Opportunity.—Capable man required to supervise manufacture of inexpensive wireless sets. Part interest in profits and weekly salary. No capital required.—Box T.4, BERTRAM DAY'S ADVERTISING OFFICES, 9 and 10, Charing Cross, S.W.1.

Traveller Wanted to sell wireless accessories on commission basis.—SAXBY & Co., 3, Gayford Road, Shepherd's Bush, W.12.

REPRESENTATIVES WANTED.

Representatives Wanted.—Gt. Britain only, by manufacturers. For leading product.—Write c/o LITCHFIELD & Co., 12, Great Castle Street, London, W.1.

BUSINESS OPPORTUNITIES.

Wireless.—The coming boom. Opportunity occurs for gentleman with £750—£1,000 available to join advertiser in business manufacturing wireless accessories, etc. Technical or commercial side. Capital required to cope with orders.—Write "H," c/o WILLMORE'S, Chiswell Street, E.C.1.

TRADE ENQUIRIES.

To Manufacturers of Crystal Sets, wholesale firm are desirous of getting in touch with above to manufacture exclusively for them. Large quantities. Cash. Write Box 28390, CLARKS, 58, Gt. Portland Street, W.1.

Wireless Dealers are advised to stock parts for making radio apparatus, as so many amateurs prefer to make their own instruments. There is also the additional profit in making your own sets from stock parts. Raw materials and partly machined parts can be had direct from the factory at the right price.—THE "NEWTONIA" WIRELESS FACTORY, 13/15, Whitcomb Street, London, W.C.2. Regent 643 and 5469.

Amateurs and Manufacturers.—Sets wired and assembled to diagram. Tested, crystal and single valve a speciality.—"RADIO," 30, Trustrons Gardens, Romford, Essex.

EBONITE "A" TYPE 4 PRONG VALVE HOLDERS

1- each, post free.

WILKINSON, LONSDALE RD., KILBURN, N.W.6 TRADE SUPPLIED. Established 1900

MORSE CODE.

Easily mastered with the "L.B." Sender. (Pat. App. for). Sends any message any speed, and will last a lifetime. Invaluable to amateurs. Price mounted on Ebonite with instructions 6/- Post free. Further particulars halpenny stamped envelope. Obtainable only from—

H. S. GRIMSHAW,

Radio Stores, Legh Street, Golborne, Lancs.

Send us your enquiries for—

INDUCTANCE TUBES

Straw or Millboard. Diameter to suit all sets. Estimates by return. Prompt delivery.

The Underwood Manufacturing Co. UNDERWOOD ROW, N.1.

MACHINERY FOR SALE.

Lorch Lathes, all sizes in stock, send for list.—PIDGEN BROS., 25, Helmet Row, Old Street, E.C.1.

BOOKS.

Technical Books.—Second-hand and New Books on every conceivable subject. Catalogue free. State wants. Books sent on approval. Books bought.—FOYLE, 121, 125, Charing Cross Road, London.

Radio Magazines, all the latest, "Radio World," 10 1/4d.; "Popular Radio," 10 1/4d.; "Radio Broadcast," 1s. 6d.; "Radio News," 1s. 6d.; "Science and Invention," 1s. 6d.; "Scientific American," 2s. 6d. Post free.—INTERNATIONAL NEWS COMPANY, LTD., 15, Bream's Buildings, London, E.C.4.

MISCELLANEOUS.

East Ham, Wanstead, Ilford, Manor Park and Forest Gate. Amateurs should not fail to come to the RADIORENDEZVOUS, 709, Manor Park Broadway (over Liptons). Club open till 10 p.m. nightly.

The Proprietors of Patent No. 101702 for improvements in and relating to wireless systems and the like are desirous of entering into arrangements by way of licence and otherwise on reasonable terms for purpose of exploiting same and ensuring its full development and practical working in this country. All communications should be addressed to—HASSETINE, LAKE & Co., Chartered Patent Agents, 28, Southampton Buildings, Chancery Lane, London, W.C.2.

The Proprietor of Patent No. 137271, for improved method for receiving wireless signals, is desirous of entering into arrangements by way of licence and otherwise on reasonable terms for the purpose of exploiting the same and ensuring its full development and practical working in this country. All communications should be addressed in the first instance—HASSETINE, LAKE & Co., Chartered Patent Agents, 28, Southampton Buildings Chancery Lane, London, W.C.2.

FIRST ALL-BRITISH
WIRELESS EXHIBITION
1922
OFFICIAL CATALOGUE

Post 6d. Free.

LIMITED NUMBER ONLY

144 interesting pages—a
valuable up-to-date guide, for
Amateur or Professional, to
the apparatus offered by over
60 prominent wireless firms.
Apply to the

Exhibition Organisers,

BERTRAM DAY & CO., LTD.

(Wireless Publicity Specialists),

Dept. W, 9 & 10, Charing Cross, S.W.1

GERRARD 8063-4.

FIVE

EXHIBITION SUCCESSES

THE PERRY AUTO-TIME MORSE SYSTEM

An aid to the rapid acquirement of speed in the transmission and reception of the Morse Code. *16 pages.*

By F. W. PERRY.

6d. Net. Post Free, 7d.

THE WIRELESS TELEPHONE WHAT IT IS & HOW IT WORKS

Including directions for building a Simple Valve Receiver for Wireless Telephone Broadcast.

128 Pages. Cr. 8vo. 78 Diagrams and Illustrations.

By PHILIP R. COURSEY, B.Sc. (Eng.), A.M.I.E.E.

2/6 Net. Post Free, 2/10

MAST & AERIAL CONSTRUCTION FOR AMATEURS

Setting forth clearly all that the experimenting amateur requires.

88 pages. Over 70 Diagrams and Illustrations.

By F. J. AINSLEY, A.M.I.C.E.

1/6 Net. Post Free, 1/8

CRYSTAL RECEIVERS FOR BROADCAST RECEPTION

Which includes directions for constructing a simple Crystal Receiver for Wireless Telephone Broadcast.

80 pages. Cr. 8vo. Over 70 Photographs and Diagrams.

By PERCY W. HARRIS.

1/6 Net. Post Free, 1/8

DIRECTION AND POSITION FINDING BY WIRELESS

A book which supplies a long-felt want.

376 pages. Demy 8vo. 250 Illustrations.

By R. KEEN, B.Eng. (Hons.), A.M.I.E.E.

9/- Net. Post Free, 9/9

THE WIRELESS PRESS LIMITED

DEPT. W.W.

12-13, HENRIETTA STREET, STRAND, LONDON, W.C.2

BEFORE YOU CAN STUDY WIRELESS TELEGRAPHY AND TELEPHONY YOU MUST HAVE A KNOWLEDGE OF MAGNETISM AND ELECTRICITY

Dear Sir,

A READER'S APPRECIATION.

I received in good condition a copy of "Mag. and Elec. for Home Study" on Saturday last, and I am very highly pleased with it. I have much pleasure in enclosing a P.O. for 6/- which I trust you will find in good order. Again thanking you for the value offered and the prompt attention.

Yours faithfully.

To many who are anxious to gain a knowledge of Magnetism and Electricity some text books on the subject have a very forbidding appearance.

The formulæ and equations too frequently haunt the non-mathematical reader and cause him to abandon his intention.

Such fears, however, need no longer deter anyone from acquiring the knowledge desired as in **MAGNETISM & ELECTRICITY FOR HOME STUDY** By H. E. PENROSE will be found **FIFTY COMPLETE LESSONS** prepared in such a form that the reader ceases to regard them as a study.

The various facts and theories are elucidated subtly but surely. No effort has been spared by the Author to explain the subject so clearly and thoroughly that no one can misunderstand him.

At the conclusion of each lesson is placed a series of questions which enable the reader to test his progress and assure himself that his knowledge is

well grounded. In this way he will know that his future study of Wireless Telegraphy and Telephony will be based upon a solid foundation.

A copy of the book will be sent **ON APPROVAL** to all who complete the request form below.

**The Manager, Mail Order Dept.,
THE WIRELESS PRESS, LIMITED,
12-13, Henrietta St., LONDON, W.C.2**

I enclose 6d. for postage.

*Please send me a copy of
**MAGNETISM & ELECTRICITY
FOR HOME STUDY. By H. E.
Penrose.***

If I retain it I will remit the sum of 6/-. Otherwise I will return the book in good condition within 5 days of its receipt.

Name

Postal Address

.....

.....

Date..... 1922

W.W. 21 10/22

The FELLOPHONE



2-VALVE RECEIVING CABINET

A high grade instrument at a very low price. This set has been especially designed for receiving broadcasting, and complies with all the Postmaster-General's regulations. It can be used either for listening in with headphones or with a loud speaker.

Additional interest and use is secured because it will receive all amateur transmitting stations within a range of 20 miles. The "Fellowphone" is mounted in a handsome oak cabinet and is sent out complete with H.T. battery, 6 volt Accumulator, 100 foot aerial, 2 shell insulators and one pair of Fellows 4000 ohms double headphones, but without valves.

British Made Throughout.

PRICE COMPLETE **£9 : 0 : 0**

(Without Valves) (Carriage 2/-)

EXTRA FOR 2 MULLARD "ORA" VALVES, 30/-
EXTRA FOR ADDITIONAL FELLOWS DOUBLE HEADPHONES, 30/- (postage 1/-).

FELLOWS MAGNETO Co., Ltd.

LONDON, N.W.10

Telephone : Willesden 1560-1.

Telegrams : Quixmag, Phone, London

EB 8

For they are jolly good Fellows

SULLIVAN INSTRUMENTS,

COMMENCING WITH THE SIMPLEST, FOR

Broadcasting Reception.

IMPROVED CRYSTAL RECEIVER

(PATENTS APPLIED FOR)

THIS Set has been specially designed for "Broadcasting" and with a view to simplicity, efficiency and reliability. By means of a switch it is adapted for use on aerials varying in dimensions and shape; the operation consists of only one adjustment—for tuning. A sensitive and robust type of crystal, and one which requires no extreme delicacy of adjustment, is employed.

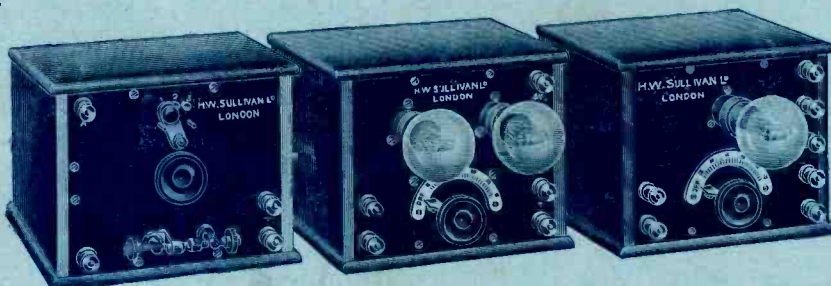

SULLIVAN PATENT CRYSTAL RECEIVER.

TWO VALVE NOTE MAGNIFIER.

ALTERNATIVE SINGLE VALVE NOTE MAGNIFIER.

Beautifully made and remarkable for its appearance and finish, this receiver forms a miniature nucleus cabinet complete in itself, to which Note Magnifier units of similar appearance may be added at will to increase the strength of reception and to enable many telephone receivers to be simultaneously used. The special advantage, so useful in practice, of this arrangement lies in the fact that by simply adding further small units to the system, any desired degree of magnification can be inexpensively obtained.

CRYSTAL RECEIVER (each)	£2 10 0
CRYSTAL RECEIVER with highly sensitive and distortionless Sullivan phones, aerial wire, insulators, etc.	4 10 0
NOTE MAGNIFIERS excluding valves and batteries, but including broadcasting royalty (each) from	2 17 6
VALVES (each)	17 6
HIGH TENSION BATTERIES , dry from	8 6
ACCUMULATORS	1 0 0

New Book of 34 Valve Diagrams (4th Edition), Price 1/- post free within the United Kingdom, Colonies and Dependencies.

DEMONSTRATION AND SHOWROOMS: Liverpool House, Middlesex Street, E.1
 (Two minutes walk from Liverpool Street and Broad Street Stations.) **TRADE TERMS ON APPLICATION.**

<p><i>Works.</i></p> <p>"LIVERPOOL HOUSE"</p> <p>MIDDLESEX ST., LONDON, E.1</p> <p>Phone: Avenue 4871</p>	<h1 style="margin: 0;">HW SULLIVAN</h1> <p style="font-size: small; margin: 0;">TELEGRAMS: "DEADBEAT, STOCK, LONDON."</p>	<p><i>Offices.</i></p> <p>WINCHESTER HOUSE</p> <p>LONDON, E.C.2., ENGLAND</p> <p>Phone: London Wall 3518</p>
--	---	---

88 Kdall

WIRELESS WORLD

AND

RADIO REVIEW

No. 167. [No. 4. VOL. XI.]

28th OCTOBER, 1922.

Registered at the G.P.O. as a Weekly Newspaper

BURNDEPT

WIRELESS APPARATUS

LONDON OFFICE & SHOWROOMS
15 Bedford Street, Strand, W.C.2

Ethophone II.

A Two-valve Broadcast Receiver with self-contained valves and H.T. Battery. Wavelength range 250 to 650 metres, which can be extended as desired by substituting special coils for plug marked "X."

British Broadcast stations audible up to 80 miles on head telephones, and 25 to 30 miles on a loud speaker. Gives perfect results even when operated by a novice. Approved by Postmaster-General, and licensed under Marconi Patents.



Supplied in Polished Walnut Cabinet, 13 x 13 x 10 inches, complete with Valves, and H.T. Battery

Price - - £28

BURNDEPT, LTD., Aerial and Eastnor Works, Blackheath, S.E.3

WESTON ELECTRICAL MEASURING INSTRUMENTS

THE WESTON MODEL 280 VOLT-AMMETER

Triple Range. 150/15/3 Volts. 15/1.5/0.15 amps.

This Precision Instrument is especially suitable for Wireless Research Work, i.e.

3 Volt Range.—Testing accumulator cells, dry batteries, measuring fall of potential across potentiometers.

15 Volt Range.—Testing 6 or 12 volt accumulator supplying voltage to valves, etc.

150 Volt Range.—Testing H.T. Batteries, etc.

0.15 Amp. Range (150M.A.)—Measuring H.T. Current to transmitting valves, determining resistance of Transformers, chokes, telephones, rheostats, etc.

1.5 Amp. Range.—Adjusting filament currents, etc.

15 Amp. Range.—Measuring output or charging current of accumulators, etc.

NOTE.—The 3 volt range may be used as a sensitive low range Milli-Ammeter.

SEVEN INSTRUMENTS IN ONE CASE.

PRICE £10.

Leather Case 15/-

Write for further particulars.

WESTON ELECTRICAL INSTRUMENT CO., LTD.

Audrey House, Ely Place, Holborn, E.C.1

Telephone: Holborn 2029.

Telegrams: "Pivoted, Smith, London."



MODEL 280

The YEAR BOOK of WIRELESS Telegraphy and Telephony 1922

1476 Pages.

Price 15/- Nett.

Demy 8vo.

Postage Inland 1/-.

Abroad 1/4.

CONTENTS :-

Record of the Development of Wireless Telegraphy—National and International Wireless Laws and Regulations—Directory of the World's Land and Ship Wireless Stations—International Allocation of Call Letters—Alphabetical List of Call Letters—Meteorological Section—International Time and Weather Signals—National Résumés of Progress in Wireless Telegraphy—Particulars of Wireless Telegraph Patents, 1921—Aviation Section—Tabular List of Aviation Stations—Useful Data Section—Wireless Terminology—Conventional Signs used in Wireless Diagrams—Companies Engaged in the Commercial Development of Wireless Telegraphy—Biographical Section—Literature on Wireless Telegraphy and Telephony—Directory of the World's Wireless Societies—Directory of Wireless Colleges and Schools—List of Licensed Amateur Transmitting Stations—Code Section—Special Articles on "The Earthing Resistance of Antennae," by Dr. Miessner—"The Recording of Wireless Signals," by Dr. Abraham—"The Birth and History of Long Distance Wireless Telegraphy"—"The Rectification Effect in its Reaction to the Composition and Structure of Crystals."

A valuable feature of the present issue is the specially drawn map, which gives, for the first time, a simple means of finding the distance and true direction of Wireless Stations in all parts of the World, from London as the centre.

THE WIRELESS PRESS, LIMITED,

DEPT. W.W., 12-13 HENRIETTA ST., STRAND, LONDON, W.C.2

FIRST IN
1908

GAMAGES

FOREMOST
TO-DAY

PIONEERS OF WIRELESS APPARATUS FOR AMATEURS

Upon the quality and design of your apparatus depends the success of your experiments. Gamage instruments are of the test and have set the standard of quality throughout, while the prices are the

lowest in London. Gamage's vast experience is at your service—all orders and enquiries, whether in person or by post, are dealt with by Wireless Experts.



Gamage's Crystal Receiving Set

As illustrated. This efficient set has been designed to meet the requirements of the Postmaster-General with regard to wavelength. The tuning coil is wound with best quality wire and is tapped in four places. This, when used in conjunction with the Variable Condenser, which is of the best possible workmanship, gives a good variation of tuning. The crystal detector, designed to prevent dust from deteriorating the sensitivity of the crystal, contains our famous "Permanite" which has given such excellent results. The task of finding a sensitive spot on the crystal is minimised by means of a buzzer and battery incorporated in the set. The advantages of such additions are perfectly obvious when it is realised that by this means it is possible to have the crystal adjusted in readiness for the reception of signals. Without the battery and buzzer a great deal of time is lost while Telephony is being transmitted in trying to find the most sensitive spot on the crystal. A truly remarkable little set for the price that will receive Telephony for 30 miles and signals from Spark stations using a wavelength of 300-500 metres for 150 to 200 miles. Complete in polished mahogany cabinet, with instruments mounted on polished ebonite; Phones, Aerial Wire and Insulators ready for use.

5 Gns.

THE "PARLIPHONE" LOUD SPEAKER

(Prov. Patent No. 21967)

ECONOMICAL. NO METAL USED IN ITS CONSTRUCTION. EQUAL IN EFFICIENCY TO THOSE THREE TIMES THE PRICE.

This Loud Speaker comprises horn and stand moulded in one solid piece of Ebonite. It contains no receiver, but the interior is screwed and made to receive a Brown's Patent Standard Receiver. In this way by simply unscrewing one ear-piece from the existing Headphones and inserting it in the "Parliphone" an efficient Loud Speaker is obtained at a small cost. The remaining ear-piece can still be utilised for tuning in the ordinary way. As no metal is used in its construction, the objectionable metallic "ring" so common to most Loud Speakers is entirely obviated, the result being a rich mellow note without the slightest distortion.



PRICE

32/6

Packing and Postage, 1/3 extra.

Pay no more than Our Prices for BROWN'S HEADPHONES

IMPORTANT.—Our stock must not be confused with the "reconditioned" 'phones at present on the market. These 'phones were supplied to His Majesty's Government, and every instrument has therefore passed the strictest test.

We have received HUNDREDS OF TESTIMONIALS from delighted and satisfied customers.

BROWN'S HEADPHONES, "A" Type, Reed Pattern, Aluminium diaphragm, 120 ohms. OUR PRICE

42/6

BROWN'S HEADPHONES, 8,000ohms. OUR PRICE

49/6

SULLIVAN PHONES 8,000 ohms. OUR PRICE

36/6

Cords 2/9 extra.

Carriage paid.

PLEASE NOTE.—Money returned if you are not satisfied.



Write now for a Copy of Gamage's WIRELESS CATALOGUE

Profusely illustrated and giving full details and prices. Post Free on request

GAMAGES · HOLBORN · LONDON · E.C.1

THE
W & M
Crystal
Detector

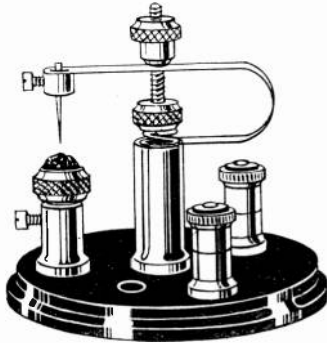

Registered Design No. 692248.
UNIVERSAL ADJUSTMENT.
INTERCHANGEABLE CRYSTAL HOLDERS.

Price 6/6 net, post free

FITTED WITH SILICON CRYSTAL.

Extra Crystal Cups 6d. each.

Absolutely the most efficient Crystal Detector yet produced, and the only one that will stand a considerable amount of vibration without requiring adjustment.

THE
W. & M
Variable
Condenser

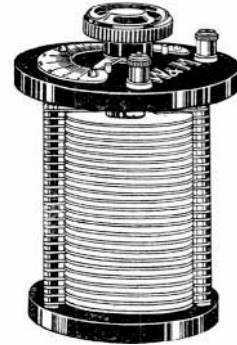

COMPACT, NEAT AND ACCURATE.
Only .025" Air space between each pair
of Vanes.

MADE IN TWO SIZES.

.0005 mfd 18/6 each net

.001 mfd 24/6 each net

Post free

State whether for panel mounting or
as separate unit.

Ebonite Tube Covers 1/6 & 2/- each extra

WE WILL SEND ON APPROVAL

and on the distinct understanding that if the buyer is in any degree dissatisfied with his purchase, he can return same within 24 hours and money will be immediately refunded.

ALL OUR APPARATUS is produced under the personal supervision of our Technical Director, Mr. Henry A. Machen, A.M.I.E.E. (late of Siemens Bros. and Co., Ltd.), whose experience in the design and manufacture of Wireless Apparatus extends over a period of Fifteen years. CATALOGUES FREE.

TRADE TERMS AND DISCOUNTS ON APPLICATION.

Manufactured solely by—

The Wainwright Manufacturing Co., Ltd.,
25, VICTORIA STREET, S.W.1.

Works: WALTHAMSTOW, Essex, and BIRMINGHAM.

Telegrams: Nominatus Vic London.

Telephone: Victoria 4319.

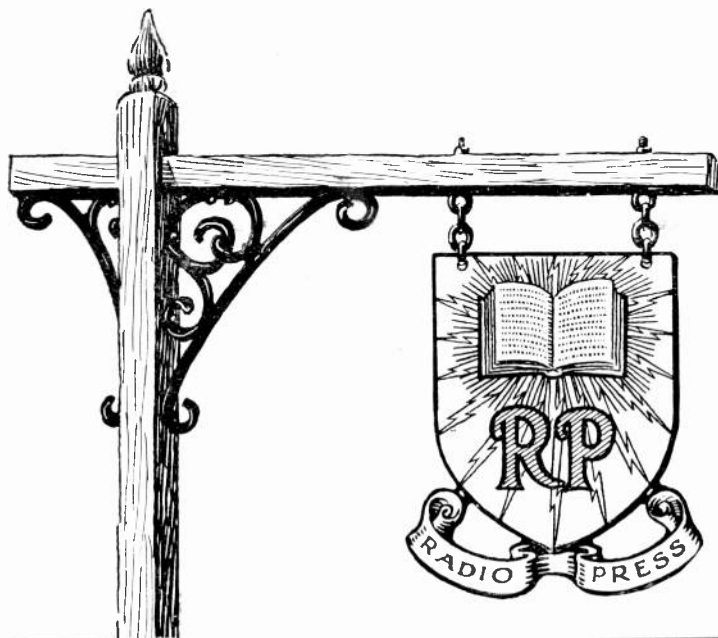

Just Published

"PRACTICAL WIRELESS VALVE CIRCUITS." By JOHN SCOTT-TAGGART, F.Inst.P.
A valuable book of diagrams with practical notes as to their use. A book which should be in the hands of all who possess a book on valves.

Price 2/6 net (Post Free 2/8).

"RADIO PRESS WIRELESS DIRECTORY."
A complete list of all land, ship and amateur call signs. A book which every real experimenter is buying.

Price 2/6 net (Post Free 2/8).

"CONSTRUCTION OF WIRELESS RECEIVING APPARATUS." 3rd (Enlarged) Edition.
By PAUL D. TYERS.

A sound book on making component parts for valve and crystal sets.

Price 1/6 net (Post Free 1/7½).

"WIRELESS VALVES SIMPLY EXPLAINED." By JOHN SCOTT-TAGGART, F.Inst.P.
A book for the amateur.

Price 2/6 net (Post Free 2/8½). Cloth 3/- net (Post Free 3/3).

"SIMPLIFIED WIRELESS."
A book for those who require elementary technical instruction, and information regarding the construction of broadcast receivers.

Price 1/- net (Post Free 1/1½).

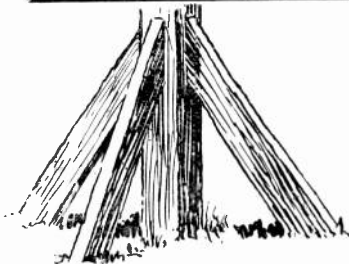

The above are obtainable from or through all wireless dealers and booksellers, or direct from the publishers,

RADIO PRESS LIMITED,
DEVEREUX BUILDINGS, DEVEREUX
COURT, W.C.2 (Opposite Law Courts).

== DUBILIER ==

Radio Music from every Electric Lampholder

Every electric lampholder can now be used with safety for picking up radio signals, "Broadcasting," etc. The "DUCON" forms a perfect attachment between the radio receiver and the electric light wires.

Every "DUCON" is tested at 2000 volts A.C., and has the highest possible insulation resistance. Shocks and short-circuits are thus rendered impossible.

The "DUCON" fits directly into any standard B.C. electric lampholder, and is provided with terminals for connections to the radio receiver.

Simplicity with Perfect Safety is the Keynote of the "Ducon."

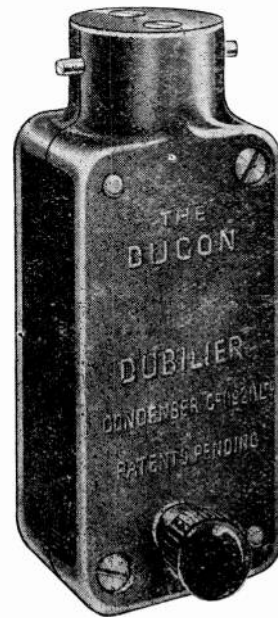

Price 10/- each

DUBILIER CONDENSERS FOR ALL PURPOSES

**THE DUBILIER CONDENSER CO. (1921), LTD.,
DUCON WORKS, Goldhawk Road, Shepherd's Bush, London, W.12**

Telephone—Ham-amersmith 1081.

Telegrams—Hivoltcon, Phone, London.

Code—Marconi International.

DUBILIER

Dubilier Grid Leaks
 are like Dubilier Condensers—
the best



We have now got into full swing on the mass production of grid leaks, and in consequence have greatly reduced the manufacturing cost. We have, as usual, decided to reduce our price accordingly, and in future the Dubilier Grid Leaks will be sold at 2/6 each.

Dealers holding stocks of Dubilier Grid Leaks will be credited in full if they return their stocks to us.

Dubilier Grid Leaks are Accurate, Constant, Guaranteed.

THE DUBILIER CONDENSER CO. (1921), LTD.,
DUCON WORKS, Goldhawk Road, Shepherd's Bush, London, W.12

Telephone—Hammersmith 1084.

Telegrams—Hivoltcon, Phone, London.

Code—Marconi International.

THE WAY TO DUBILIERS.

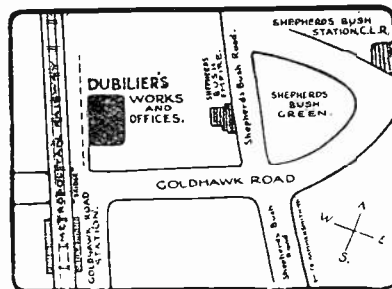

RADION

MAHOGANITE

This is the latest product of our Factories—a superior insulating material for high grade sets, which in grain and colour closely resembles mahogany. Its high insulating and non-warping properties, combined with a beautiful finish, make it an ideal material for Panels.

The Trade are warned against imitations—ordinary mottled Ebonite is *NOT* RADION - MAHOGANITE. All genuine Sheets are stamped "RADION".

Enquiries from bona-fide Manufacturers and Wireless Dealers solicited.

AMERICAN HARD RUBBER COMPANY (Britain) LIMITED,
13a, Fore Street, London, E.C.2

TELEPHONE—12754 CENTRAL.

BASKET COILS

These Coils are quite rigid, being mounted on Ebonite Former fitted with Sockets for Plug mounting.

Set of 5 Coils for use from 220 to 1,300 metres. . . . 10/6

NOTE.—An unfortunate error was made in the price of these in 'last advertisement.

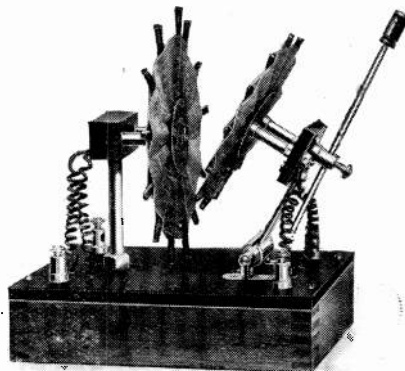

Special Tuning Stand as illustrated on Ebonite Base. . . 12/-
Complete Set of Coils and Stand 22/-
Telephone Transformer each 12/-
L.F. Interval Transformer each 21/-

REYNOLDS & BRADWELL,
41, Church Street, Birmingham.

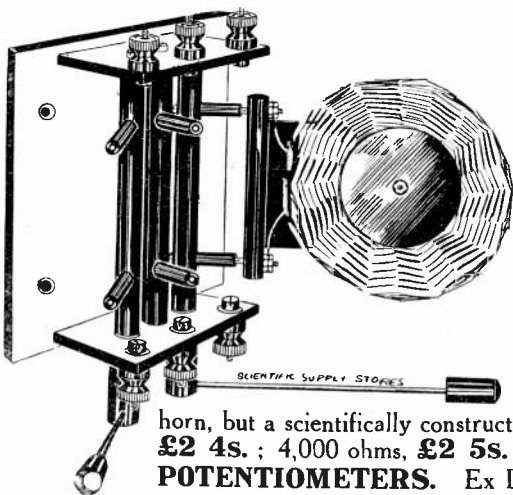

THE POPULAR 3-COIL TUNER.

For Baskets, Slabs or Lattice Coils this 3-coil tuner complies with P.M.C.'s restriction combining the highest efficiency with cheapness and practicability. With a Set of Baskets this makes the most perfect Telephony tuning unit from 150-4,000 metres on the market. Tuning Stand with 3 coil holders, 12/6, post 9d. extra. Coil Holders, 1/3 each. Tuning Stand with 7 coil holders and set of Baskets, 21/6, post 1/-.

THE POPULAR LOUD SPEAKER.

A high class adjustable Loud Speaker at a popular price. Not an earpiece with a horn, but a scientifically constructed instrument, 120 ohms, £2 ; 2,000 ohms.

£2 4s. ; 4,000 ohms, £2 5s. Post 1/6.

POTENTIOMETERS. Ex Disposal 5/6 each, post 6d.

DEWAR SWITCHES. Ex Disposal 2/9 each, post 3d.

SINGLE EARPIECE. Wound to approx. 4,000 ohms 9/6, post 6d. (guaranteed)

SENSITONE CRYSTAL. The most perfect mineral Detector 1/- per specimen

CRYSTAL DETECTOR. Complete with Sensitone Crystal 3/9, post 4d.

Scientific Supply Stores

Phone : Hop 4177

8, Newington Causeway, London, S.E.1.

Crystal of To-
day and Future

THE GREAT
"HERTZITE"

Price 2/6 post free
With Ball and
Socket Detector 5/9

VALVES—"Ora," "Xtraudion," "R.M.R." 15/- each

RUSSELL & SHAW, 38, Great James Street, Bedford Row, W.C. 1

THE WIRELESS WORLD AND RADIO REVIEW

THE OFFICIAL ORGAN OF THE WIRELESS SOCIETY OF LONDON
A MAGAZINE DEVOTED TO WIRELESS TELEGRAPHY AND TELEPHONY

CONTENTS

H.R.H. The Prince of Wales: Patron of the Wireless Society of London-	- - -	117
The Armstrong Super-Regenerative Receiver. By Percy W. Harris-	- - -	118
Electrons, Electric Waves and Wireless Telephony. By Dr. A. J. Fleming, F.R.S.	- - -	122
(continued)	- - -	

Contents continued on next page.

TOMLINSON

LONDON, LIMITED.

3, FINCHLEY RD., ST. JOHN'S WOOD

Hampstead 1844

HIGH EFFICIENCY
HEAD PHONES
(2000 ohms.)



PRICE 20/-
Post 9d. extra.

(Demonstrations Daily)

COMPLETE RECEIVING SETS INSTALLED

PARTICULARS ON APPLICATION

MEN IN THE WIRELESS SERVICES DESIRING RAPID ADVANCEMENT
 should train in spare time with the College which ensures this.
 "U.E.C." (Regent's Park, London, N.W.1) has in Twelve Years secured hundreds of successes by
Individual Postal Training for Engineering Examinations and Professional Work.
 State YOUR ambition in confidence to—SECRETARY'S DEPT (Desk W.).
UNIVERSITY ENGINEERING COLLEGE, WESTGATE-ON-SEA, KENT.
 and expert advice with the New prospectus. No. 8. will be sent you without obligation.

CONTENTS *(Continued)*

High Frequency Amplification	- - - - -	126
Experimental Station Design. By F. H. H. <i>(continued)</i>	- - - - -	128
Wireless and International Language. By Bernard Long, B.A.	- - - - -	132
Wireless in a Coal-Mine. By 2ZD.	- - - - -	133
Notes	- - - - -	135
Correspondence	- - - - -	136
Calendar of Current Events	- - - - -	137
Wireless Club Reports	- - - - -	138
Questions and Answers	- - - - -	144
Share Market Report	- - - - -	150

THE WIRELESS WORLD AND RADIO REVIEW is published weekly on Saturdays.
 All correspondence relating to contributions should be addressed to THE EDITOR,
 THE WIRELESS WORLD AND RADIO REVIEW, 12-13, Henrietta Street, Strand, London, W.C.2.
 No responsibility can be taken for MSS. or photographs sent without stamps to defray
 cost of return postage.
 Editorial and Publishing Offices : 12-13, Henrietta Street, Strand, London, W.C.2.
 Telegraphic Address : "Radionic, Rand, London." Telephone No. : Gerrard 2807.
 Advertisement Managers, Bertram Day & Co., Ltd., 9 and 10, Charing Cross, S.W.1.
 Telephone No. : Gerrard 8063 and 8064

SUBSCRIPTION RATES.

28s. per annum, post free. Single Copies 6d., or post free 7d.

Registered at the G.P.O. for transmission by Magazine Post to Canada and Newfoundland.

" EIFFEL TOWER TYPE."

MASTS

STRONG. LIGHT.
 WOOD LATTICE. EASY TO ERECT.
 ROT AND WATER PROOF.

20 to 50 feet - - - 1/3 per foot
 55 ,, 100 ,, - - - 1/9 ,, ,,

FROM STOCK. CASH WITH ORDER.

WILKINSON, Lonsdale Road, Kilburn, N.W.6
 Same Address since 1900. Trade Supplied.
 Bankers—LONDON CITY AND MIDLAND, KILBURN, N.W.6.

— **1922-23** —

Our new Season's list is now ready
 and will be sent to any address
 for two stamps.

SEND TO-DAY FOR YOUR COPY
Electrical Supply Stores
Wireless Specialists,
 5, Albert Terrace, King Cross,
HALIFAX.

VALVES

DELIVERY FROM STOCK.

RECEIVING.



Type.	Filament Voltage.	Anode Voltage.	PRICE.
R	4	60	£0 17 6
R ₄ B	4	50	1 10 0
V ₂₄	5.2	36	1 4 0
Q	5.2	50	1 4 0
		(150 as amplifier)	
QX	5.2	50	1 4 0

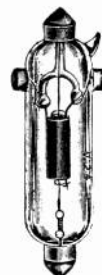

SPECIAL LOW TEMPERATURE VALVES.



Type.	Filament Voltage.	Filament Current.	Anode Voltage.	PRICE.
L.T.1	1.8	.4	36-50	£2 10 0
L.T.3	1.8	.11	„	„

TRANSMITTING.

L.T. 1.

Type	Filament Voltage.	Anode Voltage.	PRICE.
A.T.25	5.5	UP TO 1,000	£1 10 0
A.T.40X	7	„ 1,000	2 15 0

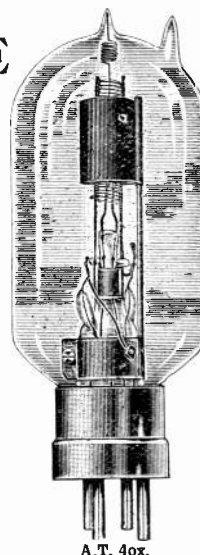

A.T. 40x.

THE
MARCONI SCIENTIFIC INSTRUMENT CO., LTD.

40 DEAN STREET, SOHO, W.1

TELEGRAMS: THEMASINCO, WESTCENT
 TELEPHONE: GERRARD 774

Showrooms that will interest you!

FREE DEMONSTRATIONS AND ADVICE

Visit our well-equipped Showrooms, and ask our experts anything you want to know; they will be happy to give you any advice, and a demonstration if necessary, and tell you which set will best suit your pocket. In addition to Complete Receiving Sets of the best quality, we also manufacture and supply all component parts.

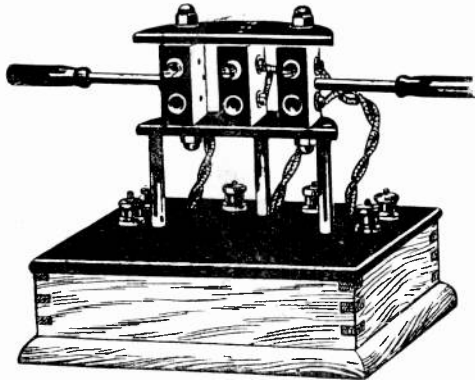

Send 3d. Stamps for our Illustrated Catalogue.

"Ideal" Valve Accumulator, 6 volt, 50 amp.
25/- per set. Carriage 3/-

"Ideal" Valve Accumulator, 4 volt, 50 amp.
24/- per set. Carriage 2/-

Filament Resistances, 5/- each.

Variable Condensers (of various capacities),
from 6/-

Fixed Condensers, from 2/6

H.T. Battery Case, 15/-

H.T. Battery Case, with 60 volt Battery, 29/-

The illustration is that of our Three Coil Holder Complete Unit for use with any standard coils, mounted on mahogany base, with ebonite top and well lacquered brass parts. The levers at the side make possible the most critical adjustment with the very minimum of friction.

Price 20/- each

List of H.T. Batteries or Accumulators free.

WATES BROS.

13/14, Great Queen Street,
KINGSWAY, W.C.2.

DAVIS & TIMMINS, LIMITED.

34a, York Road, King's Cross, N.1



SCREWS & TERMINALS FOR WIRELESS SETS.

Illustrated Lists sent Free on Request.

Tele. No.: NORTH 580.

Telegrams: CONDUCTIVITY, LONDON.

The Broadway Radio Works

DEVONSHIRE ROAD, BEXLEYHEATH, KENT.

CRYSTAL SETS

Every Set is thoroughly tested before it leaves our works. Fitted in beautifully French Polished Mahogany Cabinet with Lid.

Range 200 to 3,000 metres £4 0 0
Range 200 to 500 metres £3 15 0

The second set is specially designed to give maximum efficiency on the Broadcasting Wavelength.

CONDENSERS

Value in M.F.	Panel Mounting in Parts	Panel Mounting Assembled	Cabinet Mounting in Parts	Cabinet Mounting Assembled	Cabinet Mounting Assembled in Cabinet	Polished Mahogany Cabinet
0015 ..	23/-	25/6	24/-	26/6	33/-	6/3
001 ..	16/9	19/6	17/9	21/-	26/-	5/6
00075 ..	13/6	16/3	14/6	16/6	22/-	5/6
0005 ..	10/6	13/-	11/9	13/9	18/-	4/6
0004 ..	10/-	12/6	11/-	13/3	17/6	4/6
0003 ..	9/-	11/6	10/-	12/-	16/-	4/-
0002 ..	7/-	9/-	8/-	9/6	13/6	4/-
0001 ..	6/-	8/-	7/-	8/6	12/6	4/-
Vernier ..	-	4/6	-	5/-	9/-	3/6

Fitted with Bevelled Ebonite Dial 1/9 extra.
Special Sizes Made to Order. Price list on request.
ALL SUNDRIES AND COMPONENTS IN STOCK.
ORDERS OVER 20/- CARRIAGE PAID.

TRADE ENQUIRIES INVITED.

THE WIRELESS WORLD AND RADIO REVIEW

THE OFFICIAL ORGAN OF THE WIRELESS SOCIETY OF LONDON

No. 167 [No. 4.
VOL. XI.]

OCTOBER 28TH, 1922.

WEEKLY

H.R.H the Prince of Wales

PATRON OF THE WIRELESS SOCIETY OF LONDON.

AT the ordinary general meeting of the Wireless Society of London, held on Wednesday, October 25th, the announcement was made that H.R.H. the Prince of Wales had graciously consented to become the Patron of the Wireless Society of London and its affiliated Societies, and that he noted it was intended to change the title to that of the Radio Society of Great Britain in the near future. The President had acknowledged this communication on behalf of the Societies, expressing the extreme gratification that will be felt by all connected with the Society at this mark of His Royal Highness's interest in the work of Radiotelegraphy.

announced that the President had received a request from the Chairman of St. Dunstan's Hostel for Blinded Soldiers & Sailors asking him to bring

to the notice of the members of the Wireless Society of London and its affiliated Societies that many of these blind men in all parts of the country would be grateful to those Societies and to their individual members for any assistance they could give them in fitting and installing wireless receiving sets, so that they could take advantage of Broadcasting and so add an item of interest and pleasure to their darkened lives. He had interviewed the Chairman,

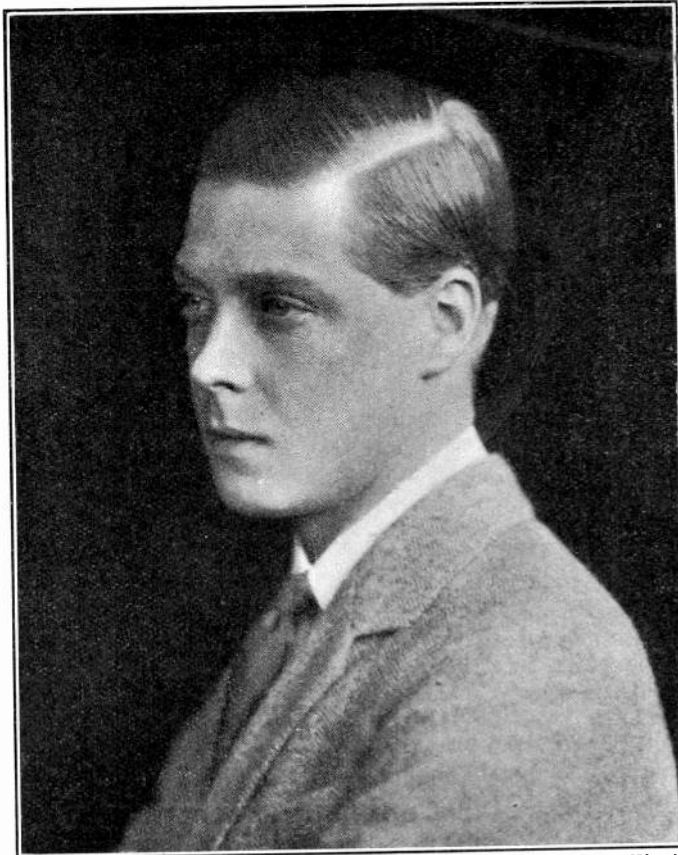

[Photo]

H.R.H. the Prince of Wales.

[L'andyk

Fraser, and seen the set that he has personally

installed, with but slight assistance from one of the members of the Society, and which gives so much pleasure to the inmates of St. Dunstan's in the reception of the music and speech broadcasted by 2 LO and others. The President fully supports this proposal and considers the scheme quite practicable. He hopes that all those interested in wireless will do the best they individually

can and that the Secretaries of the affiliated Societies will also assist by receiving and dealing with any requests which may reach them from blind residents in their locality.

It was stated that His Royal Highness desired especially to associate himself with this work as his first action on becoming the Patron of the Society.

The Armstrong Super-Regenerative Receiver

PRACTICAL DETAILS OF A BRITISH BUILT INSTRUMENT.

(Concluded from page 82.)

By PERCY W. HARRIS.

LAST week a list was given of the component parts required to build a super-regenerative receiver. Before the actual constructional work is begun, it should be pointed out that the construction of such a set cannot be recommended to the inexperienced amateur, and unless the builder is well accustomed to the operation of an ordinary regenerative receiver he will be unable to make the

First of all make a suitable cabinet. In the instrument described the component parts are mounted both on the ebonite panel and on the base to which it is attached, for which reason it is essential to make the cabinet first. A suitable box can be constructed from $\frac{5}{8}$ -in. white deal, bought in nominal nine-inch widths from the timber yard. It should be bought already planed, as this will save much work.

The method of construction can best be learnt from an examination of Figs. 4 to 6 accompanying this article. The two end pieces should be attached to the base, and the top and back made to fit in place on the ledges shown. The two latter parts are only put in place when the instrument is wired.

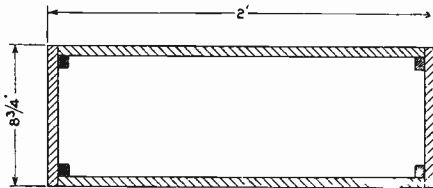

Fig. 4. How to construct the wooden case. The top and back are attached when the wiring is finished.

present instrument work. Furthermore, the Armstrong super-regenerator is as yet by no means perfect, and much remains to be done before it can be looked upon as a suitable receiver for general work. To the experimenter, however, it is a thing of delight, opening up an entirely new field of work. Whilst the actual constructional work will be found comparatively easy, the manipulation of the complete instrument requires practice, and some patience will be needed to obtain good results.

With these provisos the actual work of construction can be started.

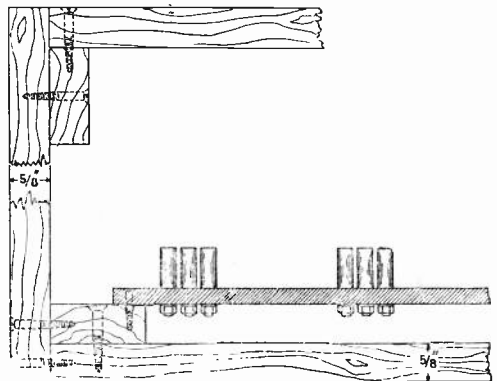

Fig. 5. Method of fixing ebonite strip with valve sockets. If valve bases with terminals are used this strip will not be needed.

The planed wood should be finished with sand or emery paper and given a coat of some water stain, followed by a coat or two of

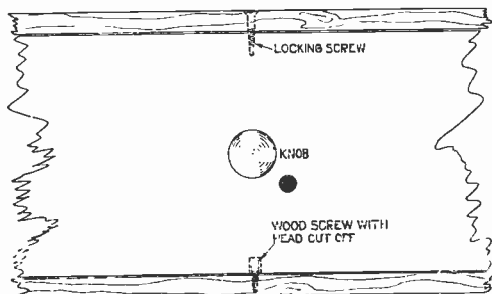

Fig. 6. Method of fixing back so as to allow easy removal.

spirit or other varnish. This method is far preferable to painting with combined varnish-stain, as in this latter case the stain does not sink into the wood, but remains in the varnish, giving a much inferior effect.

As soon as the box is finished take the ebonite panel and give it a matt finish by rubbing with fine emery. Next take your components and arrange them on the panel until you are satisfied with the layout. This should follow as closely as possible the arrangement in the instrument illustrated, and it seems essential that the three duolateral coils should be at right angles to one another in the way shown. No difficulty will be found in arranging the positions of the filament rheostats, jacks, windows for valves, variable condensers, etc., but care must be taken to get the position of the variometer correct. In the finished instrument this must come immediately above

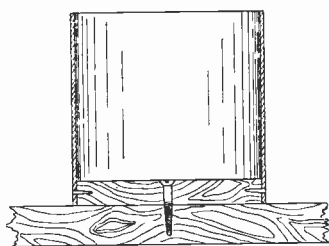

Fig. 7. Method of attaching the fixed coil to the base.

the fixed coil mounted on the base. The position of this latter and the variometer should be considered at the same time.

The absence of detailed measurements in the Figures may be noticed. At first it was intended to give all such details, but a few minutes consideration will show that as

no two sets of components will be alike in measurements (variable condensers seem to be of all sizes, irrespective of capacity), and as the parts have to fit in with one another, such measurements would be useless. A drilling plan can only be made out when all the components are ready for assembly.

The plug-sockets can be mounted in several ways. Perhaps the simplest is to drill two holes in the panel for each socket, the holes coming immediately beneath corresponding holes in the socket. 6 BA metal screws can then be passed through the holes into the base, and will hold it in place. Most sockets have screws through the side, making contact with the brass pin and socket, and to these soldering lugs may be attached for making the necessary connections. (Fig. 8.)

When all the parts have been mounted on the panel (it is of course assumed that it has

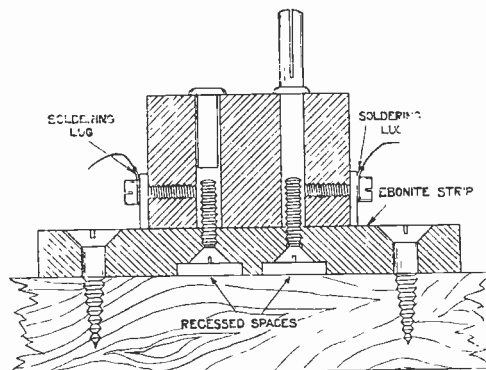

Fig. 8. Details for mounting the plug sockets.

been drilled for attachment to the wooden uprights), wire up those connections which are entirely on the panel. For simplicity Fig. 9 shows both panel and base drawn in one plane, and with the help of the illustration no difficulty will be found in making the necessary connections.

The next step is to wind the fixed coil with No. 18 D.C.C. wire. Leave a short length at the beginning, then wind a third of the coil and make a tap by twisting a loop. Wind a further third, make a second tap, and then wind to the end, leaving a short length for soldering the connection. About sixty turns will be found to go on a former of this size. A suitable method of attaching the coil to the base is shown in Fig. 7. A wooden boss is cut to fit the lower end of the former, and is secured by any suitable means, such as

by three small screws. A single screw in the centre is sufficient to hold it to the baseboard.

No instructions are necessary for the attachment of the other components to the baseboard, as these are clearly shown in the illustrations. Wiring up is comparatively simple, although soldering connections to the jacks may present a little difficulty. It will be found convenient to solder lengths of wire to the jacks before the panel is fixed to the

solutely essential, and it is not included in the American instrument, but the writer considers it worth while, if only to protect the telephones from the high voltages necessary to operate the instrument. As far as possible wiring is carried out with No. 18 or 20 tinned copper, but finer wire is used in difficult parts of the circuit. Insulating tubing is fitted throughout.

When all wiring is finished and coils and

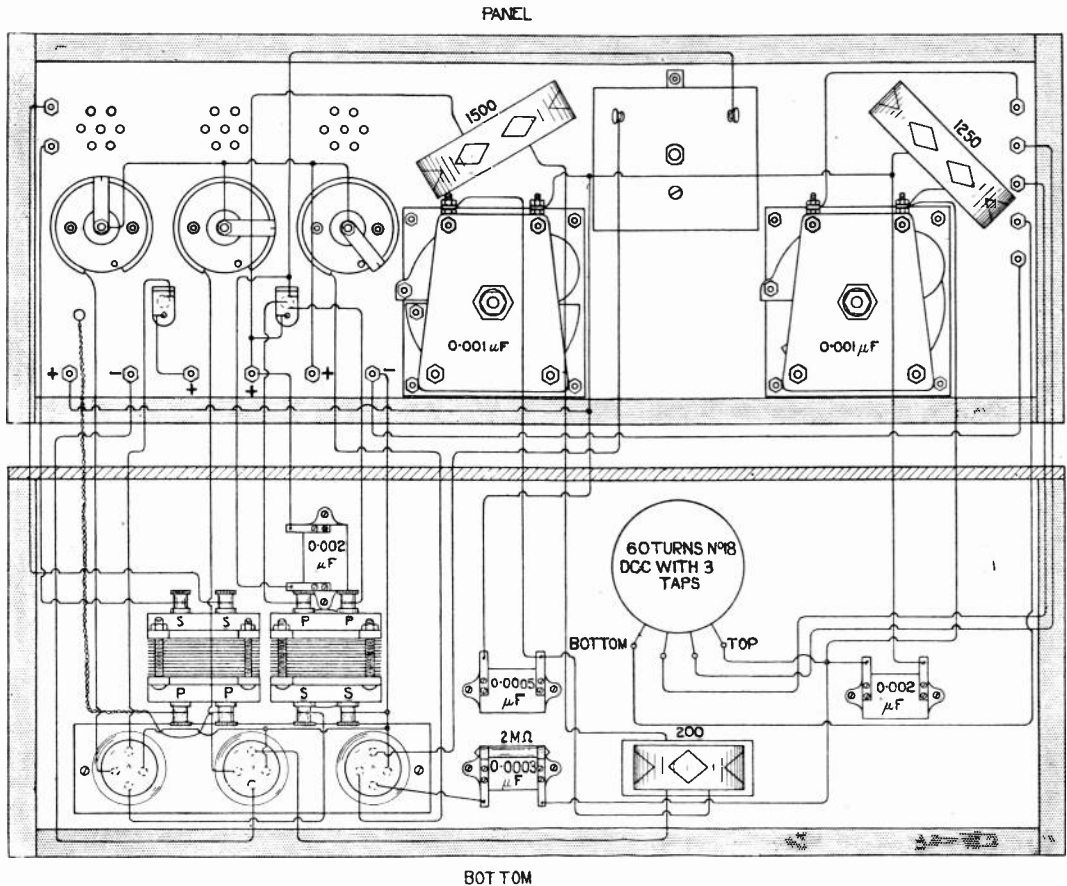

Fig. 9. Disposition of parts and wiring diagram. For simplicity both panel and base are shown in one plane, although, of course, they are actually at right angles.

uprights. They can then be conveniently cut to the required length and soldered to the respective points after the panel is in place.

If possible, every connection should be soldered. In the American instrument, on which this receiver is based, everything is mounted on the panel, but it has been found more convenient to adopt the method described here. A telephone transformer is not ab-

valves are in place, the top can be screwed down and the back fitted by any suitable method, one as used by the writer being shown in the drawings. A hole is drilled in the edge of the backboard, and this fits over a wood screw from which the head has been cut. A single screw through the top will hold the back in place, and if a knob is fitted (Fig. 6) the back can be lifted out as soon as the top screw is removed.

OPERATION OF THE INSTRUMENT.

Looking at the front of the instrument, the terminals are connected as shown in the diagram in the first article. The five terminals on the extreme left are used as follows:— The top terminal is permanently connected to one lead of a small loop aerial, the other lead of which is taken to the second, third or fourth terminal as found by experiment to be best. A flexible lead should be taken from the lowest terminal to one of the others, (found by trial, but usually the top terminal). The two terminals on the extreme right are for the L.R. telephones or loud speaker. The six lower terminals are (counting from the left) for L.T. negative, L.T. positive and H.T. negative, H.T. positive for first two valves (about 150 volts for "R." valves seems about right), H.T. positive for last valve (150 to 200 volts), oscillator valve grid-bias negative, and oscillator grid-bias positive. These last two can be shorted for most valves, but some may work better with a few volts negative on the grid.

When the plug is inserted in the left-hand jack the note-magnifying valve is cut out, and when in the right-hand jack it is in circuit.

A two-foot loop with about six to nine turns of wire will be found quite suitable with this receiver.

When all is ready and the valves are in their sockets, connect a pair of telephones to the necessary terminals and plug in the left-hand jack. Now turn up the filaments quite brightly, and a high note will be heard in the telephones. Set the tuning condenser (left) at a fairly low value, the oscillator condenser at near maximum and the variometer dial near zero. Now slowly increase the variometer until a violent squawking noise is heard, then turn back slightly until this disappears. If all is well, every movement on any adjustment will be accompanied by innumerable strange heterodyne notes, howls, squawks and hisses. Telephony will first be heard as very mushy, distorted sounds, and adjustment of all dials will be necessary to remove distortion. The receiver seems to work much more efficiently on fairly strong signals, and at six miles from Marconi House gives good loud speaker strength on two valves and six turns of wire on a two-foot former. The adjustment of the filament rheostats is very critical, and it is probable that power valves will give much better results, although up to the time of writing it has not been possible to test them

in the circuit. Capacity effects are rather marked and extension handles for the adjustments are recommended. The exact value of the H.T. seems also important, for which reason tapped batteries are an advantage. No difference in strength has been noticed in Marconi House signals at six miles and one, and 2 OM at ten miles was practically as strong on the same arrangement, all of which indicate that the strength is limited by the current-carrying capacity of the "R" valves so far used. C.W. comes in far better than spark, which is distorted. Leaflet harmonics are very loud, and, as a matter of fact, were the first signals picked up. The

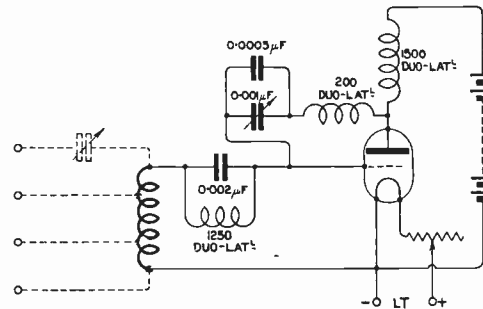

Fig. 10. Circuit of the Oscillator Valve isolated and simplified. The thick line indicates the path of the quenching oscillations through the fixed coil.

sound of spark signals is a mixture of heterodyne and true note. The high note of the oscillating valve is rather noticeable at first, but one soon gets used to it. A filter circuit on the lines indicated in previous articles in this magazine would remove this note, but would add to the complication of the receiver.

In conclusion the writer would like to state that he does not consider that the receiver described represents by any means all that can be gained by the new circuits. It is simply put forward as a working proposition which can serve as a basis for innumerable experiments. He is convinced that British amateurs will soon find a way of making it as easy to operate as the better-known arrangements. Meanwhile it remains an instrument full of strange howls and squeaks, only to be quieted by gentle persuasion.

A final word. Whatever you do, remember that the super-regenerator oscillates violently, and must on no account be used on an outside aerial. A two-foot loop is quite enough, and probably a twelve-inch loop would do as well. Used in this way it should give no trouble with radiation.

Electrons, Electric Waves and Wireless Telephony—IV.

By Dr. J. A. FLEMING, F.R.S.

The articles appearing under the above title are a reproduction with some additions of the Christmas Lectures on Electric Waves and Wireless Telephony given by Dr. J. A. Fleming, F.R.S., at the Royal Institution, London, in December and January, 1921-1922. The Wireless Press, Ltd., has been able to secure the serial rights of publication, and any subsequent re-publication. The articles are therefore copyright, and rights of publication and reproduction are strictly reserved.

THE GRAMOPHONE.

It is clear there are many matters of great scientific interest in connection with that popular instrument the gramophone. There are two types of this instrument, one employing a needle and the other a jewelled point in the sound producing portion.

On examining a gramophone record we find it to be a disc made of a certain composition which softens with heat, and on it is a close spiral groove cut in the plate. In the needle records this groove is smooth at the bottom but irregularly indented at the side. The record is made to revolve steadily at about 90 revolutions a minute by the clockwork. The so-called sound-box consists of a flat metal box, carried on the end of a hollow arm, and this box has a circular disc, generally of mica as the outer face. The centre of the disc is screwed to a pivotted arm, ending in a needle which rests in the groove in the record. As the record revolves, the needle travels in the groove, but is jerked to and fro by the irregularities on the side of the groove. This causes the lever to impart corresponding vibrations to the mica disc of the sound-box, and these create aerial waves which travel up the tube and make their exit from the horn. In the case of the Pathé gramophones the groove in the record is smooth at the sides but irregularly indented at the bottom. The sound-box lever ends in a metal point tipped with a small sapphire ball. This ball travels along the record groove and jumps or bounces over the uneven bottom like a bicycle on a rough road. These vibrations are communicated to the sound-box disc and then to the air.

The marvellous thing about the gramophone is the perfect manner in which it can

reproduce complex sounds such as speech, singing, noises of animals, bells ringing, cornets and violins playing and even hammers beating on anvils. The outline or profile of the irregularities on the side or bottom of the groove in the record is a copy of the wave form of the sound originally impressed on the master record, and this is faithfully reproduced in the aerial vibrations created as above described by the copies of the master record, which are sold to buyers.

This is perhaps the place to make reference to the history of a type of gramophone which is capable of giving a vastly louder sound or wave amplitude than the ordinary instruments. In this case the power required to create the aerial waves is not derived merely from the clockwork driving the record, but from a supply of compressed air furnished by an electric motor and pump. All that the rotating record does is to control the emission of this air and modulate it so as to produce aerial waves.

A sudden puff of air is capable of starting a compressional wave into existence in surrounding air. In fact, this is the underlying principle of all so-called wind musical instruments, *e.g.*, organ pipes, reeds, trumpets, cornets, flutes, etc.

Suppose, then, that a jet of compressed air is issuing from a pipe. If we can apply to the end of the pipe a valve which will control the jet of air and modulate it in accordance with the wave form of a musical sound, we shall produce the corresponding aerial waves.

Edison seems to have had the idea in 1876 that if such a valve could be controlled by the voice, then an instrument could be made which would greatly magnify it or act as an amplifier of speech.

In the late years of the nineteenth century Mr. Horace L. Short devised a valve intended to be used for this purpose, and a few years later the eminent engineer, Sir Charles Parsons, the inventor of the steam turbine which bears his name and has effected such a revolution in ship propulsion, turned his attention to the subject.

He invented a peculiar kind of valve consisting of a metal plate with very close narrow slits in it. These slits were closed by a kind of steel comb, the teeth of which overlaid the slits and closed them. If the comb was raised a little the slits became more or less open. Compressed air was supplied under the slotted plate, and its emission controlled

Messrs. Creed and Gaydon have now perfected a form of comb-valve which can be attached to the arm of a gramophone and actuated by any needle record. The valve is supplied with compressed air under a pressure of 10 lbs. on the square inch, furnished by a simple form of rotary pump driven by an electric motor of $\frac{1}{2}$ horse power. The indentations on the record, acting through the needle, control the motions of the comb-valve (see Fig. 31), and this, again, controls the emission of the air (see Fig. 32). The instrument therefore gives a much greater volume of sound than the ordinary gramophone, and can be heard over very large halls or for great distances in the open air. The general

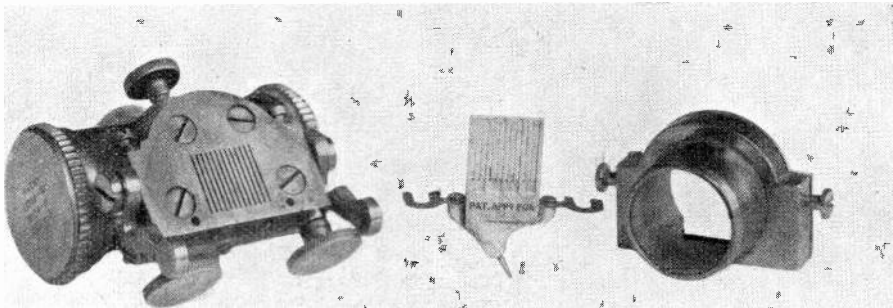

Courtesy—P. J. Riden, Esq.

Fig. 31. The slotted plate and Comb Valve of a Creed Stentorphone similar to that previously invented by Sir Charles Parsons.

by very slight movements of the metal comb, which last were actuated by the vibrations of some musical instrument or by a gramophone record. In this manner very powerful aerial vibrations were created by means of feebler sounds. This invention of Sir Charles Parsons was named an "Auxetophone," and it was exhibited to the Royal Society in London in 1904, and also at the Royal Institution. It was employed in 1906 to amplify the sounds of musical instruments, violins, double bass, cellos, etc., but its introduction was blocked or boycotted by the band-playing fraternity because they thought it would reduce the number of executants required in bands.

More recently, a similar type of instrument has been evolved by Mr. Gaydon and manufactured by Mr. Creed, of Croydon, the well-known inventor of telegraphic printing instruments. This last form of instrument has been called a stentorphone.

appearance of the instrument with its air compressor is shown in Fig. 33. The electric motor can be driven off any electric light supply circuit.

4. THE VELOCITY OF SOUND WAVES.

This discussion of aerial waves would probably be incomplete without some reference to methods of measuring their velocity, since these measurements have of late years received important practical applications in methods of sound-ranging for locating the position of a source of sound and in providing means for measuring the depth of the sea.

Very familiar experiences show us that a sound wave takes time to travel through the air. The delay in hearing the noise of thunder after seeing the lightning, or the explosion of a gun or rocket after seeing the flash or burst, shows that this is the case.

Modern methods of measuring extremely small intervals of time and of detecting feeble sounds have greatly increased the accuracy with which air wave velocity can be measured.

The following rather rough lecture experiment was devised by the writer for showing to a public audience that a sound wave takes a perceptible time to travel a distance of even a few feet.

If a sudden tap is given to the cover of this funnel by a little metal drumstick, it starts a wave of compression which runs along the zinc tube. On the rubber cover of the funnel was fixed a little metal disc, and matters were so arranged that the act of striking the tight rubber cover of the funnel, strained on it like a drum-head, closed an electric circuit, as well as started an air wave travelling down the zinc



Courtesy—P. J. Risdén, Esq.

Fig. 32. The tone arm, valve, air delivery pipe, and Record on a Creed Stentorphone.

A couple of zinc tubes, each about $2\frac{1}{2}$ ins. in diameter and 15 feet long, were united by a bend at one end so as to make a U-shaped tube, 30 ft. long. One end of this tube was covered with a diaphragm of thin sheet india-rubber, put on like the cover of a pot of jam. The other end of the tube was stopped with a cork. Two tin funnels were provided, the wide ends of which were similarly covered with india-rubber sheet, and the spouts were inserted in holes in the long tubes, one near the cork-closed end and the other near the rubber-covered end.

tube. When that air wave reached the thin rubber cover at the far end of the tube it caused it to bulge out, and in so doing, to knock over a trigger and break or interrupt the electric circuit closed in the act of starting the wave. In this circuit was inserted an instrument called a milli-ampere meter, in which an indicating needle or index arm is moved through a certain angle by an electric current passing for a certain time. If, then, the air wave takes time to travel along the tube, a certain interval of time will elapse between the closing of the electric circuit by striking the

funnel drum-head, and its interruption when the air wave so created reaches the far end and knocks over the trigger. From the deflection of the needle of the amperemeter, which then takes place, we can estimate the time taken for the air wave to travel 30 feet along the tube. From experiments made, it appears to be rather more than one thirty-fifth part of a second, which shows that an air wave travels at the rate of 1,100 feet per second.

velocity to be 334.4 metres per second, which is equal to 1,097 ft. per second.

It has been found, however, that very loud sounds certainly travel much faster in open air than sounds of moderate intensity.

It was pointed out as far back as 1808 by the French mathematician, Poisson, that the mathematical theory of the propagation of waves of large amplitude is entirely different from that which is valid when waves of small

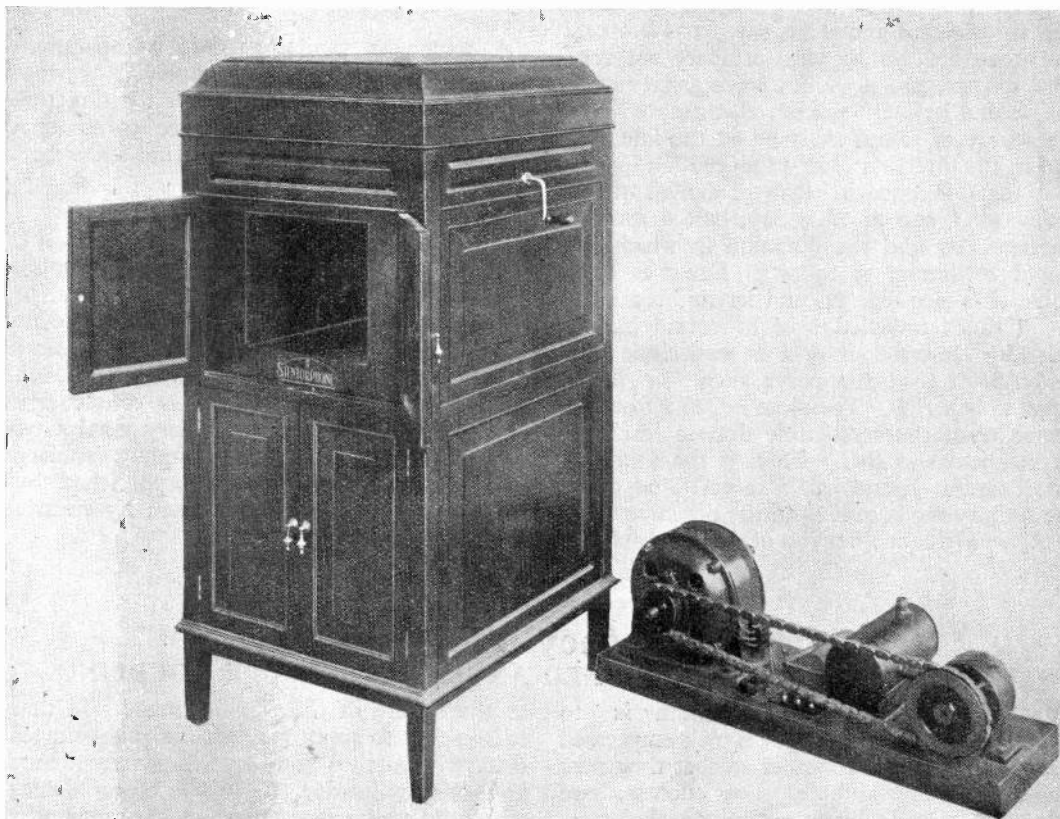

Fig. 33. View of a Creed Stentorphone Cabinet, and of the Electric motor driving the air compressor pump for supplying the compressed air.

Courtesy—P. J. Riden, Esq.

Much more exact experiments of this kind have been made and described recently by Messrs. Dixon, Campbell and Parker (see *Proceedings of the Royal Society*, London: Series A, Vol. 100, October, 1921, p. 1).

They have measured with great accuracy the velocity of compressional waves in various gases at different temperatures and in tubes made of several kinds of material.

In air at 10° Centigrade they found the

amplitude are considered. In 1900, M. Vieille, Engineer-in-chief of the French Ordnance Bureau, showed that the velocity of the air wave produced by bursting open a thin metal disc by an air pressure of 400 lbs. on the square inch was nearly double that of ordinary sound, whilst the air waves produced by the detonation of high explosives was nearly three times the normal.

If the velocity of an air wave is known, and

if the interval of time between its arrival at two places, the distance apart of which is known can be measured, then we can locate the direction of the source of sound. For suppose *A* and *B* (see Fig. 34) to be two places, the distance *AB* being known. If a sound wave sent out from some distant source arrives simultaneously at *A* and *B*, then we know that the source of sound must be somewhere in a line perpendicular to *AB*, and passing through the point half-way between them.

If the places *A* and *B* are, say, 1,100 ft. apart, and if we are dealing with ordinary not very loud sounds, and if the air wave arrives at *A* one second before it reaches *B*, then we know the source of sound must be on the line *AB* and in the direction *BA*, produced.

If the difference in times of arrival of the sound at *A* and at *B* is, say, half a second, then we can find the direction in which the sound is coming as follows. Draw to scale a line *AB* (see Fig. 34) and let this represent the distance travelled over by sound in one second. Describe as *AB* a semi-circle and find a point *C* on that curve, such that *AC* is equal to half *AB*. Then join *BC* and from the centre *O* of the semi-circle draw a line *OD* perpendicular to *BC*. Then if the sound is first heard at *B* and half a second after at *A*, the sound wave is coming in the direction *DO*. If then we have another pair of similar observing

(To be continued)

stations, we can determine another line of travel of the air wave and hence from the intersection

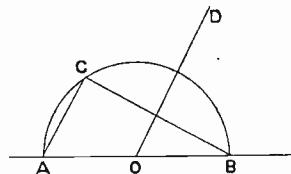

Fig. 34.

of these two lines the place of origin of the sound.

A somewhat similar method of operation called sound ranging was employed during the European War, 1914-18, for locating the position of enemy guns. Large corrections have, however, to be made for wind and other disturbing causes.

By an oversight, which is regretted, the author omitted to mention that the photographs of capillary ripples shown in Figs. 9, 10 and 13 were taken by Mr. J. H. Vincent and published by him in the *Philosophical Magazine* for June 1897, September 1898 and October 1899. Fig. 9 is erroneously stated to be shadows of capillary ripples on water. It is, in fact, a photograph of capillary ripples on a mercury surface published by Mr. Vincent in June 1897, taken by electric spark photography.

High-Frequency Amplification.

TUNED TRANSFORMER v. TUNED ANODE INTERVALVE COUPLING.

THE object of amplification is to magnify the feeble signals impressed on the aerial system so that they may be comfortably audible. For success, two conditions should be fulfilled: the characteristics of the signal itself ought not to be changed except in amplitude; and only the signals which one desires to receive should be magnified.

Generally, for financial reasons, and for the reason that the experimenter wishes to secure results with the minimum amount of apparatus, the smallest number of valves consistent with the enjoyment of signals are used. This is precisely what should be, for the difficulties of distortionless amplification increase rapidly with the number of valves.

The detecting efficiency of a valve arranged to function properly as a rectifier varies roughly

as the square of the signal strength, so that it is useless to apply very small signal voltages directly to the rectifier. High frequency voltage amplification must come before detection, and the arrangement of the apparatus associated with the valves which form the H.F. portion of the receiving gear requires careful design and handling, if good results are to be obtained.

Valves are essentially voltage operated devices, and it is necessary to maintain as high as possible the signal voltages on the grid in order that the strongest possible voltage changes will be produced in the anode side of the valve. Large potentials can more easily be produced across the input (grid-filament) circuit, the higher the grid filament impedance, and at the low wavelength upon which telephony is transmitted, great care

must be taken to keep the capacity across the input circuit as small as possible. It is better to employ amplifying valves with low capacity, and stray capacity such as is caused by long leads, and self capacities in apparatus should be reduced to a minimum.

On account of capacity, the amplification which can be secured when a resistance is connected to the anode of the valve is small at these short wavelengths, and recourse is taken to either transformer coupling or to tuned anode capacity coupling.

To obtain the maximum voltage amplification which the physical structure of the valve permits, the impedance connected to its plate circuit must be very high, and as each of the two latter methods of coupling employ the principle of resonance, it may be thought that either could be used with equal advantage.

Such is not the case. On account of the transformer being tuned, it will have one sharp point of resonance with the signal, and as a telephonically modulated wave occupies a band of frequencies, (actually equal to the difference between $(f + p)$ and $(f - p)$ where f is the frequency of the "carrier" wave and p is the range of frequencies covered by the voltages set up when the microphone is disturbed by the voice), at least half of the modulated wave will not be amplified, and of the remainder, some will be amplified to a greater extent than others. Further, the secondary has still to deal with the energy.

Now, when a H.F. transformer is designed to work with a tuning condenser across the primary winding, the two windings are generally wound close together and the effect of a condenser with capacity C across the primary is to introduce an apparent

capacity of $C \times \frac{1}{t^2}$ (where t^2 is the step-up ratio of the transformer) across the secondary winding. As the valve and accidental capacities across the secondary winding are added to the apparent capacity transferred from the primary, the turn ratio can only slightly exceed unity.

If, with great care, it is arranged that when the primary circuit is adjusted for resonance the secondary circuit is also in resonance, then the amplified signal which is impressed on the input of the second valve still resembles the signal energy which was applied to the input of the first valve, with the difference that only half the signal, that is either $(f + p)$ or $(f - p)$, is being used.

The slight distortion which has occurred, due to the sharpness of resonance in the primary of the transformer connected in the anode of the first valve, can be partly corrected by slightly mistuning the primary of the H.F. transformer connected in the second anode circuit, so that the frequencies which before were over amplified, are this time a little under amplified. It is thus quite apparent that great care requires to be exercised both in the design and construction of the H.F. transformer if clear signals are to be obtained. As the ratio of the transformer is limited to the secondary possessing the same number of turns, or in any case only a few per cent. more turns than the primary, the great advantage of using a transformer has gone. The object of a transformer is to match impedances. For best efficiency, and to straighten out the characteristic curve of the valve to minimise distortion, the primary of the transformer was given a high impedance to secure the maximum amplification, and theoretically the secondary should be wound so that the greatest voltage step-up takes place, or in other words, as the input impedance of the second valve is of the order of a megohm, the impedance of the secondary of the H.F. transformer should be of the same order. This cannot be done, and the transformer has practically a turn ratio of one to one.

Considering now the second arrangement, that is the tuned anode, it can be seen that the anode coil is equivalent to a one-to-one transformer, and theoretically each will produce identical signal voltage strength across the input of the next valve.

The anode coil, however, is quite simple to construct—there is no secondary which requires making, having similar resonance properties to its primary—and it is not surprising, therefore, that in practice the tuned anode arrangement in the hands of average experimenters will give results far superior to any other.

The remarks as to mistuning slightly apply here also.

When care is taken to keep the impedance of the input circuit high, and the anode circuit also includes a high impedance, oscillations are easily set up. It is therefore usual to connect the grid of the H.F. valves through the leak resistance to the + L.T.

It is better when tuning, to choose the lower value of capacity which produces resonance.

W.J.

Experimental Station Design.

(Continued from page 54, October 14th, 1922.)

XV.—THE LAY-OUT OF AN EXPERIMENTAL RECEIVING SET.

THERE are many considerations when designing a receiver for experimental purposes, such as wavelength range, tuning arrangements, number of valves, valve control, method of amplifying, and mode of introducing reaction. In most cases it is not sufficient to make up a set comprising a definite circuit arrangement, as it is the aim of the experimenter to vary his circuit according to the nature of the reception and also to gain a knowledge of the merits of the many systems of tuning and amplifying.

A reference to the "Questions and Answers" pages of this journal indicates how popular has become the switching of valves in and out of circuit, so that the desired degree of amplification can be obtained. This has been embodied in the receiving system under description, together with switches for a variety of other purposes, including aerial to earth or instruments, additional series condenser in aerial circuit to broaden tuning on aerial tuning condenser, connecting of aerial tuning condenser in series or parallel with aerial tuning inductance, reception on aerial or tuned closed circuit, reaction coil coupled to closed circuit, or high frequency amplifying valve plate circuit; high and low frequency amplifiers in or out of circuit; also for providing for resistance, tuned anode or transformer high frequency intervalve coupling. The operation of the switches is clearly indicated in the diagram (Fig. 1), which is reproduced on a large scale for easy reference. It is a good plan to place a piece of glass on the experimenting table with the diagram beneath it, as it is then handy for reference without turning aside while receiving.

A suggested lay-out of the instruments is shown in Fig. 2. The apparatus below the dotted line is secured to the table whilst that above is fixed either to the wall or to a board standing vertically along the back.

The large number of leads somewhat complicates the appearance of the equipment, but if joints are carefully soldered and wrapped with adhesive insulating tape, they need not be taken back to screws as branching points. Consequently the length of many leads will be considerably shortened. The wire used for

connecting up should be of fairly heavy gauge and well insulated in order that the connections may be mechanically strong and of low resistance. Single No. 18 wire, rubber-covered and braided, makes a good job and can be held down by means of small wooden cleats. Particular attention must be given to the leads forming parts of the valve grid circuits, in order to ensure perfect insulation and a minimum of capacity to other parts of the circuit, so as not to reduce the grid potential fluctuations. If the connections are made underneath the table and behind the board supporting the switches they may be run by the shortest paths, so as to cause them to cross each other from various angles instead of lying parallel and spaced as is necessary for good appearance when the leads are in view. The coils shown are of the interchangeable plug-in type in order to cover the desired wavelength range. For rapid tuning on short wavelengths where critical adjustment will become necessary, it is convenient to have a set of five coils, all adjusted to have identical values, for insertion in the secondary, reaction and H.F. transformer circuits, so that the tuning condensers which bridge these coils will have roughly similar settings. The reaction switch may of course be dispensed with, and the leads shown on its upper and lower terminals paralleled across, the transference of reaction coupling from transformer to aerial circuit being effected by moving the coil across from one holder to the other.

As explained in an earlier article, the purpose of coupling the reaction coil to the grid circuit of the second valve is in order to reduce to a minimum the chances of an oscillator valve energising the aerial. Since the publication of that article the Postmaster-General has expressed his approval of its use, though it has been recently stated in some quarters that this method does not achieve its object. It may be pointed out that when oscillations are set up in the plate circuit of the first valve, the only way in which they can energise the aerial circuit is by grid current, which by the author's investigation has been found usually to be so small that it is doubtful if the amplitude of the oscillations which can be set up in the

closed circuit coil, exceed those produced in the aerial inductance by a transmitting station giving a moderate signal strength.

As a rule it is not necessary to couple the plate circuit of the second valve with its grid circuit in order to obtain the advantages of reaction, for when using the tuned anode arrangement the impedance across the electrodes of the first valve is sufficient to set up oscillations, and particularly is this the case with the "R" type valve when the filament is not at maximum brightness. When oscillating, the adjustment of the condenser across the tuned anode coil is very critical and its setting varies in unison with the closed circuit.

Modifications can easily be made to simplify the outfit or to install and operate one valve

circuit at a time. The detector valve will, of course, be fitted first, together with the switches necessary for connecting it through to the aerial and telephone circuits. The low frequency amplifier presents no difficulty and can be added as soon as the necessary components are available. The high frequency amplifier can be installed, making use at first only of the tuned anode coil, which is probably the most efficient system of high frequency amplification.

Much could be written on the manipulation of the set, but a little experience such as can be obtained by a few hours' experimenting and a knowledge of the purpose of each component will be found more helpful.

F.H.H.

A Simple Variometer.

BASKET inductances wound on thin card* are now in general use, and by arranging to slide one over another can be made to serve as a variometer or variable coupling. A sliding motion does not lend itself to easy mounting or construction, and it is necessary to either turn one coil over or reverse the connections in order to obtain a large change in the inductive value.

Two coils wound to the design shown below and mounted one over the other, make a wide range variometer with a revolving move-

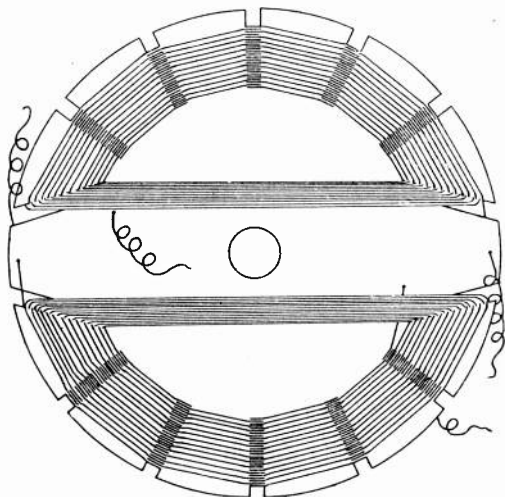

ment for adjustment. The diagram is about two-thirds full size for building a variometer for use on short wavelengths. In modifying

the design the reader must bear in mind that the slots must not be made so deep as to weaken the sections, and also of course each half must consist of an odd number of slots. The most convenient method of mounting is to hold one former down to the base of the instrument box or to a platform attached to the top, by means of a square piece of ebonite $1/32$ in. to $1/16$ in. in thickness, while the other is carried between two nuts and washers on the end of a spindle operated from the top. A hole is made in the centre of the ebonite holding down piece to give clearance to the nut which clamps the revolving inductance to the spindle. The moving inductance may practically rub on the surface of the ebonite. A condenser scale and knob can be attached to the spindle for operating the variometer and indicating the setting.

The Skinderviken Button.

The accompanying sketch shows a suggested use for a Skinderviken button or other form of microphone. The apparatus forms a useful type of microphone amplifier of very simple construction.

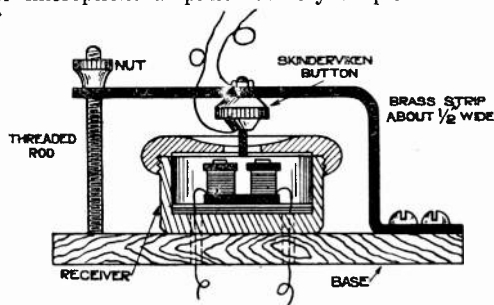

tion. The rod with the nut should carry a fine thread to allow of critical adjustment.

* Described on p. 328, June 10, 1922.

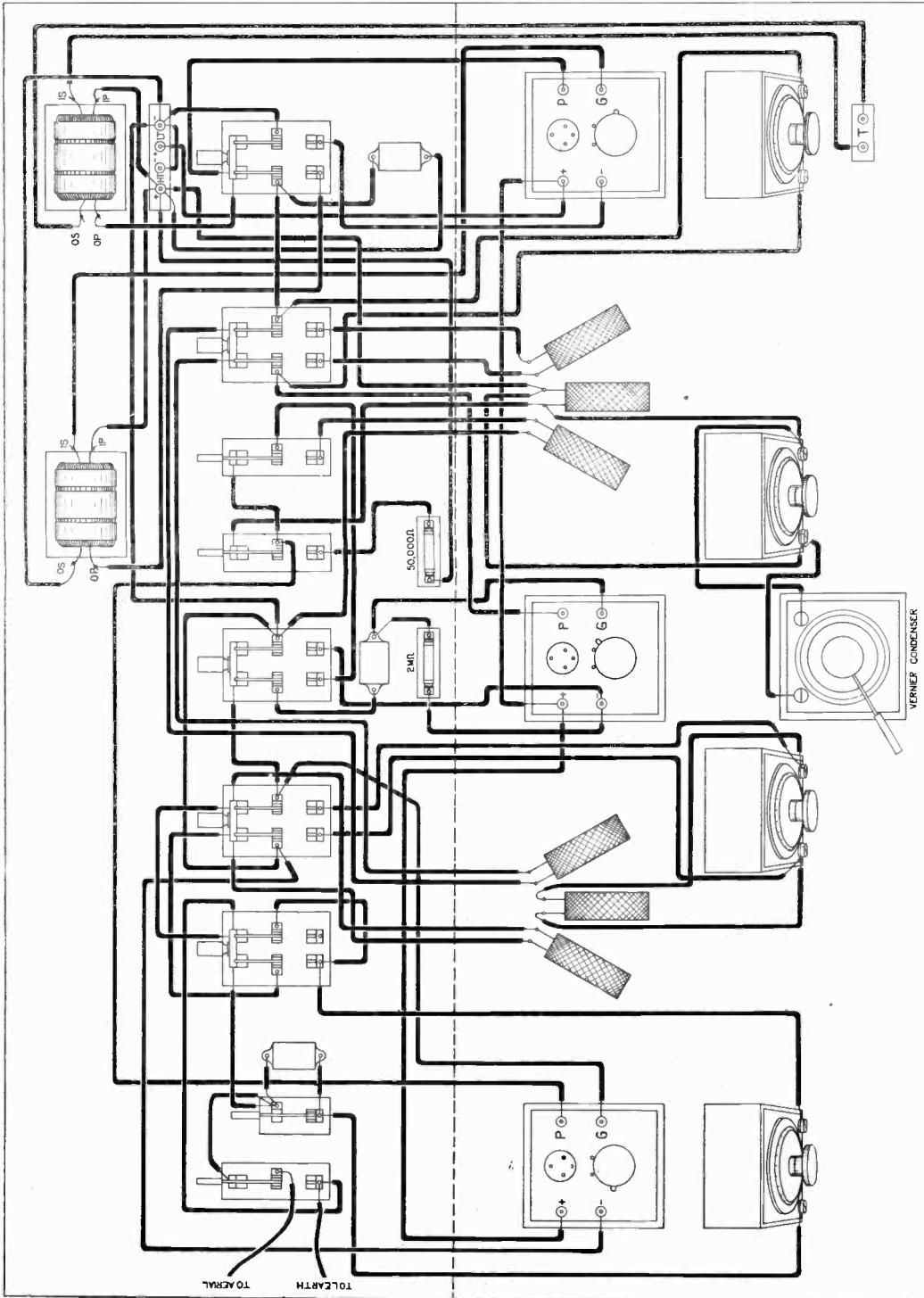

Fig. 2. The lay-out of the Apparatus of a Three-valve Receiving Set.

Wireless and International Language.

By BERNARD LONG, B.A.

WIRELESS science and practice, like other branches of technology, are absolutely international, and (on the practical side, especially) the common use of an "auxiliary" language would be of great advantage. One such language, if it can be so called, has indeed already been introduced, viz., the international code, by which a three letter combination, such as the well-known "SOS," has a definite meaning to every wireless operator at sea, no matter what his nationality. It is quite possible to carry on a sort of conversation, up to a point, in this code, just as is the case with marine flag signals. But such codes are very limited in scope, and in order to cater for all kinds of verbal intercourse, whether telephonic or telegraphic, a complete language is clearly necessary. Such a language, if widely adopted, would also have the advantage of simplifying international relations between wireless experts, enabling them to advance their science by freer and more effective co-operation.

The question is of great interest in connection with the extension of "broadcasting." In the case of music, which is already international, there is nothing to trouble about, but it is different with verbal transmission, as the effective range of a powerful transmitter may often cover many different countries, whereas the words transmitted are only comprehensible to a certain portion of the possible receivers. If, for example, a message is sent in French from the Eiffel Tower, it is of no use to people who do not understand French, and the time spent in sending it is wasted so far as they are concerned. But if all important news of interest outside France were transmitted in a language common to all nations and widely understood, it would reach a much larger public outside France than if sent in French.

In this connection Dr. Pierre Corret, editor of the French wireless journal, *La T.S.F. Moderne*, contributed a letter to *The Wireless World and Radio Review* of April 1st last, in which he pointed out the suitability of the well-known international language, Esperanto, for use in the manner suggested. Dr. Corret pertinently asked, what would be the use of either French or British wireless amateurs receiving messages across the Channel if they could not understand them? As wireless

"broadcasting" spreads, this difficulty will become more and more widely felt, and though it is not necessary to suggest that only Esperanto should be used, it would obviously be a great advantage if amateurs were to study the language in large numbers and then ask the transmitting stations to use it at certain stated times. Messages in the international tongue would reach with equal efficacy persons in every country within range; and news, in particular, could be very suitably transmitted in this way. Information sent out in Esperanto for the use of newspapers and news agencies could, moreover, be reproduced after translation, with a maximum of accuracy, since the language is extremely logical, clear and expressive, and misunderstandings (even if an abbreviated style became common in such cases) would be extremely rare.

Again, when it becomes possible to converse freely by wireless, what will be more fascinating than for English and French amateurs to compare notes and news, and strike up friendships even if not able to meet each other? At present an Englishman may often understand French without being able to speak it (and more often read it but not understand it when spoken), and unless, therefore, the French amateur could understand English, the conversation would be rather one-sided!

Esperanto, however, can soon be mastered by both Frenchmen and Englishmen, who, in conversation on actual meeting (such as often occurs), have not the slightest difficulty in talking together freely and easily, as though they had a common mother tongue. And what is possible between French and English is equally possible between any two nationalities.

These are not mere assertions, but facts proved again and again in the Esperanto movement. They are commonplaces of daily life to those who use the international language whether for business, technical or professional matters or for ordinary social intercourse; and Dr. Corret, as a wireless expert and also an accomplished speaker and writer of Esperanto, is in the best possible position to understand the significance of these two branches of human invention and the useful way in which they can be brought together. As already indicated, its simplicity and expressiveness

make Esperanto pre-eminently suitable for use in wireless work, and readers of this article who take it up will soon find out the reason. Who knows but that in the future, when a great orator, scientist, or other man of note has anything to say to the world, he will simply "wireless" it in sonorous Esperanto from Paris or some other suitable centre and be heard not only in every newspaper office within range, but by thousands of delighted amateurs as well? If the study of

Esperanto spreads as the perfecting of wireless methods advances, there will be nothing to prevent this and many other fascinating developments from taking place. The demand will be the surest guarantee of the supply of news in the international tongue; but, in the meantime, let no amateur be surprised if at any time he receives (in Morse perhaps in the first instance) messages in what may seem to be a language something like Spanish but which will prove to be Esperanto.

Wireless in a Coal Mine.

By ZD.

A SHORT time ago a party of five amateurs, including the writer, had the privilege of carrying out tests in wireless transmission and reception at Baggeridge Colliery, near Dudley, Staffs. The colliery officials offered us every facility above and below ground, and some very encouraging results were obtained.

On arriving at the colliery our first job was the erection of a single wire 100 ft. aerial, slung from the super-structure over the mine shaft, approximately 80 ft. high, to a railway bridge where it was only 4 ft. high. The earth lead was attached to the railway lines and proved a very efficient earth. A two-valve portable receiving set (1 rectifier, 1 L.F.) was connected up, and signals were received from continental stations, and on short waves 2 LO was clearly received. The next step was to test the transmitter; this, by the way, was an ordinary single valve, the usual plate and grid coils. H.T. 180 volts, filament 6 volts, current on plate 9 mA., radiation 0.16 amps. One of our objects was to establish communication from underground to the surface, and as the shaft was very deep (665 yards), we were rather uncertain about success with such limited power. To avoid probably hours of vain efforts, we decided to rig up an aerial in the cage and try to keep in touch with the receiver all the way down to the bottom of the shaft. Our cage aerial consisted of 40 ft. of ordinary lighting cable wound round the end beams of the cage from end to end, and an earth was effected by one member of the cage party holding the wire in contact with a ridge on the cage bottom. Complaints of "foot-ache" were incessant. The transmitting gear was installed in boxes on the floor of the cage, and signals transmitted which

were received on the surface receiver, but were very unsteady and somewhat hard to read. We were lowered very slowly (transmitting all the time), and stopped about every 200 yards for reports from above. Our C.W. became very much steadier, and signals increased in strength and reached a maximum when we were three-quarters of the way down. They then decreased in strength rapidly, and finally ceased altogether when we reached the bottom.



Experimenters at the Baggeridge Colliery.

The reader can imagine the surprise we felt at these results, for we considered that putting a transmitter, aerial, etc., inside a steel box (the cage), the signals would be completely screened and would not get outside with sufficient strength to be picked up. By this time we had internal notification that it was tea-time, and we came up to the surface with that object in view. The speed of the cage was vastly different to the downward journey, roughly 96 miles per hour!

After tea we went down again and carried the transmitting gear some distance from the bottom of the shaft, and rigged up the same aerial that we used in the cage, but this time in a single length suspended mid-way between the roof and floor of the working. Our "earth" was effected by burying a coil of bare wire in a patch of very wet mud, which proved quite efficient. The transmitter appeared to be working correctly, but the plate current rose from 9 mA to 12 mA, H.T. the same—180 volts, and our aerial ammeter showed 0.18 amps. However, reports from the surface told us that they could not hear

us. The aerial was then coiled up in a similar way to what it was in the cage. Again no results, so the only thing to do was to add to it, and we lengthened it to 92 ft. (single wire). The reports from the surface were most enthusiastic, and reported signals audible 6 ft. from the phones, and would we try telephony! Here I must add that the atmosphere being somewhat damp, and plenty of carbon in the air, our transmitter started giving us shocks, no matter what portion was touched, even the accumulator cases; an unpleasant shock resulted, and frequently one heard gasps and other things as an unwary hand came in contact with some part of the gear. However, we tried speech with very little success, only the words "Hello," and "2 ZD," being understandable. But with only 2.16 watts power, and nearly 700 yards of solid earth, etc., to penetrate, we considered the results very encouraging. At a future date we hope to continue our experiments with higher power, and if our measure of success increases with the power, we hope to achieve greater things than at our first attempt.

Broadcasting an Appeal for St. Dunstan's.

THE first practical application of the possibilities of radio-telephony for the broadcasting of a charitable appeal was made on the evening of Wednesday, the 18th instant, from Marconi House, when Captain Ian Fraser, the blinded Officer-Chairman of St. Dunstan's, who is one of the most capable wireless amateurs in this country, made an eloquent appeal for continued support for St. Dunstan's work for the 2,000 war-blinded men of the Empire's forces. In the course of his speech, Captain Fraser said that in his view the most interesting speculation about Radio-telephony was, whether or not it will have a great influence upon the power which an individual orator would be able to exercise by the employment of its resources in a densely populated country like England. He said that he was himself experiencing a sensation the novelty of which only a blind man could perhaps appreciate fully, for although it had been his lot to speak to many audiences, both large and small, which he could not see, yet this was the first occasion on which one

important condition had been missing—the indefinable sympathy with the audience actually before him, upon which any successful speaker must be so reliant. Proceeding to voice the needs of St. Dunstan's organisation, Captain Fraser pointed out that during the last eighteen months St. Dunstan's resources, the income from which it had been hoped would stand in good stead for the lifetime of the 2,000 men who had been trained and established, had been sadly depleted. In the last six months alone, St. Dunstan's income was less than its essential expenditure by over £17,000. Captain Fraser concluded with a moving appeal to the sympathy of his great and widespread audience. "Imagine" he said, "if destiny had placed upon you the necessity of listening to all the sounds of a world you could not see for every minute of your waking hours, and ask yourself if this would not be an awful prospect. And yet it is the lot of 2,000 men who, had there been no war, would be able to conduct their lives as you conduct yours."

Broadcasting "A Matter of Days"

AGREEMENT ON THE FORMATION OF THE BROADCASTING COMPANY.

BROADCASTING in the London area, if the date has not already been announced when these lines appear, will, at all events, be within a few days of realisation.

The Committee appointed to arrange for the formation of the British Broadcasting Company made its report to the manufacturers at a meeting held at the Institution of Electrical Engineers on Wednesday, October 18th. After a somewhat protracted meeting, during which many questions were raised and replied to, the meeting concluded by unanimously agreeing to the proposal that the Company should be registered forthwith.

It was authoritatively stated that the Postmaster General would not delay in any way the granting of the license to commence broadcasting, which would be the next step after the Company had been registered.

The meeting was presided over by Sir William Noble, formerly Chief Engineer to the General Post Office.

Sir William Noble, in reporting on the

present position, said that complete agreement had now been reached.

A meeting held at the General Post Office on May 18th last, was attended by representatives of 23 firms, all anxious to conduct broadcasting. Obviously it was impossible for that number of stations to be put up, and accordingly these representatives were invited to endeavour to come to some agreement for combination in a single company. After a good many communications between the parties and the authorities, the Articles of Association for the formation of one Company had been agreed upon. There would be an independent chairman, the first being Lord Gainford, a former Postmaster General.

It is intended that the broadcasting in the London area shall be conducted, at any rate temporarily, from Marconi House, and at an early date it is expected a temporary station will also be ready in Manchester. The provision of stations in the six other localities—Birmingham, Newcastle, Plymouth, Glasgow, Aberdeen and Cardiff—will receive immediate attention.

Notes

Lectures for Amateurs.

A series of lectures are being arranged to be given for the special benefit of amateurs at the London Telegraph Training College, 262, Earl's Court Road, S.W.5. These lectures will be given by Mr. Maurice Child and will be illustrated as far as possible by practical demonstrations. Full particulars of those lectures can be obtained from the Secretary of the College.

Lost Wireless Apparatus.

The owner of wireless apparatus dropped from a van passing through Wembley towards London on Monday, October 16th, at 11.30 a.m., may recover same through application to this Journal.

Theft of Material to make Sets.

In order to make wireless sets, a quantity of telephone and electrical apparatus was stolen by youths from the Furness Railway signal and store cabins. Prisoners pleaded guilty at Lancaster Quarter Sessions.

The Use of the Word "Broadcasted."

Captain F. Loring points out that he has been reported as having taken exception to the word "Broadcaster," whereas "Broadcasted" was the word to which he referred. He mentions that one does not speak of a horse as having "casted" a shoe, and similarly the use of the word "Broadcasted" is not correct. The error in reporting Captain Loring appeared on page 63 of our issue of October 14th, 1922.

Amersham Concert Reception.

A lecture was held at the Sycamore Hall, Amersham-on-the-Hill, Bucks, on Wednesday, October 18th.

The lecturer, Mr. O. J. Carpenter, was lent by the Marconi Scientific Instrument Company.

The chair was taken at 8 p.m. and the concert from 8.30 p.m. to 9 p.m., came through very satisfactorily, despite some "atmospheric" interference.

The hall was full to overflowing, and large numbers had to be turned away from the door.

A collection made in aid of St. Dunstan's realised £7, more than twice the previous record for similar collections at Sycamore Hall.

Licences for Military Applicants.

An official statement has been issued to the effect that officers and other ranks of the Regular Army, Militia, Territorial Army, or Officers' Training Corps, who wish to instal private wireless sets for sending or receiving messages are subject in all respects to the Postmaster General's regulations governing the installation and working of such sets. They should apply in their private capacities for licences to the Secretary, General Post Office, London, E.C., who will treat their applications on the same lines as those received from members of the public generally. The War Office accepts no responsibility for wireless sets other than those held on the authorised establishment of units.

Correspondence

To the Editor of THE WIRELESS WORLD AND RADIO REVIEW.

SIR,—As several articles and remarks have appeared from time to time concerning the advantages, and otherwise, of a frame aerial, I thought perhaps my experiences with one would interest some of your readers.

The frame is of the Maltese cross type, and the maximum height and width is 6 feet.

Twelve common or garden tin-tacks are knocked into each point half-an-inch apart, and the wire (D.C.C. No. 30) is wound round these.

Tappings are taken from the third, eighth and twelfth turns, this giving me the following ranges—300-500, 500-900, 800-1700. This with a 0.0005 A.T.C.

My set is a three-valve, with the first valve H.F. reactance-capacity coupled; with one rectifier and one L.F. with switch for the L.F.

Now for results. As I am putting this down I am listening to the *Daily Mail* concert from The Hague. Of course, it is not loud, but it is sufficiently so to hear the tunes, although the speech cannot be understood.

Last Sunday evening (24th) when atmospherics were so bad that speech from 21F, 2VD and 2ON was at times completely drowned out, these stations were picked up on the frame and their speech read.

Jamming from Boulogne FFB was entirely eliminated.

Lympne and Croydon, as well as the French aerodromes, come in very well, as also do the machines.

North Foreland, Boulogne and various ships are quite audible through the loud speaker.

I think the above results are sufficiently good to show that the frame aerial is not so bad as it is painted.

Kent.

W. E. PHILPOTT.

INCREASE OF CAPITAL FOR MARCONI COMPANY.

At an Extraordinary General Meeting of Marconi's Wireless Telegraph Company, Ltd., held on Friday, October 20th, a resolution was passed providing for the creation of 1,000,000 new ordinary shares and granting the board extended borrowing powers. Senatore Marconi explained that the two objects for which the additional capital was needed are the development of the Company's wireless telegraph services, including the erection of new important wireless stations abroad in co-operation with German, American and French wireless interests, and the new broadcasting business. The directors estimate that the latter will keep a sum of approximately £700,000 or £800,000 more or less continuously employed for some time to come. The intention is to issue immediately £1,500,000 of Debenture stock—one-half of the total amount of new Debenture stock to be created—the stock now to be issued having the right of conversion into ordinary shares at the rate of £3 of debenture stock for one ordinary share up to 1929.

THE VALVE PATENT ACTION

Judgment by Mr. Justice P. O. Lawrence.

JUDGMENT was delivered on Thursday, October 19th, in the action brought by Marconi's Wireless Telegraph Company, Limited, against the Mullard Radio Valve Company, Limited.

In this action Marconi's Wireless Telegraph Company, Limited, as the plaintiff company, claimed an injunction to restrain the defendant company from infringing the letters patent numbered 28,413, of 1913, and 126,658, and for the delivery up of the articles or apparatus made in infringement of such letters patent and damages.

The plaintiff company are the registered owners of the letters patent numbered 28,413, of 1913, granted to the company and Henry Joseph Round for an invention of "improvements in receivers for use in wireless telegraphy," and of letters patent granted to Michel Péri and Jaques Biguet for an invention of "improvements in or relating to vacuum tubes of the audion type." They pleaded that the letters patent were valid and subsisting, and they complained of infringements, and in particular of the sale by the defendant company on or about July 8th, 1921, of "two R valves" constructed in accordance with the inventions described in the complete specification of the letters patent of 1913, and in all the claiming clauses of the complete specification of the letters patent numbered 126,658.

The defendant company by their defence alleged that they had not infringed the two letters patent. They admitted that they sold and manufactured considerable numbers of thermionic valves, but they alleged that in part such sale and manufacture was by them as agents or contractors for his Majesty's Government, and in particular the Admiralty, on written authorisation in that behalf, and they denied that such valves constituted an infringement of either of the letters patent. The defendants also alleged that the letters patent were and had been at all material times invalid.

Mr. J. Hunter Gray, K.C., Mr. James Whitehead, and Mr. Trevor Watson appeared on behalf of the plaintiffs; Sir Duncan Kerly, K.C., Mr. R. Moritz, and Mr. Courtney Terrell appeared for the defendants.

Mr. Justice P. O. Lawrence, after an examination and description of the defendant company's invention and the two letters patent owned by the plaintiff company, came to the conclusion that the Mullard valve did not constitute an infringement of either of those letters patent. His Lordship decided that the attack made by the defendant company on the validity of the plaintiff company's two letters patent failed. He said that the action failed, and must be dismissed. On the question of costs his Lordship said that he would desire to hear the arguments of counsel when they had had time to consider their position.

"Chad" Batteries.

Particulars of "Chad" batteries, for use in supplying the anode circuit of thermionic valves for reception purpose, may be obtained from Messrs. Fuller's United Electric Works, Ltd., Chadwell Heath, E. A new list of batteries has been issued.

Calendar of Current Events

Friday, October 27th.

WAKEFIELD AND DISTRICT WIRELESS SOCIETY.
Lecture on "The Relation of Inductance and Capacity to Electro Magnet Waves in Receiving and Transmitting Circuits," by Mr. Watson.

BELVEDERE AND DISTRICT RADIO AND SCIENTIFIC SOCIETY.

Lecture on "The Detector and L.F. Panel," by Mr. S. Burman. Lecture on "Graphs and their Application," by Mr. T. E. Morriss.

LEEDS AND DISTRICT AMATEUR WIRELESS SOCIETY.
At 8 p.m. Demonstration of "Britwire." Apparatus, by Mr. H. F. Yardley, A.M.I.R.E.

RADIO SOCIETY OF HIGHGATE.

At 7.45 p.m. At the 1919 Club, South Grove, Highgate, N.6. Lecture by Mr. Grimstead.

Saturday, October 28th.

WORKING MEN'S WIRELESS CLUB.

At Crowndale Road, N.W.1. Exhibition and demonstration at 1 p.m., also exhibition of X-ray apparatus.

Monday, October 30th.

FINCHLEY AND DISTRICT WIRELESS SOCIETY.
Social Evening.

IPSWICH AND DISTRICT WIRELESS SOCIETY.
At 8 p.m., at 55, Fonnereau Road, Lecture on "Accumulators—Their Care and Use," by Mr. F. Boddey.

NORTH LONDON WIRELESS ASSOCIATION.

Lecture on "Short Wave Aircraft Sets (Transmission and Reception)," by Mr. A. J. Reading.

Tuesday, October 31st.

Transmissions of Telephony at 8 p.m. on 400 metres by 2 MT. Writtle.

PLYMOUTH WIRELESS AND SCIENTIFIC SOCIETY.
Lecture on "Wireless Reception," by Mr. G. H. Lock.

Wednesday, November 1st.

EDINBURGH AND DISTRICT RADIO SOCIETY.

At 8 p.m. Business Meeting.

LUTON WIRELESS SOCIETY.

At 8 p.m. At Hitchin Road Boys' School. Lecture on "H.F. Coupling and Transformers," by Mr. C. S. Dunham.

Thursday, November 2nd.

DERBY WIRELESS SOCIETY.

At 7.30 p.m. At The Court, Alvaston. Informal Meeting.

Friday, November 3rd.

Transmission of speech and concert from Bristol to the Finchley and District Wireless Society (probably via Marconi House).

RADIO SOCIETY OF HIGHGATE.

At 7.45 p.m., at the 1919 Club, South Grove, Highgate, N.6. Lecture on "Construction of H.F. Amplifiers," by Mr. G. W. Sutton, B.Sc.

BRADFORD WIRELESS SOCIETY.

At 5, Rendallwell Street, Bradford. Debate on "The Prevention of Self-Oscillation."

BELVEDERE AND DISTRICT RADIO AND SCIENTIFIC SOCIETY.

Lecture on "The Thermionic Valve," by Mr. S. G. Meadows.

Saturday, November 4th.

GLASGOW AND DISTRICT RADIO CLUB.

From 12 to 9 o'clock. At the McLellan Galleries Hall, Sauchiehall Street. Exhibition and Demonstration.

Monday, November 6th.

NORTH LONDON WIRELESS ASSOCIATION.

Lecture on "The Elementary Principles of Radio Telegraphy and Telephony, II," by Mr. F. S. Angel.

IPSWICH AND DISTRICT WIRELESS SOCIETY.

At 8 p.m. At 55, Fonnereau Road, lecture on "High Frequency Currents," by Mr. E. Mould.

Tuesday, November 7th.

Telephony by 2 MT Writtle, as above.

THAMES VALLEY RADIO AND PHYSICAL ASSOCIATION.

Presidential address and lecture by the President. PLYMOUTH WIRELESS AND SCIENTIFIC SOCIETY.

At Plymouth Chambers, lecture on "High Frequency Amplification," by Mr. L. J. Voss. LOWESTOFT AND DISTRICT WIRELESS SOCIETY.
Lecture on "Simple Telephony Transmitters," by Mr. H. C. Trent.

EDINBURGH AND DISTRICT RADIO SOCIETY.

At 8 p.m. Lecture on "Wireless Communication," by Col. Crawley.

Wednesday, November 8th.

INSTITUTION OF ELECTRICAL ENGINEERS (WIRELESS SECTION).

At 6 p.m. At Victoria Embankment. Lecture on "The Effect of Local Conditions on Radio Direction-Finding Installations," by Mr. R. L. Smith-Rose, M.Sc., and Mr. R. H. Barfield, B.Sc. REDHILL AND DISTRICT Y.M.C.A. WIRELESS SOCIETY.

At Station Road, Redhill. Lecture on "Tuning."

Thursday, November 9th.

HOUNSLOW AND DISTRICT WIRELESS SOCIETY.

At Council House, Treaty Road, Hounslow. Lecture on "Wireless for the Beginner," by Mr. S. H. Nayler.

HACKNEY AND DISTRICT RADIO SOCIETY.
Special General Meeting to discuss reorganisation of membership, subscriptions, etc.

LUTON WIRELESS SOCIETY.

At 8 p.m. At Hitchin Road Boys' School. Practical work and experiments.

DERBY WIRELESS CLUB.

At 7.30 p.m. At The Court, Alvaston. Lecture on "Protection of Overhead Lines from Atmospherics," by Mr. S. J. R. Allwood.

Friday, November 10th.

HECKMONDWIKE AND DISTRICT WIRELESS SOCIETY.

At 7.30 p.m. Exhibition and Demonstration. Opening by Mr. C. W. Leather, Checkheaton.

RADIO SOCIETY OF HIGHGATE.

At 7.45 p.m. At the 1919 Club, South Grove. Informal meeting.

Saturday, November 11th.

HECKMONDWIKE AND DISTRICT WIRELESS SOCIETY.

At 3 p.m. Exhibition and Demonstration. Opening by Lieut. H. W. Burbury, R.N., Craggstone.

LIVERPOOL WIRELESS SOCIETY.

First meeting of Winter Session at Royal Institution. Address by Prof. E. W. Marchant.

Wireless Club Reports

NOTE.—Under this heading the Editor will be pleased to give publication to reports of the meetings of Wireless Clubs and Societies. Such reports should be submitted without covering letter in the exact form in which they are to appear and as concise as possible, the Editor reserving the right to edit and curtail the reports if necessary. The Editor will be pleased to consider for publication papers read before Societies. An Asterisk denotes affiliation with the Wireless Society of London.

Leeds and District Amateur Wireless Society.*

Hon. Secretary, Mr. D. E. Pettigrew, 37, Mexborough Avenue, Chapeltown Road, Leeds.

The first instructional meeting of the session, 1922-23, was held on October 6th, at the Society's new headquarters, The Grammar School, Leeds. At 8 p.m. Mr. G. P. Kendall, B.Sc. (Vice-President) commenced a lecture entitled "The Elementary Principles of Tuning," which (as all subsequent lectures at instructional meetings) was specially arranged to meet the needs of the section of the membership having only elementary knowledge of radio matters. Mr. Kendall thoroughly examined his subject, his very clear and concise remarks being greatly appreciated by a large audience.

The first general meeting of the new session was held at the headquarters on October 13th, proceedings commencing at 8 p.m., being the occasion of the Presidential address. The President (Mr. A. M. Bage), after passing a few introductory remarks, called upon the Hon. Secretary to discharge certain business, which included election of five new members. The President then called upon the Hon. Treasurer, who announced that the annual subscription (7s. 6d. or 5s., according to age) was now due.

The President then announced that as a result of a Committee and Sub-Committee meeting, it was proposed to impose a levy on the membership, in order to be enabled to commence the installation of an experimental wireless station. As the Committee wished to have the opinion of the Society on such a proposition, the matter was decided to be put to the vote, with the result that a practically unanimous vote supported the Committee's proposal. Preliminary announcements of the annual social were given, it being resolved by a show of hands to hold a dinner, etc., on December 22nd, 1922.

The President then called upon Mr. J. O'Donohoe to make the presentation to the Hon. Secretary of a pair of Brown's telephones, suitably inscribed, in recognition of greatly appreciated services during the last session. The Hon. Secretary expressed great pleasure in accepting the gift, heartily thanking the Society for their splendid and most acceptable mark of appreciation.

The President then delivered the Presidential address entitled "The Reinartz Tuner." Amongst the many advantages claimed for this short wave tuning device of American origin, are: that the arrangement will oscillate readily at whatever wavelength the grid circuit is tuned to; there is no necessity for continual variation of coupling, and the aerial-earth circuit may function aperiodically; the tuner may be set oscillating, or to regenerate without oscillation, tuning being

effected by the grid circuit condenser only. One turn in reaction coil is sufficient to maintain oscillation as high as 600 metres wavelength. Interference is reduced at slight expense of signal strength; atmospheric disturbances are reduced, and there is no noticeable effect of "dead end" or capacity phenomena. The President explained how the above claims are justified, and remarked that the Reinartz tuner was excellent for strong signals, either Morse or telephony, but of very little use on weaker signals. In its present state the tuner is not likely to take the place of existing circuit arrangements, in spite of the fact that it is extraordinarily simple to operate and cheaper to construct. The President exhibited his Reinartz tuner, using a single valve as rectifier, the whole outfit having been put together in his workshop. The tuner was demonstrated on an aerial and many practical details explained.

The discussion which followed was both keen and prolonged, some exceptionally knotty points being submitted for analysis, to which the President ably replied.

A hearty vote of thanks was proposed and carried amidst loud applause. The President replied to the ovation, and declared Mr. T. Brown Thomson, Chairman at the next general meeting.

The meeting then adjourned.

Fulham and Putney Radio Society.*

Hon. Secretary, Mr. J. Wright Dewhurst, 52, North End Road, West Kensington, London, W.14.

On October 13th there was a large gathering and several new members were enrolled, including two ladies. After the preliminary business was disposed of, Mr. Houston opened a discussion on the various forms of amplification and the screening of transformers, and Mr. Houston promised to have a set at the next meeting with a new type of screening arrangements. Another discussion was started on accumulators and Mr. Calver gave a short explanation of the various ways the plates are now made. Mr. V. Craster mentioned a method they have in America of exchanging a fully charged element for a discharged one to obviate the waiting for accumulators to be recharged.

On October 7th Mr. E. Barker, at headquarters, produced the Prince's speech on a Brown loud speaker to a party of boy scouts.

Major K. Field, of West Kensington, also entertained a large number of scouts with the speech and the Marconi concert after.

The Society being now affiliated to the Wireless Society of London, it is to be hoped that those interested in wireless in the district will join and participate in the additional advantages gained by the affiliation.

Ramsgate, Broadstairs and District Wireless Society.*

Joint Hon. Secretaries, Mr. F. Harrison, "Rochester Cottage," St. Lawrence (Ramsgate), and Mr. F. C. Marshall, 6, Ramsgate Road, Broadstairs (Broadstairs and District).

The inaugural meeting was held at headquarters, 22, Princes Street, Ramsgate, on September 28th. Two of the Vice-Presidents attended, Sir Edward Rigg, C.B., C.V.O., I.S.O., and Sir Cecil Hertslet, K.B.E., J.P. Both expressed their great pleasure at being present at the first meeting of the Society, and that they were keenly interested in its future welfare. Mr. C. E. Hume (engineer and manager of the Ramsgate and District Electric Supply Co., Ltd.) has been appointed Treasurer of the Society, and the London Joint City and Midland Bank, Ramsgate, the bankers of the Society. A number of new members were enrolled at the termination of the meeting.

The second weekly meeting of this Society was held at headquarters, No. 22, Princes Street, Ramsgate, on October 5th, when the first lecture was given by Mr. P. F. Cotton, a member of the Committee, on "The Aerial and its Construction." A most pleasing feature of the lecture was the absence of technical expressions that are so puzzling to the beginner, and the interest of all those present was apparent by the number of questions asked. The lecturer traced the construction step by step, and the whole lecture was most enjoyable. A hearty vote of thanks was accorded to the lecturer. The third weekly meeting was held on October 12th when Mr. C. E. Hume gave a very instructive lecture on "Electric and Magnetic Fields," which was followed with keen interest, and the subject was discussed by the members and many questions were put to the lecturer, who was accorded a hearty vote of thanks. At the general request of members, the weekly meetings of the Society are now held on Tuesday evenings at 7.30 p.m.

Instruction in the reading of the Morse code will take up the first half-hour of the weekly meetings.

Application for membership is invited, and full particulars may be obtained from either of the Joint Hon. Secretaries.

North London Wireless Association.*

Hon. Secretary, Mr. V. J. Hinkley, Northern Polytechnic, Holloway Road, N.

An extraordinary general meeting was held on Monday, September 25th, to reorganise the Association for the winter.

A hearty vote of thanks was accorded to both Mr. Prior and Mr. Auckland for the services they have rendered the Association in the capacities of Secretary and Chairman respectively. The loss of their services through pressure of business is greatly regretted.

The following officers and committee were elected:—

President, Dr. Reginald S. Clay, B.A., D.Sc.; Past-President, Dr. F. C. Knight; Vice-President, Major Basil Binyon, O.B.E., B.A., A.M.I.E.E.; Chairman, Mr. H. Norman Wilson; Vice-Chairman, Mr. G. D. Meyer; Hon. Treasurer and Assist. Hon. Secretary, Mr. Frank S. Angel; Hon. Secretary, Mr. V. J. Hinkley; Committee Members, Messrs. J. Nicol, B.A., B.Sc., W. Power, A. G. Hill, A. de Villiers, J. A. Reading, H. W. Nunn.

A programme has been arranged for the coming session, details of which up to November 20th are set out below. Particulars of future lectures, etc., will be published later.

October 30th, "Short Wave Aircraft Sets" (Trans. and Recept.), By Mr. A. J. Reading. November 6th, "The Elementary Principles of Radiotelegraphy and Telephony"—II, by Mr. F. S. Angel. November 13th, "Telephone Working External Routine," by Mr. A. G. Hill. November 20th, "Telephone Headgear—Constructional," by Mr. H. Norman Wilson.

This programme has been arranged with a view to interesting both the beginners and the more advanced workers, and it is hoped that large numbers who have recently taken up wireless will join the Association's ranks, and increase their knowledge of our interesting subject.

We shall be glad if members will endeavour to attend regularly at the meetings and assist in the arranging of future programmes by volunteering to read papers and give demonstrations. Items such as descriptions of sets, discussions of difficulties met with, useful hints, etc., are very useful and assist in providing both profitable and interesting evenings. The Association is very fortunate in having much of the Polytechnic's valuable apparatus available for demonstration and test purposes.

All interested in Wireless, whether beginners or expert, are invited to write to the Hon. Secretary or to attend one of the Association's meetings, which are held weekly at the Northern Polytechnic, Holloway Road, N.1. commencing at 8 p.m.

Belvedere and District Radio and Scientific Society.*

Hon. Secretary, Mr. S. G. Meadows, 1, Kentish Road, Belvedere, Kent.

The seventh general meeting of the above Society was held at Erith Technical Institute, on Friday, October 13th.

Morse practice commenced at 7.30 p.m., during which the Secretary introduced new methods of writing down Morse, explaining the characters on the blackboard. Very satisfactory progress is maintained by all the members attending these practices.

At 8 p.m. Mr. C. E. Morriss delivered a lecture entitled "Crystal Circuits." He dealt with plain aerial reception, and coupled circuit reception, pointing out the advantages of the latter over the former, especially with respect to the selectivity obtained by loose coupling. The difficulties of tuning a coupled circuit receiver to a given signal when neither circuit is calibrated, were explained, and the ways and means of overcoming these difficulties were gone into. The lecturer detailed the various crystals he had experimented with, giving the pros and cons for each. The artificial galenas seemed to be much favoured by him for their sensitiveness and manipulation.

Mr. Meadows followed with a short lecture on "Microphones and Telephones." Emphasis was laid on the importance of joining the telephones the right way round when directly connected in the plate circuit of the valves so that the steady plate currents tends to strengthen the permanent magnets instead of to weaken them. Various useful hints were given on the rewinding of telephone magnet coils. A simple method of determining the north and south poles of the permanent magnet

was demonstrated by means of a floating magnetised needle.

Question time opened at 9.15 p.m., when the subject of aeriels was again referred to. The effect of corrosion on bare wire aeriels was discussed, and to this was attributed a falling off of aerial efficiency due to the skin effect on high frequency currents. The Secretary suggested a scheme to encourage members to experiment, whereby circuits approved by the Postmaster-General for broadcasting would be detailed on the blackboard, and each one discussed in turn by the meeting. Experimental members would then be asked to try one of these circuits at their own stations, and to make a record of the performance of the circuit tried. The results would then be reported at a meeting, and the circuits tested out on the Society's set and compared. It was decided to adopt this suggestion, and to proceed at once with its organisation.

Wireless and Experimental Association.*

Hon. Secretary, Mr. Geo. Sutton, A.M.I.E.E. 18, Melford Road, S.E.22.

The annual general meeting was held at the Central Hall, Peckham, on October 11th. There was a very full meeting, and the proceedings were marked with great enthusiasm. The juniors were first given their half-hour of buzzer practice, under Mr. Sam Middleton, and then Mr. Knight reminded the meeting that the Association's officers had retired according to rule. It was proposed by Mr. Child and seconded by Mr. Middleton that Mr. Knight be asked to preside over the meeting. Mr. William Le Queux was re-elected President, and Sir Frederick Hall, K.B.E., M.P., was elected Vice-President. Mr. Knight was then re-elected Chairman for the coming year, and Mr. Sam Middleton Vice-Chairman. Mr. Geo. Sutton was re-elected Secretary and Mr. G. Horwood Assistant Secretary; Mr. Kendall, Treasurer; Mr. Noakes, Librarian; Mr. Hoare, Assistant Librarian; Mr. Voigt, Installation Engineer; Messrs. Joughin, Hunter, Webb, Hersey and Ball were elected Committeemen. A proposal to alter the title of the Association to the Radio and Experimental Association was negatived by a large majority, but it was agreed that the title of the original Association be adopted as a sub-title, and the date of foundation printed on the Club notepaper. Thus the full title of the Association now is: The Wireless and Experimental Association (originally The Amateur Wireless Alliance, established 1913).

Leicestershire Radio and Scientific Society.*

Hon. Secretary, Mr. J. R. Crawley, 269, Mere Road, Leicester.

The bi-monthly meeting was held on October 9th at Headquarters, Vaughan College. Ten new members were admitted.

The main business of the evening centred around the proposal of the Committee to form a student's section for the benefit of those who are being attracted to radio work by the popular broadcasting. After considerable discussion the recommendations of the Committee were accepted *en bloc*, and the Secretary is now open to receive applications for membership to this new section for which no technical qualifications are necessary.

Mr. S. Skeet was then called upon to deliver his lecture on "Set Construction"; this he did very

successfully, illustrating his remarks by many beautiful examples of his own work which caused much admiration. A very interesting discussion followed, concluded by a hearty vote of thanks proposed by the President, Mr. Cyril T. Atkinson, and seconded by the Vice-President, Mr. H. E. Dyson.

The next meeting of the Society took place on October 23rd, when a general discussion was held.

All communications regarding the Society to be addressed to the Hon. Secretary.

Croydon Wireless and Physical Society.*

Hon. Secretary, Mr. B. Clapp, Meadmoor, Brighton Road, Purley.

At a meeting held at the Central Polytechnic, Croydon, on October 7th, Mr. W. A. Saville gave a lecture and demonstration on different methods of reception, one special feature being a circuit to enable one to switch in or out at will extra L.F. valves.

The Society invited members of local boy scout troops to hear the Prince of Wales's message, which was received by Mr. Saville on his set very well.

Another interesting piece of apparatus which was demonstrated was a Japanese valve which had two filaments; the lecturer explained that they could be used separately or together.

The meeting then terminated with a hearty vote of thanks to Mr. Saville for giving such an interesting lecture.

The Secretary will be pleased to give all particulars of the Society to anyone desirous of joining.

The next meeting will take place on Saturday, November 4th, 1922, at 7.30 p.m.

Plymouth Wireless and Scientific Society.*

Hon. Secretary, Mr. G. H. Lock, 9, Ryder Road, Stoke, Devonport.

A meeting of the above was held on October 10th at Plymouth Chambers, where the Society is establishing its headquarters. The main business of the evening was the discussion of the Society's wireless set. It was resolved to begin with a three-valve set, with one stage of high frequency amplification and one stage of low frequency, and the set is to be so designed as to permit readily of experimenting with various types of intervalve coupling. Offers were received from members present of five valves, two variable condensers, a three-coil holder, aerial wire and £1 in cash, so that an immediate start is to be made with the construction.

The programme for the year and copies of the rules and proposal form are now available, and can be obtained from the Hon. Secretary.

Forthcoming events include: October 31st, lecture, "Wireless Reception," G. H. Lock; November 7th, lecture, "High Frequency Amplification," L. J. Voss; November 21st, lecture, "The Armstrong Super-Regenerative Circuit," P. Arberry.

Wolverhampton and District Wireless Society.*

Hon. Secretary, Mr. J. A. H. Devey, 232, Gt. Brickkiln Street, Wolverhampton.

At a meeting at headquarters, 26, King Street, Wolverhampton, on October 11th, a very interesting lecture was given by Mr. D. P. Baker on "Time—Sundials to Wireless."

The lecturer in his discourse took the meeting back to the old methods of recording time, leading up step by step to the most modern methods of recording time by wireless. The diagrams used and the actual apparatus produced proved that the lecturer had had a wide and varied experience. The many questions addressed to Mr. Baker at the conclusion of the lecture created a most beneficial discussion, practically every member taking part.

Clapham Park Wireless Society.

Meetings are now held weekly on Wednesdays, at 7.30-9.30 p.m., at headquarters, 67, Balham High Road, and visitors are cordially welcomed. Membership is increasing rapidly.

The sixth general meeting was held on October 4th, under the chairmanship of Mr. A. E. Radburn.

Hon. Secretary reported negotiating with Wireless Society of London regarding affiliation.

Mr. A. E. Radburn's offer to provide distinctive badges for Committee and ex-officio members of Society to be worn at meetings in order that newcomers could get into immediate touch with the executive was accepted.

Mr. J. Gray's resignation from Committee owing to lack of time was received with regrets.

Mr. Gray will still do everything in his power to further the interests of the Society.

Prout (Hon. Treasurer) and Mr. F. H. Austin (a Committee member) during the proceedings.

The events proved highly successful.

Dispite the torrential rainstorm in progress the whole evening, the Hon. Secretary remarked upon the good attendance.

In view of the headquarters not being available, it was arranged that the Hon. Secretary give the Boy Scouts' organisation the names and addresses of those members who could accommodate a few Scouts on their sets to hear the Prince of Wales's speech.

A hearty vote of thanks to the demonstrators concluded the evening.

The seventh general meeting was held at headquarters on October 11th under chairmanship of Mr. A. E. Radburn.

The P.M.G.'s permit allowing Society to conduct "listening in" had received the attention of Mr. W. Brierley, who suitably framed it, with glass both back and front. It was hung in the meeting room.

The Chairman presented badges as promised, to the Committee and ex-officio members.

Mr. A. L. Beadle reported progress with the advertising sign display.

The photograph of previous meeting's proceedings was circulated. Many members expressing



Clapham Park Wireless Society.

Mr. J. A. Daniels and Mr. M. P. Prout (Hon. Treasurer) had improved the Society's aerial, and a demonstration was given by Mr. J. Ayres on his portable 2 QD transmitting station, and Mr. J. A. Daniels with his Magnavox and valve apparatus "listening in."

Those present heard the Marconi transmission to the Wireless Exhibition, also Mr. J. Ayres from his portable set, the most successful being the messages to 2 KF.—Mr. Partridge replying—finally the Hon. Secretary transmitting the best compliments of the C.P.W. Society, which was confirmed by hearty applause by all present.

A flashlight photograph was taken by Mr. M. P.

a desire to possess such a souvenir, Mr. M. P. Prout will obtain copies for them at a low figure. A hearty vote of appreciation was accorded Mr. M. P. Prout and Mr. F. H. Austin.

The Hon. Secretary reported receiving reply from The Wireless Society of London, but was awaiting further information.

Mr. C. W. Richardson offered to initiate a discussion on "Aerials," etc., at next meeting, which offer was gladly accepted.

Mr. J. C. Elvy opened a discussion on "Difficulties confronting the amateur who desires to make his own apparatus, especially crystal sets." This resulted in a controversy on crystals versus

valves. The crystal detector shone out during the discussion as worthy of being placed in the first row for experimenters in wireless.

The Hon. Secretary invited discussion and advice on the various apparatus for tuning in, cylindrical tuning inductance with one, two or three sliding contacts—the same with loose coupling cylindrical inductance—variometers. This discussion tended to lead experimenters to devote their efforts to the slab, honeycomb type. Mr. J. A. Daniels gave figures and blackboard designs.

Several letters were written on the spot by the Secretary for those who are applying for a P.M.G. experimental licence, as it is becoming generally known that such certificates facilitate the granting of licences.

Newbury and District Wireless Club.

Hon. Secretary, Mr. W. L. Taylor, The Lilies, Arthur Road, Newbury.

The first annual meeting of this club was held on September 28th, and the following officers were elected for the ensuing year:—President, Mr. H. Kent-Norris, A.M.I.M.E.; Vice-President, Capt. F. M. J. White, B.Sc.; Chairman, Mr. H. Brown; Hon. Secretary and Treasurer, Mr. W. L. Taylor; Committee, Messrs. A. Corden, H. W. Porter, P. H. Sellwood, F. Ford, J. Brown, J. B. Webb, and A. M. Povey. The balance sheet showed the club to be in a very sound financial condition. This is made possible by the generosity of the Chairman, Mr. H. Brown, who provides quarters free of cost to the club. The business of the meeting was followed by a demonstration of a fine set loaned by Mr. H. W. Porter.

A general meeting was held on October 5th, and a demonstration of a home constructed set made by the Hon. Secretary was given. This proved to be one of the best demonstrations given at the club. The transmission of a prominent local amateur 2 GG being clearly heard and enjoyed by all present.

An interesting programme has been arranged for the present session. All interested in wireless matters in the Newbury district are invited to communicate with the Hon. Secretary.

Hornsey and District Wireless and Model Engineering Society.

Hon. Secretary, Mr. H. Davy, 134, Inderwick Road, Hornsey, N.8.

On October 6th the chair was taken by Mr. H. J. Pugh. A discussion was held on obtaining better meeting rooms; as nothing new had been found, it was decided to carry on at 29, Felix Avenue, Weston Park, Crouch End.

A three-valve set was then used, and good reception of the concert transmitted by 2LO to the Wireless Exhibition was enjoyed. Also music and telephony from several amateur stations was quite clear, and weather forecasts from GFA and FL in Morse were taken down by several members. Membership is steadily increasing, and a new programme of lectures, etc., has been formed.

For particulars of the Society send stamped envelope to Hon. Secretary.

Powisland Radio and Scientific Society.

Hon. Secretary, Mr. O. Gilbert Davies, Ty-Coch, Welshpool.

At a meeting of a few wireless enthusiasts held on September 6th, under the chairmanship of Viscount Cline, the above Society was formed.

Major G. R. D. Harrison, Mayor of Welshpool, was elected President.

The Society already boasts some 30 members, and is applying for affiliation with the Wireless Society of London.

It is hoped that the Society will shortly be installed in its own quarters at the Powisland Garage, Welshpool.

The Secretary will be glad to hear from anyone wishing to join the Society.

The first meeting was held on October 20th, when Viscount Cline will lecture on "The Elementary Principles of Wireless."

Wellingborough Wireless Experimental Society.

Hon. Secretary, Mr. F. E. Ball, Victoria, Wellingborough.

Arrangements were made by this Society for local boy scouts to hear the Prince of Wales on October 7th, at their headquarters, Victoria, Wellingborough.

Falkirk and District Radio Society.

Hon. Secretary, Mr. M. B. Blackadder, Glenmorag, Falkirk.

The opening meeting of the winter session was held on Thursday, September 7th, at 23 Vicar Street, Falkirk, with Mr. G. Walker, Vice-President, in the chair. There was a large attendance, and many new members enrolled, making the membership nearly 60.

At the meeting held on Thursday, September 14th, a six-valve receiver was installed, and clear signals were heard by means of the Society's loud speaker. During the evening a short discourse on the structure of the atom was given by Mr. Willingham, which was highly appreciated.

On September 21st a three-valve receiver and a crystal receiver made by members, were exhibited and explained. Excellent results were obtained on the Society's aerial from the valve receiver. The crystal set was designed for broadcasting, so it could not be tested. The receivers had been made by Mr. A. T. Hunter and Mr. R. B. Chalmers respectively, and both gentlemen were congratulated on the high quality of workmanship and efficiency displayed on their instruments. Intending members can have full particulars from the Secretary.

Cambridge and District Wireless Society.

Hon. Secretary, Mr. J. J., Butterfield, 107, King Street, Cambridge.

An extraordinary general meeting took place at the new headquarters in the Central Liberal Club, Downing Street, Cambridge, on October 2nd. Mr. A. J. Winship, the Chairman, opened the meeting by welcoming the members to the new headquarters. He then gave a detailed account of the activities of the Society since the last meeting, held in April, and how the Committee had successfully raised funds by giving exhibitions at the Royal Show and also at the Mammoth Show. Special mention was made regarding two friends of the Society, who had kindly loaned the necessary money in order to purchase a transmitting apparatus to enable the Committee to carry out their scheme. It was announced to the members that Sir Douglas Newton, M.P., had kindly consented to become patron of the Society. Six new members were elected during the evening. It was proposed that the meetings be held each alternate Thursday and Tuesday fortnightly, this proposition being duly

carried. Mr. C. E. Lawrence was elected Hon. Treasurer in place of Mr. Banyard, who has left Cambridge. All inquiries should be addressed to the Hon. Secretary, who will be pleased to hear from any ladies or gentlemen desirous of becoming members of the Society.

Bradford-on-Avon Radio Society.

Hon. Secretary, Mr. H. Helps, 4, Ivy Terrace, Bradford-on-Avon.

The members of the above Society have built a new club-room, which takes the form of a wooden hut, 20 ft. by 10 ft. At one end is a large table upon which the receiving apparatus is arranged and at the side is a bench at which members can make their own instruments.

It was thought fitting that the opening of the new headquarters should be marked by some little ceremony. This took place on Thursday, September 22nd, when the governors of the County Secondary School were present.

The Chairman, Mr. E. Cooper, apologised for the absence of their President, Lord Fitzmaurice, and Vice-President Brig.-Gen. Palmer, C.B., M.P. He then called upon Mr. A. H. Baker, A.R.C.Sc., to declare the headquarters open.

Mr. Baker, who was received with applause, gave a most interesting and instructive speech. In conclusion, he said he had the greatest of pleasure in declaring the building open as the headquarters of the Bradford-on-Avon Radio Society.

Mr. J. Cooper, A.M.I.R.E., proposed a vote of thanks to Mr. Baker, which was carried with loud applause, and Mr. Baker suitably replied.

The Chairman then called upon Mr. Merritt, of the Western Counties Electrical and Engineering Co. (who at considerable inconvenience came from Yeovil to help the Society that evening), to tell them a little of the possibilities of radio transmission, and then to entertain the assembly with a radio concert.

Mr. F. H. Merritt wished the Society every success. A Burndept Ultra III receiver was used with a Brown loud speaker. In view of Bradford's westerly situation, the reception of the Dutch concert was a credit to the apparatus.

Mr. L. C. Willcox, of Warminster, who is Hon. Consulting Engineer to the Society, transmitted an excellent musical programme from his private station, which was received with great clarity and volume.

Hackney and District Radio Society.

Hon. Secretary, Mr. E. R. Walker, 48, Dagmar Road, South Hackney, E.8.

A report for the quarter ending September 30th, 1922, has been prepared.

The Society meets every Thursday evening at 7.30 at the Y.M.C.A., Mare Street, Hackney, E.8.

Sir Arthur Lever, Bart., has been elected a Patron to the Society, and Mr. L. L. Robinson, an honorary member.

The Society has applied for affiliation to the Wireless Society of London, as well as for an experimental licence. A Technical Sub-Committee is at present engaged in constructing the Society's wireless set, which will enable practical demonstrations to be given.

Since its inception a great deal of keenness and enthusiasm has been shown, the more expert members giving all the assistance and advice possible to new comers. There are at present

over 70 members, with an average attendance of 75 per cent. At every meeting there are one or more ladies present. Members are of all ages, from 14 to 60.

As it has been found by experience that the present basis of subscription is not practicable and too high, it has been decided to hold a special general meeting on Thursday, November 9th, to discuss various matters connected with subscriptions, entrance fee, two classes of membership (senior and junior), and altered date of next annual meeting, and all members are requested to attend.

A cordial invitation is extended to all persons, especially ladies, who are interested in the subject, whether they possess radio sets or not.

Thames Valley Radio and Physical Association.

Hon. Secretary, Mr. Eric A. Rogers, 17, Leinster Avenue, East Sheen, S.W.14.

At a general meeting held at East Sheen on October 4th, it was decided to alter the name of the Barnes, Mortlake and Richmond Wireless Society to the above title, as many members had joined from the further districts of Teddington, Kew, Wimbledon, etc.

Mr. C. Appleton-Smith was elected Chairman to the meeting, and the minutes of the last meeting were read and confirmed. The rules were duly presented, discussed and passed.

A letter from Mr. Blake, M.I.E.E., the President, was read, in which he apologised for his absence and expressed his desire to meet all members on November 7th at a special meeting, when he will give his Presidential address and lecture (with lantern slides).

It is hoped that everyone in the district interested in wireless will be present. Hearty welcome will be extended to all visitors. Tickets for visitors can be obtained from the Hon. Secretary. These tickets are free, but the number is limited.

An entrance fee to the Association was fixed at 5s. by the meeting, and the subscription is 10s. 6d. per annum.

The next meeting of the Association was held at the Girl Guides' Hut, Wigan Institute, Mortlake (close to Mortlake Station, L. & S.W.R.) on Thursday, October 19th, at 8 p.m., when the series of lectures for the season commenced.

Burnham, Highbridge and District Wireless Society.

Hon. Secretary, Mr. L. Lott, 52, High Street, Burnham-on-Sea.

A meeting was held on October 3rd, in the Adult Schoolroom, Adam Street, Dr. N. Burns, of the Lodge, Highbridge, in the chair, to consider the formation of a local Wireless Society. There was a good number of local amateurs present, and it was decided unanimously to form such a Society, all present enrolling as members, and Dr. N. Burns as Chairman for the year. A Committee was appointed. It was decided to hold meetings every fortnight, and a buzzer class each week. Annual subscriptions decided upon were 5s.; Associates, 2s. 6d. It is hoped from the enthusiasm shown at the meeting to further extend the membership, and anyone in the district can obtain full information of the Hon. Secretary.

Papers and discussions will be arranged for, also a question box, and other means of helping members new to wireless. Twenty-one members enrolled.

Questions and Answers

NOTE.—This section of the magazine is placed at the disposal of all readers who wish to receive advice and information on matters pertaining to both the technical and non-technical sides of wireless work. Readers should comply with the following rules:—(1) Each question should be numbered and written on a separate sheet on one side of the paper, and addressed "Questions and Answers," Editor, THE WIRELESS WORLD AND RADIO REVIEW, 12, 13, Henrietta Street, London, W.C.2. Queries should be clear and concise. (2) Before sending in their questions readers are advised to search recent numbers to see whether the same queries have not been dealt with before. (3) Each communication sent in to be accompanied by the "Questions and Answers" coupon to be found in the advertisement columns of the issue current at the time of forwarding the questions. (4) The name and address of the querist, which is for reference and not for publication, to appear at the top of every sheet or sheets, and unless typewritten, this should be in block capitals. Queries will be answered under the initials and town of the correspondent, or, if so desired, under a "nom de plume." (5) In view of the fact that a large proportion of the circuits and apparatus described in these answers are covered by patents, readers are advised before making use of them, to satisfy themselves that they would not be infringing patents. (6) Where a reply through the post is required every question sent in must be accompanied by a postal order for the amount of 1s., or 3s. 6d. for a maximum of four questions. (7) Four questions is the maximum which may be sent in at one time.

In view of the serious interference which an oscillating receiver can cause to other receivers in its neighbourhood, it is understood that for broadcast wavelengths, certainly, and possibly for all wavelengths, the Postmaster-General will in future allow no type of circuit which is capable of oscillating and so energising the aerial, either directly or through any circuit coupled to it.

The necessary consequence of this restriction is that if reaction of the type commonly used in the past is still employed, it must be in such a way that the oscillation point cannot be reached over the wavelength range of the receiver, however tightly the reaction coil is coupled, and with whatever values of filament voltage or plate voltage the set is worked.

In order to comply with this requirement, it is essential that the reaction coil should be sufficiently loosely coupled to the aerial inductances as not to set up oscillations, or alternatively the reaction might be arranged between the grid and plate circuits of a high frequency amplifier as shown on p. 715 of the issue of September 2nd.

We strongly urge readers who are making or using sets of the usual reacting type to either reduce the amount of reaction which they can employ to such an extent that they are perfectly satisfied that the set can never oscillate, or to cut out their reaction entirely.

"C.H.B." (Fleetwood).—(1) A satisfactory form of three-valve unit receiver is shown in Fig. 6, page 809, September 16th issue, in which however, you should note that reaction back to the aerial tuning circuits is no longer permitted. The reaction coil should be coupled back to the H.F. transformer shown on the first panel. (2) The addition of two extra valves is advised. If only one is used it should be preferably employed as H.F. (3) There is no difference between an L.F. and an audio-frequency transformer.

"W.S." (Newcastle).—The sketch submitted is all right except that (1) There is no complete path for the H.T. Negative of the H.T. battery should be joined to the negative of the L.T. battery. (2) Telephones should be on the positive side of the H.T. battery. (3) The grid connection of the second valve should go to the negative of the L.T. instead of to the positive. (4) The only form of reaction used must be to the intervalve transformer, which brings radiation to within safe limits.

"STUCKPHAST" (Swansea) submits a list of components in his possession, and asks for a diagram with a switch to cut out the first valve.

See Fig. 1. If you propose not to use a telephone transformer, high resistance telephones must be used. The transformer is connected as follows:—O.P. to plates; I.P. to H.T. +; O.S. to L.T. -; I.S. to grid.

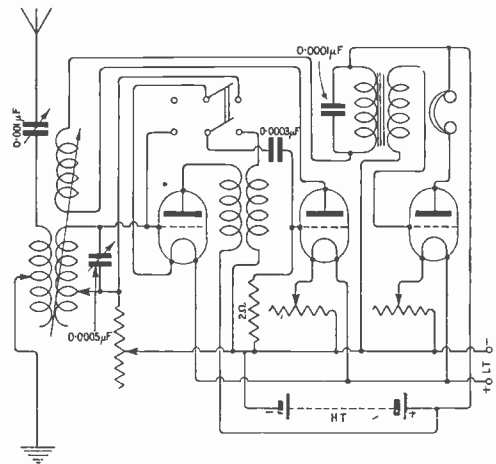

Fig. 1.

"A.F.T." (Burton-on-Trent) asks re Fig. 2, page 507, July 22nd issue, which are the battery terminals, and (2) Who manufactures "Q.X." valves, and from whom they may be obtained.

(1) The terminal at the extreme right-hand upper corner of the panel is the H.T. negative. The next terminal on the top is the H.T. positive. The terminal immediately below is the L.T. negative, and the terminal below this the L.T. positive. (2) The "Q.X." valve is made by the M.O. Valve Co., Ltd., and can be obtained from most dealers.

"W.B.D." (Dollar).—We regret we have no particulars of the set to which you refer, but you will find a good deal of useful information on transmission in the issues of this journal for May 28th and June 11th, 1921.

The Present Wireless Boom

has given an enormous impetus to the manufacture of wireless apparatus. The tendency has been to sacrifice quality to quantity in endeavouring to keep pace with the demands. Throughout this period of increasing wireless activity S. G. BROWN, LTD., have wisely refused to lower their high standard of quality even at the expense of occasional delay in fulfilling orders. As a result they have more than maintained their enviable reputation as RELIABLE wireless manufacturers, and to-day it continues to be recognised by amateur and professional alike that wireless instruments and parts manufactured by and bearing the name "BROWN" can be bought with absolute confidence in their quality, value and efficiency.



"A" TYPE. £
 Low Resistance, 58/-
 High Resistance, 62/- to 66/-
 "D" TYPE.
 Low Resistance, 48/-
 High Resistance, 52/-

(All above prices include cords).

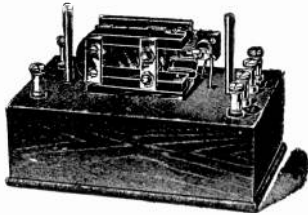

PRICES:

Low Resistance (120 ohms) input, £6
 High Resistance (2,000 ohms) input, 2/6 extra.



PRICES:
 H. 1 (Large) Low Resistance, 120 ohms Height 21".

£6 : 5 : 0
 (High resistance 2/6 to 5/- extra).

H. 2 (Small) Low Resistance, 120 ohms Height 12".

£3 : 0 : 0
 (High Resistances 2/6 to 5/- extra).

Telegrams—
 "Sadbrownix, London."

Telephone—
 Chiswick 1469.

The "Brown" Super-sensitive Telephones

These Telephones are unquestionably the clearest and most sensitive made, and, consequently, increase the distance over which wireless can be heard.

BROWN'S are recognised as the most comfortable to wear, due to their extreme lightness in weight and adaptable adjustment.

There are no wireless headphones in the world to compare with BROWN'S.

IMPORTANT NOTICE—When purchasing BROWN'S you should see that the name BROWN is stamped on the back of each ear piece. This is the *hall-mark and proof* of their *genuineness, excellence of finish and highest efficiency.*

In Universal Use. As supplied to British, Allied and Foreign Governments.

The "Brown" Microphone Amplifier

This Amplifier magnifies signals, speech, or music, without distortion, and is of considerable interest to amateurs and scientific investigators. The magnification is much greater than that obtained from a two-valve amplifier. In construction, this instrument is much more robust than other relays. This instrument satisfies the urgent demand for a reliable inexpensive amplifier, which the most inexperienced amateur can use, and which the most experienced requires. The necessary transformers are included in the base.

The "Brown" Loud Speakers with new improved Curved Horns

The requisites of a Loud Speaker are pure tone, clear articulation, and good volume of sound. The "BROWN" Loud Speaker possesses these qualities and they are enhanced by the new improved curved horn.

AMATEURS do not always need the full sized Loud Speaker (H.1) as used in Lecture Halls, and a small type (H.2) has been designed to meet their more modest home requirements both as to volume of sound and price.

THE NEW HORN of dull blacked aluminium used with both H.1 and H.2 is constructed on the logarithmic law of increasing openings and is acoustically perfect.

NOTE THIS.—The strength and clearness of all music, speech and Morse heard by one person wearing headphones is broadcasted to a whole room full of people when a Brown Amplifier and Loud Speaker are used with your set.

The most popular and perfect loud speakers ever offered to the public.

Thousands already in use in all parts of the world.

CATALOGUE POST FREE.

Visit Our London Showrooms: 19, MORTIMER STREET, W.1.

SOLE MANUFACTURERS—



Sole Agent for the Argentine—

Horacio D. Guerrero,

Las Heras 2480, Buenos Aires

Head Office and Works
 VICTORIA ROAD, NORTH
 ACTON, LONDON. W.3

London Showrooms:
 19, MORTIMER STREET,
 LONDON, W.1.

EXPERIENCE

RADIO FREQUENCY AMPLIFICATION.

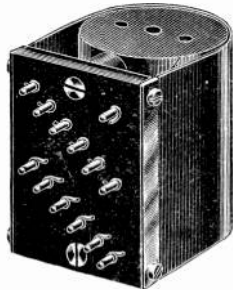

IMPROVED ADJUSTABLE REACTANCE COIL.—This is recommended where one or two stages of radio frequency amplification are required. It is more stable than a radio frequency transformer. Twelve tappings are provided and the instrument is self-tuned, no variable condenser being required. Suitable for wavelengths of 100-20,000 metres. **PRICE 25/- WITH 12-POINT SWITCH... 16/- EXTRA**

For multi-stage radio frequency amplification we recommend our improved **RADIO FREQUENCY TRANSFORMER.** This is made in two ranges:—

- (A) 100-4,000 metres, with 9 tappings. **PRICE 25/- WITH 12-POINT SWITCH... 16/- EXTRA**
 - (B) 100-30,000 metres, with 12 tappings. **PRICE 40/- WITH 12-POINT SWITCH... 16/- EXTRA**
- (B is approximately twice the size of A.)

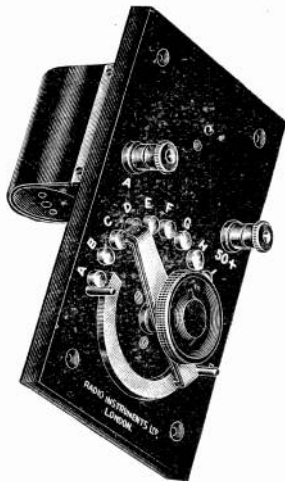

TWELVE POINT SWITCH. This is a well-made laminated switch with extra large contacts. It is exactly as fitted to our own instruments and is the best switch it is possible to obtain for wireless work. The contacts are absolutely certain.

PRICE 16/-

THE R.I. CATALOGUE covers everything wireless. Post free for 6d. Returnable with first order.

GET A COPY NOW.

DELIVERY FROM STOCK. We hold stocks at present but it is advisable to lose no time in placing your orders

PRICES AND OTHER PARTICULARS ON APPLICATION. Other R.I. Products:—Crystal Sets, Valve Sets, Loud Speakers, Precision Air Condensers, High Resistance Telephones, Fixed Condensers, Series Parallel Switches, Etc., Etc.

Radio Instruments Limited

Managing Director: J. Joseph, M.I.E.E., late Manager to Mr. H. W. Sullivan. Chief Designer: W. A. Appleton, M.B.E., M.I.R.E., late Admiralty Technical Research Officer.

ONLY ADDRESS. Works, Offices & Showrooms
12a, Hyde Street,

NEW OXFORD ST., W.C.1

Telephone: Regent 1903. Telegrams: Instradio, London.

(E.P.S.)8a.

J. BURNS, LTD.
Wangye Works,
Chadwell Heath, Essex.

We are actual manufacturers and can offer special advantages to the trade—send us your enquiries.

CONDENSERS.	retail price
'001 mfd.	16/- ea.
'0005 "	12/6 ea.
'0003 "	11/6 ea.
'0005 "	5/6 ea.
Filament Resistances	3/- ea.
Terminals with high base	1/6 doz.
Contact Studs, with nuts	9d. doz.
Sliders, with springs and studs	9d. ea.
Ebonite Panels, cut to order	3/6 lb.

Single Valve Panels

fitted with Variable Condenser, Filament Resistance, Grid Leak and fixed Condenser, Engraved Panel and Rosewood finished Box, ready for use

£4

Vulcanised Fibre and Ebonite Sheets, Rods & Tubes from stock.

Broadcasting

IS NOW ASSURED

Get Your Installation before the Rush

How to Build the Finest Receiving Station, Expanding by Instalments.

To Receive Signals You Must Have—

Aerial Wire, 150 ft. Silicon Bronze, 4/6
Insulators from 4d. each, Tuning Stand (3 coils) 30/-. Coils from 1/3, according to W.L., Detector Unit (Valve) 37/6, Phones from 24/-. Condensers Variable, 5/- to 36/-. H.T. and L.T. Batteries, see our list.

To increase range you require 1 H.F. Unit 37/6, and so that your friends can hear add 1 L.F. Unit 45/-.

Illustrated Catalogue, including List of Stations, useful books, etc., we can supply. 6d. Post free.

EONS WIRELESS SUPPLY CO.

115, FLEET STREET, E.C.4.

"H.C." (Wigan).—(1) The sketch enclosed with your letter shows the reaction coil coupled with the aerial coil. We do not recommend this. We suggest you use a secondary circuit, and couple the reaction coil with the secondary inductance coil Fig. 2. The sketch does not show the L.T. battery connected to the H.T., but this of course is a slip. (2) We cannot calculate the value of your glass plate condenser, because you have not given us the dimensions of the tinplate conductors. The calculation is quite simple, and is fully explained in Coursey's book "The Radio Experimenter's Handbook." (3) No exact dimensions and turns can be given for the construction of honeycomb coils to tune to definite wavelengths, because the inductance of the coils depends greatly upon the method of winding, tightness of winding, etc. We suggest using 30 pegs on each side of the former. About six coils will be required to cover the wavelength range you require. Wind one layer of No. 22 for the smallest coil, and twelve layers of No. 26 for the largest. (4) We see no reason why you should not receive telephony with the set.

former you have purchased should work well if connected in the above circuit.

"J.C." (Streatham) wishes (1) To wind a coil with tappings for coarse and fine tuning, to tune from 150 to 500 metres, and asks three other questions.

(1) Assuming you have a normal aerial, wind the 3" diameter tube with No. 20 D.C.C. wire. For fine tuning take tappings at the following turns:—1, 2, 3, 4, 5, 6, 7 and 8. For coarse tuning take tappings at 9, 18, 27, 36, 45, 63 and 72 turns. The tube will be 4" long. (2) Yes, you will have to submit the proposed arrangement to the Post Office. (3) This arrangement has frequently been used, and is similar to many sets on the market. (4) We suggest you see the articles on "Experimental Station Design," appearing in alternate issues.

"TUNER" (Ilford).—(1) On the primary coil make eight or nine tappings, and in the secondary, four or five. (2) Allow about 4" of movement. (3) You will probably require at least four valves. (4) This is due to the spacing of the components in your set. Reduce the number of turns in the reaction coil by one-third.

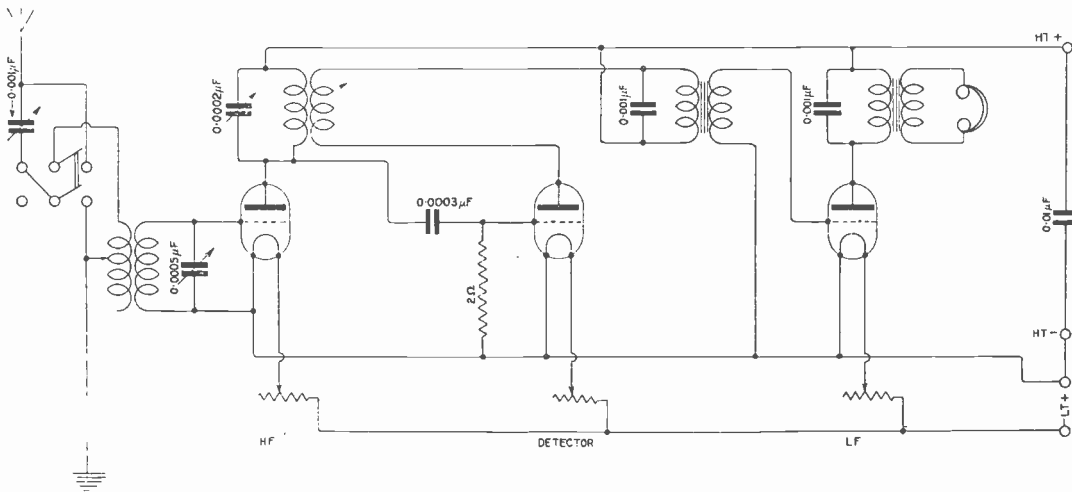

Fig. 2.

"M.J.D." (Brussels) asks (1) For criticism of his set. (2) For suggestions to improve the set. (3) If "Dewar" type switches are better than battery type. (4) If it is advisable to build the tuner as a separate unit.

(1) and (2) We think your first arrangement is better than the second. We suggest you make use of a closed circuit, and couple the reaction coil to the closed circuit inductance. (3) There is not much to choose between the types of switch you mention, but considerations of space will no doubt determine which is more suitable in your case. (4) Generally it is better to make the tuner a separate unit.

"W.J.S." (E.5) wishes to add three valves to his single valve panel, and asks other questions.

We suggest you abandon the single valve panel and construct a four-valve set on the lines of Fig. 4, page 840, but using an aerial and closed circuit. Your set would almost certainly not be licensed by the Post Office. The trans-

"J.H.L." (E.14) asks (1) How to make a simple but efficient tuner suitable for single valve set. (2) The best method of mounting basket coils. (3) Will a 4-volt accumulator suffice for the L.T. battery.

(1) and (2) We presume you wish the tuner for use over the broadcast wavelengths, and suggest you see the articles "A Broadcast Receiver," which appeared in the issues of August 26th and September 2nd. (3) A 4-volt battery will do, but a 6-volt battery would be better.

"E.R.L." (Seven Kings).—We suggest you abandon the construction of the receiver, and build a set of more usual design.

"C.H.S." (Derby) (1) wishes to build a three-valve receiver with switches to cut out the H.F. valve, or note magnifier. (2) What coils, wound on a "Lokap" winder, are required for certain stations.

(1) Page diagram in this issue. (2) We suggest you use basket coils for short wavelengths. See the issue of June 10th. For the longer wavelengths

wind coils using the narrow cam. The wire enclosed is No. 26 D.S.C., and is suitable.

"F.B." (Garches) has a single valve panel, and wishes to know the dimensions of the coils and size of wire to use for a wavelength range of 180 to 400 metres.

Coil A, 5 cms. of winding, using No. 22 S.C.C. (=0.7112 mm.) with six tapings. Coil B, 5 cms. of winding, using No. 26 S.C.C. (0.4572 mm.), with four or five tapings. Coil C, 3 cms. of winding, using No. 28 (0.3759 mm.)

"J.W.D." (Finsbury Park).—We suggest that you construct the Broadcast Receiver described in our issues of August 26th and September 2nd. Very complete instructions are given for making this set, and the results justify whatever pains are taken to make it. Plug-in coils are used, therefore you will be able to cover whatever wavelength range you may desire. Should you experience any trouble while making the set, we shall be very pleased to answer any enquiries you may address to us. See circuit Fig. 3 for experimental reception on wavelengths not used for broadcasting.

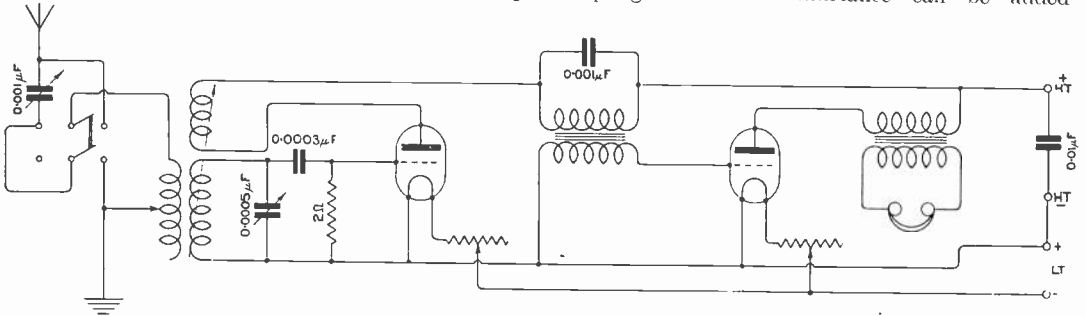

Fig. 3.

"JUMPER" (Woking) asks (1) For a criticism of his set. (2) If he can use 7/22 copper cable for his earth lead. (3) If a glass tube will do for a lead-in insulator. (4) Windings for basket coils to tune in 2 MT and FL.

(1) We do not care for your circuit. A parallel A.T.C. on short wavelengths is useless. See Fig. 3. (2) Bare 7/22 cable will suffice, but we prefer to run insulated cable to the earth connection. (3) Yes, if it is of stout construction. (4) See the issue of June 10th, page 326. For FL use honeycomb coils.

"J.E.T." (South Africa) asks (1) For dimensions of an air choke of millihenry inductance. (2) For dimensions of an L.F. choke with an inductance of 1 henry.

(1) Wind No. 30 S.S.C. wire on a former 3" in diameter, for a distance of 3½". (2) We cannot give you the exact dimensions, but if you have an interval transformer and re-wind it with No. 34 S.S.C., you will have an inductance of about 1 henry; alternatively you could make up a coil consisting of a bundle of iron wires. Make the coil ½" in diameter and 3" long, and wind No. 34 S.S.C. wire until the overall diameter is 2", then bend over the ends of the wire to form a closed coil.

"B.F.W." (S.E.4).—Wind a tube of 3" diameter with No. 22 D.C.C., and take tapings off the 25th, 54th and 80th turn.

"W.N." (N.W.1).—The answer to your first question depends entirely upon the licence you hold. If you hold an "Experimenter's" licence, we understand you may couple the reaction coil to the aerial or closed circuit coil. On the other hand, if you hold a "Broadcast" licence, the reaction coil must be so coupled that the aerial cannot ever be set oscillating. This is practically assured when the reaction coil is coupled to the H.F. transformer. The holder of an "Experimenter's" licence is considered competent to control reaction, while the holder of a "Broadcast" licence is restricted in the use of reaction. (2) We suggest you use a closed circuit, and arrange a switch in the aerial circuit for connecting the A.T.C. in series or parallel with the A.T.I. The reaction arrangement to which you refer is a very satisfactory arrangement, and we suggest you adopt it. You might also see the arrangements shown on page 792, September 16th and page 865, September 30th, 1922. (3) On higher wavelengths it is simply necessary to add inductance in series with the coupling coil. The inductance can be added

exactly as shown on page 867, September 30th issue. In the diagram are two terminals marked "X." The strap is removed and the coil is inserted. The reaction coil and A.T.I. can be constructed on the lines of a loose coupler. The values are:—A.T.C., maximum value 0.001 mfd.; Anode condenser, maximum value 0.0002 mfd.; grid condenser, average value 0.0003 mfd.; fixed condenser of 0.001 mfd.; H.T. battery condenser can be anything from 0.005 up to 0.5.

"A.M.R." (Marlborough).—(1) There is no simple accurate formula, but you might use an interval transformer with the windings correctly joined in series. (2) Yes. (3) We cannot say. Probably he will. (4) Wind the frame with 15 turns of No. 18 S.W.G. spaced ¼" apart, and take tapings to a switch.

"M.S." (N.W.8).—(1) The circuit referred to is very satisfactory. (2) See the articles on "Experimental Station Design," appearing in alternate issues. (3) A note magnifier is easily added. See several recent circuits. (4) Quite.

"A.S." (E.17).—(1) We cannot say from your description what the trouble is, but you might increase the filament battery to 6 volts, and the H.T. battery to 50 volts. (2) Make a telephone transformer to use with your telephones.

"A.E.C." (Wood Green).—It is unfortunate that you have not sent us particulars of your telephone plugs and jacks. There are so many types,

MAGNAVOX

THE WORLD'S FINEST

LOUD SPEAKER

RADIO
brings it
MAGNAVOX
tells it.

*Broadcasting faithfully reproduced
with marvellous clarity and volume*

IMMEDIATE DELIVERY.

To be obtained from all dealers or direct from the
Manufacturers & Sole Licensees

Sterling Telephone & Electric Co., Ltd.

TELEPHONE HOUSE,

210/212, Tottenham Court Road, London, W.1
Telephone No.: 4144 Museum (7 lines). Telegrams: "Cucumis, Wesde, London."

Works: DAGENHAM, ESSEX.

BRANCHES: NEWCASTLE-ON-TYNE: 9, Clavering Place.
CARDIFF: 8, Park Place.

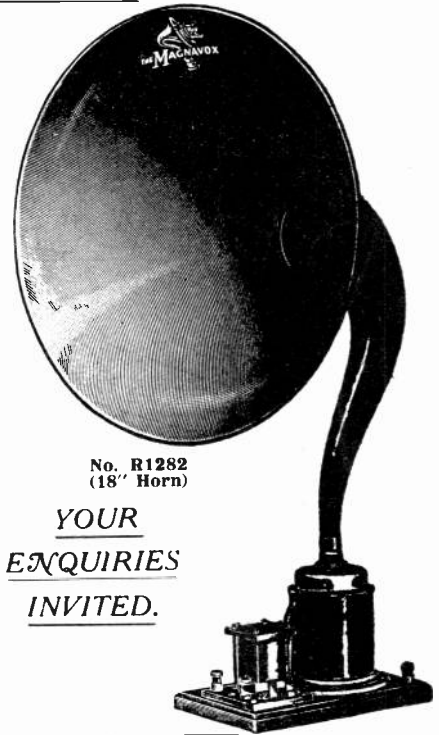

No. R1282
(18" Horn)

YOUR
ENQUIRIES
INVITED.

BRITISH EBONITE TO GOVERNMENT SPECIFICATION FOR BRITISH WIRELESS.

MANUFACTURED BY:

THE BRITISH EBONITE CO., LTD.

HANWELL

APPLY FOR LIST "W."

LONDON, W.7

**SPECIAL QUALITY RODS, TUBES,
and SHEETS FOR WIRELESS.
ALL USUAL SIZES KEPT IN STOCK.
Grained Ebonite is a Speciality.**

TELEGRAMS: "Ebonital, Han, London."
PHONE: Ealing 1689.

WHOLESALE
ONLY.

T.M.C. Wireless

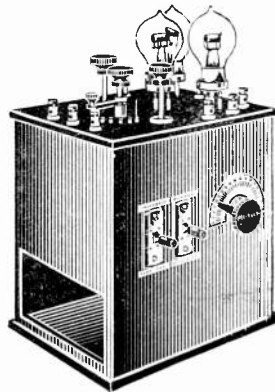

T.M.C. 3-VALVE BROADCASTING SET

A Revelation in Wireless Sets employing one-valve detector, two valves for low frequency amplification. Apparatus mounted includes Variable Filament Resistance, three Valve Sockets, Grid Leak and Condenser, two highly efficient Transformers, Grid Potential Blocking Condenser, Variable Condenser, Series Parallel Switch, Switch for using Loud Speaker or Headphones, Tuner and Reactance. Complete with Three Valves, Loud Speaker and set of "De-Luxe" Headphones. Mounted in polished Walnut. Size $9\frac{1}{2} \times 7 \times 10\frac{1}{2}$ inches high.

THE MARVELLOUS 3-VALVE SET THAT WAS
THE FEATURE OF THE EXHIBITION.

THE TELEPHONE MANUFACTURING CO. LTD
HOLLINGSWORTH WORKS, WEST DULWICH, S.E.21
TELEPHONE: SYDENHAM 2460-1 TELEGRAMS: BUBASTIS DULCROX

and ordinary jacks are quite unsuitable for H.F. work, so that we think you would get better results by using switches or the specially constructed jacks frequently advertised in this journal. We also suggest that you make use of the tuned anode

turns with a mean diameter of 4". For the smaller coils use No. 22 D.C.C. and for the larger No. 26 D.C.C.

"J.D." (Cambridge).—Diagrams are given in Figs. 4 & 5 making use of one H.F. valve,

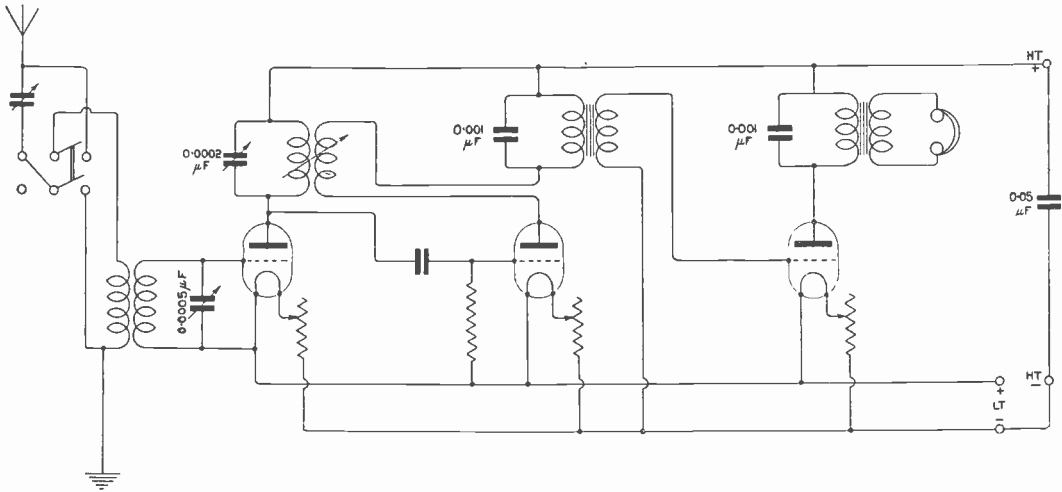

Fig. 4.

arrangement for H.F. amplification, as the results are much better than those obtained from changeable plug-in type H.F. transformers. For the short wavelengths we suggest you employ single layer coils. The A.T.I. may consist of a coil 3" diameter by 4" long of No. 22 D.C.C. with six tapings. The C.C.I. may consist of a coil 2½" diameter by 4" long of No. 26 D.C.C. with six tapings. We cannot tell you the number of turns

one detector valve and one L.F. valve, but using no reaction directly to the aerial circuit. We recommend you using a tuned anode arrangement instead of a H.F. transformer, and then coupling the reaction coil to the anode coil as shown on page 867, September 30th, 1922. This circuit works extremely well, and with the reaction coil coupled to the anode coil, will not radiate to cause interference.

"C.S." (Swanage).—The value of the con-

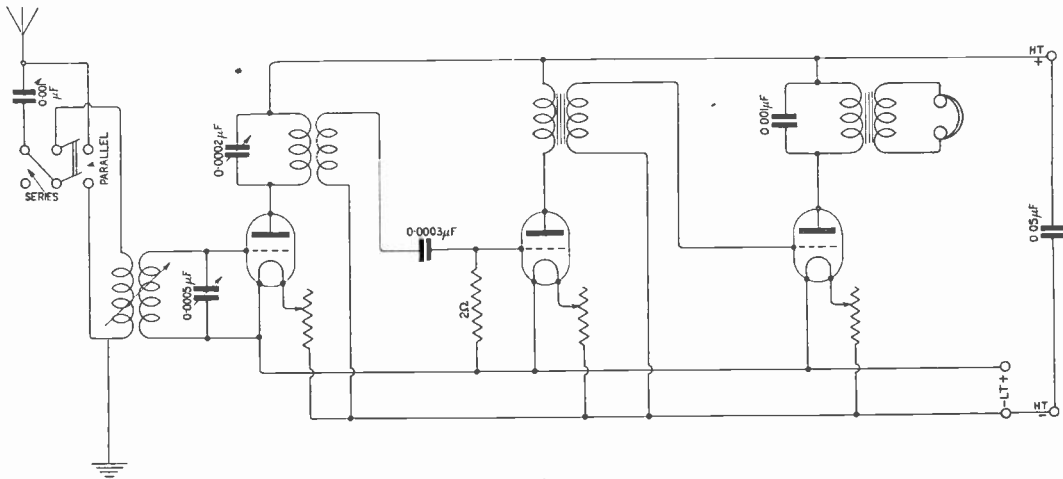

Fig. 5.

of wire in a lattice coil which has a specified inductance value. The inductance varies so greatly upon the method of winding that we suggest you wind, say, six coils, the smallest having 30 turns with a mean diameter of 2", and the largest 600

denser which shunts the H.T. battery is not critical, and may be anything from 0.01 mfd. up to 0.5 mfd. A usual valve is 0.05 mfd., and this is quite satisfactory.

"J.T.B.W." (Rainhill).—(1) From your cover-

ing letter we note that this circuit is intended to be a super-regenerative one. It is a very eccentric type; the only thing that we can be sure about is that it will not act in this way. We should strongly advise any beginner to get some experience with a normal type of set before attempting any adjustment of the Armstrong super-regenerative. (2) Neglecting for a moment the fact that the grid circuit of your first valve has no particular wavelength whatever, from the information supplied we think your wave range would probably be from 150/250 metres. (3) We should not care to hazard a guess. (4) If more than one wire is used for an aerial, the length from the lead-in to the open end may still remain 100 ft. for each wire. (See constructional details of super-regenerative receiver commencing on page 71, October 21st, 1922.

"E.E.C." (Strabane) asks (1) *The capacity of a condenser suitable for smoothing out differences of potential in rectified alternating current.* (2) *The number of plates of glass dielectric, 1/16" thick \times 3½" \times 2½", required to make this condenser.* (3) and (4) *Particulars of windings for transformer.*

(1) This will depend very largely on various conditions about which you say nothing, such as the purpose for which the rectified current is to be used, *i.e.*, for transmission or reception—voltage, about 1 mfd. (2) For this purpose, with the plate you suggest, you would require about 20,000 plates, which, of course, is quite impracticable. You should either use much larger glass plates—and even this will be impracticable—or paraffin paper or mica, according to the potential required. (3) and (4) You do not give enough data to enable us to say, as you furnish no information with regard to the frequency or output required. We should suggest that a closed core of one square inch section, with 200 turns of No. 18 wire. This will probably be on the safe side for normal frequencies.

"A.N.T." (Sparkbrook) asks (1) *What to do with his set, which is two-valve, with one stage of L.F., if reaction back on to the tuning circuits is not permitted.* (2) *How to substitute a potentiometer for his grid condenser and leak.* (3) *If this will improve reception.*

(1) You would improve results if you use your A.T.I. in series instead of in parallel with the A.T.C. for short wavelengths. If reaction is done without altogether, we should advise you to make your valve combination one H.F. amplifier and one detector. Moreover, this would give you a chance of incorporating reaction from the anode of the second valve to the inter-valve transformer, reaction of this type being quite useful. We fail to see how you can get satisfactory results with two "Ora" valves in series on 4 volts, as your diagram shows. (2) The two ends of a potentiometer wound with a resistance of about 200 ohms, should be connected direct across the 4-volt battery, and the slider connected to the lower end of the A.T.I., the connection from the battery negative to earth being, of course, omitted. (3) The improvements, if any, obtained in this way would be very small.

"H.T.P." (Lewisham).—Circuit is quite satisfactory, except for the fact that the aerial condenser is shown in parallel with the A.T.I.

The form of reaction shown is no longer permitted, and you should couple your reaction coil back to the anode coil of the first valve.

"R.O.S." (London) asks questions with regard to engraving his panel.

No ordinary workshop tools are of any use for engraving. Dies for stamping letters on metal are of practically no use as the result is too irregular and untidy to be worth while. Engraving can be done either by hand, which is a skilled craft which we do not advise you to try, or by means of an engraving machine, which is an expensive machine tool. You will be well advised to take your panel to a professional engraver. The cost of his services will be probably considerably less than the damage to the panel which you would do by trying it yourself.

"ALPHA" (Westcliffe-on-Sea) asks (1) *whether an arrangement of an intervalve transformer sketched is better than using it as a note magnifier.* (2) *How to add a third valve to his set.* (3) *How to determine whether he is adding the best value of H.T. to his plate.* (4) *For data for a transformer for 300-1,500 metres.*

(1) As shown the transformer is being added as a note magnifier. We cannot say whether it will be suitable for this. It will not if it is wound as a telephone transformer. (2) Of many possible methods, that of Fig. 2, page 772, September 9th, is very good. (3) This can best be done by trying various voltages and seeing which gives the best results; but in general the H.T. voltage is fixed almost arbitrarily, and the grid voltage adjusted to give the best results with this arbitrary value. (4) Try winding sections of about 25 turns each in heaps on a former 1½" in diameter. Connect these up alternately in the two windings and arrange taps to each section. You will probably want about 200 turns for each winding in all.

"MICRO-AMP" (Stanbridge) asks (1) *Whether there is a risk of burning out 8,000 ohms telephones on Leafield at about 30 miles, using either one or two "Ora" valves.* (2) *What is the maximum current which can be got from such valves with 30 volts on the plate.*

(1) No; the current through the telephones is determined by the saturation current of the valve, and not by the strength of the transmitting station. You could not get more than this even if you were only a mile or two away, instead of 30. (2) The maximum current through a receiving valve of this type is in general about 20 milliamps, but this is only obtained under special conditions, very different from those met with in an ordinary receiving circuit. In your case you are never likely to get more than 5 milliamps.

"NEMO" (West Kirby).—(1) The gauges of the wires are 22 and 32. (2) This depends on the sizes of the coils and the wavelengths required. Generally speaking No. 28 is all right for a closed circuit, and somewhat finer—say No. 34—for a reaction coil. (3) (c) is best, if you mean by the use of a separate heterodyne. (a) and (b) both lead to serious re-radiation, and are prohibited over the broadcasting band of wavelength. (b) gives better tuning than (a), which is thoroughly bad, and has nothing to recommend it but its cheapness.



MARCONI
GIVES
UNRIVALLED
WIRELESS
SERVICE

The MARCONI INTERNATIONAL
MARINE COMMUNICATION CO. LTD.
MARCONI HOUSE, STRAND, LONDON.

Ask Your Dealer for "BRITWIRE" PRODUCTS

(SEND FOR ILLUSTRATED LIST—PRICE 3d.)

POST ORDERS TO

BRITISH WIRELESS SUPPLY CO., LTD.

6, BLENHEIM TERRACE, LEEDS.
Tel: 26926.

18, ELDON SQUARE, NEWCASTLE-ON-TYNE.
Tel: 360 CITY.

33, HIGH STREET, SOUTHAMPTON.
Tel: 423.

11, CHURCH STREET, WEST HARTLEPOOL.
Tel: 373.

WORKS : LEEDS.

— BROADCAST

The "HESTAVOX"

RECEIVER —

Manufactured
under licence
from Marconi's
Wireless Tele-
graph Co. Ltd.

PRICE
(exclusive of
accessories)

£7 : 17 : 6

DELIVERY
FROM STOCK

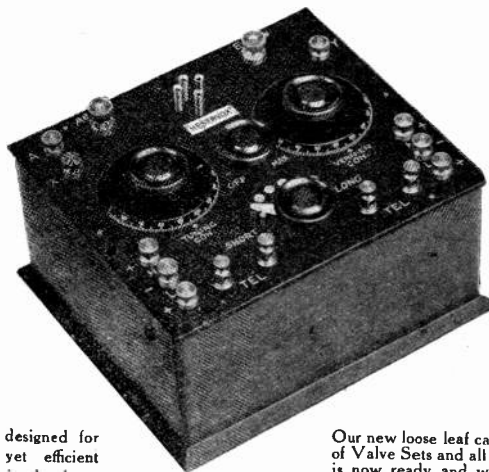

Fully approved
for Broadcast
Reception by
H.M. Post-
master-General.

PRICE
(including all
accessories from
A to E)

£13 : 18 : 6

EFFICIENCY
GUARANTEED

The above instrument has been designed for those requiring an inexpensive yet efficient Broadcast Receiving Set. Provision has been made for the addition of Low Frequency Amplifiers on the "Hestia" Unit System.

Our new loose leaf catalogue, containing full particulars of Valve Sets and all small parts required by the amateur is now ready and will be sent Post Free on receipt of 6d. Once you have this, you will be kept posted, without further charge, with all new designs of sets or parts as they become available for delivery.

TRADE SUPPLIED.

LOOSE LEAF CATALOGUE (as above) Post Free 6d.

THE HESTIA ENGINEERING COMPANY, (Dept. W.)
32, Palmerston Road, Acton, London, W.3.

Telephone :
CHISWICK 586.

"T.P." (Fulham).—Your diagram is not correct, and we suggest you make use of a simple telephony transmitting circuit before experimenting with a combination of 4 valves. If you have not had a good deal of experience with transmitters, you would find it very difficult indeed to secure satisfactory results with a circuit connected up on the principle of your sketch. A simple circuit is shown in Fig. 6. We recommend you to read "The Wireless Telephone: What it is," by Coursey.

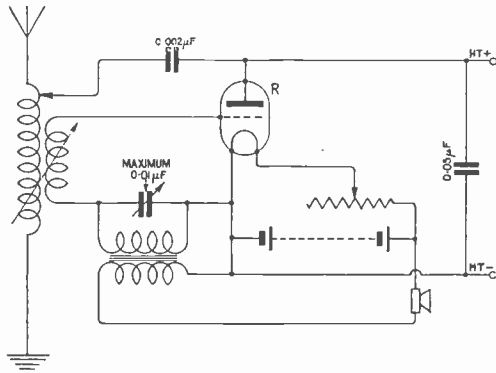

Fig. 6. Low Power Transmitting Circuit. A lead must be taken from LT—to Earth.

"DRAKE" (Bowdon) asks (1) Whether a certain circuit is satisfactory. (2) If, when using a grid condenser, the oscillations actually pass through the dielectric of the condenser so as to affect the potential of the grid. (3) For an opinion on certain methods of connecting up his aerial circuit. (4) For an explanation of Fig. 3, page 679, of the issue nearest August 28th.

(1) Yes, except that only one blocking condenser is necessary in the anode circuit, namely, that across transformer primary and H.T. battery. You will not obtain permission to use reaction of the type suggested. For short wavelengths the A.T.I. should be used in series with the A.T.C. (2) The instantaneous accumulation of a charge on one side of the plates, induces an imposing charge on the other side, thus affecting the potential of the grid. (3) Immaterial which method is employed. (4) The switch described is not a "plug-in" switch at all—it is a two-position throw-over switch. In one position the curved tongues make contact at A and C as shown in the diagram, all three valves then being in circuit. In the other position the left-hand tongue makes contact with B, which is not connected in circuit, and the right hand tongue makes contact with D. This means that the last note magnifying valve is cut out.

"TUNER" (Harlesden) asks (1) For a former to tune from 200/4,000 metres. (2) The capacity of a condenser. (3) At what point in an A.T.I. to revolve a reaction coil. (4) Data for reaction coil.

(1) Your former $8\frac{1}{2}'' \times 6\frac{1}{2}''$ will do if wound with about No. 26 wire. (2) Capacity will be about 0.0004 mfd. (3) and (4) Reaction of this type is no longer allowed owing to the fact that it is liable to give serious radiation from the aerial.

"SCAMP" (Finchley) asks (1) Whether a galvanised iron tank, $18'' \times 18'' \times 30''$, buried in wet clay, will make a good earth. (2) Whether a parallel aerial 50 ft. away will have any effect on his. (3) If a Brown microphone amplifier will make comfortably loud signals in a telephone sufficient for a loud speaker. (4) Explanation of a freak tuning effect.

(1) This should be very good indeed. (2) You are unlikely to be able to detect any difference from the presence of this aerial. (3) Hardly; in order to get sufficient strength for really satisfactory loud speech the signals before passing through the microphone amplifier would have to be rather uncomfortably strong. (4) As you say nothing about the nature of your set, it is rather difficult for us to explain this, but the effect is probably due to capacity reaction introduced via the head telephones and your body.

"L.R.T." (Merthyr Tydfil).—(1) The circuit submitted is quite correct, except that a ratio of 1/5 is rather large for an intervalve transformer. You will probably find that about 1/3 is about as large as you can efficiently employ. Also your anode resistance should preferably be considerably higher than 10,000 ohms. Also reaction of the type shown leads to pernicious re-radiation, and will be a continual source of annoyance to your neighbours. (2) You should certainly hear FL, 2MT should be possible, but we very much doubt whether you will get PCGG satisfactorily.

"H.H." (Blackheath).—We regret that we do not possess enough information to allow us to predict windings for a transformer of arbitrary form for special wavelengths as requested. The only satisfactory way of dealing with a problem like this is to make up specimens with different amounts of wire, testing for the points of best amplification, and adjusting accordingly.

"H.J.T." (Cornwall).—(1) We suggest you use the "light red" (No. 38 S.S.C.) wire for the plug in transformer, and wind the former full. If the two windings are wound on in the same direction, the outside primary wire is connected with the plate, and the inside secondary wire is joined to the grid. We cannot give you the exact number of turns, and you will have to find by experiment the most suitable value. We recommend the adoption of resistance-capacity H.F. amplification for wavelengths exceeding 1,800 metres.

(2) We consider No. 30 wire is unsuitable for winding your variometer. We suggest you use No. 22 S.W.G. The variometer is too small to cover the wave range you mention, and the design is such that the winding will possess considerable self-capacity. It would be better if you constructed special short wave coils for the broadcast wavelengths. Use the 0.001 mfd. condenser in series with the aerial. Wind a coil 3" diameter with No. 20, and take tapings at 9, 18, 27, 36, 45, 54, 63, 72, and 81 turns. To tune up to 2,600 metres, add a loading coil in series with the above coil and connect the tuning condenser in parallel. The loading coil may be $5'' \times 5''$ of No. 24, with three or four tapings. (3) A full description of an Armstrong Super-Regenerative Receiver appeared in 21st October and also many back issues.

"D.G.M." (Norwich) asks questions about the Broadcast Receiver described in the issues of August 26th and September 2nd.

We suggest you use the fixed coil as the aerial inductance and the movable as the closed circuit, and do not use a reaction coil, as one is not necessary with this set. See Fig. 7. The maximum value of the A.T.C. may be 0.0015 mfd. We think the circuit will be approved by the Post Office. See the notice at the head of these columns. We cannot undertake to advise you about patents.

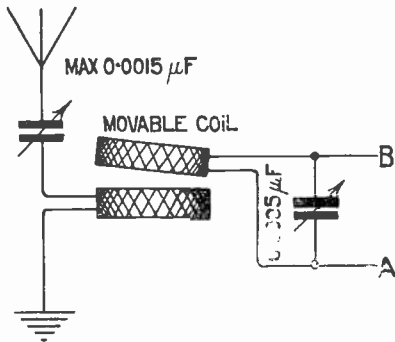

Fig. 7.

"B.Q." (Guensey).—We suggest you employ plug-in H.F. transformers up to 2,000 metres, and above this wavelength use resistance capacity. You may, of course, use one former with a number of slots, and take tappings from the primary winding as you suggest. The windings will have to be determined experimentally, but there is a lot of useful information in the articles to which you refer. (2) The ends of the L.F. transformer should be connected as follows:—O.P. to plate; I.P. to +H.T.; O.S. to -L.T.; I.S. to grid. The sample of wire has not come to hand, and we suggest you make the intervalve transformer described in the issue of August 19th, 1922. You can try earthing the cores of the L.F. transformers, and notice whether any improvement results. The cores are sometimes connected to the +H.T. (3) The range of the set will be greatly increased, and you should receive the Dutch concert with comfort. We cannot say why you do not get better results from the Brown amplifier, as you do not give sufficient particulars. However, as you say, the amplifier may require adjusting.

"VACUUM" (Calcutta) asks (1) Which of various possible arrangements will be best for aerial. (2) If it crosses the telephone wires, how high above the wires it should be at the point of crossing. (3) If the sanction of the G.P.O. would have to be obtained for taking an aerial across telephone wires.

(1) The aerial crossing telephone wires would be somewhat the better, but the difference in efficiency is not sufficient to make it essential that you should do this. (2) The wires should not cross within 5 ft. of the telephone wires. (3) We do not know whether you are legally bound to obtain the Post Office sanction to cross their wires on your own ground, but we should advise you to refer to them before doing so.

"M.E.S." (Yorks).—The values of the condensers are:—A.T.C., maximum 0.001 mfd.; C.C.C., maximum 0.0005 mfd.; H.F. transformer tuning condenser, maximum 0.0002 mfd.; Grid condenser, fixed 0.0003 mfd.; By-pass condenser, fixed 0.001 mfd.; Telephone blocking condenser, fixed 0.002 mfd.; H.T. By-pass condenser, fixed from 0.001 mfd. to 0.5 mfd. Usual valve 0.05 mfd. We suggest you wind the A.T.I. on a former 3" diameter 4" long, full of No. 22 D.C.C., taking off tappings. The secondary may consist of a coil 2½" diameter, 4" long, full of No. 26 D.C.C. with 5 tappings. The H.F. transformer may consist of a tube of ebonite 1½" diameter upon which is wound 450 turns of No. 38 S.S.C. for the primary, and the same number of turns for the secondary. The reaction may consist of 100 turns of No. 38 S.S.C. We suggest you see the articles on "Experimental Station Design," which appeared in the issues of September 2nd and 16th. The batteries and the diagram to which you refer are joined up correctly. Before constructing the set, we suggest you read the articles on "Experimental Station Design," which appear in alternate issues.

"A.E.B." (Catford).—(1) The A.T.I. may be of the single layer type, and we suggest you wind a former 6" diameter and 8" long full of No. 24 D.C.C., taking fifteen tappings. Alternatively you could find a number of basket coils and connect them in series. The reaction coil may be a coil 4" diameter and 8" long of No. 28 D.C.C. with eight tappings. (2) The variable condensers should have a maximum capacity of 0.001 mfd. Using plates and spacing washers of the size submitted, you will require 28 fixed and 27 moving. (3) The grid condenser of 0.0008 mfd. should consist of three plates, with an overlap of 1" × 1¼". No. 2 condenser, 0.004 mfd., should consist of nine plates with an overlap of 1" × 1¼". No. 3 condenser, 0.002 mfd., should consist of five plates with an overlap of 1" × 1¼". (4) We think you will be unable to make resistances of 50,000 ohms, and 5 megohms, which would remain constant in value. As they can be purchased for quite a small sum, we suggest you abandon the idea of constructing them. The grid condenser to which you refer should be 0.0008 mfd.

"C.S.A." (Aberystwyth).—(1) Circuit is quite satisfactory for a simple set. If, however, the crystal is carborundum, a potentiometer will considerably improve results. (2) The maximum wavelength of the coil suggested will be about 1,200 metres. (3) A slider is not necessary if your aerial tuning condenser is continuously variable. Always use as much A.T.I. and as little A.T.C. as possible at each wavelength.

SHARE MARKET REPORT.

Prices as we go to press on October 20th are:—

Marconi Ordinary	£2	8	0
.. Preference	2	3	1½
.. Inter. Marine	1	7	6
.. Canadian	10	3	

Radio Corporation of America:—

Ordinary	1	1	2¼
Preference	14	9	

ORA

The Valve for perfect reception

For receiving vocal and instrumental items you must have Mullard "ORA" Valves to get the best results.

Oscillates—Rectifies—Amplifies

Specially recommended where good detection and amplification are required.

15/- each

IMPORTANT NOTICE.
The great demand for Mullard "ORA" valves and other accessories has compelled us to open much larger works.

The "ORA" Valve requires about 3·8 volts on the filament and 30 volts or over between the anode and filament for efficient results.

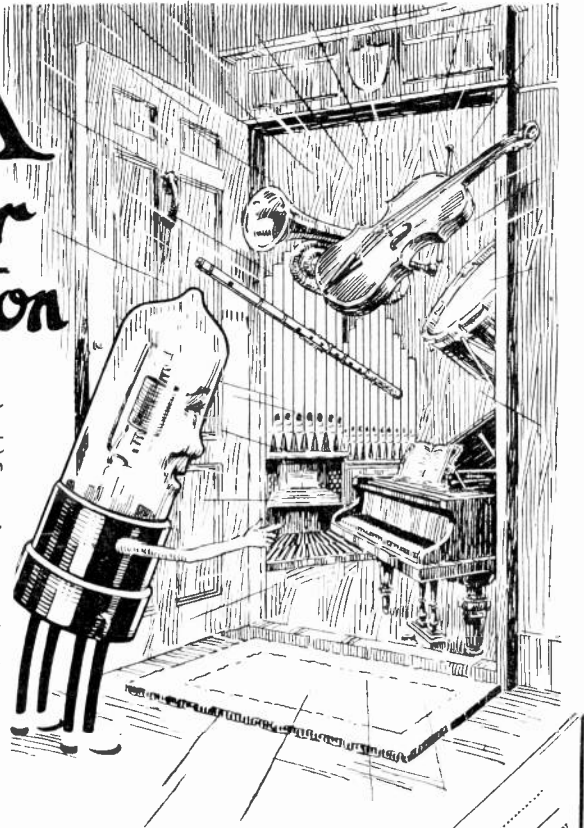

Mullard Radio Valve Co. Ltd.

45, Nightingale Lane, S.W.12.

Contractors to H.M. Admiralty,
(Signal School, Portsmouth),
War Office, Royal Air Force & Post Office.

Telephone: Codes: Telegrams:
Hattersea 1008 ABC(5 Ed) "Radiovalve Hammer" London Bentley 5



Name and Address.....
To the MULLARD RADIO VALVE CO., LTD.,
45, Nightingale Lane,
London, S.W.12.

Please send me post free:-

Quantity.	Description and Price.
.....	Telephone Head Sets 30/- Per set
.....	"ORA" Valves 15/- each
.....	Grid A Resistances 5/- each
.....	Anode A or B Resistances 5/- each
.....	BA Condensers 0003 mid. 2/6 each
.....	Combined Resistances and Condensers with Valve Bases with Terminals 7/6 each
.....	Valve Sockets 5/- each
.....	Terminal Clips 1/6 each
.....	9d. per pair

I enclose (Cheque, Money Order, P.O.) value to cover the cost.

Name of usual Wireless Dealer:

SEND THIS TO-DAY

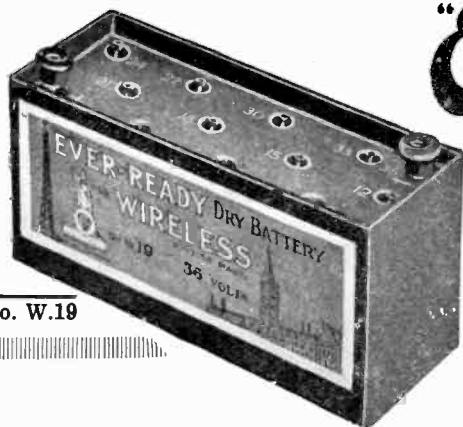

No. W.19

Ever-Ready
British Made

DRY CELLS and BATTERIES for High & Low Tension

THE STANDARD OF QUALITY



U.W.1

HIGH TENSION BATTERIES

Any size or voltage with any tappings or sockets at 3 or 6 volt intervals for use with Wander Plugs can be supplied to order

With 13 sockets as illustrated.

No. W.19, 36 volts, 24 cells, 8/6 each. Size 6 1/2 x 2 1/2 x 3 1/2.

Weight 2 lb. 8 ozs.

Wander Plugs 1/- per pair. With 2 Spring Contacts.

No. W.II, 15 volts, 11 cells, 3/6 each. Size 9 1/2 x 2 x 2 1/2.

Weight 1 lb. 2 1/2 ozs.

THE UNIT DRY CELL

"Build up your batteries as you build up your Marconi Sets."

Unlimited flexibility in size, voltage and intermediate tappings. Each cell is fitted with brass screw terminal and looped wire, and they are efficiently insulated to prevent current leak.

No. U.W. 1, 7/6 per dozen. E.M.F. 1 1/2 volts. Weight 3 1/2 ozs. Dimensions 2 1/2 x 1 5/16 diam.

Art Catalogue of Standard Sizes and Voltages and list of Accumulators for Valve Filament Supply sent on request. Dept. D.L.

THE EVER-READY WORKS, Hercules Place, Holloway, N. 7.

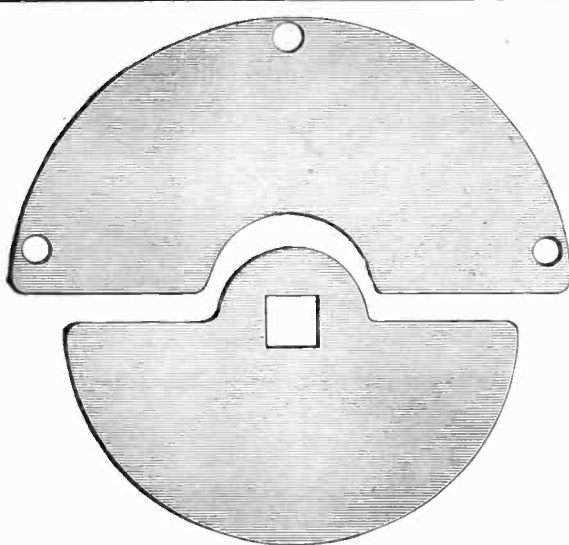

MANUFACTURERS & RETAILERS

apply for Illustrated List
and TRADE TERMS.

KEEN PRICES. PROMPT DELIVERY.

Phone—
Holborn 1812 **ORMOND ENGINEERING CO., 199, Pentonville Rd., King's Cross, N.1.**

STEVENS'S AUCTION ROOMS, Ltd.

(ESTABLISHED 1760)

An Important Sale of Ex-Government WIRELESS APPARATUS, including:

BROWN'S HEAD TELEPHONES Reed Type, 120 and 8,000 ohms, in new condition, C. MARK III 3-VALVE AMPLIFIERS (low frequency) in new condition, NEW MARK III TUNERS, MARK III C.W. TRANSMITTERS and RECEIVERS, B. MARK II 2-VALVE DETECTOR AMPLIFIERS, 50 WATT SPARK TRENCH SETS for Receiving and Transmitting, Valve Boxes, Teak Instrument Cases, a quantity of 13 ft. masts and a large quantity of Miscellaneous WIRELESS GEAR.

STEVENS'S AUCTION ROOMS, Ltd.

will sell the above by Auction at their Great Rooms,

38, King St., Covent Garden, W.C.2
Thursday, 2nd November, 1922, at 12.30 o'clock precisely.

On View Wednesday afternoon from 12.30 to 5.30 and on morning of Sale from 9.30 till 12 o'clock.

Telephone—1824 GERRARD.

Telegrams—"Auks, Rand, London."

FOR THE FINEST RANGE OF WIRELESS SUPPLIES

and **Complete Panels** for Crystal or Valves, you cannot do better than consult our catalogue.

We also manufacture Wireless Wires and Cables. Special Terms on receipt of Trade Card.

For the Amateur who desires to make up his own Panel, all parts are fully illustrated and listed.

To the purchaser of the complete Receiving Set our prices will be found most favourable.

CATALOGUE A/23 on request. Enclose Business Card for Trade Terms.



W. & G. Loud Speaker. Superior to those sold at double the price. 38/-

Ward & Goldstone
PENDLETON MANCHESTER LTD

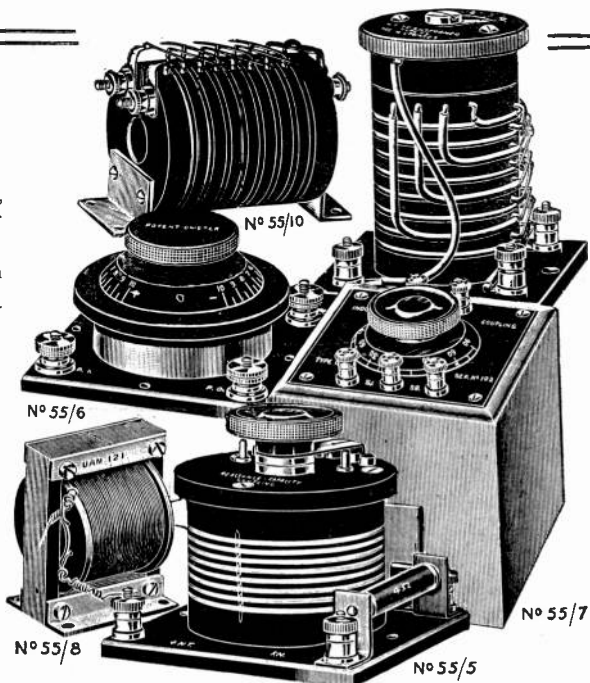

EXHIBITION PUZZLE.

(money refunded on first order of 2/6) and see if you can recognise our manufactures. We give BEST INSTRUMENT FINISH ON ALL OUR GOODS. TRADE ENQUIRIES INVITED.

FOR T(OP) V(ALUE) WRITE TO T(HAMES) V(ALLEY) Wireless & Electrical Supplies
 PHONE MOLESEY 279, WIRELESS DEPT. LATIMER ROAD WORKS, TEDDINGTON, MIDDLESEX.

IF YOU DID NOT SEE OUR STAND you probably have seen some of our Components and Accessories. Send 3d, in stamps for illustrated list

**THE
 PARAGON RUBBER MANUFACTURING CO.
 SCULCOATES, HULL. LTD.**

E BONITE Sheet, Rod & Tube ELECTRICAL MOULDINGS	WIRELESS KNOBS, LOUD SPEAKERS SLIDERS, Etc.
--	--

Wholesale only.

London Office: **PERCY W. C. TRICK,**
 20, LITTLE PORTLAND STREET, W.1
 Telephone: MUSEUM 2043.



SKINDERVIKEN BUTTON.

A Supersensitive Microphone.
 Known all over the world and patented in every civilised country. Over 60,000 sold. ENGLISH Manufacture.
 Make up your own Loud Speaker.
 Transmit your GRAMOPHONE music to any room in your house.

The only practical Microphone for use in Detectiphone Sets.

Price 5/- each

Special Low Resistance Receivers (for use with Skinderviken Buttons) 10/- each
 Special Gramophone Attachments 1/-
 Write for 16 page BOOKLET fully illustrated and containing much useful information for all interested in Electrical Sound Transmission. 8d. Post free.
Sole Proprietors:
MIKRO LTD., 274/6, Pentonville Rd., London, N.1
 (Opp. King's Cross (Met.) Rly. Station).

SPEARS and COMPANY
 FOR
TERMINALS

SCREWS, NUTS, WASHERS, PLUGS and SOCKETS, CONTACT STUDS, BUSHES, VALVE LEGS, CONDENSER VANES and TURNED and PRESSED PARTS OF EVERY DESCRIPTION.

Actual Manufacturers to TRADE ONLY

We regret we cannot supply small lots to Amateurs.
 Write for Illustrated List.
CAPSTAN REPETITION WORKS,
 PARK ROAD, HOCKLEY, BIRMINGHAM
 Telephone: 3265 Central. Telegrams: "Firettes," Birmingham



**TUBE, SHEET,
 WIRE, STRIP,
 ROD & CASTINGS**

IN
**PHOSPHOR BRONZE,
 COPPER, BRASS, &c., &c.**

**CHARLES CLIFFORD & SON, LTD.,
 BIRMINGHAM.**

W. A. C. SMITH
 236, Argyle Street,
GLASGOW,
 are Sole Scottish Agents for the
Famous Burndept Receivers

F. WIGGINS & SONS
 Telephone: Avenue 2248
MICA
 Largest Stock in the World.
**FOR CONDENSERS
 AND ALL PURPOSES.**
 102, 103 & 104, Minories, London, E.1

THE WIRELESS AGE
 THE AMERICAN MONTHLY JOURNAL OF
 WIRELESS TELEGRAPHY AND TELEPHONY
 A "Go-a-head" Magazine for Operators and Amateurs.

Sole European Agents: **THE WIRELESS PRESS LTD.,** 12-13 Henrietta St., Strand, London, W.C.2



PAN PLAYED ON A REED

WHY? Because in the days when man covered himself with the skins of wild beasts, he had no manufacturing facilities; when he wanted music the easiest thing to do was to meander down to the edge of a swamp, cut a reed and make a pipe to play upon.

But as civilisation progressed, man soon found that his reed failed him—he got out of order, the weather affected it, too many delicate adjustments were needed to get results. Then some bright inventive genius of his period made an instrument that needed no adjustment, and its success established a manufacturing rule that holds good to this present day: "No manufactured article that needs adjustment can be as good as an article built for a specific purpose that does the work it is designed and made for **without adjustment.**"

Now for the most **important announcement** that has ever been made to the British Wireless Trade.

Clear the decks for a new type of—

WIRELESS TELEPHONE HEADSET

The "3 Bee" "**BEST BRITISH BUILT**" Telephone. The Best Wireless Telephone in the world because it is built for wireless work only in a new and modern telephone factory, making **wireless telephones only.**

Get this fact firmly fixed in your mind. There is but **one** best, the "Best by Test," the "3 Bee" Telephone. America, the home of wireless, has proven that telephones of this type are the world's best by selling over 500,000 pairs of similar design in competition with telephones from all parts of the world, and these sales were made at the highest retail selling price of any telephone on the market because discriminating buyers were prepared to pay the **best** price for the **best** telephone.

Every pair of telephones bought from us are guaranteed not only to give perfect satisfaction under our money back guarantee, but in addition we guarantee them to be brand new, of British manufacture throughout. You don't need to worry about Government Surplus Disposal Board bargains, paper fittings, re-conditioned makeshifts or rewound ordinary telephones when buying a "3 Bee" Telephone.

Now we are going to prove to you that these Telephones are the world's best.

£100 in Prizes	(1st Prize	£75 0 0
	2nd	,,	£15 0 0
	3rd	,,	£10 0 0

to be divided among buyer of "3 Bee" Telephones, who send to us the most original application of a "3 Bee" Telephone Receiver, for a loud speaker, or other new device.

British Radio
8-9, STEPHENS BLDGS., GRESSE ST.,

With every pair of "3 Bee" telephones we are enclosing a certificate which entitles the buyer to submit to us a design involving the use of our telephone Receiver in experimental work. Clever amateurs, now that they can purchase a type of telephone which can be used in a loud speaker, etc., will, no doubt, work out many simple and novel methods and ways of using this wonderful instrument. Contest closes January 30th, 1923, so if you have a winning idea, write to-day for a set of these telephones and get busy. Everyone can always use an extra headset, and our money back guarantee protects you as we guarantee these telephones to be the world's best, especially on speech and music.

Read what *The Radio News*, October Number, of America, says about telephones. The editor of this journal knows.

"We venture the opinion that the size of most of the telephone diaphragms used to-day is much too small. It has been found in actual practice that a telephone receiver with a diaphragm from 2 ins. to 2½ ins. in diameter gives the best results. While it is true that the telephone receiver having a diaphragm of about 1½ ins. will, in some cases, give a louder sound, it is also, as a rule, much shriller, and does not reproduce the human voice, band, concerts, etc., as well as a larger diaphragm. Always remember that for broadcasting work a diaphragm is not only called upon to reproduce the human voice, but musical instruments as well. We are of the opinion that a small diaphragm cannot do this."

Don't buy a telephone without looking at the inside. Buy on specifications only. Read the following specifications and judge for yourselves.

Headpiece.—American type, self-adjusting. Holds ear pieces in proper position. Easy to wear and most comfortable made. Lightest in weight. Ear pieces may be easily detached so that two persons may hear with one set.

Telephone Receivers.—Built upon a new basic principle of transmitting and amplifying sound; similar in construction to the sound box of a gramophone. Clear round tonal value sounds. In many cases users find the increase in tone equals an extra valve on the receiving set. For crystal sets they pick up the faintest sounds and enable quick, sure tuning in. No metal diaphragm, so sweating ear pieces cannot cause corrosion. Nothing to rust. Sounds concentrated to centre of ears, where they should come. Proof against demagnetisation. Light in weight. Fit the ears so that all outside noises are eliminated. Perfect fit and finish; manufactured from the best of materials, and top of the market grade in every respect. Clarity and sensitivity cannot be equalled by any other type. No shorting nor loss of magnetic strength. 2½ in. diaphragm wound so as to be suitable for both high and low resistance. Works equally well upon both.

Retail Selling Prices including headpiece, cord, etc., ready for use.‡

Type	1	25/-
"	2	42/-
"	3	48/-
"	4	84/-

Notice to manufacturers, dealers and agents. Write to-day for samples and the most liberal discounts in the trade. We are now ready to supply your wants. Quick deliveries.

Our New 16-Page Catalogue of all Wireless Supplies sent free upon request.



Sales Co., Ltd.
RATHBONE PLACE, LONDON, W.1

"RADIO-WAVE" CRYSTAL BROADCAST RECEIVER.

This Broadcast Receiver conforms to the Post Office Regulations for Broadcast Receiving apparatus. There are many receivers being offered to the public which do not conform to these requirements and broadcast licence holders may later experience the annoyance of having them condemned by the Post Office Inspectors. Apart from this there are other reasons why you should not hesitate to fix your choice on the "Radio Wave" Crystal Broadcast Receiver.

- (1) You will not be confined to the reception of Broadcast. Amateur telephony and morse code messages from ships may be tuned in.
- (2) The short wave switch gives **ULTRA EFFICIENCY** on amateur wavelengths.
- (3) The twelve-point inductance switch gives 100 per cent. tuning accuracy. The instrument is therefore extremely **SENSITIVE** to the **WEAKEST OF SIGNALS**.
- (4) Only selected Hertzite crystals are used in the detector.
- (5) The detector is robust, comfortable to handle, and easy to adjust, giving every possible point of contact.
- (6) The detector cup may be easily removed—facilitating rapid replacements.
- (7) Owing to the special care taken in the construction to avoid electrical leakage this instrument should give a slightly larger signal range than the average crystal receiver.
- (8) It is a well made handsome apparatus, metal parts being highly polished and lacquered, and the cabinet work French polished mahogany.
- (9) It is sent out with full instructions, under guarantee.

Price, including cost of aerial wire, insulators, 4,000 ohms resistance headphones, with two earpieces, **£10 10.**

MADE BY:

THE MEDICAL SUPPLY ASSOCIATION, Ltd.
167/185 Gray's Inn Road, London, W.C.1. Works: London & Sheffield.

Telephones: MUSEUM 7210, 7211, 7212.



An ASHDOWN Condenser is GOOD

If it's an ASHDOWN Condenser it's the best—the name guarantees it. No other is exactly like it, nor quite so good, while the ASHDOWN actually costs less than many inferior makes. Design, workmanship, and efficiency are all that can be desired. Get the ASHDOWN and save disappointment—but it must be an ASHDOWN.

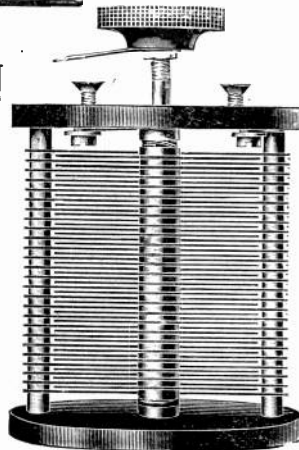

PRICES: Vernier Condensers, 5/9, Variable Condensers, '0003, 11/6; '0005, 14/-; '001, 19/6; '0015, 23/-; Mounted in polished teak and mahogany boxes, with scale, 8/9, 15/-, 18/-, 24/-, and 28/6 respectively. Including Ebonite Dials.

Stocks held by London Rep.: Mr. J. O. MADDOCK,
11, Bayham Road, Bedford Park, W.4.

H. E. ASHDOWN (Birmingham) Ltd.
Perry Barr ————— Birmingham

'Phone: Northern 859. Tel.: Segment.
Code: A.B.C., 5.h Edition, Western.

The Holborn Radio Co.

8, HIGH HOLBORN, LONDON, W.C.1

Offer the following Special Lines.

Headphones, 4,000 ohms double Headpieces	24/6
Headphones, 8,000 ohms double Headpieces	26/6
Valve Detector Panel complete in mahogany	
Case, best finish	28/6
Set of Parts with drilled panel and instructions	
for assembling above Detector Panel . .	14/9
Cabinet to fit	3/6
Amplifying Panel complete in mahogany case	42/-
Condenser, '0005, in mahogany case . .	20/-
" " for panel mounting . .	14/6
" " ready to assemble . .	8/9
Crystal Set complete with Headphones,	
Aerial Wire, Insulators, Earth Wire, etc.	65/-

PRICE LIST POST FREE. Postage extra.

If you are in trouble with your set call and see our technical adviser. Expert advice gratis.
All orders dispatched same day as received.

THE HOLBORN RADIO CO.
8, High Holborn, London, W.C.1

Telephone: Chancery 7278. (5 Doors from Gray's Inn Rd.)

The Tingey Self-Contained Cabinet Set

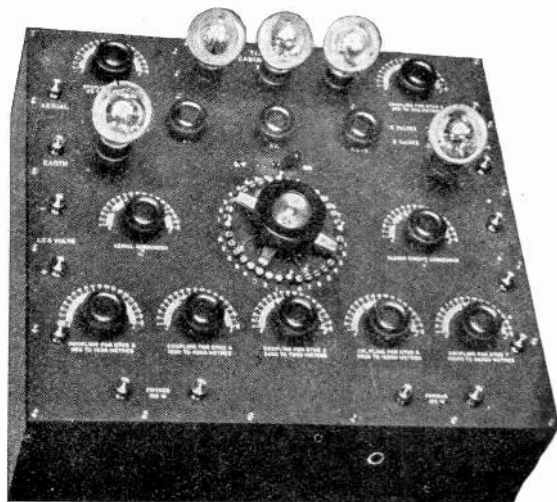

(REGISTERED DESIGN)

All Tingey Valve Apparatus is duly licensed under Marconi Patents for Amateur use in Great Britain.

This is the last word in Self-Contained Sets.

It is only necessary to attach Earth, Aerial, 6-volt Accumulator and Telephones or Loud Speaker to obtain loud clear signals or speech, on any wavelength. No Inductances are Tapped, entirely separate coils employed for each range of wavelengths, thus making the set particularly efficient on short waves.

IMPORTANT NOTICE.

This Set conforms to all requirements of the Postmaster-General.

W. R. H. TINGEY

SPECIALIST IN WIRELESS,
92 Queen St., Hammersmith, London, W.6

Telephone—HAMMERSMITH 1916.

Telegram—"TINGOIDAR, LONDON."

THROUGH THEIR EFFICIENCY, THESE TRANSFORMERS, HIGH AND LOW, HAVE EARNED A REPUTATION FOR THEMSELVES, AND ARE NOW IN LARGE DEMAND BY EVERY CLASS OF USER--

ASK YOUR DEALER FOR--

GENTS' "TANGENT"

L.F.

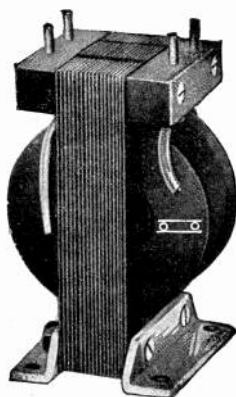

The "TANGENT" L.F. Transformer.

PRICE 22/6 each.

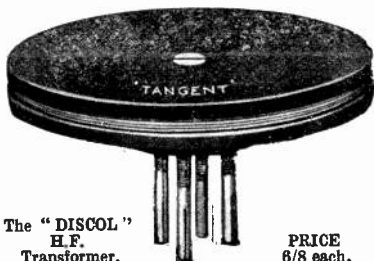

The "DISCOL" H.F. Transformer.

PRICE 6/8 each.

TRANSFORMER AND GENTS' "DISCOL" H.F. TRANSFORMER.

GENT & Co. Ltd., FARADAY WORKS, LEICESTER.

LONDON:—25 VICTORIA ST., S.W.1.
NEWCASTLE-ON-TYNE:—"TANGENT HOUSE," BLACKETT ST.

HERE WE ARE AGAIN



A new illustration is being made, this illustration not giving a true representation of the swivel, a remarkable feature of our 'phones.

Special offer Prices—

140 ohm	23/6
4,000 ohm	25/-
8,000 ohm	27/6

The hundreds of letters which we are receiving from our customers praising our 'phones prove beyond doubt that they are the finest on the market irrespective of the low price. A full description of these 'phones is given in our **CATALOGUES 4d. Post free.** Will any customer not entirely satisfied with his 'phones kindly return same, when we will refund his cash.

SOLID MAHOGANY * CABINETS. Complete with Ebonite Panels.

We pride ourselves upon our cabinet work. No cabinet is allowed to leave our works unless both the wood-work and French Polish are perfect.

The following types and sizes are standard. We shall be pleased to quote for other sizes in not less than half-dozen lots:—

Type A 1, length 7" width 5" depth 2"	each	8/6
Type A 2, length 9" width 5½" depth 5"	each	12/6
Type A 3, length 9½" width 6" depth 3½"	each	13/6
Type A 4, length 13" width 9" depth 4½"	each	20/-
Type B 1, length 7", width at base 9" height 14"	each	22/-
Type B 2, length 16½" width at base 9" height 14"	each	32/-

Measurements are approximate.

Please remit ample postage. Balance will be returned.

Wholesale Distributing Agents for Scotland, J. Corston Sinclair & Co., 47, Waterloo St., Glasgow.

Retail Agents:—Bolton—McLeod Bros., 189, Blackburn Rd. Bury—Bennett & Co., 12, Union Sq. Warrington—Economic Electric Co., 64 & 66, Sankey Street. Bradford—The Gramophone Stores, 150, Bowling Old Lane.

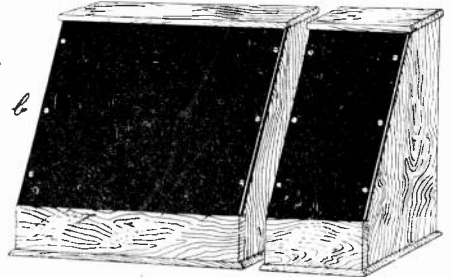
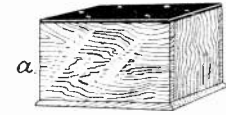

Please note new address:

J. L. CARTWRIGHT & CO. Manufacturing Electrical and Radio Engineers 24, London Road, Manchester

*Phone No.: 4209 Central.

Works: Berry Street, London Road, Manchester.

*Grams: "Pladurain," Manchester.

Dept. W.

Code: ABC, 5th Edition.

THE LARGEST STOCK of 4 B.A. TERMINALS IN ENGLAND.



Actual size.

Price, 2/6 per dozen, plated, 3/- brass; 2 B.A. Single, 9d. per dozen. And Ex W.D. Stock at knock-out prices. Wave Metres, Wheatstone Bridges

- Leading-in Tube, ebonite, R.A.F. pattern with brass rod and fittings PRICE 3/8
- Aerial Real Insulators, tested to 25,000 volts PRICE 24d.
- Accumulator Charging Resistances PRICE 25/-
- Universal Tuners. These tuners have been designed to tune in Marconi concerts, broadcasting, and Dutch Concerts, so that a baby can use them. Wavelength range, 300-1,500 metres, with .0005 m.f. condenser, PRICE 7/-
- 4,000 ohm 'phones, new patent 3-magnet type, fitted cords and tags, complete with nickel plated head bands PRICE 35/-
- Transmitting Keys, G.P.O. pattern, fitted platinum contacts PRICE 5/-
- Valve Holders, fitted in solid ebonite, fixing case drilled, fitted with valve earthing clip PRICE 1/6
- Condensers of all types, Marconi, Sullivan and all leading makes.
- New intervalve transformer Ratio 5-1 all fully tested, PRICE 15/-

Postage extra on all the above prices.

The trade supplied. Enquiries solicited.

J. LIPOWSKY, 614, OLD FORD RD. BOW. LONDON, E.3 *Phone: East 3345

REDUCED PRICES FOR VARIABLE CONDENSERS

With ENGRAVED DIALS as illustrated.

.0003	- - -	10/6	each
.0005	- - -	12/6	"
.001	- - -	17/6	"

Post free.

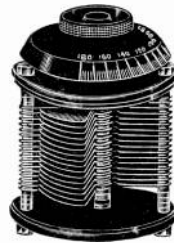

All condensers tested before despatch. State if required for panel mounting or otherwise.

FILAMENT RESISTANCES

FOR PANEL MOUNTING

3/6 each post free



Place your order immediately to avoid disappointment. Orders executed in strict rotation.

The DARTMOUTH MANUFACTURING Co. TRINITY ROAD, WEST BROMWICH.

Wires: Dartmouth Manufacturing W. Bromwich. Phone: W. Bromwich 446

SPECIALITY DESIGNS

Low Frequency Transformers
30/- each

Telephone Transformers, 22/6 ..

Coil Holder for Two Coils,
22/6 ..
(Patent applied for)

Coil Holder for Three Coils,
27/6 ..
(Patent applied for)

High Frequency Transformers
from 5/6 to 10/6 ..

High Frequency Transformers,
Reversible Type, from 7/6 to 12/6 ..
(Prov. Patent)

EFFICIENCY is the essential feature of all our designs and accessories.

We are still able to give immediate delivery of orders booked **NOW**, why not write for details of our stocks.

TRADE TERMS ON APPLICATION

**DUBILIER CONDENSERS
AND SPECIALITIES**

*Appointed agents for Manchester & District
Deliveries can be given ex stock, Manchester*



The Manchester Radio Co., Ltd.

F. H. McCREA, Managing Director
W. R. BURNE, Directing Experimental Department

155, OXFORD RD., MANCHESTER
(Entrance Boundary Street East)

Telephone: Central 4935

ACCESSORIES FOR PRIVATE WIRELESS INSTALLATIONS



**TELEPHONE HEAD SETS
AERIAL WIRE & INSULATORS
PROTECTORS FOR
AERIAL & BATTERY
EARTHING DEVICES
JACKS & PLUGS
H.T. BATTERIES,
ETC. ETC.**

Descriptive pamphlet and prices on application to

THE MANUFACTURERS:

SIEMENS BROTHERS & CO., LTD.
WOOLWICH, LONDON, S.E. 18

Telegrams: SIEMENS, WOOLWICH.

Telephone: CITY 6400.

and at

Belfast, Birmingham, Bristol, Cardiff, Glasgow,
Leeds, Manchester, Newcastle, Sheffield, Southampton.

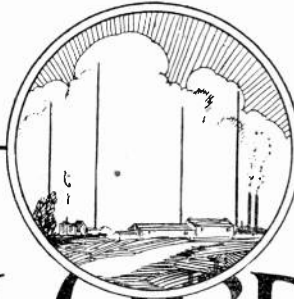

The FELLOCRYST

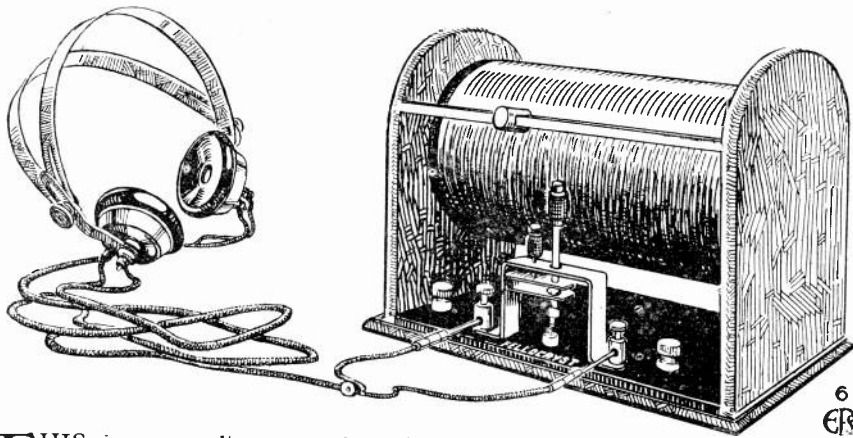

THIS is an excellent crystal receiving set, which gives very good results on all wavelengths from 300-1,500 metres, and is suitable for receiving broadcasting, ships and long distance stations.

The adjustments are simple and easily made, and the silicon crystal detector well maintains its sensitive state. No batteries are required.

The set is sent out complete and includes 100 ft. coil of 7/22 stranded copper aerial wire, 2 shell insulators and one pair 4,000 ohms double headphones.

Every set is tested and guaranteed to receiving broadcasting up to 15 to 20 miles and Morse signals from a much greater distance.

The "FELLOCRYST" is British Made Throughout.

PRICE COMPLETE £3 : 7 : 6 Postage 1/6 extra

Extra 4,000 ohms double headphones 30/- (Postage 1/-)

For they are jolly good Fellows
FELLOWS MAGNETO CO., LTD.,
 LONDON, N.W.10

Telephone : Willesden 1560-1.

Telegrams : Quixmag, Phone, London.

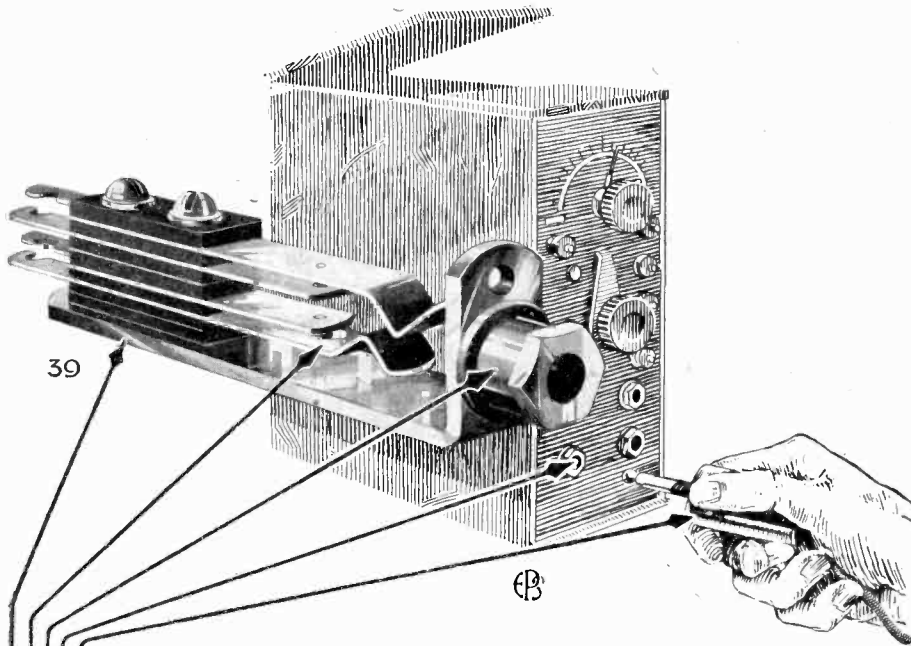

GET THE BEST OUT OF YOUR SET BY USING

THE ELWELL JACK SYSTEM

(a) Any standard telephone plug can be used but preferably the special spiral Elwell plugs which are fitted with self-tightening connection grips.

(b) The Jacks fit neatly on the panel and being heavily nickel plated add considerably to its appearance.

(c) They are easily fixed to any panel up to $\frac{1}{8}$ " thick. No fixing screws are required.

(d) Five types of jacks are available from a simple telephone jack to one controlling telephone, transformer and filament battery.

(e) Insulation tested up to 1900 volts.

Once connected up on the Elwell Jack System your receiving set becomes far more convenient to use both for broadcast reception and for experimental purposes. The following operations become quite automatic:—

1. Filaments switched on.
2. Telephones or loud speaker put across any desired number of valves.
3. Interval transformers disconnected at point of insertion so ensuring maximum efficiency.
4. Only the required number of valves light up. The remainder stay out of circuit.
5. Removing Plug completely switches off set. No errors can afterwards be made in connections or switching. Loose contacts and broken leads are permanently prevented. Comparative tests of telephones and loud speakers can be made with ease and accuracy.

Write for descriptive leaflets.

C. F. ELWELL, LTD., *Radio Engineers,*
CRAVEN HOUSE, KINGSWAY, LONDON, W.C.2

Telephone: REGENT 421.

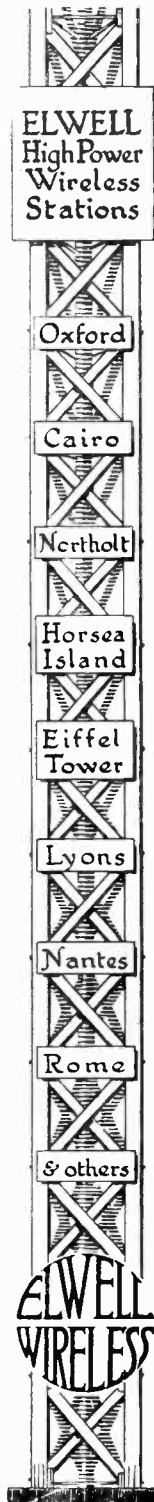

Rapid Engraving on Ebonite

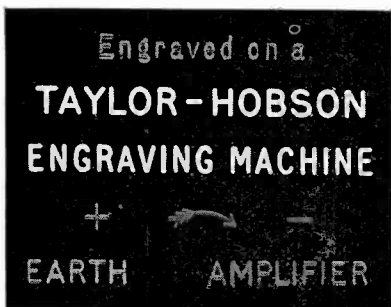

is one feature of the Taylor-Hobson Engraving Machine.

It cuts cleanly on either hard or soft surfaces at a speed which earns it a place in every efficient factory.

Send for our latest catalogue showing reduced prices.

TAYLOR, TAYLOR & HOBSON, LTD

74a, Newman Street, London, W.1

Works: LEICESTER.

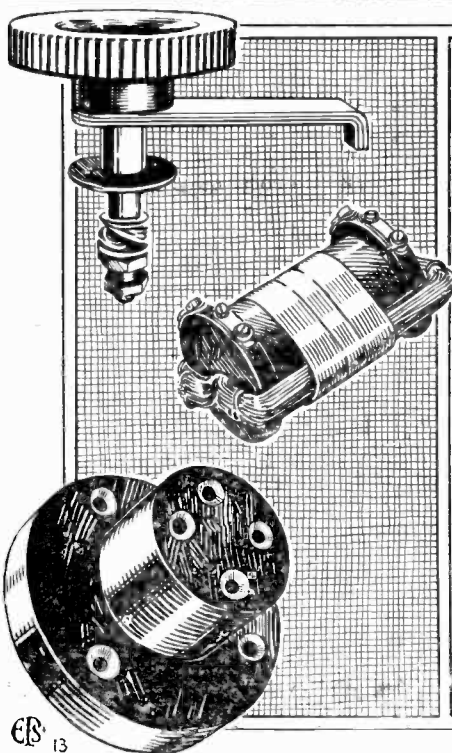

A Complete Line of Wireless Components

We stock a complete line of wireless accessories and the following are a few examples of the good value offered.

Telephone Transformer, as illustrated 15/6 each or mounted in box, with 4 terminals 18/6 each (postage 4d.)

Valve Holders—best quality Ebonite and Brass 1/9 each (postage 3d.)

Switch Arms, as illustrated 3/6 each (postage 4d.)

Ebonite Slabs—best quality, matt or polished 5/- each (postage 6d.) Size 6" x 12" x 1/4" thick.

Send for fully illustrated Catalogue.
You will appreciate the values offered.

For they are jolly good Fellows

FELLOWS MAGNETO CO., LTD.,
LONDON, N.W.10

Telephone: Willesden 1560-1. Telegrams: Quixmag. Phone, London.

VARIOMETERS

IDEAL FOR TELEPHONY TUNING.

AMERICAN Pattern in Selected Beech, wound complete with terminals, can be connected as Reaction and Coupling Coil, optimum Wavelength approx. 200 metres when used as A.T.I., but can be wound to approx. 1300 metres.

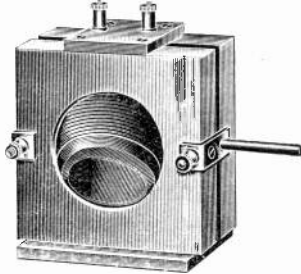

PRICE
18/6
each

Subject to good
TRADE discount.

KNIFE SWITCHES

Double Pole, Double Throw, on Ebonite **2/9** EACH

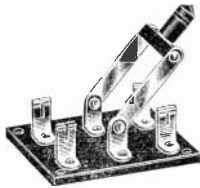

COIL PLUGS

2/- EACH

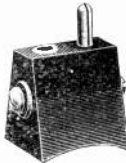

HEADPHONES HIGH QUALITY 22/6 PER PAIR
4000 ohms

ACCUMULATORS

Highest Quality. Lowest Prices.

4 volt, 40 amp., 18/6 6 volt, 40 amp.
4 .. 100 .. 30/- 6 .. 100 ..
+ volt, 24 amp., 11/9

WRITE FOR LISTS. TRADE ENQUIRIES SOLICITED.

F. YATES & Son, Ltd

WHOLESALE ELECTRICIANS.

144, Church St., Kensington, London, W. 8

Phone—Park 4276. One minute from Notting Hill Gate Central London and District Railways.

Econ Manufacturing Company, Ltd.

HAVE REMOVED TO THEIR NEW FACTORY
63a, Paris Garden, Stamford Street,
BLACKFRIARS, S.E.1 Phone Hop 2000

1/6 AERIAL INSULATORS 1/6
EACH Set of 4, 5/6 (postage 1/- extra) EACH

Universally acknowledged at the All-British Wireless Exhibition to be one of the most outstanding exhibits, and to be the most perfect form of Radio Aerial insulator in the world. Adopted by the principal wireless companies. No soldering required. No surface leakage.

Absolutely Weather proof. Can be fixed up in one minute

ECON SINGLE LORGNETTE PHONES,
120, 2,000 or 4,000 ohms - **21/-** each



Can I help you?

I WILL GIVE YOU £50

If I fail to produce over 7,000 testimonials from others I have helped to **A SUCCESSFUL CAREER.**

Yours to success,

Every man is the Architect of his own Fortune!

ARE YOU QUALIFIED? FOR THE JOB YOU SEEK?

WE TEACH
BY POST

ADVICE FREE.
Most modern charges.
PAYABLE MONTHLY.

LEARN A TRADE
OR
PROFESSION.

Write for one of our **FREE BOOKLETS** on any of the following subjects:

Architectural Drawing
Building Construction
Clerk of Works' Duties
Aviation
Boiler Engineering
Boiler Making
Chemistry
Civil Engineering
Concrete and Steel
Draughtsmanship
Electricity
Engineering
Foundry Work
Internal Comb. Engines
Marine Engineering
Mathematics

Matriculation
Metallurgy
Mining
Mine Surveying
Motor Engineering
Naval Architecture
Pattern Making
Salesmanship
Sanitation
Shipbuilding
Structural Engineering
Surveying and Levelling
Telegraphy & Telephony
Wireless Telegraphy
Special Course for
Apprentices

What proof do you carry? Your word to an employer is not proof that you are efficient, but a College Qualifying Diploma or Certificate, signed by the Professional Staff, is a proof of efficiency, and a valuable asset in seeking a remunerative position.

We specialise in all exams connected with technical subjects. If you are preparing for any exam, ask our advice. All particulars **FREE OF CHARGE.** Parents should seek our advice for their sons. If you are interested in any of the subjects mentioned above, write, naming the subject, and we will send you our **FREE BOOKLET**

Please state your age. Courses specially combined to meet all requirements.



GENUINE BARGAINS.

SPECIAL OFFER FOR THIS WEEK.

Moorhead "R" Valves, absolutely new 11/-
Ex-Army Intervalve Transformers 18/6
Ex-Army Telephone Transformers 15/-
Brown's Type "A" Telephones, as New—

H.R. 8,000 w. 40/-
L.R. 120 w. 35/-

We solicit your enquiries for all component parts. Valves are sent at purchaser's risk by registered post. Post paid on all orders over £2.

Visit our new demonstration and show rooms,
321 VAUXHALL BRIDGE ROAD, VICTORIA, S.W.1
Phone—Victoria 5413.

Whale & Co., 201 Powis St., Woolwich, S.E.18
Phone—Woolwich 548.

LESLIE McMICHAEL LTD.

PROVIDENCE PLACE, WEST END LANE, KILBURN, N.W.6

Bus Services 1, 8, 16, 28, 31 all pass West End Lane

Telephone: HAMPSTEAD 1261 Nearest Tube Station: KILBURN PARK (BAKERLOO)

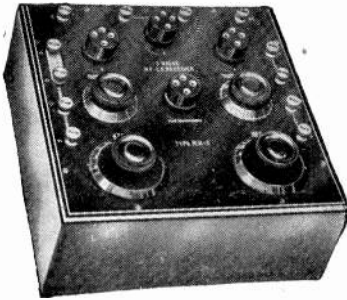

M.H.3 Receiving Set
Price £14 14 0

A Three-Valve Set for Amateurs

The Amateur who, without previous experience, desires to hear Paris and Berlin time signals, and music; the weather reports and speech from Croydon and other air stations; the Marconi, Writtle, and Dutch Concerts will find the M.H.3 an ideal instrument—easy to manipulate and **EXTREMELY EFFICIENT.**

A Three Valve Set making use of high and low frequency with highly polished ebonite panel and mahogany box. (See illustration.)

ACCESSORIES to make a complete station cost about £12.

FOR APPEARANCE } **OUR M.H. SETS**
FOR DESIGN } **(one valve to five valve)**
FOR PERFORMANCE } **are UNEQUALLED**

SEND FOR FULL DETAILS CONTAINED IN
OUR BOOKLET P.M.H. (Fully Illustrated)

32/- per Pair
4000 ohms.

All Resistances in stock.



---CQ Std bi for ERICSSON PHONES

WHEN you install your wireless set—crystal or valve—you'll get maximum results if you fit Ericsson Phones—clarity, sensitivity, strength of signals and absence of "click." Specially suited to telephony Ericsson Phones embody the accumulated experience of telephone manufacture for a generation. Easy to the head, light and comfortable. The magnets never lose their strength and "shorts" are non-existent.

Write for Particulars

The BRITISH L. M. ERICSSON
MANUFACTURING Co., Ltd.

Head Office: 67/73, International
Buildings, Kingsway, W.C.

Ericsson

TELEPHONES

**GENUINE
HELLESEN
DRY BATTERIES**



HIGH TENSION WIRELESS BATTERIES.

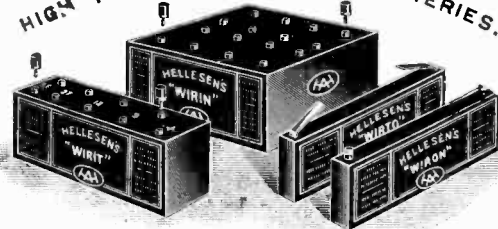

SPECIAL TRADE AND WHOLESALE TERMS

Code word.	Volts.	Details.	Price.
"WIRON"	15	Screw terminals	4/- each
"WIRTO"	15	Strip "	4/- "
"WIRIT"	36	2 insulated wander plugs	8/6 "
"WIRIN"	60	" "	14/- "

Wander Plugs and Terminals are included in the price of the Battery and are NOT AN EXTRA.
KNOWN THE WORLD OVER AS THE BEST.

ALL LISTS FREE ON APPLICATION.

A. H. HUNT, LTD.
H.A.H. Works, Tunstall Rd., Croydon, Surrey

BUTLER'S RELIABLE MANUFACTURES.
SKELETON CONDENSERS AND SETS OF PARTS FOR ASSEMBLING

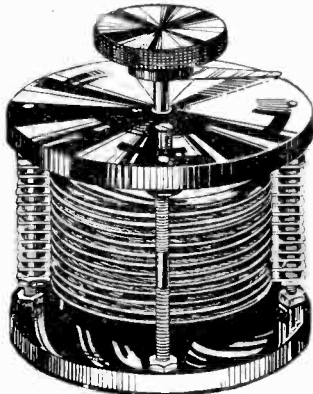

Fig. 37.

	'0002	'0003	'0005	'001	'0115
Skeleton	13/9	16	18/6	25	29/6
Sets of Parts	10/8	12	13/6	17	19/8

IVORINE SCALE 1/- EXTRA.
NEW LIST NOW READY. POST FREE 4d.

H. D. BUTLER & CO., LTD
Office: BANK BUILDINGS, 222, GT. DOVER ST., S.E.1
(Opposite Borough Tube Station)
Works: CANONBURY, LONDON, N.1
Telephone: Hop. 3029. Teleg.: "Ingenuity, Phone, London."

THE MARK OF



RELIABILITY

1 to 12 volts.

1 to 35 amps.

VOLT & AMMETER

Combined Dead Beat Pocket Type. New and not German.
Splendid Instrument in Nickel Plated Case.
Ideal for Testing Cells and Filament Current.

POST PAID **5/6** NUMBER LIMITED

OTHER EXCEPTIONAL VALUES.

- Aerial Wire. Enamelled Hard Drawn, 7/22's Copper, 5/- per 100'.
- Aerial Wire. Bright Hard Drawn, 7/22's Copper, 3/6 per 100'.
- Aerial Insulators. Shell type, 2" x 2 1/4", 9d. each.
- Aerial Insulators. Reel type, 2" diameter, brown, 3d. each.
- Filament Resistances. For panel mounting, 2/6 each.
- H.F. Transformers, plug in type, 300 and 700 metres, 4/- each.
- H.F. Transformers, plug in type, 1,000 m. 4/6; 2,600 m. 5/6 each.
- H.F. Transformers. Formers only, with pins, 3/- each.
- Tangent H.F. Transformers. All ranges, 6/8 each.
- Switch Arms. Complete fitted with knob, 1/- and 2/6 each.
- Dewar Switches. D.P. Change over, panel type, 2/- each.
- Lightning Arresters. Carbon block type, 1/6 each.
- Valve Holders. Flanged "A" type, 1/- Ebonite with 8 nuts, 1/3 each.
- Ebonite Panel, fitted with 3 Valve Holders, complete, 3/2.
- Ebonite Panel, fitted with 2 Valve Holders, complete, 2/3.
- Valve Sockets, per set of 4 with 8 nuts, 7d.
- Transformer Holder. With 4 terminals and wired, 3/6 each.
- High Note Buzzer (Army Type), worth treble, 3/- each.
- Telephone Transformers (Army Type), 9/- each.
- Wireless Jacks, with plug, as illus., page 733, 1/- the pair.
- Brown's Type "A" Headphones. Guaranteed new and unused. 8,000 ohms, 49/6; 120 ohms, 42/6. With cords, 51/8 and 44/6.
- Ever Ready Batteries (all sizes). 16 Volt, 3/6 each.
- Mica. Clear Ruby, .002" thick, 3" x 2", 1/- doz. pieces.
- Inductance Slider Rod, 1/2" square, 13" long, drilled, 6d. each.
- Slider, complete with plunger for 1/2" rod, 6d. each.
- Contact Studs. Fitted with nut and washer, 1/3 doz.
- Condenser Vanes. Best Aluminium, 3 1/2", 1/6 doz. pairs.
- Condenser Spacing Washers. Small, 3d., large 8d. doz.
- Condenser Screwed Rod, Brass 12" long, 1/4" 4d., 3/16" 6d.
- Insulating Tubing. Assorted colours, 6d. per yard.
- Sheet Ebonite, 1/4" to 1/2" thick, 4/6 per lb.
- Terminals. Mark 3 N. Plated, 4 B.A., 2/6 doz.
- Terminals. Small pattern, 9d. doz.
- Dubilier Condensers. All capacities at prices advertised.
- Grid Leaks. All resistances, 2/- and 5/- each.
- Radio Instrument L.F. Transformers, 25/- each.
- Tangent L.F. Transformers, 22/6 each.
- Ivory Scales. 0-180, good quality, 6d. each.
- Ivoryine Tablets. Set of seven, 7d. and 1/-.
- Skinderviken Microphone Buttons, 5/- each.
- Burdopt and De Forest Coils in stock. Advertised prices.
- Potentiometer 300 ohms. Panel type on ebonite, 4/6 each.
- Condenser, 5-Plate. Panel type on ebonite, 4/- each.

Write for Complete Supplementary Price List of Exceptional Values, sent Post Free.

All goods sent CARRIAGE PAID but with orders under 5/6 add 6d. for postage.

J. H. TAYLOR & CO.,
ELECTRICAL AND RADIO ENGINEERS.
Macaulay St., HUDDERSFIELD.
Telephone, 341. Telegrams: "Thorough, Huddersfield."

The ACME PRODUCTION CO. LTD

73, COLESHILL STREET, BIRMINGHAM

Manufacturers of Wireless Apparatus

Telephone 4298

Telegrams—"Maltum," Birmingham

BRITISH MANNESMANN
WELDLESS STEEL TUBULAR

MASTS

FOR

Wireless Aerials.

UNRIVALLED IN STABILITY AND
EFFICIENCY, UNSURPASSED FOR
NEATNESS OF OUTLINE AND
APPEARANCE, ECONOMICAL
IN COST

THE BRITISH MANNESMANN
TUBE COMPANY, LIMITED
NEWPORT (Mon) & LANDORE, S. WALES.

LONDON OFFICE—67, Queen Victoria Street, E.C.4
BRANCH OFFICES—Birmingham, Glasgow, Leeds,
Manchester, Newcastle.

EBONITE

EQUIPMENT

FOR

WIRELESS SETS

SHEETS, KNOBS, COIL
HOLDERS, VALVE HOLDERS,
ENGRAVED DIALS, SOLID
EBONITE HORNS FOR
LOUD SPEAKERS, PANELS

FROM STOCK

HIGHTENSITE LTD.

Normandy St., Custom House, E. 16

Phone: EAST 3153.



The RADCOM UNIT BLOCK ACCUMULATOR

As will be seen from illustration it is a new & novel form of Accumulator, enabling those interested in Wireless to make up, at a very nominal cost, a Battery of almost any voltage. The Unit is 2 Volt, 8 actual Ampere hours

FEATURES.

Being Block type there are no plates to buckle.
Impossibility of internal short-circuit.
Extended Lead Coupling Lugs.

Price - - 3/- per Unit.

POSTAGE 9d.

RADCOM RHEOSTATS, COILS, TUNERS, ACCUMULATORS

Radio
COMPONENTS LTD.

12/13, HENRIETTA STREET,
LONDON, W.C.2.

TELEGRAMS: RADPONENTS, RAND, LONDON,
TELEPHONE: GERRARD 792.

PLEASE NOTE CHANGE OF ADDRESS.

**W. J. HENDERSON,
351 FULHAM ROAD, S.W.10**

(Nearest Stations—Earl's Court or South Kensington.) ('Bus Routes, Nos. 14 & 96 pass the door.) (Two minutes from o'd address.)

SPECIAL OFFERS—SUBJECT UNSOLD.

Items listed below are guaranteed in BRAND NEW condition, in every instance complete, and in perfect working order. (Valves and batteries are not included.)

TRANSMITTERS.

Transmitters, Mk. III*, C.W., for two valves, range 500-2,000 m., easily altered for 440 m. and telephony, complete with C.O. Switch, milliammeter, key, spares, etc., etc. . . . each £8
 Transmitters, C.W. 60 w., comprising inductance 2,000-5,000 m., with tappings to rotary switch, anode tap, reaction coil, and variometer coil, thermal milliammeter, mounted on 1/2" ebonite base carrying key, valveholders, etc., etc. . . . price £4
 Transmitters, spark, "Front" and "Rear," comprising 1" spark coil, key, H.T. condenser, spark gap, etc., etc., each 17/6
 H.T. Units for Tonic Train, input 8-10 v., output up to 1,000 v., complete in case with spares; can be used with any transmitter. . . . each 17/6

RECEIVERS.

Receivers B.Mk.II (Front and Rear), for two valves (one Rect., 1 L.F.), wavelength 65 and 80 metres; easily altered for other wavelengths (see W.W. 10/12/21), complete with intervalve and telephone transformers, each £8 0 0 (if fitted with variable A.T. Condenser, extra 7/6).
 Receivers, Mk. III*, 30 watt, C.W., for two valves (one rect. and one L.F.), wavelength 350-1,800 m., complete ready for use each £8
 This instrument is arranged to interconnect with the Mk. III* Transmitter above, and together form a very useful portable Transmitter and Receiver.

Complete lists on request.

TUNERS.

Tuners, C.W. 60 watt., wavelength 2,000-5,000 m., complete and in case with two .0015 variable condensers, C.O. switch (Std. by and Tune), etc., etc. (see Amplifiers below) . . . each £5
 Tuners, Short Wave, Mk. III* complete in every respect, with spares each £9

AMPLIFIERS.

Amplifiers, C.Mk. IV, 3 valve, H.F., intended for use in conjunction with 60 watt tuner above, but can be altered for use on other wavelengths, complete with three slot-wound H.F. Transformers, potentiometer, filament rheos'a, etc., etc., price each £3
 Amplifiers, C.Mk.IV, 3 valve L.F. (or 1 rectifier and 2 L.F.) complete with telephone transformer, etc., etc. . . . each £8 10s.
 Amplifiers, C.Mk.III, 3 valve, L.F., same components as C.Mk.IV above each £8 10s.

WAVEMETERS.

Heterodyne Wavemeters, calibrated, 500-3,000 m. complete with charts each £4

CONDENSERS.

Condensers, Mk. III Type, complete with bevelled scale and knob, and ebonite case—
 .0015 mfd. each 40/-
 .0003 mfd. each 15/-

Goods above £2 in value carriage paid.

Terms, CASH WITH ORDER.

WARNING

LETTERS PATENT No. 141,344

THE TRADE AND THE PUBLIC ARE WARNED that INDUCTANCE COILS HAVING A CELLULAR STRUCTURE and generally sold as Honeycomb Coils are protected by Letters Patent as above, of which we are the beneficial owners and under which the IGRANIC ELECTRIC COMPANY LIMITED OF BEDFORD ARE THE SOLE LICENSEES in this country.

It having come to our knowledge that there are upon the market coils made in infringement of our patent, WE HEREBY WARN BOTH MAKERS AND USERS OF COILS THAT IT IS OUR INTENTION TO TAKE SUCH ACTION as we may be advised, to RESTRAIN ALL INFRINGERS.

**WESTERN ELECTRIC COMPANY LIMITED,
Norfolk House, Norfolk Street,
Victoria Embankment.**

"Hello CQ!"

**IF YOU WANT SUPER VALUE
CALL OR WRITE TO US AT ONCE.
You should inspect our Stock if possible**

PHONES (Single Earpiece) wound 150 Ohms. L.R., unused ex-Government Stock. Highly sensitive, can be rewound to 4,000 ohms, if required. Price 3/9 each. (Postage 6d.)

FULLERPHONES. Ex-Government, in handsome walnut case. Contents: 2 Earpieces L.R. (can be rewound), 1 Microphone, 2 Dewar Switches (2-way), 1 Buzzer, 1 Tapping Key, 3 Choke Coils, 3-1 M.F. Fixed Condensers, Ebonite Panel and various Terminals, etc. Size of Box approx. 10" x 10" x 7". Cost Government about £10 each. Our price complete, 15/- post free. A splendid investment.

PULLEYS (Aerial). Aluminium with Bronze Bush. R.A.F. Surplus. Look splendid on your aerial. Large size, 3 1/2", 1/8 each, medium, 2 1/4" 1/4, small, 2" 1/2. Post free.

**TRADE SUPPLIED. WE ARE ACTUAL MANUFACTURERS
AND CAN QUOTE KEENLY FOR ANYTHING.**

**National Wireless & Electric Co.,
7, Church Road, Acton, London, W.3.**

THE ZODEL COIL WINDER

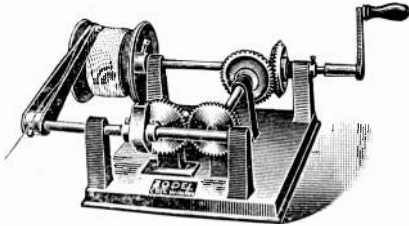

FOR DUO-LATERAL FORM COILS.

Why pay high prices for coils when you can produce the best Duo-Lateral formation type for the mere cost of the Wire?

The Zodel Machine is designed on scientific lines. Built by engineers. So simple that a child can use it. Winds Duo Lateral Coils in a couple of minutes on any former, from 3/16" to 1" wide. The Coils produced have been proved to have the lowest distributed capacity.

CASH PRICE **£2 : 0 : 0** POST PAID

Obtainable from all Wireless Stores or direct from—

WALLACE HEATON, Ltd., RADIO EXPERTS
84, HIGH STREET, SHEFFIELD.

INFORMATION THAT IS VALUABLE TO YOU

IS TO BE FOUND IN EVERY ISSUE OF

"CONQUEST"

The Monthly
Magazine of
Popular Science.

THE WONDERFUL CONTENTS OF THE
NOVEMBER ISSUE
INCLUDE ARTICLE ON

Making the most of your Wireless Receiver—Wireless Notes—Simple Experiments in Science—Painting with Light—Sapphire Mines of Queensland—London Tube Improvements—Useful Hints for the Home—Why Chameleons Change Colour—Talking in the Train—Hints for Guy Fawkes Night—A Scientist's Diary—Novel Ideas of Interest and Utility—Photographic Notes—The Heavens in November, etc.

Copy of Reader's Letter—

A HEADMASTER'S APPRECIATION.

DEAR SIR,

Enclosed please find cheque for 6/- in payment for book, "Magnetism and Electricity for Home Study," which you sent me on approval.

It is a book for which I have been seeking for quite a long time. The lucid way in which the author puts the matter before the reader; the sequence followed (proceeding from the known to the unknown); the numerous analogies and associations with ordinary everyday things, and the excellent sketches and diagrams, together with test questions and summaries make the work admirable for self study or as a book for school use. As a schoolmaster I am using it as a base for the science scheme in my school.

ABUNDANTLY
ILLUSTRATED.

PRICE: **1/-** NET.

Obtainable at all Bookstalls and Newsagents, or Post Free 1/3 from The Publishers, CONQUEST, 12-13, Henrietta St. W.C.2

A big Shillingsworth! Order your copy to-day.

BOOKS FOR THE LIBRARY

CONTINUOUS WAVE WIRELESS TELEGRAPHY. Part I. By W. H. Eccles, D.Sc. Price 25/- net. Post free 25/9. 407 pages. 306 diagrams and illustrations.

THERMIONIC TUBES IN RADIO TELEGRAPHY AND TELEPHONY. By John Scott-Taggart, A.M.A.I.E.E. Price 25/- net. Post free 25/9. 424 pages. 344 diagrams and illustrations.

THE THERMIONIC VALVE and Its Development in Radio Telegraphy and Telephony. By J. A. Fleming, M.A., D.Sc. Price 15/- net. Post free 15/9. 279 pages. 144 diagrams and illustrations.

WIRELESS TELEGRAPHY AND TELEPHONY.—First Principles, Present Practice and Testing. By H. M. Dowsett, M.I.E.E. Price 9/- net. Post free 9/9. 331 pages. 305 diagrams and illustrations.

TELEPHONY WITHOUT WIRES. By Philip R. Coursey, B.Sc. (Ehg.), A.M.I.E.E. Price 15/- net. Post free 15/9. 414 pages. 250 diagrams and illustrations.

STANDARD TABLES AND EQUATIONS IN RADIO TELEGRAPHY. By Bertram Hoyle. Price 9/- net. Post free 9/6. 159 pages.

FIFTY YEARS OF ELECTRICITY—THE MEMORIES OF AN ELECTRICAL ENGINEER. By Dr. J. A. Fleming, M.A., D.Sc., F.R.S. Price 30/- net. Post free 31/- . 371 pages, 111 plates.

THE WIRELESS TELEGRAPHIST'S POCKET BOOK OF NOTES, FORMULAE AND CALCULATIONS. By J. A. Fleming, M.A., D.Sc. Price 9/- net. Post free 4/6. 352 pages. 39 diagrams and illustrations.

T.S.F. LA TÉLÉGRAPHIE SANS FIL. LA TÉLÉPHONIE SANS FIL. By G. E. Petit and Leon Bouthillon. Price 12/6 net. 13/- post free; paper cover, 15/- net. 15/9 post free. Cloth bound. 304 pages, 197 diagrams and illustrations.

PREPARED RADIO MEASUREMENTS WITH SELF-COMPUTING CHARTS. By Ralph R. Batcher, E.E. Price 10/6 net. Post free 10/11. 132 pages.

The Wireless Press Ltd.,

Dept. W.W.

12-13, Henrietta Street, London, W.C.2

The Experimenter's own Tuner

HERE is a particularly efficient Tuning Unit designed for the amateur with an Experimenter's License. Two double pole rotary switches are used for Series-Parallel and for Stand by-Tune. A solid Ebonite three coil Holder, of substantial construction, is supplied ready made. It will take all standard Coils. Range from 180 metres to 26,000 metres with suitable coils—with or without reaction.

27/6

Mahogany Cabinet to fit, 3/6 extra.

Full Sets of parts for assembling this excellent Tuner include : 16 Terminals, 2 Rotary Switches complete with studs and stops, Ebonite Panel drilled and tapped, set of engraved ebonite name plates, complete 3 coil Holder, systoflex tubing and wire. Full instructions for assembling and wiring are included.

Ready assembled, complete with Cabinet, 43/6
Postage 9d. extra in each case.

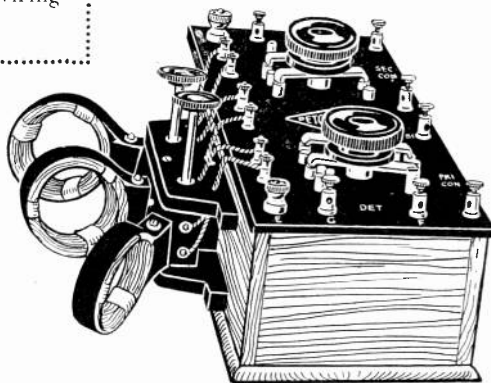

THE PETO SCOTT CO.
FEATHERSTONE HOUSE,
64, HIGH HOLBORN, W.C.1
WORKS: New Southgate & Tottenham, N.

WITH GOOD APPARATUS YOU CAN GET GOOD RESULTS
THE "W.P."

Morse Practice Key

Well Made. First-class Finish. Thoroughly Reliable.

Price **7/6** Post Free

THE WIRELESS PRESS, LTD.
12-13, Henrietta Street, London, W.C.2

Questions and Answers COUPON

To accompany Questions sent in during the week commencing Oct. 28th, 1922.

VOL. XI, NO. 4.

See Conditions on Page 144.



A good judge

of a thoroughly sound book will recommend to every student and experimenter the new edition of "Elementary Text-book on Wireless Vacuum Tubes." This is the 4th edition; it has been thoroughly revised and has been enlarged. It contains pages and pages about the new Armstrong super-regenerative circuits and other new inventions. Major Armstrong himself writes the following introduction to the new edition:

"I have read Mr. Scott-Taggart's book with the greatest of interest. It is a most complete treatise of the vacuum tube art and I recommend it to all students of the subject."

This book was employed by Counsel in recent wireless patent litigation and has commanded respect in every part of the World. It is being translated into foreign languages as it has become an authoritative standard. Beautifully produced, it will be a book to admire as well as to study—and the possession of it will indicate to your friends the level of your attitude towards wireless.

Perhaps we may mention incidentally that it is obtainable from, or through, all wireless dealers and booksellers for the sum of TEN SHILLINGS, or direct from the publishers.

Radio Press Ltd.

DEVEREUX BUILDINGS,
DEVEREUX COURT,
STRAND, LONDON, W.C.2.





Series No. 4

— Makers of over —
Half the World's Telephones.

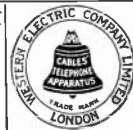

Western Electric

LOW FREQUENCY AMPLIFIER

Supplied in either one or two stages complete
in a compact case of polished mahogany.

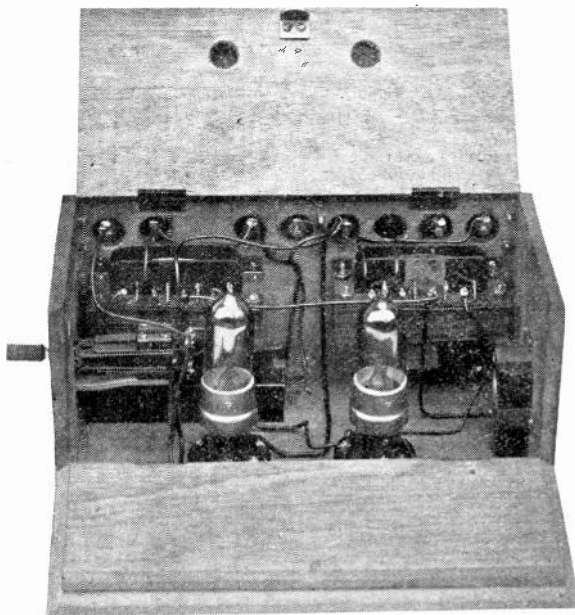

The stages of amplification are controlled by a key fitted at one end of the case. The filament can be seen and inspected through a window in the case and ventilation discs control the temperature of the compartment. Simply designed, this Western Electric Low Frequency Amplifier can be depended upon for unflinching efficiency.

Western Electric Company Limited.

62, Finsbury Pavement, London, E.C.2
Telephone—London Wall 7608

WORKS:—

North Woolwich, London, E.16
Telephone—East 3840 (10 lines)

Also at BEXLEYHEATH, KENT, and NEW SOUTHGATE, N.11

Birmingham—Grnville Buildings, 12, Cherry St.
Leeds—Standard Buildings, City Square.
Cardiff—Motor House Chambers, 1, Wood St.

Manchester—Northern Assurance Buildings.
Newcastle—20 Saville Row.
Glasgow—49, West Campbell Street.

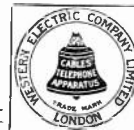
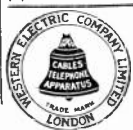

THE WIRELESS WORLD EXCHANGE AND MART

TARIFF. Advertisements are accepted for this Section at the rate of twopence per word, with a minimum charge of two shillings. The advertiser's name and address will be charged for and single letters and single figures will be counted as words. Compound words will be counted as two words.

DEPOSITS. All advertisements must be prepaid in the form of Postal Orders, the remittance being forwarded to Messrs. Bertram Day & Co., Ltd., 9 & 10, Charing Cross, S.W.1.

Intending purchasers may deposit the purchase money of any article advertised or sold by advertisers with Messrs. Bertram Day & Co., Ltd., who will acknowledge its receipt to the vendor and the depositor, the full addresses of whom should be given. Subject to special agreement between the parties, it is understood that all goods are sent on approval, each party paying carriage one way in the event of the goods being returned. The deposit will be retained until due advice of the completion of the purchase has been given or until the articles have been retained and accepted. In order to cover postage, etc., a fee of 6d. in respect of sums of £1 and under, and 1s. for sums in excess of £1, must be paid at the same time as the deposit. For persons not resident in the United Kingdom these fees are doubled. We cannot undertake to receive any deposit less than 2s. 6d.

FOR SALE.

Three-Valve Amplifiers.—L.F., C. Mk. III Brand new. A beautiful panel, four transformers, three intervalve, one telephone. A limited quantity only. £5 15s. each.—GEO. AXE, 52-4, Ben Jonson Road, Stepney, E.1.

Three-Valve Mark C III Amplifier, absolutely new in mahogany case, what offers?—B., 10, Parsifal Road, Hampstead, N.W.6.

C. Mk.2, 3-Valve Amplifier, Including Valves, £5 10s.—A. S. MILLS, 38, Mattison Road, N.4.

Two-Valve High Frequency and Amplifier. H.T. Unit. Accumulators for filament. Aerial coil and tuner, all on board. Aerial. In fact everything complete. £15 or near offer.—JINMAN, The Nook, Byfleet, Surrey.

Burdopt Ultra III Receiver, in use few months. Cost £25. Sale £15. Mark III* Tuner, brand new. £9.—KINGSBURY MOTOR WORKS, St. Albans.

Brown's Microphone Amplifier, 120 ohm. Write DRURY, 13, Otterburn Terrace, Jesmond, Newcastle-on-Tyne.

Mark III* Tuner. Marconi. Perfect condition. Ideal for broadcast and amateur reception. £10.—Box F.6, BERTRAM DAY'S ADVERTISING OFFICES, 9 and 10, Charing Cross, S.W.1.

Accumulators.—Brand new. Lyon and Wrench: 6 volts 140 amps, 99s.; 4 volts 140 amps, 69s. Lucas: 6 volts 210 amps, 120s.; 4 volts 210 amps, 80s.—Sussex Wharf, East Greenwich, S.E.

Brown Phones!! Perfect condition. Only few pairs left. Adjustable diaphragm 8,000, 1,500, 120 ohms. Genuine, 37s. 6d. pair.—L.P., 26, Brockley Grove, S.E.4.

Home Entertainment, Cinema Machines, Real Films, lowest prices. Catalogue free.—KINEMATOGRAPH, 9, Dames Road, Forest Gate.

Mark IV, 3-Valve Detector Amplifier, perfect, £5 5s., also H.F. Panel for above, with P.I. Transformers, 400 and 1,000, £1 1s.—CHAS. CLEMENS, High Street, Pershore.

Aerial Equipment is Useless without Masts. We supply from 1s. 8d. each. Stamp.—Downes, Arthur Street, Derby.

Single Valve Set, mouth old, complete with tuner, 0-001 and 0-005 variable condensers, 4,000 ohm telephones, etc., absolutely complete for receiving, cost £18. Cheap £8. Owner purchased 4-valve.—Box G5, BERTRAM DAY'S ADVERTISING OFFICES, 9, 10, Charing Cross, S.W.1.

B.A. Screws, Nuts and Washers, assorted gross 2s., lists 2d.—J. H. BENNETT, Station Road, Willesden Junction.

Cozwhy Filament Fuses will protect your valves from burn-outs. $\frac{1}{2}$ or $\frac{3}{4}$ amp., 10d. each, 8s. doz. Polished ebonite fuse-holders, plated ph.br. springs, 2s. 6d. each, 11s. set of five. Post free. Cash with order.—BESWINNING'S, 49, Cowley Road, Ilford.

Wireless Masts.—Improved Girder Type. Light and strong. 30 to 50 ft. at 1s. ft., 50 to 100 ft. at 1s. 6d. ft. Cash with order, carriage forward.—F. ARMSTRONG, Weybridge.

Wireless High Tension Battery Cabinet. Simple, economic. Well finished. Seven tapings, 20 to 80 volts.—Particulars, ROWCELL, 28, Rendezvous Street, Folkestone, Kent.

R. Valves 10/- each, £5 per dozen. B Valves 12/- each, £6 per doz n. All new and tested. Post free. B. CALVER, 52, Linver Road, London, S.W.6.

TRADE ENQUIRIES.

Keen Quotations Required for all wireless materials and components necessary for manufacture of sets.—NATIONAL WIRELESS & ELECTRIC Co., 7, Church Road, Acton.

Manufacturers, Lists, samples, and keenest prices required for all wireless supplies, parts, accessories and material. Manufacturer also to quote for very cheap 2,000 ohm single car pieces.—CARTER & Co., Webster Street, Greenheys Manchester.

Designer of Electrical Plant supplies designs or blue prints for wireless sets and motors, etc. Send for quotation. Special experimental designs.—PICKLE, Buckhurst Hill, Essex.

Clearance Sale

To reduce accumulation of stock. Variable condenser, Rotary 0005 mfd. Air Dielectric, Ebonite top in mahogany case, $4\frac{1}{2} \times 4\frac{1}{2} \times 3\frac{1}{2}$, 12/6 each while they last. Number limited. Post 1/-.

FALLON CONDENSER COMPANY,
230a, HERMITAGE ROAD, LONDON, N.4.

Electradix Radios

NOTICE.

9, Colonial Avenue, Minories, E.1.

In order to remove any erroneous impression we state here, once and for all, that we have for years been Sole Agents for:—

1. TATE MOTORS AND DYNAMOS, in all sizes and voltages.
2. NORTHERN CABLES AND WIRES, from heavy cable to the finest silk-covered magnet wire.
3. FLETCHER'S "PENRHYN" SLATE, in all shapes for Electrical purposes.
4. AS SUPPLIERS OF ENGINE SETS, Radio Units and Components, Electric Drills, Instruments, etc., new and ex-W.D., reconstructed in our own workshops.

That we have tons of Wireless and Electrical goods in stock at our City Depot, and when we say in stock we mean it. The goods are there ready for immediate delivery.

If you want 1,000 Dynamos, we are the only firm in London that can deliver at once. 10,000 Insulators, 20,000 Valve Legs, 20 Morse Inkers, 50 Weston Relays, 5,000 Resistance Units, 2,000 Telephones, 100 Marconi Receiving Sets calibrated for Broadcast Wavelengths, 200 Ammeters and Voltmeters, or a single Syphon Tape Recorder, Marconi Direction Finder, 50-watt Valve Transmitting Sets, etc., etc., we can supply from stock.

We have a large number of bargains not catalogued, and you are cordially invited to inspect these.

Colonial Avenue is the first on the left in the Minories, nearly opposite Aldgate Station, Met. Railway.

For LESLIE DIXON & CO.,
H. Leslie Dixon,
M.I.E.E., A.M.I.E.

TRADE **Grelco** MARK

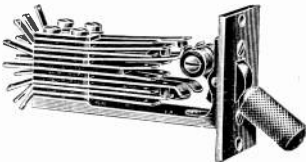

Dewar Switches. Multiple Contact. 4, 6 and 8 way. Price 4/6. Postage 4d.



The Original Green Egg Insulator. Highest Insulation. Price 6d. Post 1½d.



Aerial Aluminium Pulleys. Bronze Bush Price 1/6. Post 2d. Complete with hemp cord, spliced, Price 2/- Post 2d.



Ebonite Leading-in Insulators. Terminals each end as shown. 6" Price 1/6, postage 2d. 9" Price 1/9, postage 3d. 12" Price 2/-, postage 3d.

VALVE SOCKETS WITH NUT & WASHER. PRICE Per 1/6 doz. Post 2d.

We supply every article for Wireless at the very lowest prices. A visit will convince you. Fully Illustrated Catalogue in preparation.

Grafton Electric Company

Showrooms—54, GRAFTON STREET, TOTTENHAM COURT ROAD, LONDON, W1 Telephone—Museum 247. Works—Slough.

THE WIRELESS WORLD EXCHANGE AND MART

Wireless Insurance!

LIVERPOOL MARINE AND GENERAL INSURANCE CO., LTD.

London Office: 7, Angel Court, Throgmorton St., E.C.2.

FIRE. ACCIDENT. MARINE.

Write for particulars of our SPECIAL WIRELESS POLICY (Annual Premium 7/6) which covers fire and other damage to the complete Wireless Set and also indemnifies the Owner against claims arising from damage to property or persons through the breakdown of outside aerial and its supports.

HEATH & Co., Ltd.

Instrument Works, New Eltham, S.E.9 are prepared to undertake in their fully equipped works—**Wireless Apparatus and Parts for the trade.** Quotations given to Blue Prints. Immediate attention. Phone—Lee Green 301. Wire—Polaris, London.

I Buy Wireless Gear of every description.

Send your particulars to:

WILKINSON,
Lonsdale Rd., Kilburn, N.W.6
SAME ADDRESS SINCE 1900.

Your Case Work

Let us quote you for your wireless casework. We are specialists in this class of work and feel sure our workmanship and prices will interest you.

Phone—L.W. 2720.

CARRINGTON & NEWBERRY LTD.,
18, 23, Normans Buildings, Old Street, E.C.

To the Trade

CONNOLLY'S (Blackley) LTD.

Blackley, Manchester.

ENAMELLED WIRES for MAGNETS and AERIALS

London Office: 18, Victoria St., S.W. 1
Tel. Vic 6368. Telegrams: Lifehold, Vic

TRADE ENQUIRIES—continued.

Haslam Company, 34, Chapel Street, Bridlington. wish to get into communication with manufacturers of repute, of wireless sets with a view of taking over sole agency of the East Riding of Yorkshire.

Actual Manufacturers Wireless Parts and accessories, requiring orders, communicate **WIRELESS INSTALLATIONS, LTD., 15, Aldersgate Street, E.C.**

Wireless Dealers are advised to stock parts for making radio apparatus, as so many amateurs prefer to make their own instruments. There is also the additional profit in making your own sets from stock parts. Raw materials and partly machined parts can be had direct from the factory at the right price.—**THE "NEWTONIA" WIRELESS FACTORY, 13, 15, Whitcomb Street, London, W.C.2.** Regent 643 and 5409.

SITUATIONS VACANT.

Practical Wireless Man Wanted, capable of designing, assembling, etc. Must have excellent knowledge, splendid prospects for right man. **NATIONAL WIRELESS & ELECTRIC CO., 7, Church Road, Acton.**

YOUNG MAN FOR SALES DEPARTMENT of leading firm of wireless engineers. Commercial experience essential. Preference given to man with wireless experience. Write stating experience, age and salary required to Box No. E6, **BERTRAM DAY'S ADVERTISING OFFICES, 9/10, Charing Cross, S.W.1.**

SITUATIONS WANTED.

Ex-Army Wireless Officer, eight years' practical and technical experience, seeks wireless appointment as wireless engineer, organiser, demonstrator, etc. Experienced organiser, used to controlling large staff, keen, energetic, and willing to go abroad.—Reply Box E7, **BERTRAM DAY'S ADVERTISING OFFICES, 9 10, Charing Cross, S.W.1.**

Energetic Young Man with good business knowledge and first class wireless experience, becoming disengaged from War Office appointment offers his services to firm where abilities would be appreciated. Would assist management radio department, take up technical position or any other similar appointment. London district preferred.—**G. "Newman's Cottage," Weybourne, Farnham.**

Advertiser, Telegraph Engineer (28), shortly returning from abroad, desires to hear of a position in wireless manufacturing or trading concern where additional capital could be used to advantage and a salaried partnership secured.—Box F5, **BERTRAM DAY'S ADVERTISING OFFICES, 9 and 10, Charing Cross, S.W.1.**

Experienced Instrument Maker in wireless and electrical trades seeks position.—**W. A. BLUNDEN, 8, Fairlight Avenue, Harlesden, N.W.10.**

Scientific Instrument Maker (28), 12 years' experience. Good theoretical and practical knowledge of construction and design of modern wireless instruments, desires change of position where knowledge would be of value.—Box E.5, **BERTRAM DAY'S ADVERTISING OFFICES, 9 and 10, Charing Cross, S.W.1.**

WANTED TO PURCHASE.

Wanted.—Weston Loud Speaker, low resistance. Good condition, deposit.—**RADIO, 162, Hagley Road, Birmingham.**

Wanted.—Seven-valve R.A.F. receiver or other high frequency amplifier. Write particulars lowest price.—**MINTER, 14, Mardy Street, Carliff.**

A.S.A. Guaranteed Wireless Products

Best Filament Resistances	3/-
15v. H.T. Batteries—The Best	3/-
Grid Leaks and Condensers	2/6
Fixed Condensers, .002	2/-
Laminated Switch Arms and Bush	2/-
Condenser Vanes, the best	doz. 1/-
Vernier Condensers, .0001	4/6
Variable Condensers in Cabinet, .0005	18/6
100' 7 22 Aerial Wire	4/-
4000 ohm Headphones (good)	25/-
Crystal Receiving Sets	25/-
Sets of Parts for 2-Valve H.F. Amplifier	30/-
2-Valve L.F. Amplifier	40/-
3-Valve H.F. and L.F. Amplifier	60/-
Cabinets, 10" x 6" x 4", polished	5/-
Condenser Boxes, polished	2/6
3-Coil Honeycomb Holders	16/6
H.F. Transformers, for Broadcast	3/6
Honeycomb Coils from	1/6
Concert Coils	per pair 2/-
Coil Holders, for same	5/-

OUR LIST BEATS THEM ALL.

Amateur Supplies Association

134, Coteford Street, Tooting, S.W.

Works: 196, High Street, Merton, S.W.

Government Surplus Apparatus.

We still have a few tons of Government surplus in stock, which we will clear at cut prices to make room for our own manufactured products.

B. Mark II Receivers, with Aerial	£ s. d.
Tuning Condenser, New	5 0 0
Mark III Tuners, New	10 0 0
C. Mark III Receivers	each 6 10 0
60' Rubber-covered Flex, and two Ebonite Insulators, New	0 2 0
Navy 7, Calibrated Condensers, .001 mfd., cost £12	3 0 0
One only, Navy Tuner, cost £15	3 10 0
Telephone Plug and Jack	pair 0 1 9
Three only, 50 Watt Trench Sets, New, to clear	each 3 0 0
G.P.O. Standard Microphones, each	0 3 0
One only R.A.F. Seven-Valve Receiver, three H.F., one Rect., three L.F., New	12 10 0
One only, Navy 1 K.W. Alternator	7 10 0
Four-way Leads, New, bundle of ten	0 2 0
17 P.O. Double Current Keys. Cost £9 10s., as New	1 10 0
49 G.P.O. Sounders. Cost £10	0 17 6
Four only, Silvertown Relays, New	3 0 0
Two Reversing Relays, for Turner Trigger Circuit	2 0 0
Also four P.O. Duplex Transmitters, cost about £90	each 1 0 0
17 Field Switchboards, in polished Oak Cases, with 12 lines, bell and loud speaker, New. Cases alone cost about £5 each	1 12 6

British Wireless Supply Co. Ltd.

6, Blenheim Terrace, Leeds.

Tel. 26926.

THE WIRELESS WORLD EXCHANGE AND MART

ELECTRADIX WIRES

Highest Conductivity at Lowest Prices.

Gauge.	D.C.C.	S.S.C.	D.S.C.
16	1 7	—	3 6
18	1 9½	—	3 9
20	1 11	4 0	4 6
22	2 5	4 6	5 0
24	3 0	5 0	5 9
26	3 6	5 6	6 6
28	4 2	5 9	6 10
30	5 2	6 6	8 1½
32	6 6½	8 2	9 0
34	7 9	9 6	10 7
36	9 2	11 3	12 3½
38	11 10	13 6	17 3
40	16 2½	17 0	23 5

Prices at per lb. Postage Extra. Earth Clips, 6d. each. 7/22 Aerial Wire, 7/- per 100 ft. EVERYTHING FOR WIRELESS IN STOCK.

LESLIE DIXON & CO.,
9, Colonial Avenue, Minories, E. 1
(near Aldgate Station) Telephone Avenue 4166.

BOOKS.

"Principles of Radio Communication." Morecroft—920 pages—profusely illustrated. New. Cost 45s. Take 32s. Post paid.—LOWLEY, Kirkgate, Ripon.

Radio Magazines, all the latest, "Radio World," 10d.; "Popular Radio," 10d.; "Radio Broadcast," 1s. 6d.; "Radio News," 1s. 6d.; "Science and Invention," 1s. 9d. "Scientific American," 2s. 6d. Post free.—INTERNATIONAL NEWS COMPANY, LTD., 15, Bream's Buildings, London, E.C.4.

MISCELLANEOUS.

East Ham, Wanstead, Ilford, Manor Park and Forest Gate. Amateurs should not fail to come to the **RADIORENDEZVOUS**, 709, Manor Park Broadway (over Liptons). Club open till 10 p.m. nightly.

Don't Spoil your Valves, Don't Unduly Disturb the Aether. A curve of your valve made for your guidance, and it will pay you in improved results. Send your valve and postal order, 4s. 6d., to E. McCALLUM DAY, City Chambers, Broad Street, Birmingham.

MACHINERY FOR SALE.

Lorch Lathes, all sizes in stock, send for list.—PIDGEN BROS., 25, Helmet Row, Old Street, E.C.1.

Send us your enquiries for

BOXES, CABINETS, SPREADERS, CONDENSERS and parts, LEAD-IN-TUBES, and all accessories,

to the Trade.

COMPETITIVE PRICES
PROMPT DELIVERIES

The Central Aircraft Co.
179 High Rd., Kilburn, N.W.6

Phone—Hampstead 4403-4 8018.

ENGRAVING

for every style of instrument on any material.

F. OSBORNE & CO., LTD.
27, Eastcastle St., Oxford St., London, W.1
Est. 1874. Museum 2264

Wireless Outfits and Accessories

Specialities in Variable Condensers in Ebonite—Celluloid Cased. .0005 at 17/6, .001 at 25/-. Post Free. Highest Class Workmanship and materials only employed.

P. MORTIMER, 36, BEECHFIELD ROAD, CATFORD HILL, S.E.6.

To Radio Firms

Radio Man, Six Years' Experience, various types latest apparatus land stations, experimental and aircraft, requires post with progressive firm. Salary commission basis. Highest references. Security if required. —Apply Box B.7, BERTRAM DAY'S ADVERTISING OFFICES, 9/10, CHARING CROSS, S.W.1.

MY ELECTRICAL WORKSHOP

A BOOK for the ELECTRICAL EXPERIMENTER
By FRANK T. ADDYMAN,

PRACTICAL & INTERESTING.

249 pages. 169 diagrams, etc.

PRICE 7/- NET.
(Postage 9d.)

THE WIRELESS PRESS, LIMITED

Dept. W.W.,

12-13 Henrietta Street, London, W.C.2.

BE UP-TO-DATE READ THE WIRELESS TRANSMISSION OF PHOTOGRAPHS,

By MARCUS J. MARTIN.

143 pages. 139 Diagrams and Illustrations.

Price 5/- net. Post free 5/6

THE WIRELESS PRESS, LIMITED,

DEPT. W.W.

12/13, HENRIETTA ST. STRAND, LONDON, W.C.2

Elgie's Weather Book

FOR THE GENERAL READER.

By JOSEPH H. ELGIE.

Author of

"THE STARS NIGHT BY NIGHT," "THE COMPLETE STAR GUIDE," "STAR AND WEATHER GOSSIP."

PRICE 5/- NET. POST FREE 5/6

CONTENTS:

The Atmosphere; Wind; Rain; Clouds; Snow, Hal and Dew; Fog; Depressions; Thunderstorms; Anticyclones; Frost and Thermometers; Evaporation; Haloes and Coronas; Supposed Weather Signs; Climate; Weather Vocabulary; Index.

"Mr. Elgie is not tiresomely technical, as experts commonly are: he writes in a well-read readable way. Anyone who wants to know more about weather will find him a pleasant as well as a competent guide."—*The Daily Mail*.

"There is not a dull moment."—*The Dundee Advertiser*.

THE WIRELESS PRESS, LTD.

12-13 Henrietta St., London, W.C.2

BEFORE YOU CAN STUDY WIRELESS TELEGRAPHY AND TELEPHONY YOU MUST HAVE A KNOWLEDGE OF MAGNETISM AND ELECTRICITY

Dear Sir,

A READER'S APPRECIATION.

I received in good condition a copy of "Mag. and Elec. for Home Study" on Saturday last, and I am very highly pleased with it. I have much pleasure in enclosing a P.O. for 6/- which I trust you will find in good order. Again thanking you for the value offered and the prompt attention.

Yours faithfully.

To many who are anxious to gain a knowledge of Magnetism and Electricity some text books on the subject have a very forbidding appearance.

The formulæ and equations too frequently haunt the non-mathematical reader and cause him to abandon his intention.

Such fears, however, need no longer deter anyone from acquiring the knowledge desired as in **MAGNETISM & ELECTRICITY FOR HOME STUDY** By H. E. PENROSE will be found **FIFTY COMPLETE LESSONS** prepared in such a form that the reader ceases to regard them as a study.

The various facts and theories are elucidated subtly but surely. No effort has been spared by the Author to explain the subject so clearly and thoroughly that no one can misunderstand him.

At the conclusion of each lesson is placed a series of questions which enable the reader to test his progress and assure himself that his knowledge is

well grounded. In this way he will know that his future study of Wireless Telegraphy and Telephony will be based upon a solid foundation.

A copy of the book will be sent **ON APPROVAL** to all who complete the request form below.

**The Manager, Mail Order Dept.,
THE WIRELESS PRESS, LIMITED,
12-13, Henrietta St., LONDON, W.C.2**

I enclose 6d. for postage.

*Please send me a copy of
**MAGNETISM & ELECTRICITY
FOR HOME STUDY. By H. E.
Penrose.***

If I retain it I will remit the sum of 6/-. Otherwise I will return the book in good condition within 5 days of its receipt.

Name

Postal Address

.....
.....

Date.....1922 **W.W. 28/10/22**

FIVE

EXHIBITION SUCCESSES

THE PERRY AUTO-TIME MORSE SYSTEM

An aid to the rapid acquirement of speed in the transmission and reception of the Morse Code. 16 pages.

By F. W. PERRY.

6d. Net. Post Free, 7d.

THE WIRELESS TELEPHONE WHAT IT IS & HOW IT WORKS

Including directions for building a Simple Valve Receiver for Wireless Telephone Broadcast. 78 Diagrams and Illustrations.
128 Pages. Cr. 8vo.

By PHILIP R. COURSEY, B.Sc. (Eng.), A.M.I.E.E.

2/6 Net. Post Free, 2/10

MAST & AERIAL CONSTRUCTION FOR AMATEURS

Setting forth clearly all that the experimenting amateur requires. Over 70 Diagrams and Illustrations.
88 pages. Cr. 8vo.

By F. J. AINSLEY, A.M.I.C.E.

1/6 Net. Post Free, 1/8

CRYSTAL RECEIVERS FOR BROADCAST RECEPTION

Which includes directions for constructing a simple Crystal Receiver for Wireless Telephone Broadcast. Over 70 Photographs and Diagrams.
80 pages. Cr. 8vo.

By PERCY W. HARRIS.

1/6 Net. Post Free, 1/8

DIRECTION AND POSITION FINDING BY WIRELESS

A book which supplies a long-felt want. 250 Illustrations.
376 pages. Demy 8vo.

By R. KEEN, B.Eng. (Hons.), A.M.I.E.E.

9/- Net. Post Free, 9/9

THE WIRELESS PRESS LIMITED

DEPT. W.W.

12-13, HENRIETTA STREET, STRAND, LONDON, W.C.2

"The Model Engineer"

A special paper for young Engineers, Apprentices, Students and Amateurs interested in Mechanics, Electricity and Model Making. It contains practical articles by experienced writers on Electrical and Mechanical subjects, Locomotives, Motor Cycling, Model Aeroplanes and Wireless Telegraphy.
Published every Thursday. 5d. post free.

"Junior Mechanics & Electricity"

The paper for beginners of all ages in Mechanics, Electricity and Model Making. All the articles are written in simple language so that everybody can read and understand them. It is well illustrated. There is also a Queries and Replies section, from which much valuable information can be obtained.
Published on 1st of each month. 4d. post free.

SOME USEFUL BOOKS.

Practical Lessons in Metal Turning .. 2/9	Small Accumulators .. 10½d
Engineering Mathematics Simply Explained .. 2/3	Electric Bells & Alarms .. 10½d
Practical Dynamo and Motor Construction .. 1/9	Electric Batteries .. 10½d
Practical Induction Coil Construction .. 1/9	Small Dynamos and Motors .. 10½d
Petrol Motors Simply Explained .. 1/9	Induction Coils for Amateurs .. 10½d
Workshop Wrinkles and Recipes .. 1/9	Small Electric Motors .. 10½d
	Alternating Currents .. 10½d
	Windmills and Wind Motors .. 10½d
	Wireless Telegraphy Simply Explained .. 10½d

Every Boy's Book of Electricity, 3d.

Every Boy's Book of Engines, 3d.

Book List sent post free on receipt of card.
PERCIVAL MARSHALL & CO.,
66m. FARRINGDON ST., LONDON. E.C.

RADIO & MODEL ENGINEERING

Edited by M. B. SLEEPER.

Price **7d.** monthly. Post free **8d.**

Subscription **7s.** per annum.

THE WIRELESS PRESS, LTD.,
12-13 HENRIETTA ST., LONDON, W.C.2

THE A B C OF WIRELESS

By PERCY W. HARRIS

THE Book for the "Man in the Street."

Price **6d.** nett. Post free **8d.**

What is Wireless? How Does it Work?
THE "A B C" WILL TELL YOU.

THE WIRELESS PRESS, LTD.
12-13, HENRIETTA ST., LONDON, W.C.2

The Construction of Amateur Valve Stations

By **ALAN L. M. DOUGLAS**

78 pages. 55 Diagrams and Illustrations.

PRICE **1/6** NET.

(Postage 2d.)

THE WIRELESS PRESS, LIMITED
Dept. W.W.,
12-13 Henrietta Street, London, W.C.2.

NEW DIRECTORY OF AMATEUR & EXPERIMENTAL TRANSMITTING STATIONS

Price **6^D** post free.

THE WIRELESS PRESS, LTD., Dept. W.W.
12-13, Henrietta Street, London, W.C.2

AMATEURS THIS IS JUST WHAT YOU WANT

THE VEST POCKET Dictionary of Technical TERMS USED IN WIRELESS WORK.

Over **1,500** definitions.

Price **2s. 6d.** net. Post free **2s. 9d.**

THE WIRELESS PRESS, LTD.,
12-13 Henrietta Street, Strand, London, W.C.2

THE RADIO EXPERIMENTER'S HANDBOOK

By **PHILIP R. COURSEY,**

B.Sc. (Eng.), F.Inst.P.

113 pages. 99 Diagrams and Illustrations.

PRICE **3/6** NETT.

(Postage 6d.)

THE WIRELESS PRESS, LIMITED,
Dept. W.W., 12/13, Henrietta St., Strand, London, W.C.2

DON'T WORK IN THE DARK.

If you have a Wireless Set and know but little of the principles of its working, you are missing a great amount of the interest and pleasure which the man obtains who has this knowledge.

*It is nice to get good results
but where is the satisfaction
if you know not how they are
obtained?*

The Elementary Principles of Wireless Telegraphy

By R. D. BANGAY,

tells in the simplest possible manner, the theory and practice of wireless.

The Author makes the subject intelligible to persons who do not possess much technical knowledge, and at the same time it is brief and accurate.

The book is so arranged as to be useful as a reference book for students and amateurs.

It is published in two parts

PRICE **4/-** EACH
(post free 4/5)

or combined in one volume

PRICE **7/6** NETT
(post free 8/3).

The Wireless Press, Limited

Dept. W.W.

12-13 Henrietta St., Strand, London, W.C.2

ENLIGHTENMENT!

The increasingly important part played by the Valve in all Modern Wireless Installations makes it essential that all those interested in Wireless communication should have at least an elementary knowledge of its action and the principles underlying its various uses

The Oscillation Valve

The Elementary Principles of its
Application to Wireless

BY

R. D. BANGAY

215 Pages

110 Diagrams

Price **6/-** nett

(post free 6/6)

CONTENTS.

General Consideration of Wireless Telegraph Receivers. The Oscillation Valve. The Fleming Valve. The Three-Electrode Valve. The Application of the Oscillation Valve to Receivers. The Valve as a Magnifier. The Valve as a High-Frequency Magnifier. Reaction between Sheath Circuit and Grid Circuit of Valve. The Application of the Three-Electrode Valve to Transmitters. The Theory of the Soft Valve.

The Wireless Press Ltd., Dept.
W.W.
12-13, Henrietta St., London, W.C.2

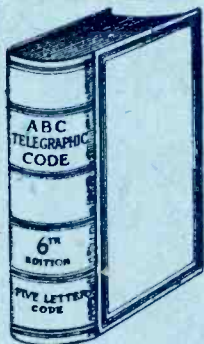

AN ENTIRELY NEW WORK.
The ABC Telegraphic CODE 6th Edition

FIVE-LETTER CODE.

An up-to-date Work, containing Five-letter Artificial Code Words with at least a TWO-letter difference and a **TERMINAL-INDEX** of the words at the end of the Book.

Cost of Cabling brought to a Minimum :: Simple to Use.

PRICE **£3 3s. 0d.** net (U.K. and Colonies.)

Inland Parcel Post 1/6 per copy. Continental Book Post 2/- per copy.

Publishers:—

EDEN FISHER & CO., LTD., 6, 7 & 8, Clements Lane, E.C.4
 And 95, 96 and 97 Fenchurch Street, London, E.C. 3.

RADIO INSULATION

AS SPECIFIED AND USED BY THE BRITISH ADMIRALTY

BRITISH MADE

PAXOLIN

BRITISH MADE

TUBES DISCS PLATES, &c.

MANUFACTURED IN ALL FORMS, SIZES AND THICKNESSES

BY

THE MIGANITE & INSULATORS Co. LTD.

EMPIRE WORKS

WALTHAMSTOW

LONDON, E.17

TELEGRAMS:—"MYTILITE, PHONE, LONDON."

TELEPHONES:—WALTHAMSTOW 738, 739

Registered "NIPHAN" Trade Mark.

**WATER-TIGHT PLUGS
 and CABLE COUPLINGS**
 TO MEET HOME OFFICE REQUIREMENTS



COUPLING CONNECTING CABLES

Phones: 2600 Gerrard 12061 Central.

As used by H.M. War Office, Electric Supply Companies, Railway Companies, Marconi's Wireless Telegraph Company
SIMMONDS BROS., LTD.
 4, 6 & 8, NEWTON STREET, HOLBORN, W.C.

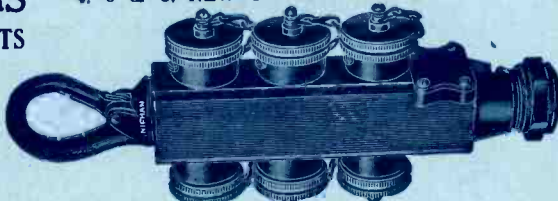

SIX WAY TEE CONNECTORS

Telegrams: "Nippon, London."
 Patented in England and Abroad.

AUCKLAND'S

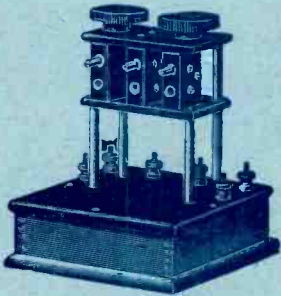
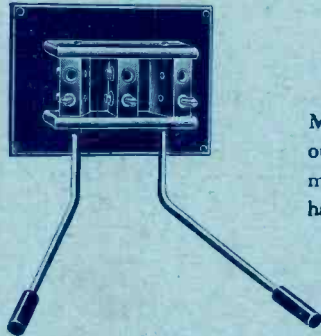

TABLE STAND FOR COILS

Registered Design 688454.
Exact as illustrated.

Price **21/-** each,
2-Way - - 18/-



PANEL TYPE COIL HOLDERS.

Made of Solid Ebonite through-out, and finished in workmanlike manner. Fitted with extended handles as shown to avoid Capacity Effects.

Price **13/6** each.



DUO LATERAL COILS

Made under De Forest Patents.
Supplied Mounted only.

Prices from **5/-** each.

INTERVALVE TRANSFORMERS.

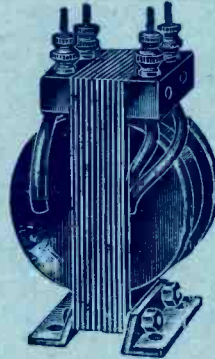

Layer Wound and Spaced.
Stalloy Cores, most efficient.

20/-

From Stock.

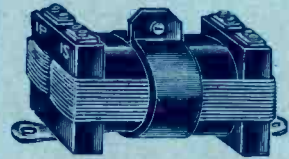

TELEPHONE TRANSFORMERS

Unmounted (as illustration)
suitable for 120 w. Phones.

Price **13/6** each.



CONDENSER DIALS.
Fitted with Knob and Bush,
Engraved to 180°

3/9 each.

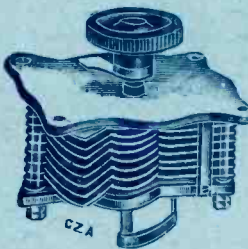

VARIABLE CONDENSERS,

For which we are specially noted.
Top plate; Die cast and fitted
with ebonite bush.

Bottom plate; Die cast and fitted
with ebonite bush.

Vane spacing '072.

Centre contact made by P.B. strip.

'0002	'0003	'0005	'001
15/-	16/-	18/-	24/-



THE NEW UNI-WAVE INDUCTANCES.

Duo Wound.

Range from
300-30,000 m.

Inductive Values
are to be found in
Catalogue.

Price per set of 8,
12/6

G. Z. AUCKLAND & SON, 395, St. John Street, E.C.1
Factories—ISLINGTON, N. WIRELESS INSTRUMENT MAKERS. 'Phone 3173 CLERKENWELL