

The
**WIRELESS
WORLD**

**WAR WIRELESS
IN ITALY**

**BORNEO
WIRELESS
STATION**

**THE AMATEUR
POSITION**



**"ANTI-SULPHURIC" ENAMEL
RESISTS ACID FUMES, Etc.**

Digitized by Google

**GRIFFITHS BROS. & Co. (London) Ltd.
MACKS ROAD, BERMONDSEY, S.E. 1st.**

Original from
UNIVERSITY OF MICHIGAN

SULLIVAN INSTRUMENTS

Sullivan "Universal" Galvanometers and Shunts for Land and Sea use

SULLIVAN TELEPHONE RECEIVERS

Fast Speed Wheatstone Automatic Transmitters and Receivers guaranteed at 400 words per minute, and Wheatstone Apparatus generally. Precision and Standard Measuring Equipments for D.C. and A.C. (high frequency) determinations, Condensers of Low Power Factor, etc

H. W. SULLIVAN, WINCHESTER HOUSE, LONDON, E.C., ENGLAND

Telegrams—
'Deadbeat, London.'

Telephone: Office: 3518 London Wall.
Works: 4871 Avenue.

WORKS: LIVERPOOL HOUSE, MIDDLESEX STREET
LONDON, EC.

P. ORMISTON & SONS

(P. H. ORMISTON) :: ESTABLISHED 1793

79 Clerkenwell Rd., London, E.C. 1

"Ormiston, London." :: :: 13259 Central

Silk and Cotton Covered H.C. Copper Wire, Resistance Wires, Fuse Wire, Binding Wires, Charcoal Iron Core Wire, Asbestos Covered Wire, Braided and Twisted Wires, Bare Copper Strand and Flexibles of any Construction, Wire Ropes and Cords (fine sizes) in Galvanized Steel, Phosphor Bronze, &c.

COMMERCIAL UNION ASSURANCE CO., LTD.

Head Office:

24, 25 & 26, CORNHILL, LONDON, E.C.

The following classes of Insurance effected: FIRE, LIFE AND ANNUITIES, MARINE, LEASEHOLD REDEMPTION AND SINKING FUND, ACCIDENT, including Personal Accident, Third Party, Burglary, Plate Glass, Fidelity Guarantee, Employers' Liability and Workmen's Compensation, including Domestic Servants' Insurance. The Company also act as TRUSTEES AND EXECUTORS.

FIRE. LIFE. MARINE. ACCIDENT.

Capital fully Subscribed	£2,950,000
Capital Paid Up	£295,000
Total Assets (including Life Funds)	
31st December, 1913	£14,902,252
Total Annual Income exceeds	£8,500,000



THE BRITISH SCHOOL of TELEGRAPHY *Ltd.* 179, CLAPHAM RD. LONDON. S.W.

EXPERT TRAINING FOR YOUNG GENTLEMEN (15-25) IN INLAND, CABLE & WIRELESS TELEGRAPHY. Good Appointments are open to our students as soon as qualified, the demand for Skilled Operators in all Services being greater than the supply. Special Short Course suitable for men wishing to obtain Government Certificate and enter the service of the Marconi Co. At several recent Government Exams, all candidates obtained 1st Class Government Certificate. No Branches or Postal Tuition. Fees moderate. Recognised by the War Office, Admiralty, Wireless Telegraph and Cable Companies.

WRITE FOR PROSPECTUS. A. W. WARD (Manager). 'Phone: BRIXTON 215

THE WIRELESS WORLD

No. 77
Vol. VII



AUGUST,
1919

“AVANTI ITALIA”

How British Wireless Men Helped Italy to Victory.

By Captain S. B. Balcombe.

NOVEMBER in France, 1917, with all the excitement of the break through by the Tanks at Cambrai caused enormous excitement for the B.E.F., but immediately it was known that reinforcements in the substantial form of several of the best divisions were to be sent to Italy to help our Allies to stay the Huns in their temporary victory of Caporetto, the excitement was even greater.

Each division that was “resting” or withdrawn from the line, was congratulating itself that it had been the lucky one selected, and when those five divisions which were actually chosen ultimately entrained for the sunny south, there were few pangs of regret at leaving those walls of mud which had been their abode for months past. The excitement of a new front, combined with the natural curiosity of the soldier as to how the Italian soldier compared in prowess of arms with the other allied nations, by whose side we had fought, and the wonderful scenery which one knew of as being unsurpassed, gave ample food for conversa-

tion. I, unfortunately, was debarred from taking part in the touring with the “Force,” and had to go to England to get the wireless gear and the personnel to man it. The sorting out of “junk,” the annexation of “gadgets” for experiments, and the wholesale confiscation of spares which were not on the official list of stores, together with the collection of the personnel all took up time, and December was well advanced before any definite news of a move became known.

The gear, which consisted of short-wave Bellini-Tosi-Marconi sets of latest pattern, aeroplane compass sets of the whirligig type, interception sets, and numerous other smaller sets was all packed up straight from the factories, and in due course we started off on the great adventure, fifty strong, with a multitude of packing cases, mast sections and charging sets, all stowed safely away on the same train.

During transit the stores at times very nearly came to grief. What they suffered from transference by crane from train to ship when embarking, and from ship to train on arrival at the other

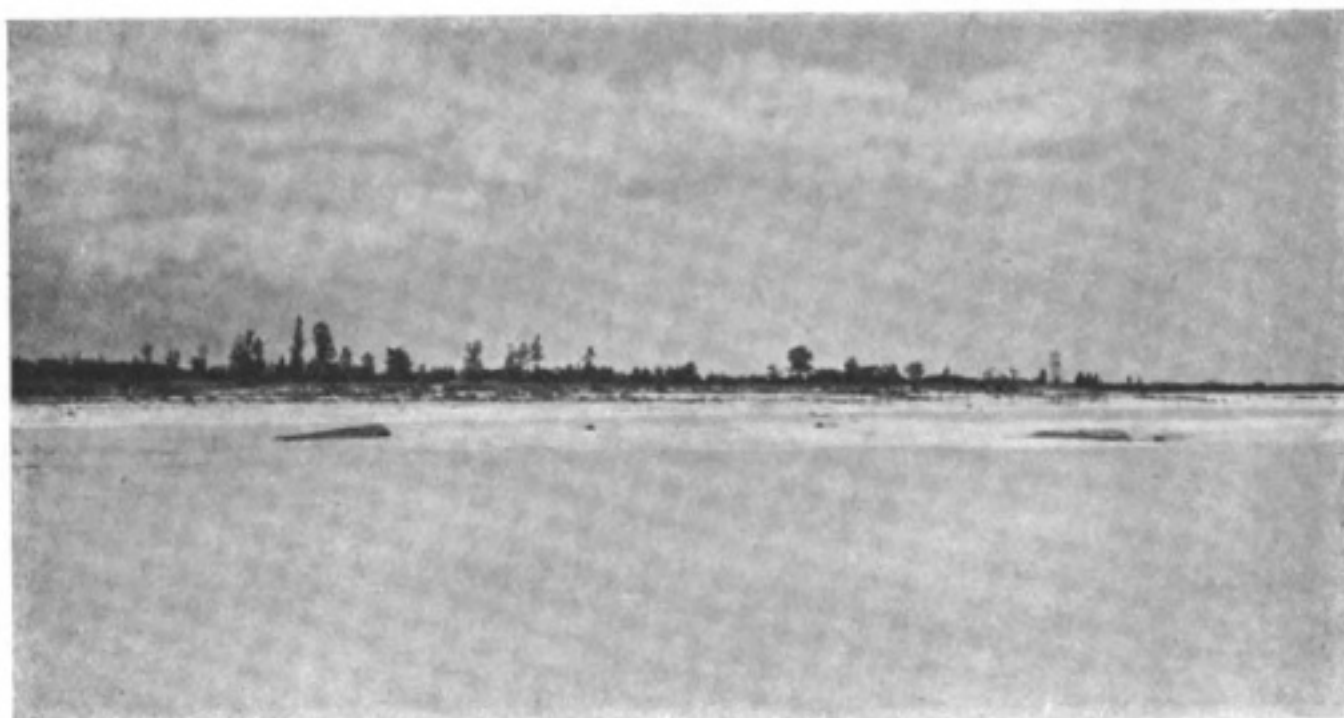

June 15th, 1918, on the Piave. Note the remains of the pontoon bridge.

side, with many bumps and bangs in the hold and at the quay side, nearly turned my hair white, and I prayed that some fairy godmother had kindly looked after the interior of the cases, as the prospects of doing any big repairs when we arrived were absolutely unknown, and the thought of having broken gear, and the necessity of sitting still whilst awaiting replacements from England was not a cheery prospect, as I knew by experience what expeditious results have been achieved when anyone at the front had asked for spares from England.

Anyhow the unpacking at our journey's end revealed nothing worse than a few missing terminals, or a valve or two broken, so that with our spares brought into operation and a few hours' work on the part of the instrument repairer, we were soon able to "get things going."

The powers decreed that the Piave front should be our destination and a few days' reconnaissance of the front gave me the opportunity to erect stations at points where the tactical situation demanded them.

With a wide expanse of the Venetian

plain in front of us, no difficulty was found in obtaining good positions for the stations, and we made our headquarters at Treviso. Unfortunately this town was a marked place for the Hun bombing planes, and they gave us a right royal greeting on our first night's arrival, and kept it up to well towards the middle of March. To say the least of it, things were decidedly unpleasant and the group wireless headquarters had more than one escape, no less than 20 bombs falling within a radius of 100 yards, and on one occasion a bomb alighted within 20 yards of a wireless set without disturbing it. "Archies" also provided many thrills and an occasional "dud" which missed its mark landed in alarming proximity to a Bellini-Tosi set, greatly to the distraction of the operators performing at the time, but they carried on notwithstanding. Another bomb splinter made havoc of an hydrometer which the electrician was manipulating at the time the "egg" fell, and a call upon our reserve stock was afterwards necessary.

These planes afterwards had a very lively time with our own machines

" AVANTI ITALIA "

which carried out reprisals with great zest. The leader of these raids was the well known Canadian airman, Major Barker, V.C., D.S.O., M.C., and it will be interesting to readers to learn that this gallant officer, who acted upon wireless information supplied by aeroplane whirling stations, was successful on more than one occasion in bringing them down or driving them off. He was very keen indeed on wireless reports of the enemy plane positions, and were he on the ground at the time the report was received at the aerodrome, he would immediately go up and endeavour to bring the enemy down.

The Hun wireless was singularly inactive during these months, and it was not until early in May that any sign of activity prevailed. This was interesting because from November, when the offensive ceased, until May, the Hun had been on the defensive and had not, with the exception of an occasional raid, undertaken any operations. To-

ward the end of May and the early part of June increased wireless activity was very apparent on the part of the Huns, and our wireless intelligence was kept very busy locating these stations. Later, in the middle of June, the increase in enemy stations was most marked and this led our "I" branch to make deductions, which were correct, that an offensive was imminent. How right these deductions were is borne out by the fact that the enemy offensive commenced on the morning of June 15th and ended in dismal failure. To what extent wireless was responsible for the correct deduction of the date of the offensive being made is perhaps for the staff to say, but one may conjecture that it paid no very small part.

During this battle a listening set was temporarily isolated together with the operators and interpreters, and I believe two of the men were killed. One of the survivors succeeded, however, in destroying the instruments and burying



The Italian lines on Monte Viali. There was a W/T station just by the gun in the (left) centre of the picture.



On the Piave front near Nervesa.

A shell bursting over W/T station.

the papers in a shell hole; these were ultimately recovered when we counter-attacked and regained the small loss of ground given under the first weight of the attack. It is interesting to note that one of the survivors succeeded in preventing himself being made prisoner by feigning death and remaining on his stomach in a shell hole for a considerable period. His companions in this shell hole were both dead, and this helped him in making his ruse good, but I believe a very unhappy quarter of an hour was spent, whilst Austrian parties were searching for wounded and passing their hands through his clothing for any spare "souvenirs" that were to be had.

After the enemy had been soundly trounced a period of inactivity was enforced, but we were kept fully occupied by enemy wireless which was not so much of a tactical nature as practice to keep their hands in, and they needed the latter badly. The operating was simply appalling, rarely, if ever, rising above five words a minute, and the style and

formation beggars description. It was no uncommon thing for a message to be repeated at least half a dozen times and for the receiving station finally to give it up as a bad job. Whatever use such operators could be in a "show" such as in France one fails to see, and such inefficiency, I understand, was not confined to operating, but was found to exist in the apparatus itself. Many of the sets obtained their "juice" by means of a bicycle-driven generator and it was amusing to hear the note obtained. One could imagine the Austrian hard at work on his pedals; gradually the note would get higher and higher, but so slow was the operating that long ere the message was finished the pedaller was tired out and the note had dropped in pitch about half a dozen octaves. A long drawn out "gurr" often intervened, and finally the signals died out entirely, leaving the operator wondering how much, if any, the receiving station had got of his message; usually it was confined to the first two words. Furious requests would then be made for a repetition of the message

" AVANTI ITALIA "

and again the farce would start, intermingled with perhaps another two or three stations on the same game, until the interception operator in our lines would throw up the sponge, and leave them to fight it out. A nearer approach to Bedlam has yet to be conceived, I should imagine.

We were always on the look-out for enemy stations using continuous wave sets, but we never found them. Possibly, as they were not sufficiently trained for spark work the idea of giving the operators C.W. was out of the question, and therefore it was not instituted.

During August a rather alarming incident happened at one of our own stations. Atmospherics had been very heavy, and with our excellent amplifiers in use, they occasionally resembled machine gun fire, so that working was at times impossible. It was during one of these periods that a terrific thunder-storm took place and burst right overhead one of the stations, actually striking the aerial which was being earthed at the time. The bill of damages consisted of a 200 volt H.T. battery completely burnt out, two telephone transformers, two pairs of Brown's telephones, some condensers and a few valves. The set was earthed at the time and the aerial was disconnected from the set, yet due to its being isolated in the open it was struck. The hut was completely wrecked, the set put out of action, and all was in a chaotic condition, but luckily no one was inside at the time. This particular station was about 30 miles away from our Headquarters and the repairs were effected, the hut patched up, and the set again working, 24 hours after this incident happened.

Several distinguished visitors interested in wireless telegraphy visited the British Expeditionary Force in

Italy, chief amongst these being Senatore Marconi. He inspected one of the stations at Malo and expressed his satisfaction at the work performed. Such praise coming from the great inventor was very welcome. Liaison work with the French Force in Italy, the Italian Army Section and the Supreme Command was very finely carried out, and Colonel Bardeloni of the Italian Army was enthusiastic in anything connected with wireless telegraphy. Early in October every one was working toward the offensive which was to be undertaken against the enemy, and in this respect wireless played a very big part. Every effort was made to locate the enemy stations and intercept as many enemy messages as possible, with excellent results. Positions of enemy wireless stations obtained by big Direction Finders were verified by photographs taken from aeroplanes and by other means, and when we opened the offensive I believe the complete battle order of the enemy was known to us. How well this offensive succeeded is ancient history; it was all over in about ten days. Much booty in the way of wireless gear fell into our hands, in fact we had an enormous dump of apparatus of every description, but very little of real use.

Lord Cavan, on a visit to the Wireless Headquarters, thanked the personnel for their work, and said how valuable it all was. The Chief of Intelligence wrote the following: "Let me say how much I appreciate, too, the good work and long diligence of all your show in connection with Intelligence; it has helped us a lot." At least one Military Cross, one D.C.M., one M.S.M., and mentions in despatches fell to the lot of wireless men in Italy during the twelve months' war they waged there. Such a record is one to be proud of.

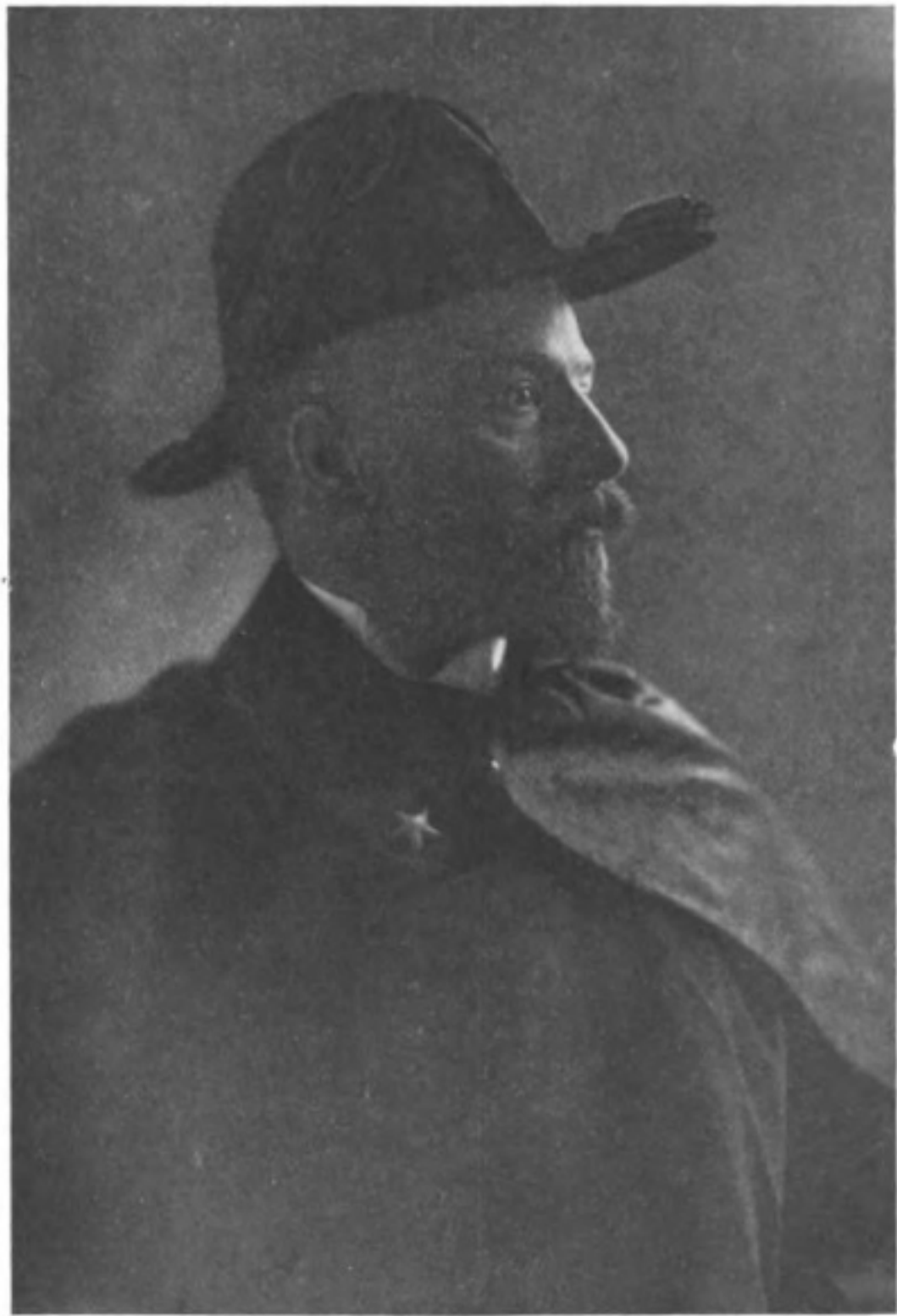

MARQUIS LUIGI SOLARI.

Personalities in the Wireless World.

IN his early youth Marquis Luigi Solari chose the ways of the sea. Upon finishing his studies at the Royal Lyceum of Ancona and at the Cavallero Institute of Florence, where was also Senatore (then Mr.) Marconi he entered the Royal Naval Academy at Leghorn in 1887. Obtaining his commission in the Royal Italian Navy in 1892, after several voyages across the Atlantic and to the Near East, he was sent on a mission to China during the Boxer Revolution.

After travelling around the world he resumed the study of electricity, obtaining the diploma of Electrical Engineer at the University of Turin. Whilst at the Electrical Laboratory of the Royal Navy at Spezia he was called upon to conduct researches in wireless telegraphy and succeeded by means of apparatus constructed at Spezia in establishing wireless communications with Calvi (Corsica) and Biot (South of France). In view of these successful experiments the Marquis Solari did his utmost to bring about the widest application of wireless telegraphy in Italy.

He was in charge of the wireless station on board the battleship *Carlo Alberto* whilst the historical tests on board that vessel were being carried out under the direct supervision of Senatore Marconi. From the Mediterranean the *Carlo Alberto* went to Russia and thence to Canada being all the time in communication with the station at Poldhu. The Marquis Solari wrote the official detailed report of these experiments and, further, directed and superintended the erection of various wireless installations on board Italian warships, the first wireless stations in Rome and La Maddalena and the first international wireless line opened for public service between Bari (Italy) and Antivari (Montenegro). He was then asked to direct, under the supervision of Senatore Marconi, the erection of the high power station at Coltano (near Pisa).

As a delegate of the Italian Government the Marquis was at the Berlin Wireless Conference and at the International Congress of Electricity at St. Louis, where he read a paper on the history and progress of wireless telegraphy. For two years he was head of the Wireless Department of the Italian Ministry of Posts and Telegraphs. He was the promoter of the first applications of wireless telegraphy in China between Taku and Peking.

In view of the necessity of developing the Marconi system in Southern Europe, and in order to combat the progress of the German system which was so strongly supported by the German Government for imperialistic purposes, the Marquis Solari for several years assisted in the conduct of negotiations with the Governments of Portugal, Spain, Serbia, Bulgaria, Roumania, Turkey and Greece, resulting in the introduction of the Marconi system into all these countries.

He now directs the wireless telegraph service on board the steamers of the Italian Merchant Marine, and is in charge of the Marconi Works at Genoa and the Marconi Office in Rome.

The Marquis Solari is a Commander of the Royal Italian Navy, is decorated with bronze medals for the campaigns of China and Africa and is a Cavaliere Ufficiale della Corona d'Italia, a Cavaliere dei SS. Maurizio e Lazzaro, a Commendatore of Danilo and a Cavaliere of St. Anna.

The Theory of Valve Rectification

By W. S. Barrell.

(Continued from July Number.)

A NEW development in rectifiers might here be mentioned. In wireless telegraphy, as also in other electrical work, it is often necessary to rectify alternating current for some particular purpose. For example, it may be that a valve transmitter has been installed, and the only means of obtaining the necessary high tension voltage for the anode is an alternator and step-up transformer. If this were applied direct to the valve circuit undamped oscillations would not be radiated from the aerial. On the other hand, by inserting a high-power rectifier in one of the leads from the secondary of the transformer, the alternating current is rectified, direct current applied to the valve and continuous waves radiated from the aerial.

This high-power rectifier is essentially a large Fleming valve, having but two electrodes, filament and anode, the main points of difference from the receiving valve being in the design.

In the first place the size of the anode is an important factor. It must be of sufficient area to deal with the energy passing through the valve, as if too small it is liable to become excessively hot. On the other hand it should not be too large, as since all the metal in the valve must be devoid of any occluded gas, extra work is entailed in gas-freeing. Secondly, the vacuum must be of a very high order.

RECTIFICATION BY THE THREE-ELECTRODE VALVE.

The sensitiveness of a two-electrode or Fleming valve as a detector may be

greatly increased by placing between the filament and anode a third electrode which is known as the grid. This may be either a metallic plate with a number of holes punched in it, a spiral or a wire network, the constructional details as to size, distance from filament and such like depending upon certain principles which need not be discussed in an elementary article of this nature.

It has already been shown that the number of electrons emitted from an incandescent filament depends upon its temperature increasing with an increase of temperature, and provided saturation is not reached the current through the valve will increase as the anode voltage increases. Again, any variation of potential in the path of the electron stream will cause a change to take place in the electron current.

The function of the grid, referred to above, at once becomes apparent, for if its potential be lower than that of the filament, that is to say, if the grid potential is negative with respect to the negative end of the filament, it will, since the electrons are also minute negative charges, tend to repel them and consequently reduce the current between the anode and the filament. The electrons will therefore congregate between the grid and filament setting up what is known as the space charge. Should the grid lose some of its negative charge the space charge will be reduced with an increase of current through the tube and the application of a positive potential to the grid will to a great extent neutralize the space charge with a still greater increase in anode current.

Langmuir has shown that in the three-electrode valve the plate cur-

THE THEORY OF VALVE RECTIFICATION

rent conforms very approximately to the formula :

$$I = A (V_a + \kappa V_g)^{\frac{3}{2}}$$

where I = Current in amperes
 V_a = Voltage on the anode
 V_g = Voltage on the grid

and A and κ are constants depending upon the geometrical design of the valve.

Very interesting experiments have been described by Armstrong* showing the effect of the grid in a valve. Special tubes were made having two independent anodes made in the form of flat plates placed parallel to each other and symmetrical with respect to the filament but having only one grid placed on one side of the filament as shown in Fig. 7, a and b. Under exactly similar conditions of high tension voltage and filament current it was found that a much greater current passed between the filament and anode in the case shown in Fig. 7a, that is when no grid was interposed between the anode and cathode. In both cases the grid was left quite free and with no connection whatever to any other part of the circuit. It seemed certain that in the case shown in Fig. 7b the grid opposed the flow of electronic current, and investigation showed: "That this was due to the

charge accumulating on the grid when exposed to bombardment by the electrons passing from the filament to the plate." The electrons attach themselves to the grid giving it a powerful negative charge which impedes the flow of electrons from the filament to the anode, with a consequent reduction in current.

As in the case of the Fleming valve, the phenomena of the three-electrode type can be best understood by the study of a characteristic curve. As, however, the circuit and method for this have been fully treated in standard works it will not be repeated here, and the reader is referred to these works for full details.

It will be assumed, therefore, that a curve has been drawn which will be of the nature shown in Fig. 8.

Before passing to a detailed consideration of this curve, it should be noted that the general shape of these characteristic curves is practically always the same, although the exact position of the curve relative to the current and voltage axes may be very different in different circumstances. The curve is raised, for example, by increasing the anode or high tension voltage, or by reducing the number of turns per inch of the grid in

* Annals N.Y. Sci. Vol XXVII. Aug., 1917

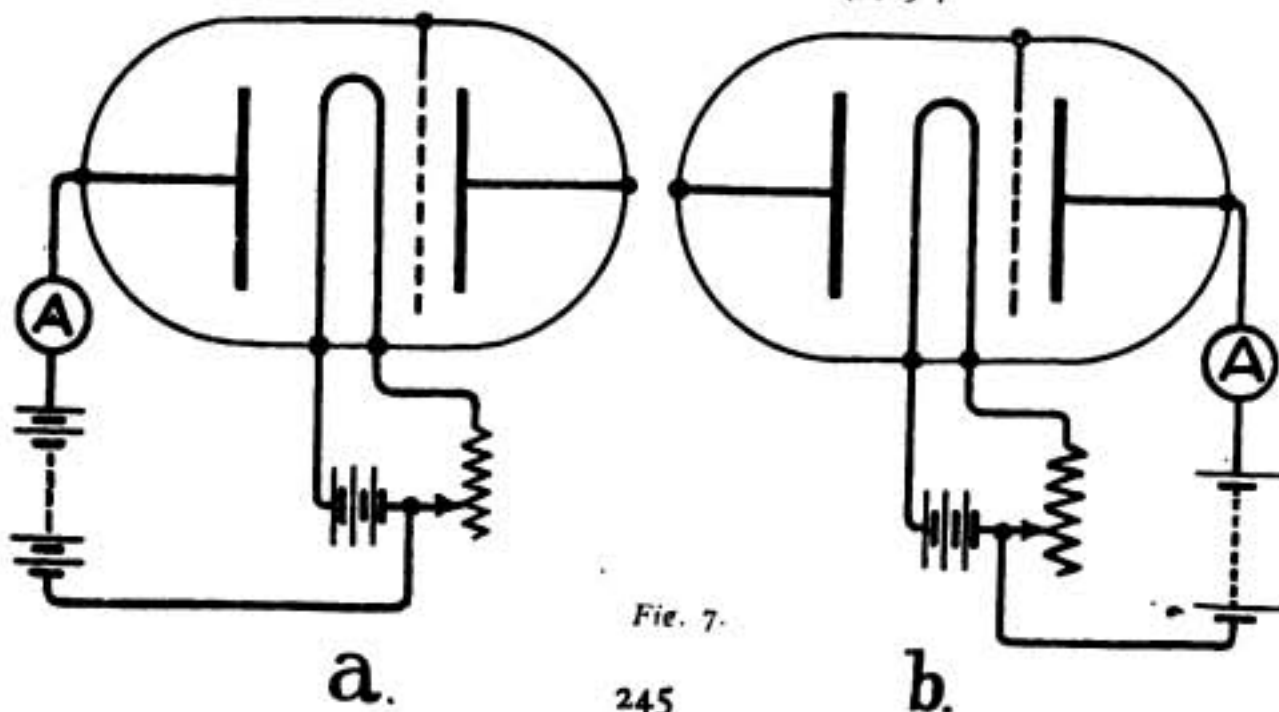

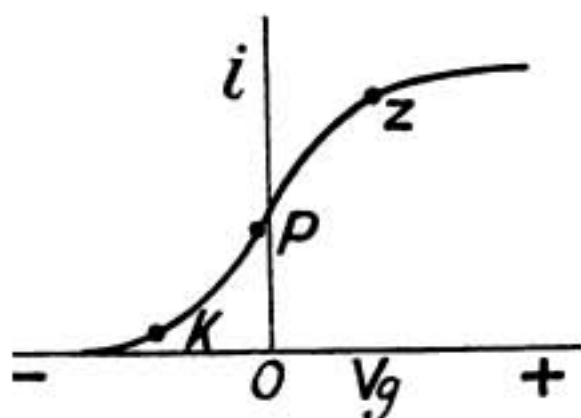

Fig. 8.

the case of a valve with a spiral grid. Hence it should be evident that the point at which the curve will cut the current (vertical) axis depends upon the above factors and other geometrical details of the tube.

The main difference in obtaining the characteristic curves of the two-electrode and three-electrode valves should be borne in mind, namely, that in the case of the former the current in the anode circuit is plotted against *anode* voltages, whereas in the case of the three-electrode valve with a fixed anode voltage, the current in that circuit is plotted against the voltages on the *grid*. Thus the voltage across the grid circuit controls the current flowing in the anode circuit.

A study of Fig. 8 shows that starting at, say, the point P an increase in grid voltage causes an increase, and a decrease in grid voltage causes a decrease, in the current in the anode circuit. This is the fundamental action of the valve.

It follows that if an alternating E.M.F. be impressed on the grid variations in anode current will ensue, the positive half-waves producing an increase and the negative half-waves a reduction. If then the potential of the grid be so adjusted that the valve is normally operating at the point P, Fig. 8, the oscillations in the grid circuit will be repeated in the anode circuit. These oscillations are of much too high frequency directly to affect the telephone receiver connected in the anode circuit,

consequently the valve must be so adjusted that the effect of a whole group of oscillations impressed on the grid is transformed into one low frequency variation in the telephone current; that is, it must be rectified. This can be done by working the valve at one of the bends κ or z , Fig. 8, in a manner similar to that described with the Fleming valve.

In Fig. 9 is shown the arrangement for connecting the three-electrode valve to a simple circuit which should be compared with Fig. 3.

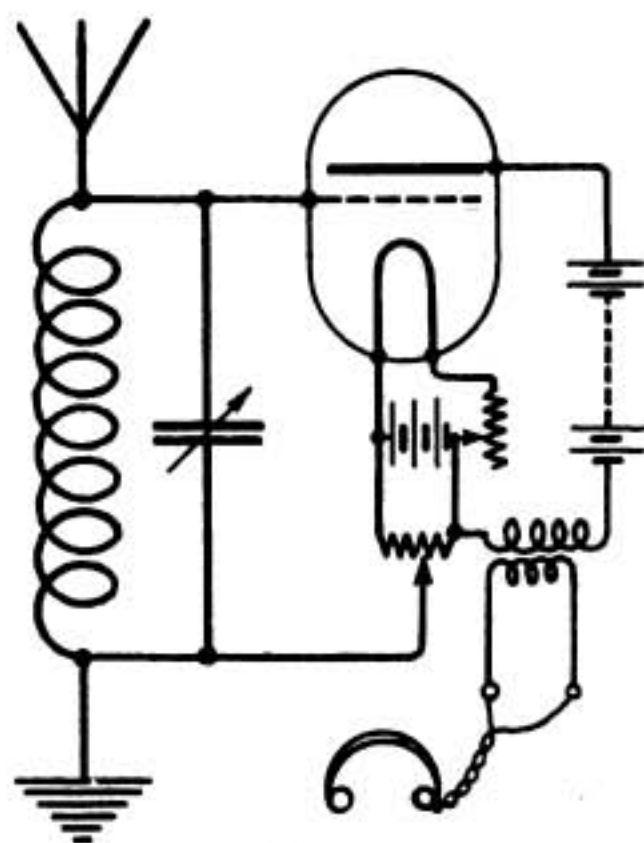

Fig. 9.

In this case it will be seen that the grid and filament are connected across the oscillatory circuits, constituting the control. By means of the potentiometer the normal potential of the grid is adjusted to the point κ on the curve, Fig. 8. By reason of the curvature of the characteristic the mean anode current is increased during the oscillations similar to that shown in Fig. 4 and fluctuations are obtained through the telephones having the same frequency as that of the spark at the transmitting station.

(To be continued.)

Digest of Wireless Literature

HIGH FREQUENCY ALTERNATORS.

By M. LATOUR.

(Continued from July Number.)

THE homopolar type of the above machine possesses the advantage that the flux does not change its direction in the teeth of the rotor during rotation, so that from the point of view of the losses, all the advantages of the homopolar machine are thus secured.

Theoretically as there are no conductors in the stator slots, it should be possible to construct this machine for any frequency. In practice, however, it would be necessary to reduce the air gap proportionally to the size of the teeth which becomes impossible for mechanical reasons. If this reduction of the air gap is not effected the maximum and minimum reluctance of the magnetic circuit become sensibly equal.

These variable reluctance machines can give rise to a frequency multiplication similar to that obtained in the Goldschmidt machine having poles of alternate polarity. In this case, with a machine having all poles of the same sign, the windings become the seat of currents which may be represented by all the *odd and even* terms of the Fourier Series. From this point of view these machines should be able to yield the highest frequencies without excessive peripheral speed.

5. ALTERNATORS UTILISING PART ONLY OF THE ARMATURE PERIPHERY.

The difficulty encountered in constructing a machine either of the usual

type with poles of alternate sign, or homopolar, for very high frequencies, without increasing the peripheral speed, resides in the practical impossibility of accommodating the windings in the slots. Thus with a peripheral speed of 150 metres per second, for 30,000 ~ the pole pitch is only 2.5 mms. Reserving 2 mms. for the thickness of the tooth, there is only 0.5 mm. for the slot.

It is, however, possible to imagine a machine having only a fraction of the required number of poles, and to combine together several machines so as to distribute the total number of poles between them. Thus in place of a single machine a system of three machines (I, II and III, Fig. 5) may be considered, in which the succession of the poles takes place by passing from one machine to the other, and by omitting two poles out of three on each machine. The space gained by the omission of these poles allows for the easier accommodation of the windings. Fig 5 represents the poles of the rotors of the three machines on the left, and the stators on the right. The first N pole is shown on Machine I, the following S pole on Machine II, the second N pole on Machine III., and the second S pole back again on the first machine, and so on. On each rotor two-thirds of the normal number of poles are omitted. On the

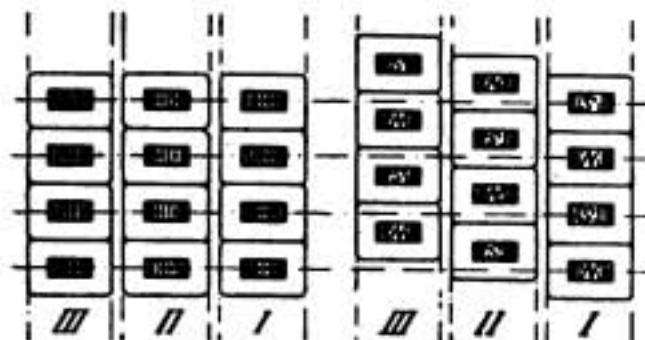

Fig. 5.

three stators two teeth out of each three are also omitted as shown.

This method may be applied equally to the homopolar machines and to the variable impedance alternators that have been dealt with above. In these cases it is merely necessary that blank spaces should replace the poles of opposite sign. Fig. 6 illustrates the arrangement

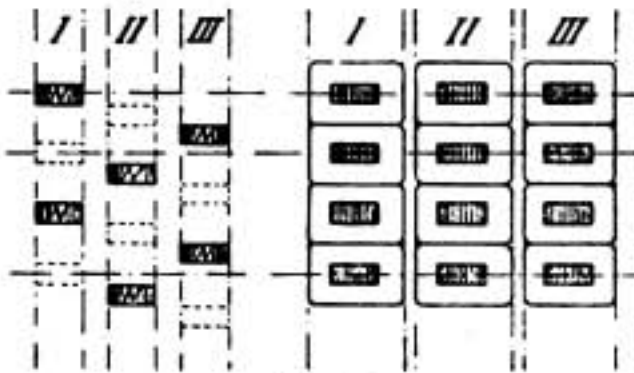

Fig. 6.

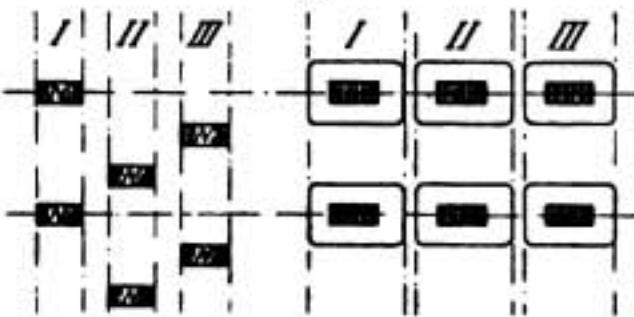

Fig. 7.

for a homopolar machine, and Fig. 7 that for a variable-reluctance alternator.

The author concludes by indicating that each machine of the above series really generates a fundamental frequency = 1/3rd the output frequency of the group, combined with a third harmonic; and shows that by combining the three machines into one frame the fundamental frequency is eliminated and the total losses consequently reduced.

VACUUM-TUBE AMPLIFIERS.
By LIEUT. M. C. BATSEL (SIGNAL CORPS, U.S.A.).

Electrical World, 73, p. 568
(March, 1919).

The most fundamental and most useful property of the vacuum tube is its ability to amplify alternating electrical currents, voltages or power. This am-

plifying ability arises from the fact that the power required to cause a given variation in the potential of the grid of a tube is less than the power associated with the resulting variations of the current in the plate circuit. The Signal Corps of the United States Army has made two important uses of vacuum-tube amplifiers, for the amplification of weak ground currents in the reception of earth conduction telegraph signals and the picking up of stray telephonic currents, and for the amplification of radio signals both at radio-frequency before being rectified by a detector and at audio-frequency after the radio-frequency signals are changed to an audible frequency by means of the detector.

Although a vacuum-tube amplifier in a sense, returns more energy than it receives, amplification does not violate the principle of the conservation of energy and does not literally give something for nothing. It may be likened to the action of an ordinary direct-current generator. An increase in the field current (or voltage) of the generator will cause a similar increase in the voltage produced by the armature and correspondingly in the load current. The increase in output will be much greater than the increase of power in the field circuit, but this added power is, of course, derived from mechanical forces which drive the generator shaft. In an analogous sense, the amplified power derived from a vacuum tube is obtained from the battery which supplies the plate voltage and current of the tube. In the generator the field voltage controls the output through the agency of a magnetic field. In the vacuum tube the grid voltage controls the output through the agency of an electric field.

When the grid of a tube is maintained at a mean potential more nega-

DIGEST OF WIRELESS LITERATURE

tive than any part of the filament the only current which flows in it is a very small one due to leakage or gas ionization. Therefore the amount of power required to cause a given change in the grid potential is small. Since the vacuum tube operates by virtue of the

between the filament and the grid, resulting in the maximum power output from the tube. Such a transformer is known as an "input transformer," and its use with vacuum-tube amplifiers is almost universal. The combination of input transformer and tube is called

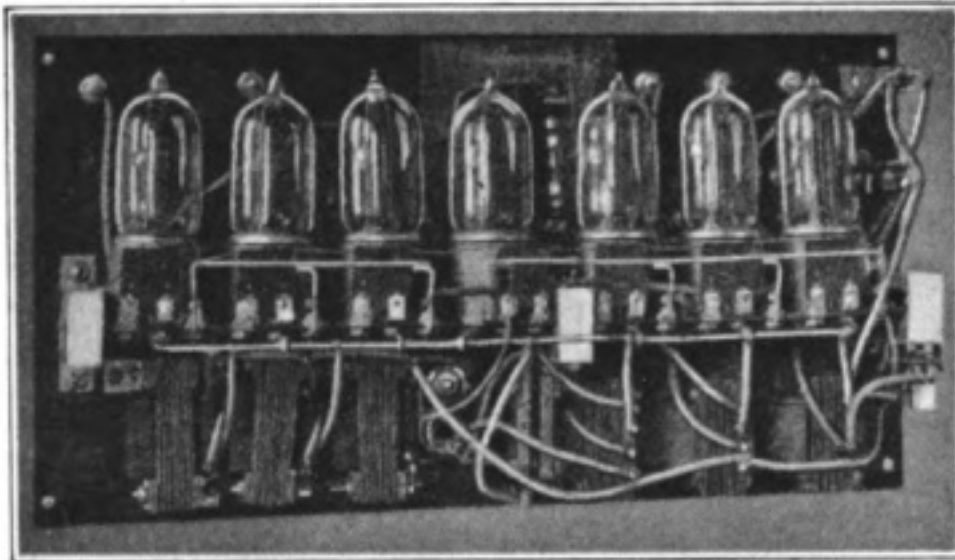

Fig. 1.

potential difference established between the filament and the grid, it is desirable to transform the power supplied to as high a voltage as possible. If the source of voltage has an impedance Z_1 ,

one "stage" of amplification. Several stages may be connected in series or cascade, the plate circuit of one tube feeding into the primary of the input transformer of the next stage, and so on.

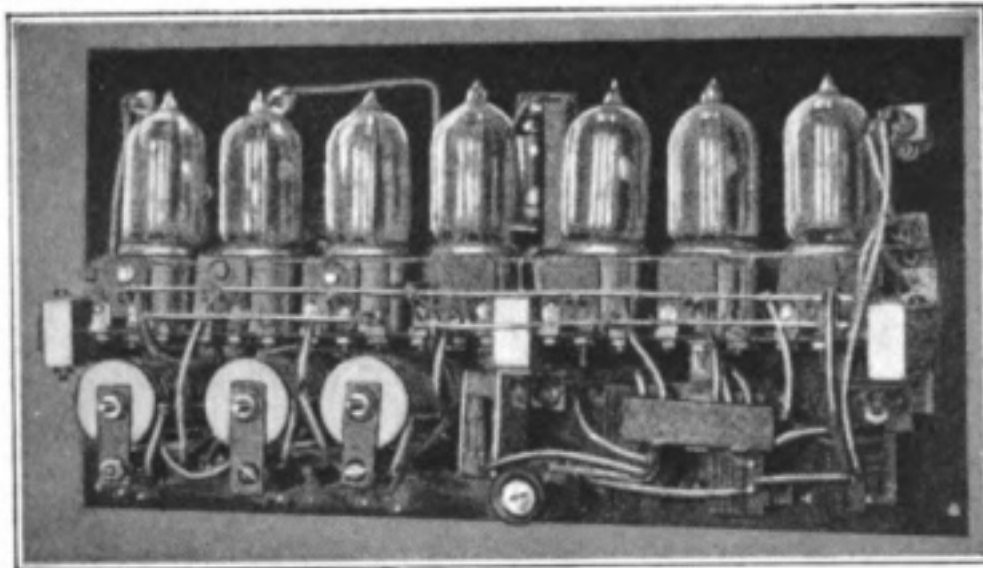

Fig. 2.

a transformer to supply current to the grid filament circuit should have a ratio K in the step-up sense such that $K^2 Z_1 = Z_2$, where Z_2 is the impedance of the grid filament circuit. The maximum power is then derived from the source of voltage, and the greatest possible potential difference established

AUDIO-FREQUENCY AMPLIFIERS.

One of the first pieces of radio equipment manufactured for the U.S. army after the establishment of the radio development organization was the type SCR-72 two-stage audio-frequency amplifier designed and constructed by

the Western Electric Company. Many hundreds of them were produced and have in service given excellent satisfaction.

There are no adjustments of any kind. Simplicity and reliability are the outstanding features. The power of the output signal is from 40,000 to 60,000 times that of the input signal.

If the signal to be received is weak and is masked by interfering noises of equal or greater loudness, it is found that amplification beyond a certain degree is detrimental. If the interfering noises are amplified to be louder than this rather critical value, the ear is overburdened and is unable to distinguish the signal as well as when both signal and interference are weaker.

The input transformer which was used in the SCR-72-B amplifiers and in certain other equipment which involved stages of amplification built in units, was designed and manufactured by the Western Electric Company. It is a shell-type transformer and its winding is composed of about 6,000 feet (1,830 m.) of No. 40 enamelled copper wire covered with a single layer of silk.

RADIO-FREQUENCY AMPLIFIERS.

The principal use to which these amplifiers have been so far applied is in connection with radio direction-finders. In this work the signals are generally so weak (since the amount of energy picked up by the small loop antenna is so meagre) that extremely high amplification must be employed. To build a reliable efficient amplifier of more than three stages, at any one frequency, is practically impossible, since very grave difficulties are met with in keeping it from howling or oscillating. It is, however, quite feasible to amplify a radio signal at its radio frequency, pass it through a detector tube and then amplify the resulting audio frequency

current. This not only gives the increase due to both the radio and the audio-frequency amplifiers, but in addition increases the detector tube efficiency since, within limits, the efficiency of detection increases with the signal strength. Thus the receiver usually works out best in seven stages—three radio, one detector and three audio. Properly designed sets of this kind, operated non-oscillating and without regeneration, will give signals more than 10^{14} times as strong as would be obtained with a simple one-tube detector. By using a regenerative feed back much higher amplification can be realized, but the operation becomes less stable.

Of the several methods which may be used for transferring the output of the plate circuit of one tube of a radio-frequency amplifier to the input or grid circuit of the next tube, the iron-core input transformer has been most used. Air-core transformers have also been successfully utilized, but they result in a less stable unit. The core is made up of laminations of enamelled soft steel $1\frac{1}{2}$ mils. thick (0.38 mm.). The primary and secondary windings each consist of a single layer of No. 40 enamelled copper wire. The magnetic circuit contains a short air gap.

Figs. 1 and 2 show rear views of the panels of seven-stage radio-audio frequency amplifiers made up with iron and air-core radio frequency input transformers respectively. The three radio stages are on the left of the picture, the detector in the middle, and the audio stages on the right in each case. The tube sockets are carried on sponge rubber to reduce vibration. The other parts are carried directly on the panel. The two amplifiers are identical in outside appearance. The filament rheostat provides control of the degree of amplification, and no other adjustment is

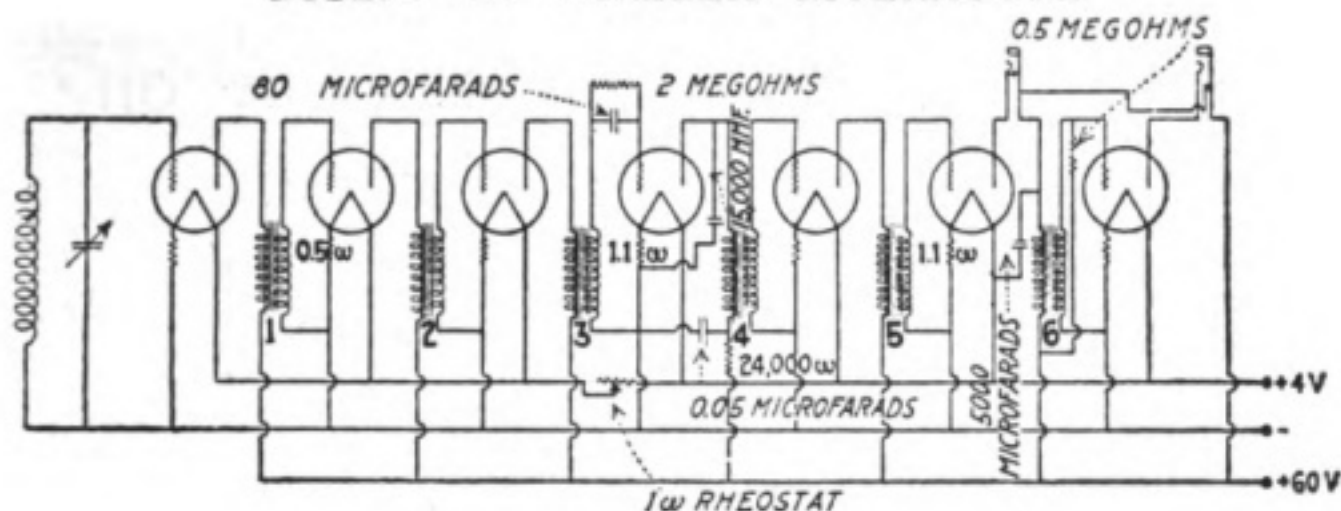

Fig. 3.

needed. The particular sets illustrated were designed for use in air-planes. Others of very similar appearance have been made for ground use. The circuit diagram is shown in Fig. 3. The batteries for supplying the plate current are contained in a separate box. It is

desirable to have the box as small as possible because it is more convenient to mount several small boxes in an airplane than one large box. The plate battery consists of three standard 20-volt dry batteries in series. The filament battery must supply 7.7 amp. at 4 volts.

The Amplification of Photo-Electric Currents.

A HINT TO RESEARCH WORKERS.

IN 1887 Hertz noticed that when rays of ultra-violet light fell on a spark-gap the electric discharge was facilitated, and Wiedemann and Ebert showed in 1888 that this action has its seat at the cathode. In the same year Hallwachs found that a negatively-charged body loses its charge when subjected to the action of ultra-violet light, whilst the same investigator and Professor Righi showed, independently of each other, that an insulated and electrically neutral body acquires a positive charge by the same means. It is now an established fact that æther-waves of a frequency corresponding to that of ultra-violet light will release electrons from metallic bodies. If, for example, a polished metal plate is connected to the negative terminal of a voltaic battery the positive terminal of which is connected to a perforated metal plate situated at a certain distance from the zinc plate, and the latter is brought under the influence of light from an elec-

tric spark, electric arc, or mercury vapour lamp, then it is possible to detect the passage of a current between the plates. Photo-electric cells have been constructed on this principle and a type evolved by J. Kunz and J. Kemp has been used by them as a receiver in wireless telegraphy. A paper by C. E. Pike, contributed to the *Physical Review** deals with the amplification of the photo-electric current by means of the three-electrode valve. The writer shows that such currents can be amplified by this means from 1600 to 5000 times, and that the weaker the light the smaller the primary photo-electric current and the larger the amplification. Further investigation of this problem may lead to results which would increase the value of the photo-electric cell as a detector and there still remains to continue the research with ultra-violet and interrupted light, with alternating currents.

* February, 1919.

The New Wireless Service on the Island of Borneo.

By JACQUES BOYER.

AFTER Australia and New Guinea, Borneo is the largest island in the world, but, in spite of its wealth in minerals, animals and forests, only 1,800,000 people inhabit its area of 735,000 square kilometres. The Dutch possess more than two-thirds of the island, whilst the other part of its territory, in the north-west, belongs to the English. In this latter-named region are first distinguished British Borneo, which comprises the possessions acquired from the Sultans of Brunei and of Sulu in 1879-80 (an area of 79,632 square kilometres), then the Kingdom of Sarawak (an area of 102,400 square kilometres with over 640 kilometres of sea coast) which has been under an English protectorate since 1888. The present white Rajah is named Brooke and is the descendant

of a London family. He succeeded his father in May, 1917. Under the control of the British Government he exercises authority over a population of various races, estimated at 600,000 inhabitants.

The special feature, however, which alone interests us in this article, is that the Indo-Malay Archipelago did not possess up to last year any radiotelegraph station. Furthermore, in view of the difficulty of maintaining cables in tropical waters, ordinary telegraphy could not have been utilised without incurring expenditure out of proportion to the traffic over the line which would have connected Borneo with Singapore, which is situated at a distance of about two days and a half by sea. One cargo boat alone, a vessel of 1,500 tons, maintained the postal service and the transport of travellers and goods in both

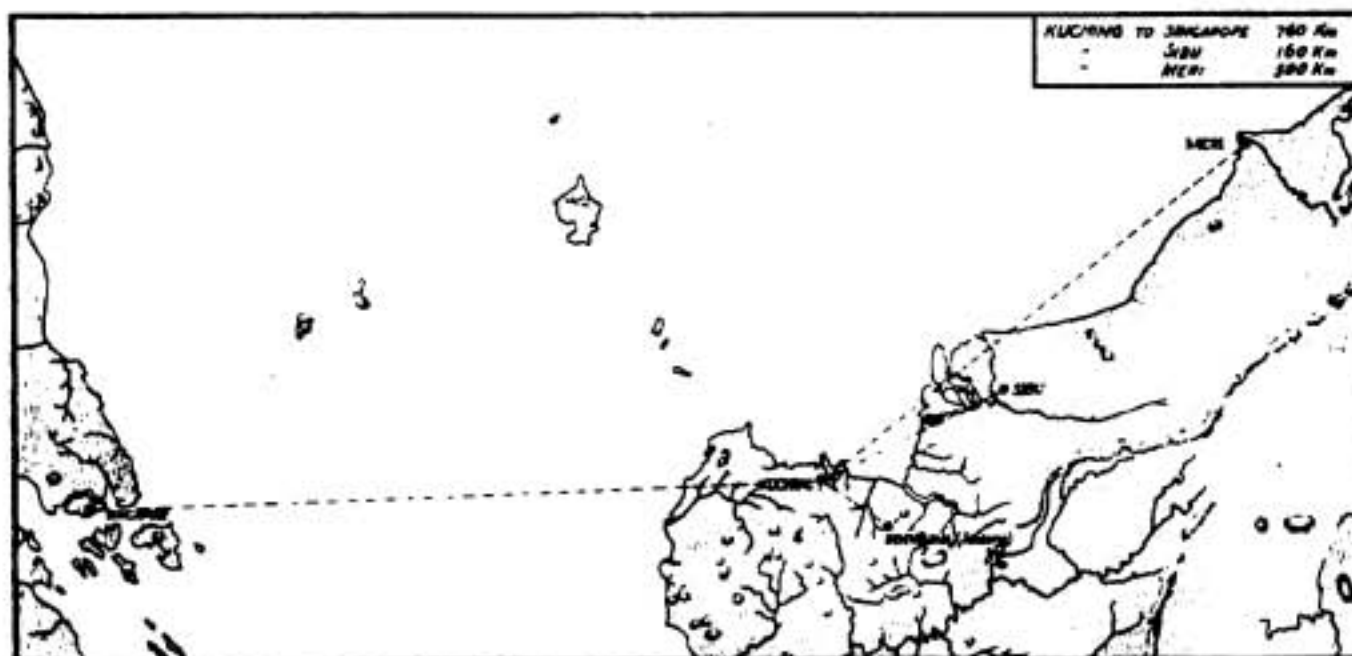

THE NEW WIRELESS SERVICE ON THE ISLAND OF BORNEO

directions. The Island was therefore isolated for a part of the week. Even before the war the Rajah recognised the necessity of establishing a wireless service in his dominions. It was therefore decided to install a station in the capital, Kuching, a commercial town of 40,000 inhabitants, principally Chinese, and to supplement this station by three others of less importance at

the surrounding districts. Lastly Simunjan, on the river Sadong, whose waters are greatly feared by Captains of vessels on account of the eddy, is a port through which pass annually 30,000 tons of coal obtained from the mines in the district.

The English Government charged the Anglo-French Wireless Limited, a branch of the Compagnie Générale de Radiotélégraphie Française (C.G.R.)

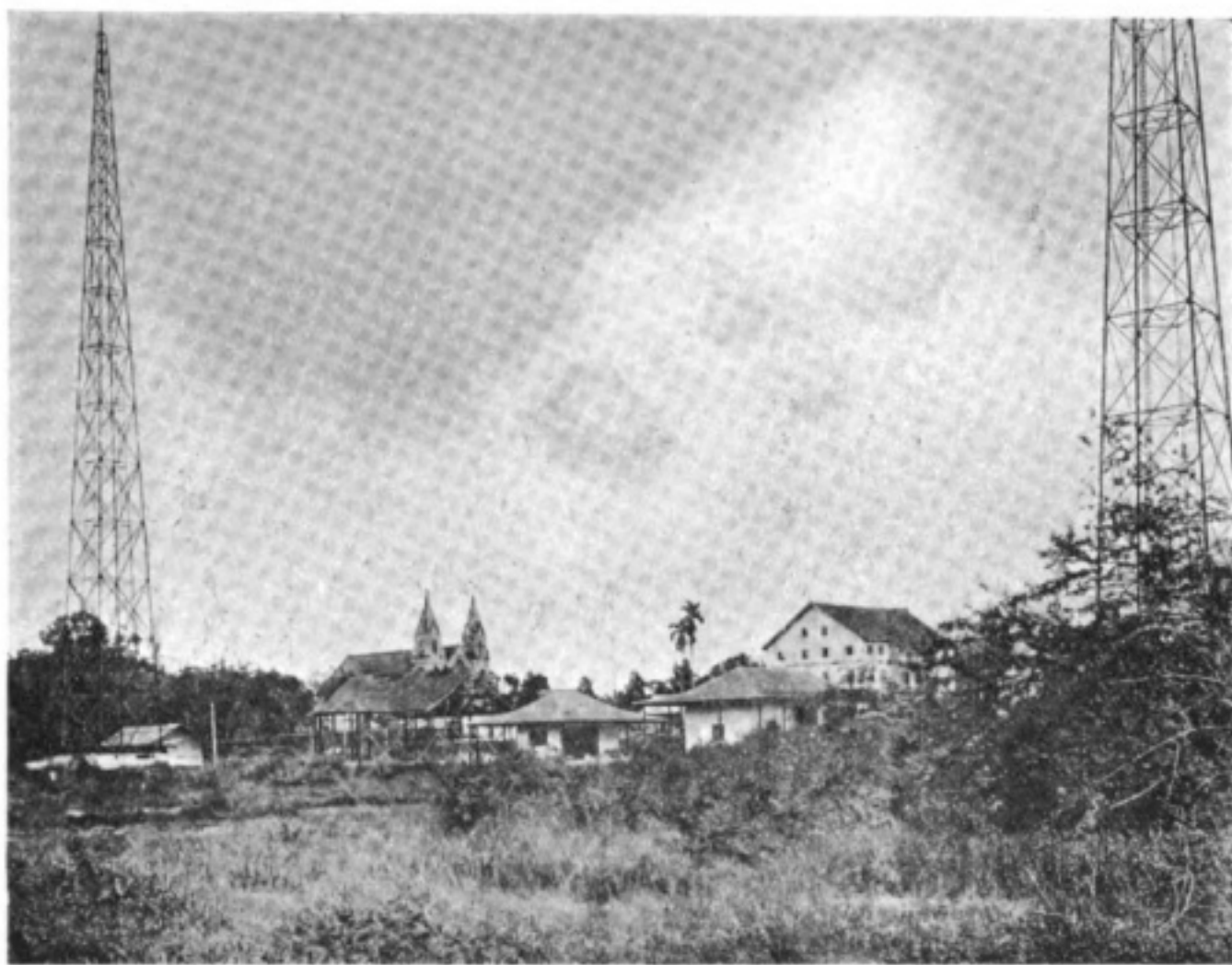

General view of the Kuching Station.

Meri, at Sibü, and at Simunjan respectively. The first of these little towns is situated towards the eastern part of the possession in which are found the petroleum layers belonging to the Anglo-Saxon Petroleum Company. Sibü, situated 60 miles up the river Re-gang, one of the most important in Sarawak, has a Dyak population and vast plantations of rubber are present in

whose patents it was working within the British Empire, to install the system. Unfortunately hostilities suspended the realisation of the enterprise. However, the submarine war having revealed the desirability for rapid communications with Singapore and with Allied vessels navigating in these waters, on account of the pirates which infested the Malay Archipelago, the Rajah of

Borneo insisted on the immediate construction of the radiotelegraphic system projected for Sarawak. Now, the Anglo Wireless having disappeared in the interval, the C.G.R. despatched a technical mission to Borneo, which mission between May, 1916, and June, 1917, succeeded in erecting four wireless stations which we are now about to describe.

Each of these stations comprises a petrol motor generating group charging

girder poles which, in their turn, support two small wooden masts of a height of 10 metres to which are fixed the terminal yards. The antennæ are of the so-called T-type, excepting that of the less important station of Simunjan, which has two wooden masts 30 metres high which were constructed on the spot.

Let us now enter into a few details concerning the engines and apparatus of the Kuching station. Its generating

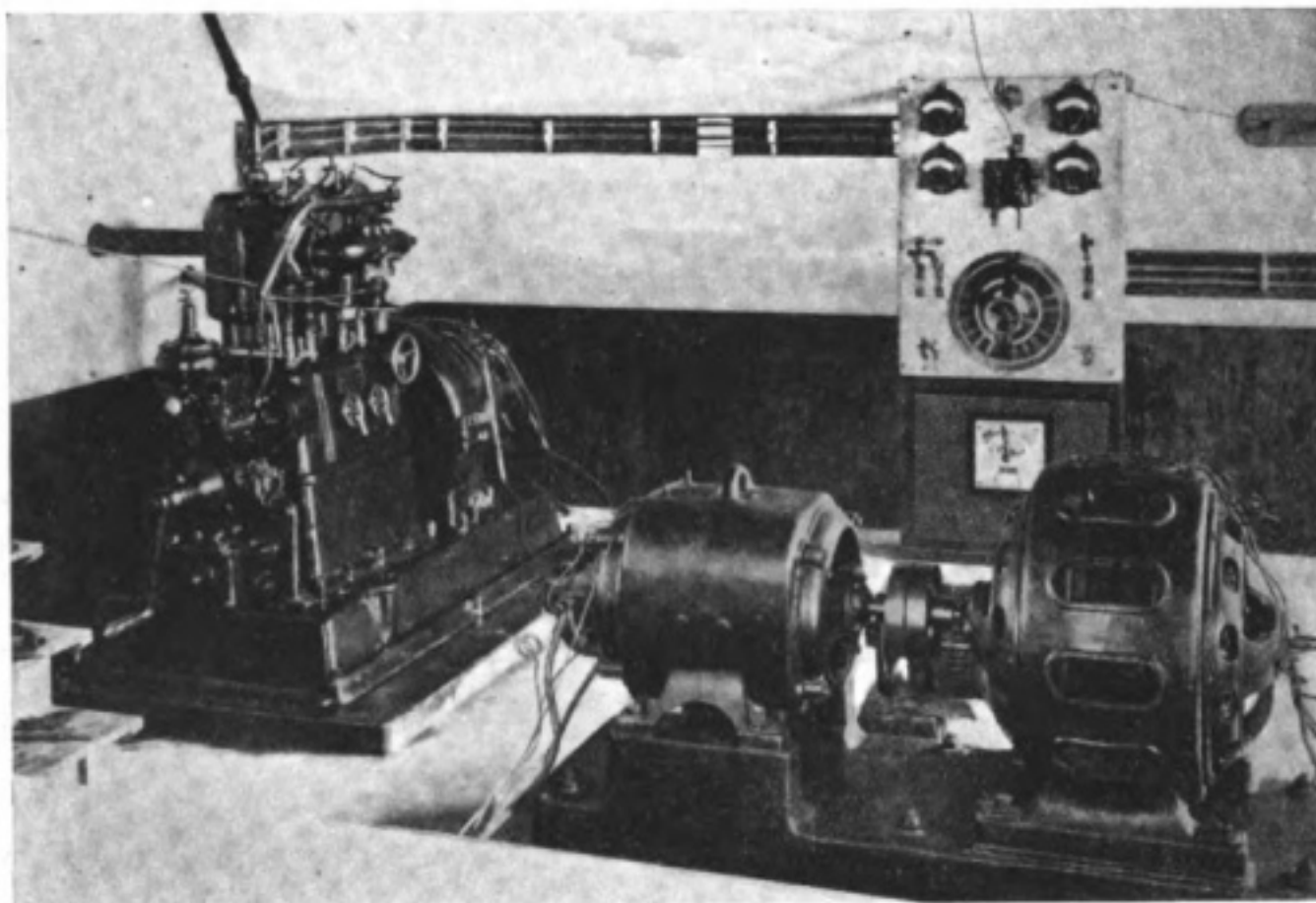

The power plant at Kuching.

a battery of accumulators. The latter feeds a converter group producing the alternating current, of 500 periods, of the oscillatory circuit. The spark corresponding to the sound of about 1,000 vibrations per second is a suitable note for piercing the parasitic sounds which are so numerous in the tropics.

In all stations of Sarawak, the antenna, as is shown by our photographs, is supported by two square-based metal

group can supply 118 amperes at 110 volts or 81 amperes at 160 volts. It is charged through the intermediary of a switch board fitted with automatic circuit-breakers. It further includes a battery commutator switch and a battery of accumulators of 60 elements, giving 800 ampere-hours. The converter group which is controlled from the operating room comprises a D.C. motor, coupled to an alternator of

THE NEW WIRELESS SERVICE ON THE ISLAND OF BORNEO

500 periods, capable of giving eight kilowatts. The transmitting apparatus is of the well known "C.G.R." type, with 56 adjustable spark gaps in series. The capacity used is 200 micro-microfarads. On the whole the transmission apparatus of Kuching resembles that in use on board French armoured cruisers.

For reception a variable coupling is employed and in view of its extremely reduced damping this system permits

1,800 metres. At the outset, transmissions were also made on a 600 metre wave, by inserting a condenser in the antenna, when it was only desired to work with Simunjan. Afterwards a wave of 1,800 metres was uniformly adopted, experience having shown that this wavelength was the most suitable for the daylight traffic performed by the stations of Sarawak, which were all closed during the night. Very good

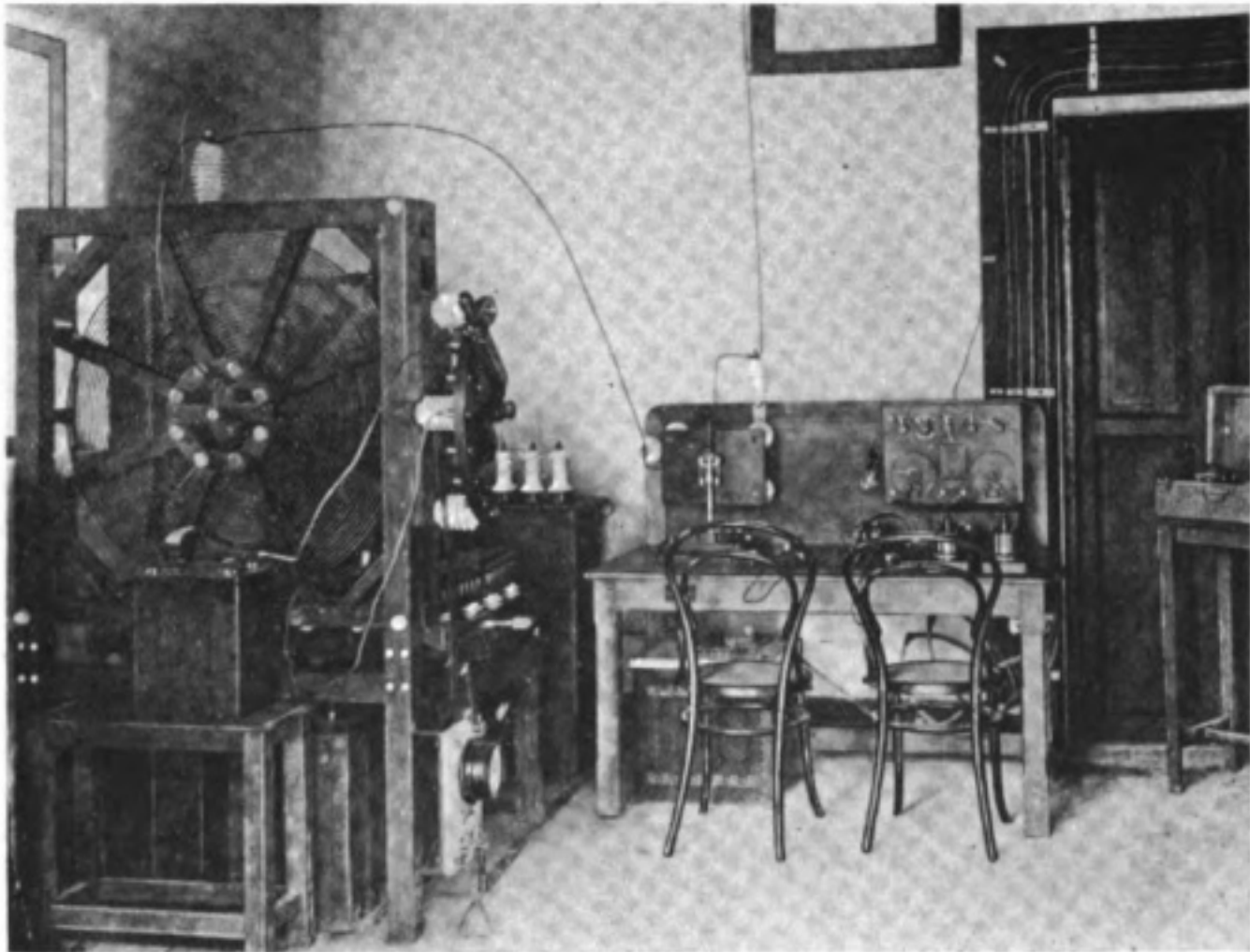

Operating Room at Kuching.

of very sharp tuning which is indispensable for a radiotelegraph station in the tropics. The two metal lattice poles, bearing the aerial, measure 75 metres and two small masts of 10 metres surmount them. This antenna, the spread of which is 102 metres, is composed of five wires supported by yards of 10·5 metres.

The length of the wave provided for long-distance communications is

signals were obtained at Singapore from Kuching, using a continuous current power input of only 60 amperes at 110 volts.

As the accompanying photographs reveal, the Engineer of the C.G.R. resorted exclusively to the services of the Malays, who were recruited on the spot and did not receive special training, for the erection of the masts of Kuching, Meri,

Sibu and Simunjan. Each race, moreover, shared the various tasks to be accomplished. The Dyaks, incomparable for work in the jungle, undertook the clearing of the ground for the sites. The Tamil Indians executed the ballastings and the concreting of the foundations. They set to work in the following manner in the erection of each mast. After having constructed a caisson

The stations of Meri and of Sibu do not differ in principle from that of Kuching but their power is only four kilowatts. The masts of the first are 60 metres in height plus a small wooden mast of ten metres, whilst those of Sibu are ten metres less.

The following are the distances which separate the stations of Sarawak from Singapore and from each other:

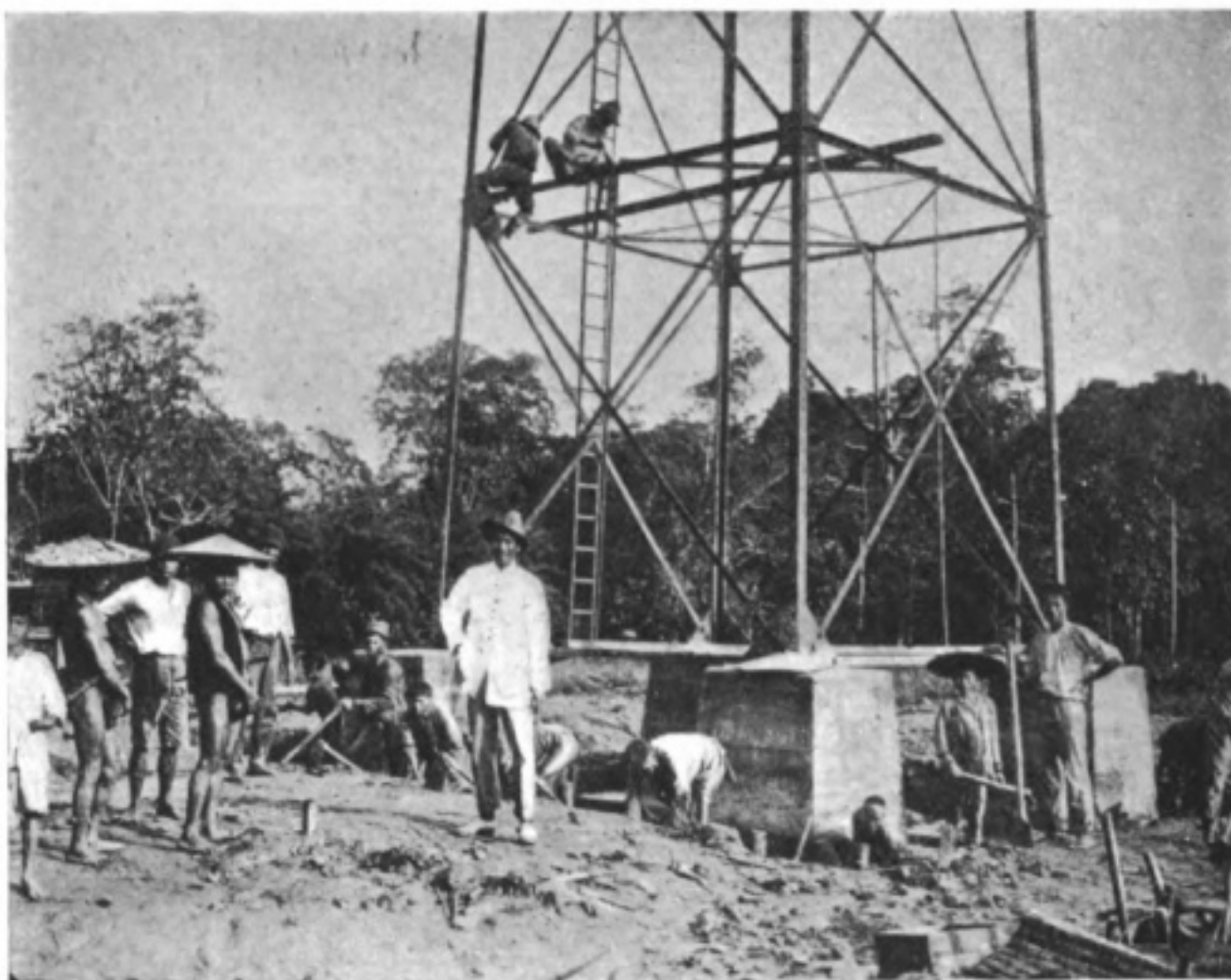

Building a mast.

on the site selected so as to form an empty space in the centre of the concrete block, they afterwards placed there one of the metal feet of the mast which they afterwards sealed. They then ran around the feet of the mast a counterweight of cement in order to avoid the ground heaping up. Next, Chinese workers erected the buildings of stone and wood.

Distance from Kuching to Singapore—
760 kilometres.

Distance from Kuching to Meri—500
kilometres.

Distance from Kuching to Sibu—160
kilometres.

The stations of Meri and of Sibu, situated near the coast, can communicate between themselves or direct with

THE NEW WIRELESS SERVICE ON THE ISLAND OF BORNEO



View of the Meri Station.

Singapore. However, for reasons of service the various stations of Borneo send their radiotelegrams through the medium of Kuching, exceptional cases apart. Their traffic is considerable as, apart from government telegrams, the messages sent by English merchants in rubber, gutta-percha, pepper and tan derived from mangroves, are amply sufficient to keep them going. Kuching sends every day at 8 a.m. (Singapore time) the time signals for the use of all

the other wireless stations of the Island whose commercial work is carried on between 9 a.m. and 2 p.m., which is the most favourable time from the point of view of atmospheric conditions. Let us add by way of conclusion that the installation of this wireless system, whilst the war was in full progress, and having regard to the local difficulties to be overcome, does the greatest honour to the French technicians who carried out the operations so successfully.

Stray Waves.

THE AMATEUR POSITION.

THE nose of the Hun has now been delicately adjusted to the grindstone, although the lock-nuts have not yet been tightened up. In other words, peace has been signed, but up to the time of writing not ratified. We now look forward to a proof that a state of war no longer exists—we do not count the small fry, Bulgaria and Co., or the war which flickers along the north-western frontier of India—in the shape of a speedy abolition of the more nauseous clauses of D.O.R.A., amongst which prominently figure those relating to the practice of radiotelegraphy by amateurs.

We are able to state that the authorities, fully mindful of what is expected of them, have already devoted a considerable amount of time to the question of private wireless working and that as soon as general conditions permit their decision will be put into execution. Last month we warned our readers that the Postmaster-General is confronted with a situation vastly different to that which existed before the outbreak of the late unpleasantness on the Continent, because of the fact that now most amateurs want to use three-electrode valves, not only for reception but for transmission also, and as we pointed out, the valve is, after the early American amateur, one of the most perfect "jamming" devices ever invented, that is, if badly manipulated. Therefore some distinction will probably have to be drawn between those applicants who are highly-skilled in the use of valves and have some serious work on hand, and those to whom the valve is simply a

charming new toy which can be made to whistle, and shout the Parisian time-signals all over the room. The thought of fifty valves, all oscillating unknown to their owners, "howling" in "fifty different sharps and flats," all less than five miles from a wireless telephone station or a research laboratory, is disturbing enough to make a professional worker put 200 v. on the grid.

There is no doubt but that the government will cheerfully extend the fullest possible facilities to competent and responsible people who, though professional wireless men in war time, become amateurs in peace, and to all who are judged likely to respect official and commercial rights.

D. F. APPARATUS ON AEROPLANES.

A. S. Blatterman in the *Electrical World* describes the D.F. apparatus designed for the large Handley-Page machine. The Handley-Page apparatus is provided with two distinct sets of loops; one is mounted rigidly on the struts of the wings of the planes, a main coil fore and aft and an auxiliary coil athwartships. These coils are sewed into a canvas band about six inches wide, and cemented to the struts and the entering edges of the planes. They are used for straight homing flying. A similar set about 3 feet square is mounted inside the fuselage of the aeroplane in such a manner that it can be rotated about a vertical axis by a disc and pulley device. By means of this set of coils and a graduated dial the line of one of the land beacon stations can be taken, and if two such readings are obtained quickly at different

STRAY WAVES

stations, the location of the aeroplane can be determined. When the fixed winged coils are used it is necessary to alter the course in order to make the direction set, the latter being on the maximum signal and not on the minimum signal or zero signal as in ground D.F. work. The accuracy obtainable with this apparatus is about $\pm 1^\circ$.

GERMAN WIRELESS ACTIVITY.

From the *Jahrbuch der Drahtlosen Telegraphie* we learn that the Wireless Telegraphy Research Department is again in full swing. At a meeting held in December, 1918, the agenda included the preparation of lists of names of persons who have been occupied on scientific and technical work in wireless telegraphy during the war, the determination of the state of their investigations, the collection of reports and patents originated during the war, the continuation of the work begun, and methods of using available apparatus. The Department was requested to take charge of all documents and apparatus, to avoid the loss of scientific information that had been obtained, and the publication mentioned was requested to publish a list of secret patents and important foreign patents with explanatory notes. In some things the German way is excellent and this prompt, organised gathering together of scientific assets is an undoubted sign that our late opponents are still to be reckoned with in the world of wireless work.

D.C. MOTOR USING THERMIONIC TUBES INSTEAD OF SLIDING CONTACTS.

We publish herewith the complete paper on the above subject due to W. H. Eccles, D.Sc., and F. W. Jordan, B.Sc., which was read before the Physical Society of London.

In physical laboratories, especially those in which electric waves and oscillations are studied, circumstances sometimes arise in which a wheel or disc has to be spun rapidly under light load and with absolute freedom from the sparking that occurs in the best ordinary direct-current motor. In such cases a motor employing a rotating magnetic field can be used if alternating current is available, but often alternating current is not at hand. We therefore describe in this paper a small perfectly sparkless motor that can be run from a direct-current supply, such as that used for lighting. Apart from the applications alluded to, this new motor might be used for maintaining gyrostats in rotation, for driving stroboscopes, and so on.

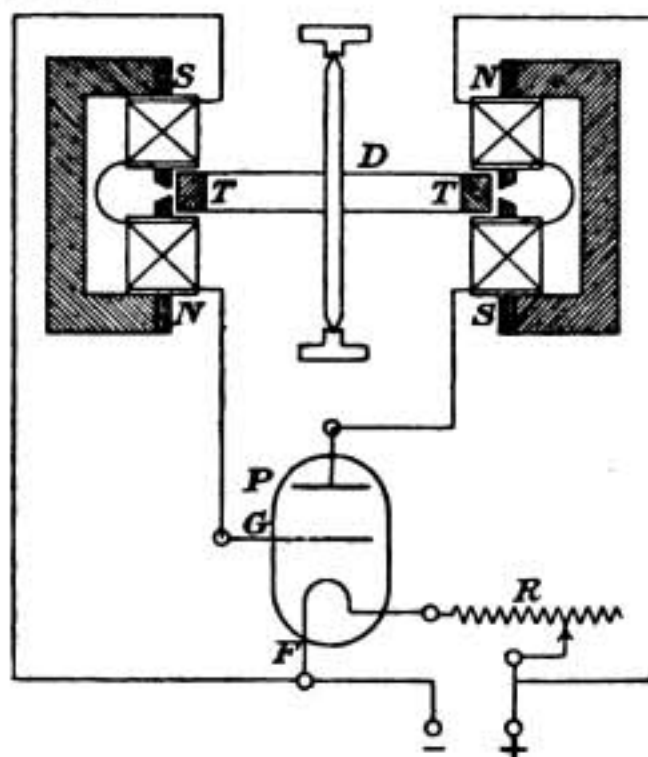

The motor is an application of the three-electrode ionic relay now so well known. In such relays there is a glowing filament *F* functioning as cathode, a plate or cylinder *P* as anode, and an intervening grid *G* as control electrode. A constant E.M.F. is applied between filament *F* and anode *P* and causes a steady stream of electrons to pass from filament to anode across the vacuum.

When a control voltage is applied between filament and grid the anode current increases if the grid is made positive relative to the filament, and it diminishes if the grid is made negative. Either terminal of the filament may be taken as the zero of potential, but it is customary to take the negative terminal. For instance, in the small tubes shown with the motor, the anode current may be about 1.5 milliamperes when the grid is at the same potential as the negative terminal of the filament, and 2.5 milliamperes when the grid is at + 5 volts and 0.4 milliamperes when the grid is at - 5 volts. The current flowing into the grid in the former case is 150 microamperes and in the latter zero. When an alternating voltage is applied to the control electrode an alternating current appears in the anode or repeat circuit superposed upon the steady current that flows in the quiescent state. This alternating current is capable of doing work, and the power thus made available is much greater than that expended in the control circuit—a fact implied in calling the tube a relay.

In the motor to be described a number of iron teeth are carried by the rotating part of the motor past an electromagnet connected into the control circuit of the ionic relay, and these teeth generate in the windings of the electromagnet an alternating E.M.F. that is applied to the grid of the tube. The corresponding alternating current in the repeat circuit is sent through a second electromagnet connected in that circuit and also placed near the rotor. Its position relative to the former electromagnet and to the teeth is so adjusted that the alternating current in it tends to accelerate the movement of the rotor. Put briefly, we may say that the passage of an iron tooth in front of the control magnet applies to the grid an E.M.F. that produces, by means of the

relay, a current in the second electromagnet in such a direction as to pull forward the tooth just approaching it. In consequence the spin of the rotor increases until frictional and other losses consume all the energy liberated from the battery in the anode circuit.

Obviously a motor constructed on these principles may take many different forms. In the one sketched in the figure, the rotor is a horizontal ebonite disc 12 cm. in diameter mounted on a vertical spindle; the electromagnets are the polarised magnets from a pair of 4,000 ohm. Brown telephone receivers. The iron teeth are twelve in number and fixed at equal distances on the rim of the ebonite disc.

“BEAT” RECEPTION OF INSECTS' SOUNDS.

It is fairly well known that the human ear is sensitive only to waves of frequencies between about 30 and 25,000, and that therefore sounds produced by air disturbances at higher or lower frequencies are inaudible to us, though in certain cases the physical effect of the vibration can be felt. The ear, as a detector, may be said to have “flat” tuning, being operative only over a limited range. Bats and certain insects are said to emit sounds which are much too high pitched for us to be sensible of them, and a writer in the *English Mechanic* puts forward the suggestion that by means of employing the well-known “beat” method of wireless telegraphy this disability may be overcome. To entomologists this experiment should prove of considerable interest, but for ourselves, having chicken-keeping neighbours, we have no desire to eavesdrop on beetles and butterflies. Providence obviously intended us to be deaf to certain noises—and we presume to agree with the proposition.

“W/T. R.E.”

An Account of the Work and Development of Field Wireless Sets with the Armies in France.
By Capt. B. F. J. Schonland, O.B.E., R.E., late Staff Officer (Wireless)
1st Army, France.
(Continued from July Number.)

THE village of Paschaendale has a commanding view of the country on the Roulers Plain below it, and our possession of the village and ridge in December, 1917, made things very uncomfortable for the Boche. Unfortunately the country on our side of the ridge was, as is well known the most terrible slough, quagmire and quicksand that has ever existed. To lay cable above ground was useless, as it was cut by enemy fire as soon as laid, so a “C.W” wireless set was installed in Paschaendale village and from a tiny aerial kept in communication with Ypres, eleven kilometres away. In spite of very heavy shelling it gave prompt information of targets for the artillery for many days. Eventually the whole set was blown up by a shell. A new one was installed a little way back, and the same communication kept up. The work of this set was invaluable.

In the first battle of Cambrai, November, 1917, our sudden attack with Tanks took the enemy completely by surprise. Wireless sets were carried forward in some of the Tanks and then removed, small masts erected and good communication obtained with their “base.” The advance was so rapid that the sets with infantry battalions and brigades had a big start over the telephone communications. Though lines for the latter were laid at a “gallop” once the trench system was crossed, for

several hours the B.F. sets did the necessary transmission of situation reports and orders. The enemy’s sudden counter-blow on November 29th resulted in the cutting of the main trunk telegraph and telephone lines between the two army corps affected, within a few hours of the first attack. As a consequence the wireless stations in the sector had a very busy time. Not only were they flooded with traffic, but they had constantly to retire and to re-erect their stations. The experience gained by all concerned, in the way of traffic disposal and regulation under conditions of abnormal pressure, was great. It led to changes in organisation which were felt the following year, when such cases of traffic “flooding” the stations were of almost daily occurrence.

No mention has so far been made of the Power-Buzzer, an instrument which we adopted from the French and later improved. In some respects hardly a “wireless” set—for it was part of a method of signalling by conduction through the earth—this, too, was manned and run by the wireless sections. It may shortly be described as an induction-coil “buzzing” a current into the earth by means of two earth-pins a hundred yards or less apart, connected to the coil by well-insulated cable. This buzzed current spreading out along the earth’s surface was picked up by two similar earth-pins connected to a three-valve amplifier. As the Power-Buzzer required no aerial wires

and could work over a range of from one to three thousand yards it was much used for the very forward infantry communications over areas where the enemy's barrage fire was intense. Its working was, of course, affected by the nature of the country between it and the amplifier. Owing to its extreme simplicity, portability, and the ease with which the length of cable could be repaired if broken, the Power-Buzzer was very successful in trench-warfare. It was often carried over with the second wave of attacking infantry, both for raids and for actual attacks. It could always be found in a hole near or in the front line, sometimes in a forward post in front of the front line; a hole dignified by the name of dug-out, that served the operator for shelter, bedroom, dining-room, office, and home generally.

Like the B.F. set, the Power-Buzzer was in every attack in 1917, though still nearer the enemy—so near that a story is told of a German who seized one of the earth-pins during a fight and remained fixed to the spot, earth-pin glued to his hand, while the operator kept his key pressed and another disarmed him! Even the mud of Flanders, though restricting the range, could not prevent the Power-Buzzer from saving the forward communications of the Naval Division in the battle of Ypres. Some idea of the small distances involved in such work, distances which could be covered in no other way may be gathered from the case of the Power-Buzzer in Bullecourt in May, 1917. Bullecourt, as readers may remember, was the high-water mark of the 1st Battle of Arras, and round this little village raged one of the most furious struggles the war produced. Even after the enemy's direct attacks had ceased he kept shelling it all day and all night. Communication with the village was well-nigh impossible over one stretch of five hundred

yards. This stretch was spanned for several weeks by a Power-Buzzer installed in a dug-out in the village. The earth-pins were some fourteen yards apart, also in the dug-out.

This narrative has now been brought up to the close of the year 1917. The probationary or at least the youthful stage of the development of the W/T section R.E. was over at the end of that year. As I have tried to show, it had gradually grown from nothing to an organisation which was proving daily of incalculable value to the fighting troops. In spite of prejudice and difficulties, it was now plain that the salvation of forward communication in battle lay in wireless telegraphy.

My account of the work of wireless with the Signal Service in France must now be continued for the year 1918. The reader will have seen how, from a small beginning, a large organisation had sprung up. Great expectations were entertained of the work this organisation would do in 1918. That these were justified the sequel will show. During the winter of 1917-1918 the training of officers and men in the sets was brought to a very high pitch of efficiency, while the sets themselves were improved and increased in number and in power. The experience already gained in battle led to the design and production in large quantities of a number of new types of forward sets, notably a special pattern of continuous wave set and a very small portable spark set, known as the "loop" set. Events showed that sets could not be produced fast enough, so great was the demand during the epic fighting of the last year of the war.

The opening of the year brought with it the proud German boast of their great offensive which was to drive the Allies into the sea. In the mists of

the morning of March 21st the expected attack from the Hindenburg line took place. Thanks to his elaborate preparations which included the provision of many light motor wireless sets the enemy succeeded in driving us back to within a few miles of Amiens. His wireless sets were working day and night, a veritable wireless "barrage," but our own were by no means idle. In spite of inevitable disorganisation, the difficulties of keeping accumulators charged, etc., our sets were everywhere of great value. One incident in the retirement should be historic. A battalion of the 37th Division, at Epinedes-Dallon, near St. Quentin, was ordered to cover the retirement of the division, and supplied with a trench set with which to keep in touch with headquarters. The battalion bravely did its work, though eventually surrounded by overwhelming odds. They held out until a message was received from the divisional general, thanking them for this great stand, whereby the retirement of the remainder had been safely accomplished. Back came their reply, "Goodbye, we are going to fight our way out."

After his attack further north and his suicidal attempt to take Paris, the tide turned against the Boche. The fourth British army in front of Amiens caught the enemy napping. The way wireless was used to "camouflage" our attack I hope to mention later. Our advance, owing to secrecy and careful preparation, was swift. The wireless sections of divisions, corps and armies were ready for a speedy advance, and had an enormous amount of traffic to deal with. One station, for example, dealt with 1,100 messages in six days, most of which messages had to be coded and de-coded. The pack-sets and motor wireless sections with the cavalry had work in plenty. Captured enemy

wireless sets became a drug on the market!

So the advance went on until three armies, the First, Third and Fourth were "going over the top" together. The story of their advance is well-known—how the First Army pushed forward to Cambrai, turning the enemy's flank while the two armies below fought their way to the Hindenburg line, broke through it, and pushed on. What was "Sparks" doing all this time? The answer is best given by the two maps reproduced herewith. The first shows the distribution of spark sets and Power Buzzers on the First Army front just prior to the August offensive. I have not included the continuous wave artillery wireless system in this, for fear of complicating it. In the second map, which shows the same front after the offensive had started I have included the continuous wave system on a part only of the front. The reader will realise that the efficient working and control of so many stations in such a small area was a big problem. "Sparks," as you see, was busy! But he got busier still as the advance went on. Through Cambrai, St. Quentin, Douai, still we pushed on, faster and faster until the last few weeks when Lille, Valenciennes, Roulers, Mons, and Maubeuge saw our victorious troops.

As the advance quickened its pace it became more and more difficult to maintain even the most vital telegraphic communications with the troops. The Germans in their retreat had in most cases wrecked their own elaborate system of telegraph routes. Where the routes were not wrecked the wires were often touched with acid, and the poles carefully sawn half through. These little tricks of the wily Hun often gave trouble, while his habit of blowing up cross-roads and flooding the country by the destruction of locks and dykes

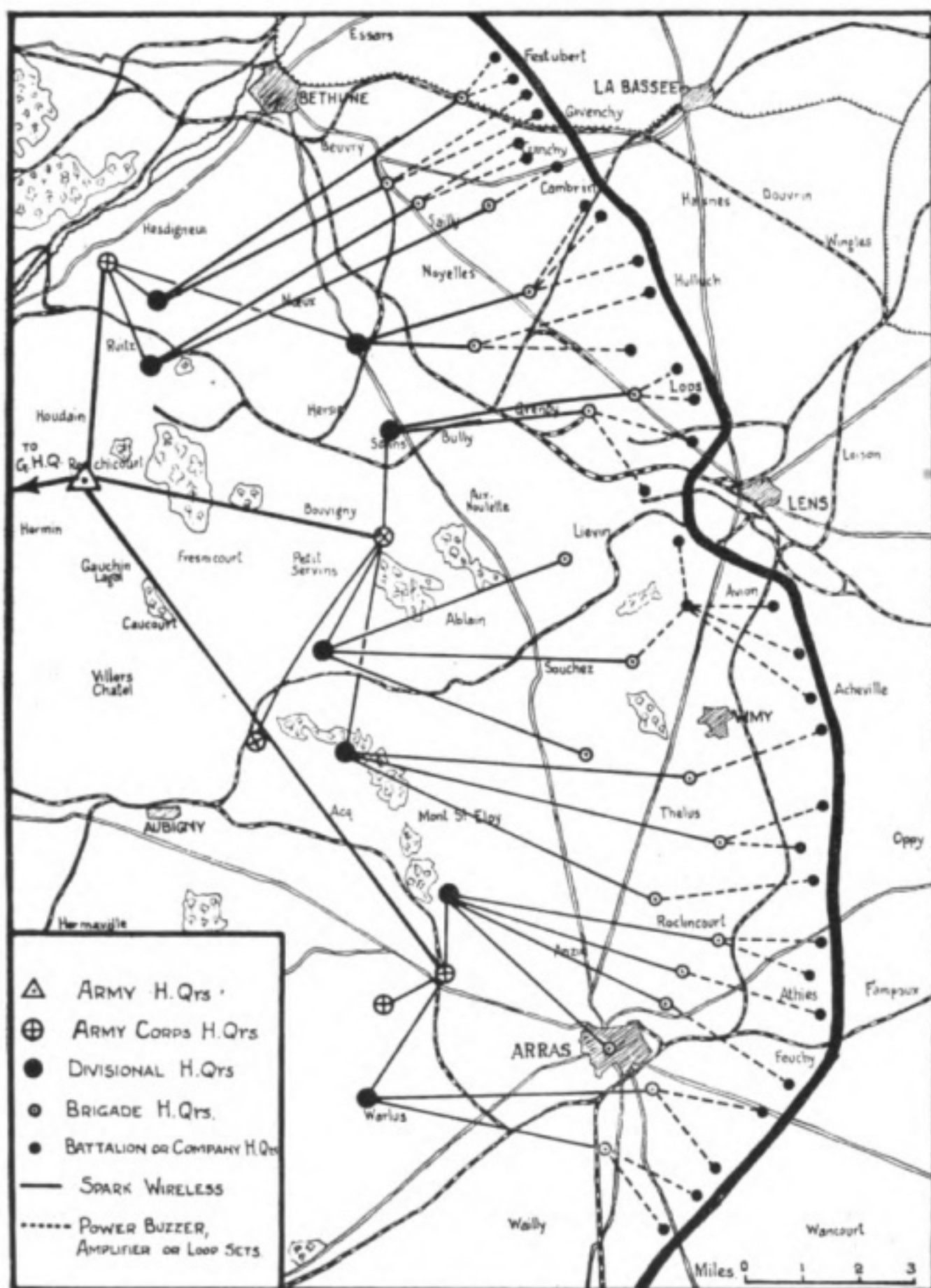

The First Army front just prior to the great offensive of August, 1918.

made the motor-cyclist despatch rider's life a most unhappy one.

A detailed account of the work of wireless in the last months of the war would be a very big undertaking. The number of sets was then enormous, and new sets arrived daily from England, only to be swallowed up immediately. Besides the spark system—the "B.F." Sets, "loop" sets, Power-Buzzers, more powerful "Wilson" Transmitters and Mk. III Tuners, and the $1\frac{1}{2}$ k.w. sets at army headquarters—which was working hard everywhere, the continuous wave system was of incalculable value to artillery and other units. I can only quote some typical instances. I have referred to the "loop" set, a very small portable spark set produced in 1918 for forward work. Once our rate of advance reached from three to six miles a day, the Power-Buzzer with its smaller range was put aside, and the most forward link in the wireless chain was filled by this little set. The supply of sets at the time of the armistice had not sufficed to equip all divisions fully in this respect, but some of these tiny sets were dealing with sixty to eighty messages a day in forward positions, such as company to battalion headquarters.

The B.F. sets with brigades and division did what was expected of them. That is to say they were often at it day and night without a rest, transmitting and receiving orders for future attacks, sending back reports of attacks in progress, ordering ammunition and supplies, and generally taking the traffic while lines were being repaired. Even the spark sets at army corps and army headquarters, whose work was usually of a control nature, to stop jamming and to see that no information was divulged by careless operating, had their chance. The difficulties involved in the maintenance of line communication and des-

patch-rider services, which I have touched on above, though wonderfully overcome in most cases, meant that it was not uncommon for a batch of thirty or forty messages to be sent from the signal (telegraph) office to the wireless station for transmission. The writer remembers one evening when an army corps had a dozen messages for its divisions, all concerned with an attack which was ordered by one of the messages for the following morning. To get messages to the divisions by line telegraph was impossible all lines were "down." Bridges too were "down," and to add to the difficulty the divisions had moved forward. To find them by despatch-riders in the darkness and with roads and bridges blown up was a hopeless proposition. So the corps wireless station started up and called its divisional stations. They all replied when called, and the messages were safely despatched, all other traffic ceasing till the "S.O.'s." (Urgent Operations Priority) had been duly acknowledged. The attack next day caused the fall of Valenciennes. The efficient working of the spark wireless system meant a great deal at such a time; thanks to the work of the personnel concerned, to organisation, and to careful preparation, it never failed.

Continuous wave sets with the "gunners" were in use with both heavy and field artillery. If difficulty was experienced in laying and maintaining telegraph lines for infantry "command" purposes, the difficulty here was still more acute. The cry from the artillery was for more C.W. sets, and still more! With the Forward Observation Officer in his O.P., with the guns themselves or with the headquarters of the artillery brigade, the valves of the C.W. sets were flickering night and day, and that their success was great is beyond any doubt. One divisional ar-

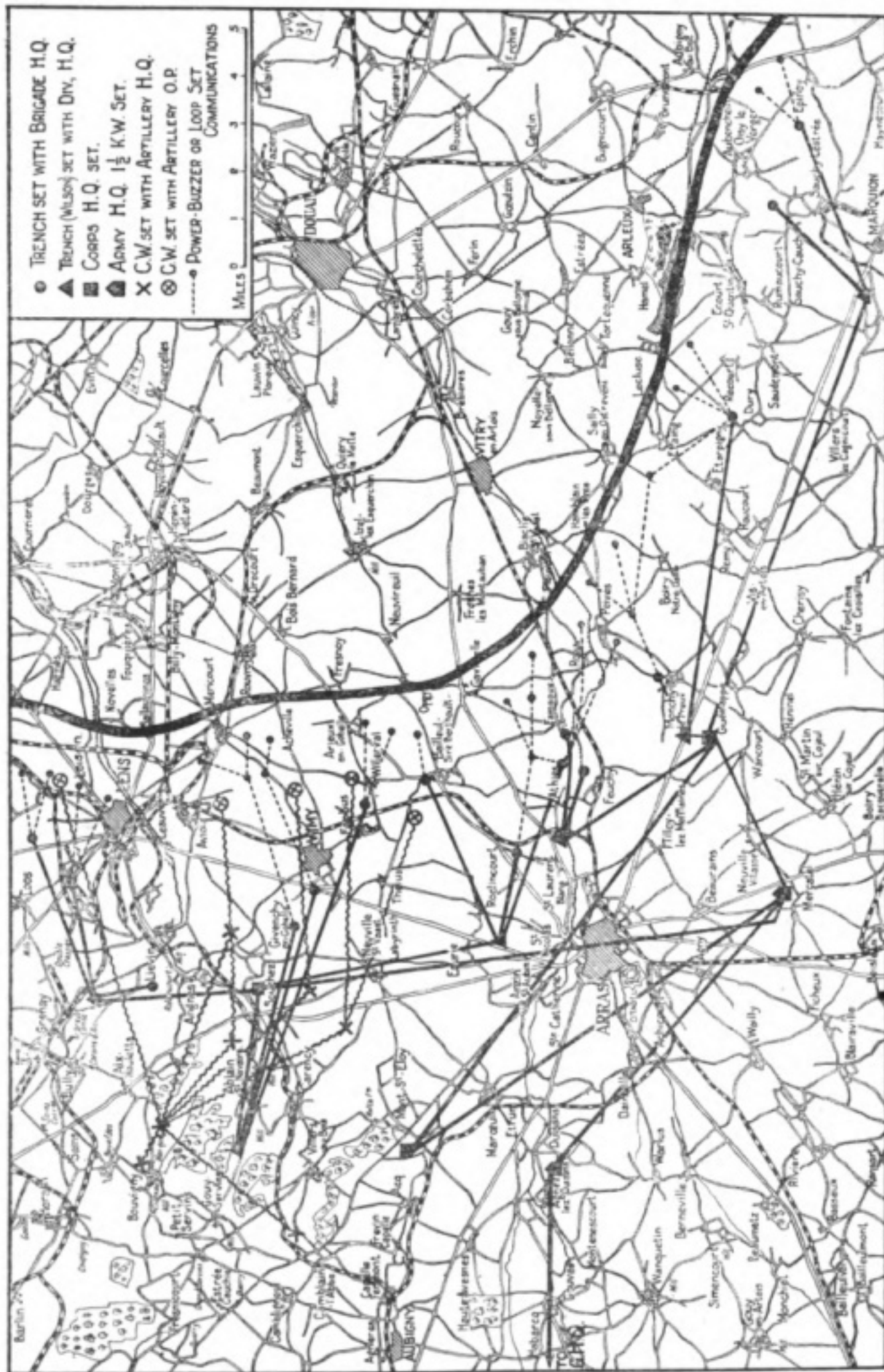

The First Army Front after the British Offensive in August, 1918, had started.

"W/T. R.E."

tillery brigade used practically nothing but C.W. sets for its communications to O.P.'s and batteries for at least three weeks on end, giving up laying telephone line altogether. It was still using C.W. only when last I heard of it.

A striking example of wireless as sole means of communication is afforded by the Canadian Independent Force. A most formidable collection of armoured cars, machine guns and pompoms mounted on cars and lorries, this force would "sail out into the blue" once the fighting became open enough, engaging machine-gun nests and anti-tank guns with great success. One car carried a C.W. set which kept the force in touch with a special set at a convenient headquarters behind our line, sending back reports and keeping the force itself informed of the progress of events elsewhere. That it was possible to keep such a detached force in close touch with the commander of the main body of attacking troops is a remarkable de-

monstration of the value of wireless in modern warfare.

Similar service was rendered by C.W. sets provided for parties of scouts working as special observers all along the front, and sending back reports by wireless. These reports which were concerned with the progress of our operations, the movements of the enemy, and possible targets for our artillery, were sent and acknowledged without the slightest trouble over distances varying from ten to twenty miles. A collection of the messages sent by only one such station during a day of battle makes interesting reading. From the first message:—"Our men over (the top) 5 a.m. enemy barrage (come) down 5.05 a.m. our troops reached—and—," onwards through the heat and turmoil of the day's battle, the messages show how perfect and rapid was the wireless communication. The staff frequently expressed their appreciation of the continuous success of these sets.

(To be continued.)



Photo.

Wireless Directing Artillery.

A.I.A.

Notes of the Month

ROYAL AERONAUTICAL SOCIETY'S GARDEN PARTY.

DIRECTIONAL wireless, in all probability, will render nautical astronomy as dead as a doornail." Such was the assertion of Commander T. Y. Baker, R.N., of the Compass Department of the Admiralty, in a lecture on "Navigation on a Transatlantic Flight," given appropriately enough in a Hangar at the Handley-Page Aerodrome on the occasion of the Jubilee Garden Party of the Royal Aeronautical Society on June 29th. Commander Baker followed up his interesting pronouncement with a verbal picture of the time when by means of whole chains of directional wireless stations and specially prepared curve charts it will be possible for aerial and marine navigators to plot their positions independent of all adverse conditions.

At the same function there was a most attractive exhibit of modern scientific aids to aerial warfare. This had been prepared by the Technical and Research Department of the Air Ministry and included various types of wireless transmitters and receivers employed by the Royal Air Force for telegraphy and telephony and a direction-finding outfit such as was fitted by the R.A.F. to big bombers of the Handley-Page type.

WIRELESS EQUIPMENT OF THE N.C.4.

The official description of the American Naval seaplanes which figured in the recent Transatlantic flight, contains the following interesting details: "Com-

plete wireless installation, including telegraph and telephone and wireless direction indicator, is provided. System should give a radius of about 300 miles (480 km.) while in the air and of 100 to 150 miles while on the water.

"Electric energy is furnished by an electric generator operated by a wind-driven propeller. Energy is delivered to storage batteries. In addition to operating wireless set the storage batteries operate a complete lighting system for interior of the boat and for wing-tip, and tail lights as well as lights for night landing.

"The wireless operator and engineer are stationed in the main after-compartment just aft of the gasoline tanks. Each is provided with a complete instrument board. Each of these operators has a cylindrical upholstered stool with back rest weighing 5 lb. (2.2.kg.) complete, in the interior of which can be stored the small hand tools required for emergency work."

CANADIAN D. F. STATIONS.

During the war the Canadian Naval authorities erected four stations equipped with direction-finding apparatus for the purpose of locating enemy vessels and aiding allied or neutral shipping. The stations, which are constructed on the Bellini-Tosi principle, are situated at Cape Sable, Nova Scotia; Shebucto Head, Halifax Harbour; Cape Canso, and Cape Race, Newfoundland. They are now being operated for the benefit of shipping in general.

WIRELESS CLUB NOTES.

THREE TOWNS WIRELESS CLUB.

June 19th was devoted to instructional purposes, the Chairman being Mr.

NOTES OF THE MONTH

Jerritt, who congratulated the members on the splendid progress they were making. He also informed the members that he had that day received from the Postal authorities his 10-inch induction coil, which was a good sign for amateurs, as it showed that the hard and fast rule with regard to the use of wireless apparatus was being relaxed.

June 26th.

There were several new members enrolled at this meeting. Mr. J. Jerritt presided. Mr. Voss, one of the members, gave an interesting lecture on Primary and Secondary Batteries. It is hoped as soon as permission can be obtained to construct instruments for the Club and also to apply for a licence and erect an aerial.

The Club will be pleased to welcome visitors and to enrol new members. All communications should be sent to W. Rose, Hon. Sec., 7 Brandreth Road, Compton, Plymouth.

SHEFFIELD AND DISTRICT WIRELESS SOCIETY.

A very enthusiastic meeting was held in the Council Room of the Literary and Philosophical Society on June 20th, when a permanently organised Wireless Society for Sheffield and the surrounding district was formed. H. E. Yerbury, Esq., M.I.C.E., M.I.E.E., who presided over the meeting, was elected as President for the ensuing year. It is proposed to secure premises in the centre of the City, if possible, where members may meet to read and discuss papers, and where, eventually, it is hoped, by arrangement with the Postmaster-General, to instal an Aerial and the necessary instruments for experimental work.

The Hon. Secretary is Mr. L. H. Crowther, 156 Meadow Head, Norton Woodseats, to whom application for membership should be sent.

THE NORTH MIDDLESEX WIRELESS CLUB.

A meeting of the Club was held on June 3rd at Shaftesbury Hall, Bowes Park, and was well attended.

The Chairman expressed his pleasure at being able to see the Club back in its old premises and after a few appropriate remarks, called on Lieut. Holton to continue his lecture on valve-receivers. Lieut. Holton then took up his subject at the point where he had left off at the previous meeting and explained by means of diagrams a number of ways in which these wonderful instruments could be used.

At the close of the meeting a vote of thanks was proposed and duly carried.

Another meeting of the Club was held on June 17th, at Shaftesbury Hall, Bowes Park, the chief feature of the evening being Mr. A. G. Elam's description of a method of Wireless Telephony, illustrated by diagrams, and a very simple and amusing analogy explaining the action of valve detectors. Mr. Elam has promised to continue his paper on the "Arc" method of wireless speech at a future meeting of the Club.

A vote of thanks was proposed to Mr. Elam at the close of his lecture, and was duly carried.

Full particulars of the Club may be had from the Hon. Secretary, Mr. E. M. Savage, "Nithsdale," Eversley Park Road, Winchmore Hill, N.

EXHIBITION OF WIRELESS TELEGRAPH APPARATUS.

Those attending the British Scientific Products Exhibition at the Central Hall, Westminster, between July 3rd and August 5th, will have the opportunity of inspecting a very fine selection of wireless apparatus which is being displayed by Marconi's Wireless Telegraph Co., Ltd. This includes the Marconi Low Power Telegraph sets for Aircraft direction - finding apparatus,

short-range wireless telephone sets (special 20 watt sets working with frame aerials inside the building) and the Marconi $\frac{1}{4}$ k.w. Cabinet set.

Similar apparatus will also be on view at the Shipbuilding, Engineering and Machinery Exhibition at Olympia (September 25th to October 17th), and in addition there will be shown the various standard ship sets.

The same Company is exhibiting at the Federation of British Industries Exhibition at Athens (October 13th to November 14th).

NEW WIRELESS STATIONS.

The coast station at Nieupoort has been closed.

New stations have been established at Ostend and Antwerp.

Pending the re-establishment of normal services, these Stations are only open for communications exchanged

(1) Between the Owners and Masters of ships. Such telegrams must be written in plain language and refer to the route or the safety of the vessels.

(2) Between Masters and Naval Authorities. Communications concerning mines may be sent in code or plain language.

MARCONI'S WIRELESS TELEGRAPH CO. v. THE POSTMASTER-GENERAL.

The hearing, before Mr. Justice A. T. Lawrence, of the arbitration between Marconi's Wireless Telegraph Company and the Postmaster-General, to assess the damages due to the Company for the repudiation by the P.M.G. of the contract between the Company and the Government for the erection of six wireless stations in the Imperial wireless chain, is still continuing as we go to press.

THE BRITISH SCIENTIFIC PRODUCTS EXHIBITION.

The above exhibition was formally opened on July 3rd, 1919, by the Most

Hon. the Marquess of Crewe, K.G. (President of the Exhibition), assisted by Lord Moulton, K.C.B., and the other members of the Organising Committee. The Chairman (Lord Sydenham) and the other speakers referred to the very great importance of Scientific Research and of the value of the British Science Guild (and of these exhibitions in particular), as an intermediate link between the academical side of scientific research, and the practical and industrial application of such researches by the manufacturers of the country. Sir Richard Gregory (Chairman of the Exhibition Organising Committee) pointed out that no one could say in what direction a given piece of scientific research or discovery would lead or would find practical application, any more than one could foretell the subsequent career of a young child. As an example he instanced the important developments of wireless telegraphy and telephony from apparently unproductive laboratory investigations. The use of the valve for wireless telephony was an excellent illustration of the application of an obscure physical phenomenon (the unilateral conductivity of the vacuum space in an electric lamp) to an important commercial field.

GOLD MEDAL FOR RADIO WORK.

On May 7th at a meeting of the Institute of Radio Engineers in New York, Mr. E. F. W. Alexanderson was presented with the Institute's Gold Medal in recognition of his original research and inventions in the field of radio-telegraphy. Mr. Alexanderson is well known to most of our readers as the inventor of a high-frequency alternator which is capable of generating several kilowatts of H.F. energy at 200,000 cycles. He has also invented a very important magnetic amplifier

The Weagant "X-Stopper."

(Continued from July Number.)

As mentioned in the previous part of this description (July Number, p. 211) it has been found as the result of the extended experiments with this apparatus, that whereas the "grinder" type of atmospheric appears to be propagated in a vertical direction, perpendicular to the earth's surface, the "clicks" arrive at the receiving station from various horizontal directions. It is therefore not possible to cancel out the X's of this latter type by the arrangements that have already been described. The "grinders" are found to be the most troublesome form of X's in transatlantic reception during the warm days and the "clicks," which sound like relatively widely spaced crashes in the telephones, are most noticeable during the cooler periods of the day and year. They do not, however, except on rare occasions, reach an intensity sufficient to interfere with the reception of signals, the strength of which is equal to the normal strength of Carnarvon or Nauen. With weak signals, however, the intensity of this type of atmospheric is sufficient at times to cause great difficulty in reception.

If a single receiving loop is employed as in Fig 3 (June issue) it will pick up, if properly tuned, atmospherics of both the above-mentioned types.

In order then to cancel out *all* the atmospherics from the detector circuit it is necessary to have a source of atmospherics of the *same frequency and decrement* as those occurring in this loop circuit. This auxiliary source of X's must not at the same time introduce into

the detector circuit any signal currents (although tuned to the same frequency as the incoming waves) or these would partially or entirely cancel out the signal currents originating in the main receiving loop. This desired source of X's may be secured by making use of the principle employed in the two-loop arrangements already discussed, by reversing the connections to one of the loops so that instead of cancelling out the X's and leaving the signals, we cancel out the signal currents and leave the X's. The source of atmospherics thus obtained is then connected in opposition to the signal and X currents, as shown in Fig. 9. In this diagram A and B are the two outer loops connected through the tuning circuits $L_1L_2C_3C_4L_8$; and $L_3L_4C_7C_8C_9$ in a similar manner to the previously described arrangement, Fig. 4. The coils L_8L_9 form the fixed coils of the goniometer coupling between the two outer loops. The third goniometer coil is shown split into two parts $L_{10}L_{10}'$ coupled to L_8 and L_9 . This coil forms an intermediate circuit coupled inductively through $L_{11}L_{12}$ to the detecting (or amplifying) valve as indicated.

The main reception takes place on the central loop E which is coupled to the same intermediate circuit through coils L_5 and L_7 , while the atmospheric disturbances are cancelled out in this circuit by proper adjustments of the sense of the couplings $L_8L_9L_{10}$.

This arrangement was found to result in a material improvement in working over that obtained with the two-loop circuits.

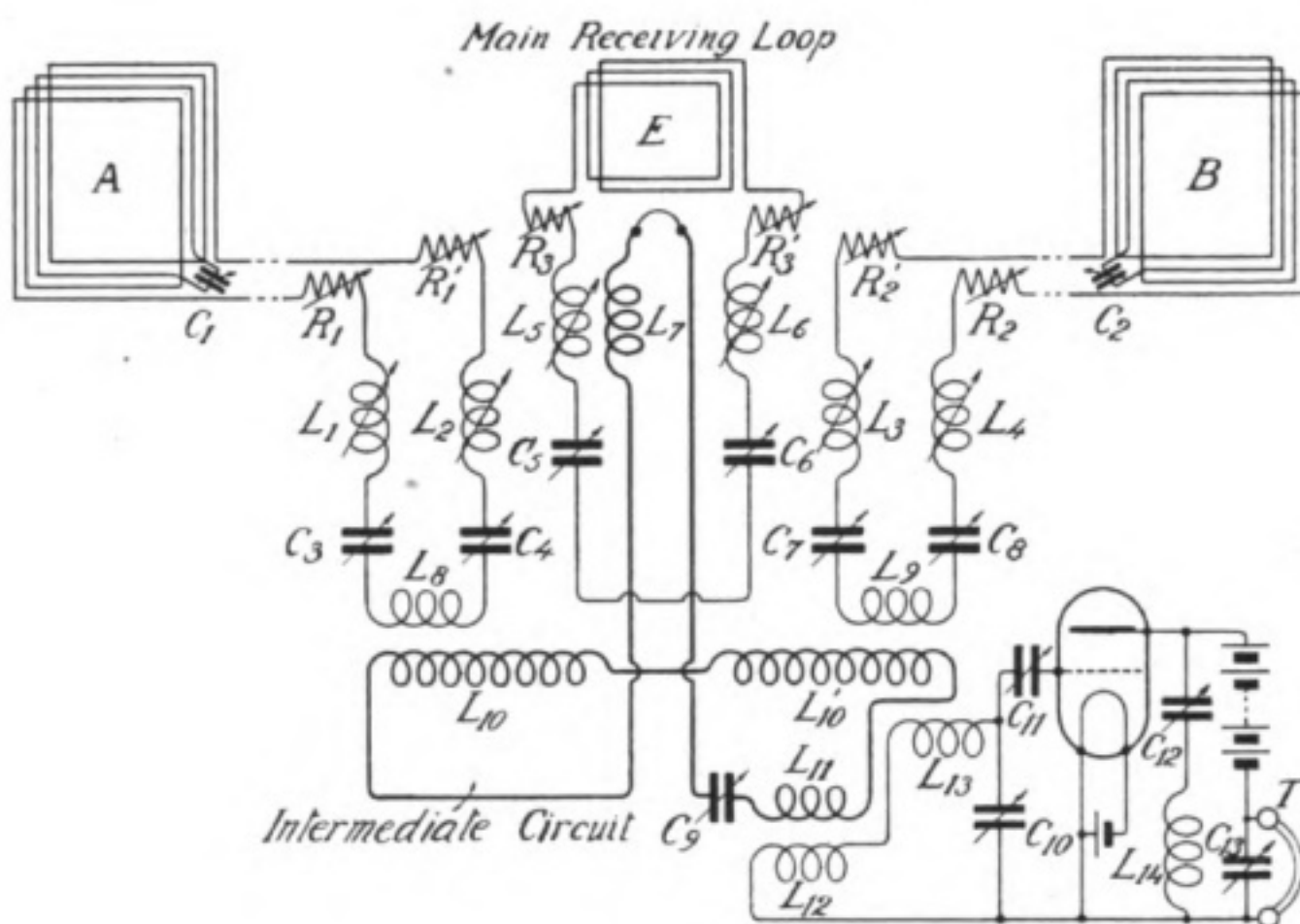

Fig. 9.

A modified form of this three-aerial arrangement is indicated in Fig. 10. The main point of difference lies in the substitution of two low horizontal wires for the third receiving loop. The signal is received on this aerial which is coupled to the goniometer intermediate circuit exactly as in Fig. 9. The outer loops pick up the static and signal, but are arranged to cancel out the signal between themselves by the goniometer $L_1L_2L_3$.

It should be noted that in the arrangement shown the two localised loops connected to the station by long horizontal leads have been replaced by two extended loops stretching out from the station itself.

This was found a more satisfactory arrangement as it dispensed with certain disturbing effects sometimes experienced

when the leads were used. It was further found essential to insert inductances L_9L_{10} in the *upper* wire of these loops as otherwise the tuning of the loops could not be varied at the station end so as to enable reception of various wavelengths. The best position for these coils is near the centre of the upper wire. Their effect was much less if inserted in the lower wire.

Many arrangements have been experimented with at various stations of the American Marconi Co., in order to gain the advantage of this three-aerial arrangement in a limited space. Very successful results have been secured with a combination of a receiving loop and a double "horizontal wire" aerial only 30 feet long, provided that arrangements are made for rotating the "horizontal wire" aerials in any direction in

THE WEAGANT "X-STOPPER"

the horizontal and vertical planes, so that the signal can be cancelled out and the static left in their circuit as was done in the case of the two outer loops of the large arrangement. A multi-valve amplifier is of course essential with such small aerials in order to receive over long distances.

As to the results obtainable we may quote a typical example from Mr. Weagant's paper read before the Institute of Radio Engineers in which these arrangements were described: "Many attempts had been made during the summer to copy these stations [Eiffel Tower and Lyons on 8,000 metres giving weak signals] with the two-aerial arrangement, but the results were satisfactory only occasionally and when the grinder type of static was that which existed. When the other type [clicks] was present these

stations could not be read. During the test with the three-aerial arrangement on one occasion, in the evening, static of extreme intensity was experienced, and the intensity of the signal from Eiffel Tower was much below normal ["fading effect"], with the result that with the two-aerial arrangement it was barely possible to tell that the signal was present. Using the three-aerial arrangement the signal was not only readable but of such intensity that it could be read with the telephones a couple of feet from the ear. Continued use has established beyond question that this performance is not occasional or accidental, but consistent, and that with this arrangement transatlantic radiotelegraphy can now be carried on free from interruptions due to static of any kind whatever except local lightning."

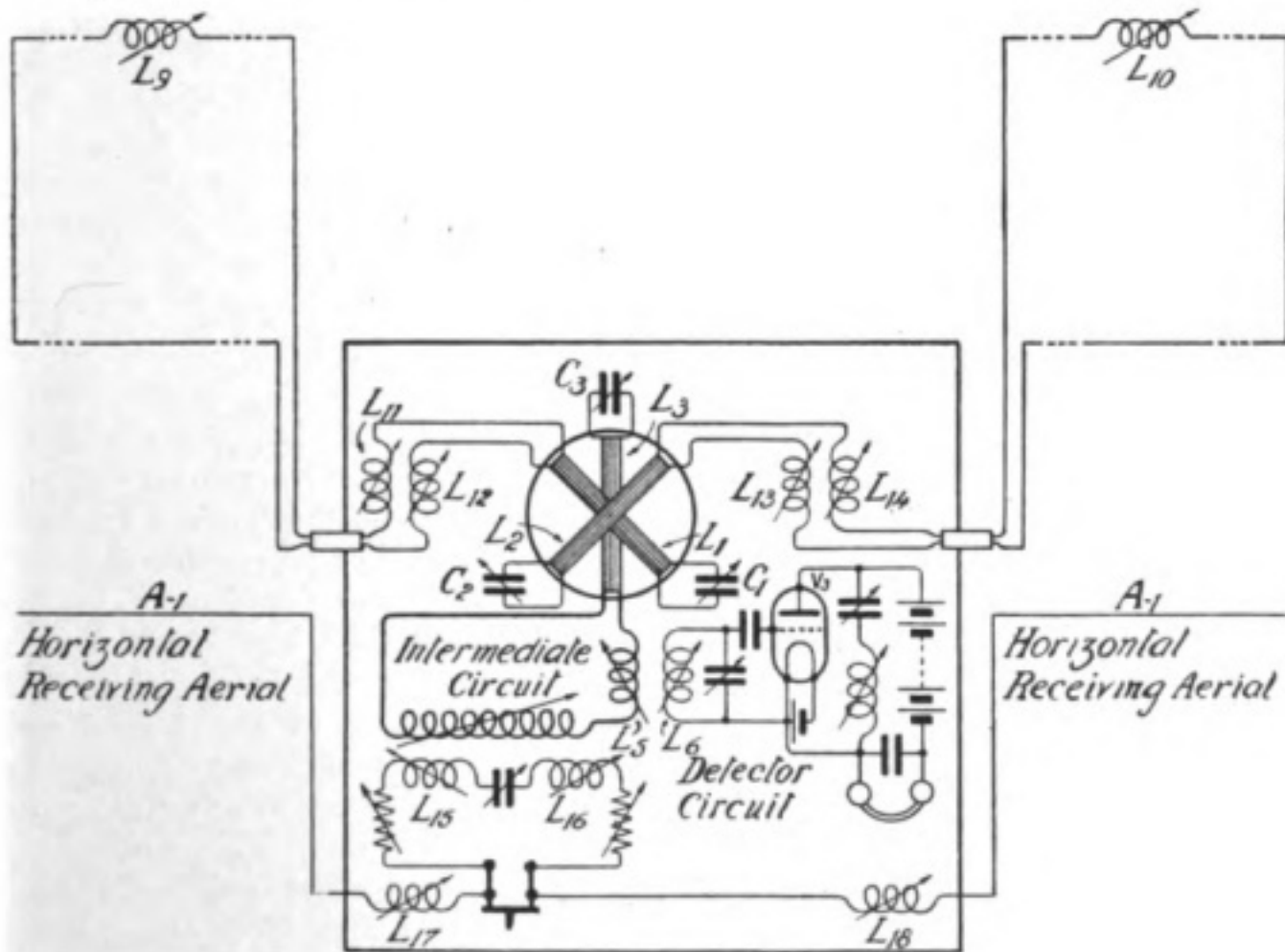

Fig. 10.

The Damping of Wireless Telegraph Signals

Some Special Investigations in the West Indies.

By G. H. WOOD, A.M.I.E.E.

THE following was written at a time when the author was in charge of the Trinidad-Tobago W/T. Service. Owing to the breakdown of cable communication between British Guiana and Trinidad for a considerable period all the telegraph traffic between British Guiana and the outside world had to be dealt with by the Trinidad Wireless Service. Although the Trinidad W/T. Station at Port-of-Spain should have been in easy range of the W/T. Station at Georgetown it had been found quite impossible to work direct by daylight, and all traffic had to be relayed by Tobago. This led to a great waste of time and to very uneconomical working, and was generally unsatisfactory. The author therefore conducted a research to endeavour to discover the cause of the extraordinary damping of W/T. signals between Port-of-Spain and Georgetown, the results of which are embodied in this article.

In connection with the matter of the extraordinary damping of W/T. signals between the Port-of-Spain Station and Demerara Station we may note the following facts:—

The power of the Port-of-Spain Station is 5 k.w.

The power of the San Fernando Station was 3 k.w.

The power of the Tobago Station is 3 k.w.

The power used by the Georgetown Station for the purpose of this report is unknown, probably 5 k.w., but at all events sufficient power was used to ensure good daylight communication under ordinary conditions.

All three of these stations are under ordinary conditions within easy daylight range of the Georgetown W/T. Station.

We now come to the "damping effect" in question. We know that the San Fernando Station, when it was working, i.e., some years ago, was easily able to exchange traffic with the Georgetown Station, but that the Port-of-Spain Station is quite unable to exchange traffic with Georgetown during daylight, although traffic can be exchanged at night when atmospheric conditions are favourable.

During daylight hours, the whole of the Port-of-Spain-Georgetown traffic has to be relayed by the Tobago Station, a station of smaller power, lower aerials, and no nearer to the Georgetown Station. From this fact and from the fact that the power available, etc., should be ample to ensure good communication (as it does to other places at greater distances in other directions) we gather that there is some extraordinary damping effect existing between Port-of-Spain and Georgetown which absorbs and damps the transmitted waves. As the damping effect is quite

THE DAMPING OF WIRELESS TELEGRAPH SIGNALS

regular and shows practically no variation we can safely assume that the damping is not caused by any unusual conditions in the æther. A theory as to this effect is now given showing that this damping effect to be made up of two quite separate components.

Referring to the accompanying map of Trinidad:—

- (a) The Southern Hills contain up to 20 per cent. of iron ore.
- (b) The Northern Hills contain "stringers of magnetite" 18 inches thick.
- (c) The Maracas Valley contains 67 per cent. of iron ore.



Map of Trinidad, showing iron ore deposits and sandstone region.

- (d) It is also known that North of San Fernando and running in a North-easterly direction there is a band of iron ore stretching practically across the Island and averaging 8 miles in breadth.
- (e) In the South of the Island the deposits known as the Moruga sandstones occur; these vary in breadth up to a maximum of about 20 miles (approx.) and contain a considerable percentage of iron ore.

Experiments were carried out with a ship steering round the South and East

coasts of Trinidad with the following results:—

In Moruga (South coast) signals from Port-of-Spain were very good. Signals were lost altogether at Casa Cruz, and were very weak at Guayaguayare. Signals strengthened slightly from Guayaguayare up the East Coast, but were completely lost so soon as the hills of the Northern Range intervened, and were not heard again until the ship was two or three miles North of Galera Point.

For the particular purpose of this investigation we must note particularly that at Moruga the signals from Port-

of-Spain were very good, whilst at Guayaguayare signals were very weak.

It is known that in connection with wireless telegraph stations in Northern South America that the dense tropical forests exercise a large damping effect on wireless waves.

Let us study the question as to why W/T. signals from the Port-of-Spain Station should be "very good" at Moruga and "very weak" at Guayaguayare. On referring to a map of Trinidad which shows the areas of land under cultivation, we find that a straight

line from Moruga to Port-of-Spain gives the smallest area of forest to be passed over by the æther waves. On the other hand, a straight line from Guayaguayare to Port-of-Spain passes over a maximum of forest; i.e., waves transmitted to Guayaguayare will have at least twice the amount of forest to pass over than waves sent to Moruga. (It is regretted that in the absence of the map referred to the exact distances cannot be given.) Also, a straight line from Port-of-Spain to Moruga passes over about nine miles of the Moruga Sandstones; whilst a straight line from Port-of-Spain to Guayaguayare passes over about eighteen miles of the Moruga Sandstones.

Thus we see that waves from Port-of-Spain to Moruga will have a minimum of forest and of Moruga Sandstones to pass over, whilst waves to Guayaguayare will have a maximum of both forest and Moruga Sandstones to pass over.

We can therefore readily understand the difference in the damping between Port-of-Spain and these two places.

We now come to the second part of the question. We know that whereas a 3-k.w. Station at San Fernando was able to work the Demerara Station during daylight hours, the 5-k.w. Station at Port-of-Spain is quite unable to work Demerara during daylight hours, although it is able to work greater distances in other directions. Experiments were carried out by a ship steaming round the South and East coasts of Trinidad. It was found that signals from Demerara were very weak all along the South and East coasts of Trinidad, but were strong from Galera Point northwards.

(Note: The receiving apparatus of the ship in question was somewhat insensitive, the aerials being small and low; a carborundum detector, however, was used.)

It would appear therefore that some damping effect exists between the whole

of the South and East coasts of Trinidad, and which effect disappears at Galera Point (the most north-easterly point of Trinidad). This damping effect would naturally effect both the San Fernando and Port-of-Spain stations.

A theory has been advanced that this damping may be due to a dephasing effect of the Demerara Coast line, i.e., waves from Port-of-Spain on striking the Demerara coast line and travelling along a portion of it are put so much out of phase that by the time they arrive at Georgetown Station they partially neutralise one another. I have no opinion to give on this theory, but suggest that the damping effect in question may be purely due to absorption; certainly part of it would be. Waves from Port-of-Spain to Georgetown have 95 miles of land to travel over at the Demerara end. It should be particularly noted that at Galera Point (where signals from Georgetown are well received) the waves would miss the coast line and travel only over the sea; thus we may assume that the damping due to the land is purely absorption, or the dephasing effect mentioned or both.

If we take a straight line from Port-of-Spain to Georgetown we note that it passes through Guayaguayare and over the land of Demerara for a distance of 95 miles (approx), and a line from San Fernando to Georgetown passes through Moruga and also over the land to Demerara for a distance of 95 miles (approx.). We also know that a line from Port-of-Spain to Georgetown will pass over the band of rock containing a high percentage of iron ore situated to the north of San Fernando. A line from San Fernando to Georgetown does not pass over this band.

We are now able to say that the damping between Port-of-Spain and Georgetown is composed of two components:—

THE DAMPING OF WIRELESS TELEGRAPH SIGNALS

- A. That in the island of Trinidad itself being
1. Absorption due to forest.
 2. Absorption due to iron in rock, i.e.,
 - a. The band running N.E. from San Fernando.
 - b. The Moruga Sandstones, 18 miles broad.
- B. That due to the Demerara coast being

which is much smaller than in the case of Port-of-Spain.

2. Absorption due to iron in rock, i.e., Moruga Sandstones, 9 miles broad.

It will be noted that there is about 17 miles less of iron in rock between San Fernando and Georgetown than between Port-of-Spain and Georgetown.

B. That due to the Demerara Coast

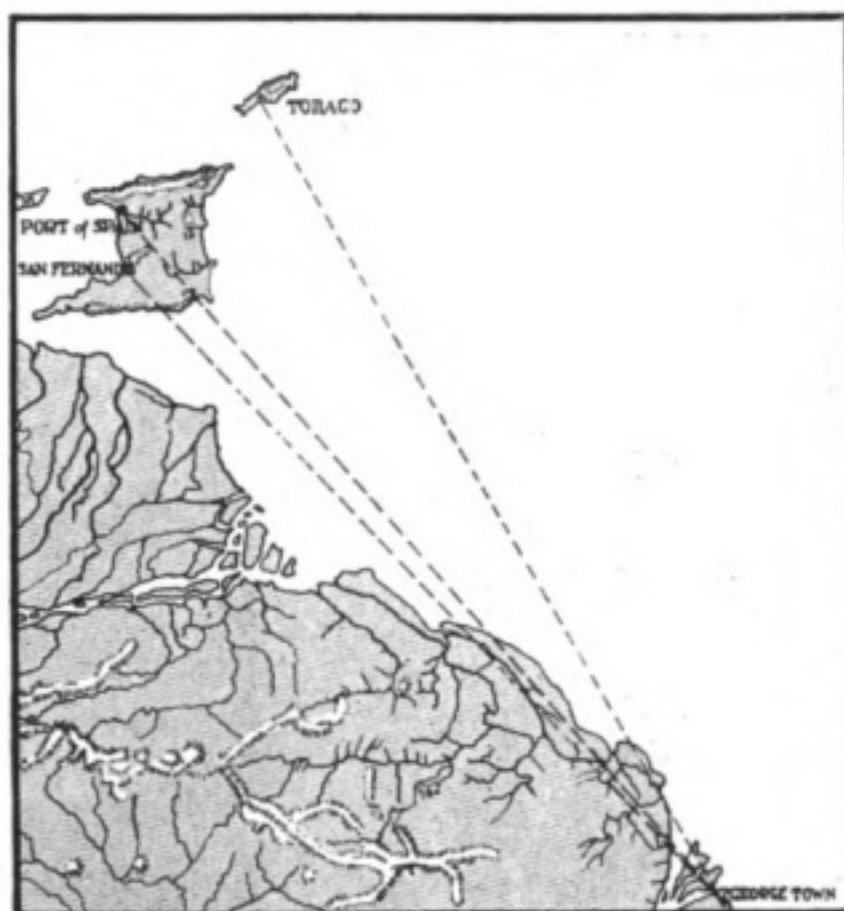

Map showing relative positions of stations referred to in article.

1. Absorption of Soil. (N.B., the nature of this soil should be ascertained.)
2. Dephasing effect of coast line if any.

This total damping is sufficient to prevent daylight communication.

The damping between San Fernando and Georgetown is composed of:—

- A. That in the island of Trinidad itself being
1. Absorption due to forest,

being the same as in the case of Port-of-Spain.

The total damping in this case was of such an order that daylight communications could be held with Demerara.

The damping between Tobago and Georgetown being due to absorption by sea only is much less than in the two former cases, and is of an order to enable easy daylight communication to be maintained.

Aircraft Wireless Section

Edited by J. J. Honan (late Lieutenant and Instructor, R.A.F.).

These articles are intended primarily to offer, as simply as possible, some useful information to those to whom wireless sets are but auxiliary "gadgets" in a wider sphere of activity. It is hoped, however, that they may also prove of interest to the wireless worker generally, as illustrating types of instruments that have been specially evolved to meet the specific needs of the Aviator.

AIRCRAFT WIRELESS SETS. THE NO. 1 TRANSMITTER—(Continued). Fittings and Accessories.

HOT-WIRE AMMETER.

THE oscillating aerial current is measured by means of its heating effect upon a conducting wire, having a high coefficient of expansion.

In the ordinary type of instrument, shown in Fig. 11, the current-carrying wire is stretched between two points, and is connected at its centre point to a fibre which passes around the axle of a drum carrying the indicating-needle. The other end of the fibre is tensioned by an anchoring-spring.

As the conducting wire is heated by

the current it expands, and the slack is taken up by the tensioned fibre, the consequent movement of which rotates the drum, and the indicating-needle supported thereon.

The disadvantages of this type of ammeter are (a) that the fibre is apt to slip to some extent around the drum axle without rotating it, and (b) that in resetting the needle to zero any alteration of the initial tensioning of the conductor tends to throw the calibration of the indicating scale out of the true.

Should the ammeter break down when in use, and so open the earth circuit, the instrument should be short-circuited by joining the terminals with a piece of wire.

In the Ewen ammeter the indicating-needle is carried on a collet mounted on a jewelled spindle set at right angles to the conducting wire. On the same spindle is mounted a hair-spring which exerts a twist between two fibres suspended between it and two points on the conducting wire. The torque on the bifilar members and the tension of the conductor are initially adjusted by the makers, so that the needle points to zero, and this adjustment is then sealed up.

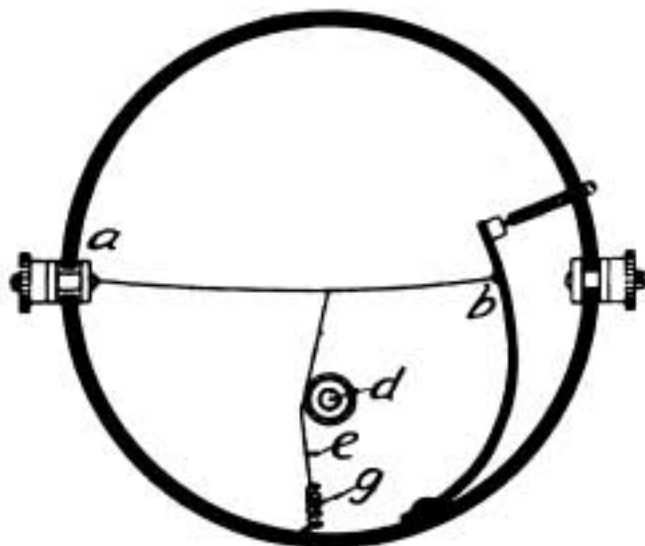

Fig. 11.

AIRCRAFT WIRELESS SECTION

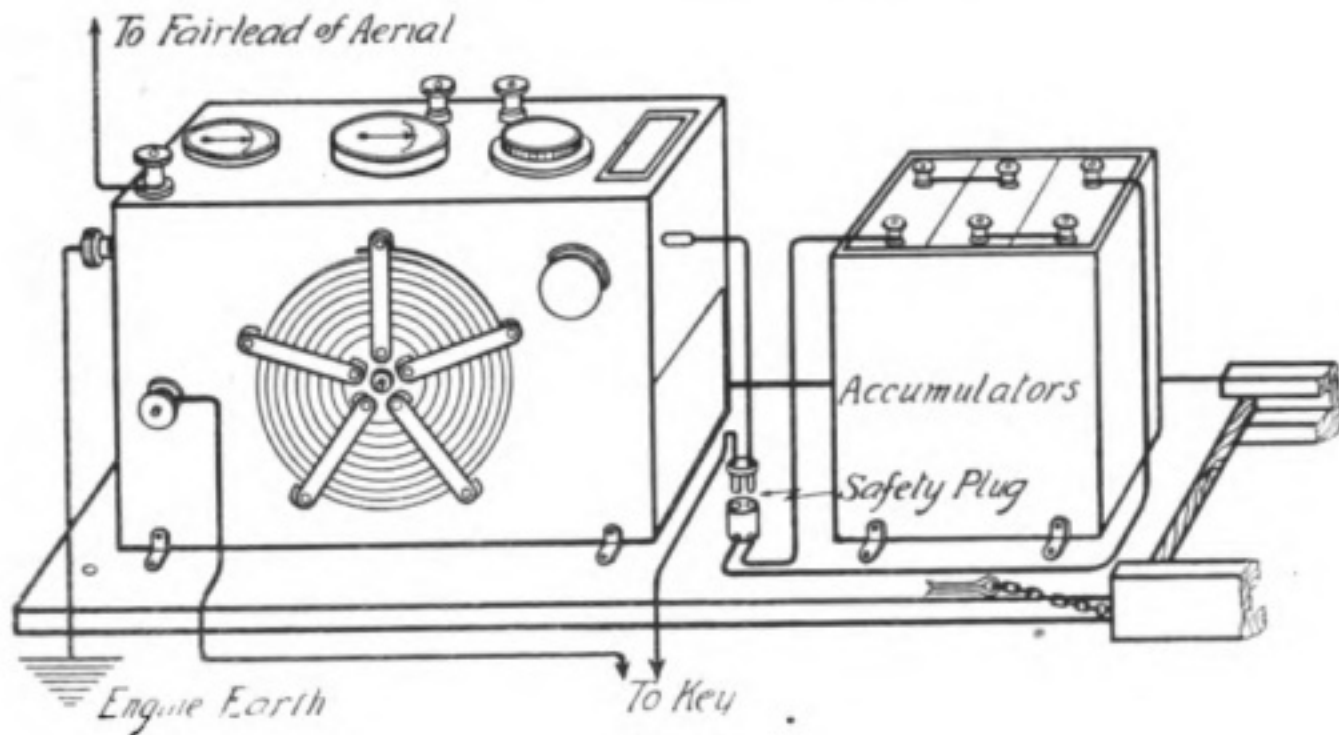

Fig. 12.

As the conductor expands under the action of the current, the sag affects the equilibrium of the bifilar suspension, and thereby allows the hair-spring to rotate the spindle and the indicating-needle.

In resetting the needle to zero, the whole unit, comprising the spindle, hair-spring, and needle, is rotated upon a central pivot by means of an external lever, leaving the calibrated scale still true to reading.

FITTING THE No. 1 SET.

As, apart from the spark-gap, break contacts, and the helix clips, there are no parts on the transmitter likely to give rise to trouble from vibration effects, it is not necessary to use spring suspension devices or shock absorber, in fitting the set into the bus. As an extra precaution, an elastic cord suspension, similar to that used in slinging valve sets is sometimes employed; or the transmitter may be fitted with "artificial sponge" buffer at the base.

In practice, however, provided that the locking nuts on the adjustable parts have been duly tightened up, it is suffi-

cient to clamp both the transmitter and the battery directly on to a baseboard by means of a couple of metal lugs and a screw turnbutton, as shown in Fig. 12, and then to slide the whole piece into a wooden retaining-frame screwed down in a convenient place in the nacelle, preferably behind or under the pilot or passengers' seat.

An improved form of helix clip is shown in Fig. 13. This has a locking-nut, which, when the contact has been adjusted, can be screwed down on to the metal ribbon, and prevent any possible displacement from vibration.

The three accumulators are fitted into a wooden box built to house them snugly, and this is also clamped to the baseboard with the set.

Obviously, however, the particular arrangement and placing of the set and battery is simply a matter of expediency and accommodation. They can be stored wherever they will fit, provided that the transmitter is reasonably accessible in case any adjustments are necessary in the air as regards wavelength—or possible minor faults. It is also wise

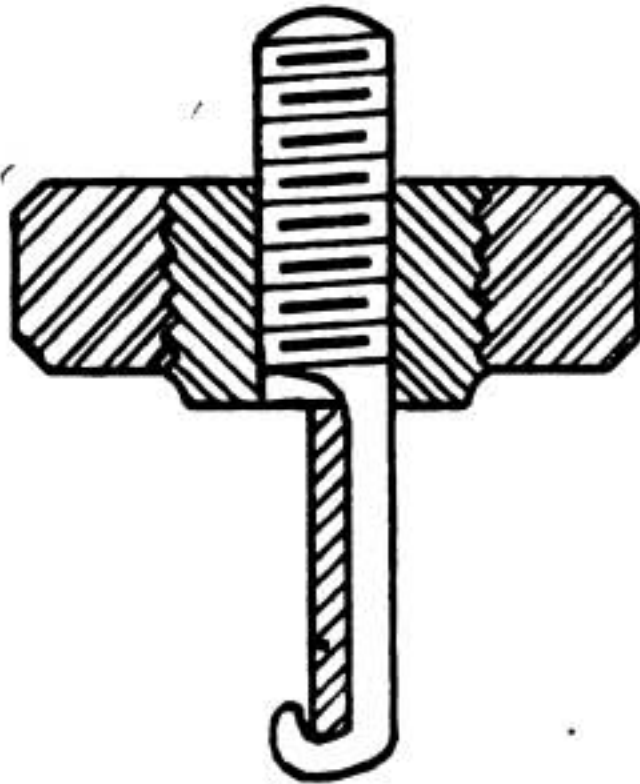

Fig. 13.

not to place the transmitter where it may be subjected to contumelious treatment, deliberate or otherwise, from the pilot's or observer's feet. Old habits die hard in some people, and there are still pilots who will debit any little untoward bump, or sudden change in the weather conditions aloft, to the account of the unfortunate wireless gear, in which case excessive radiation may take place and a new set be required.

THE SAFETY PLUG.

This is generally employed in the wiring arrangement. It is not considered healthy to have leads, capable of emitting sparks if short-circuited, kept "live" for a longer period than is absolutely necessary in an atmosphere that may be highly charged with petrol vapour. The practice is based upon a tradition that a blaze, following a crash, was once upon a time officially attributed to this cause.

The leads from the battery are therefore taken to a socket, and the circuit containing the transmitter and key ends in a plug which is inserted into the

socket only when the set is required for action. When the set is temporarily out of use the plug is withdrawn and the circuit outside the battery is then dead. The wiring arrangement, including the plug, is shown in Fig. 13A. The safety plug may be placed in any convenient site. Somewhere near the key, preferably, in order to avoid if possible any natural irritation that may arise from conscientious but futile attempts to radiate signals without the aid of the battery.

THE KEYS.

Care should be taken to fix the key in a position, and at a height, that gives the operator the minimum trouble in sending. The tension and adjustment screws should always be tested prior to flight. These are small points, and obvious, but it pays to attend to them.

KEY SIGNAL LAMPS.

Where two or more keys are to be fitted it is desirable to introduce an auxiliary circuit, which when any one

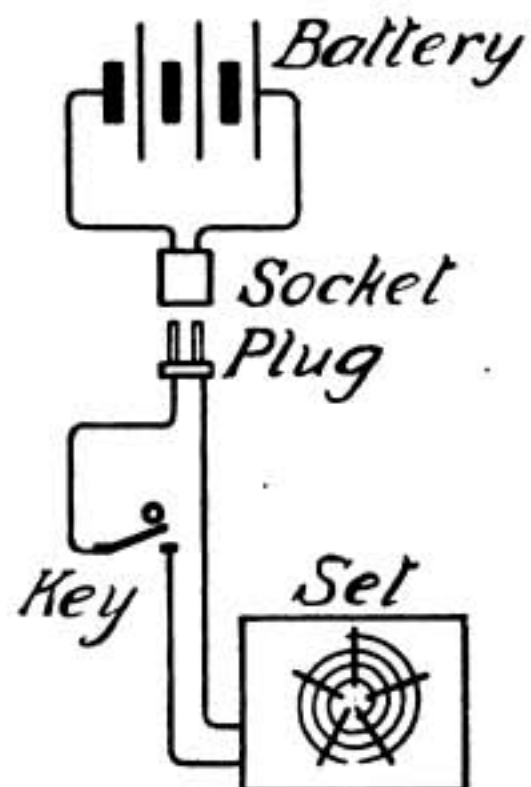

Fig. 13A.

AIRCRAFT WIRELESS SECTION

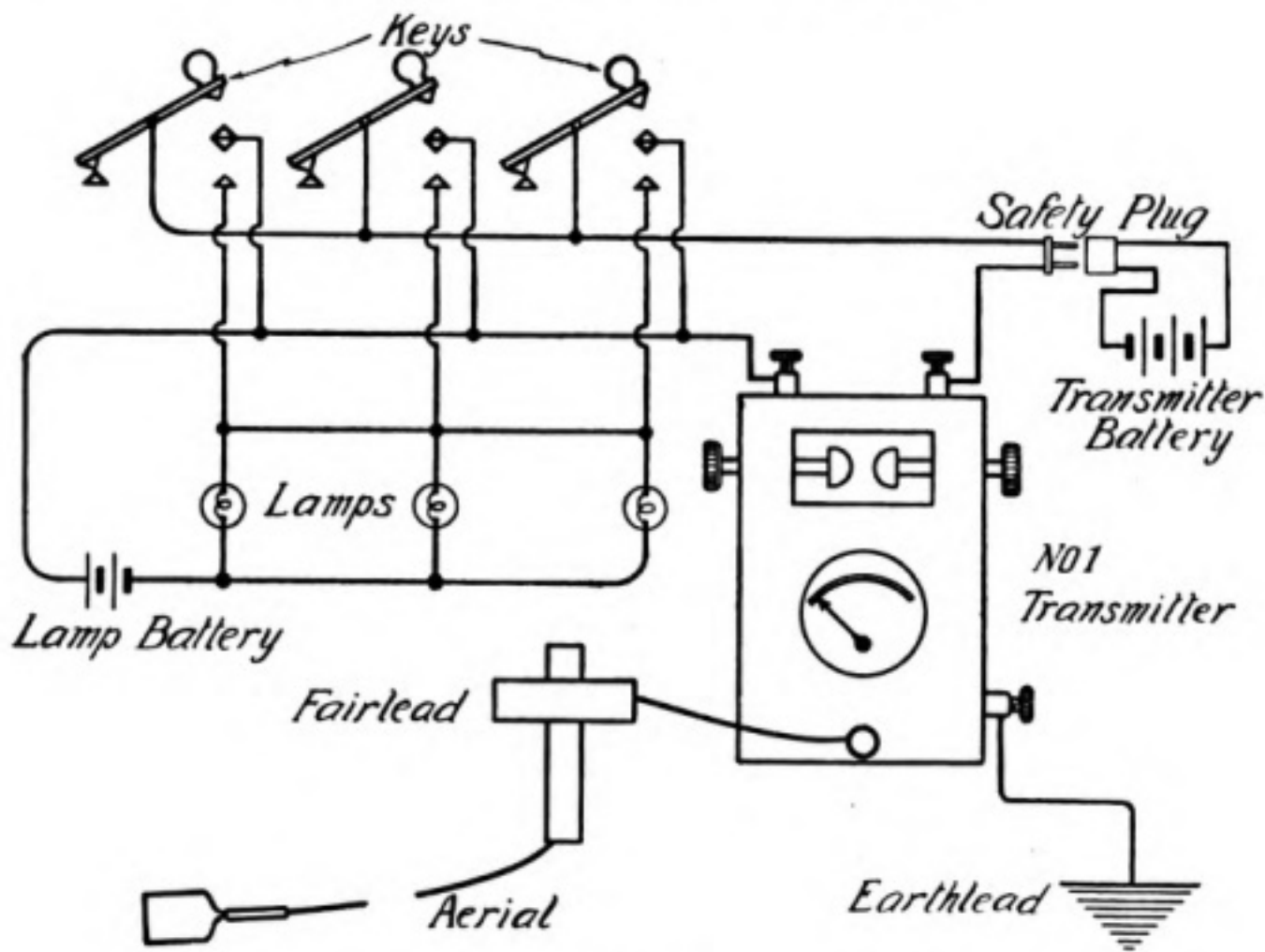
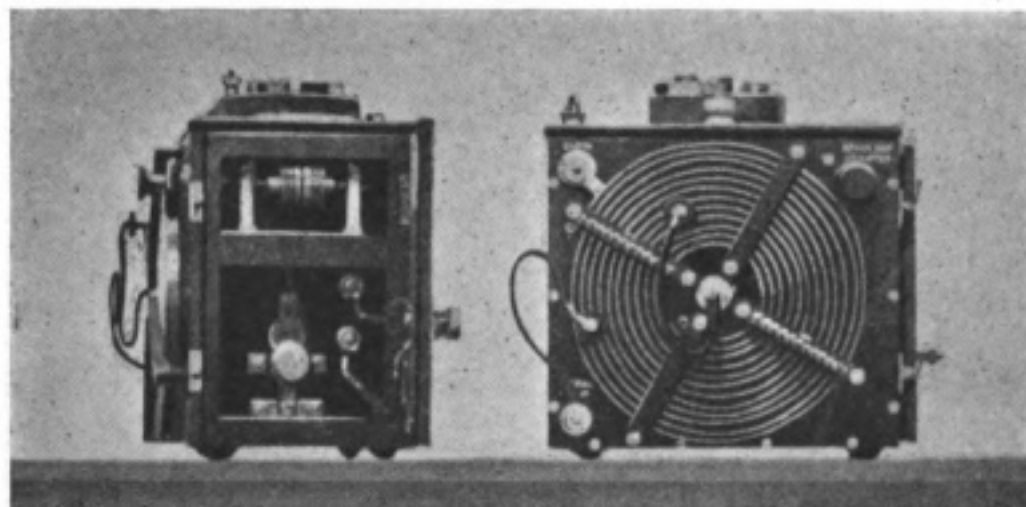

Fig. 14.

key is being used, lights up a small signal lamp mounted on the base of each key, so as to avoid simultaneous signaling by warning other operators that the set is in use.

A simple wiring arrangement for this purpose is shown in Fig. 14 as applied to a set comprising three keys and three

signal lamps. One additional dry cell or accumulator is sufficient for the three lamps. The contacts require careful adjustment to ensure that, whilst they do not "short" in the idle position, the ordinary pressure exercised in operating the sending key is sufficient to close both the set and the lamp circuits.



The No. 1 Transmitter.

Aviation Notes.

THE TRANSATLANTIC AIR ROUTE.

UNFORTUNATELY, like most monthly periodicals, we are compelled to go to press so far in advance of the date of publication that it is impossible to keep hot on the track of late events. Otherwise it would have been possible to record the first real non-stop cross-Atlantic flip in our last number.

It is perhaps old news by now, but it will be long before it grows stale. Hawker's dash provided plenty of thrill, but lacked success; whilst the American achievement somehow failed to stir the blood to fever heat—though their record will always stand good.

It was left to Alcock and Browne—the two new Knights of the Air—to crown the dash and pluck that flavoured the Sopwith flight with the laurels of success.



Photo:

The R34.

Topical Press.

AVIATION NOTES



Photo: *The Officers of the R34.* Topical Press
Back row, left to right: Capt. Coombes, Lt.-Com. Lar sdowne (U.S.A.), Lt. Durrant (Wireless),
Capt. Greenhard (1st Officer), Major Pritchard, Lt. Shotter (Eng. Officer).
Front row, left to right: Major Cooke (Navigator), Col. Hunt (C.O. of East Fortune),
Major Scott (Comm. of R34).

REGARDING WIRELESS.

It is most unfortunate from the "wireless" point of view that the sets carried by both the British buses should have gone wrong from the start.

In both instances service instruments of proved utility were carried, and the only inference to be drawn is that the poor "wireless gadgets" were afforded somewhat haphazard attention.

Under the exceptional circumstances that surrounded the setting-out on a voyage of so uncertain and perilous a nature, it is easy to understand that both pilot and navigator had more pressing concerns than the well-being of the W/T. sets, and that these only came in

for such care as could be spared to a "side show."

"SOME" ORGANISATION.

It is only right, however, to point out that this apparently insignificant defect practically rendered futile, so far as these two buses were concerned, quite an extraordinary amount of spadework that had been quietly but thoroughly carried out in wireless quarters with a view to rendering every possible assistance to the ventures, both prior to the start and whilst in passage.

This organization did not seek for publicity, and has been given but little notice in the press, though the various

parties concerned have received a full and warm appreciation of their efforts from various British and American official sources.

Perhaps it will not be out of place to detail some of the arrangements that were made, and that actually proved of great service, more particularly in the case of the NC₄, which with characteristic Yankee thoroughness, succeeded in maintaining its W/T gear in an efficient condition throughout the passage.

The organization in question comprised the British Admiralty and the Royal Air Force; the American Naval Service; the various Steamship Companies whose vessels ply the North Atlantic; and last, but by no means least, the Marconi Company, which rendered such assistance as could only be secured by the exceptional wireless

service that it controls and by the willing co-operation of its widespread staff.

DETAILS.

The captains of all North Atlantic vessels rendered most valuable assistance in furnishing exhaustive weather reports which were promptly transmitted to various coast stations and forwarded to official headquarters for compilation and record.

Special facilities were given by the Admiralty for the transmission of these messages from such vessels as were out of range of Valentia. In addition, the Marconi Company made special arrangements for reception at their Ballyunion Station. Three experienced operators were detailed by them to that station solely for work in connection with the receiving of meteorological reports relayed from ships at sea.

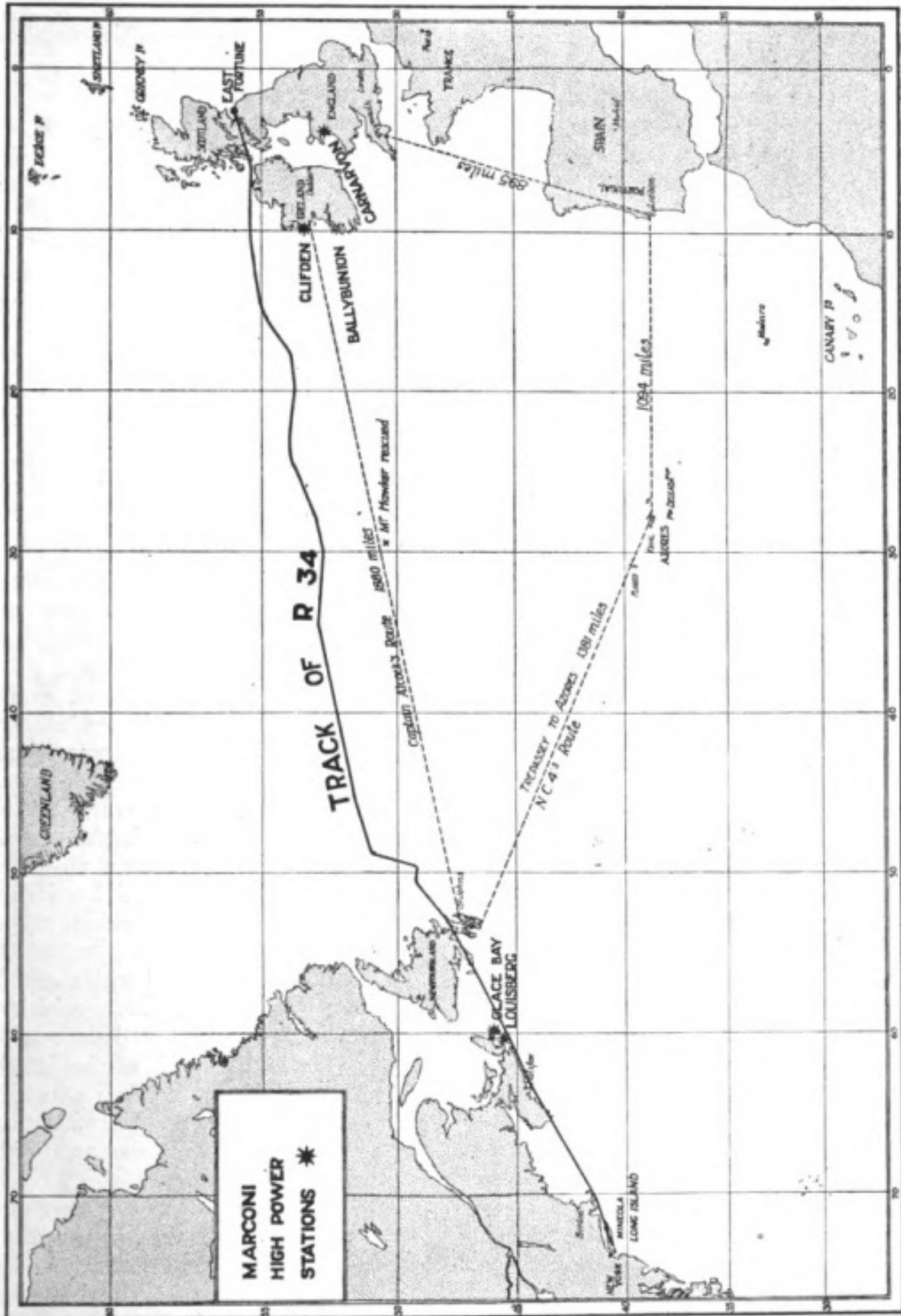

Photo:

The Wireless Station at East Fortune.

Topical Press.

AVIATION NOTES



The routes of the three successful Transatlantic flights.

Continuous land-line communication was maintained from Ballybunion Station so that all such messages could be forwarded to London without delay, where a special day and night staff was maintained at the Air Ministry to deal with them.

Arrangements were made with the Canadian Marconi Company for the Cape Race Station to be advised immediately any plane made a start, and to inform all ships accordingly; and, further, to distribute all weather reports issued by the Air Ministry for their guidance *en route*.

The Carnarvon Station was entrusted with the transmission of meteorological reports at specified times.

All ships' operators were instructed as to the calls allotted to the various planes that were in readiness to start, and were also asked to co-operate with the aviators in respect of requests as to their position, S.O.S. calls, etc.

A special chart was periodically prepared by the Marconi people showing in detail for the Aviator's guidance before setting out, the number and approximate position of all ships carrying wireless that would probably be met with or overtaken during the flight.

These are but some of the steps taken to ensure a thorough co-ordination of land and sea wireless facilities in the service of Aviation, but sufficient has been said to indicate the work that was done, and the credit that is due, even if it has not been rendered by the public generally, to those who, standing quietly in the background, have done such painstaking and useful work.

The day will doubtless come, sooner or later, when we shall have a regular Transatlantic Aircraft Service in existence, able to wing a serene course straight from port to port. Air Navigation will by then have ceased to be a doubtful quantity vaguely dependent

upon a chance "sight" of the celestial bodies, and happy in the achievement of a lucky trip across the pond.

When this time arrives the wireless man will have been found worth his salt, whether for actual work in the air, or for services in meteorological spadework.

Meanwhile there is no reason why his present work should be ignored.

THE R34.

As this is being written, news has been received of the safe arrival of the R34 at Mineola, Long Island, after an uninterrupted flight of 3,500 miles at an average speed of 33 miles per hour.

The Air Service has *not* neglected its wireless gadgets, and the vessel has been kept in continuous touch with the world throughout her voyage.

In a trial flight, previous to setting out on her transatlantic trip, she succeeded in setting up direct communication in the air by wireless between the Firth of Forth and the Azores, a distance of roughly 1,500 miles.

Besides a low-power 600 metre spark instrument, she carries a high-power C.W. set which has a range up to 1,500 miles, the latter being an extraordinary achievement for an air-borne transmitter. There is also a wireless telephone outfit giving a range of 50 miles.

In addition, she is fitted with a multi-valve receiving-set of great sensitivity, and a radiogoniometer installation.

The wireless cabinet is carried in the forward or navigating gondola which is in telephonic communication with each of the other three gondolas and with the various crew stations.

The call letters D.M.D. were allotted to the vessel, and the Marconi Station at Clifden sent out signals under this prefix every two hours whilst the ship was *en route*. Arrangements were also made to maintain communication

AVIATION NOTES

with the wireless stations at St. John's, East Fortune, Pembroke, Ponta Delgada, and the Air Ministry.

The following extract is taken from an official statement by the Air Ministry issued prior to the flight:—

"The Marconi Company have kindly placed at the disposal of the Air Minis-

try their very complete organization of wireless facilities over the North Atlantic, including the free use of their private telegraph lines, and the two high-powered stations at Clifden and Glace Bay. The airship will use these two stations as beacon stations for her wireless direction-finding apparatus."

Wireless and the Cadet Corps.

OUR readers will be interested to learn that instruction in wireless telegraphy is one of the activities increasingly associated with the cadet movement.

The photograph reproduced herewith, taken at the Technical School, Plymouth, shows a class of cadets of the No. II. Plymouth Company, Devon (Fortress), R.E., receiving instruction from Mr. J. Jerritt, Chairman of the Three Towns Wireless Club, and Principal of the Bedford Park Training School of Telegraphy, whose kind offer to assist was readily accepted by the O.C. Cadets, Capt. G. W. Turpitt, B.Sc.

The weekly lessons are much appreciated, and the cadets make good progress both in the practical and the theoretical side. The working of land lines is also explained and practice taken with the sounder and buzzer alternately.

Gen. Sir R. I. Scallon, G.C.B., D.S.O., when addressing cadet officers in Plymouth last year, referred to the dearth of really good signallers in the Army, but it is hoped that with the



Photo:

W. H. Hawkings.

active and patriotic enthusiasm of such expert telegraphists as Mr. Jerritt the cadet companies may supply to the Territorials, year by year, a number of young signallers who will ultimately acquire a high state of efficiency.

The Library Table

"THE PRINCIPLES OF ELECTRIC WAVE TELEGRAPHY AND TELEPHONY."

By J. A. FLEMING, D.Sc., F.R.S.

London: Longmans, Green & Co.

(Fourth Edition, 1919.) pp. xv + 707.

Price 42/- net.

THE publication of the fourth edition of Dr. Fleming's "Principles of Electric Wave Telegraphy and Telephony" affords ample evidence of the lasting popularity and demand for this well-known work. In the third edition which was published in December, 1916, considerable alterations and extensions were made as compared with the original book issued in 1906, in order to bring the volume more up-to-date and to incorporate the results of recent research, discovery and invention in the radio field. The growing bulk of the book has now necessitated an attempt being made to reduce the number of pages without sacrificing the value of the contents. In the new (fourth) edition just issued this has been accomplished by the adoption throughout of a somewhat smaller size of type, and of a more compact style of setting, especially in the mathematical portions. By this means a reduction of over 20 per cent. has been made in the size of the volume without sacrificing the clarity of the reading.

The general scope of this work is too well known to require any very detailed exposition to the general reader. As in the previous editions the author's aim has been to deal throughout as far

as possible with the general underlying principles of wireless communication rather than with elaborate and detailed explanations and descriptions of individual apparatus and specialised parts of wireless sets. Many descriptions have however, been given of various apparatus and instruments since such are necessarily essential to a proper exposition of wireless principles.

The historical portions of the book, both in the first chapter on the "Production of High-frequency Currents and Electric Oscillations," and in the chapters on "Detectors of Electric Waves" and the "Apparatus of Electric Wave Telegraphy" have been revised to a considerable extent, and the descriptions of the older and less useful apparatus and instruments have been omitted, although in some cases references to the original paper or descriptions have been retained.

In the theoretical sections dealing with the subject mathematically, the bulk of the matter is necessarily the same as in the previous edition, but some additional information has been incorporated relative to the "High-frequency Resistance of multiple-stranded Insulated Wire," and to the reasons and causes of the increased high frequency resistance that is often experienced with such wires as compared with what is expected from the direct current resistance and the degree of stranding. In the section on the radiation from various forms of oscillator and aerial, some additional notes of recent theories have also been added.

In Chapter VII (The Apparatus of Radiotelegraphy) a slight rearrangement of the matter has been made by the transfer of part of the theoretical dis-

THE LIBRARY TABLE

cussion of direction finding apparatus to a special section, dealing with such gear, that has been added at the end of Chapter VIII on Radiotelegraphic Stations.

The description of the heterodyne receiver remains as in the previous edition, but in this connection it may be mentioned that this receiving arrangement is treated rather more as a specialised form of detector than as a general C.W. receiver for which purpose it is almost universally used. The "range," viz.—3,000 miles,—is also now somewhat in error, as C.W. transmission has been accomplished over much greater distances than this. Any one particular detector or receiver can seldom strictly be said to have any particular "range" as the distance over which signals may be read by its use depends so much upon the other auxiliary apparatus with which it is employed, and upon the power of the transmitting station from which signals are being received.

In conclusion it should be mentioned that some previous existing misprints have now been corrected, but that unfortunately the error in the Table on page 123 has not yet been amended

THE THEORETICAL PRINCIPLES OF WIRELESS TELEGRAPHY.

By I. R.

London: Gee and Co. (4th Edition).
1s. net.

THIS is the kind of treatise for which we are "truly thankful." Our copy came into the office on one of those beautiful snowy days in April which make our English spring what it should not be, and we forgot at once the icicles on the window-frame, the chilly zephyrs which blew along the floor and our miserable attempts to ignite

the pieces of slate which some fair unknown had placed in the grate along with the old blotting paper we had discarded the previous day. Every page of this book creates laughter and leaves memories which obtrude themselves upon the mind at moments when one least desires to chuckle. The Chart of Faults on C.W. Sets is alone worth the price of the whole book, and we cannot resist quoting a few reasons which are given to account for specified faults:—(1) Valve dropped from height on stone floor. (2) Shortage of electrons. (3) Gas turned off at meter. (4) Wick used up. (5) Mistake by operator (rare). (6) No signals in the air. (7) Aerial mixed with earth. (8) No phones. (9) Grid grinding against plate.

A new chapter has been added, on the Slide Rule, and needs no further commendation from us than the statement that in our opinion it might have been written by Stephen Leacock in one of his most Leacockian moods. The appendices on the Corkscrew Rule and Waves, the latter taking the form of a letter to "My Dear Children" from "Aunt Mollie," are delightfully funny and well up to the standard of the rest of the matter. We heartily recommend that this book be kept at hand and taken in doses after *mauvais quarts d'heure*.

THE PURCHASE OF BOOKS FOR READERS.

The publishers of **THE WIRELESS WORLD** are pleased, at all times, to obtain for readers any of the publications reviewed in these columns, as well as books on all technical subjects. Orders should be accompanied by a remittance covering the full cost of the book and postage. Should the amount forwarded exceed that required, the balance will be returned to the sender.

Personal Notes

MILITARY CROSS FOR RADIO MAN.

MR. J. Scott-Taggart, M. S. Belge E., A.M.I. Radio E., has been awarded the Military Cross for his services in connection with wireless work during the last phases of the fighting in 1918. This gentleman is well-known to our readers as the author of numerous articles on thermionic valves.

DEATH OF LORD RAYLEIGH.

It is with great regret that we have to record the death, at the age of 78, of Lord Rayleigh, O.M., which occurred at his residence at Terling Place, Witham, Essex, on the night of June 30th. The deceased peer was born on November 12th, 1842. He had a brilliant career at Cambridge, graduating as Senior Wrangler in 1865. In the following year he was elected to a Fellowship at Trinity College, a post he vacated in 1871, the year of his marriage to a sister of Mr. Arthur Balfour. He succeeded to the title on the death of his father in 1873 and that year marked his selection as a Fellow of the Royal Society. In 1879 Lord Rayleigh was elected to the Chair of Experimental Physics at Cambridge which was then vacant owing to the death of Clerk Maxwell. As mathematician, physicist, and chemist Lord Rayleigh excelled, but space does not permit us completely to catalogue his achievements in these sciences. He made his reputation by a series of papers on optical questions, wrote a classical treatise on acoustics, discovered Argon, and his work in electricity was made the basis on which

the legal definitions of the electrical standards of E.M.F., current and resistance were established. His researches include work on the mechanical principles of flight, photography, the theory of the telephone, the distribution of alternating currents in conductors, and light. To him we are largely indebted for the establishment of the National Physical Laboratory.

Lord Rayleigh, indeed, died full of years and honours, most of the prizes and decorations specially awarded to scientists falling to him, amongst which was the Nobel prize for Physics, in 1904.

SENATORE MARCONI A PEACE DELEGATE.

The new Italian Ministry has selected Senatore Marconi as one of the Italian peace delegates. The illustrious scientist was appointed a Senatore by the King of Italy in 1915 and seems to be entering more and more into the public life of his country. It is surely most fitting that he, whose genius has so greatly contributed to the preservation of human life and the promotion of international communication, should now receive the signal honour of being made a peacemaker.

NEW APPOINTMENT.

Dr. Alfred N. Goldsmith, Professor in charge of electrical engineering at the College of the City of New York, has been appointed Director of Research of the Marconi Wireless Telegraph Company of America. Dr. Goldsmith is Editor of Publications for the Institute of Radio Engineers, and has recently written an important book on the subject of Radio-telephony.

Correspondence

DEAR SIR,

Now that the wireless transmission of signals over many thousands of miles is a matter of daily occurrence, and when furthermore it has been proved practicable to transmit wireless signals direct from England to Australia, I shall be glad to have the advice of some of your more expert readers on a rather interesting theory which I have evolved.

I believe it is now generally accepted that for the purpose of radiotelegraphic transmission the earth may be treated as a conducting sphere over which the "base" of the wireless waves may be said to travel. It is also equally accepted that this conducting sphere is surrounded by another but larger sphere of conducting air known as the Heaviside layer. This conducting layer is situated, I believe, at a height of some 30 miles above the earth's surface. For the purpose of understanding my theory let us consider the case of a hypothetical wireless station situated at the North Pole. This station is presumed to have sufficient power to communicate with Australia. The waves radiated by this station would then spread out in rings in every direction and by the time they reached the Equator, they would consist of large rings of energy, the total circumference of the ring being equal to the circumference of the earth and the height of the ring 30 miles or the height of the Heaviside layer from the surface of the earth. These rings of energy would be vertical to the surface of the earth.

We now come to the most interesting point of all. On passing the Equator and, of course, still continuing between the conducting surface of the earth and the conducting inner surface of the Heaviside layer, the ring of energy commences to grow smaller until on reaching the South Pole the whole of the remaining energy (that is to say, the energy not absorbed by the surface of the earth and any intervening conductors) would concentrate at the South Pole and probably be reflected back again. According to this theory and provided that losses are not too high the strength of signals at the South Pole would be very much stronger than at the Equator.

I am now waiting to hear of the case of the poor wireless operator on board a steamer who quite innocently sails across the focus point situated exactly 180° from a larger power station such as Carnarvon, Arlington, Lyons or Nauen. It would not be at all pleasant to receive the concentrated energy from a big power station all at once on an ordinary ship's aerial. May not this theory account for some of the mysterious disappearances of ships which have taken place during the war, and which for lack of better evidence have been attributed to mines and submarines?

Yours faithfully, REDAX.

SIR,

To-day, the amateur is like a prisoner at the bar. He is awaiting the verdict of a scientific court martial. The jury (whoever such good men may be) know at the present moment exactly what their ultimate decision will be. Why then, don't they come from their recess at once and tell us whether we, the body of earnest pre-war pioneers, can once more take up a fruitful and fascinating research, or whether we are doomed to abandon for ever a labour of love. I ask you, is it fair that we should all be condemned, simply because we bow, without distinction, to the very vague and most misleading term "amateur"? It would surprise many of the officials who are to judge us, to learn that in the ranks of the so-called amateurs there are men whose word is an authority in the radio field. True, in this ever growing band of experimenters there exists a most regrettable personage, whose sole ambition and ability seems to be that of distorting the already over-worked aether, and inflicting upon his numerous victims an untiring bombardment of artificial atmospherics.

For the illustrious service which so many of these amateurs have rendered during the war, they are justified in demanding permission to "carry on." Let the men who hold our future in their hands be content to rigorously sweep out the non-technical novice, who is injurious to both the private experimenter and the commercial operator, but in regard to the real amateur—hands off!

I notice in the July issue of the WIRELESS WORLD certain veiled insinuations that although there is practically no doubt about the ultimate permission being granted to make use of "Spark Excitation apparatus," there is a possibility of the poor amateur being forbidden to indulge in C/W work. If such prophesy is fulfilled, well, the amateur may as well pack up at once, for it is upon the lines of C/W transmission and reception that the post-war experimenter intends to carry out a most fascinating research.

The one dominant thought of those who are eagerly awaiting their release from the restrictions of D.O.R.A. is Valves. The reason is obvious, because the introduction of the thermionic generator and rectifier of high frequency currents opens out a vast field of scientific exploration.

Last, but not least, without the assistance of C/W we are robbed of our interest in Wireless Telephony. Therefore, as a radio amateur myself, I appeal on behalf of my fellow students for an early gratification of a desire that is irresistible.

I remain, earnestly yours,
J. BALDERSTON.

The Construction of Amateur Wireless Apparatus

This series of Articles, the first of which was published in our April number, is designed to give practical instruction in the manufacture of amateur installations and apparatus. In the following article the author deals with the important question of Inductances and Variometers. The Wireless Press, Ltd., has arranged with Marconi's Wireless Telegraph Co., Ltd., to supply complete apparatus to the designs here given, as soon as Amateur restrictions are released.

Article Five.—INDUCTANCES AND VARIOMETERS.

WITH regard to the shellac varnish we mentioned in the last article, unless the amateur decides to purchase the varnish from an electrical firm we recommend him to make it himself. Varnishes obtained from the ordinary colour shop, though labelled as "shellac varnish," are liable to contain ingredients other than shellac, which may entirely take away the insulating property when dry. The varnish should be made by dissolving shellac, and shellac only, in methylated spirit. It will be found that if a wide-mouthed bottle is filled with shellac and then spirit poured in to cover it, the resulting solution will be of about the right thickness for use. The shellac takes some time to pass into solution, but it is best not to attempt to hasten matters by applying heat.

Of course, enamel-covered wire need not be varnished. The covering is not hygroscopic and needs no protection from the air. Enamelled wire is particularly suitable for the construction of slider inductances. These are coils of variable inductance obtained by the sliding contact of a jockey on the turns of the coil. Only quite a narrow strip

need be prepared along the track of the jockey. The enamel can be removed by means of sandpaper. A slider coil of this type is always rather a dangerous method of tuning the aerial circuit, as if a short wavelength is being received the slider will be near one end of the coil and the majority of turns will be out of action. These turns are, however, coupled with the inactive portion of the coil, and if the natural wavelength of the idle portion should happen to be the same as that being received, a pronounced rejector effect will result, with a consequent weakening of signals. It is always safer to tune the circuit by the employment of separate units of inductance, the necessary adjustment being obtained by the use of a variable condenser or variometer.

In the last article we dealt at some length with the construction of inductances for both transmitting and receiving circuits. We now propose to give the amateur some examples of the manner in which inductances may be used as variometers and couplings.

VARIOMETERS.

The word "variometer" is generally taken to mean a coil whose inductance

CONSTRUCTION OF AMATEUR WIRELESS APPARATUS

can be varied continuously between certain limits. A tuning coil with step by step tappings or a sliding contact on the turns themselves is sometimes referred to as a variometer, but in practical wireless a continuous variation is generally understood to be implied when we speak of a variometer. A variometer is a particularly useful instrument to the amateur who does not wish to go to the expense of purchasing a variable condenser; the latter cannot be made very cheaply unless reliability and accuracy are sacrificed. Quite good wavemeters, for example, can be made by using a fixed condenser shunted by a variometer as the oscillatory circuit. The chief disadvantage lies in the fact that it is difficult to get a large range of wavelength with a single fixed condenser. This need not trouble the amateur, since of course the complete range of the wavemeter may be as large as desired by using a number of fixed condensers which can be connected in parallel one by one, a condenser being added for each range. By carefully choosing the correct capacities for the condensers the ranges can be made to overlap properly so that no blank series of wavelengths occurs over the whole range of the instrument.

The usual form of variometer for receiving circuits consists of two induct-

ance coils connected in series electrically and arranged mechanically so that the magnetic field which the current causes in one coil is also linked with the turns of the second coil. Since the same current is flowing through both coils a field is also formed in the second coil, and consequently the total magnetic field linked with the circuit depends upon the physical position of the coils with respect to each other. Imagine, for example, that we have two formers, as indicated by (a) and (b) in Figure 1 placed axially opposite each other and of such sizes that one can be slid right inside the other. Then if we start with the formers as shown in Fig. 2, the series connection of the windings being arranged so that the magnetic fields due to the coils are in opposition, we shall obtain the minimum inductance possible with the coils under consideration. The inductance of the circuit will increase as the inside coil is pulled out, until the total inductance is equal to the sum of the separate inductances when the distance apart is such that there is no appreciable mutual action between the windings. If now we reverse the connections to one coil and move them together again, the total inductance will increase until the maximum value possible is reached when the coils are again in the position shown in Figure 2. The

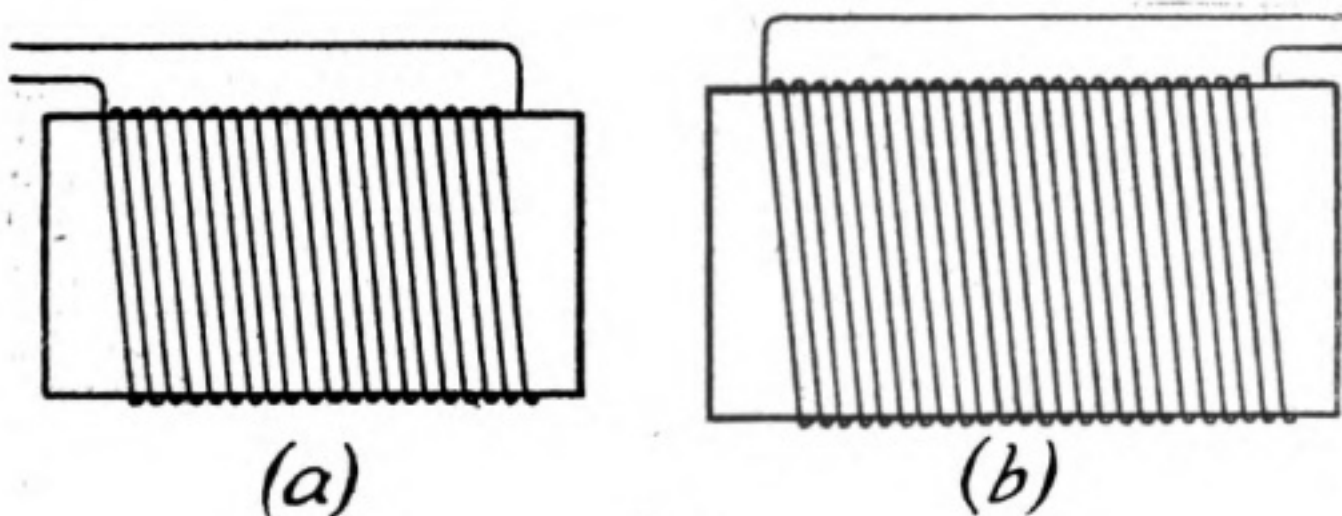

Fig. 1.

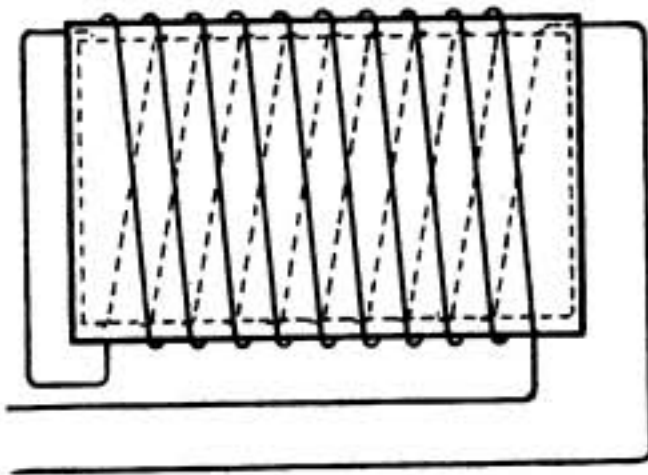

Fig. 2.

only disadvantage of this arrangement lies in the necessity of employing a switch to reverse one coil when in the "out" position in order to get the full range. A variometer of this simple type, i.e., two cylindrical coils sliding inside each other gives the largest change of inductance that can be realised in practice. If there were no magnetic leakage between the circuits in the "inside" position, it is theoretically possible, assuming the self-inductance of each coil to be the same, to get a variation from zero to four times the inductance of a single coil. This ideal case is not obtainable in practice as magnetic leakage always exists. In any case it is best to make the variometer so that each coil has about the same value of inductance.

The necessity of reversing one coil can be avoided by employing the construction indicated in Figure 3. This type of variometer consists of a short cylindrical former of ebonite wound with insulated wire. Inside this former a spherical coil is arranged so that it can be rotated on an axis along a diameter of the cylinder. Flexible leads are brought out from the ends of the spherical winding which is connected in series with the cylindrical inductance. The spherical coil is arranged so that it can be rotated through 180 degrees. It will be seen that when the axes of the

two formers are coincident and the fields due to them oppose, we have the smallest inductance. Then as the inner coil is rotated until the fields are again coincident but in the same direction the inductance will gradually increase to its maximum value. This construction does not necessitate the use of a reversing switch because the act of turning the inside coil does the necessary reversal. A variometer of this type is not quite so easy for the amateur to make, since the inside former must be spherical in shape in order that it may be rotated without fouling the cylindrical former. These

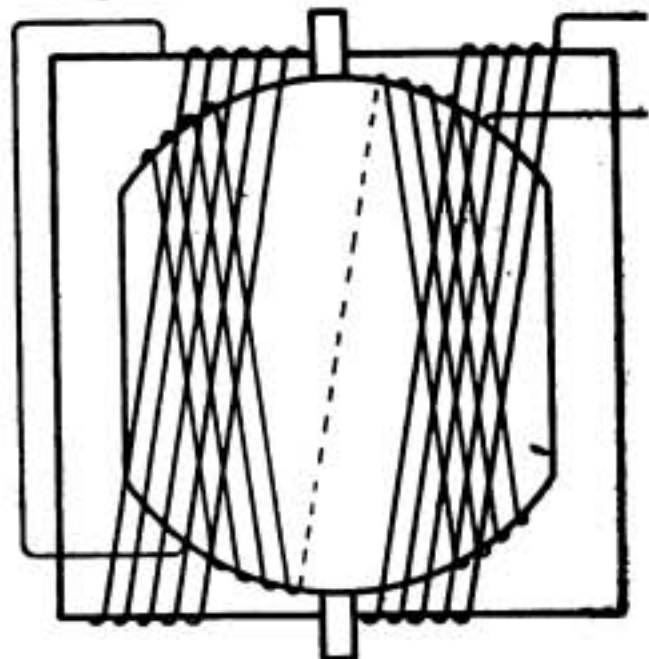

Fig. 3.

spherical formers can be purchased ready turned up and drilled for the spindle, and the rest of the apparatus is comparatively simple to construct.

Another form of variometer frequently employed consists of pancake windings as illustrated diagrammatically in Figure 4. In this figure A and B are two pancake windings connected in series. C and D are two similar inductances also connected in series. The two sets of coils are arranged so that C and D are carried by an arm which can be rotated about the centre O; so that when C is over A, D will be directly over B, and when C is

CONSTRUCTION OF AMATEUR WIRELESS APPARATUS

over B, D is over A. If then the two pairs of coils are connected in series as shown in the sketch, it will be clear to the reader that we have in this system a variometer exactly similar to the one we have just described. The inductance will be a minimum when C and D are in such a position relative to A and B that the resultant field is a minimum, and the total inductance will increase

ing the relative position of two inductances which we have just described can be equally well used as an adjustable coupling between two circuits. When making up experimental circuits on the table it is most convenient to lay the coils end to end. The coupling being adjusted by simply moving the formers nearer to or further away from each other. The arrangement can be made

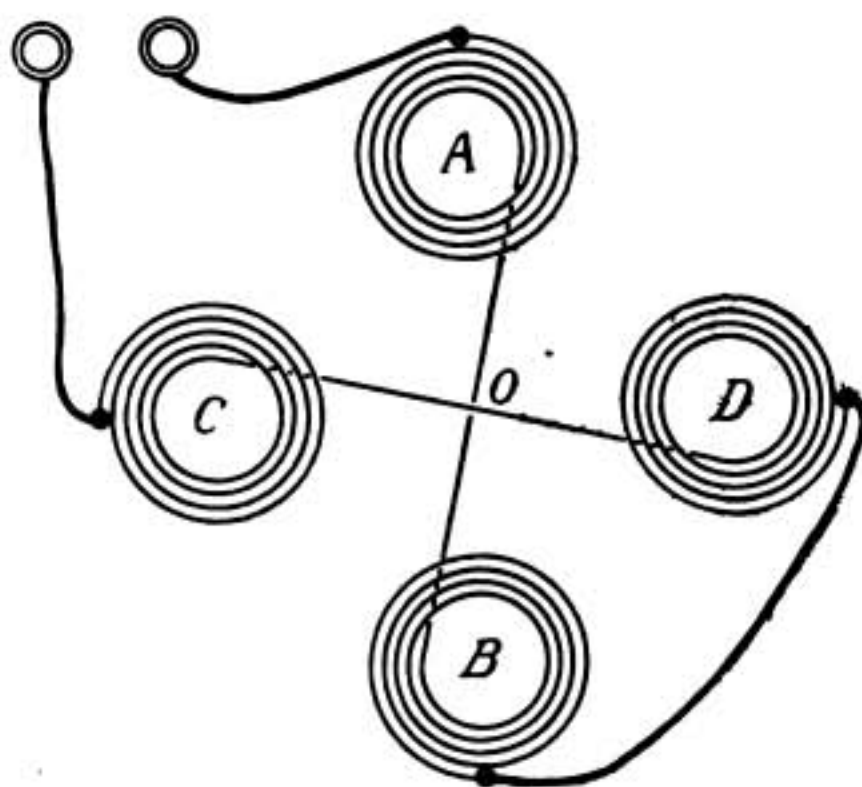

Fig. 4.

as the top coils are rotated through 180 degrees. This type of variometer is more suitable for a transmitting circuit as the pancake windings can be done easily with rubber covered cable—whereas they are difficult to do with the fine wire such as is used in the circuits of a receiver.

Couplings.

Of course the amateur will understand that any of the methods of chang-

quite neat by making wooden rails for the coils to slide on. If the circuit is for transmitting, or has high potentials between the component parts care should be taken to use well seasoned and dry wood for the rails. In any case it is safest to soak the wood in paraffin wax before use. Also see that the coils do not come into contact with the metal screws used in the construction of the rails.

Patent Section

124,138. Wireless signalling. Wright, G. M., Marconi House, Strand, London, July 18th, 1918. No. 11804 (Class 40 (v)).

Directive wireless signalling; aerials. In a directional aerial of the frame type, an adjustable condenser d located in an accessible position is connected to the top of the frame by a pair of symmetrical leads. In order to keep the transformer winding symmetrical and to make the earth connection readily adjustable to the potential node, a split transformer winding a, b is used, and an inductance c with an adjustable earthed contact is connected between the two parts a, b .

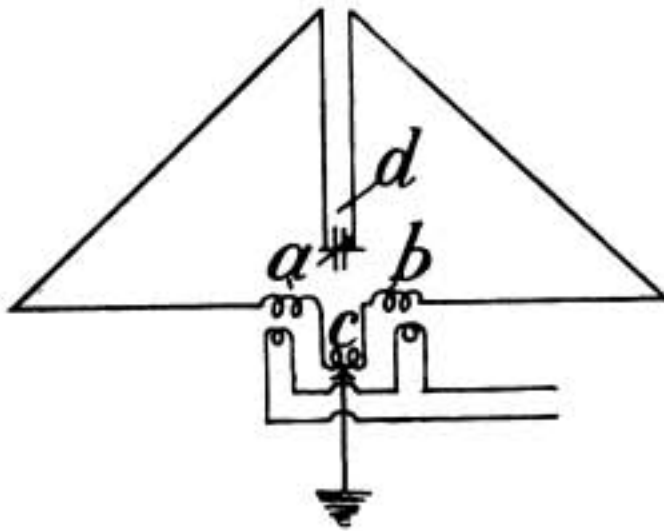

1402. Wireless telegraphy. Clarke, E. R., 35, Leinster Gardens, Hyde Park, London, January 28th (Class 40 (v)).

In a method of tuning the aerial and secondary circuits, the secondary circuit contains a fixed capacity and inductance representing the aerial capacity and inductance, and the tuning-devices (capacity or inductance or both) in each circuit are operated by a single handle. In the arrangement shown in Fig. 1, the inductances P, L are equal to the inductances P', L' , the condenser K' is equal to the aerial capacity, and the variable condensers C, C' are equal and operated by the same handle. In order to increase the range of wave variation, the aerial or the secondary circuit, or both, may contain an inductance Y , Fig. 2, and two variable condensers G^1, G^2 so arranged that, when one condenser is at its maximum capacity, the other is at or near its minimum. A switch S is mounted on the same shaft as the vanes of the condensers and is arranged to short circuit

either the condenser G^1 or the condenser G^2 and inductance Y . Thus, when the switch S short-circuits the condenser G^1 and the condenser G^2 is at its maximum, the aerial is tuned to the maximum wavelength, and this can be continuously reduced by reducing the capacity G^2 until this reaches its minimum, when the switch S short-circuits this condenser and the inductance Y and removes the short-circuit from the condenser G^1 , which is then at its maximum capacity; reduction of the capacity of the condenser G^1 then effects a further decrease in the aerial wavelength. The method of simultaneously adjusting the aerial

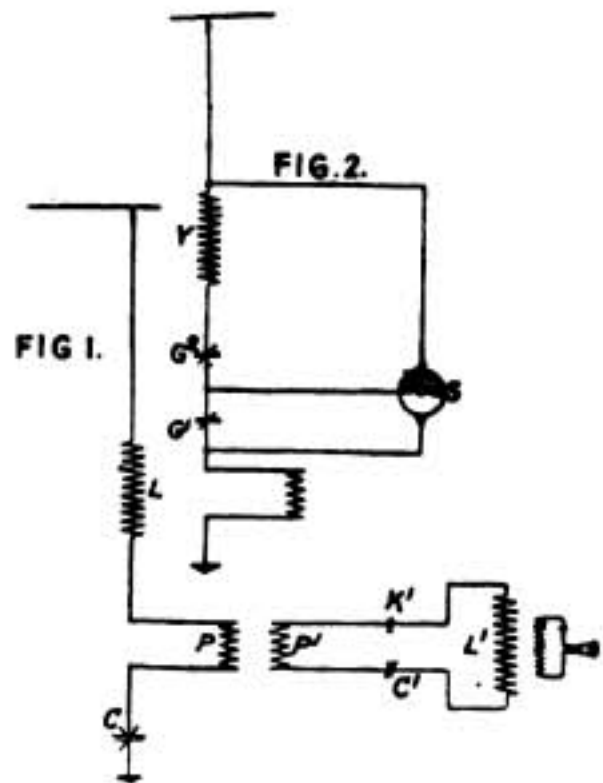

and secondary circuits is also applicable to heterodyne systems for receiving continuous waves, a device for varying the frequency of the heterodyne circuit being mounted on the same shaft as that for varying the aerial and secondary circuits. The same method can be applied to receiving systems using audion detectors, the aerial, grid, and anode circuits being simultaneously adjustable. The Provisional Specification states that tuning may be effected by simultaneously adjusting an inductance and a series condenser mounted on the same shaft as the variometer, the circuit being thereby graduated on a straight-line law.

Questions and Answers

NOTE.—This section of the magazine is placed at the disposal of all readers who wish to receive advice and information on matters pertaining to both the technical and non-technical sides of wireless telegraphy. Readers should comply with the following rules: (1) Questions should be numbered and written on one side of the paper only, and should not exceed four in number. (2) Queries should be clear and concise. (3) Before sending in their questions readers are advised to search recent numbers to see whether the same queries have not been dealt with before. (4) The Editor cannot undertake to reply to queries by post (5) All queries must be accompanied by the full name and address of the sender, which is for reference, not for publication. Queries will be answered under the initials and town of the correspondent, or if so desired, under a "nom-de-plume." (6) Will readers please note that as amateurs they may not at present buy, construct or use apparatus for wireless telegraphy or telephony. (7) Readers desirous of knowing the conditions of service, etc., for wireless operators, will save time by writing direct to the various firms employing operators.

I.M. (Wiltshire).—From the questions our correspondent asks it seems to us that he has not yet done much experimental work in wireless, and that he is somewhat ambitious in trying to control a model boat by wireless. However, we trust that when I.M. does start work he will not be discouraged by a few initial failures. We are of the opinion that with a well-designed transmitter, a ½-in. spark coil, and a good coherer and relay, our friend should be able to control up to about 50-100 yards.

(2) It would be possible to have two receiving sets to respond to different wavelengths, but these receivers will have to be well designed in order that they shall only respond to their particular wavelength.

(3) What size spark coil would be required to transmit a distance of 40 miles, using the latest apparatus?

Where does our correspondent intend to use the latest apparatus, at the transmitting or receiving end? I.M. does not seem to realise that a spark coil of only a few watts will be heard over a much greater distance when received with, say, a three electrode valve amplifier, than if received on an ordinary crystal receiver.

With the latest type receiver a coil of about 40 watts would give good signals over a distance of 40 miles.

(4) Radiodynamics (The Wireless Control of Torpedoes and other Mechanism), by B. F.

Miessner (Crosby Lockwood & Son, 7, Stationers' Hall Court, Ludgate Hill, E.C.), may be helpful.

A.M. (North Finchley).—Wishes to know: (1) the necessary formula for finding the length of wire required for a coil for a desired wavelength when capacity of condenser and length of wavelength are known.

(1) If the aerial is small it can be considered as concentrated capacity without inductance, so that the formula $\lambda = 1885 \sqrt{L (mhy) \times C (mfd)}$ may be used knowing the capacity of the aerial the necessary inductance of the tuning coil can then be calculated. If A.M. will refer to our answer to G.B. (Plymouth) in the June issue of the WIRELESS WORLD, he will there find the method of arriving at the capacity of the aerial.

Having found the required inductance, the following formula is used to find the length of wire required when wound on a circular coil:

$$L = \frac{\pi^2 n^2 d^2 l}{1000 k} \quad (mhy)$$

where n = number of turns of wire in 1 centimetre length of coil

l = length of coil in centimetres

d = diameter of coil in centimetres

k = a factor depending on the ratio of the diameter of the coil to its length,

When $\frac{d}{l}$.1	.5	1.0	1.5	2.0
k	.96	.81	.69	.6	.53

A curve can now be drawn connecting the inductance and the length of several windings to find the length which gives the desired inductance.

(2) We are inclined to think that the size of wire you propose using for your secondary coils is on the small side and suggest your using about No. 28 if you are using a crystal detector. You will also find this gauge easier to wind. No. 24 for the primary would be suitable.

(3) If our correspondent will refer to the WIRELESS WORLD of May, 1915, or to W. H. Nottage's Calculation of Inductance and Capacity, page 123, he will find a table, worked out from the above formula, giving the inductances of coils of various diameters and lengths and from this table it is a simple matter to find a coil which will give the desired inductance.

If our coil of 16 cms. diameter is wound with 10 turns to the centimetre and is 26 cms. long, then the inductance will be 5152 mhya. If the coil is wound 20 turns to the centimetre,

QUESTIONS AND ANSWERS

then the inductance of a coil of the same diameter and length will be

$$\frac{20^2 \times 5152}{100} = 2\ 608\ \text{mHys}$$

We strongly recommend A.M. to obtain W. H. Nottage's book, as it would prove most useful to him in the calculation of aerial capacities, inductances, and other necessary calculations for wireless investigation.

D.J.M.C. (Edinburgh).—We think it extremely unlikely that any employer would appoint you as a wireless operator for two months, because you would leave the job just as you were beginning to be useful.

E.P.B. (France).—(1) It is possible to insert a three-electrode amplifying valve at each end of a telephone line, to act as a "speech relay," provided that it is connected in the circuit of the receiver only, so as to amplify only the incoming signal. This arrangement is not the most usual one. (2) and (3). The most useful arrangement of the valve relay is in the centre of the telephone line, unless the line is very long, when several repeating stations may be inserted at approximately equal intervals between the extreme ends of the circuit. This arrangement has been used for the long over-land telephone lines in America. When only one valve is used as the repeater in this manner special "bridge" circuits must be used to enable the repeater to work in both directions, i.e., to relay speech from either end of the line. Many such circuits have been devised, and one typical one is shown in the Fig.

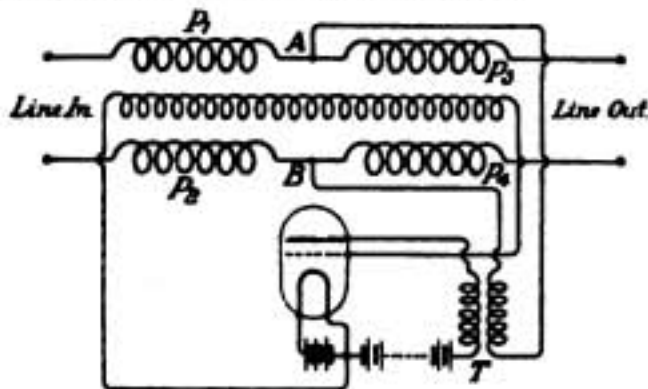

The original speech current passes through all the primary windings P_1, P_2, P_3, P_4 , in series, and so induces a voltage on to the grid of the Valve V through the secondary winding S . The amplified current from the plate circuit of the valve is fed through the medium of the transformer T across the two lines at A, B . This amplified current passing out to the lines flows through the two pairs of primaries in opposition and so produces no resultant effect on S . If this balance is not secured continuous oscillations would be set up by the valve and the line would be unworkable.

J.V.M. (Manchester).—(1) and (2). Obviously the best way is for you to apply direct to firms manufacturing wireless apparatus. We think you should be able to find the job you require, but we have no inside information.

J.H. (Hawick).—At present the field for wireless operators is the reverse of overcrowded, and we advise you to complete your course as soon as possible.

H.S. (Nr. Congleton).—(1) Most commercial wireless operators on board ships have to purchase their uniform. (2) The wearing of spectacles will not debar you from obtaining a position as a wireless operator if your sight is by that means rendered good.

AERIAL RADIO (Marquise).—(1) You do not state to what Company you refer. We do not think that there exists at present a demand for wireless operators or wireless mechanics solely for aircraft work. (2) Neither are there, to our knowledge, any vacancies for telephony or D.F. operators. See Note 7 at the head of these columns. (3) We think not, but Marconi's Wireless Telegraph Company specialises in wireless telegraphic apparatus for aircraft. Thanks for kind remarks and good wishes.

J.C.J. (Bow).—There are only a few such firms, mostly railway companies, and these select men already in their employ. Why not apply to the Marconi International Marine Communication Co., Ltd., Marconi House, Strand, W.C.2. Please see Note 4 at the head of these columns.

EXPERIMENTER (Dukinfield).—Questions 1 and 2. You give diagrams of two circuits and ask whether they are suitable for certain purposes. We regret we cannot pass an opinion, because the suitability of a circuit for transmitting a given distance or for receiving on a given wavelength does not depend upon the diagram but upon the values of the power inductance, capacity, etc., employed, none of which you specify.

SHARE MARKET REPORT.

The Marconi Share Market has been dull owing to settling by holders who wish to subscribe to the New War Loan.

Prices as we go to press (July 16th):—
 Marconi Ordinary, £5 10s. od.; Marconi Preference, £4 15s. od.; Marconi Marine, £3 5s. od.; American Marconi, £1 9s. 9d.; Canadian Marconi, 16s. 9d.; Spanish and General, 14s. od.

WANTED for Manchester, by an Electrical Supply Company dealing principally with amateurs, a competent man with good knowledge of Latest Wireless Telegraphy and capable of dealing with Correspondence relating to this subject, and having a practical knowledge of Electricity; also to attend to a shop. Send references and salary required to U.E.S., BERTRAM DAY & Co., 110, Strand, London, W.C. 2.

WANTED the following numbers of the "Wireless World":—April, June, 1913; June, July, 1907; January, February, March, April, May, September, 1918; February, 1919. Write with full particulars, price, etc., to Box N. Wireless Press Ltd., Marconi House, Strand, W.C. 2.

TECHNICAL BOOKS. Second-hand and New Books on every conceivable subject. Catalogue free. State wants. Books sent on approval. Books bought.—FOYLE, 121/125, Charing Cross Road, London.

WANTED. WIRELESS WORLD, June 1917.—C. CRAWFORDS 202, Coleherne Court, London, S.W.5.

Company Notes.

THE MARCONI INTERNATIONAL MARINE COMMUNICATION COMPANY (LIMITED)

THE REPORT OF THE NINETEENTH ORDINARY GENERAL MEETING

The Nineteenth Ordinary General Meeting of the Marconi International Marine Communication Company (Limited) was held yesterday at the Cannon Street Hotel, E.C., Mr. Godfrey C. Isaacs (managing director) presiding.

The Secretary (Mr. H. W. Corby, F.C.I.S.) read the notice convening the meeting and the auditors' report.

The Chairman said:—Ladies and gentlemen, our chairman, Senatore Marconi, having been called by his Government to Italy on important business, is unable to be present to-day, and therefore I am called upon to preside at this meeting.

The report and balance sheet are in your hands, and I presume you will approve of my adopting the usual course of taking them as read. I will therefore proceed at once to deal with the figures in the accounts. If you will refer to the balance sheet, the capital account at the end of the year stood at the same figure as it did at the end of 1917. You are, however, aware that this year the capital has been increased to one million and a half, of which to-day some £1,200,000 has been issued. The Debentures stand at £111,340, as compared with £112,280 in the preceding year, 47 Debentures of a par value of £940 having been redeemed. The reserve account is unchanged, except that there now appears a reserve for obsolescence of plant of £50,000. No comment is needed upon the creditor balances.

TRAINING OF OPERATORS.

To profit and loss account £105,417 10s. is carried forward from the preceding year, and the balance for last year was £186,341 17s. 1d., making the total £291,759 16s. 1d. The profit for the year shows a slight reduction, but this is due entirely to a considerable expenditure incurred in providing and training a very large number of operators in a very short time. It was a matter of the utmost importance to the country that these operators should be provided, for as everybody knows the Mercantile Marine and the wireless upon the ships played a very important part in helping to win the war, and your directors did not hesitate to expend whatever sum was necessary to provide within the shortest time possible what was asked of them. In these circumstances I feel sure that no shareholder will complain that notwithstanding the fact that the company did a substantially bigger business during the year, a proportion of the profit was sacrificed to the service of the country. (Hear,hear.) On the credit side of the accounts it will be seen that plant, apparatus, furniture, and stores shows a substantial increase over the preceding year, which is entirely due to the increased number of installations installed and owned by the company on board ships. Otherwise, I think there is no figure calling for any explanation on the credit side of the account.

THE PROFIT AND THE DIVIDEND.

In the profit and loss account the gross profit figures at £563,205 7s. 3d., as compared with £470,657 16s. 7d. in the preceding year, an increase of £92,548 in round figures, the net result, however, being less for the reason I have already stated, and which appears in the item of £267,707 15s. 2d., under the heading of "expenses of ship telegraph stations, including loss of plant and apparatus and cost of training operators." Depreciation, of course, stands at a higher figure in consequence of the continuous increase in the number of installa-

tions. In the appropriation account it will be noted that an interim dividend of 5 per cent. was paid on the capital as it stood at the end of 1918, which absorbed £30,000 and, subject to your approval, the final dividend of 10 per cent. upon the paid-up capital will require in round figures a further sum of £120,000. The balance of £141,759 16s. 1d. will be carried forward, and is subject to excess profits duty for the years 1916, 1917, and 1918, which has not yet been finally adjusted.

WIRELESS AND SHIPS.

As the report informs you, the company's business has continued to increase. The number of stations installed and worked by the company at the end of the year was 2,549, and stands to-day at 2,638. Taking into consideration the large number of ships which have been lost during the war, I think we have every reason to be satisfied with our position. We now look forward to the benefit of our telegraphic receipts, of which, as you are aware, we have been deprived during the last four-and-a-half years. Having regard to the very much larger number of vessels now fitted with wireless telegraph stations, the great increase in coastal stations, and above all, the greater acquaintance which the world at large has to-day of wireless telegraphy, we have every reason to hope that our telegraph stations on board ships will be more freely used in the future than they were in the past. I will not prophesy what may be the development of wireless telegraphy upon ships as a result of navigation of the air.

THE DIRECTION-FINDER.

We think it probable, too, that an additional source of revenue to the company will arise from the more general use on board ships of what is known as the direction-finder, which has now been so very materially improved that it gives promise of proving of considerable value to navigators. That, together with the latest invention of Senatore Marconi, promises to prove a great boon to navigation. This new discovery provides a means whereby a ship in the densest fog may discern the approach of another ship, provided that that ship be also fitted with this apparatus, and at the same time giving an approximate idea of the distance of the approaching ship. We are at present engaged in giving a commercial shape to this new apparatus, and as soon as possible its value on board ship will be demonstrated. We have great hopes that by this means all risk of collision at sea during the thickest fogs will be eliminated, to which end, of course, every ship would have to carry the apparatus, for it stands to reason that if a great liner were fitted and a small tramp were not, the danger of collision and the loss of one or the other, or both, of the ships might result. Inasmuch as this new device should provide means of disposing of that which is so great a danger in misty and foggy weather, it is not unlikely, we think, that every ship which goes to sea will be eventually fitted with this new installation, and we shall all be spared the harrowing accounts of the terrible losses which from time to time it has been so distressing to read in the daily Press resulting from some terrible collision at sea. For all these matters some considerable capital expenditure is likely to be necessary, and we have made all the requisite provision for those purposes.

LOSS OF OPERATORS DURING THE WAR.

I much regret having again to report the loss of a considerable number of operators during the past year in consequence of enemy action. During the war over 800 wireless operators in our employ were torpedoed or had their ships sunk by gunfire or striking mines, 182 of them lost their lives, and 38 were severely injured. I am sure that no men in any capacity did greater service to their country than the wireless operators, and I think we have every reason to hope that the long period of anxious and dangerous work is now a thing of the past, and that in future they will carry on their vocation under peaceful and more pleasant conditions. (Hear, hear.)

The company now employs upwards of 5,000 wireless operators, a large number of inspectors in all parts of the world, and a very considerable clerical staff, all of which are growing in numbers almost day by day. One of the first considerations of your board is to provide for the well-being, good understanding, and contentment of the employees of the company, and they have already done, and are doing, a great deal to this end. To encourage thrift, a savings bank has been formed for the purpose not only of taking care of the savings of the men, but also of furnishing facilities for the withdrawal of moneys at any of the principal seaports of the world. A welfare department has been established to look after the social, athletic, and educational interests of the men; and a service magazine is now about to be published to keep all employed in the service wherever they may be situated acquainted with the doings of the company and their fellow-members of the staff. All these are matters to which during the war we were unable to give the attention which we felt they required, but from the moment the Armistice was declared they were taken in hand. You will remember, of course, that prior to the war a pension scheme was inaugurated, and to-day there is one thing further which your board is desirous of introducing.

SHARES RESERVED FOR EMPLOYEES.

We think it is of the first importance that every man employed in the company should have the opportunity, if he so wishes, of investing his savings in the business in which he is employed, and we, therefore, propose, and subject to its not meeting with your disapproval, reserving for and issuing from time to time in all 100,000 of the 100,000 unissued shares of the company, to all those employed in the company who desire to interest themselves in it. (Hear, hear.) This exclusive, of course, of the directors and the managing director. We ask, therefore, for your approval of our carrying out this programme and disposing of these shares at such a price, and on such terms and conditions, as the directors may think fair and proper in the circumstances.

MR. ALLEN'S APPOINTMENT AS JOINT GENERAL MANAGER.

I have to inform you that Mr. H. W. Allen who, as you know, was appointed a member of the board last year, has, at my request, resigned the secretaryship of the company in recent months after having occupied that position since the incorporation of the company in 1900, and he has, at my request, assumed the joint general management of the company with Mr. W. W. Bradfield, also now, as you know, a member of the board. (Hear, hear.) From my own knowledge a great many shareholders have been acquainted with Mr. Allen in his capacity as secretary and have appreciated, as highly as the board have done, the service which he has rendered during a great number of years, and particularly through the most trying and difficult period of the company's history, and I am sure you will join with us in giving him, as joint general manager, all the support and confidence which he received from you during the time he acted as secretary. (Cheers.) Mr. Corby, who has been so good a second to Mr. Allen during many years, has been appointed secretary to the company in Mr. Allen's place. (Hear, hear.)

THE LATE PUBLIC TRUSTEE AND THE BOARD.

I regret to have to inform the shareholders of the loss which we have suffered in recent weeks

by the death of Mr. Henry Spearman Saunders, who had been a director of the company since its formation. I have also to inform you that Sir Charles Stewart, K.B.E., who is known to all of you in connection with the very important position which he held for many years as Public Trustee, has joined our board, and we look to him with great confidence to render us substantial assistance in the efficient discharge of the responsibilities which we carry in the conduct of this business. (Cheers.) I conclude, gentlemen, by moving, "That the report of the directors submitted, together with the annexed statement of the company's accounts at December 31st, 1918, duly audited, be received, approved, and adopted."

Mr. Maurice A. Bramston seconded the resolution, and in the absence of questions or remarks from shareholders, it was at once put to the meeting and carried unanimously.

RE-ELECTION OF DIRECTORS.

Captain H. Riall Sankey, C.B., R.E. (retired).—Gentlemen,—I have great pleasure in submitting the following motion: "That Mr. Sidney St. J. Steadman and Sir Charles J. Stewart, K.B.E., the directors retiring in accordance with Article 67, be re-elected directors of the company." It is quite unnecessary for me to say anything in support of that motion. I also have to move: "That Mr. Henry W. Allen, Mr. William Walter Bradfield, and Mr. Maurice Alfred Bramston, the directors retiring by rotation, be re-elected directors of the company." You have already heard to-day about Mr. Allen and Mr. Bradfield. Mr. Bramston is before you and you all know him quite well. I have great pleasure in moving their re-election.

Mr. Alfonso Marconi formally seconded the resolution, which was unanimously agreed to.

The Chairman.—I have now to move a resolution in similar terms to the one which was submitted to you last year, and which it is our custom always to put, namely: "That the remuneration of the directors in respect of the year ending December 31st, 1919, shall be the sum of £5,000, subject to such further sum, if any, as may be determined at the next general meeting of the company, such sum to be paid free of excess profits duty, the company waiving its right of recovery of such duty under section 49 (2) of the Finance Act, 1916." That resolution is similar to the one you were good enough to pass at the last meeting.

Mr. Sidney St. J. Steadman having seconded the resolution, it was carried unanimously.

THE DIVIDEND RESOLUTION.

Mr. Henry W. Allen, F.C.I.S.—I have pleasure in moving "That a final dividend of 10 per cent., equal to 2s. per share, less income tax, upon the capital now issued and paid up, be and the same is hereby declared for the year ended December 31st, 1918. That the said dividend be payable on July 14th to the shareholders registered on the books of the company at June 10th, and to holders of share warrants to bearer."

Mr. W. W. Bradfield, C.B.E., seconded the resolution, which was carried unanimously.

Mr. C. B. Clay.—I move "That Messrs. Cooper Brothers and Co. be re-elected auditors for the ensuing year, and that their remuneration for auditing the accounts to December 31st, 1918, be 400 guineas."

Mr. A. B. Croft seconded the resolution, and it was unanimously carried.

The Chairman.—That concludes our business for the day.

Mr. Wharton Marriott.—Gentlemen, I think we ought not to part without according a hearty vote of thanks to the chairman and the board, and also to all the officials who have served the company so extremely well that no words of gratitude from us would really make up for it. I move that our thanks be given to them. (Hear, hear.)

Mr. John Evans seconded the vote, which was unanimously agreed to.

The Chairman.—Gentlemen, on behalf of my colleagues and all the officials of the company, I thank you for your vote of appreciation.

The proceedings then terminated.