

The
**WIRELESS
WORLD**

**BRITISH ARMY
WIRELESS
IN RUSSIA**

**WIRELESS
TELEPHONY**



**"ANTI-SULPHURIC" ENAMEL
RESISTS ACID FUMES, Etc.**

**GRIFFITHS BROS. & Co. (London) Ltd.
MACKS ROAD, BERMONDSEY, S.E. 16.**

SULLIVAN INSTRUMENTS

Sullivan "Universal" Galvanometers and Shunts for Land and Sea use

SULLIVAN TELEPHONE RECEIVERS

Fast Speed Wheatstone Automatic Transmitters and Receivers guaranteed at 400 words per minute, and Wheatstone Apparatus generally. Precision and Standard Measuring Equipments for D.C. and A.C. (high frequency) determinations, Condensers of Low Power Factor, etc

H. W. SULLIVAN, WINCHESTER HOUSE, LONDON, E.C., ENGLAND

Telegrams— "Deadbeat, London." Telephone: Office: 3518 London Wall. Works: 4871 Avenue. WORKS: LIVERPOOL HOUSE, MIDDLESEX STREET LONDON, EC.

P. ORMISTON & SONS

(P. H. ORMISTON) :: ESTABLISHED 1793

79 Clerkenwell Rd., London, E.C.1

"Ormiston, London." :: :: 13259 Central

Silk and Cotton Covered H.C. Copper Wire, Resistance Wires, Fuse Wire, Binding Wires, Charcoal Iron Core Wire, Asbestos Covered Wire, Braided and Twisted Wires, Bare Copper Strand and Flexibles of any Construction, Wire Ropes and Cords (fine sizes) in Galvanized Steel, Phosphor Bronze, &c.

COMMERCIAL UNION

ASSURANCE CO., LTD.

Head Office:

24, 25 & 26, CORNHILL, LONDON, E.C.

The following classes of Insurance effected: FIRE, LIFE AND ANNUITIES, MARINE, LEASEHOLD REDEMPTION AND SINKING FUND, ACCIDENT, including Personal Accident, Third Party, Burglary, Plate Glass, Fidelity Guarantee, Employers' Liability and Workmen's Compensation, including Domestic Servants' Insurance. The Company also act as TRUSTEES AND EXECUTORS.

FIRE, LIFE, MARINE, ACCIDENT.

Capital fully Subscribed	£2,950,000
Capital Paid Up	£295,000
Total Assets (including Life Funds)	£24,902,252
31st December, 1913	£8,500,000
Total Annual Income exceeds	£8,500,000



THE BRITISH SCHOOL of TELEGRAPHY Ltd.

179, CLAPHAM RD
LONDON, S.W.

EXPERT TRAINING FOR YOUNG GENTLEMEN (15-25) IN INLAND, CABLE & WIRELESS TELEGRAPHY. Good Appointments are open to our students as soon as qualified, the demand for Skilled Operators in all Services being greater than the supply. Special Short Course suitable for men wishing to obtain Government Certificate and enter the service of the Marconi Co. At several recent Government Exams. all candidates obtained 1st Class Government Certificate. No Branches or Postal Tuition. Fees moderate. Recognised by the War Office, Admiralty, Wireless Telegraph and Cable Companies.

WRITE FOR PROSPECTUS. A. W. WARD (Manager). 'Phone: BRIXTON 215

THE WIRELESS WORLD

No. 76
Vol. VII



JULY
1919

“W/T. R.E.”

An Account of the Work and Development of Field Wireless Sets with the Armies in France.

By Capt. B. F. J. Schonland, O.B.E., R.E., late Staff Officer (Wireless)
1st Army, France.

THE great war has seen many marvellous adaptations of man's ingenuity and science as aids to victory. Scarcely a field of knowledge but has had its quietly-won results turned into martial channels, their development hastened by the pressing needs of the time. Science, with all its brain power, all its facilities for research, has had to turn from peaceful paths and to produce new tools for warfare, on sea and land and in the air. With such an adaptation of science and engineering this series of articles has to deal. The story of the work of field wireless sets in France is the story of an entirely new development of the wireless art. A new development, because though our armies were well equipped with field wireless sets before the war, these sets were not of the kind used in France, largely used that is. They were used with our forces in Egypt, Palestine, Salonika, Mesopotamia, East and South-West Africa, when as sole means of communication between units fight-

ing in desert or jungle, advancing rapidly, moving constantly, they did invaluable work. In France the problem was an entirely different one, and prior to the war, the British Army possessed no sets capable of solving it. Though indeed the problem, that of communication in battle in trench warfare, could hardly have been foreseen. How wireless telegraphy solved it, and so successfully that the number of trench wireless sets can now be reckoned in thousands, the following pages will show. I hope, too, that the story of the W/T sections R.E. working as part of the ordinary and extraordinary communication of the huge army in France, as part of the Signal Service, will show that, thanks to the heroism and enthusiasm of the operators, they contributed in no small measure to the final victory.

The wireless sets brought over to France by the original Expeditionary Force in August, 1914, numbered about a dozen. They were $1\frac{1}{2}$ kilowatt sets mounted in lorries or in limbered wagons, the latter for use with

the cavalry. During the rapid movements of the first few months these stations did a certain amount of good work, but conditions were against their employment to any great extent, as moves were too rapid during the retreat and subsequent advance from the Marne. Once the opposing armies had "dug themselves in" on the fronts that changed so little for four years, these sets were not used and they remained inactive during the year 1915.

The advent of trench warfare, however, and the ever-increasing weight of enemy artillery brought to bear on our trenches, made the problem of maintaining communication with our forward troops very difficult. The great concentration of infantry and guns on a front of attack complicated the scheme of communications. Telephone and telegraph "buzzer" lines had to be laid everywhere. But once an enemy barrage came down, telephone cables were sure to be cut. True, they could be laid along the sides of communication trenches, or buried in special trenches at night, but even the latter expedient was not a sure means of maintaining communication. Though the regulation depth was increased from a foot to six, and even eight feet, a direct hit from a Boche "5.9" would cut the line.

During the latter part of the year 1915 those responsible for organising the work of the Signal Service began to look round for some auxiliary method of communication, to carry back the "S.O.S." of the fighting infantry. Visual signalling by flag or lamp, they had, and the finest visual signallers in the world. But cover from enemy observation was not easy to find in that shell-shattered land. The dust and smoke of a barrage, too, was enough to obscure any flagwagging or lamp-signalling, while many a good visual "circuit" was useless owing to the morning

mist, at a time when information was all-important.

Many ideas were tried, some at a later date than that which I am considering. Carrier-pigeons, which did good work while trench-warfare lasted, though subject to many drawbacks, message-carrying rockets, which were never very successful, even messenger-dogs! The infantry "runner" always used in the last extremity, was a brave man, but often it cost him his life which could ill be spared.

And then, about the end of 1915, it was decided to try wireless sets. Possibly some success obtained by our Allies the French led to this decision. Certainly the enemy, from whom we were never unwilling to adopt an idea, as he from us, was not using anything but a few powerful stations for his very long rear communications. Before describing the sets that were tried, I will briefly indicate what was required of them from a military and technical point of view.

Wireless was required as a means of communication between the headquarters of battalions, brigades and divisions, to supplement the telephone and telegraph in case of the failure of the last two through lines being broken by shell-fire or difficult to lay. Later, as we shall see, wireless was required to supplement and even replace all "wire" communications in the army, both in the actual front line and in the area behind the trenches. These wireless sets were to transmit and receive orders and reports during battle and to move forward with our advancing troops. Clearly the range required of them was not great, varying from a thousand yards to ten or twenty miles. The aerials used had, however, to be as low and as inconspicuous as possible, sometimes merely ground aerials, and the sets were to be under conditions of working and screen-

"W/T R.E."

ing which did not make for efficiency. Moreover, as they had to be quickly dismantled and carried forward, everything about the sets, masts, instruments, accumulators, etc., had to be simple and as small and light as possible. The design and development of these short range trench wireless sets with their special needs and peculiarities, can well claim place as a new branch of wireless engineering.

So in the spring of 1916 there came out to France a number of small "boy-scout" wireless sets, christened at G.H.Q. Wireless Headquarters, the "B.F." sets. History does not relate the origin of this name, and though the succeeding years saw sets which better fulfilled the conditions given above, the "B.F." set is used to this day. Suitable operators, most of them old Marconi men, were obtained from the infantry and other sources, and after a period of training, the B.F. sets had their baptism of fire. They went into "action" in the 1st Battle of the Somme, July 1st, 1916. The map (Fig. 1) shows the distribution of stations during one phase of the battle. Time and again these sets got "through" important messages when all other means of communication failed. Some idea of the conditions under which they worked may be got from the station at Waterlot Farm, on a rise in full view of the enemy, and only about nine hundred yards away from him. To keep two fifteen-foot masts standing was almost impossible, and this station had to use ground aerials (insulated cables laid along the ground for a hundred yards). Some very important messages were yet despatched in this way, and enemy counter-attacks broken as a result.

Lack of facilities for transport and for charging of accumulators and many minor difficulties which occurred were natural with a new organisation, as yet

not fully equipped. Opposition and criticism, too, were not absent, but these were to die away later. It was during this Somme offensive that the poor Corps wireless officer, struggling to keep his sets going, with bad carborundum crystals and accumulators which he could not get charged, was daily asked the facetious question: "Hullo, Sparks, got any messages through?" A remark not calculated to help poor "Sparks," who, nevertheless, thanks to the keenness of himself and his men, eventually turned the tables on his interlocutor and—but I am anticipating. However funny it was to some people to see "Sparks" and his men wandering about the trenches with their "gadgets," their portable boxes of wireless magic, to the Huns at any rate they did not seem in the least bit funny. In the captured report on the Somme operations by General von Arnim, the report in which he contrasted our excellent fighting equipment with that of his own troops, he particularly asked that small portable trench wireless stations, such as we had used, should be quickly provided for him. That this was done was evident to us a few months later, when the now familiar Telefunken trench-sets began "U-M"ing all along the line. Imitation is the sincerest form of flattery, and after the *début* of "W/T.R.E.," it was still the British who kept the mastery of the Aether, both in novelty of idea and in general efficiency of service.

The success first obtained on the Somme was maintained in succeeding operations and gradually prejudice and opposition alike were won over. More men and better equipment were provided, with correspondingly better results from wireless communication. Schools were started during the winter of 1916-1917 for Signal Service officers, to give them some knowledge of the

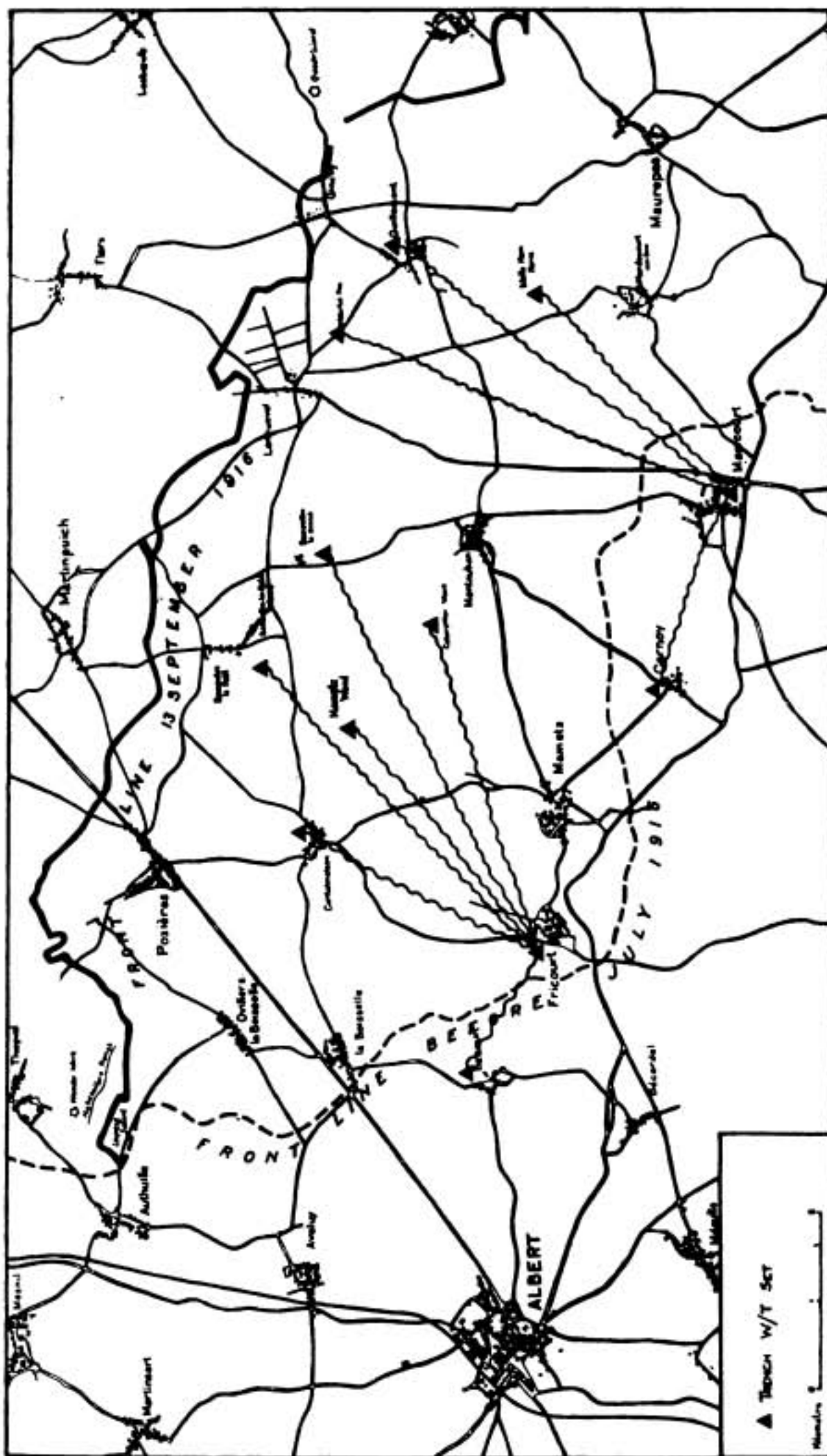

Fig. 1.
Trench Wireless first used in battle. First Battle of the Somme, September, 1916.

"W/T R.E."

working conditions, possibilities and needs of the sets. The number of sets was increased by production in special factories in England, and operators were trained at depots in England and France. The need being recognised, a staff of wireless experts at Woolwich was busy investigating the trench wireless problem, and applying to it all that modern wireless practice could suggest. In particular that revolutionising instrument, the three-electrode valve, was called in to help.

The battles of 1917; the German retirement to the Hindenburg line, Vimy Ridge and Arras, and the battle of Ypres which culminated in the capture of the Paschaendale ridge, all these added to the laurels of the "W/T.R.E."

Amongst hundreds of cases of heroism of the operators and invaluable service to the fighting infantry, I can only mention a few instances. In the first battle of Arras, for example, prior to the commencement of operations, the second corps wireless section had stations erected near the front line in communication with the 73rd Brigade Advanced H.Qrs. At 7 a.m. on April 15th one "B.F." set was moved forward to advanced Battalion H.Qrs. Only visual signalling of doubtful reliability existed until the trench set was established. During the battle visual signalling became impossible and wireless was relied upon to maintain communication. A large number of messages of the utmost tactical importance were sent at critical periods of operations, over an average distance of 8,000 yards. Continuous communication was maintained in spite of heavy shellfire.

During this battle of Arras one of the most important objectives was a peculiar hill crowned by the village of Monchy-le-Preux. This hill commands the country for miles around. The possession of it was invaluable to

our artillery observers and a great loss to the enemy. The hill and village on top were captured in a rush, the Boche retiring in disorder to the valley beyond. Owing, however, to the speed of their advance our troops were out of touch with the higher command, and the guns behind them. Out of touch, did I say? What is this queer mast affair some sappers are rigging up in the garden of what was once a pretty cottage? Up go the small steel masts in spite of the shells streaming into the village, which seem determined to wipe out this and every other cottage before many minutes are over. The aerial up, it is not long before they have installed their tiny set in the cellar and are "through," R9 signals each way. Just in time, too, for the Boche at the foot of the hill show signs of a counter-attack. "Get at the guns, Sparks, get at the guns!" And "Sparks" bends to his key, like operator on sinking ship. "S.O.S. Barrage, S.O.S. Barrage, S.O.S. Barrage" goes out on 350 metres for every battery of artillery behind to pick up. They do pick it up. Within a minute the answer comes as the shells whistle overhead. The German counter-attack withers away under our shelling, and Monchy is saved. For several hours afterwards the little set keeps the garrison in touch with the general and the guns behind until a telephone line can be laid.

The third instance is concerned with a continuous wave set. These sets were introduced about the middle of 1917 and proved very successful, later designs giving admirable results. The very low and short aerials on which they would work made it possible to instal them in positions under enemy observation and in very forward positions. They were therefore utilised for directing artillery fire from forward O.P.'s (Observation Posts). (*To be continued.*)



COLONEL BLANDY, D.S.O.

Personalities in the Wireless World.

THE subject of our biography this month, Colonel Lyster Fettiplace Blandy, D.S.O., Royal Air Force, now in charge of "Communications" at the Air Ministry, was educated at Haileybury College and the Royal Military Academy, Woolwich. He was given a commission in the Royal Engineers in March, 1895, and after passing ten years in Bermuda, the West Indies, and Canada, engaged on work in connection with submarine mining and coast defence search-lights, he returned to England. For two years he was employed at Pembroke Dock, and from 1908 to 1912 as Inspector R.E. Stores at Woolwich. During this period he had considerable work to do with the field wireless sets which were being perfected at this time for our Army.

From Woolwich Captain Blandy, as he then was, went to Aldershot at the beginning of 1913 to command a small unit of 30 to 40 men, the Wireless Signal Company which was destined to be the nucleus at General Headquarters of Wireless in the British Army if war should break out. The only other unit at that time was the Wireless Signal Squadron, a unit whose object in life was to work with Cavalry and maintain wireless communication with Headquarters.

On the outbreak of war Captain Blandy proceeded to France in charge of an advance party to make the preliminary signal arrangements for G.H.Q. Arriving at Le Cateau on August 13th, 1914, he supervised general Signal work during the retreat, the advance to the Aisne, and the movement to the Belgian frontier, and was shortly afterwards given charge of the wireless communications of the army, being responsible for the development of these up to July, 1917, when he was brought home to take charge, as Chief Experimental Officer, of the Army Signals Experimental Establishment. On the formation of the Royal Air Force in April, 1918, Colonel Blandy was appointed Chief Experimental Officer of the R.A.F. Wireless Experimental Establishment, and from there was transferred to his present post in the Air Ministry.

Colonel Blandy has received the following decorations, besides being mentioned in despatches, for his services during the war:—The D.S.O., the French Legion of Honour, the Order of the Crown of Belgium, the Belgian Croix de Guerre.

The Theory of Valve Rectification

By W. S. Barrell.

ONE of the many uses to which the thermionic valve is put is that of rectification, and it is proposed to outline the elementary theory of this function, firstly, in the case of the two-electrode or Fleming valve, and, secondly, in the case of the three-electrode valve.

To begin with, it should be borne in mind that whichever type of valve is being used the fundamental basis of its operation is the same, for both depend, for working, upon thermionic currents.

The nature of the phenomena in a valve will depend a great deal on the degree of vacuum produced within the tube, i.e., whether the valve is what is popularly known as hard or soft, but in what follows we shall only deal with valves that have been well exhausted, and are known as hard, the degree of vacuum being about 10^{-6} mm. pressure of mercury. In this class of tube the current between the electrodes will be strictly thermionic, the absence of gas rendering the presence of positive ions impossible.

Previous to the invention of the Langmuir pump it was generally accepted that unless gas was present in the tube electronic emission could not take place. Langmuir was able to show, however, that not only was the presence of gas quite unnecessary for the emission of electrons but that this emission was much more regular in hard tubes. He further showed that it followed definite laws, and formulated the equation for the emission from a filament surrounded by a cylinder charged to any given potential.

$I = 14 \cdot 65 \times 10^{-6} l r^{-1} (V^{\frac{3}{2}})$
where I = current in amperes
 l = length of cylinder
 r = radius of cylinder
 V = Potential of cylinder in volts.

NATURE OF THERMIONIC CURRENTS.

In any conductor there are present minute negatively-charged particles which are known as electrons. If the conductor be raised to a high temperature the activity of the electrons is considerably increased and a number will break through the surface layer. The number of electrons which escape in this manner per unit area of the conductor is proportional to the temperature of the conductor and the material of which it is made.

Professor Richardson has shown that the number of electrons emitted per sq. centimetre per second is

$$N = aT^{\frac{5}{2}} e^{-\frac{b}{T}}$$

where T is the absolute temperature of the filament, a and b are constants depending upon the material, and $e = 2 \cdot 718$.

Now these electrons are negative charges of electricity each representing 10^{-19} coulomb. If, then, no attractive force be applied, these electrons will return to their source, the filament, but, on the other hand, it will readily be seen that if a positively charged anode be placed in the tube and the filament raised to incandescence the electrons will be attracted towards the anode and absorbed by it.

We shall thus have a negative current passing from the filament to the anode, but not in the opposite direction.

THE THEORY OF VALVE RECTIFICATION

RECTIFICATION BY THE FLEMING VALVE.

In order to simplify the study of valve rectification it will be necessary to draw what is known as the "Characteristic Curve of the Valve." It has been found that if the filament heating current is kept constant and a varying voltage applied to the anode we shall get varying readings of current in the anode circuit, the current variations depending upon the variations in voltage. We thus have our independent and dependent variables and can plot a curve with values of anode current as ordinates and anode volts as abscissæ.

There are several ways of connecting up a circuit for curve drawing, and perhaps the one most easily understood is that shown in Fig. 1.

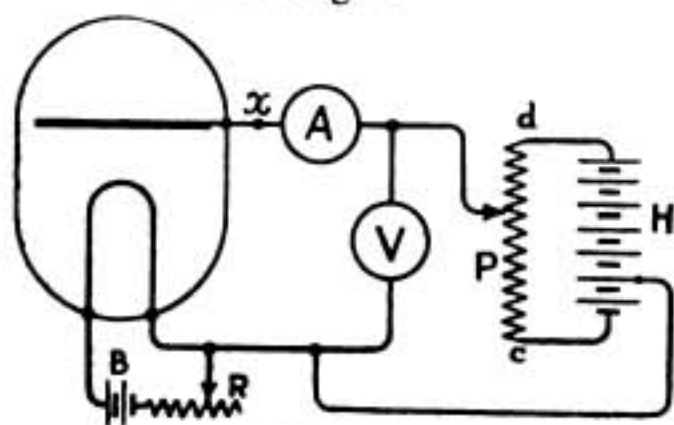

Fig. 1.

The filament is lighted by a 4-volt accumulator B, the series resistance R being adjusted to give a current of approximately 0.37 amp. H is a battery of a few dry cells, and is so arranged that in conjunction with the potentiometer P any voltage may be applied to the anode, its value, either positive or negative, with respect to the negative end of the filament, being indicated by the voltmeter V. A is a microammeter and serves to measure the anode current.

It is advisable to break the voltmeter circuit when reading the current on the micro-ammeter A, but if the

former be connected across the microammeter as well as across the battery (i.e., if the upper lead be connected to "x" instead of where shown) then the foregoing proviso is *absolutely necessary*, for with the voltmeter circuit complete the instrument A will register the current flowing through the voltmeter as well as that flowing through the valve.

Our circuit being all ready we will proceed to take a series of readings. Commencing with the potentiometer slider at c and closing the voltmeter circuit, the potential of the plate will be indicated. If our instrument is of the central zero type it will at once show whether the plate potential is positive or negative with respect to the filament. Suppose the reading to be -3, the current flowing through A is then measured and will probably be zero. This procedure should be repeated for different positions of the slider P, say every $\frac{1}{2}$ volt, up to the position where the slider is at d. We shall thus have two sets of readings—one the values of V, the other the values of current I, and plotting the former as abscissæ and the latter as ordinates we shall find that a curve such as is shown in Fig. 2 is given.

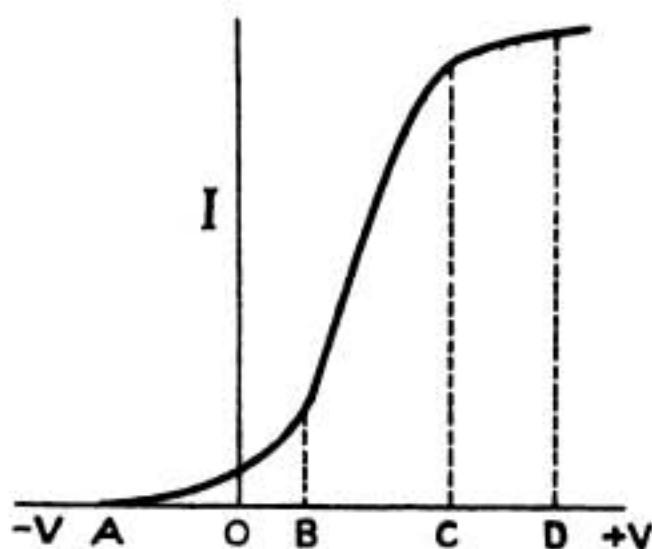

Fig. 2.

The reader will at once notice that the shape of this curve bears a striking resemblance to the characteristic curve of a carborundum crystal in that it may be divided roughly into three parts, each being almost a straight line. The slope of the part AB is about the same as the portion CD, BC being much steeper; in the latter case dI/dV being obviously much greater.

In this, as in the case of the carborundum curve, it will be evident that up to a certain point B an increase in voltage V will cause but a small increase in the current I , but if the same increase of voltage be applied after this point a greater increase in current will follow. Again, after passing the point C the current remains practically constant, provided the filament current remains uniform, or, in other words, saturation has been arrived at.

In Fig. 3 is shown a two-electrode valve connected to a simple receiving circuit for the reception of spark signals (damped waves).

It will be seen that the plate and filament of the valve are connected across the oscillating circuit, and that instead of using a separate battery for the anode potential the low tension accumulator battery has been utilized. A potentiometer $c d$ of about 250 ohms is joined across the cells, and the slider P allows the potential of the plate to be adjusted to the point B (see Fig. 2) which, as we shall show, is the best position for rectifying.

In order to state a definite case and for ease in explanation we will assume that the incoming wave gives a variation of $+1$ and -1 volt, the position of the potentiometer slider being adjusted to give the plate a zero potential. From Fig. 4 it is seen that normally a current of .02 micro-amps. will flow through the telephones, producing a steady deflection. This is represented by Xa Fig.

4. The positive half wave will increase the plate potential to $+1$ volts with a consequent increase of current to 0.62 micro-amps. shown by X_1b . The negative half wave will, however, reduce the anode potential to -1 volts with a reduction in plate current to 0.001 micro-amps. This is represented by $X_2 b_2$. A study of Fig. 4 will show that the increase in plate current due to the positive half waves is greater than the decrease due to the negative half waves and that the

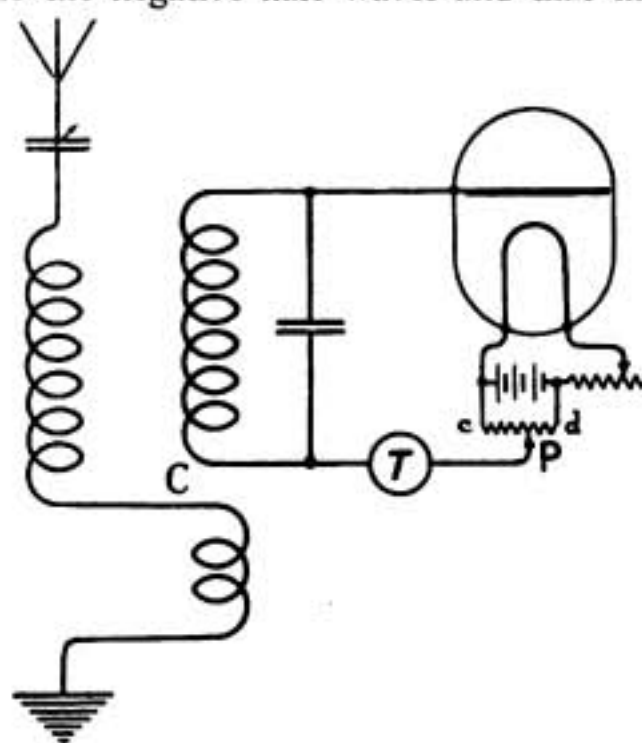

Fig. 3.

mean increase is equal to $Xa_1 - Xa = Y$. This then is the current through the 'phones, and we may, for convenience, say that the signal strength is equal to Y . Now let us suppose that the amplitude of the incoming wave is but one-half of the previous example; this will give a variation of only $\pm .5$ volt. The positive half wave in this case will increase the plate potential to $+ .5$ with a current increase from .02 to .2, and the negative half waves will cause a reduction in current to .006, these two current values being represented by ZZ^1 and Z_1Z^2 respectively (Fig. 4). Taking a_2 as the mean increase and a as the normal we have a signal strength in this

THE THEORY OF VALVE RECTIFICATION

case equal to W which is $\frac{1}{4}Y$. This shows that with one-half the amplitude the signal strength is reduced to one-quarter. Now $\sqrt{\frac{1}{4}} = \frac{1}{2}$ and in general

the signal strength is proportional to the square of the amplitude of the incoming oscillations. From the foregoing the reader will at once appre-

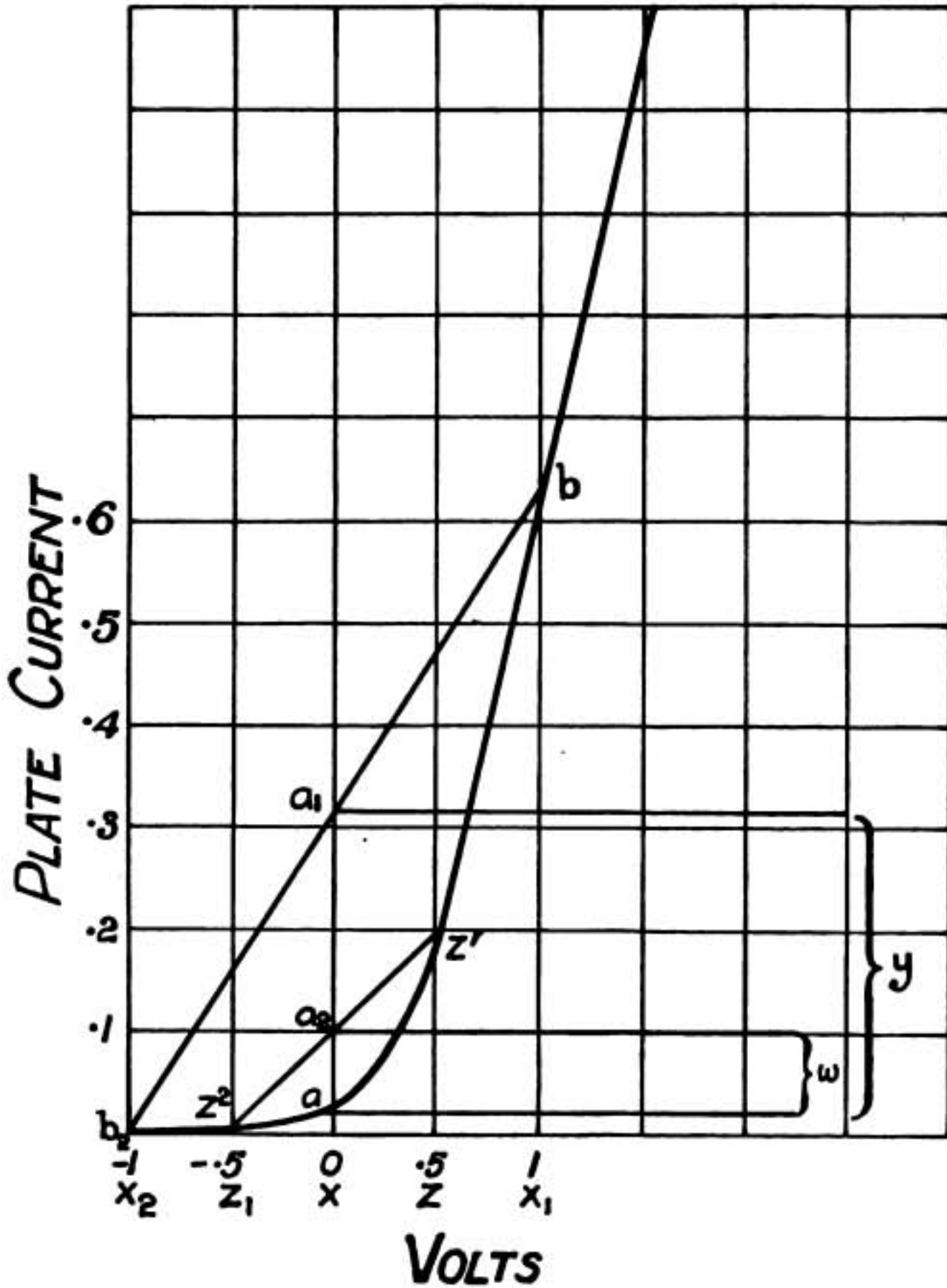

Fig. 4.

ciate the enormous value of reaction and high frequency magnification which increase the amplitude of the waves affecting the receiving aerial.

In connection with the characteristic curve shown in Fig. 2 a very interesting experiment can be made by plotting the sensitivity curve on the same paper. The circuits needed for this experiment can be arranged as shown in Fig. 5 where the valve circuit is fundamentally the same as in Fig. 1 but with the addition of a coupling coil L , tuning condenser C , and telephone transformer. A buzzer set B is also set up and tuned to some convenient wavelength. This latter should preferably be arranged on a small board so that the distance x between the two coils L and L_1 can be easily varied. First of all the wavelength of the valve circuit is tuned to that of the buzzer set by means of the variable condenser C and once having the two circuits syntonized the characteristic and sensitivity curves may be plotted simultaneously. Commencing with the potentiometer at c , as already explained, the current through A is read, these two readings giving the first point on characteristic curve. An additional reading has now to be taken. Assuming the circuits in tune and the buzzer working, the distance x between coils L and L_1 is varied until the buzzer signal is just audible. This distance is

carefully measured and plotted as the ordinate against voltage V as the abscissa and gives us the first point on the sensitivity curve. Thus for every position of the slider P along the potentiometer cd a reading of the current through A is taken and also of the distance x between the coils L and L_1 . x plotted against V provides the characteristic curve, and x against V the sensitivity curve.

Fig. 6 shows these two curves plotted on the same paper. From the sensitivity curve we see that there are two points on the characteristic curve which give the strongest signals, one being at the lower and the other at the upper bend. This is as might be expected because the two bends are about the same, the difference in actual working being that if the upper bend is used there will be a reduction in anode current for each signal instead of an increase as when working at the lower bend. It should further be noted that the sensitivity of the particular valve from which this curve was plotted is slightly greater at the upper bend. About the middle of the curve the sensitivity is at a minimum, this point being known as the "Balance point." Certain precautions such as screening are necessary in performing this experiment in order to prevent direct action from the buzzer on to the telephone transformer,

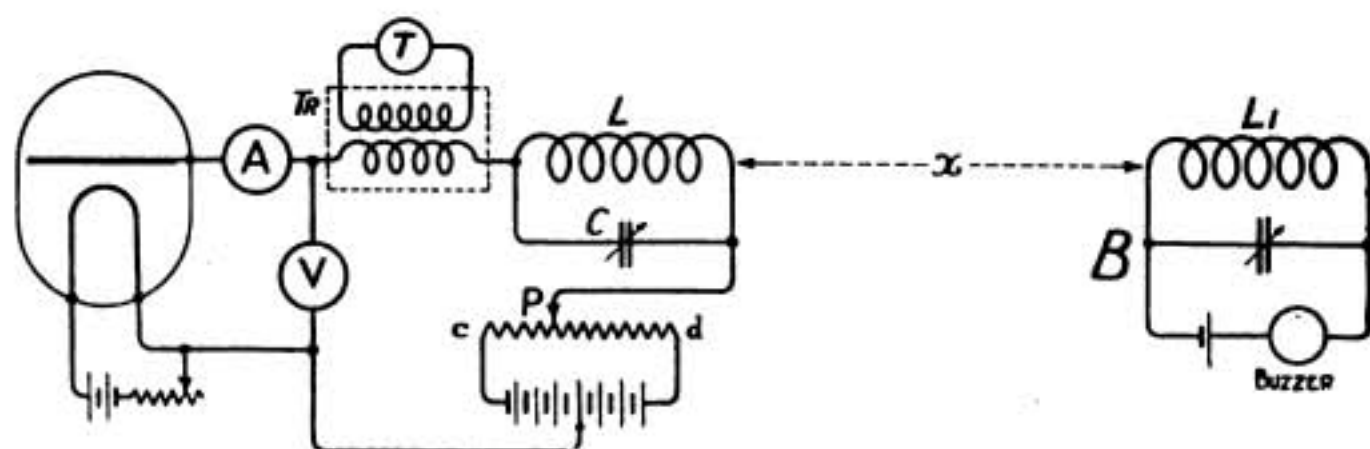

Fig. 5.

THE THEORY OF VALVE RECTIFICATION

etc., with consequent faulty readings. It should also be remembered that the coils L and L_1 must always be strictly parallel to each other throughout the test. It is possible to perform the experiment by rotating the coil L_1 , instead of increasing or decreasing its distance from L , and noting the angle through which the coil is turned. This method, however, is rather elaborate, and the distance method is, at any rate for the student, to be recommended.

It was stated above that the distance between the buzzer and valve set was varied until signals were just audible. As a matter of fact any strength of signal will do equally well, *provided this same signal strength is maintained throughout the experiment*, and as it is very difficult to estimate strengths accurately it is much better to arrange the distance so that signals are just on the vanishing point.

(To be continued.)

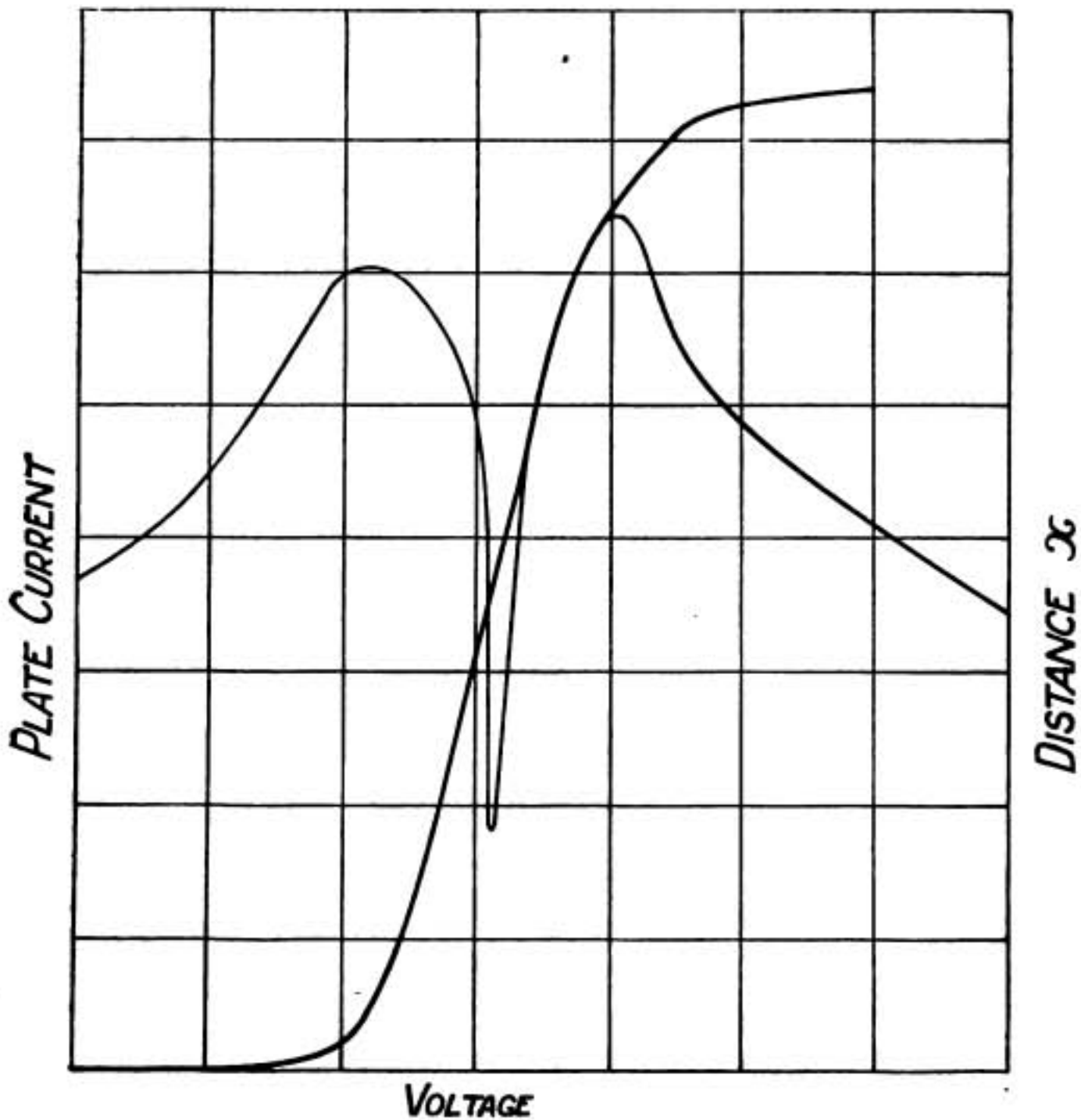

Fig. 6.

Digest of Wireless Literature

HIGH FREQUENCY ALTERNATORS.

By M. LATOUR.

Abstract of Paper read before the Société Internationale des Electriciens.

FOR several years it has been possible to construct on a commercial scale high power alternators (i.e., of larger size than 100 kw.) of which the natural frequency corresponds to that of the electrical oscillations in wireless aerials. It has thus been possible to excite these aerials directly by the alternators without the complications of any species of transformation, and with all the advantages of transmission by undamped oscillations.

It is proposed to discuss in the following pages the different types of machine which are available for the generation of high frequency currents; but not the means whereby it is possible to increase the frequency of the current outside the alternator, by means of doubling or tripling transformers. This discussion is limited solely to these types of alternator which yield directly, without any external apparatus, the frequency necessary for the excitation of radio-telegraphic aerials.

The various arrangements may be classified as follows:—

1. Machines in cascade,
2. Internally-cascaded machines,
3. Homopolar disc machines,
4. Variable reluctance alternators,
5. Alternators utilising part only of the armature periphery.

1. MACHINES IN CASCADE.

In 1904 machines had been con-

structed giving a frequency of 10,000 periods per second; and in particular Lamme had presented a paper to the American Institute of Electrical Engineers* giving specifications of a homopolar machine with an output of several kw., at 10,000 ω using only a relatively moderate peripheral speed.

The production of a frequency of the order of 80,000 periods appeared to be hardly possible without the employment of some special arrangement, such as the connection of several machines in cascade.

Figure 1 indicates one such arrangement. For example take four machines $A_1 B_1$; $A_2 B_2$; $A_3 B_3$; $A_4 B_4$, having the same number of poles and mounted

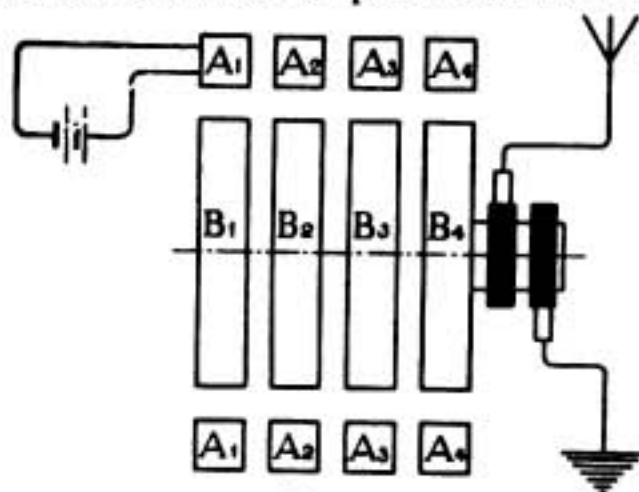

Fig. 1.

upon the same shaft. The stators and rotors of these machines carry windings which we may take as being two-phase. The first machine $A_1 B_1$ is excited by direct current in A_1 , and yields two-phase currents of frequency f from the winding B_1 . These currents of frequency $=f$ are collected from B_1 by means of slip rings (not shown in the figure) and excite the two-phase windings on the inductor A_2 of

*B. G. Lamme, Trans. American Institute of Electrical Engineers, 21, p. 405 (1904).

the machine $A_2 B_2$, so that the resulting rotating field revolves in the opposite direction to the rotation of the shaft. Two-phase currents of frequency $2f$ are thus set up in B_2 . These are utilised for supplying the inductor A_3 of the machine $A_3 B_3$ producing a field rotating in the opposite direction to the shaft. The currents set up in B_3 have thus a frequency of $3f$. Finally these currents of frequency $3f$ serve to excite the windings of A_4 of the machine $A_4 B_4$. A current of frequency $4f$ is thus obtained in B_4 which supplies the aerial.

Thus the frequency may be multiplied indefinitely by increasing the number of machines. With n machines a current of frequency nf would be obtained, f being the natural frequency of each machine.

It is possible to remove the complication of the slip rings between the successive circuits, as well as the slip rings on B_4 , by making the fixed and moving parts (stators and rotors) serve alternately as fields and armatures. Referring to the figure it is merely necessary that A_1, B_2, A_3 and B_4 should serve as fields, and B_1, A_2, B_3, A_4 as armatures. The connection between the machines could be made through condensers in order to annul the effective reactance of the windings. In 1912 M. Bethenod constructed the first high frequency alternator based on the principle shown in Figure 1. In this experimental alternator, each elementary machine had a fundamental frequency of 6,000 cycles.

An output of the order of 1 kw. in the aerial was obtained at $4 \times 6000 = 24,000$ cycles per second.

This system of machines in cascade shows particular advantages for very high powers. For example, supposing that it is desired to obtain 500 kw. in the aerial at a frequency of 15,000. Two groups of machines may be used

each comprising two elementary machines designed to give 250 kw. at 7,500 cycles per second. Putting these in cascade, the two groups would yield 500 kw. at 15,000 \approx . Alternatively three groups would be possible each comprising two elementary machines designed for 166 kw. at 5,000 cycles. Putting these in cascade, the three groups would yield 500 kw. at 15,000 periods.

2. INTERNALLY-CASCADED MACHINES.

In 1893 M. Boucherot enunciated the following theorem*

"In a suitable alternator with alternate poles of opposite polarity, the armature system is the seat of an E.M.F. and a current represented by an infinite series of odd terms of the Fourier series; and the inductor the seat of an E.M.F. and a current represented by an infinite series of even terms of the Fourier series."

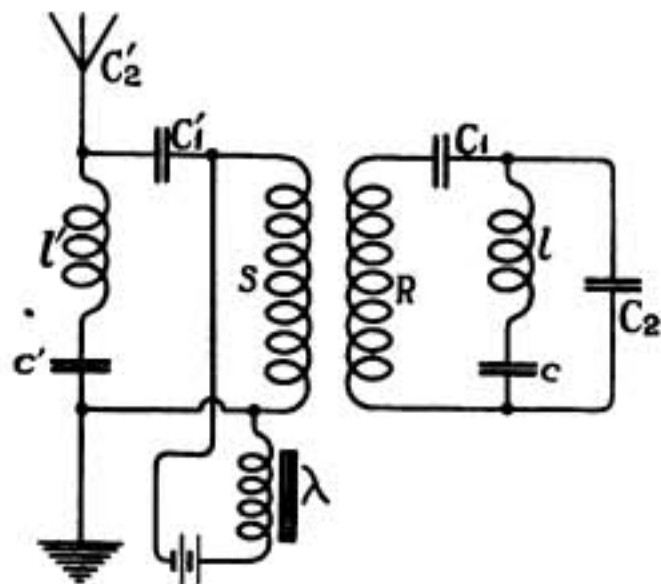

Fig. 2.

The alternator due to M. Goldschmidt, represented diagrammatically in Figure 2 was the practical outcome in 1907 of the ideas put forward by M. Boucherot in 1893. The stator and rotor of the high frequency single-phase

**Lumière Electrique*, March 25th, 1893, p. 554.

alternator of the Goldschmidt type are indicated in the figure by S. and R. In this alternator the odd multiple frequencies f and $3f$ are set up in the rotor and the even multiple frequencies $2f$ and $4f$ in the stator, this last frequency $4f$ becomes the output frequency. The rotor circuit is closed by a system of inductance and capacities so that it is in resonance for the two frequencies f and $3f$ —the branch lc forming a short circuit for the frequency f , and the condenser C_2 combined with the rotor inductance tuning to the frequency $3f$. In the stator circuit, which is excited by a continuous current through the protective choke λ , is arranged the system of inductances and capacities $l' c', C_1', C_2'$ to tune the stator to the frequencies $2f$ and $4f$. The capacity C_2 represents the aerial capacity.

The current of frequency f set up in the rotor gives rise to an alternating magnetic field, which may be resolved into two rotating fields of half the strength. One of these rotating fields is turning in the same direction as the movement of the rotor at the frequency f and thus sets up a current of frequency $2f$ in the stator, in a similar manner to the separate machines in cascade. The current of frequency $2f$ gives rise to an alternating magnetic field, which may in turn be resolved into two rotating fields one of which revolves in the opposite direction to the shaft and rotor. This sets up a current of frequency $3f$ in the rotor. The current of frequency $3f$ similarly sets up a current of $4f$ frequency in the stator. In effect the machine Figure 2 represents in a single machine the summation of the four cascaded machines of Figure 1.

3. HOMOPOLAR DISC MACHINES.

The homopolar machines with rotat-

ing iron disc do not carry any windings upon the moving part. This is an important advantage when high peripheral speeds are considered. This type of machine has been employed for some time to obtain high frequencies. M. Thury between 1893 and 1900 constructed a number of homopolar machines for 10,000 \approx frequency. One of these exhibited in 1896 had a rotating inductor with 200 polar projections revolving at 3,000 r.p.m. for a frequency of 10,000. At this frequency the output was 3 - 4 kw. with an open-circuit voltage of 150 volts.

In 1904, M. Lamme constructed a similar machine, but using for the first time specially thin laminations (0.075 mm. thick). The diameter of the inductor was 62 cms., the speed 2,000 r.p.m. and peripheral speed 100 metres per second.

M. Alexanderson has constructed homopolar machines with a disc form to allow of peripheral speeds higher than 200-300 m/sec. Figure 3 indicates an alternator of this type. The coil B provides the exciting field which traverses the disc A and the polar lamina-

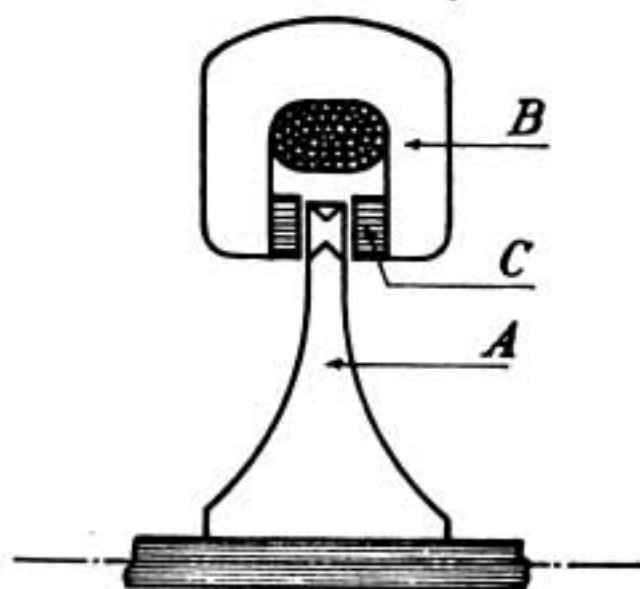

Fig. 3.

tions C. The windage losses are reduced by filling in the spaces between the polar projections with non-magnetic material. In later forms these fillings

DIGEST OF WIRELESS LITERATURE

of non-magnetic metal are joined together to form a damping system. In these machines the hysteresis losses are higher than in the ordinary type of alternator with alternate poles.

4. VARIABLE RELUCTANCE ALTERNATORS.

An early form of variable-reluctance alternator is shown in Figure 4. It comprises an excitation winding on the stator which constitutes at the same time the working winding by introducing the choking coil shown in the figure. When the rotor teeth are opposite the stator the flux is a maximum through the stator teeth; when the spaces are

opposite the stator teeth the flux is a minimum. An E.M.F. is thus obtained, having the same frequency as that of a homopolar machine with the same number of teeth on the rotor. The rotor must be laminated as the flux is variable.

For high frequencies the rotor teeth are small and close together, and the effective flux variations are small compared with the total flux. Further, the flux in the rotor teeth changes its direction for each pole pitch passed over so that the losses in the rotor should be larger than in the stator. The output of the variable impedance machine is much less than that of the homopolar machine in which the rotor polar projections are always traversed in the same direction by the main flux.

The variable impedance machine may equally be made of the homopolar form. In this case the central exciting winding is traversed by a variable flux depending upon the relative position of the rotor and stator teeth exactly as in Figure 4.

(To be continued.)

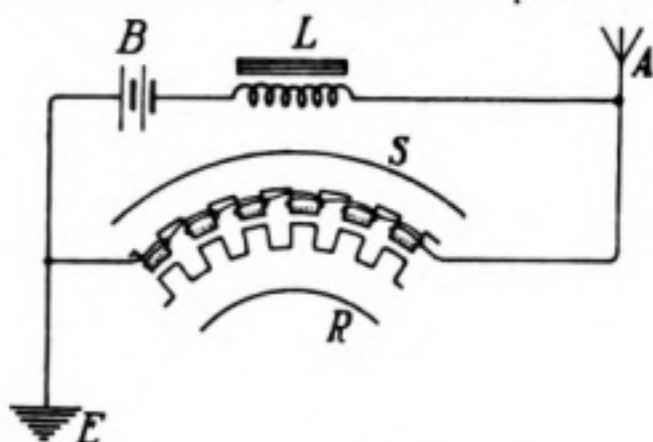

Fig. 4.



Photo Topical Press Agency
The Wireless Telephony Apparatus in use at Marconi House during the recent Demonstration.
(See page 199.)

Stray Waves.

NOMENCLATURE IN WIRELESS TELEGRAPHY.

D OUBTLESS owing to the rapidity with which the art has developed little attention has been devoted to the question of suitable names for wireless telegraph apparatus, phenomena and processes. The Army, the Navy, the Air Force, private manufacturers and private experimenters have during the past four years been engaged in inventing, developing and perfecting wireless appliances with the primary object of beating the common enemy, and their creations have been hurried off to their respective spheres of usefulness without formal christening. This is especially true of valves, for which there has been such an enormous and urgent demand. Now, however, that the world has time to breathe, it certainly is desirable, before we go any further, to make an attempt to select and standardise the names of certain parts of the modern wireless installations, more especially on the receiving side and in connection with thermionic valves.

The indefatigable Dr. W. H. Eccles, has given this idea a very business-like fillip with his suggestive article which appeared in *The Electrician* for April 18th, 25th, and May 2nd; indeed, there is evidence that it was in his mind as far back as 1917, for in his article on Ionic Valves (*Year Book of Wireless Telegraphy and Telephony, 1917*), he devoted a certain amount of space to it. Dr. Eccles now suggests that "a vacuum space containing three electrodes" shall be called a "tri-electrode" or "triode," and following up the no-

tion, that valves with two, four and five electrodes should be respectively styled "diode," "tetrode" and "pentode." Now, although we think these names are excellent and quite suitable for use in "valve" literature or in text-books we do not believe that they will win popularity amongst wireless engineers and operators, that is, amongst the men who have to handle and use valves. They are really too academic and refined to become familiar, and one must remember, too, that there are still certain difficulties opposing their use. Dr. Eccles himself refers to these. It seems to us a better plan to distinguish the various valves by names indicative of their usual functions in radio-work—"two-electrode high power" and "two-electrode low power" (for rectification), "three-electrode high power" (for wireless transmission), "three-electrode low power" (for rectifying and amplifying received currents) and so on. Such words, coupled with the names of the men associated with particular forms of valves, Fleming, Round, etc., should prove far more attractive and handy. The standardisation of names does not necessarily call for extreme refinement of word-building.

Mr. J. Scott-Taggart in a letter to *The Electrician*, makes the pertinent suggestion that the "high-tension" battery would be more correctly described as the plate or anode battery. In earlier days, when the plate battery had a p. d. of some 200 volts the former name was quite appropriate, but now that we work with voltages ranging from 4 to 50 volts it has become a misnomer; "plate battery" whether in any specific case a separate battery or the filament battery is used, seems to cover

STRAY WAVES

all requirements. The use of "cathode battery" follows as a matter of course.

PROGRESS OF WIRELESS TELEGRAPHY.

In our April number we published a letter from Mr. Godfrey C. Isaacs to *The Electrician* in which he defends British enterprise and invention against the insinuation that they have contributed but little to the development of wireless work. This letter elicited the following from Mr. Lee de Forest:—

(*Electrician*, May 2nd, 1919.)

Sir: In your issue of March 7th you publish a letter from Godfrey C. Isaacs. He makes therein two statements which are so astonishing that I must ask further elucidation thereof.

First: Why does he now for the first time intimate a distinction between "the three electrode valve" and the Fleming invention? We have always been taught by the Marconi writers that they were the same.

Second: Why would not "all the developments of the three electrode-valve" have been possible "without Dr. Fleming's great invention," since both are clearly and admittedly direct developments from the "Edison effect" lamp?

Third: By what warranty of truth, or fact, is the "Poulsen arc" continuous-wave system, which has transmitted messages over the record distance of 12,000 miles a "Marconi" (whatever that is) developed entirely in this country by Marconi himself, with the assistance of British engineers?

The technical world knows to-day that the arc was Poulsen's invention, developed to commercial high power by C. F. Elwell and Fuller, both American engineers, and rather recently "adopted" by the Marconi Company to replace their obsolete spark system; now Alexander's high-frequency generator,

with his magnetic amplifier and the audion modulator, is being adopted for the "Marconi" trans-Atlantic telephone "press service." But this letter of Mr. Isaacs is the first attempt I have yet seen to specifically claim "the long-distance continuous wave system" as an actual Marconi invention or development. I believe your readers are entitled to further elucidation.—I am, &c.,

LEE DE FOREST.

New York, April 7th, 1919.

Mr. Isaacs' reply is as follows:—

(*Electrician*, May 19th, 1919.)

Sir: I have read Mr. Lee de Forest's letter published in your issue of the 2nd instant. He would appear to be strikingly ignorant of the past history and present developments of wireless telegraphy. His letter is so full of inaccuracies that I have neither the time nor the inclination to correct them, except upon one point.

The Committee of eminent scientists appointed by the Postmaster-General in 1913, and which sat under the presidency of the late Lord Parker "to consider and report on the merits of the existing systems of long-distance wireless telegraphy" reported that

"The only continuous high-frequency generator we have yet seen tried with success over long distances is the Marconi continuous high-frequency machine. . . ."

It was this system, erected at the Carnarvon Wireless Station, which has proved itself able successfully to transmit messages to Sydney, Australia. No Poulsen arc, or any other arc, had anything whatsoever to do with this world's record in wireless telegraphy.—I am, &c.,

Marconi's Wireless Telegraph Co. Ltd.,
GODFREY C. ISAACS,

Managing Director.

London, May 5, 1919.

WIRELESS TELEPHONY AND AIRCRAFT.

A short article under this heading which we published in our May number has resulted in a letter from Mr. E. Sahnou, Ex-Wireless operator, R.A.F., who says:—

"Everybody knows that the Wireless Telephone was invented and even perfected to a certain degree before the commencement of hostilities by the Marconi Co., but surely it is realised that its perfection and installation as applied to aircraft is solely the work of the R.A.F. experts.

The daily press were quite correct when they credited the R.A.F. with having perfected Radio Telephony between ground and aircraft and *vice versa*, even though it may have been found necessary to encroach on previous discoveries (owing to the urgency of the situation) of the Marconi Co., in order to do so.

May I also ask, with reference to your statement 'that the ability of the operator to hear messages in spite of the deafening noise of the engine is chiefly due to a modification of the Fleming Valve and its circuits as worked out by a Marconi Engineer,' whether the said engineer was, albeit a Marconi man, in or engaged with the R.A.F.?

No one would wish to discredit the Marconi Co.'s splendid work during the past years, but why do I so constantly see articles which lead one to believe that without the Marconi Co., the wireless of the world could not be carried on? Is it merely an ingenious advertising device or is there really some cause for grievance?

Take all the credit due to you by all means but please do not try to lower the prestige of that most excellent body of men, the Wireless R.A.F."

When we wrote the article to which our correspondent objects our desire

was simply to put on record actual facts, not with a view to advertising for any company or discrediting the R.A.F. We should do the same if it were a similar point at issue between *any* two organizations or inventors. We said that the general tendency of the press had been such as to lead the public to believe that the Royal Air Force had invented and perfected the art of wireless telephony, and we gave our reasons, with which our correspondent apparently agrees, for stating that such a belief is erroneous. We admitted freely that improvements and refinements in wireless telephone apparatus as carried on aircraft had been made possible by actual war experience and indicated that what remained for the R.A.F. to do was the adaptation of the apparatus to the special conditions which arose when it had to be fitted to aeroplanes. If Mr. Sahnou admits that in perfecting the adaptation of wireless telephony to aircraft it was found necessary to encroach on previous discoveries, then he concedes our point and in no way is any discredit reflected upon the R.A.F.

The first wireless telephony set used in this country in connection with aircraft was produced by a Marconi engineer, using Marconi circuits and valves. This was worked out in the summer of 1915 and priority over all other experimenters can be claimed for it.

We do not think that our readers will share in Mr. Sahnou's insinuation that we have tried to lower the prestige of the R.A.F.; indeed, the appointment of an ex-officer of that Force as our Aviation Wireless Correspondent, goes a long way in support of our plea of "not guilty." Mr. Sahnou's *esprit de corps* is most commendable, but we feel that in writing his letter he has been influenced more by feelings than by facts.

An Alternative to "Fleming's Rule"

By A. Benjamin.

IT was whilst attending a course of lectures at the Military School of Electric Lighting, Gosport, that it occurred to the writer that it would be an advantage to have a more facile rule than Fleming's for determining the relation between lines of force, motion of a conductor, and direction of current. Necessity proved the mother of invention, for sitting in cramped desks is not conducive to the easy performance of the digital gymnastics demanded by Professor Fleming's otherwise excellent rule.

The following rule will, I think, prove easy to remember and apply.

GENERATOR RULE.

Let the direction of lines of force when passing *from left to right*, as in Fig. 1, (i.e., the same direction as that of handwriting) be called the "positive" direction; and the opposite direction "negative," as in Fig. 2.

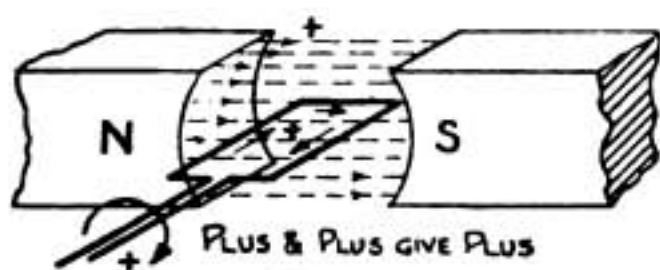

Fig. 1.

Let the *clockwise* rotation of the rectangular conductor in Fig. 1 be called the "positive" direction of motion, and the anti-clockwise rotation, as in Fig. 2, "negative."

Further, let the *clockwise* direction of the current round the conductor, as in Fig. 1, be termed "positive," and the reverse direction, as in Fig. 3, "negative."

Then, given any two factors, the third may be determined by applying the algebraic rule of multiplication or division, namely, that

- (a) Two positives yield a positive,
- (b) Two negatives yield a positive,
- (c) A positive and a negative yield a negative.

Thus, in Fig. 1, we have

Lines of Force = *plus*,
 Motion of Conductor = *plus*,
 Therefore, Direction of Current = *plus*,
 (or clockwise as indicated).

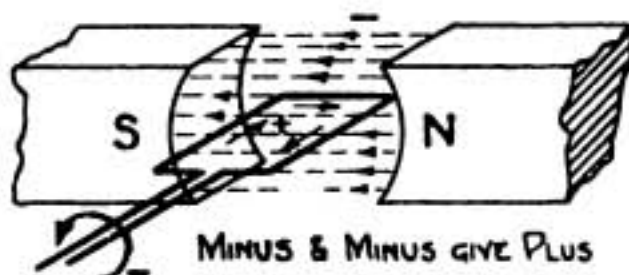

Fig. 2.

In Figure 2 we have

Lines of Force = *minus*,
 Motion of Conductor = *minus*,
 Therefore, Current = *plus*,
 (i.e., still clockwise).

In Figure 3 we have

Lines of Force = *plus*,
 Motion of Conductor = *minus*,
 Therefore, Current = *minus*,
 (or anti-clockwise).

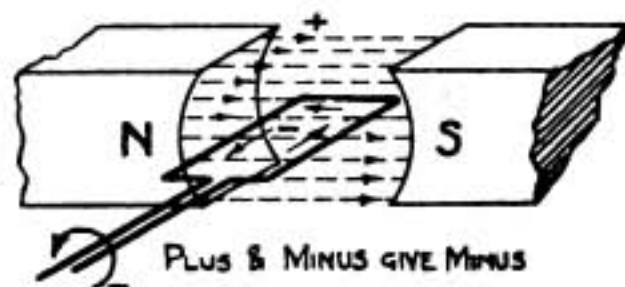

Fig. 3.

The rule can quite easily be applied to a simple straight conductor in a magnetic field by imagining this conductor to be either the left or right arm of the rotating rectangle in the first three figures.

Thus, in Fig 4, if we are given the polarity of the magnets, and are

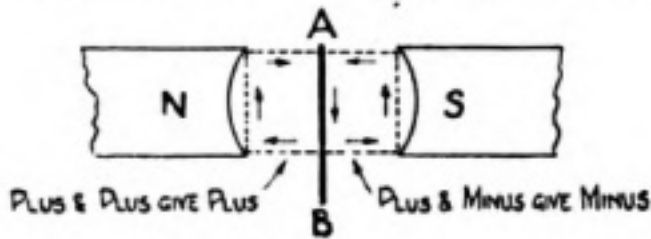

Fig. 4.

told that AB is moving downwards, then, if we think of AB as the *left* arm of the rectangle, we have *positive* lines of force with *negative* (anti-clockwise) motion of conductor, producing *negative* direction of current, which, in

AB, is from A to B. If we had imagined AB to be the *right* arm of the rotating conductor, we should still have as the result the current flowing from A to B.

If the poles are oblique, instead of horizontal, or are even vertically one above the other, it is quite simple to imagine (without actually performing the contortion) the body turned so that the left hand coincides with the upper pole.

In the above illustrations, we have taken lines of force and motion of conductor as the two factors given in each case, but if *any* two factors be given, the third may be deduced by the above rule.

MOTOR RULE.

For a motor, instead of using the left-hand rule, simply reverse the answers given by the above generator rule.



Photo

The wireless operator on R.34, the world's largest airship.

Topical Press.

Transatlantic Wireless Telephony

AS stated in our April issue, wireless telephonic communication was established for the first time between Ireland and America in March last, and we are now able to give particulars of this most interesting and important experiment.

The objects of the test were to prove that with a combination of the oscillating valve transmitter and the modern Marconi type of valve receiver only quite a small amount of power is required to transmit either telegraphic or telephonic messages across the Atlantic, and also to obtain some data as to what power would be required,

using these modern methods, for continuous commercial operation over such a range. Both objects were successfully attained.

In these experiments communication was attempted in one direction only, the sending apparatus being installed at Ballybunion, Co. Kerry, Ireland, and the receiver at Louisburg, Cape Breton, Nova Scotia.

At Ballybunion a portable petrol motor was used as prime mover to drive an electric generator, which supplied approximately 2.5 kilowatts at 12,000 volts to the oscillating valves. The valves employed were of the pattern designed by the Marconi Company, and known as Type M.T.1, and two of



Ballybunion Wireless Station.

these were used in parallel as oscillation generators. For speech transmission a third valve was used to vary the input to the oscillators in accordance with the microphone currents produced by the voice.

With the power input above stated, the aerial current registered was sixteen amperes at a wave length of 3,800 metres.

The aerial was of umbrella form supported at the centre by a mast 500 feet in height. At the receiving station in Louisburg a Type 55 receiver was installed. As our readers will probably remember, this type of receiver was illustrated and described in the March issue of *THE WIRELESS WORLD*. After a few preliminary tests to London and Chelmsford, a regular daily programme extending over ten or twelve days was sent from Ballybunion, all these programmes being duly received at Louis-

burg. At this distance of 1,800 miles the speech was of sufficient strength to be easily understood, provided interference from spark stations was not too great.

It is interesting to note that the strength of speech from Ballybunion at Chelmsford, about 500 miles away, was such that the signals were clearly audible on a "frame" aerial only six feet square, using the Type 55 receiver.

Besides speech, continuous wave Morse signals were also transmitted from Ballybunion, and these signals were reported as "strong" at Louisburg.

As the tests proceeded it was recognized that to obtain reliable telephonic communication over the range through any probable interference, increased power was desirable, and as a more powerful engine was not immediately

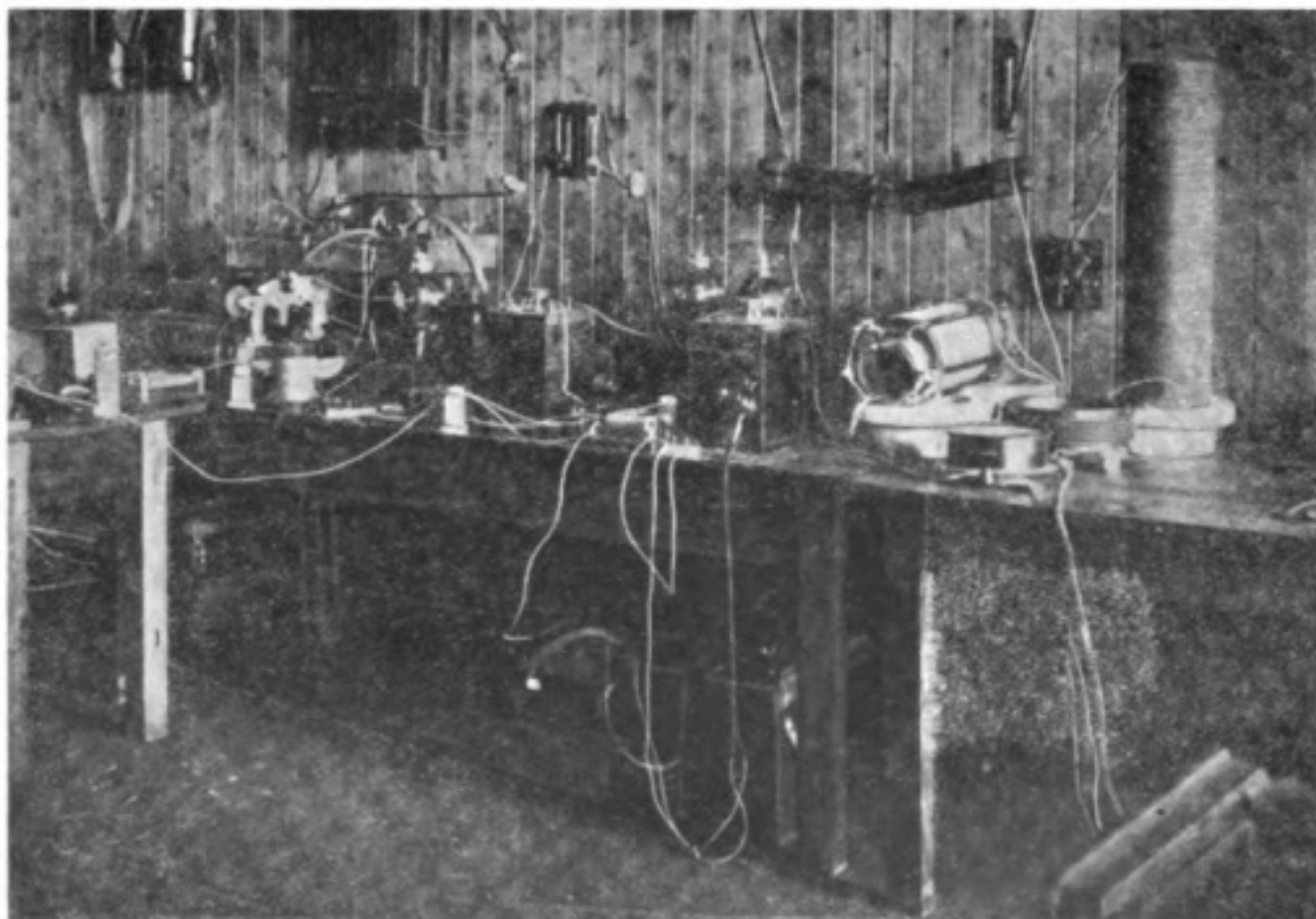

The transmitting apparatus by means of which Wireless Telephony between Ballybunion (Ireland) and Nova Scotia was accomplished.

TRANSATLANTIC WIRELESS TELEPHONY

available, the experiments were temporarily discontinued. It should be clearly recognized that there was nothing in the nature of a "freak" in connection with these tests. Every programme over the whole period of the trials was received, and the whole of the transmission was done during hours of daylight, generally between 10 a.m. and 1 p.m. G.M.T. As these experiments mark a definite stepping stone in

the history of wireless communication, we take this opportunity of placing on record the names of the engineers who were directly concerned in successfully carrying out the tests. These were Mr. W. T. Ditcham, who was responsible for designing and installing the transmitting circuits at Ballybunion, and Mr. W. J. Picken, who was in charge of the receiving apparatus at Louisburg.

THE TRANSMISSION OF SPEECH BY LIGHT.

A PAPER on the above subject was read by Dr. A. O. Rankine before the Physical Society of London on May 9th, describing the results of experiments carried out at University College, London, at the request of the Admiralty Board of Invention and Research.

The paper was concerned chiefly with the manner in which it is possible to produce a beam of light fluctuating in accordance with speech sounds. The electrical conductivity of a selenium cell varies with the intensity of the light falling on it, so that by connecting the cell in series with a battery and a telephone receiver, the fluctuating beam of light from the transmitter can be reconverted back into sound waves. At the transmitter two main possibilities are open; to control the source of light by the speech or to effect the control of the beam from a steady source. For the latter method the speech is caused to interrupt the light with the proper periodicity and amplitude, *after* it has left the source.

In the experiments described, the sun was generally used as source of light, although an arc lamp was sometimes employed. The method consists in interposing a fixed grid into the beam of

light to cut it up into narrow bands. The grid is mounted close upon a lens which focusses the source upon a small concave mirror. This mirror is attached to a small lever controlled by the diaphragm of a phonograph sound-box, into the trumpet of which the speaker's voice is directed. The beam of light from this mirror is directed through a second lens and grid system, similar to the first, and thence on to the receiving station. When sound waves fall on the diaphragm the small mirror is thrown into vibration. This causes the image of the first grid to move about over the second grid. When the dark and light bands of this image coincide with the bars and spaces of the second grid the maximum strength of light beam passes to the receiver. When, however, the vibration of the mirror caused by the speaker's voice causes the image to move, the amount of light passing through the second grid will be correspondingly varied, since the grid and image no longer coincide.

In the present form of the apparatus lenses (and grids) about 7 inches diameter are employed, and the bars and spaces of the grids are each $\frac{1}{10}$ " wide. A speaking range of $1\frac{1}{2}$ miles has been easily covered, while the articulation at the receiver is remarkably good.

Field Wireless Telephony and Direction-Finding.

An Account of a recent successful Demonstration.

ON May 27th a very interesting demonstration of wireless telephony and direction-finding by wireless was given by Marconi's Wireless Telegraph Co. Ltd., to representatives of the Press, the apparatus employed being that which has been specially designed for pack or wheeled transport. At Broomfield, a village near the Marconi Works at Chelmsford, a field wireless telephone was erected, consisting of a standard set arranged as a combined telephone and telegraph station. The guaranteed range of this

apparatus for telephony is 60 miles over normal flat country; for telegraphy by the "tonic train" method 100 miles, and for telegraphy by C.W. transmission 200 miles. Under favourable circumstances all these ranges can be approximately doubled. The whole station can be erected in 10 minutes by six men, though it is possible for two men to erect and work it. The masts are of steel, 30 feet high and support a single horizontal aerial, and the "earth" simply consists of metal gauze laid directly on the ground. The prime mover (Fig. 1 left hand) is a two-

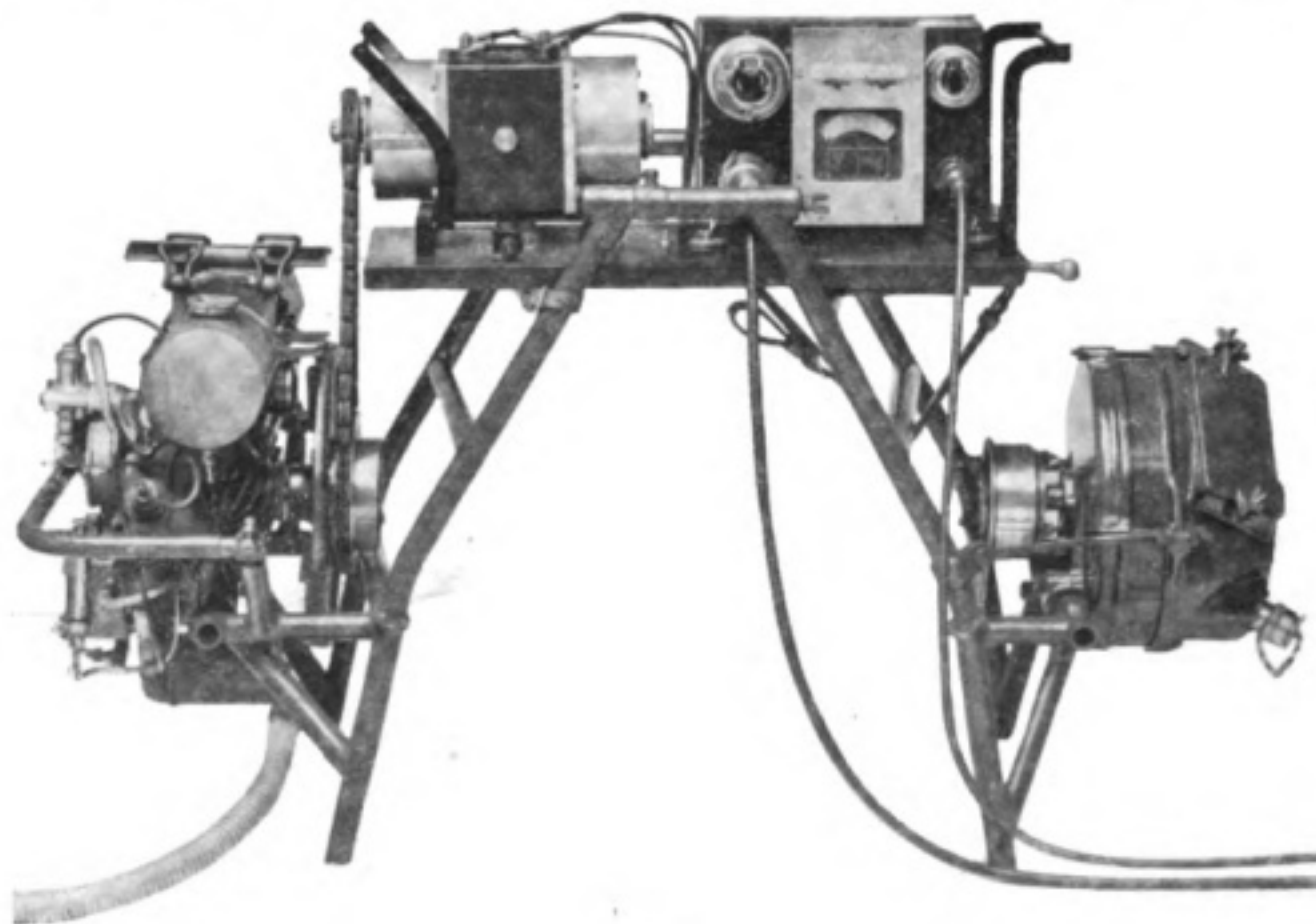

Fig. 1.

The pack set arranged for charging accumulators.

FIELD WIRELESS TELEPHONY AND DIRECTION FINDING

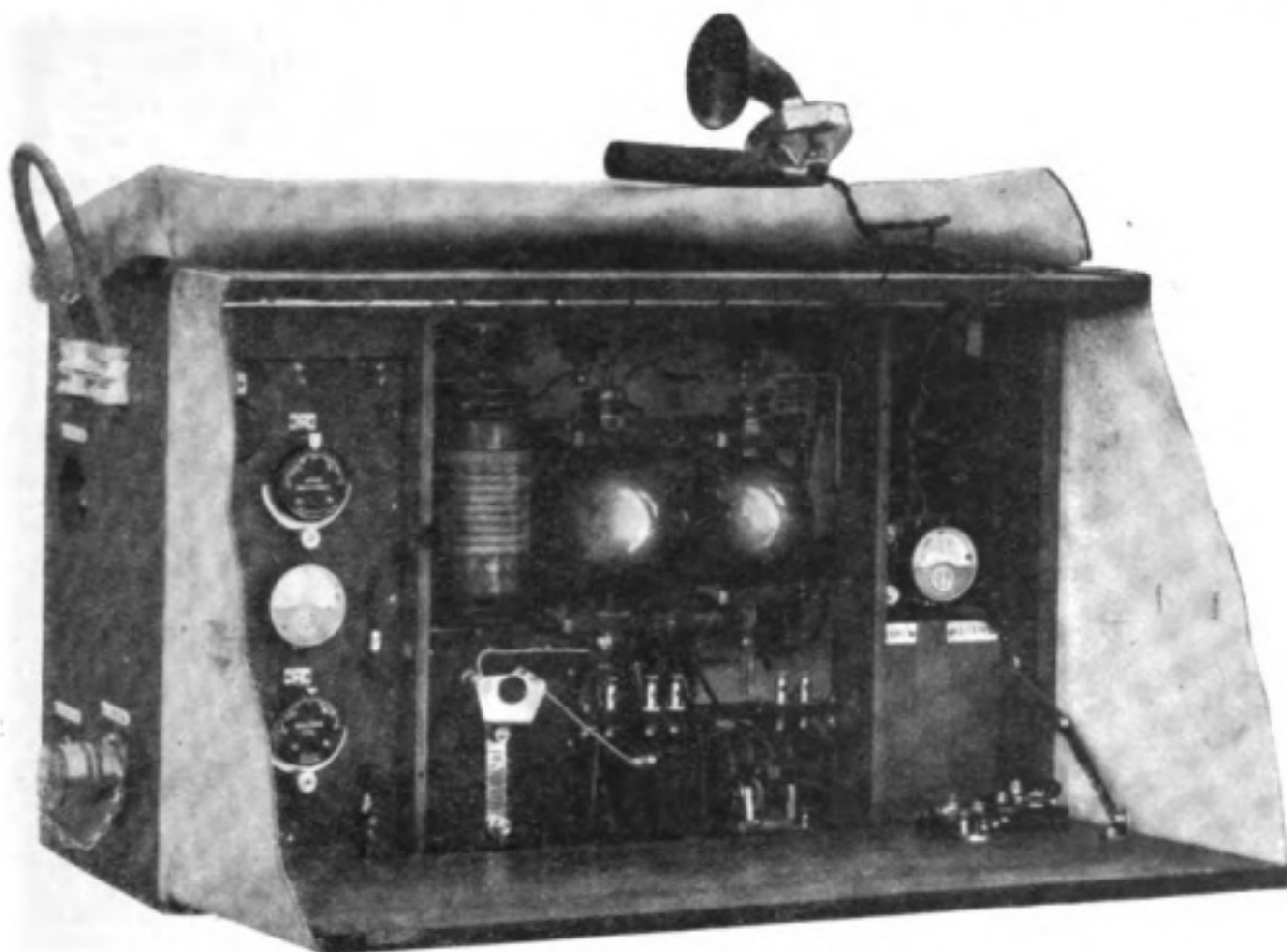

Fig. 2.
The portable wireless telephone transmitter.

cylinder $2\frac{3}{4}$ h.p. petrol engine, and drives a high-frequency $\frac{1}{2}$ -kilowatt alternator (Fig. 1 right hand) which is completely enclosed as a protection from adverse weather conditions. The power generated by this alternator is led to the transmitting circuits by armoured connectors, where it passes through the transformers, one of which steps up the potential from 100 volts to 10,000 volts, the current then being rectified to direct current by a Fleming valve for the purpose of feeding the main transmitting valve (Fig. 2). Another transformer steps the E.M.F. down to 8 or 10 volts and supplies the filament of the Fleming valve, whilst a third supplies the filament of the main transmitting valve. Connection from the alternator to the various transformers is controlled by the main change-over (transmitting to receiving)

switch, which at the same time connects the aerial either to the transmitter or receiver.

The receiver (Fig. 3) consists of a simple tuning device connected to the aerial by a change-over switch. The received currents are amplified by a series of 3-electrode valves, the last of which rectifies them and feeds the telephones through a transformer. The filaments of the receiving valves are heated by current supplied by a 6-volt accumulator battery, and the "high tension" circuits (filament-plate circuits) are fed by a 20-volt. battery (see Fig. 4). The accumulator charging dynamo with switchboard and cut-outs is shown in Fig. 1.

By means of this installation telephonic communication with Marconi House, London, was obtained and the Mayor of Chelmsford held speech with

Mr. Godfrey Isaacs. Several representatives of the Press also conversed with London and satisfied themselves that the quality of speech attained was much better than the ordinary "wired" variety. Whilst this demonstration was taking place another party of visitors, including the Mayor of Colchester, proceeded by motor-bus towards Colchester. They took with them in the bus a complete telephone receiving set and were able to hear conversation and gramophone music which was being transmitted from Chelmsford. When this party was some 10 miles distant from Chelmsford a lorry containing a portable wireless station was pushing ahead with sealed orders from the Mayor of Colchester as to where the apparatus was to be erected. The object in view was to demonstrate the accuracy with which wireless direction-finding plant can locate wireless stations and to this end two direction-finders had been previously erected, one at Braintree and the other at Malden.

In due course the lorry reached the spot designated in the sealed orders; here the apparatus was set up and signals were transmitted for the benefit of the direction-finders. Within a few minutes the necessary observations had been made and notified by wireless telephony to Broomfield, where the calculated position of the lorry was marked on the map, and communicated by wireless telephone to the Mayor of Colchester, who replied to the effect that the direction-finding apparatus had succeeded in locating the spot to which he had directed the lorry.

The value of this method of ascertaining the bearings of wireless stations cannot be over-estimated, and for purposes of navigation, both marine and aerial, a direction-finding set is undoubtedly destined to become generally adopted. The apparatus used for the demonstration is shown in the accompanying illustration, and is of the Marconi-Bellini-Tosi type. It consists electrically of two main parts, the aerial

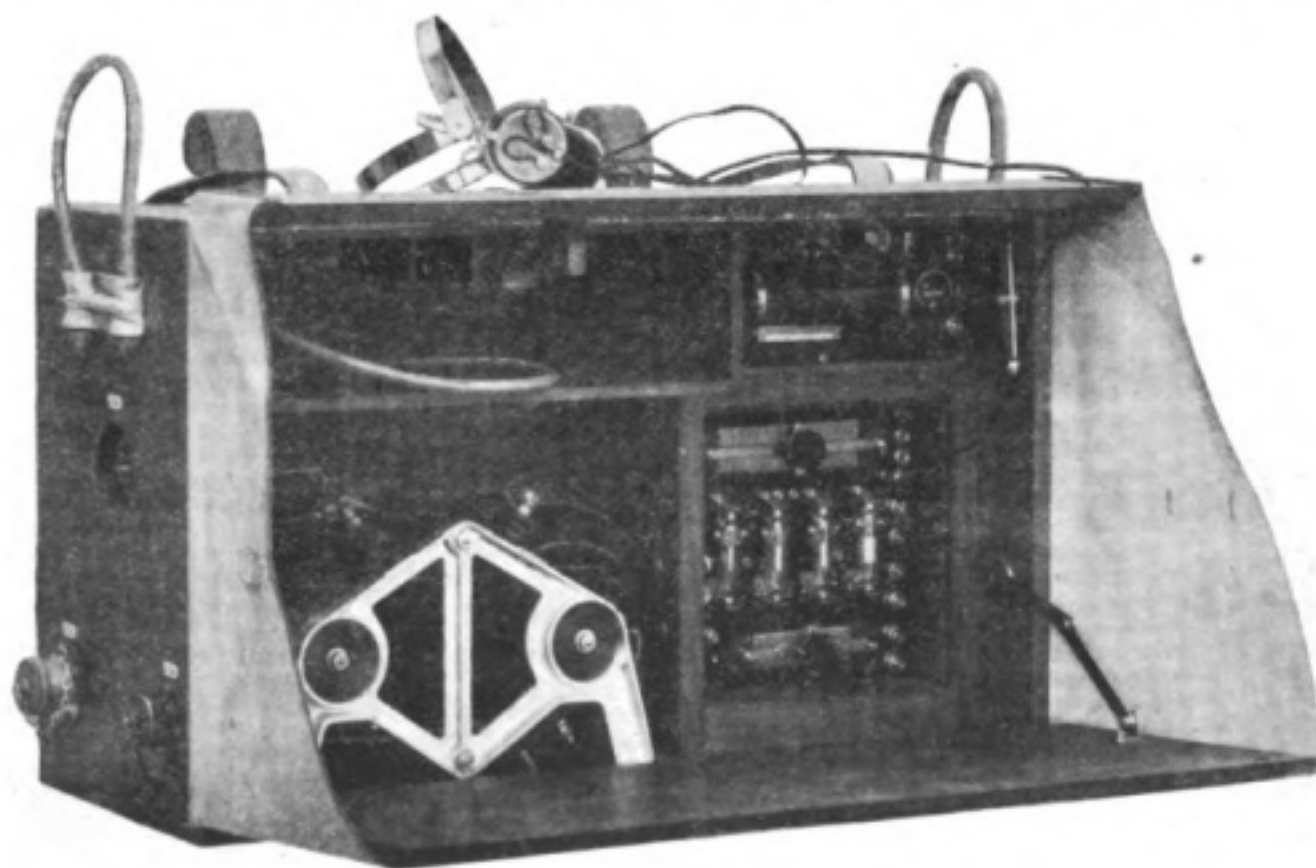

Fig. 3.
The portable wireless telephone receiver.

FIELD WIRELESS TELEPHONY AND DIRECTION FINDING

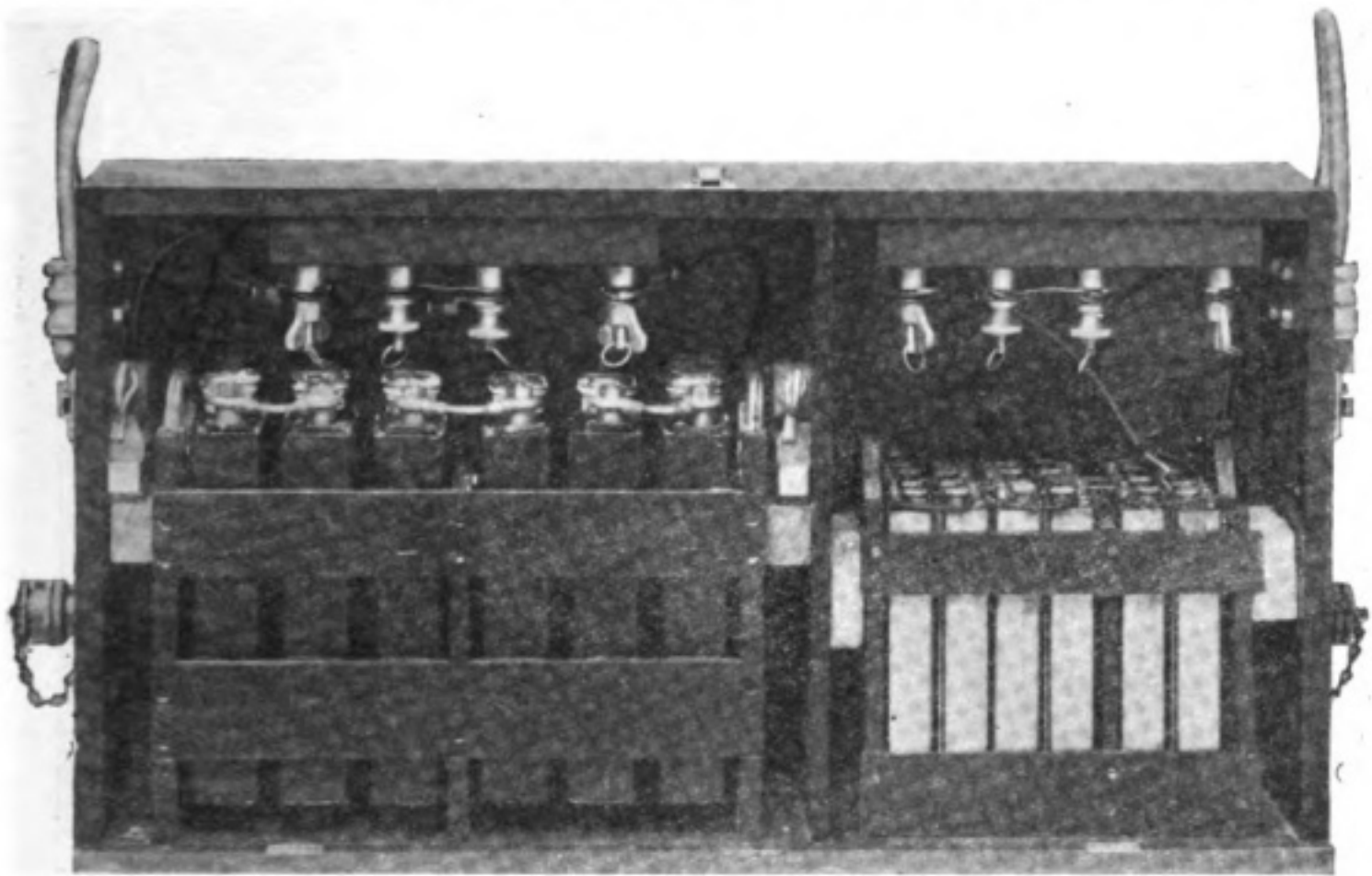

Fig. 4.
The accumulator batteries for the receiver.

circuits and the detecting circuits, the aerial system comprising two closed oscillatory circuits insulated from each other and from the earth. Each of these oscillatory circuits consists of an aerial loop in series with which are a coil of wire and a condenser, the latter being inserted in the middle of a coil, for symmetry. The two aerial loops, which are of equal size, are suspended in vertical planes crossing each other at right angles. The two coils of wire are also of equal size and also cross each other at right angles in vertical planes. Inside these crossed coils a third coil, called the exploring coil, is mounted on a vertical spindle by means of which it can be set at various angles with reference to the fixed coils. Each aerial loop is a directional aerial which receives best when its plane is in the direction of the sending station, and if its plane is at right angles to the direction

from which the signals are coming it receives nothing. In intermediate positions it receives signals, the induced current due to which varies as the cosine of the angle between the plane of the aerial loop and the direction of the sending station. Except in the case when one of the aerials is in a plane exactly at right angles to the direction from which signals are coming currents are induced in both aerials, their relative strength depending on the direction of the sending station with reference to the planes of the two aerial loops. These currents pass through the corresponding crossed coils in the direction-finding instruments and produce in the space enclosed by them two magnetic fields at right angles to each other. The two fields, whose relative strength depends on the relative strength of the currents induced in the two aerials, combine to form a resultant field at right angles to



Photo. *The Mayor of Colchester and Captain H. R. Sankey on the omnibus. Note the "flame" aerial.* Topical Press Agency.



Photo *Inside the omnibus. The Town Clerk of Colchester receiving a message.* Topical Press Agency.

FIELD WIRELESS TELEPHONY AND DIRECTION FINDING

the direction at which signals are coming. Consequently the exploring coil will receive the strongest signals when its plane is at right angles to that of the resultant field, that is to say, when its plane is in the direction from which signals are coming. A pointer attached to the spindle on which the exploring coil is mounted indicates the position of the latter, and consequently the direction of the sending station.

The detecting apparatus consists of the usual tuning arrangements and a super-sensitive seven-valve receiver, similar to that which was described in the February number of the *WIRELESS WORLD*. This amplifier consists generally of a series of 3-electrode valves linked together by transformers. The valves amplify the high-frequency oscillations received in the aerial circuit, the last one being arranged as a rectifier. This instrument is designed for use on com-

paratively short wavelengths, the approximate limits being 3,000 metres for spark reception and 10,000 metres for continuous wave reception.

The bearings taken with this direction-finding apparatus probably do not exceed in accuracy those taken with a good optical instrument under favourable conditions, yet reliable bearings may be taken with it when direct bearings cannot be taken owing to bad weather or other causes. Under fairly good conditions bearings may be taken within two or three degrees, the accuracy of the results obtained depending almost entirely on the care with which the observations are made, the error due to the instrument itself not exceeding one degree. It is not necessary to "swing ship" in order to take bearings, and deviation owing to the iron work of the ship is practically non-existent unless the conditions are exceptionally un-



One of the Direction-Finding Stations described in the accompanying article.

favourable. The range of the set is from about 10 to 50 miles depending on the power of the wireless station from which signals are being received or upon the size of the aerial which is available.

By means of this system ships at sea or aircraft in flight will be enabled to obtain their positions during fog or bad weather from coastal or aerodrome stations. Another application of the direction-finder is to find out whether a ship is on a course which will take it inside or outside lightship or isolated light-

house; similarly when making a harbour a few signals from a station in the harbour will show at once if the ship has drifted to one side of the entrance.

On May 28th a similar demonstration was given to the representatives of the technical press, and Sir Joseph Ward, Premier of New Zealand, spoke by wireless telephony to Chelmsford from Marconi House. The demonstration was repeated again on the following day in the presence of various military attachés, army and navy officers and other officials.

FACILITIES FOR DIRECTION-FINDING AT SEA.

AN important new Notice to Mariners (No. 1019 of the year 1919) has been issued by the Admiralty concerning wireless direction-finding, and the arrangements which have been made for ships to avail themselves of this means of ascertaining their bearings. The methods of asking for and giving bearings and the waves to be used will shortly be standardised by International agreement; and the particulars of the D.F. stations will eventually appear in the International list of Radiotelegraph stations. Meanwhile each country is publishing regulations governing the use of its own D.F. stations.

There are two principal systems of D.F. stations at present in use, viz. :—

- (a) Where each D.F. station is fitted with transmitting and receiving gear and works independently of others.
- (b) Where several D.F. stations (all of them usually near a harbour entrance or difficult passage) are linked together by special land telegraph lines, being thus controlled by one station which alone

is fitted with transmitting apparatus. The controlling station in such cases is not necessarily a D.F. station, but may be an ordinary coast station.

Lists of existing D.F. stations in Canada, Newfoundland, the United States and the United Kingdom are given, with details of call signals, range, longitude, latitude, and the wavelength employed.

Full instructions governing the methods which should be followed by ship stations when requesting bearings are also given, together with the manner in which the various coast stations will reply and comply. It is of importance to note that D.F. stations in the United Kingdom keep watch and take bearings on the 450 metres wave, and that ships with Marconi apparatus can adjust their transmitting gear very nearly to this wave (using reduced power) by cutting out half the primary transmitting condenser and adjusting the A.T.I. till the earth lamp shows maximum current in the aerial. The primary slider should be "all in."

The Notice concludes with a list of the charts affected.

Notes of the Month

GENERAL FERRIÉ.

GENERAL Ferrié, C.M.G., LL.D., Technical Director of the French Wireless Service, occupied the place of honour at a complimentary dinner given at Princes' Restaurant on Monday, May 12th, by the members of the Council and of the Wireless Committee of the Institution of Electrical Engineers.

In addition to the General, the company included Mr. C. H. Wordingham, C.B.E., President of the Institution, in the chair; Major E. A. Barker, Mr. Charles Bright, Mr. W. R. Cooper, Dr. W. H. Eccles, Major J. Erskine-Murray, Lieut.-Col. W. Ll. Evans, Mr. Andrew Gray, Prof. G. W. O. Howe, Mr. J. S. Highfield, Capt. J. K. Im Thurn, Mr. W. Judd, Mr. J. E. Kingsbury, Prof. E. W. Marchant, Sir Henry Norman, Sir Richard Paget, Mr. C. C. Paterson, Mr. W. R. Rawlings, Mr. P. F. Rowell, Capt. H. Riall Sankey, Mr. E. H. Shaughnessy, Capt. Slee, Mr. Roger T. Smith, Mr. A. C. C. Swinton, Mr. J. E. Taylor, Mr. R. H. Tree, Lieut.-Col. A. D. Warrington-Morris, and Capt. S. Vokota.

The toasts of H.M. the King and the President of the French Republic having been honoured, the Chairman proposed the health of the guest of the evening, and was followed by Dr. Eccles. In his reply, General Ferrié gave an interesting account of the great part played by wireless telegraphy in the war.

W/T. IN CHINA.

The Marconi Company have signed a contract with the Chinese Government whereby both parties agree to form the "Chinese National Wireless Co." with a capital of £700,000, each party subscribing half this amount, for the purpose of setting up factories for the maintenance of wireless equipment. Shanghai will probably be the location of the main factories, with auxiliaries at Peking or Tientsin. The Government will grant a special charter to the Company, which is assured of a successful future. In view of the bad general state of the Chinese telegraph system, it is believed that there is a splendid opening for the development of wireless in China.

THE NEW WIRELESS TELEGRAPHY BILL.

The text has recently been issued of Lord Somerleyton's Merchant Shipping (Wireless Telegraphy) Bill. The Bill provides that every British passenger steamer, or a ship of 1,600 gross tonnage or upwards shall be fitted with wireless telegraphic apparatus, shall maintain a wireless service of a nature to be prescribed by the Board of Trade, and shall carry one or more certificated operators. Where it is considered that the provision of the apparatus is unnecessary or unreasonable, the Board of Trade may exempt certain ships or classes of ships. A clause of the Defence of the Realm Act rendered it compulsory for vessels of over 1,600 tons gross to carry wireless for the duration of the war, and the new Bill seeks to perpetuate this.

AMATEUR WIRELESS IN AMERICA.

The war time restrictions on amateur, technical and experimental receiving stations in the U.S.A. have been removed, and those on sending stations are expected to disappear before long. As a result, the market for small wireless sets has opened and the buying has already become large. The ranks of amateurs are now augmented by numbers of men who became acquainted with radio work whilst on service, and with the air and ground requirements in connection with flying steadily increasing, there promises to be a heavy demand for wireless apparatus. It is of interest to note that in 1914 the sale of this class of material amounted, in round figures, to \$672,600.

AMATEUR WIRELESS IN GREAT BRITAIN. A WARNING.

On May 13th at Sutton Coldfield, Mr. H. P. Frazier was fined £25 and £3 3s., advocate's fee, for having in his possession, without the written permission of the Postmaster-General, an apparatus for the reception of messages by wireless telegraphy. We would draw the attention of amateur wireless men, or rather, of all our readers, to Section 22 of D.O.R.A., and point out that *it is still in force* up to the time of our going to press. Without the Postmaster-General's permission one may neither harbour wireless apparatus, nor traffic in it.

WIRELESS CLUB NOTES.

The Three Towns Wireless Club of Plymouth is in full swing. The meetings of May 1st and 7th were devoted to instructional purposes. On May 21st, Mr. Voss described his wireless experiences in the R.F.C. and on May 28th he lectured on the subject of valve

receivers and transmitters. The Hon. Sec., Mr. W. Rose, announces that it has been decided to make Plymouth the headquarters for amateur clubs in Devon and Cornwall, and to hold an annual exhibition of wireless apparatus.

The North Middlesex Wireless Club held its 18th meeting (the first since the war began) at the Village Hall, Old Southgate, on May 21st. The Chairman, Mr. A. G. Arthur, welcomed the old members and congratulated many upon their safe return to civil life. He referred also to the great loss sustained by the club, through the death while on active service, of Mr. R. A. P. Davison their Treasurer. Mr. Savage, the Secretary, then set forth the condition of the club, financial and otherwise, and stated that he hoped to arrange future meetings at the club's old home at Shaftesbury Hall, Bowes Park. Next, Lieut. L. G. Holton gave a lecture on valve receivers, which was enthusiastically followed by those present. Full particulars of the club may be obtained from the Hon. Secretary, Mr. E. M. Savage, "Nithsdale," Everley Park Road, N.21.

It is proposed to form a Wireless Society for Sheffield and district. Those desirous of joining should communicate with Mr. L. H. Crowther, 156 Meadow Head, Norton Woodseats, Sheffield.

The Leicestershire Wireless Society, which practically ceased to exist during the war, is being revived under the name of the Leicestershire Radio Society. Messrs W. J. Rowlett and P. Holyhead have been appointed hon. secretary and hon. treasurer respectively. The chief object of the Society is to assist amateurs to study wireless in all its branches, and with the coming of peace it is anticipated that good, practical work will be accomplished.

Correspondence

THE AMATEUR POSITION.

THE amount of interest which is being evinced in what has come to be termed the "amateur position" is astonishing. So many kind enquiries and eager interrogations reach us by mail and telephone that we feel more than ever assured that we are but voicing the just and reasonable claims of a very considerable body of citizens when we ask those in whom the public has vested its authority to take the shackles from wireless enthusiasts, to return to them their property and give them leave and licence to use it. We are fully aware of the new technical difficulties which have arisen as a result of the wartime development of new methods and apparatus, and which now confront the authorities who are considering the question of amateur wireless working; they can be summed up in one word—valves. That a return to crystal reception and spark transmission will in due time be permitted we have little or no doubt. *Already the Postmaster-General has signified his readiness to issue licences for the reception of time signals by clockmakers in connection with their business.* Nevertheless, those who are familiar with the use of ionic valves well know that carelessness in or ignorance of their manipulation may lead to much more serious "jamming" than is likely to occur with a spark transmitter if the wavelength and power specified in its licence are not exceeded. A denial of all facilities for valve work would be a heavy blow to amateurs because their interest in these inventions has risen to a degree such as we have never seen equalled in connection with any other instrument used in wireless telegraphy. We again reiterate our firm belief that once the Peace

Treaty is signed the authorities will announce and bring into force their decisions concerning this very important national question, and that amateurs will be reinstated. But we hesitate before arousing hopes in regard to the use of continuous waves by amateurs.

The following letter from a correspondent who desires to remain anonymous is typical of many we have received:—

"DEAR SIR,

"I have followed with much interest your articles in the *WIRELESS WORLD*, re the position of the amateur. I quite agree with all the arguments brought forward in favour of the continuance of the amateur, and think it would be highly unjust, and a bad policy, if the Government prohibited experimenting in this direction, and also in many cases an ungrateful return for services rendered.

"I had a very efficient station for some time preceding the war. Part of my apparatus was used in a local Fort, and I was responsible for teaching wireless to a youth who gave his services to the Army in this work. I was too old myself to do the same. I was also responsible for carrying out experiments in wireless signalling on the examination vessels in the Mersey prior to the war.

"Needless to say, I am very anxious to re-start. If there is any information or advice that you can give me I shall be much obliged."

A most interesting letter has been received from Mr. John M. Clayton, of 1301 Welch St., Little Rock, Arkansas, who describes some of the work of amateurs during their last "season." It seems that transmission by amateurs over a distance of 2,000 miles is by no means rare, and he looks forward to working with an English confrère. Mr. Clayton assures us that the whole fraternity "over there" is watching with interest the outcome of the pro-amateur agitation in this country, and is anxious to get into touch with someone who will write concerning the pre-war work of English amateurs. Will the wireless clubs kindly take note of this?

The Weagant "X-Stopper."

(Continued from June Number.)

THE need for the spacing of the two loop aerials comprising this special type of receiver can be made evident by an examination of the diagrammatic sketch of Fig. 5.

The two closed loop aerials A and B are shown coupled to the common radio-goniometer coils L_6 , L_6 by means of the inductances, L_5 , L_7 , as in Fig. 4. The extra tuning coils L_1 , L_2 , L_3 , L_4 are omitted for simplicity. The direction of the incoming signal wave is represented by the arrows, and the supposed direction of propagation of X impulses by the arrows X X.

Assuming, in the first place, that the two loops are spaced one and half wavelength apart between their centres, then at some given instant the signal wave may be represented by some such curve

as D.E.F.G.H. It is at once evident that the space occupied by either of the loop aerials is covered entirely by one complete half-wave of the signal, and that when the negative half-wave is covering one of the loops, the positive half-wave will cover the other. This being the case the current induced in loop A by the signal wave, will at any given instant be opposite in direction to that set up in loop B, hence their effects upon the common secondary circuit L_6 , C_2 may be made additive by reversing one set of coils, L_5 or L_7 .

On the other hand, the wave carrying the X impulse in the direction indicated by the vertical arrows, will reach both loops simultaneously, so that the resulting currents set up in these loops will at any given instant be in the same direction in both loops. Hence,

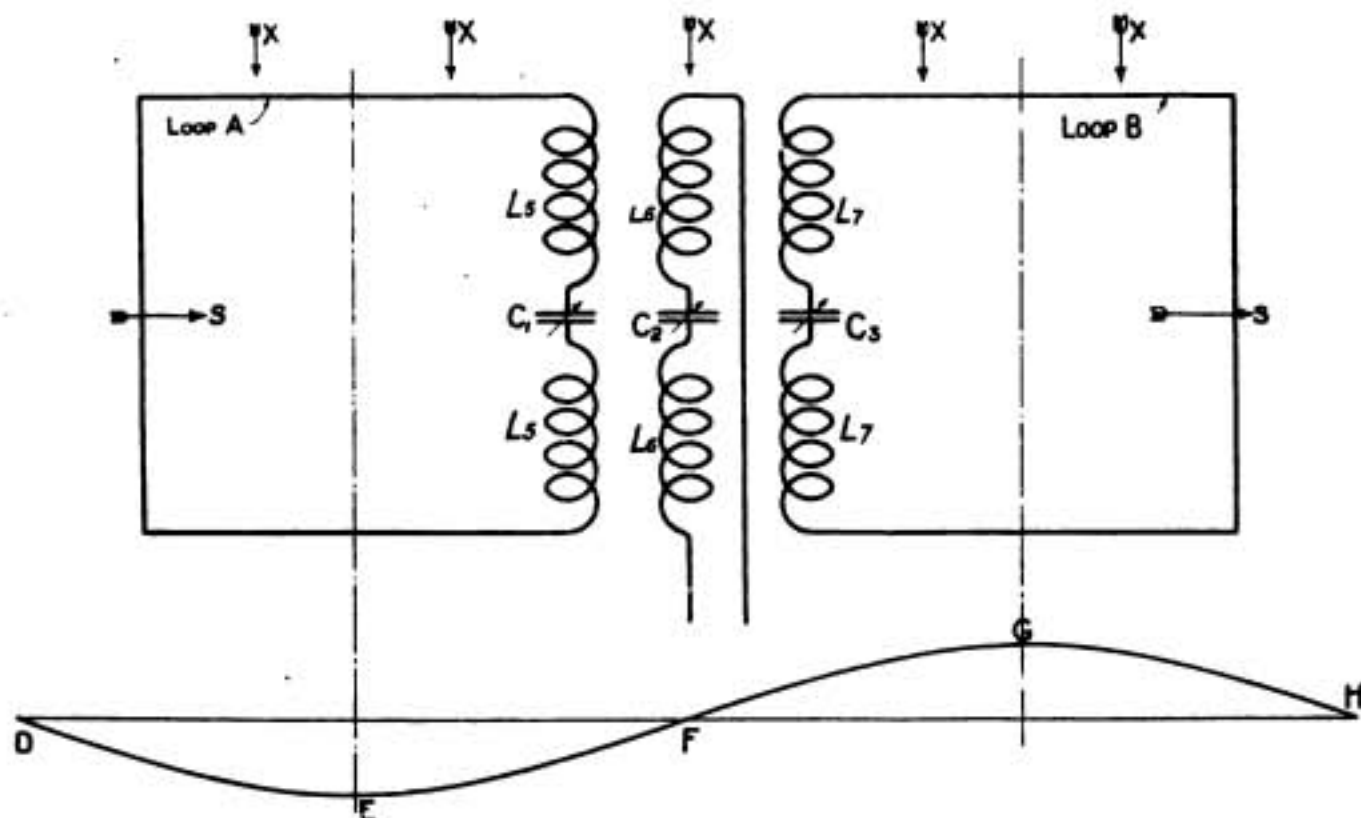

Fig. 5.

THE WEAGANT "X STOPPER"

owing to the reversal of one of the set of coils (necessary as mentioned above to secure addition of the two signal currents) these two X impulse currents will cancel out and produce no effect upon the receiver connected to the secondary $C_2 L_2$. Hence the signal will be heard with approximately twice the strength that would be obtained with a single loop, while the "X" will be nearly, if not quite eliminated.

It remains now to consider what will be the effect upon the signal of altering the spacing of the loops, or what amounts to the same thing, of using a given pair of loops with signals of various wavelengths. This matter is of considerable importance in connection with the practical application of the method, since it would obviously be impractical to instal a large number of such aerial systems at different loop spacings in order to enable one given station to receive from several other transmitting stations. In the case of many stations it would also be extremely inconvenient to employ aerial systems stretching out over such long distances. Take for example the case of reception of a long-distance station using a wavelength of 15,000 metres. The half-wavelength "loop spacing" necessary for this would be 7,500 metres, but as may be seen from Fig. 5 the extreme parts of the loops stretch to almost one whole wavelength apart—i.e., in this case 15,000 metres, or say at least $9\frac{1}{4}$ miles for the necessary extent of the station grounds. Hence the most likely condition to arise in practice is a loop-spacing of *less* than one half wavelength.

Referring again to Fig. 5, it is to be expected that if the loop spacing is reduced relative to the wavelength, the resultant signal intensity would also be reduced. The simplest way of illustrating

this effect is by means of a vector diagram—Fig. 6.

OV_1 represents the voltage induced in one loop—e.g., A—and OV_2 , the corresponding voltage in the second loop B.

In the case where the mean loop spacing = $\frac{1}{2}$ wavelength, there will be a phase difference of 180° between these two voltages. This is represented in the diagram by drawing OV_1 and OV_2 at an angle of 180° . Since one coupling coil is reversed the effect on the secondary circuit will be the vector difference of V_1 and V_2 . In this case this becomes the algebraic sum, and is represented by $OV = V_1 - V_2$ where the voltage $V = V_1 - V_2 = 2V_1$. Suppose now that the loop-spacing is reduced to $\frac{1}{3}$ rd. wavelength.

The electrical phase difference between the two induced voltages will now be 120° . This condition is shown in Fig. 7.

The resultant voltage is the vector difference of OV_1 and OV_2 , and is shown as the vector OV in the diagram. In this case $V = 1.173 \times V_1$.

Similarly when the loops are $\frac{1}{4}$ wavelength apart the resultant induced voltage V becomes $= 1.41 \times V_1$; when $\frac{1}{6}$ th wavelength apart, $V = 1 \times V_1$ at $\frac{1}{10}$ th wavelength, $V = 0.62 V_1$; (Fig. 8) and so on.

It should be noted that the resultant induced voltage steadily diminishes as the loop spacing is reduced, but that it does not disappear as long as there is any appreciable spacing at all between the two loops.

The balance of the two loops for the X-interference remains unaffected by the change of loop spacing relative to wavelength, so that it becomes possible to amplify the reduced signal strength

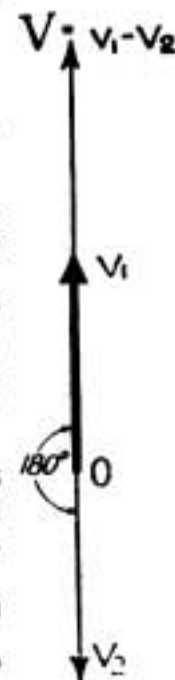

Fig. 6.

consequent upon a small loop spacing and yet not to amplify up the atmospheric interference to the same extent as would be the case if no "X-stopping" arrangement were in use.

As an example of what may be accomplished in practice the following results may be quoted:—

Using a loop spacing of 5,000 feet, and receiving from Nauen on 6,000 metres, the resultant signal was approximately 40 per cent. greater than that due to either aerial alone; this case corresponds to a loop spacing of approximately $\frac{1}{4}$ wavelength.

When receiving from Carnarvon on 14,200 metres, the loop spacing becomes approximately $\frac{1}{9}$ th the wavelength, and the resultant signals were materially weaker than when receiving on one loop, but the troublesome atmospheric noises were eliminated.

To carry the loop spacing reduction still further, it is easy to calculate the resultant signal strength with, say, a loop spacing of 100 ft. and a wavelength of 3,000 metres. Using the vector diagram method of Figs. 7 and 8, it is found that the resultant signal

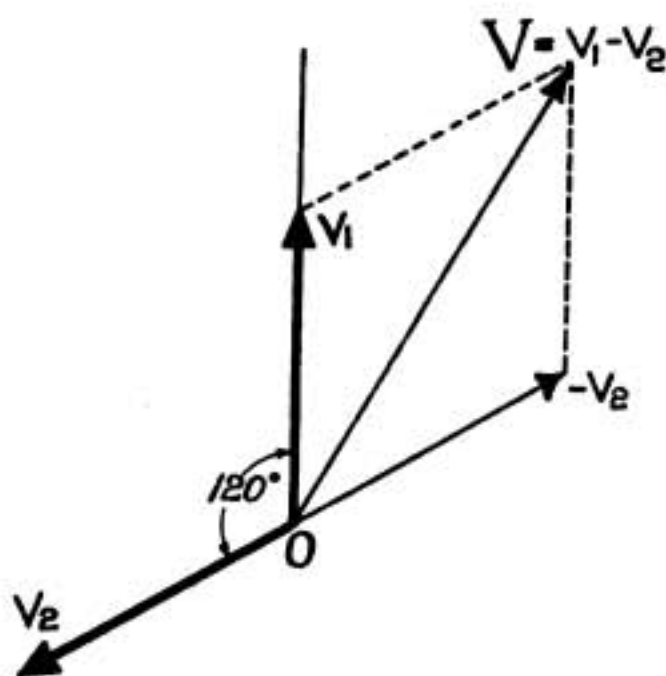

Fig. 7.

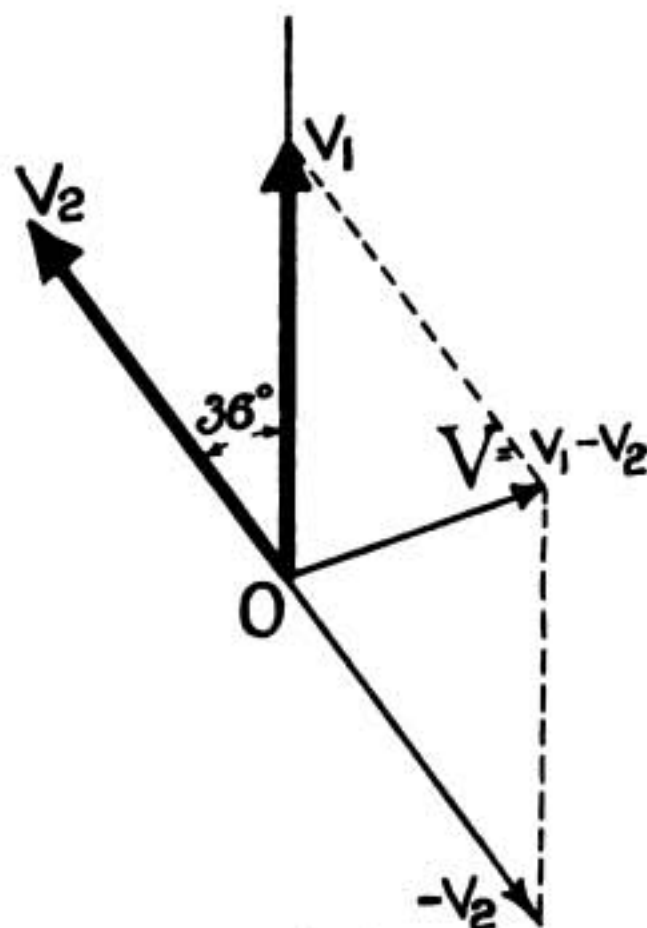

Fig. 8.

strength = $0.0639 \times$ the strength received on a single coil. Hence merely a 16-fold amplification could restore this signal to normal strength while retaining the full advantages of the X-balance.

This reduces the size of the apparatus to much more practical limits, and would probably render it more suitable for use in many cases where the full-sized aerial loop spacing would be impracticable.

Such a reduced aerial system might be within practical possibility for use on shipboard, but if fixed would necessitate turning the ship in line with the incoming waves.

By the addition of a third receiving loop it becomes possible to secure a somewhat more perfect balancing out of atmospherics—including as well the "clicks" which have in general a more localised horizontal direction of propagation than the "grinders" which as has been shown are generally propagated in a vertical direction.

Wireless in Northern Russia

WITH THE BRITISH EXPEDITIONARY FORCE.

By a Wireless Officer.

THE system of wireless inter-communication as now established by the War Office in North Russia is one of the most complete and efficient that the writer has during an experience of some seventeen years been privileged to be associated with.

Early in 1918 a small force of Allied troops was landed on the bleak and uninviting Murman coast. The reasons for this landing are well known to the public, but only a few of us have any conception of the many difficulties—diplomatic and otherwise—that had to be dealt with by the General Officer Commanding and his Staff.

The writer's duty was to ascertain the possibilities for wireless working, both as a means of local inter-communication and for communicating with England direct, and in a future article it is hoped that the many unique experiences encountered may be related.

There are at present four chief stations, namely, Murmansk, Archangel, Kandalaksha and Kem, each of which communicates with, controls, and supplies press messages to a number of outpost stations.

At this point the writer would like to relate how he succeeded in establishing communication (both ways) with an outpost some eighty miles from the base with an ordinary spark Marconi pack set.



The author and staff at Kem. Twenty degrees below zero!



Kem Wireless Station, showing 3-k.w. spark set. This station is also fitted with a 250-watt C.W. valve set.

This set was only rated for thirty miles; however, the writer with vivid and painful recollections of earlier days, when one's sleep was haunted by visions of coherers, magnetic detectors and Poldhu low-frequency sparks, had taken himself strongly to think before making the proposal. He had keen men, with the knowledge that in wireless, determination and enthusiasm are often more effective than the literal carrying out of instructions contained in the inevitable "book of words." The writer established not one but two pack sets at distances of between seventy to ninety miles away on lonely outposts which previously could only be communicated with by runners—a seven days' journey. Moreover, the intervening country is very mountainous. These stations are still in hourly use and the Headquarters Staffs would feel the loss of them very much indeed.

The principles upon which the writer worked are quite simple. At the

base stations the output for transmission on spark is about 3 kilowatts—certainly more than enough to cover the required distance and to be heard with a carborundum potentiometer receiver at the pack station—while the receiver was a carborundum potentiometer with three valve amplification. It is sufficient to say that signals both ways have always been of maximum strength.

The stations at Kandalaksha and Kem are in closed railway trucks or Russian Teplushkas, suitably lined and heated for the very severe winter. During the past five or six months the main stations have been installed with the latest C.W. (continuous wave) apparatus. The transmitters are of the valve type and have an output of 250 watts with a transmitting range of about 600 miles over mountainous country. A very fine sustained musical note is heard in the receivers from these sets. The receivers are of quite new design and embody some unique features which

WIRELESS IN NORTHERN RUSSIA

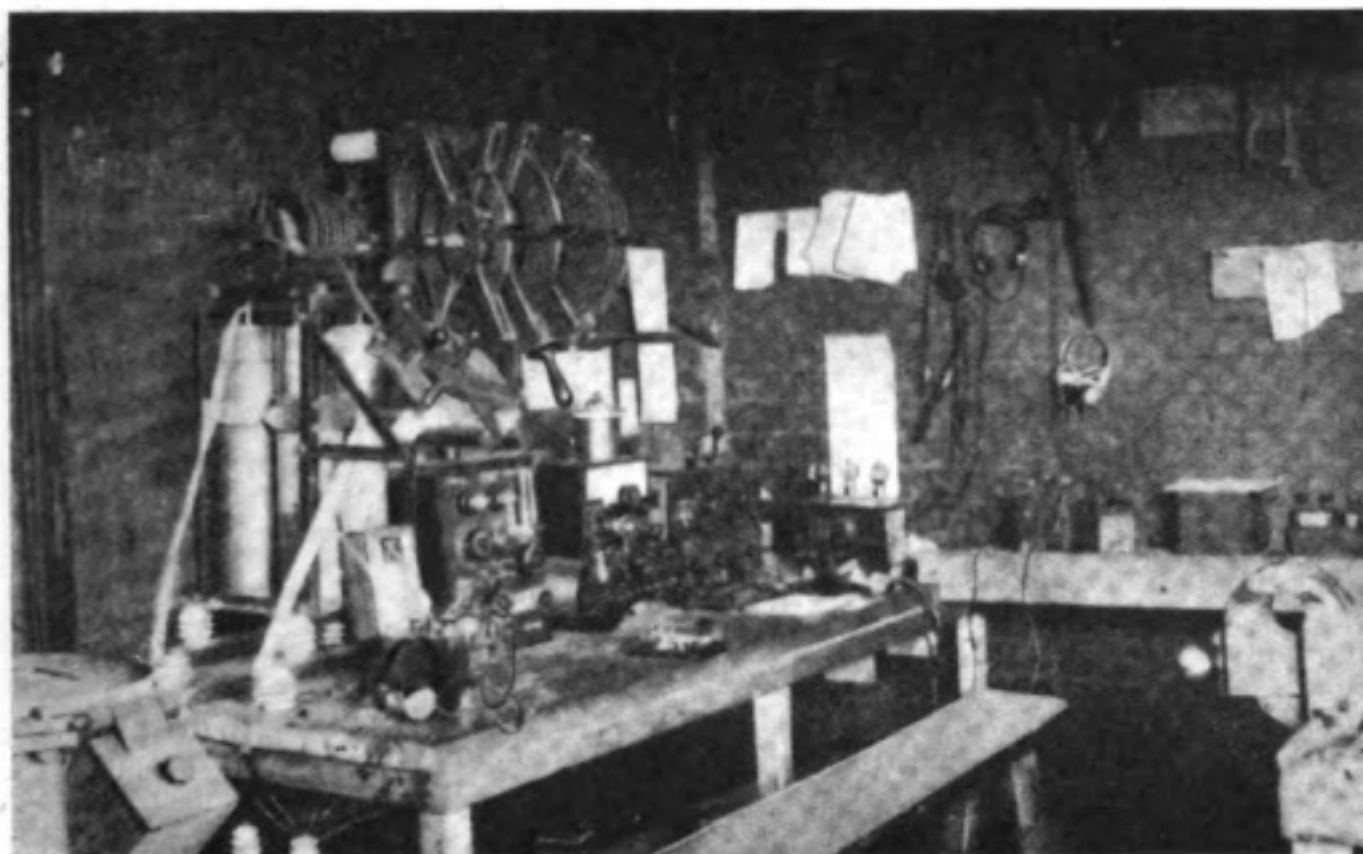

Kandalaksha Wireless Station, showing 2-kilowatt spark set.

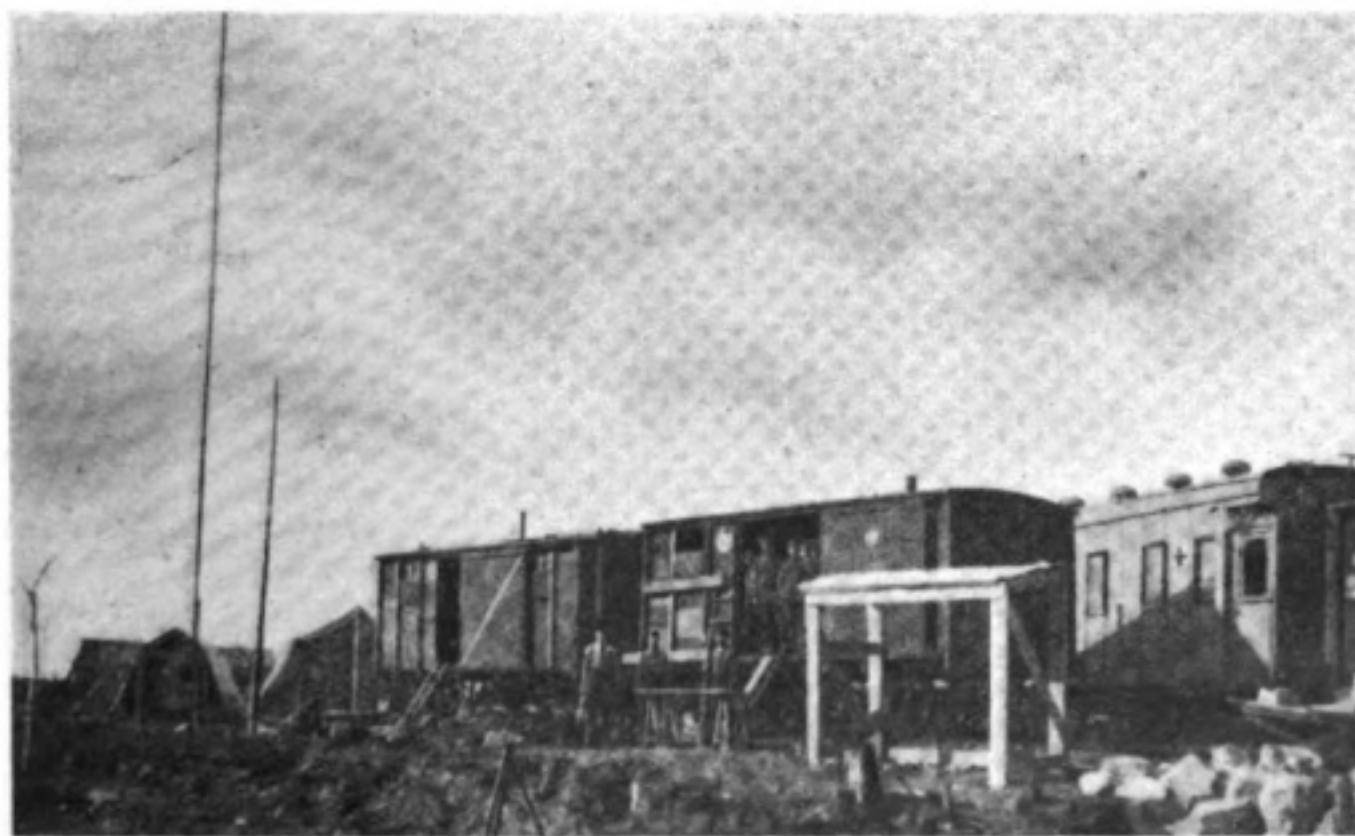

Exterior of Kandalaksha Wireless Station. Note the telescopic masts.

at a later date may be described in detail. The whole installation comprising the army type 250 watt set makes a very fine station and is a pleasure to operate by reason of its comparative simplicity, absolute reliability and wonderful efficiency. Amplifiers are, of course, part of the installation.

One of the greatest difficulties in the winter was the question of "earths." The Murman coast is, as the writer has suggested, rocky and mountainous, and does not, therefore, even in the summer, offer very good earthing facilities. In the winter months when the light soil is frozen hard, the question of using a ground earth is out of the question. So then at all our stations the counter capacity system is employed. Generally the lower capacity is greater than the aerial, but the writer, using a single strand T aerial and a single strand lower capacity of the same shape and length as

the aerial, got practically the same results as with a larger lower capacity. In any case—so far as can be judged at present—a good counter capacity would appear to be equally as efficient and far more constant than the average "earth." The writer hopes to make further experiments in this direction during the next few months.

The photographs printed with this article will convey to readers some idea of the conditions and situations under which the wireless section of our Engineers work, among the ice in winter—and with the help of the mosquitoes in summer.

In conclusion the writer would like to note the great impetus—by reason of his interest, help and encouragement in the early days—given by General F. G. Marsh, C.M.G., C.B. (India Army), to the work of his Wireless Officer.

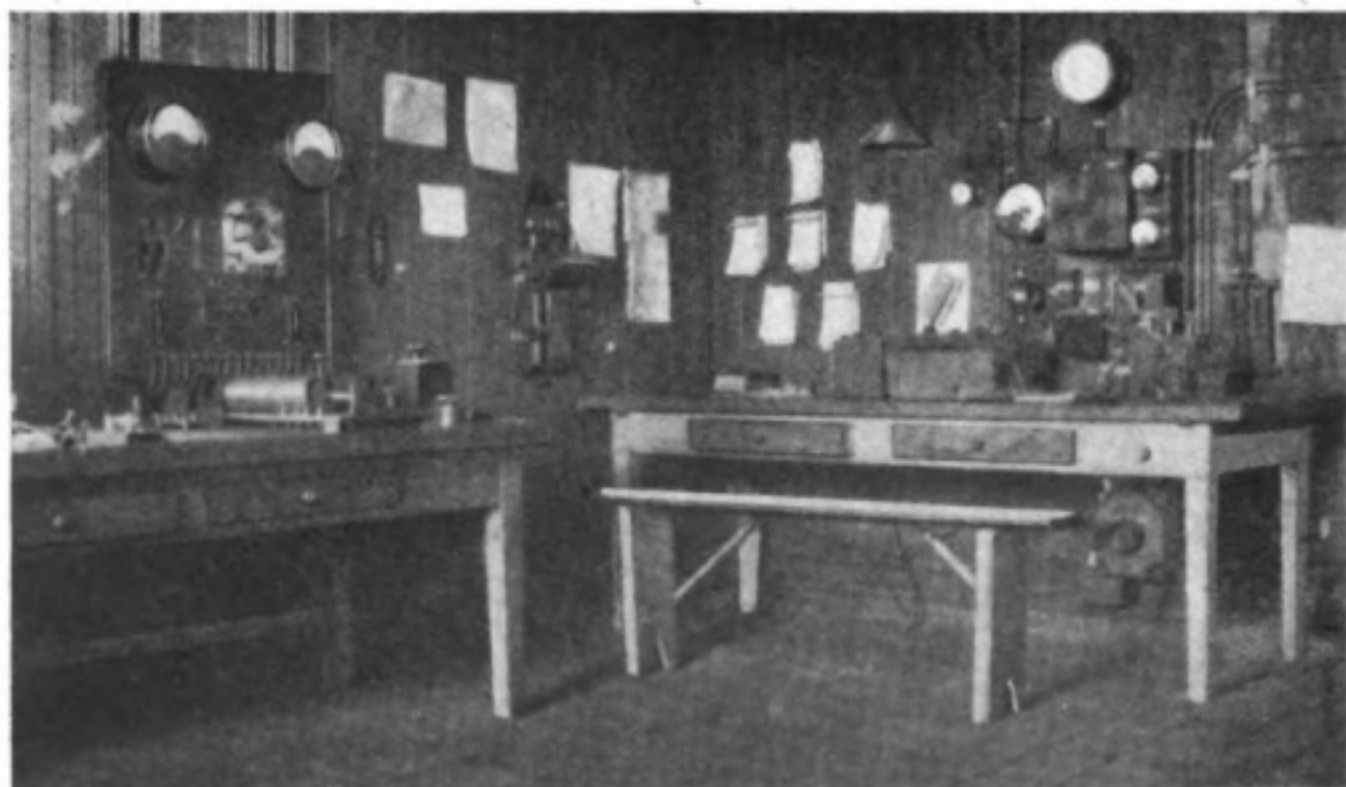

Interior of Murmansk Wireless Station. On the table under the switchboard at the left-hand is a long-wave C.W. receiver for the interception of American stations.

Aircraft Wireless Section

Edited by J. J. Honan (late Lieutenant and Instructor, R.A.F.).

These articles are intended primarily to offer, as simply as possible, some useful information to those to whom wireless sets are but auxiliary "gadgets" in a wider sphere of activity. It is hoped, however, that they may also prove of interest to the wireless worker generally, as illustrating types of instruments that have been specially evolved to meet the specific needs of the Aviator.

AIRCRAFT WIRELESS SETS.

THE NO. 1 TRANSMITTER (STERLING)—(Continued).

MAINTENANCE.

IN order to maintain the set at maximum efficiency, a certain amount of care must be given to adjustable parts and other details, and it is proposed in this section to touch upon one or two points that will repay attention.

THE MAKE-AND-BREAK.

Perhaps the most important detail in this connection is the "break."

In the first place, it is by means of the break that the spark frequency is controlled, and thereby the pitch of the note in the receiving phones. Each break represents one breaking-down of the spark gap, the radiation of one wave train or series of damped high-frequency oscillations, and one "click" in the phones.

In the next place, the adjustment of the break affects both the amount of current flowing in the primary circuit, and also the value of the voltage induced across the ends of the secondary of the induction coil; both are important factors in the efficient working of the set.

If, for a given frequency, it can be arranged that the primary circuit is closed for a large proportion of the time

elapsing between one break and the next, then the current has more time to "grow," and build up the magnetic flux passing through the core of the induction coil, thereby giving rise to a greater induced e.m.f. when the succeeding break does take place. For example, suppose a break took place once per second, and that the primary circuit remained unbroken for $\frac{9}{10}$ ths of a second, the remaining $\frac{1}{10}$ th being the time taken by the armature to swing away from the contact and back again, it is obvious that such an arrangement would be more advantageous in developing a high secondary e.m.f. than if the respective stages took each half a second.

Also it is evident that the sharper and more rapidly the "break away" from the primary is effected, the greater will be the induced voltage across the secondary, the value of which is determined by the time rate of magnetic flux variation.

In practice it is found that owing to imperfect contacting of the points at the higher frequencies, a larger value of primary current is usually obtained with a low note than with a high one. At the same time the general considerations previously set out hold good relatively for any frequency.

THE STERLING BREAK.

The original Sterling break is illustrated diagrammatically in Fig. 8. It consists of a thin steel-blade armature fixed to a block at its lower end, and vibrating between two rubber buffers at the top. Slightly below the centre of the blade is the adjustable contact screw, which is held in position by a bridge-piece secured to the side of the box, and makes contact with a similar

The upper adjusting-screw which determines the swing of the blade away from and towards the core of the induction coil is usually fixed, the brass washers carrying the rubber springs or buffers being sweated on to the shank of the screw.

It will be found by experiment that this break has a natural note of its own at which it gives the most satisfactory results. The frequency of such note cannot be varied to any considerable

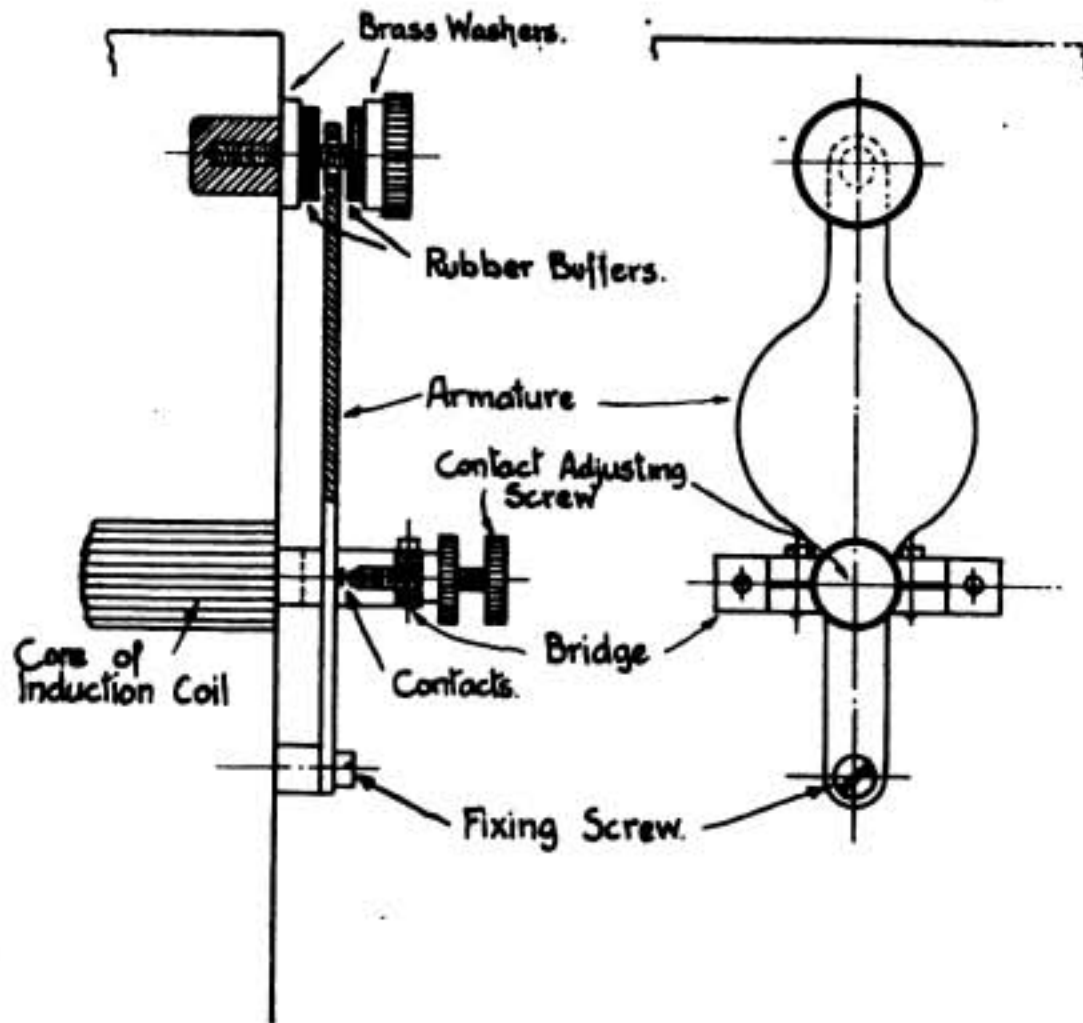

Fig. 8.

point secured to the armature. Both points are generally either of platinum or tungsten-steel. A platinum point should not be used in conjunction with a tungsten point as such a combination is likely to give rise to trouble owing to "sticking."

This type of break is controlled by means of the central adjusting-screw which fixes the distance between the two points.

extent without diminishing efficiency, so that it is somewhat inelastic in this respect.

Another disadvantage is that the break is not so rapid and sharp as in the type described in the next paragraph.

THE CLAPPER BREAK.

This break, which was eventually fitted to all No. 1 Service sets, is illustrated diagrammatically in Fig. 9. Its principal advantage is in the method

AIRCRAFT WIRELESS SECTION

adopted for securing a rapid "break away."

The armature in this case is of soft iron about $\frac{3}{32}$ " thickness, and is rivetted to a thin steel carrying-spring. The actual contact is separate from the armature proper, being carried on a small steel reed. This reed is fixed to the wall of the set by the same screw fixture as the armature spring, but is

rapidly, under the influence of the blow, and thereby make a rapid, clean break.

Also, it will be observed that in this arrangement the reed is left proportionately longer in contact with the central screw point, so that the primary current has more time to grow and so saturate the iron core of the induction coil with magnetic lines of force. As

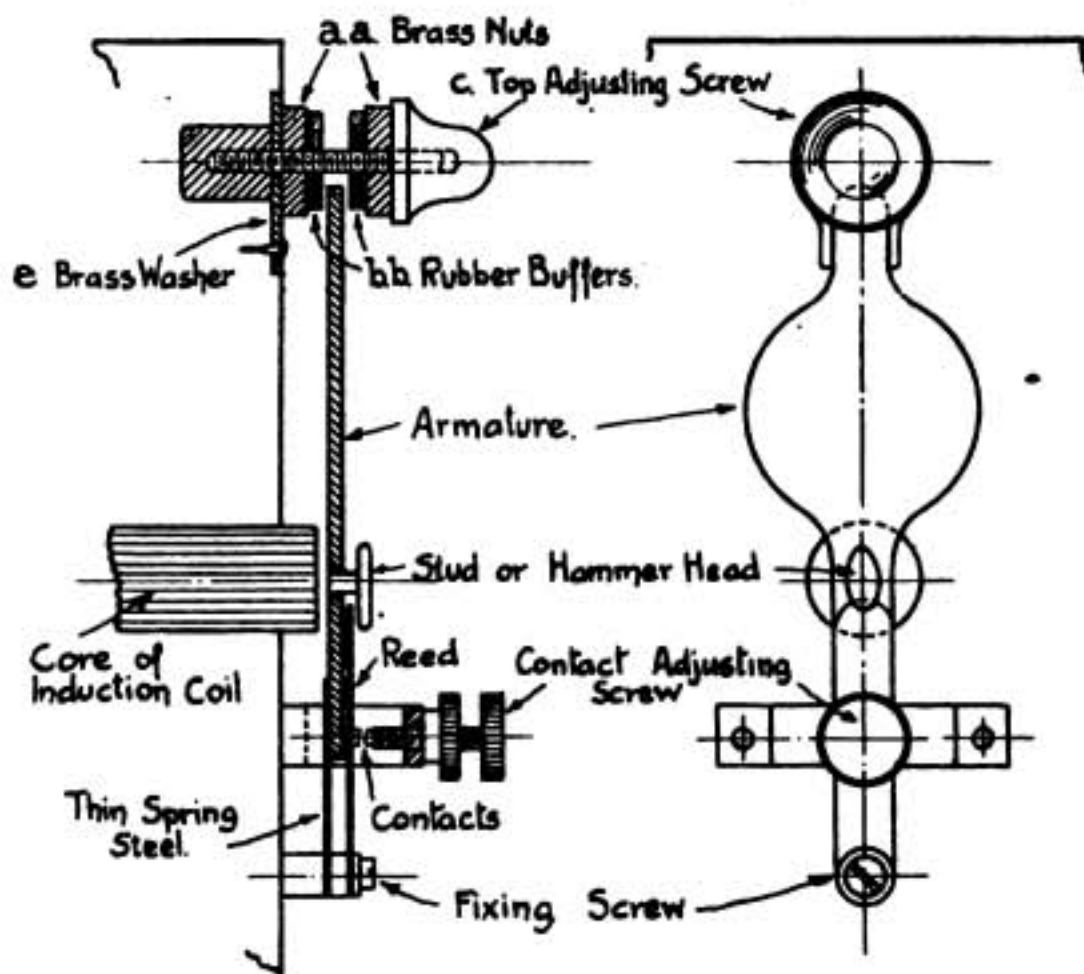

Fig. 9.

separated from it by a small brass distance-plate. The top of the reed passes beneath the overhanging edge of a stud or hammer-head carried by the armature, and as the latter moves forward under the attraction of the core, it travels some distance, gathering speed as it does so, before the edge of the hammer-head engages the top of the reed, and thereby breaks its contact with the other point. When this does take place, however, it is easily seen that the impact of the moving hammer-head will cause the reed to spring forward

previously mentioned, both these features are conducive to greater radiation efficiency.

The distance of the reed from the edge of the hammer-head stud is controlled by the centre screw, whilst the swing of the armature between the rubber buffers or springs is adjusted by means of the upper screw.

With this break the spark frequency can be varied between 120 and 300 per second without any serious loss in efficiency.

GENERAL CARE OF BREAK CONTACTS.

Contact points should always have a perfect surface, and should meet truly and over their whole area. The points may be ground on an oil-stone using the locking-nut (reversed) as a jig. They are expensive items nowadays to replace, and it is well worth while to treat them carefully.

Each time a transmitter has been used in the air, the contact points should be overhauled. It is better to be sure on the ground than sorry in the air.

SPARK GAP.

The spark gap should be adjusted before the set is placed in the bus, and the locking-nuts screwed tightly up in order to prevent subsequent displacement from vibration when in the air. A good dense spark springing equally from all parts of the discs indicates the correct distance—approximately 1.5—2 millimetres. Too close a gap gives rise to a "flame" discharge, which should be avoided. The discs should be frequently examined and kept scrupulously clean.

SHUNT CONDENSER OF INDUCTION COIL.

This is, perhaps, a relatively insignificant little adjunct, but it plays an important part in securing the general

efficiency of the set, so that a few words about it may not be out of place.

The condenser is placed in shunt across the make-and-break as shown in Fig. 10 and its function is to prevent sparking across the points when they break contact.

At the instant before break the primary circuit is surrounded by a heavy magnetic field, built up by the flowing current and its inductive action upon the iron core. At the moment when the points separate, this field instantaneously collapses, and in so doing cuts the coils of the primary winding and induces in it a high transient value of e.m.f.

In other words, the circuit "kicks" against the disturbance to its state of equilibrium, the direction of this reactive impulse being such as to tend to maintain the flow of current previously existing.

As at the moment of break, the points are still barely separated, this induced e.m.f. would be sufficient to spark across the thin layer of intervening air, and thus maintain a conductive path the effect of which would be to prolong the break, were it not for the shunt condenser which offers a more convenient path and reservoir for the momentary rush of current so created.

Its effect, therefore, is to ensure a clean, sharp break in the primary, and consequently the highest possible value of induced e.m.f. across the ends of the secondary for application to the spark-gap.

When the points again make contact, they short-circuit the condenser plates, which are thereby discharged ready for the ensuing break.

(To be continued.)

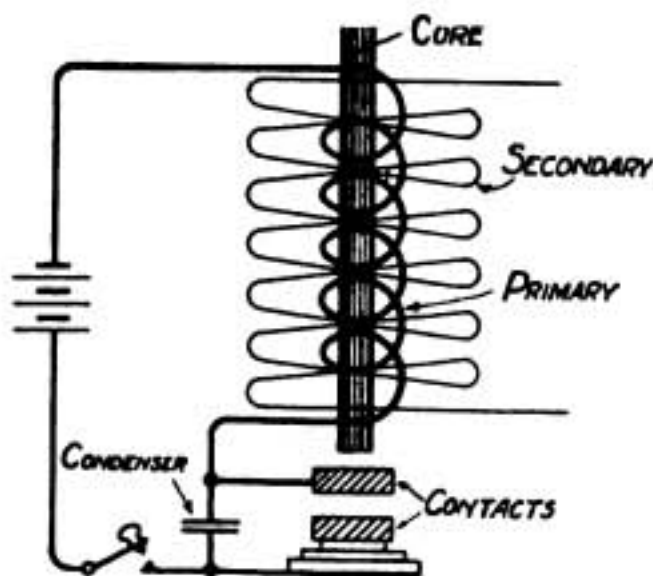

Fig. 10.

Aviation Notes.

THE TRANSATLANTIC FLIGHT.

FOR four long years of bloody war, heroism has been a commonplace, and men have risked their lives and died in millions, having no witnesses other than their comrades, and, for the most part, with no audience outside a small circle of kith and kin, to hear and applaud the story of their efforts.

Six months have barely elapsed since that time, and already it is possible for two gallant men by risking their lives in a single daring enterprise to rouse the feelings of the whole country to an extent almost without parallel.

It is not so much values that have altered as the focus of the public eye. Gallantry will always receive its full measure of appreciation when it can be distinguished. In the welter of war it is so often lost in the crowd.

The details of the flight have been

told so often that they need no repetition, the sudden start by the Americans for the Azores *en route* for Europe, the sporting instinct which led Hawker and Grieve to make their attempt in the face of weather conditions that were certainly no more favourable than

those that had till then kept them earth-bound for two months. Followed seven days of silence when it was known that they had failed, and fear grew to a practical certainty that both had paid the last penalty for their daring. Finally came the dramatic climax of their reappearance from the unbeaten track of the Atlantic on the now famous ship "that carried no wireless"; and their triumphal return from Thurso to London when all Scotland and England besieged the railway sta-

tions to do them honour.

So far as navigation was concerned, wireless played no part. The Sopwith



Photo:

F. N. Birkett.

Mr. Harry Hawker.

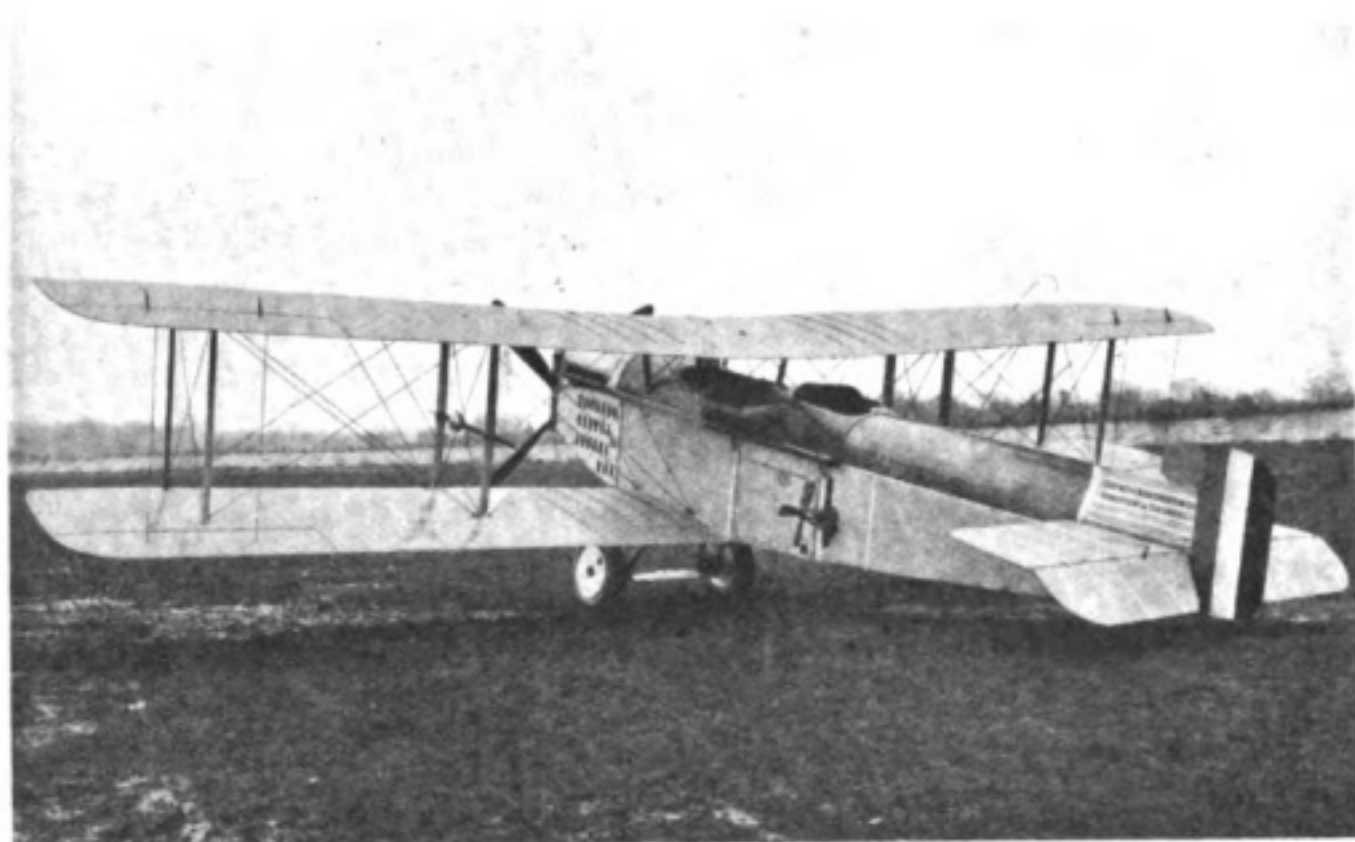

Photo:

Giles' Agency.

The Sopwith machine on which Mr. Hawker and Commander Grieve attempted the non-stop Atlantic flight.

was originally fitted with a 2-kilowatt spark set (R.A.F. No. 55A), but this appears to have been damaged and discarded during the trials.

A lighter service set was subsequently sent over, but unfortunately it arrived only just before the flight was made, and was apparently fitted in hurriedly and without proper opportunity of testing. This was the 52A—a modification of the No. 1. Transmitter (generally known as the Sterling) which has been described in the last two issues of the *WIRELESS WORLD*. It is somewhat heavier than the No. 1, and has a range of between 30 and 40 miles with crystal reception. A self-excited alternator, driven by a wind screw fixed in the slip stream of the propeller, supplies the primary current, thus dispen-

sing with the battery and make-and-break.

The 52A has been used to a considerable extent in the service, and is known to be a very reliable and efficient set within the limits for which it was designed.

Obviously though, even when working at its best, its only utility so far as navigation was concerned on the transatlantic flight would be confined to picking up location from passing ships. No direction-finding apparatus of the radio-goniometer type was carried by the Sopwith.

From Commander Grieve's own account, he found it very troublesome to keep a true course even approximately, and he expresses the opinion that the future of air navigation undoubtedly lies with directional wireless "when this has been perfected."

AVIATION NOTES

THE AMERICANS.

Meanwhile, when all has been said about our own men, the Atlantic has been crossed by the Americans. True, it was done in stages, and the American Navy was strung out along the course. But that does not detract in any way from the merit of the performance. They had chosen the southern route deliberately, partly because the weather conditions were expected to be better, and partly because of the break allowed by the Azores.

The record of the journey shows that the undertaking was no light one, and but adds to the credit due to Lieut.-Commander Read.

The three seaplanes, NC1, NC3 and NC4, left New York on May 8th for Trepassey Bay, Newfoundland. The NC4 was forced to descend off the coast of Mine owing to engine trouble, but the two others reached Halifax safely after a flight of nine hours. On May 10th, these two completed the journey to Trepassey Bay, and on May 15 they set out for the Azores.

Two futile attempts were made on that day, the first with a crew of six, and the second with a crew of five. In neither case would the machines rise from the water, so they were put back until the next day.

Meanwhile the NC4 had been repaired and had reached Trepassey Bay, and on the evening of May 16th, all three planes started on their long-distance trip to the Azores, a distance of 1,400 miles, each carrying a crew of four.

Only one, the NC4, made the passage, reaching Horta, in the Island of Fayal, after a flight of 15 hours 18 minutes.

The NC1 was forced to the sea some 200 miles north-west of Fayal. After being afloat for five hours its crew was

rescued by the steamer Ionia. The plane itself subsequently sank.

The NC3 had an even more adventurous passage. She was forced down to the sea some 200 miles from Ponta Delgada—the official destination—and after being lost for some days succeeded in arriving safely at that port, having "taxied" the whole distance through a heavy gale.

Meanwhile the NC4 had reached Ponta Delgada, and on May 27th safely traversed the 800 miles of sea between that point and Lisbon, in just under 9 hours.



Photo: Topical Press Agency
Commander Read of the N.C.4.

The final stage of the journey was from Lisbon to Plymouth, some 800 miles across the Bay of Biscay. A start was made on May 30, but owing to engine trouble the machine was forced to descend at Mondego after covering about 100 miles. The following day, however, saw the end of the journey, the NC4 arriving at Plymouth at 2.20 on the afternoon of the 31st.

Details are not available concerning the exact wireless equipment of the American planes, but Commander Read stated they had received messages from land stations over a range of 1,600

miles, and that their own signals had been picked up 700 miles away. The latter range is particularly good for an air-borne set.

The flight marks a definite step in the progress of aviation. It is a record of success won by indefatigable effort in the face of unfavourable circumstances, and in spite of mishaps that would be sufficient to daunt any but men of indomitable spirit. The safeguards afforded by the chain of American Naval ships, of which we have heard so much, did not prevent the loss of the NC3; nor was it of much assistance to the NC1.

The credit is to the Americans, and it would become us ill to attempt in any way to "damn it with faint praise."

THE TARRANT TRIPLANE.

Disaster befell the Farnborough mystery bus on her maiden flight. The laborious work of over nine months was smashed to firewood in as many minutes. Both the pilot, Captain F. G. Dunn, late R.A.F., and his assistant, Captain P. Townley Rawlings, D.S.C., sustained fatal injuries, whilst the four passengers were all more or less seriously hurt.

What apparently occurred was that when the machine had acquired a speed of about 35 miles an hour, the pilot began to feel doubtful whether he could "take off" on the tractors only, and opened out the "pushers," with the result that she heeled over, dug her nose into the ground, and half somersaulted.

ADVENTUROUS R34.

Towards the end of May the R34 set out from Inchinnan on the Clyde to East Fortune, a distance that should have taken two hours. She struck a fog on her way, lost her bearings, and commenced a wandering cruise that lasted for 21 hours, before finally coming home to roost.

She carried a crew of 31, three dogs, and a cat, and as there was no other food on board, the quadrupeds displayed unusual animal sagacity in securing accommodation in inaccessible positions, whilst the passengers contemplated moodily the prospect of combining the modern art of Aviation with the ancient cult of Anthropophagy.

Luckily before the fatal lots were drawn, wireless messages from Farnborough and Berwick brought the wanderers back to their bearings and averted the unpleasant fate that threatened the plumper members of the crew.



Photo:

The wreck of the Tarrant triplane.

Topical Press Agency.

The Construction of Amateur Wireless Apparatus

This series of Articles, the first of which was published in our April number, is designed to give practical instruction in the manufacture of amateur installations and apparatus. In the following article the author deals with the important question of Inductances. The Wireless Press, Ltd., has arranged with Marconi's Wireless Telegraph Co., Ltd., to supply complete apparatus to the designs here given, as soon as Amateur restrictions are released.

Article Four.—INDUCTANCES.

THE standard unit of inductance chosen for use in ordinary electrical engineering is the *henry*. Now the frequency of the alternating currents flowing in the oscillatory circuits of a wireless transmitter or receiver is so high that the henry is much too large to be convenient for the specification of inductance for wireless purposes. The inductance of the windings of an oscillatory circuit is therefore generally measured and stated in *microhenries*; that is, in millionths of a henry. The values of inductance employed vary from a few microhenries (mhys) in the case of a short wave primary circuit for a spark transmitter, to 50,000 mhys or more as for the secondary winding of a long wave receiving jigger. It is very necessary that the amateur should familiarise himself with the appearance of coils of varying inductance, so that he can form a rough estimate of the inductance of a coil simply by looking at it. This is not so difficult as one might imagine at first sight, and once the faculty is acquired it is of immense value when making up receiving circuits. It may be of some assistance in this respect for the ama-

teur to remember that a coil wound with one layer of No. 20 S.W.G. double silk covered copper wire on a former about 3 inches in diameter by 4 inches long has an inductance of about 400 microhenries. Also, assuming that we keep the dimensions of the coil constant but wind it with wires of different gauges, the inductance will be proportional to the square of the number of turns on the coil. We do not propose here to give any detailed instructions for the calculation of inductances; data of this nature can be found in many text books and pocket books.

INDUCTANCES FOR TRANSMITTERS.—In the article on aerials and earth systems we laid great stress on the importance of avoiding all constructions which would lead to the introduction of unnecessary resistance into the aerial circuit. This applies more especially to transmitting aerials. For the same reason it is desirable to design the aerial tuning inductance and jigger primary of a transmitting set so that the high frequency resistance is kept as low as possible. This is why bare copper tube is often employed in this connection. The tube can be formed into a spiral and supported in any convenient

manner. Copper petrol piping, as used on motor cars and motor cycles is very suitable for the purpose. The pipe need only have very thin walls as owing to the "skin effect" the current is confined to the surface of the conductor. Stranded wire is also much used for winding the inductances of a transmitting circuit. The amateur should note that it is absolutely necessary that each individual strand be separately insulated. It is of no advantage to use 7/16 standard conductor for the construction of a jigger primary; since the conductors forming the cable are not separately insulated, it behaves just as though it were a solid conductor of equivalent surface. Also it should be noted that there is no particular advantage in increasing the sectional area of a solid conductor beyond a certain size (depending upon the frequency), because eddy current losses in the copper rise as the size increases, and consequently the reduction in ohmic resistance resulting from the greater cross section is negated by the larger losses when the conductor is traversed by high-frequency current. The mode of laying up the stranded wire is also of great importance. Ordinary cables used in electrical work, such as 7/16 flexible wire, consist of a single wire running down the centre of the cable with six wires laid round it in a spiral of very coarse pitch. It is easy to see that if we take seven separately insulated wires and lay them up in this manner the outside conductors will be considerably longer than the wire forming the core of the cable. It is obviously undesirable to have the separate conductors of different lengths. Also, in this method of laying up, each wire preserves its relative position with reference to the centre of the cable throughout its whole length. In order to minimise "skin effect" it is desirable that a surface conductor at one point

in the cable should be a centre conductor at another point and so on. In this manner we obtain the most uniform distribution of current over the whole cross section that is possible. These conditions are most simply met by the process of laying up in threes. In this method three insulated conductors are taken and laid up spirally together to form a cable. No core is used. Then three of these cables are taken and laid up spirally, forming a cable of nine conductors. Then three of the nine conductor cables are laid up—and so on until a cable of the required size is obtained. If the amateur will study this method of construction he will see that—

- (1) Each conductor is the same length, and
- (2) Every conductor appears on the surface at different points in the cable, and also passes to the centre.

A model can easily be made by laying up a number of lengths of smooth string in this manner; and if different coloured strings are used, the path of any individual thread can be easily traced out. Stranded conductors of this type are generally specified by stating the number of "threes" in the cable. For instance a cable consisting of twenty-seven strands of No. 30 S.W.G. copper wire is described as $3 \times 3 \times 3/30$, and if each strand is double silk covered, the letters D.S.C. are placed after the figures denoting the size.

In order to reduce the overall diameter of the finished cable, enamelled wire is largely used for the component strands. This covering is quite satisfactory as far as insulation goes, but it has the disadvantage that some types of enamel are very difficult to remove for the purpose of making connection on to the conductor. It is most necessary that good contact should be made on to each

THE CONSTRUCTION OF AMATEUR WIRELESS APPARATUS

strand of the cable. The best method is to bare each conductor individually, care being taken to avoid breaking any strands, then the whole bunch is sweated together to form a solid end to the cable. Soldering compounds should not be used in this operation, as, if the strands are very fine, corrosion is certain to result with a corresponding rise in the resistance of the contact or joint. It is useful to note that some enamels are soluble in acetone. When this is the case cables made up from wire so insulated can be most easily cleaned for soldering by washing off the enamel with acetone. The amateur should take great care that no strands are broken in the cleaning operation. The presence of an unconnected strand in the cable is certain to cause a rise in the high-frequency resistance, and the conductor would be better without the strand altogether.

It will perhaps be of help to the amateur if we give a brief description of the way he should set out to construct the primary circuit of a coupled circuit spark transmitter. We shall assume that he has in his possession a spark coil of some type and that his licence allows him to employ a wavelength of 150 metres for transmission. Now the design of the circuit will be entirely dependent upon the value of the maximum capacity which the coil will charge, and this depends upon the power of the coil and the gauge of wire with which the secondary is wound. The best way to determine this capacity is by experiment. Take a number of sheets of glass—old half-plate negatives from which the emulsion has been removed are very suitable—and have at hand a number of sheets of tinfoil cut to the correct size to form the plates of the condenser. Now commence building up a condenser with the glass and tinfoil, and after each plate is added

test the character of the spark by connecting the secondary terminals of the coil and the gap (whatever type it may be) across the condenser. Now continue increasing the number of plates in the condenser until the spark becomes ragged and irregular. We then know that the capacity is just too large for the coil to charge satisfactorily, and the correct value will be given by taking off one or two plates. This condenser may be employed in the finished transmitter, or its capacity may be determined by comparison with a standard condenser or inductance and the actual condenser of the correct size purchased. Having obtained our condenser the required inductance to give the desired wavelength may be determined by a similar process of experiment. We will suppose for example that the amateur has decided to make a self-supporting spiral of copper tube for the inductance of his jigger primary circuit. Take a wooden former of the correct diameter and say 1 foot long. Now, a spacing of half an inch between the turns will be very suitable; therefore wind three or four turns of insulated wire on the former spaced $\frac{1}{2}$ inch apart. Connect these turns in series with the gap and condenser and set the coil in operation. The wavelength to which the circuit is oscillating can be determined by making an observation with a wavemeter in the vicinity. Note this wavelength; if too long remove some of the wire from the former, if too short wind on some more turns. By this process of trial and error the exact number of turns required can be found out. Now by unwinding the wire from the former the amateur can at once measure its length, and thus obtain a figure for the quantity of copper pipe to be purchased. Of course, it is essential that the pipe should be made up into a helix of exactly the same

dimensions as the experimental winding on the former.

The amount of aerial tuning inductance required will be dependent upon the dimensions of the aerial which is available for transmitting, and provided that the amount necessary is not very great it will be quite good enough to employ solid conductor of at least the same section as the aerial wire itself. Thus, if the aerial is made up from 7/19 silicon bronze wire, and has only one wire in it, 7/19 copper rubber insulated cable will be quite suitable. The amount of wire required can be determined experimentally by winding a former of the same dimensions as the finished coil with copper wire, correct spacing between turns being preserved. By inserting this coil in series with the aerial to earth, and exciting the circuit by means of a shunted buzzer, the wavelength of the system can be measured. Turns can then be added or taken off the coil until the desired wavelength is obtained. Then using the experimental coil as a model the finished inductance can be made up. It is of advantage to be able to adjust the tuning of the aerial between small limits in order to secure exact resonance with the primary circuit. The amateur can get this adjustment by making the permanent aerial tuning inductance with, say, two turns less than the required number; then by employing a small extra inductance, consisting of six turns of bare conductor formed into a spiral of the same diameter as the fixed inductance, provided with an adjustable contact clip, the necessary fine tuning adjustment can be obtained. If it is found that a large amount of inductance is required to bring the aerial up to the licensed wavelength, we recommend the amateur to make up his tuning coil from stranded cable. It will be necessary to make a former of insulating material,

such as ebonite, on which to wind the cable, as it is not stiff enough to be self-supporting.

INDUCTANCES FOR RECEIVERS.—It is not necessary, in the case of a receiving circuit, to take such extreme care to reduce all resistances to the lowest possible limit. It is a mathematical fact that, even though the receiving circuits were absolutely ideal and possessed no internal losses, the efficiency of a receiver can never exceed 50 per cent. In any case when a three-electrode valve is employed for magnification of the received high-frequency current, the damping of the circuit can always be reduced to zero by a suitable adjustment of the reaction coupling. Consequently, for all ordinary receiving circuits, we can rule out as unnecessary the use of stranded wire. This wire is expensive when purchased in the quantities required for the coils of a receiving circuit, and the advantage gained is too small to be of account. There are cases, in commercial work, where stranded cable must be employed. For example, an intermediate circuit consisting of a large air condenser shunted by two small inductances would necessitate the use of stranded cable for the coils; but the average amateur will not require circuits of this special nature.

The coils for the oscillatory circuits should always be wound in only one layer. This is desirable in all cases and absolutely essential where the ratio of inductance to capacity is large. This latter condition obtains in the case of a jigger secondary circuit, where the potential produced across the tuning condenser is applied directly to the rectifier (e.g., crystal or valve) or to the grid of a three-electrode valve. This circuit must be designed so that the applied potential difference is the maximum possible, and this condition implies that the condenser should be as small as possible

THE CONSTRUCTION OF AMATEUR WIRELESS APPARATUS

and the inductance correspondingly large. If the inductance coil were wound in two layers, the terminal ends of the coil would be directly over each other, separated only by the thickness of the insulating covering of the wire. The ends therefore would have a considerable capacity to each other, and this capacity would be in parallel with the tuning condenser connected across the coil. Consequently the total effective capacity in the circuit would be much greater than if the coil were only a single layer one. It is obvious that the ideal case is exemplified in a single layer coil whose natural wavelength is that of the received signal; this is not a suitable arrangement in practice as adjustment of wavelength is necessary, and this could only be obtained by a variation in the length of the coil.

Various methods have been proposed and used for increasing the inductance of a coil, without increasing its capacity unduly, and at the same time keep-

ing the dimensions small. Lap and pile windings are examples. These windings are not easy to do with fine wire by hand, and since the amateur is not usually concerned with keeping the weight and size of his apparatus down to the smallest possible limit, we advise him to stick to simple single layer windings.

With regard to the gauges of wire to be used for different circuits, No. 20 or 22 is very suitable for aerial tuning inductances, intermediate circuits, etc.; No. 28 or 30 is good for jigger secondaries. All wire should be high conductivity copper and double silk covered. The finished coils should be given two thin coats of shellac varnish, and, if the former will stand heat, should be baked in a warm oven or before a fire. The coils in any case must not be used until the varnish is quite hard and dry. Shellac varnish, before quite hard, is quite a good conductor.

Patent Section

123,081. Electric signalling and telephony. Ehret, C. D., 2118, Land Title Building, Philadelphia, Pennsylvania, U.S.A. February 1st, 1919. No. 2585. Convention date, February 1st, 1918. Not yet accepted. Abridged as open to inspection under Section 91 of the Act (Classes 40 (iv) and 40(v)).

Telephoning or signalling between stations upwards of 100 miles apart is effected over line conductors having a resistance greater than 25 ohms per mile, amplifiers C^1 being arranged at points a plurality of wavelengths apart. The speech or signal waves are preferably im-

pressed upon high frequency current from a generator g^1 . The resistance of the conductor is at least 25 ohms per mile for pole line and 50 ohms per mile for cables, and currents of frequencies from 20,000 to 200,000 cycles per second are used. The amplifier preferably of the audion or thermionic type, may be from 50 to 200 miles apart. The lines may be loaded with inductances l , inductive or non-inductive leaks k being arranged as shown in Fig. 4. A source of high-frequency current g^1 may be connected to line at a point mid-way between the terminal station.

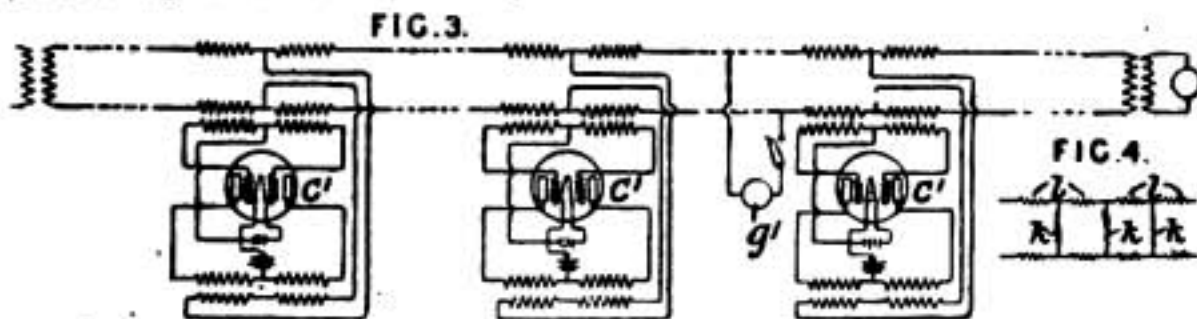

The Library Table

ALTERNATING CURRENT ELECTRICAL ENGINEERING.

By PHILIP KEMP, M.Sc. TECH.
(VICT.), A.M.I.E.E.

London: Macmillan & Co., Ltd.,
17s. net (pp. 494.)

THIS text book is intended as a general volume covering the bulk of the work usually associated with the title of Alternating Current Engineering. It is designed to cover the syllabus for the Alternating Current paper of the City and Guilds Examinations, and for the B.Sc. Examination in Electrical Engineering. The matter dealt with in this book is essentially of the type and style usually associated with College lectures, which are intended to be supplemented by separate Laboratory or Practical Courses. The commercial side of A.C. Engineering is, therefore, not touched upon at all, nor is what may be termed the "manufacturing" side which is concerned with constructional details and the various forms of A.C. machinery as actually put on the market. For the purposes, however, of College courses of the above type the book appears to cover the ground in a very excellent manner, except in a few minor details. This particular subject is from its nature one that is quite inseparable from mathematical reasoning and formulæ, but the author has endeavoured to simplify these down to their essential parts only, and to put the more advanced (calculus) explanations in the form of footnotes which may be passed over by the uninitiated reader. This practice, however, has not been consistently followed, as in one or two places

the integrations have been incorporated into the text.

The book commences with the usual type of introduction dealing with the production of an E.M.F. from a varying magnetic field. A useful feature in this section is the emphasis given to the idea of "linkages" and "change of linkages," rather than to the "cutting" of flux by a conductor, and also to the importance of considering non-sinusoidal wave forms as well as those following a pure sine curve. The general tendency, however, of modern practice is in the direction of more uniform sine wave forms so that these considerations are gradually becoming less important.

Two very useful chapters are devoted to vectors and circle diagrams, the latter being treated very fully. A useful distinction has been made in the form of the arrow head put on the vectors to distinguish between the various vectors in a diagram representing voltage, current, magneto-motive force and flux. The distinctions are, however, rather confused in the printing of some of the diagrams throughout the book. Chapter VI. treats of Capacity and Condensers and summarises the effects of capacity in alternating current circuits and networks, as well as their various uses and the meaning and effects of Resonance. A very limited table of Specific Inductive Capacities is, however, given and some of the values quoted do not entirely agree with common experience.

The author seems to pin his faith entirely to paper condensers for practically all purposes, although the Moscicki glass tube condensers are briefly described. Mica condensers seem to be quite "outside the pale" in spite of

THE LIBRARY TABLE

their increasingly extensive employment for many purposes. The sections on the uses of condensers are also somewhat brief, while such a very extended application as their use in Magnetos is altogether omitted.

The wave forms of alternating current are further dealt with in two Chapters, IX. and X. The pages devoted to Harmonic Analysis are somewhat limited, and only two methods are discussed, probably because the author prefers his own method (for which good tables and data are given) to any other. A considerable number of ways of analysing a periodic curve have been published latterly, and some mention might perhaps have been made of some of these, although, on the other hand, the average college student has quite enough to remember if he knows merely one workable method without risking possible confusion by studying several different analyses. The sections devoted to the effect of magnetic saturation and hysteresis on the wave-form of the current, as well as the harmonics that are introduced under other conditions—such as by an A.C. Arc—are instructive from the wireless point of view, especially in connection with the application to static and other forms of Frequency Raisers.

Chapters XI. and XII. on A.C. Instruments begin the more specialised portion of the book as distinct from the purely general introductory matter. A feature rarely found in text books is a description of the cathode-ray oscillograph and its method of use, although important recent improvements such as the use of incandescent cathodes, etc., are not mentioned. These improvements make the instrument much more useful in operation, and enable photographic records to be more readily obtained. The influence machine method of excitation can also with advantage be

replaced by high voltage batteries or by rectified alternating current obtained by the use of rectifying valves.

The all-important Transformer, Alternator, and Induction Motor are given three chapters each—one of which is in each instance devoted to design. These design chapters appear particularly good for the student's use as giving a plain, straightforward treatment without unnecessary complications, provided that the details of most recent practice (in the way of efficiencies, regulation, etc.), are supplied to the student by his lecturer.

The transmission of power by overhead lines and underground cables is treated mathematically in Chapter XX., while Synchronous Motors and Rotary Converters each receive a Chapter.

A very useful Chapter is devoted to Power Factor Improvement, and treats mainly of the over-excited synchronous motor and the various conditions under which it may be employed. The use of condensers for this purpose is also briefly discussed.

Mercury Vapour Converters and Electrolytic Rectifying Valves are discussed briefly, while the book closes with two Chapters devoted to the series and repulsion motors.

Taken as a whole the book gives a very good treatment of all parts of the subject and misprints are remarkably few, although considerable confusion may arise through the use of the section heading "Ohms Law for Alternating Current Circuit" on p. 10, when the complete (impedance) formula is not given but merely the usual form of Ohms Law, as used for D.C. circuits. A slight error appears on p. 135 where two discs referred to in the text are shown in the accompanying figure as squares; and again on p. 221, the expression "length of the core = 16.4 cm." should be "side of core section. = 16.4 cm."

Personal Notes

NEW HONOUR FOR SIR O. LODGE.

ON June 6th at Clarence House, the Duke of Connaught presented to Sir Oliver Lodge the Albert Medal of the Royal Society of Arts, which was awarded to the famous scientist "in recognition of his work as the pioneer of wireless telegraphy."

MR. CHARLES BRIGHT KNIGHTED.

His Majesty the King has conferred on Mr. Charles Bright, F.R.S.E., M.Inst.C.E., M.I.E.E., the honour of Knight Bachelor. Mr. Bright is consulting engineer to the Commonwealth of Australia, and has been engaged in the construction and laying of cables in many parts of the world. He has served on numerous Committees, including the R.F.C., Inquiry Committee of 1916, and represented the Australian Commonwealth at the International Radiotelegraphic Conference in 1912.

MARCONI COMPANY'S NEW DIRECTOR.

Marconi's Wireless Telegraph Company, Limited, announces that Sir Charles J. Stewart, K.B.E., has been elected to a seat on the Board. Sir Charles, who was born in 1851, is a barrister-at-law, having been called to the bar in 1883. He was Senior Official Receiver to Companies Winding Up from 1890-1897, when he became Clerk to the London County Council. Sir Charles was Chairman of Messrs. S. Allsopp & Sons from 1900-1907, and in the latter year he became

Public Trustee, which position he held until a recent date.

MILITARY CROSS FOR EX-WIRELESS OPERATOR.

Our congratulations go to Capt. R. W. Newcomb, who was decorated by the King with the Military Cross on May 17th last at Buckingham Palace, "for conspicuous bravery in the field."

Immediately prior to the war, Mr. Newcomb (who was in the employ of the Société Anonyme Internationale Télégraphique sans Fil) was operator in charge on board the S.S. "Lapland," but on the outbreak of hostilities he immediately joined up in a London Regiment as a private.

NEW APPOINTMENTS.

Mr. F. C. Raphael, M.I.E.E., has been appointed manager of the Cable and Wireless Department of the Edison Swan Electric Company, Limited (Ponders End, Middlesex). Prior to the war Mr. Raphael was well known as the editor of "The Electrician" and "Electrical Engineering" successively. Shortly after the outbreak of war, being too old for the Army, he joined the Royal Naval Anti-Aircraft Corps, but subsequently obtained a commission in the London Electrical Engineers, R.E. (T). At the time of his demobilisation he held the appointment of Assistant Inspector under the C.I.R.E.S.

Mr. A. H. Morse, A.M.I.E.E., Mem. I.R.E. (New York), has been appointed Managing Director of the Marconi Wireless Telegraph Company of Canada, Ltd. Mr. Morse is well-known in North American wireless circles.

Company Notes

THE MARCONI INTERNATIONAL MARINE COMMUNICATION COMPANY, LIMITED

DIRECTORS' REPORT.

The Directors submit herewith the Balance Sheet and Profit and Loss Account for the year ended 31st December, 1918.

The Company's business has continued to show substantial expansion. The Gross Revenue for the year amounted to £563,205 7s. 3d., showing an increase over the preceding year of £92,547 10s. 8d. This increase was again derived mainly from rentals of additional ships fitted. It will be borne in mind that the restrictions on private messages from ships at sea have only been removed since May 1st of this year. The net Profit for the year amounts to £186,341 17s. 1d.

In the Directors' Report last year, Shareholders were advised that His Majesty's Government had decided to make the provision of Wireless Telegraph Apparatus compulsory on merchant ships of 1,600 tons gross and over, and to require that two operators be carried on all these vessels. At the request of the Board of Trade, this Company undertook to provide the necessary apparatus and the trained operators. It, therefore, became necessary to arrange facilities in all parts of the country for the simultaneous training at the Company's expense of a very large number of operators. Thereby a large and extraordinary expenditure has been incurred during the year under review which will not recur, and it is responsible for a small reduction in the Profits compared with the preceding year notwithstanding the substantial increase in the year's revenue.

The losses sustained in consequence of attacks upon the mercantile marine during the year 1918 have been debited to Profit and Loss.

The Directors have pleasure in recommending the payment of a final dividend of 10 per cent. for the year 1918, which with the interim dividend of 5 per cent. paid in January last will make 15 per cent. for the year.

During the year 47 Debentures of a par value of £940 were redeemed.

The total number of Public Telegraph Stations owned and worked by the Company on the high seas increased from 2,265 at the end of December, 1917, to 2,549 at the end of

December, 1918. The organisation of the Company, together with that of its associated Companies, with a total of over 4,000 mercantile vessels fitted with Marconi Telegraph Stations, has continued to render inestimable service.

The Amalgamated Wireless (Australasia) Limited, in which this Company is interested, has paid a Dividend of 5 per cent. in respect of the year ending 30th June, 1918.

The increase of the Capital of the Company to £1,500,000 was duly confirmed at the Extraordinary General Meeting, held on the 2nd May, 1919, and 600,000 new Shares were offered to the Shareholders, at par, on the 10th May last.

An official quotation on the London Stock Exchange was granted for the Company's Shares in April last.

It is with regret that the Directors have to record the names of further members of the Company's Telegraph Staff who have lost their lives in the service of their country.

The Directors regret to record the death, on the 9th May, of Mr. Henry Spearman Saunders who had been a Director of the Company since its incorporation.

Since the last Ordinary General Meeting, Mr. Sidney St. J. Steadman and Sir Charles J. Stewart, K.B.E., have been appointed Directors of the Company. In accordance with Article 67, these gentlemen retire and, being eligible, offer themselves for re-election.

The Directors retiring by rotation are Mr. Henry William Allen, Mr. William Walter Bradfield, and Mr. Maurice Alfred Bramston, who, being eligible, offer themselves for re-election.

The Auditors, Messrs. Cooper Brothers and Co., also retire and offer themselves for re-appointment.

By Order of the Board,
H. W. CORBY,

Secretary.

Marconi House,
Strand, London, W.C.2.
6th June, 1919.

THE MARCONI INTERNATIONAL MARINE COMMUNICATION COMPANY, LIMITED.
Dr. BALANCE SHEET, 31st December, 1918. Cr.

<p>TO CAPITAL— <i>Authorised and Issued.</i> 600,000 Shares of £1 each To 5.567 5/8 PER CENT. FIRST MORTGAGE DEBENTURES OF £20 EACH TO GENERAL RESERVE ACCOUNT TO RESERVE FOR OBSCURENCE OF PLANT TO CREDITOR BALANCES TO PROFIT AND LOSS ACCOUNT— Balance as per Appropriation Account, 31st December, 1917 Balance of Account for the year ending 31st December, 1918</p>	<p>£ s. d. 600,000 0 0 111,340 0 0 25,013 13 0 50,000 0 0 200,083 18 0 105,417 10 0 180,341 17 1 201,750 16 1 £1,511,095 7 10</p>
<p>BY PLANT, APPARATUS, FURNITURE AND STORES <i>Note.</i>—Owing to the war it has not been possible to obtain certified Inventories for Apparatus and Stores amounting to £104,411 7s. 11d. The balance, £407,886 11s. 1d. has been certified by representatives of the Company.</p> <p>BY LICENCE AND RIGHTS AND SHARES IN ASSOCIATED COMPANIES BY DEBTOR BALANCES BY CASH AT BANKERS AND IN HAND BY INVESTMENTS IN WAR LOANS</p>	<p>£ s. d. 602,301 1 0 220,086 11 7 335,723 17 9 52,575 5 11 101,308 13 7</p>

H. RIALL, SANKEY
 HENRY W. ALLEN } *Directors.*

Dr. PROFIT AND LOSS ACCOUNT for the year ending 31st December, 1918. Cr.

<p>TO SALARIES AND DIRECTORS' REMUNERATION TO GENERAL CHARGES TO EXPENSES OF SHIP TELEGRAPH STATIONS, including loss of Plant and Apparatus and cost of training Operators TO DEPRECIATION OF PLANT AND APPARATUS TO DEBENTURE INTEREST TO BALANCE CARRIED TO BALANCE SHEET</p>	<p>£ s. d. 40,168 11 1 11,990 13 0 207,707 15 2 51,242 18 0 5,083 19 5 186,341 17 1 £503,444 13 9</p>
<p>BY SHIPS' TELEGRAMS, CONTRACTS, RENTALS AND SUNDRY RECEIPTS BY TRANSFER AND OTHER FEES</p>	<p>£ s. d. 563,205 7 3 230 6 6 £503,444 13 9</p>

APPROPRIATION ACCOUNT.

<p>TO INTERIM DIVIDEND of 5 per cent. for the year ending 31st December, 1918, paid 15th January, 1919 TO PROPOSED FINAL DIVIDEND of 10 per cent. for the year ending 31st December, 1918 TO BALANCE carried to next Account, subject to Excess Profits Duty for 1916, 1917 and 1918</p>	<p>£ s. d. 30,000 0 0 120,000 0 0 141,750 16 1 £291,750 16 1</p>
<p>BY PROFIT AND LOSS ACCOUNT, as per Balance Sheet</p>	<p>£ s. d. 291,750 16 1 £291,750 16 1</p>

REPORT OF THE AUDITORS TO THE SHAREHOLDERS.

We have audited the above Balance Sheet with the books in London and accounts from Rome. We have obtained all the information and explanations we have required, and in our opinion such Balance Sheet is properly drawn up so as to exhibit a true and correct view of the state of the Company's affairs according to the best of our information and the explanations given to us and as shown by the Books of the Company.

COOPER BROTHERS & CO., } *Auditors.*
 Chartered Accountants

LONDON, 6th June, 1919.

Questions and Answers

NOTE.—This section of the magazine is placed at the disposal of all readers who wish to receive advice and information on matters pertaining to both the technical and non-technical sides of wireless telegraphy. Readers should comply with the following rules: (1) Questions should be numbered and written on one side of the paper only, and should not exceed four in number. (2) Queries should be clear and concise. (3) Before sending in their questions readers are advised to search recent numbers to see whether the same queries have not been dealt with before. (4) The Editor cannot undertake to reply to queries by post (5) All queries must be accompanied by the full name and address of the sender, which is for reference, not for publication. Queries will be answered under the initials and town of the correspondent, or if so desired, under a "nom-de-plume." (6) Will readers please note that as amateurs they may not at present buy, construct or use apparatus for wireless telegraphy or telephony. (7) Readers desirous of knowing the conditions of service, etc., for wireless operators, will save time by writing direct to the various firms employing operators.

T. AERIAL (Cheshire).—Asks whether if two stations which lie E. and W. desire to communicate with maximum strength signals, their aerials should be parallel to each other, that is, N. and S.

(2) Would the same apply whether the download be taken from the ends or the centre?

Answer.—(1) In the first place an aerial is only directional to any useful degree when the length of the horizontal portion is several times the length of the download. In order that the aerial may radiate the maximum energy in a certain direction, the free ends of the aerial must point away from the station to which it is desired to transmit. The aerials in the above case would therefore point away from each other and would be in the same straight line.

(2) A "T" aerial is only very slightly directional. Curves showing the intensity of the field around an aerial will be found in most text books on Wireless Telegraphy.

If the receiving station is fitted with a wireless compass using a frame for the aerial, then strongest signals will be received when the plane of the frame points to the transmitting station, that is the plane of the frame will be in a line with the receiving and transmitting stations.

It is quite possible to obtain readable signals on a 5-ft. frame by using several audions in cascade.

MESSENGER (Christchurch).—(1) You ask "Is it true that there are more operators than can be employed?" This question is of such a comprehensive nature that we cannot answer it definitely. We are inclined to think that there is a steadily growing demand for wireless operators. (2) Not to our knowledge. (3) The Marconi International Marine Communication Co., Ltd., Marconi's Wireless Telegraph Co., Limited, Siemens Bros., and, of course, the Post Office. A very limited number of Shipping Companies employ their own operators.

H.S. (Biddulph Park, nr. Congleton).—(1) Six to nine months study at a good school, but it depends largely upon how long you need to attain the necessary operating speed. (2) and (3) Elementary arithmetic only.

C.D.H. (Seaford).—You would require a complete course of electrical engineering, plus a specialised study of high-frequency currents. Write to the various engineering colleges for prospectuses of such courses, stating what you want to do.

J.M. (Portsmouth).—(1) Yes, but not in that only, of course. (2) The fee for the P.M.G. examination in wireless is five shillings. Apply to the Secretary, G.P.O., London.

C.R.E. (Swine, nr. Hull).—(1) The wireless call of the S.S. *Titanic* which sank in 1912 was MGY. (2) Depends upon the rules of the club you propose to join. At present there is not a great activity amongst wireless clubs, owing to the restrictions on amateur working. Until a club is started near enough to your home for you to attend its meetings you might become a corresponding member of a club elsewhere. The Three Towns Wireless Club, 7, Brandreth Road, Compton, Plymouth, is willing to admit such members.

L.A.W., c/o G.P.O.—Asks: (1) Whether the formula in the Wireless Year Book for 1918 for the calculation of the capacity of concentric cylinders is correct?

Yes, this formula is quite correct when air is the dielectric used, as the Specific Inductive Capacity of air is 1. If any other dielectric is used then it is necessary to include in the numerator of the formula the value of the S.I.C. of the material used.

(2) We are unable to state the exact S.I.C. of paraffin waxed paper, but it would probably be about 2.

(3) It is not essential to have a battery connected in the grid circuit of a three electrode valve. In some valve receivers the grid potential is adjusted by means of a potentiometer connected across the battery used for the filament. The potentiometer can, however, be dispensed with, when the correct point on the characteristic curve of the valve is obtained by

QUESTIONS AND ANSWERS

adjusting the plate voltage, and the temperature of the filament.

(4) What factors govern the sizes of wires and ratio of turns in a telephone transformer? *Answer.*—The current flowing in the primary side of the transformer, that is the detector side, the inductance of the primary side, and the current required to work the particular type of telephones used, are the principal factors which govern the sizes of wires used and the ratio of the number of turns. The design of the telephone transformers is somewhat empirical and is a matter of trial.

DALLY (Hastings).—Asks several questions about the cost of various pieces of apparatus used in connection with valve reception, and requires the names of the various grid valves. (1) It is almost impossible to give any indication of the cost of any apparatus for use in wireless transmission or reception, as no wireless apparatus has been on the public market since the outbreak of war, and we cannot forecast what prices will rule when the embargo is raised. Other circumstances which affect the cost of any wireless apparatus for an amateur are: (a) his ability and facilities for making it himself, (b) the range of the set, whether for receiving or transmitting, and, (c) the finish of the whole apparatus. A set can therefore be made with an outlay of a few shillings or as many pounds.

We are unable to furnish "Dally" with any names of grid valves as the valves at present are simply known as three electrode transmitting or receiving valves, a few having a type letter.

(2) What apparatus is required to convert an Auto-jigger crystal receiver into a valve receiver?

Answer.—A three electrode receiving valve. A battery with a series resistance to light the filament of the valve; this battery would have to give a current of about .5 amps. so that an ordinary dry cell would not suffice; a high tension battery capable of giving from 100-200 volts. The exact H.T. Voltage required depends on the characteristics of the valve. A pair of H.R. telephones, or preferably a pair of L.R. telephones and a telephone transformer.

(3) In a heterodyne receiver what produces the waves at the receiver end? In a heterodyne receiver the waves or "beats" as they are technically known, are produced by superimposing on the circuit oscillations of greater or less frequency than the frequency of the waves received. Thus if the received waves have a frequency of 50,000 per second and oscillations of 49,000 per second are superimposed we obtain a musical note with a frequency of 1,000 per second in the receiver. There are several methods of obtaining these superimposed oscillations, the most usual being to couple a reaction coil connected in the plate circuit of the valve, to the coil connected in the grid circuit.

The coil in the grid circuit can either form the A.T.I. of the receiver or the jigger secondary coil.

(4) Continuous waves cannot be received on an auto-jigger receiver by including a single buzzer in the aerial circuit. It would be possible by using a double buzzer, that is two buzzers in series. Connecting a condenser across the buzzer terminals would have no effect.

(5) Yes, wireless telephone waves can be heard by anyone listening on a crystal receiver.

C.T.A. (Leicester).—(1) We regret we are unable to give the exact function of the condenser C.4 on page 95 of the May issue of the WIRELESS WORLD; perhaps the writer wished to insulate the filament and high tension batteries from earth, a somewhat unusual proceeding. As this condenser has a capacity of .01 mfd. its capacity would be very large compared to that of the aerial and would not, therefore, appreciably effect the wavelength.

(2) For remarks on the design of telephone transformers see our answer to L.A.W., c/o G.P.O., in this issue. We have obtained good results on a variety of circuits by using a small ignition coil similar to that used for motor car ignition before the high tension magneto came into use.

(3) Telephone transformers with a closed iron core are used, but from our experience they are little, if any, more efficient than an open core transformer.

D.A.N. (S.W.19).—Unfortunately D.A.N. gives no details of the coil with which he gets a 3-cm. spark at the electrode gap when it is disconnected, or whether only the secondary leads are disconnected and not the aerial circuit. The spark may be caused by the electrode rods acting as an Hertz resonator with the condenser across the break acting as the exciting agent.

SHARE MARKET REPORT.

There has been renewed activity in the share market for the various Marconi issues owing to the prospects of the Parent Company's claim against the Government, the improved position of the International Marine Company shown in the report which has just been issued and the proposed reconstruction of the Marconi Wireless Co. of Canada.

Prices are all well maintained as we go to press: Marconi Ordinary, £6. 3. 9; Marconi Preference, £5. 11. 3; American Marconi, £1. 10. 0; Canadian Marconi, 18s. 0d.; Spanish and General, 15s.; Marconi International, £3. 10. 0.

WANTED the following numbers of the "Wireless World":—April, June, 1913; June, July, 1917; January, February, March, April, May, September, 1918; February, 1919. Write with full particulars, price, etc., to Box N. Wireless Press Ltd., Marconi House, Strand, W.C. 2.

TECHNICAL BOOKS. Second-hand and New Books on every conceivable subject. Catalogue free. State wants. Books sent on approval. Books bought.—FOYLE, 121, 125, Charing Cross Road, London.