

GENERAL LIBRARY  
APR - 9 1919  
UNIV. OF MICH.

# The Wireless World

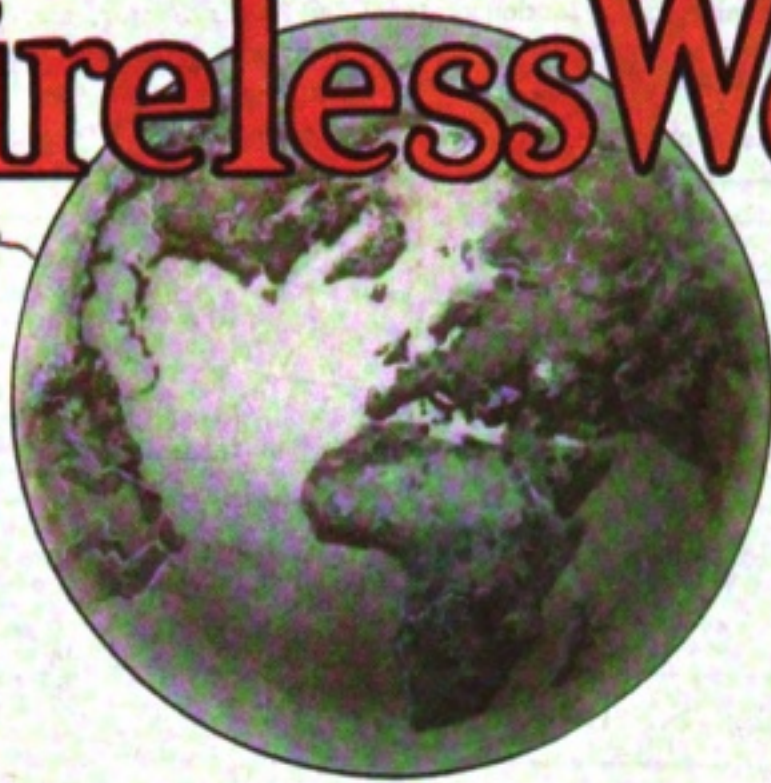

**CONTENTS**

SUBMARINES AND THEIR WIRELESS  
THE OSCILLATING VALVE  
WIRELESS FORECASTS OF SIR WILLIAM CROOKES

DIGEST OF WIRELESS LITERATURE, ETC.

Price **10<sup>D</sup>** NET

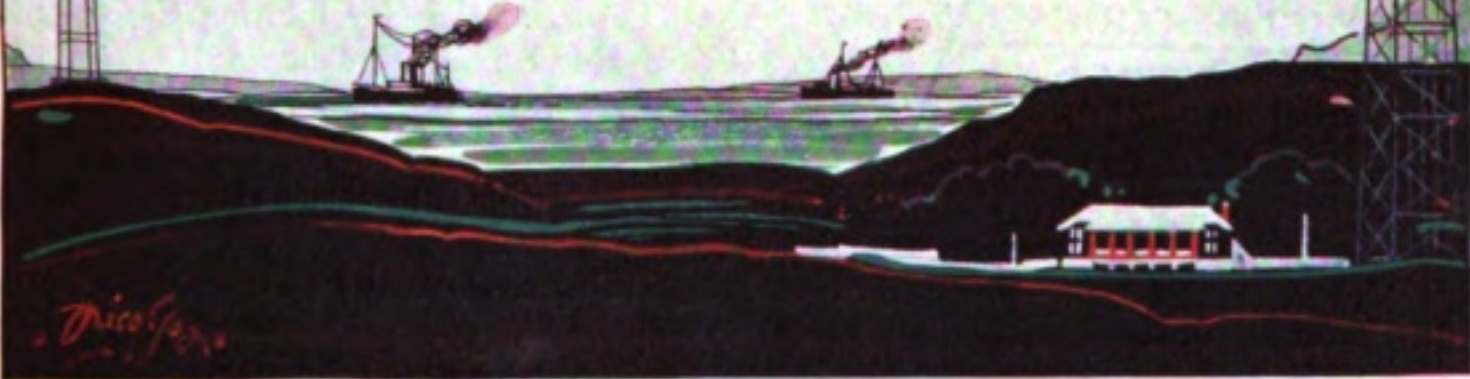
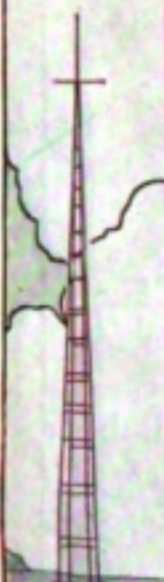

**"ANTI-SULPHURIC" ENAMEL** *RESISTS* **ACID FUMES** **ETC.** **GRIFFITHS BROS. & Co. (London), 1 MACKS RD., BERMONDSEY, S.E.**

# SULLIVAN INSTRUMENTS

Sullivan "Universal" Galvanometers and Shunts for Land and Sea Use.

SULLIVAN TELEPHONE RECEIVERS.

Fast Speed Wheatstone Automatic Transmitters and Receivers, guaranteed at 400 words per minute, and Wheatstone Apparatus generally. Precision and Standard Measuring Equipments for D.C. and A.C. (high frequency) determinations, Condensers of Low Power Factor, etc.

**H. W. SULLIVAN** WINCHESTER HOUSE, LONDON, E.C., ENGLAND.

Works: LIVERPOOL HOUSE, MIDDLESEX ST., LONDON, E.C.

Telegrams: "Deadbeat, London."

Telephone } Office: 3518 London Wall.  
Works: 4871 Avenue.

Silk and Cotton Covered H.C. Copper Wire, Resistance Wires, Fuse Wire,  
Binding Wires, Charcoal Iron Core Wire, Asbestos  
Covered Wire.

**P. ORMISTON & SONS, 79, Clerkenwell Road, London, E.C. 1.**  
(P. J. ORMISTON & P. H. ORMISTON.) "Ormiston, London." Established 1793. 13259 Central.  
Copper Strand & Flexibles of any Construction, Wire  
Ropes & Cords, down to the finest sizes, in Galvanized Steel, Phosphor Bronze, etc.

Braided

and Twisted Wires, Bare

Copper Strand & Flexibles of any Construction, Wire

Ropes & Cords, down to the finest sizes, in Galvanized Steel, Phosphor Bronze, etc.

## Manual of Wireless Telegraphy

FOR THE USE OF NAVAL ELECTRICIANS

By COMMANDER S. S. ROBISON, U.S. Navy

An Excellent Textbook for  
Marconi Students. Recom-  
mended by the leading  
teachers. Cloth 8vo. New Edit.  
241 pp. Illustrated. 8s. 6d. net  
or 8s. 11d. Post free from  
S. RENTELL & CO., Ltd.  
36 Maiden Lane, Strand,  
LONDON.

## THE BRITISH SCHOOL OF TELEGRAPHY, LTD.

179, Clapham Rd., London, S.W.

Phone: BRIXTON 215.

### EXPERT TRAINING FOR YOUNG GENTLEMEN (15-25) IN INLAND, CABLE, & WIRELESS TELEGRAPHY.

THIS old-established and up-to-date School is recognised by the War Office, Admiralty, Wireless Telegraph and Cable Companies as a training centre for Operators for their Services.

**GOOD APPOINTMENTS** are open to our students as soon as qualified, the demand for Skilled Operators in all Services being greater than the supply.

**SPECIAL COURSES** for men desirous of entering the Royal Flying Corps, Royal Engineers, Royal Naval Reserve and Royal Naval Volunteer Reserve (Telegraph Sections).

**SPEED PRACTICE** for improvers daily and three nights weekly.

**SPECIAL SHORT COURSE** suitable for men wishing to obtain Government Certificate and enter the service of the Marconi Co.

At several recent Government Exams. all candidates obtained 1st Class Government Certificate.

No Branches or Postal Tuition. Fees moderate. Write for Prospectus.

A. W. WARD (Manager).

Please mention "The Wireless World" when writing to Advertisers.

# THE WIRELESS WORLD

With which is incorporated "The Marconigraph."

A MAGAZINE DEVOTED TO WIRELESS TELEGRAPHY AND TELEPHONY

Registered at the G.P.O. for transmission by Magazine Post to Canada and Newfoundland.

**SUBSCRIPTION RATES.**—United Kingdom and British Empire (outside North America), 12s. per annum, post free; United States, Canada, and Newfoundland, \$3.00 per annum, post free; and Europe, frs. 15 per annum, post free.

Single copies, 10d. each, or post free 1s. 1d.

Articles submitted for acceptance by the Editor (which will be paid for on publication) should be addressed to Marconi House, Strand, London, W.C. No responsibility can be taken for MSS. or Photographs sent without stamps to defray cost of return postage.

Telegraphic Address: "Expense, Estrand, London." Tel. No.: City 8710 (10 lines).

---

---

## CONTENTS.

| TECHNICAL ARTICLES.   |         | PAGE |
|---|---------|------|
| The Oscillating Valve. By E. V. Appleton, M.A., B.Sc., R.E. . . . .   | .. .. . | 538  |
| Digest of Wireless Literature .. .. .                                 | .. .. . | 544  |
| Some Aspects of Radio Telephony in Japan. By Eitaro Yokoyama .. .. .  | .. .. . | 569  |
| Instructional Article .. .. .   | .. .. . | 578  |
| Questions and Answers .. .. .   | .. .. . | 589  |
| GENERAL ARTICLES.   |         |      |
| Wireless Aid in Fighting Forest Fires. By Douglas R. P. Coats .. .. . | .. .. . | 531  |
| Portrait and Biography: Sir William Crookes .. .. .                   | .. .. . | 536  |
| Operators' Notes .. .. .  | .. .. . | 547  |
| Submarines and their Wireless. By S. C. Anselmi .. .. .               | .. .. . | 549  |
| The Vision of a Scientist .. .. .                                     | .. .. . | 554  |
| Correspondence .. .. .  | .. .. . | 557  |
| Maritime Wireless Telegraphy .. .. .                                  | .. .. . | 559  |
| The Armistice .. .. .   | .. .. . | 562  |
| Notes of the Month .. .. .  | .. .. . | 566  |
| Among the Operators .. .. .   | .. .. . | 575  |
| Library Table .. .. .   | .. .. . | 585  |
| Personal Notes .. .. .  | .. .. . | 588  |
| MISCELLANEOUS ARTICLES.   |         |      |
| Welcome to the American President .. .. .                             | .. .. . | 543  |
| A New Technical Course in Wireless .. .. .                            | .. .. . | 546  |
| Long-Distance Wireless .. .. .  | .. .. . | 565  |
| The s.s. <i>George Washington</i> .. .. .                             | .. .. . | 577  |
| Share Market Report .. .. .   | .. .. . | 587  |

LICENSED BY H.M. POSTMASTER-GENERAL.

**DAY and EVENING  
CLASSES.**

**EAST LONDON WIRELESS TELEGRAPH COLLEGE**

172a & 228  
ROMFORD ROAD,  
FOREST GATE,  
LONDON, E.7

Established 1895.

Write for Prospectus.

**DAVIS & TIMMINS,**  
 LIMITED,  
**KING'S CROSS,  
 LONDON, N.**



TRADE MARK.

Established 1878.

**METAL THREAD SCREWS**  
**Nuts, Bolts, Terminals &c.**

Telephone: North 580 (2 lines).  
 Telegrams: "Conductivity, London."



**COMPAGNIE  
 FRANCAISE  
 MARITIME ET  
 COLONIALE de  
 TÉLÉGRAPHIE  
 : SANS FIL :**

**Siège Social : 35, Boulevard des Capucines  
 PARIS**

**Ateliers : 32, Rue de la Briche, St. Denis  
 (Seine)**

**Construction, installation  
 et exploitation de stations  
 de télégraphie sans fil.  
 Au premier Novembre, 1913. 80  
 stations de bord en exploitation.**

Transmission et réception des radiotélégrammes à bord  
 des paquebots — S'adresser au télégraphiste du bord.  
 S'adresser au Siège de la Compagnie, 35 Boulevard  
 des Capucines, à Paris.

1°—Pour la transmission des  
 radiotélégrammes à destina-  
 tion des paquebots en mer.

2°—Pour la transmission par  
 télégraphie sans fil (voie  
 Marconi) des télégrammes à  
 destination des Etats-Unis et  
 du Canada.

3°—Et pour tous renseigne-  
 ments.



**INTELLECTUAL  
 EFFICIENCY**



**LET HIM GIVE YOU A  
 REAL COMMAND  
 OF ENGLISH**

It will take only a few of your spare  
 minutes at home; no repellent grammar  
 study; each lesson as clear as daylight,  
 and inspiring to the highest degree. Com-  
 mence now—let Mr. GRENVILLE KLEISER  
 teach you through his Postal Course in  
 Practical English, how to

**Enlarge your Stock of Words—  
 Use the Right Word in the Right  
 Place—  
 Write Tactical, Forceful Letters,  
 Stories, Sermons, Advertisements,  
 etc.  
 Become an Engaging Conversation-  
 alist—  
 Enter the Best Society—  
 Be a Man of Culture, Power, and  
 Influence in your Community.**

Good English is absolutely necessary to  
 the highest success in life. What material  
 benefit is it to have good ideas if you cannot  
 express them adequately—if you cannot  
 make others see them as you do?

We will send you by post full particulars  
 of this famous Course. No cost, no obliga-  
 tion to you. Just send a post card to-day,  
 giving your name and address, to:—

**Messrs. FUNK & WAGNALLS CO.,  
 W Dept.,  
 Salisbury Square,  
 LONDON, E.C.4.**

# The WIRELESS • WORLD •

Volume VI.

No. 70.

JANUARY, 1919.



## Wireless Aid in Fighting Forest Fires

*Special Coach Tours in New Brunswick*

By DOUGLAS R. P. COATS

AMONGST the lessons which we have recently learned in abundance, a prominent place must be given to a realisation of the value of wood. Until our struggle against the Germans brought about a shortage of this important article in our little islands, we did not grasp the extent to which wood in peace-time entered into our everyday requirements. In pre-war days this natural product poured into England from all over the world. Many countries contributed their quota, the vast bulk of what we used was brought to us from overseas, and a very small percentage indeed was drawn from our own countryside. We have lived to see Portuguese foresters at work in English woods endeavouring to meet the needs of the critical period of the war from our own resources.

The forest products of Canada have, ever since the country began to be exploited, constituted one of the Dominion's most important sources of wealth. According to the most recent available statistics, the total area of land within her confines

covered by timber, is estimated at between five and six hundred million acres. Of these vast woods about half rank as commercially valuable. Canadian timber finds its way to all parts of the world—to the United States, to Great Britain and to the Australian Colonies. The Dominion saw-mills are both extensive and well appointed, giving employment to large numbers of men, besides furnishing freight for railways and shipping, so that altogether it will be seen that the prosperity of forest industry looms large in the world of Canadian economics. It is estimated that the total values of the forest products for 1916 amounted to one hundred and ninety million dollars.

We are all of us familiar with the ordinary purpose for which wood is employed, and the tribulations through which we have recently passed in the lack of paper have demonstrated the significance of the gigantic figures attained by the importation of wood pulp. But there are a variety of specialised uses to which particular kinds of wood are put, which do not come within the ken of a large number of us. It is



not, for instance, a matter of universal knowledge that, in certain essential parts of aeroplane construction, spruce has been found immensely more efficient than any metal. Now, the particular species of fir which supplies this wood grows in marketable quantities in but two places in the world—the North Pacific forests and the German Provinces along the Baltic Sea (including a portion of the Russian territory which the Hun recently overran).

The Canadian people have long since realised the high value of their forest lands, and have taken active steps to combat the destructive forest fires which have been responsible, in the past, for wholesale destruction of life and riches. Amongst other agencies for arousing Canadian public interest in the conservation of this source of their national wealth, an important place is taken by the Canadian Forestry Association, an independent body whose membership amounts to about 7,000, all keenly alive to the perils threatening the forests of the Dominion, and determined to overcome the ravages of spruce-bugs, blight, and fire, with the assistance of the most modern methods and appliances. It is true that the Governments of the lumbering provinces maintain small armies of rangers and fire-wardens, engaged in the duty of patrolling the forests and enforcing protective laws. But unless such

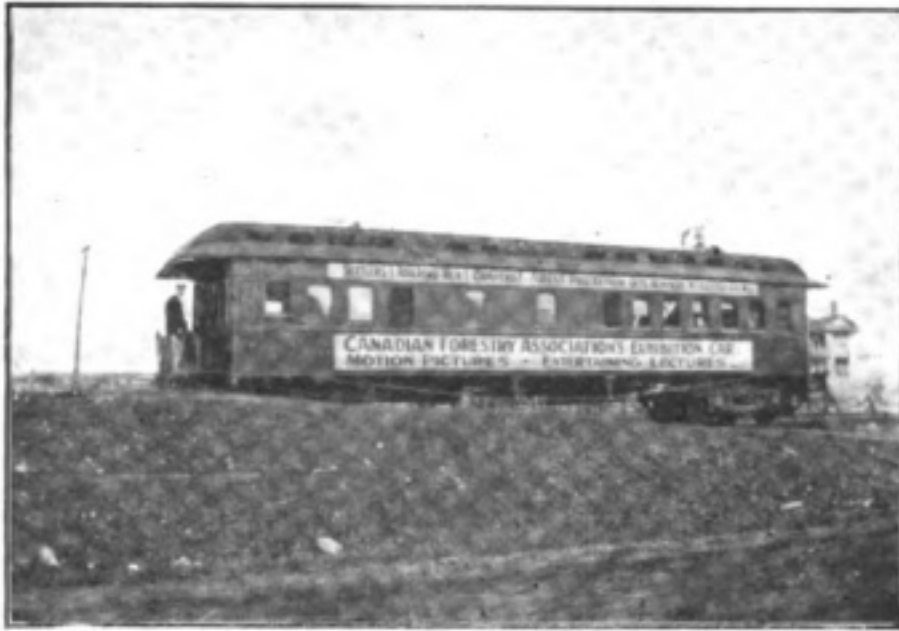

THE EXHIBITION COACH WHICH TOURED THROUGH FOUR PROVINCES.

forest products, including special exhibits calculated to arouse their interest in the various devices used for combating forest fires. Wireless is destined to play an important part in this warfare against fire, solving as it does the problem of instantaneous communication in these vast lumber districts. Look-out posts have been established in considerable numbers to keep watch from the best points of vantage over the lumber lands, so that as soon as an outbreak occurs information may be immediately transmitted to the proper authorities, who are thus enabled to take such steps as are possible to rush assistance to the spot, to localise the conflagration and extinguish the blaze with the least possible delay. Prompt action is the vital point in such a matter as this. Measures, to be effective, must be taken before the areas affected have become unmanageable, and the only agent which can execute this task satisfactorily is wireless. Wired telegraphy, or telephonic communication, is liable, at any moment, to be rendered useless by the very agency it was intended to combat. Aeroplanes may prove of valuable service in this connection, but here again, for means of communication, reliance must be placed upon the ether waves. The possibilities of an aeroplane forest patrol service were discussed at length in a recent conference of the Forestry Protective Association in Montreal, and experiments are being carried out in British Columbia which may result in the general adoption of the "plane," and the abandonment of the old-fashioned methods of forest protection, through the means, above alluded to, of a system of look-out towers with men maintaining a continual watch over the trees, and linked with head-

governmental action be backed, by public opinion, the work of these officials would be sorely hampered; indeed, even as matters stand, the carelessness of ignorant picnickers in failing to damp down their fires, ere they leave their camping places, is responsible for originating large numbers of serious outbreaks.

One of the methods employed by the Canadian Forestry Association to arouse public interest in this connection has been that of collecting material for a general exhibition of

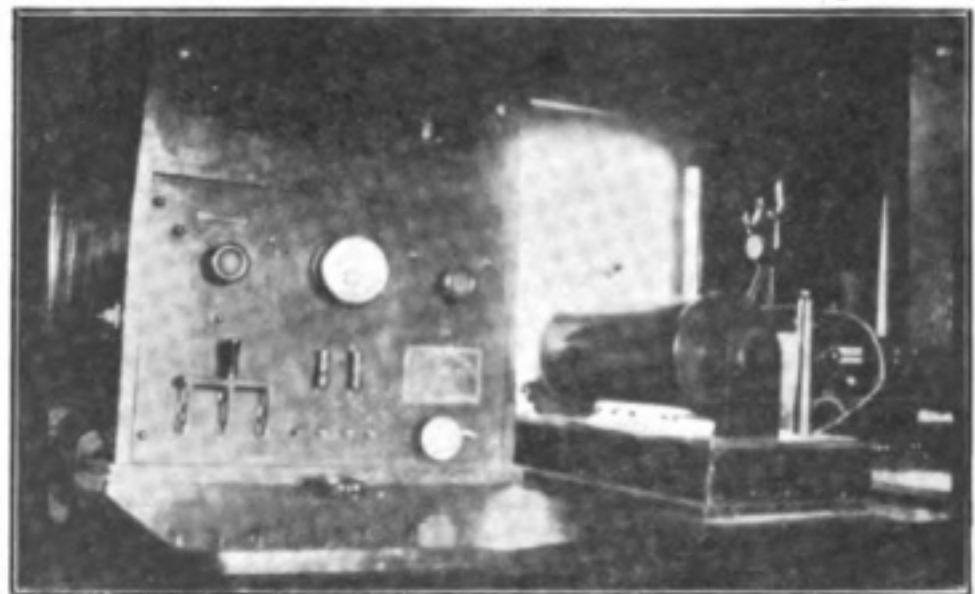

THE TRANSMITTING GEAR OF THE WIRELESS INSTALLATION ON THE EXHIBITION TRAIN.

quarters by telephone. A number of difficulties have yet to be overcome, however, before the aeroplane can be used with success for this purpose, the main stumbling block at present being connected with the problem of landing. Whatever may be the outcome of these experiments, there can be no question that the day is at hand when wired telephones, as a means of communication between the observation posts, will be replaced by the more practical and reliable methods of wireless.

The vast character of the evil with which man is faced by fires in these regions may be judged from the figures attendant upon a recent destructive conflagration in Minnesota, when a forest fire got out of hand and swept in destruction across a whole countryside, causing a loss of over a thousand valuable lives, and completely destroying no fewer than twenty-one townships.

Amongst the various schemes originated by the Forestry Association for giving the public that "dig in the ribs" which it frequently so badly needs, was an exhibition arranged in one of the Canadian Pacific Railway Company's coaches, recently sent on a tour through the provinces of Ontario, Quebec, New Brunswick and Nova Scotia. Stops were made at selected centres *en route*, and lectures were

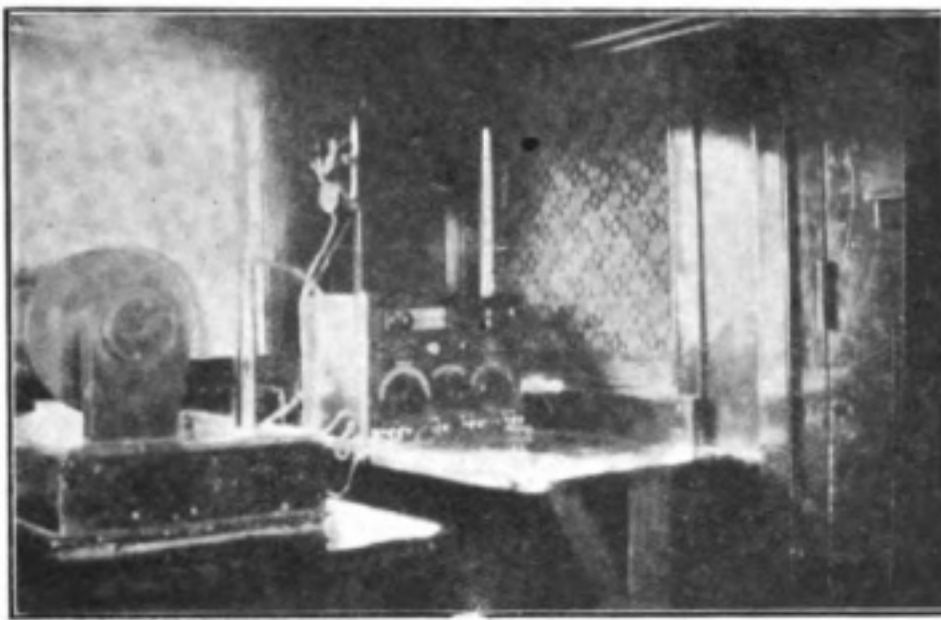

THE RECEIVING GEAR OF THE WIRELESS INSTALLATION ON THE EXHIBITION TRAIN.

delivered to visitors, either in the car itself or in local halls hired for the purpose. Antiquated and modern methods of fighting forest fires were contrasted by moving pictures, whilst the same agency illustrated the complete process of production of a magazine, from the cutting of logs in the primeval forests to the conversion of the "raw material" into pulp and its manufacture into paper, closing finally with the printing stage. One of the exhibits which attracted special attention was a splendidly

finished model aeroplane, built to scale in Sitka spruce, the wood so much in recent demand for fighting machines, a species of timber so difficult to obtain in the higher grades required that the preservation from fire of the forests where it grows has become a matter of international importance.

On this exhibition train the Marconi Wireless Telegraph Company of Canada installed one of their  $\frac{1}{4}$  kw. outfits, assigning to the present writer the novel work of operating the set, and delivering "talks" on wireless to the audiences who flocked to see our travelling exhibit in the towns visited throughout New Brunswick. Everywhere in this beautiful province the keenest interest was displayed in wireless telegraphy by the local inhabitants, many of whom knew by bitter experience the terrors of a forest fire. The provincial government officials at Fredericton, the capital of New Brunswick, are devoting considerable study to this vital question of forest protection. Colonel Loggie, the Deputy Minister of Lands and Mines, who visited the exhibition in company with the Minister of Agriculture, appeared particularly interested in wireless, and it would not be a matter of surprise for us to find New Brunswick amongst the first Canadian provinces to apply to the safeguard of their woods and forests dwellers the invention which has achieved such astounding results in saving life and property at sea.



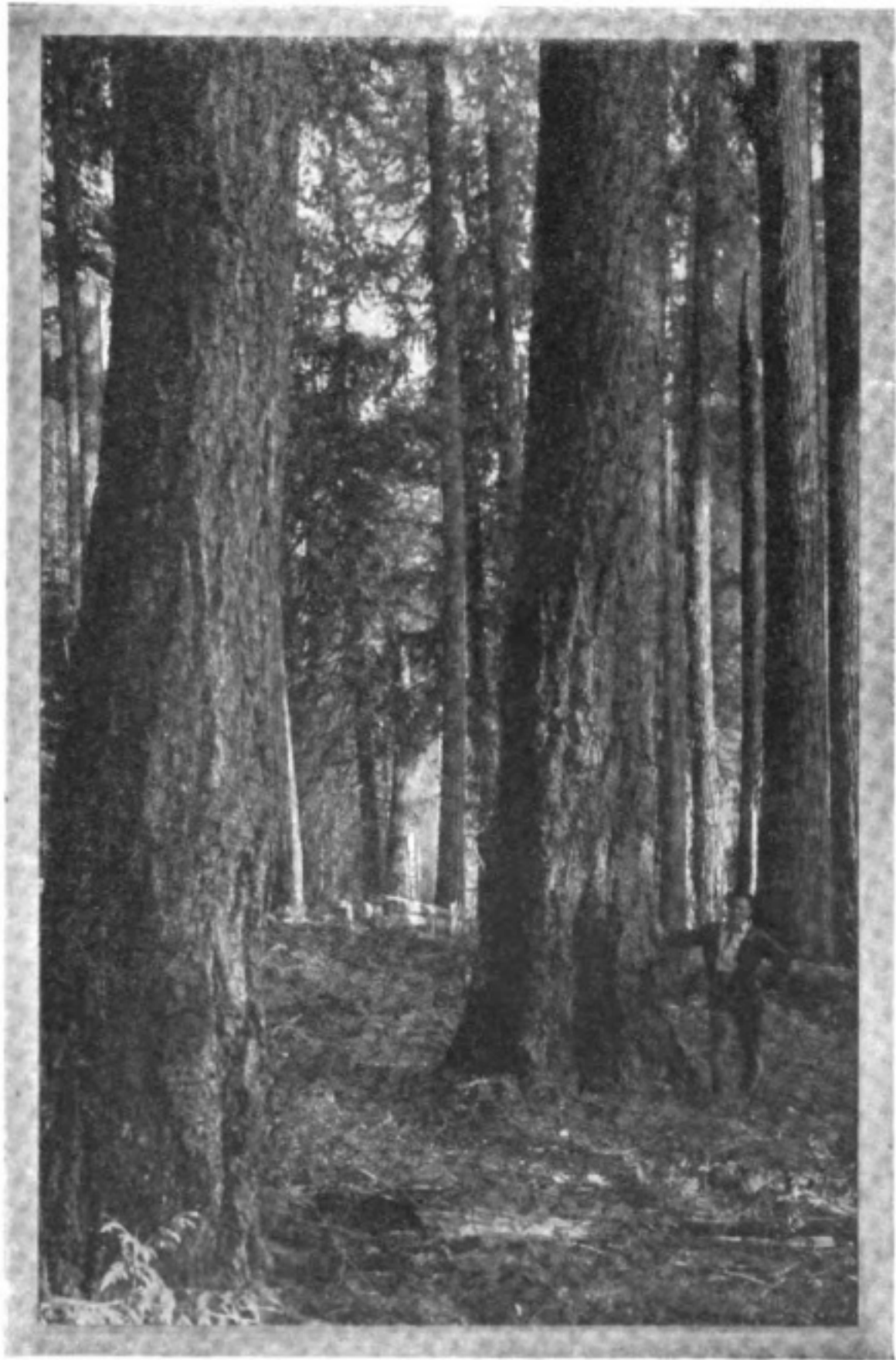

A GROVE OF CANADA'S GIGANTIC TREES.

PERSONALITIES IN THE  
WIRELESS WORLD

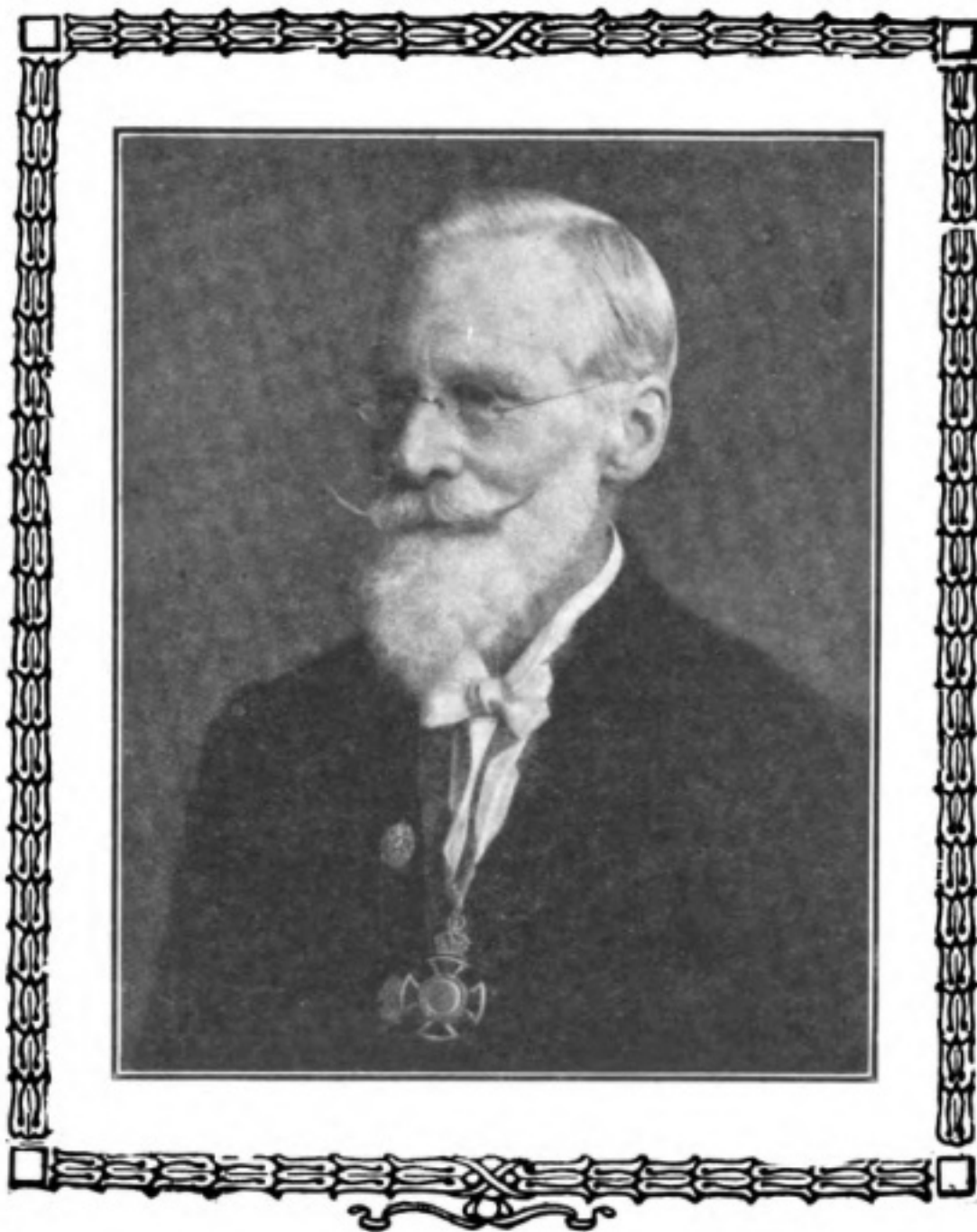

SIR WILLIAM CROOKES



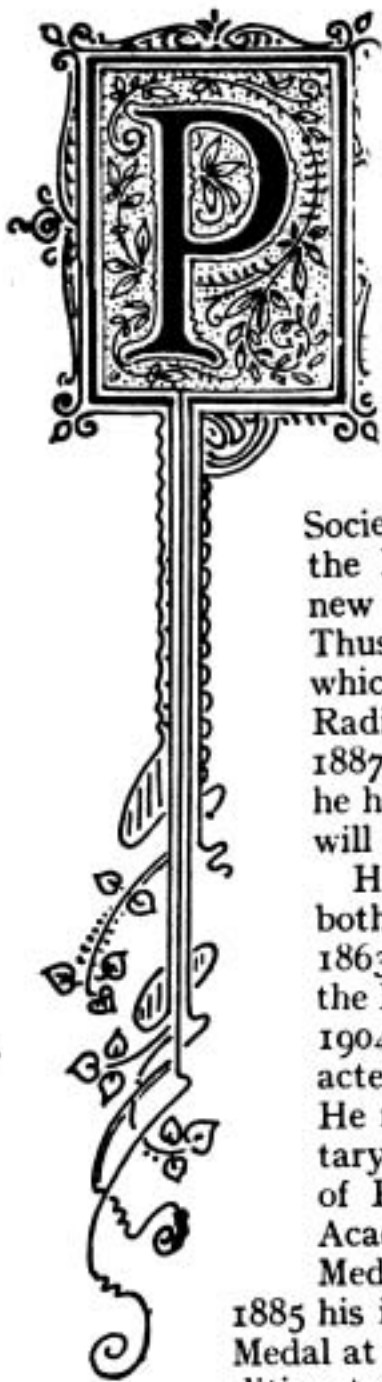

PROPHECY has perhaps seldom been more strikingly fulfilled than in the case of the prognostications of Sir William Crookes with regard to wireless telegraphy, a brief record of which will be found on pages 554-557 of this issue.

Sir William Crookes was born five years before Queen Victoria ascended the throne, and in 1848 entered upon his scientific training at the College of Chemistry under Dr. Hofmann. In 1857 he became a Fellow of the Chemical Society, and five years later was awarded a medal at the International Exhibition for the discovery of a new element, which received the name of thallium. Thus was initiated a long series of discoveries, amongst which may be cited those of the Radiometer in 1875, Radiant Matter in 1879, the Genesis of Elements in 1887, and the Sphintharoscope in 1903. Since 1859 he has been Editor of the *Chemical News*, so that 1919 will mark his sixtieth anniversary in this connection.

His connection with the Royal Society has been both long and distinguished; he became a Fellow in 1863 and won the Royal Medal of the Society in 1875, the Davy Medal in 1888, besides the Copley Medal in 1904. He was enrolled a Member of its Council in 1877, acted as Vice-President in 1885-6 and again in 1907-8. He received the appointment of their Foreign Secretary in 1908-12, and finally filled the supreme office of President between 1913 and 1915. The French Academie des Sciences bestowed upon him their Gold Medal and a prize of 3,000 francs in 1880; whilst in 1885 his invention of the radiometer secured him a Gold Medal at the International Inventions Exhibition. In addition to having filled the Presidential Chair of the Royal Society, he is a Past-President of the British Association of the Society of Chemical Research, and of the Society for Physical Research.

Foreign lands have vied with his Mother Country and her Colonies in doing him honour. His valuable contributions to the advancement of science have been specifically acknowledged in various ways by Argentina, France, Holland, Italy, Mexico, Roumania, and Sweden. He was created a Knight Bachelor in 1897 and has been invested by many eminent foreign and colonial institutions with a number of distinctions and honorary degrees, which include the Elliott-Cresson Medal awarded to him by the Franklin Institute (Philadelphia) in 1912.

# The Oscillating Valve

By E. V. APPLETON, M.A., B.Sc., R.E.

THE necessary conditions for the performance of any of the functions of a double-anode valve may be derived from the experimentally determined relations between the following quantities: Plate voltage, plate current, grid voltage, grid current, and filament temperature. Let the values of these quantities be denoted by  $V$ ,  $I$ ,  $v$ ,  $i$ , and  $\theta$  respectively. Simple experiments yield the relations which obtain between them.

The most important relation is that between  $V$ ,  $I$ , and  $v$  when the filament temperature is kept constant. This relation is represented graphically for a typical hard valve by the curves of Fig. 1, which are termed the static characteristics of the valve in question. It is the aim of this article to show how the conditions required for the production of continuous electrical oscillations by any three-

electrode valve can be foretold from its static characteristics.

From Fig. 1 it is clear that  $I = f(V, v)$ .

Langmuir,\* assuming that the space charge effect is the main factor tending to discourage the flow of electrons from filament to plate, has shown that for the middle parts of the curves we may write this more definitely as  $I = A(V + Bv)^2$  where  $A$  and  $B$  are constants. This expression is rather unwieldy for mathe-

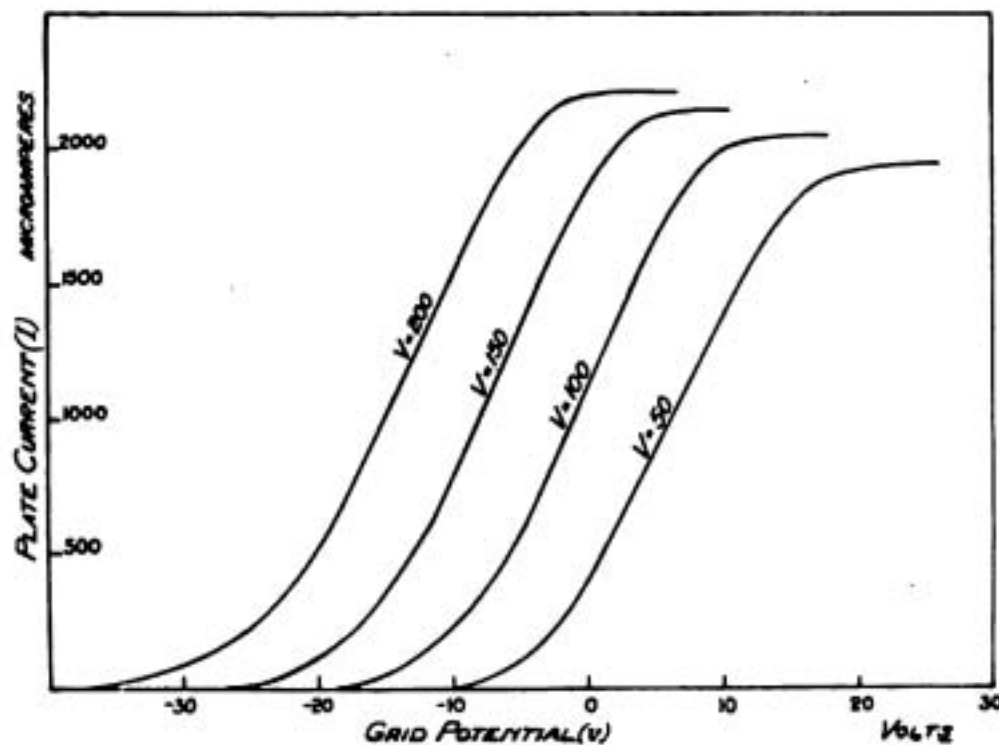

FIG. 1.

mathematical work, and a simpler one has been suggested by Vallauri,† who proposes to consider the straighter parts of the characteristics as approximately parallel straight lines. This means that the characteristic surface may be regarded as approximately plane, and may be expressed by the relation  $I = av + bV + c$ , where  $a$ ,  $b$ , and  $c$  are constants. This expression will be used in all the subsequent mathematical work in this article.

In most oscillating valve circuits some external coupling is necessary between the grid or control circuit and the anode or plate circuit. Either electromagnetic or electrostatic coupling may be employed, the former, however, being more commonly used. Fig. 2 represents two typical circuits with electromagnetic linkage.

In circuit ( $\alpha$ ) the oscillating circuit is in the plate circuit while the reaction coil ( $l$ ) is connected to the grid. In circuit ( $\beta$ ) these positions are reversed. The

\* Langmuir, *Proc. Rad. Eng.*, Sept. 1915.

† Vallauri, *L'Electrotecnica*, Nos. 3 and 4, 1917.

frequency of the oscillations generated is determined largely by the inductance and capacity values of the oscillatory circuit.

Circuit ( $\alpha$ ) has been dealt with experimentally and mathematically by Vallauri, who has shown that the conditions under which the largest oscillations are produced coincide with the conditions of greatest amplifying power. This fact is illustrated by Fig. 3, which shows the values of oscillatory current obtained in an oscillating circuit when the grid of the valve is maintained at various voltages. The static characteristic for the particular value of plate voltage is also shown. It is clear that the highest values of oscillatory current are obtained when the valve is maintained at conditions represented by the steep parts of the characteristic. The curve also shows that the oscillations begin abruptly and end abruptly at particular values of grid voltage.

The value of mutual inductance required for the production of infinitesimal

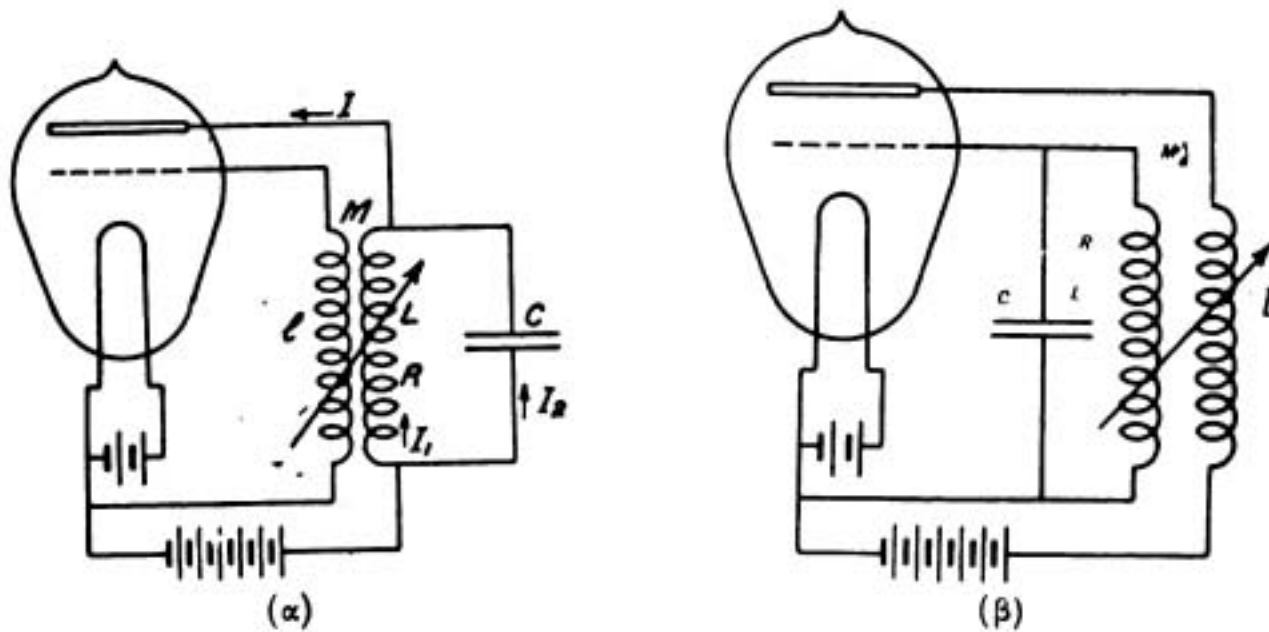

FIG. 2.  $R^1$  IS BATTERY RESISTANCE.

oscillations can be deduced using the equation  $I = av + bV + c$ . Embodying this, Kirchhoff's equations for circuit ( $\alpha$ ) become :

$$I = a \left( v - M \frac{dI_1}{dt} \right) + b \left( V - IR^1 - L \frac{dI_1}{dt} - RI_1 \right) + c \quad (1)$$

$$L \frac{d^2 I_1}{dt^2} + R \frac{dI_1}{dt} = \frac{I_2}{C} \quad (2)$$

$$I = I_1 + I_2 \quad (3)$$

These equations yield an oscillatory solution with zero damping when :

$$M = - \frac{bL + (1 + bR^1) RC}{a} \quad (4)$$

producing oscillations in such a case of frequency  $n$  where :

$$\frac{1}{n} = 2\pi \sqrt{CL} \times \frac{1 + bR^1}{1 + bR^1 + bR} \quad (5)$$

which reduces to  $\frac{1}{n} = 2\pi \sqrt{CL}$ , when  $R$  is small.

(For the significance of  $R$ ,  $C$ , and  $R^1$  see ( $\alpha$ ), Fig. 2.)

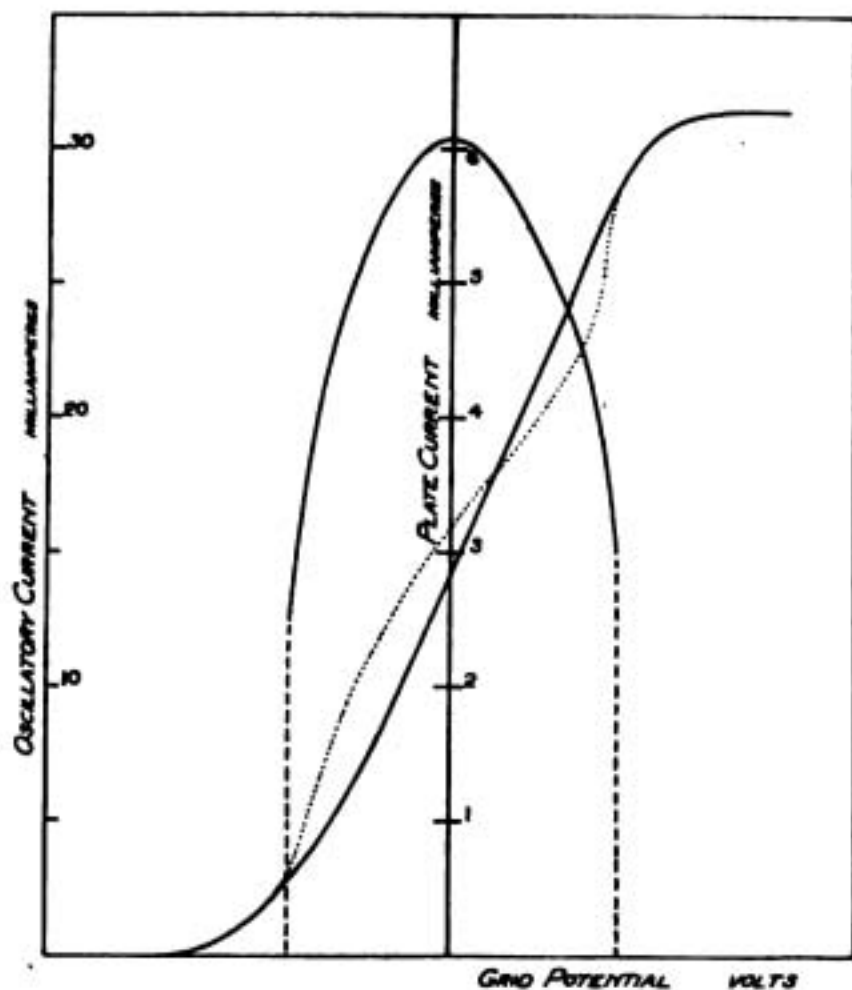

FIG. 3.

tions tend to increase indefinitely. However, when the grid voltage changes are large enough to cause the plate current to reach saturation and zero values no further increase of oscillatory current can be produced by increasing  $M$ . This is illustrated by Fig. 4, which shows the relation between oscillatory current and mutual inductance for a circuit similar to ( $\alpha'$ ), Fig. 2. This curve also shows that if the coupling is increased over a certain amount the oscillatory current decreases slightly.

The present writer has shown\* that the essential mathematical result of Vallauri can be obtained in a manner which is less mathematical and which makes clearer the physical processes involved.

Consider an oscillation started in the  $LC$  circuit of Fig. 5. Every time the point  $A$  is positive with respect to  $B$  the plate current is increased and a number of electrons flows into the upper plate of the condenser. These electrons tend to neutralise the positive charge which at that instant is residing there: thus the natural damping of the oscillatory circuit (due to

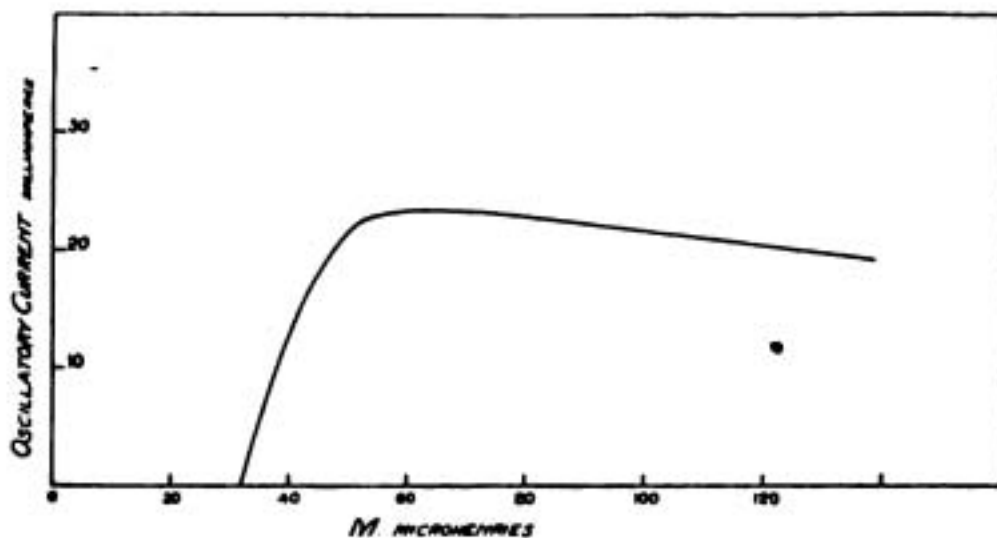

FIG. 4.

\* *Electrician*, December, 1918.

resistance, etc.) is increased. If, however, a tube could be arranged which produces the opposite effect—that is, the plate current is decreased when the oscillation makes  $A$  positive with respect to  $B$ —the result would be to tend to neutralise the natural damping of the oscillatory circuit, bringing about the possibility of producing persistent oscillations.

It is clear that stating this condition is tantamount to saying that the tube must possess a negative resistance. A. W. Hull has produced such a tube, which is known as the Dynatron (see *THE WIRELESS WORLD*, June, 1918), and has shown that the value of the resistance required for persistent oscillations

is  $-\frac{L}{CR}$ . With such a tube, of course, no

reaction coil is necessary. With an ordinary three-electrode valve the reaction coil brings about the same result.

Let us assume that a feeble oscillation exists in the  $LC$  circuit and that the voltage produced by it between  $A$  and  $B$  is  $V \sin \frac{t}{\sqrt{LC}}$ . The alteration in plate current produced by this will be  $bV \sin \frac{t}{\sqrt{LC}}$ . Now, for such a voltage the oscillatory current is at any instant  $\sqrt{\frac{C}{L}} V \cos \frac{t}{\sqrt{LC}}$ .

If we now assume the grid circuit to be activated by electromagnetic induction in the ordinary way\* the value of the E.M.F. induced in it will be

$$-M \frac{d}{dt} \left( \sqrt{\frac{C}{L}} V \cos \frac{t}{\sqrt{LC}} \right).$$

This E.M.F. will bring about an alteration in plate current of value

$$\frac{aM}{L} V \sin \frac{t}{\sqrt{LC}}.$$

Thus for a voltage change of  $V \sin \frac{t}{\sqrt{LC}}$  the resultant current change will be

$$\left( \frac{aM}{L} + b \right) V \sin \frac{t}{\sqrt{LC}}.$$

This means that the effective resistance of the tube when the grid is activated is

$$\frac{1}{\left( \frac{aM}{L} + b \right)}.$$

Thus, for persistent oscillations we must have :

$$\frac{aM}{L} + b = -\frac{CR}{L}$$

—i.e.,

$$M = -\left( \frac{bL + CR}{a} \right),$$

which is the same result as Vallauri's for practical cases where  $bR^1$  (see Fig. 2,  $\alpha$ ) is small compared with unity.

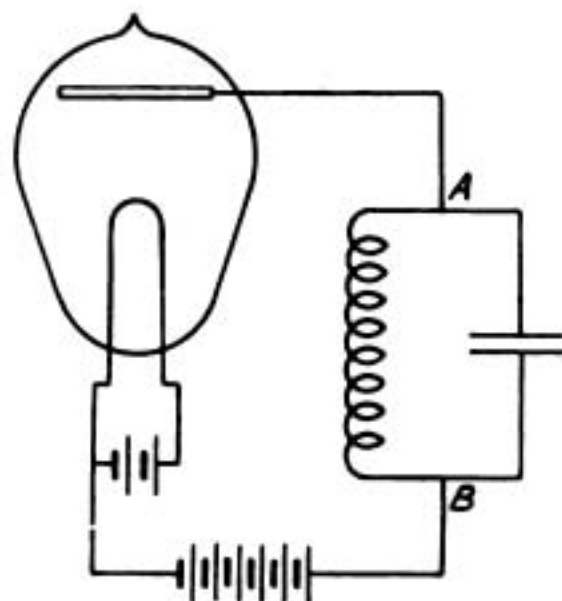

FIG. 5.

\* E.g., see Fig. 2, ( $\alpha$ ).

Fig. 6 shows the phase relations between the various quantities involved.

The above investigations have been made on the assumption that the grid currents involved are negligible. In practical work the high plate voltages used make them practically so. Bethenod \* has worked out fully the conditions for infinitesimal oscillations allowing for appreciable grid currents and finds that  $M$  must conform with the equation :

$$\frac{M^2 n}{L} + (a + m) M + RC + bL = 0 \quad (6)$$

Here the letters have the same significance as before and  $m$  and  $n$  are the slopes of the plate voltage-grid current and grid voltage-grid current characteristics respectively.

It is obvious from the nature of the valve characteristic that if the induced voltage in the grid circuit is sufficient to bring the plate current to saturation

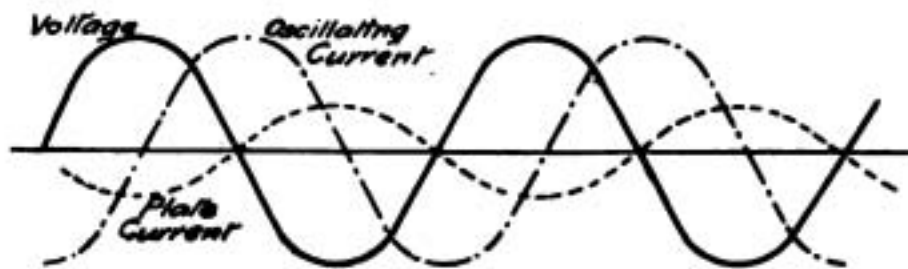

FIG. 6.

and zero values a sinusoidal grid voltage change will result in flat-topped plate current variations. Now a flat-topped wave when analysed in a Fourier series is found to contain harmonics, particularly odd ones, and if such an oscillation circuit is

used for transmission these harmonics will be radiated.

It is evident that the existence of these means a loss of efficiency, since only one of the wave-lengths radiated can be used at one time by a receiving station.

If the changes of plate current take place about an operating point which is not half-way up the characteristic the mean value of the plate current (when the valve is oscillating and the saturation and zero values of the plate current are almost being reached) will depart from the normal value. If the operating point is below the centre of the characteristic the mean plate current will increase when oscillations commence, but if it is above the centre the mean plate current as read by an ordinary D.C. galvanometer is reduced.

The actual values of mean plate current for a circuit such as that depicted in Fig. 2 ( $\alpha$ ) are shown by the dotted line graph of Fig. 3.

The circuit shown in Fig. 2 ( $\beta$ ) has not been dealt with by Vallauri, although it is a well-known oscillatory receiving circuit. If the coupling between the plate and grid circuits is over a certain amount the plate current variations induce E.M.F. variations in the oscillatory circuit and the resistance losses are neutralised.

An approximate value of the mutual inductance required can be obtained as follows :

Let  $Q$  be the charge of the condenser at any instant.

Then we have by Kirchoff's equation :

$$L \frac{d^2 Q}{dt^2} + R \frac{dQ}{dt} + M \frac{dI}{dt} + \frac{Q}{C} = 0 \quad (7)$$

Now at this instant the plate current,  $I$ , will have a value given by

$$I (1 + bR^2) = a \frac{Q}{C} + bV + C.$$

$$\therefore (1 + bR^2) \frac{dI}{dt} = \frac{a}{C} \frac{dQ}{dt} \quad (8)$$

\* Bethenod, *La Lumière Electrique*, October 14th, 1916.



Substituting now in (7) we have :

$$L \frac{d^2Q}{dt^2} + \left( R + \frac{aM}{C(1+bR^2)} \right) \frac{dQ}{dt} + \frac{Q}{C} = 0 \quad \dots \quad (9)$$

Thus, an undamped oscillation is obtained in the L.C. circuit when the coefficient of  $\frac{dQ}{dt}$  is zero—i.e.,

when 
$$M = -\frac{CR(1+bR^2)}{a} \quad \dots \quad (10)$$

In all the above work a consistent set of units—e.g., volt, ampère, ohm, coulomb, henry, and farad—is assumed.

## Welcome to the American President

ON December 4th last President Wilson left New York, *en route* to Europe, to take part in the Peace Conference, perhaps the most important which the world has ever seen. The late titanic struggle and its aftermath have presented a long series of novel precedents, not the least amongst them being an official visit paid to Europe by the President of the United States during his term of office.

One curious feature in connection with his voyage is that it should have been made on a vessel constructed by the North German Lloyd in pre-war days, and named after the famous American patriot, with the view of propitiating Cousin Jonathan and inducing his citizens to travel on board her. In this particular object, at all events, the German shipping magnates have succeeded beyond their wildest dreams. President Wilson had a grand send-off. He started in glorious weather, and the spectacle of the great liner, flying the Presidential flag, as it steamed down the bay and joined the waiting escort of American warships constituted a brilliant spectacle worthy of the occasion.

We have seen a statement made in the general Press that the steamer is fitted with an especially powerful wireless installation ; but we have, up to the present, not succeeded in finding any satisfactory grounds for the allegation. Her original German wireless set was the ordinary TK 1 kw. with an estimated normal range of 250 miles. It is, however, quite likely that since the Americans took her over they have installed fresh apparatus, of—it may be—greater power.

In any case, we notice that the President kept in continual touch with official business by means of radiotelegraphy all through his voyage, and even utilised the aerials of the *George Washington* to nominate a new Secretary of the Treasury in place of Mr. McAdbo. A number of messages to other nations were radiated in the same way, and the Paris Press gave publicity to a wireless message emphasising the long years of penitence that will be necessary for Germany before any true American could think of holding out the hand of friendship, or of paying her a visit.

Arrangements have been made in Mr. Wilson's temporary home in Paris whereby, through the famous Eiffel Tower station, he will be kept in direct communication with Washington. War-time brought wireless into the forefront of national intercommunication, and there are plain indications that peace-time will confirm and strengthen this position.

# Digest of Wireless Literature

## "THE THEORY OF THERMIONIC AMPLIFIERS."\*

IN the introductory part of the article the author discusses the case of a valve with two electrodes. It is pointed out that Richardson's equation is derived under the assumption of both cathode and anode being equipotential surfaces. The practical case of a filamentary cathode is met by W. Wilson's equation, which is stated. All theoretical equations, however, presuppose a pure electronic discharge. In practice one has to take into account the inevitable presence of residual gas, which leads to larger values of current than those obtained from the equations.

Next the case of an amplifying valve is taken up.

Denoting the potential applied to the plate by  $E_b$ , the stray field between grid and filament can be expressed by

$$E_s = \frac{1}{\mu_0} E_b + \epsilon \quad \dots \dots \dots (1)$$

where  $\mu_0$  is a constant always greater than unity. Its value will depend on the construction of the valve. In general  $\mu_0$  is the larger, the finer the mesh is made.  $\epsilon$  is also a constant, the numerical value of which is usually comparatively very small.

The physical meaning of  $E_s$  is clear: it is the force which drags a certain portion of the electrons emitted from the filament *through* the grid.

Let us now apply to the grid a potential  $E_c$ . If this potential is positive a certain number of electrons will be absorbed into the grid. If  $E_c$  is made negative and its absolute value larger than or equal to  $E_s$  (which is always positive, since  $E_b$  is assumed positive), all electrons will be repelled from the grid, and none of them will reach the plate. In order that electrons should reach the plate we must then have  $E_s + E_c > 0$ —that is to say, if  $E_c$  is negative, its absolute value must be smaller than that of  $E_s$ . In the last case no electrons get into the grid, although a certain number of them pass through it. The impedance of the grid circuit can therefore be considered as infinite.

We have seen that the number of electrons reaching the plate, or, in other words, the value of the plate current, will depend on the value of  $E_s + E_c$ . From experimental results, the author expresses this functional relation by means of the equation:

$$I = \alpha (E_s + E_c)^2$$

where  $I$  is the plate current and  $\alpha$  is a constant for a given valve.

With the aid of (1) we can write the last equation in the form:

$$I = \alpha \left( \frac{1}{\mu_0} E_b + E_c + \epsilon \right)^2 \quad \dots \dots \dots (2)$$

which can be presented graphically either by an  $I, E_b$  curve (if  $E_c$  is kept constant) or by an  $I, E_c$  curve (if  $E_b$  is kept constant).

\* "The Theory of Thermionic Amplifiers," by H. I. Van Der Bijl, *The Physical Review*, 2nd Series, vol. xii., No. 3, September, 1918.



in the usual way by finding  $\frac{\delta I}{\delta E_b}$ , therefore the average value of  $\frac{I}{R_0}$  during a cyclical variation is given by

$$\frac{I}{R_0} = \frac{I}{2\pi} \int_0^{2\pi} \frac{\delta I}{\delta E_b} dt = \frac{2\alpha}{\mu_0} \left( \frac{I}{\mu_0} E_b + E_c + \epsilon \right),$$

whence

$$R_0 = \frac{\mu_0}{2\alpha \left( \frac{I}{\mu_0} E_b + E_c + \epsilon \right)} \quad \dots \quad (4)$$

Should, however, the external circuit contain a resistance,  $R$ , we can easily transform our equation (2) to include that case also by substituting  $E_b = E - RI$ , where  $E$  is the constant voltage of the source in the external circuit. We then obtain

$$I = \alpha \left[ \frac{I}{\mu_0} (E - RI) + E_c + \epsilon \right]^2 \quad \dots \quad (2^1)$$

From the last equation we obtain

$$\frac{dI}{dE_c} = \frac{\delta I}{\delta E_b} \cdot \frac{dE_b}{dE_c} + \frac{\delta I}{\delta E_c} = 2\alpha \left( \frac{I}{\mu_0} E_b + E_c + \epsilon \right) \left( 1 - \frac{R}{\mu_0} \frac{dI}{dE_c} \right)$$

whence

$$\frac{dI}{dE_c} = \frac{2\alpha \left( \frac{I}{\mu_0} E_b + E_c + \epsilon \right)}{1 + \frac{2R\alpha}{\mu_0} \left( \frac{I}{\mu_0} E_b + E_c + \epsilon \right)}$$

which can be written with the aid of (4) in the form :

$$\frac{dI}{dE_c} = \frac{\mu_0/R_0}{1 + R/R_0} = \mu_0 \frac{I}{R + R_0}$$

Multiplying both sides of last equation by  $R$ , we obtain

$$\frac{RdI}{dE_c} = \mu_0 \frac{R}{R + R_0} \quad \dots \quad (5)$$

Now  $RdI$  is the change of voltage across the resistance  $R$ , inserted in the plate circuit, caused by a change  $dE_c$  in the voltage applied to the grid. Therefore the ratio  $\frac{RdI}{dE_c}$  expresses the *voltage amplification*. We see, then, that this amplification is always smaller than  $\mu_0$  and approximates that value when the external resistance is very large in comparison with the internal resistance of the valve.

The author discusses further the question of current and power amplification. Since the current in the grid circuit is either zero or negligibly small, these amplification ratios become indeterminate. An artificial method had, therefore, to be employed.

In conclusion an experimental verification of the various results, obtained theoretically, is given.

A NEW TECHNICAL COURSE in Wireless has been established by the Portsmouth Education Committee at the Municipal College. The training of wireless operators will be undertaken as a part of the regular work of the College, and the course will extend generally over two years, the first being devoted to general electrical engineering, the second to wireless telegraphy, etc. All boys joining under 16 years of age must attend the full two-years course unless already qualified in the first-year subjects. The fee will be £5 5s. per annum.

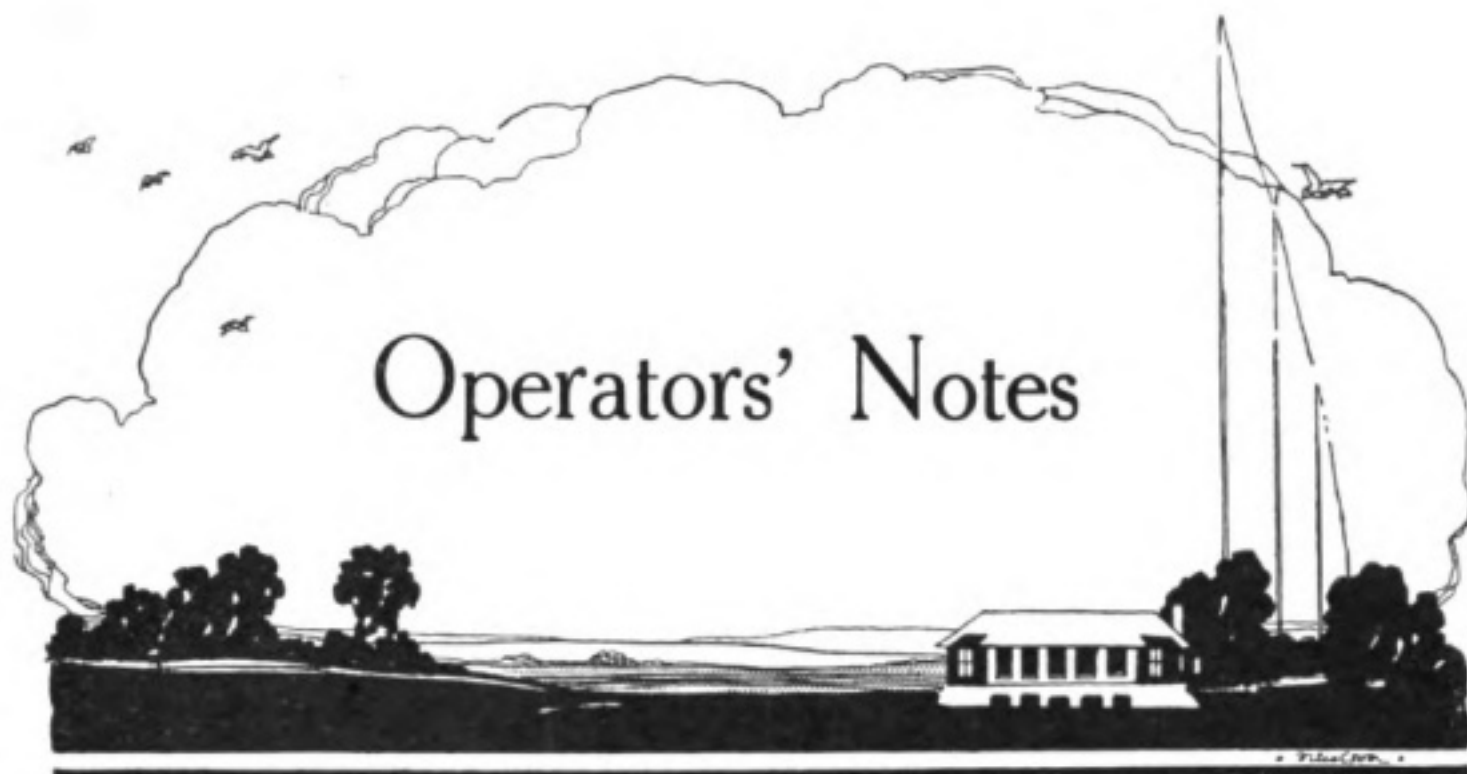

### *Time Signals.*

THE efficient navigation of a vessel depends entirely upon the possibility of being able to prick off her position accurately on the chart, and so enabling the master to reduce the distance run between ports to the minimum consistent with perfect security. In determining a vessel's position when out of sight of land latitude is calculated by the aid of sights taken with the sextant, but longitude can only be accurately determined provided that the vessel's chronometers are either keeping perfect time or have a known error. However, the most modern chronometers are liable to vary a few seconds per day, and an unsuspected error of one second might cause the vessel's position to be pricked off about a quarter of a mile east or west of her true position. In the case of a vessel approaching the land in thick weather after some days without sighting land, the accumulated error might possibly result in disaster, and the master of a vessel would in such circumstances follow a course which would give the land a wide berth, a proceeding, unfortunately, which would result in lengthening the distance run (consequently increasing coal consumption and other expenses), and also the time taken on the voyage.

One of the most valued direct aids to navigation is provided by the time signals transmitted from various land stations at certain hours, so that it is possible in nearly all parts of the world to determine the error of a chronometer by means of making comparisons between it and the time signals received.

Full particulars of the stations from which time signals are transmitted are to be found in the *Year-Book of Wireless Telegraphy*, pages 905-927.

In order to take full advantage of these signals the operator must be capable of tuning them in rapidly and accurately, especially as it is, of course, frequently necessary to pick up the signals at a great distance. It is not sufficient merely to obtain readable signals, but every effort must be made to increase their strength, thus enabling some method of reducing atmospheric interference and jamming to be adopted, such as using minimum coupling. It is obvious that time signals (which are usually a series of dots) could not be absolutely relied upon if received through interference, more especially owing to the fact that the operator has to "relay" the signals to the navigating officer, and therefore his attention cannot be wholly concentrated on the work of reception.

The wave-length of time signals transmitted from the various stations is given in the *Year-Book*, and the writer found it extremely useful to compile a chart having

columns for date, time, name of station transmitting, wave-length, distance, strength of signals, ATI and Billi condenser adjustment, etc.

As the wireless telegraph apparatus is never installed in the Chart Room, where the ship's chronometers are kept, and as it would be extremely inadvisable for the chronometer to be carried to the Wireless Room in order to compare its time with the signals received, it is necessary for a method to be evolved whereby the received signals can be "relayed" to the master or navigating officer without incurring a delay of more than half a second. The signals themselves, owing to "lag" in the working of relays, etc., used at the transmitting stations, might have an error of as much as one-fifth of a second, which error, however, can be disregarded.

The method of communicating the received signals to the Chart Room will depend to a great extent upon the relative positions of the Wireless and Chart Rooms, but as the majority of vessels have telephonic communication between these two rooms, there is, in vessels so equipped, no difficulty in re-transmitting the signals as they are received. The best method, making use of the telephone installation, is for the operator to place the telephone transmitter (in the Wireless Room) on the bench, or within very easy reach, the telephone receiver in the Chart Room being held by the navigating officer, who would be standing in front of the open chronometer. As the time signals are heard the operator should tap the telephone transmitter sharply with a pencil, which would give a sharp, clearly defined sound in the telephone receiver in the Chart Room. Whenever it is necessary for the operator to "tap" the signals, either on the telephone transmitter, on the bench, or on the bulkhead, he should always be seated comfortably, as otherwise a slight movement of the ship may cause him to tap prematurely or too late, which would confuse the officer who was noting the chronometer time.

If the Wireless Room adjoin the Chart Room a good method is for the operator to tap the bulkhead as he receives the signals, but if it be possible, the best method would be to lengthen the double headgear telephone lead, so that the operator, while actually receiving the signals, would at the same time be noting the corresponding chronometer time, and noting the error, if any.

The problem is rather more complicated when the Wireless Room is some distance from the Chart Room, and there is no telephonic communication between the two. If there be an uninterrupted view from the bridge to the Wireless Room, one method is to make visible signals corresponding to the time signals.

During daylight, for example, a small flag might be so arranged at the Wireless Room that on the receipt of each dot of the time signals the operator could cause it to drop. At night a portable lamp could be used, having a Morse key inserted in series for the operator to tap in a manner corresponding to the signals received. In the majority of cases, however, visible signals would be entirely unsuitable in bad weather, and in any case would involve the "relaying" of signals at the chart-house door, consequently the total error might be considerable.

In ships where the Wireless Room is some distance from the Chart Room, and no telephone system is fitted, it is more usual for an officer to be in the Wireless Room to set a stop-watch by the time signals. The stop-watch is then taken to the chronometer, and the error noted. This, however, is not an entirely satisfactory method, and in such vessels it would be advantageous for the master to authorise the running of a twin lead-covered or armoured lead from the Wireless to the Chart Room, which could be used either for "house" telephones or buzzer and key. When wire communication exists between the two rooms the master could make arrangements making it possible for the wireless telegraph receiver to be quickly connected (and disconnected) to the "line" instead of to the receiving phones, which would be connected to the "line" at the Chart Room end. This could easily be arranged by the use of small terminal boards, and by its use errors would be reduced to an absolute minimum, thus enabling the master to place the fullest confidence in this invaluable development of the utility of wireless telegraphy.

# Submarines and their Wireless

## *Some Personal Experiences of a Radio Engineer*

By S. C. ANSELMINI

IN the middle of the great European war, a comrade in the Wireless Service and I were sent out to the Iberian Peninsula to fit certain units of the Spanish Navy with wireless. Our numerous, varied and interesting adventures had commenced long before we actually arrived at Cartagena, our place of destination.

This port forms one of Spain's principal naval bases and possesses as magnificent a natural harbour as can be found along the whole of the littoral. I had diversified my voyaging at sea by trips on all sorts of vessels—battleships, gunboats, destroyers, torpedo boats—and had become very keen on travelling in a submarine.

Spain claims to be one of the first nations to have produced a submarine vessel moved by electric power, albeit that during the lifetime of Isaac Peral, the naval engineer, upon whose achievements she bases her claim, the pioneer's efforts were treated with contempt, and his desire to enhance the prestige of his country was frustrated. What Isaac Peral accomplished was to design and construct, at his own private expense, a small submersible boat propelled when under water by an electric motor and storage battery. Now that the recent struggle has demonstrated the potentialities of these under-water craft, Peral's countrymen are desirous of letting all the world know their claims to be first in the field.

At the beginning of 1917 there was not a single submarine in the Spanish Fleet, and the first instalment of this new sea arm was constructed in the U.S.A. and crossed the Atlantic by its own power. Great was the flutter of expectation all over the Peninsula when the news arrived that this vessel, named *Isaac Peral*, after Spain's first submarine engineer, was on its way to Cartagena. Just before reaching the Canary Islands, however, a rather serious mishap occurred, involving lengthy repairs in Las Palmas; the delay damped down public enthusiasm, and put a stop to the demonstrations with which it had been arranged to herald its arrival.

As soon as the *Isaac Peral* reached Cartagena, I went on board and found her to be a vessel displacing about 500 tons and fitted—so far as wireless telegraphy is concerned—with a single  $\frac{1}{2}$  kw. American Marconi panel set. The aerial, of a T-shape with sloping down extensions composed of two wires, was upheld by a single mast about 25 feet high. It possesses a reliable range of about 100 miles. I found that this under-water boat was, in addition to wireless, fitted with Fessenden's submarine signalling apparatus. It was my privilege to witness many interesting evolutions of this craft, and some of the accompanying illustrations are reproductions of photographs taken during a diving trial.

In August, 1917, a small flotilla of three submarines purchased from the Italian Government reached Cartagena. They had been built in Spezzia. I watched these three Italian vessels as they came in, from the deck of a Spanish torpedo boat, and it was a really wonderful sight to see the ease with which they manœuvred as they entered the naval yard and swung round to their mooring places. A few days later I received orders to place myself at the disposal of the commander of the flotilla, as the wireless sets on board required some modifications. My ambition for submarine voyaging was to be fulfilled! I made a dash for the *A.I.* and quickly disappeared down her hatchway. I found the commander of the boat in overalls superintending some engine repairs, explained the object of my visit, and was taken round the ship on a tour of inspection, leaving the wireless installation to the last.

I found the latter to consist of a  $\frac{1}{2}$  kw. Marconi standard ship station set, completely enclosed in a cupboard located immediately abaft the engine room. In my opinion, such an arrangement was far from ideal, as wireless tests were almost impracticable when the Diesel engines were running, as the noise made by the two 600 h.p. engines was simply deafening, despite the closing of the watertight door between the engine room and the after part of the vessel. Even the most experienced wireless ear would have found it difficult under such conditions to pick up any signals from a 3 kw. station not twenty miles away. The transmitter consisted of the regular  $\frac{1}{2}$  kw. converter and synchronous disc-discharger mounted on a shaft extension; the transformer, condensers, chokes, etc., being of the usual type. Space-saving had been carried too far, and I found that all the parts were so closely mounted as to render inspection extremely difficult. The receiving part of the installation consisted of the magnetic detector and tuner. These I replaced by an opposed-crystal receiver, which gave considerably more efficient results. On these vessels, owing to lack of elbow room, all the operating had to be conducted, not sitting but standing, a very awkward arrangement if there be much traffic to handle. This state of affairs, however, did not prevail during my stay on board. These Italian submarines carry a T-shaped aerial mounted on a mast about the same height as that of the *Isaac Peral*, and when the boat is ready to submerge this mast has to be taken down from its socket and the aerial wires coiled up, whilst the leading-in insulator must be removed and replaced by a water-tight cover.

The pressure on a submarine when submerged at any depth becomes severe and every hatchway and cover must be absolutely water-tight. Despite all precautions, some water finds its way in after one has been running a few hours submerged, but usually in such small quantities as to cause little inconvenience. On one occasion

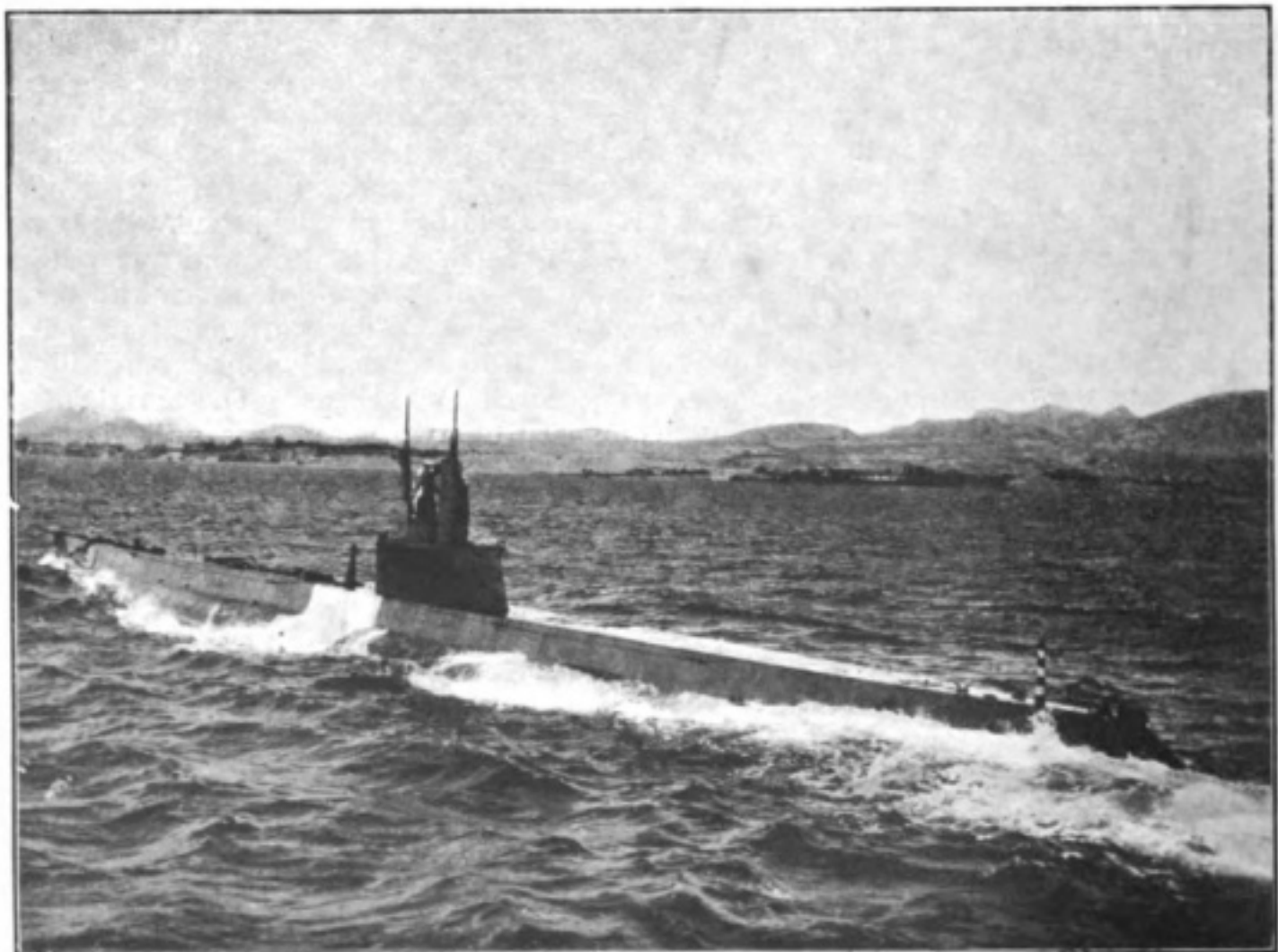

THE "ISAAC PERAL" RUNNING ON THE SURFACE OFF THE SPANISH COAST.





THE "ISAAC PERAL" RUNNING AWASH.

I noticed that water was slowly trickling down on to the aerial tuning inductance and finding its way thence to the transmitting condenser. After discovering what had been going on, I ceased to be surprised at the profuse sparking which occurred when I first started the set. A very merry little picnic party was held one day, when the vessel remained under water for ten consecutive hours, eight of which were actually spent resting on the bottom of the sea at a depth of about 120 feet. The meal was cooked

on an electric stove and ended up with hot coffee and a game of cards.

The clearness with which articles can be seen in the water even at some depth caused me considerable surprise. On one occasion I followed the evolutions of the *A.3.* in the escorting motor-launch; and, although the submarine was navigating directly under us at a depth of 30 feet, its fish-like form was plainly discernible. It is this permeability of water to light which accounts for the success of aeroplanes in locating submarine craft. My two illustrations, on page 552, one of a torpedo under water, and the other a view taken in the conning tower of the submarine whilst submerged at a depth of 15 feet, will illustrate my point. The torpedo picture speaks for itself, the other photograph demands some explanation. My plate was exposed for a period of eight seconds, yet the image is not blurred in the slightest degree, a fact which constitutes no small tribute to the steadiness with which the boat was making her way. I utilised no flashlight, relying upon the natural illumination obtained through the portholes of the conning tower, and the luminosity of the water at this depth is demonstrated by the excellent portrait of the second officer which was obtained under such circumstances.

Perhaps the following description of the Italian-made *A.1.*, *A.2.* and *A.3.* may interest my readers, in view of the fact that they are the result of my personal observation during the period I served upon them. They were constructed at the F.I.A.T. yards in Spezzia, and do credit to the excellence of Italian workmanship. Their displacement submerged is approximately 200 tons and their two 600 h.p. Diesel engines drive them at a surface speed of 12 knots. Electric accumulators enable them to maintain a speed of 5 miles per hour under water. The conning tower projects to a height of 5 feet above the



IN THE ACT OF SUBMERGING.



SPENT TORPEDO AS VIEWED FROM THE DECK OF THE SUBMARINE ESCORT.

ately underneath is located the operating or navigating room; here we find the various devices for working the vessel, including steering wheels, controlling both the ordinary rudder and the horizontal hydroplanes. These latter are fixed forward and astern of the submarine and serve the same purpose as those fitted on flying machines. The moving finger of a pressure gauge indicates the angle at which the vessel is travelling during ascent or descent, whilst other apparatus shows whether the craft is maintaining an even keel when running submerged. At such times the motive power utilised is generated by two large electric motors fed from an accumulator battery placed beneath the floor of the vessel. Special exhaust valves have been installed to expel the noxious gases formed during the charging of the accumulator battery.

Surface-vessel steering is carried out by the needle compass; but in a boat beneath the sea the influence of terrestrial magnetism is not felt, and the ordinary compass therefore becomes useless. This difficulty is overcome by the use of the gyro-compass, an elaborate electrical instrument, the main feature of which consists of a gyro-wheel, whereof the axle is adjusted so as always to remain parallel to the earth's axis in space. The frame of the gyro is fixed to the ship and moves with it. The underlying principle of the instrument rests upon the assumption that the rotation of the earth is changeless and undeviating, and that a large rotating wheel resists any tendency to being shifted relative to space. This gyro wheel is mounted upon ball bearings so exquisitely adjusted that when the electrical current which drives it has been

deck and is furnished with five portholes through which the commander may reconnoitre the surrounding waters when travelling awash. Access is obtained by three hatchways, one at the bow, another at the stern and one on top of the conning tower; each hatchway being closed by means of a domed cover, hinged like a lid. Two long periscopes of a telescopic pattern pierce the conning tower and extend 15 feet above the deck. The roof answers the purpose of a navigating bridge when the vessel is travelling on the surface, being fitted with compass, steering wheel and other gear, all of which can be removed into the interior when submersion is imminent. Immedi-



INSIDE THE CONNING TOWER AT THE DEPTH OF 15 FEET UNDERWATER.

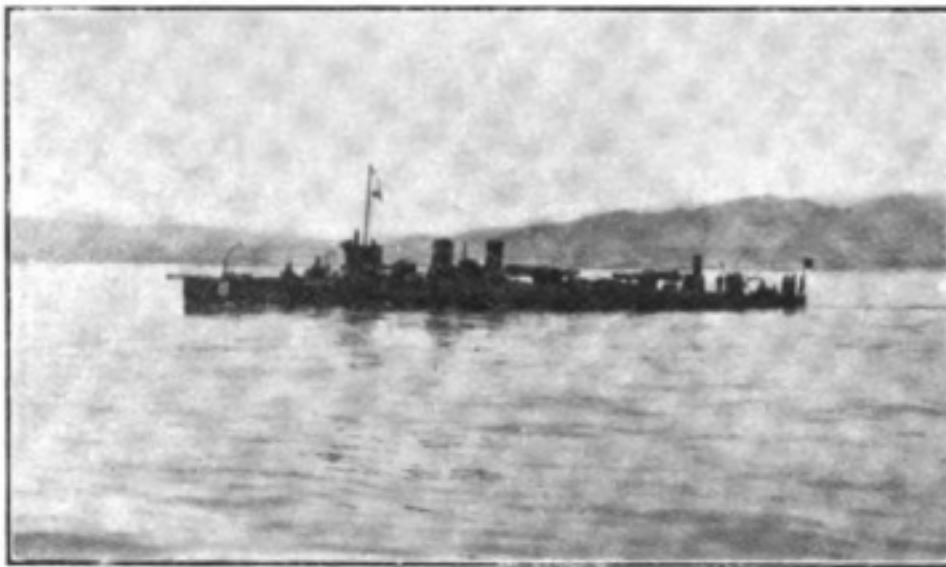

THE ESCORT.

switched off from the motor, the spin of the wheel does not cease for 14-16 hours. The complicated nature of this piece of mechanism may be gauged by the fact that it costs £2,000 to produce each instrument.

Signalling between two submarines or between a submarine and a battleship, when the former is under water, is carried on by means of sound waves. The Fessenden oscillator, used in the case of the Spanish submarines, consists of two large circular plates riveted to the hull of the ship on the port and starboard sides of the bow. These plates are set into vibration by electric currents controlled from a switchboard inside the boat. Two plates are used so that when they act as receivers, the telephones can be switched on to one or the other side, thus giving the direction from which the sound proceeds. The splashing of the oars of a small rowing boat can be distinctly heard when the boat is resting even at a depth of many feet. This signalling appliance possesses a normal range of approximately eighteen miles.

*(To be continued.)*



CAPE PALOS, NEAR CARTHAGENA. THE LOCALE OF A MARCONI WIRELESS STATION WELL KNOWN TO MARINERS.

# The Vision of a Scientist

## *Some Remarkable Forecasts of Sir William Crookes*

ON the advent of Senatore Marconi's wireless telegraph innumerable claims to priority were put forward by scientists and others who endeavoured to prove that they themselves had undoubtedly thought of the same thing years before. One by one these claims were proved to be false, until now the originality of the famous Italian inventor's work is universally recognised. The success of Senatore Marconi's early work was largely based upon his clarity of vision and his ability to recognise the possibilities that lay in the utilisation of etheric waves. Obviously the raw material for the invention was found in the pioneer work of Hertz and others, but it was his clear understanding of what Hertz had done that provided the driving force to overcome innumerable difficulties.

There was, however, another scientist whose vision was marked by the same clarity. That man was William Crookes, F.R.S., later to be honoured with a knighthood. The scientific achievements of this great man are briefly recorded on another page. Here it is our purpose to reproduce a portion of a paper contributed by him to the *Fortnightly Review* for February, 1892—four years before Marconi took out his first British patent and five years after Hertz announced his famous discoveries. It is also of interest to note that it was in this year that Edouard Branly invented the first crude coherer.

We wish to lay emphasis upon the fact that this paper, which is without question the most remarkable and detailed prophecy of wireless telegraphy ever promulgated, antedated practical radiotelegraphy by no less than four years. It is only by bearing this fact in mind that readers will appreciate Sir William Crookes's remarkable prophetic vision. The paper was entitled "Some Possibilities of Electricity," and as it has been virtually inaccessible to the public for many years, we reprint herewith the whole of that portion which has a bearing on wireless telegraphy.

"We know little as yet," said the writer, "concerning the mighty agency we call electricity. 'Substantialists' tell us it is a kind of matter. Others view it, not as a matter, but as a form of energy. Others, again, reject both these views. Professor Lodge considers it 'a form, or rather a mode of manifestation of the 'ether.' Professor Nikola Tesla demurs to the view of Professor Lodge, but thinks that 'nothing would seem to stand in the way of calling electricity ether associated with matter, or bound ether.' High authorities cannot yet even agree whether we have one electricity or two opposite electricities. The only way to tackle the difficulty is to persevere in experiment and observation. If we never learn what electricity is; if, like life or like matter, it should always remain an unknown quantity, we shall assuredly discover more about its attributes and functions.

"The light which the study of electricity throws upon a variety of chemical phenomena—witnessed alike in our little laboratories and in the vast laboratories of the earth and sun—cannot be overlooked. Without going into transcendental speculations as to the origin of all things, it may be mentioned that the theory which now meets with most favour as best representing the genesis of the chemical elements is, that at the time each element was differentiated from the all-pervading protyle, it took to itself definite quantities of electricity and upon these quantities the atomicity of the element depends. Professor Oliver Lodge expresses this when he says, 'Every monad atom has associated with it a certain definite quantity of electricity; every dyad has twice this quantity associated with it, every triad three times as much, and so on.'\* Helmholtz considers it to be probable that

\* *On Electrolysis*, British Association Reports, 1895.

“ electricity is as atomic as matter and that an electrical atom is as definite a quantity  
“ as a chemical atom. This, however, must not yet be regarded as a certainty, for  
“ it is possible that all the facts at present known may be explicable in another way.  
“ If an atom of matter is endowed with the property of taking to itself one, two,  
“ three, or more units of electricity, it does not follow that electricity is atomic.  
“ Imagine the atoms of matter to act like so many bottles, capable of holding one,  
“ two, three, or more pints. Imagine electricity to be like water in the ocean,  
“ which for the purposes of this argument may be considered inexhaustible and  
“ structureless. One of the atomic ‘ bottle ’ elements dipped into the ocean would  
“ certainly take to itself, one, two, three or more pints of water. but it would by  
“ no means follow that the ocean was atomic in that it was capable of being divided  
“ up into an infinite number of little parcels, each holding a pint or its multiple.

“ For this and other reasons I think we must accept the hypothesis of the atomic  
“ character of electricity as not yet definitely proved, although it is not improbable.

“ I have spoken of the ‘ ether ’—an impalpable, invisible entity, by which all  
“ space is supposed to be filled. By means of the ether theory we can explain  
“ electrical phenomena, as well as those appertaining to the phenomena of light.

“ Until quite recently we have been acquainted with only a very narrow range  
“ of ethereal vibrations, from the extreme red of the solar spectrum on the one side  
“ to the ultra-violet on the other—say, from three ten-millionths of a millimetre  
“ to eight ten-millionths of a millimetre. Within this comparatively limited range  
“ of ethereal vibrations and the equally narrow range of sound-vibrations all our  
“ knowledge has been hitherto confined.

“ Whether vibrations of the ether, longer than those which affect us as light,  
“ may not be constantly at work around us, we have until lately never seriously  
“ enquired. But the researches of Lodge in England, and of Hertz in Germany,  
“ give us an almost infinite range of ethereal vibrations or electrical rays, from  
“ wavelengths of thousands of miles down to a few feet. Here is unfolded to us a  
“ new and astonishing world—one which it is hard to conceive should contain no  
“ possibilities of transmitting and receiving intelligence.

“ Rays of light will not pierce through a wall, nor, as we know only too well,  
“ through a London fog. But the electrical vibrations of a yard or more in wave-  
“ length of which I have spoken will easily pierce such mediums, which to them will  
“ be transparent. Here, then, is revealed the bewildering possibility of telegraphy  
“ without wires, posts, cables, or any of our present costly appliances. Granted a  
“ few reasonable postulates, the whole thing comes well within the realms of possible  
“ fulfilment. At the present time experimentalists are able to generate electrical  
“ waves of any desired wavelength from a few feet upwards, and to keep up a  
“ succession of such waves radiating into space in all directions. It is possible, too,  
“ with some of these rays, if not with all, to refract them through suitably shaped  
“ bodies acting as lenses, and so direct a sheaf of rays in any given direction ;  
“ enormous lens-shaped masses of pitch and similar bodies have been used for this  
“ purpose. Also an experimentalist at a distance can receive some, if not all, of  
“ these rays on a properly constituted instrument, and by concerted signals messages  
“ in the Morse code can thus pass from one operator to another. What, therefore,  
“ remains to be discovered is—firstly, simpler and more certain means of generating  
“ electrical rays of any desired wavelength, from the shortest, say, of a few feet in  
“ length, which will easily pass through buildings and fogs, to those long waves  
“ whose lengths are measured by tens, hundreds, and thousands of miles ; secondly,  
“ more delicate receivers which will respond to wavelengths between certain defined  
“ limits, and be silent to all others ; thirdly, means of darting the sheaf of rays in  
“ any desired direction, whether by lenses or reflectors, by the help of which the  
“ sensitiveness of the receiver (apparently the most difficult of the problems to be  
“ solved) would not need to be so delicate as when the rays to be picked up are

B

“ simply radiating into space in all directions, and fading away according to the  
“ law of inverse squares.

“ Any two friends living within the radius of sensibility of their receiving instru-  
“ ments, having first decided on their special wavelength, and attuned their respective  
“ instruments to mutual receptivity, could thus communicate as long and as often  
“ as they pleased by timing the impulses to produce long and short intervals on the  
“ ordinary Morse code. At first sight an objection to this plan would be its want  
“ of secrecy. Assuming that the correspondents were a mile apart, the transmitter  
“ would send out the waves in all directions, filling a sphere a mile in radius, and it  
“ would therefore be possible for any one living within a mile of the sender to receive  
“ the communication. This could be got over in two ways. If the exact position  
“ of both sending and receiving instruments were accurately known, the rays could  
“ be concentrated with more or less exactness on the receiver. If, however, the  
“ sender and receiver were moving about, so that the lens device could not be adopted,  
“ the correspondents must attune their instruments to a definite wavelength, say,  
“ for example, fifty yards. I assume here that the progress of discovery would give  
“ instruments capable of adjustment by turning a screw or altering the length of  
“ a wire, so as to become receptive of wavelengths of any preconcerted length. Thus,  
“ when adjusted to fifty yards, the transmitter might emit, and the receiver respond  
“ to, rays varying between forty-five and fifty-five yards, and be silent to all others.  
“ Considering that there would be the whole range of waves to choose from, varying  
“ from a few feet to several thousand miles, there would be sufficient secrecy; for  
“ curiosity the most inveterate would surely recoil from the task of passing in review  
“ all the millions of possible wavelengths on the remote chance of ultimately hitting  
“ on the particular wavelength employed by his friends whose correspondence he  
“ wished to tap. By ‘ coding ’ the message even this remote chance of surreptitious  
“ straying could be obviated.

“ This is no mere dream of a visionary philosopher. All the requisites needed  
“ to bring it within the grasp of daily life are well within the possibilities of discovery,  
“ and are so reasonable and so clearly in the path of researches which are now being  
“ actively prosecuted in every capital of Europe that we may any day expect to  
“ hear that they have emerged from the realms of speculation into those of sober  
“ fact. Even now, indeed, telegraphing without wires is possible within a restricted  
“ radius of a few hundred yards, and some years ago I assisted at experiments where  
“ messages were transmitted from one part of a house to another without an inter-  
“ vening wire by almost the identical means here described.

“ The discovery of a receiver sensitive to one set of wavelengths and silent to  
“ others is even now partially accomplished. The human eye is an instance supplied  
“ by Nature of one which responds to the narrow range of electro-magnetic impulses  
“ between the three ten-millionths of a millimetre and the eight ten-millionths of a  
“ millimetre. It is not improbable that other sentient beings have organs of sense  
“ which do not respond to some or any of the rays to which our eyes are sensitive,  
“ but are able to appreciate other vibrations to which we are blind. Such beings  
“ would practically be living in a different world to our own. Imagine, for instance,  
“ what idea we should form of surrounding objects were we endowed with eyes not  
“ sensitive to the ordinary rays of light but sensitive to the vibrations concerned in  
“ electric and magnetic phenomena. Glass and crystal would be among the most  
“ opaque of bodies. Metals would be more or less transparent, and a telegraph wire  
“ through the air would look like a long narrow hole drilled through an impervious  
“ solid body. A dynamo in active work would resemble a conflagration, whilst a  
“ permanent magnet would realise the dream of mediæval mystics and become an  
“ everlasting lamp with no expenditure of energy or consumption of fuel.

“ In some parts of the human brain may lurk an organ capable of transmitting  
“ and receiving other electrical rays of wavelengths hitherto undetected by instru-  
“ mental means. These may be instrumental in transmitting thought from one

“ brain to another. In such a way the recognised cases of thought transference, and the many instances of ‘ coincidence,’ would be explicable. I will not speculate on the result were we eventually to catch and harness these ‘ brain-waves.’

“ Whatever be the length of the electric wave, the velocity with which it travels is constant, and is equal to the velocity of light, or about one hundred and eighty thousand miles a second. Professor Oliver Lodge, who has worked for some years on these subjects, gives formulæ \* for calculating the frequency of vibration and the wavelength of the electrical rays given by the discharge of Leyden jars of different capacities. The bigger the jar and the greater the size of the circuit the longer will be the waves. Thus a pint jar discharging through a two-yard circuit will give waves of a length of fifteen or twenty metres, and they will follow each other at the rate of ten million a second. A jar the size of a thimble will give waves only about two or three feet long, and they will succeed one another at the rate of two hundred and fifty or three hundred millions a second. With every diminution in size of the apparatus the wavelengths get shorter, and could we construct Leyden jars of molecular dimensions, Professor Lodge considers the rays might fall within the narrow limits of visibility. We do not know the intimate structure of a molecule sufficiently to understand how it could act as a Leyden jar; yet it is not improbable that the discontinuous phosphorescent light emitted from certain of the rare earths when excited by a high-tension current of electricity in a good vacuum is really an artificial production of these electric waves, sufficiently short to affect our organs of vision. If such a light could be produced more easily and more regularly it would be far more economical than light from a flame, or from the arc or incandescent lamp, as very little of the energy is expended in the form of heat rays. Of such production of light Nature supplies us with examples in the glow-worm and the fire-flies, whose light, though sufficiently energetic to be seen at a considerable distance, is accompanied by no liberation of heat capable of detection by our most delicate instruments.”

---

## Correspondence

To the Editor, THE WIRELESS WORLD.

DEAR SIR,—My attention was directed to a book by Charles Bright, *Telegraphy, Aeronautics and War*, on the ground that there were several references in it to code matters, and I therefore procured a copy, eagerly hoping that a new luminary had appeared in the firmament of code experts, but my expectations were speedily shattered, and instead of a brilliant star I found a body of very low magnitude indeed.

The tenor of the whole work is that while wireless under certain favourable circumstances may be usefully employed as an auxiliary to cables, it was worthless, in fact dangerous, to use it for sending business messages in code, or for use in time of war. In the able review of *Telegraphy, Aeronautics and War* which appeared in your December number, it was pointed out that many of Mr. Bright's conclusions were based upon erroneous assumptions—in fact, for a Fellow of the Institute of Radio Engineers he would appear to be surprisingly ignorant of some quite elementary features of wireless telegraphy. When he touches upon code matters his ignorance is positively abysmal.

On page 52 the author asserts that “ the present war soon gave proof that it would never do to rely upon ‘ wireless ’ as a secret method of communication,” and farther on he points out that there can be no certainty of the origin of wireless messages. Is the writer endeavouring to impugn the marvellous work done by the Signal Division of the Admiralty? They have provided perfect systems of coding

---

\* *Modern Views of Electricity*, pp. 246-7.

and call signals, which have been used regularly during the war, nearly half a million wireless messages being exchanged every week, without any question whatever as to their authenticity or the enemy benefiting from them. Many naval officers have stated that there can be no doubt whatever that had the invention and development of the submarine preceded that of wireless telegraphy this country would have been defeated, and when one considers how the efforts of the huge fleet of motor boats, scouts, trawlers, destroyers and other craft detailed to counter the barbarous campaign of piracy, were co-ordinated and controlled by "wireless", messages *in code*, even the most jaundiced or biased opponents of radiotelegraphy must admit that Mr. Bright's contentions are absolutely fallacious. Curiously enough, however, when it suits his case the author changes his tone, as in a later chapter he recommends the State administration of wireless for "secrecy reasons." If, as he iterates and reiterates, there can be no real secrecy in wireless messages, this is a peculiar argument, to say the least of it.

Turning to the commercial use of wireless, the author appears to think that messages in code cannot be accurately transmitted. He seems to be oblivious to the fact that up to the time when the Government took over the Marconi high power stations for war purposes a large volume of transatlantic business was being handled, and the banks and leading commercial men of the City are eagerly awaiting the re-opening of this service. With regard to accuracy, not only does the ever-increasing demand prove that the Marconi system has been satisfactory in every way, but all the cable men who have accepted posts in Marconi's Wireless Telegraph Company are amazed at the exceedingly small number of errors in transmission of coded messages.

Mr. Bright repeatedly states that codes or cipher codes are of no value, and on page 158 he says, "It is well known that, provided a sufficient number of words are passing, any cipher yet invented can be deciphered." Now this is a broad, comprehensive and sweeping assertion. The author does not employ any qualification such as "as far as I know." There is a finality about the statement that arouses my curiosity, and I should like to challenge Mr. Bright to arrange, either through the intermediary of THE WIRELESS WORLD, or in some other way, to test the accuracy of his statement impartially, and under much more favourable conditions than he can have had in his mind when he so calmly laid down the law.

(Signed) J. C. H. MACBETH.

*The Editor, THE WIRELESS WORLD.*

DEAR SIR,—On page 263 of the August issue is an article headed "A Radio Phenomenon" dealing with the effects of smoke passing through an aerial.

In both the cases mentioned the effects noticed were produced by smoke from passing trains. This "smoke" was probably composed largely of steam from the engine exhaust, and I venture to suggest that the observed effects were due to steam rather than to smoke. On several occasions whilst perusing works on electricity I have seen it stated that a jet of high-pressure steam, issuing from a boiler, produces such an effect that a severe electric shock will be experienced on touching that part of the boiler from which the steam issues.

Reverting to the case in question I suggest that the exhaust steam from the engine produces an effect inside the engine similar to the above and carries off with it some of the electric charge. On being intercepted by a wireless aerial these steam clouds will naturally discharge to earth through it, producing an effect in the receiving instrument akin to static interference. It might be termed "home-made" static.

Trusting this will be of interest, and with best wishes,—Yours, etc.,

(Signed) A. DINSDALE.



# Maritime Wireless Telegraphy



## HISTORY-MAKING BY WIRELESS.

It was very justly observed by one of our weekly contemporaries that radiotelegraphy has provided a new mode of opening up negotiations between opposing armies, unknown to our forefathers. Without wireless, in the conditions obtaining on the Western Front, it is very difficult to say how the *Parlementaires* could have advanced without considerable danger to themselves. Considerable delay must, at all events, have arisen when they desired to consult their own Headquarters concerning the terms of the victors. Indeed the services which wireless has performed all through the period of armistice have continued to be notable in this respect. Communications have gone on all day and every day between the opposing forces, and the solemn (though belated) protests of both the British and French Governments against the scandalous treatment of prisoners of war belonging to their respective nationalities have been carried by the same medium.

At sea, the difference between the procedure of the present time and former days has been to the full as marked. Instead of sending light frigates under a flag of truce, the ether waves enabled Admiral Meurer to make an appointment for rendezvousing at sea, and then to proceed straight to the appointed meeting place. We have by this time become so familiar with the smooth working of radiotelegraphic conversation that scarcely any feeling of wonderment appears to have been stirred amongst Press or public by the clockwork regularity of the whole set of complicated operations. That matters have worked with so few hitches is due to wireless alone. Surely here there is some room for congratulation, if not for wonderment. Never before has the history of naval war witnessed the abject surrender of a fleet in complete order, unscathed by warlike operations. And equally it is without precedent that, in the course of carrying out such operations as have been dictated by the conqueror, a beaten foe has been able to receive instant admonition for shortcomings and afforded opportunities for explaining his difficulties and for putting matters straight without the slightest delay. Occasions have occurred when armistices have broken down and hostilities been renewed, simply owing to misunderstandings brought about by lack of communication between the parties concerned.

One of the batch of twenty submarines, which were due on a certain day towards the close of November, did not turn up, and immediately the British Admiral fired off the following message from his aerials :—

"Request you will report on the sinking of U93, as the same appears to have been avoidable."

A full apology and explanation of the incident was returned by wireless from the German authorities, and arrangements were made for the prompt surrender of another vessel in place of that which had failed to turn up.

Again, the British found some of the gear which ought to have accompanied the surrendered vessels was missing on their arrival. A complaint was forthwith radiated in the following terms:—

"Torpedoes you failed to send with the latest convoy of submarines you will forward by next transport."

Once more the erstwhile Bully, but now obsequious under-dog, hastened to put the matter straight.

The change from truculence to oily deference, which was plainly marked in the attitude of the Teutonic seamen, appears to have put the finishing touch upon the contempt felt by our glorious sea dogs. They could waste small respect on men who had proved themselves so bold in shelling defenceless towns and torpedoing hospital ships, and then become so supremely anxious to save their own skins when it came to a question of fighting man to man and ship to ship.

We do not know whether the Germans attempted to utilise the ether waves for toadying palaver. We do know that they had been rapped on the knuckles for such attempts when their delegates first visited the quarter deck of our admiral's ship. It may have been due to such a cause, or it may have simply been due to the same contemptuous spirit of taking no risks when dealing with a treacherous foe, that a wireless message went out from the British Commander ordering that:—

"You will stop using your wireless until further orders."

Assuredly Sir David Beatty is disappointed at having been baulked of the prey whose arrival he had been awaiting with such eagerness for four long years.

It is reported that not long before Armistice Day he called his men together on board "Big Lizzie." "Men," said he in his abrupt incisive manner, which gives the impression that he is biting his words as they issue from his mouth, "they're coming out. I always said they would." On the day of the Great Surrender he once more addressed them. "Men, I always told you they'd come out . . . not on a piece of string though."

This feeling of disgust is plainly to be seen written between the words of his wireless messages. Surely as without precedent as any other item in this extraordinary naval *débâcle*, is the way in which, through the ether waves, the British Admiral has been making the Huns "eat dirt."



[Graphic Photo Union.

THE WIRELESS AERIALS OF A BRITISH MAN-OF-WAR WITH THE NAVAL AIRSHIP WHICH ESCORTED THE GERMANS TO THEIR SURRENDER.



[Graphic Photo Union.

A NOTABLE GROUP ON THE VICTOR'S QUARTER DECK. READING FROM LEFT TO RIGHT : ADMIRAL BEATTY, ADMIRAL RODMAN, U.S.N., HIS MAJESTY, THE PRINCE OF WALES, AND ADMIRAL SIMS, THE COMMANDER OF THE U.S. NAVAL FORCES.

#### A NOVEL INCIDENT IN THE WAR AT SEA.

We notice in the pages of one of our contemporaries a reference to an incident which occurred early in 1917 in the Mediterranean, not far from the island of Crete. The s.s. *Huntsend* was torpedoed by one of the pests who at that time infested the waters of the Great Sea, and, in accordance with the custom, sent out an appeal by wireless for help. An escorting destroyer took off everyone on board and steamed away, leaving the vessel derelict. Meantime another destroyer, some distance away, had picked up the wireless message, and hurried to the spot. A visit to the unfortunate vessel soon disclosed the fact that there was nobody left on board; so the gallant bluejackets boarded the ship and, after strenuous efforts, succeeded in fetching her sufficiently near the shore to be beached for repairs. These were executed, and in the course of time the salvaged vessel reached England. Wireless telegraphy had been responsible for initiating a dual task. Through its agency rescuers had been summoned to save lives; and through its agency one more sorely needed vessel had been preserved for "carrying on" our overseas trade.

One would have thought that under the regular maritime rules the men who preserved the vessel from destruction would have received salvage money. According to our contemporary, however, that is not the case up to the present, and, assuming the fact to be as stated, an injustice would appear to have been done them in this respect.

# The Armistice

---

## *How Marshal Foch's Wireless Message was Received in London*

---

IN the very early days of the war wireless operators who happened to have their instruments tuned to a certain wavelength frequently heard, during both day and night, the following message transmitted by a well-known German station: "Krieg ist erkl art gegen England, Frankreich und Russland" ("War is declared against England, France and Russia"). The note of the signals was shrill and defiant; the message, considering all that lay behind, was a veritable challenge to the world. Whilst Brialmont's masterpieces at Li ge were falling into unconsidered heaps of concrete and steel beneath the blows of Krupp's 8.4 inch howitzers and the invading flood of "field-greys" was smothering everything Belgian, this message continued to be flung out with monotonous insistence. The impression received by those who heard it so often was that Germany considered England, France and Russia to amount to about a bite and a half and that they were trying to make our flesh creep, like the Fat Boy in the *Pickwick Papers*.

Some four years later the final answer to this war-cry was sent out, appropriately enough, by a French wireless station in Paris—that pot of gold on the end of the rainbow, which dazzled the wits and escaped the paw of the Blonde Beast. As everyone knows, in the forenoon of Friday, November 8th, the German delegates were informed of the terms upon which the Allies and the United States were willing to grant an armistice; those terms had to be accepted or rejected within 72 hours, that is, by 11 a.m. on November 11th. What need is there to describe the state of expectancy into which the world was thrown at this stage? It seemed too good that the terms should be accepted; yet incredible that they should be refused. This mixed sense of excitement, hope and curiosity was specially intense in the minds of a few men in the Admiralty wireless station at Marconi House who had been detailed to maintain a special watch upon all wireless activity in connection with the armistice proceedings. Marshal Foch and the delegates used the Eiffel Tower station in order to communicate with the German High Command at Spa, at which place there was another wireless station, so that the watch became easily resolved into an observation of the messages transmitted by these stations, particularly those from Eiffel Tower.

Would they sign? Would they sign early? Or would they hang on to the last minute? These were the burning questions which besieged the minds of those who sat by day and by night in that small room below the aerials of Marconi House. Eiffel Tower was by no means silent during those hours in which the German delegates stared into the face of Nemesis and saw that it was graven steel. There was the first whining cry from Erzberger to his masters when he realised that his council-table craft would not be needed. Foch's "Take them or leave them!" had from the outset abolished bargaining. Then came another cry, that Foch would not until the terms were accepted—not even for humanity's sake—call off his dogs of war from Mons, M zi res and Sedan.

Again the Eiffel Tower spoke to Spa. "Two naval cipherers" were desired

by the delegation to proceed from Germany to the Marshal's headquarters. ("Ah," said the watchers to each other, "that is Wemyss at work.") Time wore on; Friday and Saturday passed but still IT did not come, and the watch continued. To the men engaged it all became a great drama witnessed by wireless. One could piece it together by the aid of the messages and envisage the scene, the voluble, gloomy Teutons, the grizzled, politely firm Foch and the immaculately groomed British admiral, model of cool efficiency. One wanted to be "in at the death," and it was with reluctance that the telephone receivers were handed over to the relief.

Sunday passed and it was felt that things were about to happen. Every time the note of the Eiffel Tower station was heard and the operator's pencil began to move a thrill passed over the little waiting company. Have they done it? Is

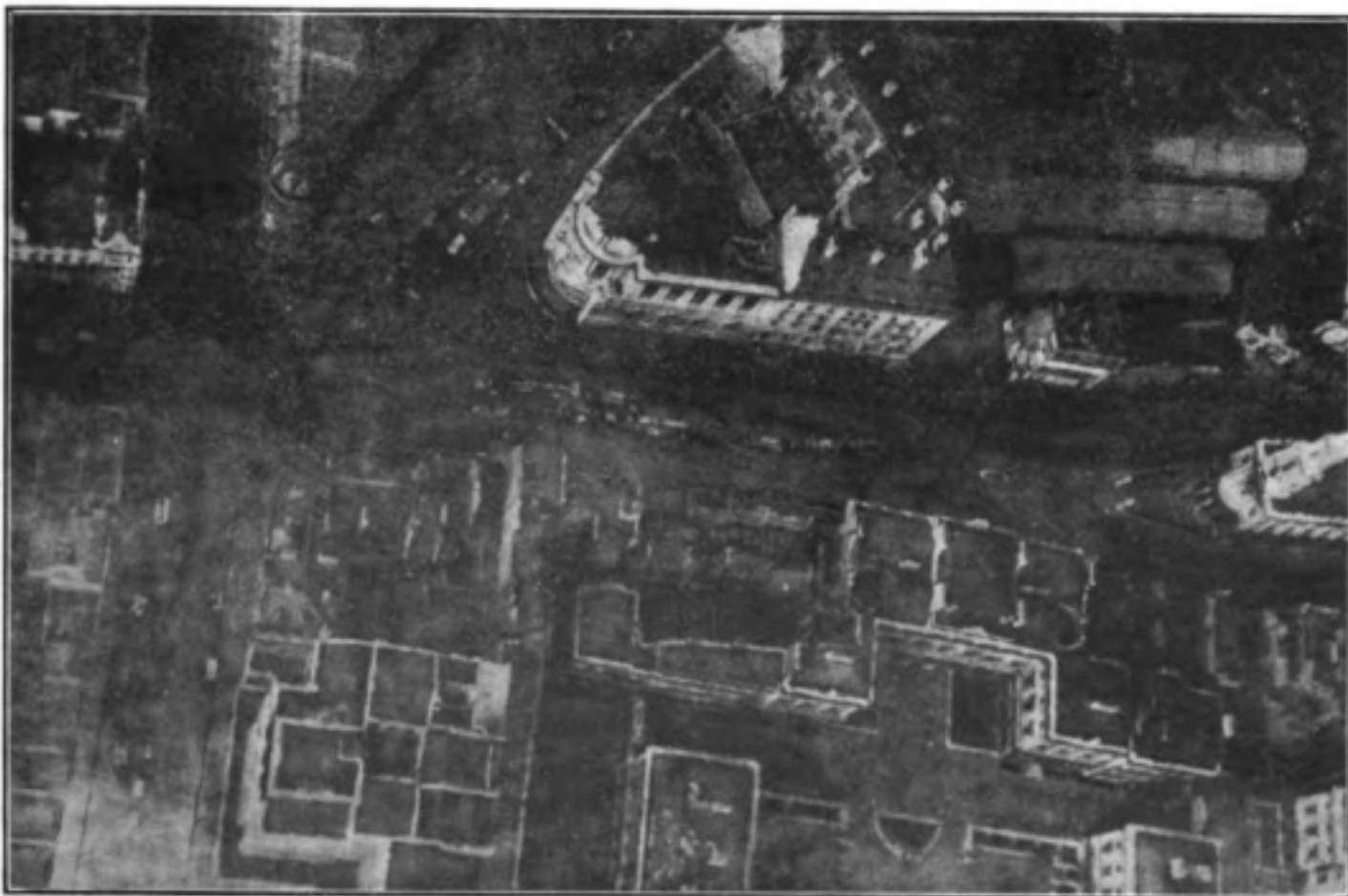

*The Central News, Ltd.*

AN AIRSHIP VIEW OF THE STRAND, KINGSWAY AND MARCONI HOUSE. THE AERIALS ON WHICH THE ARMISTICE MESSAGE WAS RECEIVED ARE STRETCHED ABOVE THE BUILDING. }

the war over? Nothing! Only a courier was held up by broken bridges and gunfire. ("Still couriers? Why don't they sign?")

The early hours of Monday, November 11th, and only about nine hours remaining in which to save the German army from the tender mercies of the "contemptibles," the degenerate *poilus* and "those idiotic Yankees"; a few more hours of killing, a few more hours till dawn. In that quiet upper room overlooking the Strand the excitement of the preceding days had given place to a nervous intentness. Never did men await a more tremendous moment or wireless operators a more historic message, and yet London slept,—that London which before lunch-time was to become as light-hearted and irresponsible as a continental city at carnival; London slept, save in those busy places where night workers still fashioned the engines and munitions of war. A strange contrast! To one man it was given to make the shell or sharpen the bayonet; to another that he should keep his ear as it were at the door of the chamber whence Peace might issue.

And then, as light came, as the dawn came to sad south-western Europe, illumining its desolation and the little crosses on its myriad graves, another message also came; it was the answer to that German mandate of August, 1914, that war should be.

*" Marshal Foch to Commanders-in-Chief: Hostilities will cease on the whole front on November 11th, at 11 a.m. The Allied troops will not, until further orders, pass beyond the line reached at this date and time. Signed: Marshal Foch."*

This message was written by a Frenchman and transmitted by wireless in French and English to the listening world. What it said was that hostilities should cease; what it meant was that Germany, having staked everything, had lost all save her shame and blood-guiltiness. It was noted that the formation of the Morse characters as sent from the Eiffel Tower station was occasionally tremulous or erratic. Small wonder that this was so! There was a man whose heart beat swifter for *la patrie* in that hour. After the manner of his kind the Englishman who wrote down the message here in London grumbled about his pencil and smoked hard to hide his feelings.

The news was hurried off to the authorities—a small boy on a bicycle bore it. There is something of humour in that fact when you consider that the British Empire was waiting for him.

\* \* \* \* \*

From the windows of the wireless room the watchers looked out on London a few hours later to observe the results of their labours. At nine o'clock it amounted to little more than rumour; the early milkman had it and a man in a Department which "controlled" something had heard it over the telephone. In large offices the mails remained unopened and young ladies were slow to uncover their typewriters. By ten o'clock it really began to be a fact and one could see the truth *leaking out*. Girl clerks at Somerset House lined the windows or dashed hatless into the Strand; it is reported that even their lady supervisors thawed after a short preliminary frost and became quite malleable. Presently newspapers appeared, early even as "noon editions," and the glorious, amazing news at last reached the mind of the public. It reached people's hearts too. And then the covers of the typewriters were snatched and became drums of victory, office towels and dusters flew as flags, the Strand received as a torrent the staffs of its offices. Excited groups in the street waved and cheered to people on the tops of passing 'buses, who first stared, then understood and became galvanised. Suddenly came a sound which the Strand had heard before, and the crowds were hushed for a moment. It was the dull report of the maroons. Eleven o'clock had struck and the Great War was over. So, then, there was nothing for wireless operators to do—but to go on watching.

It is interesting to compare the manner in which Marshal Foch's message was conveyed to England with that in which the news of the victory of Waterloo was brought. In the latter case, picture the despatch-rider in his gallop to the coast, the slow hazardous passage across the Channel in some cockle-shell packet-boat, the furious dash to London, with trails of cheering villagers and scared poultry, the awakening of a Minister of State—you can see him gradually gathering his Georgian dignity in spite of his nightcap—and finally the audience of the King. The other picture shows us the dapper soldier writing on a telegraph form, a military telegraphist saluting and sitting down to manipulate a knob for two minutes, the wireless station, the movement of machines, the intermittent glare of a spark and the quiet routine of reception and despatch in that small room in Marconi House. Less than an hour after Germany had acknowledged in writing her defeat the news was in London and on its way to the Press via the Censor, the intelligence having arrived at the speed of 186,000 miles a second.

They say that ours is not an age of romance, but romance is only wonder and never dies, although its nature changes with the changing years.

# Long-Distance Wireless

THE recent announcement of direct wireless communication between England and Australia and the reception of the signals in Australia upon newly designed apparatus has brought us many queries from readers as to what type of receiver was used. We are therefore pleased to be able to reproduce here two photographs, one showing the aerial tuning inductance and condenser and the other the valve receiver used in connection therewith. The receiver, which utilises three small Marconi Q-type valves, was constructed entirely in Australia by Mr. E. T. Fisk, managing director of Amalgamated Wireless (Australasia), Ltd., and his staff, and, as will be seen, has a very compact appearance.

We are not yet in a position to give the practical outlines of the circuits used, but hope in the near future to give our readers a complete diagram of connections. The success of this reception over a distance of 12,000 miles is even more remarkable when it is considered that the signals were received on a very small aerial at Mr.

Fisk's own private house. Signals were also received on the same apparatus not only from Carnarvon but from a number of other European stations almost equally distant, the strength of reception on many occasions being sufficient to enable the signals to be read several feet away from the telephone receivers laid upon the table. It has been stated that the war has brought forward the science of aviation to a position which it would not have otherwise occupied for some forty or fifty years, and while the same can scarcely be said about wireless telegraphy it is an undoubted fact that the wide application and extensive study of

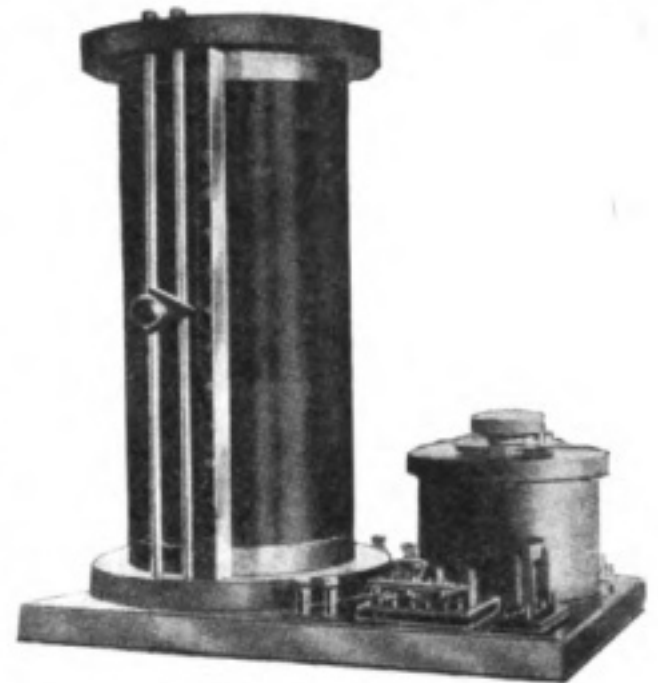

AERIAL TUNING UNIT.

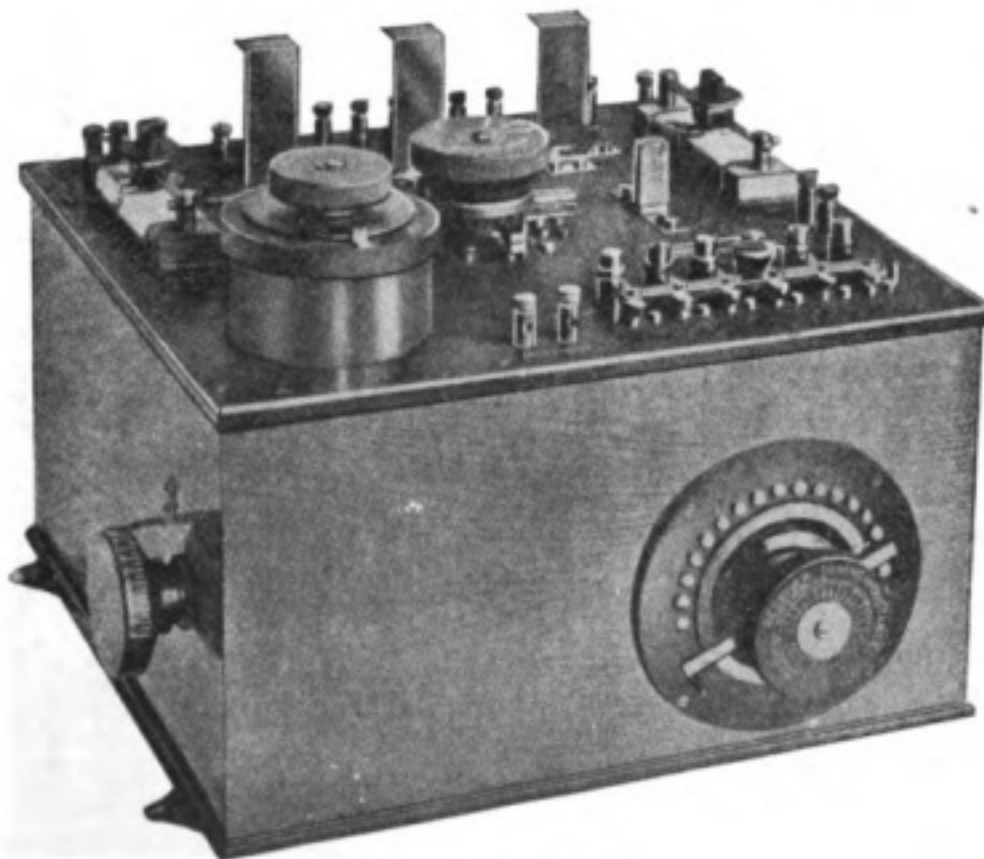

VALVE AND SECONDARY TUNING UNIT.

this subject brought about by war conditions have made possible many of the recent advances from which the veil is only just being lifted. We are looking forward with interest to the possibilities opened out by the fitting of modern and highly sensitive receivers to ships at sea when these vessels resume the normal commercial working, and we have no doubt that in the near future the power used will be found to be not below but in excess of requirements. On this subject we shall have more to say in an early issue.

# Notes of the Month

## FREEDOM.

LIBERTY is in a bad way. The ex-Kaiser and his satellites deliberately organised a *régime* of a highly centralised nature, in which repression of liberty was carried to its furthest extreme. This course was deliberately adopted by them in order to contribute to the efficiency of their war machine. The Allied Powers, loudly proclaiming that Freedom was the basic principle for which they stood, found themselves handicapped for the struggle by the liberty which their individual citizens enjoyed. Their first concerted action was, therefore, to abolish all personal freedom of action, with the result that the sacred cause had to be upheld by a violation of its first principle! As the war progressed, the stringency wherewith the suppression of deed, word, and even thought was carried increased ever more and more, until we found ourselves unable to have a voice in what we should eat, what we should drink, or wherewithal we should be clothed. We were told, and tried hard to believe, that all this would be merely temporary; but is it?

Many of us notice with considerable misgiving that it appears very much easier to surrender liberty than to regain it. Mr. Lloyd George, when replying to some deputies from a teetotal organisation, who urged still further "control," answered that "we should certainly not fail to profit by the lessons of the war"! The United States of America, which owe so much of their radiotelegraphic progress to the freedom from restraint enjoyed in the past by their wireless experimentalists and wireless workers in general, instituted the most rigorous repression for the purposes of the war; and now that peace has come we observe the foreshadowing

of a purpose to keep this industry in leading strings under the guise of "Navy Control." An announcement was made towards the end of November last that

"Mr. Wilson has approved a scheme for the permanent control of all wireless communication by the American Navy. The plan, which is based upon purchase of plants, will be submitted to the next Session of Congress."



CAPTURED GERMAN WIRELESS. THE POWER UNIT AND MAST GEAR LORRY.



Without any wish to prejudge the issue, which must largely depend upon the details of the measure, we should like to point out the danger which lurks under the apparently innocent cloak of State control of wireless. The industry is young, and, despite its already marvelous developments, there are still immense possibilities ahead of it, which demand for their

realisation the utmost exercise of human ingenuity. It is notorious that State enterprise does not tend to foster progress. Indeed, the British Post Office, which is sometimes given as an instance of a successful State organisation, owes a very great proportion of its success to the pressure brought to bear upon it from outside. Government industrial enterprise cannot always rely upon the invigorating criticism and indomitable perseverance of men like Sir John Henniker Heaton.

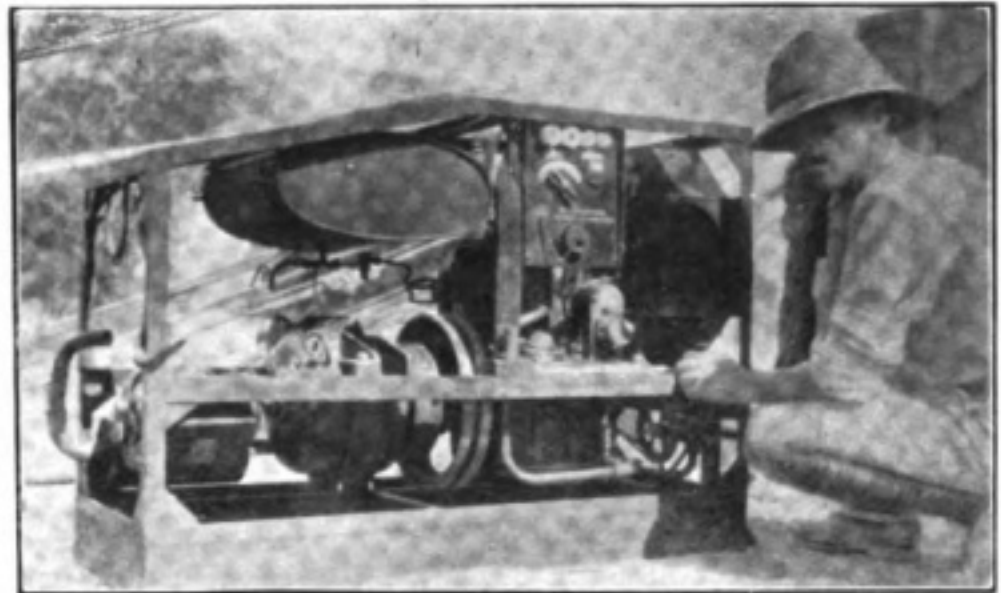

CAPTURED GERMAN WIRELESS.  
THE POWER UNIT OF 1½ KW. SET.

#### WIRELESS AND THE PRESS.

One of the developments of this war which have come to stop is the intimate connection between wireless and the Press. The former commends itself as a method of communication specially suitable for newspaper work, and future developments in this direction are likely to be startling. In the interests of the public it is highly desirable that both should be freed from their present fetters at the earliest possible moment. It is hardly too much to say that the recent bloody struggle would have lasted only as many months as it did years, if the wireless services of the Central Empires had been free, and the Press at liberty to put their readers in

possession of the facts. The Prussian Junker gang, however, controlled both means of communication and media of publicity, with the result that the German people are only now beginning to have some glimmerings of the truth. It may be said that such repressive manipulation is characteristic of autocracy, and that its antithesis will be free from the taint. Alas! experience tells a different tale, and

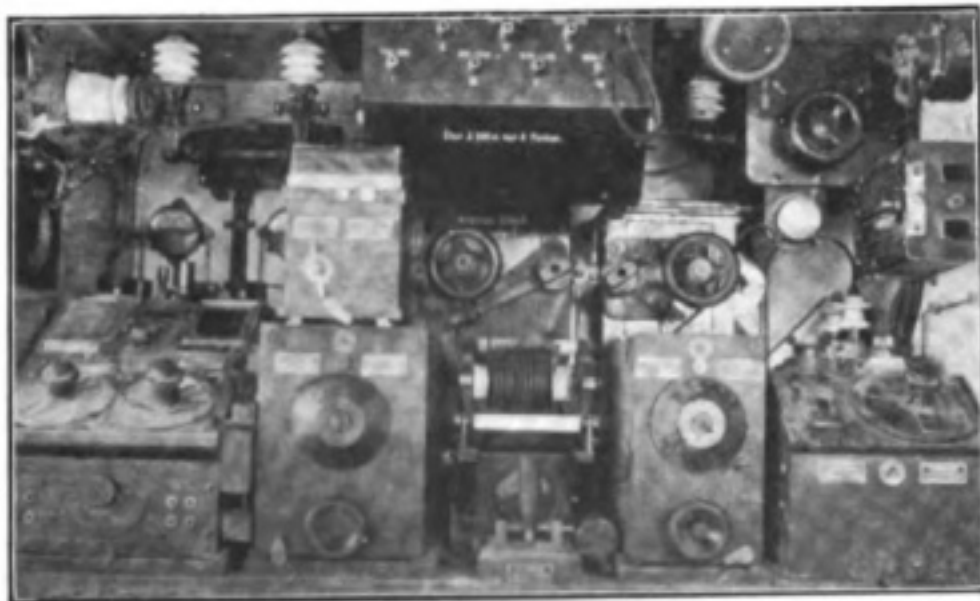

CAPTURED GERMAN WIRELESS.  
GENERAL VIEW OF THE APPARATUS.

we find the new rulers of Germany radiating from Nauen wireless station messages about the fell intent of France and England, unjust action in extending armistice demands, etc., quite in the manner and with the same motives as the *ancien régime*.

#### GERMAN WIRELESS CONTROL.

The Bolsheviks gained—and to a large extent maintain—their tyranny in Russia by their absolute control of Russian radiotelegraphy. No sooner is Kaiserism deposed from Germany and revolutionaries rampant, than we learn from Berlin sources that “the control of wireless stations in Germany is in the hands of the “Independent Socialist Party and the Spartacus group.” According to this announcement, the Central Wireless management has fallen completely into the hands of Liebknecht and Ledebour. The Berlin News Agency further reports that, acting in conjunction with the Executive Council of the Workers’ and Soldiers’ League, the Central Wireless management succeeded in setting aside the Government, which has the greatest interest in controlling reports which are going abroad, and in constituting itself an independent authority. The Central Wireless managers, Herren Meyenburg and Hartmann, have answered this statement with the assertion

that all German wireless stations are under the control of the people’s mandatories, of all the interested Imperial Departments, and of the Executive Council, so that any misuse by any single party whatsoever is out of the question.

Why is it that the absolute control of wireless telegraphy is thus eagerly sought for? Partly, no doubt, that the people

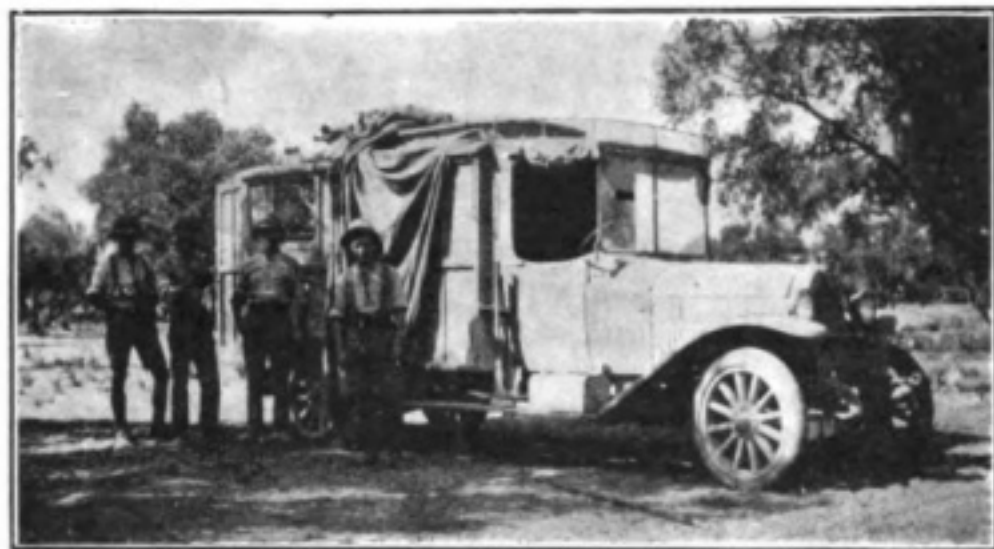

CAPTURED GERMAN WIRELESS. THE APPARATUS LORRY.

who are opposed to the men in power may not communicate freely between themselves or with sympathisers abroad. But mainly the idea is that through wireless they may control the Press. Germany has been long familiar with these methods of manufacturing (or stultifying) public opinion. It is a matter in which we have perforce had to imitate her during the war; let us hope that peace will soon see us quit of it. Press censorship and liberty cannot long continue side by side.

#### OUR ILLUSTRATIONS.

Considerable interest attaches to some of the trophies which have been taken from our beaten foe. Especially is this the case with the scientific instruments, the interest of which is likely to be permanent. In the immediate present the scientific experts working on our own side can satisfy a natural curiosity by observing the devices used by the enemy against whom they matched themselves. In later days, when the particular devices in question have become obsolete, these trophies will retain an historical interest—that which attaches to gear in use during a critical period of British military history. The pictures which will be found on pages 566 to 568 show the wireless gear utilised for field purposes by the Germans, and experts on our own side will be able to see from our prints sufficient details to enable them to grasp the particular form of the devices thus employed.

# Some Aspects of Radio Telephony in Japan

By EITARO YOKOYAMA

(Engineer of the Ministry of Communication, Tokio, Japan)

*Reproduced by permission from Proceedings of the Institute of Radio Engineers*

(Continued from page 487 of our December issue)

## INFLUENCE OF ELECTRODE MATERIALS ON DISCHARGE.

A DISCHARGER with copper electrodes, as shown in Fig. 2, was used at first. The secondary oscillation current produced in this case was not only very unsteady, but lasted only a few seconds. By replacing the copper anode by an aluminium one the secondary oscillations were greatly improved, as mentioned above. It is interesting to note that in the ordinary atmosphere a discharger with copper-copper electrodes gives stronger oscillations than one with copper-aluminium electrodes, though there is a little difficulty in starting the discharge in the former case.

A series of tests was made, several different metals being tried as electrodes, and it was finally found that aluminium was the best material for the negative electrode. With aluminium as a negative electrode and various metals as the positive electrode, the measurement of secondary oscillation current and corresponding primary supply current was made, other circuit conditions remaining the same. The results of these measurements are plotted in the curves of Fig. 14. It is noticeable in the curves that the combination of aluminium-aluminium electrodes gives the poorest result. This is probably due to the effect of polarity, dissimilar electrodes giving better result.

A series of experiments was also made with several different crystals (artificial and natural), such as silicon, carborundum, magnetite, zincite, etc., as electrodes. It is very interesting to find that there were several combinations of electrodes

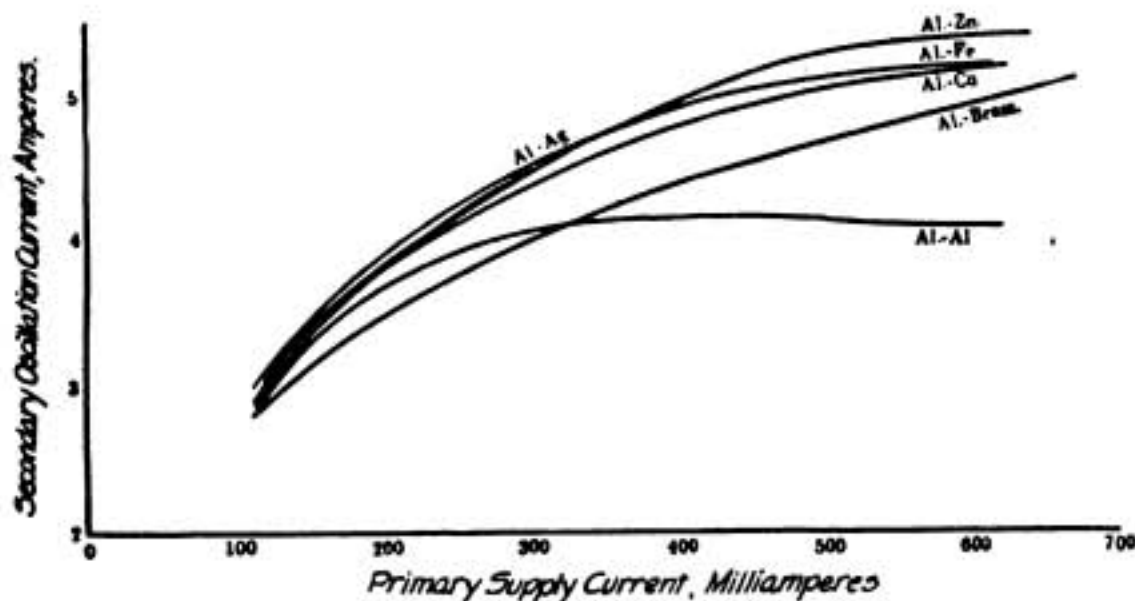
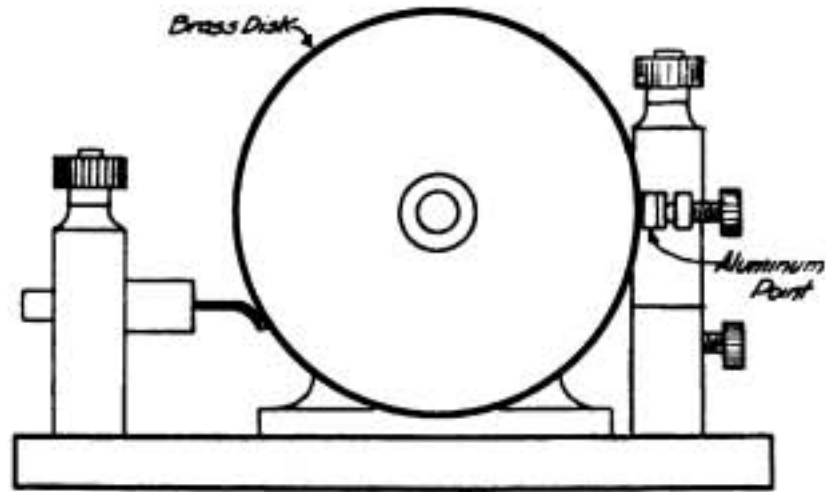

FIG. 14. OSCILLATION CURRENT PRODUCED WITH DISCHARGERS HAVING COMBINATIONS OF VARIOUS ELECTRODES.

which gave very good results without the use of aluminium as the negative electrode. Generally speaking, the results with crystals were nearly the same as those with metals. However, it is very difficult to shape crystals into suitable forms; and since there is no necessity for the use of crystals as electrodes, the investigations were carried no further in this connection.

**INFLUENCE OF SUPPLY VOLTAGE ON OPERATION OF DISCHARGER.**

In the ordinary atmosphere a small clearance between electrodes is necessary to obtain continuously a discharge with a voltage less than 500. The use of so small a gap is likely to give rise to frequent short circuits. In the case of the use of such a gap in air it is necessary to insert a certain amount of resistance in series in the primary supply circuit in order to prevent short circuits which might injure some parts of the apparatus because of the passage of



ELEVATION.

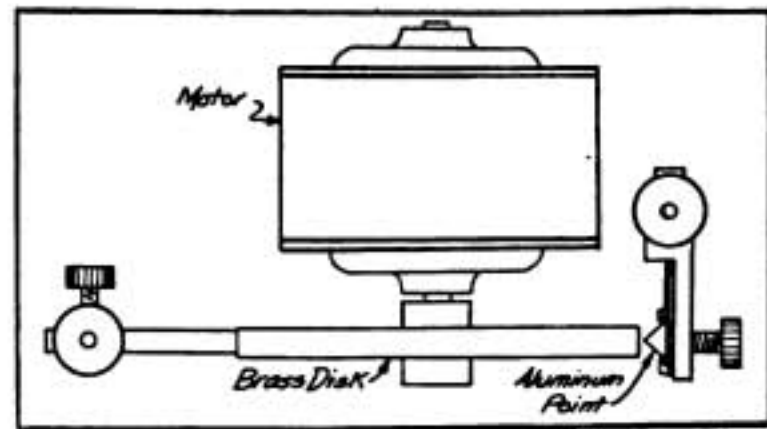

PLAN.

FIG. 15. T. KUJIRAI'S ROTARY GAP.

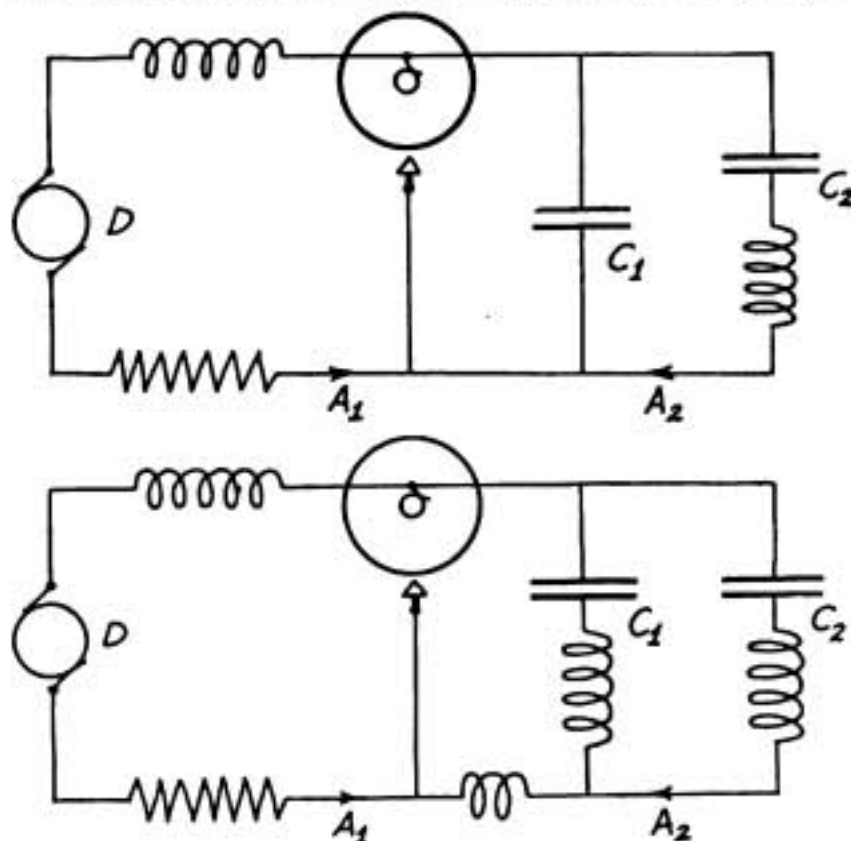

FIG. 16. CIRCUIT ARRANGEMENTS FOR THE ROTARY GAP.

abnormally large currents. As described, the rarefied air discharge works well with a fairly wide clearance of electrodes in comparison with one at atmospheric pressure, though the shorter the clearance the better operation can be obtained. As the operating conditions prevent short circuiting, and the lack of air in the discharger doubtless greatly assists regular working, series resistance can be easily dispensed with, and a much lower voltage for the power source is sufficient for perfect functioning of the discharger. The experiment being made of varying the supply voltage from about 320 to 580, it was confirmed that equally good results were obtained at any point in this range of the supply voltage,

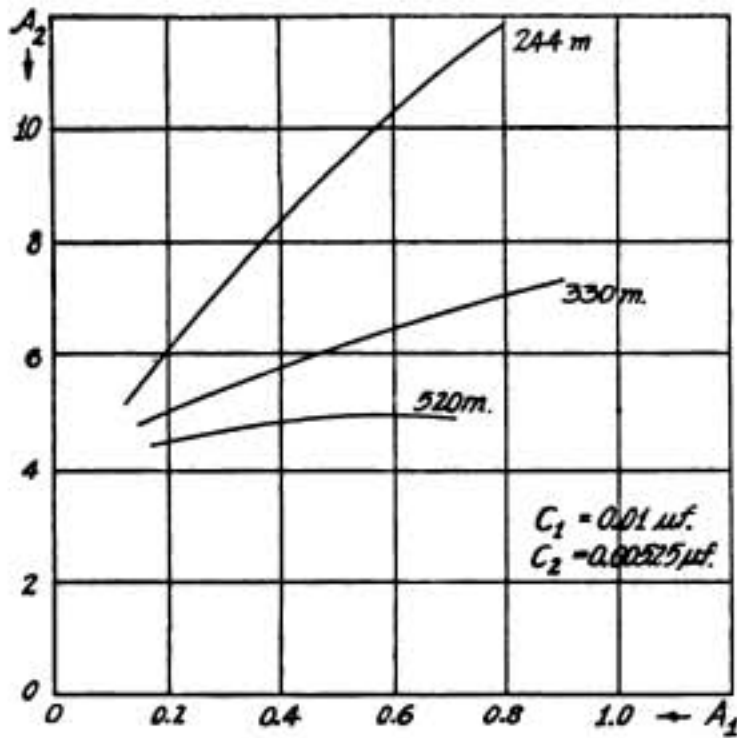

FIG. 17A. VARIATION OF OSCILLATION CURRENT WITH SUPPLY CURRENT.

as atmosphere, but the latter stage can be made equally as suitable by introducing a certain kind of gas in the discharger instead of air. Since the discharger working in stage (2) can be, moreover, operated through a much wider range of air pressure than when in stage (4), satisfactory operation in stage (2) is less effected by variation of pressure. A discharger in stage (2), with a special kind of gas inside, is therefore as good as and has a longer life than a discharger in stage (4) with air.

Supposing a discharger to have been well constructed, and with the precautions observed which have been considered under the several headings above, it will still finally reach the end of its life because of the pressure variation of the contained air arising from the following well-known causes: (a) Imperfect elimination of occluded gas from the metallic bodies, and of water vapour from the surfaces of these metallic bodies and the glass wall; (b) disappearance of gas due to discharge; (c) changes in electrode surfaces due to discharge.

The defect (a) can be eliminated to a certain extent by submitting the glass and the metallic bodies of the discharger to high temperature when constructed. As regards the defect (b), there seems to be no means whereby it can be perfectly cured, though it can be regulated by a method similar to that used for the adjustment of the "hardness" of X-ray tubes. As for the defect (c), the use of electrodes constructed as in Fig. 13 (b) makes the discharge steady for some time

the gap terminal voltage remaining nearly constant and in the vicinity of from 230 to 240.

#### SOME CONSIDERATIONS RELATIVE TO THE LIFE OF DISCHARGER.

Descriptions have already been given of the proper construction for the rarefied air discharger. In the long run deviations from good adjustment will occur even in a well constructed discharger, and the secondary oscillation current will gradually fall off. Some consideration will be given here to the causes of this effect and their remedies.

The life of the discharger depends largely upon its working in either stage (2) or (4). It has already been mentioned that stage (4) is much more suitable than stage (2) in a discharger with rarefied air

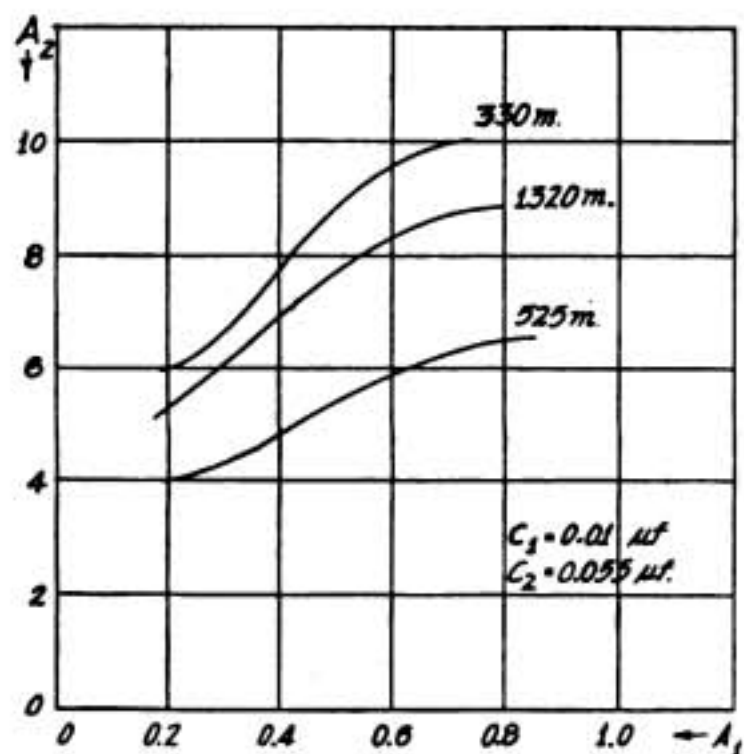

FIG. 17B. VARIATION OF OSCILLATION CURRENT WITH SUPPLY CURRENT.

from the beginning, but the irregularity gradually increases in the long run, the smooth, straight line discharge altering into a poor discharge in the form of a brush. The discharge could be improved by covering the surface of the electrodes with a thin film of glass or enamel except at the centre of discharge surfaces.

**ROTARY GAP FOR  
RADIOPHONE  
TRANSMITTER.\***

Mr. T. Kujirai has invented a kind of nearly sustained oscillation producer which is suitable for radio-telephone transmitters.

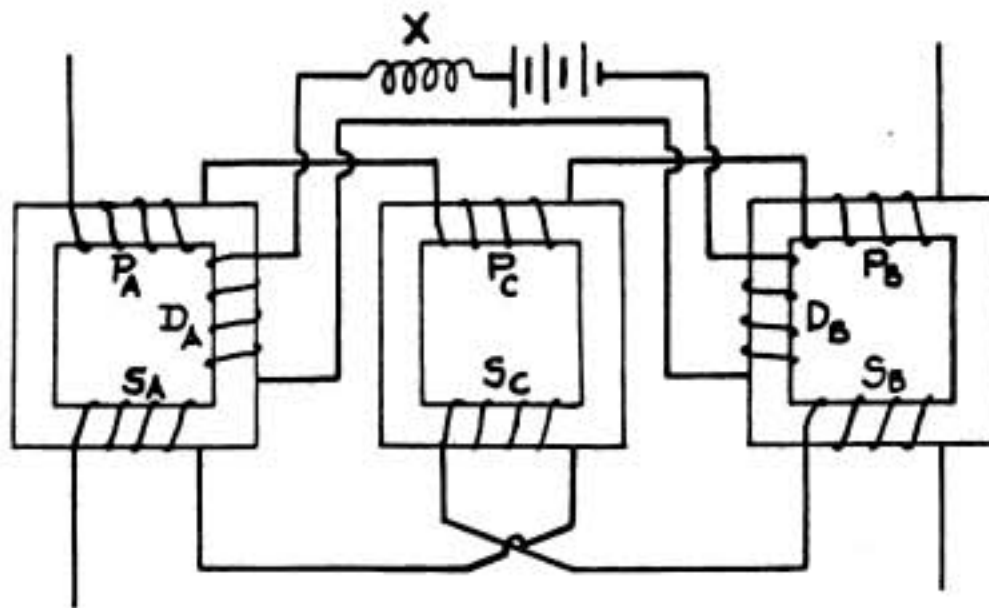

FIG. 18. ARRANGEMENT OF THE STATIC FREQUENCY TRANSFORMER OF T. KUJIRAI.

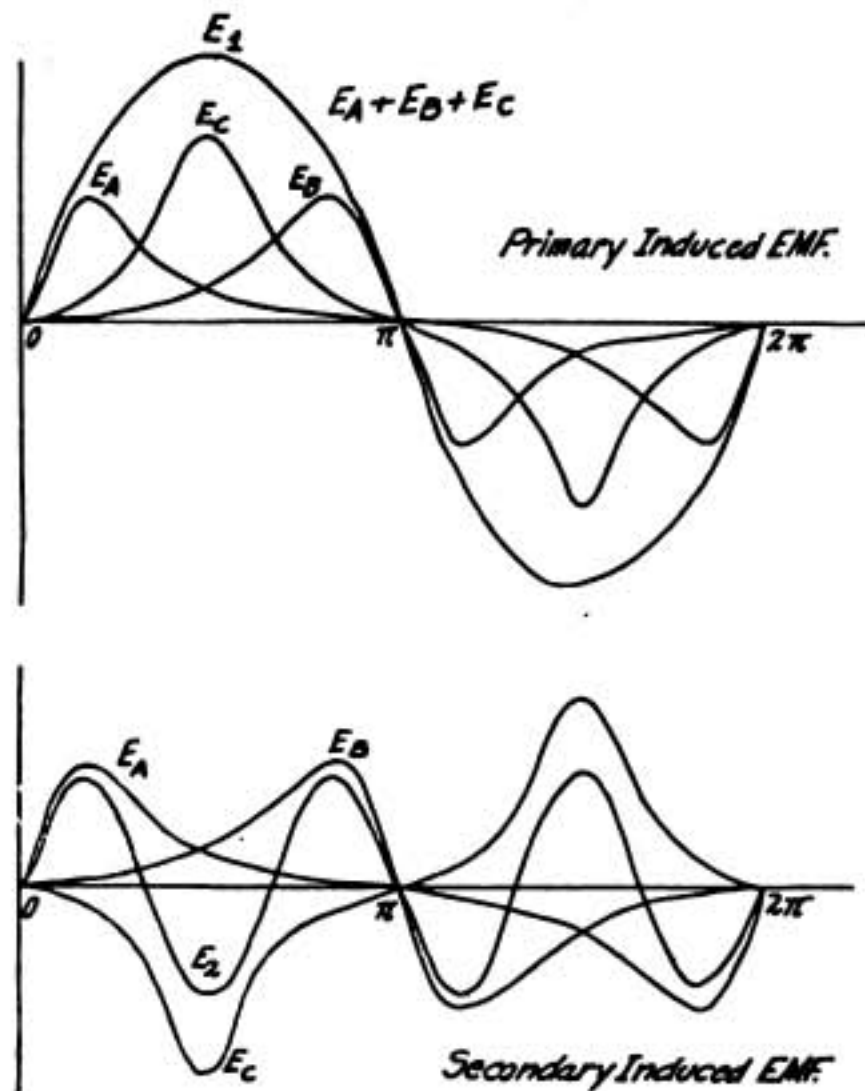

FIG. 19. DIAGRAM SHOWING THE PRINCIPLE OF KUJIRAI'S TRANSFORMER FOR TRIPLING FREQUENCY.

His first device was made public in Japan as early as 1910. The principal part of the apparatus consisted of a metallic or carbon rotary disc, directly driven by an electric motor, as one electrode, this being in light contact with a metallic or carbon brush as the other electrode; direct current being used as the power source. His sustained oscillation producer was a combination of the rotary gap and an ordinary oscillation circuit in shunt.

The apparatus has been successively improved, until he finally modified it in 1912, producing a form which is more suitable for radio telephone purposes. The latest arrangement consists of a rotary brass disc and an aluminium point, which is shown in Fig. 15. The circuit arrangements used by him in connection with his gap are shown in Fig. 16.

The power is supplied from a 500-volt direct current generator through a resistance and an inductance

\* For much of the information here given the writer is indebted to the inventor.

to a gap not greater than 0.5mm. (0.02 inch) in length. The supply current used in his arrangements varied 0.2 to 1.0 ampere, depending on the capacity in the oscillation circuit.

The frequency of oscillation may be varied through a wide range without affecting the stability of the discharge by varying one of the capacities in the oscillation circuit.

Figs. 17 (a) and (b) are sample curves showing the variation of the oscillation current with the supply current.

Using this arrangement, he is said to have succeeded in communicating articulate speech more than twenty miles (32 km.).

#### STATIC FREQUENCY TRANSMITTER.\*

Among others,† Mr. T. Kujirai has invented a method of tripling the frequency of an alternating current in 1915, which method was found to be very useful, not only in the common electrical engineering field, but also in radio telephony.

This static frequency transformer consists of three elements, two of which have their cores oppositely polarized by direct current through an inductance,  $X$ , and windings  $D_A$ ,  $D_B$ , Fig. 18, while the third element is non-polarized.

The primary ( $P_A$ ,  $P_C$ ,  $P_B$ ) and secondary ( $S$ ,  $S_C$ ,  $S_B$ ) windings are respectively connected in series, but the secondary ( $S_C$ ) of the non-polarized transformer element is connected in opposition to those ( $S_A$ ,  $S_B$ ) of the other two polarized elements.

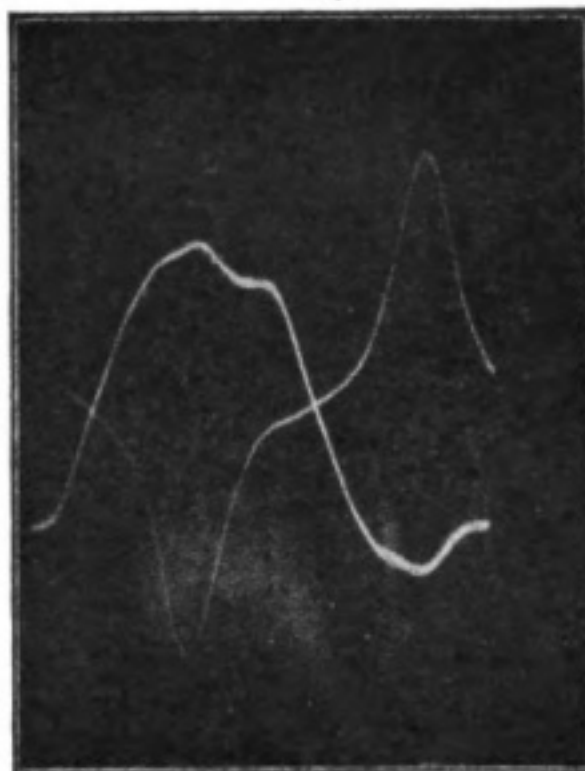

FIG. 20A.

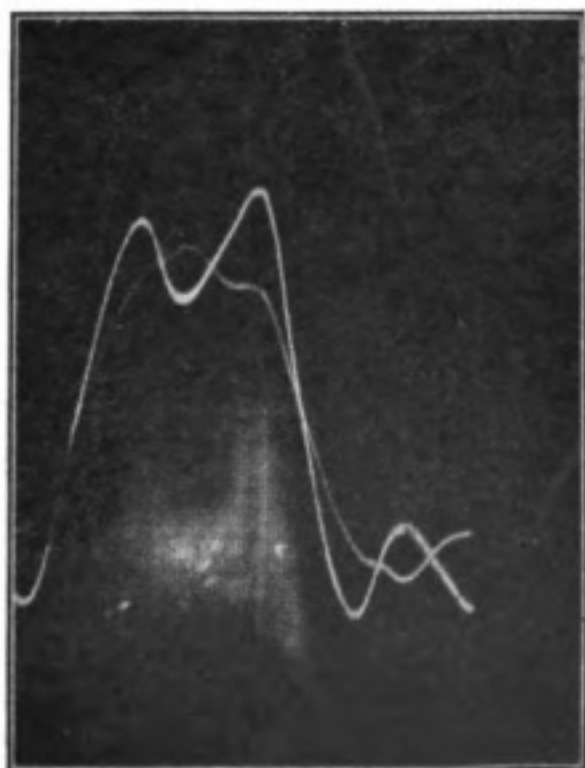

FIG. 20B.

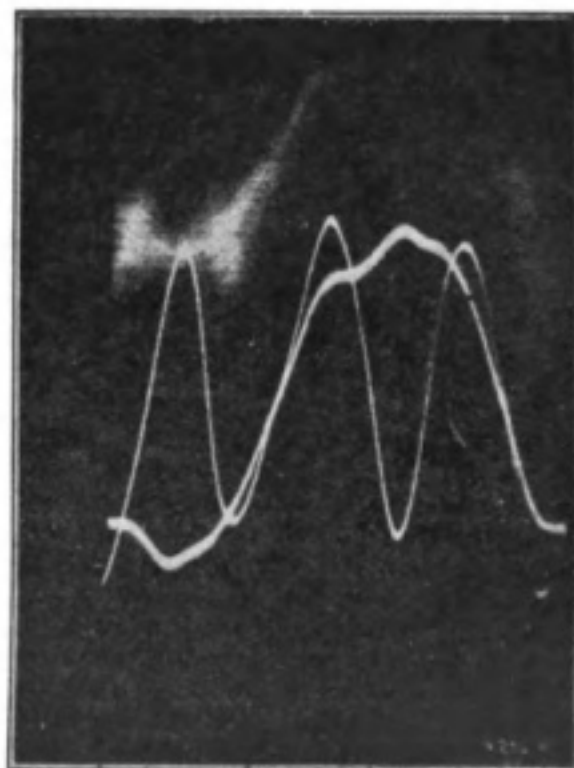

FIG. 20C.

FIGS. 20A, 20B, AND 20C. OSCILLOGRAMS SHOWING THE CONSTITUTION OF SECONDARY E.M.F. IN THE STATIC FREQUENCY TRANSFORMER OF KUJIRAI.

\* For much of the information here given the writer is indebted to the inventor.

† See the paper "Radio Frequency Changers," by A. N. Goldsmith, "Proceedings of the Institute of Radio Engineers," March, 1915.

The function of this arrangement is that the induced electromotive forces  $E_A$  and  $E_B$  (Fig. 19) in the secondary windings of the polarized transformer elements are asymmetrically distorted owing to the magnetic saturation of their iron cores, while the induced e.m.f.,  $E_C$ , in the non-polarized transformer element remains entirely symmetrical, but remarkably peaked owing to the low magnetic density in its iron core. The distorted e.m.f.'s being superposed in opposition to the symmetrical one, the resultant of these e.m.f.'s will have such a form as  $E_2$  (Fig. 19), which has a weak component of the fundamental frequency and a strong third harmonic, as well as higher harmonics.

Figs. 20 (a), (b), and (c) are oscillograms showing the constitution of the secondary e.m.f.; (a) is an induced e.m.f. in the non-polarized core transformer; (b) the resultant e.m.f. of the two polarized core transformers; and (c) the resultant of the e.m.f.'s of the three transformers. The oscillograms were taken by the inventor at University College, London.

Fig. 21 shows an example displaying the construction of a static frequency transformer which is now being used for experiments in radio telephony in connection with a radio frequency current alternator of the Alexanderson type in the Electrical Engineering Laboratory of Tokio Imperial University. The principal electrical data of the transformer are as follows:

|                     |     |     |     |     |     |                 |
|---------------------|-----|-----|-----|-----|-----|-----------------|
| Primary capacity    | ... | ... | ... | ... | ... | 1.3 k.v.a.      |
| Primary frequency   | ... | ... | ... | ... | ... | 40,000 cycles.  |
| Secondary frequency | ... | ... | ... | ... | ... | 120,000 cycles. |
| Primary voltage     | ... | ... | ... | ... | ... | 260 volts.      |
| Secondary voltage   | ... | ... | ... | ... | ... | 120 volts.      |
| Primary current     | ... | ... | ... | ... | ... | 5 amperes.      |
| Secondary current   | ... | ... | ... | ... | ... | 3 amperes.      |

(Concluded.)

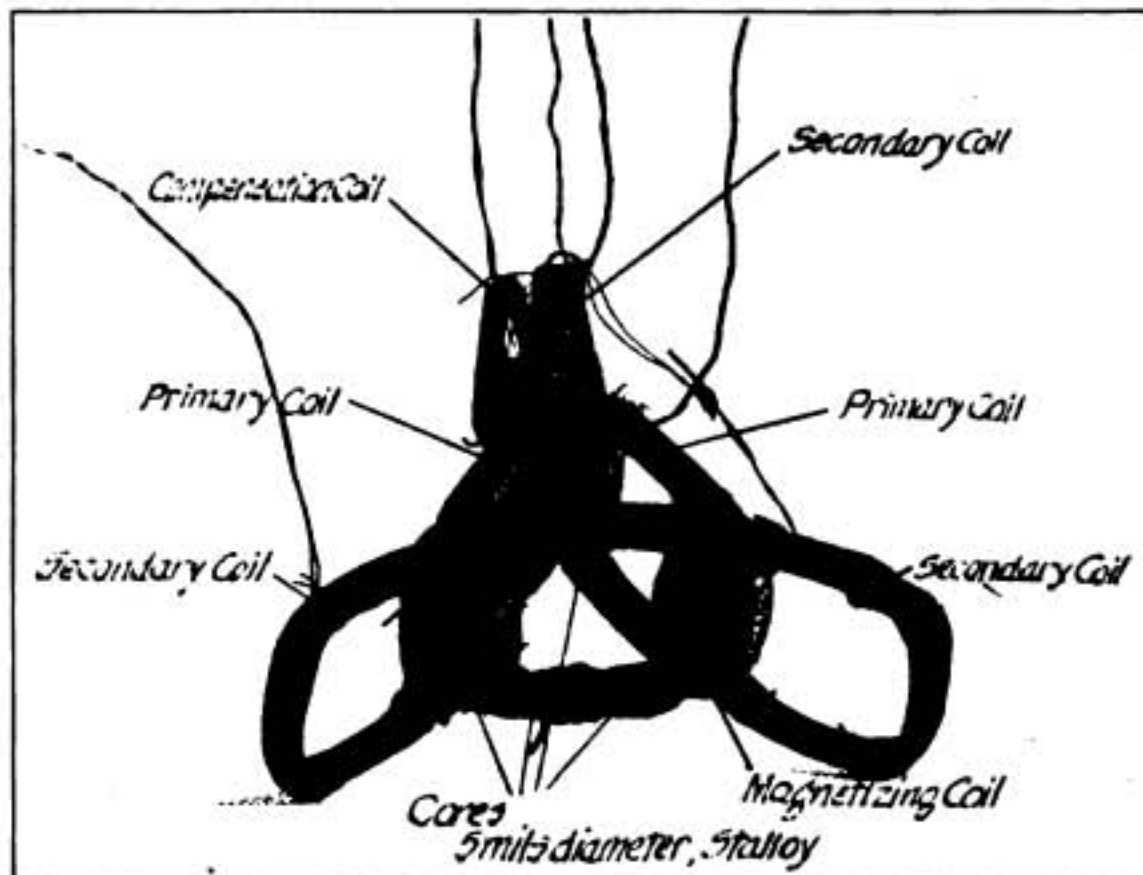

FIG. 21. STATIC TRANSFORMER WITH CASE REMOVED.



# Among the Operators

*The recording of the first five names brings the list of the brave operators who have lost their lives at sea by enemy action, in the wireless service of their country, to a close. Messrs. Slade and Bartlett have lost their lives through misadventure at sea, and the death of the remainder mentioned this month has been due to natural causes. Both on our own part, and on that of our numerous readers, we extend to the parents and relatives of these young men, who so nobly upheld the "wireless tradition," the deepest sympathy in their sad bereavement.*

MR. STANLEY OWEN LEWIS, formerly with Messrs. Evans & Evans, architects, of Pontypridd, was born in that town on May 24th, 1899, and educated at the intermediate school there. He was trained at the South Wales Wireless College, Ltd., Cardiff, and after gaining the P.M.G. Certificate, appointed to the operating staff in August, 1917.

Born at Greenwich on July 25th, 1900, MR. GEORGE HALTER was educated at Lombard Wall School, Charlton; South Church Hall School, Southend, and East Ham Technical College. After serving with the Western Electric Company, North Woolwich, as an instrument assembler, he trained at the East London Wireless Telegraph College, Forest Gate, E. He received the P.M.G. Certificate, and was given an appointment by the Marconi Company in May, 1917.

MR. ARTHUR HENRY JEFFRIES was born at Cambridge on April 24th, 1891, and went to St. George's School, Battersea, and St. Luke's School, Cambridge, for his education. Commencing his career as an apprentice to electrical engineering, with Messrs. B. Newton and Ward Brothers, of Cambridge, he attended the British School of Telegraphy, Ltd., London, and subsequently joined the Seaforth School of the Marconi Company. Mr. Jeffries's service dated from November, 1910.

Of London, MR. CLAUD CHRISTOPHER SELBY TUPPEN was born at Bayswater on December 8th, 1894. He received his education at Bedford Grammar School and the Royal Military College, Sandhurst. Attracted to wireless telegraphy, he trained at the British School of Telegraphy, Ltd., London, where he gained the P.M.G. Certificate. Mr. Tuppen was appointed to the Marconi Company's staff in April, 1916.

MR. WILLIAM JOSEPH MOLONEY was born at Limerick on July 6th, 1900. He was educated at the Munster and Connaught College, and received his training in radiotelegraphy at the Irish School of Telegraphy, Cahirciveen. On qualifying for the P.M.G. Certificate, Mr. Moloney was placed on the staff of the Marconi Company in May, 1918.

Looe, near St. Keyne, Cornwall, was the birthplace of MR. JAMES SLADE on December 21st, 1894. Commencing his education at Duloe Council School, he continued at Longmore Lane Council School, Liverpool. He was first employed by Messrs. Ellis Davies & Company, tea merchants, subsequently being trained in wireless telegraphy at the Liverpool Wireless Telegraph Training College. He won the P.M.G. Certificate, and joined the operating staff of the Marconi Company in August, 1914.

MR. GEORGE HENRY BARTLETT, born at Camberwell, London, on November 17th, 1899, was educated at St. Dunstan's College, Catford, and worked for his father's firm, Messrs. G. H. Bartlett & Company, export packing case manufacturers, of Hatton Wall, E.C. His wireless training was received at Marconi House School, and on receipt of the P.M.G. Certificate he proceeded to sea in the Marconi Company's service in December, 1917.

MR. FREDERICK ARTHUR ORMSON GUEST was born on June 9th, 1898, at Barnsley, and received his schooling there at the High School, Pannal Ash College,

# ROLL OF HONOUR.



Harrogate, and Wakefield Grammar School. He was employed by Messrs. John Guest & Sons, Ltd., Barnsley, in his father's office, leaving to take up wireless telegraphy. Trained at the Manchester Wireless Telegraph Training College, Mr. Guest qualified for the P.M.G. Certificate and entered the service of the Marconi Company in February, 1917.

Born on July 3rd, 1895, at Putney, MR. GEORGE WILLIAM GAGAN was educated at All Saints' Upper Grade School, Putney, the London County Council School at Hotham Road, and afterwards employed as an assistant to a printer's reader. Trained in wireless telegraphy at Marconi House School, he obtained the P.M.G. Certificate, and joined the Marconi Company's staff in August, 1915.

Formerly a leading telegraphist in the Royal Navy, MR. THOMAS GODFREY WRIGHT was born at Wimbledon on January 7th, 1872, and educated at Oakland Road School, Anerley, and Mitcham Road Board School, Croydon. He served His Majesty four years, when he was invalided, receiving very good discharge papers, and entered the Marconi service in December, 1912.

MR. PHILIP IVOR RYCROFT THOMAS was born on August 17th, 1900, at Clifton, near Bristol, and attended Redland Hill House School, Bristol, for his education. His training in radiotelegraphy was received at the East London Wireless Telegraph Training College, Forest Gate, E., and on gaining the P.M.G. Certificate, Mr. Thomas was placed on the Marconi Company's operating staff in June, 1917.

MR. ROBERT WILLIAM CROSSLEY was born at Castleton, near Rochdale, on January 10th, 1897, and pursued his studies at the Trinity Wesleyan Schools. He was a student at the Manchester Wireless Telegraph Training College, and on receipt of the P.M.G. Certificate was appointed a sea-going operator in April, 1916.

---

## The s.s. "George Washington"

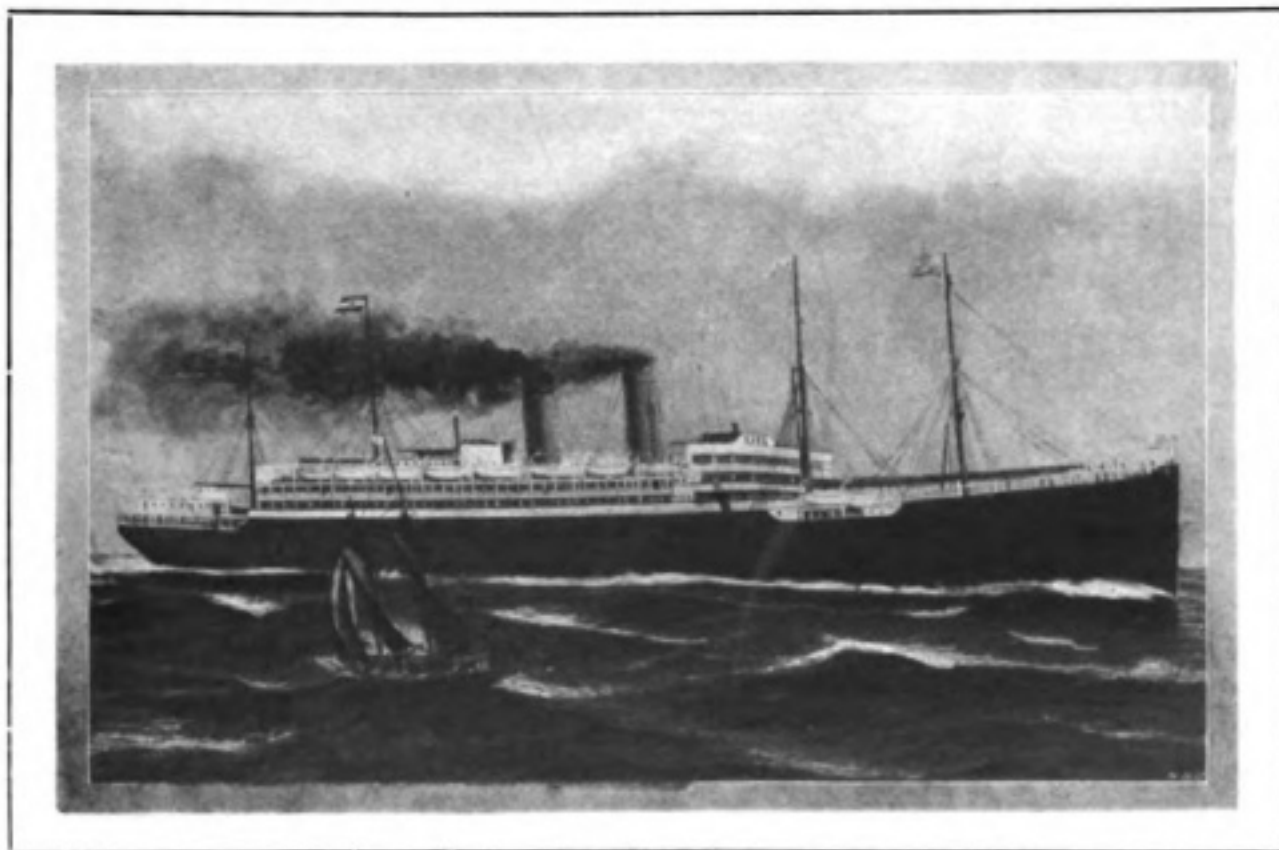

[Courtesy of "Syren and Shipping."]

THE VESSEL WHICH CARRIED PRESIDENT WILSON ACROSS  
THE ATLANTIC.

# Instructional Article

NEW SERIES (No. 10).

*EDITORIAL NOTE.*—Below we give the tenth of a new series of twelve *Instructional Articles* devoted to PHYSICS FOR WIRELESS STUDENTS. Although at first sight the subject of physics would not seem to have a very intimate connection with wireless telegraphy, yet a sound knowledge of this subject will be found of the greatest use in understanding many of the phenomena met with in everyday radiotelegraphy. As in previous series, the articles are being prepared by a wireless man for wireless men, and will therefore be found of the greatest practical value.

## THERMO-CHEMISTRY OF THE SIMPLE VOLTAIC CELL (Continued).

**Energy Transformations in the Voltaic Cell.**—If a piece of zinc is put into dilute sulphuric acid an exothermic \* action ensues; the metal disappears, hydrogen is evolved and zinc sulphate is formed. It is possible to equate the zinc and acid on the one hand to the products of the action on the other hand, thus:

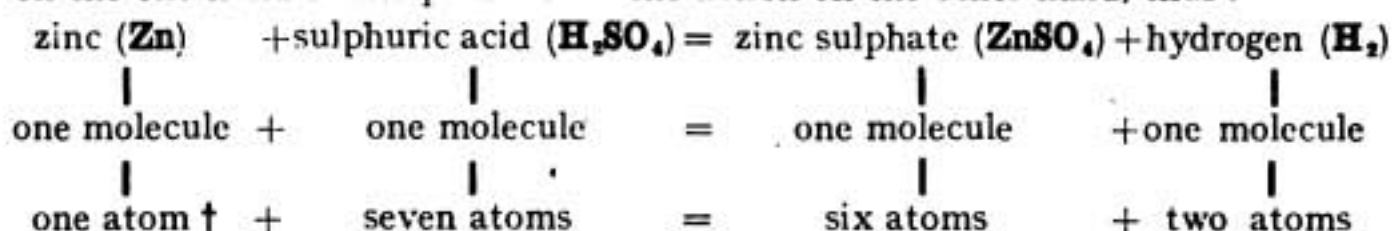

We begin with two molecules and have two molecules left; we begin with eight atoms and eight are left. As, however, we wish to take into consideration the evolved heat, we write the equation:

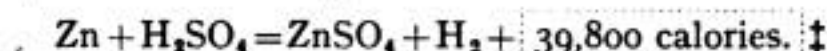

The third term on the right is the heat evolved during the formation of a **gramme-molecule** of zinc sulphate, where gramme-molecule is the molecular weight of zinc sulphate taken as grammes.

|                               |   |   |    |    |    |    |     |
|-------------------------------|---|---|----|----|----|----|-----|
| One molecule of zinc sulphate | { | 1 atom of zinc, of atomic weight            | .. | .. | .. | .. | 65  |
|                               |   | 1 atom of sulphur, of atomic weight         | .. | .. | .. | .. | 32  |
|                               |   | 4 atoms of oxygen, each of atomic weight 16 | .. | .. | .. | .. | 64  |
|                               |   |   |    |    |    |    | 161 |

Weight of one molecule of ZnSO<sub>4</sub> .. .. . 161  
 One gramme-molecule of ZnSO<sub>4</sub> = 161 grammes.

Now this heat energy, although not destroyed, is lost; it is not available for useful work and serves only to increase the temperature of the liquid and thus expedite the rate at which the chemical action proceeds. We cannot control it in the strict sense in which we control mechanical or electrical energy and it quickly passes beyond our reach. Now note that when zinc takes its place in our voltaic cell relatively very little heat is evolved in spite of the fact that precisely the same chemical action occurs. Indeed, if a plate of *chemically pure* zinc be used the temperature effect in the cell directly due to the formation of zinc sulphate is exceedingly small. It may well be asked, "But if the same exothermic action is

\* The action as a whole is exothermic. Actually, the separation of the (SO<sub>4</sub>) group from the hydrogen is endothermic, and this absorption takes place at the expense of the heat of the Zn—SO<sub>4</sub> combination. Hence, calories voltaically available = calories evolved minus calories absorbed.

† The zinc molecule is mon-atomic.

‡ Approximately.

there, what happens to the heat?" The reply is that *it is immediately set to work*, and that *where work is done energy is transformed*. For this heat energy of the chemical action in a voltaic cell performs work by causing the current to flow, or, as it is sometimes said, by forcing electricity up the potential slope from the zinc to the platinum. In other words, the heat is transformed into electrical energy.

Further, when the current passes through the circuit it does work with the result that another transformation of energy is effected, electrical energy being converted back into heat owing to the internal and external resistance.

We have now traced the potential energy through its various changes in a voltaic cell, and may draw the conclusion that the intensity of a cell depends upon the chemical action which is involved. The "life" of the cell depends mainly upon the amount of active material it contains—that is, upon the length of time for which the essential chemical action can continue; but it is the amount of heat available to be transformed which, together with the temperature of the cell, decides its E.M.F. From this it would seem that it should be possible to build a cell with a very high E.M.F. by selecting those materials which would give a chemical action of high thermal value. Unfortunately the fact is that up to the present no voltaic cell giving an E.M.F. of much more than two volts has been produced. It is true that there are very many exothermic actions which correspond *in theory* to a much higher E.M.F., but in such cases the heat evolved is unavailable for transformation by voltaic means. For instance, when a mixture of iron oxide and powdered aluminium\* is burned the heat evolved corresponds to a temperature of about 3,000 deg. C., but such an action cannot be turned to account in a voltaic cell.

#### CALCULATION OF E.M.F. OF CELL FROM THERMO-CHEMICAL DATA.

If we know the heat value of the chemical action which goes on in a voltaic cell we can calculate the E.M.F., though for very accurate work due account has also to be taken of the *temperature coefficient*, which is a ratio representing the rate of change of the E.M.F. with respect to the absolute temperature of the cell. To avoid the introduction of a mathematical idea not hitherto mentioned in these articles we will ignore the temperature coefficient.

Taking the case of our simple zinc-platinum cell, we know that 39,800 calories are evolved during the formation of one gramme-molecule of  $ZnSO_4$ , or what amounts to the same thing, during the solution of 65 grammes of zinc (*see p. 578*) in sulphuric acid. Therefore, the heat value of the solution of one gramme of zinc is  $39,800 \div 65 =$  (say) 613 calories. We also know that if one ampere flows through the cell for one second .000338 grammes of zinc are dissolved,† so that the amount of heat corresponding to the solution of this weight of zinc is  $613 \times .000338$  calories.

One calorie is the equivalent of  $4.2 \times 10^7$  ergs; hence the energy of the solution of .000338 grammes of zinc can be written

$$E = 613 \times .000338 \times 4.2 \times 10^7 \text{ ergs.}$$

This corresponds to the passage of one coulomb. Now if when one coulomb passes the work done is one joule (or  $10^7$  ergs) the p.d. is one volt. Hence we may write

$$\begin{aligned} E \text{ (in volts)} &= \frac{613 \times .000338 \times 4.2 \times 10^7}{10^7 \text{ (or 1 joule)}} \\ &= .87 \text{ volts.} \end{aligned}$$

As a general formula the following is applicable, though it does not take into account the temperature:

$$E \text{ (in volts)} = \frac{h z J}{10^8},$$

\* The trade name of this mixture is Thermit.

† Because the electrochemical equivalent of Zn is .00338 per e.m. unit, and therefore one tenth of this value per ampere—*i.e.*, .000338.

where  $h$  is the heat evolved in the cell during the solution of one gramme of  $Zn$ ,  $z$  the electrochemical equivalent of zinc, and  $J$  the equivalent of heat in ergs.

### CHEMICAL NAMES, SYMBOLS AND FORMULÆ.

The following table is not a full list of known elements, such substances as gadolinium, neodymium and other rare metals having been omitted because, apart from the subject of the Periodic Classification, they appear to be of small interest or utility. The weights of the atoms compared with the oxygen atom, which is taken as 16, are approximate:—

| Name.                           | Symbol.   | Atomic Weight. | Name.                           | Symbol.   | Atomic Weight. |
|---------------------------------|-----------|----------------|---------------------------------|-----------|----------------|
| Aluminium ...                   | <i>Al</i> | 27.1           | Molybdenum ...                  | <i>Mo</i> | 96             |
| Antimony ( <i>Stibium</i> ) ... | <i>Sb</i> | 120.2          | Neon ...                        | <i>Ne</i> | 20             |
| Argon ...                       | <i>Ar</i> | 39.9           | Nickel ...                      | <i>Ni</i> | 58.7           |
| Arsenic ...                     | <i>As</i> | 75             | Nitrogen ...                    | <i>N</i>  | 14             |
| Barium ...                      | <i>Ba</i> | 137.4          | Osmium ...                      | <i>Os</i> | 191            |
| Beryllium ...                   | <i>Be</i> | 9.1            | Oxygen ...                      | <i>O</i>  | 16             |
| Bismuth ...                     | <i>Bi</i> | 208.5          | Palladium ...                   | <i>Pd</i> | 106.5          |
| Boron ...                       | <i>B</i>  | 11             | Phosphorus ...                  | <i>P</i>  | 31             |
| Bromine ...                     | <i>Br</i> | 79.96          | Platinum ...                    | <i>Pt</i> | 194.8          |
| Cadmium ...                     | <i>Cd</i> | 112.4          | Potassium ( <i>Kalium</i> ) ... | <i>K</i>  | 39.1           |
| Caesium ...                     | <i>Cs</i> | 132.9          | Radium ...                      | <i>Rd</i> | 225            |
| Calcium ...                     | <i>Ca</i> | 40.1           | Rubidium ...                    | <i>Rb</i> | 85.5           |
| Carbon ...                      | <i>C</i>  | 12             | Selenium ...                    | <i>Se</i> | 79.2           |
| Cerium ...                      | <i>Ce</i> | 140.2          | Silicon ...                     | <i>Si</i> | 28.4           |
| Chlorine ...                    | <i>Cl</i> | 35.4           | Silver ( <i>Argentum</i> ) ...  | <i>Ag</i> | 107.9          |
| Chromium ...                    | <i>Cr</i> | 52.1           | Sodium ( <i>Natrium</i> ) ...   | <i>Na</i> | 23             |
| Cobalt ...                      | <i>Co</i> | 59             | Strontium ...                   | <i>Sr</i> | 87.6           |
| Copper ( <i>Cuprum</i> ) ...    | <i>Cu</i> | 63.6           | Sulphur ...                     | <i>S</i>  | 32             |
| Fluorine ...                    | <i>F</i>  | 19             | Tantalum ...                    | <i>Ta</i> | 183            |
| Gold ( <i>Aurum</i> ) ...       | <i>Au</i> | 197.2          | Tellurium ...                   | <i>Te</i> | 127.6          |
| Helium ...                      | <i>He</i> | 4              | Thallium ...                    | <i>Tl</i> | 204            |
| Hydrogen ...                    | <i>H</i>  | 1.008          | Thorium ...                     | <i>Th</i> | 232            |
| Iodine ...                      | <i>I</i>  | 126.9          | Thulium ...                     | <i>Tm</i> | 171            |
| Iridium ...                     | <i>Ir</i> | 193            | Tin ( <i>Stannum</i> ) ...      | <i>Sn</i> | 119            |
| Iron ( <i>Ferrum</i> ) ...      | <i>Fe</i> | 55.9           | Titanium ...                    | <i>Ti</i> | 48             |
| Krypton ...                     | <i>Kr</i> | 81.8           | Tungsten ...                    | <i>W</i>  | 184            |
| Lead ( <i>Plumbum</i> ) ...     | <i>Pb</i> | 206.9          | Uranium ...                     | <i>U</i>  | 238.5          |
| Lithium ...                     | <i>Li</i> | 7.03           | Vanadium ...                    | <i>V</i>  | 51.2           |
| Magnesium ...                   | <i>Mg</i> | 24.3           | Zinc ...                        | <i>Zn</i> | 65             |
| Manganese ...                   | <i>Mn</i> | 55             | Zirconium ...                   | <i>Zr</i> | 90.5           |
| Mercury ( <i>Hydrargyrum</i> )  | <i>Hg</i> | 200            |                                 |           |                |

In most cases where the derivation of the symbol from the name is not apparent, the Latin name has been added. For example, it is difficult to see why tin is given the symbol Sn unless the Latin name for tin, *Stannum*, is shown.

An examination of the accompanying list of elements will show that they have not been named in accordance with any strict system. Some of them were known centuries ago and their names are connected with legends or are descriptive of some property they possess or were thought to possess. Oxygen, for example, was thought to be a constituent of all acids and therefore was named from the Greek *oxys* (acid) and the root *gen* (to generate). The word hydrogen is made up from *hyd-r* (water) and *gen* (to generate), whilst phosphorus is derived from *phos* (light) and *pherō* (to bring). Magnesium is named after the place from whence magnesia was obtained, Magnesia, in Asia Minor. Copper is called Cuprum, a name derived from *aes cyprium* (Cyprus ore), so called because it was dug in Cyprus.

With regard to some of the more modern names an attempt has been made to systematise them, so that in order to distinguish between the non-metallic elements and the metals the latter have been designated by words terminating in the syllable *-um*. In the case of selenium and tellurium it may be noted that their names received this termination because these elements were formerly considered to be metals; they are now classed as metalloids.

When we come to the names of compounds we find a much better state of things. In view of the enormous number of known compounds a generally recognised system of nomenclature is absolutely essential if confusion is to be avoided, and accordingly chemists have evolved names which indicate the *composition* of compounds, not only by combining the names of the constituent elements but by using an understood system of prefixes and final syllables of definite meaning.

In the case of **binary compounds**, that is, compounds made up of two elements, the names of the elements are simply brought together as in the following examples :

|                                      |     |     |                   |
|--------------------------------------|-----|-----|-------------------|
| Potassium combined with iodine       | ... | ... | Potassium iodide. |
| Calcium           "       "   oxygen | ... | ... | Calcium oxide.    |
| Sodium           "       "   bromine | ... | ... | Sodium bromide.   |

It does not follow because two elements combine with each other that the resulting binary compound is always the same in composition, because some elements *will combine in different proportions*. For example, carbon combines with oxygen in the proportion of one atom of carbon to one atom of oxygen, forming carbon **monoxide**, a gas which may often be seen burning with a blue flame on the surface of a coke fire in a grate with an insufficient draught. Yet an atom of carbon will also combine with *two* atoms of oxygen, forming carbon **dioxide**, a gas of quite different nature, being non-inflammable. Again, an atom of phosphorus combines with three atoms of chlorine, forming phosphorus **trichloride**, and also with five atoms of chlorine, forming phosphorus **pentachloride**. Sometimes phosphorus trichloride is called **phosphorous** chloride, and phosphorus pentachloride is called **phosphoric** chloride, denoting respectively which compound contains the lesser and which the greater number of chlorine atoms.

When an element combines with oxygen the binary compound which results is called an **oxide**. *With the exception of hydrogen every non-metallic element will form an oxide which will combine with water to produce an acid*. Such acids are termed **oxyacids** and the oxides from which they are derived are called **anhydrides** or acid-forming oxides. Some elements will combine with oxygen in more than one proportion forming more than one anhydride, and to distinguish between two oxyacids which are formed from two anhydrides containing the same non-metallic elements but different amounts of oxygen, the syllables *-ous* and *-ic* are employed.

*Examples :—*

(1) **Oxides.**

|   |     |     |     |                         |
|---|-----|-----|-----|-------------------------|
| Mercury and oxygen                          | ... | ... | ... | Oxide of mercury.       |
| 1 atom of mercury and 1 atom of oxygen      | ... |     | ... | <b>Mercuric</b> oxide.  |
| 2 atoms       "       "   1       "       " | ... |     | ... | <b>Mercurous</b> oxide. |

Note that the same *-ous* and *-ic* principle is applied also to distinguish between two compounds containing different amounts of a metallic element. Mercurous oxide is a very good example of an unstable compound ; the extra mercury atom is so feebly attached to the system that on exposing the substance to light it breaks up into the stable mercuric oxide and mercury.

(2) **Anhydrides.**

|                                       |     |                           |
|---------------------------------------|-----|---------------------------|
| Sulphur (1 atom) and oxygen (2 atoms) | ... | Sulphur <b>dioxide</b> .  |
| Sulphur (1 atom) and oxygen (3 atoms) | ... | Sulphur <b>trioxide</b> . |

(3) **Oxyacids.**

|                                   |     |     |                          |
|-----------------------------------|-----|-----|--------------------------|
| Sulphur <b>dioxide</b> and water  | ... | ... | Sulphur <b>ous</b> acid. |
| Sulphur <b>trioxide</b> and water | ... | ... | Sulphur <b>ic</b> acid.  |

There are other oxides, derived in every instance from a metallic element, which combine with water to form **hydroxides** ; these compounds all combine with acids

to form **salts** and the oxides producing these hydroxides are therefore known as **basic or salt-forming oxides**.

*Example :—*

|   |     |     |     |     |   |
|---|-----|-----|-----|-----|---|
| Calcium and oxygen                      | ... | ... | ... | ... | Calcium <b>oxide</b> (lime).                  |
| Calcium oxide and water                 | ... | ... | ... | ... | Calcium <b>hydroxide</b> (slaked lime).       |
| Calcium hydroxide and hydrochloric acid | ... | ... | ... | ... | Calcium chloride ( <b>a salt</b> ) and water. |

A certain number of acids contain oxygen—not all, as formerly believed—but the characteristic common to all acids is that they contain hydrogen. The four non-metallic elements, chlorine, bromine, fluorine and iodine, constitute a group called the halogen\* group, each member of which produces an acid when combined with hydrogen. Being binary compounds these acids are called respectively, hydrochloric acid, hydrobromic acid, hydrofluoric acid and hydriodic acid. They produce salts which are also binary compounds and the names of these follow the usual rule.

*Examples :—*

|                      |     |     |     |     |                   |
|----------------------|-----|-----|-----|-----|-------------------|
| Potassium and iodine | ... | ... | ... | ... | Potassium iodide. |
| Sodium and bromine   | ... | ... | ... | ... | Sodium bromide.   |

Many elements will combine with sulphur to form binary compounds called **sulphides**, some of which, analogous to oxides, will form acids resembling the oxyacids in constitution, except that sulphur takes the place of oxygen; these acids are called **thio acids**. "Hypo," so largely used in photography, is thio-sulphate of sodium, a **thio salt**.

The system of naming compounds which are not binary is as follows. The first part of the name is just the name of the metallic part of the base; thus if the base is oxide of copper, the first part of the name of a copper salt is the name of that metal. The second part is a combination of the name of the acid with which the base is treated and either of the syllables **-ate** or **-ite**. If the name of the acid ends in **-ic** the name of the salt formed ends in **-ate**; if the name of the acid used ends in **-ous** then the syllable **-ite** is suffixed to the name of the salt.

*Examples :—*

|  |    |            |    |    |           |
|--|----|------------|----|----|-----------|
| The basic oxide and nitric acid produce a <b>nitrate</b> . |    |            |    |    |           |
| ..   | .. | nitrous    | .. | .. | nitrite.  |
| ..   | .. | sulphuric  | .. | .. | sulphate. |
| ..   | .. | sulphurous | .. | .. | sulphite. |

When chemical action occurs between a base and an acid, such as between zinc and sulphuric acid, it is found that a certain number of the hydrogen atoms of the acid are replaced by a certain number of metallic atoms from the base; in the particular case given one atom of zinc displaces two atoms† of hydrogen. It is not possible to replace *all* the hydrogen of *every* acid by metallic atoms and therefore those acids which contain only one atom of replaceable hydrogen are called **monobasic** acids. Following the same system the words **di-basic**, **tri-basic** and **tetra-basic** are used to describe acids containing respectively two, three, and four atoms of hydrogen which can be replaced by metallic atoms. Sulphuric acid is dibasic, nitric acid and hydrochloric acid are monobasic, whilst orthophosphoric acid is tribasic. Although an acid may be, for example, dibasic it does not necessarily follow that all the hydrogen atoms are replaced in a given action by metallic atoms. If they *are* all replaced

\* Meaning "producer of sea-salt." So called because the compounds formed by sodium with these elements in some ways resemble sea-salt.

†  $Zn + H_2SO_4 = ZnSO_4 + H_2$



the resulting salt is called a **normal salt**; on the contrary, if the metal replaces only a certain number of hydrogen atoms and leaves some undisturbed the salt is styled an **acid salt**.

*Example* :—Sulphuric acid ( $H_2SO_4$ ) is dibasic and the metallic element sodium will replace either one or both of the hydrogen atoms, giving in the first case **acid sodium sulphate** ( $NaHSO_4$ ) and in the second case **normal sodium sulphate** ( $Na_2SO_4$ ).

### Chemical Symbols and Formulæ.

The symbols allotted to the elements are in some cases the first letter of their names—hydrogen, H, carbon, C, sulphur, S, and so on. In instances where the names of two or more elements begin with the same letter they are distinguished by symbols composed of the initial letter and the second, or in some cases by the initial and third letters. A glance at the table of elements will suffice to show the method which has been adopted.

Chemical formulæ are more than a mere indication of the composition of particular substances, for they show the *proportions* in which the atoms have combined. The symbol representing any element is understood to denote *one atom* of that element. Thus  $Zn$  means "one atom of zinc" and  $O$  means "one atom of oxygen." In order to represent a *molecule* of an element we must consider the number of atoms which compose it; this number is written as a subscript to the symbol. A molecule of zinc contains only one atom and might be written  $Zn_1$ , but it has been agreed that in cases of monatomic molecules the figure 1 shall *not* be written; hence the symbol  $Zn$  may be taken to mean "one molecule of zinc composed of one atom." Oxygen is di-atomic and therefore to represent its molecule we write  $O_2$ , whilst ozone, its allotrope, is  $O_3$ . In some formulæ the student will find elements whose molecules consist of more than one atom *represented by only a single atom*, such as in  $NaHSO_4$ ; knowing that the hydrogen molecule is di-atomic he may wonder why  $H$  is allowed to be shown as an atom by itself. Of course, it is not actually alone although it is but a single atom. The molecule is the smallest particle of a substance *which can exist in a free state*, but the hydrogen in  $NaHSO_4$  is *not* free but combined with oxygen, sulphur and sodium.

Turning to the question of compounds, the same rules apply. An example already familiar to us is that of sulphuric acid, the formula for which is  $H_2SO_4$ ; this denotes "one molecule of sulphuric acid composed of seven atoms, namely, two of hydrogen, one of sulphur and four of oxygen." On examining this formula the reader may think it strange that we speak of it as being *one* molecule when, if  $O_2$  constitutes a molecule, there are *two* molecules of oxygen present, not to mention the one molecule of hydrogen ( $H_2$ ) and the odd sulphur atom. The answer to this difficulty is that we are now dealing with oxygen *in combination with other elements*, a very different thing to *free* oxygen, for its identity is merged in that of the acid and we cannot assume that its atoms stand in the same relation to each other or have the same motions as when in the free state. Free oxygen is gaseous but the oxygen in sulphuric acid does not display the properties of a gas; and free sulphur is yellow but the sulphur in the acid is not. It is true that in a molecule of  $H_2SO_4$  there is *sufficient matter* to make up two molecules of oxygen, yet it should be easy to see that unless those four atoms are free from other elements and divided into two groups each one consisting of two atoms combined with each other in a particular manner, they can as little be regarded as two *molecules* as can a stack of bricks be regarded as a church. The same holds good in the case of the two atoms of hydrogen. It is the complete combination of the *seven* atoms which is the true molecule. If we liken two molecules of oxygen to a simple structure composed of four bricks we can compare the  $H_2SO_4$  molecule to a more pretentious building, to help to build which the bricks of the simpler building have been pulled apart and used.

To denote more than one molecule of a substance the necessary figure is placed before the symbol or formula.

|       |           |    |                |     |         |     |     |     |            |
|-------|-----------|----|----------------|-----|---------|-----|-----|-----|------------|
| Two   | molecules | of | oxygen         | are | written | ... | ... | ... | $2O_2$     |
| Two   | "         | "  | zinc           | "   | "       | ... | ... | ... | $2Zn$      |
| Four  | "         | "  | hydrogen       | "   | "       | ... | ... | ... | $4H_2$     |
| Two   | "         | "  | sulphuric acid | "   | "       | ... | ... | ... | $2H_2SO_4$ |
| Three | "         | "  | zinc sulphate  | "   | "       | ... | ... | ... | $3ZnSO_4$  |
| Four  | "         | "  | water          | "   | "       | ... | ... | ... | $4H_2O$    |

Remember that the figure *in front* of a formula applies equally to all the symbols ; thus  $4H_2O$  does **not** mean  $(4 \times 2)$  atoms of hydrogen combined with one atom of oxygen but **four molecules** of water each of the composition  $H_2O$ —a total, therefore, of **twelve atoms**—*i.e.*,  $(4 \times 2) = 8$  atoms of hydrogen and  $(4 \times 1) = 4$  atoms of oxygen.

Certain instances are known in which a group of atoms in a molecule appear to be capable of acting as a single atom, that is, they seem to cling together during some chemical actions and act *as a group* in the same way as a single atom would. In such cases the symbols of the group are enclosed in brackets.  $(NH_4)_2SO_4$  is the formula for **ammonium sulphate**, the figure 2 outside the brackets showing that there are two of these "compound atoms"—a phrase which is permissible only to express the peculiar behaviour of the  $(NH_4)$  group. The whole molecule contains fifteen atoms—*i.e.*, 2 of  $N$ , 8 of  $H$ , 1 of  $S$  and 4 of  $O$ . **Normal ammonium carbonate** is represented by  $(NH_4)_2CO_3$ . When this salt is exposed to air it decomposes into **hydrogen ammonium carbonate** and ammonia, the equation being—

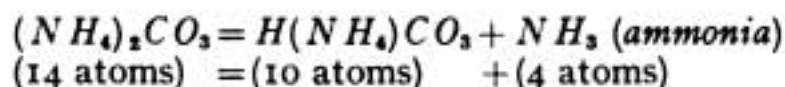

In this case, in accordance with the conservation law no atoms are made or destroyed, but a complex molecule splits up into two simpler ones. When normal ammonium carbonate is gently heated it decomposes much more completely into ammonia, carbon dioxide and water, four fairly simple molecules, as may be seen from the equation which is

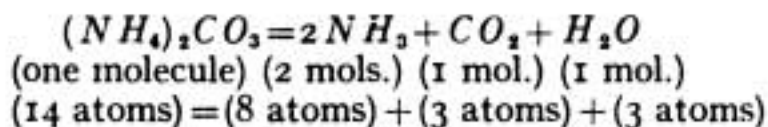

Ammonium sulphocyanate is written  $NH_4S(CN)$ , which signifies that an atom of carbon and an atom of nitrogen seem to act together as one atom. We will give one more example of a formula containing the sub-group  $(CN)$ , for in an earlier article\* we referred to the conversion of ammonium cyanate into urea by the application of heat and pointed out that by the mere re-arrangement of the atoms in the molecule a substance is obtained differing greatly from the original. The equation of this remarkable action is as follows :—

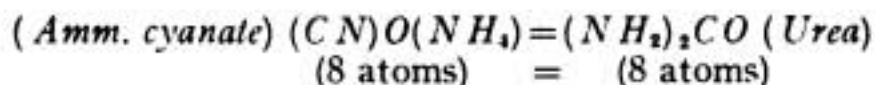

Here we have the same number of molecules (one) after the action as before it, and the very same atoms, yet a drastic alteration of the formula. This example is important not only because it presents a typical form of chemical action but also because it was the first case of the production of an animal compound by what may be termed artificial means.

\* THE WIRELESS WORLD (November, 1918).

# The Library Table

nicola



*STANDARD TABLES AND EQUATIONS IN RADIOTELEGRAPHY.* By Bertram Hoyle, M.Sc. Tech., A.M.I.E.E. London: The Wireless Press, Ltd. 9s. net.

Wireless telegraphy has now fortunately reached a stage when a vast amount of detailed information is available to the engineer and designer. The rule of thumb methods and the old tedious ways of trial and experiment in arriving at, for example, capacity and inductance values have long since been displaced by accurate formulæ, and it can safely be said that nine-tenths of the calculations of a modern wireless station of any power can be worked out with the certainty of accurate results. Whilst all the information necessary for such calculations is available to those who seek it, it has only now been brought together within the covers of a single volume, and Mr. Bertram Hoyle is to be congratulated upon the excellent way in which he has fulfilled his task.

There are a number of points in the general arrangement of the book to which we would like to draw the reader's attention. Firstly, we have in the case of some of the more difficult expressions a number of worked examples which will be particularly welcomed by those who are not well versed in the use of such equations, while a special point has been made in giving in every paragraph dealing with an equation a list of the meanings and units used in that equation. As is pointed out in the introduction, this has enabled the author to maintain the identity of the symbols and their meanings as used in certain equations of different authors, thus facilitating back reference to the originals when required. Secondly, the major portion of the extremely useful tables until now printed in *The Year Book of Wireless Telegraphy and Telephony* are included in the present book, together with numerous others abstracted intact from other sources or modified to suit the particular requirements of the present work, while several others are computed by the author himself especially for the volume.

The book opens with a lengthy and carefully compiled table of contents, which will greatly facilitate a search for information and save a great deal of time which would otherwise be spent in going through the main index.

In the first part of the book we find a number of generally useful formulæ and equations, followed by logarithmic and trigonometrical tables. Next follows a table of functions E and B used in calculating aerial capacity by Professor Howe's formulæ, followed by a table of function Q for use in Lorenz's equation  $L_s = an^2Q$  cms., and a number of other tables of constants drawn from various sources. We then find some highly useful wire tables for copper, aluminium and resistance wires, together with tabular information on the effective resistance of copper wires carrying high-frequency currents of various frequencies. Space does not permit of our mentioning even a fraction of the total number of these formulæ and equations,

c

and in fact an adequate review could only be given by quoting practically the whole of the table of contents. In addition to purely "wireless" information, a great deal of useful matter has been included of particular interest to engineers, such as wire gauges, screw threads, nuts and bolts, screw threads for gas and water pipes, pipe bends and tees, conversion charts for temperatures and so forth. It is worth while to draw attention to the "Notes on Elementary Arithmetic for Operators," wherein are contained a number of contracted methods of calculation of practical interest to many people other than operators.

"Indispensable" is a much abused word, particularly in regard to books, but we think that it can safely be claimed as an accurate designation of the work before us, which should be found upon the bookshelf of every wireless engineer, research worker and serious amateur.

*THE L. S. D. OF FLYING AND THE PERMANENT WAY OF THE AIR.*

*By Captain A. Swinton. London: The Aeroplane and General Publishing Co., Ltd. 6s. net.*

This book, which happily appeared at a time when hostilities had ceased, is an attempt to place before the public the commercial side of peace time aviation and to educate the man in the street in the matter of the commercial aspect of flying. The subject being very much "in the air," it is inevitable that the author should draw largely upon his imagination for the figures given, and we have no doubt that many will be found to disagree with some of the statistical statements. This, however, is inevitable in any such pioneer work, and as only actual experience gives us some reliable figures, we must, of course, accept theoretical "approximation."

Chapter I, entitled "The Uses of the Flying Machine," contains a general survey of the subject, and, although we think that several of the author's arguments are laboured and set out to prove what is already generally accepted, it will nevertheless serve to remove many misconceptions. In passing, we may mention that on page 15 the author thinks he has coined a new word, "aerogram." We would point out that this word was coined many years back in the United States by a commercial wireless telegraph company, and was printed in large letters upon the top of every one of their telegraph forms. In addition to this, the word is in common use by journalists in the United States as a variation on marconigram, and its introduction as a word describing a message carried by aeroplane is therefore not to be encouraged.

Chapter II—"A Glance Backwards"—is purely historical and seems a little out of place in this volume, save for the few paragraphs at the end dealing with aviation immediately prior to the war. Elementary technicalities and types of machine are dealt with in Chapter III, and a special word of commendation is due to the excellent illustrations. Further chapters deal with trade considerations, the "Permanent Way" and its cost, running costs, the mails of the world, and the State and flying. In the chapter on permanent way cost very detailed estimates are given, and it is here particularly that criticism will be directed by many readers. For example, in a consideration of a London-to-Sydney scheme, where most of the flying is oversea, we find figures worked out for 60 alighting and refilling stations, land—two acres each—is estimated to cost £5 per acre, and this multiplied by 60 gives the total cost of land as £600. We do not know on what the author has based his estimate in this matter, but seeing that the aerodromes will naturally require to be as near as possible to commercial centres, and seeing that there will be great competition for suitable sites, the figure of £600 for the land would seem to be a long way out. Similarly the cost for sheds, quarters, slipway, motor launches, searchlight and wireless accommodation is estimated at £3,000 per station, which seems to us to be very much on the low side. Many other of the detailed estimates are open to similar criticism, and when we consider that each one of the items, and

consequently the possible error, is multiplied by 60, the approximate total is so unreliable as to be absolutely useless.

Many of the problems to be met with in commercial aviation are passed over quite lightly, and we are much interested in the author's statements under the heading of "Fog." "With regard to the question of fog," says Mr. Swinton, "the author does not think that this is such a very serious matter. Aeroplanes are to be directionally controlled by wireless; when this control is brought to the pitch of exactitude required, it will not be necessary for the pilot to see his way, as he will be automatically steered from point to point by a system of radio-telegraphy; these waves would not be materially affected by fog or by rain or by any other conditions of the atmosphere. It is probable that collisions will be avoided by the same means. The question therefore of being able to see does not appear to matter as much as one might think." On this quotation comment seems needless!

Chapter IX, which deals with the "Aerial Ford" and the "Aerial Taxi," endeavours to establish a parallel between the Ford car and the aeroplane in regard to quantity production. Having explained that Mr. Ford made it possible to buy a reliable fully equipped five-seated motor-car for the sum of £125, when previously no car of a similar performance could be bought anything like so inexpensively, the author goes on to say that if such cars can be produced so cheaply there is no reason why the cost of aeroplanes should not be brought down in the same proportion. We think this argument is based on a fallacy. A great deal of the success of the Ford car has been due, as Mr. Swinton points out, to simplicity and cheapness of construction as opposed to beauty and æsthetic distinction, but it must not be forgotten that the interchangeability of parts and the possibility of obtaining replacements for broken parts in practically any town has also contributed to its commercial success. Let us, however, consider the case of an aeroplane. "Finish" on a motor car may be a luxury. If the non-wearing portions of the axle are rough or smooth this makes no difference to the speed at which the car will run or its liability to break down; "finish" on an aeroplane may make all the difference to speed, and the difference between a rough and a smooth strut may mean the difference between an inefficient and efficient machine. The high degree of efficiency in a modern aeroplane is undoubtedly due to handwork, and the careful tests which have to be applied to even the most minute portion of the machine must militate against the success of quantity production. There is all the difference in the world between a breakdown on the road and a breakdown in the air. In the one case it means but temporary inconvenience and delay; in the other it would probably mean death and destruction to crew and machine.

In spite of its faults, however, the book is to be welcomed as a courageous attempt to tackle problems which must be faced sooner or later, and at this time when the newspapers so frequently publish accounts of commercial flying schemes, it is well that we should have a work of this nature to stimulate our thoughts.

---

## Share Market Report

LONDON, *December 12th*, 1918.

BUSINESS fell off considerably in the shares of the Marconi groups during the last month in sympathy with other markets. In spite of this the prices are fairly steady. Marconi Ordinary, £4 12s. 6d.; Marconi Preference, £3 12s. 6d.; Marconi International Marine, £3 10s.; Canadian Marconi, 13s. 6d.; American Marconi, £1 11s. 3d.; Spanish and General, 14s. 6d.

# Personal Notes

## PROMOTION.

LIEUTENANT G. FERNEY STEVEN, of Berwick, mentioned in despatches for services in the field, has been promoted Captain. He joined up at the commencement of hostilities, being then seventeen years of age, leaving his studies at the Royal High School, Edinburgh, for the purpose. When trained, he qualified as a First-Class Army Signaller, and was attached to the Lothian Brigade Signal Section. Later he was gazetted Second Lieutenant in the Northumberland Fusiliers, and subsequently transferred to the Wireless Training Centre, Worcester, qualifying there as Wireless Officer, R.E. Captain Steven is the younger son of Major Steven, T.D., editor of the *Berwick Journal*, and served for two years in France.

## MATRIMONIAL.

A pretty ceremony was witnessed at St. John's Church, Newlands, near Hull, on October 24th last, when the marriage of MR. SYDNEY STANSBRIDGE and Miss Doris May Cragg, of Hull, was solemnised. Inspector Stansbridge, who is acting as representative of the Marconi International Marine Communication Co., Ltd., at Hull, and his bride received as a wedding gift a pair of silver castors and a combination breakfast dish, with the congratulations and hearty good wishes of his colleagues.

On November 2nd, at Oakfield Baptist Chapel, Sale, Cheshire, the wedding took place of MR. SILVIO CALVIN ANSELM, one of Marconi's Wireless Telegraph Company's engineers, and Miss Doris Mary Battersby, of Sale. Mr. Anselmi has during the past three years been engaged on naval installation work in Spain, and recently returned to headquarters. Another of the Company's engineers, Mr. W. B. Cole, officiated at the organ.



MR. AND MRS. S. C. ANSELM.

# Questions & Answers

**NOTE.**—This section of the magazine is placed at the disposal of all readers who wish to receive advice and information on matters pertaining to both the technical and non-technical sides of wireless telegraphy. Readers should comply with the following rules: (1) Questions should be numbered and written on one side of the paper only, and should not exceed four in number. (2) Queries should be clear and concise. (3) Before sending in their questions, readers are advised to search recent numbers to see whether the same queries have not been dealt with before. (4) The Editor cannot undertake to reply to queries by post. (5) All queries must be accompanied by the full name and address of the sender, which is for reference, not for publication. Queries will be answered under the initials and town of the correspondent, or, if so desired, under a "nom-de-plume." (6) During the present restrictions the Editor is unable to answer queries dealing with many constructional matters, and such subjects as call letters, names and positions of stations.

J. L. (Helensburgh).—(1) At the present time the Marconi Company are not accepting learners, but only men who are in possession of the Postmaster-General's first-class certificate. (2) This is answered in one. (3) This depends on your telegraph speed, but, assuming that at the time you sat for the examination your speed was only just sufficient to pass for the second-class certificate, and supposing that you apply yourself diligently under suitable instruction, the time taken should be, roughly, from two to three months.

F. H. F. (H.M.S. —).—We do not know from what source you gathered the totally erroneous information given in your letter that discharged naval operators will not be accepted for the Marconi service on the grounds that, after being on the lower deck of a warship, his social position would not be good enough. Candidates for the Marconi service are accepted purely on their own personal merits and knowledge. Snobbery of this nature had, we thought, been killed by the war; certainly it has no influence upon the selection of wireless operators for the Marconi service.

ERB. (Bardon Hill).—The instruction you have received and the knowledge you state you possess would considerably shorten the period it would be necessary for you to spend in a wireless school in order to obtain your P.M.G. first-class certificate. As mentioned in our reply to J. L. (Helensburgh) above, at the present time the Marconi Company are not accepting learners, and, therefore, if you wish to enter their service as a wireless operator, it will be necessary for you to obtain a first-class certificate, and place your name on their waiting list.

V. M. A. (Brocton).—(1) The Marconi Company has no boarding school. (2) See our advertising columns. (3) About nine months. (4) The terms depend upon the particular school which you select, and would no doubt be reduced if you explain the degree of knowledge which you possess of telegraph operating. (5) To answer this question would be in effect to give you a complete statement of the Conditions of Employment for Wireless Operators, which obviously cannot be done in the space at our disposal. If you communicate with the Traffic Manager, The Marconi International Marine Communication Co., Ltd., Marconi House, Strand, London, W.C.2, he will forward to you these conditions of employment, which will explain themselves.

Y. L. S. (Guildford) asks:—In a cage aerial, or any aerial of more than one wire, is there any mutual repulsion between the charges of each wire, as they are of the same polarity, and, if so, does it have any practical effect?

*Answer.*—This repulsion exists, but is not marked, and does not in any case have a practical effect on the construction of the aerial. Our correspondent is probably aware of the fact that the addition of extra wires to an aerial does not increase the capacity proportionately. For example, if two more wires are added between the twin wires on the ordinary ship's aerial the capacity is not doubled.

U. D. (S.S. —).—All the information you desire regarding the society in question is obtainable from The Secretary, Institution of Electrical Engineers, 1, Albemarle Street, London, W.1. With regard to your second suggestion for the arrangement of apparatus on the wall of the silence cabin, why not put this to the Suggestions and Inventions Committee? If it is novel and practicable you will thus obtain credit for it, and if not, you will probably be told the reason.

W. J. H. (Southampton).—The matter to which you refer is somewhat complicated by reason of differences in design, and differences between the fixed and rotary dischargers when used in conjunction with the  $1\frac{1}{2}$  kw. set. It is an undoubted fact that in order to get the maximum efficiency from the set the L.F.I.C.I. must be carefully adjusted. The fact that in some cases taking out the L.F.I.C.I. increases the current in the low frequency circuit sufficiently to blow the fuses is no indication that one is getting greater radiation, as the power factor of the circuit may be lower. The quality of the spark may also be considerably modified by such a change, so that signals may not be so clearly audible at the distance at which it is desired they should be received.

When the disc discharger is used in place of the fixed gap there are additional factors to be taken into account.

**KNOWLEDGE (Elswick).**—(1) The objections to making a condenser with sheet iron plates instead of zinc or copper are several. The first and most important relates to the magnetic properties of the iron, which would set up loss due to hysteresis. Secondly, if it were an air condenser one would get the effects of the atmosphere upon the iron, resulting in rust and other forms of oxidation. In the case of a condenser immersed in oil, unless both iron and oil were of a high degree of purity, one would expect the plates to be eaten away much more quickly than the other metals. Thirdly, it must not be forgotten that the conductivity of iron is less than that of copper, and the resistance losses will, therefore, be higher. (2) The billi condenser is merely a variable condenser of very small capacity obtaining its name from the fact that its capacity is usually in the order of billionths of a farad. There are several formulæ for calculating the capacity of condensers made up of two concentric cylinders. If the distance between the cylinders be small compared with the leads, the capacity per unit length is

$$C = \frac{\frac{1}{2} K}{\log_e \frac{r_2}{r_1}}$$

where  $K$  = the dielectric constant of the dielectric between the cylinders, and  $r_1$  and  $r_2$  are the radii of the inner and outer cylinders (see *Calculation and Measurement of Inductance and Capacity*, by W. H. Nottage, page 46). (3) The object of the condenser in the circuit which you illustrate is to make the circuit periodic. It can thus be brought into resonance with the intermediate circuit of the multiple tuner, giving a degree of selectivity which would be impossible without it.

**E. W. S. (Hull).**—Youths in training at the Marconi Company's London School commence without pay, but after they have made some progress and can pass a certain series of tests, they are paid at the rate of 5s. per week. At a later stage, and on passing a further test, they are paid 17s. 6d. per week, and immediately upon obtaining their first-class P.M.G. certificate receive 30s. per week. As the Marconi Company are no longer accepting students for free training, but only those who have already passed the P.M.G. examination, all men now entering the London School are paid 30s. per week for the short period they remain there in order to become acquainted with the Company's own methods and clerical work. The Marconi Company does not provide food and sleeping arrangements for their students, but a Welfare Department exists, from which can be obtained on application a list of approved apartments and boarding houses, together with any other information and advice which the students may require.

**M. J. (Ramsgate).**—As stated above, the Marconi Company are not now accepting men for free training. With the knowledge you possess, the time required to complete your studies and obtain a first-class P.M.G. certificate would not be long, but, of course, you would have to be prepared to take your chance on any waiting list which may exist at the time you receive your certificate. With all the problems of demobilising, resignation of operators who desire to return to their old occupations now that hostilities have ceased, and other factors, it is even more difficult than previously to forecast what the Company's requirements are likely to be, but if you are prepared to wait for a period after obtaining your certificate, we should imagine that you would have a fair chance of employment, provided, of course, you are physically fit and otherwise suitable for the Company's service.

---

**To obtain "THE WIRELESS WORLD" you must place a standing order with your newsagent or subscribe for it through the Publishers.**

---



---

**THIS MAGAZINE CAN BE SENT FREE TO OUR TROOPS ABROAD BY LEAVING IT AT A POST OFFICE.**

---



---

**THE YEAR-BOOK OF WIRELESS TELEGRAPHY & TELEPHONY.**—We have had the opportunity of securing a few copies of earlier issues and can offer them as follows—

1915 edition, 5/- United Kingdom; 6/- Abroad, post free.  
1916 edition, 5/- United Kingdom; 6/- Abroad, post free.  
**THE WIRELESS PRESS, LTD.,** Marconi House, Strand, London, W.C.2.

---

**SPECIMEN COPIES.**—We shall be pleased to send entirely free of charge a few specimen copies of **THE WIRELESS WORLD** to the friend of any reader likely to be interested in the magazine.—Send a postcard to Sales Manager, **THE WIRELESS WORLD, Marconi House, W.C.2.**

### **SPECIAL NOTE.**

**THE MARCONI FREE TRAINING SCHEME IS NOW CLOSED.**

**Correspondents who wish to train as Wireless Operators should apply to the nearest Wireless Training School or College.**