

VOL. IV.

Registered at the G. P. O. for transmission to Canada by Canadian Magazine Post.

NO. 38

THE WIRELESS WORLD

PRICE
6^D NET

MAY
1916

PERIODICAL ROOM
RECEIVED
MAY 20 1916
UNIV. OF MICH.
LIBRARY

Adventures on
Mexican Border

Arc Generators in
Radiotelephony

The Darien Station

Dicofon

Digitized by Google

Original from
UNIVERSITY OF MICHIGAN

SULLIVAN INSTRUMENTS

Sullivan "Universal" Galvanometers and Shunts for Land and Sea Use.

SULLIVAN TELEPHONE RECEIVERS.

Fast Speed Wheatstone Automatic Transmitters and Receivers, guaranteed at 400 words per minute, and Wheatstone Apparatus generally.

Precision and Standard Measuring Equipments for D.C. and A.C. (high frequency) determinations, Condensers of Low Power Factor, etc.

H. W. SULLIVAN WINCHESTER HOUSE, LONDON, E.C., ENGLAND.

Works: LIVERPOOL HOUSE, MIDDLESEX ST., LONDON, E.C.

Telegrams: "Deadbeat, London."

Telephone } Office: 3518 London Wall.
 { Works: 3518a

Silk and Cotton Covered H.C. Copper Wire, Resistance Wires, Fuse Wire,
 Binding Wires, Charcoal Iron Core Wire, Asbestos
 Covered Wire

P. ORMISTON & SONS, 79 CLERKENWELL ROAD
 LONDON, E.C.
 Established 1793. 13259 Central.

Ropes & Cords, down to the finest sizes, in Galvanized Steel, Phosphor Bronze, etc. Braided and Twisted Wires, Bare Copper Strand & Flexibles of any Construction, Wire

NORMAN, SMEE & DODWELL

MANUFACTURERS OF HIGH-CLASS VARNISHES for Coach Builders and Decorators, Railway Carriage and Locomotive Builders, and Ship Builders Special Insulating Varnishes for Electrical Purposes

Offices and Factory: MILES LANE, MITCHAM, SURREY.

The "RAVEN" Stylograph

A perfect writing Instrument, ready for use ;
 easy flowing, requires no adjustment,
 and has a large capacity for
 ink. Length, in use, 4½"



complete
 with filler,
3/6 each
 or by Registered Post to
 any part of the World,

EDEN FISHER & CO., LTD.

Wholesale and Export Stationers and Printers,
 95, 96, & 97 FENCHURCH STREET, LONDON, E.C.

3/9

The Post Office Electrical Engineers' Journal.

Contents of Part 1, Vol. IX. 1st April, 1916:—

- Long Distance and Cable Telephony (Underground and Submarine). By B. S. COHEN, A.M.I.E.E., and J. G. HILL, A.M.I.E.E.
- Secondary Cell Installation for Telegraph Offices. By J. M. FERNANDEZ LAMOTHE, C.A. Rly. Telegraphs, Rosario, Argentine.
- Notes on the Design of a Crystal Receiver for Wireless Telegraphy By L. B. TURNER.
- The Bridge Megger. By J. B. SALMON.
- Home-Grown Telegraph Poles. By G. MORGAN, I.S.O.
- Notes and Comments; Roll of Honour, Etc.

Publishers **H. ALABASTER, GATEHOUSE & CO., 4 Ludgate Hill, E.C.**

Price 1s. post free 1s. 3d.

Annual Subscription, postage inclusive, 5s.

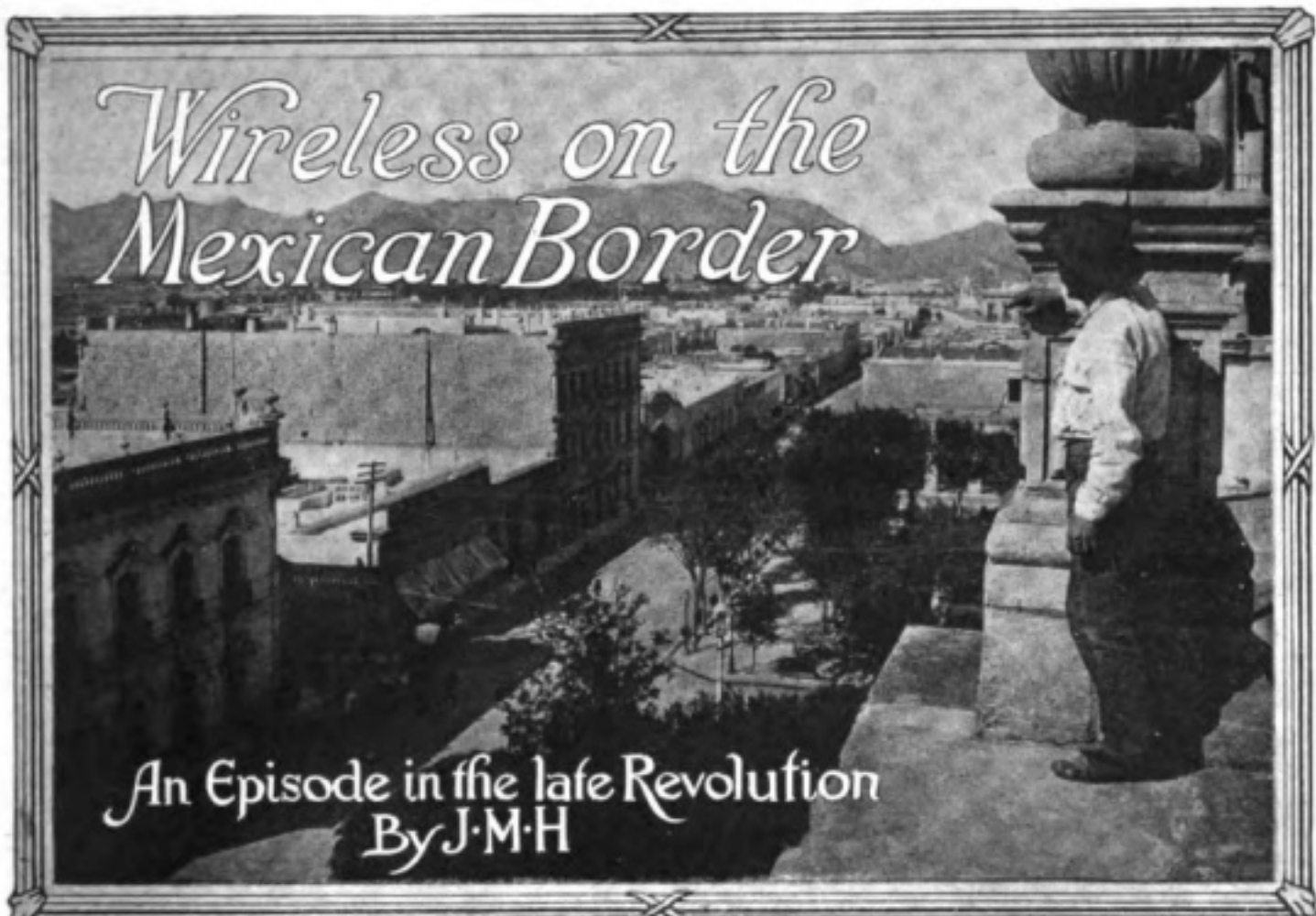

[Photo: Underwood.]

VIEW OF CHIHUAHUA, THE MOST IMPORTANT CITY OF NORTHERN MEXICO, WHICH IN 1913 WAS DESERTED BY SALVADOR MERCADO, THE FEDERAL MILITARY GOVERNOR, WITH 3,000 TROOPS.

"ACROSS THE RIO GRANDE."—This phrase was the star of hope for those fugitives from justice in the United States of America thirty or forty years ago who, by crossing a narrow bridge spanning the river, entered another country, and were immune from the long arm of the law, as at that period extradition was not recognised in the turbulent republic of Mexico.

El Paso, in the United States, was the rendezvous for these desperadoes, who, when the sheriff was hot on their trail, had merely to run over the short wooden bridge separating the two countries and could from the Mexican side of the river hurl defiance at their pursuers. The city of El Paso is now a flourishing town, possessing many modern conveniences, and is an important railway junction.

A small percentage of the population consists of Mexicans, some of the better class owning considerable property, the remainder being of the labouring class, who reside in *adobe* (clay) houses near the bank of the river, whilst others work in El Paso and return to their homes in Mexico in the evening.

I was instructed to proceed from San Francisco, California, to El Paso, Texas, to take charge of the radio station. The apparatus had been partly installed, and the work consisted of tuning and getting ready for commercial business.

The border station formed the apex of an inverted triangle, the base being composed of the systems of other stations, and was situated some distance outside the city limits; the two lattice-work towers, which could be seen for miles, were three hundred feet in height, and the station, a one-storied three-roomed building, stood in a large plot of ground, on one side being the river, whilst at the other side and parallel to it

was an irrigation ditch. The residents on the other two sides were Chinese, who raised vegetables for the local market and had several Mexican labourers employed in tilling the ground. It was a frequent occurrence to hear voices in heated altercation punctuated by revolver shots, the Chinese landlords using the revolver to intimidate their Mexican employees.

The antenna was composed of phosphor-bronze wire, containing nearly 3,000 feet, and on one occasion, during a terrific storm of wind, rain and lightning, the entire aerial was blown down and hung a twisted and tangled mass of wreckage around the guy wires and towers. After the storm abated it was found necessary to go up aloft and with pliers clear away the fragments and make a new antenna. In order to protect the property on the station, one of the operators was always on the premises, and, as



BIRD'S-EYE VIEW OF EL PASO, TEXAS, LOOKING SOUTH.

I had chosen to stay there one night, retired about midnight, but was disturbed about five the next morning by the sound of musketry and machine-gun fire; this went on more or less all day and only ceased as darkness came on. At first it was thought the firing was caused by United States soldiers at target practice, but later on we learned that revolution had broken out and the rebels under General Madero were trying to overthrow the Government of Porfirio Diaz, and the border city of Juarez, close to El Paso, was the scene of severe house-to-house fighting between the rebels and Government troops. Several newspaper correspondents asked permission to be allowed to ascend to the top of the aerial towers, which was given, and accompanying them I had a splendid panoramic view of the Mexican battle. Uniformed Government soldiers and picturesquely attired rebels could be seen running hither and thither, and the bodies of those shot falling to the ground. Several days later one of the correspondents stated



A STREET IN A VILLAGE IN THE NEIGHBOURHOOD OF THE UNITED STATES FRONTIER. NOTE THE PICTURESQUE COSTUME OF THE WOMAN IN THE FOREGROUND.

that there was to be a sensational event in the afternoon, saying that he had heard officially that one of the Government generals had been captured by the rebels and was held a prisoner. It appears that this military officer had ruled the civil population with extreme harshness, and now that they had him at their mercy the rebels plotted to surround the house wherein he was imprisoned, take him out and either hang or shoot him. An intimation of this plot was conveyed to Señor Madero, provisional president, who, being of very humane principles, determined to save the Federal officer from the angry mob of rebel soldiers.

It was arranged that during the noon siesta, when all the people go to sleep after



[Photo: D. W. Hoffman.]

MEXICAN REVOLUTIONARY SOLDIERS SERVING UNDER THE REBEL LEADER, GENERAL VILLA.



MEXICAN SCENERY NEAR THE CITY OF JUAREZ. THIS VIEW GIVES A VERY GOOD IDEA OF THE COUNTRY WHICH THE UNITED STATES ARMY HAS TO TRAVERSE IN ITS ATTEMPT TO ROUND UP THE REBELS.

the usual late breakfast, a horse would be in readiness for the prisoner, his freedom given him, and he was told to ride along the bank of the river for four miles and then cross the narrow ford to the American side, where an automobile would be in readiness to rush him to a safe zone. Only a few of Madero's trusted officers were in the secret. After breakfast we ascended again to the top of the aerial towers, and through binoculars could see every detail of the little Mexican city. Bathed in brilliant sunshine, not much activity was noticed, and comparative silence reigned, when suddenly a loud clamour was heard of many voices, and through the field glasses we noticed a mob of Mexicans, with their curious conical-shaped straw hats, making for a certain point of the town towards the bank of the river, where a plantation ran parallel to it for a long way. Scanning the landscape we noticed, at a distance of about three-quarters of a mile, a figure on a white horse emerge from the forest screen and gallop at headlong speed along the road, followed by the yelling mob of half-crazed Mexicans. The picture was certainly dramatic in the extreme, and was a real race for life. Many shots were fired, and one seemed to strike the horse on the flank, causing it to swerve to one side, but the rider kept his seat, occasionally turning his head to look at his pursuers, who seemed to be handicapped by being unable to get over the uneven road at any speed.

When the horseman arrived at the prearranged spot on the bank of the river he turned sharply and forced his horse into the shallow stream. The bullets of his pursuers began to scatter the water around him, but the horse clambered up the opposite bank apparently unscathed. A large grey automobile appeared, and the general, jumping off his horse, entered the car and was whisked away sooner than it takes to write.

The newspaper men descended and wrote lengthy accounts of the occurrence, which were despatched by wireless to various parts of the United States.

When the Madero forces were in complete control of the northern part of Mexico it was the custom for residents of El Paso and tourists from other parts of the United States to visit the city of Juarez and look at the damage done to the houses by rifle and machine-gun fire and the Mexican followers of Madero always treated the foreigners with the greatest courtesy, and willingly showed them places of interest in the ancient historical border city.

America and the Allies

There have been many indications that our Transatlantic cousins are fully in sympathy with the Allies, and although officially the United States is neutral, much points to the fact that the average American is decidedly pro-ally. Marconi's Wireless Telegraph Co., Ltd., have received from a shareholder in one of the Western States the following letter:—

“ Having received my Marconi cheque a short time ago, I hereby enclose it and wish you to forward it to the Red Cross Fund for the Army, if it be no trouble to you. I deeply sympathise with you in this war, and hope you will win out in the end.”

PERSONALITIES IN THE WIRELESS WORLD



[Photo: Topical Press.]

MR. FREDERICK KOLSTER



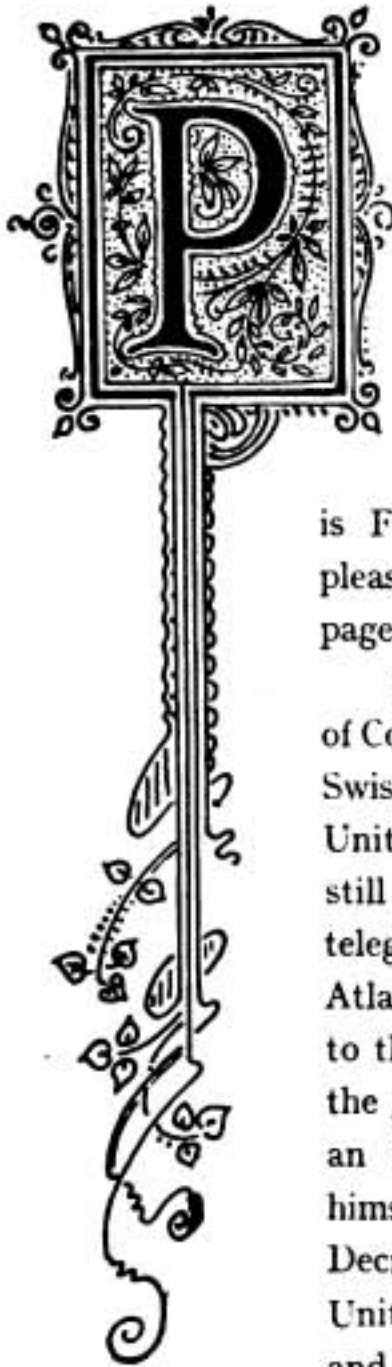

PROGRESS in radiotelegraphy owes much to the genius and investigations of scientists in the United States, where, happily for our Transatlantic friends, wireless research is unhampered by Government restrictions and the Defence of the Realm Act. Prominent in the ranks of American scientists interested in wireless telegraphy is Frederick A. Kolster, whose portrait we have pleasure in presenting to our readers on the opposite page.

Mr. Kolster, Radio Physicist of the Department of Commerce, Bureau of Standards, Washington, is of Swiss birth, and was brought by his parents to the United States of America thirty-three years ago while still an infant. His work in connection with radiotelegraphic matters is well known on both sides of the Atlantic, and many original papers contributed by him to the literature of wireless telegraphy have proved of the greatest use to investigators the world over. As an inventor Mr. Kolster has already distinguished himself by producing the "Kolster Direct-Reading Decremeter," an instrument largely used by the United States Government, and of the greatest utility and efficiency. A description of this interesting invention is to be found in the "Scientific Papers of the Bureau of Standards," Nr. 235.

Taking a prominent part in the activities of the well-known Institute of Radio Engineers, Mr. Kolster figures in the list of members and on the Committee of Standardisation. Wireless investigators and experimenters will watch with interest the career of this young scientist, who, at thirty-four, has already brought himself into such prominence.

The Methods Employed for the Wireless Communication of Speech (ii)

By PHILIP R. COURSEY, B.Sc.

(Read before the Students' Section of the Institution of Electrical Engineers, on February 2nd, 1916.)

THE ARC METHODS OF GENERATING OSCILLATIONS.

If we take an ordinary continuous current arc and, while maintaining the arc length constant, we vary the current passing through it, and at the same time measure the P.D. between its terminals, we obtain what is called the characteristic of the arc. In the case of all ordinary arc discharges, this characteristic is what is called a "falling" or "negative" one, that is to say, when the current is increased the voltage falls, and *vice versa*.

Hence, if we connect across such an arc an oscillation circuit containing a condenser, there will be a sudden rush of current into the condenser tending to charge it: this current rush will momentarily cause a decrease in the arc current with, as a result, a corresponding rise of the P.D. across the arc terminals. This voltage rise tends to further charge the condenser to a voltage *above* the normal running voltage of the arc. As soon, therefore, as the charging current of the condenser begins to fall off the arc current will rise again to its normal value, accompanied by a fall of P.D. across its terminals.

We have now the condenser charged to a higher voltage than that across the arc, and as a consequence it immediately begins to discharge back through the arc.

This discharge current is in the same direction through the arc as the supply current, and hence causes a fall in the arc P.D. by reason of the increased current. This further facilitates the condenser discharge. As the condenser completes its discharge, the arc current falls and the P.D. rises again to their normal values, when the cycle is repeated over again and continues indefinitely as long as the supply is maintained and the arc retained of a constant length.

Hence the condenser will be continuously charged and discharged at regular intervals, depending on the inductance in the circuit, the capacity of the condenser, and the length and other conditions of the arc—in other words, continuous oscillations will be set up in the circuit by virtue of this action of the arc.

Looking at the production of oscillations in this way, we can at once see that the strength of the oscillations set up in the shunt oscillation circuit depends on the "steepness" of the arc characteristic, since, if we have an arc with a steeper characteristic curve, a given change in the current through the arc will give rise to a greater variation of the voltage at the arc terminals than it would under similar conditions with a "flatter" characteristic, or, in other words, greater charges will be im-

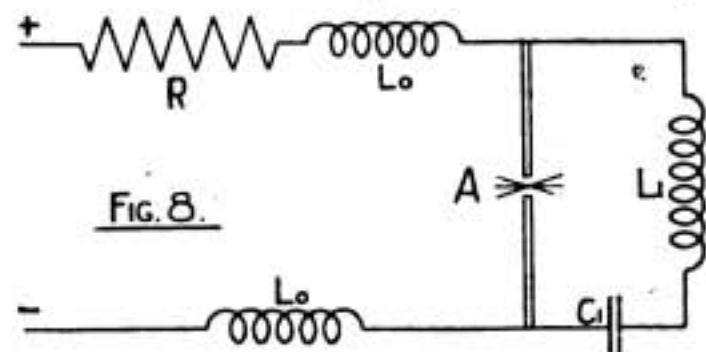

parted to the condenser in each cycle, with a correspondingly greater amplitude of the discharge current—*i.e.*, more energy will be imparted to the oscillation circuit, and the oscillations will be consequently vigorous. Hence, it is easier to make an arc with a steep characteristic oscillate than it is one with a flatter curve; and as it is always more difficult to make an arc generate high frequency oscillations than it is low frequency ones, it follows that we require an arc which has a very steep characteristic in order to produce oscillations of wireless frequencies with any degree of readiness. By inspection of the characteristics, we see that they become much steeper for small arc currents, while at the same time for a given current a longer arc at higher voltage has a steeper characteristic, and hence in general low current arcs oscillate better than heavy current arcs—in fact, it is found, as soon as one begins to experiment with such arcs, that there are certain fairly well-defined current limits and arc lengths within which it is necessary to keep if oscillations are to be set up at all. The exact values of the current limits depend entirely on the type of arc and carbons, its length and conditions of use, and also on the values of the capacity and inductance in the shunt circuit.

As a rough guide for experimental purposes it will generally be found necessary to limit the supply current value to not more than about 2 or 3 amperes when employing arcs in air between ordinary solid arc lamp carbons, if it is desired to generate oscillations approaching wireless frequencies. With lower frequencies the supply currents may be increased. The arc length must, moreover, be kept very short. On the other hand, if very high frequencies are desired for experimental purposes, it will be generally found advantageous to employ special carbons for the arcs. Some grades of graphite rods are very suitable for this purpose, while the employment of compressed air or other gases round the arc often leads to considerable advantages from the point of view of the steadiness of the oscillations that are produced, as well as their intensity. The ratio of the capacity to the inductance in the oscillation circuit is also very important; a rough guide to begin with may be taken as ratio of inductance to capacity=about 100, when both are measured in absolute units (centimetres). This figure is, however, liable to very considerable variations to obtain the best effects, depending on the arc employed, on the supply voltage, and current, and more especially on the gas surrounding the arc. The use of a suitable choking inductance in the supply circuit to the arc is also important to secure more vigorous oscillations by confining them to the oscillation circuit and preventing them going back on to the supply mains. From the above it is evident that, as the allowable current through the arc is limited in order to secure efficient generation of the oscillations, it is essential to employ high voltages if any considerable oscillatory energy is required. These results are best obtained by connecting a number of arcs in series, and running them off a high voltage supply circuit, with a common oscillation circuit connected across all the arcs. This method has been employed from time to time by various manufacturers in attempts to produce a commercial form of apparatus suitable for the generation of powerful oscillations.

THE POULSEN ARC.

About 1902 V. Poulsen discovered that if an arc were set up in an atmosphere of hydrogen or coal gas instead of air its characteristic was much steeper than that of the same arc burning in air, hence he employed such an arc in an atmosphere of hydrogen as a generator of continuous oscillations of wireless frequencies. It was also found

that the use of a water-cooled copper anode with a carbon cathode for the arc when used in the hydrogen or coal-gas atmosphere, referred to above, resulted in the production of steadier and stronger oscillations; while the employment of a transverse magnetic field across the arc was also claimed in his patents as additional means of ensuring steady and vigorous oscillations.* These features form the essentials of all the Poulsen arc apparatus, although, as is only natural, a number of improvements and alterations have been carried out from time to time in the commercial development of the apparatus.

The use of the electromagnets in the Poulsen apparatus was with the object of maintaining the arc in a definite position on the electrodes, and of a definite shape and length, and thus served to render the arc more regular and the oscillations more stable. It is possible also to so arrange a radial magnetic field in the neighbourhood of the arc that the arc keeps moving round the edge of the electrodes, thus bringing fresh electrode surface into play, and maintaining the arc at a more constant length by promoting a more regular wear of the electrodes. By this means it is possible to dispense with the necessity of rotating one of the electrodes (generally the carbon) that is otherwise necessary to ensure even wear of the electrode and regularity of the arc.

It has also been suggested, however, that the use of the powerful magnetic fields customary in the Poulsen apparatus has a greater utility than that of causing a mere steadying of the arc; and that the strong field really causes vibrations or oscillations to be set up in the arc, after the manner of arc interrupters, the arc being actually blown out by the magnetic field in some cases, and then automatically re-struck again by reason of the applied voltage being sufficient to jump the small ionised space between the electrodes. Some such action as this may possibly take place in the

Poulsen apparatus, as with suitable design it is found possible to increase the allowable current passing through one arc from a few amperes, which is all that is possible when operating in air with no magnetic field, to 25 or more amperes when used in the commercial Poulsen apparatus. This leads to a considerably increased output from the arcs.† The conditions which determine the production of oscillations of maximum intensity from arcs, from the point of view of the influence of the supply voltage, current, shunt capacity, frequency of oscillations, etc., have been studied by a number of

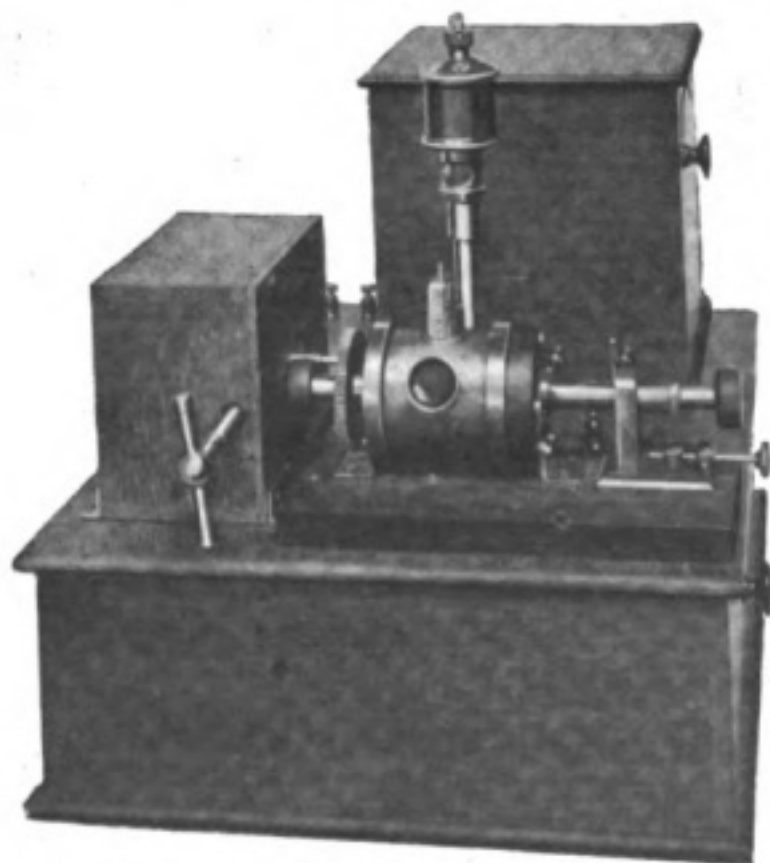

AN ARC GENERATOR USED FOR WIRELESS TELEPHONE TRANSMISSION.

* See V. Poulsen, British Patent No. 15599, 1903.

† See, for example, De le Rive, *Pogg. Ann.*, 76, p. 281 (1849); Ruhmer, *Electrotechnische Zeitschrift*, 26, p. 382; Kosler, *Electrotechnische Zeitschrift*, 28, p. 142 (1907); Hahnemann, *Electrotechnische Zeitschrift*, 28, p. 353.

different experimenters. Reference may here be made, for example, to a paper by F. Mercer recently read before the Physical Society of London * on this subject. His conclusions may be summarised as follows :

" 1. There is a definite value of inductance for any given capacity which gives a maximum current in the shunt circuit.

" 2. The effect of increasing the gas pressure becomes more marked as the electric pressure is increased, but as the gas pressure rises the steadiness of the arc diminishes. The effect is somewhat similar to that obtained by increasing the arc length.

" 3. Any effort made to increase the output by the use of a magnetic field, or by altering the arc length, or the resistance in series with the arc, is detrimental to the steadiness of operation."

These conclusions were of necessity obtained from the consideration of a limited number of experiments made on one type of arc (the copper-carbon arc in air), and therefore cannot be applied to any and every type of arc oscillation generator without modification.

DR. FLEMING'S " OIL-ARC."

A recent development of the Poulsen arc apparatus enclosed in an atmosphere of hydrogen is one that has been carried out at University College, London, under Dr. Fleming, with the idea of dispensing with the cumbersome electromagnets required to produce the magnetic fields used in the Poulsen and other similar apparatus, and also of the necessity of providing a continual supply of hydrogen or coal gas.

Moretti has recommended the employment of an arc in an atmosphere of water vapour,† while in many other forms alcohol or methylated spirit vapour has been used to provide a hydrocarbon atmosphere to obtain an arc with a steep characteristic suitable for generating powerful oscillations.

In the oil-arc a number of arcs between carbon and copper electrodes are struck just over the surface of a heavy oil. The heat generated by the arcs causes vaporisation of the oil, and consequently an atmosphere of hydrocarbon vapour is created round the arcs.

No magnetic field is employed, and the oil generally provides sufficient cooling without having to resort to water cooling, but a water circulation through the oil may be provided if desired. The arrangement mentioned has been at present constructed for handling powers up to a maximum of about 2 kw. ; but it is probable that modifications would have to be introduced to enable it to be available for much higher powers. In connection with the operation of arcs of this type—*i.e.*, copper carbon arcs—it is interesting to note that it is not essential that the copper electrode should be positive, and the carbon negative, as is usually supposed,‡ and as is customarily the case, for example, with the Poulsen arcs, as advantages are often found in using the reverse connection. This is often more especially the case when difficulty has been experienced in starting up the arc and obtaining stable oscillations. Under these conditions a reversal of polarity will frequently cause strong oscillations to be set up, which persist when the polarity is again reversed back to the normal direction. The normal direction, copper positive, generally gives oscillations of more constant frequency than those obtainable if the polarity is maintained in the reverse direction.

* *Proc. Phys. Soc. Lond.*, 26, p. 372, June, 1914.

† See *Science Abstracts*, 16 B., No. 879.

‡ See, for example, *Barecca, the Electrician*, 60, p. 522.

When an arc is running in air there is always a burning away of the carbons ; if, however, the arc is placed in an atmosphere which is rich in carbon (hydrocarbon gases), the gas will be decomposed by the heat of the discharge, and carbon deposited on the arc electrodes. It is thus possible to have an arc in which the carbons "grow" instead of wearing away when in use. This is the case to a slight extent with the "oil-arc" described above, as when it is in use practically the only adjustments that are generally necessary (after the preliminary striking) are occasional movements of the electrodes further apart to compensate for the slight lengthening of the carbon rod.

It is obvious, however, that if the carbons wear away in some gases and grow in others, there must be some gas or mixture of gases in which these effects will exactly balance one another, and no adjustments of the arc should be necessary once the initial starting has been accomplished.

One such mixture is of acetylene and hydrogen (of which the relative proportions are best found by experiment). This mixture has been successfully employed in the Colin and Jeance apparatus, which will be described more fully below.

The same result could in all probability be achieved in the oil-arc (and similar apparatus) by the use of suitable liquids, or mixtures, instead of the oil at present employed.

THE COLIN-JEANCE ARC GENERATOR.

This arrangement, originally patented in 1909,* is in the main very similar to the Poulsen apparatus, in that it consists of three copper-carbon arcs connected in series, and burning in an atmosphere composed of a mixture of acetylene and hydrogen in such proportion that the normal wear of the carbon electrode is compensated for by the deposition of carbon from the gaseous atmosphere. The mixture of gases may be conveniently generated from mixture of calcium carbide and calcium hydride.

The usual supply voltage varies between 500 and 750 volts. The Colin-Jeance patent, referred to above, is, as far as I am aware, the first instance of the employment of an intermediate circuit tuned to the oscillation frequency for coupling the arc-

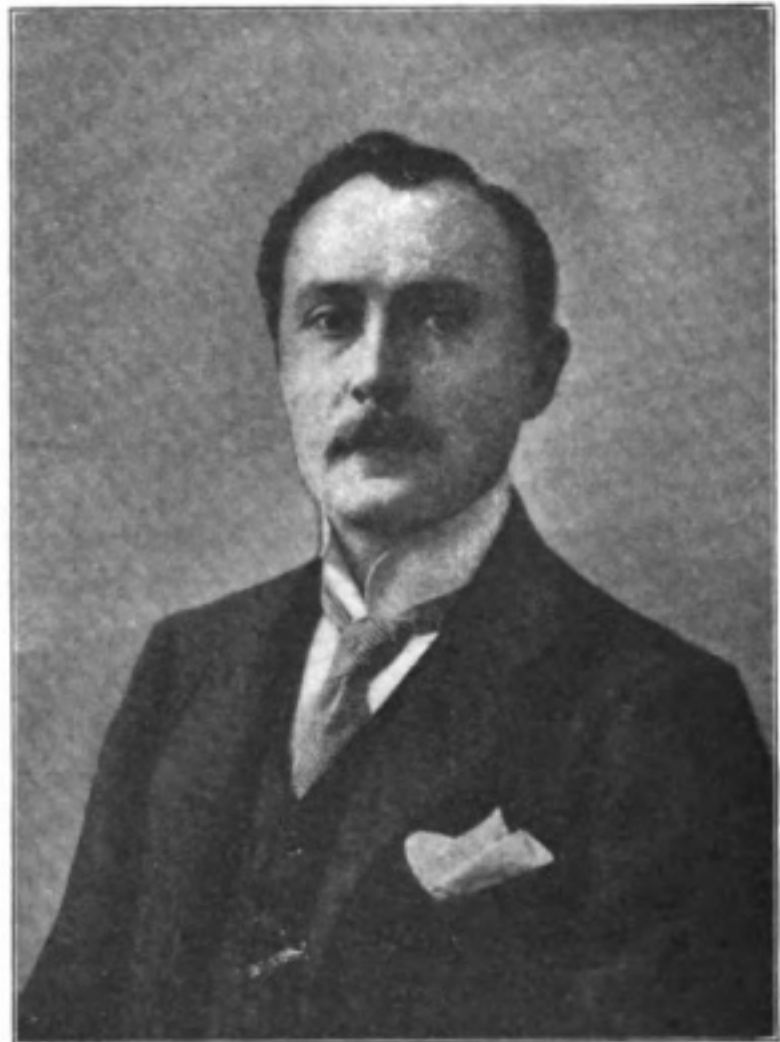

[Photo: C. Vandyck

W. DUDELL, F.R.S., WHO HAS CARRIED OUT MANY IMPORTANT INVESTIGATIONS WITH THE ARC, AND TO WHOM WE OWE MUCH OF OUR KNOWLEDGE OF SUCH OSCILLATORS.

* British Patent, 18436, 1909.

shunt circuit on to the aerial circuit. This arrangement is often employed now in this and other apparatus as it enables better tuning to be obtained and a purer wave radiated. On the other hand, the majority of arcs produce oscillations which are seldom of constant frequency, so that under these conditions it is generally found that the aerial current is not of by any means constant strength, because if the arc frequency varies it quickly falls out of tune with the aerial circuit, and therefore the current in that circuit quickly falls off. The presence of the intermediate circuit aggravates this trouble, since it renders the relative tuning of the arc circuits and the aerial circuits much sharper. On the other hand, since the intermediate circuit enables a purer wave to be radiated it enables sharper tuning to be employed at the receiver, thus minimising interference from other stations and also from atmospheric disturbances since the coupling can then be weakened.

It may be as well to mention here (as it was omitted in the preliminary discussion of the arc methods of producing oscillations) that the frequency of the oscillations in the shunt oscillation circuit across the arc does not depend merely on the values of the inductance and capacity in that circuit, as it does in the case of the majority of spark transmitters, and in the cases of oscillations in closed metallic circuits. This is on account of the fact that the resistance of the arcs is not negligible as it is in the majority of the other cases. Moreover, the effective resistance of the arc varies very considerably with the arc length and arc current, as shown by the characteristic curves previously shown.

The complete expression for the oscillation frequency in a circuit containing Inductance, L henrys ; capacity, C farads ; and resistance, R ohms, is

$$n = \frac{1}{2\pi} \sqrt{\frac{1}{LC} - \frac{R^2}{4L^2}}$$

and it is therefore only when R is negligible compared with L that the frequency is given by the simpler formula $n = \frac{1}{2\pi} \sqrt{CL}$, which is the one most commonly employed. In this case n is a function of the arc length, etc.

To meet this case a formula has been devised by G. Nasmyth,* and is as follows :

$$n = \frac{1}{2\pi} \sqrt{\frac{1}{LC} - \frac{\left(R - \frac{c+ld}{A}\right)^2}{4L^2}}$$

Where n is the frequency L is the inductance in henrys, C is the capacity in farads, R is the resistance in the oscillation circuit in ohms, A is the current through the arc, l is the length of the arc, and c and d are constants depending on the nature of the arc electrodes, and on the nature of the gas surrounding the arc.

Hence it is evident that quite small changes in the arc length supply current, etc., will produce changes in the frequency of the oscillations. This variable frequency is one of the great drawbacks to most arc transmitters, and renders their successful operation for prolonged periods a matter of some difficulty.

THE DUBILIER ARC GENERATOR.

This apparatus is similar in general outline to the ones previously described, with the exception that attempts have been made to render the apparatus as a whole

* *Physical Review*, 27, p. 117, 1908.

more portable, at least for the smaller powers. The arc is arranged to take place inside a closed copper cylinder, provided with means for adjusting the internal carbon electrode which forms the other arc terminal from outside the cylinder. The cylinder is generally fitted with radiating flanges to assist cooling. This arrangement usually renders water cooling unnecessary. A hydrocarbon atmosphere is employed, produced by the vaporisation of alcohol or methylated spirit, which is allowed to drip into the arc chamber when required, while a safety valve maintains the gas pressure approximately constant.

THE T.Y.K. ARC.

An interesting development of the arc oscillation generators has been made recently by some Japanese investigators, and is known as the "T.Y.K." system, from the initials of its inventors, W. Torikata, E. Yokoyama, and R. Kitsmura.* Its chief novelty lies in the materials used for the arc electrodes. These are made up from a pair of such substances as the following :

Silicon, ferro-silicon, carborundum, boron, magnetite, iron pyrites, molybdenite, etc. The combination of magnetite and brass is said to give on the whole the most satisfactory results. A continuous current supply at about 500 volts is usually employed. It would appear that this apparatus is merely another particular case of what is apparently an oscillating arc, but really seems to be a quenched short spark operating at the usual arc voltages. Further details of such effects will be given below, see pp. 25 and 26.

A curious point in connection with these oscillation generators is that the materials employed for the electrodes are also capable of acting as rectifiers of alternating currents, and, in fact, of forming wireless detectors. For instance, it has been shown by Dr. Eccles† that ordinary crystal contact wireless detectors can be utilised to set up electrical oscillations of feeble intensity in a suitable oscillation circuit connected across them. This T.Y.K. apparatus therefore seems to correspond to some such action as this, but on a much more powerful scale.

(To be continued.)

Australian Wireless Corps

Recruits being urgently needed for the formation of a wireless corps for active service abroad, the matter was taken up by the Amalgamated Wireless (Australasia), Limited, and it is highly satisfactory to state that on the operators attending the school being informed of the urgency of the request, fifteen experienced telegraphists who are now going through a course of wireless at the Marconi School, 97 Clarence Street, Sydney, willingly marched to the Town Hall recruiting depot, and only one failed to pass the eye test of the recruiting officer.

This patriotic response should go a long way towards inducing others to enlist promptly.

* British Patent, 19823, 1912.

† W. H. Eccles, *The Electrician*, 72, p. 1058, *ibid.* 66, p. 384, etc.

Digest of Wireless Literature

WIRELESS TRANSMISSION PROBLEMS.

At a recent meeting of the New York Electrical Society, held at the Engineering Societies' Building, Dr. Michael I. Pupin delivered an address in which a number of questions in radiotelephony were touched upon. Not only were the various problems involved in the recent developments in long-distance telephony analysed with simplicity and clarity, but Dr. Pupin declared that the great problem of "static" had at last been solved. He said that the discovery of the means of eliminating atmospheric trouble, which had cost him seven years of experimentation, not to mention the work of others, will make possible the transmission of messages by wireless telephony to every part of the world. This sounds rather too good to be true, and until the invention has been subjected to exhaustive tests we are inclined to be rather sceptical.

Dr. Pupin first took up in their historical order the various problems of wireless transmission. A broad description of the constructive elements of the wireless transmission system was given, to show that, as far as these constructive elements are concerned, there is no essential difference between the wireless transmission system and the ordinary electrical transmission system. But the difference, slight as it is, in the constructive elements, necessitates the introduction in the wireless system of a radically different mode of operation, namely, the employment of electrical forces of very high frequency.

The earliest method of producing these high-frequency electrical forces was briefly described, and Dr. Pupin expressed it as his personal opinion that Joseph Henry, in 1842, first discovered electrical oscillations which Marconi first employed in wireless transmission. After Professor William Thompson formulated, in 1855, the law of motion of electricity along conductors, the time was ripe for the invention of wireless telegraphy. However, it was not invented until 1895, when Marconi, stimulated by the beauty of the Hertzian experiments, and while repeating them in Righi's laboratory in Bologna, discovered that an oscillator connected to the ground and a resonator connected to the ground gave electrical transmission by electrical waves of high frequency enormously increased range. A distinct period in wireless telegraphy was inaugurated when Marconi discovered the new art. The problems which were solved during this inventive period were few, but every one of them was epoch-making. The first problem was the substitution of the high-frequency generator for the oscillator, with its noisy and unreliable spark gaps. This was accomplished by the patient and persistent work of E. F. W. Alexanderson and others.

The second great step was the introduction of amplifiers into wireless work. Dr. Pupin referred to his first announcement of the electric amplifier in 1911, made before the National Academy of Science. It was an induction generator of special construction. Since that time the vacuum tube amplifier has been developed. He referred to the work of Fleming in this connection, and pointed out that much had been accomplished in perfecting the vacuum tube with a hot cathode. Amplifiers that work with reliability and are capable of amplifying feeble electrical impulses even hundreds of thousands of times have been brought into use.

The speaker went on to point out that these tubes not only amplify, but actually

reproduce very feeble electrical impulses with an accuracy which defies the finest microscope ever constructed.

Dr. Pupin called attention to the fact that articulate speech transmitted from Arlington to Honolulu (4,900 miles) was reproduced at Honolulu by a vacuum tube amplifier with such accuracy that the listener at Honolulu recognised the speaker at Arlington, although the energy of the feeble electrical waves conveying this speech was probably amplified 100,000 times at Honolulu.

"The third great problem solved lately by the inventive genius of man," he continued, "is that of regulating the power output of the generator at the transmitting station. To illustrate: the generator at Arlington which supplied the electrical energy for the transmission of speech to Honolulu delivered something like 100 horse-power, yet its output was regulated by the human voice. It looks as if we were on the threshold of regulating the electrical output of our high-frequency generators by what may be called mere will power. In considering all these things it would seem that there is nothing to prevent us from transmitting telegraphic and telephonic signals from any point of the earth to any other point.

"And yet there is a most serious obstacle indeed. I refer to the well-known interfering action of the static. What is the static? It is the everlasting presence of electrical waves in the terrestrial atmosphere due to electrical discharges in it. The electrical charges in the atmosphere are produced by the action of sunlight and other causes. The electrical waves produced by the electrical discharges in the atmosphere are so much more powerful than the waves coming from the distant wireless transmitting station that they drown out the messages. When means have been found to protect the receiving station effectively from the disturbing influence of the static, there will be no obstacle in the way of employing wireless telegraphy and wireless telephony as the simplest means of universal communication."

* * * * *

MULTI-PHASE RADIO TRANSMITTERS.

Mr. William C. Woodland recently presented to the Institute of Radio Engineers a paper on the Use of Multi-phase Radio Transmitters, which is of considerable interest to all concerned with wireless engineering. The production of radio frequency current from currents of commercial frequency, says the author, is a matter of great interest and usefulness. The fact that a pure sine wave is not necessary or even desirable for radio purposes makes possible a great many ways of dividing up audio frequency current so as to duplicate the results obtained by radio frequency generators.

For example, it is possible to divide up audio frequency 3-phase currents into any number of intermediate phases, all of which have equal wave peaks occurring successively. By placing a separate radio transmitter in each phase, it would seem possible to operate at almost any desired frequency.

Several advantages of multi-phase current over single-phase current may be pointed out.

1. In an 8-phase, 60-cycle equipment the tone of the spark would be equivalent to that given by a 480-cycle generator. The condensers, however, would operate on 60-cycle current, which would allow the use of much larger capacity and a lower voltage for the same total amount of energy. The larger condensers discharging at a comparatively low voltage would give short thick sparks of low resistance, resulting in

improved efficiency. The lower voltage would increase the life of both the condensers and the transformers.

2. The reliability of the equipment would be increased ; because if a transformer or condenser should break down, the message might be finished on the other phases with no more trouble than a slight weakening of power.

3. There would be some advantage in having to break only 58 per cent. of the corresponding single-phase current at the key.

4. Spare transformers and condensers could be carried at less expense than with single-phase equipment.

5. It is possible to operate multi-phase equipments with very high-power factors and leading current, so that the generator voltage does not fall on depressing the key.

6. When operating directly on 60-cycle, 3-phase current, the efficiency is certainly very much improved.

Mr. Woodland's attention was first called to the use of multi-phase current for radio transmission in the early part of 1912, when it occurred to him that by dividing up a 3-phase, 60-cycle current, the results of the higher frequency generators might be duplicated. He did not at that time have in mind anything further than placing a separate radio transmitter of the fixed gap type in each phase, depending on it to discharge at the peak of the wave independently of the other sets.

This plan did not meet with success on account of the fact that the maximum point of the wave is not sufficiently definite to secure the phases against interference with each other. He found also that other investigators had carried the work up to this point, but that all systems had been rendered more or less inoperative because of the interference mentioned above.

All of these difficulties were overcome by the use of a rotary spark gap in each phase which had for its purpose the definite localising of the point of discharge.

The remainder of the article consists of a detailed description of the apparatus employed by Mr. Woodland, who mentions that already eight (8)-phase, five (5)-phase, four (4)-phase and three (3)-phase equipments of this description have been built with entire success.

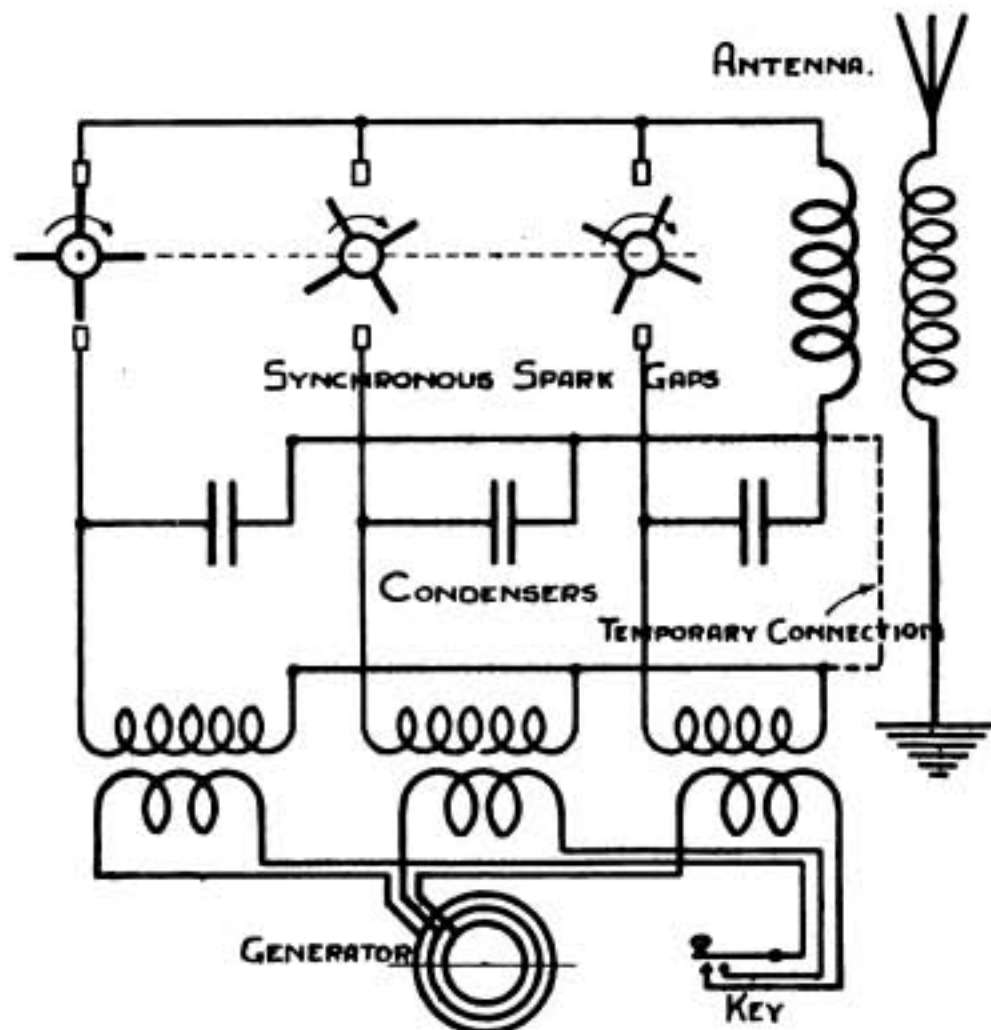

A THREE-PHASE TRANSMITTER.

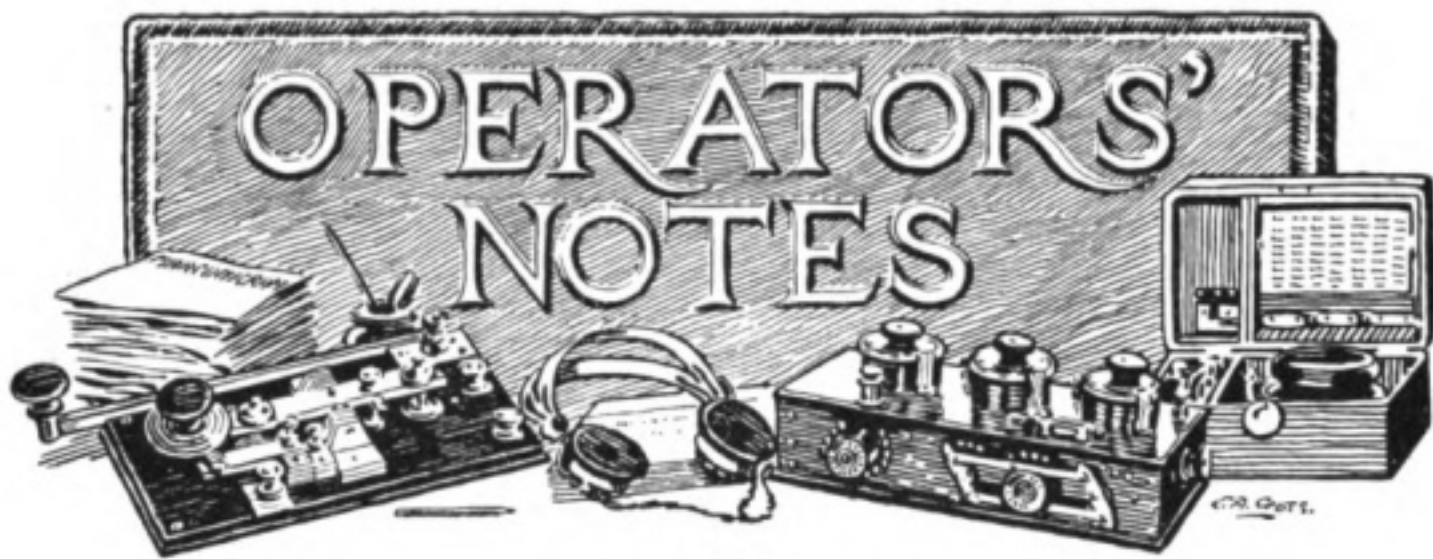

Repairing a Broken Magnetic Detector Spring

By H. W. POPE

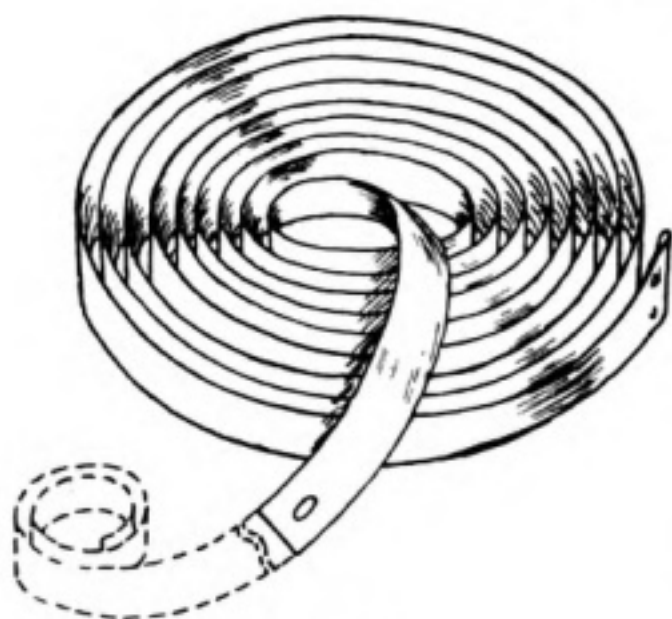

FIG. 1

end of the spring for a distance of about three inches, and drilled a fresh hole with a $\frac{3}{16}$ in. drill, and opened the hole out to an oval shape with a rat-tail file.

I then unscrewed two of the pillars (A) of the spring-barrel (B), and attached the drilled end of the spring to the hook on the hub, the looped end of the spring was then passed over one of the remaining pillars, and a coating of vaseline applied. Then by taking out the two main pillars (C) that hold the two main plates together at the spring end of the mechanism, I found there was room to replace the unwound spring and barrel.

Next rebuilding the whole clock-work, with the exception of the two barrel-pillars (B) and the two pillars of the main frame (C), I wound the spring

Whilst I was winding a magnetic detector the other day I had the misfortune to break the spring. Casting about for a way to repair it, I hit upon the following, which was quite satisfactory.

I first fitted a handle from one of the rubber stamps to the band-wheel of the detector with a brass wood-screw, so that I could keep an intermittent watch during the repairing operations.

I next took out the spring-barrel and got the spring out with a pair of pliers, wrapping the whole job in a towel in case the spring should fly. Starting up the blow-lamp, I took the temper out of the broken

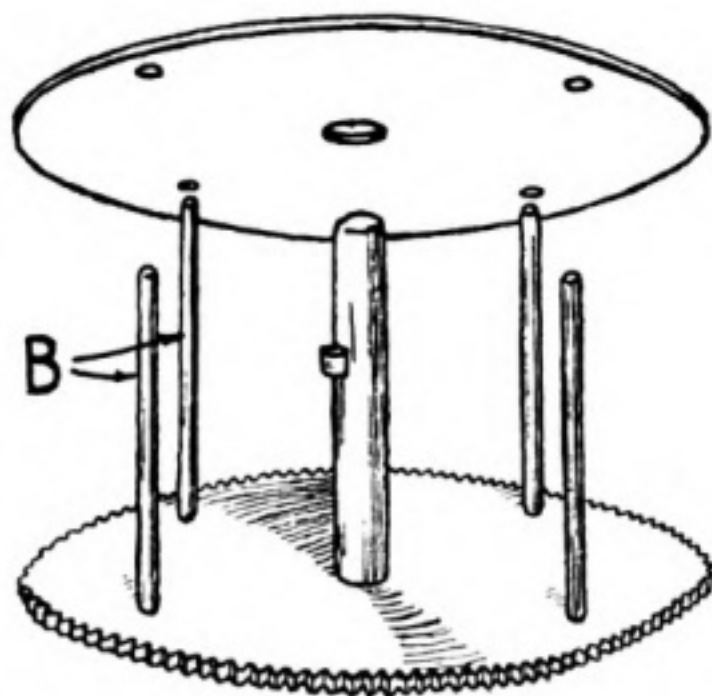

FIG. 2

up with the ordinary winding handle and ratchet until I could see that the spring stood well inside the ring of the safety pillar holes. I then set the catch on the underside of the spring-barrel so that the spring could not unwind, and reassembled the whole mechanism; lastly, the catch was adjusted, the strain being taken off it by means of the winding handle. A thorough oiling was given, and the clockwork returned to its case. I found on trial that the detector would run for nearly the same time as it did previously, in spite of the spring being 15 inches shorter. Before the accident the detector would run for about two hours and five minutes, whereas it now runs for about one hour and forty-five minutes.

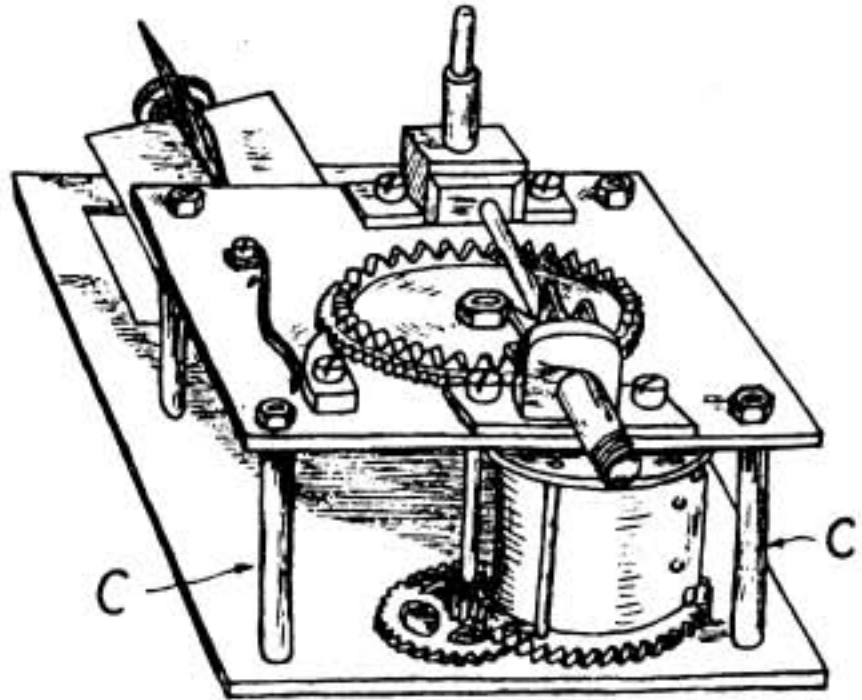

FIG. 3

President Wilson Favourable to Amateur Wireless Organisation

President Wilson has sent a letter to Mr. J. Andrew White, acting president of the National Amateur Wireless Association, New York, commenting favourably on the organisation of the amateur radio operators of the country, which, he says, would undoubtedly be a valuable asset to the nation.

Share Market Report

London, April 12th, 1916.

The market for wireless shares has been more active since the issue of the company's circular. Latest prices : Marconi Ordinary, £2 2s. 6d. ; Marconi Preference, £1 17s. 6d. ; Marconi International Marine, £1 5s. 6d. ; American Marconi, 15s. 6d. ; Canadian Marconi, 7s. 9d. ; Spanish and General Wireless Trust, 5s.

At Bradford recently, Willie Slater, 21, described as a Marconi operator, was charged with having worn, without authority, a naval uniform cap. In view of the medical testimony offered, an order was made for prisoner's detention in Menston Asylum.

We are officially informed by the Marconi Company that this man was not, and never has been, in their employ.

Dr. Fleming's Elementary Manual of Wireless Telegraphy*

Reviewed by Philip R. Coursey, B.Sc.

THE fact that this book has now reached the third edition is evidence that it is appreciated by its readers, and fills a want in the literature of the subject. It is written mainly for the use of students who wish to obtain an introduction to the technical side of the subject of wireless telegraphy. It is assumed that the reader of the book is familiar with the elementary portions of electrical engineering, such as the generation and control of electric currents, both direct and alternating, and their chief properties; and also to a certain extent with electrical measurements. The book serves as an excellent introduction to larger and more advanced treatises and text books dealing more fully with the apparatus and with the mathematical theory of the subject, such for example, as the *Principles of Electric Wave Telegraphy and Telephony*, by the same author.

The scope of the work can perhaps best be conveyed by a more detailed consideration of its contents.

The first chapter opens with some elementary facts about electric currents, the distinction between direct and alternating currents, and between undamped and damped oscillations; as well as the meaning and importance of the logarithmic decrement of the oscillations. It then quickly passes on to the "skin effect" of high frequency currents, and formulæ for the calculation of the high frequency resistance of wires and spirals.

Inductance and capacity are then explained and formulæ given for their calculation in certain standard cases. The next portion of this chapter contains a mathematical determination of the natural time period of an oscillatory circuit containing inductance, capacity, and resistance. As this involves the use of differential equations it may not perhaps appeal to many readers who are not conversant with the calculus, although the explanations given are, on the whole, very clear and easily followed. The treatment is simplified by neglecting the resistance of the circuit as this is generally very small, but unfortunately no mention is made of the effect this resistance has in the final formulæ for the frequency, as, for example, in circuits including an oscillating arc (which are described later in the book), the arc resistance in most cases causes considerable modification of what would otherwise be the natural frequency of the circuit. A brief consideration of resonance and resonance curves closes the chapter.

Chapter II. passes on to the practical production of damped electric oscillations by the discharge of a condenser, and treats in detail of the construction of induction coils, and of hammer and mercury break, and Wehnelt electrolytic interruptors for use with them. Alternators and transformers are then considered before the author passes on to spark gaps and spark voltages, with a brief account of quenched spark dischargers, and the construction of condensers and jiggers for the oscillation circuits. The description of rotary spark dischargers is, however, reserved to a later chapter on radiotele-

* *An Elementary Manual of Radiotelegraphy and Radiotelephony*, by J. A. Fleming, D.Sc., F.R.S. Third Edition. Longmans, Green & Co., London. 7s. 6d.

graphic stations, and only an exceedingly brief mention of them is made here, while in addition the somewhat erroneous impression seems to be conveyed that if tuning of the low frequency spark circuit is adopted only very low spark frequencies, such as one spark every four or five periods of the alternator, can be obtained.

In the next chapter a very good summary running into some 38 pages is given of the various methods that have been put forward for the production of undamped oscillations, by high-frequency alternators of various forms (including the Goldschmidt alternator); Poulsen and other oscillating arcs; and various methods with quenched spark dischargers yielding a continuous succession of feebly damped waves of very high group frequency. The Marconi multi-disc discharger for continuous waves is also included (Fig. 24 describing its mode of operation has, however, been inverted by the printers), although, as mentioned above, the simple synchronous disc discharger has not up to this point been described in detail. The special application of these oscillation generators to the problems of radiotelephony is set out in the last chapter of the book.

Chapter IV. is of a much more advanced nature than any of the others in the book, and treats of the theory of the propagation of electromagnetic waves through the æther. It is of necessity largely mathematical, although the treatment and the text, as is usual in Dr. Fleming's works, are clear and easily followed, while his frequent comparisons with commonplace matters or well known phenomena, both here and in other portions of the book, add considerably to its value. The mathematical sections can be omitted by the reader, if so desired, without seriously hindering the continuity of the book.

Chapter V. devoted to radiating and receiving circuits, discusses the various forms of antennæ and closed circuit radiators. A trifle too much distinction appears to be drawn between aerials which are earthed by an actual conductive connection, and those fitted with balancing capacities, as the latter, if laid out on the ground and of sufficient area, furnish a very satisfactory earth connection for signalling purposes. No mention is made of the use of stranded copper wire with each strand enamel insulated, in the section on the construction of aerials, although the material is frequently employed, especially for small aerials. The inverted cone aerial of Fig. 11 is, moreover, scarcely typical of those used in most portable stations, the inverted L or simple umbrella aerials being much easier to erect. The chapter closes with an account of various directive aerials, including the Bellini-Tosi, and other arrangements.

A good summary of various forms of oscillation detectors is given in Chapter VI. Rather more space is devoted to the more historical forms than to the ones now used in practical working. This, however, is necessary if the student is to obtain a clear grasp of the fundamentals of oscillation detectors, and of the developments that have taken place in modern forms. The tone wheel, tikker, heterodyne, and other detectors are not mentioned in this section, although they are described later under Radiotelegraphic Stations. A description of the very sensitive three electrode valves, or audions as they are generally called, might with advantage have been included as well. As the book is written for students who may perhaps be carrying out experiments for themselves, a caution might have been included in connection with the use of the Einthoven galvanometer with an oscillation valve, as the "electron-current" passing to the plate circuit of the latter (even without boosting voltage) would frequently be sufficient to destroy the fibre of the galvanometer apart altogether from any rectified signal current.

In the next chapter, on Radiotelegraphic Stations, some good illustrations and

descriptions are given of various apparatus and complete stations, and a brief consideration of the effect of atmospheric conditions on the range of signalling. A feature of special interest to the amateur constructing his own apparatus, is the mention in many places throughout the book of convenient sizes of parts and their constructional details.

Chapter VIII., on Radiotelegraphic Measurements, describes such practical measurements as those of H.F. currents and voltages ; capacity and inductance measurements, and the use of the cymometer or wave meter for the measurement of oscillation frequency and wave-length, and for the delineation of resonance curves and their use in the determination of decrements. The information in this chapter should be of especial use to the laboratory student.

In the last chapter the author gives a summary of the problems of radiotelephony using the various forms of undamped oscillation generator described in Chapter III., and of the results achieved up to 1915. The mention of liquid microphones with which most of the long distance work has been achieved is very brief. A short description of the " valve " oscillation generators as used by the Marconi Co. is also given.

The book contains some 190 illustrations and is closed with a useful index, in which, however, further references to some of the more recently added portions of the book might well be included. As a whole, it is well printed on good paper, and in spite of a few small misprints which have crept into the text, should be eminently suited to retain the position of good repute which its earlier editions have already attained.



Answers to "Wireless World" Problems

WE have pleasure in printing below the answers to the two problems presented to our readers in the April issue. The first problem, it will be remembered, was as follows :—

A condenser (capacity 12 milli-microfarads) is made up of twelve smaller condensers of four different sizes (in parallel), viz.,—4, 2, 0.5, and 0.25 milli-microfarads, respectively. How many of each size are there ?

This is a problem for the mathematicians and others who have benefited from the Instructional Articles in THE WIRELESS WORLD. The solution is as follows :—

It is clear that there can only be *one* of the largest size, for two of 4 mmfds. and one of 2 mmfds. gives 10 mmfds. for only three condensers, leaving 2 mmfds. for nine condensers. Hence, let x y z be numbers of other sizes respectively,

$$\text{Then } 1 + x + y + z = 12, \text{—i.e., } x + y = 11 - z \quad \dots \dots \dots (1)$$

$$\text{and } 4 + 2x + \frac{y}{2} + \frac{z}{4} = 12, \text{—i.e., } 4x + y = 16 - \frac{z}{2} \quad \dots \dots \dots (2)$$

$$\text{Solving (1) and (2) gives } 3x = 5 + \frac{z}{2} \quad \dots \dots \dots (3)$$

$$3y = 28 - \frac{7z}{2} \quad \dots \dots \dots (4)$$

Now (3) and (4) are divisible by 3, and therefore $z = 2$, whence $x = 2$, $y = 7$.

∴ 1, 2, 7, 2, are respectively the numbers of condensers of each size.

The answer to the Electrician Christie's amusing problem is that 2 gallons of petrol will find 9,261 Germans in a week. We hope so.



WIRELESS NEUTRALITY.

THE lot of a neutral must sometimes be a very hard one, and it is made especially hard when one of the belligerents happens to be Germany, whose impudent pretensions can be characterised by no less an adjective than "colossal."

Shame is totally absent from them, and both the Central Powers have had to withdraw diplomatic representatives from the United States, whose patience, though long-suffering, became finally exhausted. Baffled by American vigilance with regard to their wireless plots at Sayville, they nevertheless have recently had the effrontery to protest against the suppression by the American wireless censors of the German Admiralty's announcement regarding the sinking of the British mine-sweeper *Arabis*, and in this instance were even able to extract from the U.S. Secretary of the Navy a promise that there should be no censoring of wireless information coming officially from a foreign Government when such information had already been printed in the territory of the enemy country.

So much for the treatment which Uncle Sam receives from the Hun. As far as Great Britain and her Allies are concerned, American statesmen were always ready to acknowledge that diplomatic conduct has invariably been absolutely "correct." But from this side also the "inevitableness of things" has constantly brought troublesome questions on the *tapis*. Sir Cecil Spring Rice, the British Ambassador, has on more than one occasion found himself obliged to make communications to Mr. Lansing about German secret wireless stations, and British subjects constantly ask that protests shall be made against what appears to them as "complacency" displayed by the American Government towards the wireless lucubrations of Germany.

These come, as often as not, from Britishers resident in other parts of the empire than the "old country." Here we are all too used to having the British lion's tail twisted by our cousins across the water, and look upon such a procedure as "Pretty Fanny's Way." But our Colonial fellow-subjects are less complacent, and the *Sydney Sun* not long ago published a memorial from Australian travellers relating to their voyage on one of the American steamers engaged in the conveyance of Australian mails and passengers across the Pacific. Our Antipodean contemporary comments:—

"It is about time the Federal Government did something to protect Australians travelling by American steamers from German faked wireless news services when crossing the Pacific."

The Australian journal certainly made out a good case and produced a formidable list of imaginary British reverses and German successes, printed in the ship's wireless newspaper.

A most benevolent neutrality was displayed towards German war news and a most grudging neutrality marked the news about the Allies. Yet *half the cargo and more than half the passengers carried by these steamers are supplied by Australia.* The *Sun*, therefore, suggests that the Commonwealth Government might, irrespective of the British Imperial authorities, approach the United States authorities independently, and endeavour to induce the latter to take steps for the protection of Australasians on the high seas against such intolerable and unneutral annoyance.

* * * * *

A WIRELESS BATTLE.

Wireless plays an important part in every operation at sea, and this fact recently received a most striking illustration on the occasion of the battle between the *Alcantara* and the *Greif*. It will be remembered that the *Alcantara* was a converted liner taken over from the Royal Mail Steam Packet Co. and fitted out as an auxiliary cruiser. Her wireless apparatus, unless it had been replaced by fresh fittings since her conversion, was only of that power which was settled by the Berne Convention as not to be exceeded by merchant vessels. German ships notoriously evade these regulations, and it is quite plain that the apparatus employed on the *Greif* was of a far more powerful nature than that of the English vessel. As soon as the concealed enemy disclosed her true character and started to jam the signals of the *Alcantara*, she cut the latter's wave-length with remarkable readiness, so that a stubborn action was fought between the wireless rooms as well as between the guns. With regard to the latter, the weight of metal appears to have been on the side of the Germans, but the superiority in gunnery combined with more skilful



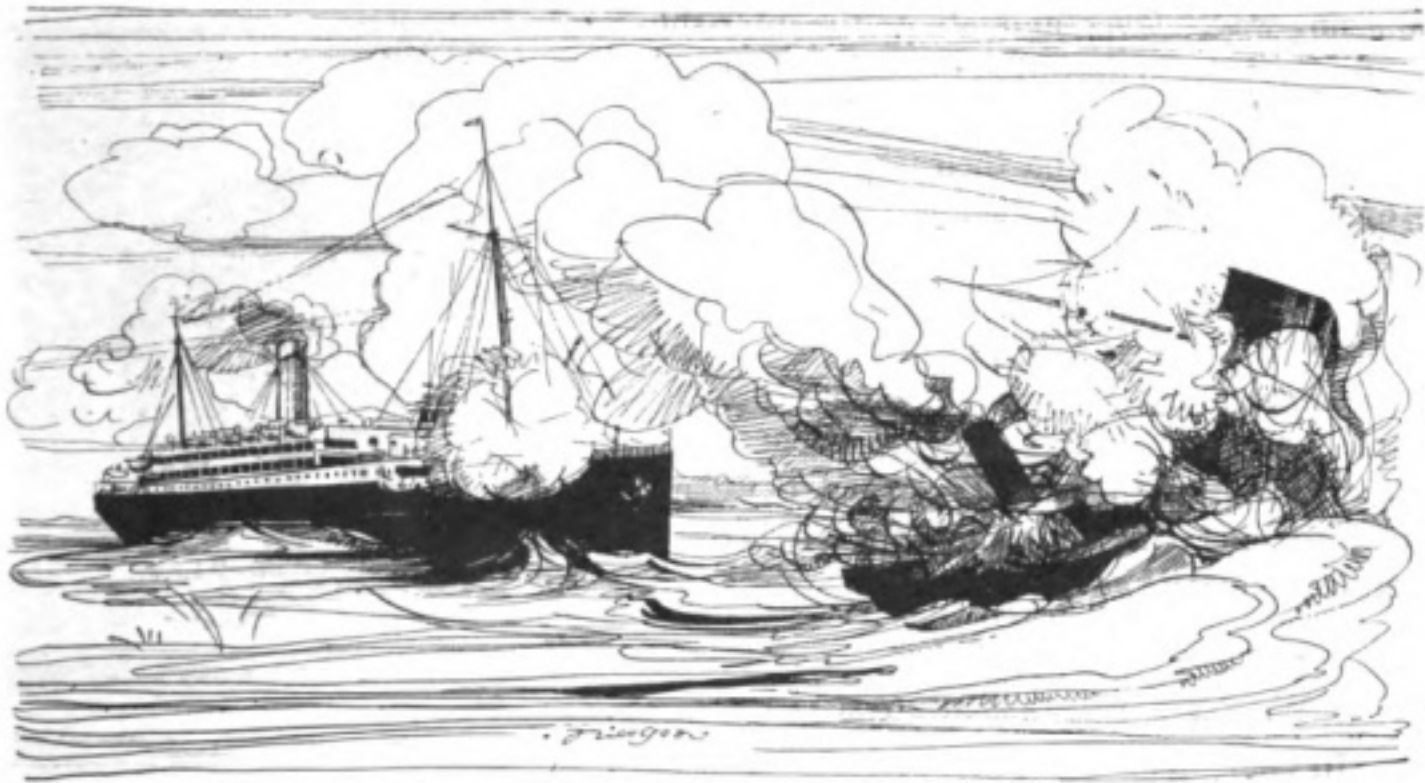

seamanship, enabled the British to outclass and overcome the enemy. Still, the wireless superiority of the latter prevented the British vessel from sending out calls for assistance, or any advice of the fierce struggle in which she was engaged, and it was not until her guns had wrecked the *Greif's* wireless cabin, and put her radiotelegraphic apparatus out of commission, that the word flashed forth to all the patrolling ships in the neighbourhood that the *Alcantara* had caught a raider and was engaged on an unequal struggle. We do not know whether it was the *Alcantara's* wireless message, released from jamming, or the sound of gunfire which brought the other vessels to the spot. When they arrived, the issue was already decided, and the *Alcantara* had won a remarkable victory. Accounts differ as to whether the torpedo which was responsible for the British cruiser sharing the fate of her adversary was fired from the *Greif* in her death-throe or from an attendant submarine. But, from whichever cause it may have arisen, every indication appears to point to the fact that the British cruiser fell a victim to an honourable attempt to save as many as possible of the *Greif's* crew from a watery grave. The whole incident reflects great credit upon our British sailors, and illustrates the fact that wireless strategy and tactics have become as important as "coal strategy." Where our fathers fought with one weapon we have to fight with ten, and the brain of the commander must be an alert and receptive thing.

* * * * *

THE CROWDED ÆTHER.

It must be many years since the waters of the Mediterranean were ploughed by so many war vessels as is the case to-day. Indeed, if the tale be reckoned up completely, so as to include fighting ships of all sizes, patrol boats, transports, *et hoc genus omne*, I suppose that these present days may be taken to be producing records. Practically every vessel carries wireless, and, although some of them are not permitted to despatch messages unless in exceptional circumstances, there is a vast conglomeration of message-bearing æther waves of varying lengths and intensity, criss-crossing each other in an

amazing way. Over and above the inter-ship messages, there is the ordinary traffic of Marconi-grams, besides all the Press war messages from the Entente stations on their way to the East, Admiralty code messages and signals from a large number of land stations, including the enemy installations in Turkey and Bulgaria, prominent amongst which is Ok Meidan station. Less distinct, but still audible and recordable, come the æther waves from the German Norddeich station near Berlin. Are we not justified in characterising the æther as decidedly overcrowded?

* * * * *

WIRELESS ANIMALS AND ARCANA.

In our issue No. 28 of July, 1915, we inserted a note about a *wireless dog*, and recently our attention has been directed by one of the Grand Fleet chaplains to a *wireless cat*. The reverend gentleman insists upon the sacrosanct nature of the wireless room, and warns all and sundry that whatever else on his battleship he may be permitted to show them there is one spot treated with reverence, a very Holy of Holies, unapproachable save by the high priests of radiotelegraphy! That spot is the wireless room. The reverend gentleman himself appears to have penetrated into it on one occasion, at all events, and witnessed the *arcana* contained therein. He is anxious not to "divulge" any of the mysteries," but ventures to say that "it is very different in general economy

"from the wireless room of a dozen years ago." There is, says he, but one outsider who possesses a "free run" there. This is the *wireless cat*, a creature "endowed by nature with an aptitude for the pursuit of science." The chaplain's picture of the absolute imperturbability of this favoured animal to the weird sights and sounds which day and night pervade this room are both instructive and amusing. As the pet and property of the operating staff, on the analogy of most of the books pertaining to this specialised branch of signalling, it is generally described as "the Wireless Cat with Addendum One." Whenever it wants to signal "annoyance" it radiates the message in wireless waves by means of its *addendum*. The reverend chronicler closes his description with the remark that this interesting specimen of the feline tribe belongs to the softer sex and is—at present—*télégraphie sans "fille."*



EN HÂTE, MAIS SANS PRÉCIPITATION.

Amongst their other delightful characteristics our French Allies have been distinguished throughout their long and glorious history for their faculty of neat expression. An amusing example is furnished in the columns of one of our contemporaries. Dealing with the services rendered by Wireless, the French journalist relates how, by this means, the lives of the citizens of Nancy are preserved from destruction by the shells of the Boches.

"The great siege guns of the enemy are kept under observation, and the moment one is fired our air scout gives notice by wireless telegraphy, and the town

"siren hoots. Now radiotelegraphy moves faster than shells and, during the short interval between the start of the shell and its arrival, sufficient time elapses for the siren to sound the alarm fifty seconds in advance." The City Fathers have warned those under their care that this notice should suffice for persons domiciled within the danger zone to leave the upper regions of the house and take refuge in the cellars "en hâte, mais sans précipitation"—with hurry but without flurry.

Our French journalist expresses a pious hope that the Mayor will give some rehearsals in the City Hall so that the citizens of Nancy may see with their own eyes "how their worthy Mayor makes his retirement from garret to cellar with hurry but without flurry." As French Mayors are traditionally as fond of the "good things of life" as their English prototypes, M. le Maire is probably already "bombé" in another sense, and such a "rehearsal" would be likely to prove interesting.

* * * * *
RESCUED FROM THE GERMANO-TURKS.

The attention of the world at large has been recently struck by the successful activity of our Russian Allies in Asia Minor and Mesopotamia. Their magnificent exploit in the capture of Erzerum and their further successes at Bitlis and Trebizond, which we all hope to see speedily consummated by the total expulsion of the Ottoman troops from Armenia and Mesopotamia, have recalled to our minds the sufferings of the Armenians at the hands of the Turks through a long continued series of years. These sufferings culminated in the awful slaughter perpetrated by these same Ottoman perse-

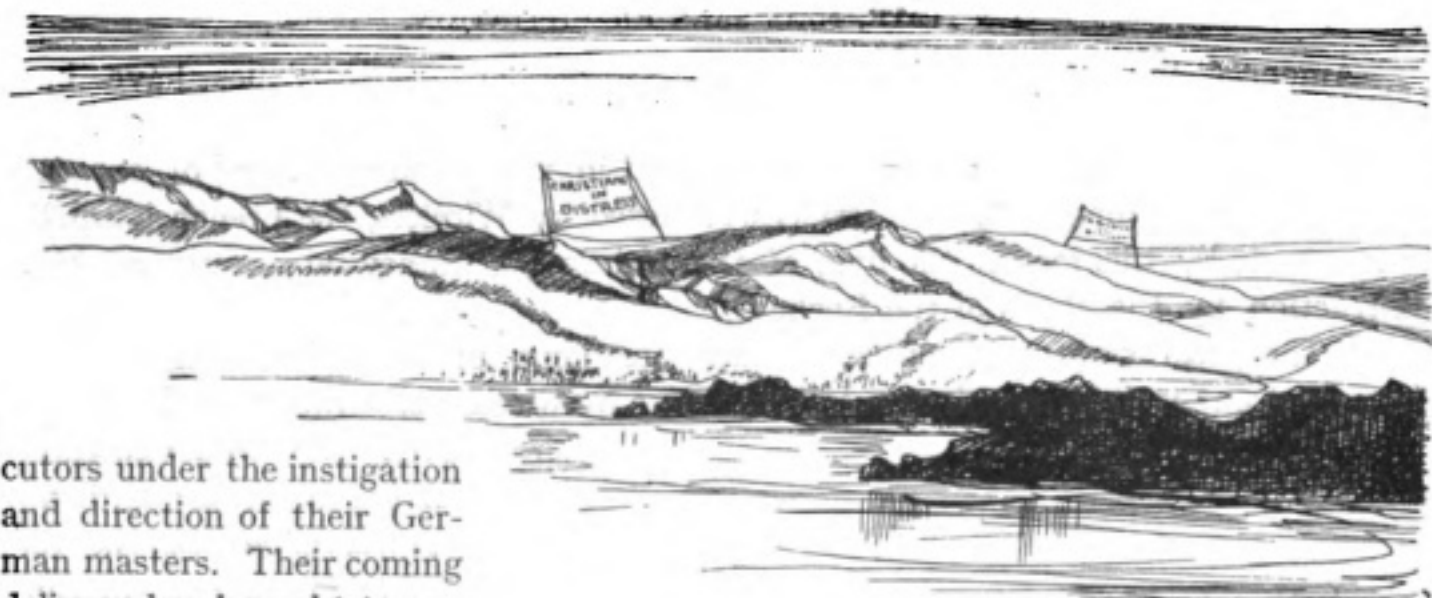

cutors under the instigation and direction of their German masters. Their coming delivery has brought to our minds a picturesque 'SOS' rescue of a party of 4,000 Armenians by French and British cruisers in which *wireless played its part*.

Dikran Andreasian, Pastor of the Armenian Protestant Church of Zeitoun, himself one of the 4,000 rescued fugitives,

tells the tale. Notified from Antioch by the Turkish Government to prepare for banishment, the Armenian inhabitants of six villages of Mousa Dagh were smitten with panic, for they knew what it portended, and—taking time by the forelock—withdrew to the heights, where they dug themselves in. Despair nerved them to maintain a stout defence against 15,000 Mohammedans, who, finding themselves unable to storm the position, surrounded Mousa Dagh on the landward side with the intention of starving them out. The sea laves the foot of the mountain slopes, but there is no port here, and days passed without even a sign of a sail upon the horizon. The Turks attacked again and again, and the defenders' ammunition showed signs of running short. Two immense flags were erected, on one of which were printed in large clear type the *English words*, "Christians in distress : Rescue."

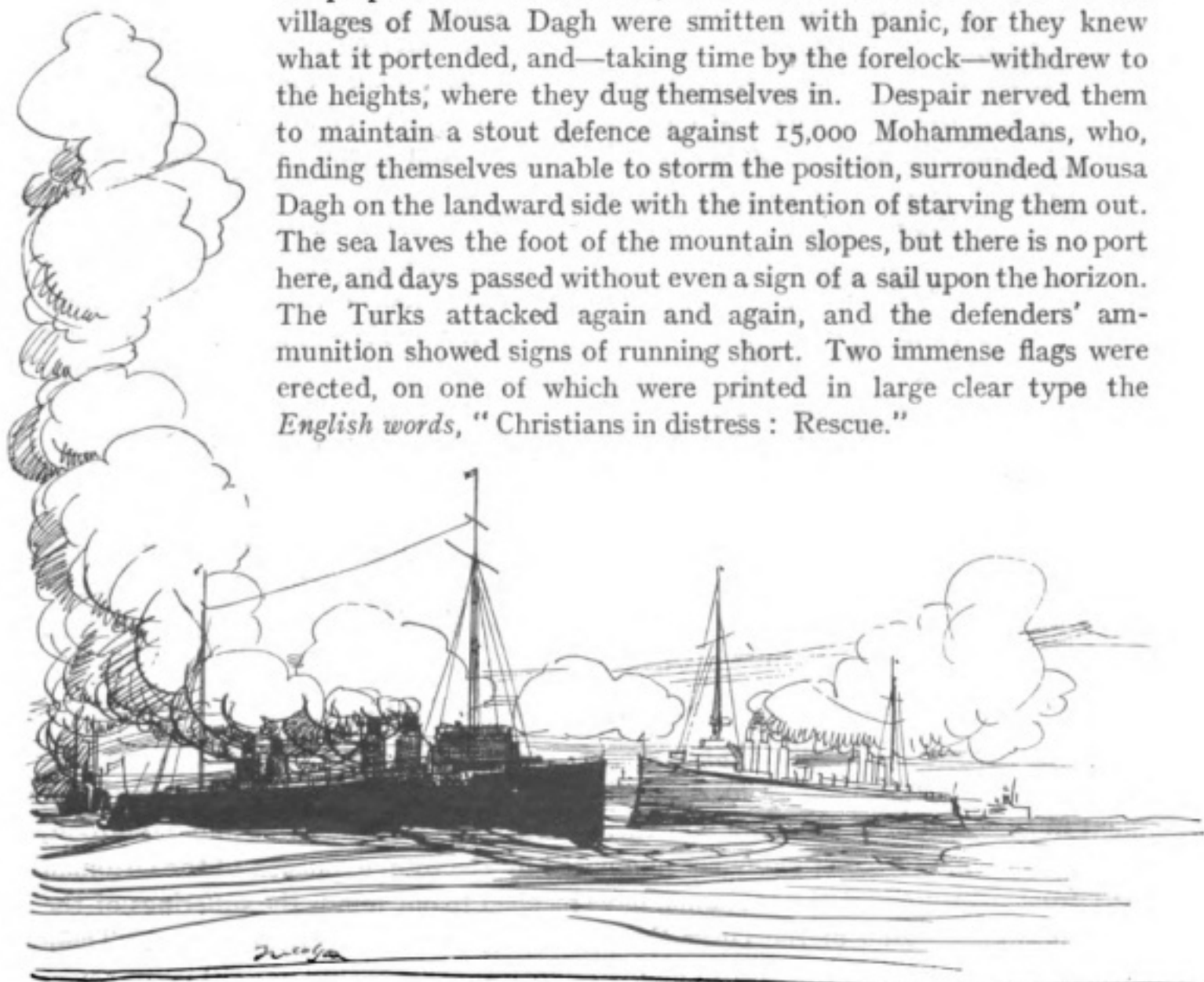

One Sunday morning, the 53rd day of the siege, the French four-funnelled *Guichen* came in sight and communication was established with her. The commander, unable to deal with so great a number himself, sent a *wireless message* to the Admiral of the Fleet for instructions, and, before very long, the flagship *Ste. Jeanne d'Arc* appeared, followed by other Entente war vessels. Thus, through the instrumentality of radio-telegraphy, there were rescued from an awful fate, 427 babies under 4 years of age, 508 girls, and 2,495 men and women above 14 years of age.

* * * * *

TURKISH FICTION AND BRITISH FACT.

The Constantinople bulletins issued by the German Wireless have for some time past been making claims to have won successes against the various British forces in Mesopotamia. Many of those claims are altogether without foundation, a fact which has several times been officially exposed by the British Government. Others rest on the retirement of reconnoitring forces, after the achievement of their object, to the main body to which they belong. These are represented as retreats after defeat. Amongst letters home from members of the fighting parties in this district some interesting examples were recently published in the *Times* from an officer belonging to the British Force at Kut-el-Amara, who has been in action. The account given of the composition of such a reconnoitring party, thrown out from every main force in its advance with the object of collecting information and gathering supplies, will illustrate the part played by wireless and expose the attempts of the enemy to create a deceptive impression of success out of the safe return of such patrols. Our correspondent's letter states: "I was in command of the column—a small one—consisting of half a battery of Royal Horse Artillery, one squadron of cavalry, one double company and pack wireless. We had a small scrap 25 miles out, but luckily (or unluckily) the enemy was not a raiding party, but consisted merely of a few truculent Arabs, whom a couple of shells and a little long-range fire soon dispersed to the four winds, and we resumed our march unmolested, to the great relief of the Division with whom I had been in communication by wireless." On this occasion our British officer brought his reconnoitring column safely back and duly made his report to headquarters.



The Darien Radio Station of the U.S. Navy

By Lieut: R. S. Crenshaw, U.S.N

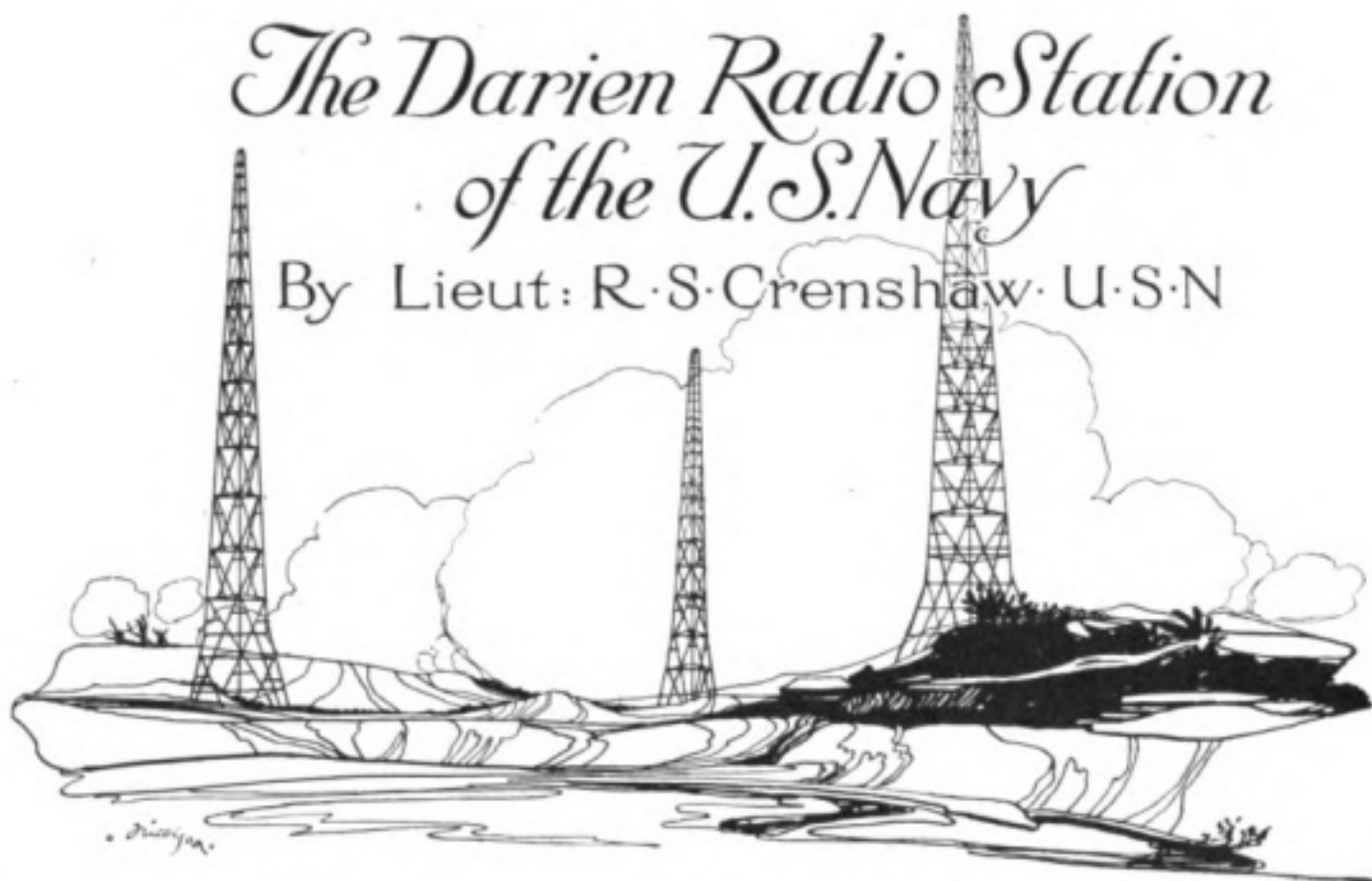

(Abbreviated from the Proceedings of the Institute of Radio Engineers, N.Y.)

LINE DRAWINGS BY J. W. NICOLSON.

In its system of radio communication for the canal zone the Navy has maintained the high standard set by the canal in general in having thoroughly modern equipment. The layout comprises one coastal station at each end of the canal for ship to shore work.

The Darien radio station is located just twenty-five miles south of Colon on the Panama Railroad. The railroad runs from the east boundary of the reservation, which contains eighty-seven and one-half acres. The south-west boundary is the canal itself, from which runs a channel 20 ft. deep and 75 ft. wide into the centre of the station plot.

Work was started on construction in December, 1913, by the Quartermaster's Department of the Panama Canal.

The dwellings on the site are the house for the Radio Officer, cottage for the chief electrician in charge, and barracks for the operators, equipped to house seventeen men. Servants' quarters are also provided in the barracks building. Rations are commuted at a dollar a day per man, and a mess is run by the operators.

All the buildings are screened, including the porches. There is such a large breeding area for mosquitoes about the site, that the cost would prohibit sufficient sanitation work to keep the mosquitoes down entirely, and the means adopted are: (1) to keep the screening as tight as possible; (2) each morning a sanitary inspector makes the rounds and catches the mosquitoes inside the living quarters and office; (3) no containers are allowed to collect water in which there may be breeding on the station site; (4) all drains are kept clear so that no water stands in puddles; (5) around the edge of the water the bank is kept skinned to allow the small fish to eat the mosquito larvæ (this means is remarkably effective); (6) the force of five labourers allowed the station is kept at work on the grounds to keep the jungle growth cut down as well as possible.

When one case of malaria appeared, the whole station was put on a quinine diet for ten days in order to prevent an epidemic.

The other buildings of the station, with the exception of the boat-house, are of concrete. The boat-house is of old form lumber left over from the concrete work, and corrugated iron roofing robbed from old, abandoned shacks on the site, one of which was a distillery.

The power-house is 60 ft. by 30 ft., and contains the motor generators for the main transmitting set.

The main distributing and controlling switchboards are here, with the auxiliary transformers. This building also houses the machine tools, a small lathe, a drill press, milling machine, and emery grinder, and is fitted with a 5-ton overhead travelling crane. All wiring is in conduit in wire trenches.

The operating building contains the arc room (where is located the main transmitting set with its auxiliary electric controlling devices), the receiving room, and the office, beside a spare room for an auxiliary sending set if needed later. The arc room and the receiving room both have wire mesh embedded in their walls, floor, and ceiling, in order to prevent induction from the transmitting set injuring the receivers. The building is fireproof, which is necessary on account of the action of the continuous oscillations used at such high voltage. The charging current into iron in the vicinity of any live lead heats the iron quickly. Some of the reinforcing had to be taken out of one concrete base because the current jumped to it, and one wall, 19 in. (47 centimetres) away from

the end of the helix, heats so that the hand cannot be kept on it after a twenty-minute run. The reinforcement in this wall is merely metal lathing, but it is directly in the field of the main helix.

The contract for the towers was let to the Penn Bridge Co., which, in turn, sublet the fabrications to the Toledo Bridge and Iron Works, and the erection to Mr. J. O. Childers. In all three towers there are about 1,000 tons of structural steel. They are 600 ft. (183 metres) high each; the feet form a triangle 150 ft. (46 metres) on a side, and the tower tapers to a 10-foot (3 metres) triangle at the top. An iron ladder runs up the outside of one leg on each tower, having rest platforms about every 50 ft. (15.2 metres).

When first erected there was considerable swaying in the bottom long diagonals, but these and others above were stiffened up by cross bracing,

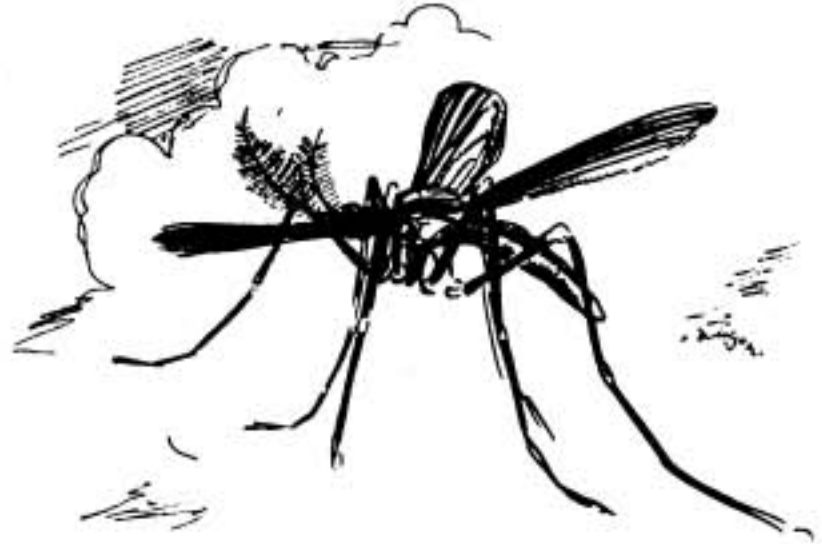

ANOPHELINE MOSQUITO—
THE "TERROR OF PANAMA"



THE SANITARY INSPECTOR

and now they are perfectly rigid. When the antenna was hoisted and adjusted to the sag, which would give a pull of about 13,000 lb. (5,500 kilograms), the top of each tower was pulled over only 4 in. (10 centimetres) during hoisting, and settled back to 2 in. (5 centimetres), when hoisting stopped. All the bend was in the upper 200 ft. (60 metres).

As mentioned earlier in this article, it was the first intention to locate the towers on the tops of the hills, but on making the actual location, it was found that the thrusts (which come on to the footing at the angle of slightly over 16° from the vertical) would be nearly too parallel to the face of the hills to give solid backing for the footings. They were finally located, so that all footings except one butt into the



A TYPICAL NATIVE VILLAGE



"LABOURERS KEEP THE JUNGLE GROWTH CUT DOWN"

hills. In order to do this, however, the footings were put on about the 120-foot (36 metres) level instead of the 170-ft. (52 metres). The surface of Gatun Lake is normally at the 85-ft. (26 metres) level. The block for each footing is 16 ft. (5 metres) deep and 20 ft. (6 metres) square, heavily reinforced with old railroad rail. Each block filled entirely the hole excavated for it without back filling, in order to have it bearing in undisturbed earth. The distance between towers is: One and two, 897 ft. (273 metres), two and three, 751 ft. (254 metres), one and three, 969 ft. (295 metres), the antenna covering about six acres.

The Darien towers being farther apart, and not so directly beneath the antenna, seem not to affect the capacity as at Arlington. Darien evidently has a greater effective height than Arlington.

The antenna was made at New York Navy Yard and shipped to Darien, each wire on a separate reel, and tagged to mark the points where other wire crossed. The cables are all phosphor-bronze, the outside ones being $\frac{3}{8}$ -in. (1.9 centimetre) diameter, the four strain cables through the mast, $\frac{1}{8}$ in. (0.9 centimetre) diameter, and the sixty-six radiating wires of regular antenna wire. The first 150 ft. (48 metres) of the down land of twenty-six wire is a fan, and is then grouped by spacing hoops to form the rat-tail. Each corner is insulated with the Arlington type of Locke insulators with, however, two strings in parallel, as the strain was too near the mechanical breaking limit of the insulators. Lightning has already struck the antenna twice without damage, because of the safety gap feature of these insulators and the towers being grounded. An electric winch on each tower furnishes the power needed for handling the antenna. The feet of each tower are insulated.

The feet rest on ten porcelain block insulators 11 in. (27.9 centimetres) high, having each three petticoats. Insulators are also placed under the yokes, which secure to the anchor bolts for taking the upward thrusts, and others are placed between the footing and the channel irons projecting from the block to take the side thrusts. However, the arc "pulls" better with the towers grounded, so they are operated in that condition by being grounded through large knife switches to the ground system of the station.

The general ground conditions of this site are excellent, since the Gatun Lake lies on three sides of it, with an arm reaching into the centre of the station plot. An artificial ground was laid in addition to cover all the land as follows: 100,000 ft. (30,000 metres) of annealed copper wire was laid in the shape of a grid, forming rectangles about



GATUN LAKE, WHICH HAS BEEN UTILISED TO FORM
AN INTEGRAL PART OF THE PANAMA CANAL.

50 ft. (15 metres) on a side. All inter-sections were soldered; the ends of all wires, on reaching the water's edge, were run 100 ft. (30 metres) into the lake, and the main ground plate and the ground plate for each tower are tied into the large grid by busses reaching well out into it. This ground system is buried about 4 in. (10 centimetres) for protection.

The signalling is done by short circuiting or opening a compensation helix in series in the antenna circuit. The key for accomplishing this contains 13 pairs of points mounted on a yoke in parallel, so that each pair of points breaks only the voltage due to one turn of the auxiliary helix. This yoke is on the armature of a solenoid, the current controlling which is broken in a strong magnet field, and the key is thus positive and fast in action. The D.C. supply is protected from the radio-frequency current by having air core choke coils in both positive and negative lead to the machines. There are field spools in the negative lead, and carbon rod protection in the power-house guards further against high voltages getting into the D.C. generators. This set gives Arlington a signal easily readable through all but the worst electrical storms.

The arc can be controlled entirely from the operator's seat, the main generator voltage being controlled there, circuit breakers closed or tripped, the arc struck and starting resistance arc short-circuited. While running, the arc is regulated to take up the wear of the carbon by foot pedals, so that the operator may not have to interrupt his sending. All circuits are electrically interlocked, so that on starting the correct sequence must be followed.

Only Government work is handled by this station, and at present there is not enough of this to demand continuous watch so that schedules are run. The comple-



THE PLAZA AND CATHEDRAL, PANAMA. THE SQUARES OF LATIN AMERICA ARE REMARKABLE FOR THEIR BEAUTY.

ment requires eight operators on watch, two at a time, a chief radio electrician in general charge, a hospital steward of the Navy in charge of sanitation and general health work, a yeoman (who is a clerk for the station and for the Radio Officer), and a machinist. Five labourers are employed on the grounds, which were high jungle when the station was built. The Radio Officer of the canal zone lives here, having his office in that of the station. With excellent telegraph and telephone service to all parts of the Isthmus, the station, though isolated, is in close touch with the Canal Government.

Postmaster-General's Report

The following is an extract from the Postmaster-General's Annual Report, which has just been published :—

Wireless Telegraphy.—Between April 1st and July 31st, 1914, 326 new licences had been issued under the Wireless Telegraphy Act for experiments or the reception of time-signals, while 131 licences for experimental stations had been cancelled or had expired. In 26 cases permission to conduct temporary experiments was given by letter. On the outbreak of war there were in existence 2,158 licences for private land stations as compared with 1,963 on March 31st, 1914. No licences for fresh stations have since been issued, and all existing stations, except a few required for Government work, have been dismantled. Private apparatus generally has been taken into Post Office custody for the period of the war. Under the Defence of the Realm Regulations measures have been taken to prevent the use of unauthorised wireless apparatus.

At the end of July, 1914, there were 942 merchant ships registered in the United Kingdom carrying wireless apparatus under licence from the Postmaster-General, as compared with 879 ships on March 31st, 1914. The number of radiotelegrams dealt with at the Post Office Coast Stations between April 1st and July 31st, 1914, was 26,145 (21,911 inwards and 4,234 outwards), as compared with 19,942 during the corresponding period of the previous year—an increase of about 31 per cent."

Colonial Import Duty

Information relating to the rates of import duty leviable in the British Self-Governing Dominions, Colonies, Possessions, and Protectorates, is contained in the return recently published by the Board of Trade on "Colonial Import Duties, 1915." The Return is arranged with the object of bringing together the various tariff classifications and rates of duty for each principal group of articles, the information being shown for each British Possession under each group. Electric machinery and apparatus (including wireless telegraphy) forms one of the headings into which the groups are divided.

To Our Readers

THE recent controversy as to the presence in Paris, at the Entente Economic Council, of Mr. Hughes, the Australian Prime Minister, has somewhat forcibly reminded many of us of the famous declaration of policy on the part of George Canning, which he introduced into the King's Message of December 12th, 1826: "I have called the New World into existence to redress the balance of the Old." George Canning, it will be remembered, was the most progressive of the British Foreign Ministers in the early part of the nineteenth century; and it is interesting at the present juncture to remember that he was responsible for the treaty which combined England, France and Russia for the settlement of the affairs of Greece.

This far-sighted policy has been recently carried to lengths undreamed of by our nineteenth century statesmen; it has met with a glorious response, and the way in which Australia, New Zealand, Canada, India, and indeed all the British Overseas Colonies and Dominions, have rallied to the support of their Motherland in her fight for Civilisation against "Kultur" has rendered praise not only superfluous but impertinent.

All of them have recognised that, though far away, they are closely concerned in the titanic struggle. I recently came across a long article published in a leading Australian newspaper which bears directly upon the point. The antipodean journalist placed in the forefront of his argument the "indirect but unmistakable evidence" of Germany's designs on the Commonwealth as evidenced by "the numerous wireless stations which she established round and about us prior to the war." Besides a number of plants of small power, intended only for inter-island communication, there were four installations, containing ocean plants of high power, located in German East Africa, German New Guinea, German Carolines, and German Samoa. Communication could be established with Berlin, and these powerful stations were able to exercise a most undesirably inimical influence throughout the Indian and Pacific Oceans. Taking into account the insignificance of the German colonies, it would be the height of fatuousness to accept domestic needs as the explanation for their existence. No! they were "war plants" in the fullest sense of the words, important tentacles of the Teutonic octopus whose deliberate intention was to strangle the independence of Britain overseas.

Australians, moreover, have never forgotten the war-plot which was really responsible for the disappearance of the German fleet at Kiao-Chau, synchronising with the acute stage of the Agadir crisis four years ago. Five powerful vessels of war were suddenly "lost" in the Pacific Ocean. Thanks

to a fortunate accident which took an Australian ship near New Guinea *en route* to Sydney, it was discovered that the German war-fleet was lurking off Rabaul with steam up, ready to head for Australia at a moment's notice immediately on receipt of a wireless message from Berlin.

The radio-telegraphic work of the Australian Government has been immensely increased since the outbreak of war. We are proud to know that the Amalgamated Wireless (Australasia) Company has rendered invaluable assistance to the naval and military authorities. They were in possession of the only organisation capable of affording this help, and the Directors placed the entire organisation unreservedly at the disposal of the Commonwealth for war purposes as soon as hostilities opened. Naturally we are not at liberty to speak in detail of the Company's manifold activities in this direction, but we have the satisfaction of knowing that it has already received official recognition.

In matters wireless, as in other spheres, the children of Britannia have rushed to her aid. On the Gallipoli Peninsula the wireless equipment of the Australian Light Horse signal troops performed useful service, and more recently still the first complete wireless signal corps organised in Australia sailed to play their part in active service. New South Wales and Victoria contribute each their quota of men, and it is a highly satisfactory evidence of the patriotic activities of the Amalgamated Wireless (Australasia), Ltd., that a large number of experienced telegraphists, in the course of receiving their wireless training at the Marconi School, 97, Clarence Street, Sydney, marched to the Town Hall and enlisted, as soon as the urgency of the call for recruits was realised. The Australian papers have celebrated the organisation and dispatch with the greatest enthusiasm, and published on behalf of the citizens of the great Commonwealth a hearty farewell greeting to "this little coterie of Australians destined to serve as strangers in a strange land."

When we count up the assistance given by the Australians, in money, in valiant soldiers, in statesmen, in economists, and in wireless telegraphy, are we not justified in saying that, in a sense truer than any which applied in the day of George Canning, our own beloved monarch is "calling in the New World to redress the balance of the Old"?

The Editor

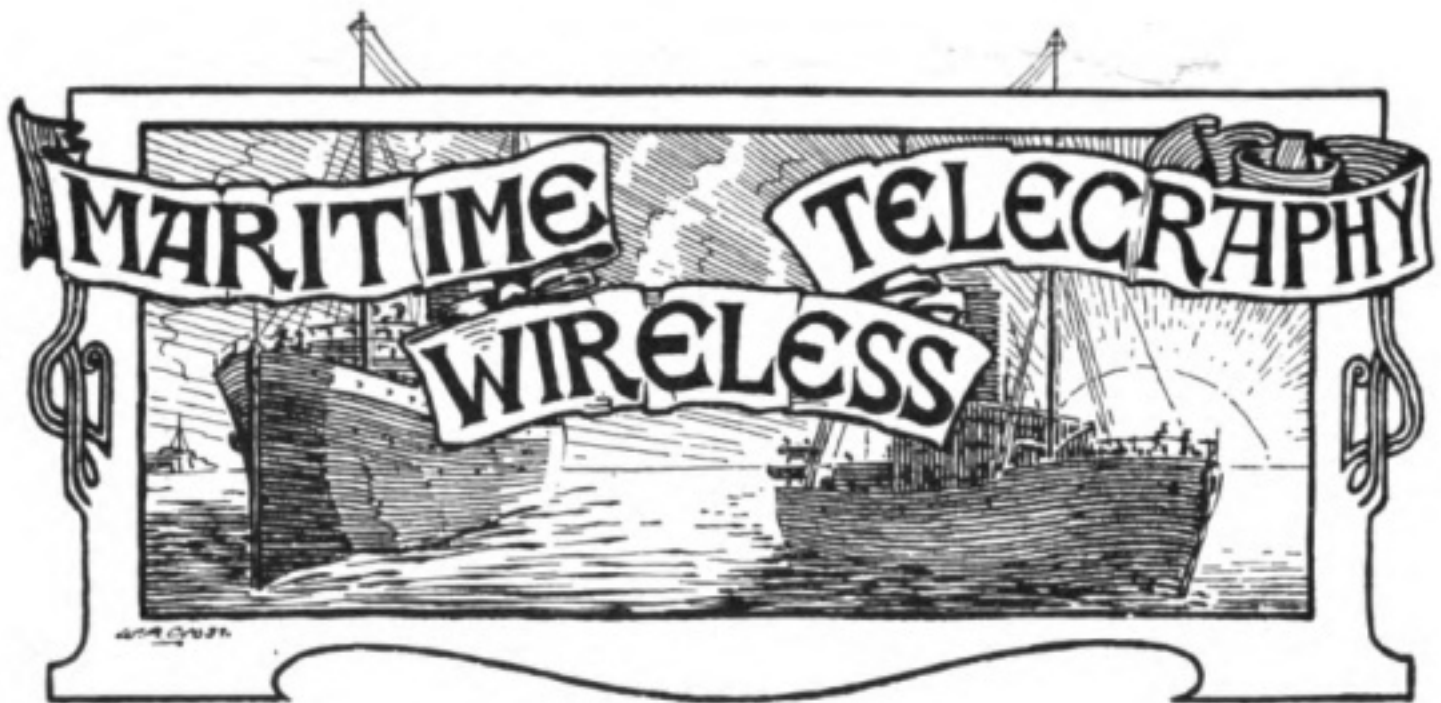

LOSS OF THE "ENGLISHMAN."

In connection with the sinking of the s.s. *Englishman* it should be placed on record that the Marconi operator was able to get into touch with another vessel before he left his ship. The *Englishman* was outward bound, and carried no passengers. The 10 victims include 7 horse attendants, 3 of whom were American citizens. Most of the survivors of the lost liner have now reached port.

* * * * *

ATLANTIC LINER SUNK.

The large British steamer, *Minneapolis*, of 13,543 tons gross, has been torpedoed and sunk in the Mediterranean. She carried a large crew, all of whom were saved, with the exception of eleven, who, unfortunately, were killed. Wireless appeals for help were sent broadcast, and this was doubtless responsible for the small loss of life. We are enabled to reproduce a photograph of the lost steamer. She was one of the best known Atlantic liners, and was built for the Atlantic Transport Company by Harland and Wolff, at Belfast, in 1900. In normal times she carried a number of first class passengers.



THE S.S. "MINNEAPOLIS," WHICH WAS TORPEDOED AND SUNK IN THE MEDITERRANEAN WITH A LOSS OF ELEVEN LIVES.

DUTCH LINER TORPEDOED.

The Royal Dutch Lloyd liner *Tubantia*, of 13,911 tons, which was on a voyage from Amsterdam to Buenos Aires, was torpedoed and sunk two miles from the North Hinder Lightship (38 miles west of Flushing). Thus was another dastardly act committed by the German pirates, with their usual brutal callousness. Her SOS calls were answered both from England and Holland, and, fortunately, all the passengers and crew were saved. A delayed wireless message received at Ymuiden from the *Tubantia*, via Scheveningen, ran: "*Tubantia* torpedoed and lost, am now leaving ship with captain,

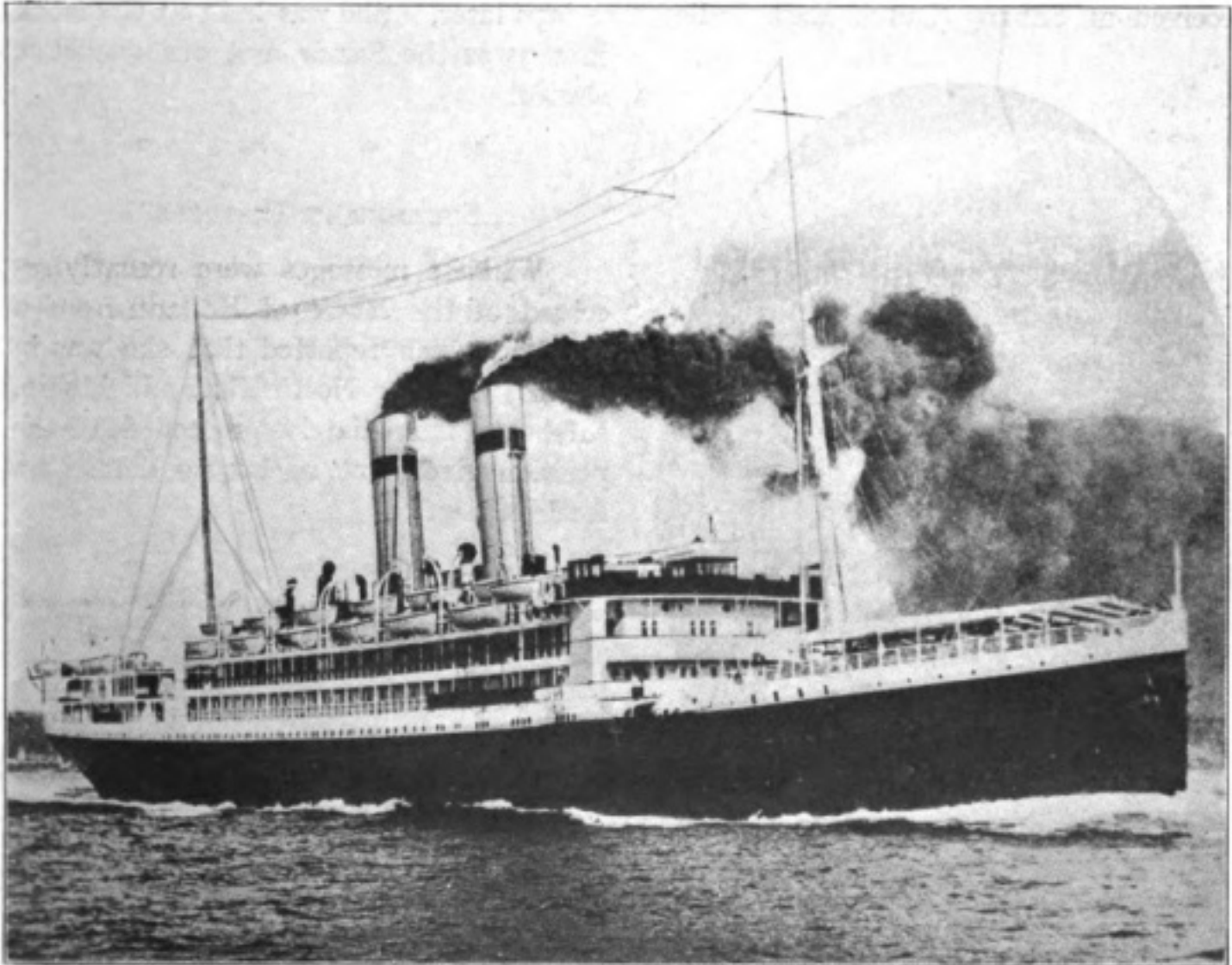

[Photo: Photopress

THE DUTCH LINER "TUBANTIA," OF 13,911 TONS. SHE WAS QUITE A MODERN SHIP.

do not worry." It was signed by the senior wireless operator. Another wireless message was received in Amsterdam from the captain, which made it clear that the torpedo struck the stern of the vessel, damaging the steering gear and admitting water to the corridors and engine room. The vessel, which remained afloat for about three hours, is represented in our illustration.

The Germans really seem to believe that "All is fair in love and war," for, after the torpedoing of the *Tubantia*, a wireless message was received at Flushing saying "*Tubantia* struck a mine." The captain of the vessel sent no telegram to this effect, so that, apparently, the submarine which torpedoed the vessel sent it.

D

SINKING OF THE "CLAN MACTAVISH."

In connection with the sinking of the above vessel we are now enabled to publish a photograph of her, together with the gallant commander who put up so brave a fight against such terrible odds.

* * * * *

JAPANESE STEAMER MISSING.

The Japanese steamer *Hokoku Maru*, of 5,038 tons, has been posted for inquiry at Lloyds as being very much overdue. The steamer left Singapore for Durban, bound from Portland (Oregon) for the United Kingdom, and a wireless message was received at Sabang (Dutch East Indies) two days later. She was built at Greenock in 1895 as the *Sunda*, and was owned at Darien.

* * * * *

STEAMER IN DISTRESS.

Wireless messages were recently received at the Hook of Holland from a steamer which reported that she was in distress near the North Hinder Lightship. Lifeboats immediately proceeded to the position given, but, so far, no details are forthcoming.



[Photo: Central Press

THE S.S. "CLAN MACTAVISH," WHICH WAS SUNK BY THE GERMAN RAIDER "MOEWE" IN THE ATLANTIC AFTER BRAVELY RESISTING. INSET: CAPTAIN OLIVER, HER PLUCKY COMMANDER.

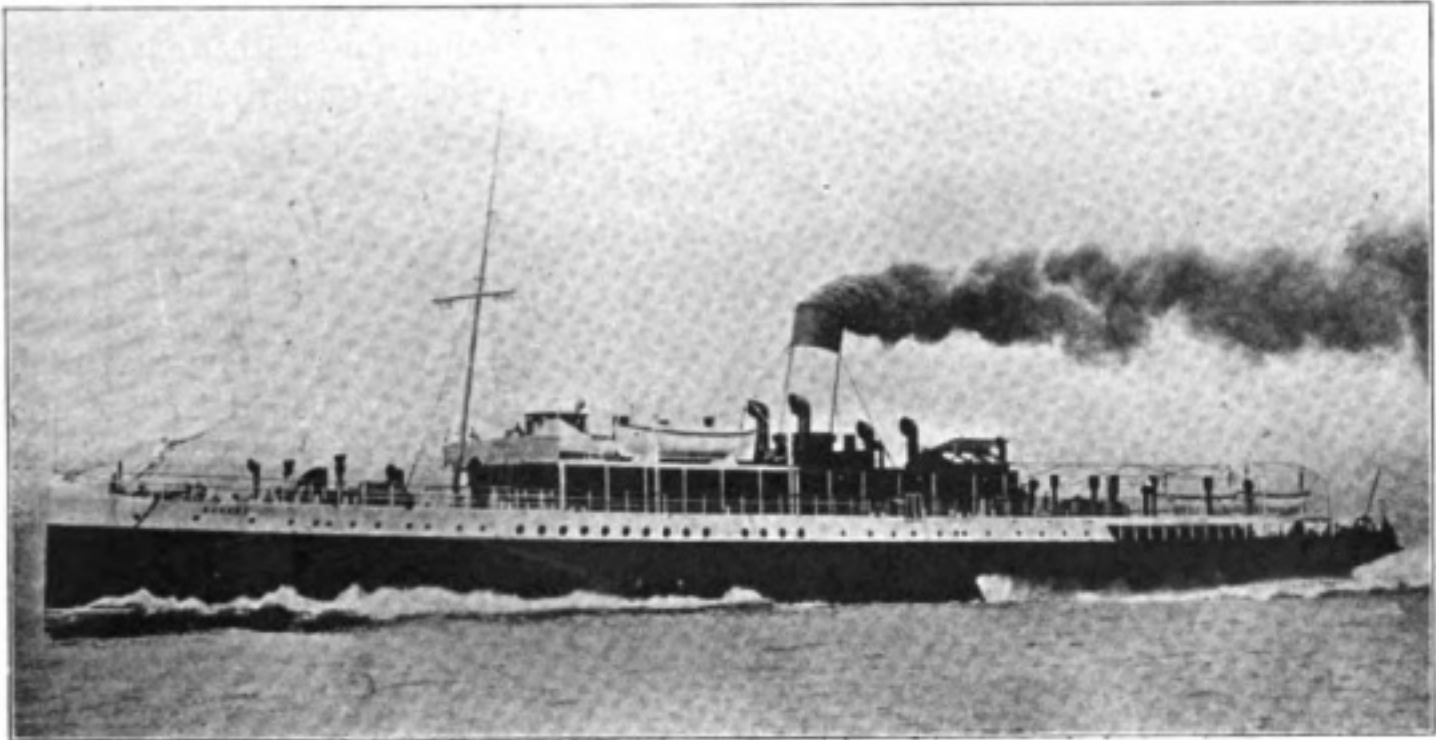

[Photo: L.N.A.]

THE CROSS-CHANNEL STEAMER "SUSSEX," TORPEDOED AND SUNK
BY A GERMAN SUBMARINE, UNFORTUNATELY WITH LOSS OF LIFE.

SINKING OF THE S.S. "SUSSEX."

Germany's record of crime will stain her character to the end of all time. The chivalry of the sea, which forms the heritage of all maritime nations, is strangely lacking on the part of our Continental enemy. Germany's depraved methods of warfare have again been emphasised in the sinking of the cross-Channel steamer *Sussex*. The ship was unarmed, and thus a very strong lever is put into the hands of the President of the United States in dealing with the incident from an American point of view.

It transpires that the force of the explosion caused by the torpedo dismantled the wireless apparatus, but the crew succeeded in rigging up a temporary one, by means of which calls for assistance were sent out and were picked up on both sides of the Channel. Vessels at once put out to the rescue from Folkestone and Dover, and from the French Channel Ports, and were quickly on the scene. Unfortunately several lives were lost, but this discredit only adds to those already laid to the charge of the "All-Highest Wilhelm."

* * * * *

CRACK CARGO BOAT LOST.

The s.s. *Palembang*, of 6,674 tons gross, and trading between Rotterdam, London and Java, was sunk near the Galloper Buoy recently. It has not been determined whether she was sunk by a mine or torpedo. As far as can be ascertained no one saw any trace of a submarine. The only steamer in the neighbourhood at the time was the Dutch collier *Merak*, which passed, homeward bound, a quarter of an hour before the *Palembang* sank, and was apparently not in a position to render assistance. The wireless operator on board the *Palembang* sent out a call for assistance, which was answered about one hour later by a British torpedo boat; she discovered the lifeboats and took the crew into Harwich. The ship sank within a quarter of an hour of the accident, but, fortunately, all on board were saved with the exception of one man, a

Javanese. Had it not been for wireless telegraphy it is doubtful whether any of those on board would have been saved, as, owing to the celerity with which the lifeboats had to be launched, several of them were badly damaged and could not have remained afloat for a very long period.

* * * * *

STEAM TENDER FOUNDERS.

From Vancouver, British Columbia, comes a Lloyd's message stating that Digby Island reports by wireless that the Cannery steam tender *Alpha*, bound for Execution Bay, Alaska, had foundered off Ratchell Island. One survivor reached Metlakatla and reports that the remaining five of the crew were swimming with lifebelts when last seen.

* * * * *

ACTION OF THE DUTCH.

In connection with the danger arising from mines and torpedo craft in the North Sea the question is being considered in Dutch Government and shipping circles of using tugboats equipped with wireless telegraph apparatus and appliances for rescue work to convoy Dutch liners. The whole question is one of serious moment to Dutch shippers and shipowners and calls for immediate settlement.

* * * * *

CAPTURED BY THE "MOEWE."

The following letter descriptive of the sinking of the s.s. *Flamenco* by the notorious German pirate *Moewe* is published by our contemporary *The Syren and Shipping*; it admirably illustrates the value of wireless telegraphy in these times and the fear with which it is regarded by the enemy:—

" At Sea, February 26th

" I suppose by this time you have heard of the loss of my ship, but perhaps not all
 " the details. On February 6th, at 8.30 a.m., I noticed a steamer on my port beam
 " steering in the same direction as myself, but a little more to the west. She looked
 " rather like an intermediate P. and O. steamer, so I just stayed on the bridge watching
 " her. She was closing in rapidly, and I thought her intention was to go under our
 " stern. When she was about 300 yards away, her bulwarks opened and I found
 " myself looking into the muzzles of two big guns. At the same time a shot was fired
 " across the bow and the signals ' Stop immediately ' and ' Don't use your wireless '
 " were hoisted up, accompanied by the German naval ensign. I immediately com-
 " menced to send out wireless messages. Then the fun began; they sent five
 " shots into me, one right under the bridge, covering me with dust, rust and bits of
 " wood; the others, one after the other, into different parts of the ship, wounding three
 " of my men and killing my dog. I naturally thought they intended to sink my ship by
 " gunfire, so ordered the crew to their boat stations and then went to my cabin and
 " destroyed all Admiralty correspondence. My boats were then away from the ship,
 " and I found myself left alone, but all firing had stopped. The boats from the Germans
 " came alongside and took me off, as the ship was then in flames, so they got nothing
 " out of the ship. They were mad when they found there was nothing.

" On arrival on board the *Moewe*, the Captain (Count von Donah) sent for me and
 " asked me why I had used my wireless against his orders. I told him I did so because
 " it was my duty to do so. He then said: 'It was my duty to destroy you as you were
 " placing my ship in danger.' I said I quite expected to be killed by the way they
 " were going about it, but that I was not allowing the thought of that to stop me. He
 " then held out his hand and said: 'You did right, and I would have done the same.'

" One thing of interest. On arrival of the *Moewe* I passed a German sailor sitting
 " on an upturned case on which was written in plain letters 'Clan, G. R. Mackenzie
 " (Glasgow), Limited.'

" P.S.—I was sunk off Fernando Noronha."

* * * * *

SAVING OF S.S. "POLLENTIA'S" CREW.

Public opinion has been deeply impressed by the news lately published in the press concerning the saving of all persons on board the British steamer *Pollentia*, effected by the Italian steamer *Giuseppe Verdi* under extremely difficult circumstances, mention of which was made in the March issue of THE WIRELESS WORLD. All testimonials agree upon the fact that the crew of the s.s. *Pollentia* owe their safety to the Marconi wireless telegraph service and to the perfect organisation for transoceanic wireless communication established by the Marconi Company.

In fact, when, on January 19th last, the s.s. *Pollentia* sent out her call of distress she was lost in the middle of the Atlantic Ocean, considerably out of the beaten route of other vessels. The s.s. *Giuseppe Verdi* picked up her call and changing her route according to the wireless indications received from the s.s. *Pollentia*, was able, after two days of anxious and tragic search, to approach the sinking vessel and so save all human lives on board.

The Rome Office of the Marconi Company has received many congratulatory letters from all quarters, and we are now pleased to publish two of those letters, one from the Italian Ministry of Posts and Telegraphs, and the other from the Transatlantica Italiana Steamship Company, owners of the s.s. *Giuseppe Verdi*, speaking in glowing terms of the splendid services rendered by wireless telegraphy to humanity.

" Ministry of Posts and Telegraphs.

" ROME, March 3rd, 1916.

" To the Marconi Company, Rome.

" DEAR SIR,—I have read with great interest and deep satisfaction the abstract
 " of the P.V. concerning the saving of the British steamer *Pollentia's* crew, effected by
 " the s.s. *Giuseppe Verdi*, and made possible by the exchange of wireless messages
 " between the two steamers, under most difficult circumstances.

" By this well deserving feat maritime wireless telegraphy adds a new achievement
 " to the countless services already rendered to humanity by the genius of Guglielmo
 " Marconi.

" Allow me, therefore, to join my share of praise to the Company that has organised
 " the maritime wireless telegraph service and to their bold and able operators.

" For the Minister,

" (Signed) DURAN."

" Transatlantica Italiana.

" GENOA, February 9th, 1916.

" To the Marconi Company,

" Rome Office, Rome.

" DEAR SIRs,—In the name of the Transatlantica Italiana, I am pleased to inform you that, on the occasion of the saving of the crew of the s.s. *Pollentia* (flying the British flag), effected by our steamer *Giuseppe Verdi* in the northern part of the Atlantic Ocean (lat. 46.52 N. and long. 28.34W.G., on January 23rd, 1916), the ' Marconi telegraph ' proved to be not only of inestimable benefit, but it has been ascertained that, without this wonderful invention, due to an Italian, the crew of the s.s. *Pollentia* could not have escaped a certain death.

" The Chairman

" (Signed) VENCESLAO CARRARA."

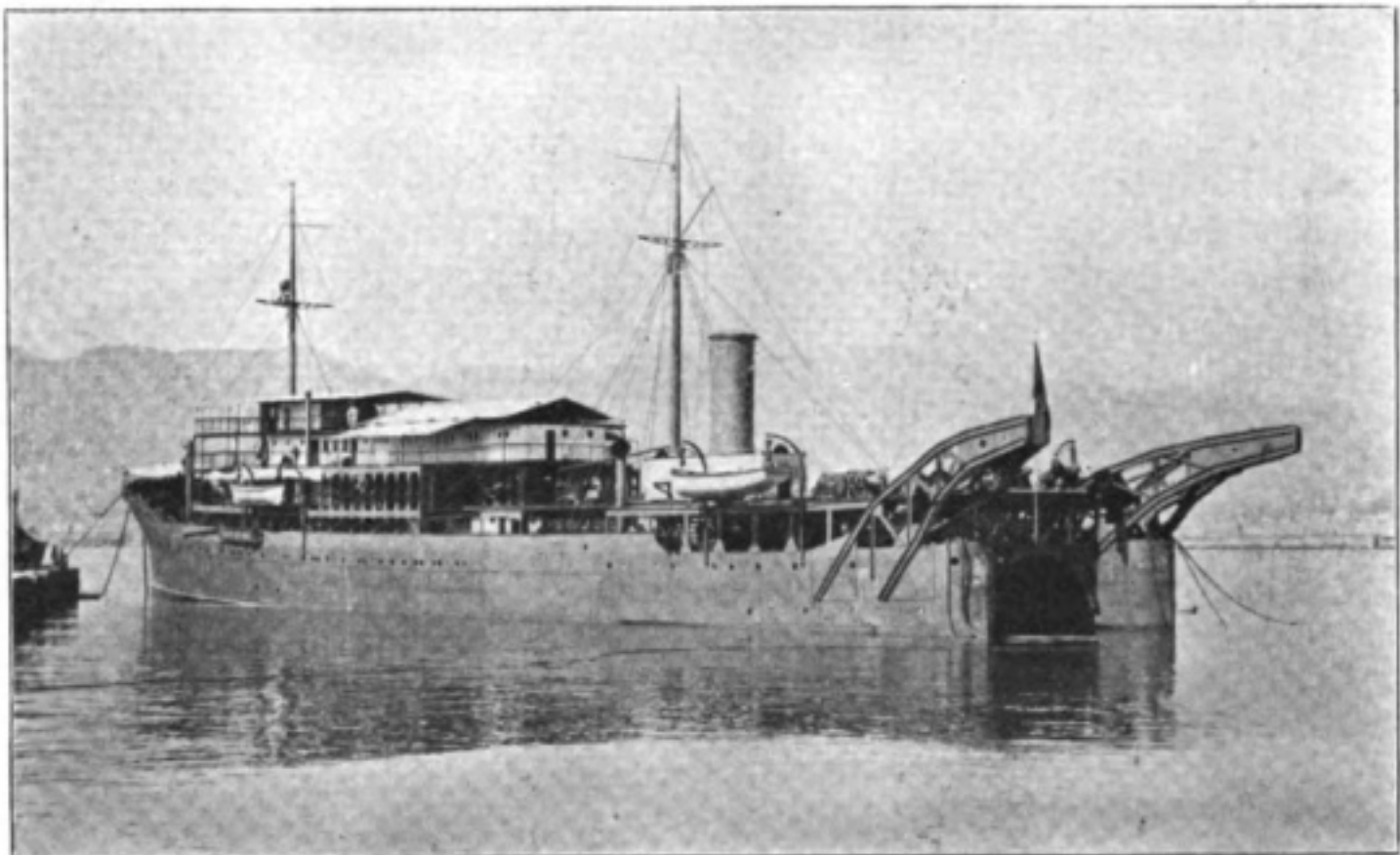

[Photo by the Courtesy of "Engineering."]

THE NEW BRAZILIAN SUBMARINE DEPOT SHIP "CEARA."

NEW SUBMARINE DEPOT SHIP.

By the courtesy of the editor of *Engineering* we are enabled to publish a photograph of the new Brazilian Diesel-engine-propelled submarine depot ship *Ceara*. She was built for the Brazilian Navy to act with the submarine flotilla of that country, which comprises several submarines of the Laurenti type, constructed by the builders of this depot ship. As armament the *Ceara* has 8 guns, 4 of 3'937 inches and 4 of 2'244 inches calibre. Her chief characteristic is that the afterpart is constructed in the form of a floating dock, which can accommodate one of the units of the submarine flotilla, and this is well shown in our illustration. Extra accommodation is provided on board for the crews of six submarines, about 130 all told. She is fitted with wireless telegraph apparatus and represents the latest practice in Diesel engine work.



Drawn by W. A. Cross after the famous picture by Ingres

LA SOURCE (A PROPHECY)

Oscillating Circuit Calculations

By SAMUEL LOWEY

THE formula usually made use of in finding values of CL for oscillating circuits is :—

$$\lambda = 600\pi\sqrt{CL}, \text{ or approximately } 1885\sqrt{CL}$$

when λ = wave-length in metres, C = capacity in microfarads, and L = inductance in microhenries.

It is not difficult to work from this formula, but it is convenient to have values of CL for different wave-lengths ready worked out.

The values of CL for wave-lengths from 1,000 to 10,000 metres are given on the spiral scale, Fig. 1, which, being of considerable length, enables one to read to about four significant figures.

In the numbers on CL scale two decimal points are shown : the one to use is the one nearer to the wave-length scale which is being read ; thus, for 1,385 metres, $CL = .54$, while for 4,380 metres, $CL \approx 5.4$.

The λ scale may be divided by any power of 10, providing that the CL scale is divided by the same number squared.

To avoid errors when doing this, a coarse scale of large range has been added immediately below the spiral scale.

The complete formula, which takes into account the resistance (R —ohms) of the circuit is :

$$\lambda = \frac{600\pi}{\sqrt{1 - \frac{R^2}{4L^2}}}$$

In the majority of cases, when the resistance is low, the error produced by neglecting the resistance is exceedingly small ; but in certain cases, even with low resistance, the amount of the error assumes large dimensions.

To give an example : In a circuit having capacity .1 microfarad and inductance 1 microhenry, the wave-length from scale would be 596.1 metres.

If the resistance is 1 ohm, 1.3 per cent. has to be added to wave-length, while, if resistance is 2 ohms, the addition is 5 per cent. ; 5 ohms, 65 per cent. ; while the circuit loses its oscillatory property if the resistance rises as high as 6½ ohms.

While this is a very extreme case and one not likely to be encountered, particularly by amateurs, it is desirable to have some means for finding what the amount of this error is

$$\frac{600\pi}{\sqrt{1 - \frac{R^2}{4L^2}}} \div 600\pi\sqrt{CL} \text{ gives the quantity } \frac{1}{\sqrt{1 - \frac{R^2C}{4L}}}$$

A curve of this quantity, Fig. 2, is given corresponding to different values of $\frac{R^2C}{4L}$. In filling in values of R , C , and L only very approximate numbers need be used.

In a circuit having $L = 1,000$ microhenries, $C = .0001$ microfarads, $R = 200$ ohms

$$\frac{R^2C}{4L} = .001. \text{ The value of } \frac{1}{\sqrt{1 - \frac{R^2C}{4L}}}$$

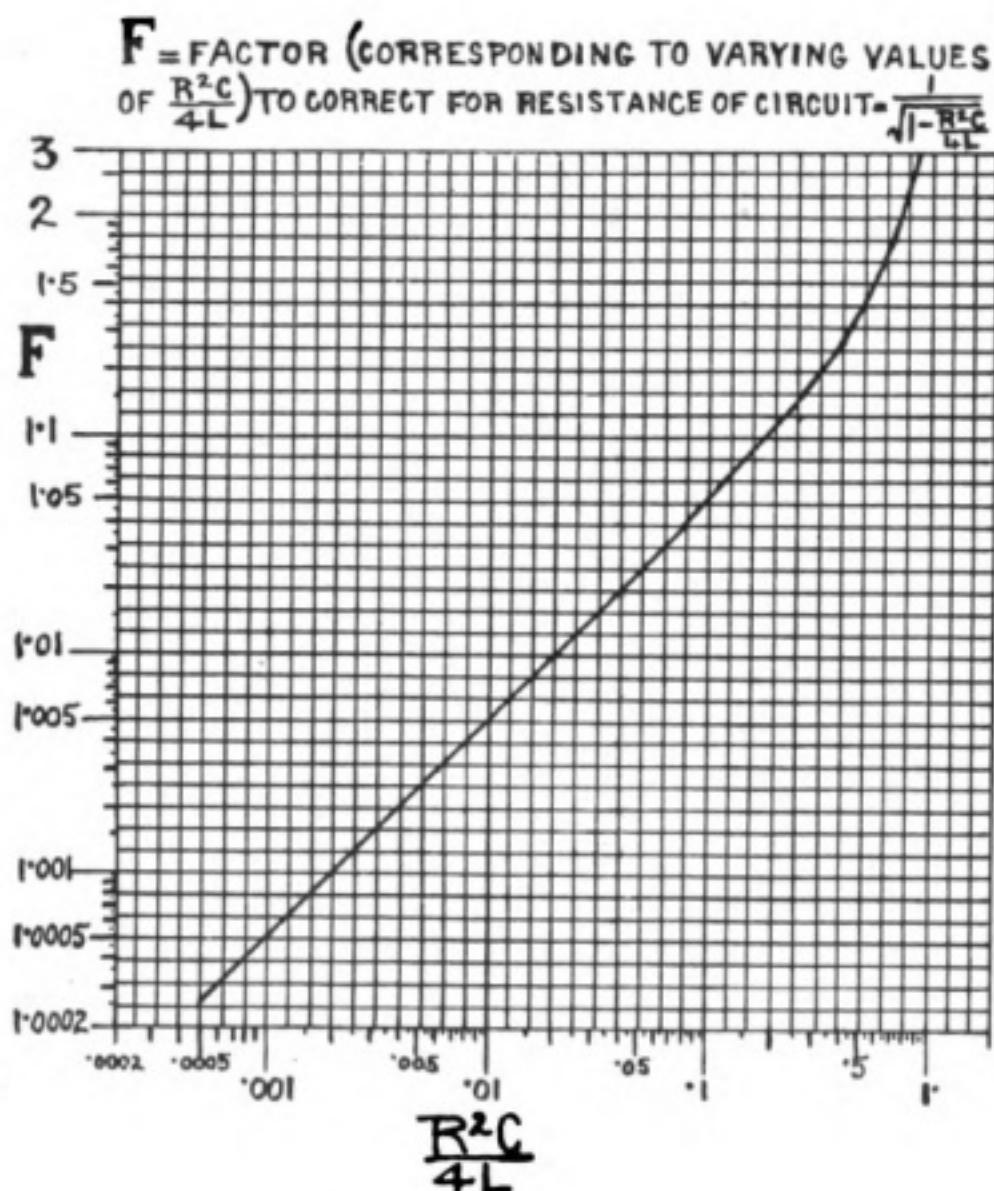

FIG. 2.

(F from curve) is 1.0005, which means an addition of .05 per cent. only to the wave length as read from scale.

An amount such as this can be neglected usually.

Corps of Royal Engineers (Wireless Section)

We understand more officers are required for the above branch of the service. Candidates should forward their applications to Major A. Handley, R.E., O.C. Wireless Training Centre, St. Martin's Gate, Worcester. It is essential that candidates should have a thorough knowledge of the theory and practice of wireless telegraphy; and in sending their applications candidates should state fully their training and experience, and whether they have had any previous military service. The term of service will be for the period of the war, and successful candidates will be required to serve at home or abroad.

Correspondence

DEAR SIRs,—With reference to a notice in the January WIRELESS WORLD under "Foreign and Colonial Notes," I must inform you that the wireless station opened at Lourenço Marques and three others erected in the Mozambique Province were offered to the Government of the Province by the Government of the Union of South Africa as a present, and not as payment for any services rendered.

The above station recently got communication with VND (Durban), 300 miles distant, which I think is a record for a $\frac{1}{2}$ -k.w. station, though it was during night time.

Yours very faithfully,

(Signed) DOMINGOS BARRETO.

Inhambane, February 9th, 1916.

[Mr. Domingos Barreto is the District Director of Posts and Telegraphs at Inhambane, Portuguese East Africa.—ED.]

* * * * *

WIRELESS AT BOWES PARK.

OUR paragraph under the above heading in recent issues of THE WIRELESS WORLD has brought forth the following letter from a reader at Bishop's Waltham, in Hampshire :

"I am glad to find that someone else has had a similar experience to mine. On the strength of my 'wireless' I was credited with several German relations, including two nephews fighting in the German army.

"I had the usual visits from the police, but was able to satisfy them that these relations did not exist, and since then have had no bother.

"I have never been able to trace the author of the libel, in spite of the offer of a reward, but it will no doubt come out some day, and then he will be sorry for himself.

"Yours truly,

(Signed) "ARTHUR F. HARDY."

* * * * *

ASYMMETRICAL TRANSMISSION PHENOMENA.

SIR,—I am very interested in the article on "Asymmetrical Transmission Phenomena," which you published in the April issue of THE WIRELESS WORLD. Judging from some rough observations I made a few years ago, I believe that between Malta and Port Said there exists a small area where it is practically impossible to communicate with the Port Said station, although there is no intervening land whatever, and signals are easily exchanged at a much greater distance. Perhaps some operator who is well acquainted with this part of the Mediterranean may be able to furnish detailed particulars, as all such information is welcomed by investigators and often serves a very useful purpose in solving radiotelegraphic problems.—Yours, etc.,

"REDAX."

London

WIRELESS IN THE TROPICS.

SIR,—An article in your February number regarding "Wireless in the Tropics" is just to hand. Practically the same results were observed by me while cruising up the Econdido River in Nicaragua, in 1912. I was told to keep in communication with the station at Bluefields, but upon entering the river six miles from the station and until our return no communication was possible.

My normal daylight range was 350 miles. The equipment consisted of an independent steam engine, generator (2 kw.) alternator, and air compressor. The intervening land was low, swampy, and covered with a heavy tropical forest, and, so far as could be ascertained, there were no mineral deposits.—Yours, etc.,

P. S. BERRY.

(Superintendent of Wireless Telegraphs, Belize, British Honduras.)

Richmond Royal Horse Show, 1916

We have been asked to make known that the Richmond Royal Horse Show will this year be held in aid of the Fund of Queen Mary's "Star and Garter" Hospital and Home for paralysed and totally disabled sailors and soldiers. The show will take place

on June 16th and 17th.

It is the intention of the Directors to devote this year's entire profits to endow and name a room in the Home. One or two gifts of animals have already been made by generous donors, and we trust that some of our readers may be able to help this worthy object, if only by their presence at the show.

* * *

THE MEXICAN
REVOLUTION.

Wireless telegraphy is being extensively employed by the United States Army in Mexico, wireless telegrams constantly passing between Army headquarters at El Paso, Texas, and the Front.



By the courtesy of the "Passing Show."

TRANSATLANTIC WIRELESS TELEPHONY.

BRITISH EDITOR: "Hullo! Is that New York? Will you be good enough to let us have the latest news about our war, please?"

Among the Operators



THE LATE OPERATOR ANDERSON

DEATH THROUGH PNEUMONIA.

We regret to announce the death from pneumonia of operator John Anderson. Mr. Anderson, who was the wireless operator upon the Ellerman liner *Koranna*, was taken ill at sea and, after being taken ashore at Durban, died in hospital there on March 24th. A native of Fraserburg and in his twenty-first year, the late gentleman's service in the Marconi Company dated from January, 1915. Previous to joining the *Koranna* he saw service upon the s.s. *Menominee* and the s.s. *Glenlogan*. We offer our sincerest sympathy to Mr. Anderson's parents in their sad bereavement.

* * * * *

AUXILIARY SHIP SUNK.

In the list of survivors of His Majesty's Mercantile Auxiliary *Fauvette*, which struck a mine off the East Coast and sank, we are pleased to find the name of Mr. E. Rogers, wireless operator.

* * * * *

SAVED FROM CAPTIVITY.

The Admiralty has announced the list of officers and men of H.M.S. *Tara* who survived the loss of the ship, and, after being captured by the Senussi, were rescued from captivity. This includes Mr. Robert Neil, warrant telegraphist, R.N.R., and C. W. Birkby, wireless telegraphist. Both men are to be congratulated upon their rescue from the hands of such fanatical enemies.

* * * * *

THE SHELLED LINER "ENGLISHMAN."

The shelled *Englishman*, which our readers will remember was sunk on March 24th, carried two wireless operators—M. Longworth Dames and J. C. Crawford. Both of these gentlemen were fortunately saved. Mr. Dames, who is 19 years of age, is a comparatively new recruit to the Marconi Service, having joined in January, 1915. A native of Bath, he received his education at King's School, Worcester, and, taking an interest in wireless telegraphy, underwent a course of wireless instruction at the London Telegraph Training College. Upon receiving his appointment to the Marconi Company's staff, he proceeded to



OPERATOR M. L. DAMES



OPERATOR J. C. CRAWFORD

sea upon the s.s. *Oxonian*, from this ship transferring to the s.s. *Ghazee*, and thence to the *Makarini*. At the time of the disaster he had already served nearly five months upon the *Englishman*.

The junior operator, Mr. John Crawford, is a native of Ayrshire, and is 19 years of age. He was educated at Dalry School, Ayrshire, and received his preliminary wireless training at the North British Wireless Schools, Glasgow. Joining the Marconi Company in October, 1915, he was appointed to the *Englishman* as his first ship. Both of these gentlemen are none the worse for their exciting adventure.

* * * * *

A TRUE WIRELESS HERO.

In the Christmas number of *THE WIRELESS WORLD* we announced the death of Mr. Arthur Henry Dews, wireless operator of the torpedoed liner *Marquette*. We have now had the opportunity of perusing a letter sent by Captain David N. Isaacs to the parents of the late Mr. Dews, from which it appears that the ill-fated gentleman met his death under circumstances of the greatest heroism. The whole wireless service will, we are sure, be thrilled with pride upon learning the facts given below. Captain Isaacs writes:—

“ On that fateful day, your son, with several others, was seated on a raft when
 “ I reached it. It was only a very small raft, but within a few minutes about six
 “ more men came along and hung on with me, making about twelve altogether. After
 “ a few hours the intense cold began to tell on everyone, especially those with little
 “ clothing on. Then the trouble started. We put those suffering the most on to
 “ the raft, three of the men being quite helpless. It was whilst pushing one of my
 “ own unit on the raft, after he had fallen off
 “ three times, that I noticed your son slip off the
 “ raft on the other side. He had got off to
 “ make room for the others. I swam round his
 “ side, and he said he was all right and smiled
 “ bravely. The sea was getting rougher and it
 “ was a terrible job to keep the raft from turning
 “ over. One man fell off and drifted away before
 “ he could be caught. Big pieces of wreckage
 “ came along and several of the men swam to these.

“ Your son, seeing what difficulties we were
 “ in, though suffering intensely from the cold,
 “ thought it would be better if he could pick up a
 “ piece of wreckage, and swam just a few
 “ yards to a fairly large piece. I watched



THE LATE OPERATOR A. H. DEWS

“ him get perched safely on to that, and he still seemed quite able to stick it.

“ I regret I cannot tell you much more as my efforts to keep our raft right side up occupied all my time from then on, as it meant certain death to at least four of those still on it. I had contracted a severe cramp myself, and so crawled on to the edge of the raft about five hours after, just getting to it. From where I was I could look around, and, after a while, I could pick out your poor lad sticking to his board gamely, but he gradually got out of sight and I saw him no more. I have made every inquiry from our men, but no one can tell me anything. He left no message that I know of, as he apparently had no thought of giving in. I feel positive his end was due to exposure. There were three ships rescuing the survivors, and it was not until the next day that I found that he was amongst the missing.

“ I can only add that my deep-felt sympathy goes out to you all in your great loss. A sadder or more painful task could never be set anyone than to have to write such a letter as this, but if your sorrow is lessened, even a little, by the knowledge that your poor son gave his life for the great cause in such a noble manner, I shall feel more than repaid.”

* * * * *

AN HEROIC FRENCH OPERATOR.

In connection with the sinking of the *Provence II.* we have culled a report, the following of which is a translation, from the *Echo de Paris* of March 20th :—

“ A man living at Havre, who was fortunate enough to escape from the wreck of the *Provence II.*, gives moving details of the heroism of the wireless operator on board. This operator, named Joseph Huby, and who comes from a village near Lorient, stuck to his post until he was drowned. When the torpedo struck the vessel, Huby sent the SOS distress signal and continued to do so, without an interval, the whole time the ship remained afloat. The torpedo struck the boat and the stern sank rapidly into the water, but Huby still remained seated before his instrument, energetically working the key. He remained there alone. The passengers had made their way to the fore-part of the ship, which was gradually rising out of the water ; in fact, the acute angle to which the ship was gradually attaining threw them off their feet. A large number of them precipitated themselves into the water. Whilst all this was going on forward, Huby, in his cabin, continued to send out his desperate appeal, until the water reached him. At this point the fore-part of the ship rose suddenly, until the *Provence II.* was vertical in the water. Then, with fearful rapidity, she disappeared, engulfing with her the brave telegraphist whose prompt action was instrumental in saving those who succeeded in escaping.”

* * * * *

THE NORTH SEA FIGHT.

Among the list of those killed in the engagement between H.M.S. *Alcantara* and the German raider *Greif* we regret to find the name of wireless telegraphist operator James Beckett, R.N.R. Mr. Beckett, who volunteered for active service in the first days of the war, is a native of Gillingham, Kent, and is an ex-Post Office man. He joined the Marconi Company's London School in April, 1913, and, after completing

his training, joined the s.s. *Amazon* in May of that year. He afterwards served on the s.s. *Sardinia*, *Sicilian*, *Maryland*, *Rappahannock* and *Corinthian*, serving for three voyages on this last ship. As mentioned above, he volunteered for active service in August, 1914, and, in due course, was appointed to the *Alcantara*.

We take this opportunity of expressing our deep sympathy with the relatives of the late Mr. Beckett in the terrible loss which they have sustained.

* * * * *

THE LOST "MINNEAPOLIS."

This ship, one of the largest of the sub-



THE LATE OPERATOR J. BECKETT, R.N.R.



OPERATOR O'HALLORAN

marine victims of this war, carried two operators, Messrs. T. F. O'Halloran and George Petrie. The senior operator, Mr. O'Halloran, makes his home at Tralee, Ireland, and is 25 years of age. He was educated in his native town, and entered the Marconi Company's London School in May, 1913. After completing the course of instruction he was appointed to the s.s. *Ausonia*, and afterwards served on the s.s. *California*, *Mumari*, and a number of other vessels. He was appointed to the *Minneapolis*

in December last, and, we are glad to say, received no injury when that vessel was sunk.

The junior operator, Mr. George Petrie, is a Scotsman, having been born in Dundee in 1894. He received his preliminary wireless training at the North British Wireless Schools, and proceeded to London for his final training at Marconi House in November, 1915. The *Minneapolis* was his first ship, and he also came through the exciting experience with no injury.



OPERATOR G. PETRIE

Some Interesting Signalling Devices

A REPRESENTATIVE of THE WIRELESS WORLD recently had an opportunity of inspecting a number of very interesting devices placed on the market by Messrs. Graham & Latham, Ltd., military engineers, of 104, Victoria Street, Westminster, S.W., for use in Morse signalling on land and sea. To those unacquainted with military and naval requirements the number of different signalling instruments in use at the present day is liable to create considerable surprise.

Messrs. Graham & Latham were one of the first firms to realise the advantages of specially designed dry batteries in combination with metallic filament bulbs for flash signalling purposes, and they have now produced many highly efficient and readily portable sets, which, we understand, have been taken up in large numbers by the authorities. One of the most ingenious forms of signal lamp made by this firm consists of a small fitting placed inside the barrel of a rifle, signalling being effected by a switch attached to the trigger. When the signaller wished to communicate with some point he aims the rifle containing the lamp at the point at which the corresponding signaller is situated. The great advantage of this arrangement is that the enemy cannot possibly intercept the signal, for the dispersion of the light even at considerable distances is very small, and the signal can only be seen directly in the line along which the rifle is aimed. Signals from this rifle Morse lamp have been read with the naked eye up to 800 yards at night, and with a telescope at twice this distance. At three-quarters of a mile tests have shown the lateral dispersion to be but four yards.

Another useful signal lamp made by this firm is the "Chapman," in which the projector, tripod, key, battery and reading lamp are all separate and detachable units, each contained in a convenient leather wallet for carrying on the waist-belt.

For disc signalling Messrs. Graham & Latham, Ltd., have placed upon the market a greatly improved form of disc, capable of manipulation at a much higher rate of speed than the older model, and, at the same time, being of strong although light construction.

In buzzer sets, for use either for practice or for signalling along a telephone wire, this company have specialised for some time, and they have just produced a new tunable buzzer which should find many purchasers. For those who require practice with lamp as well as buzzer a combined set has been produced to give signals by both audible and visual methods.

Another novelty recently produced by this firm is the dummy sounding key, which gives signals like those of a Post Office sounder and serves as an excellent means of learning this form of reception at a very small cost.

Space will not permit us to deal with many of the other signalling instruments obtainable from this enterprising house, but we must not omit mention of the Electric Mast-head Morse Lamp Portable Equipment, comprising a water-tight teak case, having a powerful dry battery and a lamp with 40 feet of rubber flex and plug attached, spare bulb, and Morse key arranged for operating with lid either open or closed. The total weight is but 15 lb., and the dimensions 10 by 6 by 8 inches.

Readers who are interested in the above devices are advised to write to Messrs. Graham & Latham, Ltd., for their Signalling Catalogue and Electrical Supplement, the fifth edition of which is now ready and obtainable post free upon request.

A Hero of the Service

Magnificent Upholding of the Marconi Tradition

By the courtesy of Messrs. Elders & Fyffe, Ltd., we are able to publish a copy of a protest made in due form before a Notary Public by the master, third officer, and two members of the crew of the torpedoed steamship *Zent*, which was attacked without the slightest warning by a German submarine. This protest contains a vivid description of the last moments on board the liner and of the magnificent heroism of the operator, Mr. Proughten, who lost his life at the post of duty. We do not think we can do better than publish this document exactly as it stands.

“ BY THIS PUBLIC INSTRUMENT OF PROTEST, Be it known and made
“ manifest unto all people to whom the same shall come that upon the Seventh day of
“ April one thousand nine hundred and sixteen personally appeared before me, Atwell
“ Hayes Allen, Notary Public, George Ernest Martin, master of the late steamship
“ or vessel *Zent*, and noted protest, and again on the Seventh day of April in the year
“ of our Lord one thousand nine hundred and sixteen before me the said Atwell Hayes
“ Allen, Notary Public, duly authorised, admitted and sworn, residing and practising
“ at Queenstown, in the County of Cork, in that part of the United Kingdom of Great
“ Britain and Ireland called Ireland, personally appeared the said George Ernest
“ Martin, master of the steamship *Zent* of Belfast of the burthen of 2,485 tons register,
“ and also at the same time and place personally appeared, came and appeared Archibald
“ Robertson Gibbons, third officer, Charles Crosby, cook, and Albert Coleman, fireman,
“ being lately all of and belonging to the said vessel who did severally duly and solemnly
“ declare and state as follows that is to say :—

“ That the said vessel sailed from Liverpool on the 4th day of April inst. bound on
“ a voyage from thence to Santa Marta, Colombia, in ballast, the said vessel being then
“ tight, staunch and strong, well manned, victualled and found, and in every respect
“ fit to perform her said intended voyage. The weather was fine and they proceeded
“ down the Channel without anything of
“ importance occurring until they were about
“ 28 miles S.W. of the Fastnet light, at 10.20
“ p.m. on the 5th of April; they had no
“ lights burning, the night was dark and
“ clear, the moon had set, the sea was smooth
“ with westerly swell, and the vessel pro-
“ ceeding about 13½ knots, the course being
“ S. 54 W. true. The appearer, Archibald
“ Robertson Gibbons, third officer, being on
“ watch and a careful look-out being kept.
“ Nothing was observed until suddenly at
“ the hour mentioned a terrific explosion
“ occurred at the starboard side of the vessel,
“ occasioned by a torpedo striking the vessel.
“ It practically blew the side out of the



THE LATE OPERATOR PROUGHTEN.

" ship and immediately afterwards a second torpedo struck the vessel abreast of
 " No. 3 hatch, also on the starboard side, and the vessel promptly foundered and had
 " completely disappeared in about two minutes from the first explosion. On the first
 " torpedo striking the vessel, the wireless operator, Mr. Proughten, at once proceeded
 " to his station and sent out the distress call SOS, giving the position of the vessel by
 " the emergency set of instruments, as the first torpedo had destroyed the dynamo of
 " the ordinary apparatus, and Mr. Proughten was never seen again, but appearers
 " have ascertained that he succeeded in sending the call before the ship foundered,
 " and the brave gentleman's life was sacrificed to his duty and by his self-sacrificing
 " devotion to duty he was the means of calling the assistance by which the survivors
 " were saved. They got three boats down to the water, but the vessel retained her
 " speed and foundered so quickly that the three boats capsized and all the occupants
 " were precipitated into the sea. They remained clinging to wreckage and to the
 " upturned boats for about 2½ hours and those who survived were picked up by a
 " British naval patrol boat, and of a crew of sixty all told only the four appearers
 " and seven other were saved. Two bodies were picked up and brought to Queenstown
 " and buried. Nothing whatever was saved from the vessel.

" And these appearers do protest, and I, the said Notary, do also protest against
 " the aforesaid murderous outrage and occurrences and all loss and damage occasioned
 " thereby.

" We, George Ernest Martin, Archibald Robertson Gibbons, Charles Crosby and
 " Albert Coleman do solemnly and sincerely declare that the foregoing statement
 " is correct and contains a true account of the facts and circumstances, and we
 " make this solemn declaration conscientiously believing the same to be true and
 " by virtue of the provisions of the Statutory Declarations Act, 1835.

" (Signed) G. E. MARTIN, *Master.*

" (Signed) A. R. GIBBONS, *Third Mate.*

" (Signed) C. O. CROSBY, *Chef.*

" (Signed) A. COLEMAN.

" Thus declared and protested in due form of law at the office of me the said
 " Notary at Queenstown on the day and year hereinbefore written.

" (Signed) ATWELL H. ALLEN,

" *Notary Public,*

" *Queenstown.*

" SEAL."

Mr. Proughten belongs to East Finchley, and was in his twenty-eighth year.
 He was educated at Finchley, and joined the Marconi Company's London School in
 October, 1913. Upon completing his training, he was appointed to the s.s. *Ascania*,
 later being transferred to the s.s. *Den of Ewnie*. From this ship he proceeded to the
Antillian, and was appointed to the *Zent* in April, 1915. He was on his fourth voyage
 on this vessel when the disaster occurred.

From the "Globe."

" In the matter of wireless telegraphy England easily comes first." Rule, Britannia:
 Britannia rules the air-waves.

The Action of Crystal Detectors

By F. Basil Cooke, F.R.A.S.

IN wireless literature there has, perhaps, been more said on the subject of detectors than on any other part of the wireless plant, and yet it is very hard to get just the information required.

This article on crystal rectifiers is written in the hope that it may be of some interest and use to experimenters. Nowadays, as the amateur is deprived of his set and cannot carry out the practical part of his researches, he cannot do better than learn all about the why and wherefore of what is to him an established fact. The writer has studied the subject of crystal rectifiers for the past five years, and although it is not claimed that this article is in any way original as far as principles are concerned, yet it is hoped that readers will find something in it to ponder over.

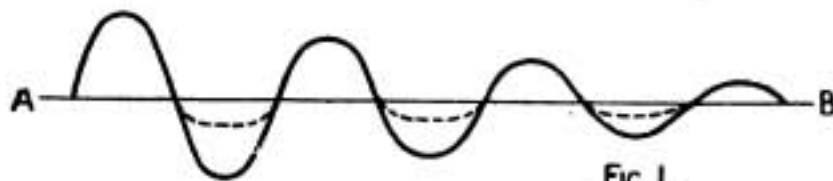

Everyone now in the wireless field knows that certain mineral crystals have the property of allowing a current to pass in one direction only—that is to say,

they possess unilateral conductivity. The usually accepted theory of the working of a crystal is that the incoming current, being of an oscillatory character and of such great frequency that it will not affect a telephone receiver, has to pass through a crystal which blocks out half of the wave, only allowing the other half to pass. As this is equivalent to an intermittent continuous current the effect on the magnets of the telephone is cumulative, and consequently for each wave train, usually consisting of about 15 alternations, there is a pull by the magnets on the telephone diaphragm, giving a click.

This story seems to explain the phenomena to which we are all accustomed; but, in the opinion of the writer, there seem to be two reasons so vitally opposed to this theory as to completely condemn it. Before attempting a criticism it would be well briefly to review a few points about crystal detectors generally. In the first place, it appears to be generally accepted that the crystal detector is by far the most sensitive detector known, when handled by an expert. Secondly, we know that in the same crystal there are points very sensitive; although immediately adjacent there are



places absolutely inert. Further, the chemical composition of a crystal does not play a significant part, and optically, physically, geologically and chemically there is no explanation for this curious fact. A tremendous amount of work has been done in connection with the unilateral conductivity of certain crystals, notably silicon and carborundum, and the results all show that in no single instance is a crystal a perfect rectifier. When a sensitive point is tried alongside of an inert one on the same crystal the difference in this unilateral conductivity is not nearly sufficient to account for the difference experienced from a wireless point of view. The pressure plays a very important part in the sensitivity of a point.

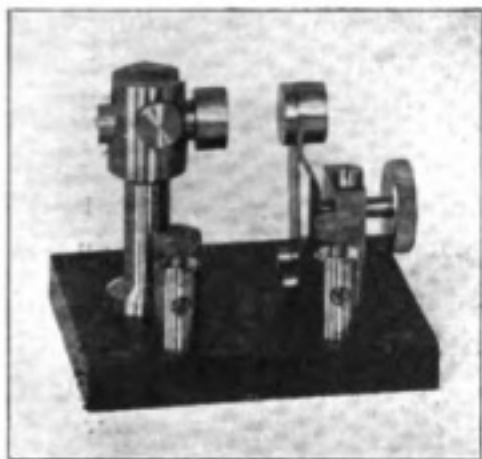

FIG. 3. A CARBORUNDUM CRYSTAL HOLDER IN WHICH THE CRYSTAL PASSES AGAINST A STEEL PLATE

Let us now try and see why the accepted theory fails to account for the observed results. Imagine a crystal possessing perfect rectifying properties. Neglect the loss of current in all other parts of the receiving apparatus and consider the loss in the crystal itself. There are two great sources of loss—namely: (1) resistance, which is considerable; and (2) that due to the unilateral property of the crystal, which only allows half of the received current to pass. Of these the latter is the greater. We then see that, with a perfect valve and neglecting all other losses, we are only using one-half of the received current. If, on the other hand, as is the case in practice, the crystal is not a perfect valve, then there is considerably more loss. To explain this point, which seems to the writer to be of vital importance,

we will glance at the usual diagram.

In Fig. 1 let *AB* be the axis of the curve. If there is no rectification the wave form is as represented in the figure. When we introduce a crystal the wave takes the form shown dotted, the top but the bottom half rectification the bottom the top half being the 'phones. As, however, current does get direction this will tend the maximum direction the final available current. It will be obvious at portion of the incoming under this hypothesis.

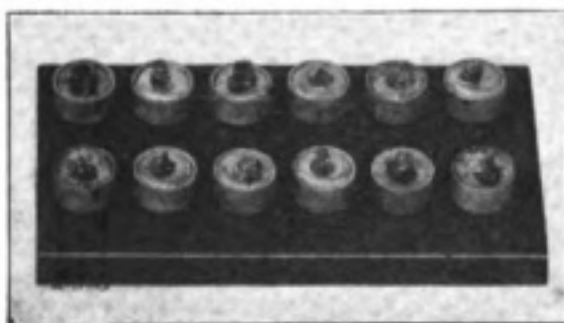

FIG. 4. MOUNTED CARBORUNDUM CRYSTALS FOR USE IN THE HOLDERS SHOWN IN FIGURES 3 AND 5

half remaining the same shortened. For perfect half vanishes altogether, available for use in ever, some of the through in the reverse to neutralise the effect in and has to be subtracted, rent being shown in Fig. a glance what a small wave can be utilised In the second place, the

more perfect the rectification the greater should be the effect, but experiments fail to show such a result. Comparative tests have been made with a good Fleming valve detector and a good crystal, the result being most marked. In the case of the valve the rectification was very much more perfect than with the crystal, but the received signals from a station were very much better with the crystal than with the valve. This alone seems to give a flat contradiction to the usual theory.

There are several detectors on the market which utilise much more of the wave than a valve can possibly do, and yet none of them is as sensitive. There seems to be little doubt that the true explanation for crystal working must embrace the fact that all of the received current is being utilised instead of about one-third.

From some experiments carried on at the Sydney University by Professor O. U. Vonwiller a likely



FIG. 5. ANOTHER FORM OF THE HOLDER SHOWN IN FIGURE 3. THIS IS MADE INTERCHANGEABLE WITH THE FLEMING VALVE

explanation may be found from a thermal-couple effect. Without going into details, it seems to afford a satisfactory explanation for a number of the observed facts. In this case it will be obvious that all of the received current would be utilised in the form of heat and, owing to the poor heat conductivity of crystals, the heat would be localised at the point of contact, which, of course, is what would most naturally be required. It would then answer the question of why a sharp point is better than a blunt one, and why one metal point is better than another for a particular crystal. In conclusion, amateurs are strongly advised to try some experiments for themselves, and it is certain that, with a little pains, they will be well repaid for their trouble. Of course, while the war continues they cannot listen to signals, but what is to prevent them having a crystal and trying the unidirectional effect for themselves? All that is required is a sensitive galvanometer. Measurements of the deflection can be made in one direction and then, with the current reversed, in the other direction. Different voltages, etc., may also be tried. A graph should be made in each case so that the whole operation can be observed at a glance. There is a tremendous amount of very useful and fascinating work to be done in this direction, and now, while we are deprived of our aerials, is the time to do it.



Institute of Radio Engineers, New York

WE have just received a copy of the "Year Book" of this institution for 1916, than which no better evidence could be afforded of the excellent progress and manifold activities of this Society. A glance at the lists of membership shows a total of no less than 984, most of these being residents in the United States. England and Ireland can boast of 5 Fellows, 9 Members and 26 Associates, and, in view of the interest taken in wireless telegraphy by Germany, we are surprised to see that only 2 Fellows and 1 Member figure as belonging to that country.

The membership of the Institute consists of five grades: Honorary Members, Fellows, Members, Associates and Juniors. Among other advantages, all Members of the Institute are furnished, without extra expense, with copies of all issues of the "Proceedings of the Institute of Radio Engineers." Six issues of this are published per year, and the most recent developments and discoveries are clearly presented in its pages. Meetings are held monthly in New York, except during July and August of each year. At these meetings scientific, engineering, and other papers relative to the art of radio communication are presented by Members of the Institute specially qualified to treat the subject. As an example we may mention that on April 5th a paper by Dr. Louis W. Austen on "Experiments at the United States Naval Radio Station at Darien, Canal Zone," was read. A second paper by Mr. Bowden Washington, on "Some Small Direct Current Sets," was also to be read, time permitting.

We have also received the Institute of Radio Engineers' Report of the Committee on Standardisation for 1915, containing definitions of terms, tests and rating, standard graphical symbols, and definitions of trade names. This is a most useful and interesting publication to all concerned in wireless telegraphy.

Instructional Article

NEW SERIES (No. 9).

The following series, of which the article below forms the ninth part, is designed to provide wireless telegraphists, amateurs, and technical students generally, with clear and precise instruction in technical mathematics, in order that they may be enabled to read and understand the more advanced technical articles which appear from time to time.

RELATIVE VELOCITY.

60. One very useful application of the vectorial method of calculation is its use in solving problems concerning relative velocities and accelerations.

In Fig. 41 let OA and OB be two straight railway lines, crossing at O . Imagine two trains travelling away from O , train OA travelling at 50 miles per hour, and train OB at 20 miles per hour. If we assume further that the two trains passed through O at the same time, then one hour later train OA will be at A —50 miles from O , and train OB at B —20 miles from O . Thus the distance between the two trains has increased, in one hour, from nothing (when they passed through O at the same time) to AB —to scale, 40 miles.

After the next hour the trains will reach A_1 and B_1 , AA_1 being 50 miles, and BB_1 20 miles. It is obvious from the Fig. that A_1B_1 is equal to twice AB , or to 80 miles. Thus, during the second hour the distance between the trains has again increased by 40 miles ($80-40$) and so we see that the distance between the trains increases at the rate of 40 miles in each hour, OR the *speed of A relative to B* is 40 miles per hour in the direction BA (or B_1A_1 which is parallel to BA).

Now, by completing the parallelogram $OBAC$, we see that OC will give us the velocity of A relative to B , and OC is the result of the vectorial subtraction

$$OA - OB = OA + AC = OC.$$

Thus, to obtain the velocity of one moving point relative to a second moving point, we subtract vectorially the velocity of the latter from the velocity of the former.

Example.

The fly-wheel of a steam engine, 5 ft. in diameter, rotates at 120 revs. per minute. What is the average acceleration, during a quarter of a revolution, of a point on the rim?

The definition of acceleration is "rate of change of velocity." For example, if a train increases its speed from 30 miles per hour to 50 miles per hour in 5 minutes, the average acceleration during that 5 minutes is:

$$(50 - 30) = 20 \text{ miles per hour per 5 minutes ;}$$

or

$$\frac{20}{5} = 4 \text{ miles per hour per minute.}$$

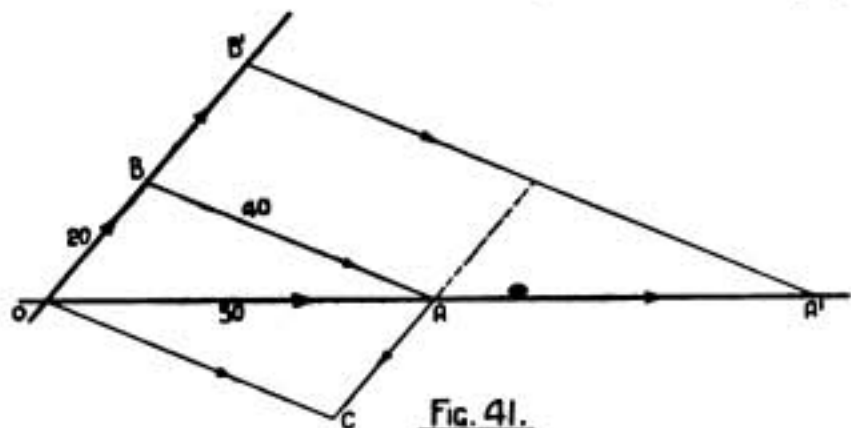
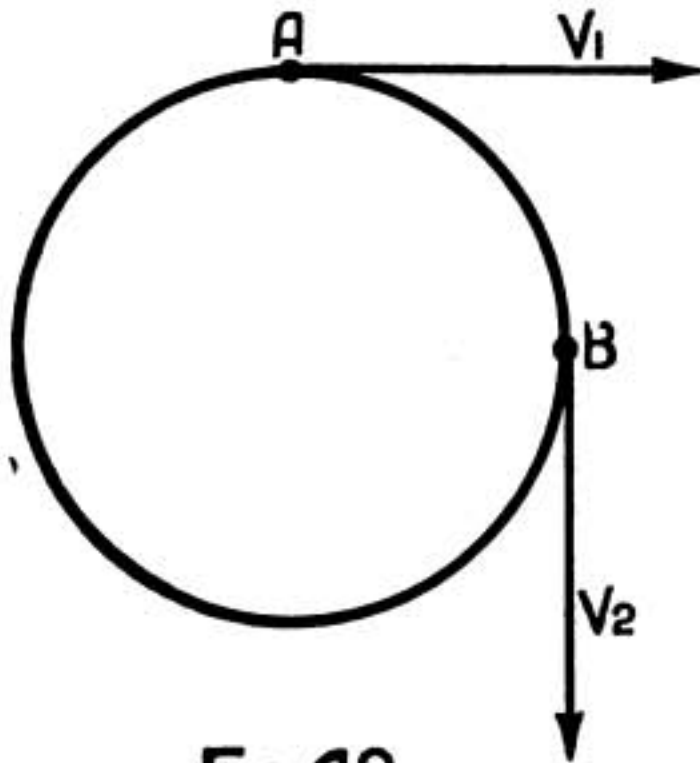

Fig. 41.

FIG. 42.

At first sight it would seem that a point on the rim of a fly-wheel which is rotating at a constant number of revolutions per minute would have no *change* of velocity, and therefore no acceleration. Referring, however, to Fig. 42, we see that during the transit from A to B the velocity has changed, not in *amount* but in *direction*—i.e., from V_1 to V_2 .

Thus, to get the acceleration we must find the value of $(V_2 - V_1)$, the *change* of velocity, and divide this value by the time occupied by the quarter revolution.

Now the point on the rim travels through 120 revs. per minute

$$\begin{aligned} &= 120 \times \pi \times \text{diameter} = (120 \times \pi \times 5) \text{ ft. per minute} \\ &= \frac{120 \times 5\pi}{60} = 10\pi = 31.416 \text{ ft. per second.} \end{aligned}$$

Let OP (Fig. 43) = $V_1 = 31.416$ ft. per second.

OQ = $V_2 = 31.416$

OR = $-V_1$

Then $OS = OQ + OR = V_2 + (-V_1) = V_2 - V_1$.

Now, obviously, since triangles OQS and ORS are right-angled triangles

$$\begin{aligned} OS^2 &= OQ^2 + QS^2 \\ &= OQ^2 + OR^2 \\ \text{or } OS &= \sqrt{OQ^2 + OR^2} \\ &= \sqrt{(31.416)^2 + (31.416)^2} \\ &= \sqrt{2(31.416)^2} \\ &= (31.416) \times \sqrt{2} \\ &= 44.4 \text{ ft. per second.} \end{aligned}$$

Also angle POS is 135° , and so the *change in velocity* during the quarter revolution is 44.4_{135° ft. per second. Now 120 revolutions take 1 minute or 60 seconds; therefore, 1 revolution takes $\frac{1}{60}$ second, and $\frac{1}{4}$ revolution takes $\frac{1}{240}$ second.

Therefore, the average acceleration is 44.4_{135° ft. per second per $\frac{1}{240}$ second = $(44.4 \times 240)_{135^\circ} = 355.2_{135^\circ}$ ft. per second per second.

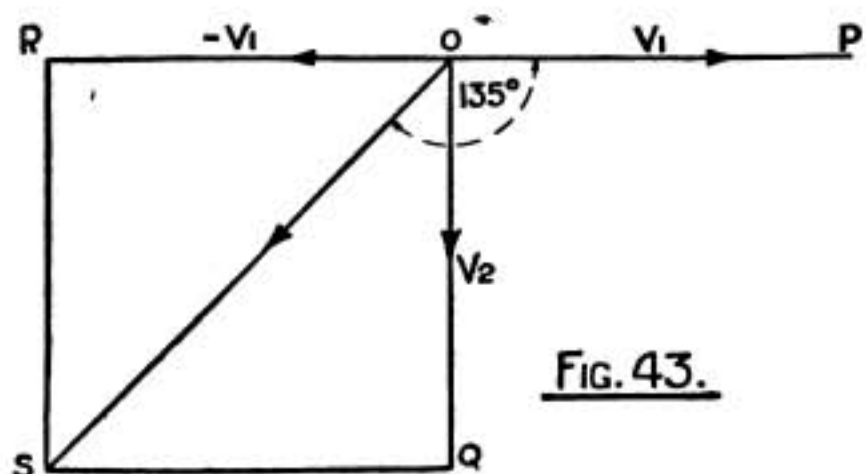
FIG. 43.

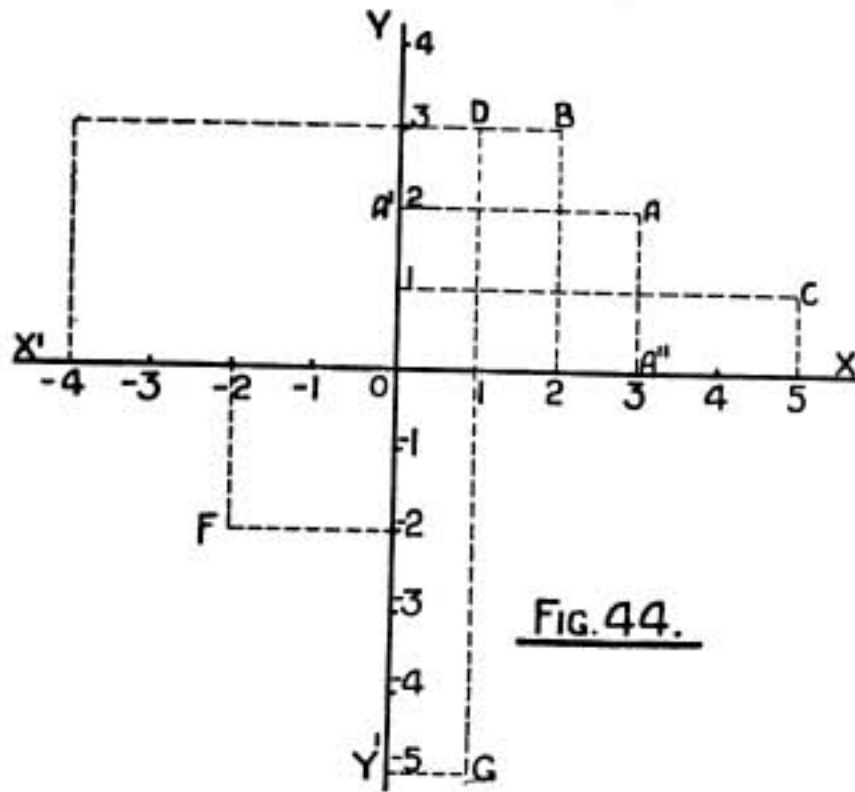

FIG. 44.

Squared Paper.

61. The great value of a piece of paper divided off into equal squares lies in the fact that it enables us, first, to completely *specify the position* of a point on its surface, and, secondly, to arrange that the position of such points may represent *conditions* of things or *facts*. This latter point will become more evident a little later.

In Fig. 44 we have a piece of squared paper, divided into four approximately equal parts, as shown by the lines XX^1 and

YY^1 at right angles to one another and crossing at O . Let us number them along OX and OY —1, 2, 3, 4, etc., and along OX^1 and OY^1 —-1, -2, -3, -4, etc., as shown.

If now we count, say, three divisions along OX from O and then count two divisions up, we arrive at the point A , which is three divisions to the right of YY^1 and two divisions above XX^1 . This point A would be written as (3, 2).

This is the process of *plotting* the point (3, 2).

It is important to remember that the *horizontal measurement always precedes the vertical*, and bearing this in mind we see that the expression (3, 2) is sufficient to completely specify the position of the point A . In the same way the point (2, 3) is two divisions along OX and three divisions up, giving us B ; C is the point (5, 1) and D is (1, 3).

62. The line XX^1 is known as the "axis of x ," or the " x -axis," and the distances measured along or parallel to it are known as the "*abscissæ*" of the various points: the line YY^1 is called the " y -axis," and distances along or parallel to it are known as the "*ordinates*" of the points.

Thus, $AA' = A''O = 3$ is the abscissa of A (3, 2), and $AA'' = A'O = 2$ is the ordinate of A .

The abscissa and ordinate are classed together as the *co-ordinates* of A .

63. These points A, B, C , and D , are all in the *first quadrant*, and it will be noticed that only points in this quadrant

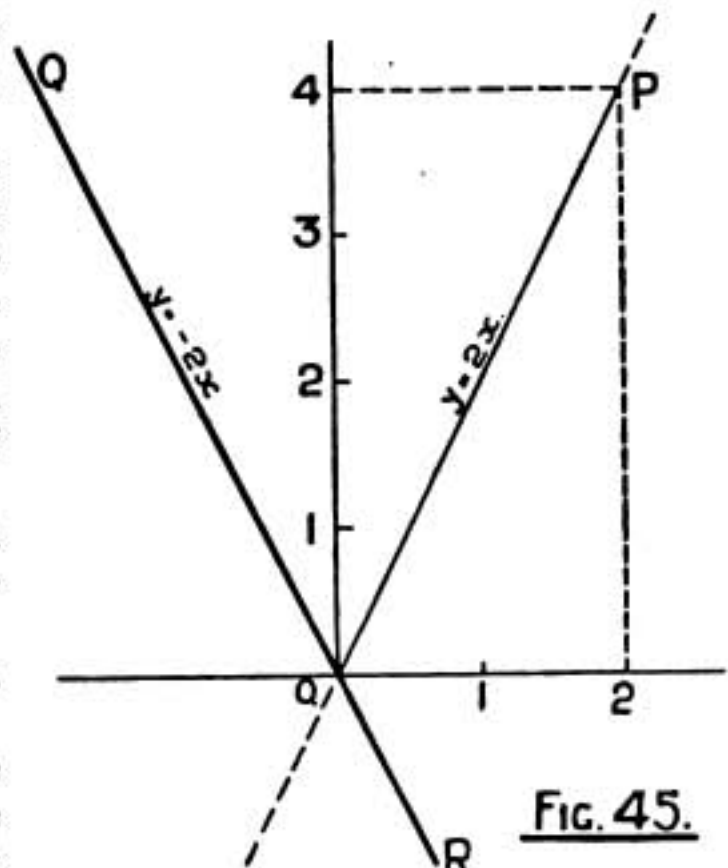
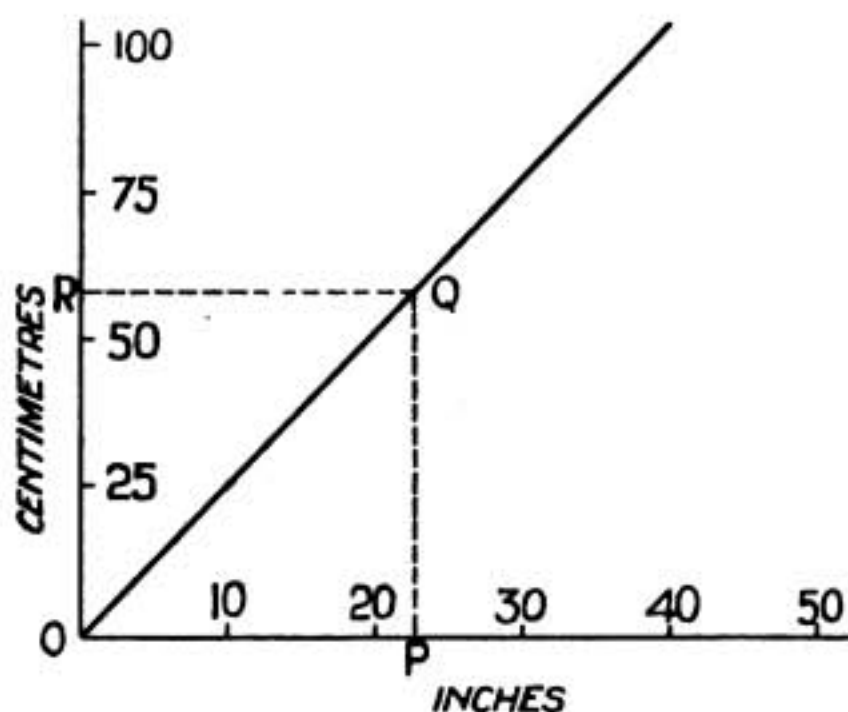

FIG. 45.

**FIG. 46.**

($1\frac{1}{2}$, 3), among others. At each of these points the ordinate is equal to twice the abscissa, or the y -value is equal to twice the x -value. We are, therefore, justified in saying that for all points on the line OP , $y=2x$, or OP is a curve connecting x and y for the equation $y=2x$, or OP is the curve of $y=2x$.

64. This statement requires some amplification. We have taken only two points O and P as the two limits of our "curve," but it will be seen that by producing OP in the same straight line in both directions that all points on the produced parts also comply with the condition that y shall equal twice x . Thus OP is part of the curve $y=2x$.

It may seem somewhat foolish to call OP , which is a straight line, a "curve"; this, however, is simply because it is convenient to have a common term which can be applied to all lines showing, in this way, the relation between various pairs of quantities. It will be seen later that the relations are not always shown by straight lines.

The straight line, QR , is the curve of $y=-2x$.

65. As a simple example of a use for straight line curves let us take the curve of Fig. 46. This is drawn between $(0, 0)$ and $(40, 101.6)$. At the latter point the ratio $\frac{y}{x} = \frac{101.6}{40} = 2.54$. Thus, all along the curve, $y=2.54x$. That is, if we take any length OP along the x -axis from O , run up vertically from P to reach the curve at Q , and then along horizontally to reach the y -axis at R , then $OR=2.54 \times OP$. Now 1 inch = 2.54 cms, and so if OP to

have both their co-ordinates positive. The points E , F , and G in the second, third and fourth quadrants respectively, are the points $(-4, 3)$, $(-2, -2)$, and $(1, -5)$ respectively.

In Fig. 45 is shown the first quadrant only, and a straight line is drawn from the "origin" O ($0, 0$) to the point P ($2, 4$). Now considering the point P , we see that the ordinate (4) is equal to twice the abscissa (2). Similarly at the origin O it is also true that the ordinate (0) is equal to twice the abscissa (0). Now we see that the straight line passes through the points $(\frac{1}{2}, 1)$, $(1, 2)$, $(1\frac{1}{2}, 2\frac{1}{2})$,

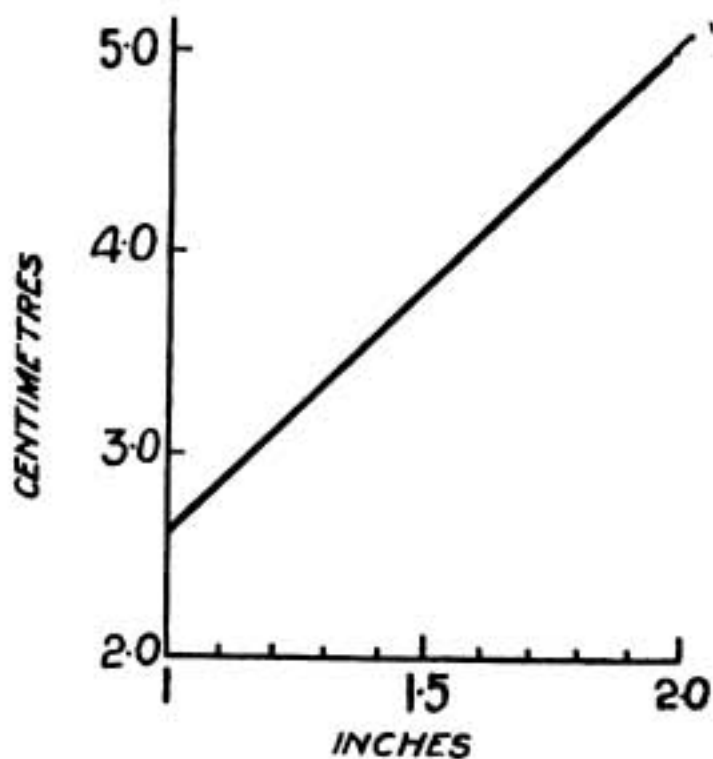
**FIG. 47.**

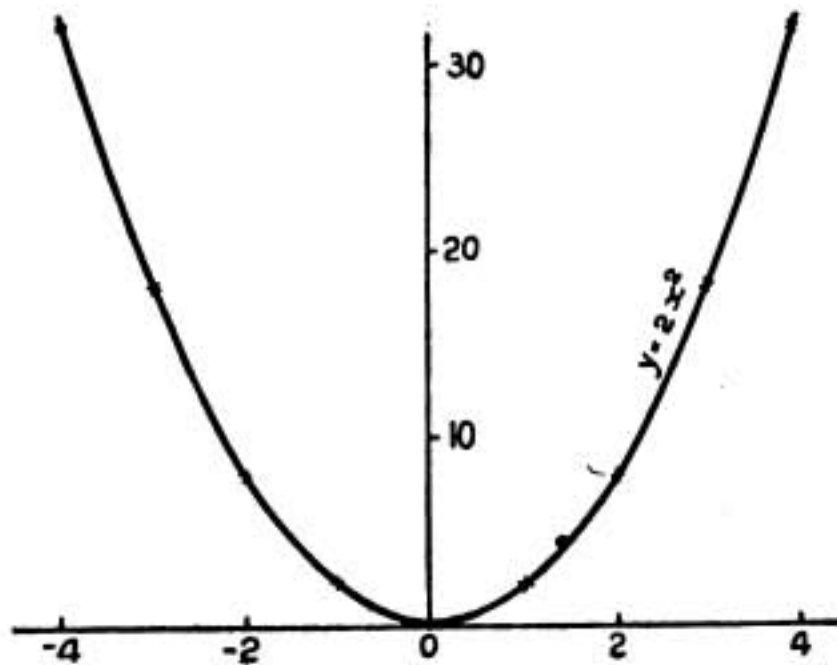

FIG. 48.

scale represents a certain length in inches, then OQ will represent, to its scale, the same length in centimetres. Thus we can, with the help of this curve, convert any length within the range of the curve from inches to centimetres or vice versa.

66. In this connection it is important to notice that it is only necessary to have scales, each of which covers the ground from 0 to 1, as we only want it to give us the *significant figures*. The position of the decimal point can be filled in independently

of the curve. Thus one point on the curve would show us that

- 25 ins. = 63.5 cms.
- .00025 ins. = .000635 cms.
- 2,500,000 ins. = 6,350,000 cms, and so on.

Again, if we wanted to read off various corresponding values of inches and centimetres between 1 inch and 2 inches only, it would obviously be absurd to plot the values from 0 to 10 ins., and 0 to 25.4 cms, as the readings we wanted between 1 in. and 2 ins. would be so close together that large percentage errors would result. We should get much better results if we were to plot the particular small portion we want to a *larger scale*, as shown in Fig. 47. Now 1 in. = 2.54 cms, and 2 ins. = 5.08 cms, and so we draw a straight line from (1, 2.54) to (2, 5.08). From this curve we can read off any values we require between the limits 1 to 2 ins. and 2.54 to 5.08 cms.

67. In Fig. 45 we plotted the curve for the very simple equation $y=2x$. Let us now plot the curve for the less simple equation $y=2x^2$. The first step is to tabulate a few values as follows :

When $x=1$, then $x^2=1$ and $2x^2=y=2$
 $x=2$, then $x^2=4$ and $2x^2=y=8$.

Continuing—

If $x=1$ | 2 | 3 | 4 | 0 | -1 | -2 | -3 | -4
 Then $y=2$ | 8 | 18 | 32 | 0 | 2 | 8 | 18 | 32

The points must now be plotted and a fair curve drawn through them. In this case, Fig. 48, we obviously get quite a different curve from the straight line of Fig. 45.

There are several important

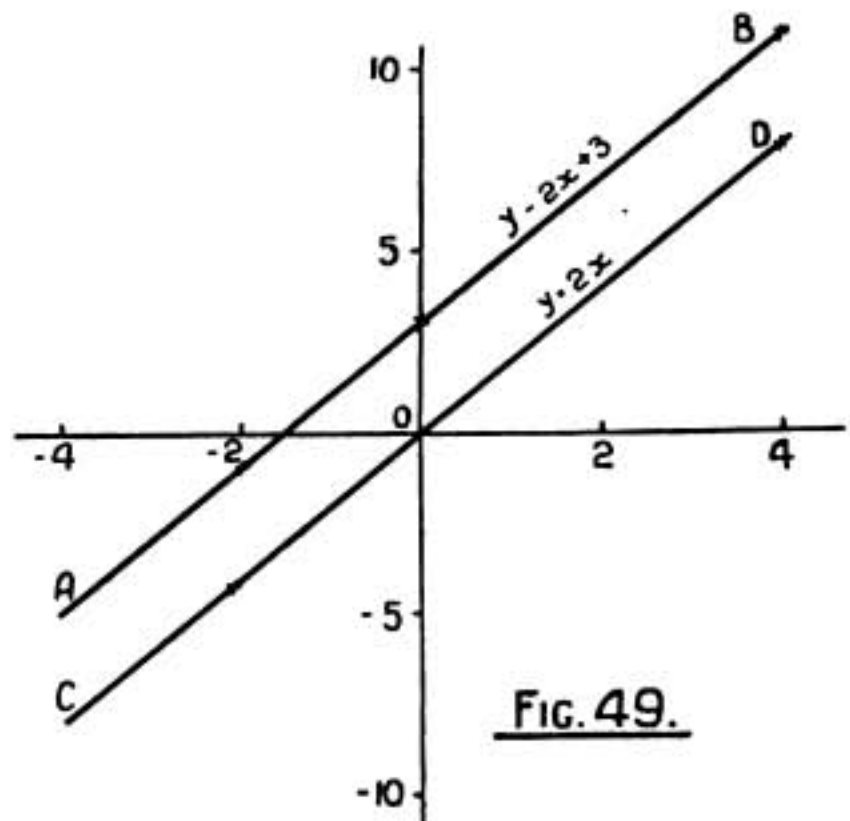

FIG. 49.

things about this curve. The first is that it is symmetrical about the y -axis. The second is that as the curve only just *touches* the x -axis at the origin and does not *cross* to below it, there are no negative values of y . This is obvious, for y is the *square* of something, and the square of either a positive or a negative quantity is *always positive*. Thirdly, the *slope* of the curve is everywhere changing, and the farther from the origin we go the steeper the slope. This can be expressed by saying that the greater x becomes the steeper the slope of the curve, or the greater x becomes the faster does y increase. This is a general way of expressing the fact; in exact terms it can be shown by more advanced mathematics that the *rate of increase of y* is equal to four times x .

Thus when the rate of increase of y is

$x=0$	1	2	3	4	5
0	4	8	12	16	20 and so on.

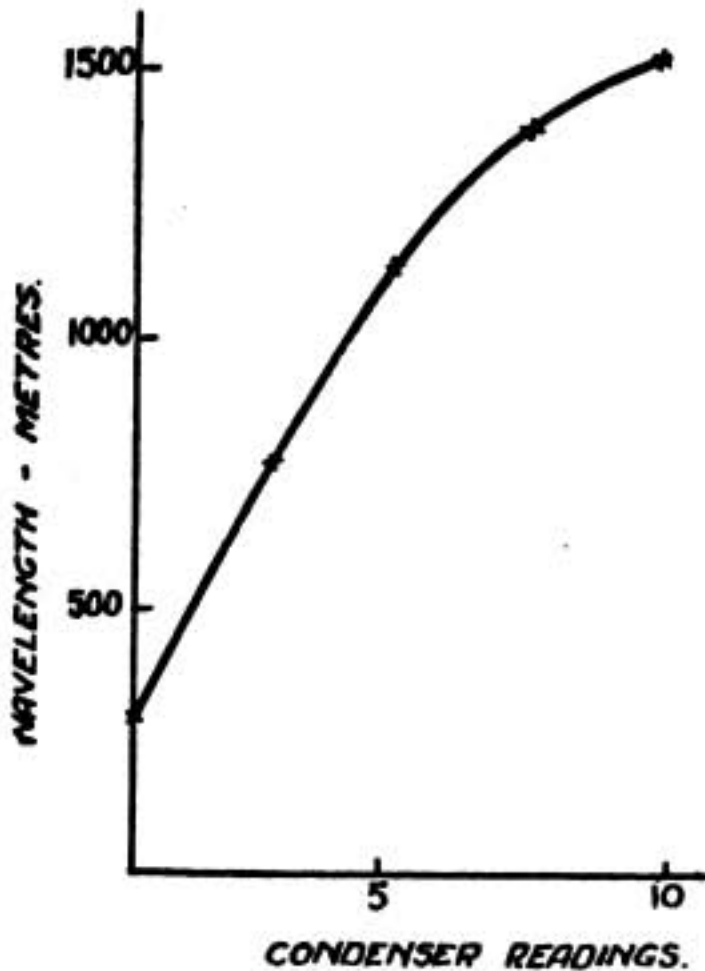

FIG. 50.

$x=0$	2	4	-2	-4	, and so on.
$y=3$	7	11	-1	-5	

Plotting these values we get the curve AB (Fig. 49). For the purpose of comparison let us plot on the same sheet the curve $y=2x$ —curve CD . We see at a glance that the curves are exactly similar, and that the curve, $y=2x+3$, is the curve $y=2x$ *shifted up* bodily through three divisions as a result of the $+3$ term which has been added. We shall consider this point in more detail in a later article.

70. In all the examples we have so far dealt with we have had equations such as $y=2x$, but it must not be imagined that x and y are the only two quantities which

68. As a general statement we can say that when we have an equation which does not include any powers of x and y other than the first, the curve connecting the values of x and y will be a straight line. The curves for equations containing x^2 , x^3 , x^4 , etc. will not be straight lines. For example, the curves of

- $x=y$.
- $y=3x$.
- $17x=5y$.
- $x = \frac{9y}{7}$ will be straight lines, while the curves of $x=y^3$.
- $y=3x^5$.
- $17x^4=5y^3$.
- $x = \frac{9y^7}{7}$ will not be straight lines.

69 A slightly different type of equation to $y=2x$ is one such as $x=2y+3$, the difference consisting in the added constant $+3$.

Making out a table of values of x and y we get

can be dealt with in this manner. We can plot any two quantities which are in some way inter-dependent, provided we know a sufficient number of pairs of values.

As a very common example, in wireless telegraphy we can draw a *calibration curve* of a circuit containing a fixed inductance and a variable condenser. The necessary pairs of values are, of course, simultaneous values of the scale reading of the condenser and the observed wave-length of the circuit. Suppose we have the following values :

Condenser at	..	0	2.5	5	7.5	10
Wave-length	=	300	770	1,140	1,390	1,510 metres.

Fig. 50 shows the curve obtained by plotting these values.

Again, by plotting distance along a road against height above sea level we get the *contour map* of Fig. 51.

71. For some special purposes we use squared paper, which is divided up not equally, but in a logarithmic ratio ; that is, divided just like the scales on a slide rule. This kind of paper gives straight lines for the curves of such equations as $y=2x^2$, and so simplifies dealing with them.

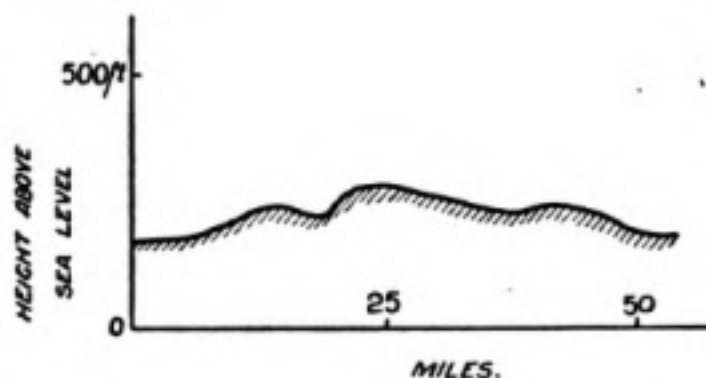

FIG. 51.



[Photo Central News

SURVIVORS FROM S.S. "TARA," RESCUED FROM THE SENUSSI BY THE DUKE OF WESTMINSTER'S ARMOURD CAR FORCE. THE UPPER FIGURE ON THE LEFT HAND SIDE IS G. W. BIRKBY, WIRELESS OPERATOR



"AIRCRAFT IN WARFARE." By F. W. Lanchester, M.I.C.E., M.Inst.A.E. London : Constable & Co., Ltd. 12s. 6d. net.

It is impossible now for even the most sceptical to blind themselves to the utility of aircraft in warfare. The present unhappy campaign has, and is, amply demonstrating this fact. Various countries may possess different ideas. For example, Germany has pinned the greater part of her faith on airships (*i.e.*, of the gas-bag type). The Allies, on the other hand, whilst using "lighter than air" machines to a certain extent, have utilised to a very large degree the "heavier than air" machine.

The sub-title to Mr. Lanchester's book is "The Dawn of the Fourth Arm." He attempts to show, and there is a great deal of truth in what he says, that, in the near future, air operations will occupy as important a position in warfare as do those on land and sea at the present time. The author deals with every phase of the subject, and discusses it from every point of view. His chapters include: comparisons between aeroplanes and airships, the technical aspect of aeronautics, matters dealing with gun-fire, and bomb and grenade dropping, rockets and air-borne torpedoes.

The book forms a worthy, if controversial, contribution to the literature on Aeronautics.

* * * * *

"SUBMARINES." By F. A. Talbot. London: William Heinemann. 3s. 6d. net.

The late Sir Robert Ball set the fashion of writing readable books on technical subjects for the benefit of the general public. This sort of volume has found favour with the busy man of affairs for the acquisition of that insight into technical subjects which affords him an intelligent enjoyment of his newspaper. Mr. Talbot's book belongs to this class, and succeeds in arousing interest. Its readability enables us to record a few minor and incidental faults as perhaps inevitable. Its most serious defect consists in a somewhat loose use of the English language, resulting at times in that absence of lucidity which certainly should be avoidable by the adoption of the popular style. Thus, on page 32 we are informed that the Lake type differs from its rival in having the superstructure throughout the entire length of the boat. Then the writer goes on to say that "the main advantage of the superstructure, as advanced by its adherents, is that it makes the vessel more seaworthy," etc. Seeing that both kinds have a superstructure, this paragraph is distinctly confusing to the untechnical reader. There are times when a little more technical explanation would add to, instead of detract from, lucidity. Such is the case, for instance, when the author on page 49 refers to "reserve buoyancy" and leaves his reader to puzzle out exactly what he means. On page 91, the periscope is said to be a means of riveting the "observer's attention

upon what is *transpiring*" (the italics are ours), a statement which would rouse the ire of the English purist, while the inclination to verbosity is exemplified in such expressions as "dynamic flight." What sort of thing, by the way, is "static flight"? The writer is over-fond, too, of the word "factor," and sometimes employs it when a more direct designation is possible. But it must be confessed that these faults are not numerous or prominent, and would for the most part be ignored in the interest of the reading. A reference to the use of wireless on submarines is made, but the subject, unfortunately, receives no detailed treatment.

* * * * *

"THE BOY ELECTRICIAN." By Alfred P. Morgan. London: Duckworth & Co. 5s. net.

Among the many books for boys which have passed through our hands, this one will make a particular appeal to all who love to experiment and dabble in electricity. It is at once evident, upon opening the volume, that it is written by an American for Americans, but nevertheless it should be welcomed just as heartily on this side of the Atlantic as in the United States. The author explains on almost every page how some piece of apparatus can be made, and we cannot but admire the ingenuity with which many of the simple instruments are designed.

Commencing with the chapter on Magnets and Magnetism, we next proceed to a consideration of static electricity, and thence to static electric machines, cells and batteries, electro magnetism, measuring instruments, telegraphs, and practically every other application of the electric current. Numerous illustrations, both photographic and line, elucidate the text, and in many cases obviate lengthy explanations. Wireless Telegraphy is not forgotten, Chapter XIV. being exclusively devoted to this subject.

Space will not permit us to deal critically with the whole of this volume, and we will therefore confine ourselves to a few remarks on the "wireless" portion. We should not be doing our duty to future wireless experimenters if we failed to draw particular attention to the statement on page 47 as follows:—

"A good ground is absolutely necessary for the proper working of the apparatus. Amateur experimenters usually use the water or *gas pipes* for a ground. . . ." (the italics are ours). The highly dangerous practice of connecting the earth lead to a gas-pipe cannot be too strongly condemned. We are afraid that if the new experimenter attempts to connect his lead to such an earth, he will probably be the victim of an explosion which will effectively put an end to any further experimenting. We have many times pointed out in our pages how dangerous is this practice.

On the plate facing page 270 a bad error is made in entitling what is obviously an oscillation transformer as "an oscillation condenser"; and we are afraid that the relay described on pages 276 and 277 would scarcely be sensitive enough to work with the coherer indicated. In any case no mention is made of the size of wire to be used. Perhaps the author had some doubts himself on the subject, for, on the following page, he remarks concerning the outfit: "It will require some very nice adjustment before you can get it working properly."

The chief fault we have to find with this chapter, which is obviously designed to teach boys the principles of Wireless Telegraphy, as well as the construction of apparatus, is that the author makes no mention whatever of the name of Marconi. Considering that the whole of the gigantic fabric of wireless telegraphy has been built up upon the foundation laid by this great inventor, the omission is quite inexcusable.

Altogether this is a highly interesting and practical book for boys, containing a liberal education in elementary practical electricity.

In view of the fact that both the construction and manipulation of wireless apparatus are at present prohibited in this country, we think that the Publishers would do well to attach a small slip to all copies sold in the United Kingdom, warning readers that any attempt to carry out the experiments in Chapter XIV. will render them liable to prosecution under the Defence of the Realm Act.

* * * * *

"THE MATHEMATICAL ANALYSIS OF ELECTRICAL AND OPTICAL WAVE-MOTION." By H. Bateman, M.A., Ph.D. Cambridge: At the University Press, 1915. 7s. 6d. net.

Considerable attention is now being devoted in the scientific world to the study of the theory and propagation of electrical wave-motion, and, as a result, our knowledge of the underlying principles of wireless telegraphy is growing apace. The book under review, although highly mathematical in its treatment, will doubtless be welcomed by investigators who are endeavouring to solve the many problems with which we are daily confronted. In the preface the author explains that the book is intended as an introduction to some recent developments of the Maxwell's Magnetic Theory which are directly connected with the solution of the partial differential equation of wave-motions.

* * * * *

"ELEMENTARY THEORY OF ALTERNATE CURRENT WORKING." By Captain G. L. Hall, R.E. London: The Electrician Printing and Publishing Co., Ltd. 3s. 6d. net.

Within the last few years a large number of text-books have been published dealing with the elementary theory of alternating current, and endeavouring to make clear to the student those principles which it is so important he should understand. Captain Hall has produced a well-written and clearly illustrated book, which will serve as an excellent introduction to the study of the larger treatises. The treatment is not of an advanced mathematical nature, and should be readily comprehensible to the student who has received an elementary mathematical training.

* * * * *

"EXPERIMENTAL PHYSICS. A TEXT-BOOK OF MECHANICS, HEAT, SOUND AND LIGHT." By Harold A. Wilson, M.A., D.Sc., F.R.S. Cambridge: At the University Press, 1915. 10s. net.

Intended as a text-book for use in connection with a course of experimental lectures on mechanics, properties of matter, heat, sound and light, this book requires in the reader no previous knowledge of physics, and therefore will be found useful for those who are about to commence such studies. For some reason or other physics is not studied by the home-student to anything like the extent that it should be, and we are convinced that many more would take it up if they knew of the interest attaching to it. The study of sound is most fascinating, and a knowledge of this branch of physics should be of considerable practical use to the Wireless Operator, who is occupied, of course, in transcribing sound signals from the telephone. Light-waves are closely related to the ether-waves transmitted and received by wireless stations, so that here again we find a reason for the study of physics by the practical wireless man. We can strongly recommend this book for study in the quiet hours off watch, when a desire is felt to probe more deeply into the mysteries of nature.

Personal Notes

In our personal paragraphs in the February issue on page 765 we erroneously mentioned the name of Mr. G. M. Bosworth as a director of the Marconi Wireless Telegraph Company of America. This is not the case, the gentleman in question being a director of the Marconi Wireless Telegraph Company of Canada, Ltd.

* * * * *

Lieutenant Duncan Sinclair, son of Mr. J. H. Sinclair, a master at Aske Boys' School, Hatcham, has been gazetted as Equipment Officer in the Royal Flying Corps. The Headmaster of the school, in congratulating Lieutenant Sinclair, stated that his success was largely due to the keen work which he had done in connection with the School Wireless Telegraphic Club and the Cadet Corps.

* * * * *

Information has reached his friends in Wishaw that Second Air Mechanic Alexander Dalziel, Wireless Operator, Royal Flying Corps, has been awarded the D.C.M. Details are not to hand, but it is known that the decoration was won by strict attention to duty under shell fire. He underwent a course of wireless training in Glasgow, and, having obtained his certificate, joined the Army. He has been attached to the 108th Heavy Battery, Royal Garrison Artillery, in France, for over a year.

* * * * *

The clerical employes of Amalgamated Wireless (Australasia), Ltd., of Sydney, N.S.W., in conjunction with the operating staff, recently presented Mr. Cliff Atkinson, traffic clerk, with a cabinet of cutlery, a dinner service, and an afternoon teaset, on the eve of his marriage.

* * * * *

We are very pleased to learn that Temporary Second Lieutenant Alexander Rorke, of the 17th Divisional Signal Co., Royal Engineers, has been awarded the Military Cross "for conspicuous conduct during operations in repeatedly repairing telephone and telegraph wires under heavy shell fire, thereby keeping intact the lines of communication." We offer our sincere congratulations to Lieutenant Rorke, who, before the war, was in the Drawing Office of the Marconi Company.

* * * * *

We have pleasure in reproducing this month a portrait of Mr. G. E. Pohu, who recently proceeded to sea on his first trip as a wireless operator. Mr. Pohu joined Marconi's Wireless Telegraph Co., Ltd.,



LIEUT. ALEX. RORKE.

F

on July 1st, 1913, as a telegraph messenger, and soon showed himself to be a youth of more than usual smartness and ability. After nine months' service as a messenger he was appointed to more important work inside the office and quickly "made good" in his new position. During his spare time Pohu studied wireless telegraphy in the Marconi Company's Evening Classes, and upon obtaining his Postmaster-General's Certificate of Proficiency transferred to the Marconi International Marine Communication Co., Ltd., and received the appointment above mentioned to the operating staff. We congratulate Mr. Pohu on his advancement, and trust that he will continue to progress as rapidly as he has done heretofore.



OPERATOR G. E. POHU.

* * * * *

From the *Leeds Mercury* we learn that Arthur Barrett, A.B., Acting Wireless Operator, is home at Wetherby on leave, just recovered from a wound received off Cape Helles, Gallipoli, during the evacuation of the Peninsula. The vessel on which he was serving had her wireless damaged by a shell, and Barrett volunteered to ascend the rigging to effect the necessary repairs, it being impossible to despatch or receive messages. Before he completed the task he was shot through the left ankle by a sniper from the shore, but he pluckily finished his work before descending.

In the engagement in the North Sea when the *Blucher* met her end he was aboard the *Lion*, and on that occasion was wounded in the arm by a flying splinter of shell.

* * * * *

We understand that the D.S.O. has been awarded to Lieutenant-Commander E. L. Colley Grattan, R.N., who was in charge of the wireless telegraphy at Cape Helles in Gallipoli from May 1st until the evacuation of the Peninsula. Admiral de Robeck reports that the work carried out by this officer has been of inestimable service. A similar distinction has been conferred on Commander J. F. Somerville, R.N., Fleet Wireless Officer, who performed duties of exceptional difficulty most efficiently. Acting Warrant Telegraphist John A. Britten, R.N., has been the recipient of the Distinguished Service Cross. He displayed great ability and resource in erecting a wireless station at Cape Helles under fire. We congratulate these very gallant gentlemen.

* * * * *

We learn with regret that leading telegraphist Arthur Crane, R.N., of Catford, was washed overboard and drowned on February 24th. He was in the battle of Heligoland on August 28th, 1914, and later saw much arduous service in the North Sea.

Company Notes

MARCONI WIRELESS TELEGRAPH COMPANY OF AMERICA

The operations of this Company for the past fiscal year show, before allowing for reserves, a net income of \$288,994.68, as compared with \$271,888.71 for the year 1914.

While progress has been hampered by the restriction of ocean travel, and the postponement of the Marconi transatlantic wireless service owing to the European war, nevertheless the Directors feel that substantial improvements have been made in the operation of the company's affairs, and that the past twelve months reflect the beneficial results of careful organization of executive and administrative forces. The new policies of standardising wireless equipment and contracting for its use on a basis which provides a fair return for the service rendered are now well established with ship owners, and have found favour with newcomers into the mercantile marine field. Important economies in operation have been effected and have resulted in a substantial saving, as is later shown. Although the efforts of the officers during the past year have been largely directed to conservation and perfection of organization on account of the indefinite suspension of transatlantic activities, the company has extended its service materially and greatly raised the standard of its mechanical and electrical equipment, thereby laying the foundation for further extension of operations with the return of normal conditions.

With wireless communication featured prominently in the official measures taken for the safeguarding of the country, it is reassuring to know that the company, representing practically the entire American field of commercial wireless telegraphy, is managed by Americans and conducts its operations under the direct supervision of the United States Government. Any suggestion that its control is in the hands of foreign interests through capital investment is directly refuted by a very recent analysis of its list of stockholders—numbering 23,027, of whom 21,664 are residents of the United States.

Notwithstanding that practically all passenger traffic to and from European countries has been suspended by reason of the war, and that American shipping has been withdrawn from the Pacific, it is gratifying to report that, due to excellent coastwise service, the receipts from message traffic during 1915 were only about 8 per cent. less than for 1914.

There are at present nearly 500 ships equipped with Marconi apparatus manufactured by the company, the majority of such equipments being leased at the company's new rental rates, in each case for a term of years. A considerable increase in the number of contracts has been made; and among the largest may be mentioned the equipment, early in the year, of thirty ships of the Standard Oil Company of New Jersey, and, at the close of the year, a contract for standard installations on thirty-six large power barges about to be operated on the Mississippi

River by the Inland Navigation Company. The apparatus is now being installed on the first of these barges, and the remainder will be equipped as fast as they are placed in service. This large equipment of Marconi wireless apparatus on inland river barges (the largest of which approximates 5,000 tons) is the most interesting and promising development of the company's marine service during the year. The application of wireless on such a large scale to river navigation is being watched with keen interest by other large freight carriers, and in fact the entire shipping industry of the country. Since the beginning of the year 1916 thirty-five ships have been equipped with Marconi apparatus, and, with every American shipyard working to full capacity, the company expects to contract for many new installations during 1916. Particularly is this so in view of the now generally acknowledged truth among all progressive ship-owners that no vessel in coastwise or ocean trade is completely equipped unless fitted with a Marconi wireless installation. The United States Government requires many steamships to carry wireless apparatus, but the increasing number of voluntarily equipped vessels indicates clearly the utility and economic value of Marconi equipments now regularly installed on small freight steamers, river barges, pleasure yachts, and tug boats.

In a tornado which blew continuously for eighteen hours in south-west Texas, beginning on August 16th, 1915, the company's station served as the only means of keeping the important city of Galveston in touch with the rest of the world. The storm spent the greater part of its fury on this gulf port, and, notwithstanding its sea-wall protection, water backed up from the bay and filled the streets to a depth of several feet, rendering power plants and the land telegraph and telephone services useless. When at last the mast of the Marconi shore station was blown down and the rising waters silenced the apparatus, the operators were transferred to a ship lying in port, from which communication was at once established with the company's station at Port Arthur. Messages were handled for steamship companies, the military authorities and the general public without interruption. In the midst of the widespread devastation, the mast and guy anchors of the company's station at Port Arthur also gave way, but here again communication was quickly re-established from a near-by steamship.

There has been no change in the commercial status of the transatlantic stations, the high-power equipments remaining closed to business on account of the war. The British Admiralty still holds for Imperial Government use the English plants constructed to operate with the company's Belmar and New Brunswick duplex stations, and, thus far, because of the war, it has been impossible to open similar direct service with Norway and Northern Europe, through the newly completed high-power stations at Marion, Mass., and Chatham, Mass.

Reliable and rapid service has been maintained between the company's stations in California and Hawaii, and the volume of traffic shows steady improvement.

The Hawaiian stations are known as two-way stations, being constructed so as to work with California and Japan simultaneously. The Japanese Government recently notified the company that its new wireless stations at Funabashi and Otchisi, near Tokio, are complete and tests are now being made daily with a view to early inauguration of a public service, spanning 5,600 miles of the Pacific. Negotiations on traffic regulations are now in progress with the Japanese Government Department of Communications, and it is expected that by means of the Japanese Government cables the service will be extended to China, Manchuria, and other Far Eastern countries.

The new circuit connecting the United States with Alaska was opened in August, 1915, and has since furnished reliable communication throughout the 826 miles covered by the company's stations at Astoria, Ore., Ketchikan and Juneau, Alaska. Although operated in competition with the submarine cable, the wireless traffic has shown steady increase each month, and has given practically continuous service, whereas the cable is operated but six hours daily. Many times since the opening the cable service has been interrupted, and the company's system has furnished the only means of communication with the territory. A reduction of some 20 to 25 per cent. in rates, and the establishment of three classes of dependable service, have been the means of making the Marconi service exceedingly popular, and it has been highly commended by the Alaskan Press, commercial houses and the public.

Satisfactory progress has been recorded in the development of a commercial wireless telephone. The year brought about several interesting developments in the art of wireless telephone communication, and pending the decision of the research engineers as to the relative merits of these developments the Directors have thought it advisable to delay the commercial introduction of the wireless telephone.

The engineers have given special attention to the design of suitable wireless equipment for aeroplanes and are confident that highly efficient apparatus for communication from aircraft will soon be developed. The United States Government, and also foreign Governments, have expressed the keenest interest in such apparatus.

The injunction order issued by the U.S. District Court, restraining the DeForest Radio Telegraph and Telephone Company from infringing fundamental Marconi and Lodge patents, was affirmed by the Circuit Court of Appeals on May 13th, 1915.

The trial of the suit begun October 24th, 1914, against the DeForest Company, based upon infringement of the Fleming vacuum valve patent, is actively progressing.

The injunction issued in the suit by the company against the Atlantic Communication Company (the Telefunken system of Germany) has been modified with the consent of the Directors to permit an increase of power in the Sayville

station, and a bond filed to protect the interest of the company.

On August 14th, 1915, suit for infringement of the Marconi and Lodge tuning patents was begun against Kilbourne and Clarke, of Seattle, and is now being vigorously prosecuted at Seattle, Wash.

By instituting system, with a rigid scrutiny over all expenditures, and by using the most efficient methods, the management of the company has effected a substantial reduction in expenses, totalling \$111,054.55 compared with the previous year.

The income derived from investment of surplus funds amounted to \$87,010.01, and adding \$17,922.96 interest on stock subscription, the total income from these sources for the year was \$104,932.07, as against \$150,274.21 for the previous year. The reduction is explained by the liquidation of investments necessitated by capital expenditures. The reserves set aside out of the 1915 profits for the depreciation account have been determined on practically the same basis as in 1914. After setting aside all reserves, the net profits for the year amounted to \$177,316.51, or an increase of 18.30 per cent. over the profits for the previous year. This amount has been added to the surplus, increasing that account to \$541,887.52 at December 31st, 1915, and the Reserve set aside at that date against depreciation amounts to \$373,415.34.

AMALGAMATED WIRELESS (AUSTRALASIA), LTD.

THE fifth half-yearly ordinary general meeting of the Company was held at the registered office, Wireless House, 97 Clarence Street, Sydney, on February 29th last. The directors' report for the six months ended December 31st, 1915, states that trading for the period has still been seriously interfered with by the war, and profits from this source are naturally reduced.

The ship's message traffic, specially referred to in the last report of the directors, shows an increase as compared with the last report, but remains adversely affected by censorship and naval restrictions.

The number of ships now operated by the Company remains as before; additional ships have been fitted but only counterbalance those withdrawn from the Company's operation by sale or otherwise.

The manufacturing Department continues to meet all local and mercantile demands and also the urgent requirements of the naval authorities.

The Training School continues to do admirable work, and has supplied many important calls upon it for skilled operators in both civil and official service.

Mr. John M. Jolly, one of the directors, owing to his continued absence from Australia, has resigned. It is not proposed for the present to elect a director in his place.

The net profit for the period under review amounts to £2,229 17s. 6d., which, with £1,101 14s. 7d. brought forward from the previous half-year, leaves a balance to the credit of profit and loss account of £3,331 12s. 1d., which the directors propose to carry forward to next account.

Pastimes for Operators

II.—PHOTOGRAPHY

By PERCY W. HARRIS

With Illustrations by the Author.

PERHAPS no hobby amongst wireless men has more devotees than photography. It may well be called the King of Hobbies for both sea-going and shore-station operators, as not only does it give pleasure to the person practising it, but it also enables his companions, relatives and friends to share in his enjoyment. Many are the homes which look forward with eager anticipation to the next batch of prints from their "boy at sea" or in foreign climes; a piece of descriptive writing cannot equal a photograph, how perfect it may be in its power of depicting strange and interesting events.

Although operators take their travels a little of some sort, few practise the best advanced



A COMPLETE DEVELOPING AND FIXING OUTFIT.

tions, and share in his Many are the look forward to the next batch of prints from their "boy at sea" or in foreign climes; a piece of descriptive writing cannot equal a photograph, how perfect it may be in its power of depicting strange and interesting events.

so many operators take their travels a little of some sort, few practise the best advanced

photography unfortunately has the reputation of being "messy" and expensive, and in truth often it is so when carried out in an indifferent and unsystematic manner, but considerable experience has convinced the writer that it need possess neither of these faults if properly managed; and, indeed, at times it may even be rendered profitable.

THE QUESTION OF COST.

The matter of expense must be considered under first cost and "running expenses." The first cost covers the camera, and accessories, and the developing and printing outfit (for it is presumed that the photographer will carry out all of the processes himself—he is no true photographer if he doesn't!). The running expenses depend entirely on the size of the camera and the number of photographs taken and printed. The camera need be neither elaborate nor expensive; good work can be produced as easily with a thirty-shilling instrument as with an elaborate machine costing as many pounds, although the range may not be so wide as with the more expensive outfit. The quarter-plate size is as useful as any, and will give a picture of reasonable size without enlarge-

ment, although the "vest pocket" type of camera is deservedly popular, on account of its extreme portability. The folding pocket type should be chosen if possible and as good a lens as the purchaser can afford should be selected. An excellent instrument capable of turning out beautifully crisp and sharp negatives of quarter-plate size under all ordinary conditions can be purchased new from several makers for about £3 10s., and many a good serviceable camera of this quality can be bought second-hand through a reputable dealer for about two guineas. A "Vest Pocket" camera can be purchased for £1 10s. or less.

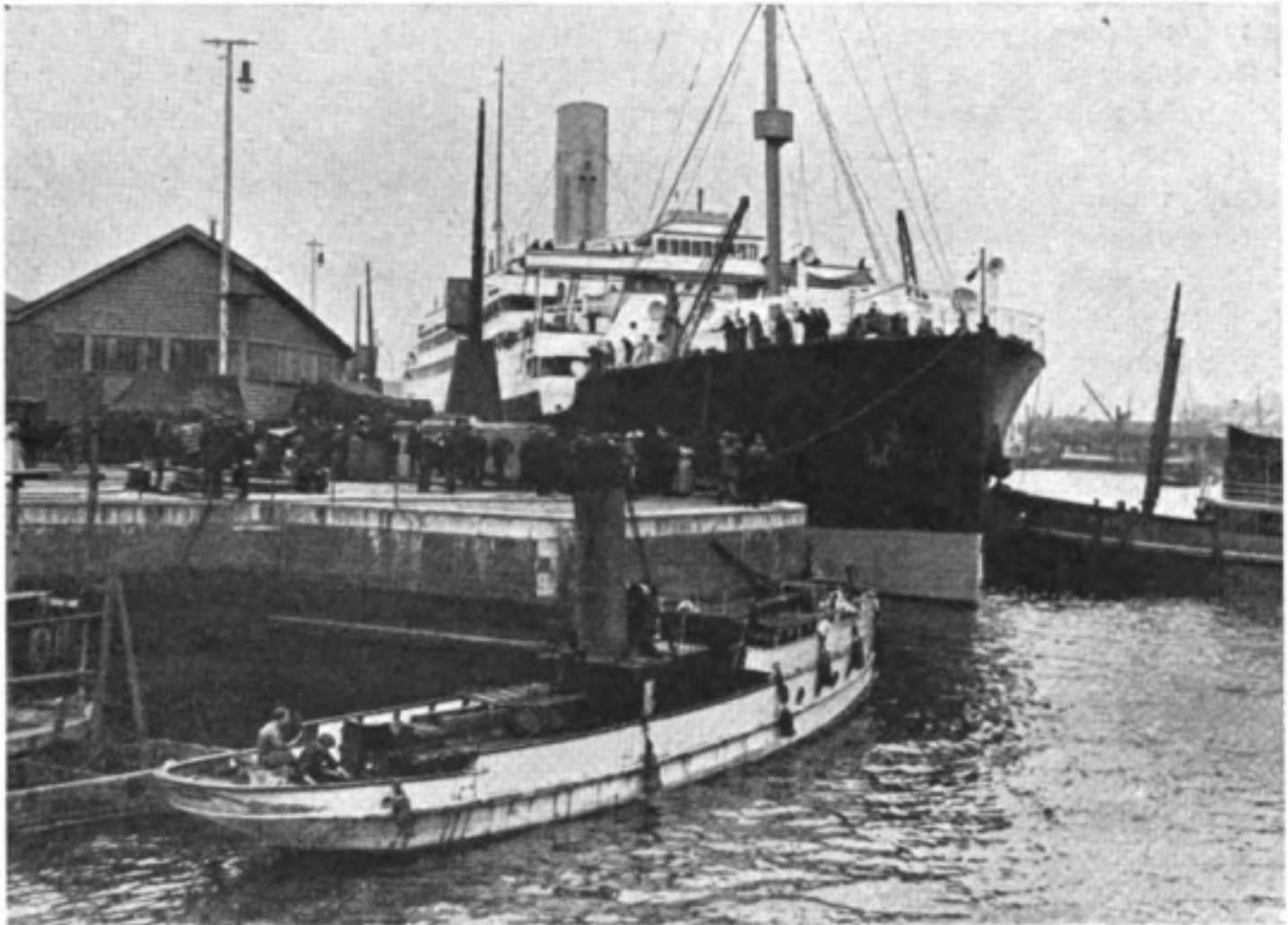

S.S. "ANDES" ON SAILING DAY. AN AMATEUR SNAPSHOT FROM AN UNCONVENTIONAL STANDPOINT IS USUALLY FAR MORE INTERESTING THAN THE CONVENTIONAL PICTURE POSTCARD.

A NOTE ON LENSES.

A word or two concerning the difference between various lenses may be useful here. Photographic lenses can be roughly divided into three classes: achromatics, rapid rectilinears (sometimes called "aplanats" on foreign cameras) and anastigmats. None of these give sharp pictures if improperly focused (a point to be borne in mind when blaming the camera for a poor picture!), but all will give good results if properly handled. The "achromatic" type is the cheapest, and is that fitted to the cheap snap-shot cameras of the "Brownie" class. It works with a fairly small stop ($f/11$ and under), and gives good results in bright light such as one usually gets at sea, but the definition falls off slightly at the corners of the picture, and there is a tendency to distort straight lines falling near the edges. The rapid rectilinear or symmetrical lens is of a higher grade, working at a larger aperture (usually $f/8$) and possessing

greater defining power and absence of the distortion mentioned above. The anastigmat is the finest of the three, giving "pin-sharp" pictures to the very edge and enabling good pictures to be taken in poor light or with very short exposures. Pictures taken with anastigmat lenses may often be enlarged to an enormous size without becoming "fuzzy." The photograph of a jumping horse shown on page 160 was taken with a high-grade anastigmat at one-thousandth of a second on a plate $3\frac{1}{2}$ in. by $4\frac{3}{4}$ in. (9 cm. by 12 cm.), and has been enlarged up to 3 ft. in length without showing appreciable falling off in definition. Such lenses are expensive and require care in focusing to get the best results.

Besides the camera, it is very useful to have a stand or tripod for work ashore when snap-shots cannot be taken. Very handy and portable telescopic tripods are obtainable in metal, and if carefully used will stand any reasonable amount of wear and tear. Good work in bad light may often be done by resting the camera on some convenient support, and the author has on more than one occasion photographed the interiors of mosques in the Near East without a stand by pressing the camera against a pillar to steady it. Some form of exposure meter is a *desideratum*, as the lighting at sea and abroad is most deceptive. This point will be considered further on in the article.

A SIMPLE DEVELOPING OUTFIT.

The developing and printing outfit need not be at all expensive or elaborate, for work in the dark-room has been greatly simplified during the last few years. The photograph on page 157 shows all that is needed in the way of bottles, dishes, etc. In addition a printing frame will be required. The large bottle at the back can easily be obtained from the steward, and is used to contain the fixing solution. The smaller bottle is that holding the concentrated developer, of which there are a number of excellent makes now obtainable (Azol, Victol, Rodinal, Certinal, Kodol, etc.). A 3 oz. bottle of any of these costs about 1s. 3d., and will make at least 72 oz. of developer for plates and films, or slightly less for gaslight papers. The small dark-room lamp, burning oil, costs 1s. 9d., and has served faithfully for several years, often under trying conditions. The dishes shown are of porcelain, which has the advantage of being readily cleaned, but xylonite trays are preferred by many for their lightness and unbreakability. Underneath the

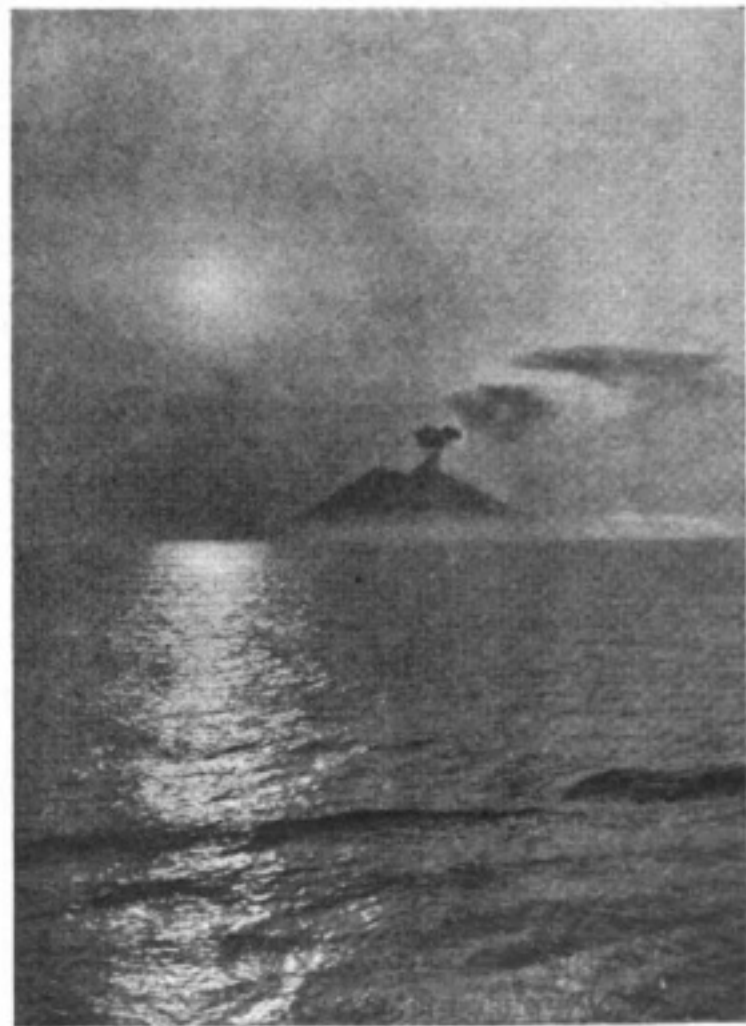

"STROMBOLI, EVENING." DELIGHTFUL EFFECTS SUCH AS THESE ARE EASILY OBTAINABLE EVEN WITH THE CHEAPEST CAMERAS.



EXPOSURE $1/10000$ TH OF A SECOND. AN EXAMPLE OF HIGH-SPEED WORK WHICH CAN ONLY BE UNDERTAKEN WITH THE FASTEST OF LENSES, SHUTTERS AND PLATES. IT IS A PURE WASTE OF TIME TO ATTEMPT THIS KIND OF WORK WITH AN ORDINARY CAMERA.

measure is a small box of hypo eliminator. A celluloid stirring rod for keeping prints under the solutions completes the outfit.

PLATES OR FILMS ?

A question asked by practically every beginner is "Which shall I use, plates or films?" Both have their advantages. Films are preferred by many camera users for their lightness, daylight loading, the facility with which they can be changed, and the fact that they can be developed without a dark-room. Half a dozen rolls of film, each containing enough for twelve exposures, may be carried about with-

out inconvenience in the pockets of a coat, whereas six dozen plates, even of small size, form a burden not lightly to be taken up. The disadvantages of films are that they are more expensive than plates (but not much more with plates at their present war price); they do not permit of the use of a focusing screen on ordinary cameras; they are inconvenient to develop, except in special and expensive tanks; and, last but not least, it is necessary to wait until the whole spool has been exposed before any particular film can be developed. This is a fruitful cause of wastage, for many enthusiasts "run off" the remaining two or three exposures of the reel on subjects they do not particularly wish to snap, just for the sake of being able to develop some special photograph in which they are interested.

Plates are rather weighty, but they are far easier to handle in developing than films, and can be procured in many speeds and qualities to suit particular work. Films are only obtainable in one speed, which is not so fast as that of many plates, with the result that the highest speed work is invariably done on the latter. It is true that plates require to be loaded into the dark slides and developed in a dark-room, but if the photographer makes a practice of seeing that his slides are full each night and of developing after dark he is not likely to be much inconvenienced in this respect.

Although the writer commenced his photographic work at sea with films, he soon abandoned them for plates, and never regretted the change. The ability to use a camera focusing the picture on the ground glass screen is an advantage not to be

overlooked, and the convenience of being able to develop a single plate when required will be much appreciated. Unless the operator wishes to photograph very extensively, he will not require to take a large stock of plates to sea, and the weight of a good supply for the whole voyage should not exceed that of a couple of pairs of boots. Before leaving the subject it may be mentioned that films are usually more liable to scratches and pin-holes than plates, due to the fact that the sensitive material has to be drawn through the back of the camera from one spool to another.

EXPOSURE.

In a short article such as this detailed consideration cannot be given to points such as exposure, and the reader is advised to purchase the Watkins Manual, costing a shilling. In this book exposure and development have been brought down to an exact science, easily understandable by all and productive of the finest results, if only a few simple rules are followed.

The wise photographer at sea will not guess his exposures, but calculate them with some form of exposure meter or calculator. Of these the Bee Meter is as good as any, costing 3s. 6d. The Burroughs-Wellcome Calculator, at 1s., is also excellent. Conditions of light at sea are very deceptive even to the expert, and, furthermore, they differ with every latitude. The cost of an exposure meter will be saved in one voyage in plates or films which would otherwise have been wasted, so that its purchase is to be recommended from motives of economy alone.

DEVELOPMENT AND FIXING.

If no dark-room is provided on board, the operator will have to do his developing at night, unless, of course, he uses a daylight developing film tank. The highly concentrated developers mentioned in a previous paragraph are particularly recommended for use at sea, as they occupy little space, are clean and non-staining in working, and may, furthermore, be used equally well for gaslight papers. A dilution of one part of concentrated developer to thirty of water is a good working solution, in which a plate will develop in six or seven minutes. Stronger solutions give quicker development. The many tablet and powder developers now sold are also very convenient. After development is completed the plate need not be washed, but can be placed straight in the fixing bath, provided this latter is made with acid fixing salt. The dish should be rocked for a few seconds immediately the plate is immersed in the fixing solution, and then left until the creamy colour is gone, and half as long again. This point is important, for a plate is not fully fixed immediately the creamy appearance is removed, and if taken out at once may develop yellow stains after a month or two.

WASHING.

The proper washing of plates and films is one of the chief difficulties which present themselves to the seagoing operator. A supply of running water is, of course, out of the question, except in port, and as a consequence many negatives have been ruined. Fortunately, however, hypo eliminators are now obtainable, and by their use all traces of fixing salt can be removed with a minimum of water, a couple of dozen negatives and prints being completely washed with a single filling of the water tank in the cabin "clock" or washstand.



"A HOUSE IN POMPEII." MANY OPERATORS VISIT NAPLES IN THE COURSE OF THEIR VOYAGES. POMPEII IS EASILY REACHED BY THE ELECTRIC RAILWAY AND SHOULD NOT BE MISSED BY THE PHOTOGRAPHER.

The small box under the graduated measure in the first illustration contains enough hypo eliminator to remove the hypo from a thousand or two negatives or prints, and costs 9d. The substance may be used as follows:—

Dissolve a pellet of the hypo eliminator in water according to the instructions, and pour the solution (which can be used many times over) into a dish. Give the negative or print a brief rinse in a little water after removing it from the fixing bath and then place in the eliminator for three minutes, the dish being rocked continually. At the expiration of this time remove the negative and soak it in three changes of water (two or three minutes for each change). A couple of ounces of water for each quarter-plate is quite enough, and the negative or print is then set up to dry. Plates and prints treated with this eliminator by the author three years ago are just as good now as on the day they were made, and will probably be so in thirty years' time. If running water is available, washing for three minutes after the removal from the eliminator is quite sufficient.

If a fan be provided in the cabin, this will be found very useful for drying, twenty minutes in front of a fan usually sufficing to dry a negative, and much less time for a print.

MAKING THE PRINTS.

For printing there are many different kinds of paper, but the two most popular at sea are "self-toning" and "gaslight." The first prints out in daylight and has the

advantage that the progress of printing can be judged by inspection from time to time ; the second, as its name implies, prints by artificial light. Self-toning papers give prints varying in colour from a warm brown to a purplish brown, depending on the make of paper and the treatment given. Gaslight papers give black and white prints, which have to be developed and fixed. Their chief advantages are speed and the fact that no daylight is required for their manipulation. With an ordinary electric light, as fixed in the cabin, negatives can be printed very rapidly, thin negatives requiring only a few seconds. Development occupies but a minute or two and fixing about ten minutes, washing being carried out as described under the last heading. A point to be remembered when selecting a printing process is that, whilst self-toning papers give excellent prints from *good* negatives, nothing beats gaslight paper for obtaining the best result from a poor negative.

A FEW GENERAL HINTS.

Operators taking cameras to sea in these times should make themselves fully acquainted with the restrictions imposed by the authorities upon photographing, so as to avoid contravening the Defence of the Realm Regulations.

Stick to one make of plate or film, paper and developer, until you have thoroughly mastered the technique. Developers in particular vary enormously in their properties, and you may be misled as to whether or not a plate is fully developed with a strange solution. When you have a developer and materials which give satisfactory results don't experiment with others unless you can afford to waste a good many photographs.

Keep the direct rays of the sun out of the lens, or you will get foggy negatives.

Ninety per cent. of photographic failures come from under-exposure. "If in doubt, double the exposure," is a safe rule to follow.

Paste your prints in an album if you wish to keep your collection intact. Make duplicate prints for friends. Slip-in albums are a snare and a delusion. They should properly be called "Slip-out" albums.

Don't be misled by colour effects. Remember that a photograph comes out in monochrome. This is why most sunset photographs are so disappointing.

When choosing a camera, do not attach too much importance to high speeds on the shutter ; they are rarely accurate. A shutter with $\frac{1}{2}$ th, $\frac{1}{10}$ th, $\frac{1}{25}$ th, and $\frac{1}{100}$ th sec. will be far more useful for general work than one with $\frac{1}{25}$ th, $\frac{1}{100}$ th and $\frac{1}{500}$ th.

The speed of $\frac{1}{2}$ th sec. is very useful for portraiture in diffused light or in the shade of a deck house.

Never take portraits in the full sunlight ; the results are rarely flattering and may get you disliked by both sexes.

A WORD IN CONCLUSION.

This article is written mainly for those who have had a little experience with a camera and need guidance. If you desire to study the subject from the beginning you can obtain from any of the large camera makers (Kodak, Houghtons, Butchers, etc.) a free booklet explaining the basic principles of the art and telling you just what to do when starting. Finally, the Editor of THE WIRELESS WORLD will be pleased to answer readers' queries and give advice on photographic subjects to all who require it, in the "Questions and Answers" column of this magazine.

“Follow the Crowd”

A Jolly Revue at the “Empire”

THE “Empire,” Leicester Square, is known the world over as *the* house for revues. They always seem to get hold of the right people, and manage somehow or other to stick to them. Such favourites as Miss Ethel Levey, Miss Fay Compton, Mr. Robert Hale, and Mr. Joseph Coyne always draw large audiences. The house was packed when we were privileged to witness the performance. The whole thing was perfectly staged, and the dresses, particularly in the “Vogue” scene, were superb. There are some taking bits of music in it too, but, what will particularly attract our readers, a whole scene is devoted to wireless telegraphy. The Marconi cabin on the s.s. *Empire* is portrayed, while a very portentous radio set graces a table inside the cabin. By the courtesy of the manager, we are enabled to reproduce herewith a picture of Mr. Robert Hale as the Marconi operator, discussing men and things with a deck hand, who is impersonated by Mr. Tom Walls. The whole course of this conversation is interrupted by wireless signals, and the operator has continually to break off in order to receive these wonderful messages which arrive from all parts of the world. His discussion on political affairs is most amusing, but this is capped by the receipt of a marconigram announcing the arrival in his own family of a trio of little Hales.

We cannot close this short *critique* without a reference to the excellence of the dancing, and the superbly pretty scenery which graces the first scene of Act 2—“At Honolulu.”

Our advice to all our readers is not to “Follow the Crowd” but to lead them, in order that they may be sure of obtaining admission to the theatre.



[Photo copyright by Empire Theatre, Leicester Square, W.C.]

THE MARCONI OPERATOR “DISCUSSING
MEN AND THINGS WITH A DECK HAND.”



Readers are invited to send questions on technical and general problems that arise in the course of their work or in their study to the Editor, THE WIRELESS WORLD, Marconi House, Strand, London, W.C. Such questions must be accompanied by the name and address of the writer, otherwise they will remain unanswered: and it must be clearly understood that owing to the Defence of the Realm Act we are totally unable to answer any questions on the construction of apparatus during the present emergency.

NOTE.—In view of the large number of questions which now reach us from readers, we regret that we cannot undertake always to answer queries in the next issue following the receipt of letters. Every endeavour will be made to publish answers expeditiously.

J. E. A. (Leeds).—We are unable to give you any information on the subject of the wireless equipment of aeroplanes.

We are also not in a position to supply advanced copies of articles in the forthcoming Year-Book.

For the purpose of joining the service you mention, you will probably find a general knowledge of practical wireless telegraphy of far more use to you than specialised information as to the particular sets at present in use.

J. H. D. (Edinburgh).—The first series of instructional articles have been reprinted as *The Elementary Theory of Wireless Telegraphy*, by Bangay Price, 1s. 2d., post free.

The second series are in preparation, and an announcement will appear in due course in THE WIRELESS WORLD.

The P.M.G.'s examination consists of a practical and an oral examination in theory. No papers are published, but you will find the series of Test Cards published by the Wireless Press, Ltd., price 1s. 2d., post free, to be useful in preparing for the examination.

O. K. C.—In calculating the wave-length of an aerial from its calculated or measured inductance and capacity, the formula

$$\lambda = 1885 \sqrt{LC}$$

must not be used since it is only true for a circuit with localised inductance and capacity. For an aerial with no added inductance the formula is

$$\lambda = 1885 \sqrt{LC} \times \frac{2}{\pi}$$

as shown in the article on the calculation of wave-lengths of aerials in the March number.

Even this formula is only true for an aerial with a uniform inductance and capacity per unit length. For an aerial of two parts with different values for these quantities per unit length (such as formed by a flat top aerial and its down lead) the formula becomes very complicated as explained in the footnote to the article referred to, which will answer the other queries in your letter.

J. H. (Highgate).—We advise you to read again the text-books on electricity and magnetism which you studied up to 1914, as the discovery you have made is fully explained in them in a much better way than can be done in the space at our disposal in these columns. When a current flows along a wire it creates a magnetic field round it. The lines of force produced form close circles round the wire.

If the wire is vertical a compass needle will point in the direction shown in the figure where *W* is a section of the wire in which the current is flowing upwards.

For a horizontal wire you should take a short magnetised needle suspended by a thread, and you will then find that if the needle be above the wire it will deflect with the north pole to the right, and if underneath it will deflect to the left.

If it is on the same level as the wire it will set vertically with the north pole down when on one side, and with it up when on the other side of the wire.

The figure will explain this also if it be regarded as a vertical section through the wire.

P. B. Vannes (France).—The book on *Theory of Electrical Oscillations*, by Mr. L. Cohen, has not yet been published, but an announcement will appear in this journal when it is on sale. Enquiries as to the vacancies for and prospects

of constructional and installation engineers in the Marconi Companies should be addressed to the Head Office of the particular company it is wished to join.

S. S. T. (Gt. Yarmouth) enquires: (1) What is meant by the reciprocal of the capacity of a condenser.

(2) Referring to Hawkhead and Dowsett's "Handbook," page 152, he enquires what is meant by the angle of lag or lead for an alternating current circuit.

(3) On page 163 it states that a frequency of 30,000-20,000 will give an audible note, and enquires how a spark of 600 to 700 gives an audible note.

Answer.—(1) The reciprocal of any number is obtained by dividing unity (i.e., 1) by that number. Thus the reciprocal of 2 is $\frac{1}{2}$, of 9 is $\frac{1}{9}$ and so on.

The reciprocal of the capacity of a condenser is obtained in the same way. Thus a condenser with a capacity of 2 microfarads has a reciprocal value of $\frac{1}{2}$ or 50, and this number may be used for calculations with respect to the condenser exactly as shown on page 88 of Hawkhead and Dowsett.

(2) When an alternating current flows in a circuit including an inductance or condenser or both then, in the general case, the current and the voltage at any part of the circuit *will not reach a maximum at the same instant* but one will reach its maximum at a short time after the other. Instead of reckoning the interval between these points in fractions of a second it is necessary to reckon it in angular degrees; the complete period of one alternation of the current (or voltage) wave being divided into 360 "electrical degrees" and the intervals between any points, such as the two maxima referred to, divided in proportion. This method is adopted for purposes of calculation.

(3) The statement on page 163 should read "a frequency of 30 periods to 20,000 periods per second will give an audible note. Hence since 600 to 700 come between these limits, an audible note is given by sparks of these frequencies."

J. J. M. (Co. Westmeath).—The *Handbook of Technical Instruction*, by J. C. Hawkhead and H. M. Dowsett, contains all the theoretical information necessary to pass the Postmaster-General's Examination, and the student who masters this volume will find his period of study at a wireless college considerably shortened. There is no need to purchase any other books than the ones you mention, but if you require a good book on Elementary Electricity and Magnetism, we would recommend that by Hadley, obtainable from the Wireless Press, Ltd., at 2s. 10d., post free. A very useful book on Elementary Practical Mathematics is that by Frank Castle, obtainable through the Wireless Press, Ltd. In reply to the last portion of your question, the Marconi Official Records should suit you admirably.

W. B. (Brighton).—The sale of wireless telegraph apparatus is prohibited by the Defence of the Realm Act. The Postmaster-General gives permission in certain circumstances for the use of keys, buzzers, etc., for "non-wireless" purposes, and if you wish to use these we would suggest that you write to the G.P.O. giving full particulars of what you desire to do. You will then be officially informed of what can be allowed.

A PARTMENTS, special terms to Marconi Students only 15 minutes by tube to "The Strand," good table, excellent references, 16/6 per week inclusive.—MRS. BARRY YORKE, 22 Hogarth Road, Earls Court, London, S.W.

THE YEAR-BOOK OF WIRELESS TELEGRAPHY & TELEPHONY.—We have had the opportunity of securing a few copies of earlier issues and can offer them as follows—
1913 edition, 2 copies only } 3/- post free United Kingdom
1914 edition, 12 copies } 4/- Abroad.
1915 edition, 4/- United Kingdom; 5/- Abroad.
THE WIRELESS PRESS, LTD., Marconi House, Strand, London, W.C.

WIRELESS WORLD, VOLUME 3,—BOUND COPIES ready March 15. Price 4/6 net, postage 6d. extra, United Kingdom; 1/6 extra abroad. BINDING CASES. Price 1/3 post free, including Index, INDEX only sent post free upon receipt of 2 penny stamps.—THE WIRELESS PRESS, LTD., Marconi House, Strand, London, W.C.

THE ELEMENTARY PRINCIPLES OF WIRELESS TELEGRAPHY, by R. D. Bangay. Price 1/2 post free. A book eminently suitable for the beginner.—THE WIRELESS PRESS, LTD., Marconi House, Strand, W.C.

BINDING CASE for Volume III. of THE WIRELESS WORLD. Price 1/3 post free.—THE WIRELESS PRESS, LTD., Marconi House, Strand, W.C.

COPIES of Volume II. of THE WIRELESS WORLD, cloth bound, bevelled boards. Price 4/6 net. Postage for United Kingdom, 8d. Abroad at Foreign Parcel Post Rates. As a few copies only remain, orders should be placed at once.—THE WIRELESS PRESS, LTD., Marconi House, Strand, W.C.

SPECIMEN COPIES.—We shall be pleased to send entirely free of charge a few specimen copies of THE WIRELESS WORLD to the friend of any reader likely to be interested in the magazine.—Send a postcard to Sales Manager, THE WIRELESS WORLD, Marconi House, W.C.

MORSE CODE CARD, showing Alphabet, Numerals, Abbreviations, etc., at a glance. Price 2d. post free.—THE WIRELESS PRESS, LTD., Marconi House, Strand, W.C.

ANY BOOKS reviewed in the WIRELESS WORLD or other magazines will be forwarded per return upon receipt of remittance covering cost of book and postage.—THE WIRELESS PRESS, LTD., Marconi House, Strand, W.C.

MAP OF THE WORLD, 1916 Edition. Showing location of over 700 Wireless Stations. Price 1/8 post free.—THE WIRELESS PRESS, LTD., Marconi House, Strand, W.C.

The simplest method of obtaining "THE WIRELESS WORLD" — Place a standing order with your newsagent.