

# WIRELESS

# WORLD

MONTHLY 3<sup>D</sup>

Engineering

Library

620.5

W8

W92

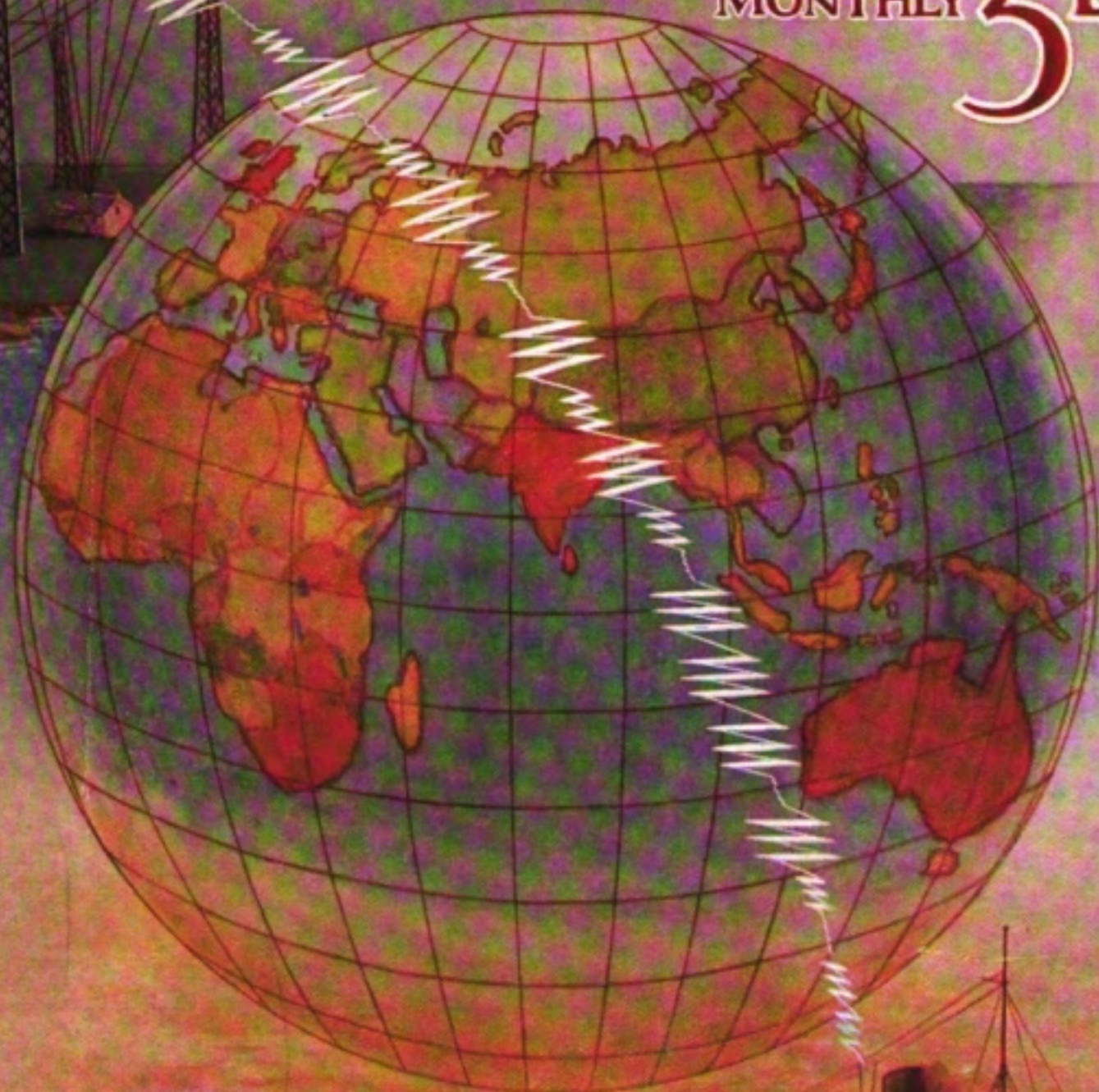



# Sullivan Instruments

## Sullivan "Universal" Galvanometers and Shunts for Land and Sea Use

Testing and Signalling Instruments of every description for Submarine Cables, **SULLIVAN TELEPHONE RECEIVERS** for Wireless Telegraphy and Telephony, as used by the principal Governments and Wireless Telegraphy Companies—resistance values from 5 to 15,000 ohms.

## Fast Speed Wheatstone Automatic Transmitters and Receivers, guaranteed at 400 words per minute, and Wheatstone Apparatus generally.

Precision and Standard Measuring Equipments for D.C. and A.C. (high frequency) determinations, Condensers of Low Power Factor, etc.

All instruments guaranteed, and accompanied, if desired, with Certificates of Accuracy from the National Physical Laboratory at cost price.

## H. W. SULLIVAN,

Winchester House, London, E.C., England.

Works: Liverpool House, Middlesex Street, London, E.C.

Telegrams: "Deadbeat, London."

Telephone: Office: 3518 London Wall.  
Works: 3518a "

Codes: Western Union (Universal Edition); A.B.C. (5th Edition); Engineering (2nd Edition).

Silk and Cotton Covered H.C. Copper Wire, Resistance Wires, Fuse Wire, Binding Wires, Charcoal Iron Core Wire, Asbestos Covered Wire

**P. ORMISTON & SONS,** 79 CLERKENWELL ROAD  
LONDON, E.C.  
Established 1793. 13259 Central.  
"Ormiston, London" Braided and Twisted Wires, Bare Copper Strand & Flexibles of any Construction, Wire Ropes & Cords, down to the finest sizes, in Galvanized Steel, Phosphor Bronze, etc.



## VULCANIZED FIBRE

Sheets, Rods and Tubes.  
Machine Work and Special Shapes.

**J. BURNS, LTD**, 189 CENTRAL ST., LONDON, E.C.



## "Wireless" TELEPHONE RELAY

IMPROVED FORM will MAGNIFY CURRENT over 100 TIMES.

For INCREASING the RANGE of a Receiving Station.  
For RECORDING Messages and TIME SIGNALS.  
For operating LOUD SPEAKING TELEPHONES.  
For working CALLS and RELAYS.

Also BEST RECEIVERS made for Wireless and other RELAYS and Loud Speakers.

For Particulars and Prices apply Patentee and Sole Manufacturer,

**S. G. BROWN, 4 Gt. Winchester St., London, E.C.**



Please mention "The Wireless World" when writing to Advertisers.





Vol. 2.—No. 16. (New Series)

July, 1914.

Subscription  
5/0 per annum  
post free.

Price 3d.  
Post Free 5d.

## Safety at Sea

**J**UST two weeks after the *Empress of Ireland* sank in the St. Lawrence River, the House of Commons was occupied in debating the Mercantile Shipping (Convention) Bill—a measure designed to minimise the dangers of ocean travel. The provisions of the Bill relating to wireless telegraphy are printed on page 250 of this issue, and it will be seen that their scope is to give effect, so far as the British Mercantile Marine is concerned, to the decisions of the conference which assembled in London towards the end of last year and which, in January last, agreed upon an international standard as to the precautions to be adopted to reduce the perils of the sea. Parallel legislation is being carried elsewhere, and there is every reason to anticipate that within a comparatively short time the great shipping nations will have in operation a code of safety binding on all owners and crews of foreign-going passenger ships.

It has not required the recent terrible disaster to remind us as to the need for legislation such as is now proposed, for the alarming facts as to the extent of the destruction of human life at sea had already created a consensus of opinion throughout the world in favour of reasonable reform. This movement resulted in the holding of the International Conference to which we have already referred, and the Bill which the President of the Board of Trade explained to the House of Commons on June 12th embodied the results of that conference. Members of the House of Commons intimately connected with the shipping industry

gave the measure their approval. Sir Archibald Williamson, speaking with an intimate knowledge of a fleet of steamers trading regularly with the United States, observed that although not one of these had a crew of fifty nor carried passengers it had been found that the installation of wireless telegraphy was a distinct advantage. He advocated the installation of wireless telegraphic apparatus on cargo steamers, not only because it made for safety, but because it gave owners the commercial advantage of knowing where their steamers were at any given moment, and when they would arrive at any given port.

The fear was expressed by one member that wireless telegraphy might become a monopoly, but Mr. John M. Robertson, the Parliamentary Secretary to the Board of Trade, promised that the Board of Trade would take "vigilant precautions against an approach to anything of the kind." There has never been any "monopoly" in wireless telegraphy in this country, and we fail to see in what way the Bill will create one.

Shipowners are business men after all, and like other business men they are guided in making their purchases by considerations of efficiency and economy. If the vast majority of ships are equipped with Marconi apparatus it is surely because of the outstanding advantages to shipowners of that system and of the services of "an excellently managed and efficient organisation," to quote the expression of one of the speakers who took part in the debate.



MR. E. T. CHAMBERLAIN



# Personalities in the Wireless World

## EUGENE TYLER CHAMBERLAIN

*United States Commissioner of Navigation*

**T**O control the navigation of any country is a task of great responsibility, as it is likely to have a great effect, either for good or ill, on the prosperity of that country according to the manner in which it is carried out. Especially is this the case in a land which owes its development and maintains its greatness largely on the wealth and importance of its maritime trade. The United States, therefore, has been thrice blessed in having for her Commissioner a man of such keen foresight and statesmanship as are possessed by Mr. Chamberlain. It was not the least of President Cleveland's achievements when he prevailed on Mr. Chamberlain in 1893 to accept the post, for in the twenty-one years that he has held the office, Mr. Chamberlain has effected such far-reaching changes and introduced so many important measures relating to vessels and shipping, that he has practically reorganised the maritime system of the United States and made it one of the foremost in the world.

One of his ideals is to secure, as far as possible, the safety of "those who go down to the sea in ships, and occupy their business in great waters." How far he has succeeded in his purpose we dare not declare, lest we should be accused of fulsome flattery. All we can say is, "Ask those whom his ordinances affect and the reply will leave you more than satisfied of the truth of our statement." But to those who have not the means of obtaining information in this way, the following details of Mr. Chamberlain's work will be of interest. Soon after taking office he started to carry into effect the recommendations of the International Marine Conference of 1898, and so brought into operation the revised international rules, inland rules, and the Great Lakes

rules for preventing collisions and for establishing definite lines for the application of these regulations. He was also, to a large extent, responsible for the passing of the White Law of December, 1898, for the improvement of the conditions of seamen on American ships, and it was he who urged the measure, included in the Act, which requires the inspection of certain sailing vessels and the examination of their officers, and prohibiting the departure of unseaworthy American ships. Again, in 1903, when the Department of Commerce and Labour was created, he joined others in urging the importance of wireless telegraphy as a means of promoting safety to life on vessels at sea, and the United States Government have found his co-operation invaluable in the framing of the legislation on this subject.

Mr. Chamberlain was born in Albany, New York, September 28th, 1856, and was educated at the Albany Academy and at Harvard University, where he graduated in 1878. For one year he took up the profession of teaching, but later was engaged in business. This knowledge he found of great value, when, two years afterwards, he entered on a journalistic career, which he continued to follow till, in 1893, President Cleveland appointed him Commissioner of Navigation, and he took up his great life work. He is one of the four honorary associates of the Society of Naval Architects and Marine Engineers, and is a member of the Maritime Law Association. In 1903 he was secretary of the Pan-American Customs Congress which met at New York to promote uniformity in Customs and Navigation Laws among the American Republics. Again, he was delegate at the International Congress on the Safety of Life at Sea, which was held in London last year.



# Trans-Ocean Wireless Telegraphy

## *New Transatlantic Service.*

### THE ENGLISH STATION DESCRIBED.

ALMOST everywhere the triumph of wireless telegraphy is complete—on land and on sea, in peace and in war—and one recalls with considerable amusement the extraordinary manner in which Mr. Marconi was treated by scientific men while solving the great problem. It is only a few years ago since Mr. Marconi announced to the world that he had succeeded in sending a wireless signal across the Atlantic. Immediately the detractors were up in arms. It was nonsense; the reading was an error, it was a deliberate deception. To-day we know that the signal was really sent and really received, and events have proved it to be the forerunner of a new means of bringing the corners of the world nearer than ever before.

It was in 1900 that Mr. Marconi, encouraged by the success of his cross-Channel and other experiments over varying distances, arrived at the decision to make a serious attempt to send an electric wave across the Atlantic and detect it on the other side. He had long held in view the application of his system of wireless telegraphy to transatlantic working, not merely as an experimental feat, but with the object of making it a means for commercial communication. It was obvious, however, that if such a purpose was to be brought to fruition it would necessitate the employment of more powerful electromagnetic waves than those previously used, and it was, above all things, necessary to be perfectly certain that the production of these waves would not prevent or cripple the already established wireless communication between ships and the shore. Moreover, the nature of the plant to be employed required careful consideration.

After many experiments, the construction of the plant was commenced. Poldhu, on the Cornish coast, was the locality chosen for

the site, and that name will go down in history as the birthplace of transatlantic wireless telegraphy. The construction of appropriate buildings was commenced in October, 1900, by Marconi's Wireless Telegraph Company. In the following month the machinery began to be erected. The aerial was to consist of a ring of twenty masts, each 200 feet high, arranged in a circle 200 feet in diameter, the group of masts supporting a conical arrangement of wires insulated at the top and gathered together at the lower points in the shape of a funnel. In December, 1900, the building was so far advanced that drawings were prepared showing the arrangement proposed for the electric plant in the station; this being delivered, experiments were carried out at Poldhu in January, 1901, for the purpose of ascertaining how far it would be efficient for the objective in view. At Easter, 1901, by means of a short temporary aerial, experiments were conducted between Poldhu and the Lizard, a distance of six miles, which was sufficient to show that the work was being conducted on the right lines.

During the next four months much work was done in modifying and perfecting the wave-generating arrangements, and numerous telegraphic tests were conducted during the period by Mr. Marconi between Poldhu in Cornwall, Crookhaven in the South of Ireland, and Niton in the Isle of Wight. A delay occurred owing to a storm on September 18th, 1901, wrecking a number of the masts, but sufficient restoration of the aerial was made by the end of November, 1901, to enable Mr. Marconi to contemplate making an experiment across the Atlantic. He left England on November 27th, 1901, in the steamship *Sardinian*, for Newfoundland, having with him two assistants, Messrs. Kemp and Paget, and also a number of balloons and kites. He arrived at



St. John's, Newfoundland, about December 5th, and made arrangements for sending up a balloon and an attached aerial wire, having previously instructed his assistants at Poldhu to send from 3 p.m. to 6 p.m. each day a programme consisting of the letter "S" (which in the Morse code consists of three successive dots) at short intervals. Signals began to be sent out in this way from Poldhu on Wednesday, December 11th, and, after some difficulty in elevating the aerial wire in Newfoundland by means of a kite, Mr. Marconi received the "S" signals at Newfoundland on Thursday, December 12th, 1901. On Friday, December 13th, he confirmed this result, and on Saturday, December 14th, he was able to send a message to Major Flood-Page, one of the Directors of Marconi's Wireless Telegraph Company in London to this effect:

"St. John's, Newfoundland, December 14th, 1901.—Signals are being received, weather makes continuous tests very difficult, one balloon carried away yesterday."

In these experiments the actual power employed in Cornwall for the production of the waves was not more than 10 or 12 kw. In February, 1902, Mr. Marconi made arrangements for the erection at Poldhu of a permanent structure.

The plant and equipment at Poldhu have since been modified to adapt the design of the station to the requirements of modern radiotelegraphic practice, but it ceased to be employed for transatlantic work in 1907, when a new station was opened at Clifden, on the west coast of Ireland, to communicate direct with another station at Glace Bay in Nova Scotia. These two large stations began to exchange radiotelegraphic messages across the Atlantic on October 7th, 1907, and millions of words in Press and private messages have since been transmitted. The long history of this great achievement was related by Mr. Marconi in a lecture at the Royal Institution of Great Britain, delivered on March 13th, 1908, in which he recounted the various stages of the work and the steps by which success had been finally attained. After an interval of interruption due to a fire which destroyed part of the Glace Bay Station in August, 1909, commercial communication was re-established across the Atlantic at the end of April, 1910.

Now to the Clifden-Glace Bay service is about to be added another, which is calculated to more effectively bring together the two Continents and to cope with the enormously increasing use of transatlantic telegraphic communication which the cheapness and efficiency of the Marconi system has made possible.

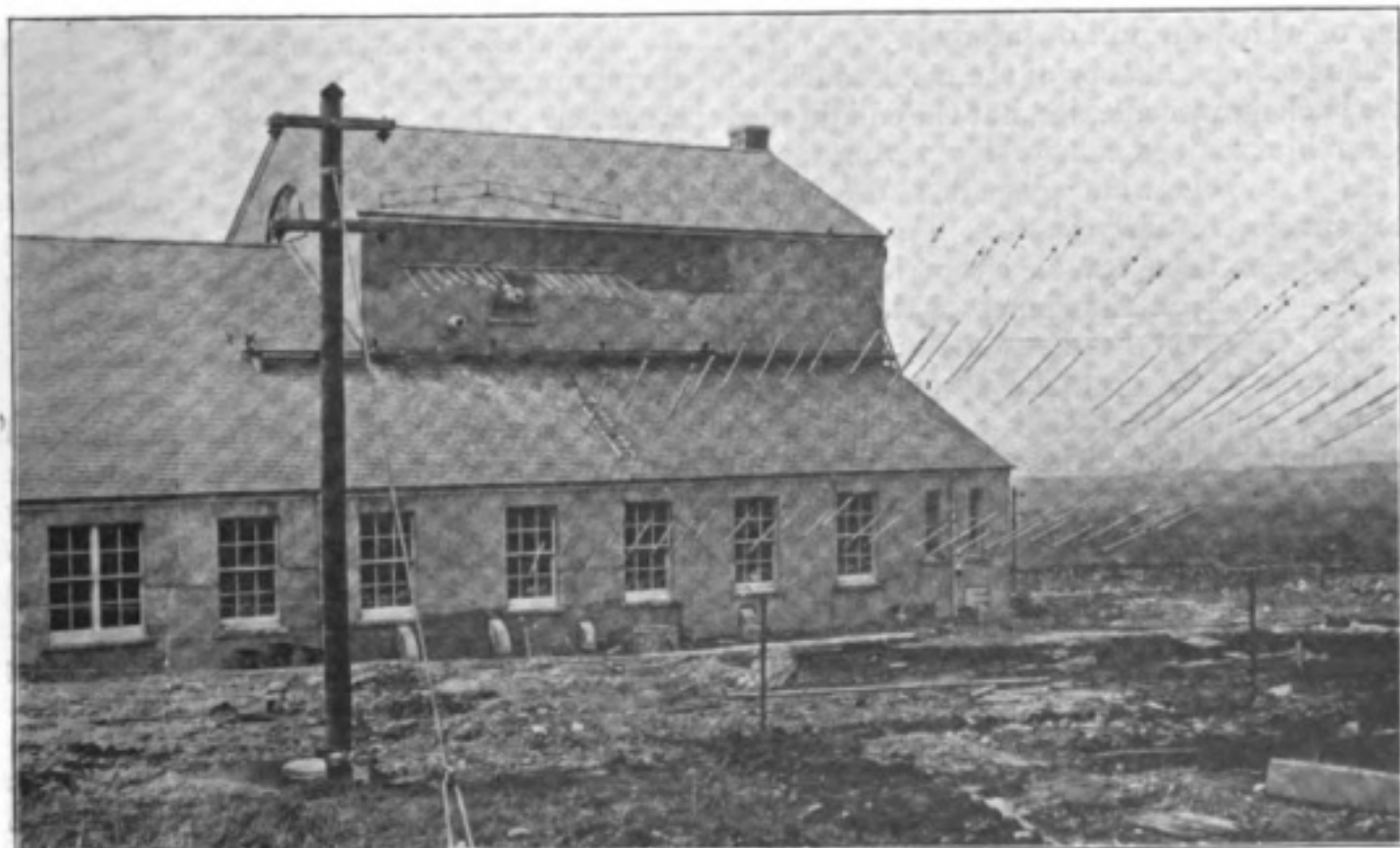

*Carnarvon Station Building, showing Leading-in of Aerial.*

B



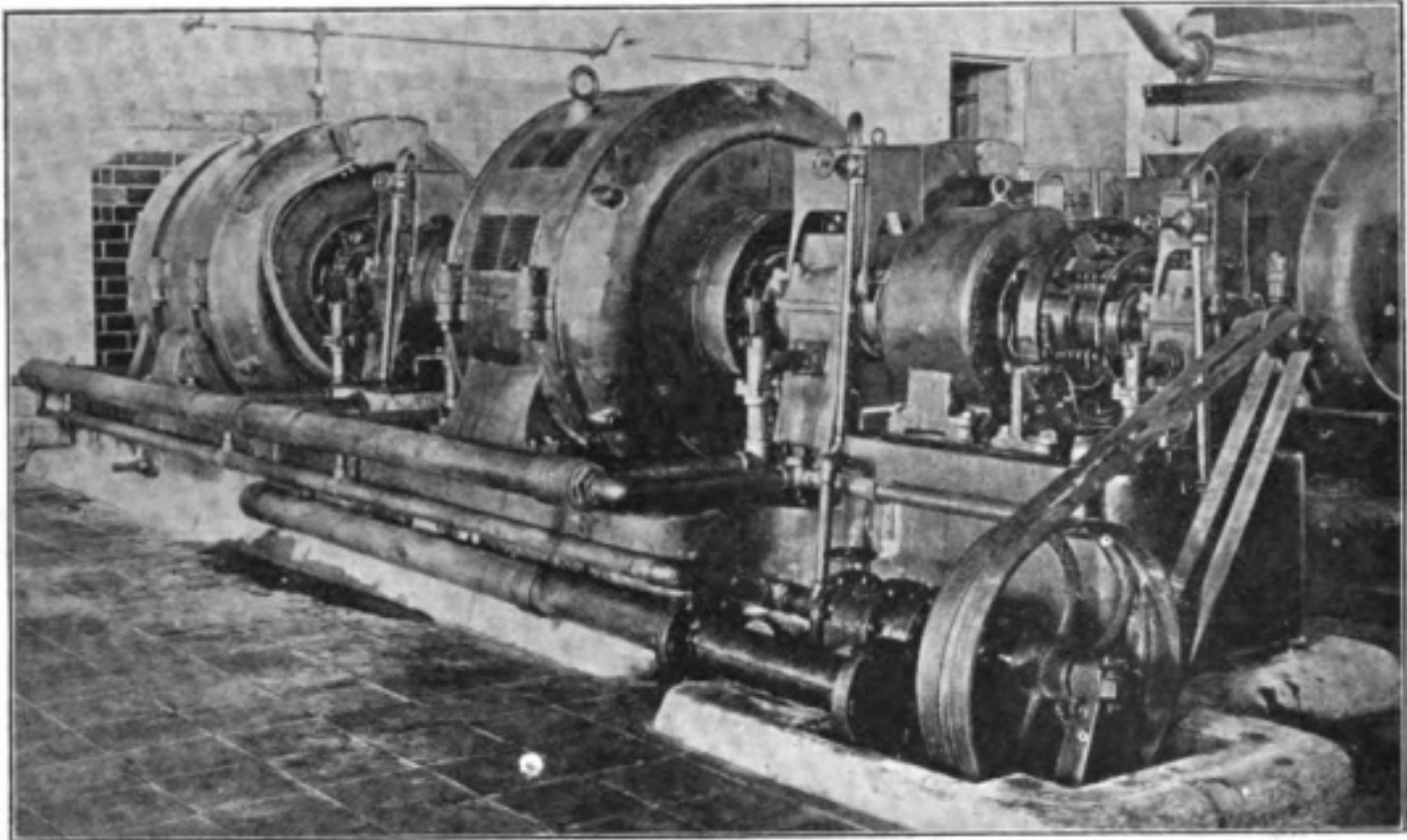

*Main 300 kw. Motor Alternator.*

The stations are situated in North Wales and in New Jersey, U.S.A., and private land lines will connect these terminals with London and New York. As the service will shortly be inaugurated this is a suitable occasion on which to give an account of it, as well as of the work which it is intended to carry on.

The British station is located in the neighbourhood of Carnarvon, the whole surroundings of which are full of interest.

The recorded history of the neighbourhood goes back many centuries, but the enlightened research of trained scholarship within recent years has somewhat dispelled the mists that envelop its early history. For instance, the fact has been revealed that long before Cæsar set foot on the shores of the "White Island" its every headland along the North Wales coast was occupied by what, to the military engineer of that day, must have been impregnable cities. These were so systematically grouped that the appearance of an invader at Chester could be signalled to Carnarvon, and thence along the western coast, with a promptness that, in a sense, anticipated the wireless telegraphy of to-day.

Until far into the Middle Ages Carnarvon was the richest and busiest city in Wales. Since then, however, it has fallen on evil days, commercially. For generations its local industries have been a diminishing

quantity. The riveter's hammer on the iron and steel ships of the Clyde and Tyne sounded the knell of about the last of its flourishing trades.

The site on which the New Jersey Station stands has also passed through many vicissitudes, and during the construction of the New Brunswick transmitting station an old farmhouse, which in revolutionary days was a mansion of importance, having been at one time a paymaster's office of the revolutionary army, was used as the construction office. Rumour has it that Lafayette had his headquarters at this old farmhouse for a time during the American War of Independence. But the whirligig of time brings its revenges, and historic places in North Wales and in New Jersey now come into prominence through scientific achievement.

The station in North Wales, although familiarly known as Carnarvon Station, is not actually within the confines of that city. The transmitting section is situated a few miles east of Carnarvon, on the Cefn-du Mountain, the station building being about 680 feet above sea level. The receiving section is at Towyn, one of the most pleasant seaside resorts in North Wales, about three-quarters of a mile from the village and a distance of about 62 miles by road from Cefn-du.



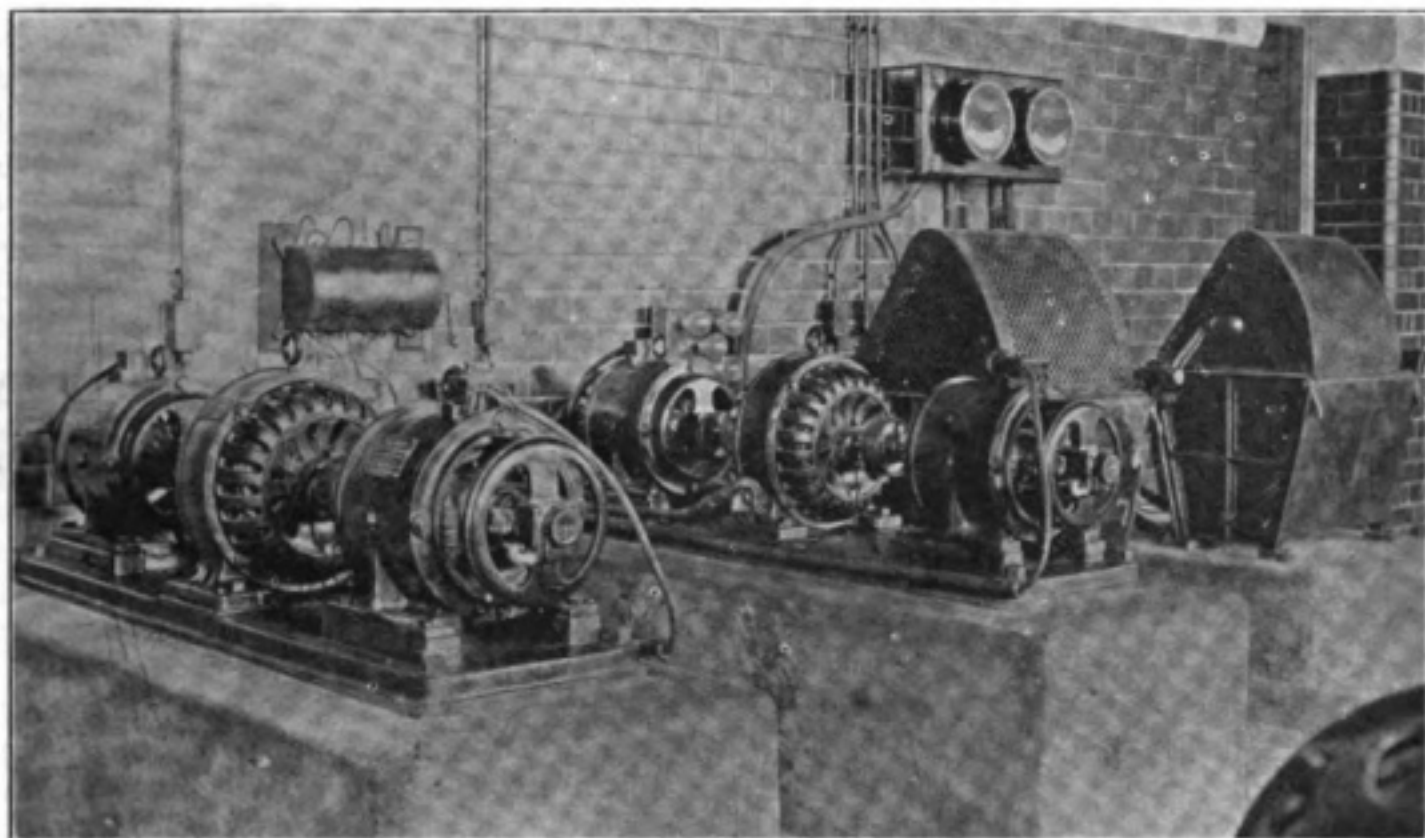

*Signalling Motor Generators.*

The transmitting and receiving sections are separate to enable duplex wireless telegraphy to be effected—that is to say, to make possible the simultaneous reception from, and transmission to, America. It is not usual to have so large a distance separating the two sections, but it was necessary to do so in this case owing to certain geographical features. In duplex working the receiving section must be placed in a certain definite direction with respect to the transmitting section, and here the correct angle could not be obtained with a suitable site at a nearer distance owing to the configuration of the country.

There are four wires connecting the two stations, these being carried on the same poles as the Post Office telegraph lines.

The transmitting station consists of one large building measuring approximately 100 feet by 83 feet, which is divided into three sections, known as the main machinery hall, the annexe, and the extension.

In the main machinery hall are located the transmitting sets, switchboard, transformer room, stores, offices and emergency operating room. Auxiliary plant, consisting essentially of electrically driven blowers, D.C. generators, ventilating fans, and some small motor generator sets used in connection with the signalling circuit are placed in the annexe, which also provides an office for the

shift engineers and accommodation for the fitting shop. The extension is devoted entirely to experimental apparatus.

On the two upper floors of the north end of the building are arranged most of the actual wireless apparatus, consisting of condensers, bus-bars, jigger, and inductances.

The main transmitting sets are in duplicate, each set comprising a 300 K.V.A., single-phase alternator, generating at 1,750 volts and 150 frequency, directly coupled to, and driven by, a 500 B.H.P. three-phase self-starting motor, suitable for 440 volts and 50 frequency; this in its turn is directly coupled to a shunt-wound exciter giving 300 amperes at 40 volts.

The alternator is directly coupled to the discharger, which is of the rotating disc type, the coupling being an insulated one. Lubrication throughout the entire set is forced. The disc discharger is enclosed in a sound-proof room.

An insulated foundation is provided for the disc, and should it be required at any time to run this asynchronously, an independent 50 horse-power 110 volt shunt motor having a quickly removable insulated coupling is provided for the purpose.

The main switchboard consists of ten panels, each 2 feet wide and 8 feet high, upon which are mounted the necessary





*Transformers, Inductances and Isolating Switches.*

instruments and circuit breakers and switches for the control of the various parts of the plant. The mains and main motor panels are provided with time limit relays; the cables from the switchboard to the various machines are all lead covered, and are suspended on racks on the sides of the trenches.

The transformer room is worthy of note. Here are transformers each having a capacity of 75 K.V.A., as well as low-frequency inductances. There is an electrically operated safety switch in the transformer primary circuit which is controlled by a master switch. Each transformer is provided with isolating switches in both primary and secondary circuits, and these are carried by an iron framework immediately over the transformers. The low-frequency inductances are arranged to facilitate adjustment of the amount of inductance required.

In the emergency operating room is all the apparatus necessary for transmission and reception from the transmitting station instead of from the distant operating station. In addition there is here a master switch, under the control of the operator, which automatically operates (1) the safety switch in the transformer room, (2) the receiving aerial isolating switch, (3) the receiving crystal protecting switch, (4) an illuminated sign "Ready to Transmit," situated in the shift engineer's office, and (5) a disconnecting switch in the main earth lead, to unearth the aerial when required for receiving, thus completely avoiding any possibility of damage to the receivers when the aerial is required for transmitting.

The auxiliary plant is, as we have already stated, situated in the annexe. Here are motor generator sets in duplicate, each consisting of a three-phase induction motor directly coupled to a 50 kw., 110 volt, shunt wound, D.C. generator, in connection with which is used an automatic pressure regulator. The blowers are also in duplicate, each set consisting of a positive rotary blower of the out-board bearing type, driven through spur gearing by a motor suitable for 440 volts, three-phase, and 50 frequency. Air is conducted to a reservoir, thence distributed where required. The disc discharger chambers are ventilated by means of exhaust fans, each driven by a three-phase induction motor. Duplicate signalling circuit motor generators are provided, each consisting of a three-phase induction motor running at 1,460 revolutions per minute, directly coupled on either side to a D.C. shunt wound protected type generator. Liquid starters for use in connection with the auxiliary disc motors, are, like the other machinery installed here, supplied in duplicate, to guard against any possible temporary interference of the service.

From the shift engineer's office, which is partitioned off from the annexe, an uninterrupted view is obtained of the machinery hall, main switchboard, and the auxiliary plant.

The small but well-arranged repair shop is capable of dealing with almost any class of repair work likely to be required, and it is equipped with modern power-driven tools.

The latest type condensers are installed, the banks being arranged symmetrically on two floors. The pots are used three in series.



The bus-bars are of copper-sheet, stiffened by Duralumin angle plates. They are supported on standards and separated by means of porcelain insulators. The main bus-bar is extended beyond the condenser banks, and divides immediately over the disc chambers, the ceiling of which is provided with specially insulated glands, through which pass the main connectors conducting the current from the condenser bus-bars to the side discs. Each branch of the main bus-bar is connected up to one transmitter by means of quickly removable change-over links.

The jigger, of the usual independent primary and secondary type, consists of a suitable number of turns of special H.F. cable, wound on insulated frames, which are supported so that their axis lie along the axis of the windings. Provision is made for one of these frames to be easily movable in a line along its axis for the purpose of varying the coupling between the primary and secondary.

The aerial tuning inductances are three in number, and are provided with the necessary tappings for tuning purposes. The aerial is of the directional type, and extends from the building in an easterly direction up the mountain side. It is approximately 3,600 feet long, and averages 500 feet in width. Ten tubular masts support the aerial,

and these are arranged in four rows of three, two, two and three, each row being 900 feet apart. The aerial diverges from the leading-in insulator to a line of rod insulators supported by the triatics between the tops of the first row of three masts, thence to the triatic supported by the other rows in succession, the plane of the wires following roughly the contour of the mountain at a height of just under 400 feet. Even tension is kept in every wire by means of a balance weight, thus minimising the possibility of breakage of wire due to wind pressure.

The earth system is briefly as follows: a ring of metal plates is buried in a circle, with the building as centre. This is connected by means of radial wires with another ring of larger radius. From the outer ring wires are run to the end of the aerial, whilst from the first circles of plates wires are brought overhead to the common earth wire. On two opposite sides of the building are earth terminals, passing through the wall to which the common wire is connected.

There are ten tubular steel masts, each 400 feet in height, the lower half being 3 ft. 6 in. in diameter, and the upper half being 2 ft. 6 in. The lower half is built of quarter sections, or quadrants each 15 feet in length, and the upper half is built of semi-circular sections each ten feet in

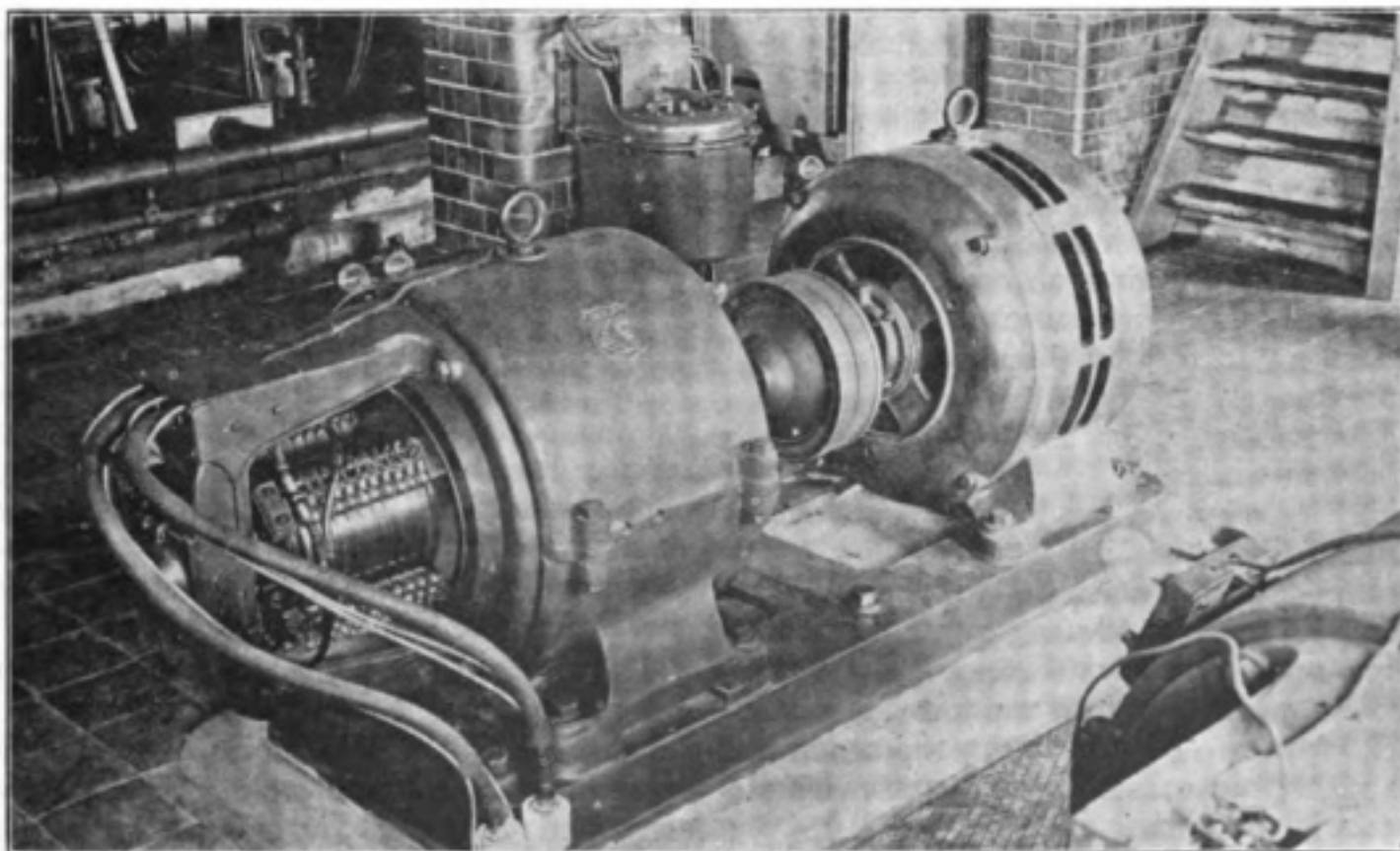

50 kw. Motor Generator Set.



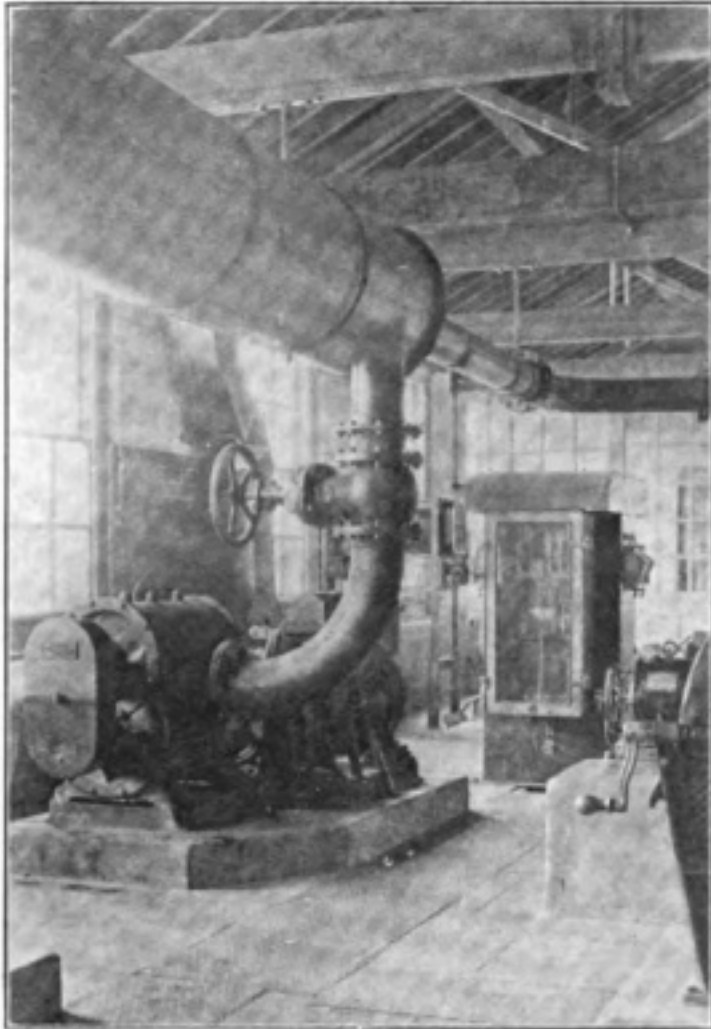

*Rotary Blower, showing Air Reservoir.*

length. All the sections have outside flanges, by means of which they are bolted together. Each mast is provided with a gallery at the top, which can be reached by a ladder running up inside, access to the ladder being by means of a manhole. The triatics are attached to a halyard passing through a block at the top of the mast, and another at the bottom, and are made fast to bollards. A winch with warping drums is placed between each two masts. The foundation plate for each mast stands on a block of concrete measuring approximately 12 feet by 12 feet by 6 feet, and weighing approximately 48 tons.

Four sets of seven stays of 3 inch steel wire rope with solid core are used for each mast. A stay is insulated about every hundred feet of its length. The stay anchors consist of concrete blocks measuring about 12 feet by 12 feet by 12 feet, and weigh approximately 97 tons. The intermediate pairs of masts are provided with back stays in order to lessen the strain on the mast-head caused by the greater length of triatic which they support.

Power is supplied to the station by means

of an overhead transmission line which provides a three-phase supply at 10,000 volts. The power station, belonging to the North Wales Power and Traction Company, is situated at Cwn Dyli, about  $11\frac{1}{2}$  miles distant. The prime movers are high pressure water turbines, the water being obtained from a lake very near Snowdon. There is a transformer station adjacent to the wireless station, where the voltage is reduced from 10,000 to 440 volts, at which pressure it appears on the main switchboard.

At the Towyn station the receiving aerial is supported by five masts, each 300 feet high; these masts are erected on a range of hills at the back of the town, the last mast being about 1,400 feet above sea level. A balancing aerial is also erected carried on 80 feet poles, the purpose of the balancing aerial being to balance out the effect of signals transmitted from the stations at Cefn-du, so that the signals received across the Atlantic are not in any way affected by the signals from the transmitting station at Carnarvon.

The station is equipped with all the latest types of receiving apparatus, and the operating building has been designed to accommodate sufficient operators to deal with a traffic of 100 words per minute duplex. The operators for both stations are all located in the various operating rooms at the Towyn station, as are also the operators for working the land lines.

The signalling switches at the transmitting station are controlled from Towyn, where the punched tape from the Creed instrument is put through a Wheatstone transmitter, which, by means of relays at the Carnarvon station, actuates the signalling switches, making and breaking 300 kw.

The large and continuously increasing volume of traffic with which the Marconi service has had to cope is proof of its popularity. The latest inventions have been introduced to facilitate its rapid disposal, and with a view to eliminating to the greatest extent human agency.

The Marconi Company have opened large new premises at No. 1, Fenchurch Street, London, E.C., which serves as a main telegraph office. The new premises are connected by direct land lines with the Company's offices at Marconi House, Strand,

London, W.C. The public office has a commanding position, facing as it does the banking centre of the world, Lombard Street, and Gracechurch and Fenchurch Streets, the home of shipping and produce. The office is fitted with panelling, doors and counter of Cuban mahogany, the walls above the panelling and the ceiling being covered with lincrusta of rich and elegant design. In the basement are to be found the compressor for the Lamson tubes, and several busy motor generators vie with one another to supply power to mechanism of most recent invention in the operating room. Here also is ample accommodation for the rapidly accumulating and vast records which it is the duty of a telegraph company to keep, according to the provisions of the International Telegraph and Radiotelegraphic Conventions.

To ensure an uninterrupted public service and to provide against the risk of fire, the land lines connected to both the Welsh and Irish stations can be worked either from the office in the Strand, or from the main office in Fenchurch Street.

Let us follow the handling of a telegram from the time of its acceptance at the counter of the telegraph office. Immediately it is handed in it is dispatched by a special tube leading from the public office to the instrument room, where it is trans-

ferred to punchers. The rapid tapping will convince any onlooker that an expert is transferring the message on to the tape. Then it is passed to the man in charge of the Creed transmitter on the next table, which automatically reproduces punched tape at the high-power wireless station at Towyn. There another operator transfers the tape to the wireless transmitter by means of which the dots and dashes are flashed into space and received at the station in New Jersey. Here again expert telegraphists transcribe and hand the messages to the land line system connecting with all the important cities and towns in the United States and Canada. The same operation is repeated when a message is transmitted in the other direction—that is, from the United States to England—the only difference being that in London the signals, by means of the Creed printer, are recorded in letters on tape, which is automatically gummed, and handled by the scrutineer, who separates the tape and affixes it on the Company's forms for delivery to the addressees.

The apparatus being in duplicate, there is, therefore, every assurance of an uninterrupted service, and to ensure the greatest speed the lines are worked duplex.

Messages exchanged between this country and the Dominion of Canada will continue

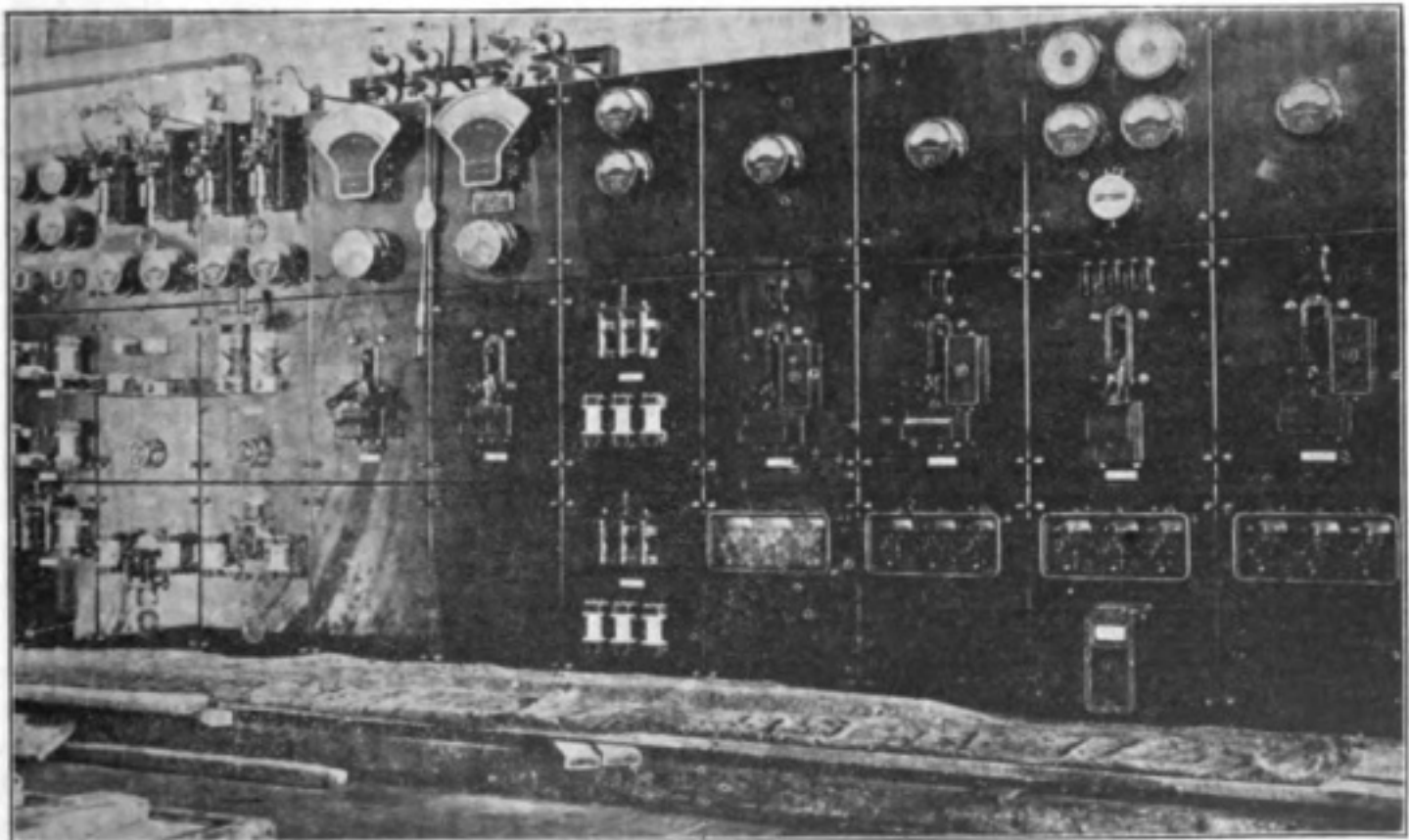

*The Main Switchboard.*



to pass through the Clifden-Glace Bay Wireless Telegraph Service, and the duplicate facilities now arranged enables the Company to deal more effectively with the hundreds of thousands of words entrusted to them for transmission.

All classes of telegrams are dealt with—ordinary plain language, deferred night letters, week-end letters, Press, and shore to ship and ship to shore messages. Cypher is as easily dealt with as plain language, and the rates have been reduced to a level placing telegraphy in the reach of a far wider public, and effecting a saving of about 33½ per cent., as compared with the charges for transmission by other means.

This brief account of the arrangements made to provide an efficient and economical service must convince even the layman that long-distance wireless transmission as well as communication with ships of all nations is becoming more and more interwoven with our daily social and commercial life. It has been and will continue to be a great factor in the lowering of rates as well as a permanent entity in the world of telegraphs.

A public banquet was held at Carnarvon, on May 20th, in honour of Mr. Marconi, who was accompanied by Mrs. Marconi. The Mayor of Carnarvon presided, and he was supported by representatives of Liverpool's shipping industry. The object of the gathering was to celebrate the completion of the new station.

Responding to the toast of his health, Mr. Marconi, who was cordially received, said that wireless telegraphy had made enormous progress in recent years, and he was certain that at the time of his first experiments, nearly twenty years ago, hardly anyone would have dreamt that it would have been possible to utilise it for direct commercial communication between England and America, or between England and South Africa. He remembered perfectly well that when he first started his experiments in England, and it was thought wonderful if he could communicate over a distance of two miles, he received a letter from the Admiralty stating that if ten or fifteen miles could be covered it would be all that was really wanted. Now if for some reason one could not communicate direct to almost any point in the Mediterranean or North Atlantic they were all very much

surprised, and had to admit that there must be something radically wrong either with the apparatus or the persons who were working it. The uses of wireless telegraphy at the present day were many, but he thought that the first practical purpose to which it was put over seventeen years ago still remained the most important. He referred to its use on board ship in safeguarding the lives of those that travel on the sea. The number of ships and shore stations equipped with wireless telegraph apparatus was rapidly increasing, and that such equipment was now considered almost indispensable was shown by the fact that several Governments had passed laws making a wireless telegraph installation compulsory in all ships entering their ports. Many of the results he had been able to obtain had been rendered possible by the work of his predecessors and by the co-operation and help which had been afforded him by his assistants. One of the greatest gratifications of all those who had worked in this fascinating subject was to know that whilst telegraphy through space was facilitating and cheapening our methods of communication with distant parts of the world, it was also diminishing the perils and increasing the comforts of those that go down to the sea in ships.

The following Marconigram was received during the dinner: "To the Chairman, Marconi Dinner, Sportsman Hotel, Carnarvon. The Glace Bay staff, although some 2,000 miles away, wish to join you tonight in honouring their chief, whose work has not only rendered this possible, but is about to link the capitals of the old and new worlds together by a bridge whose foundations rest on the Welsh hills and the Garden of New York.—Signed White."

The *Boletin Oficial* of April 21st publishes a decree authorising the Argentine Post Office to spend 50,000 pesos paper (about £4,400) on the erection of two wireless telegraph stations at Posadas and Puerto Aguirre in the National Territory of misiones.

According to the *Indiaman* wireless telegraphy in India is making satisfactory progress. The wireless station at Peshawar is now in working order, while from Rangoon comes the news that the masts for the station there are being set up, and that the installation of machinery will soon be taken in hand.

# Telemechanical Problems

By L. H. WALTER, M.A.

The following article, written specially for THE WIRELESS WORLD by an author who is well known for his researches in Wireless Telegraphy, deals with a subject which is rapidly coming to the front. The article was written before the publication of the last number of THE WIRELESS WORLD, in which was given the first authoritative account of the great progress in "Distant Control" realised by the Marconi Company. Mr. Walter is also apparently unaware of the work done in this field by Commander Ryan, R.N., of the Marconi Company, who, in 1906 gave several demonstrations of his wireless controlled motor-boat in Portsmouth Harbour, and has since repeated his experiments on the Long Water at Hampton Court and on the the Tidal Water at Heybridge, Essex. The reason why so little publicity has been given to these successful experiments is that it was realised that until the one defect has been overcome there can be no opening of real utility for such appliances in actual warfare. This defect is that, however "selective" the device may be, so far as keeping it out of the control of the enemy is concerned, it cannot prevent that enemy from putting it beyond any control by the simple process known to the wireless operator as "sitting on the key." With such an engine of destruction as a torpedo, the risk of having it liable to "run amok" is too serious to be allowed, and until this defect has been overcome, the wireless torpedo must remain outside the realm of practical utility. The subject, however, is one of considerable fascination, and in the next issue of the WIRELESS WORLD we hope to return to it.—

Ed. W. W.]

FROM the earliest days of Hertzian wave telegraphy the idea of operating or controlling mechanisms from a distance solely by the aid of electric waves has attracted the attention of numerous experimenters, and quite a large amount of work has been done in perfecting the electrical and mechanical arrangements which form no inconsiderable portion of the apparatus required. Nevertheless, although radiotelegraphy itself has advanced, especially of late years, there is but little progress to record in wireless telemechanics beyond the stage already reached in 1906; telemechanics being the term so aptly employed by the French to describe the art of controlling mechanisms in this way.

This condition of suspended animation is probably due to several causes. Thus, although in Germany, for instance, the setting and regulating of clocks—apart from a mere time-signal service—has been effected by wireless means, such an application is now forbidden in France, while in the United Kingdom it is obvious that this and several other possible applications would infringe the monopoly of the Post Office, and are hence not permissible. It follows, then, that wireless telemechanical devices are practically limited in their application—for the present, at all events—to naval or military purposes, such as steering of dirigible torpedoes and boats, the firing of mines, etc. This probably is the chief cause of the neglect above referred to, added to which the greatly increased number

of high-power stations now working has introduced a further complication which has seriously to be reckoned with in connection with the accidental operation of wirelessly-controlled apparatus.

This being the present state of affairs, it is proposed to pass briefly in review the main problems for consideration and the chief types of apparatus which have been designed to meet these conditions, having regard to those devices which have proved successful in practice, and finally to indicate the lines along which, in the writer's view, it would be possible to advance in the direction of the automatic craft of the future.

The term "wireless control," implying, as it does, the idea of actuating, by means of a single receiver, several circuits or devices having different functions to perform, necessarily also implies the use of some selecting arrangement or selector.

The way in which the selection of circuits has been carried out by various inventors has produced a variety of different mechanisms, but the common object is the same in all—namely, (1) To change the position of a switch over from one contact to another particular one. This is the first and chief object of any system of telemechanics. (2) The second object is to secure that even when brought on to the desired contact the local (firing, for instance) circuit shall not be closed at once unless this position has been rendered as a result of the desired sequence of operations. (3) The third object is that there shall be a quick



return to the initial, or receptive state, or rest position; while (4) the final and most important distinctive characteristic which a telemechanical device should possess is, that it should be indifferent to the effects of unauthorised attempts to operate the circuit-closing apparatus by means of either accidental or deliberate interference caused by other radio emissions.

A point is made by some inventors that the controlled object should, in addition to complying with the above requirements, be able to notify the controlling station that the signals are being received and duly executed. Such an addition, however, while helping to increase the expense and also the weight carried, to some extent defeats its own object in these days when the direction from which a signal comes can be quickly determined. The course of the object controlled is quite sufficient to enable one readily to judge whether or not the orders of the controlling station are being carried out, the course at night being made visible by shaded lights.

The first object, the setting of the switch-arm can be effected in various ways. Among the earliest devices we find those of Orling and Braunerhjelm, Jamieson and Trotter, Varicas, and also Tesla, employing a form of rotating commutator or its equivalent. All of these were capable, as arranged, of dealing with a few circuits only, such as three or four—often less. There is no delayed contact, thus (2) is ignored. The need for (3) hardly arises where only two or three circuits have to be passed over before the sequence recurs, while (4) is lacking in all these arrangements. With the exception of Varicas' not one of these schemes appears to have been put into practice.

Varicas' boat carried out in 1901 the simple steering evolutions required, but the apparatus was quite unprepared to cope with any intentional interference.

Coming now to more comprehensive arrangements it is possible to reduce their number by classifying them as falling into either one of two classes of selector systems: (a) those operated by means of a code, or (b) those comprising a rotating contactor and a retarded contact device.

#### WALTER'S SELECTOR SYSTEM.

As an example of codal selectors the system devised by the writer in 1898 may

be taken, not because it is considered the best—for the writer is prepared to admit that in its early form it left something to be desired—but because it is practically the earliest comprehensive method, and also because it has served as a model on which numerous later systems have been founded, such as those due to Chimkevitch, to Hüls-meyer, Branly, and others. The system was worked out as a selecting device suitable for *any* telemechanical, as opposed to telegraphic purpose, although Righi and Dessau in their "Telegraphie ohne Draht" (second edition), and also Mazzotto in his book, describe the writer's arrangement as though it were to be used for selective wireless telegraphy, like the later system of Anders Bull, which has many points of similarity. The original idea involved the use of synchronous rotating discs at the sender and receiver, both released by the act of sending a preliminary signal. One complete revolution of the discs then resulted, if no further signal impulses were received, and the arrangement was then in its initial receptive state. The receiver disc comprises a number of contact studs placed on the periphery of the disc, corresponding to the code signal selected for one circuit; these studs are all connected with a safety device. If during the disc's rotation impulses are received when the contact brush is exactly on one of the studs so connected, the safety device has its circuit closer advanced one step for each such correctly timed impulse, and finally makes an operative contact when the desired evolution (steering, firing, etc.) is carried out. Should, however, any impulses arrive when the brush is not on a codal stud, the safety device flies back to its initial position, thus preventing the actuation of the apparatus by unauthorised or interfering impulses. It is well understood that the transmitter has as many codal discs as there are circuits to be controlled, and there are a corresponding number of safety devices. Special relays are also used for the purpose of stopping an evolution when the next evolution is one which cannot be carried out without conflicting with the first (*e.g.*, "helm to port" and "helm to starboard").

Although apparatus of this type was kept at work in the author's laboratory for several years it has never been fitted on an actual boat owing to the fact that the idea appeared to be before its time, as people at

that date were not inclined to take even wireless telegraphy itself very seriously. Hülsmeier's system, however, which dates from 1906, and is practically identical with that of the writer, was tried in Germany on a practical scale, and is said to have proved satisfactory, although it has not been possible to obtain any further particulars. The much-discussed system due to Prof. Branly is also carried out on almost identical lines; his earlier arrangement of 1906 being later completed, in 1907, by the addition of a safety device like that of the writer.

#### GARDNER'S TORPEDO-CONTROL.

The highly-ingenious system devised by J. Gardner appears to have been the first comprehensive arrangement to be put into operation on a practical scale, and has proved to be one of the most thoroughly reliable methods of controlling vessels by means of wireless impulses.

At the first glance the apparatus, which is based upon an application of Watt's centrifugal governor, appears to be unlike any of the other systems; but on looking at it from the point of view of a selecting system it is clear that the device combines the properties peculiar to both the classes as already defined. The governor, with its hinged balls maintained near the axis by means of a spring, is normally stationary, in which condition the sliding collar on the spindle is in the rest position, and all circuits are open. On impulses being received from a suitable transmitter, a step-by-step mechanism causes the governor spindle to rotate; the governor

balls tend to fly out against the action of the spring, and the collar moves along the spindle, carrying with it a contact brush which is able to pass over a series of contacts connected to the various circuits to be controlled. When the periods of impulses and no impulses are equal the governor maintains a constant speed, and it is thus possible by varying the relative durations of the impulse periods and of the periods of etheric silence to make the contact brush pass on to any required contact and to maintain it there. At the highest speed of rotation the firing contact is made.

One of the chief advantages of this system is that, should anything go wrong, the "off" position is reverted to automatically, and the torpedo comes to rest.

By the kindness of Mr. J. Gardner the writer is able to give a photograph of this interesting dirigible torpedo, which is the only British wirelessly-controlled craft that has stood the strain of actual tests. Although these trials were carried out when there was quite a lot of shipping about, there has never been any mishap, and this the inventor attributes to the simple property possessed by the system of causing the vessel to rest when the impulses cease. The short funnel which will be noticed in the photograph is for the escape of the battery gases; the aerial being supported from a pole which fits in the socket just forward of the funnel.

#### DEVEAUX'S DIRIGIBLE TORPEDO-BOAT.

Turning now to the second class of selector systems, we find that this is represented in



*Fig. 1.—Gardner's Wireless Controlled Boat.*



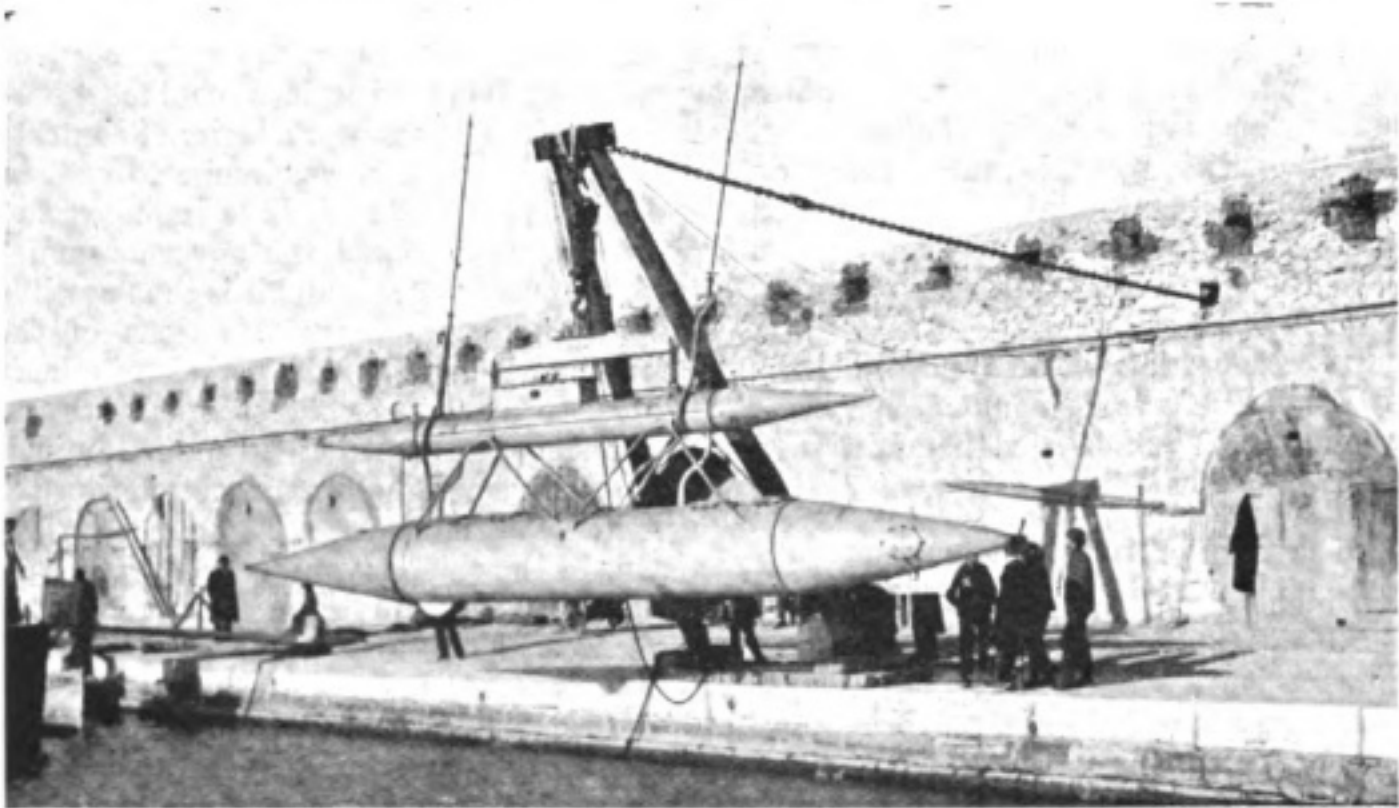

Fig. 2.—Deveaux's Dirigible Torpedo-Boat hoisted out of the water.

the torpedo-boat of Lalande and Deveaux. The method adopted is exceedingly simple, but the boat represents the most ambitious attempt in the history of wirelessly-controlled apparatus. The selector system comprises (1) a circular distributing switch, having on it the studs pertaining to the circuits to be controlled; and (2) a circuit-closer which only allows the current to pass when the distributing switch arm has reached the desired contact stud. In the actual apparatus the distributing switch has twelve studs, of which nine lead to the nine operating circuits employed; the remaining three are distributed among the others and constitute rest positions, with a view to saving the switch arm from having to execute a complete circle each time.

In order to carry out the double function mentioned, an electro-magnet is provided which moves forward by one tooth at each Hertzian impulse a twelve-toothed step-by-step arrangement connected to the distributor arm. During the period when this arm is being advanced, no closing of the operating circuits is possible owing to the circuit-closer being opened by means of a projection on the end of the armature of the electromagnet. Thus, if twelve impulses are received the distributor would describe a complete revolution. On the other hand,

if the impulses cease after the distributor has been carried from a rest stud to one of the operative studs, the circuit-closer will complete that circuit after a brief interval of time, which is caused to elapse owing to the intervention of a retarding device. This latter consists of a train of clockwork which, by virtue of its inertia, does not allow the circuit-closer to operate at once; a delay of twice the time required for the distributor to be moved forward by one tooth has been found sufficient. M. Devaux's paper, which was published in the Bulletin of the *Société Internationale des Electriciens* in 1906, will be found to give full information as to the circuit arrangements, but no illustrations of the boat itself.

By the courtesy of M. Montpellier, the editor of *l'Electricien*, the writer is able to make good this deficiency and to give two photographs of this craft, one showing the vessel when hoisted out of the water, and the other giving a general idea as to its appearance and the visibility of its antenna when afloat; the French cruiser *Saint Louis*, shown in the background, was watching the trials, which took place off the port of Antibes in the early part of 1906.

The boat itself, which weighs 6,700 kg., consists of two cigar-shaped bodies formed of steel plate, one above the other, on the

principle of the Sims-Edison dirigible torpedo. The upper cylinder, 9 metres long by 45 cm. in diameter, acts as a float; it is provided with two small masts, which serve to support the wireless antenna, consisting of five wires kept at a height of about 3 metres; and these masts have lamps, about half-way up, for the purpose of facilitating steering operations. The lower cylinder is 11 metres in length and 1 metre in diameter, and contains the torpedo-ejecting tube and a Whitehead torpedo of 450 mm. diameter; the accumulator battery and the propelling motors are also contained therein. The control apparatus is intended to be placed in the lower cylinder, where it would be protected from the enemy's gunfire by 2 metres of water, but in the trials the apparatus was placed in a sheet metal box on the top of the upper cylinder in order to be available should any adjustments be required. The trials were carried out over a comparatively short radius, 400 to 1,800 metres,

but it is stated that these distances could easily have been exceeded, though to what extent is not said.

The transmitting station from which the boat's evolutions were controlled was on land, and had a five-wire antenna 15 metres in height; but no information is available as to the actual wave-length employed, although, from the size of the receiving antenna, it was probably very short, of the order of 80 to 100 metres.

#### DETECTORS FOR TELEMCHANICAL PURPOSES.

The question of the detector to be employed in connection with a telemchanical system is one of some importance. In the earlier days the coherer was, of course, the only one available, and even later on was the only one suitable for the purpose; it has in fact, given very satisfactory results both on Gardner's and on Devaux's dirigibles, and on other craft where it has been employed.

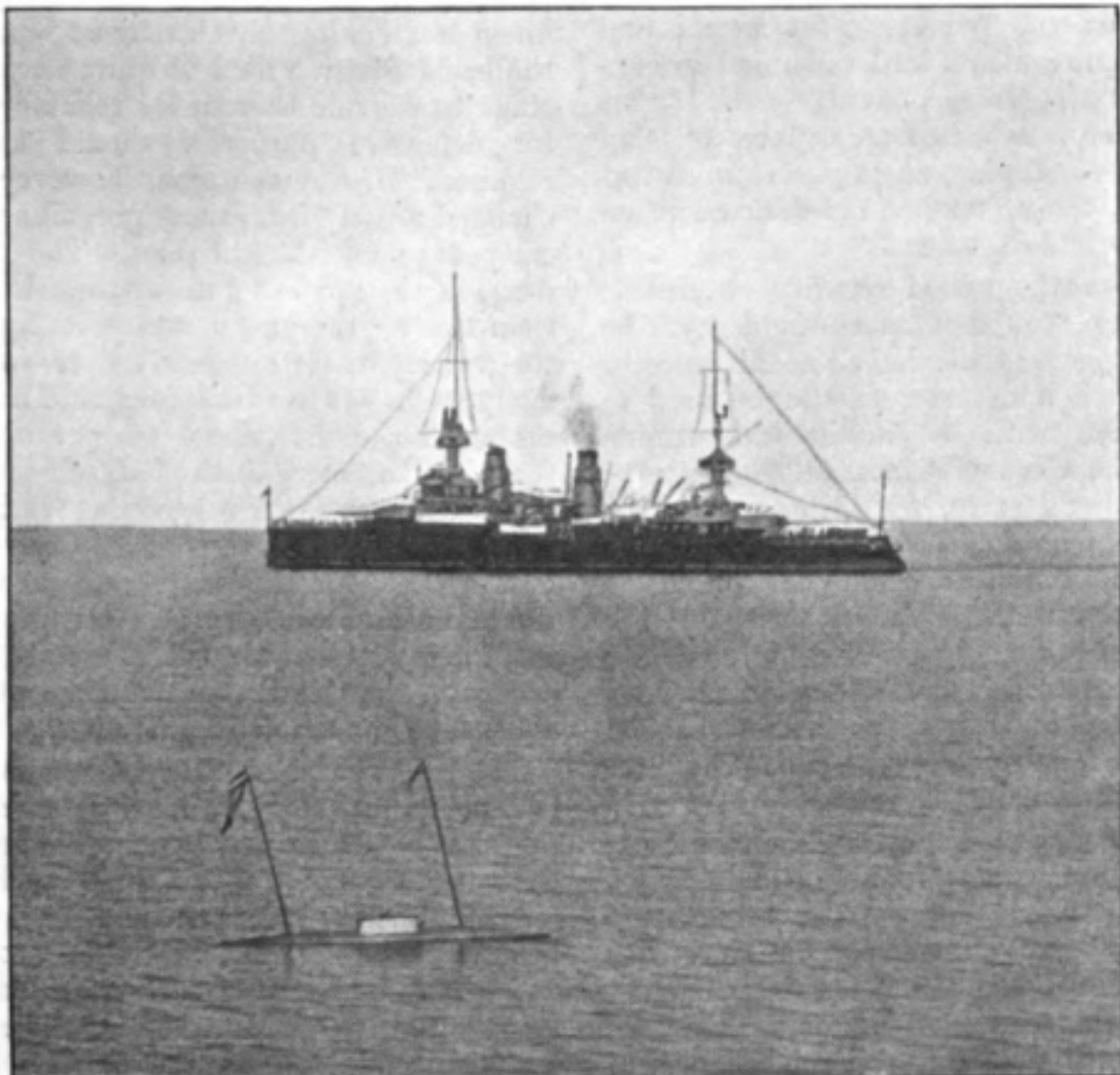

*Fig 3.—Devaux Boat in Foreground.*



Still, at that time the ideas regarding tuning were of rather a primitive and not very exacting nature, and so the fact that the selectivity obtainable when a coherer is used is of a very limited kind did not make itself so evident.

A much higher degree of selectivity is obtainable by the use of mechanical tuning in addition to the electrical. The simplest form of mechanical tuning consists in tuning to the spark-frequency employed, by means of some monotelephone relay, for instance; but in order to take full advantage of this arrangement it is necessary to employ some detector of the constantly responsive type in place of the coherer. Since crystal detectors cannot at present be used for relay working, and are, further, too variable, while the glow-lamp form of detector is unsuitable, unless a complication in the way of a magnifying relay is introduced, the only remaining detector which is suitable is the electrolytic. Now, it is well known that electrolytic detectors show an exceedingly regular behaviour until they get near the stage when the point is past work; and recent improvements in details, and in connection with relays, having proved that such detectors are, in fact, capable of relay operation even when the signals are not at all strong, the writer favours their adoption for telemechanical work.

Owing to the added security obtainable by tuning to the spark-frequency, he would suggest that in a codal selector system such a detector should be used in conjunction with a mechanical tuning device, like Gardner's monotelephone relay or Mercadier's relay, for instance, for the purpose of releasing the codal disc, while the subsequent impulses could be caused to actuate the detector alone, without the mechanical tuning device, or even to actuate a separate detector, independent of the first. The different classes of telemechanical apparatus require, however, somewhat different treatment in this respect.

For the codal selector class the combination just described would probably suffice. With Gardner's arrangement a similar combination would also be advantageous; but since with this system the torpedo, if once actuated by an interfering series of impulses, might be sped up until the firing contact was closed, it would seem desirable to add some further

safeguard, such as the use of two spark-frequencies, for instance: one to be used for the ordinary contacts, and the other to complete an additional safety circuit when the firing circuit is to be brought into operation. This same consideration applies to Deveaux's system, where the retarded contact is the only safeguard against unauthorised operation of the apparatus. Here, however, there would be some difficulty in using several spark-frequencies, and so it would seem that some safety appliance will have to be introduced before the system can be looked upon as being nearly as safe as Gardner's.

A number of other points of interest remain to be discussed, such as the questions of wavelength, of preventing sparking at contact, and the design of relays, but these must be omitted from the present article, which is already exceeding its allotted space.

Summing up: it may be said that, although there is not a large amount of practical experience to draw upon, the results so far obtained when the wireless art was very much less completely developed encourage the belief that it would be quite easy at this stage to provide thoroughly reliable devices for defensive purposes, should they be required. The conditions, however, have changed greatly from those prevailing in the early days of telemechanics. The fighting range of the modern gun is so much greater than that of the gun of ten years ago that the present battle range of a fleet—which is likely to be not less than four, and probably six or even eight miles—has put it out of the power of shore-controlled, self-propelled craft, especially those carrying their own prime mover, to attempt any attack upon a hostile fleet, for the simple reason that it would be impossible to see the torpedo at anything approaching the shorter distance except in the clearest and calmest weather, and hence impossible to guide it.

The only sphere of utility remaining to it lies in its use for harbour defence. For purposes of this nature, as an aid in repelling the attacks of torpedo-boats and submarines, there appears to be a good future before the wirelessly-controlled torpedo, and it is to be hoped that no great time will be allowed to elapse before some such weapon is adopted for the defence of our rather vulnerable ports and harbours.

# Wireless in the Icefields

*Its Aid to Seal Hunters*



"S. S Newfoundland"



Capt. Randell of Bellaventure



Bellaventure arrived in port with dead & survivors of Newfoundland disaster



Landing survivors from Bellaventure



Crowd outside the Seamen's Institute where identification of the bodies was made

*The accompanying illustrations give some idea of the part played by wireless telegraphy in the recent disaster which befell the sealing fleet off Newfoundland. The "Bellaventure," which is fitted with a Marconi installation, was one of the first to receive news of the disaster, and she made valiant efforts to reach the steamer "Newfoundland," whose survivors she found in a pitiable condition. Further aid was summoned by wireless, and although the loss of life was heavy, it is a source of some comfort to remember that it would have been even greater had there been no wireless.*



# Digest of Wireless Literature.

ABSTRACTS OF IMPORTANT ORIGINAL ARTICLES DEALING  
WITH WIRELESS TELEGRAPHY AND COMMUNICATIONS READ  
BEFORE SCIENTIFIC SOCIETIES.

## Horizontal Antennae.—

The experiments of C. A. Culver in the propagation and interception of energy in wireless telegraphy (described in the *Physical Review*) confirm and extend the tests made by Kiebitz and others, and would appear to indicate that horizontal antennae placed very near the earth's surface exhibit efficiencies both as receiving and radiating systems which are comparable with a simple vertical aerial. The data also appear to indicate that when utilising such low horizontal antennae either as absorbing or radiating systems the free end of the aerial should point in the direction of the second station. This appears not to conform to Marconi's law of horizontal antennae, and may be due to local topographical conditions. The fact that energy was intercepted and radiated when both ends of the horizontal systems were grounded seems to indicate that we are dealing in such cases with what Sommerfeld calls a surface wave, as more or less distinct from a space wave.

## Application of Polyphase Currents to Radiotelegraphy.—

To determine to what extent polyphase currents might be utilised for wave production, experiments were carried out upon a high-frequency polyphase generator, and these are described by E. G. Gage in the *Electrical World* of New York. In this polyphase alternator the armature and the field structures revolve in opposite directions, each being driven by a 1 h.p. series-wound motor directly connected to the shaft and capable of running at from 3,000 to 3,500 r.p.m. The armature is a laminated unit having laminations 0.02 in. in thickness. The machine can deliver alternating currents at 6,000 cycles, either single-phase, two-phase or three-phase, arranged to deliver either 9,000 cycles or 18,000 cycles single-phase current, though

the power obtainable at 18,000 cycles is very small. The arrangement described by Mr. Gage is hardly a true three-phase system, as known in alternating current practice, since the phases are individually connected to their separate transformers. It is simply three single-phase quenched-spark sets, each operating at 6,000 cycles and so arranged that the discharges take place in regular rotation, producing a resultant of 36,000 sparks per second at the maximum speed of the alternator. In the first tests of the apparatus, which were made in 1912 and 1913, an artificial antenna was used for very long wave-lengths. For working at higher wave frequencies a real antenna of 0.001 microfarad capacity and 4 ohms apparent resistance at the working wave-length, or 1,050 metres, consisting of an inverted L 100 ft. high and having a single vertical lead, was utilised. Using a wave meter calibrated to 15,000 metres maximum wave-length, with a rectifier as receiver, 8,000 sparks per second on one phase produced an antenna current of 0.6 amp., with a clear, piercing note, there being no sign of partial discharges. Adding the second phase, the note corresponding to 16,000 sparks could be heard, but although each phase taken separately produced an apparently absolutely clear note, when they were run together a faint hissing entered into the tone given by the receiving telephone. Upon cutting in the third phase the antenna current increased to 1.5 amp., all sense of musical pitch became lost, and the hissing slightly increased. The hissing sound was much smaller in amplitude than that of the musical tone. In fact, the hiss was hardly distinguishable and could not be heard when the musical note was present. The reason for this is probably that an absolutely clear note was not obtained on each phase, and that the weak partials existing in it became prominent when the musical tone

was increased in pitch to a point above the upper limit of audibility. Interesting results were secured in the measurement of decrement of the resultant wave, with all three phases in operation. This quantity was evaluated both with and without interrupters in the antenna circuit, and identical results were had in both cases. It was found impossible to obtain for the resultant wave as small a decrement as that of any phase taken separately. The importance of this observation would seem to be that the value of polyphase currents used according to this method is not great for obtaining *undamped* oscillations. If the decrement can be kept reasonably small (say 0.1 per period, as in an actual case), there remain other advantages, such as (1) comparatively low potentials in all circuits; (2) a constantly excited antenna circuit which is well adapted for the use of the sensitive heterodyne receiver; (3) flexibility, in that by use of an interrupter any audible note may be produced if it is desired to telegraph by the usual group frequency method; (4) sufficiently persistent excitation to permit wireless telephony, and (5) the possible use of the tikker receiver. No special long-distance tests were made, but single-phase signals of 8,000 group frequency were heard by several stations over 15 miles away and were reported as very clear and readable. The same stations (which used rectifying detectors) were unable to hear the 16,000 or 24,000 group frequency unless an interrupter was inserted in the antenna circuit. Both these latter group frequencies were heard very loudly when received by a small testing station located on the same grounds as the transmitting station and employing a tikker. It was found that placing an interrupter in the transmitting antenna circuit to produce audible groups of waves gives no advantage in so far as loudness of signals is concerned. The apparatus used did not seem to produce an entirely clear musical note, perhaps because in this instance accumulations of oxide in the rotating commutator interfered with its regular action. In sustained wave practice there would seem to be no reason for its use, since the tikker may be advantageously employed, and when it is desired to use rectifiers as receivers a better way to render the signals audible would be to operate at a lower group

frequency by running each phase on a lower octave.

**Wave Propagation —**

In the *Physikalische Zeitschrift*, G. Lutze gives an account of wireless signals from Norddeich-Eiffel Tower observed in free balloons at heights up to 6100 m. It was found that the Eiffel Tower signals fell to one-eighth of their loudness in ascending from 1,050 to 5,500 m., Paris being 9° below the horizon at the latter height. The Norddeich signals fell to about half their intensity. The loudness was determined by the shunted telephone method. The experiments prove the existence of Sommerfeld's surface waves. The large decrease in the strength of space waves from Eiffel Tower is accounted for by the fact that the station is intercepted by the horizon. Measurements of the influence of the distance between the stations upon the loudness show a decrement intermediate between the value for wet and the value for dry ground.

**Working Microphones in Parallel.—**

Dr. W. H. Eccles describes in the *Electrician* a method of R. Goldschmidt which enables microphones to be worked in parallel. As it is impossible to make two microphones which will remain perfectly alike electrically, it has hitherto been necessary to use microphones in series. The present invention, it is claimed, overcomes the difficulty for a pair of microphones by putting in series with each microphone a coil so wound that the surging of the compensating currents which always arises through unequal operation of the instruments is prevented by the mutual inductive action of the coils. Fig. 1 shows the arrangement:  $M_1$ ,  $M_2$  are

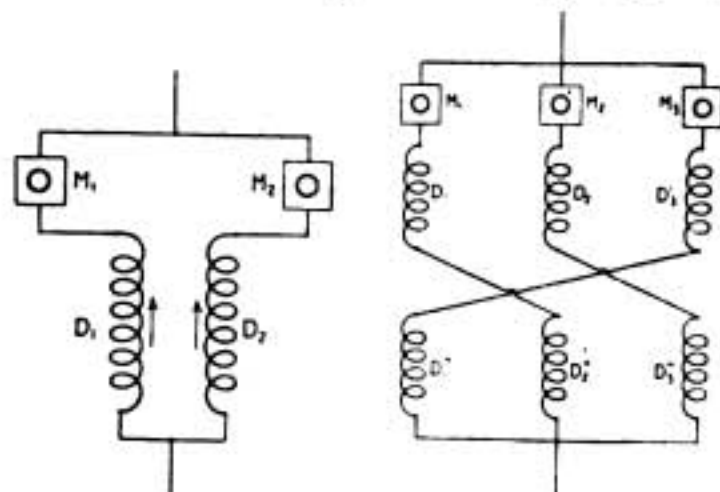

Fig. 1.

Fig. 2.

C



the microphones, and  $D_1$ ,  $D_2$  are coils wound oppositely on a common core. Equal currents down the coils cancel each other's magnetic field, but a circulating current would build up a field and therefore experiences a great choking effect. When more than two microphones are to be connected in parallel they may be caused to work uniformly by pairing them and applying the above method. But a more advantageous arrangement is that shown in Fig. 2, where coils  $D'_1$  and  $D''_1$  act on each other, and the remaining coils are paired similarly. Still another method is given in the specification. A coil in series with each microphone acts on one and the same secondary current. If the microphones operate unequally, the presence of the secondary tends to choke the circulating current; if they operate equably, the secondary current tends to neutralise the self-inductance of the coils. The method promises to be of importance in radiotelephony.

#### Electromagnetic Waves.—

H. Barkhausen publishes in the *Elektrotechnische Zeitschrift* the results of his experiments on the propagation of electromagnetic waves. The comparison of these results and theory shows complete agreement as long as the distance between transmitting and receiving stations is short, so that the curvature of the earth need not be taken into consideration. For long distances the propagation of the waves seems to take place by two entirely different methods. First, normally the refraction of the waves which can be calculated from theory brings only a weak wave to the receiver and the amount transmitted is smaller the shorter the wave-length. Wave transmission during the day occurs in this way. Secondly, irregularities in the atmosphere may produce reflections in the air so that a much larger amount of wave energy comes to the receiver, and this amount is independent of the wave-length.

#### Transformation of Frequency of A.C.—

H. Rukop and J. Zenneck give, in the *Physikalische Zeitschrift*, the results of their investigation and the latter's arrangement wherein he uses a condenser circuit across the alternating current arc to obtain a current of three times the frequency of the arc current. The influence of the atmo-

sphere surrounding the arc, of arc length, of the strength of the main current, and the capacity in the oscillation circuit is investigated. The best results are obtained with an arc sealed into a vessel originally containing air. When the original frequency is 4,000 per sec. an efficiency of 49 per cent is reached, and with a frequency of 8,000 per sec. an efficiency of 41 per cent.

#### Cathodic Detectors.—

The Holweck valve, which is described in the *Revue Electrique*, is based on the emission of negative electrons from incandescent bodies. The Wehnelt cathode is used in place of the usual lamp filament, and it has a surface of emission ten times larger than that of filaments formerly employed for this purpose, and it is covered with a special oxide. Instead of making the distance between the anode and cathode greater than 4 mm. or 5 mm., it is reduced in the present apparatus to 0.1 mm. This is claimed to ensure so intense an electronic emission that it is practically impossible for the valve to get out of order. Fig. 3 shows the connection

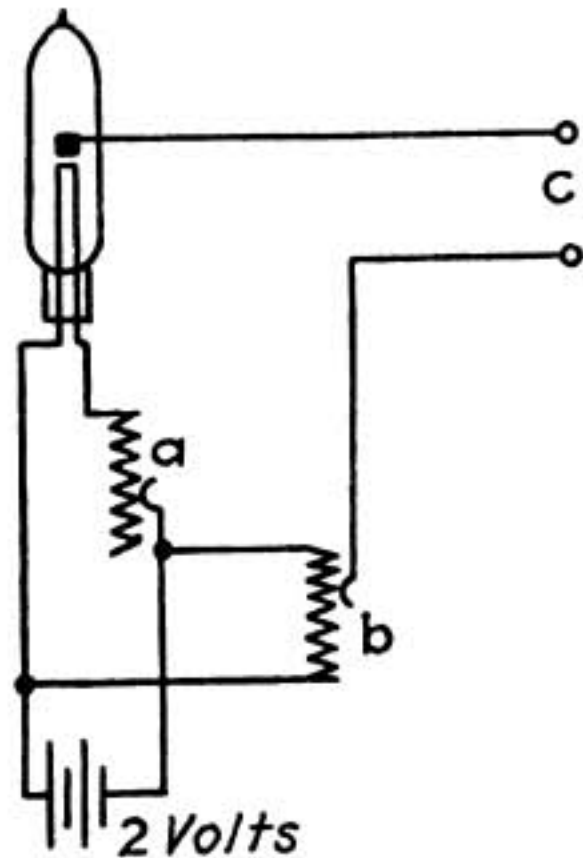

Fig. 3.

of the Holweck valve;  $a$  is the heating rheostat,  $b$  is the slide wire potentiometer, and  $c$  the receiver. It is necessary to be able to regulate the temperature of the cathode and to introduce an additional E.M.F. in series with the anode.

# The Albert Medal

## *Royal Society of Arts Award to Mr. Marconi*

IT will be a source of satisfaction to many to learn that the Royal Society of Arts have awarded Commendatore G. Marconi the Albert Medal for this year. It is a fitting tribute to the great inventor, who can most certainly lay claim to "distinguished merit in promoting commerce," one of the requisite qualifications for the conferment of this distinction.

The Albert Medal was founded in 1864, to commemorate that high-born philosopher and patriot, the late Prince Consort, who himself was the protagonist of the great artistic and industrial renaissance for which the late eighteenth and the early nineteenth centuries will be famous.

The first recipient of the medal was Sir Rowland Hill, who received it in recognition

such as no age has hitherto experienced. For instance, in 1866, it was awarded to Michael Faraday, a name too well known to require commentary. Next year it was awarded to Sir W. Fothergill Cooke and Professor Charles Whetstone in recognition of their work in establishing the first electric telegraph. Lord Kelvin received the honour in 1879 for "special signal service in the transmission of telegraph messages over ocean cables." In 1892 it was awarded Thomas Edison for "his improvements in telegraph, telephone, electric lighting, and his discovery of a means of reproducing vocal sounds by the phonograph." In 1896 to Professor Hughes for "numerous inventions in electricity and magnetism, especially the printing telegraph and the microphone."



"of his creation of the penny postage and of his other reforms in the postal system of this country, the benefits of which have, however, not been confined to this country but have extended over the civilised world."

Each succeeding year has added a distinguished name to the list of those whom the Society has delighted to honour in this way. The list is far too long to make individual mention of every holder of the medal. Nevertheless, there are certain names which must always be of interest to students of the new science, in that they are forerunners who have done their part, and a noble part it has been, in the promotion of world-wide intercommunication

To Sir William Crookes in 1899 for "laborious researches in chemistry and physics." The following year, to Henry Wilde for the "discovery and practical demonstration of the indefinite increase of the magnetism and electric forces from quantities infinitely small"—a discovery now used in all dynamo machines. In 1902 to Professor Bell "for his invention of the telephone." In 1910 to Madame Curie for "the discovery of radium." Last year it was awarded to His Majesty King George, "in respectful recognition of His Majesty's untiring efforts to promote the progress of the arts, manufactures and commerce in the United Kingdom and throughout the British Empire."



# Coupling

By J. St. Vincent Pletts.

THE coupling of two circuits is always defined as the ratio of the mutual inductance to the geometric mean of the separate self inductances of the circuits. This is only natural, as the definition has been derived from the consideration of two circuits between which the coupling is assumed to be purely inductive, though this is probably never absolutely true in practice, even when there is no metallic connection between the circuits. A glance at Fig. 1, where there is no mutual inductance, is however sufficient to show that this definition can only apply to a particular case, and that, whenever there is any capacity common to the two circuits, a broader definition is required.

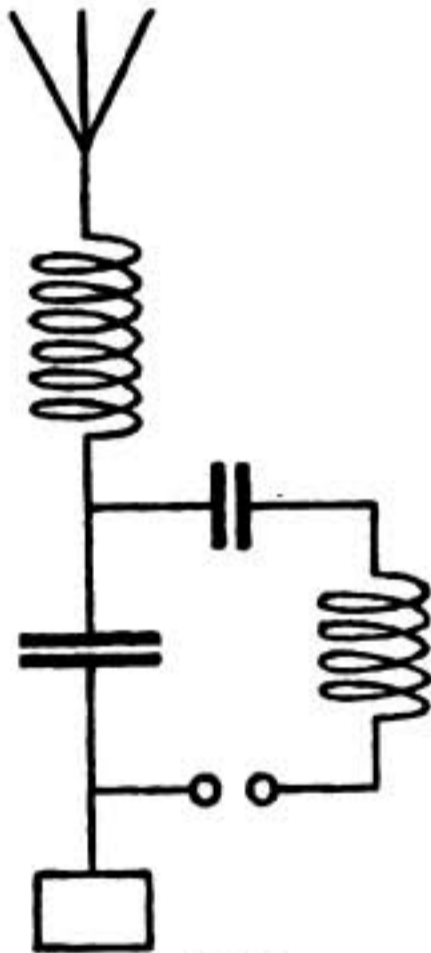

Fig. 1.

If a wireless engineer had to experimentally determine the coupling of the circuits shown in Fig. 1, he would have no hesitation in measuring the two wavelengths produced, and in giving the coupling as the ratio of the difference to the sum of their squares. It is evident too, upon consideration of the pulsating waves produced, that he would be perfectly right, because this gives the recognised measure of the rate of transference of energy between the circuits. We may therefore safely take

this as our definition of coupling, which we must now determine in terms of the constants of the circuits.

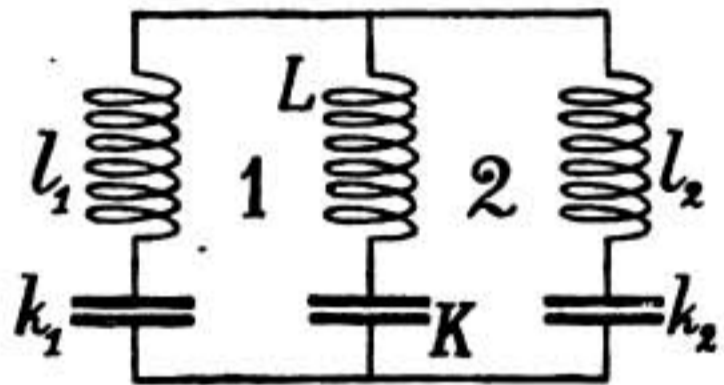

Fig. 2.

The general case of coupling is shown in Fig. 2, where the two circuits 1 and 2 have an inductance  $L$  and capacity  $K$  in common, as well as independent inductances  $l_1$  and  $l_2$ , and independent capacities  $k_1$  and  $k_2$ , respectively.  $L$  is of course the mutual inductance, and we may by analogy call  $K$  the mutual capacity. Moreover we shall greatly simplify the resulting equations if we carry this analogy between the inductances and capacities much further, and call the whole capacity in either circuit its self capacity, just as we call the whole inductance its self-inductance. We shall then have:—

$$\begin{aligned} L_1 &= L + l_1 \\ L_2 &= L + l_2 \\ K_1 &= \frac{Kk_1}{K + k_1} \\ \text{and } K_2 &= \frac{Kk_2}{K + k_2} \end{aligned}$$

and it should be noted that neither of the self inductances can ever be less than the mutual inductance, and neither of the self capacities can ever be greater than the mutual capacity

If  $c_1$  and  $c_2$  be the currents in the circuits 1 and 2 respectively, we can now (assuming the resistances to be negligible) write down

the two simultaneous differential equations :—

$$\left( LD^2 + \frac{1}{K} \right) c_2 + \left( L_1 D^2 + \frac{1}{K_1} \right) c_1 = 0$$

$$\left( LD^2 + \frac{1}{K} \right) c_1 + \left( L_2 D^2 + \frac{1}{K_2} \right) c_2 = 0$$

and, by eliminating  $c_2$  and rearranging, we get :—

$$\left\{ (L_1 L_2 - L^2) D^4 + \left( \frac{L_1}{K_2} + \frac{L_2}{K_1} - \frac{2L}{K} \right) D^2 + \left( \frac{1}{K_1 K_2} - \frac{1}{K^2} \right) \right\} c_1 = 0$$

If now we assume that the two circuits are in tune, so that :—

$$p = \frac{1}{\sqrt{L_1 K_1}} = \frac{1}{\sqrt{L_2 K_2}}$$

then, dividing by  $L_1 L_2$ , and putting :—

$$m = \frac{L}{\sqrt{L_1 L_2}}$$

we obtain :—

$$\left\{ (1 - m^2) D^4 + 2 \left( p^2 - \frac{m^2}{LK} \right) D^2 + \left( p^4 - \frac{m^2}{L^2 K^2} \right) \right\} c_1 = 0$$

Calling the three coefficients  $\alpha$ ,  $\beta$  and  $\gamma$ , and putting :—

$$c_1 = e^{qt}$$

the four values of  $q$  are given by the roots of the equation :—

$$\alpha q^4 + 2\beta q^2 + \gamma = 0$$

so that :—

$$q = \pm i \sqrt{\frac{\beta \pm \sqrt{\beta^2 - \alpha\gamma}}{\alpha}}$$

and :—

$$c_1 = A \sin q_1 t + B \sin q_2 t.$$

Now our definition of coupling is :—

$$k = \frac{\lambda_1^2 - \lambda_2^2}{\lambda_1^2 + \lambda_2^2}$$

and since the frequencies are inversely proportional to the wave-lengths, this can be put in the form :—

$$\begin{aligned} k &= \frac{q_2^2 - q_1^2}{q_2^2 + q_1^2} \\ &= \frac{\sqrt{\beta^2 - \alpha\gamma}}{\beta} \\ &= \pm \frac{m \left( p^2 - \frac{1}{LK} \right)}{p^2 - \frac{m^2}{LK}} \end{aligned}$$

$$\begin{aligned} &= \pm \frac{m \left( \frac{mK}{\sqrt{K_1 K_2}} - 1 \right)}{\frac{mK}{\sqrt{K_1 K_2}} - m^2} \\ &= \pm \frac{m - s}{1 - ms} \end{aligned}$$

where :—

$$s = \frac{\sqrt{K_1 K_2}}{K}$$

From this we see that when  $K$  is infinite and we have only electromagnetic coupling,  $k = m$ ; while when  $L$  is zero, and we have only electrostatic coupling, as in Fig. 1,  $k = s$ . Thus the ordinary definition of coupling really gives the coefficient of electromagnetic coupling, and the coefficient of electrostatic coupling may be defined as the ratio of the geometric mean of the self capacities to the mutual capacity.

Consideration of the above expression for the coupling, and more particularly of the curves derived from it, led me to the conclusion that it was incomplete, and Mr. Kindersley, whose insight into these matters is unique, was able to point out the cause. The case shown in Fig. 2 is not quite general, and the most general case of coupling is that shown in Fig. 3 when the inductances  $L_1$  and

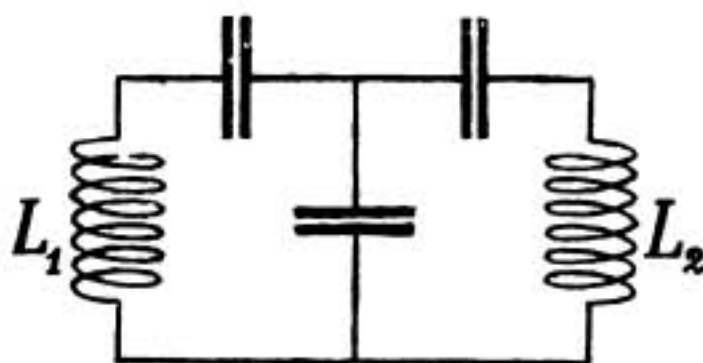

Fig. 3.

$L_2$  are placed within one another's field, for not only does this produce mutual inductance between the circuits, but it enables the effect of this mutual inductance to be reversed without reversing the effect of the mutual capacity. Therefore, while in the case shown in Fig. 2 the two effects must always oppose each other, it is possible in the case shown in Fig. 3 for them to help each other, so that the complete expression for the coupling must evidently be :—

$$k = \pm \frac{m \pm s}{1 \pm ms}$$

The relation between these three is well



shown by Fig. 4, in which  $k$ ,  $m$ , and  $s$  may be allotted indiscriminately to the ordinates, abscissæ and parameters of the family of curves. If  $k$  be allotted to the ordinates

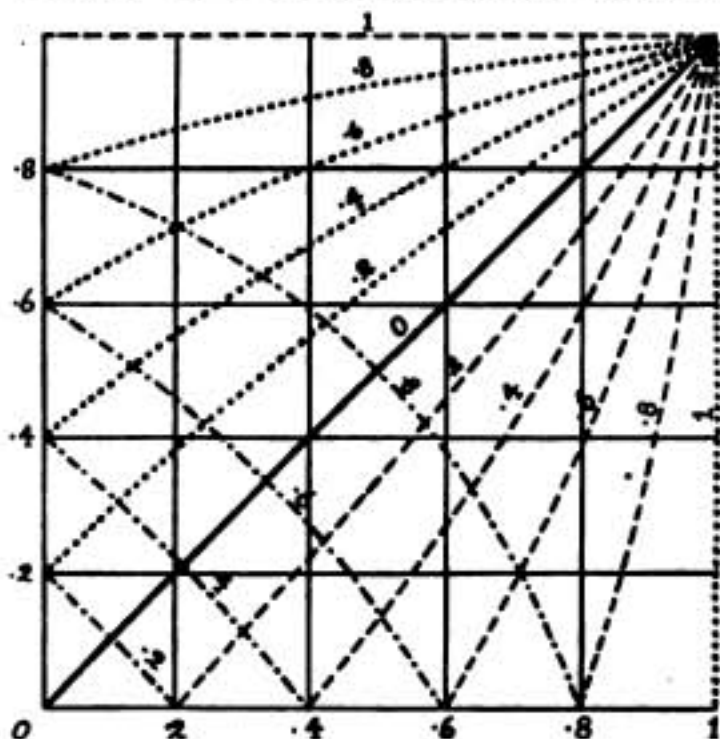

Fig. 4.

the dotted lines, if to the abscissæ the dashed lines, and if to the parameters the dotted and dashed lines, only exist when the effects of the mutual inductance and mutual capacity are assisting each other, and vanish altogether in the case shown in Fig. 2.

Some interesting conclusions may be drawn from the above. We have already seen that if either  $m$  or  $s$  be zero, the other is equal to  $k$ . We also see that if any one of the three variables be unity, another must also be unity, whatever the value of the third. That is to say that if either the electromagnetic or electrostatic coupling be absolutely tight, the combined coupling is also absolutely tight, even if the other is quite loose. Conversely, if neither of the component couplings be absolutely tight, no combination can produce an absolutely tight combined coupling. Again, except when the two component couplings are assisting each other, the combined coupling will be zero whenever:—

$$m = s$$

that is, whenever:—

$$p = \frac{1}{\sqrt{LK}}$$

or whenever the natural period of the common part by itself is equal to that of the separate circuits.

## COMMUNICATIONS

### Horizontal Aerials

To the Editor of THE WIRELESS WORLD.

SIR,—The article which you published in your May number gives me the opportunity to make the following remarks.

The directional effect of bent antenna can no longer be considered as a fact which has been universally proved. Frequent observations have been made recently which dispute this directional effect. Mr. Marconi, for instance, stated some time ago that the station at Glace Bay could be heard in a southern direction at a distance of 6,000 kilometres, although in that direction its signals should be at minimum strength. Further it is stated that the station at Nauen, near Berlin, can communicate with the station at Sayville, in North America; and yet Nauen possesses a bent antenna, which, according to the assumption hitherto accepted, should have an absolute minimum in the direction of Sayville.

As I have pointed out in the reports of investigations carried out over a number of years on behalf of the German Imperial Telegraph Testing Office, a directional effect of horizontal antenna cannot be proved universally. The measurements of radio-telegraphic receiving intensities are subject to grave errors, and if the observations are extended over a long period no regular direction difference is found. The question will only be solved when the objective measurements of the receiving intensities are more sensitive and more exact than they are at present.

I have studied especially such simple horizontal antenna as have no distinctly vertical parts, but which were carried, like telegraphic lines, close to the earth, and which I have termed "earth antenna" in contrast to the elevated aerial conductors. This type certainly does not possess any directional difference greater than the accuracy of measurement. In one case only could I determine lateral minima with these antenna—namely, when they were excited with oscillations which were quicker than the fundamental oscillation of the antenna.

This case is easy to explain if it is considered that there is a node of voltage on

the conductor which divides the whole antenna into two parts carrying opposite charge. The whole antenna then acts as a pair of antenna, the directional effect of which has been investigated; this pair of antenna, however, is not symmetrical. As to the results of the theoretical investigations on the subject, especially those of H. Sommerfeld, I have the following remarks to make:

Very complicated assumptions about the influence of the earth are necessary if a directional effect is to be admitted. We do not know whether these assumptions are correct, as there is not sufficient knowledge of the conductive values of the earth for high-frequency alternating currents. At any rate it is improbable that these complicated qualities of the ground exist under all circumstances. As demanded by theory, and according to my experience, the conditions are probably realised when a system of wires which is buried in the direction opposite the antenna is used as earth, while the ground underneath the antenna is dry. Unhomogeneous surroundings of a station (open sea on the one side and land on the other) naturally must cause differences in the direction. These differences, however, appear with every form and shape of aerial; they are no particular property of the antenna with which they happened to be observed.

The bent antenna and the purely horizontal antenna, however, have one excellent property which makes them especially suitable for high-power stations. For large sending capacity they can be insulated with comparative ease. They should be used for this much more important property than for their directive property, which certainly does not exist to the extent formerly assumed.—Yours, etc.,

F. KIEBITZ.

Berlin.

*To the Editor of THE WIRELESS WORLD.*

SIR,—The instances mentioned by Dr. Kiebitz in which the directional effect appears to him to be non-existent are both over very long distances.

It is reasonable to expect that when the expansion of a wave has carried it into the

semi-conducting and wave-dissipating region in the upper atmosphere, and the whole of the top of the wave has been cut off in consequence, the want of symmetry has been lessened and the directive effect decreased. There is also a flow in the wave itself influenced by its own want of symmetry and by the ground over which it travels which can account for some lessening of the directive effect with distance. But that it is only lessened and not done away with altogether is shown by some fairly recent tests made between the Glace Bay and Clifden stations. It was found that very much stronger signals were obtained on a system of receiving aerials pointing away from Clifden than on a similar system pointing towards Clifden. There is ample reliable evidence that a suitable bent aerial causes the wave to possess considerable directive effect over short distance and over moderately long distance.

Some of Mr. Marconi's original tests communicated to the Royal Society in 1906 were carried out between Poldhu and Clifden a distance of 500 kilometres. In that paper a case is mentioned in which the ratio of maximum to minimum received current measured by Duddell thermo-ammeter was as much as 4 : 1, a difference of strength too great to be explained by instrumental errors. Dr. Fleming in the same year published careful confirmatory tests made over a short distance which gave a ratio  $2\frac{1}{2}$  : 1.

The existence of a directional effect is undoubted, but bent aerials are not used to-day for the only reason that they possess this property. It is mainly a quality which requires to be remembered and made use of when selecting a site and laying out the aerial.—Yours, etc.,

H. M. DOWSETT.

Chelmsford.

### "Aerials and their Radiation Wave Forms."

Owing to pressure upon our space we have been obliged to hold over until next month the fourth of the series of articles by Mr. H. M. Dowsett on "Aerials and their Radiation Wave-forms." Previous articles appeared in the April, May and June numbers of THE WIRELESS WORLD.



# The ENGINEERS Note Book



[Under this heading we propose to publish each month communications from our readers dealing with general engineering matters of various kinds in their application to wireless telegraphy, and we would welcome criticisms, remarks and questions relating to the matter published under this heading. We do not hold ourselves responsible for the opinions and statements of our contributors.]

## The Micrometer Screw Gauge and Thickness Gauge.

By M. V. R.

THESE two instruments although well known and used by engine makers, appear to be known, but very little used by engineers in charge of the erection of plant. For instance, in the case of a bearing, a man will say it should be just a nice working fit—i.e., no definite allowance is stated. What this nice working fit should be would, of course, be well-known to an experienced fitter. In a first-class engine makers' shop it would be got at by allowing, say  $5/1000$  in. difference in diameter between the shaft and the bearing in which it is running. It is not always easy to judge if a bearing has sufficient play. Take the case of the big end bearing in a small high speed oil engine, with the crank chamber totally enclosed. There is not much room to work in, and the bearing will probably have to be taken down several times before a good fit is obtained; also it is difficult to tell what kind of a fit is obtained until the engine is started up, because in turning the shaft by hand there is the piston to move up and down in the cylinder and the friction due to all the other bearings.

Although these differences between shaft and bearing are comparatively small, they are quite easily measured by means of the micrometer screw gauge. The reason these small distances are not oftener measured is probably due to the fact that engineers imagine these measurements are only made possible by the means of expensive instruments in the hands of highly skilled men. As a matter of fact, providing a man can use a micrometer gauge, he is just as well

able to tell whether a certain distance is  $5/1000$  in. or  $6/1000$  in. as he is able to tell whether another certain distance is 5 in. or 6 in., and the actual measurement can be made just as quickly.

To take the case of the bearing mentioned above. Supposing a difference of  $5/1000$  in. is required between the diameter of the shaft and the diameter of the bearing. This can be ascertained in the following manner: The bearing is taken down and a piece of soft lead wire laid lengthwise along the crank pin, the bearing is now bolted up again tight, this will flatten out the lead wire, and will give the difference in diameter between the crank pin and the bearing.

The thickness of the flattened out lead wire can be measured by means of the micrometer gauge. If it happens to be, say,  $8/1000$  in., then one knows that the bearing requires  $3/1000$  in. taking off. The use of the micrometer gauge is perhaps better shown up in the case of a main shaft bearing of a large oil engine. Supposing the bearing has had to be renewed. It is very difficult to tell the state of a bearing in large engines by merely barring round, and once the engine is started up it cannot be turned round slowly as is the case with the steam engine. The oil engine will be up to normal speed in a few seconds, and the bearing or shaft damaged if sufficient play has not been given to the bearing.

In using the lead wire it is worth noting that it should be laid along the top or the bottom of the shaft, as the slides are often eased off a little. Also in the case of white metal bearings the wire is liable to be pressed into the white metal liner if the bearing is bolted up too tight. There is no doubt that an experienced man would make quite

a good job of a bearing without taking the above measurements, but he would probably take more time. So the method has the advantages that it does not require an experienced fitter, and less time would be required to get an engine running. Although the above method is a good guide as to the play to be left in a bearing, it does not mean that these measurements be made and an engine boxed up and put on full load without paying any more attention to the bearing. It will require watching just the same as any other newly fitted piece of machinery. The play or slackness in a bearing is usually termed its "allowance." A few useful allowances are given below for various types and sizes of bearings.

TABLE OF ALLOWANCES FOR VARIOUS SIZES OF BEARINGS.

HORIZONTAL BEARINGS.	
Diameter of Shaft.	Allowance.
1 in. to 3 in.	.. 1/1,000 in. to 2/1,000 in.
3 in. to 5 in.	.. 2/1,000 in. to 4/1,000 in.
5 in. to 12 in.	.. 4/1,000 in. to 6/1,000 in.

For cross head pins and gudgeon pins, a fair allowance is, for pins from 1 in. to 4 in.,  $4/1000$  in.

In the bearing mentioned above it was found that it was necessary to take off  $3/1000$  in., in order to bring the allowance down to  $5/1000$  in. This can be measured in the following manner:—

On each edge of one half of the bearing a part about one inch long is filed away, so on turning the brass over on to a surface plate a thickness gauge of  $3/1000$  in. will just enter, the two edges are then filed down level to the part that has been gauged in the usual way, with the surface plate smeared with red lead.

In the case of a bearing with a solid bush it is not so easy to give the allowance—at least not with the ordinary sized micrometer gauge. The best method is to caliper the bush and the pin or shaft and then try a thickness gauge between the two calipers.

The chief use of the thickness gauge is in giving the correct clearances to various moving parts.

In all types of internal combustion engines clearance has to be given between the various tappets and valve spindles.

Take the case of a petrol engine; a man

who is well acquainted with this type of engine will suggest that the clearance between the exhaust valve spindle and the tappet which operates it should be very small—say, the thickness of a postcard. Postcards may vary in thickness from  $5/1000$  in. to  $20/1000$  in.

As the power of the engine depends partly on the exhaust valve opening and closing at the right instant this clearance should only be the amount that the valve spindle lengthens when the engine warms up, plus a small allowance to prevent friction between the roller on the tappet and the cam which operates the valve.

A difference of, say,  $5/1000$  in. in the lift of an exhaust valve would not at first sight appear to have any effect on the power of an engine. But if one considers that the engine is running at (in the case of a petrol engine) 1,500 revolutions per minute and that the engine is doing work on the exhaust gases due to the exhaust valve not lifting as soon as it should, and also in closing too early and not getting rid of all the exhaust gases, then the  $5/1000$  in. becomes quite important.

These clearances are given in the following manner:—

A thickness gauge, with gauges varying from  $3/1000$  in. to  $25/1000$  in. is required. One with the gauges going up by  $1/1000$  in. is the best, as you have not to put two or three gauges together to make up, say,  $17/1000$  in.

The shaft is turned round until the exhaust valve is down on its seating and a further movement of the shaft does not give any further movement of the tappet. The clearance is then found by inserting a thickness gauge between the tappet roller and the cam which operates the valve. The gauge should be tried in two or three positions as the shaft is turned round until just before the valve begins to lift. From the above it will be seen that it is more important to have just the correct clearance in high speed internal combustion engines than in those running at a slower speed. As the petrol engine has usually a fairly short valve spindle the clearance here can be made very small; also as most of the spindle is on the outside of the engine it does not get very hot and hence does not expand to a very great extent.





## NOTES OF THE MONTH

ONE of the most interesting applications of wireless is that by means of which the position of the ship may be located in foggy weather. The apparatus is known as the Wireless Direction Finder, which, in its original form, was invented by Bellini and Tosi, and is now being manufactured and fitted by the Marconi Company. It has been in service for many months in the R.M.S. *Eskimo* sailing between Hull and Christiania. One of the latest vessels to be fitted with this apparatus is the R.M.S. *Royal George*, which carried it for the first time when she sailed from Avonmouth on June 17th. This well-known Canadian liner should now be able to find her position even in the thickest weather and without the aid of compass or sextant, when she is within a radius of 50 miles of a fixed wireless station or one on board a ship whose position is known.

\* \* \*

In the opinion of Mr. L. B. Foley, the Superintendent of Telegraph, of the Delaware, Lackawanna, and Western Railroad, wireless telegraphy has now a definite place in the railway world. Mr. Foley is well qualified to speak upon this subject, as the application of wireless has been tried with excellent results upon the railway with which he is connected, and any opinion expressed by so prominent an official is at least entitled to respect. He read a paper before the annual meeting of the Association of Railway Telegraph Superintendents in New Orleans last month, in the course of which he gave an account of the system employed on the Lackawanna Railroad, where five wireless stations have already been established, as follows: Hoboken (W B U, 2,100 metres wave-length); Dover (W B X, 1,000 metres wave-length); Scranton (W P T, 1,620

metres wave-length); Binghamton (W B T, 1,620 metres wave-length); Limited Train, (W H T, 1,000 metres wave-length). A 5-kw. station is being erected at Buffalo, and when this is completed it will give a wireless service between Hoboken and Buffalo.

According to Mr. Foley, the Company's experience with wireless telegraphy during the few months that they have had it in operation has been invaluable in many ways, and they have decided to extend the service over the entire system. At first he regarded the wireless service as an admirable auxiliary to the ordinary telegraphs, but the devastating storms of March 1st and 2nd, which destroyed all other means of communication and left the company entirely dependent upon the wireless service has convinced him that the latter is not merely an auxiliary, "it is a valuable substitute." Mr. Foley concluded an interesting address by recalling some of the advantages of the service to the railway companies, from which we quote the following conclusions:

Communication by wireless telegraph to and from stations and moving trains is no longer an uncertainty. There are many fields for the wireless telegraph in railroad train operation. It will not be necessary to increase the number of trainmen, as a trainman can easily learn the telegraph alphabet, or a telegrapher can be utilised to operate the wireless, also performing the duties of a trainman. Later it may be found necessary and profitable to install a telegrapher on limited trains running long distances without stopping, to handle commercial telegrams for the public. Telegraph offices on trains, in the future, may be of as much value to the public as branch offices in hotels or other places where large numbers

of people congregate. With direct communication the train dispatchers can keep in touch with the conductor of a train; in fact, the wireless permits the dispatcher to board every train. The Lackawanna Company has used the wireless for handling train orders and finds it as accurate and reliable as the telegraph or telephone in transmitting these orders. The total loss of means of communication between stations, caused by prostration of poles and wires, is a thing of the past.

\* \* \*

A remarkable number of fires at sea have occurred within a year or so. Is this a mere coincidence, or is it due to the fact that wireless messages now make us immediately aware of the fate of a burning ship? The agonising thought arises that in the past many ships that were merely written up at Lloyd's as "missing" may have burned to the water's edge and all on board lost because help was beyond call. We know that the crew of at least one burning ship would have been lost and the exact cause of the calamity would have remained a mystery but for the appeals sent over the seas by the Marconi instrument, which summoned passing steamers to the aid of the survivors. The *Columbian's* crew would probably have met such a fate but for the merciful Marconigram, brief though it was. Inevitably a request is now made for equipping the boats of a ship with a small wireless outfit similar to that described in last month's WIRELESS WORLD. A small boat holding a shipwrecked company is a helpless thing on the ocean, difficult to perceive from a distant steamer, hopeless at night, and in a rough sea unseeable even in daylight. As was explained by a witness before the Departmental Committee, a wireless outfit could easily be stowed in an ordinary ship's boat.

\* \* \*

The application of wireless telegraphy to the collection and distribution of information regarding the weather has received a further extension by the steps just taken by the Governor-General of Madagascar to warn mariners by means of wireless of the approach of cyclones. A service of wireless storm warnings has been organised by way of trial on the eastern, north-western, and western coasts of Madagascar. The telegram of alarm emanating from the observa-

tory at Tananarivo will be issued during the whole duration of the probable passage of the cyclonic disturbance in the zone of action of the stations at every even hour (except between midnight and 6 a.m.) alternatively by the stations at Mayotte and of Majunga in case of a cyclone affecting the north-western part of the island or on the Channel of Mozambique, and alternatively by the stations of Mayotte and of Diego in case of a cyclone affecting the north-eastern and eastern parts of the island. The telegram of alarm will be preceded and followed by the warning — — — . . . — — — repeated at short intervals; this signal has been specially reserved for this purpose and, should occasion arise, will indicate in itself, for want of more precise details, that there is a reason to fear the passage of a cyclone. The masters of vessels at sea, provided with wireless telegraphic installations, will be able to signal directly to the radio-telegraphic stations of the Colony of Madagascar any disturbance of cyclonic appearance which they may encounter, in order to extend as much as possible the range of this service of warning signals.

\* \* \*

We are probably nearer than many people imagine to the time when the expression "ordering by wireless" will be as common among the sea-going community as is the expression "mail orders" among land lubbers. Trans-ocean travellers appreciate to an increasing extent the convenience of dispatching through the wireless telegraph office on board the ocean liner instructions to the hotel, the garage, the tailor, the theatre, and to the hundred and one tradesmen who cater for the travelling public, so that on arrival in port delay is reduced to a minimum. An example theatre booking by wireless telegraphy which has been brought to our notice will serve to illustrate our remarks. Early last month the manager of the Queen's Theatre was surprised to receive a prepaid marconigram from a party of Americans on the *Olympic*, then in mid-ocean, asking whether seats for the performance at that theatre were available for Monday evening, June 8th. By arrangement with various libraries four boxes and ten stalls were secured, and an answer to this effect was dispatched to the *Olympic*. A reply came: "O.K. We shall be there"



## Some Odd Rescues

TO the many uses of wireless telegraphy there seem to be literally no limits. Within the past few weeks two stories have been told of how it has been the means in a somewhat remarkable manner of saving life. Of course, this is nothing new. In the history of Mr. Marconi's invention life has been saved more than once on a large scale from the perils of the deep by wireless telegraphy; but the most recent instances are so out of the common as to be worthy of special mention.

On her arrival at Liverpool recently the ss. *Orduna* brought the news of how a doctor prescribed for a patient at a distance of upwards of a hundred miles away. Just before the *Orduna* entered the Straits of Magellan a message was received from the British steamer *Brodstone*, stating that the master of the latter was ill, and requesting the surgeon of the *Orduna* to prescribe for him. The symptoms were carefully detailed and considered by the doctor, who then sent a message to the master of the *Brodstone* directing him what treatment he was to adopt. Thanks to this advice, the master was able to navigate the *Brodstone* through the Straits of Magellan; and that he appreciated the doctor's services may readily be inferred from the fact that, when both vessels arrived at Punta Arenas, he sent his thanks and a fee to the surgeon of the *Orduna*. Never, we venture to say, has a fee for professional services rendered been paid in such unique circumstances.

\* \* \* \* \*

The other story comes from the Allan liner *Victorian*, which also arrived at Liverpool recently. On May 13th the *Victorian*, when about 120 miles from Anticosti, received from the island an urgent appeal for medical help. The *Victorian* immediately headed in the direction of Anticosti—a small island situated in the Gulf of St. Lawrence—to find on arrival that Mr. William Peak, one of the three wireless operators employed at the Heath Point Station on the island, had, as a result of a shooting expedition, received very severe injuries,

and was lying in a critical condition far from medical assistance.

The Heath Point station is closed during the winter months, and when the accident occurred the operators had only been at the station about a week. Mr. Peak, and the other operator who was not on watch, were out duck shooting and had sighted a flock of ducks, and had their guns cocked ready to shoot. The birds, however, passed out of range, and Mr. Peak put his gun aside, but his companion probably forgot to do so, for a moment later the gun of the latter went off. Mr. Peak was standing within a yard of his friend, and the shot went through his left cheek, shattered the roof of his mouth, and passed out at his right eye. He was unconscious when placed on board the ss. *Victorian*, and did not rally till some twenty-four hours later. The operators at the station were naturally greatly distressed at the accident, especially as they had no hope of obtaining medical aid, until they obtained communication with the Allan liner.

How the *Victorian* came to the island and sent a boat for the injured man, how he was taken aboard, and, thanks to the service of the ship's doctor and good nursing at the Northern Hospital, Liverpool, was brought back to comparative health, is another thrilling story of the greatest of the modern wonders of the world.

### Wireless Operators Complimented by Lord Mersey.

The Marconi operators on the *Empress of Ireland* gave their evidence before the Commission of Inquiry on June 19th. The report of their evidence is not yet available in this country, but the following was included in the Press accounts telegraphed from Canada:

"Ronald Ferguson, chief Marconi operator of the *Empress of Ireland*, and his assistant, Edward Bamford, were called after the luncheon interval. They told the story of the night from their point of view in clear-cut phrases. When they had finished Lord Mersey said: 'You spoke well, you young gentlemen. You are a credit to the service you are in.'"

# The Tragedy of the *Empress*

WITHIN the last month the world has been appalled by tidings of a disaster at sea. There is no need to write up the details here. Only too dramatic is this simple statement, that the *Empress of Ireland* came into collision with the *Storstad* on May 29th last, and of the 1,500 souls aboard 1,023 were lost. It is a harvest too terrible to think upon, and we are forced to take the meagre source of comfort that remains to us in the fact that even the 500 saved might have perished with their companions had it not been that one of the greatest of human discoveries gave its help to the helpless and sent out the warning cry which brought rescuers swiftly on the scene.

In order to thoroughly appreciate the part played by wireless telegraphy in the work of rescue it is well to recapitulate the main incidents of the disaster. On May 29th the *Empress of Ireland* was in the vicinity of Father Point, in the St. Lawrence River; a thick sea-fog enveloped her so that she was forced to go dead slow. Shortly before the fog had descended she had sighted a vessel, about three miles away, approaching her. Suddenly, without a moment's warning, the bows of the on-coming ship (which eventually turned out to be the Norwegian collier *Storstad*) loomed out of the fog, and

collision was unavoidable, the bows of the *Storstad* striking the *Empress of Ireland* amidships. The unfortunate vessel was ripped up aft to the propeller, and it was plain that she was doomed. Immediately the operator sent out the wireless call for help. It was picked up by the Marconi station at Father Point, and without delay the Government steamers *Eureka* at Father Point Wharf and the *Lady Evelyn* at the Rimouski Wharf were notified of what had occurred.

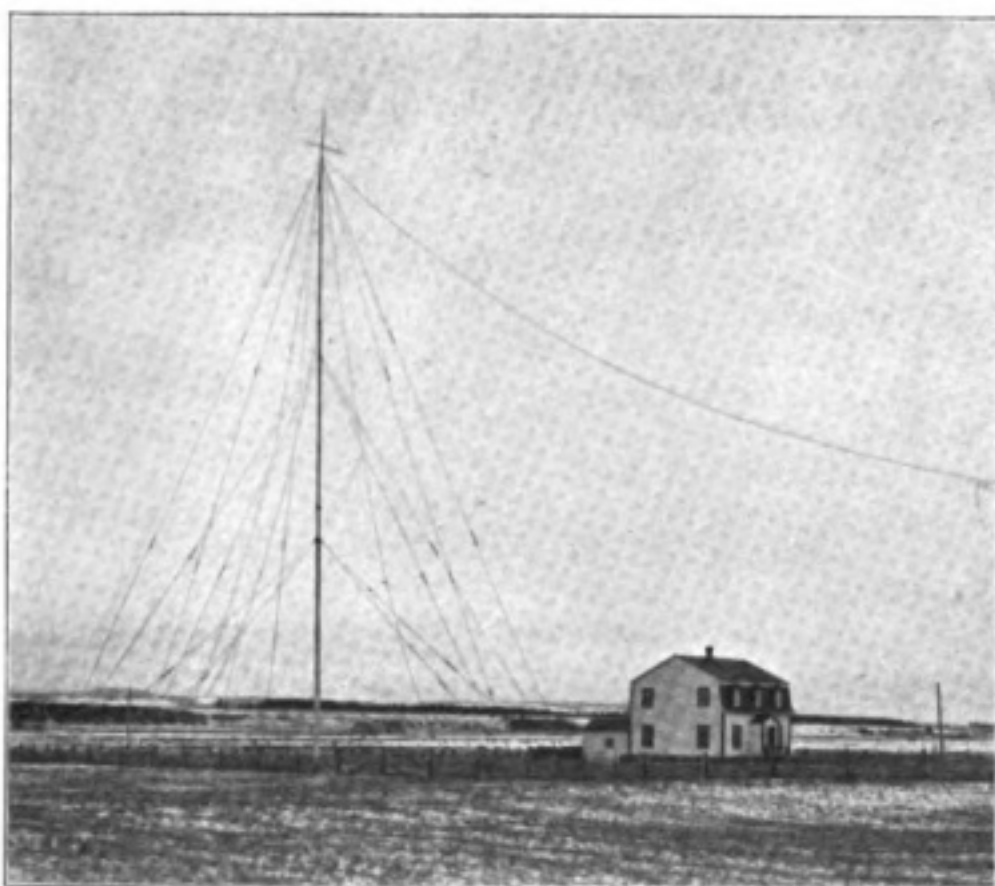

Father Point Wireless Telegraph Station, where the first news of the tragedy was received.

By this time the sun was rising, so that the *Eureka* was able to make all haste to the relief of the damaged vessels. She was followed by the *Lady Evelyn*. The rescue ships found that their worst fears had been realised, and they were only able to pick up a remnant of the

*Empress of Ireland's* passengers. These they found in terrible plight, for the temperature was only four degrees above freezing point. But willing hands brought the sufferers aboard, and everything that kindness suggested or that the emergency would permit was done for their relief. It was not a long journey—some twenty miles—to Rimouski, and the four hundred of the saved reached that port within a very short time.

In England the news of the disaster





Mr. R. Ferguson (left) and Mr. Bamford (right) the wireless operators on the "Empress of Ireland"

created a profound sensation, and early the offices of the Canadian Pacific Railway, both in Liverpool and London, were besieged with anxious inquirers. The wireless station at Father Point did invaluable service by transmitting messages and was largely responsible for the publication of accurate statements. The first account of the calamity received in London by the Marconi Transatlantic Wireless Telegraph Service created a profound sensation and left no doubt that a disaster of great magnitude had occurred. This message was one of the most concise and accurate of the early accounts. It ran: "*Empress of Ireland* rammed by Norwegian steamer *Storstad* off Father Point 1.45 a.m. and sank in ten minutes. Steamships *Eureka*, *Lady Evelyn* went to assistance. *Empress* took list and unable to get most boats out. About one thousand lives lost. Captain, both operators, both assistant pursers, chief engineer, chief steward, and about 350 others saved. Chief officer and purser missing. Will advise any further news."

Later there followed a fuller report from Mr. Whiteside, officer in charge at Father Point.

At 1.45 this morning I was awakened by operator Leslie, who reported that the *Empress* was struck by another boat. I rushed to the instruments and asked him for present position so that I could send Government steamers *Eureka* and *Lady Evelyn* to her assistance. She replied,

"Am about twenty miles from Rimouski." Then her signals trailed right off. I knew I had heard the last of the *Empress of Ireland*. I immediately got the captain of the *Lady Evelyn* and the captain of the *Eureka* on the telephone, told them the circumstances, and asked them to leave for the scene at once. The *Eureka*, a Government pilot boat, had just put a pilot on a steamer, and had at that moment tied up at the wharf, so that the captain got right away and was first on the scene of disaster. The *Lady Evelyn* was a little farther away, but followed closely. From the time of the *Lady Evelyn's* arrival on the scene until she tied up again at Rimouski Wharf we were kept busy at Father Point wireless station clearing traffic from the survivors.

The chief Marconi operator, Ferguson, on board the *Empress* was able to give a full and vivid report:

The first intimation of anything having happened was when the whistle commenced blowing at approximately 1.45 a.m. (American time). Mr. Bamford, the junior operator, had relieved me ten minutes previously, and when the vessel struck I came into the operating-room and took over the phones from him, telling him to stand by for distress signals. Between the time of the collision and the time the dynamos went out of commission we had only eight minutes. My cabin was on the top deck. Immediately after the shock I saw lights passing, ran to the wireless-room, and called the stations, "Stand by for distress signal; have struck something." The chief officer said, "Call SOS," so I sent out the message "SOS, have struck something, sinking fast, send help."

The station at Father Point replied immediately asking where we were. I replied, "Twenty miles past Rimouski." I was trying to confirm this answer at the request of Father Point, when the power was cut off. The water had got into the stokehold, cut off the steam, and put the dynamos out of commission. Before the apparatus became useless I got from Father Point a message, "OK, sending *Eureka*, *Lady Evelyn* your assistance." Mr. Bamford had in the mean-

time brought me some clothes, and when I had dressed I ran out along the deck shouting, "Plenty of assistance is coming, and a ship will be here in less than an hour." I then returned to my cabin and was preparing to work on the emergency gear, but just then the ship gave a fearful lurch, causing the accumulators to burst open the doors of the cupboard and scatter the contents over the floor of the cabin. As it was impossible to do any more, I went out on the deck and picked up a deck chair, and just as I had put my arm through it I was thrown into the water. When Mr. Bamford was thrown out of the ship he landed safely in a floating boat. After swimming about a quarter of an hour I managed to scramble into a lifeboat, from which I was able to reach the *Storstad*. When the *Lady Evelyn* came alongside I jumped aboard her and gained an entry into her wireless cabin by means of the window. I used her gear to establish communication with Father Point station, to which I communicated all the details of the disaster that I had knowledge of, and asked for clothes and supplies and a train to be sent to Rimouski Wharf. When Mr. Bamford reached the *Storstad* he took out one of her boats and rendered what assistance he could. He then boarded the *Eureka* with those whom he had rescued, and these were landed at Rimouski. The bows of the *Storstad* are terribly torn, and are striking evidence of the force with which she struck the *Empress of Ireland*.

Most interesting too is the same officer's summing-up of the part played by wireless telegraphy in the work of rescue, for, coming as it does from an eye-witness and at the same time one who is more particularly acquainted with the ship's management, it can be taken as authoritative:—

*I do not think it has been realised what part the wireless played in the affair. I was only able to work for eight minutes, but without that the only boats which would have been available for the passengers would have been those on the starboard side of the Empress of Ireland, and it is not likely that more than 40 or 50 would have been saved.*

### Wireless Surgery

**A** LABOURER on Swan Island in the Gulf of Mexico recently had his foot crushed in a tramcar accident. A surgical operation was necessary, but there was no surgeon. But if it had not a surgeon the island had a wireless telegraph station in charge of an operator gifted with sufficient resource to cope with such an emergency. He sent out an appeal far and wide, which was answered by the Ward liner *Esperanza*, over four hundred miles away.

He explained his case. "Could the ship's doctor help?" The captain and the doctor held a consultation. It would be a pity for the ship to turn from her course, yet the loss of life must be averted if possible. Then it was that a happy inspiration occurred to the doctor. He volunteered to deal with the case by wireless. "Sparks" on board was quickly at work asking the shore station for details of the case. Then, message by message, the doctor directed the way to deaden the pain, the amputation of the foot, each stroke of the knife, the binding of the arteries to prevent loss of blood, the washing of the wound with antiseptics, etc. When the operation was over he kept in touch, by wireless relay from ship to ship, with his patient until there was no longer any fear of blood poisoning setting in.



*The C.G.S. Lady Grey arriving at Quebec with 209 dead bodies picked up from the "Empress of Ireland."*



# Maritime Wireless Telegraphy

THE opening of Canadian navigation this year will see several of the lake boats carrying wireless for the first time, many of the ships of the Canada Steamship Lines having been so equipped since the Dominion Government legislated last year that passenger boats on the Great Lakes must install wireless apparatus. The *Cascapedia*, which is now travelling on the North Shore route between Quebec and Natashquan, is one of the best-known boats to have been so equipped. Others are the *Chicora*, *Chippewa*, *Corona*, and *Cayuga*, the four big steamers which ply between Toronto and Hamilton; the *Dalhousie City* and *Garden City*, plying between Niagara and St. Catharines; the iron ore boats, *Kingston* and *Toronto* and the *Macassa*, which ply between Toronto and Kingston. The six boats of the Canadian Pacific lake fleet are also equipped with wireless, as are several salvage tugs and the *Nuronic*, *Hamonic*, *Huronic*, and *Saronic* of the Northern Navigation Company's fleet. Besides the owners, shippers, and passengers being protected by these boats carrying wireless, a greatly improved service of wireless reports will be given concerning the movements of ships this year through the Marconi Wireless stations on the lakes. In addition to the stations at Port Arthur, Sault Ste. Marie, Tobermory, and Midland, the Marconi Company have, since the closing of navigations last fall, completed the construction of stations at Sarnia, Burwell Toronto, and Kingston, so that a close watch may now be kept on the boats from the time they leave the head of the Great Lakes until they reach Montreal.

\* \* \*

England is proud of her new transatlantic liner, the *Aquitania*, and the Cunard Company particularly so, for she is the largest British liner in commission, and yet has achieved a record for speed on her maiden voyage to New York.

Her measurements are 901 feet long and 97 feet broad, with a gross tonnage of some 57,000 tons. In every way she is a masterpiece of design and equipment. Her engines

are of immense power, and, indeed, the engine room is a masterpiece in itself. As regards appearances, although so bulky, she is by no means uncomely, for her architecture has been designed with due regard to proportions, with the result that her gigantic size is scarcely apparent, and this increases the sense of homeliness and comfort for her passengers. The main dining saloon is about 150 feet long by 100 feet broad, and can seat 600 people at a time. Two higher decks are entirely given over to passenger accommodation, and contain numbers of self-contained suites. Wooden bedsteads in almost every cabin replace the traditional ship's berths. The main public rooms are concentrated on the A deck, the highest of all except the boat deck. The drawing-room forward is followed, on the other side of the main staircase, by the lounge, a big room in Georgian style, the decks on each side for a length of nearly 150 feet being formed into a garden lounge with wicker chairs and ivy-clad walls.

As regards safety provisions, the *Aquitania* is well supplied. She has eighty-four watertight compartments in addition to the forty-one in the double bottom, and the watertight doors in the bulkheads are closed by hydraulic pressure. For a great part of her length the ship has a double skin, the longitudinal bulkheads being 18 feet from the outer skin. Eighty large boats are provided, which are capable of holding everyone on board, and the most modern appliances for launching them from the vessel have been adopted. Furthermore, there are two motor boats which have been added with a view to towing the lifeboats should occasion arise. Both are supplied with wireless telegraphy equipment, and we doubt not but that this innovation will be readily recognised as a most important one and likely to prove of immense advantage should the mother ship find herself in difficulties or meet with damage (which we hope not).

This wireless equipment is of an exceptionally powerful type, and designed to provide a minimum working range by day of 650 miles, over open water, when employed with

an aerial having a mean height of 130 feet. By night its capacity will be increased to twice this distance.

The transmitting apparatus is arranged to work on wave-lengths of 300 to 1,200 metres, the normal wave-length being 600, while the receiving apparatus is arranged for the reception of all wave-lengths from 100 to 4,000 metres. The aerial consists of four parallel wires, evenly spaced on ash suspenders, hanging between two masts. The earth connections are of special design, of insulated copper, and are connected to convenient points on the hull of the ship. The generating plant consists of a continuous current motor, designed to run off the ship's mains at 220 volts and to furnish the mechanical power to drive a direct-coupled

arranged in such a manner as to enable the transformer to supply energy at the voltage suitable for use with the wireless apparatus designed for transmitting on the wave-lengths specified above. In conjunction with the transformer, low-frequency inductances of special design are furnished for insertion in the transformer primary circuit, to enable its being brought into resonance with the alternator frequency, a condition necessary for the production of a tuned spark of a distinctive note and of good quality.

The condenser battery consists of four independent zinc sheet condensers with an additional unit for aerial tuning.

The number of studs on the disc discharger provides for transmission on a musical spark of twice the alternator frequency

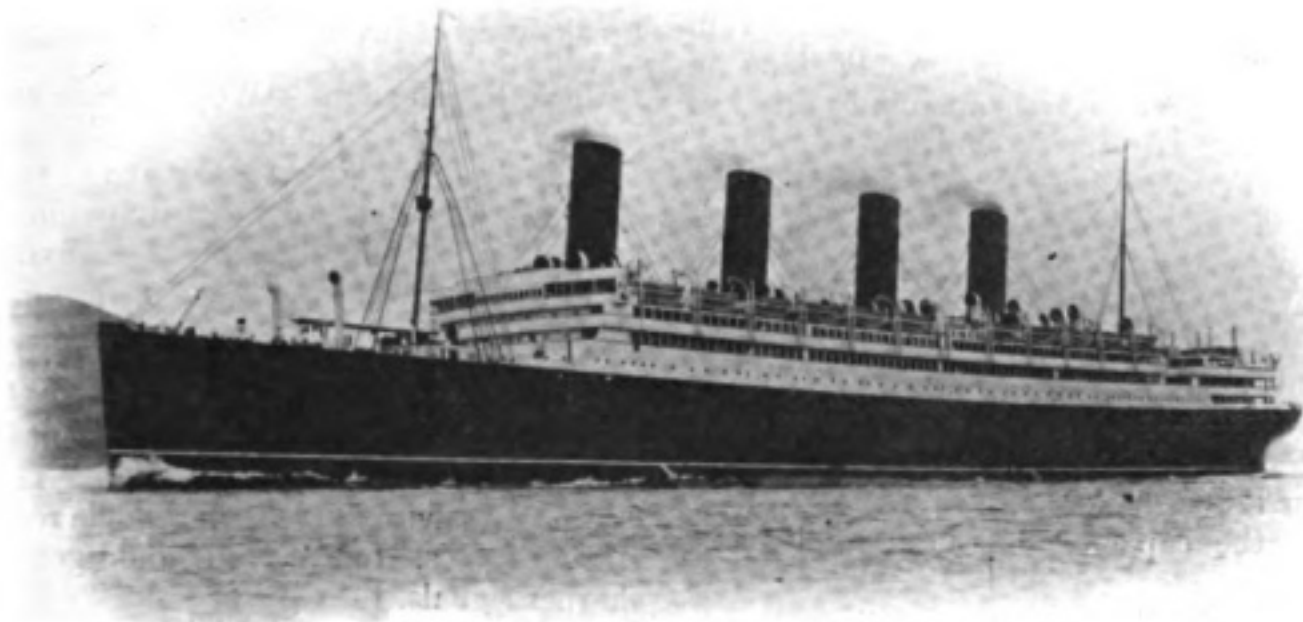

*The New Cunarder: R.M.S. "Aquitania."*

single-phase generator on signalling load, together with a disc discharger mounted on an extension of the alternator shaft. The motor alternator set is provided with an automatic starting reostat fitted with no-volt release, and with field regulating resistances for both the motor and alternator excitation circuits. The windings of the machines are protected against injurious induced effects from the high-frequency circuit by means of suitable resistance shunts in the form of carbon sticks or straight filament lamps. The switchboard is of the enamelled slate type divided up into panels and furnished with all the latest type of instruments and switchgear.

The transformer is of the 5 K.V.A. type. The pressure at the primary windings is 500 volts and the secondary windings are

—that is, 600 sparks per second when the alternator is running at normal speed. Two separate receivers are furnished. One is of the magnetic receiver type and works in conjunction with the Marconi Multiple tuner, so that the combination is capable of syntonising the receiving circuit to all waves between 100 and 1,500 metres; the other receiver is of the Marconi Crystal pattern, with a range of adjustment in reception for all wave-lengths between 1,100 and 3,000 metres. It is fitted with two crystals, which can be used for balanced or independent working as desired.

The emergency apparatus consists of a Marconi 10" induction coil energised from a battery of twelve accumulators and capable of transmitting over a distance of 250 miles for a minimum period of twelve hours.



## The Choice of Words

### IN TELEGRAPHY

WE would commend to the notice of the compilers of the "Dictionary of Slang" a number of wireless expressions which have gained currency, particularly in the United States of America, for, if the efforts of the more staid telegraphists are of any avail, the picturesque expressions which occasionally brighten the speech of their colleagues, and enliven the pages of certain transatlantic telegraph journals, will possess no more than historical interest.

Animated by the desire to maintain the purity of the English language, the students in wireless telegraphy at the East Side Association Institute, of New York, have decided to "put the soft pedal" (an expression used by the Philadelphia *Bulletin* in announcing this decision) on all slang in referring to message transmission by wireless telegraphy. In their efforts to "can" colloquial expressions the students have issued a manifesto which informs their "Fellow-workers" that they do not "push the key," "slam down" or "flop over the aerial switch," nor "juggle" the variable condenser. Translated into English as she is not spoken in New York, this means that operators "depress the transmitting key, raise or lower the aerial switch, and alter or change the capacity of the variable condenser."

"Electricity in our language," continues the manifesto, "is not 'juice'; neither is radio interference 'jamming.'"

"Electrostatic induction is not 'kick-back.' We do not 'fiddle' the potentiometer: we adjust it. The transmitting condensers do not 'blow up,' 'explode' or 'go up the flue'; they puncture.

"The secondary winding of the power transformer is not 'baked,' or 'fried out'; it is burned, or short-circuited.

"A hot bearing at the motor generator is not 'frozen.' It melted and stuck fast.

"The aerial does not 'squirt juice'; it brushes.

"Wireless messages are not 'smashed' through the ether; they are transmitted through the ether.

"We have long since forgotten the term 'loose-coupler'; we are, however, quite

familiar with the inductively-coupled receiving transformer.

"The term 'jigger' in our tongue is obsolete; we know all about high-frequency oscillation transformers."

The manifesto ends as follows: "Finally, we are optimists from the very bottom. We believe that the English language will not suffer by our declaration." We sincerely hope not!

---

## Another Information Bureau

CONDUCTED BY OUR IRRESPONSIBLE EXPERT.

W. H. B. (Peckham).—No, the hammer-break was *not* invented by Mrs. Pankhurst.

Chas. R. (Hendon).—We regret we cannot furnish you with the name of the second operator who was on the Ark at the time of the flood, as we had temporarily to close our local office at the time of the inundation referred to, and a large portion of our staff records perished.

Horace H. (Manchester) writes: "I am thinking of substituting the present gold point on my silicon detector by a needle. Could you advise me of the probable result?" *Answer*: Yes, Horace, you would get much sharper signals.

P. J. B. (Liverpool) writes as follows: "I am anxious to qualify as a wireless operator on a lifeboat. Would you please tell me what steps you recommend me to take?" *Answer*: First learn wireless, then get wrecked.

N. F. B. (Dublin).—No, lady operators are not the rule. *Telegraphie sans fille*, as they say in France.

Montmorency de F. (Southend) says: "I have a  $\frac{1}{2}$  kw. Marconi installation and I am thinking of fitting a ship to it. Can you offer me any advice?" *Answer*: The size of aerial determines the best kind of ship. First erect your aerial, measure it, then buy a ship whose distance between the masts is approximately equal to the length of the horizontal part of the aerial wire.

George R. (Worthing).—We can't help it. It's no fault of ours. If you got brain fever after reading the last lot of Answers to Correspondents it was probably because the mental fare was too strong. We have recently heard from nine foreign powers and three amateur societies that since reading this column they have received a totally different idea of wireless to what they had before, and we can't satisfy everyone. What do you expect for threepence, anyway?

Dr. F. (Manchester).—Sparking at the rigging is caused by wireless waves coming into collision with brain waves from the passengers.

N. R. G. (Hull) asks: "Is it possible to see by wireless?" *Answer*: "It was, once, but the secret has been lost. A clever inventor recently devised a wireless telescope, which by a suitable focussing arrangement could be made to show the interior of any house within five miles. We regret to say that while giving a demonstration on the roof of Marconi House he accidentally turned it in a westerly direction and at once expired from shock. In falling he broke the telescope and in spite of the feverish attempts of the staff to repair it, nothing could be done, so the secret died with him.

Schoolmaster (Penrith).—The "Jigger" is so called from "jig," to dance, and received its name from the fact that the first person who leant up against one during transmission "jigged" or danced for some hours afterwards.

#### *Hints for Young Operators.*

Always wear your bridge coat in the Clapham Road.

It is inadvisable to adjust the spark-gap when the Senior is sending.

All is not spark that splutters.

It's no good going on to "tune" side if the magnetic clockwork is run down.

---

According to the *Standard* it is recorded in the official diary of the Royal Flying Corps that on the occasion of the King and Queen's visit to Aldershot last month His Majesty was in wireless communication with a B.E. aeroplane.

## *Hints for Learners*

BY A BEGINNER.

THE chief things necessary to make a wireless are the wireless instruments. (This does not imply that the instruments are wireless, but simply that they are wireless instruments.) An aerial is also a useful thing to possess. My reason for having one is because I found that where there is no aerial to snatch up the messages, a continual and distracting noise is made by the pattering of spent signs on the roof. Thus I should advise beginners to put up the aerial as soon as possible; but in so doing they should take great care to guard against the frenzied ravages of the wire-worms, which were fortunately discovered by an irresponsible correspondent of THE WIRELESS WORLD a few months ago.

\* \* \*

In order to send messages the dots and dashes should be carefully painted pea-green and put on the roof to dry, as usual. They may be obtained from any reliable morse-monger. For every message at least two bags of best volts should be used. These should be carefully mixed, in a frying pan, with some stout ampères, which may be obtained through the tap from the mains. Used volts and ampères should be preserved, as from time to time the proprietors of the provincial watt-depots insert advertisements in the leading comic papers, inviting people to bring any old volts and amperes for conversion into fuel for accumulators.

\* \* \*

The tuning-fork for the receiving instruments should be made of isolated wire, wound round a hollow rod or a solid tube. The wire is best when thin, thick, middling or otherwise. A crystal detective is useful, but to obtain selective signals a private detective is better.

---

The cruiser and destroyers engaged in the search for Mr. Hamel, the missing airman whose disappearance on May 23rd is so wrapped in mystery, kept continuously in touch by wireless as they slowly patrolled the Channel, ever extending their line toward the French coast, and with their searchlights directed on to the sea.



## Contract News

**Orders have been received during the past month to equip the following vessels with Marconi Apparatus.**

Name.	Owners.	Installation.
<i>Essequibo</i> .. .. .	The Royal Mail Steam Packet Co. .. .. .	1½ kw. and emergency
<i>Ebro</i> .. .. .	" .. .. .	" .. .. .
<i>Erin</i> .. .. .	Sir Thomas Lipton .. .. .	" .. .. .
Two ships building .. .. .	The Glen Line .. .. .	" .. .. .
Three ships building .. .. .	Furness, Withy & Co. .. .. .	" .. .. .
<i>City of Madrid</i> .. .. .	Ellerman and Bucknall S.S. Lines .. .. .	½ kw. and emergency
<i>Crown of Seville</i> .. .. .	Crown S.S. Co. .. .. .	1½ kw. and emergency
Five ships building .. .. .	Compañía Sud Americana de Vapores .. .. .	" .. .. .
Two ships building .. .. .	Lampport & Holt .. .. .	" .. .. .
<i>Abinsi</i> .. .. .	Elder Dempster & Co. .. .. .	" .. .. .
<i>Tuscania</i> .. .. .	Anchor Line .. .. .	" .. .. .
<i>Valiant</i> .. .. .	Harland & Wolff .. .. .	1½ kw. (disc).
<i>Ormara</i> .. .. .	British India S. N. Co. .. .. .	1½ kw. and emergency

**Vessels Fitted with Marconi Apparatus since the last issue of the "Wireless World."**

Name.	Owners.	Installation.	Call Letters.
<i>Euripides</i> .. .. .	Aberdeen Line .. .. .	1½ kw. and emergency	MSE
<i>Indralena</i> .. .. .	Commonwealth & Dominion Line .. .. .	" .. .. .	MTG
<i>Parthenia</i> .. .. .	Donaldson Line .. .. .	" .. .. .	MNS
<i>City of Exeter</i> .. .. .	Ellerman City Line .. .. .	" .. .. .	MSW
<i>Sable I.</i> .. .. .	Captain Farquhar .. .. .	" .. .. .	—
<i>Candidate</i> .. .. .	Harrison Line .. .. .	" .. .. .	MTD
<i>King Orry</i> .. .. .	Ile of Man S.P. Co. .. .. .	" .. .. .	MPE
<i>Hirschel</i> .. .. .	Lampport & Holt .. .. .	" .. .. .	—
<i>Kaikoura</i> .. .. .	New Zealand Shipping Co. .. .. .	" .. .. .	MRS
<i>Magellan</i> .. .. .	Pacific S.N. Co. .. .. .	" .. .. .	MIH
<i>Karmala</i> .. .. .	P. & O. S.N. Co. .. .. .	" .. .. .	MTF
<i>Ricardo a Mestres</i> .. .. .	Andrew Weir & Co. .. .. .	" .. .. .	MTB
<i>City of Rangoon</i> .. .. .	Hall Line .. .. .	½ kw. and emergency	MTP
<i>City of Winchester</i> .. .. .	" .. .. .	" .. .. .	MSY
<i>Rufford Hall</i> .. .. .	" .. .. .	" .. .. .	MSV
<i>Ibez</i> .. .. .	The Great Western Railway .. .. .	" .. .. .	MSC
<i>Aquitania's</i> 2nd launch .. .. .	Cunard Line .. .. .	Lifeboat .. .. .	—
<i>Tyrolia</i> .. .. .	Canadian Pacific Railway .. .. .	1½ kw. and emergency	MLE
<i>Montfort</i> .. .. .	" .. .. .	" .. .. .	MLW
<i>Ruthenia</i> .. .. .	" .. .. .	" .. .. .	MLN

**The following Coast Stations are advised by the Berne Bureau as having been opened recently.**

	Call Letter.	Normal Range in Nautical Miles.	Wave-length, Normal.	Nature of Service.	Hours of Service.*
BELGIAN CONGO: <i>Basankusa</i> * .. .. .	OQU	300	900, 1,200	—	7 a.m. to 11.30 a.m.: 4 p.m. to 5 p.m.
GERMANY (PROTECTORATE) <i>Loine (Togo)</i> .. .. .	KBL	600	300, 600, 1,400, 1,800, 2,500	P.G.	7 a.m. to 10 a.m.: 6 p.m. to 9 p.m.

\* This station is open for public correspondence in the inland service of the Belgian Congo.

CARTOON OF THE MONTH

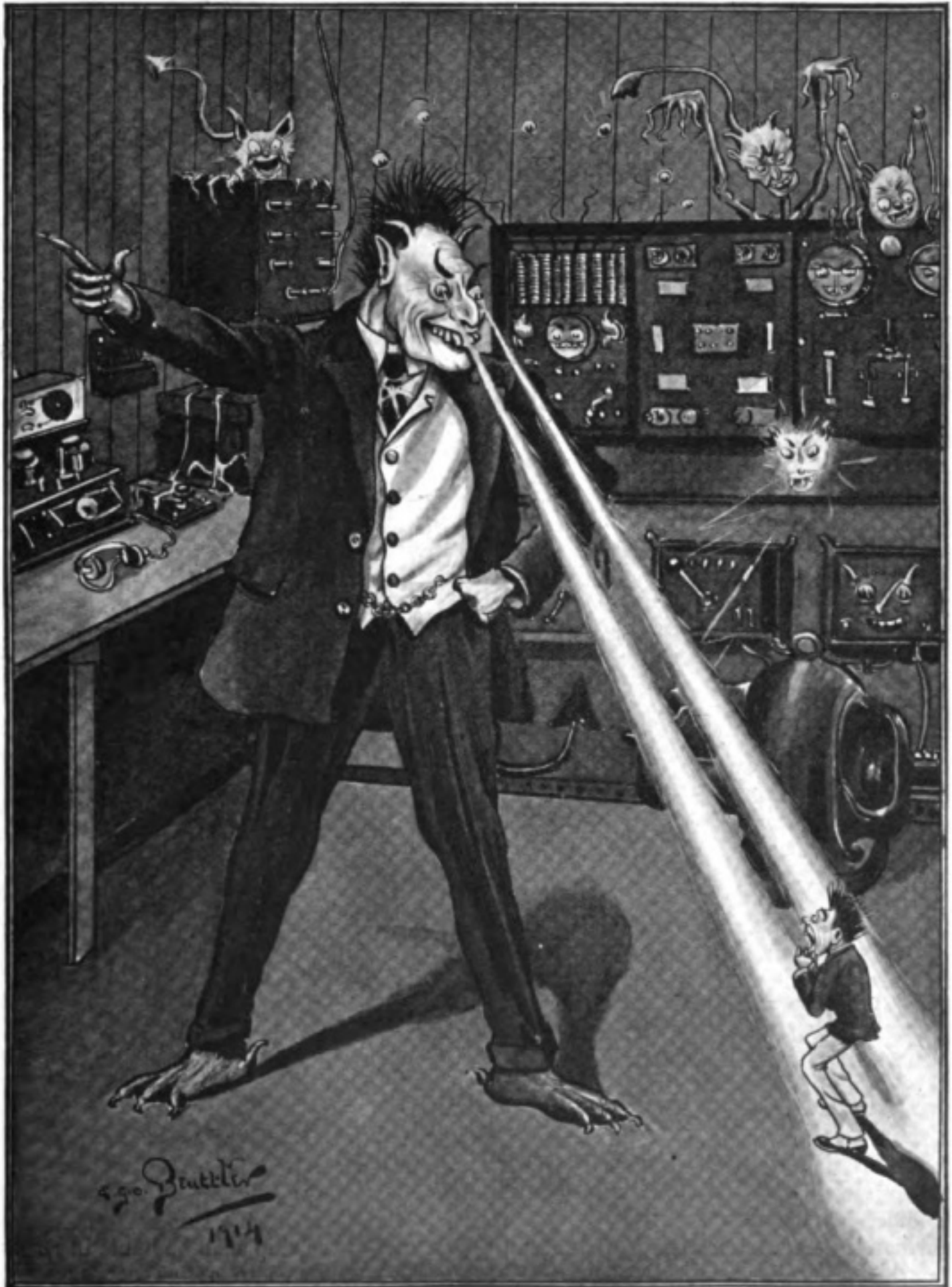

Wireless Worries

*What a Candidate feels like when going up for his P.M.G. Examination.*



# Compulsory Wireless Telegraphy

## *Proposed British Legislation*

**A** BILL to amend the laws relating to merchant shipping so as to give effect to the International Convention for the Safety of Life at Sea, signed in London on January 20th last, was presented to the House of Commons on May 21st by Mr. John Burns, the President of the Board of Trade.

The Bill is divided into six parts, containing 29 clauses and 5 schedules. The first part relates to ice and derelicts, and provides that if the master of a British ship fitted with a wireless telegraphy installation meets with, or is informed of, any dangerous ice or dangerous derelict, or any other imminent and serious danger to navigation on or near his course, he must send out the wireless danger call — — — (TTT), to be followed after an interval of one minute by the message, repeated three times at intervals of ten minutes.

Every wireless telegraphy station under the control of the Postmaster-General, or licensed by him, must, on receiving the wireless danger call, refrain from sending messages for a time sufficient to allow other stations to receive the message. Compliance with this provision will be deemed to be a condition of every licence granted by the Postmaster-General under the Wireless Telegraph Act, 1904. This provision does not interfere with the transmission of the wireless distress call, which will remain . . . — — — (SOS).

Clause 5 places the master of a British ship under an obligation to render speedy assistance on receiving a wireless distress call, and where he does not proceed to the assistance of the persons in distress, he must enter the fact and the reasons justifying his action in the official log book and, if necessary, immediately inform the master of the ship from which the call is received. This section of the Bill also sets out the penalties to which a master of a ship, or any person, is liable if acting in contravention of the provision.

The compulsory wireless clauses (15 to 17 inclusive) are in Part III. of the Bill, which we set out below :—

### WIRELESS TELEGRAPHY.

15.—(1) Subject to the provisions of this Act, every British ship registered in the United Kingdom which carries fifty or more persons shall be provided with a wireless telegraphy installation, and shall maintain a wireless telegraphy service which shall be at least sufficient to comply with the rules made for the purpose under this Act, and shall be provided with certified operators and watchers in accordance with those rules.

(2) In reckoning the number of persons carried on a ship for the purpose of this section, persons shall not be counted who are exceptionally and temporarily carried on a ship—

(a) As the result of *force majeure*; or

(b) As the result of the necessity of increasing the number of the crew to fill the places of members of the crew who are ill or disabled; or

(c) As the result of the obligation on the part of the master to carry shipwrecked persons, or persons in like circumstances; or

(d) If so provided by regulations of the Board of Trade, as cargo hands for a part of the voyage not being between one continent and another, and not being, during the time the hands are carried, outside the limits of latitude thirty degrees north and thirty degrees south.

(3) If this section is not complied with in the case of any ship, the master or owner of the ship shall be liable in respect of each offence to a fine not exceeding five hundred pounds, and any such offence may be prosecuted summarily, but if the offence is prosecuted summarily the fine shall not exceed one hundred pounds.

16.—(1) The Board of Trade, in consultation with the Postmaster-General, may make such rules with respect to wireless telegraphy installations and service on British ships which are registered in the United Kingdom and with respect to the carrying on those ships of operators and watchers for the purposes of wireless telegraphy as appear to them necessary or expedient to carry into effect the provisions of the Convention mentioned in Part V. of the Third Schedule of this Act.

(2) The Board of Trade may by rules made under this section exempt from the obligations of this Act as to wireless telegraphy:—

(a) Ships while on voyages the course of which does not take the ship more than a hundred and fifty sea miles from the nearest coast, if the Board are satisfied that the route and the conditions of the voyage are such as to render compliance with those obligations unreasonable or unnecessary; and

(b) Sailing ships on which, owing to the peculiar or primitive nature of their build, it is impossible to provide a proper wireless telegraphy installation.

(3) The Board of Trade may by rules made under this section provide that any automatic calling apparatus which is certified by them to be efficient and to have been accepted by the parties to the Convention may be substituted, for the purposes of the provisions of this Act, and any rules made thereunder relating to wireless telegraphy, for a certified operator or watcher.

17.—The Board of Trade may postpone the operation of the provisions of this Act relating to wireless telegraphy as respects any particular ship for such period as the Board of Trade determine in each case, if it is shown by the owners of the ship that they have taken all reasonable steps to comply with the provisions of this Act as respects the ship, but that they have been unable to do so owing to difficulties in obtaining delivery of any wireless telegraphy apparatus or of obtaining the services of certificated operators or watchers.

The period of postponement under this

section shall not exceed one year in the case of ships which are required in pursuance of the Convention to provide a first-class wireless telegraphy service, and two years in the case of ships which are so required to provide a third-class wireless telegraphy service, and in the case of ships which are so required to provide a second-class wireless telegraphy service shall not exceed one year as respects the provision of the wireless telegraphy installation and two years as respects the provision of a continuous watch.

Clause 19 (Part IV.) proposes to confer upon the Board of Trade power not to grant a safety certificate, unless they are satisfied, on the report of a wireless telegraphy inspector, as respects provisions relating to wireless telegraphy that the certificate can be properly granted.

The Postmaster-General (and the Board of Trade, if they desire to do so for any special purpose in connection with wireless telegraphy on board a ship) may appoint officers for the purpose of inspecting ships with a view to ascertaining whether the requirements of the Act relating to wireless telegraphy are complied with on board any ship.

The wireless telegraph inspector may go on board any ship at all reasonable times and do all things necessary for the proper inspection of the installation on the ship; he may also require the master of the ship to supply him with any information which it is in the power of the latter to supply with respect to the provision on the ship of operators or watchers, and require the production of any certificate granted under this Act in respect of the installation, and of the certificates of the operators and watchers on the ship.

Failure on the part of the master of a ship to supply information in accordance with this section will render him liable to a fine not exceeding twenty pounds, and any person impeding an inspector in pursuance of his duties is liable to a similar penalty.

The proposed Bill is intended to give effect to the International Convention for the Safety of Life at Sea, the clauses of which relating to wireless telegraphy are published in the "Year Book of Wireless Telegraphy and Telephony, 1914."



# The State and Wireless Telegraphy

## *National Research Work*

THE report of the Committee appointed by the Postmaster-General to consider how far and by what methods the State should make provision for research work in wireless telegraphy was issued as a White Paper on June 8th. The original chairman of the Committee was Mr. C. E. Hobhouse, but on his appointment as Postmaster-General his place was taken by Lord Parker. The other members of the Committee were:—Sir Joseph Larmor, M.P., F.R.S., Sir Henry Norman, M.P., Dr. R. T. Glazebrook, F.R.S., Mr. W. Duddell, F.R.S., Mr. R. Wilkins, Rear-Admiral Charlton, Commander J. K. Im Thurn, R.N., Sir A. F. King, Mr. W. Slingo, Commander F. Loring, R.N., Major C. H. C. Guest, M.P., and Lieutenant-Colonel J. S. Fowler, R.E.

As a preliminary the Committee inquired what research in connection with wireless telegraphy is already being carried out by the Government in this country and in the United States and Germany. They find that valuable work of the kind is done by the engineering department of the General Post Office, which, however, is sometimes hampered by insufficiency of funds, while the questions it investigates are unavoidably such as have an immediate bearing on service problems rather than on the scientific principles underlying wireless telegraphy. The work carried on by the Admiralty again is almost entirely restricted to matters bearing on the adaptation of wireless telegraphy to service conditions, and the same is true of the War Office. Both in the United States and in Germany the State makes more liberal and extensive provision for research and experiment in wireless telegraphy than is made by the State in this country.

In the United States the work is undertaken by three distinct departments—namely, the Navy, the Army Signal Service Corps, and the Bureau of Standards—but in order to secure economy and co-operation

all these departments are for purposes of laboratory research brought under one roof in the buildings of the Bureau of Standards.

In Germany the work is carried out by the Post Office in the Kaiserliches Versuchsamtsamt, a building containing 30,000 square feet of floor space. The work undertaken in this building is not confined to wireless telegraphy, but covers the whole range of electrical engineering as applied to telegraphy, whether ordinary or wireless, and telephony. It is under the direction of Dr. Strecker, assisted by a large and competent staff, the research work in wireless telegraphy being under the charge of Dr. Kiebitz and Dr. Breisig. Research work of importance in wireless telegraphy has also been conducted by Dr. Lindemann at the Reichanstalt in Berlin, and by Dr. Reich in the Naval and Military Radio-Electric Laboratory in Göttingen.

The conclusions reached by the Committee may be summarised as follows:—

(1) It is desirable to establish some body or institution to initiate and control research in matters of general principle which cannot conveniently be investigated in departmental laboratories, to co-ordinate as far as may be the work now undertaken by the Post Office, Admiralty, and War Office, respectively, in connection with experiment and research in wireless telegraphy, so as to prevent work undertaken by one department overlapping work undertaken by another, and thus secure economy, and to discuss any difficulties arising in practice.

(2) The work now being done by the departments should be continued and extended, opportunities being also found for the departmental engineers to carry out such experiments and tests as may be approved by the body or institution to be established for the purposes above referred to, and may require high power and service conditions.

(3) It is desirable to establish a Research Laboratory (as distinguished from the existing departmental laboratories and service stations), in which research work bearing on the practical needs of the services should be carried out under the guidance of the body or institution above referred to.

(4) Though the work to be undertaken by the new body or institution and in the new laboratory, the establishment of which we recommend, will principally concern wireless telegraphy, it is undesirable to exclude therefrom the problems of ordinary telegraphy and telephony.

The report recommends that the National Committee should consist of 12 members—two representing the Admiralty, one the War Office, two the Post Office, two (not departmental officers) appointed directly by the Treasury, three appointed by the Treasury on the nomination of the Royal Society, and one appointed by the Treasury on the nomination of the Institution of Electrical Engineers, together with the Director of the National Physical Laboratory.

No member of the Committee should give advice connected with telegraphy or telephony to any commercial firm on any matter connected with the work of the Committee, except with the consent of the Committee, and in any doubtful case such consent should not be given without the approval of the Department concerned.

Any member of the Committee who may act as adviser to any private firm or individual on any subject dealt with by the Committee or investigated in the Research Laboratory should notify the fact to the President of the Committee, and, if the President thinks fit, acquaint him with the nature of the advice he has given or may give from time to time. In any matter of importance which may be brought before the Committee it should be the duty of the President to call the attention of the Committee to the fact that one of their number is interested in his private capacity, and thereupon the Committee should have power, if it consider it desirable, to request the member in question to withdraw while such matter is being discussed.

This restriction upon the private activities of the members does not necessarily

mean that the Committee will hold themselves aloof from what is going on in commercial stations. Nor will the proposed scheme of national research supplant in any degree the important scientific work carried on by Mr. Marconi and his engineers. The scheme outlined in the report seems very modest in comparison with the organisation established by Mr. Marconi and his Company for investigating the scientific and engineering problems of wireless telegraphy and telephony, and we venture to predict that it will be in the powerful commercial stations in different countries carrying on operations at all times of the day and night, observed by men of long practical experience, trained in scientific research and working under the direction of the great inventor of wireless telegraphy, that factors for the solution of these problems will be found.

The report recommends that the duties of the Committee, which should meet at regular intervals, should be to promote the progress of telegraphic research, to formulate schemes of investigation at the Research Laboratory or elsewhere, to supervise the experiments, and to discuss the results; to consider problems submitted by the Departments and arrange for experiments for their elucidation; and to examine plans and designs for new methods and apparatus submitted to them and report thereon if they see fit. The Government Departments would continue to conduct researches or inquiries arising out of their own administration, ampler provision being made for this purpose in the departmental estimates, and where the results of these independent inquiries are of general interest they should be communicated as far as possible to the Committee. The Departments should assist in the work by carrying out researches that can be most conveniently made at their respective stations, but the Committee would stand in a purely advisory relation to them as regards their stations and the work done at them. An annual report would be made to Parliament, and such researches published as may be considered useful for the advancement of science generally and are not of a confidential nature.

#### COST OF THE SCHEME.

The annual cost of the Research Labo-



ratory is put at £4,800, including £2,255 for staff and £1,100 as honoraria for the members of the National Committee, and the initial capital expenditure is estimated at £7,300. Capital expenditure has been considered under three heads:—(a) mast, aerial and earth connection; (b) buildings; and (c) equipment. It is assumed that the National Committee will require the erection of a single wooden mast, 150 ft. high, with suitable antennæ and earth connections; a one-storey building near the foot of the mast, divided into three parts, one to contain the power plant, one the transmitting, and one the receiving apparatus. One room in this building would need to be metallically screened, to permit of the use of certain types of delicate apparatus. A laboratory building, with a total floor space of 4,000 ft., is also proposed. The estimates are accepted by the whole of the Committee except Sir Alexander King and Mr. Wilkins, who regard them as somewhat too liberal. These two members, with Major Guest, also consider that the expenditure should be met, at any rate to begin with, by a lump sum grant (payable by annual instalments) covering five to seven years, the National Committee being left to determine how the money should be expended; whereas the other members hold that it would be a far better plan for the National Committee to prepare a scheme of work annually and forward it, with estimates of the money required for the ensuing year, to the Treasury, which, if they were approved, would make provision accordingly. This is the plan adopted in the case of the Advisory Committee for Aeronautics.

A schedule to the report specifies the following subjects for investigation:—

*Improvements in methods of measurement of fundamental electrical quantities under high-frequency conditions.*

*Transmitting Condensers.*—Measurement of efficiency of dielectrics used at different voltages, frequencies, and temperatures; quantitative results by which losses can be predetermined.

*Insulating Materials.*—Behaviour at high frequencies and voltages, and best methods of use.

*Receiving Condensers.*—Efficiency of different types.

*Transmitting and Receiving Inductances.*—Study of details of design with a view to minimising energy loss.

*Receiving Devices.*—Investigation of crystal and valve detectors under different conditions, and best methods of modifying these to obtain desired characteristics. Effect of variation of coupling between detector circuit and the rest of the receiving circuit. Effect of variation of inductance and capacity in receiving circuit. Methods of mounting and preparing crystals. Methods of amplification of received signals, both acoustic and electrical.

*Aerial Wires and Earth Connections.*—Measurements of losses due to brushing from different types of aerials at high frequencies. Measurement of decrement of aerial and earth system. Conductivity of different kinds of soil at high frequencies. Measurement of losses in steel plate earth connections. Measurements on model aerial to assist in design and to predetermine losses. Investigation of "earth antennæ."

*New Systems and Apparatus.*—Investigation of new systems of wireless telegraphy and apparatus employed therein, which may be submitted to the Committee and deemed by the Committee worthy of investigation.

Among the subjects the following are instanced as requiring immediate attention:

(1) Researches into the methods of measuring and standardising electrical quantities under high-frequency conditions. Among these would be included measurements of voltage, current, power, resistance, inductance, capacity, wave length, and decrement.

(2) Investigations into the methods of standardisation and construction of instruments such as condensers, inductances, resistances, wave-meters, etc., and the determination of the losses in such instruments.

(3) A study of receiving circuits in general, including variations in type of inductances, condensers, detectors, telephones, relays and amplifiers.

The plant necessary for investigation into these matters would not, at first at any rate, be very extensive, and could be temporarily accommodated in the existing rooms of the National Physical Laboratory.

# Amateurs' Experiences

## *Winding a High Resistance Telephone Receiver*

By E. J. GHEURY, F.R.A.S.

THE finest wire obtainable is No. 50 S.W.G., but, to get about 4,000 ohms. per set of phones, No. 48 S.W.G. single silk covered is sufficient. Wire tables give the following particulars for bare No. 48 S.W.G. copper wire. Diameter, 0.0016 inch; area of cross section, 0.000002011 sq. inch; weight, 0.04092 lb. per mile; resistance per mile, 21,044 ohms. (at 60° Fahr.). This gives 32,142 ohms. for the resistance per ounce at 60° Fahr.

This information refers to *bare wire* only, and the point should be borne in mind, as manufacturers sell the wire by the weight, and in the case of such fine wire the weight of the conductor is but a fraction of the total weight of the insulated wire.

An idea of the fineness of the bare wire may be gathered from the fact that, as seen in the microscope side by side with human hair, its diameter is somewhat less than half the diameter of the hair, and while the silk removed from the wire can withstand a pull of 200 grammes, the bare wire breaks under a load of about 35 grammes, the silk insulation being therefore six times as strong as the metal wire. From the figures given above it is easy to calculate that the weight of one mile is 18.590 grammes, so that to get one milligram of bare wire, one must strip the insulation off a length of 3.4 inch of wire, and at least 10 times this amount will be required to get a weight which can be measured without special appliances. The only way to do this is to cut the wire into short lengths of about 3 inches. Burning off the insulation is not practicable, as the heat of a match is enough to volatilise the wire. The best way to remove the insulation is to pass rapidly the end of the wire half an inch *above* the top of the flame of a candle; this is enough to clear the silk, which can then be made to slide carefully along the wire away from the charred end. If silk cinders cause the silk to stick to the wire, let the end of the wire rest on a piece of

paper and pass the blade of a penknife on the charred portion *without exerting any pressure* besides the weight of the penknife itself; this will remove the cinders and release the silk. This method should be used to clear the ends for connections; with care and good luck a foot or perhaps more of bare wire can be obtained in one piece. By these means the author, taking a piece of covered wire which weighed 15 milligrammes, and cutting it in short pieces, found that the bare wire weighed 8 milligrammes, while the insulation (*minus* the few millimetres burned off at one end of each piece) weighed 7 milligrammes; these results were verified by ascertaining that when the bare wire was in one of the scalepans and the silk removed from it on the other, the weight of bare wire slightly exceeded the weight of insulation. It may be assumed, therefore, that the weight of No. 48 bare wire is half the weight of insulated wire, and one must estimate any quantity required accordingly.

On the ordinary size bobbins, and using No. 48 single silk covered wire, it is not possible to wind more than about 1,200 ohms.—this will give 4,800 ohms. for the set of two ear pieces.

The chief difficulty and risk of breakage arises from the tendency of this fine wire to twist after it has been submitted to slight tension or rubbing, as unavoidably happens while winding. The wire being so fine, each twist that is allowed to "run up to a kink" means a serious weakening of the wire resulting almost invariably in breakage, which is not noticed because the insulation is so much stronger than the wire. The best way to avoid such a mishap is to keep the wire constantly under slight tension while winding; if it has to be slackened for some reason and twists, insert at once a short piece of thin wood (half a match will do) in the loop left at the end of the twists, as shown at H (in illustration), and keep it there, rotating it slowly while, as tightening is resumed



gradually, the twists gradually run up toward the loop, allowing in this way all the twists to come undone one by one without any harm done to the wire.

The accompanying illustration shows a winding gear improvised in a few minutes, which worked exceedingly well and enabled the winding of several coils to be performed without a single hitch. A is a block of wood, the face of which is about 4 inches square, the thickness being such that it stands safely on its base. C is the reel from which the wire is unwound; the bore must be freed from any projecting splinters or burrs that may cause undue resistance to rotation. It may be fixed on a brass bush (electric

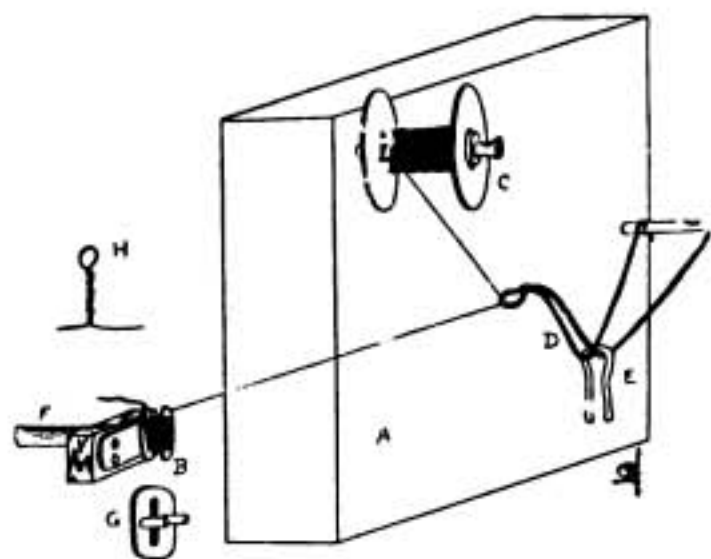

wire connector with screws removed does very well), a 3-inch nail driven in the block serving as spindle. D is the tightening gear, made of 8 inches of No. 16 S.W.G. wire twisted loosely round another nail so as to be free to turn round it as a pivot; E being a piece of thick wire to ballast it and of such weight that, when winding, the wire D is deflected 30° or so from the position it would take under the influence of gravity alone. B is the coil being wound, fixed on a piece of wood by two small nails *with a round head*, so that the wire is not likely to be caught by any projecting part (as would be the case when winding the inner part of the coil if screws were used to fix the coil on the wood). The piece of wood is then perforated at the exact spot corresponding to the axis of the bobbin and forced on the driving axle. The winding is best carried out by a clockwork arrangement. A small electric motor, fixed to the high speed axle of any old clock train of wheels, so as to work with a reduction gearing, the bobbin being fixed to the low

speed axle, will be even better, if available, owing to the ease with which the speed can be varied. Speed in winding is fraught with risks that one will wisely avoid; a hitch may occur, and one turn per second, instead of half a turn, may make all the difference between breakage or success in dealing with the emergency.

To start winding, the bobbin having an insulated coating of shellaced paper, one twists the end of the No. 48 wire round the tinned end of a short length (3 inches) of fine flexible wire (4-38, for instance); a trace of flux and an instant's contact with a medium hot soldering iron, taking care not to touch the free wire itself, and the connection is done. It is insulated by placing it in the fold of a piece of tissue paper ( $\frac{3}{8}$  in. by  $\frac{1}{2}$  in.), folded over the bare portion and kept closed by a trace of shellac. The flexible must be well insulated, as it will be in close proximity to the high and low tension ends of the coil. The joint is then put on the bobbin and a turn of the thick wire is taken to secure it, the end being then turned towards the axle and left free, as shown in the figure. One can do away with such an end piece, and start winding the fine wire at once, but should the end break while connecting after the coil is wound, the whole labour is wasted, and the wire has to be taken off and the bobbin rewound. Once the winding finished, a similar piece of flexible is connected to the outer end of the coil and passed through a hole in a piece of silk ribbon 2 inches in length and of the width of the coil, and this ribbon is wrapped round the coil and kept in place by a drop of shellac. Both bobbins of an ear piece should have the same number of turns but a difference of a few turns will not matter. To obtain, approximately, equality of number of turns, equality of resistance is a good enough guide, but this necessitates much bother in the adjustment of the length by cutting off bit after bit until the correct resistance is reached, and the process requires a Wheatstone bridge and a sensitive galvanometer which are not found in the laboratory of every amateur electrician. It is better and simpler to use a common cyclometer and actually register the number of turns wound. In a Lucas cyclometer, 15 turns of the "star" correspond to 0.1 mile, and it is easy to estimate intermediate numbers with an approximation of two or three turns, which is quite

sufficient. An adapter shown at G, easily made by one whose fingers are not all thumbs, can be secured on the face of the coil if the slot be of such size as to allow of fairly tight fit on the projecting end of the core. The cyclometer is screwed on a piece of wood held by a weight, and is placed so that the prongs of the adapter are caught in the "star." Note the reading, go on winding until the bobbin is quite full; note the reading again, and take the difference between the two readings. For the second bobbin, note the reading, add the above difference to it, and stop winding when the cyclometer registers the result of this addition. The two coils will then have practically the same number of turns.

Finally, when putting the receiver together again, one must not forget to connect them in such a way that, looking at the two faces of the bobbins, if the current flows in a clockwise direction in one coil, it does flow in a counter-clockwise direction in the other coil; the two cores will then possess opposite polarity.

### An Experimental Quenched Spark Gap.

By EARL C. HANSON.

[Our contributor describes a simple quenched gap which he has constructed. We gladly publish this description, coming as it does from the United States, for we think that amateurs in this country will be interested to learn what American experimenters are doing.—ED. W.W.]

THE aim of this article is to describe a quenched gap which is suitable to the needs of the wireless experimenter.

The size of the gap can be increased or diminished without changing its operation.

The two end pieces are cut from  $\frac{1}{2}$  inch fibre, 4 inches square. Through the centre of each piece a  $\frac{1}{4}$ -in. hole is drilled. Twelve copper discs are turned down till the surface is true, the thickness being  $\frac{1}{4}$  in., and the diameter of each  $1\frac{1}{2}$  in. A  $\frac{1}{2}$ -in. hole is next drilled through the centre of each plate and a larger drill is then used to drill half way through from each side.

Fig. 1 shows the gap taken apart and brings out clearly the construction of the

disc, as well as the outer groove and the thin rim of the plate that is used to prevent the current from sparking across on the outer portion of the disc where the rubber rings are placed. The rubber rings are cut from  $\frac{1}{8}$  in. material, and the rim is  $\frac{1}{4}$  in. wide.

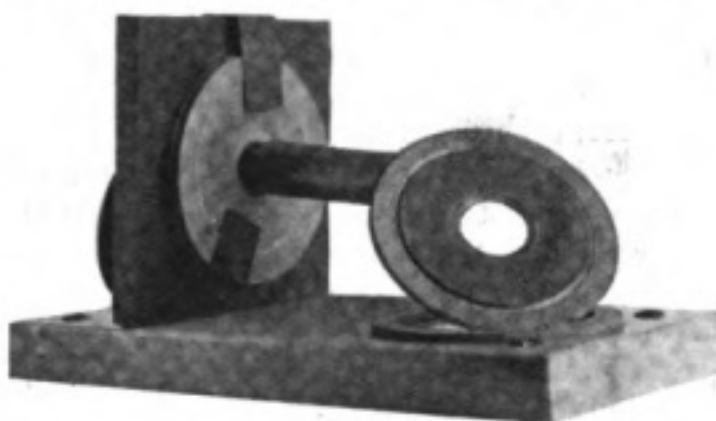

Fig. 1.

Two rubber plates  $1\frac{1}{2}$  in. in diameter and with a  $\frac{1}{2}$  in. hole through the centre are used as end discs. The square end pieces have binding posts screwed to the fibre and are connected with the end copper discs by means of copper strips. A 6-in. bolt,  $\frac{1}{3}$  in. in diameter is passed through one of the end pieces and then several layers of empire cloth are wound tightly on the bolt so as to allow the twelve discs to fit over the bolt. The rubber rings are next placed between each pair of metal plates. The outer end piece is then placed on the bolt and a nut screwed on. The gap is then completed and placed on a marble or oak base. Fig. 2 shows the completed quenched gap.

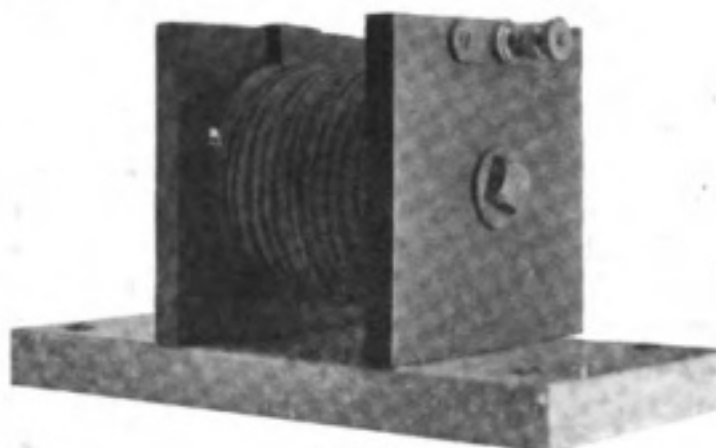

Fig. 2.

Place the quenched gap in the circuit in place of the usual gap and adjust the tone of the gap by screwing up the nuts on the end pieces. The tone depends largely on the distance between plates and the condenser used in the circuit.



## Among the Wireless Societies

**Barnsley.**—*Change of Secretary.*—Mr. C. Pickering has resigned the secretaryship of the Barnsley Amateur Wireless Association, and has been succeeded in office by Mr. G. W. Wigglesworth of 2, Blenheim Grove.

**Birmingham.**—*Masts and Aerials.*—At the May meeting of the Birmingham Wireless Association, Mr. W. F. B. Bartram read a paper on the overhauling of aerials. He dealt chiefly with the jointing of ropes, and to illustrate his remarks he made several "splices" and "bound joints" with hemp rope, galvanised-iron rope and ordinary flexible steel rope. In addition to this, Mr. Bartram dealt fully with the staying of aerial masts, and warned amateurs to put in a stay rope on the aerial side of a mast. A discussion then followed on methods of joining masts and their erection. Mr. Bartram strongly advocated the use of bamboos where possible, for lengthening existing masts, and gave a rough description of a high mast made in lattice form from laths of 3 in. by 2 in., which cost the owner only about 15s. for material. One member gave a description of an aerial mast he was about to erect, made of strong steel tubing, height, 70 feet, which cost, with all guy-wires, joints, etc., £4.

**London.**—*The D.C. Arc.* The use of the direct-current arc for wireless telegraphy and telephony formed the subject of a lecture Mr. G. G. Blake delivered before the Wireless Society of London at the May meeting. The lecturer showed at the outset four different methods of using an arc for the reproduction of the human voice, or making it act as a loud-speaking telephone. He next dealt with the use of the arc as a generator of high frequency alternating current and made mention of the singing arc discovered by Mr. Duddell in 1900.

One of the difficulties in wireless telephony has been to provide a microphone capable of carrying a large current without becoming parked or overheated. When dealing with a small amount of power such as the lecturer

used for his interesting experiments during the evening, an ordinary "solid back" microphone answers very well, but it is unsuitable for use with large currents. One way of getting over the difficulty mentioned by Mr. Blake is to connect a number of similar microphones in parallel with all their mouthpieces connected to one trumpet. This method is not thoroughly practical, however, as the conductivity of each microphone varies from time to time and there is the likelihood of one or more of them overheating.

**Leicester.**—*New Society Formed.*—The interest displayed in wireless telegraphy in Leicester and district has now taken practical shape, for a number of gentlemen interested in this branch of science have formed themselves into a society, which has for its objects "the discussion of things relative to wireless telegraphy." At the inaugural meeting Mr. C. R. Chadfield, of Rothley, presided, and amongst others present were Messrs. A. L. Harris, Edward Marston, F. J. Yates, A. B. Rylands, C. S. Skeet, P. Holyland, F. Dyson, H. Headley, H. May, and Geo. Tarratt. It was agreed to name the newly formed body the Leicestershire Wireless Society. Mr. Chadfield was elected chairman and Mr. Harris hon. secretary.

**Newport.**—*Lecture on Induction.*—At a recent meeting of the Newport and District Wireless Society, Mr. J. H. M. Wakefield, M.I.M.E., delivered a lecture on "Inductance and Induction as Applied in Wireless Telegraphy," illustrating his important points by lantern slides of the P.O. Wireless Station at Fishguard, and by diagrams of the apparatus used at other stations. The necessity for more accurate knowledge of the principles of inductance, and of more accurate measurement and more calculation in the design and construction of amateur apparatus were clearly shown in the lecture, and in the subsequent discussion, which was energetic and well sustained.

## QUESTIONS AND ANSWERS

Readers are invited to send questions on technical and general problems that arise in the course of their work or in their study to Mr. H. Dobell, 21 Maltese Road, Chelmsford. Such questions must be accompanied by the name and address of the writer, otherwise they will remain unanswered.

F. F. (Littleborough).—I notice that carborundum is frequently recommended, but what is the other element of the carborundum detector?

*Answer.*—A carborundum crystal pressing against a steel plate, or a fairly thick steel spring is as good as anything. The crystal is best mounted in a cup in soft metal, but quite good results can be obtained by simply holding it, unmounted, between two springy bits of steel, or even brass.

G. A. M. W. (Seaforth, Liverpool) is troubled by the proximity of a neighbouring ship-station. We fear this is the allotted fate of amateurs placed as he is. However, he might read our reply to W. G. D. in this issue, and perform some interesting experiments on the subject. Why not find some new and great solution to the difficulty?

He is now anxious to take up Wireless Telephony, and asks us to recommend a good book on the subject. The second edition of Fleming's "Principles," has an excellent chapter on the subject; and Erskine-Murray, Ruhmer . . . but why continue: is it not written in the Bibliography List in the "Year Book"?

G. A. M. W. also wants to make a Goldschmidt alternator giving a frequency of 30,000 or 40,000 per second. We fear he is somewhat ambitious. Such a machine presents very great mechanical difficulties to the amateur.

I. B. M. (Dundee).—I have a small receiving station consisting of a twin-slide tuning inductance, wound with 70 ft. of 24 S. W. G. enamelled wire, silicon-gold detector, blocking condenser, and 1000-ohm 'phones. The aerial is of the "T" type, four wires, 50 ft. long, and averaging 50 ft. in height. I can hear Cleethorpes, Paris, Norddeich, and Neuen, but not G.C.C. or G.I.V. Can you suggest any alteration of my apparatus to enable me to receive these stations. Would a loose coupler give any better results?

*Answer.*—The diagram shows the ordinary direct-coupled two-slide connection. I. B. M.'s intuition—as shown in his last sentence—is perfectly correct; he would have seen it confirmed if he has read our reply to W. E. D. in the February 1914 number. He had better read, also, the reply to P. H. in our last issue. We take it for granted that he has the "YEAR BOOK," and therefore knows that the two stations referred to have wave-lengths which are very short compared with those of the "long-distance" stations.

A. C. (New Brighton) asks us to explain why he does not get FL on his apparatus, which consists of quite a respectable aerial, a gas-pipe earth, two tuning-inductances of considerable value, and a silicon-platinum detector connected straight between the aerial and the first tuning-inductance, so that he has several thousand ohms resistance in his aerial-earth circuit. The italics show where the reason lies. Nothing more need be said, except to recommend him to read about crystal receivers in the "Elementary Principles" and innumerable answers in these columns. But we should have thought that even with this arrangement FL might have "come through," since its low-frequency spark has so much brute force behind it.

By the way, A. C. says, "The aerial is taken-in about two-thirds of the way along: is this right?" No, certainly not. The lead-in should come either from one end or from the centre.

C. H. G. (Bradford).—How can I calculate the maximum wave-length that it is possible to tune in with an aerial of  $x$  metres natural wave-length, and in series with an inductance of 7 micro-henries?

*Answer.*—If you have two rectangles of paper, one 2 in. broad and 2 in. long, the other 1 in. broad and 4 in. long, you will admit that they both have the same area—namely 4 square inches. Suppose you make the first one an inch longer, keeping the breadth the same: its area will now be 6 square inches. But suppose you add that same inch to the length of the second one, keeping its breadth the same. Its area will now be 5 square inches—quite different from the new area of the first piece. Do you not see that the same argument applies to the wave-lengths of aeriels? The natural wave-length of an aerial depends on two things—its inductance and its capacity—rather as the area of a piece of paper depends on its length and its breadth. Now you can have two aeriels of exactly the same wave-length but with quite different values of inductance and capacity: so that the effect of adding the same amount of inductance to each will be quite different. See reply to S. F. H. in February 1914 number.

E. J. B. (Malta).—I propose to make apparatus to transmit about five miles. Will an  $\frac{1}{2}$  in. spark-coil used in conjunction with an oil-immersed step-up transformer produce a 1 in. spark; if so, what wire would be required to make the transformer windings? (2) My 'phones have a resistance of 200 ohms. Will these be suitable for crystal detectors, if used with an induction coil?

*Answers.*—(1) We are afraid not. You cannot get more power out of your  $\frac{1}{2}$  in. spark-coil than you put in, and an average  $\frac{1}{2}$  in. spark-coil certainly will not provide enough power to give a 1 in. spark to work over five miles however many transformers you use. Even if you got over all the difficulties which you would experience when you tried to make the 10,000 volts current from your coil pass through your transformer-primary, and your difficulty with the break of your coil when you put that transformer-primary across the coil-secondary, you would undoubtedly lose some of your power in the process: so why not use the  $\frac{1}{2}$  in. spark-coil direct? With "plain aerial" (if you are allowed it) and a good high aerial of a single wire you would get some distance over sea.

(2) Yes, if the induction coil is suitable; its secondary resistance should be somewhere about 5,000 ohms at least.

B. G. P. (Wallasey) asks how the multiple tuning inductances in the magnetic detector are constructed and arranged.

*Answer.*—We never give details of construction of patented articles: but we can give you some hints. They are not wound as "step-up" transformers: the magnetic detector, unlike the high-resistance crystal detectors, does not require high voltage; in fact, it gives the strongest signals when put direct in the earth-lead, where the voltage is minimum and the current maximum. But in any case, your question "If so, what is the ratio of turns?" shows that you expect to apply the ordinary low-frequency ideas of voltage transformation to circuits of high frequency and "resonance"; this is not possible.

As for the type of wire used, the same wire which you use for your aerial-tuning inductance can be employed, though for the intermediate circuit this should not be used if it is very small.



The effect of winding the four coils over each other would be fatal. It would be possible to wind D over B and E over G, but even this would detract from the efficiency of the instrument, for D ought to be variable with regard to its "coupling" with B, and E with regard to its coupling with G.

A. P. A. (Luton) proposes to wind the primary of a telephone transformer *outside* the secondary, on a prolongation of the iron core of the latter, instead of winding the primary on the core and the secondary on top of primary. We think this would only be practicable for very strong signals, and do not recommend it.

He asks if the primary should be of the same resistance as his telephone, and whether he needs a cell in 'phone circuit. The answers are Yes and No. And the secondary, if he is using high-resistance crystals, should be anything up to 10,000 ohms or so.

He also asks if a metallic lining in a liquid dielectric variable condenser will effect its capacity. If the total capacity of the condenser is fairly large, the additional capacity due to the lining will be negligible: it will assume some importance when the condenser is set to its minimum readings.

Question (3) is:—In a spark-gap for a  $\frac{1}{2}$  in. coil, must the electrodes be of zinc or can he use aluminium? He can use aluminium, or even copper, brass, or iron.

Question (4) is:—Will a potentiometer of 300 ohms resistance be sufficient for a carborundum detector or should he add another 100 ohms? Three hundred ohms will be sufficient, but naturally the battery will last longer if the resistance is made higher, since it is constantly discharging through the whole resistance.

D. A. C.—(1) Not having room enough in my garden to put up an aerial I propose to fix my aerial between two chimneys. Would this be dangerous in the case of a thunderstorm? (2) What is the diameter (in millimetres) of 14 and 22 S.W.G. copper wire, and what is the comparative size in B. & S. gauge of these wires?

Answers.—(1) If you make provision for earthing your aerial to a really good earth, direct, and without taking it indoors or through any inductances, at the beginning of a thunderstorm, it will be a safeguard rather than a danger. We do not mean that you should not have a lead-in to your apparatus, but that in addition to this there should be an outside lead straight to earth which could be connected in a moment when thunderstorms developed. When we spoke about it as a "safeguard" we meant a safeguard for the building: if you want a safeguard for yourself when you are receiving, we recommend two devices: a very short spark-gap—say  $1/100$  in.—fixed permanently between the lead-in of your aerial and your ordinary earth-connection, and (if you are in the habit of using a series-condenser in your aerial-circuit) a very long highly inductive "air-core choke" between the top end of your condenser and earth. This choke would form such a long-wave circuit to earth that your received signals would not pass down it, while it would prevent your aerial (which otherwise is insulated from earth by the series condenser) from accumulating static charge from the atmosphere.

(2) No. 14 S.W.G. has a diameter of 2.032 mm. or .080 in., and the nearest to this in B. & S. gauge is .08081 in., which is No. 12 B. & S.

No. 22 S.W.G. has a diameter of .7112 mm., or .028 in., and the nearest to this in B. & S. gauge is .02846 in., which is No. 21 B. & S.

C. W. V. (Bickley).—(1) Is it possible to operate a half coil from 210 volt C.C.? (2) Could I use lamps as a resistance, if so what connections would I require?

Answer.—The usual practice is to work the coil off an accumulator of suitable voltage, keeping the latter continually charging from the d.c. mains through lamps, or other suitable resistances. But there is no reason why you should not dispense with the accumulator, provided that you put your coil across such a resistance as to get the right voltage across the coil-terminals. Thus: suppose

you know that the coil works well on about 2 amps. at 6 volts; you must arrange resistances so that along one of them you get a voltage-drop of 6 volts when 2 amps. are flowing, and put your coil across this resistance. Now at 210 volts, one 50 c.p. carbon-filament lamp will pass about two-thirds of an ampere: so three such lamps in parallel will pass about 2 amperes. Therefore, if you put a resistance of 3 ohms in series with such a group of lamps, you will have about 2 amperes passing through this resistance, and a consequent voltage-drop of 6 volts across the 3-ohm resistance—by Ohm's Law. This voltage-drop is of the right value for your coil: therefore connect the latter across the 3-ohm resistance. Then, when the contact-maker is "making," most of the 2 amps. will pass through the coil, for the resistance of the primary is probably only a very small fraction of the 3 ohms to which it is in parallel. By making the resistance variable, and by changing the number and candle-power of the series lamps, you will be able to adjust things so as to get the best results. Of course, the method has the objection—chiefly economic—that you are wasting current through the 3-ohm resistance.

If you try a simpler plan, and put your coil directly in series with the lamps and the mains, you will probably have terrible trouble with the contacts.

C. S. S. (Rouen, France).—(1) I have a 40-metre aerial composed of four wires and joined in the middle with a wire going down to the apparatus. At one end the four wires come down from a pole of 15 metres and stop at 4 metres off the ground. Is this right? (2) Must I have my wires separate or join them at both sides? They are at present free at one side, the low side. (3) I have a 4,000 ohm double receiver and a galena detector. Is not the receiving resistance too great? In this case, what must I do? (4) I have a double-sliding tuning-coil and receive F. L., Norddeich, Poldhu, Cleethorpes, and all the French stations. What is to be done in order to get further? (5) Would a detector with "amalgame jégou" be better than a crystal? (6) Is my diagram good?

Answers.—(1) and (2) Impossible to say definitely, but we recommend you to try leading-in to your instruments from the high end instead of from the middle. Leave the ends free at both ends if you lead in from the middle; if you try leading-in from the high end, simply prolong the four wires downwards, only joining them just where they enter the house, and leave the free ends separate.

(3) If your galena detector is of very low resistance, it may be better to connect the two ear-pieces in parallel instead of series, or to dispense with one of them altogether, putting a pad in its place.

(4) and (5) Raise, at any rate, the lower end of your aerial: make the whole aerial longer and, if possible, higher. Better still, buy all the back numbers of THE WIRELESS WORLD and spend a day or two studying the numberless "Answers," picking out the ones which apply to you. Increase your tuning inductance so as to tune to the longest waves sent out by any station. Try other detectors, particularly carborundum with battery and potentiometer, and zincite-bornite.

(6) No, not very. You have your crystal connected to the *earthed* end of your tuning inductance, and your telephones (which are very nearly at earth-potential through your head) to the high-potential aerial-end of it. Change these about. Make sure that the condenser across the telephones is of the right value: it should really be adjustable in steps, so as to suit each note-frequency.

N. E. J. M. (Watford) asks various questions about a receiving jigger which he is making and about a direct-coupled set which he is using. On the latter Norddeich is louder than Paris, but when he puts his hand on the tuning-inductance Paris signals are "three times as loud." He then asks, "Have I got enough inductance to get Poldhu?" He gives details of the various coils, and presumably expects us to work out their inductances.

Without doing this we can say off-hand that from the symptom mentioned, he has not got—or at any rate is not using—enough inductance even for Paris. He gets Norddeich stronger than Paris because the former has a

shorter wave and is probably just about tuned-in; then on putting his hand on the tuning inductance he practically puts a condenser across it and lengthens the wave-length of the circuit, thus getting more into tune with the longer Paris wave. Obviously, since Poldhu is yet again longer than Paris he must use more inductance.

But wait. He mentions that his tuning-coil is wound in one direction and his extra aerial-tuning inductance in the opposite direction, and he wants to know if this affects the receiving at all. If these two coils are so placed as to act on one another, and are connected so as to form one continuous winding, their mutual action will decrease their total inductance. To avoid this, they should be placed at some distance from one another and turned at right angles. Or, of course, the connections to one of them can be reversed, but this is liable to lead to further complications.

With regard to his questions as to a suitable secondary for his jigger he should decide what wave-length he wants to reach; then remember that we have said over and over again that a very small condenser—somewhere of a maximum value of .0003 mfd.—is desirable across the secondary; then he should work out the approximate inductance required to give his maximum wave-length with the maximum value of that condenser; finally he should work out the size of the coil, gauge of wire, etc., to give this inductance; using the information scattered broadcast in these columns and in the "Year Book." If he wants to have a good range of wave length, he should profit by the Instructional Articles and realise that if he has one long secondary, even with a number of tapings, the self-capacity of it will interfere with his getting a large range, since even when he reduces the condenser to a minimum, the self-capacity of the coil will still be there; so that he should make two or three secondaries, to stand one on the top of the other as required, using one only for shorter waves, two in series for the next range, and so on.

W. G. D. (Sedbergh).—My receiving station is about 18 miles S.W. of Cullercoats. I have the same difficulty as referred to by W. A. M. (Liverpool) in the May number of THE WIRELESS WORLD, that I cannot tune out G. C. C., even on 12,000 metres. Will you please explain the balancing-out system? The average height of my aerial is 35 ft., and the natural wave-length 500 metres. My 'phones are 1,500 ohms. I have made a small jigger—primary, 2½ in. diameter, 5 in. long, 20 D.C.C., 12 tapings; secondary, 2 in. diameter, 6 in. long, 26 E.C., with 10

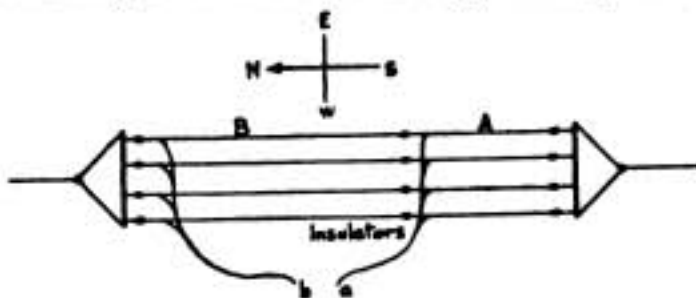

tappings—but have had no success. Would the method described in the accompanying diagram work? Could I use (A) for short waves and connect the two parts together for longer waves?

Answers.—(1) Put up a long, low directional aerial pointing away from the "jamming" station, so as to get good signals from that station but weak ones from other stations: make these signals act on your jigger-secondary—or better still on an intermediate circuit such as that shown in the description of the Multiple Tuner in the "Elementary Principles"—in such a way as to oppose the signals from your main aerial: the two aerial-circuits must be tuned to the same wave, or you will not get opposition. We cannot give more details: it must rest with you to find them out. Before doing this you might try making up a circuit which is tuned to the jamming wave, and putting it directly in your aerial-circuit. Here it will act as a kind of "trap" for the jamming wave, and weaken it considerably.

(2) We do not at all like your proposed plan. You might try dividing your aerial in the middle by a good long insulating piece, and leading-down from the two central ends, thus forming, when the two down-leads are joined, a T-aerial for the longer waves, and when one set of down-leads is insulated, a shorter inverted L aerial for the short waves. In any case, to get down to very short waves you will probably need a variable condenser in series with the aerial. Your short-wave jigger-primary is far too long. Do not trouble to make it variable by tapings: wind it, for about 1 in., over the bottom end of the secondary, and do your tuning on the variable condenser and tuning-inductance.

E. W. M. (London).—I propose to make a receiving jigger for magnetic detector. Would the following dimensions be suitable:—Primary: 10 in. diameter, 12 in. long, 22 S.W.G. enamel copper wire, 32 to the inch, with sliding contact. Secondary: 8 in. diameter, 12 in. long, 28 S.W.G. silk-covered copper wire 52 to the inch, with 24 tapings brought to a stud switch. Will it be best to have a variable condenser across the 'phones and one across the secondary. Is it better with the magnetic detector to use high-resistance 'phones and rewind the coils of the detector, or to use 120 ohm 'phones with the existing coils, or does it make no difference. What is approximately the best speed to run the detector? I have been experimenting for some time with crystal and electrolytic detectors and wish to compare these with the magnetic detector.

Answers.—The whole point is this: A crystal-detector jigger is—or should be—designed to transform the oscillations, which at the foot of the aerial are low in voltage and high in current-value, to a high voltage and low current value, since a crystal requires a high voltage, being a high-resistance detector, and "potential-operated." For this reason, the jigger-secondary is made with an enormous amount of inductance in order that the condenser, which tunes it to the incoming wave, may be very small: for the smaller this is, the higher will be the voltage to which the signals raise its plates.

On the other hand, the magnetic detector has a very low resistance and is "current-operated": it, therefore, works well if put direct in the earth-lead: whereas the crystal would work miserably if so placed, and needs a transforming jigger.

The only object of a jigger with a magnetic is to make the apparatus more selective, not to increase signals by changing the oscillations in any way; so that the magnetic jigger-secondary should be of about the same inductance as the primary. Therefore your proposed jigger is not suitable. It would probably be all right if you wound the secondary with the same thick wire as the primary.

But the position in which you place your condenser, across the jigger-secondary, makes us think that you do not appreciate the fact that in a similar crystal-circuit the actual oscillating-circuit is formed by the jigger-secondary and its condenser, whereas with the magnetic the oscillating circuit actually includes the magnetic-detector-primary-coil, so that the obvious thing to do is to connect the condenser in series with the jigger-secondary and the detector-primary.

With regard to the telephones: If there is nothing to choose between the two telephones except in their actual resistance, a pair of 150-ohm 'phones with the existing coils will give as good results as high-resistance 'phones with a re-wound detector; and probably your 120-ohm 'phones would be quite satisfactory. But makers have specialised a good deal on high-resistance 'phones for wireless, and it is quite possible that these, with the re-wound detector, would give rather better results than a low-resistance pair not specially designed (as to diaphragms, etc.) for "wireless." As for the speed for the detector, this depends on many things: nature of iron forming the band, thickness, and method of winding of latter, strength and adjustment of magnets, and even—to a certain extent—note-frequency of received signals. An average value is about 4 ft. per minute.



## INSTRUCTION IN WIRELESS TELEGRAPHY

(Second Course)

## (III) Distribution of Potential Current in Aerials

[The article in the March number completed the first course of instruction. The present is the third of a new series of articles, which will deal chiefly with the application of the principles of wireless telegraphy. Those who have not studied that series are advised to obtain a copy of "The Elementary Principles of Wireless Telegraphy," which is now published, price 1s. net, and to master the contents before taking up the course of instruction. An announcement concerning the second examination will be made shortly.]

714.—Before going into the question of the construction and insulation of aerials, we must first consider how the voltage of the aerial is distributed when oscillating currents are flowing in it.

Taking the case of an aerial directly excited by an induction coil—*i.e.*, "plain aerial," the maximum **initial voltage** to which the aerial is charged will depend upon the

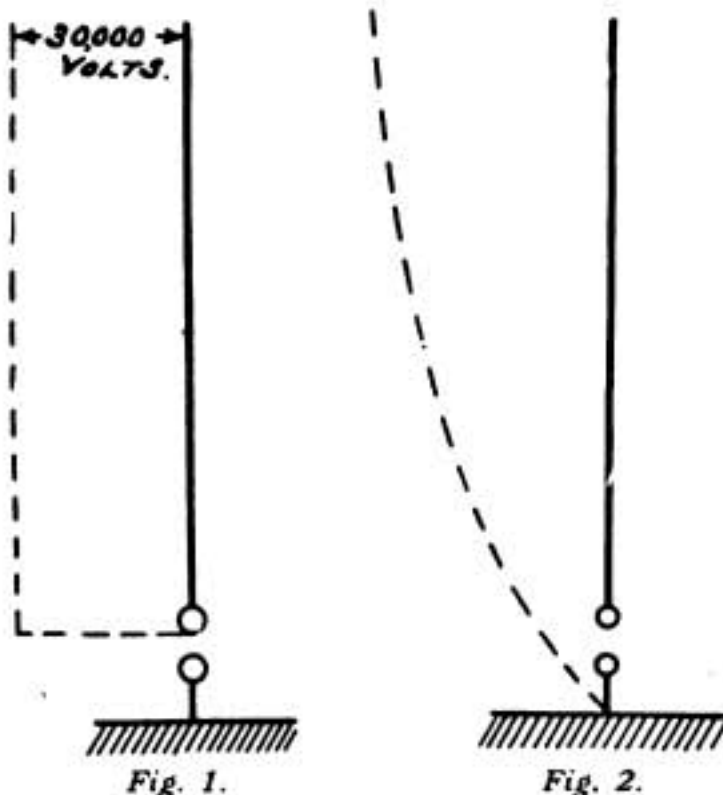

voltage applied across the spark gap by the induction coil. This voltage can be regulated by increasing or decreasing the length of the spark gap.

(The voltage required to jump an air gap where points are used for the electrodes is about 12,000 volts for each centimetre length of air gap. If knobs or balls are used for electrodes, the voltage required will be

increased to an extent depending upon the curvature of the ball. Thus, using balls 1 in. in diameter, it is found that a voltage of approximately 30,000 volts for each centimetre length of air gap is required.)

Assuming for the sake of explanation that we are using ball electrodes set one centimetre apart, then at the instant immediately before the gap is broken down the whole aerial is charged up to a uniform voltage of 30,000 volts. In this case the distribution of the voltage along the aerial wire can be shown diagrammatically, as in Fig. 1, by a line drawn parallel with the aerial at a distance from it representing 30,000 volts.

If the capacity of the aerial be represented by  $C$ , the voltage to which it is charged by  $V$ , and the energy in the aerial by  $J$ , then  $J = \frac{1}{2}CV^2$  (see "Elementary Principles of Wireless Telegraphy," page 58). This energy can be regarded as "potential" energy, as opposed to the energy due to a current flowing through an inductance, which may be regarded as "kinetic" energy.

At the next instant the gap is broken down, and the "potential" energy in the charged aerial is transferred to "kinetic" energy in the form of a current of electricity passing through the inductance of the aerial to earth.

If  $L$  represents the inductance of the aerial, and  $I$  represents the current flowing through that inductance, and  $J$  again represents the energy in the aerial, then  $J = \frac{1}{2}LI^2$ . Therefore, when the current is oscillating, the energy in the aerial **at any instant**,

$$= \frac{1}{2}C(V)^2 + \frac{1}{2}L(I)^2.$$

Taking the instant when one quarter of an oscillation has taken place, the voltage of

the aerial has become zero, and therefore  $\frac{1}{2}CV^2 = 0$ .

At this instant, therefore, the whole of the energy is transferred to the current flowing through the inductance, and consequently **the current in the aerial is at its maximum.**

Similarly, taking the instant when one-half oscillation has taken place, the current has become zero, and therefore at this instant the whole of the energy is transferred to the charge in the capacity of the aerial, and consequently **the voltage of the aerial is at its maximum.**

Assuming, for the moment, that none of the energy is lost either in radiation or resistance, then the energy in the aerial will be the same at the end of the first oscillation as it was originally, but since the spark gap is broken down the bottom end of the aerial must be considered as connected to earth, and therefore the voltage at this point will remain at zero while the maximum voltage will be found at the free end of the aerial. Thus, it will be seen that the distribution of voltage over the length of the aerial will take a different form from that shown in Fig. 1. It will take the form of a sine curve, Fig. 2.

**715.**—At first sight it would appear that the maximum value of the voltage obtained at the free end of the aerial would be the voltage to which it was originally charged. This, however, is not the case, for the following reason:

At the moment when the aerial is first charged, the charge is uniformly distributed over the whole of the aerial, as shown in Fig. 2, and since the capacity of the aerial is also

distributed over the whole of the aerial, it follows that **the whole of the capacity of the aerial is charged to an equal voltage.**

On the other hand, after the first oscillation when the charge in the aerial is distributed, as shown in Fig. 2, the whole of the capacity in the aerial is not charged to the same voltage, and therefore **the free end of the aerial must necessarily become charged to a higher voltage than originally, in order that the aerial may store up the same amount of energy as before.**

It can be shown mathematically that the voltage at the free end of the aerial at the end of a complete oscillation will be  $\frac{\pi}{2}$  times

the original voltage to which it was charged, assuming (1) that the voltage is then distributed in the form of a sine curve and (2) that no energy has been lost or radiated during the oscillation.

This will be readily understood by referring to Figs. 3 and 4.

Fig. 3 shows the distributed voltage along the aerial wire, the dotted line showing the original charge put into the aerial by the induction coil and the full line showing the charge in the aerial at the end of the first oscillation.

Fig. 4 shows the variation of voltage at the free end of the aerial wire during the first oscillation. Up to the point A the curve shows the comparatively slow rise of voltage while the aerial is being uniformly charged up by the induction coil to a value of 30,000 volts. At the point A the spark gap breaks down and oscillations commence, and the voltage at the end of the aerial rises

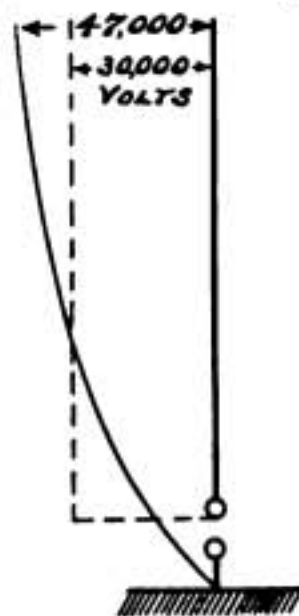

Fig. 3.

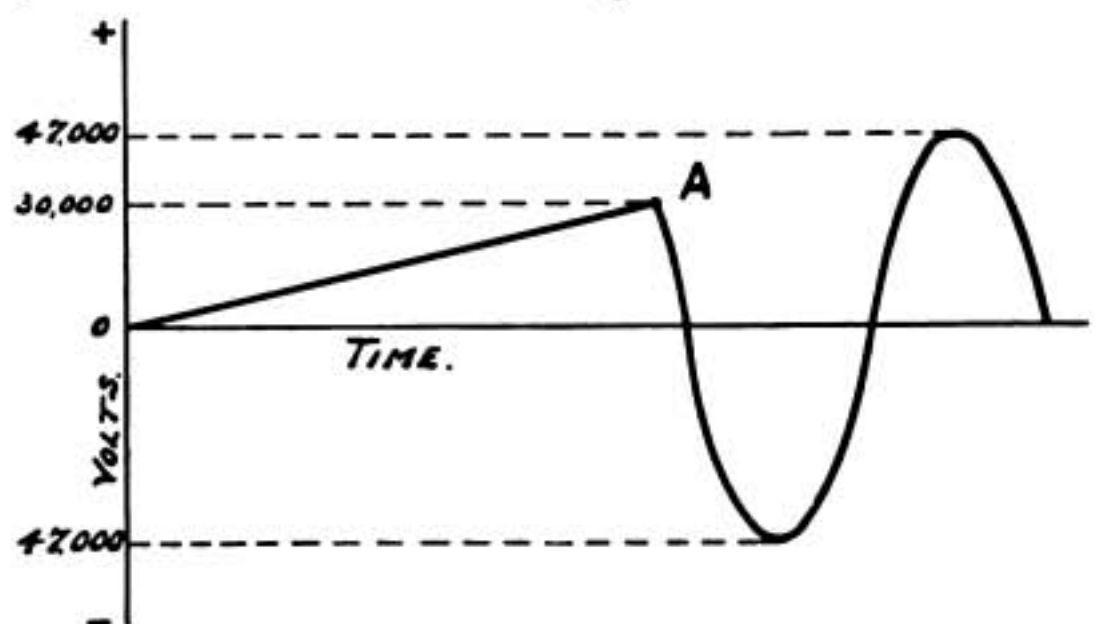
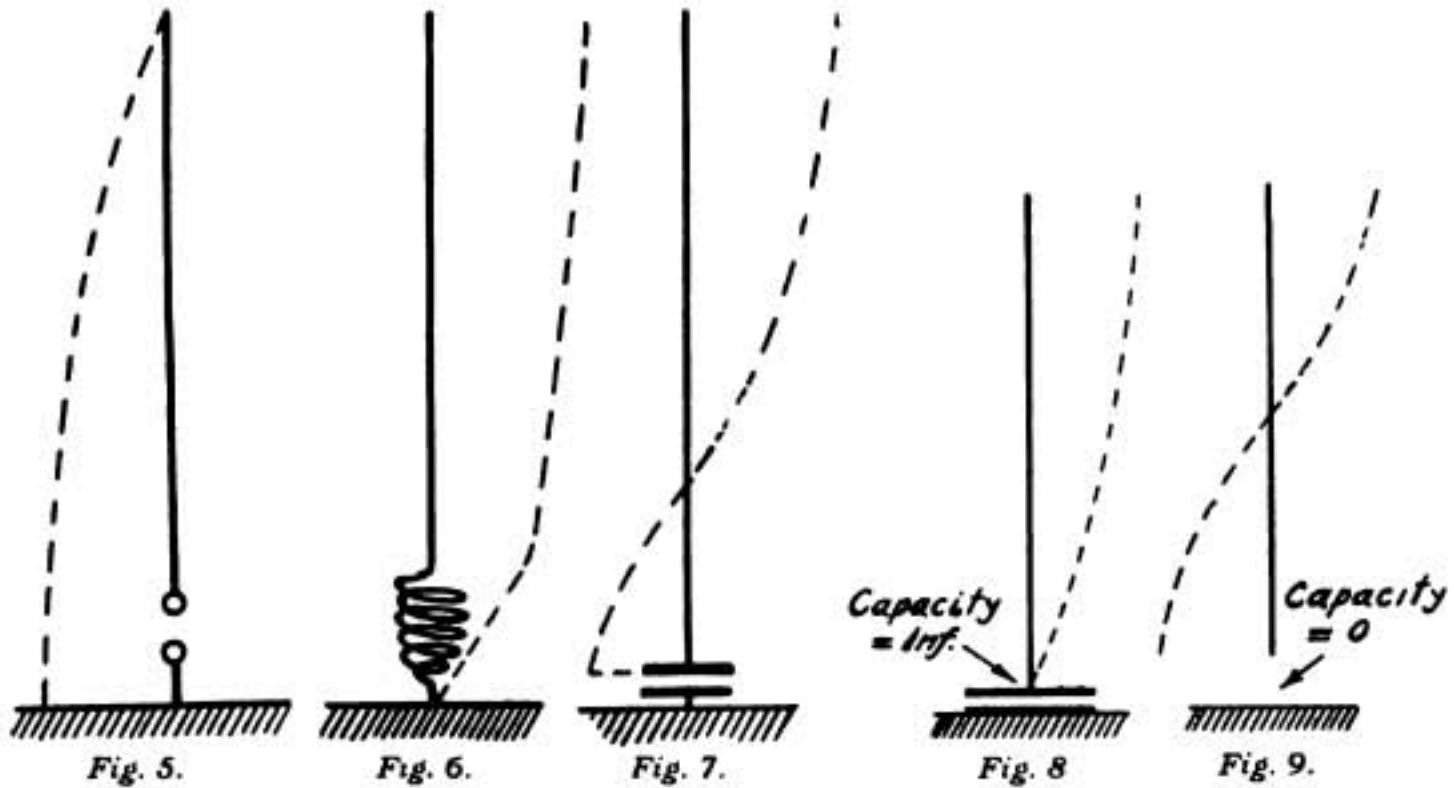

Fig. 4.





to a value  $\frac{\pi}{2}$  times the original charge = about 47,000 volts.

**716.** We have said that the energy stored up in the aerial when the whole of the charge is in the aerial =  $\frac{1}{2}C(V)^2$ . This is only true when the whole of the capacity of the aerial is uniformly charged to the voltage  $V$ . **When the aerial is oscillating and the voltage is distributed as a sine curve, the effective capacity of the aerial must be taken as  $\frac{2}{\pi}$  times the true capacity.** Therefore, the energy stored up in the aerial when oscillating =  $\frac{1}{2} \frac{2}{\pi} C(V)^2$ .

Similarly, when the aerial is oscillating and the current is distributed as a sine curve, the effective inductance of the aerial must be taken as  $\frac{2}{\pi}$  times the true

inductance, and therefore the energy due to the current passing through the inductance of the aerial when the aerial is oscillating

$$= \frac{1}{2} \frac{2}{\pi} L(I)^2,$$

so that the energy in the aerial at any instant during the oscillation

$$\begin{aligned} &= \frac{1}{2} \frac{2}{\pi} C(V)^2 + \frac{1}{2} \frac{2}{\pi} L(I)^2 \\ &= \frac{C(V)^2}{\pi} + \frac{L(I)^2}{\pi} \end{aligned}$$

**DISTRIBUTION OF CURRENT IN AN AERIAL.**

**717.** We have already explained in paragraph 714 that at the moment when the voltage at the end of the aerial is at its maximum, the current flowing into the aerial is at zero, and the distribution of the voltage along the aerial when the latter is oscillating to its fundamental wave-length is such that there is a node of potential where the aerial is connected to earth, and an anti-node of potential at the free end of the aerial. The distribution of the current is the reverse to this. It is obvious that the maximum current will flow at the earth end of the aerial, for all of the current which flows into the aerial must necessarily pass this point, whereas taking a point half way up the aerial only that current which is required to charge the upper half of the aerial will flow past this point, and taking the extreme end of the aerial no current can flow through it. **Thus, the distribution of the current in an aerial will take the form of a sine curve with its anti-node at the point where the aerial is connected to earth, and its node at the free end of the aerial, as shown in Fig. 5.**

This current will vary from a maximum value when the potential of the aerial is at zero, to zero when the potential of the aerial is at its maximum.

**EFFECT OF CONNECTING AN INDUCTANCE OR CAPACITY IN SERIES WITH AN AERIAL.**

**718.** When an inductance is connected in series with an aerial, the distribution of

voltage along the aerial when oscillating is similar to that already described for a simple aerial, except that the inductance must be regarded as a continuation of the aerial, and therefore the voltage increases along the inductance as well as along the aerial, as shown in Fig. 6; thus the greater the inductance that is connected in series with an aerial the higher will be the voltage across that inductance when it is oscillating.

It is most important to bear this point in mind when designing inductance coils to be used for transmitting purposes, for the coil must be very highly insulated from earth at the end which is connected to the aerial, and, further, very high insulation must be allowed where the aerial wire enters the building.

The effect on the distribution of the voltage, of connecting a condenser in series with an aerial, is to create a node of potential in the aerial above the condenser, as shown in Fig. 7.

The exact position of the node will depend upon the relative values of the capacity of the condenser, and the capacity of the aerial.

Taking the two extreme values of capacity of the condenser, we find that if an infinitely large capacity be connected in series with an aerial, the node will be found exactly at the junction of the aerial and the condenser, as shown in Fig. 8, for an infinitely large capacity is equivalent to a direct connection to earth. On the other hand, if we connect an infinitely small capacity in series with an aerial, the node of potential will occur half way up the aerial, as shown in Fig. 9.

Thus any intermediate capacity between the values of infinity and 0 will create a node

somewhere between the bottom of the aerial and half way up the aerial, according to the relative values of the capacity of the aerial and the capacity of the condenser.

HARMONICS.

**719.** Any oscillatory circuit in which the capacity and inductance are distributed, that is to say, any "open" oscillatory circuit, will oscillate to harmonics of the fundamental wave.

The first harmonic has a frequency of 3 times the fundamental frequency, the second harmonic 5 times, the third harmonic 7 times, and so on.

Thus the wave-length of the first harmonic will be one-third the fundamental wave-length, that of the second harmonic one-fifth, and that of the third one-seventh.

When the aerial is oscillating to the first harmonic the distribution of the voltage along it will take the form shown in Fig. 11, from which it will be seen that there are two points on the aerial of maximum voltage, one at the end of the aerial, A, and the other a third of the way up the aerial at the point B. Further, a node of voltage is obtained at the point C, two-thirds of the way up the aerial, as well as at the point D, where the aerial is connected to earth.

The distribution of voltage along an aerial oscillating to its fundamental, its first harmonic, second harmonic, and third harmonic, is shown diagrammatically in Figs. 10, 11, 12 and 13 respectively.

These harmonics can be distinctly detected with a sensitive wave-meter when an aerial is excited as "plain aerial." It will

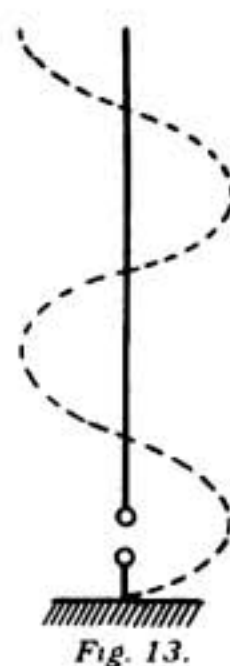
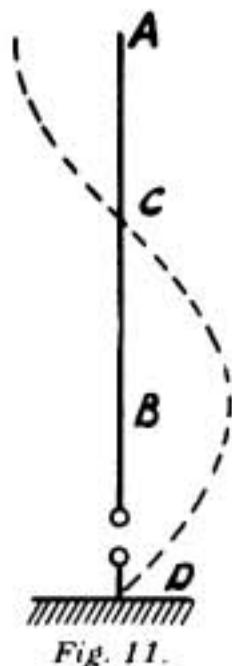
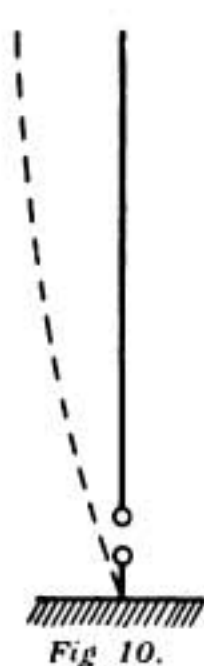



be noticed, however, that the fundamental wave-length gives by far the strongest signals in the wave-meter. The first harmonic will be very much stronger than the second, and the second stronger than the third, and so on. Difficulty will be found in detecting any of the higher harmonics on account of their weakness.

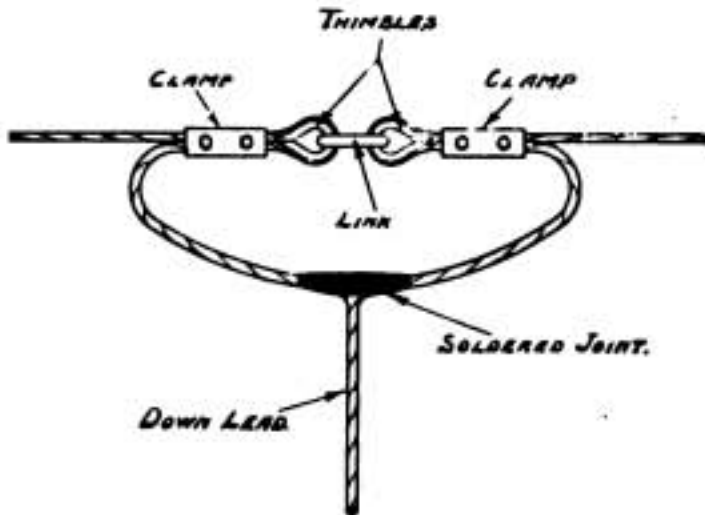

Fig. 14.

**720.** When an aerial is directly excited, as for instance by means of an induction coil, the harmonics are only feebly produced, and similarly when an aerial is excited indirectly by a coupled "closed" oscillatory circuit which is tuned to the fundamental wave-length of the aerial, the harmonic wave-lengths of the aerial will be only feebly produced, practically all of the energy being radiated in the fundamental wave-length.

If, however, the coupled "closed" oscillatory circuit be tuned to one of the harmonics of the aerial, the aerial will not oscillate to its fundamental wave-length, and consequently only the harmonic to which the "closed" oscillating circuit is tuned will be radiated. As a matter of fact, an aerial excited to one of its harmonics will radiate even more efficiently than when excited to its fundamental wave-length.

Use is therefore made of this phenomenon to avoid the necessity of inserting a condenser or a large inductance in series with the aerial, thus reducing its efficiency as a radiator, when a station is required to transmit a long wave-length and a short wave-length on the same aerial, and where it is possible to arrange that the short wave-length is a harmonic of the long wave-length.

In the early days of wireless telegraphy all ships fitted with wireless could transmit on either of two wave-lengths, which were called respectively "Tune A" and "Tune B." Tune A was a wave-length of 360 feet, and Tune B was a wave-length of 1,080 feet. Thus it was usually arranged that the wave-length of the aerial was approximately 1,080 feet, and that the primary circuit of Tune A was tuned to the first harmonic of this wave, namely 360 feet, and that of Tune B to the fundamental.

It is, however, not possible to arrange this now, for the International Convention of Radio-Telegraphy have laid down that all ships must be able to transmit wave-lengths of either 600 metres or 300 metres, and in this case the lower wave-length is not a harmonic of the higher wave-length.

#### CONSTRUCTION OF AERIALS.

On pages 145 to 155 in "The Elementary Principles of Wireless Telegraphy" some general information is given regarding the shape, size and properties of aerials.

**721.** Aerials as a rule receive less attention and consideration than any other part of a wireless station, partly because they are outside and out of reach, and partly because many people make the mistake of thinking that anything is good enough for an aerial. Poor results have in many cases been traced to faulty aerials.

The first points to consider are the mechanical strength and electrical conduc-

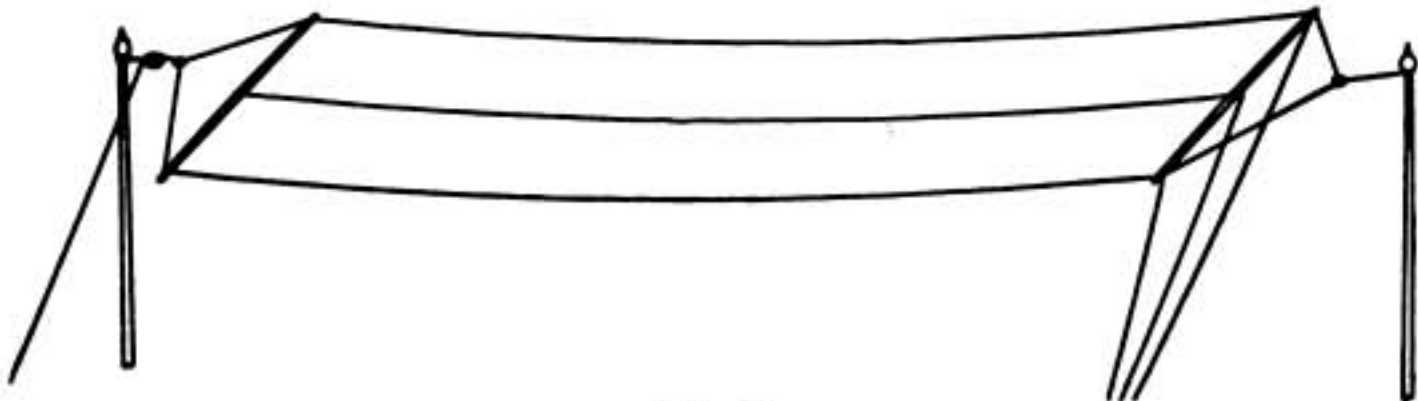

Fig. 15

tivity of the material of which the aerial is made.

Copper wire is the best conductor available at a reasonable price, but it is unfortunately too soft to use in a pure state. There are two alloys of copper, however, that have many times the tensile strength of pure copper, namely—phosphor bronze and silicon bronze. Of the two, silicon bronze is the better for our purpose, as it has a higher conductivity than phosphor bronze and nearly the same tensile strength.

The following table shows the relative advantages of the three materials at a glance:

Material.	Tensile strength. Tons.	Conductivity. Per cent.
Hard-drawn copper...	14	100
" " silicon bronze	40	42
" " phosphor bronze	50	28

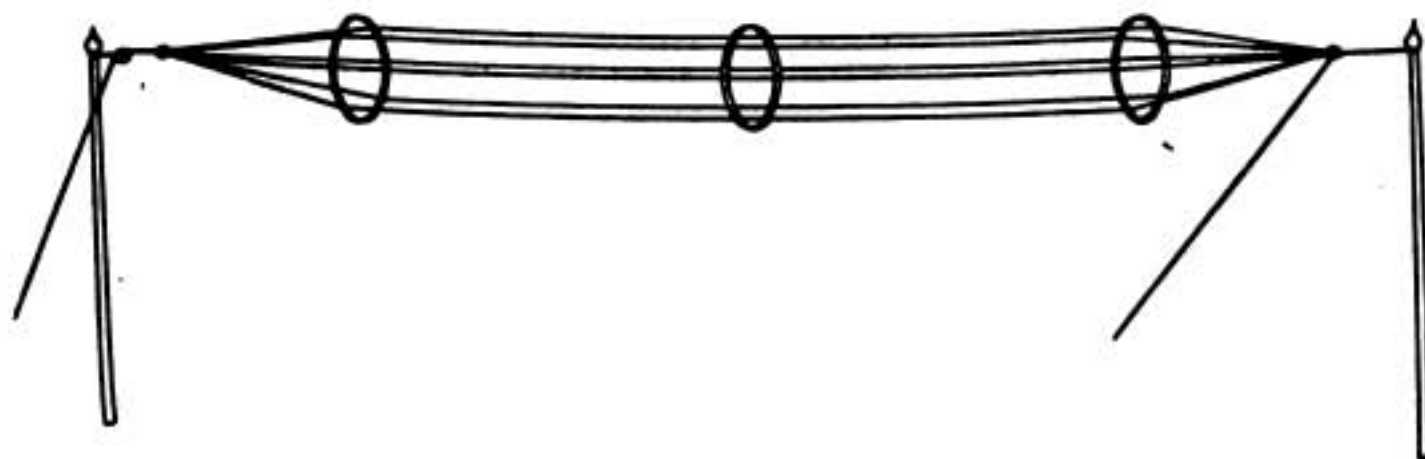

Fig. 16.

Whenever a joint is made in an aerial wire, it should be soldered, for although a twisted joint may make a good enough connection when new, it must be remembered that the wire is exposed to all weathers, and will in time get coated with an oxide of copper, which has a high resistance; thus we may get a thin film of a poorly conducting material between the twisted wires.

For transmitting purposes such joints will probably not have any very serious effect, as the oscillatory currents in the aerial will be sufficiently powerful to break down the resistance of the oxide film by sparking through it.

When receiving, however, the oscillatory

currents in the aerial will in most cases be too weak to do this.

When a hard-drawn metal is soldered, owing to the effect of the heat, its tensile strength is reduced very much, so that it is inadvisable to put any severe strain on the soldered joint.

722. There are many ways of avoiding this. A simple and effective method is shown in Fig. 14, which illustrates the junction of the "down-lead" to the horizontal wires of a T aerial.

It will be seen that all the horizontal stress is taken off the soldered joint by the steel link, and as the down-lead is not as a rule under very great tension, it is not generally necessary to support it also.

In order to increase the capacity of an aerial, two or more wires are suspended parallel to one another. A few wires spaced far apart increase the capacity to a greater extent than a large number of wires close together.

For this reason "spreaders" are employed to keep the wires on an aerial separated.

For commercial working, where the utmost efficiency is unnecessary, it is usual to simplify the aerial as much as possible; thus on ship stations it will generally be found that only two, or perhaps three, wires are used in the aerial, carried by spreaders about 10 or 12 feet long, as shown in Fig. 15.

On the other hand, on most of the battleships in H.M. Navy, the aerials consist of four or six wires carried on circular spreaders some 6 or 8 feet in diameter, as shown in Fig. 16.

Such aerials are usually called "squirrel cage" aerials, on account of their appearance.



# The Marconi Examination Awards

WITH last month's issue of THE WIRELESS WORLD we published an inset announcing the results of the examination which was organised by the Marconi Company with a view to encouraging the study of wireless telegraphy among members of the Territorial Forces, Boys' Brigade and Church Lads' Brigade, Boy Scouts' Association, and other organisations of a similar nature, but we take this opportunity to add that in every way the competition has been a pronounced success, not only on account of the enthusiasm with which the project has been received and the number of the competitors, but also on account of the proficiency which is manifested in the papers sent in; and the three units sending in the competitors who came out head in the three sections—viz.,

"Senior," for Territorials and Cadet Battalions; the "Junior," for the Boys' Brigade, Church Lads' Brigade and Cadet Corps; and the "Junior" for the Boy Scouts' Association, have good reason to be proud of their success. They have gained an honour which is not an empty one, besides acquiring a complete set of field station wireless telegraph apparatus.

It is intended that these and the other prizes and certificates shall be publicly presented to the successful competitors in the near future. The presentation will take place, in all probability, in Marconi House, but it is difficult to fix a date suited to all parties. As soon, however, as the matter is definitely settled notification will be sent to them individually.

---

## A Text Book for Beginners.

"THE ELEMENTARY PRINCIPLES OF WIRELESS TELEGRAPHY," by R. D. Bangay. 160 pp., 86 Illustrations. (London: The Marconi Press Agency, Ltd., Marconi House, Strand, W.C. 1s. net.)

This book has been designed to meet the requirements of the large and continually increasing circle of wireless experimenters. As indicated by the title, it deals only with the principles underlying the subject, but a thorough knowledge of these principles is essential to amateurs, and the lucid exposition given by the author is in itself a justification of the enterprise of the publishers. The literature of wireless telegraphy is not too rich in books of this kind, therefore this friendly and instructive guide through the theory and practice of wireless will be welcomed, especially by those who do not

possess much technical knowledge. It will be especially useful to members of the Territorial Force, Boys' Brigade, Church Lads' Brigade, and the Boy Scouts' Association.

---

Nearly 3,000 Boy Scouts spent their Whit Monday among the Surrey Hills, among them being a South London Troop with their wireless apparatus. According to a *Standard* representative, "the real aristocrats" at the camp were the members of the 1st South Norwood Troop, who had a wireless installation all to themselves. They were not far away from the house of the Lord-Lieutenant of Surrey, and "their voices had a pardonable ring of pride when they told me 'We have just been in communication with the house!' A moment later they announced that the weather report from Paris was to hand."

## Among the Operators

[This section is devoted to recording items of particular interest to wireless telegraph operators.]

Mr. J. M. Harrison, the operator in charge of the wireless telegraph station on board the S.S. *Aorangi*, has sent us the following list of some exceptionally long distances over which the vessel heard wireless stations during a voyage from San Francisco to Australia: Sydney, 2,100 (weather message copied); Wellington, 1,800; Chathams Island, 2,300; Awanui, 2,310; Honolulu, 2,000; Point Arguello, Cal., 3,400; Panama, 4,100, all at strength 2. San Francisco, 3,552 (Press copied); San Francisco in port at Papeete, 3,660 miles, strength 2. S.S. *Malsonia*, 2,700; S.S. *Talune*, 1,400; Triangle Island, 2,800, at strength 3.

With the exception of one night signals were audible for the whole of the voyage from Sydney to San Francisco and return. On March 9th, Chathams, Honolulu and San Francisco were audible at the same time.

An operator in the employ of the Brazilian Agency of the Marconi Company left that employ to enter the army. Tiring of his new occupation, he sought to re-enter the wireless service, and the following is a translation of a letter addressed by him to the Company:—

"The most eminent Mr. —, the very worthy Manager of the Marconi Wireless Telegraph Company—greetings. Putting my hand to the pen to address this missive to such a distinguished personage is in order to most respectfully thank him for the innumerable proofs of consideration which the same personage has always shown to my insignificant person; notwithstanding that your Excellency now appears to be offended with me because of some motives about which I should rather say nothing. Eternally mortgaging my gratitude seeing that your Excellency has such an abounding and benevolent heart and of a superior education; which runs *vis-a-vis* with your noble and humanitarian sentiments, and which is the reason that permits me to write to you to-day. As your Excellency cannot ignore that, youth is always ready on occasions to lose itself in the abyss of madness which happened to me when I took the unfortunate step of becoming a soldier, and of which to-day I find myself so repentant. As I have already written to your Excellency begging you to allow me to return to the Company,

which if granted I will always show that my character is honourable and without a stain. But now finding myself in such straits I submitted myself to the health authorities, and which resulted in to-day being judged incapable of serving in the Army by the Medical Board of the Hospital. I hope after my exclusion I shall be re-admitted although it may be necessary to pass a new examination, knowing that a person so benevolent and humanitarian as you always were will not leave me in despair. Subtracting all this pleonasm I will accept any other position should there not be at present a vacancy, and remain as always your admirer."

The death occurred recently, under distressing circumstances, of Mr. George Macauley, timekeeper at the Marconi Station, Clifden, Ireland. While cycling homewards to Ballinaboy, some two miles from Clifden, deceased lost control of his machine on a precipitous hill. The machine ran into a wall, with fatal consequences. Macauley was popular with all his comrades at the Marconi station, and the news of his untimely death came as a shock to them. He was a young man of many high qualities, and his manner endeared him to all with whom he came in contact.

Once again wireless operators have proved that in cases of emergency they are capable of rising to the highest traditions of the service. The story of the *Empress of Ireland* disaster is told elsewhere in this issue, and we need only recall here the careers of the operators who played their part manfully and well throughout most trying circumstances.

Mr. Ronald Ferguson, the senior operator, was born at New Brighton, and joined the Marconi International Marine Communication Co. on December 12th, 1910, as a learner in the Liverpool School. On obtaining the Postmaster-General's Certificate he was appointed operator on board the *City of York*. He has also served on the *Dina*, *Megantic*, *Mauretania*, *Campanello*, as well as on the *Empress of Ireland*. The junior operator, Mr. Edward Bamford, was born in Manchester, and did not join the Marconi Company until November 24th, 1913. He served first in the *Michigan*, and after three voyages he was appointed to the *Empress of Ireland*.



**Patent Record.**

The following patents were applied for during the past month:—

11708 & 11709. May 12th. Josef Schiessler (divided application on No. 2944/13). Arrangements for Wireless Telegraphy and Telephony. (*Complete*). Antennæ for Wireless Telegraphy and Telephony. (*Complete*).

11928. May 14th. Riccardo Arno. Generating electro-magnetic oscillations or high-frequency currents and methods derived therefrom for producing a continuous wave-flux or a continuous electro-magnetic flux or continuous current. (*Complete*).

11934. May 14th. Horace Manders. Method and means of producing oscillatory currents of electricity of small decrement and close wave train from alternating and continuous currents of electricity.

12257. May 18th. Wm. J. Mellersh-Jackson (for Fratelli Marzi di G.B., Italy). Method and means for production of sustained electric oscillations particularly for radio-telegraphy or radio-telephony. (*Complete*).

12277. May 18th. Adrian F. Sykes. Apparatus for electric signalling, especially applicable to Wireless Telegraphy.

12364. May 19th. Peder O. Pederson. Improvements in or relating to receivers for wireless telegraphy and telephony for diminishing atmospheric influence on such receivers. (*Complete*).

12633. May 22nd. John Hays Hammond, Junr. System of radio-control. (Divided application on 13310/13). (*Complete*).

12652. May 22nd. Fernand Holweck. Cathodic detectors. (Addition to 2206/14). (*Complete*).

12910. May 26th. Egmont Charles Hoegerstaedt. Method for generating electro-magnetic waves without mechanical motion.

13247. May 29th. Marconi's Wireless Telegraph Co., Ltd., and H. J. Round. Vacuum tubes used as magnifiers and producers of continuous electrical oscillations.

13248. May 29th. Marconi's Wireless Telegraph Co., Ltd., and H. J. Round. Production of continuous electrical oscillations and the utilisation thereof for wireless telegraphy and telephony.

13359. May 30th. Eugene Victor Gratzc. Electric clocks or timekeepers operated and controlled by wireless waves.

13374. June 2nd. Charles S. Lenz. High-frequency current rectifier for rectifying high-frequency wave impulses in a wireless receiving circuit.

13472 and 13474. June 2nd. Sterling Telephone & Electric Co., Ltd., and T. D. Ward Miller. Crystal and the like detectors. Rotary spark-gaps.

13497. June 3rd. Edouard Belin. Arrangements for regulating timepieces and the like by wireless signals. (*Complete*).

13520. June 3rd. Signal Ges., M.B.H. Radiating system for signalling by electric waves from aeroplanes. (Addition to Nos. 736 and 23728 of 1913). (*Complete*).

**Company Matters.**

**T**HE Annual Meeting of the Compagnie Française Maritime et Coloniale de Telegraphie Sans Fil (the French Marconi Company) was held in Paris on May 26th, the Chairman of the Company, Baron de la Chevreliere, presiding. The Annual Report submitted to the meeting stated that the Company had fitted 30 additional ships during the year 1913, making a total of 76 ships fitted at December 31st, 1913. The number of telegrams sent and received by ships during the year was 130,464, an increase of 47,583. A dividend of 10 per cent. on the Ordinary Shares payable on the 10th July was declared, and Commendatore G. Marconi was re-elected a Director of the Company.

\* \* \*

The report of the directors of the Marconi International Marine Communication Co., Ltd., appears on page 271.

An Extraordinary General Meeting was held immediately after the Ordinary General Meeting, which approved the necessary alteration to the Memorandum of Association authorising the Company to adopt the superannuation scheme referred to in the report.

The retiring Directors, Commendatore Guglielmo Marconi and M. Maurice Travailleur, were re-elected. General Albert Thys was elected to the Board on July 10th, 1913.

\* \* \*

The Annual General Meeting of the Société Russe de Télégraphes et Téléphones sans Fil (Russian Marconi Company) was held in St. Petersburg, on Saturday, June 13th, when a dividend of 6 per cent. was declared.

**Share Market.**

*June 20th, 1914.*

The share market has been featureless during the past month, closing prices being as under: Marconi Ordinary, £2 18s. 9d.; Marconi Preference, £2 8s. 9d.; Marconi International, £1 7s. 6d.; American Marconi, 13s. 9d.; Canadian Marconi, 6s. 9d.; Spanish Trust, 6s. 9d.

## THE MARCONI INTERNATIONAL MARINE COMMUNICATION CO., LTD.

**T**HE Directors' Report and Balance Sheet of the Marconi International Marine Communication Co., Ltd., for the year ending December 31st, 1913, was presented at a meeting of the shareholders of the Company on June 30th. According to this statement, the Company's business continues to show satisfactory progress, the net profit for the year under review amounting to £37,029 5s. 7d. after deducting the sum of £23,881 1s. 10d. for depreciation and allowance for debenture interest, as compared with a net profit of £24,435 17s. 11d. for the preceding year.

The revenue from ships' telegrams, subsidies, etc., amounted to £146,316 18s. 11d., which is a substantial increase over the amount of £100,322 17s. 10d. for the year 1912.

The number of telegraph stations owned and worked by the Company as public telegraph stations on the high seas increased during the year from 580 at the end of 1912 to 788 at the end of 1913. The number fitted to the present date is 873. There are now some 2,000 ships of different nations, exclusive of ships of war, fitted with Marconi telegraph stations.

The Company's business is well organised, and the discipline on board ships excellent. Of this there could be no better testimony than the immense number of lives and the number of ships which the Company and its officers have been instrumental in saving in the past, and continue to save year after year.

An international convention for the safety of life at sea was signed in London on January 20th, 1914, and a Bill to give effect thereto is now before Parliament. Under this Bill wireless telegraphy is rendered compulsory upon ships carrying 50 or more persons, including crew. It is probable that this is only intended as a first step in this direction, for it is difficult to understand why when 50 persons are on board a ship they should be provided with the means of being saved, but if the number be only 49 all may be allowed to drown. In the opinion of the Directors, every ship which sails 50 miles or more from the coast should

be fitted with wireless telegraphy. Apart from the necessity of providing so valuable a life-saving apparatus for those employed upon the smaller craft, it is obvious that when misfortune befalls a large vessel every small boat within the radius of a wireless call should be capable of being summoned to immediate aid. Had this been the practice in recent years many more thousands of valuable lives would have been saved.

In Australia the Company's licence and business have been transferred to a Company representing an amalgamation of interests in which the Marconi International Marine Communication Company holds a number of shares.

In July, 1913, the Directors offered 102,028 shares at a premium of 5s. per share to the Shareholders in proportion to their holdings. The issue was guaranteed by the Spanish and General Wireless Trust Limited in consideration of a commission of 1s. 6d. per share on the whole issue and an option over the remaining 43,916 unissued shares of the Company at the price of £1 5s. for two years from June 27th, 1913, and the whole of the shares offered were duly subscribed and allotted.

In accordance with the power contained in Articles 29 and 30 of the Company's Articles of Association, the Directors in January last adopted regulations for the issue of share warrants to bearer and copies of such regulations may be obtained upon application to the Company.

Being of opinion that the time had arrived to make some provision for the employees of the Company on retirement, the Directors entered into a provisional agreement with the North British and Mercantile Insurance Company for the establishment of a superannuation fund.

The Directors recommended the payment of a final dividend for the year 1913 of 5 per cent., which with the interim dividend already paid will make 10 per cent. for the year, the total of which will amount to £30,604 0s. 6d.

The sum of £3,500 is allocated to the repayment of Debenture Account, leaving a sum of £6,067 13s. 10d. to be carried forward.



# Positions of Operators

(June 13th, 1914)

- Abbott, S. H. V., *California (P.S.N.)*.  
 Adams, J. H. S., *Berrima* (resigned).  
 Adams, F. W., *Michigan* (Warrens).  
 Adams, G. E., *St. Andrew*.  
 Adnitt, C. H. H., *Edinburgh Castle*.  
 Akehurst, C. J., *Highland Laird*.  
 Akerman, A. R., *La Negra*.  
 Albrow, H. V., *Arzila*.  
 Alderton, C. G., *Beacon Grange*.  
 Alford, L. W. G., resigned.  
 Alchurch, H. P., *Devonian*.  
 Allison, W., sick leave.  
 Allnutt, C. M., *City of London*.  
 Allott, N. E., *Chili*.  
 Allsworth, H. P., resigned.  
 Alston, S. K., on leave.  
 Alton, H. F., *Mesaba*.  
 Alton, T. F., *Chaleur*.  
 Ambler, P., *Mexico (P.S.N.)*.  
 Amott, F., *Maryland*.  
 Anderson, G. A. L., joined Wireless Co.  
 Anderson, G. D., *Elephantia*.  
 Anderson, L. N., *Saxonia*.  
 Andrews, A., *San Dunstano*.  
 Angill, A. G., *Irishman*.  
 Arbuckle, D., *Grampian*.  
 Aris, B. F., *Waipara*.  
 Arlaud, C., *Sardinia*.  
 Armstrong, C. C., *Oropean*.  
 Armstrong, S., *Normannia*.  
 Arnolds, A. C., *Cevic*.  
 Arrowsmith, G., *Appam*.  
 Ashbrook, J., *Arabic*.  
 Atkinson, J., *Corcoevada*.  
 Atkinson, W. F., *La Correntina*.  
 Atkinson, W. H., *Narragansett*.  
 Auvache, J. E., *Medina*.  
 Avery, F., *Chaudiere*.  
 d'Avigdor, A. H. D., *Carmania*.  
 Bailey, F. M., *Arabic*.  
 Baile, H. H., *Teutonic*.  
 Bain, W. R., *Kelembank*.  
 Baker, A. E., *Euripides*.  
 Baker, F. H., *Orteric*.  
 Baker, J. R., *Oriasa*.  
 Balding, G., unattached.  
 Balfour, G. W., *Liverpool*.  
 Ballard, A. E. R., *Oruba*.  
 Bamford, E., in Montreal.  
 Bamford, J. R., *City of Vienna*.  
 Banbery, W. C., *Durham Castle*.  
 Band, H. J., *Star of Australia*.  
 Barber, C. E., *Highland Brae*.  
 Barber, W., *City of Exeter*.  
 Barker, L. T., *Matura*.  
 Baron, C. F., *Huanchaco*.  
 Barrell, W. S., unattached.  
 Barron, T. G., *Baron Jedburgh*.  
 Bartlett, C. H., *Demosthenes*.  
 Baxter, B. O., *San Wulfrido*.  
 Benmon, T., *Ascot*.  
 Bean, H. H., *Arzila*.  
 Beardmore, G. A., *Caledonian (Leyland)*.  
 Beatson, F., *Asturias*.  
 Beckett, G. N., *Panoras*.  
 Beckett, J., *Corinthian*.  
 Beilby, W., *Uranium*.  
 Belcher, H. F., *Armada Castle*.  
 Bell, A., *Highland Laird*.  
 Bell, E., unattached.  
 Bell, J. A., *Rarburn*.  
 Bellhouse, G. L., *Benefactor*.  
 Bernard, R. A., *Malla*.  
 Berry, C., *Bovic*.  
 Bessell, B. W., *Minnetonka*.  
 Beynon, A. R., *Kanawha*.  
 Biggins, J., *Dominion*.  
 Bilton, W. W., *Hantonis*.  
 Birch, A., unattached.  
 Birtwistle, W., *Himalaya*.  
 Blake, E., *Macedonia*.  
 Blezard, J., *Magdalena*.  
 Blight, W. T., *Poona*.  
 Bliss, G. E., *Carnarvonshire*.  
 Blizzard, R. E., *Tara*.  
 Blow, A. G., unattached.  
 Bloxham, A. I. W. H., *Grantully Castle*.  
 Blundell, E. T., *Orfordshire*.  
 Boileau, J. M., resigned.  
 Bolster, A., *Teesta*.  
 Bone, D. W., *Monmouthshire*.  
 Boon, N. A., *Bogota*.  
 Boorne, E. V., *Takada*.  
 Bower, A. D., sick leave.  
 Boeling, J. E. K., *China*.  
 Bowman, H. A., *Welshman*.  
 Boxer, H. R., *Hurunui*.  
 Boylan, J. A., *San Bernardo*.  
 Bradfield, T., *Mashobra*.  
 Bradley, F. A., *Chignecto*.  
 Brain, R. L., *Haverford*.  
 Bramley, J. R. C., *Italia*.  
 Bransby, A. H., *Highland Brigade*.  
 Branton, S. V., *Pera*.  
 Brenner, J., *Barranca*.  
 Brennan, J., *Empress of Britain*.  
 Brett, C. H., *Limerick*.  
 Brewer, C. H., *Caledonia*.  
 Bridges, W., *Deana*.  
 Bright, A. E., *Masilia*.  
 Brindle, F., *Kathiascar*.  
 Brookes, J. F., *Ardeola*.  
 Brophy, M. J., *Drina*.  
 Brown, A. C., *Gulacian*.  
 Brown, A. H., *Demerara*.  
 Brown, A. R., *Montagua*.  
 Brown, J., *Potaro*.  
 Brown, J. A., *Briton*.  
 Brown, S. W., *Desado*.  
 Brown, Stanley W., *Dresado*.  
 Browne, A., *Huasco*.  
 Browne, C., *Alastian*.  
 Brun, L. S., *Perugia*.  
 Bruton, A. F., resigned.  
 Bryan, H. F. B., *Sardinian*.  
 Bryant, P., *Varela*.  
 Budge, J., *Quillota*.  
 Bull, J. G., *City of Madras*.  
 Burgess, A. F. T., *Ucayali*.  
 Burgham, G. M., *Ruapehu*.  
 Burke, M. M., unattached.  
 Burnett, W. C., *La Blanca*.  
 Burnett, W. J. T., *City of Chester*.  
 Burrows, T. R., *Borda*.  
 Butler, J., *Iernia*.  
 Butterworth, J. M., *Abosso*.  
 Buttle, J. G., *San Tirso*.  
 Calne, G., *Minneapolis*.  
 Caldwell, A. C., *Suetic*.  
 Caldwell, J., *City of Paris*.  
 Calver, F. N., *Aquitania*.  
 Calver, G. H., *Megantic*.  
 Cameron, R. S., *Pardo*.  
 Camfield, J., *Bohemian*.  
 Campbell, M. J., *San Urbano*.  
 Candy, W. H., *Montcalm*.  
 Carey, J. P., *Drumcree*.  
 Carnaby, N. E., *Berwick Castle*.  
 Carroll, J., *Arzila*.  
 Carruthers, G., *Campania*.  
 Carter, B. A., *Baroda*.  
 Carter, W., *Chagrea*.  
 Cauvin, M. A. H., *Manzruen*.  
 Cavanagh, H. S., *Alaunia*.  
 Chadwick, J. G., sick leave.  
 Chapman, G. G., *Monjolan*.  
 Chapman, T. J., *Ekma*.  
 Chesterton, A. J., *Itapora*.  
 Cheyne, J., *California*.  
 Chick, C. A., *Trafford Hall*.  
 Chick, O., *San Melito*.  
 Chick, W. H., *Orotava*.  
 Child, L. J., *Oriasa*.  
 Church, G. I., unattached.  
 Church, T. M., unattached.  
 Clark, F., *Star of India*.  
 Clark, J. W., *Izurutu*.  
 Clark, J. W. A., *Pathan*.  
 Clark, L. B., *Sagamore*.  
 Clark, P. S., *Assaye*.  
 Clarke, A. H., *Oceanic*.  
 Clarke, A. M., *San Francisco*.  
 Clarke, H. T., *Comrie Castle*.  
 Clarke, J. G., *Sagamore*.  
 Clarke, W. F.,  
 Clarke, W. J., *Victorian (Leyland)*.  
 Clarkson, G., *Crown of Toledo*.  
 Cleary, L. F., *City of Glasgow*.  
 Cleaver, W. W., *Orama*.  
 Cleverley, E. S., *Amazon*.  
 Clifford, A. J., *City of Bombay*.  
 Cobham, A., *Franconia*.  
 Cocks, H., *Ingoma*.  
 Coiley, P. J., *San Gregorio*.  
 Coldwell, G. A., *El Cordoba*.  
 Coleman, T. H., *Gloucestershire*.  
 Condou, W., unattached.  
 Connell, J., *Liverpool Depot*.  
 Cook, J., *Ricardo a Westra*.  
 Cook, F., *Georgian*.  
 Cook, G. E., *Athenic*.  
 Cookson, V., *Sachem*.  
 Cornuck, D. R., *Scindia*.  
 Cornuck, W. L., *Gujurat*.  
 Cottam, H. T., *Lochboisdale*.  
 Cousens, E. C., *Nubia*.  
 Cousens, W. T., *Clearway*.  
 Cowhey, K. S., *Laconia*.  
 Cox, E. J., *Knight Templar*.  
 Cox, L. H., *Eupion*.  
 Cox, W. G., *Baltic*.  
 Coysh, W. D., *Mongolian*.  
 Craigie, J. A., *Campania*.  
 Craven, W. M., *Themistocles*.  
 Crawford, J. G., *Andorhina*.  
 Crofts, A., *City of Durham*.  
 Croke, L. G., *Mantua*.  
 Crookes, W. D., *Tyrolia*.  
 Crosby, S., *Asian*.  
 Cross, S. R., *Megantic*.  
 Crossman, C. H. G., unattached.  
 Cruess Callaghan, S., *Koranna*.  
 Cryan, W. J., *Michigan*.  
 Cunningham, J., *Luceric*.  
 Cutlisch, H. E., *Karoo*.  
 Dale James, W. R., *Marmora*.  
 Daly, D. G., *Tren*.  
 Daly, R. H., *Walmer Castle*.  
 Damen, O. G., *Inanda*.  
 Daniels, J. H., *Missouri*.  
 Darby, P. T., *Francis*.  
 Darracott, R. B., *Alnwick Castle*.  
 Davey, A., *Erinpura*.  
 Davies, F., *Caronia*.  
 Davies, J. E., *Orduna*.  
 Davies, J. I., *Mimiro*.  
 Davies, W., *Liverpool Depot*.  
 Davis, A. C. J., *Manora*.  
 Davis, G. E., *Desabla*.  
 Davy, W. H. G., *Karema*.  
 Dawson, B., *Canopic*.  
 Dawson, W., *Philadelphian*.  
 Day, E. J., *Palena*.  
 Dean, F. A. W., *Californian*.  
 Dean, J. J., *Botanist*.  
 Dennison, P., *Den of Crombie*.  
 Dennis, F. L., *Minneceaska*.  
 Dewey, G. H., *Vitruvia*.

- Dewitt, D. T., *Barneson*.  
 Dick, J., *Ausonia*.  
 Dicks, A. G., *Rangatira*.  
 Dickinson, A., *Peru*.  
 Dixon, E. W., *Namur*.  
 Dods, L. A., *Victorian* (Allan).  
 Docherty, P., *Moldavia*.  
 Donnan, W. J., *Indian*.  
 Donnegan, J. J., *Berwindmore*.  
 Driscoll, J. R., *Waicera*.  
 Dohan, J., on leave.  
 Duff, J., *Corsican*.  
 Duncanson, J., *Bamora*.  
 Durston, W. J., *Cambrian*.  
 Dyer, E. W., *Corinthian*.  
 Earl, H. E., *Aeon*.  
 Earl, W. F., *Highland Rover*.  
 Earle, H., *Huallaga*.  
 Ebbetts, F. T., *Ellore*.  
 Eccles, P. B., *Delphic*.  
 Eddington, D. F., *Oruba*.  
 Edwards, W. G., *Karama*.  
 Egan, M. B., *Gaika*.  
 Elliott, B. S., *Empress of Asia*.  
 Emery, B. F., *Arnkola*.  
 Empson, T. L., *Hankura*.  
 Enthwistle, A. M., *Aragon*.  
 Erbach, E. W., *Matina*.  
 Evans, A. W. N., *City of Baroda*.  
 Evans, C. F., *Manzman*.  
 Evans, T. H., *Runic*.  
 Fagg, G. K., *Audes*.  
 Farman, A. H., *Zent*.  
 Farmery, J. C., *Calypso*.  
 Farrell, R. T., *Suazi*.  
 Ferguson, R., *Empress of Ireland* (enquiry).  
 Findlay, J. N., *Whakarua*.  
 Firman, A. R., *La Rosarina*.  
 Firth, P. S., *Idaho*.  
 Fitton, F., *Ruthena*.  
 Fitzgerald, J. M., *Potomac*.  
 Fletcher, L., *Carmania*.  
 Ford, H., *Stephen*.  
 Foreman, D. G., *Ionian*.  
 Foster, R. T., *Tagus*.  
 Fowler, W., *San Zeferano*.  
 Fox, L. C., *Paparoa*.  
 Fox, W., *Knight Companion*.  
 Foyle, H. J., *Kentucky*.  
 Fraser, R., *Caledonia* (Anchor).  
 Freeman, H. T. E., *Pardo*.  
 Fry, F. A., *Hubert*.  
 Gadd, W. C., *Aronada*.  
 Gale, B., *Lusitania*.  
 Gale, W., *Asturias*.  
 Gallagher, H. J., *Omrah*.  
 Garbutt, H. W., *Kia Ora*.  
 Gardner, F. T., *Candidate*.  
 Gardner, R. S., *Numidian*.  
 Garner, G. J., *Minneceaska*.  
 Garwood, F. W., *Akabo*.  
 Gascoyne, R. A., *Oriental*.  
 Gibb, J., *Cufic*.  
 Gibson, A., *Orita*.  
 Giles, A. M. D., on leave.  
 Giles, R. W., *Changuinola*.  
 Gill, C. J. A., *Merion*.  
 Gillam, A. C., *Carpattia*.  
 Gillett, B. A., *Caribbean*.  
 Golding, J. H., *Guildford Castle*.  
 Goodsell, W. B., *San Valerio*.  
 Gornall, J., *Karina*.  
 Graham, T., *Winfredian*.  
 Grant, P. C., *Galician*.  
 Graves, D., *Vandyck*.  
 Graves, W. P., *Hypatia*.  
 Gray, F., *Uranium*.  
 Gray, J. H., *Caronia*.  
 Gray, W. F., *Tanda*.  
 Green, E. H., *Campanello*.  
 Greene, A. L., *Highland Pride*.  
 Greenstreet, P., *Whakarua*.  
 Gregory, R. V., *Potaro*.  
 Gregson, A. J., *Caesarea*.  
 Gregson, E. A., *Numidian*.  
 Greig, A. F., *Campanello*.  
 Gresham Barber, K., London office.  
 Griffith, J. T. R., *Munster*.  
 Griffiths, A., *Vauban*.  
 Grover, A. F., *S. Y. Lysitra*.  
 Groves, W. G., *Zealandic*.  
 Gullen, F., *Mechanician*.  
 Haddock, R. B., *Kenilworth Castle*.  
 Hagon, W. R., *Manzanaras*.  
 Hague, W. J., *Duendes*.  
 Haining, A. J., *Kildonan Castle*.  
 Halcrow, A., *San Jero timo*.  
 Hall, H., *Caraquet*.  
 Halsall, T. H., *Hesperian*.  
 Hamlet, M. B. W., *Peru*.  
 Hancock, L. A., *Palascan*.  
 Hanson, A. E., *Poleric*.  
 Harding, R., sick leave.  
 Hardy, R. S., *Laurentic*.  
 Hardy, H. E., *S. Y. Doris*.  
 Hardy, C. L., *Bovic*.  
 Harford, R., *Minneapolis*.  
 Harlow, E., *St. George*.  
 Harris, A. J., *Lake Michigan*.  
 Harrop, T., *Danube*.  
 Hart, H. P. J., *Nyanza*.  
 Hartigan, M. J., *Sardinian*.  
 Harvey, D., *Cassandra*.  
 Hatfield, A. H., *Cedric*.  
 Hathaway, A. D., *Rimutaka*.  
 Hawes, H., *Hydaspes*.  
 Hawkes, G. E., *Letitia*.  
 Heath, W. H., *Garth Castle*.  
 Hendersin, W. C., *Jose de Larrinaga*.  
 Hendry, A. O. R., *City of Naples*.  
 Henry, R. J., *Nicoya*.  
 Herbert, C. W., *Medic*.  
 Herbert, T., *Sicilian*.  
 Herd, H., *Corsican*.  
 Hewitt, S., *Milwaukee*.  
 Hickling, W., *Herbice*.  
 Hicks, W. J., *El Torro*.  
 Higgins, W. M., *Andania*.  
 Hill, A. E., *Otranto*.  
 Hill, A. G., *Inverlay*.  
 Hill, E. G., *Tunisian*.  
 Hill, G. R., *Vauban*.  
 Hill, V. J., *Anglian*.  
 Hilton, F., *Scotian*.  
 Hindle, T., *Victorian* (Leyland).  
 Hitchner, J. W., *Barpeta*.  
 Hoare, H. R., *Corinthic*.  
 Hobbs, P. R., *Abosso*.  
 Hodge, T. H., *Chilka*.  
 Hodgson, W. H., *Chinkoa*.  
 Holden, H., *Kandahar*.  
 Holden, T. F., *City of Karachi*.  
 Holker, N., *Saldanha*.  
 Holland, E. J., *Barjora*.  
 Holliday, P., *Demerara*.  
 Holman, C. G., *Empress of Britain*.  
 Holmes, T. B., *Historian*.  
 Hooley, T. E., *Berrindale*.  
 Hood, J. A., *Ullonia*.  
 Hooper, P. H., *Galeka*.  
 Hopps, R. G., sick leave.  
 Horne, T., *Lusitania*.  
 Horwood, H. J., *Alaunia*.  
 Hosking, L. G., *Palermo*.  
 Howard, E., sick leave.  
 Howard, J. Q., *City of Birmingham*.  
 Howard, W., *Hermione*.  
 Howlett, W. J., *Manitou*.  
 Huggins, W. T., *Nauralia*.  
 Hughes, C. L., *Highland Harrie*.  
 Hughes, C. K., *Magellan*.  
 Hughes, L. E., *Olympic*.  
 Hughes, W. J., *Adriatic*.  
 Hugo, V. S., unattached.  
 Humphreys, E. H., *Wilcannia*.  
 Hunt, F. G., *Cambrian*.  
 Hunt, G., *Victorian*.  
 Hunt, H. B., *Ballarat*.  
 Hunter, A. E., *Parthemia*.  
 Hutchison, W. E., *Highland Corrie*.  
 Inder, W. W., *Cymric*.  
 Ingle, G. W., *India*.  
 Iredale, J. J., *Canada*.  
 Ings, W. A., *Star of Australia*.  
 Isherwood, T. P., *Afric*.  
 Jacobs, A. G., *Ascania*.  
 James, F., *City of Poona*.  
 James, R. C., *Kasenga*.  
 James, R. H., *Royston Grange*.  
 Jamison, A. F., *Orones*.  
 Jeffries, A. H., *Ulster*.  
 Jeffries, F., *California* (Anchor).  
 John, W. L., *Syria*.  
 Johnson, F., *Denia*.  
 Johnson, W. A., *San Fraterno*.  
 Johnston, M., *Kasama*.  
 Jolly, E. E., *Briton*.  
 Jones, A. E., *India*.  
 Jones, A. V. G., *El Argentino*.  
 Jones, C. E., *La Marguerite*.  
 Jones, C. F., *Quillda*.  
 Jones, H., *La Blanca*.  
 Jones, J. P., *Calgarian*.  
 Jones, O., *Qaterley*.  
 Jones, R., *Columbia*.  
 Jones, Richard, *El Uruguayo*.  
 Jones, T. G., *Canopic*.  
 Jones, W. A., *Canada*.  
 Julius, A., *Orduna*.  
 Kean, O. P., *Manhattaa*.  
 Keen, F. L., *Saxonia*.  
 Kelly, J. A., *Carthaginian*.  
 Kelly, K. C., *Sicilia*.  
 Kett, H. S., *Philadelphian*.  
 Kenworthy, H. D., *Goorkha*.  
 Kinder, F. V., *Westmeath*.  
 King, B., *Colorado*.  
 King, R. R., *British Sun*.  
 King, V. M., *Araguaya*.  
 Kingsbury, A., *Makarini*.  
 Kingsford, J. R., *S. Y. Sapphire*.  
 Knapman, W. H., *Simla*.  
 Knox, T., *Ulysses*.  
 Kull, G. R., *Llandoverly Castle*.  
 Lacock, T. J., *Scandinavian*.  
 Lambert, E., *South Point*.  
 Lambert, G. H., *Circensia*.  
 Lambert, L. J., *Mendi*.  
 Langham, A. E., *Charles E. Harwood*.  
 Langley, A., *Goorkha*.  
 Law, C., *Shenandoah*.  
 Law, S., *Pannonia*.  
 Lawson, A. L., *Aranuaya*.  
 Lawton, A. H., *Flamenco*.  
 Lea, R. H., *Highland Enterprise*.  
 Learman, E. E., *Anglian*.  
 Leche, W. J., *Ben Macbrece*.  
 Ledward, T. A., *Aguila*.  
 Lee, G., *Musician*.  
 Lee, R. A. C., *S. Y. Cassandra*.  
 Lee, W., *Mexico* (P.S.N.).  
 Leech, H. S., *Cymric*.  
 Leeds, K. F. N., *Ellenga*.  
 Lees, E. A., *City of Winchester*.  
 Lees, J. H. D., *Nagoya*.  
 Lefebvre, H. H. R. A. C., *Faron Napire*.  
 Leighton, L. H., *Narragansett*.  
 Leith, R., *Aquitania*.  
 Leith, S. A., sick leave.  
 Lemon, S., *Alsatian*.  
 Leonard, D. P., *Laucastrian*.  
 Lever, G. H., *Marquette*.  
 Lewington, W. H., *Francisco*.  
 Lewis, W. T., *Lacovia*.  
 Lewis, S. B., *Buffalo*.  
 Lewis, S. W., *Deana*.  
 Lightfoot, H. J., *Darro*.  
 Lillis, W., *Celtic*.  
 Lindsay, M. J., resigned.  
 Lines, W. T., *Pannonia*.  
 Linnell, F. J., *Rectorua*.  
 Lister, C., *Caribbean*.  
 Litchfield, C. P., *Den of Ruthven*.  
 Lithgow, W. H., *City of Columbia*.  
 Little, H. T., *Exmouth II*.  
 Lock, H. G. W., unattached.  
 Longton, C. E., *Letitia*.  
 Lovelock, J. D., *Michigan*.  
 Lovett, F. J., *Melford Hall*.  
 Lovibond, R. A., *Parana*.  
 Lucey, J., *Candia*.  
 Lund, A. C., *Brarmar Castle*.  
 Lush, J. K., *Nestor*.  
 Lynch, G., *Ghazee*.  
 Lyons, J., *Oronas*.  
 Macdonald, J., *Marina*.  
 Machan, J. W., *City of Corinth*.  
 Mackenzie, C. F., sick leave.  
 Mackintosh, J., *Atahualpa*.  
 Macleod, S. E. S., *Hororata*.  
 Macnab, J. A., *Bohemian*.  
 Macrae, C., *Cedric*.  
 Macrae, K., *Jugoma*.  
 Madgwick, G., *Mahroussa*.



- Makin, A. E., Canadian Co.  
 Maltby, P. B., *City of Bristol*.  
 Mangan, D. D., *Chirropo*.  
 Mares, A. H., *Castalia*.  
 Marriott, J. E., *Dunluce Castle*.  
 Marsh, J. E., *Dominion*.  
 Marshall, W. T., *Scandinavian*.  
 Martin, P. B., *Olympia*.  
 Martin, S. F., *Melania*.  
 Martlieu, J. E., *Asturias*.  
 Massey, C. T., *Mesaba*.  
 Massey, W., *Dakar*.  
 Masters, C. E. E., *Highland Laddie*.  
 Mather, J., *Andania*.  
 Matthews, E. N., *Niceto de Lurrinaga*.  
 Matthews, W. C., *Eskimo*.  
 Mattinson, E. V., *Cassia*.  
 Mattock, P., *Oriana*.  
 Maudsley, C. B., *Coronia*.  
 Morris, J., *Den of Airlie*.  
 Mauro, O. G., *Junin*.  
 May, A. H., *Manitou*.  
 May, P. B., *Armada Castle*.  
 Mayoock, T. C. C., *Star of Scotland*.  
 Mayer, E. D., *Edinburgh Castle*.  
 McCarthy, C. F., *Philadelphia*.  
 McCarthy, C. M. M., *Pomsonian*.  
 McCarthy, C. J., *Isis*.  
 McCormack, D. C., *Sandon Hall*.  
 McCreath, R. V., *Drumlanrig*.  
 McCrohan, T., *Inca*.  
 McCutcheon, W. J., *Reventazon*.  
 McEnery, T. C., *Aysen*.  
 McGehe, W. J., *Calgarian*.  
 McKenna, J. M., *Crofton Hall*.  
 McLachlan, D., *Genesee*.  
 McLennan, R. F., *Gloucester Castle*.  
 McMillan, J., *Hesperides*.  
 Melling, H., *Denbigh Hall*.  
 Meredith, M. W., *Italia*.  
 Middleton, P. G., *Hilary*.  
 Miles, J. L., sick leave.  
 Miles, L. J., *Victorian* (Allan).  
 Miller, D., *Brilliantia*.  
 Miller, W., *Persic*.  
 Miller, W. J., *Start Point*.  
 Mills, H. H. L., *Liverpool Depot*.  
 Mills, L. C., *Star of Ireland*.  
 Mills, W. H., *Minnehaha*.  
 Mitchell, A. J. H., *Galuscy Castle*.  
 Mitchell, F., *Khyber*.  
 Mitchell, P. M., unattached.  
 Mitchell, S. W., *Appalachee*.  
 Mole, H., *Custodian*.  
 Monsey, M., *Scotian*.  
 Montgomery, J., *Pretorian*.  
 Montgomery, B. H., *Chaleur*.  
 Moodie, T., resigned.  
 Moody, J., *Balmoral Castle*.  
 Moon, A. T., *Angora*.  
 Moore, J. J., *Quernmore*.  
 Moore, J. H., *Arankola*.  
 Morgans, R. H., *Lackawanna*.  
 Moriarty, D. J., *Matoppo*.  
 Morris, P., *Desado*.  
 Morris, C. E., *Kalomo*.  
 Morris, T. P., *C. A. Canfield*.  
 Morrison, L. D. G., *Barala*.  
 Morrison, J. D., *Saturnia*.  
 Morse, W. S., *Vandyck*.  
 Moss, C. O., *Antony*.  
 Mountain, R. H., *Drina*.  
 Mowe, F. H., *S. Y. Valiant*.  
 Mulhall, J. P., *Caraguet*.  
 Munro, H., unattached, Glasgow.  
 Murch, R. W. B., *Puluca*.  
 Murphy, D., *Wakutane*.  
 Murphy, E., *Mauretanian*.  
 Murphy, H. P., *Ortega*.  
 Murphy, J., *Mandaro*.  
 Murphy, W. F., resigned June 5th.  
 Murray, T. W., *Aguilania*.  
 Muschamp, T., *Brilon*.  
 Myron, G., *Tritonia*.  
 Nailer, E. I. F., *Borderer*.  
 Nash, R. H., *Herefordshire*.  
 Naylor, A. T., *Gaecon*.  
 Needs, W. A., *Nellore*.  
 Nelson, G. H., *Winifredian*.  
 Nethercoate, J. K., resigned.  
 Newby, F. W., *Asturias*.  
 Newman, W., *Highland Watch*.  
 News, L. S., *Canning*.  
 Nicholas, W. G., *Bolton Castle*.  
 Nicholls, G. J. G., *Huntsman*.  
 Nicholson, A., *Taroba*.  
 Nicholson, J., *Winifredian*.  
 Nightingale, F., *Bandra*.  
 Nixon, C. S. C., *Devoa*.  
 Noble, H., *Palma*.  
 Nolan, J. J., *San Hilario*.  
 Norwood, P. R., *Warwickshire*.  
 Nowlan, C. F., *Moto*.  
 Obey, W. C., *Aleantara*.  
 O'Brien, G. W., *Marere*.  
 O'Carroll, M. E., *Cassandra*.  
 O'Connor, A. W., *Highland Warrior*.  
 O'Connor, J., *Iropuio*.  
 O'Connor, P., *Principello*.  
 O'Connor, P. J., *Narragansett*.  
 O'Connor, T., *Montfort*.  
 O'Donnell, T. J., *Laurentic*.  
 O'Halloran, T., *Otaki*.  
 O'Keefe, P., *Vedamore*.  
 Oliver, C. A., *Moloya*.  
 Oliver, H., *Arcadia*.  
 O'Riordan, T., *Marengo*.  
 Osborne, A. J., *Tunisian*.  
 Osborne, A. E., *Sutherland Grange*.  
 Osborne, J. Edward, resigned May 15th.  
 Osborne, J. Edwin, *Cluny Castle*.  
 Osborne, R. F., *Trent*.  
 O'Sullivan, D., *Mount Temple*.  
 O'Sullivan, C. F., *Turcoman*.  
 O'Sullivan, J. P., unattached.  
 Overall, E., on leave.  
 Owen, A. W., unattached.  
 Owen, L., *El Toro*.  
 Owen, B. M., *Carpentaria*.  
 Owen, W., *Aaro*.  
 Owlett, R. A. J., *Ivernia*.  
 Packer, R. H., *S. Y. Iolanda*.  
 Pales, F. A., *Ascania*.  
 Palmer, H. M., *Pakeha*.  
 Pannett, W. E., *Menominee*.  
 Parker, C. T., *Khisa*.  
 Parker, E. P., *Nezasa*.  
 Parkinson, W., *Kathamba*.  
 Patrick, R. V., *Kildonan Castle*.  
 Payne, J. H., *Peshawar*.  
 Payne, T. A., unattached.  
 Pavitt, H. J., *Ausonias*.  
 Pearson, D. E., on leave.  
 Peever, F., *Tropic*.  
 Penketh, G., *Cardiganshire*.  
 Pennington, C. J., *Star of Victoria*.  
 Penrose, H. E., *Minnehaha*.  
 Pepper, G. F., *Llanstephen Castle*.  
 Perfect, A. E., sick leave.  
 Perkins, C. W., *Leicestershire*.  
 Perkins, H. J., on leave.  
 Perlman, A., *Bloemfontein*.  
 Peterson, T. G., *Morea*.  
 Pettingill, W., *Orsova*.  
 Phelan, N. J., *Orisa*.  
 Pink, Alfred, *City of York*.  
 Pitchford, G. R. J. W., *Lanfranc*.  
 Pitkeathly, W., *Garth Castle*.  
 Planterose, E. A., *Arabia*.  
 Pollard, F. G., *Arlanza*.  
 Ponsford, W. H., *Grantully Castle*.  
 Pope, H. W., *Crown Point*.  
 Porter, H. R., *Winifredian*.  
 Pott, G. M., *Grampian*.  
 Potts, A. S., *Ortega*.  
 Potts, J. W., *Nanerie*.  
 Power, P. J., *Galeka*.  
 Power, W., *Sagamore*.  
 Preece, E., *Surat*.  
 Preston, M. A., *Panama*.  
 Pritchard, F., *Liverpool Depot*.  
 Proughton, A. J., *Tonasoanda*.  
 Quinlan, J. F., *Orcoma*.  
 Raitlan, N., *Marere*.  
 Ralphs, P. L., *San Isidoro*.  
 Rapsey, C., *Patia*.  
 Ratcliffe, L. G., *City of Calcutta*.  
 Ratcliffe, T. C., *Avon*.  
 Rattee, S. G., unattached.  
 Raw, W., *Arawa*.  
 Rawsthorne, W., *Pacuare*.  
 Rea, J., *Aracalaca*.  
 Read, C. A., *Sachem*.  
 Reid, H. S., *Highland Loch*.  
 Reid, S., *Haverford*.  
 Reid, W. H. W., *Benalla*.  
 Reidy, M., *Etonian*.  
 Renshaw, P. J., *Ullonia*.  
 Renwick, W. D. R., *Highland Heather*.  
 Revell, J. L., *Dunluce Castle*.  
 Reynolds, A. J., *Galileo*.  
 Reynolds, F. W. J., *Carnarvonshire*.  
 Rhodes, T., *Ionian*.  
 Ricci, R. E., *Tainui*.  
 Rice, H. W., *Carmania*.  
 Rice, P. F., *Indrabarrak*.  
 Ridley, K. M., *Aeneas*.  
 Rivett, F. W., *City of Edinburgh*.  
 Robb, T., *Toronto*.  
 Roberts, C. O., *Oropesa*.  
 Roberts, D., *City of Benares*.  
 Roberts, G., *Virginian*.  
 Roberts, M., *North Point*.  
 Robertson, C., *Remuera*.  
 Robertson, D., *Cardiganshire*.  
 Robertson, J. K., *Cheyenne*.  
 Robinson, F. V., *Highland Piper*.  
 Robinson, L., *Glenitice*.  
 Robinson, S., *Superic*.  
 Robson, E. W., *Cameronia*.  
 Rookes, C. E., *Turcoman*.  
 Rosney, P. J., *City of Dunkirk*.  
 Ross, W. M., *Hesperian*.  
 Rowdon, W. A., *Aidan*.  
 Rowlands, H., *Manister*.  
 Rowlatt, F. W., *Viking*.  
 Rudderham, S. W., *Oceanic*.  
 Rundle, E. H., *Persia*.  
 Rushforth, A., *Potosi*.  
 Rushworth, F. B., *Sicilian*.  
 Rushton, F., *Carpathia*.  
 Russ, E., *Cretic*.  
 Ryan, J., *Agadir*.  
 Ryan, L., *Mongolian*.  
 Ryan, V. A., *Hawkes Bay*.  
 Ryan, W. G., *Montreal*.  
 Salmon, J. B., *Highland Glen*.  
 Salmon, J. L., *Empress of Russia*.  
 Salter, T. H., *Asian*.  
 Salway, R. L., *Mongara*.  
 Sanders, C. T., *Arcadian*.  
 Sanderson, L. T. N., *Star of England*.  
 Sandison, J. L., *Baltic*.  
 Sandham, T. D., *City of Lincoln*.  
 Sandford, J., *Merion*.  
 Sandon, W. E., *Commonwealth*.  
 Sang, H. K., *Athenia*.  
 Saril, S. R., joined Wireless Co.  
 Sayer, H. T., *Great City*.  
 Scales, C. W., *Atlantian*.  
 Schofield, A., *Guatemala*.  
 Scott, M., *Knight Bachelor*.  
 Scott, R. C., *Emeraldas*.  
 Scully, E., *Nacahoe*.  
 Searl, C., *Empress of Asia*.  
 Sedding, N., sick leave.  
 Seddon, W., sick leave.  
 Seeney, H. W., *Berbice*.  
 Sellers, G. H., on leave.  
 Sequelra, H. C., *Tuakina*.  
 Sharp, E. W., *Thongva*.  
 Sharpe, C. H., *Ascania*.  
 Sharpe, F., *West Point*.  
 Sharpe, W. H., *Egypt*.  
 Sharples, E., *Katuna*.  
 Shatwell, E., *Walton Hall*.  
 Shaw, A. H. H., *Armenian*.  
 Shore, R. M., *Mamari*.  
 Shrimpton, E. T., *Kaipara*.  
 Silvester, W. H., *Hull Trawler Columbian*.  
 Simmons, E. A., *Guildford Castle*.  
 Simmons, H. F., *Pachitea*.  
 Simmons, J. M., *Victoria*.  
 Simpson, J. C., *Arcadian*.  
 Simpson, T. A., *Callao Depot*.  
 Simms, W. R., *Sazon*.  
 Sinclair, D. H., *Herbert G. Wylie*.  
 Single, G., *Darro*.  
 Skinner, J. S., *Andes*.  
 Slater, F., *Iberian*.  
 Sloggett, S. W., unattached.  
 Smith, A. C., *Antilian*.  
 Smith, A. F., *Intaba*.  
 Smith, D. A., *Highland Heather*.  
 Smith, F. J., *Imperial*.

- Smith, F. J. D. B., *Drumcliffe*.  
 Smith, H. F., *Berrima*.  
 Smith, H. S., *Nagara*.  
 Smith, L. J. G., *Arlanza*.  
 Smith, P. S., *Celtic*.  
 Smith, S., *Liverpool Depot*.  
 Smith, W., *Salmo*.  
 Smith, W. H., *Inkosi*.  
 Smythe, G. W., *Malda*.  
 Snow, H. C., *Cretic*.  
 Snow, W. E., *Hyacinthus*.  
 Snowden, H., *Kingstonian*.  
 Soames, R. T., *Waimara*.  
 Soar, R. A., sick leave.  
 Solway, H. E., *Canadian Co.*  
 Sotheran, A. W., *Banca*.  
 Southam, R. W., *Olway*.  
 Spence, R. S., *Devonian*.  
 Spicer, S. W., *German*.  
 Spiers, J., *San Ricardo*.  
 Sproat, D. M., *City of Marseilles*.  
 Sproat, H., *Mexico*.  
 Spurgeon, W. P., *Geelong*.  
 Standen, T. F., unattached.  
 Stanley, H. J., *Nore*.  
 Stannard, C. E., *City of Norwich*.  
 Stansbridge, S., *Adriatic*.  
 Stansfield, E. R., *Miltindes*.  
 Starkoy, J., *Kinfauns Castle*.  
 Stephen, A. K., *Gascon*.  
 Stephenson, J. A., *Highland Hope*.  
 Stevenson, A., *Gaika*.  
 Stevenson, P., *Nisearu*.  
 Stevenson, J. I., *Indrapura*.  
 Steward, E. H., *Adriatic*.  
 Stewart, I. C., *Virginian*.  
 Stewart, W. M., *Calabria*.  
 Stickleland, A. G., *Muritai*.  
 St. John, H. W., *Viking*.  
 Stocker, A., *Canadian Cruiser Margaret*.  
 Stockton, S. A., *Braemar Castle*.  
 Stone, J. B., *Olympic*.  
 Strong, R., *Wolton Hall*.  
 Stubbs, T. H., *Agadir*.  
 Studholme, J. J., *Patrician*.  
 Sturdy, H., *Quitpue*.  
 Styles, A. C., *Ionic*.  
 Summerlin, S. C., *S. Y. Alberta*.  
 Summers, E. B., *Calabria*.  
 Sutherland, D., *Cameronia*.  
 Sutherland, W. G., *Mauretania*.  
 Sweetnam, R., *Delta*.  
 Synge, W. A., *Oreio*.  
 Taylor, C. G., *Durham Castle*.  
 Tanplin, I. H., *Danube*.  
 Taylor, G. R. W., *Kemeric*.  
 Taylor, A., *Tortoguro*.  
 Taylor, A., *Chignecto*.  
 Taylor, A. W., *Moumouth*.  
 Taylor, C. G., *Durham Castle*.  
 Taylor, H. W., *San Lorenzo*.  
 Taylor, R. F., *Seal*.  
 Taylor, W., *Oasis*.  
 Taylor, Wilfred, *Etonian*.  
 Taylor, W. G., *German*.  
 Teahon, S., *Pretorian*.  
 Terraneau, E. G., *Nerehana*.  
 Thomas, G., *Cambrian*.  
 Thomas, G. H., *Edvard L. Doheny*.  
 Thomas, H., *Italinga*.  
 Thomas, W., *Alpatus*.  
 Thomas, W. H., *El Paraguayo*.  
 Thomasson, F., *Franceonia*.  
 Thomasson, H., *Oralava*.  
 Thompson, A., unattached.  
 Thompson, A. T., sick leave.  
 Thompson, W. J., *Nankin*.  
 Thompson, E. A., *Highland Scot*.  
 Thomson, G., *Salsette*.  
 Thomson, J., *Highland Watch*.  
 Thomson, J. R., *Georgie*.  
 Thomson, H., *Cameronia*.  
 Threlkeld, T. G., *Forcestershire*.  
 Tilford, G. L., *City of York*.  
 Timperley, J. H., on leave.  
 Tunbridge, T. O., *Carthaginian*.  
 Tozer, E. C., *Columbia (Anchor)*.  
 Turner, G. E., *Gloucester Castle*.  
 Turner, J., *Salamis*.  
 Tyler, G. R., *Teutonic*.  
 Tyler, W. E., *Sorata*.  
 Turner, A., *Balmoral Castle*.  
 Underwood, H. G., *Karonga*.  
 Utting, R. T., *Tongarira*.  
 Veale, R. J., *Oriana*.  
 Vincent, J., *Mulla*.  
 Vincent, J. R., *Bellona*.  
 Wainwright, A. C. L., *Baron Erskine*.  
 Wakeling, G. P., *Elysia*.  
 Walker, H. P., *S. American Coast Service*.  
 Walker, R. S., *Kingstonian*.  
 Walker, S. R., *East Point*.  
 Walker, T. R., *Anchiera*.  
 Wall, D. G., unattached.  
 Wallace, W. W., *Roseric*.  
 Wallworth, W. A., *Cedric*.  
 Walsh, L., *Bayano*.  
 Walsh, S. P., *Liverpool Depot*.  
 Ward, A., *Highland Harris*.  
 Ward, H., *Galway Castle*.  
 Ward, J. N., *Ceramic*.  
 Ware, W. R., *Montecuma*.  
 Warner, E. L., *Falaba*.  
 Warner, N. S., *San Antonio*.  
 Warren, H. G., *Keelung*.  
 Wasley, J. G., *Eagle Point*.  
 Waters, F. H., *Engliakman*.  
 Waterworth, A., *Principello*.  
 Watkins, L., *Lake Manitoba*.  
 Watkinson, E. A., *Kenilworth Castle*.  
 Watson, G. H., *Athenia*.  
 Watts, B. O., *Aragon*.  
 Webb, C. B. N., *Derbyshire*.  
 Webb, R. A., *Callao*.  
 Weller, C. A., *Ruahine*.  
 Weller, E. S., *City of Delhi*.  
 Wellington, C., *Antillian*.  
 Weselby, A., *Kabinga*.  
 Wheeler, N. B. W. M., *Saxon*.  
 Whitaker, C. H., *Minnetonka*.  
 White, H. E., *Kioto*.  
 White, V., *Den of Ogil*.  
 Whittaker, H. A., sick leave.  
 Whittred, H., *Chaudierre*.  
 Wickers, H. M., *Itacera*.  
 Wignall, R. M., *Orcomes*.  
 Wilcocks, A. E., *Perugia*.  
 Wilkins, A., *Hildebrand*.  
 Wilkins, J., unattached.  
 Wilkings, D. A., *Rappahannock*.  
 Wilkinson, E., *Amazon*.  
 Wilkinson, J., *Atlantian*.  
 Willett, F. W., *Kasemba*.  
 Williams, A. C., *Orcomes*.  
 Williams, F. A., *Aleutara*.  
 Williams, D. F., *Taqua*.  
 Williams, G. V., *Dioby*.  
 Williams, J., *Kansas*.  
 Williams, J. R. T., *Tokomaru*.  
 Williams, J. T., *Miami*.  
 Willis, H. C., *Malora*.  
 Wedger, N. G., *Llanstephen Castle*.  
 Wilson, H. O., *Limbari*.  
 Wilson, N. J., *Saturnia*.  
 Wingrave, D. W., *Balantia*.  
 Winsor, W. F., *Cocconador*.  
 Wood, C. B., on leave.  
 Wood, C. E., *C. S. Restorer*.  
 Wood, D., *Ashtabula*.  
 Wood, T. A., *Oalo*.  
 Woodhouse, W. A., *Norseman*.  
 Woods, F., *Swanmore*.  
 Woods, L. J., *Panama*.  
 Woodward, J. E., *Commanchee*.  
 Woollam, M. W., *Manchester City*.  
 Woolley, L., *Kinfauns Castle*.  
 Woolway, C. J., *Statesman*.  
 Wright, E., *Brodator*.  
 Wright, F. M., *Menominee*.  
 Wright, G. J., *Llandiobery Castle*.  
 Wright, T. G., *Edavana*.  
 Wright, D., *Michigan*.  
 Wroughton, F. N. M., *Marathon*.  
 Wyard, I., *Quitpue*.  
 Wyatt, F. C., *Kenuta*.  
 Wyatt, R. G., *Bornro*.  
 Wyatt, A. W., *Mooltan*.  
 Yelding, A. T., *Kafue*.  
 Yelland, W. P., *Manora*.  
 Yorston, J. F., *Elmira*.  
 Young, P. E., *Empress of Russia*.  
 Young, J., *Galician*.

## New Staff

(May 14th for June.)

- |                              |                                 |                               |
|------------------------------|---------------------------------|-------------------------------|
| Alton, H. F., May 8th.       | Heath, W. H., May 8th.          | Montgomerie, J., April 30th.  |
| Berry, C., April 16th.       | Haddock, R. B., May 13th.       | Owlett, R. A. C., April 16th. |
| Bessell, B. W., May 6th.     | Hood, J. A., April 16th.        | Pales, F. A., May 4th.        |
| Bone, D. W., May 5th.        | Ings, W. A., May 5th.           | Pavitt, H. J., April 20th.    |
| Carroll, J., April 15th.     | Kelly, J. A., April 30th.       | Reidy, M., May 8th.           |
| Dawson, W., April 30th.      | Kenworthy, H. D., April 20th.   | Rudderham, S. W., May 11th.   |
| Drohan, J., April 15th.      | Kull, G. R., May 11th.          | Ryan, L., April 25th.         |
| Freeman, H. T. E., May 11th. | Mitchell, A. J. H., April 20th. | Simmons, E. A., April 17th.   |
| Gillam, A. C., April 16th.   | Macnab, J. A., April 16th.      | Stockton, S. A., May 13th.    |
| Harvey, D., April 30th.      | McLennan, R. F., May 13th.      |                               |

## Resignations

- |                             |                            |                             |
|-----------------------------|----------------------------|-----------------------------|
| Allen, G. A., April 4th.    | Kelly, C., May 14th.       | Redgate, H. J., May 9th.    |
| Dawson, R., April 25th.     | Ledger, F. H., May 2nd.    | Roden, C., May 11th.        |
| Ellis, R. O., May 14th.     | McCormack, G. N., May 2nd. | Rodway, J. C., April 29th.  |
| Emanuel, R., May 7th.       | Munday, R. A., April 29th. | Waddoup, J. B., April 30th. |
| Garrett, E. W., April 29th. |                            |                             |



### Marconi House Notes.

As the season advances, so the interest in the Marconi Athletic Club deepens; and if, as we have no reason to doubt, the activity of the members is sustained, the Club should show a record report at the end of the year.

#### Cricket.

In the Cricket Section good work has been accomplished, and the general form of the players has been distinctly above the average. Unfortunately the club have not been able to win all their matches; nevertheless the scores indicate that in every case they have made a "very good try," which is, after all, the next best thing to success. Recent matches have been:

##### THE FIRST ELEVEN.

May 9th—Won from the Linotype C.C., 46 runs to 35.

May 16th—Won from the L. and N.W.R. C.C., 59 runs to 44.

May 23rd—Draw with Coningsby C.C., 18 runs for 3 wickets to 136.

June 6th—Lost to Craven Lodge C.C., 54 runs to 80.

June 13th—Lost to Linotype C.C., 54 runs to 94.

##### SECOND ELEVEN.

May 9th—Lost to Oyez C.C., 66 runs to 93.

May 16th—Won from Bramtoco C.C.—95 runs to 23.

May 23rd—Draw with Ealing Congregational C.C., 66 runs to 8 (for 3 wickets).

May 30th—Lost to Fulham Palace III. C.C. 30 runs to 61.

June 13th—Lost to Oyez C.C., 30 runs to 34.

#### Tennis.

The contest for the Interdepartmental Shield continues to occupy the Tennis Section. In the preliminary tournaments the Field Station Department beat the Betulander Company's Team by four games to one, the latter being outclassed in the Doubles, but in the Singles their player, Mr. Kirwan Ward, made an excellent fight against Mr. Bangay and won for his side their only success. The teams comprised the following members:

For the Betulander Company—Messrs. Kirwan Ward, Crowe, and Davis.

For the Field Station Department—Major Cochrane and Messrs. Bangay and Walmesley-Cottam.

The Accountants easily beat the Secretary's Department by four games to love.

Messrs. Adkin, Ogle, and Merritt represented the losing side, while Messrs. Cummings, Rice, and J. A. Smith played for the Accountants.

#### Swimming.

The membership of the Swimming Club continues to increase in numbers. Both the relay races of May 21st and May 28th against the Shaw, Savill, and the Union Castle teams respectively were lost, though only by a narrow margin. The club had arranged a relay race against the Union Castle Club for June 24th, while other relay races of

August 20th and October 1st have also been fixed up. On June 9th the relay against the Royal Mail had to be scratched.

#### Art.

Difficulties in connection with the arrangements for the Art Exhibition have necessitated its abandonment, at least for the present. Possibly, however, the Committee will be able to arrange one during the forthcoming winter, and in that event an announcement will appear in due course.

#### Personal.

Leonard Bernard has been appointed cadet on board the new steamer *San Francisco*, which has



been constructed under the superintendence of Capt. P. F. Donnelly for the Isthmian Lines of London and New York. Previous to joining his vessel, young Bernard studied radio-telegraphy at the Marconi School, Liverpool, and, although not commencing

life afloat as a wireless operator, the knowledge of radio-telegraphy will be of valuable assistance to him in the course of his studies. He was born at Punta Arenas, Chile, in 1889, and although still a youngster he has travelled extensively in South America. Previous to taking up his wireless studies he was a student at Ellesmere College, Shropshire, where he completed his education.

Lieutenant-Commander B. E. Reinold has been appointed to H.M.S. *Marlborough* for torpedo and wireless telegraphy duties.

Mr. N. A. Collard (Departmental Manager at Elswick Shipyard) is Chairman of the Newcastle-on-Tyne Wireless Association, and with Mr. F. S. Gibson (Eastern Telegraph Co.), Secretary, and Mr. G. H. Mann and Mr. N. Hall form the technical committee appointed to deal with difficulties and suggestions raised by corresponding members of the Association.

**WANTED.**—"MARCONIGRAPH." Nos. 1 and 2 Vol. I., at double face price.—ROBERT D'HONDT Blankenberghe, Belgium.

**FINAL DIGEST FOR MARCONI STUDENTS** (Copyright).—A very useful Revision Book for advanced Students, 9d. post free. **SECOND EDITION** out shortly; considerably enlarged and improved, embracing Handbook. Particulars later.—Sole Publishers, WALLASEY SPECIALITY CO., 11 Leasowe Avenue, Wallasey, Cheshire.

**BOOKS** on Wireless Telegraphy, also all other Subjects: **Secondhand at Half Prices. New 25% Discount. Catalogues Free. State Wants. Books sent on Approval. Books Bought.**—W. & G. FOYLE, 121-123 Charing Cross Road, London.