

WIRELESS

AUG 21 1918

UNIV. OF MICH.
LIBRARY

Engineering
Library

Engineering
Library

M

620.5
W8

W892

WORLD

MONTHLY 3^D

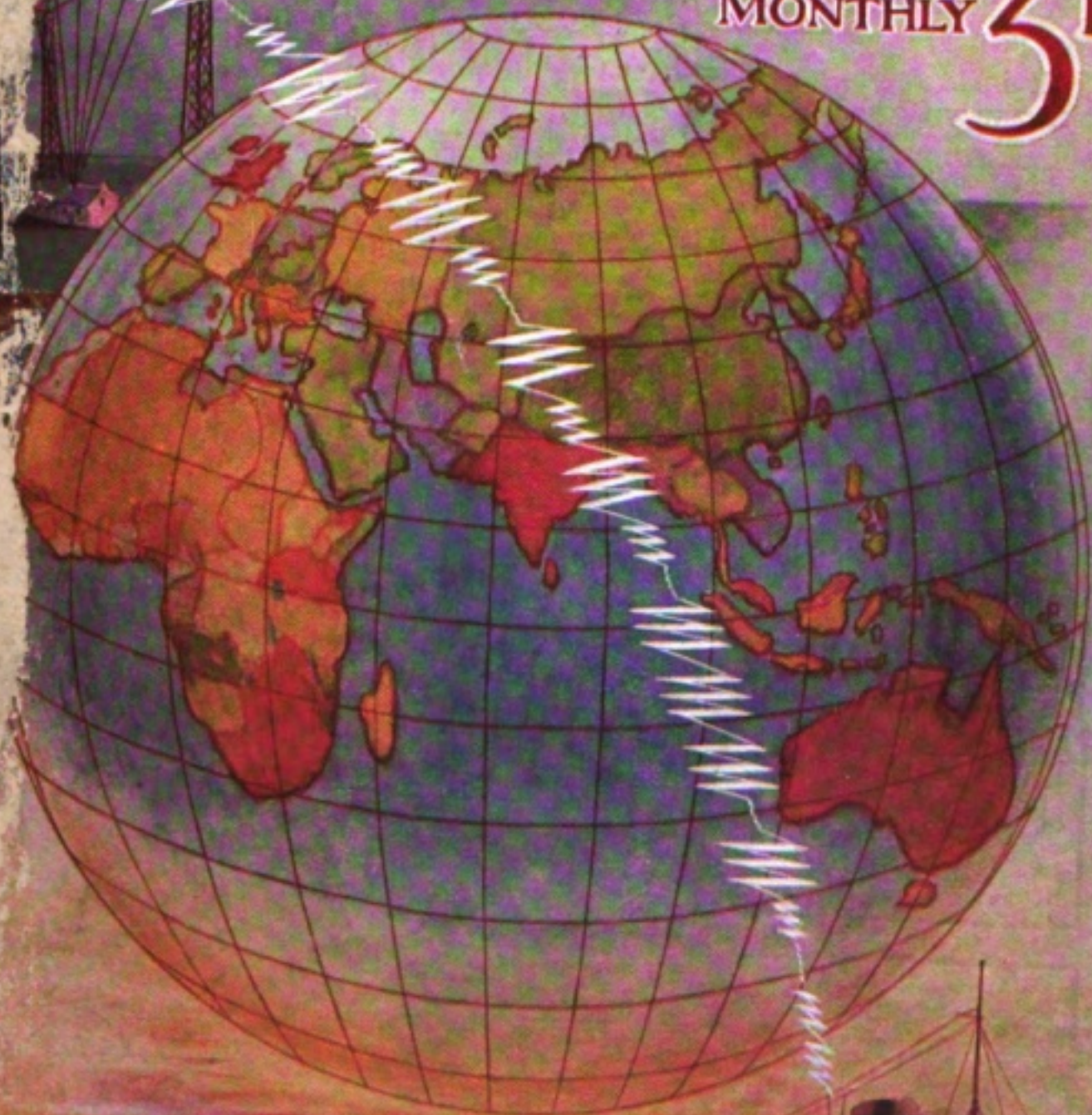

X
X

Sullivan Instruments

Sullivan "Universal" Galvanometers and Shunts for Land and Sea Use

Testing and Signalling Instruments of every description for Submarine Cables.

SULLIVAN TELEPHONE RECEIVERS for Wireless Telegraphy and Telephony, as used by the principal Governments and Wireless Telegraphy Companies—resistance values from 5 to 15,000 ohms.

Fast Speed Wheatstone Automatic Transmitters and Receivers, guaranteed at 400 words per minute, and Wheatstone Apparatus generally.

Precision and Standard Measuring Equipments for D.C. and A.C. (high frequency) determinations, Condensers of Low Power Factor, etc.

All instruments guaranteed, and accompanied, if desired, with Certificates of Accuracy from the National Physical Laboratory at cost price.

H. W. SULLIVAN,

Winchester House, London, E.C., England.

Works: Liverpool House, Middlesex Street, London, E.C.

Telegrams: "Deadbeat, London."

Telephone Office: 3518 London Wall.

Codes: Western Union (Universal Edition); A.B.C. (5th Edition); Engineering (2nd Edition). " "

Silk and Cotton Covered H.C. Copper Wire, Resistance Wires, Fuse Wire, Binding Wires, Charcoal Iron Core Wire, Asbestos Covered Wire

P. ORMISTON & SONS, 79 CLERKENWELL ROAD
 LONDON, E.C.
 Established 1793. 13259 Central.

Braided and Twisted Wires, Bare Copper Strand & Flexibles of any Construction, Wire Ropes & Cords, down to the finest sizes, in Galvanized Steel, Phosphor Bronze, etc.



TRADE MARK

REGD. No. 339440.

VULCANIZED FIBRE

Sheets, Rods and Tubes.
 Machine Work and Special Shapes.

J. BURNS, LTD, 189 CENTRAL ST., LONDON, E.



"Wireless" TELEPHONE RELAY

IMPROVED FORM will MAGNIFY CURRENT over 100 TIMES

For INCREASING the RANGE of a Receiving Station.
 For RECORDING Messages and TIME SIGNALS.
 For operating LOUD SPEAKING TELEPHONES.
 For working CALLS and RELAYS.

Also BEST RECEIVERS made for Wireless and other RELAYS and Loud Speakers.

For Particulars and Prices apply Patentee and Sole Manufacturer,
S. G. BROWN, 4 Gt. Winchester St., London, E.C.



The Wireless World.

With which is incorporated "The Marconigraph."

An Illustrated Magazine for all interested in WIRELESS TELEGRAPHY, published monthly by THE MARCONI PRESS AGENCY, LTD., Marconi House, Strand, London, W.C.

Registered for transmission by Magazine Post to Canada.

Telegraphic Address: "Expanse, London." Telephone No.: City 8710 (Ten Lines).
Codes used: Marconi, A.B.C. (4th edition), Western Union.

Subscription Rate...	5s. per annum, post free.
Single Copies	3d. each, by post 5d.
Subscription Rate in the United States	\$1.25 per annum, post free.
Do. in Canada and Newfoundland	\$1 per annum, post free.
Europe	fr. 6 per annum, post free.

All communications relating to Subscriptions, Advertisements, and other business matters, to be addressed to "The Publisher, 'The Wireless World,' Marconi House, Strand, London, W.C."

All Editorial communications to be addressed to "The Editor, 'The Wireless World,' Marconi House, Strand, London, W.C."

The Editor will be pleased to receive contributions; and Illustrated Articles will be particularly welcomed. All such as are accepted will be paid for.

CONTENTS.

	PAGE
The Path of Progress	1
Personalities in the Wireless World—The Rt. Hon. Chas. Edward Henry Hobhouse	3
'Mid Snow and Ice	4-7
DIGEST OF WIRELESS LITERATURE. Abstract of important original Articles	8
Effect on the Propagation of Electric Waves of the Total Eclipse of the Sun	17
The Seaboard of Nova Scotia	18-19
On a Variable Condenser with a Square Law. By W. DUDDELL, F.R.S.	20-23
A Transatlantic Wireless Station on an Historic Site—Louisbourg	24-27
Aerials and their Radiation Waveforms—I. By H. M. DOWSETT	28-30
Insulated Joints in the Wire Guys for Masts. By H. R. S.	30-31
The Engineer's Note Book	32-33
Notes of the Month	34-35
Maritime Wireless Telegraphy	36-37
Cartoon of the Month—Wireless Worries. IV.	38
Contract News	39
Amongst the Operators	40
Answers to Correspondents. By Our Irresponsible Expert	41
Amateurs' Experiences.—An Experimental Wireless Station. By EARL C. HANSON	42-43
Detector Crystals	43-44
The Amateur Handyman—A Magnetically Operated Detector	44-45
The Troubles of Jimmy Jones	45
Among the Wireless Societies	46-48
Questions and Answers	49-51
Instruction in Wireless Telegraphy—A New Series of Articles	52-53
Directory of Amateur Wireless Stations	53
Wireless for Railways—Opening up the Lakawanna	54-56
An Aero Exhibition	56
The Library Table	57-58
Administrative Notes	59
The Imperial Wireless Chain	60
Patent Record	61-62
The Share Market	62
Position of Operators	63-66
Resignations	66
Additions to Operating Staff	66
Marconi Orchestral Society	67-68
Marconi House Notes	68

MARLBOROUGH HOUSE WIRELESS COLLEGE

Complete Course for the Postmaster-General's Certificate.

DAY AND EVENING CLASSES.

Apply for prospectus to

THE SECRETARY, WESTBOURNE CRESCENT, CANTON, CARDIFF.

Please mention "The Wireless World" when writing to Advertisers.

JOHNSON & PHILLIPS L^D
CHARLTON, KENT

◆
**MAKE A
 SPECIALITY OF
 SWITCHBOARDS**

**FOR
 HIGH FREQUENCY
 FOR
 WIRELESS TELEGRAPH
 INSTALLATIONS**

◆
**TRANSFORMERS
 HOT WIRE AMMETERS
 FREQUENCY METERS**

Telegrams:
Enriching: London.

Telephone:
No 1846, Avenue.



"RED CROSS" AND "MALTESE CROSS" BRANDS
highest quality, London

**PORTLAND
 CEMENT.**

quick medium or slow setting
 LION WORKS, GRAYS. ESTABLISHED 1855.
 CAPACITY, 4,000 TONS WEEKLY.

35, GREAT ST. HELENS, E.C.

Telephone:
12028 Central

Telegrams:
"Britannia, London"

**BRITANNIA RUBBER AND
 KAMPTULICON CO., LTD.**

7 NEWGATE ST.
 LONDON, E.C.

**EBONITE & VULCANITE
 TUBES—RODS—SHEETS**

WATERPROOF COATS

in great variety for all Climates

**MECHANICAL RUBBER
 MATS—HOSE—TUBES
 STEAM PACKING AND
 RUBBER COMPOUNDS**

DAVIS & TIMMINS,

LIMITED,

**KING'S CROSS,
 LONDON, N.**



Established 1876.

METAL THREAD SCREWS

Nuts, Bolts, Terminals, &c.

Telephone: Central 11070.
 Telegrams: "Conductivity, London."

Please mention "The Wireless World" when writing to Advertisers.

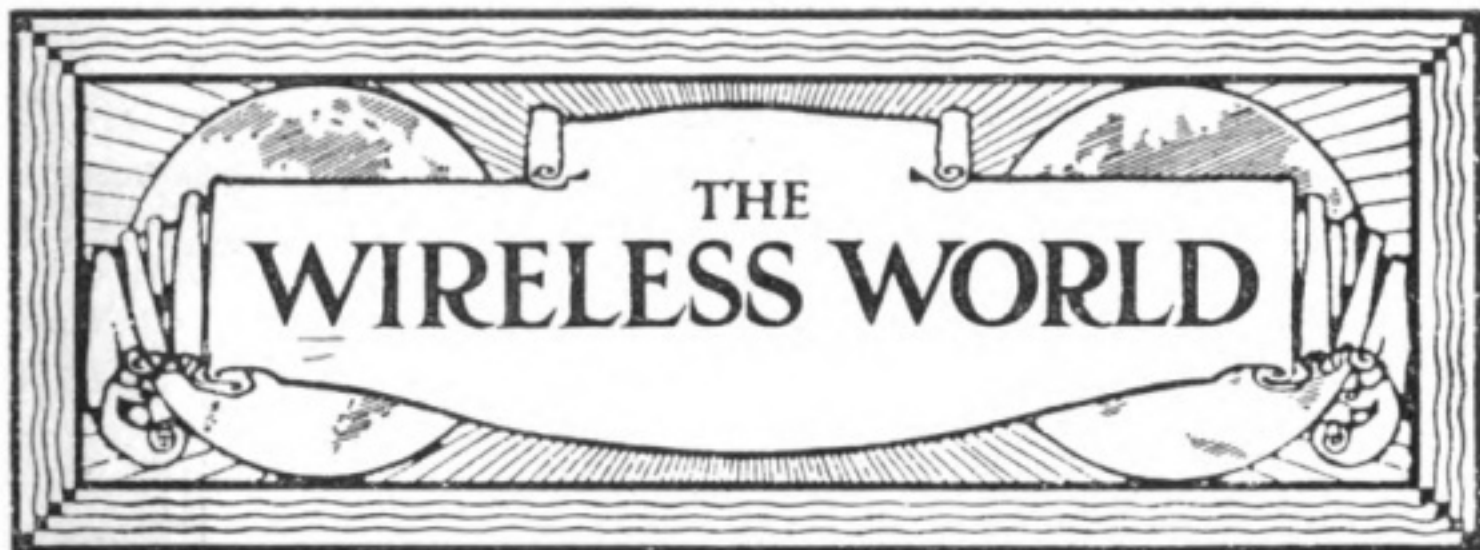

Vol. 2.—No. 13. (New Series)

April, 1914.

Subscription Price 3d.
5/0 per annum Post Free 5d.
post free.

The Path of Progress

IT is an unfailing sign of the strong desire raised in the minds of the general public to know something of the underlying principles and practical achievement of wireless telegraphy, and of the wonders which it has rendered possible in the transmission of intelligence, that with the opening number of the new volume of the *WIRELESS WORLD* it has been found necessary to increase the number of pages of the magazine to 104 and to print a quantity which is probably a record for any publication of its class.

When the *WIRELESS WORLD* made its *début* in April, 1913, its avowed object was to become a medium for the interchange of ideas concerning the further scientific and commercial development of wireless telegraphy, and at the same time to acquaint the public with its mode of operation and possible future development. It has published during the past year a number of articles by eminent scientists. But it has done even more than that; it has encouraged non-technical men to make incursions into a field which they would not have attempted without its guidance. In spite of this, however, it is extremely doubtful whether the majority of those who have been attracted to the study of the subject are able to form a really clear idea of what the underlying principles of wireless telegraphy are, and for their benefit the series of instructional articles which began in the first volume will be continued in the present volume.

Matters of interest to engineers will occupy a prominent place in succeeding

numbers of the *WIRELESS WORLD*. Short, original articles, based upon actual experience, will appear each month, and we venture to predict that many of these articles will arouse considerable interest in scientific as well as in engineering circles. An additional feature which we commence this month is "The Engineer's Note Book."

Under this heading we propose to publish each month letters and other communications from our readers dealing with engineering matters of various kinds. The subject-matter is intended to be not so much "Wireless Telegraphy" as general engineering in its applications to "Wireless." Every engineer, whether experienced or inexperienced, encounters an occasional problem or difficulty which is new to him. Sometimes he is able to find the solution himself; sometimes he finds that he lacks the particular data or the particular experience which is necessary. In either case, a letter from him would be welcomed in these columns; in the first case, his difficulty and his method of overcoming it would be of great interest—very likely of great service—to other readers; in the second case, his question published here will meet the eye of many who are best qualified to give him the help he requires—who perhaps have found themselves in the same difficulty and have learnt by experience the best solution.

Operators, who have unique opportunities for throwing some light on many of the unsolved problems of wireless telegraphy, will find in the *WIRELESS WORLD* a medium for the interchange of their experiences.



RT. HON. C. E. HOBHOUSE, M.P.

Personalities in the Wireless World

The Rt. Hon. CHAS. EDWARD HENRY HOBHOUSE

(Postmaster-General of Great Britain)

THE appointment of a new Postmaster-General is an event of importance to the Wireless World, for it means that that sphere of its influence which for convenience' sake is known as Great Britain will now be under the control of a new Governor who will perforce shape its destinies, for weal or woe.

Think of what power and authority the new Minister of the Crown assumes when he takes his seat in the Cabinet as Postmaster-General! He becomes by nomination supreme ruler of a mighty organisation. A network of telegraph and telephone cables encompassing the five Continents is under his control: he holds the threads in his hand. Packet boats are travelling over every quarter of the high seas under his command, mail trains are speeding past mountain and valley, moor and fen to fulfil his purpose. Again, messages for whither without ceasing pass and repass like motes in a sunbeam, voice speaks to distant voice, but over and above all invisible fans of light are radiating through space carrying inaudible messages to invisible ears. It is the office of the Postmaster-General to regulate this complex machine which is itself the main-spring of modern existence.

Yet every year this scene increases in grandeur and breadth. Already Wireless Telegraphy has subjected illimitable space to his suzerainty, and prophecy needs no far-sighted eye to see the day when Wireless Telephony will add another conquest to his dominion.

But after all to most of us who live in a work-a-day world, and have letters to scribble and posts to catch and telegrams to despatch, little enough time is left for contemplation. We prefer facts to words; therefore, we conclude with a sketch of the personality who fulfils the important office.

The new Postmaster-General is a man well fitted for his appointment, for not only is he

in every essential a capable Minister, but he has given more than a little consideration to the branches of public service which he is now called upon to control. Not least, has he interested himself in wireless telegraphy, and was appointed in December of last year Chairman of the Committee nominated by the then Postmaster-General to consider the organisation of State research in Wireless Telegraphy.

His Parliamentary career, if brief, has been far from uneventful. He was returned to Parliament as Liberal Member for East Wilts in 1892, and the same year was appointed private secretary at the Colonial Office. In 1906-7 he was Church Estates Commissioner, only relinquishing this post to become Parliamentary Under-Secretary for India, in the latter year. But he was not allowed to remain too long in quiet possession, for his Government were unwilling to obscure the light of one of their most promising supporters under the bushel of a subordinate position, so in 1908 he was appointed Financial Secretary to the Treasury. For three years he adequately filled this important post, and then in 1911 he was made Chancellor of the Duchy of Lancaster. Now he leaves Lancaster Place to fill Mr. Samuel's chair in King Edward Street, and if the record of the past can be taken as an augury for the future, England is promised a clever and able man of affairs at the head of her posts and telegraphs.

Mr. Hobhouse is, for the position he holds, a young man, for he is not yet 52. He is the eldest son of Sir Charles Hobhouse, who was until retirement one of India's most notable judges. He is married to the daughter of Mr. George Fuller, who is well known in Wiltshire, especially in the neighbourhood of Corsham, where his beautiful home of Neston Park is situated. Here, too, the new Postmaster-General has his country home.



THIS is a seasonable topic. Boreas is still at home to the more northerly parts of the globe, and to all accounts is holding boisterous revel with his companions of snow and ice. We are justly celebrating the successful return of the expedition which for three years has carried on hazardous research in the Antarctic. At the same time, public expectancy has been roused to the highest pitch by the hazardous journey for many thousand miles of untrodden snows across the Antarctic Continent. Furthermore, commercial circles are interested in the opening up of a Siberian sea route, which is likely to be of great and world-wide commercial importance, for its success will mean that the rich mine districts and natural wealth of Siberia will be available to the markets of the world.

The new route to Siberia has been made possible by the erection of stations on the coast of the Kara Sea, described in the *WIRELESS WORLD* in December, 1913. The first actual trip to be taken under the new conditions was performed by Mr. Jonas Lied, on board the cargo boat *Correct*, on behalf of his company, The Siberian Steamship Manufacturing and Trading Co., Ltd. His experiences made an interesting Paper, read before the Royal Geographical Society on January 23rd.

The party sailed from Tromsøe on August 6th of last year, and reached the entrance of the Kara Strait on the 10th. The steamer was fitted with wireless equipment, which had a sending range of 200 nautical miles, and before leaving Norway arrangements were made with the Russian Postmaster-General, so that during certain hours of the night communication could be made with the three wireless stations on the Yugorski Schar, Wiagatz and Cape Mare Saale. The first part of the journey was easy sailing, but the passage across the Baidaratskaia Guba was made with difficulty, and soon the vessel was held up by icefloes. While waiting for the ice to slacken the *Correct* received a visit from five Samoyedes; of whom only one understood Russian. "We took him up to the wireless cabin," said Mr. Lied, "and explained to him the purpose of this invention, but it was quite clear he did not grasp the idea at all. Still, he turned to his friends and, in his own language, gave them a very elaborate description, as though he knew all about it. We then took our guests into the saloon, where we put the gramophone to work, but to our great astonishment they did not take the slightest notice of it. Bewildered, we asked what he thought of the gramophone, whether it was a marvellous thing, but he only waved his hand in con-

tempt and said, "That's nothing! In Obdorsk there is one which shouts much louder."

The party on board the *Correct* made some little progress almost every day, and on August 22nd rounded "White Island"; they then made their way to Nosonofskoi Ostrof, which they reached five days later; that is to say, they had accomplished the journey from Tromsøe within a total of 22 days. At Nosonofskoi Nansen, who had been one of the party, left for the interior in a motor-boat sent by the Russian Government, whose guest he now became. The *Correct*, meanwhile, landed cargoes which had been brought down from the interior of Siberia by river steamers. This work occupied thirteen days, and on September 10th the vessel began her return voyage. On September 14th, at 2 a.m., wireless communication between Yugorski Schar and Wiagatz stations was overheard, and soon afterwards the *Correct* opened up communication with Yugorski. Information was requested and given as to the locality of the ship and whether any assistance was wanted. The reply was made that, "all was going well"; at the same time a message was given to be forwarded to Archangel, reporting general progress. This was the first practical use of the wireless stations in the Kara Seas made by a steamship.

Open water made travelling easy, and it was only ten days before the party reached Tromsøe again. That was on September 20th. On September 29th the vessel landed at Immingham Dock, on the East Coast of England, with £25,000 worth of Siberian produce in her hold. This consisted of hemp, flax, skins, tallow, horsehair, grain, hides and timber.

A Paper by Professor Nansen on the expedition was also read at the same meeting, and he makes some profitable remarks as regards means to be employed in making this sea route to Siberia secure. "If in the spring," he concludes, "information could be obtained as to the mean temperature of the preceding winter in the region of the Kara Sea, then it would be possible to form a fairly correct opinion of the prospects of its navigation in the coming season. Arrangements would be made accordingly. These observations might prove to be of great importance for the future navigation of this sea. It would, however, be desirable

to make more systematic investigations in the different parts of the Kara Sea during the whole of the summer and autumn. The variations in the conditions of the ice should be studied. There should also be an examination of the currents and their changes, the temperature, and the salinities in the different depths and regions of the sea. For systematic researches of this kind three or four comparatively small sailing vessels, with motors, might be employed. These vessels, if equipped with wireless telegraphy, could also render immediate service by sending wireless messages from the ice during the navigable season to the wireless stations on the Wiagatz, at the Yugor Strait, and at Mare Saale, or Yalmal. These messages could then be communicated to Europe and to ships on their way to the Kara Sea. Aeroplanes and hydroplanes would prove of great importance in the investigation of ice-covered seas like the Kara Sea."

What Dr. Nansen appeals for in respect of the Siberian route is being accomplished by the United States along the coast of North America. Two Ice Watchers, the Revenue cutters *Seneca* and *Miami*, have just left New York for a two months' battle with the ice, which threatens the vessels plying between Europe and these parts. The *Seneca* will make her headquarters Halifax, and will leave there immediately and begin a search for the great icefloes which drift down the Labrador Coast at this season. Her duty will be to determine the course of the great masses of ice, and the probable extent of their drift, keeping them in sight constantly and sending out each night a wireless warning to all vessels, telling them the exact location of the ice. The chief danger will lie in the necessity of the steamer keeping in sight of the drifting icefields, and conveying them south, for she will have to protect herself from the possibility of a sudden shift driving them towards her—a very likely occurrence if they should get into contrary tides. On the other hand, there is the danger of heavy gales arising which would drive the *Seneca* herself hard on to these walls of ice.

All the time that the *Seneca* is engaged in this work she will be off the "Grand Banks," putting into Halifax for a few hours at intervals of every ten days or so, in order to replenish her supplies.

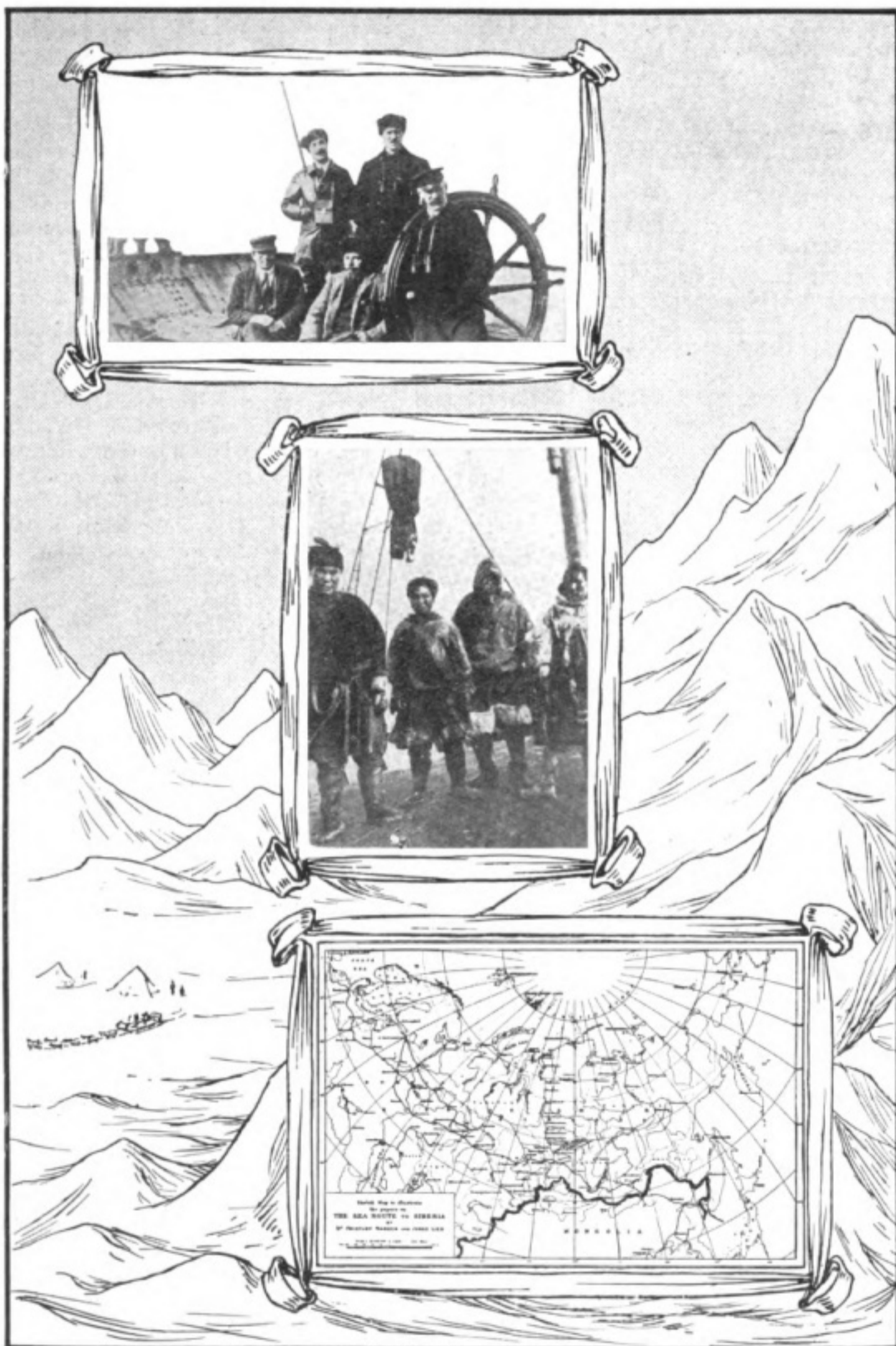

The top picture shows Dr. Nansen (on the extreme right), Mr. Jonas Lied (next to him), and other members of the party on board the "Correct." The centre picture shows a group of Samoyedes who visited the vessel.

She will be assisted in her work by the *Miami*. When the great floes have broken up into icebergs and started to drift apart towards the south, the two vessels will begin a patrol along the northern limit of the steamship lines, looking for drifts of ice. Every evening at 6 o'clock wireless reports of the position and direction of the drift will be sent out from the two vessels, and in the case of the *Seneca* such warnings will reach every steamship within 300 miles.

Shortly afterwards a warning will be sent on a shorter wave, which will be picked up by smaller ships and those closer to the patrolling cutters. In this way it is believed that the possibility of the danger of destruction to ships will be reduced to a minimum. As a matter of fact, the excellent work is the result of a recommendation made by the International Conference on safety at sea.

We conclude our *chronique glaciale* with a note upon the happy return of the Mawson Expedition from Adelie Land. Although, by means of the wireless established in this out-of-the-way region, we have from time to time had news of the expedition, it is only now that we can obtain graphic details which make us realise the grave risks which all who take part in such hazardous enterprises are prepared to face. The Mawson Expedition has been no exception to the rule. This intrepid scientist and his gallant followers have run very grave risks indeed, but they have battled manfully, and, moreover, have accomplished such useful research that they have not only won the world's admiration, but have materially increased her store of knowledge. Sir Ernest Shackleton, among others, has made his opinion of the expedition public, and a very high opinion it is too, but there is one passage in his remarks which has a direct interest to readers of the WIRELESS WORLD. Here it is in detail:—

"We already know that Mawson discovered minerals, but it is doubtful whether these will ever become of economic value; but from the economic point of view the wireless installation, which kept up constant communication with the Government—Meteorological Commonwealth Government, indeed—is now able to give weather forecasts and warnings of impending storms which were previously impossible. One foresees

that this pioneer effort will eventually result in wireless stations being established on both sides of the Antarctic for the benefit of stockbreeders and agriculturists, for when complete forecasts are available of the strong southerly blizzards and storms that sweep up suddenly to Australia, precautions can be taken, and a series of observations extending over years will enable farmers and stockbreeders to guard more or less against unexpected weather changes, which at present often prove disastrous to the stock and crops. I may be looking somewhat ahead in this, but the pioneer effort has been made, and that is the first rung on the ladder of success. The wireless stations will, of course, be useful to mariners also. The Antarctic is the breeding-place of great world-storms, and when vessels are all equipped with wireless installations they will be able to pick up warnings of impending storms.

Mr. Arthur Sawyer, the wireless operator of the Mawson Antarctic Expedition, who has been working the Macquaries wireless station since its erection at the end of 1911, returned to New Zealand before the main party owing to ill-health. Mr. Sawyer was able to keep in touch with Dr. Mawson. His life was a hard and lonely one, as he usually was on duty in his "wireless" hut from eight in the morning till long after midnight.

* * *

The first wreck of the season on the Great Lakes occurred recently, when the *Northern Queen* went ashore at Rock of Ages, Isle Royale, Michigan. This steamer had a wireless equipment on board and her signals for assistance met with an immediate response from the Canadian Towing and Wrecking Co.'s barge *Empire*, which is also fitted with a wireless installation. The *Empire* proceeded to the scene of the wreck accompanied by the tugs *Horne* and *Whalen* of the Wrecking Co.'s fleet. After two days' operation these vessels succeeded in pulling her off the rocks and towing her into port. The barge *Empire*, which carries a 1½ kw. set, communicated continuously during the two days with the Port Arthur station, enabling her owner to keep in close touch with the salvage operations.

Digest of Wireless Literature

ABSTRACTS OF IMPORTANT ORIGINAL ARTICLES DEALING
WITH WIRELESS TELEGRAPHY AND COMMUNICATIONS READ
BEFORE SCIENTIFIC SOCIETIES.

Wave-Lengths.—A paper on the most suitable choice of wave-length was contributed by Prof. A. H. Taylor to the *Physical Review*. Given a definite maximum of available power and a fixed aerial system, the author's experiments seem to show that the shortest wave-length consistent with good coupling gives the best results under all conditions, unless the absorption is very much greater than the value assumed in the paper, in which case a somewhat longer wave will be better.

Definition of Alternating - Current Terms.—The Committee on units and notation of the German Association of Electrical Engineers publishes a report, signed by Strecker, in which the following definitions are recommended. If I is the effective current, E the effective voltage between two points, and L the power consumed between these points, then the following terms are proposed:— L/E , Werkstrom (work-current); $\sqrt{I^2 - (L/E)^2}$, Blindstrom (blind current); L/I , Werkspannung (work voltage); $\sqrt{E^2 - (L/I)^2}$, Blindspannung (blind voltage); EI , Scheinleistung (apparent power); L , Leistung (power); $\sqrt{(EI)^2 - L^2}$, Blindleistung (blind power); E/I , Scheinwiderstand (apparent resistance); L/I^2 , Werkwiderstand (work resistance); $\sqrt{(E/I)^2 - (L/I^2)^2}$, Blindwiderstand (blind resistance); I/E , Scheinleitwert (apparent conductance); L/E^2 , Werkleitwert (work conductance); $\sqrt{(I/E)^2 - (L/E^2)^2}$, Blindleitwert (blind conductance); $L/(EI)$, Leistungsfaktor (power-factor). The resistance measured with direct current is called Gleichwiderstand (direct resistance). The resistance which when multiplied with the time and the square of the current gives the Joulean heat is called Echtwiderstand (real resistance). Explanatory notes of these definitions are added by J. Teichmueller

and R. Richter in *Elektrotechnische Zeitschrift*.

Water Model of the Duddell Singing Arc.—At the Physical Society of London Mr. W. Duddell, F.R.S., exhibited a water model with which a great many of the properties of electric arcs could readily be shown. The arc itself is represented by a mushroom valve, pressed on to its seat by the pull of a small electromagnet on a piece of soft iron which hangs from the under-side of the valve and nearly touches the pole of the magnet. By this device the result is obtained that the pressure tending to re-seat the valve diminishes very rapidly as the valve lifts; this being, of course, calculated to produce an effect analogous to the well-known arc effect of decrease in potential between the carbons with increase of current flowing through the arc.

Water is admitted below the valve, flows through the valve, and overflows freely from the vessel above the valve. If the flow of water is properly adjusted, the valve opens considerably, the pressure below it falls quickly, causing a decreased flow through the valve and a partial shutting of the latter; the pressure below it increases again and opens it further, and the whole cycle is repeated.

The condenser-circuit shunting the arc is represented by a large-diameter tube entering on the under-side of the valve. The water column in this tube has a periodic time of its own, and is able to oscillate in the same way as the condenser-circuit oscillates in the electric arc. Air-vessels connected to the open end of the tube, of various capacities, give a method of varying the period of these oscillations by altering the controlling force acting on the water—in other words, by altering the capacity of the circuit shunting the arc.

Some Characteristic Curves and Sensitiveness Tests of Crystals and other Detectors.—A Paper under this title was recently read at the Physical Society by Mr. P. R. Coursey, B.Sc. Referring to the well-known fact that in the case of the Fleming Oscillation Valve Detector, the second differential of the characteristic (volt-ampere) curve, when plotted, bears a considerable resemblance to the curve of sensitiveness of the valve to wireless signals, the author explained that his experiments were undertaken with the view of finding out whether any similar relation could be traced in other detectors than the valve—such as the crystal receivers so commonly employed to-day. Closed circuit transmitters and receivers were employed, and the first experiments were carried out on what is known as the "tilting coil" plan, where the receiving circuit is pivotted and tilted first in one direction and then in the other until the signals just vanish; the sensitiveness of the detector being taken as proportional to the co-secant of half the angle between these two positions, or, in other words, as inversely proportional to the projected area of the receiving coil normal to the wave. This method was found not to give strictly accurate results, as with very sensitive detectors the signals did not vanish even when the transmitting and receiving coils were at right angles. Another method was therefore adopted, the apparatus consisting of two flat spiral coils mounted vertically, the receiving coil being arranged so as to move in guides to varying distances from the fixed transmitting coil; the range of motion being about one metre—about seven times the diameter of the coils. The apparatus was calibrated by passing known values of alternating current of 1,000 frequency through the transmitting coil, and measuring the current induced in the receiving coil at different distances from the transmitting coil. The calibration curve of the coils was plotted as the ratio received current/transmitting current, against scale distance between the coils.

The curve thus obtained (a regular curve, but one which does not follow any simple law—at short distances the received current falling off inversely as the distance, at slightly greater distances inversely as the square, and at still greater distances at an

increasing power, which tends towards the cube as a limit) also serves to give the ratio of the voltages on the terminals of the transmitting and receiving coils, and thus was used to compare the sensitiveness of the various detectors; the moving coil being drawn out until the signals given by the detector under test just vanished. As a source of oscillations, various buzzers were tried, but were discarded in favour of a small eight-part commutator driven at about 3,000 r.p.m., with gauze brushes arranged to give alternate periods of make and break. The curves—for some of the most common detectors—obtained in these experiments show in some cases a very fair agreement between the sensitiveness curve and the second differential of the volt-ampere curve. This was particularly the case with the more stable of the crystal combinations; but it was by no means universally true. In the case of the electrolytic detector, for instance, or the tellurium-aluminium couple, the maximum ordinates on the second differential—that is, the points of greatest change of flexure of the characteristic curve—were found to be at places where the measured sensitiveness was either zero or very small. These inconsistencies the author attributes to the presence of at least one other action contributing to the "detector" property, which he suggests may be electrolytic in nature or in some way a "trigger" action.

Mr. Coursey's Paper is marred by a most extraordinary table "showing the relative sensitiveness of various detectors" derived from the above experiments, in which the most startling and inconsistent results are set forth. It may be that some of these are due to the fact (which is mentioned) that the same telephone receivers, of 2,000 ohms resistance, were used in each case, even though quite unsuitable for use with some of the detectors (the magnetic detector, for instance, requires telephones of about 150 ohms, while carborundum, silicon and Fleming valves are suited by resistances far higher than 2,000), but in any case the whole table would be better omitted. Three Fleming valves are taken for example; two of them are given as equal to the magnetic detector, and the third as twelve times as sensitive—no reason for this strange difference being given. Carborundum—one

of the most sensitive receivers known—is represented by two examples: one being rather more than half as sensitive as the magnetic, and the other just equal to the magnetic; while it is suggested that a suitable adjustment of the Galena detector might render it about 60 times as sensitive as carborundum.

Chemical Action Stimulated by Alternating Currents.—In a Paper read before the Royal Society, Mr. S. G. Brown describes some very interesting experiments on the effects produced by passing a rapid alternating current through simple voltaic cells.

The general effect is to stimulate chemical action; with the result that the cells will give a greater supply of continuous current than would ordinarily be possible. The alternating current will prevent the cell from polarising, this being one important effect. Another is that if the zinc anode is small, thus limiting the delivery of continuous current, the alternating current will stimulate a greater chemical action between this pole and the electrolyte, and thus increase the continuous current. The magnitude of this stimulating action depends upon the alternating current density; if this is sufficiently high, the chemical action produced may rise to such an intensity as to oxidise any known metal which may form the anode. It is suggested that this action may be involved in the phenomenon of the Branly Coherer.

A Continuous-Current Oscillation Generator.—The apparatus described by Mr. W. I. Book, in the *Physical Review*, contains many new points of design which are of interest, although the disposition of the two oscillatory circuits is the same as that used with the Duddell and Poulsen arcs. The Book discharger consists of a powerful electro magnet with tubular pole-pieces. These pole-pieces are tapered away internally at their ends, as shown in the diagram (Fig. 1), where *a* represents them. On each pole-piece is fixed a fibre ring, *b*, to one of which is fixed the annular cathode, *r*, of copper. The inside circular edge of this cathode is provided with ridges, about ten to the centimetre; these are conveniently formed by winding copper wire round a ring of thicker copper wire, and soldering the composite ring on to the inner edge of the annular copper cathode. This latter serves both to

radiate the heat away and to establish connection with the negative continuous-current main. The circular space within the grooved cathode is almost filled by the anode, formed by a disc of zinc or carbon fixed to a brass stem, *d*, held in the insulating bush, *c*, which fills one of the tubular pole-pieces. This disc of zinc or carbon, *e*, leaves

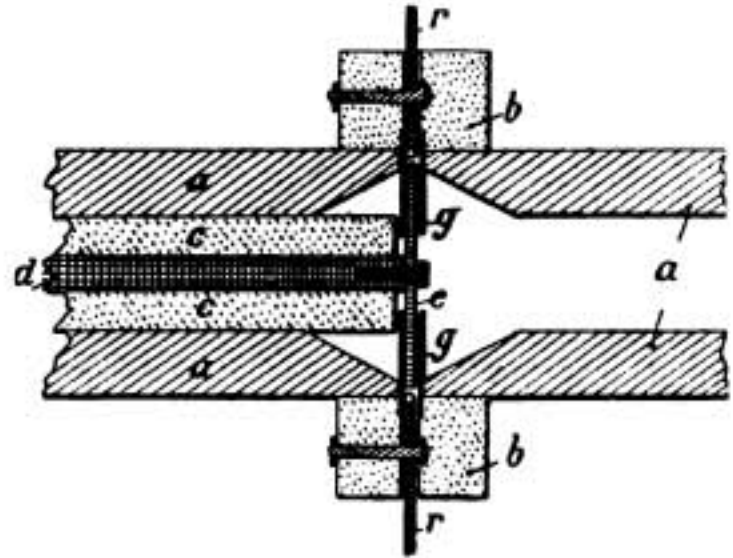

FIG. 1

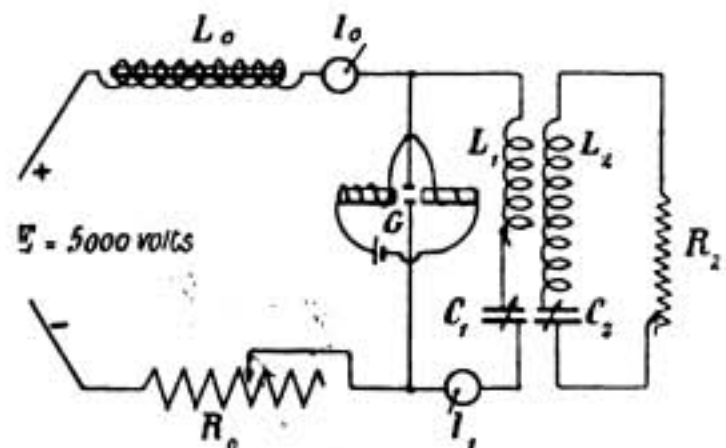

FIG. 2

an annular and very small air-gap between itself and the grooved cathode; this air-gap being, of course, in the very powerful magnetic field of the pole-pieces. The air-gap may be varied from 0.2 to 2.5 mm. by altering the size of the disc, *e*.

When a voltage of 5,000 volts is applied to the discharger, an arc is started (unless the annular gap is too large, in which case the discharge has to be started by short-circuiting the two electrodes), which is driven round the annular gap by the magnetic field. In its passage round the circle, it finds the resistance of the gap continually passing from a maximum to a minimum

and back to a maximum, owing to the grooves in the cathode. The choking-coil, L (Fig. 2) maintains a current through the gap of almost constant value, and the result of the periodic variation in the resistance of the gap is that a periodic flow and re-flow of energy into the primary oscillatory circuit is set up. The value of the oscillations thus produced reaches a maximum when the natural frequency of this primary circuit is an exact multiple of the frequency with which the gap-variation occurs, and this latter depends on a number of factors, such as the applied voltage, the length of the annular gap, and the strength of the magnetic field across the gap. It is stated that with proper adjustments the process is quite regular, and it is hoped that the discharger will be of considerable service, not only for wireless telegraphy, but also for telephony.

Influence of Atmospheric Conditions on the Transmitting Aerial.—In the course of wireless experiments great variations in the energy received have often been noticed. This is probably due to the different states of ionisation of the air, which absorbs the waves to a greater or less degree. In order to arrive more nearly at the truth of the matter a writer in the *Physikalische Zeitschrift* has made experiments on the influence of the different conditions of the atmosphere on the damping of the sending station. During a whole year he made 1,000 different observations of damping, and the results obtained show great variations. The author has arrived at the following conclusions:—

1. If the aerial is covered with hoar frost, damping is 80 per cent. greater than under normal conditions.

2. Rain has a great influence on the increase of damping, even a few drops are sufficient to bring about a variation.

3. The same influence in the case of snow.

4. Fog increases the damping very little, but a wet mist will bring about an increase of 10 per cent.

5. In proportion as the damping increases so also does the capacity of the aerial increase. With hoar frost, 1 per cent. Covered with ice, 2 per cent. During rain, 2 per cent. During snow, 1.2 per cent.

The figures for the damping of the antenna are similar.

6. A difference has also been noticed

between summer and winter. The following table gives the results arrived at:—

January	} decrease of 0.015 to 0.017
February	
March	
April	} decrease of 0.020 to 0.022
May	
June	} decrease of 0.024 to 0.026
July	

The author has likewise found that the damping varies periodically in a single day. These variations are from 10 to 20 per cent. The nature of these curves is different in winter and summer. In winter there appear to be two maxima, one occurring between 11 and 12 o'clock, and the other between 7 and 8 o'clock p.m. In summer the amplitudes are greater. The first maximum appears towards 12 o'clock, and the second towards 5, a third appearing at midnight.

The Behaviour of Ionised Spark-Gaps in Coupled Oscillatory Circuits.—Experiments carried out at the University of Strassburg (reported in the *Jahrbuch der Drahtlosen Telegraphie*) tend to show that the damping of an ordinary spark-discharger can be so increased by artificial ionisation (by means, for example, of a small Bunsen flame) that impulsive excitation is produced on a secondary circuit. This holds true whatever the length of the spark-gap; but for the best impulsive results there would appear to be a best value of coupling for every length of spark-gap; the coupling should be tightened as the gap is reduced (compare Dr. Eichorn's article in the *WIRELESS WORLD*, August, 1913). The impulsive excitation is particularly distinct with electrodes of brass and copper; it is less evident with zinc and magnesium. An electric arc placed near the spark-gap, in place of the Bunsen flame, was found to produce the same effect of shock-excitation; but this was found to be due to the ionised air of the arc, and no results were obtained so far as ionisation by ultra-violet light was concerned, except in so far as this made the spark pass more readily and more regularly.

On the Measurement of Self-Induction and Capacity of Aerials.—A. Esau discusses, in the *Jahrbuch der Drahtlosen Telegraphie*, various experimental ways of determining the inductance and capacity of the aerials used in radiotelegraphy. The two simplest methods are the well-known ones in which (in the one case) a known

capacity is put in series and the resultant diminution of wave-length noted, and (in the other case) a known additional inductance is added and the resultant increase in wave-length observed.

The author, having encountered various inconsistent results by these two methods, investigated the matter thoroughly.

If C_a denote the capacity of the aerial, and L_1 the combined inductance of aerial with an extension coil,

$$\lambda = 2\pi \sqrt{C_a L_1}$$

If a condenser of known capacity, C , is now put in series and the new wave-length, λ' , found, we have:—

$$\lambda' = 2\pi \sqrt{\frac{CC_a}{C+C_a} \times L_1}$$

and by combining the two equations, we get:—

$$C_a = C \left(\frac{\lambda^2}{\lambda'^2} - 1 \right)$$

which gives us the required value for the aerial-capacity. From this, of course, we can derive the aerial inductance, from a knowledge of the natural wave-length of the plain aerial.

The first step to take in the investigation of this method was to find out whether the value of the aerial-capacity, given by the above proceeding, was independent of the size of the shortening condenser, C .

It was found that if the shortening of the wave was not more than 10 per cent., the value of the aerial-capacity kept constant, *provided* that the condenser was introduced at a point of maximum current (current loop). If the shortening condenser was of such a value as to cause a shortening of wave greater than 10 per cent., or if it were introduced at a point which was not a current loop, results were inconstant and did not agree with those obtained by other methods. A shortening of 25 per cent., such as is often used for such tests, is undoubtedly useless for consistent results.

It was found that when λ , the wave-length at the start before the introduction of the shortening condenser, was only a little longer than the natural wave-length of the plain-aerial the results were not good, being too high. The results were best when the measurements were taken in the region of wave-lengths from four to five times

as great as the natural wave-length of the plain aerial. In other words, L_1 , the combined inductance of the aerial with extension coil, should be so great that the wave-length before the introduction of the shortening condenser is four to five times that of the plain aerial. Similar results and similar precautions hold good in the second method, wherein an extra known inductance is added, and the increase in wave-length observed.

The formula in this case becomes

$$L_1 = L \times \frac{1}{\frac{\lambda''^2}{\lambda^2} - 1}$$

where λ is the original wave-length with the original extension coil, and λ'' is the lengthened wave-length produced by the addition of the inductance L . Hence, by subtracting the original extension coil (already known) from the value of L_1 , we obtain L_a , the required inductance of the aerial.

The Range of Transmission of Wireless Stations.—Dr. L. W. Austin, from a series of experiments carried out for the United States Navy, arrives at a formula from which the range of communication can be found. The maximum distance covered during the course of these tests was 1,000 miles, over sea-water; but Dr. Austin assumes that a correction of from 10 to 20 per cent. would make the equation available also for greater distances.

If I_r denote the current in amperes in the receiving aerial-circuit, of 25 ohms resistance;

I_s denote the sending current (aerial amperes at transmitting end);

H_1 denote the height of one aerial in metres;

H_2 denote the height of the other aerial in metres;

d denote the distance between the two stations in kilometres;

λ denote the wave-length employed in metres;

then

$$I_r = 4.25 \frac{I_s H_1 H_2}{\lambda d} \epsilon^{-\frac{ad}{\sqrt{\lambda}}}$$

where a is the "coefficient of absorption" and is 0.0015 for sea-water, and ϵ has its usual significance, and is equal to 2.7183.

The above equation is stated to hold good

for the current received on a normal day, across sea-water, by a 25 ohm aerial; for any height of aerial and wave-length, and any values of sending-current. It is presumed that the sending station is coupled so as to emit one wave. It is interesting to note that the mathematical basis of this formula is the same as that by which the "Distance" table of the Marconi Multiple Tuner was tabulated many years ago.

For distance over land large corrections have to be applied, especially in the Tropics, where the sending energy required is doubled. Mountains also have a very marked influence. From the formula given above, the value of the received current is found for an aerial resistance of 25 ohms. Dr. Austin con-

with the two curves which we reproduce below.

The formula is:—

$$L = N^2 a (A - B) \times 10^{-9} \text{ henries.}$$

where

N = total number of turns

a = mean radius of coil in centimetres

A is a function of the ratio

$$\frac{\text{Mean radius}}{\text{length}} = \frac{a}{l} \text{ and is given by curve A.}$$

B is a function of the ratio

$$\frac{\text{Winding depth}}{\text{length}} = \frac{c}{l} \text{ and is given by curve}$$

B.

A study of the sample calculation given in the curve-diagram will make clear the way

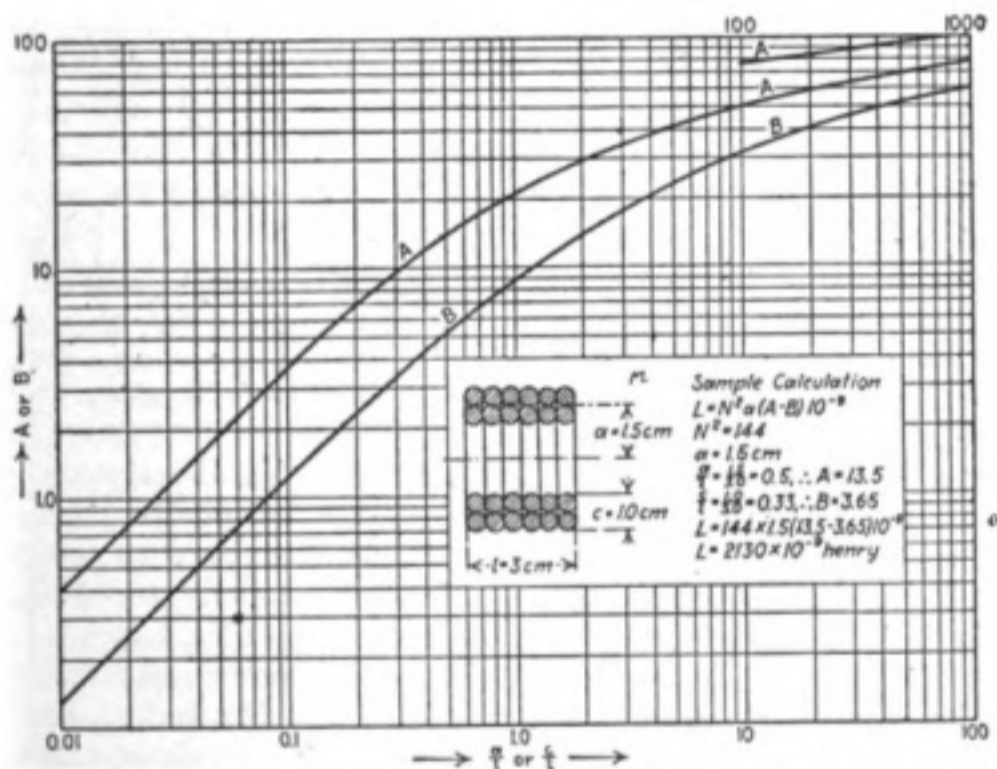

CURVES GIVING RATIOS OF MEAN RADIUS AND WINDING DEPTH TO LENGTH

siders that in such an aerial, using a perikon or electrolytic detector, a current of 10×10^{-6} ampere will just give audible signals, while 40×10^{-6} ampere is required for good communication.

Inductance of Air-Cored Solenoids.—

In the *Electrical World*, New York, Mr. L. A. Doggett gives a compact formula for the determination of the inductance of any cylindrical coil, whether a long helix or a flat "pancake." Results accurate within about 2 per cent. are said to be usual with this formula, which is used in combination

of using the formula and curves. One further point must be noted. In such coils, the ratio of the *actual copper area* to the *product of the length × winding-depth* is called the "Space Factor." The above formula as it stands is accurate when the space factor is above 35 per cent. When it has a lower value than this, the inductance obtained by the formula must be multiplied by a correction-factor, which is 1.01 for a space factor of 1/3, 1.04 for 1/4, 1.08 for 1/5, 1.12 for 1/6, 1.21 for 1/8, 1.28 for 1/10, 1.47 for 1/15, and 1.62 for 1/20.

A Causerie

This is the poem of the air,
Slowly in silent syllables recorded.

Longfellow.

THESE ideas on wireless telegraphy are not entirely original; they were prompted by an article which appeared in *St. Martin's-le-Grand*. But once given the directional aerial, it was an interesting occupation to throw out waves of thought and see what would hark back from the realm of fancy. The result was not disappointing. Ideas came crowding together, and some of these have been placed on record.

And the first impression that such a subject called forth was the divinity of it. The invention is such an inspiration, such a breath of heaven: it is something so slight and yet charged with such immensity of purpose—"infinite riches in a little room." It is, as it were, the impulse of a Creator, quickening life and sound and action from a wilderness of vapour, which because it is so intangible must always remain a nothingness to human conception. It is a magnificent achievement, for, after the fashion of a poet, the inventor has here created for us "a new world out of space." Exception may be taken to the simile of a poet, but it has been used advisedly: for, as the Greek word from which it is derived signifies, the poet creates from his imagination new regions of thought, new harmonies of sound, new realms of beauty. The painter needs his canvas and palette and brush, the sculptor his chisel and marble, the musician his instrument, but a poet relies entirely on himself; he has no need of either paint or paper, for, like the "Maker" of old, he can remember his songs, so that they be repeated from mouth to mouth, and in this way remembered from age to age without the agency either of pen or papyrus, or stylus, or waxen tablets. It is in this way that the "Odyssey" was remembered, and it is for this reason that the poet can claim to be something of a creator.

For the *thoughts* these children dreamed,
Fleeting, unsubstantial, vain,
Idle nothings as they deemed,
Shadowy as the shadows seemed,
These remain.

But after the poet, or rather *with* him, comes the scientist. At least such can be claimed of an inventor who, like Mr. Marconi, has given an invisible world a voice and works with unseen powers, although it be he is forced to use material means to convey their message to the dull'd human ear.

Surely the comparison of wireless telegraphy to a "still, small voice" is not inapt.

How often has this voice been dreamed of by the poets! Poets are such queer people, they take hold of these intangible ideas and make them realities. They do hear "voices in trees," and often in their works they foreshadow such a phenomenon as wireless telegraphy. For instance, Tennyson, in the "In Memoriam," writes:

I hear at times a sentinel
Whn moves about from place to place,
And whispers to the worlds of space,
In the deep night, that all is well.
And all is well, tho' faith and form
Be sunder'd in the night of fear;
Well roars the storm to those that hear
A deeper voice across the storm.

What better description could one find of the invention of Mr. Marconi, which may very truly be said to be a sentinel moving about from place to place and calling out the passing of the hours?

But to quote once more this poet, who, except for Browning, was the most foreseeing of the Victorian era, there is a passage in "Locksley Hall" which is worth considering. There the speaker

dip't into the future, far as human eye could see,
Saw the vision of the world, and all the wonder that
would be.

He sees the future of aviation and the aerial fleets of nations "grappling in the central blue." But more than that, he hears:
Far along the world-wide *whisper* of the South
wind rushing warm.

Another remarkable passage which by its context rather than by the actual words suggests the future voice.

Mention has been made of Browning as being another of our great fore-thinkers. Here is a passage from his "Fifine at the Fair," which, in its metaphorical language

singularly suggests wireless telegraphy in its full development, when it shall form a link to girdle the earth and radiating messages round the circumference of this planet. It is a fine piece of poetic foresight, which was written two years before the birth of Mr. Marconi :

the electric snap and spark
That prove, when finger finds out finger in the dark
O' the world, there's fire and life and truth there,
link but hands
And pass the secret on ! till, link by link, expands
The circle, lengthens out the chain, and one embrace
Of high with low is found uniting the whole race,
Not simply you and me and our Fifine, but all
The world.

Let us revert, however, to an age before. Shelley, perhaps one of the greatest poets the world has ever seen, and one not yet come into the full inheritance of his fame, gives abundant evidence of his belief in such a phenomenon. No doubt, after the manner of a prophet, he was unaware of the accuracy of his belief. Nevertheless he must have had some glimmering of the future, some undefined but actual belief of what was to be, when he wrote in "Prometheus Unbound" :

Tis the deep music of the rolling world
Kindling within the strings of the waved air,
Æolian modulations.

He did not know that he was speaking of electricity. It is clear from his imagery that he was thinking of the wind which the revolution of the world creates. Still, that does not invalidate his prophecy, albeit we, the heirs of all the ages, are in a position to realise its exact interpretation.

Probably the most absolute description of wireless telegraphy is embodied in the following lines of Shelley's revised version of "Queen Mab," which is known as "The Dæmon of the World" :

*Those trackless deeps, where many a weary sail
Has seen above the illimitable plain,
Morning on night, and night on morning rise,
Whilst still no land to greet the wanderer spread
Its shadowy mountains on the sun-bright sea,
Where the loud roarings of the tempest-waves
So long have mingled with the gusty wind
In melancholy loneliness, and swept
The desert of those ocean solitudes,
But vocal to the sea-bird's harrowing shriek,
The bellowing monster, and the rushing storm,
Now to the sweet and many-mingling sounds
Of kindest human impulses respond.*

This is indeed the "Dæmon," or guiding spirit, which

. . . breathes over the world :
. . . so passing strange and wonderful !

And how does it reach humanity ?

Floating on waves of music and of light
A chariot of the Dæmon of the World
Descends in silent power.

For the purposes of the poem the Dæmon is given a personality, and it is represented as some invisible, uncreated being, which wanders across the sleeping Universe to find a creature "robed in human hues," to be its representative in a world of humans. In *Ianthe* (which for our purpose can represent the outward and visible signs of the great wonder) the Dæmon finds such an agent, "Ardent and pure"—so he apostrophises her :

Ardent and pure as day thou burnest,
For dark and cold mortality
A living light, to cheer it long,
The watch-fires of the world among.
Therefore from nature's inner shrine,
Where gods and fiends in worship bend,
Majestic spirit, be it thine
The flame to seize, the veil to rend.

That is the message which he gives. Then, taking the spirit in his car, he brings her to minister to the world.

Fast and far the chariot flew :
The mighty globes that rolled
Around the gate of the Eternal Fane
Lessened by slow degrees, and soon appeared
Such tiny twinklers as the planet orbs
That ministering on the solar power
With borrowed light pursued their narrower way.
Earth floated then below :
The chariot paused a moment ;
The Spirit then descended :
And from the earth departing
The shadows with swift wings
Speeded like thought upon the light of Heaven.

That is the guiding star which Shelley dreamed of. Just as Spenser in the characters of the "Faery Queen" combined the symbols of many things, so the Dæmon and *Ianthe* are representative of power and divine beauty and human aspirations. They possess the same attributes which belong to wireless telegraphy. Wherefore, then, should not this wonder of modern times, which is an equally great conception, though daily familiarity has unfortunately somewhat obscured its miraculous nature, be included in their personality ?

In conclusion, therefore, wireless telegraphy is the *Ianthe* of Shelley, or the *Sentinel* of Tennyson, or the *Prometheus* of Longfellow, which

Holds aloft a flamen lighted,
Gleaming through the realms benighted,
As it onward bears the message.

Modern Battleships

Fitted with Wireless Telegraph Apparatus



One of the Vessels of the Spanish Navy, which is being fitted with Marconi Apparatus.



The latest addition to the Japanese Navy, the Battle Cruiser "Kongo," which has a Marconi Installation.

Effect on the Propagation of Electric Waves of the Total Eclipse of the Sun

THE British Association Committee for radio-telegraphic investigation have issued the following statement:—

“The forthcoming total eclipse of the sun affords an exceptional and important opportunity of adding to existing knowledge of the propagation of electric waves through air in sunlight and in darkness, and across the boundaries of illuminated and unilluminated regions. The eclipse will be total along a strip extending from Greenland across Norway, Sweden, Russia and Persia to the mouths of the Indus.

“There are two main points calling for investigation during the eclipse. In the first place, the propagation of signal-bearing waves through air in the umbra and penumbra will probably obey laws different as regards absorption and refraction from those obeyed in illuminated air. In the second place, the strength, frequency and character of natural electric waves, and of atmospheric discharges, may vary. The variations may occur either because the propagation of natural waves from distant sources is facilitated or impeded by the eclipse, or, possibly, because the production of natural electric waves or atmospheric discharges is, for some unknown reason, affected by the eclipse.

“To investigate the propagation of signals across the umbra it will be necessary to arrange for wireless telegraph stations on either side of the central line of the eclipse to transmit signals at intervals while the umbra passes between them. This transit of the umbra occupies about two minutes. It is thus very desirable that the Scandinavian and Russian stations should transmit frequently throughout several minutes before, during, and after totality. But stations other than those favoured by their proximity to the central line should endeavour to keep a complete record of the variations of signals during the eclipse. Stations in Europe west of the central line and stations in the Mediterranean and in Asia Minor may find noticeable changes in

the strength of signals, particularly long-distance signals, between the hours of 10 a.m. and 3 p.m., Greenwich time; and it is probable that the stations of India and East Africa, and ships in the Indian Ocean, may feel the effect of the penumbra in the afternoon. On the other hand, ships in the Atlantic, and fixed stations in Eastern Canada, and the United States will probably be affected by the penumbra in the early morning. At Montreal the eclipse (partial) is at its greatest phase at 5.52 a.m. standard time.

“The investigation of strays is of as great interest as that of signals. So far as is yet known, the natural electric waves reaching wireless telegraph stations in latitudes higher than 50 deg. appear to travel mostly from the south. Thus the greatest changes produced in strays by the eclipse will probably be experienced at stations in Scandinavia and Russia, to reach which the waves must cross the path of the umbra. At the same time changes of some kind are to be expected in other districts than these, and it is therefore desirable that statistical observations of natural electric waves be made all over the world, and especially at places within an earth quadrant of Southern Russia.

“The Committee propose to prepare and circulate special forms for the collection of statistics of signals and strays, especially within the hemisphere likely to be affected by the eclipse; they will endeavour to make provision for the transmission of special signals at times to be indicated on the forms; and they will offer for the consideration of the authorities controlling stations near the central line a simple programme of work.

“The Committee would be greatly aided in the organisation of this investigation if those possessing the necessary facilities and willing to make observations during the eclipse would communicate with the hon. secretary, Dr. W. H. Eccles, University College, London, W.C., at the earliest possible date.”

The Seaboard of Nova Scotia

HOW MARINERS ARE PROTECTED. THE "LURCHER" LIGHTSHIP

MARINERS will tell you that there is no more dangerous coast than the seaboard of Nova Scotia. During the winter months the rocky outline is swept by great gales and high seas, so that any vessel coming close in shore does so at a great hazard. The recent wreck of Mr. Vanderbilt's yacht off Yarmouth is a sufficient testimony to this fact, but the incident is only the latest of innumerable similar occurrences which have given this part of



the coast the title of "The Graveyard of Ships."

Already it has been furnished with lighthouses and lightships, in order to minimise the danger, but now one of the vessels in question has been equipped with wireless, and there is no doubt it will prove extremely useful, both in averting danger and in bringing help to the distressed.

The *Lurcher* Lightship No. 14 belongs to the Dominion Government, and is anchored in 60 fathoms of water two miles from the Lurcher Shoals. These are particularly dangerous to navigation and lie some 16 miles off Yarmouth on the south-west coast of Nova

Scotia. The shoal, which is known as South-west Breaker, lies parallel with the coast in the form of a bar, some three-quarters of a mile long and 100 feet wide. It is composed of rock and stone, and has a wide gap in the middle, which makes it at once doubly formidable and doubly beautiful, for the waves throw themselves against it with impetuous fury, as though anxious to break through the ramparts set up against them, and the white spume is thrown high into the air, to fall back again in the wash of the retreating wave in great flakes of foam. The *Lurcher* has to bear the buffetings of these elemental battles, for they produce strong tides and unruly seas, which set the anchor ship rolling and pitching, as one who has been stormbound for a whole week on the vessel knows only too well. Should any stranger be on board when one of the frequent gales occurs, he will hardly be comforted by the tale which is retold on every such occasion by the ship's crew with graphic force and circumstantial detail. How on one such night as this the lightship broke from her moorings and drifted towards the shoal. The crew, helpless to direct the vessel in the teeth of the terrific gale, were only able to wait as best they might the inevitable shock of the derelict vessel against the gigantic teeth of the rocks. Then, just as the fatal moment seemed near, a high wave turned the ship, and carried her bows foremost to the shore right over the narrow gap, so that she arrived without hurt on the leeward side of the rock and out of the stress of storm and breaker.

This was years ago, of course, but the tale loses nothing in the telling, and with the accompaniment of dirty weather it is sufficient to send a qualm over even the stoutest heart. However, the next fortunate visitor to the ship will be in a better position to

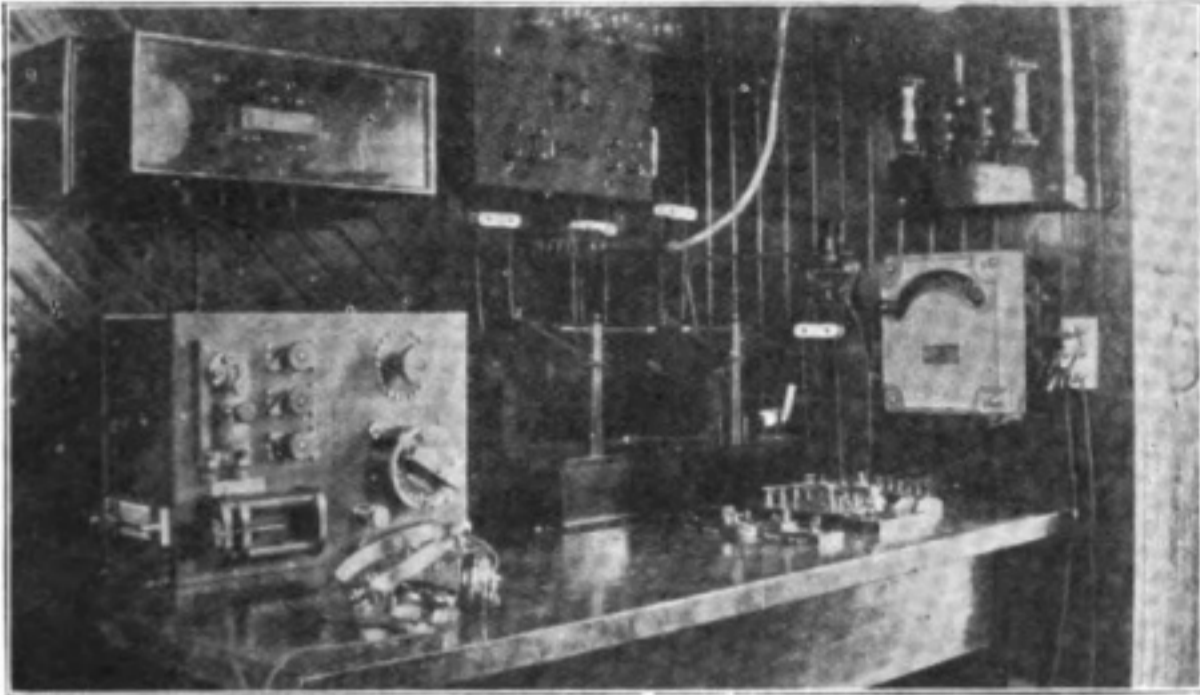

The Marconi Equipment on board the "Lurcher" Lightship.

withstand the terrors of the yarn than his predecessors, for he will know that whatever may happen there will always be the wireless to fall back upon, and should the moorings fail her once again, help will be within call. The *Lurcher* has been equipped by the Canadian Marconi Co. with a $1\frac{1}{2}$ kw. set, which enables her to communicate with Cape Sable on the one side and St. John, New Brunswick, on the other.

Not only is the lightship used as a warning vessel for the shoal, but she does a noble work in guiding mariners who are nearing the Bay of Fundy, for she marks the turning point in the course of all boats bound

to ports north of the shoal. The *Lurcher*, despite her name, is a princess among her class, for she carries a crew of 15; that is, about double the number which man the majority of the vessels of this class. Besides, she is magnificently equipped, is built of steel, and can, if desired, be navigated under her own steam, while throughout the vessel electric light is installed.

=====

OBLIGATORY WIRELESS IN ARGENTINA.— It is proposed to make it obligatory for all steamers carrying passengers arriving at or leaving Argentina ports to be fitted with wireless telegraph equipment.



Nine of the Crew of the Lightship.

On a Variable Condenser with a Square Law.*

By W. DUDELL, F.R.S.

CONTINUOUSLY variable condensers are in considerable use, especially in connection with wireless telegraphy. In using these condensers for the purpose of measurement it often happens that the quantity to be measured is proportional to the square root of the capacity of the condenser; for instance, in wave-meters of the Donitz type, which consist of a fixed self-induction and a variable condenser, the condenser being set to resonance, the wave-length is approximately proportional to the square root of the capacity of the condenser.

For this reason it would be convenient in many cases if the capacity of the condenser were proportional to the square of the distance traversed by the moving part.

Rotating-sector condensers, consisting of a number of plates or sectors which move in and out between a number of fixed ones, are often used in wireless telegraph receivers. In this case the capacity, except near the extreme ends of the scale, is very nearly proportional to the angular displacement of the moving plates; in fact, in a well-constructed sector condenser if the capacity be plotted against the angle a straight line will be obtained except at the two extreme ends of the scale. This straight line does not, however, pass through the zero point. It generally passes through such a point that if a small number of degrees (say 4 or 5 in a good condenser) be added to the readings of the condenser then its capacity is strictly proportional to this quantity.

With condensers of this type used in resonating circuits it will be found that if the capacity of the condenser be chosen so as to be convenient for tuning at the lower end of its scale, then, owing to the fact that the wave-length is proportional to the square root of the capacity, the longer wave-lengths at the top of the scale will be unduly

separated, or if the wave-lengths are conveniently spaced at the top of the scale, they are too closely crowded together at the bottom.

A number of experimenters have recognised the advantages, in certain cases, of what may be termed a square-law variable condenser; and various arrangements have been proposed and constructed to attain this result. In particular, Mr. C. Tissot† has proposed a condenser in which one set of lozenge-shaped plates (see Fig. 1) slide in and out of a corresponding set of similarly shaped plates.

It is evident that the same result can be obtained with the rotating-sector condenser provided the plates be given the correct curve. Probably a number of experimenters have already worked out the correct curve, but the author is unaware of where the results are published. The object of the present note is to put on record a curve which has been tried for the purpose, and the results obtained.

The problem is very similar to that worked out by Ayrton and Mather in the design of their electrostatic voltmeter, which is essentially a variable condenser having a definite law in order to obtain the required scale. The main difference is that in the case of the electrostatic voltmeter the rate of change of the capacity with regard to the angle determines the scale, and the zero capacity is of minor importance; whereas for the square-law condenser the actual capacity is required to be proportional to the square of the angle, and the capacity at zero position must be as small as possible.

There are a number of possible combinations of curves which give the required results. We have two sets of plates to deal with; and in what follows it will be assumed that the moving plates are fixed to a spindle and are capable of rotation through an angle

* An original contribution to the *Journal of the Institution of Electrical Engineers*.

† *Journal de Physique*, vol. 2, p. 719, 1912.

of approximately 180 degrees, and that during this rotation the moving plates enter between the fixed plates. It will also be

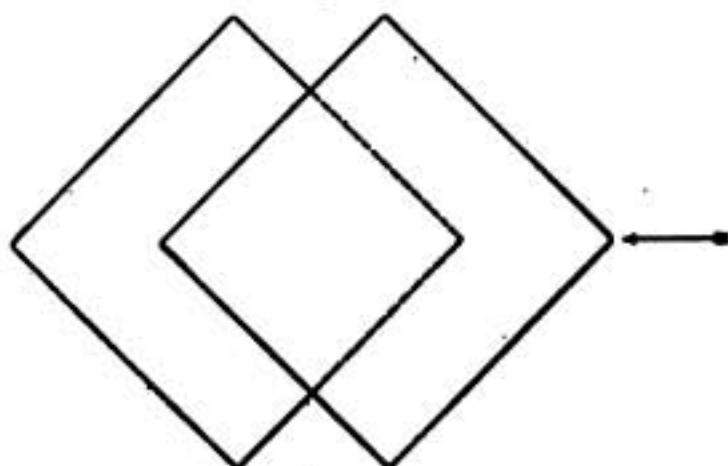

Fig. 1.

assumed that the perpendicular distance between the moving and the fixed plates is a constant, and in general small compared with the linear dimensions of the plates.

If this be the case, the capacity of the condenser is merely proportional to the area of the moving plates that are within the fixed ones, plus a small correction due to the edge effect, which will be considered later. In its simplest form the problem is therefore to design the shape of the edges of the plates so that the area of the moving plate enclosed by the fixed plate is proportional to the square of the angle through which the moving plate is rotated. There are four possible simple cases:—

The inside bounding edge of the fixed plate may be a semicircle concentric with the spindle, and the outside edge of the fixed plate may be so large that the moving plate never projects beyond it, so that its shape need not be taken into account; combined with:—

(a) A moving plate which has its outside edge shaped to a suitable curve (see Fig. 2a).

(b) A moving plate, of which the outside edge is part of a circle concentric with the spindle and the inside edge part of a spiral curve (see Fig. 2b).

The moving plates may have their outside edges parts of circles concentric with the spindles; combined with:—

(a) A fixed plate which has its inside edge constructed to a curve and the outside edge so large as not to have any effect (see Fig. 3a).

(b) A fixed plate, of which the inside edge is part of a circle and the outside edge is shaped to a curve (Fig. 3b).

There is no difficulty in working out curves which will approximately suit these four cases. There are also a number of other cases where both the fixed and the moving plates have their edges cut to special curves,

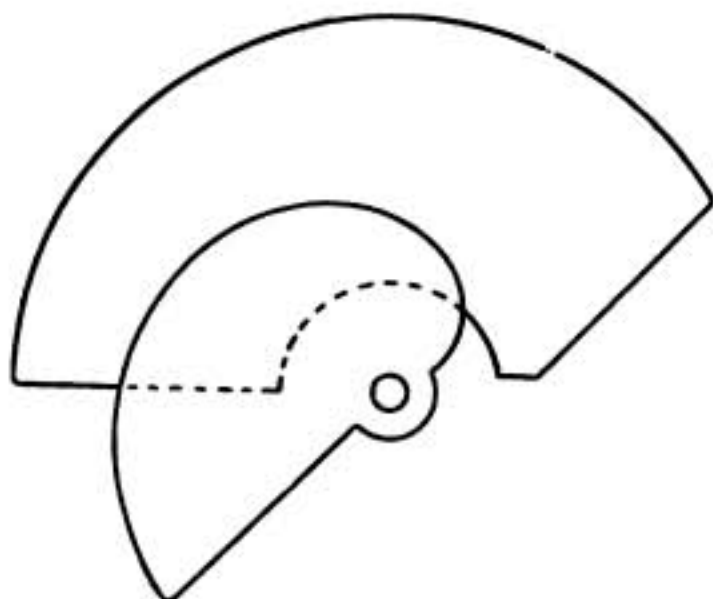

Fig. 2a.

but there appears to be no special reason for their adoption, and they are certainly more complicated to make.

In choosing between the four types mentioned above, two considerations have guided the author to adopt the type shown in Fig. 2a. First, it is essential that the moving plates shall be mechanically strong; secondly, the capacity of the condenser when the pointer is at zero must be made as small as possible. It is usual with sector condensers, in order to make the capacity perfectly definite at low values, to line the case with conducting material and to connect the fixed plates and the interior conducting surface of the condenser together. It is therefore necessary, in order to have a low zero capacity, that the moving plates should



Fig. 2b.

have as little outside surface and should be kept as far away from the case as possible.

In this respect the type shown in Fig. 2a is good, compared with the other three types, because the latter have a considerable length of the edges of the moving plates at a distance from the spindle and therefore nearer to the lining of the case. From the mechanical point of view the type shown in Fig. 2b is very unsatisfactory, as it is difficult to support the moving plates from the

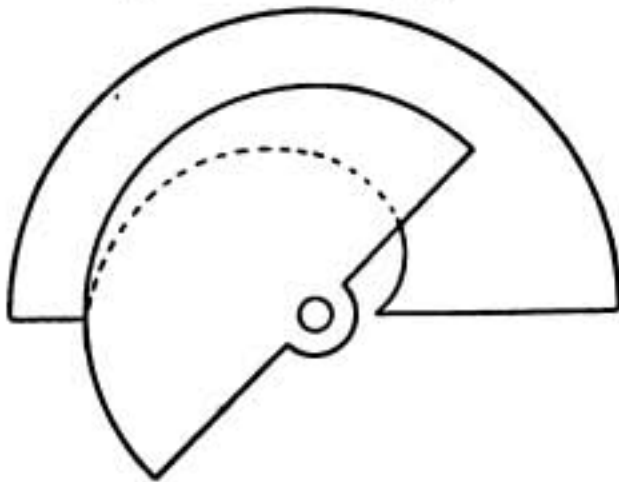

Fig. 3a.

spindle and avoid possible risk of deformation. The type illustrated in Fig. 3a is mechanically satisfactory, but in that shown in Fig. 3b there is again the difficulty of inadequate support—this time of the fixed plates.

The final choice has therefore to be made between the types illustrated in Figs. 2a and 3a. The curve for the edge required is practically the same in these two cases. In



Fig. 3b.

view of the fact that it seems easier to get a small zero capacity with the type in Fig. 2a than in that of Fig. 3a, the former was finally adopted.

The problem resolves itself into the following:—Let r (Fig. 4) be the radius of the inside edge of the fixed plates, x be one

of the radii of the curve, and θ the angle through which the moving plate is rotated from its zero position. The problem is to make the area abc , bounded between the curve and the circle of radius r , proportional to the square of the angle θ . This leads to the following formula for the curve:—

$$x^2 = 4k\theta + r^2,$$

where k is a constant such that the area $A = k\theta^2$.

In the actual condenser constructed the radius r was first taken at 2 cm. and $4k$ at $36/\pi$, the angles being measured in radians. In this case we have the area $A = 9/\pi\theta^2$ and the equation to the curve is $x^2 = 36/\pi\theta + 4$.

Or if θ is measured in degrees, by

$$x^2 = 0.2 + 4,$$

which is represented by the curve given in Fig. 2a.

The capacity of the condenser at any position θ may be easily calculated, since capacity in mfd. = $A/t \times 2n \times 8.86 \times 10^{-6}$,

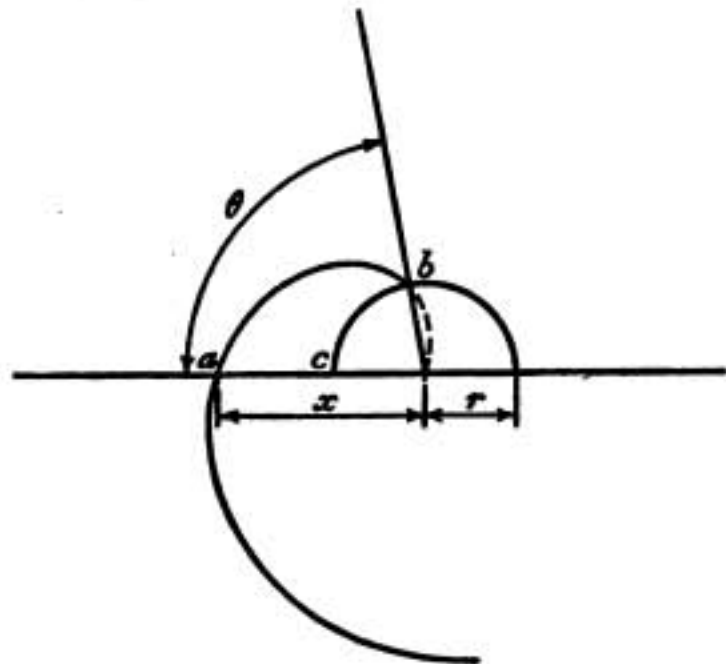

Fig. 4.

where A is the area of a plate in position θ ; t is the perpendicular distance between the plates, and n the number of moving plates—always assumed to be one less than the number of fixed plates.

The condenser as made consisted of 13 moving plates and 14 fixed plates, the clearance between the moving plates and the fixed plates being approximately 1mm. When finished, the condenser was tested and its curve plotted. It was found that the capacity was not strictly proportional to the square of the angle. A consideration of the

edge effects which have so far been neglected shows that this might be expected. It also shows that an improvement can be made by increasing the radius r without altering the shape of the curve. The radius was therefore increased by 3 mm. and the condenser was re-tested.

The calibration curve of the condenser can be very closely represented by a formula of the form—

$$\text{capacity} = a + b\theta + c\theta^2,$$

in which the constants a, b, c , have the following values:—

Before increasing radius r : a 0.022, b 0.017, c 0.0672.

After increasing radius r : a 0.025, b 0.0035, c 0.0659

where θ is measured in radians and the capacity in millimicrofarads.

It will be evident from the above figures that the increase of the radius has greatly improved the condenser and nearly made the term b negligible. Possibly, a slightly greater increase would have further improved matters. Although it has not been possible to get the initial capacity " a " as small as one would like, nevertheless the condenser has proved very convenient in use, and it is hoped that the above data may save some other experimenters from going through the work a second time.

Intensity of Wireless Signals according to the Season and Time of Day.—

According to P. Schwarzhaupt, the intensity of wireless signals is often found in the tropics to be four times as strong at night as in the daytime. Consequently, one would expect to find even in temperate regions some variation of the intensity according to the time of day and the height of the sun. The experiments of H. Mosler, published in the *Electrotechnische Zeitschrift*, were made between Norddeich and a station 420 km. away. To avoid errors, a mirror galvanometer was used for reception with a sensitiveness of 1.10-9 amp. for a distance scale of 1 m. The writer ascertained that in the course of a day there were no noticeable variations in the intensity. Even on the different days of the year the receiving intensity is practically the same; consequently, it is independent of the height of the sun. On the contrary, at night there

were important variations according to the time of year. In spring and autumn the intensity at night was double that in the daytime; in summer, on the contrary, the difference was scarcely noticeable. It was found also that the receiving intensity was not affected by the pressure of the atmosphere, variations of temperature, the speed of the wind, or the degree of humidity.

* * *

The following is a table of the relation of the intensity at night to that in the daytime for the different months of the year:—

February	2.06			
March	2.07			
April	2.20			
May	1.29			
June	1.09			
July	1.22			
August	(not recorded	owing to	severe	atmospherics)	—
September	2.14			
October	2.82			
November	3.15			
December	1.79			
January	1.64			

The author has noticed very great variations in intensity during a single night. In one instance, in seven minutes the intensity doubled, and then reverted to its former strength; in another, the intensity at night was about eight times that of the daytime. The theory of Heaviside explains these phenomena fairly well. He assumes that at a height of from 50 to 100 km. there is an ionised layer which reflects the waves towards the earth. During the day, owing to the light of the sun, this layer is at a great depth and is reflecting more rapidly, so that the transmission becomes weaker. It has been proved that such a layer exists after sunset by means of spectroscopic experiments. The writer has found that the light of the moon has no influence upon the waves.

According to the *Electrical World* a conference was held recently between Mr. Josephus Daniels, the Secretary of the Navy, and Capt. George R. Clark, commandant of the United States naval training station at Great Lakes, Ill., when it was decided that a high-power radio station and plant should be erected at the latter place. The Great Lakes station is near Lake Bluff, Ill., on the shore of Lake Michigan, and about 30 miles north of Chicago.

A Transatlantic Wireless Station

On An Historic Site—Louisbourg.

FORMERLY a great and flourishing city, afterwards a crumpled mass of ruins overgrown with rank grass and almost obliterated from sight, Louisbourg is again waking to life. Not exactly on the old spot, but a few miles to the north, the little town of to-day boasts of some 2,000 inhabitants. A few years ago it was little more than a hamlet, but, owing to its position on the coast of Nova Scotia, it has since come to be one of the chief centres of the cod-fishing industry; while quite recently the Dominion Coal Company determined to make it their chief winter port, thereby giving it a commercial prestige, which shows hopeful signs of increase; now it is to become one of the chief centres of Anglo-American communication, for the Canadian Marconi Company have erected their new high-power station here for wireless communication across the Atlantic, in order to

cope with the continually increasing traffic. The possibilities of this new enterprise are boundless, and promise to Louisbourg an era of prosperity which will go far towards reinstating the township in its former exalted position among the cities of the New World.

Louisbourg has too long been neglected; it is claimed to be the nearest port to Great Britain on the American Continent, and it is therefore likely to become of increasing importance to British trade. At present the rail communication is limited to a private line, The Sidney and Louisbourg Railway, which forms a junction with the Inter-Colonial Line, and connects Louisbourg Wireless Station with its power station at Glace Bay. The station is now in full operation, working a Duplex System in conjunction with the stations belonging to the English Marconi Company at Letter-

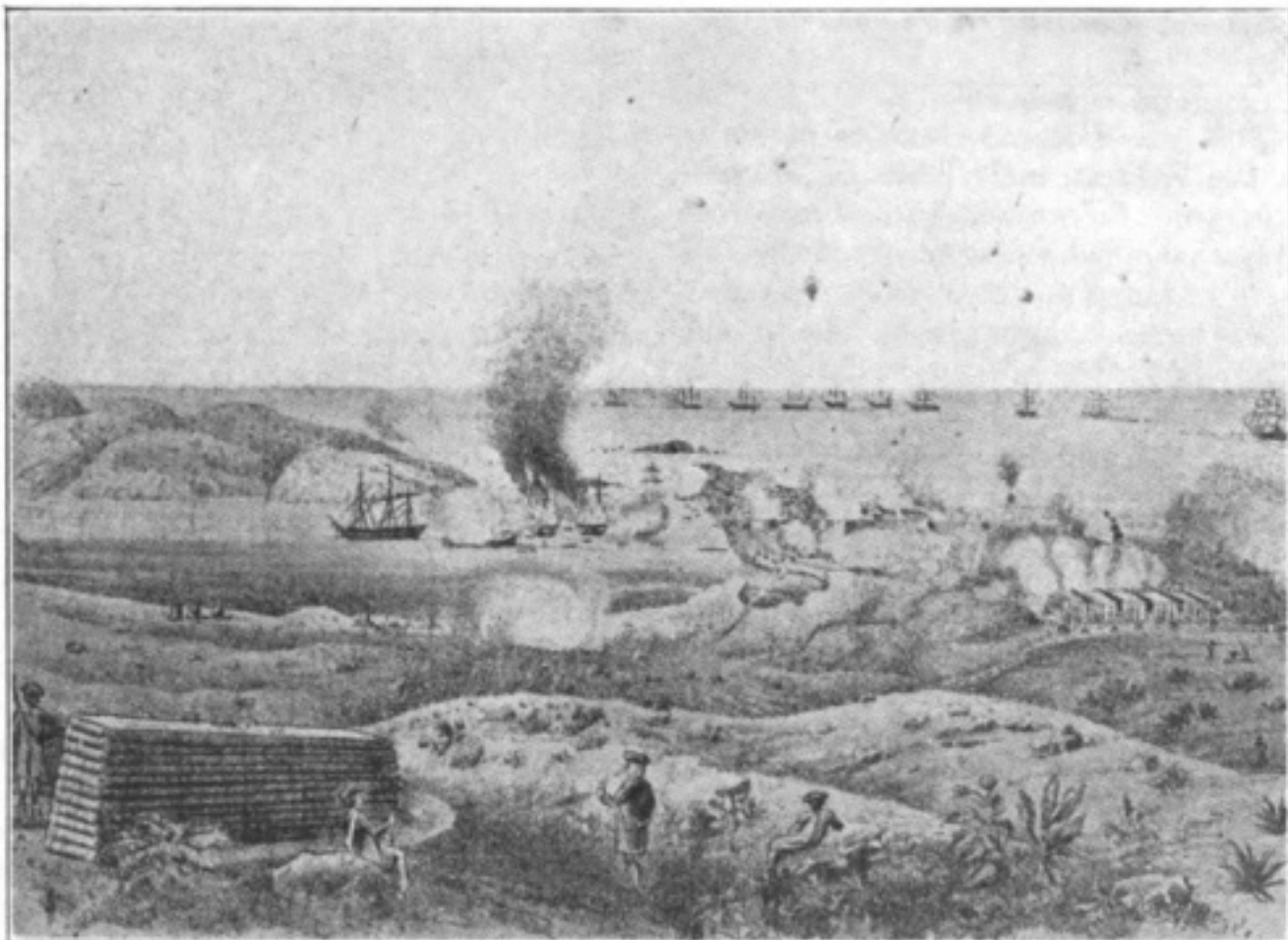

The Siege of Louisbourg, 1758, from a Drawing now at Woolwich Arsenal.

frack and Clifden, in Ireland. The station at Louisbourg represents the last word in high-power wireless land station construction, for it embodies all the latest improvements in wireless science; it is the first station in the world to work with the Duplex System, which permits of the simultaneous transmission and reception of messages at the same operating house, while another important invention which has been introduced here is the automatic transmission device, by means of which it is possible to handle messages at the rate of 100 words per minute. The whole of the operating staff of the Glace Bay station has been transferred to Louisbourg, where spacious and comfortable quarters have been provided. The engineers, however, remain at Glace Bay, the plant there supplying the necessary power for Louisbourg.

Such, then, are the new conditions prevailing in the small town which has arisen on the ashes of the older city, and let us hope that under the new auspices it will recover some of its former glories, and be to Great Britain what the first Louisbourg was to Greater France.

It is just two centuries ago that the French landed here and claimed the territory for their country. After the Treaty of Utrecht, in 1713, the Ministers of King Louis XIV. decided that if they were to retain their hold on new France they must effectually guard the eastern approaches to the St. Lawrence. For a long time they were undecided what was the most advantageous site to select for this purpose, but at length, in 1719, their choice fell on the narrow neck of land on the harbour's southern shore. These preliminaries accomplished, ships bearing hundreds of workmen were sent forth from old France and the building of Louisbourg began.

Three hillocks marked the site of the proposed city, and on these the engineers took advantage to erect strong defence works. The highest was made the citadel of King's Bastion, and contained the Governor's House, the Church of Notre Dame des Anges, and the Barracks. The



Operators' Quarters at the Wireless Station.

line of works extended from the harbour on the one side to the sea on the other. Near the harbour was the town's principal gate, defended by a spur, and on a demi-bastion was planted a strong battery of guns, which could entirely cover the entrance to the harbour. On the sea side was the Queen's Bastion, fortifications of enormous strength, while closer to the low-lying shore was a demi-bastion, "La Princesse," from which a wall extended eastward practically enclosing the city. The whole of the outer works were constructed on the system of the celebrated Vauban. First came the smooth turf of the Glacis, which rose from the surrounding moor to the parapet's edge. Four feet above was a narrow banquette, upon which infantry could stand in shelter and sweep with their musketry the slopes of the Glacis beyond. Beneath the banquette was a 20-ft. wide covered way, where troops could muster and manœuvre; while nearer the city was an 80-ft. wide ditch. The walls were 35 ft. high, crowned by a rampart, which enclosed an open space for the cannon, placed with their muzzles opening outward through the parapet embrasures. The city was almost impregnable, and it was the pride of Louis Quinze and his Ministers. The plans and documents drawn up by the engineers employed for this purpose are still to be seen in the French Colonial Archives,

and are models of engineering and architectural skill.

Under such favourable conditions it was not long before an important and wealthy town arose. Traders in those uncertain times found it to be a safe harbour, and merchant ships of every description made it their *rendezvous*.

"English, Spaniards, Portuguese, Basque Dutch and Bastonnais all come hither," wrote an English captain in 1740.

"There is one good inn, the 'Lion d'or,' and three others—all generally crowded. The Governor is very hospitable to the officers, and sets a bountiful table with the best wines."

The streets must have witnessed many a lively scene; soldiers in their white uniforms, subalterns resplendent in scarlet and gold lace, naval officers in blue, governors, dandies decked out in all the peacock beauty of their times, great ladies in satin and brocade made a brave show, and set off by their contrast with the meaner population of workmen and dependents and slaves. Monks and missionaries were also to be seen, for "Our Lady of the Angels" had to be served, and the spiritual needs of the subjects of the most Christian King were not to be denied. The world went very well then.

But the sun of Louisbourg's prosperity was soon to suffer eclipse. In 1744 war broke out between France and England, and the Governor of Massachusetts was advised by certain English prisoners who had been held captive in Louisbourg fortress that an

attack on the city, if well carried out, would in all probability be successful. Accordingly arrangements were made.

One night in April, 1745, just at the close of a public ball, a captain, attired in night clothes, rushed into the chamber of the Governor, M. Duchambon, to report that a

strange fleet had been sighted entering Gabanus Bay, five miles distant. This fleet landed a colonial force of some 2,000 men, and the siege of Louisbourg was commenced. It was arduous work for the besiegers; the harbour was found to be impregnable, and so artillery and stores had to be landed at another point on the St. Lawrence, and this could be done only with the utmost difficulty. Indomitable perseverance, however, succeeded, batteries were thrown up round the town, heavy guns mounted; and the bombardment of the city commenced. It continued practically without intermission for 49 days, at the end of which time heavy casualties and great privation forced M. Ducham-

bon and his depleted garrison to surrender.

When news of the disaster reached France, the nation was thunderstruck; it was the heaviest blow of a whole year of disaster, and she made every effort to retrieve her adverse fortune. A great fleet was sent out from Cherbourg, under the command of the Duc D'Anville, with orders to recapture the city and ravage Boston. But it was not to be; a terrific storm scattered the ships, and when D'Anville arrived at Chebucho, he realised that his position was



Balancing Aerial.

hopeless, and so great was his disappointment that he succumbed to an apoplectic stroke. He was buried on an island which to-day is known as Halifax Harbour.

His Vice-Admiral, Destournelles, gave up the forlorn hope, much to the chagrin of his officers, who passed such malicious reflections on his honour that he committed suicide; thus the expedition ended, but England did not long retain her conquest, for after the peace of Aix La Chapelle, Louisbourg was restored to France. Then with great pomp and ceremony the body of the ill-fated D'Anville was interred before the altar of "Notre Dame des Anges."

Once again France enjoyed the possession of her beautiful city, but again only for a short season. In 1758 another phase of the war broke out, and this time the young Englishman General Wolfe was commanded to lay siege to the town. Six weeks of suffering for the inhabitants, and Louisbourg was once more in the hands of her enemies. The triumph of a conqueror must be heavily alloyed with pain. Wolfe, writing of this incident to his mother, concludes "I went into Louisbourg this morning to pay my devoirs to the ladies, but found them all so pale and thin with long confinement in a case-mate that I made my visit very short." During the siege over 1,000 men had been slain. It was from this city that Wolfe set out on the expedition to Quebec, which won him fame and death.

After the fall of Quebec into the hands of the English, the conquerors decided that

Louisbourg must cease to be. Orders were given, and for a whole year the work of destruction was carried on by soldiers selected for that purpose. The guns were carried to Halifax, Boston and New York. The great cross of our Lady of the Angels was taken down, and now reposes in the library of Harvard University, and the bell has found a home in the Château de Ramezay at Montreal. The ornamental stones of the city gates and the Governor's house were carried away to adorn Colonial mansions; one of the beautiful carved chimneypieces is now in Halifax, another in Charleston, South Carolina—*Sic transit gloria mundi!*

For a century Louisbourg was to be amongst the waste places of the earth; now it is called again into existence; perhaps for a less ostentatious and romantic work, but who shall dare say that its new existence will be less historic or less important? History is not dead. We of the twentieth century are making history in our own way, and perhaps that is a nobler and

a more potent way, for it is the way of peace, and the conquests of peace outlive the conquests of war. As for romance—romance is nothing but the mist of years through which we see the past! The Wireless Station may not, to the modern sense, appear as splendid as an ancient city built at the command of Le Roi Soleil; that is because we have not yet attained the right perspective; and we must leave it to future generations to appraise at its full value the work that is now being done.

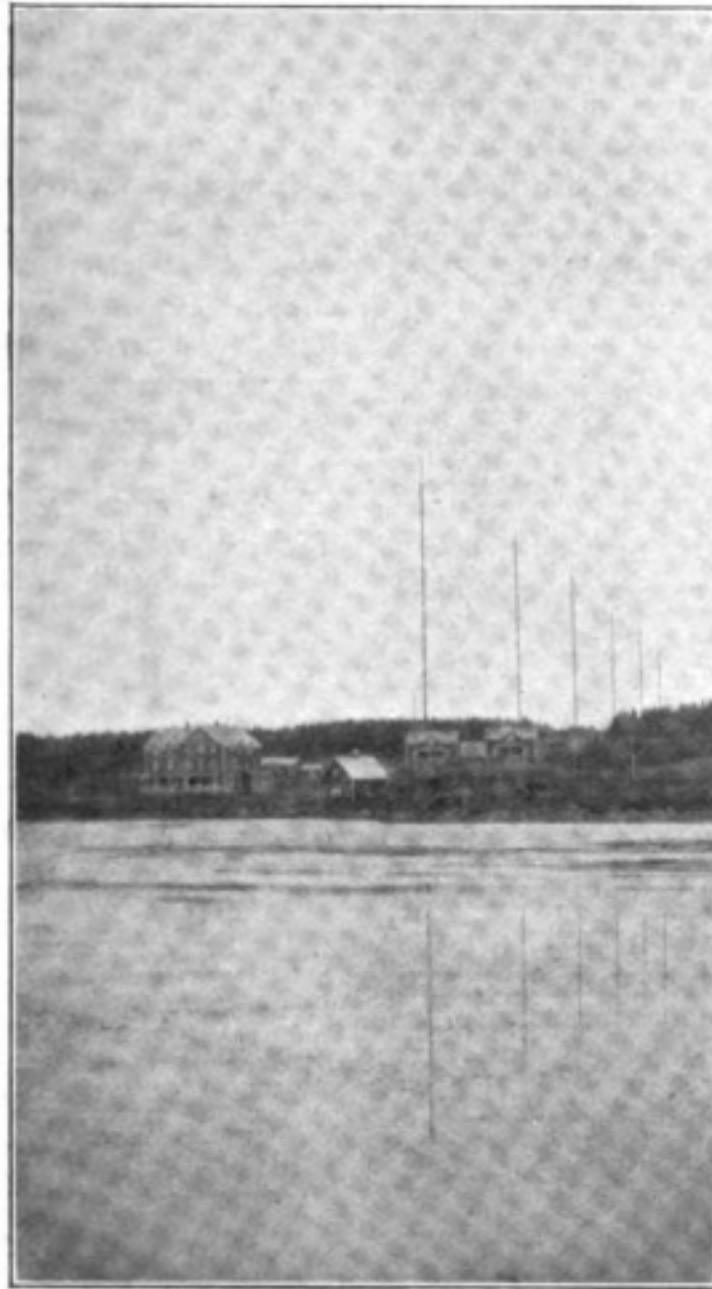

A Distant View of Louisbourg Station.

Aerials and their Radiation Waveforms.—I.

By H. M. DOWSETT.

FIG. 1 represents the wave-front of a field of electric strain generated at a point P, travelling up an aerial PL, and returning along the earth EE. PL is a thin vertical conductor of negligible capacity relative to the earth. The rate at which the strain travels along the aerial is therefore the same as its speed in free space, and the wave-front in the plane of the aerial is a semi-circle.

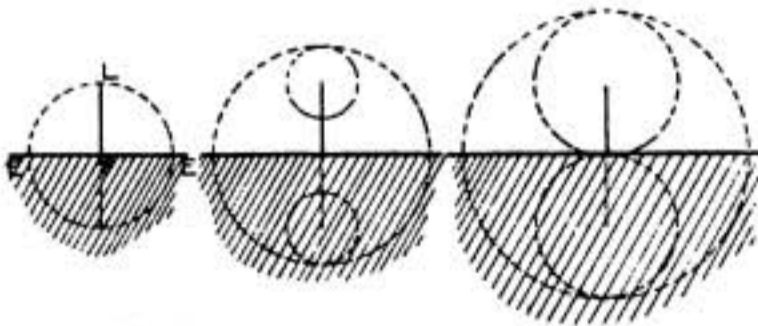

Fig. 1.

Fig. 2.

Fig. 3.

If EE is a perfect conductor, the field which cuts it results in surface currents. These currents are the exact equivalent of an earth wave shown dotted, the image of the wave in air. The reaction between the waves in air and their earth images correspond to the reaction between the waves in air and the earth surface currents. The travel up the aerial and return along the earth is therefore equivalent to a half-wave in space.

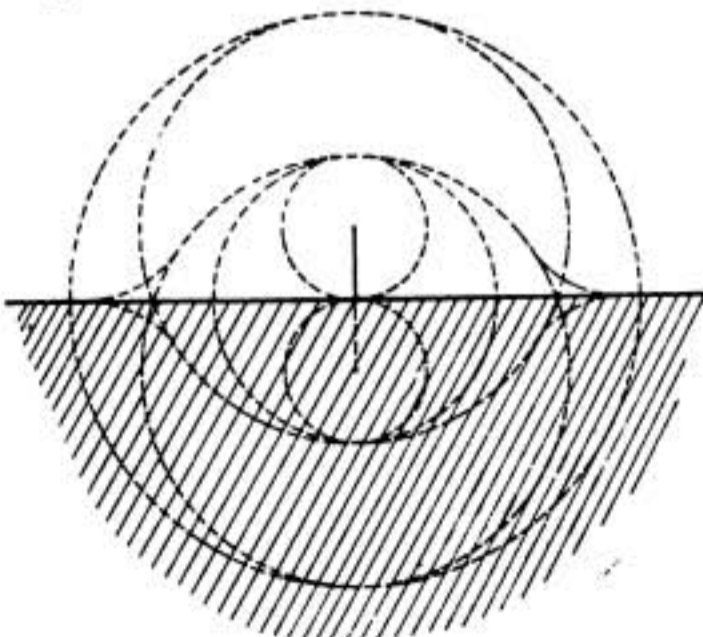

Fig. 4.

The expansion of the wave in Fig. 1 is shown in Figs. 2, 3 and 4.

The direction of travel is normal to the convexity of its front and it leaves the aerial conductor at right angles. The front of the wave takes its centre from P, the back from L, and the wave-length is four times PL.

Fig. 4 shows that part of the back of the wave must travel into the earth. There it changes into earth currents and is opposed by other currents equivalent to the corresponding part of the earth image of the wave which neutralize it.

Fig. 5 shows five waves leaving one side of the aerial, and brings out the fact that if the aerial had negligible capacity relative

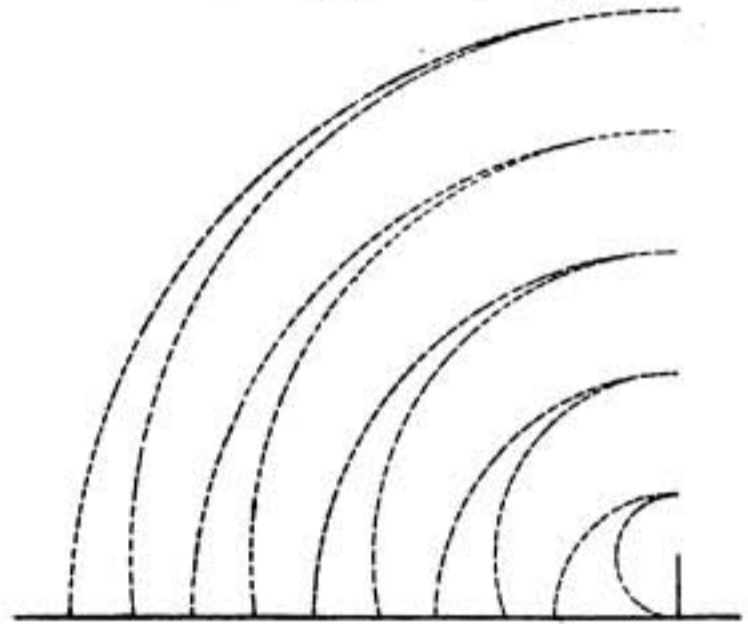

Fig. 5.

to the earth, the wave loops would practically meet at the zenith; also they would be pointed and not rounded at the top.

If the aerial has capacity, the wave travels slower along it than through free ether, and the wave-length will be more than four times the length of the aerial.

Figs. 6 and 7 represent a half-wave and two waves respectively, where the wave-length is five times the length of the aerial but the lag is supposed to be confined entirely to the space occupied by the aerial itself. The peaks of the waves still practically meet at the zenith. But the

whole wave grows out of the aerial, and therefore is initially affected right through with this lag, Fig. 8.

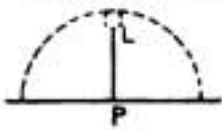

Fig. 6.

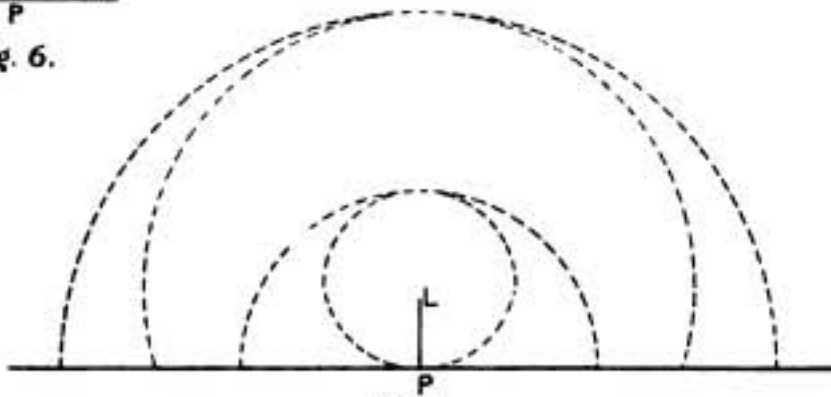

Fig. 7.



Fig. 8.

That part of the wave which leaves the aerial first, the part nearest the earth, will have thrown off some of this lagging effect and have accelerated when the top part of the wave is still influenced by it.

Fig. 9 shows this wave expanded. Both the top and the bottom part will finally accelerate until the normal speed in free ether is obtained. This involves a small change in curvature of wave-front for the first few wave-lengths, and then a constant curvature.

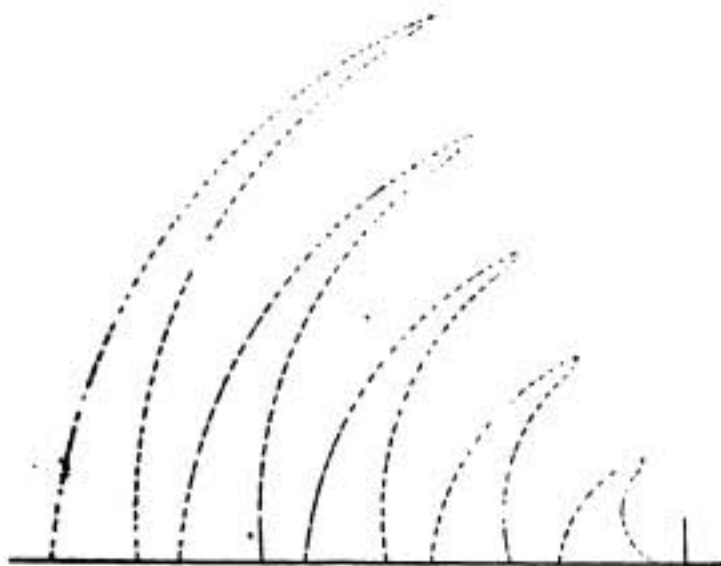

Fig. 9.

It will be seen that these wave loops do not meet at the zenith, that the acceleration after leaving the aerial tends to send the wave tops higher into space; also that the



Fig. 10.



Fig. 11.



Fig. 12.

back of each half-wave in its march forward cuts off the backward expanding part of the wave top and leaves it pointed.

Fig. 10 shows a half-wave leaving a bent aerial, the relation of height to length being 1 : 2 and the capacity of the aerial being supposed to influence only that part of the wave travelling immediately along it.

Figs. 11, 12 and 13 correct for the retardation in the neighbourhood of the aerial and show the wave expanding from a-half to three-quarters and to one wave-length. The relative size of the two loops in the plane

of the aerial is proportional to the energy sent in the two directions. Fig. 13 also indicates the amount of wave energy radiated from the bent part of the aerial normal to the earth which is dissipated in surface currents.

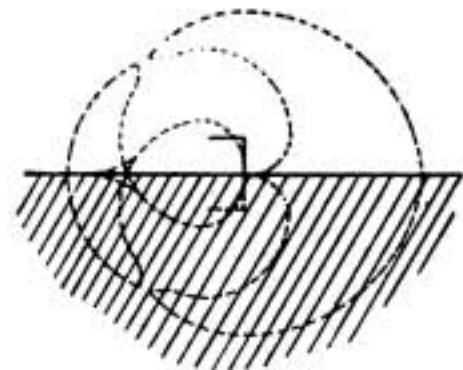

Fig. 13.

Fig. 14 shows an umbrella aerial of height equal to the length of any one of its extensions and the half-wave wave-front which would result if it had negligible capacity.

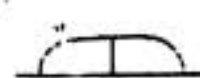

Fig. 14.

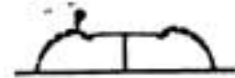

Fig. 15.

Fig. 15 shows the modified front if the capacity increases the wave-length from four to five times the length measured from ground to the end of one extension. The outer curve would result if the lag in speed occurred only along the aerial, while the inner curve corrects for lag also in the space surrounding the aerial. The radial horizontal conductors screen the space immediately above them from the disturbance proceeding from the central aerial. The wave-front therefore leaves

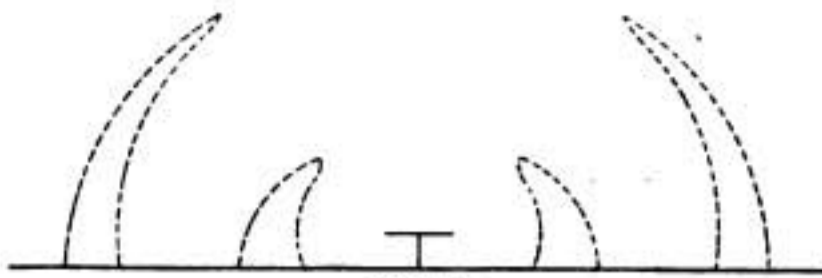

Fig. 16.

the aerial normal to the underside of the umbrella.

The bending down of the conductors causes a distortion in the field which the field tends to resist. The peak P, therefore, will be a little higher above the earth than the end of the aerial.

Fig. 16 shows two waves the second of which has just left the aerial. The peaks of the waves do not extend so high into space as those from a vertical aerial.

Fig. 17 shows a half-wave and two waves leaving an umbrella aerial of similar capacity to No. 16 but with lowered extensions. The effect of this change is to cause the vertical part of the aerial to absorb energy from the back of the wave as it gets away, to increase the loss due to radiation earthwards, and to still further lessen the extension of the wave vertically into space.

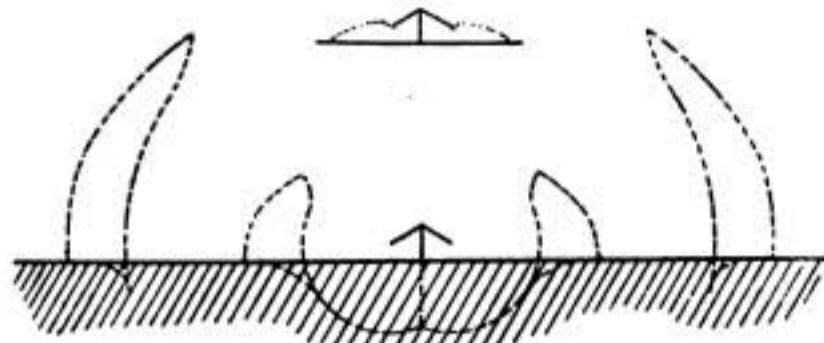

Fig. 17.

Insulated Joints in the Wire Guys for Masts.

By H. R. S.

THE masts or towers required in wireless telegraphy for supporting the aerial are rarely of the self-supporting type, although there are many notable examples to the contrary—such as the Eiffel Tower and the Arlington Tower.

Having decided on the maximum pull of

it is difficult to settle what the maximum pressure of the wind is likely to be, because some doubt exists regarding the maximum wind velocity and how this velocity varies with the height above the ground. Further, it is certain that the wind does not blow simultaneously with equal velocity

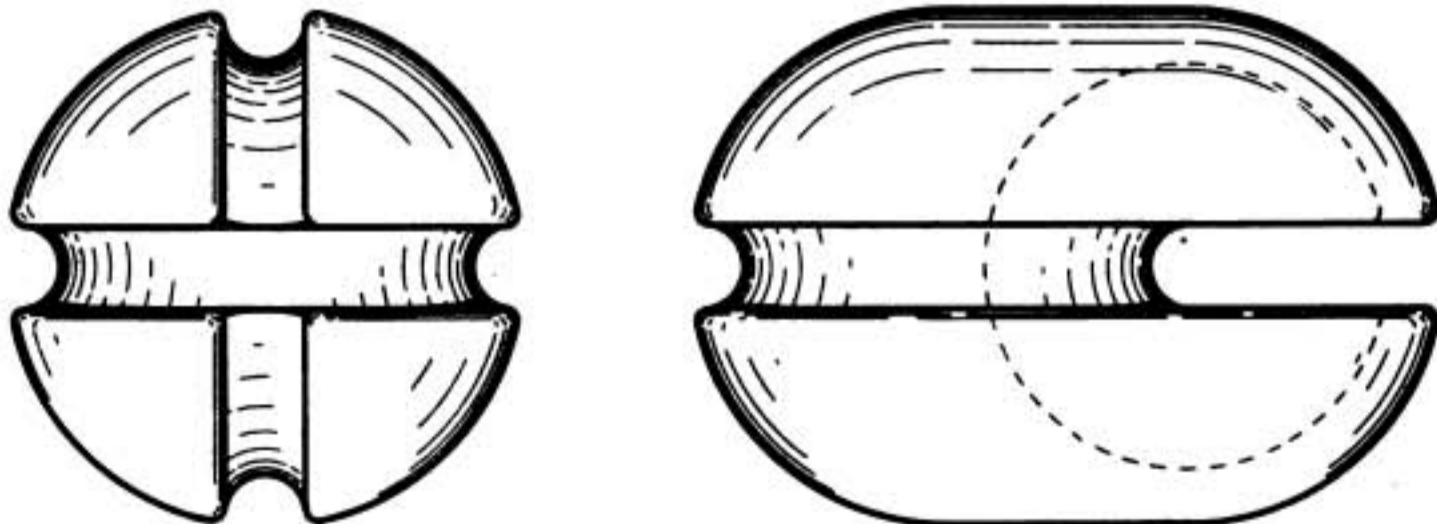

Fig. 1.

the aerial and on the maximum pressure to be allowed for the wind, it is easy to calculate the maximum stress to which any particular guy rope may be exposed, and thence deduce the size of the wire rope required. Incidentally, it may be pointed out that

over a large area, but the variation is not known.

Also the shape and inclination of a member affects the wind pressure on it. The shielding effect of one member on another behind it in the path of the wind has to be estimated,

and, finally, the increase of surface due to ice coating has to be allowed for. All these matters, however, are engineering problems of a similar nature to those which have to be considered when designing, say, a bridge.

In the case under discussion a further consideration enters, imported by "wireless" requirements, viz.: these guys must not be continuously metallic from the mast to the ground, but must be split up into sections jointed together by insulators, or

quently does not bear evenly, the pressure on the porcelain will be extremely intense at those points where the rope is in the contact, the porcelain will be cracked at these points, and the insulator will fly to pieces.

To make these loops as flexible as possible a particular variety of wire rope having a hemp core is used, and it is further served with tarline; a cushion is thus obtained between the wire rope and the surface of the porcelain, greatly helping to distribute the

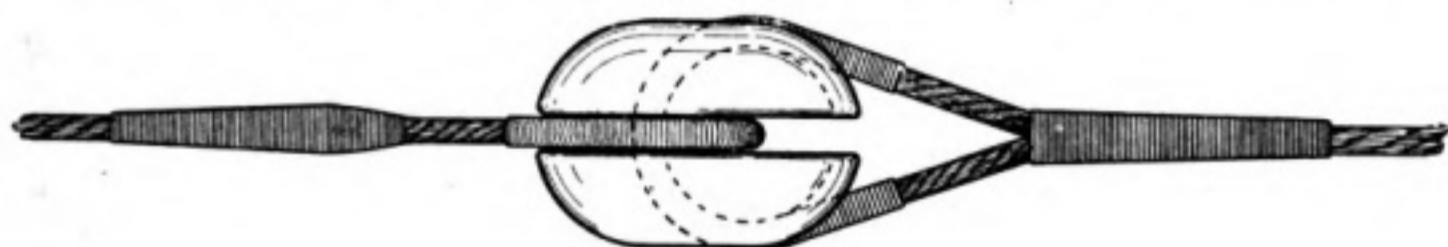

Fig. 2.

else high-frequency currents would be induced in them, causing considerable loss of power, thus reducing the efficiency of transmission.

The electrical qualities of these insulators are all-important, as the difference of potential to be withstood is of the order of several thousands of volts; they are, therefore, subjected to severe electrical tests, or, at any rate, a certain percentage of each batch are so tested. Unfortunately, the material which is electrically best suited, viz., hard vitrified porcelain, is mechanically weak and brittle, and consequently somewhat difficult problems have to be solved to obtain a satisfactory insulator that will safely withstand a pull in a guy rope of, say, 20 tons and over.

The form of insulator shown in Fig. 1 is satisfactory, at any rate for guy rope pulls not exceeding 15 tons, and is generally employed. It is specially made by hand by Messrs. Taylor Tunnicliffe, of hard vitrified porcelain, and is highly glazed, so as to accumulate as little dust as possible. The way in which it is used with wire rope is shown in Fig. 2, and it will be observed that the two wire ropes to be connected by the insulator are looped together, so that, should the insulator be fractured, the guy will not part. These loops of wire rope are laid in the deep grooves formed in the body of the insulator, and the manner in which the rope beds itself into these grooves is an important factor as regards the strength of the joint. If the rope is stiff, and conse-

pressure and preventing the local cracking referred to above. This serving has, however, a further use, because, should the insulator fail, it flies into small pieces and the sharp edges may cut into the strands of the wire rope, causing a failure of the stay.

The test results given in the following table illustrate these points.

Description of wire rope.	Pull at which Insulator failed.
2½ in. circum. hemp core, served with tarline.	13 tons, burst without warning and completely. Tarline cut, but wires undamaged.
3 in. circum. hemp core, served with tarline.	22 tons, bursting violently and completely. Tarline cut, but wires undamaged.
3 in. circum. solid core, not served with tarline.	17.4 tons, burst without warning. Strands cut by sharp pieces of broken porcelain.

The manner in which the wire rope is jointed or spliced on itself to form the loop is a matter which requires great care and good workmanship, and several failures have been due to imperfect work in this detail. For example, some years ago a 400-foot tower at Machrihanish came down, and,



Fig. 3.

although it was not absolutely proved, there is good reason to believe that the failure was caused by the drawing out of the ends of the wire rope, which had been imperfectly soldered into the sleeve, as shown in Fig. 3.

The ENGINEERS Note Book

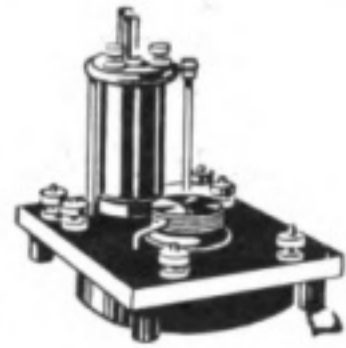

[Under this heading we propose to publish each month communications from our readers dealing with general engineering matters of various kinds in its application to wireless telegraphy, and we would welcome criticisms, remarks and questions relating to the matter published under this heading. We do not hold ourselves responsible for the opinions and statements of our contributors.]

Some Notes on Wire Ropes.

By F. E. R.

STEEL wire ropes in the hands of competent men are in most cases better and safer than chains, however well made. The strength of a chain is the strength of its weakest link, whereas if a strand in a wire rope breaks, it does not mean that the whole rope will fail.

Wire ropes have also to a great extent replaced hemp and manila ropes, especially in countries where the climate has a bad effect on the latter; the wire ropes are less cumbersome for hoisting, etc.; for instance, a hemp rope for hoisting sections in the erection of masts would be much more unwieldy than a steel rope of the same strength. They are also much more suitable for staying the masts, as they can be made taut; whereas, if a hemp rope is made taut and then gets wet, it is liable to fail owing to shrinkage.

These ropes are stronger than the material from which they are made, for the following reason.

* * *

The wire from which the rope is made up is at first about twice the diameter of the finished wire; it is then reduced in size by being drawn through a hard-steel draw-plate. The result of this drawing action is to compress the steel and at the same time to form a hard skin on the outside of the wire. This skin is, in fact, a thin cylinder which keeps the steel compressed, therefore increasing the density, and hence the strength.

This cylinder is perfectly elastic, but not

so ductile as the steel inside. If the cylinder is broken in any way, the strength of the rope is reduced from 5 per cent. to 10 per cent. New ropes are often reduced this amount in strength owing to kinks getting in the rope.

The use of small winding drums is also another cause of this skin becoming cracked. The use of a small drum is the cause of a still more serious action. A rope may pass round a small drum or pulley perhaps a thousand times, and then suddenly fail, the reason being the repeated bending of the wire. So that, while kinks usually only reduce the strength of the rope, the use of small winding drums or pulleys is even more dangerous. Steel wire ropes are more flexible than iron ones, but a bad kink will do more harm to a steel rope than to an iron one, as the iron rope is more ductile.

This damaging action by bending depends also on the speed of the winding drum or pulley over which the rope passes. For slow speeds the size of drum should not be less than 80 times the diameter of the rope, and for high-speed winding from 120 to 150 times the diameter. Guide pulleys may be less, as the rope does not pass all the way round them. They should never be less than 50 times the diameter of rope.

* * *

The weakest point in a rope is at the capping, or where it is attached to the crane hook, or to the anchor in the case of a stay for a mast.

The best method of capping, in fact the only satisfactory method, is as follows:

About 6 inches from the end the rope is seized. The wires are then frayed out, well

cleaned, and put into a cone-shaped casting ; then white metal is run in. The efficiency of a rope capped in this way is from 95 to 99 per cent.

The efficiency of a spliced rope is from 60 to 80 per cent., depending on the man who makes the splice.

The method of capping a rope by splicing a thimble into the end is usually quite good if made by an experienced man. A straight splice is in general nearly as strong as the rope itself, but when it is bent to take the thimble the wire is not uniformly loaded, so that if it were spliced for double the usual length it would not be anywhere near the strength of the rope.

The first method also has the advantage that it does not require skilled labour, as is the case with a spliced capping.

The efficiency of ropes using the various kinds of screw-grips is from 30 to 50 per cent. The use of any type of grip which tends to deform the rope is bad practice ; in the first case because it crushes the rope, and secondly because the rope is not uniformly loaded.

The efficiency of a rope is worked out in the following manner :

The rope is first fractured in the testing machine in the usual manner. Then each separate wire is fractured in a smaller machine.

Efficiency = $\frac{\text{Total load required to fracture rope}}{\text{Sum of the loads required to fracture each wire.}}$

Example.—A rope consisting of 49 wires failed at 20 tons. Each of the 49 wires failed at 9 cwt.

Then efficiency = $\frac{20}{9 \times 49} = 90.7$ per cent.

* * *

Wire ropes are layed up in two different ways. (1) Ordinary Lay. The wires in the strand are laid right-handed, and the strand layed up left-handed in the rope. Ropes layed up in this manner are cheaper to make, and are, or should be, only used for stays and guys, and never for hoisting ; the reason being that they wear out very quickly owing to only a small proportion of the wires coming in contact on the drum. (2) Lang's Lay. In this method the wires in the strand and the strand in the rope are both layed up the same way, and hence have a smoother surface and no sharp corners as in the ordinary lay. This rope wears uniformly.

No general formula can be given for the strength of wire ropes, for the simple reason that they vary so much with different makers.

If first-class ropes are used, however, the following are sufficiently accurate :

C = Circumference, measured in inches.

Breaking load in tons = $3 C^2$ (steel).

Breaking load in tons = $3 C$ (iron).

The following is an actual test on a steel wire rope, 4 inches in circumference :

Actual breaking load in tons = 51.7.

From $3 C^2$ breaking load in tons = 48.0.

So that if dealing with first-class ropes the $3 C^2$ is quite safe.

* * *

CONCRETE MIXING.

"ANGLO-INDIAN" writes to us as follows : "I have consulted various books on the subject of Salt Water for Concrete-mixing, with the result that I am still in a difficulty. My position is this : The only water readily available is sea-water, and to obtain fresh water means that it has to be carried from a river some eight miles away, which will mean considerable expense ; especially as the roads are practically non-existent. Most of my books say that salt in the water merely makes the setting of the concrete slower, and that it does not affect the final strength when set. On the other hand, sea-sand is generally condemned, unless carefully washed. What am I to do—risk the sea-water, or go to the very considerable expense and inconvenience of carting large quantities of fresh water ? Even if the sea-water will only delay the setting and not weaken the concrete, I still have to consider whether this delay will make me have to put off using the foundations for so long that this objection would be even more important than the expense of fresh water. I may mention that I have decided to cart my sand from a distance in order to avoid sea-sand, for I suppose it is clear that sea-sand cannot effectively be washed by sea-water.

The concrete is intended for various purposes, mast and anchor foundations and also building and machine foundations ; and as it is required in large quantities, the question of expense is of considerable importance, but at the same time so is the quality of the concrete. If any engineer reader will help me out of this difficulty I should be very much obliged. I can see that the same question will arise when it comes to the mixing of mortar, etc., for the actual buildings."



NOTES OF THE MONTH

THE prediction of a former Prime Minister of New Zealand that "the rapid development made in Marconi wireless telegraphy can only lead to the attainment of cheap telegraphic communication," has been brought a further stage nearer fulfilment. As all the world knows, wireless telegraph communication between Great Britain and the North American Continent has been conducted for some years past with unfailing regularity, and what better evidence of the reliability and the economy of this service is necessary than the extensive use now made of that service by the great newspapers of England, the United States and Canada. The fact that the Marconi system, as now developed and perfected, has been found adequate to meet the requirements of the Press, and that it is a medium which is employed to the full extent of its present capacity for ordinary commercial correspondence, stamps it as a service of great public utility.

Developments in the system have made it possible to provide additional facilities for public service. On February 14th last a service of night and week-end letter telegrams "Via Marconi" was brought into operation, and it provides the cheapest medium for communication between Great Britain and North America. The rates are 6d. per message (initial minimum) cheaper than cable rates, and $\frac{1}{2}$ d. per word cheaper for additional words.

Night letter telegrams which are handed in at Marconi House, Strand, London, during the evening, are delivered at their destination on the following morning immediately the ordinary traffic has been cleared. Week-end letters must reach Marconi House by Saturday midnight, and these are delivered to their destination on the following Monday. The rates for these

services are set out in the accompanying table, and the corresponding cable rates are also shown:—

NIGHT LETTERS.

	Via Marconi		Via Cable	
	s.	d.	s.	d.
London to New York : for 12 words	2	6	3	0
Each additional word	2			$\frac{1}{2}$

WEEK-END LETTERS.

London to New York : for 12 words	4	0	4	6
Each additional word	2			$\frac{1}{2}$

The only stipulation made is that these letter telegrams for North America must be written entirely in plain English or French. Code words are not admitted, except for the address. Figures, however, are allowed.

* * *

After examining the junior wireless operator of the ill-fated steamer *Monroe* the Board of Steamboat Inspectors at Philadelphia reported that wireless telegraphy has yet to prove that it can prevent collisions of ships within a short distance of each other in a fog. The Inspectors apparently were not aware of the tests recently made on the steamer *Northland*, on the United States revenue cutter *Seneca*, and in the laboratories of the United States Navy of a "direction-finder," or "radio compass"—its technical name is radio-goniometer—which shows accurately the direction from which wireless signals come. As the *New York Times* rightly points out, this Marconi apparatus is independent of the regular wireless outfits on board ship, and it requires no power for operation. All that is necessary is a separate installation of aerial wires, presenting two triangles that bisect each other at right angles, as shown in the illustration which appeared recently in the *WIRELESS WORLD* when we described the

apparatus supplied to a Hull trawler. The range of the "compass" is from 40 to 50 miles, according to the size of the wires employed, and it can be manipulated very simply either by the wireless operator or by the navigating officer. The direction-finder should ultimately be relied upon quite as much as the foghorn, although the sounding apparatus can never be dispensed with until all vessels, large and small, have complete wireless equipments. But wireless has already been of great service in locating vessels in a fog. Messages exchanged between ships and shore stations have served to keep commanders informed of vessels near them, and experienced operators can gauge the proximity of another vessel by the increasing strength of received signals as the distance diminishes. The direction-finder has not yet been adapted for general use on ships, but a good beginning has already been made, and transatlantic travellers will have many opportunities during this year of witnessing its effectiveness.

* * *

Wireless lighthouses are being established by the Government along the French coast, the first two being located on islands near the approach to the port of Brest. Two more are planned for the port of Havre. The lighthouses will operate by a system almost exactly like that of ordinary lighthouses, except that, instead of light waves, wireless waves will give the information to approaching ships. The great advantage of such lighthouses is that fog will not hinder their efficiency. When a ship approaches Brest, and is within thirty miles of the islands, wireless signals will be picked up. If the ship has an instrument to detect the direction from which the signals come it will be easy to apply the information; but even if it does not have such an instrument the receipt of any signals at all will be of assistance, for the exact positions of the two lighthouses are known, and a comparison of the strength of the signals from each will help in estimating the ship's position. Each station, like an ordinary lighthouse, will send out flashes every few seconds, together with special signals to indicate which station is sending. The sending apparatus is automatic, and is constructed so that it will run for thirty hours without any attention.

WIRELESS TELEPHONY.

WIRELESS Telephony has been much to the fore in the Press during the past month mainly on account of some important demonstrations given by Mr. Marconi.

During the early part of March Mr. Marconi joined one of the Italian war vessels at Augusta, attached to the squadron commanded by H.R.H. the Duke of Abruzzi. For four days he carried on experiments of far-reaching importance with the most satisfactory results. During the first day clear radio-telegraphic communications were received from Rome over a distance of 575 km. (356 miles); from Vienna over a distance of 970 km. (600 miles); and from Clifden in Ireland, 2,800 km. (1,750 miles) away.

These communications took place during the day, and new high resonance receivers with phonographic register-repeater were employed with excellent results.

Experiments in wireless telephony were carried out on the following day between several vessels lying at anchor at a distance of one kilometre apart, ordinary receivers being used with great success. At night wireless telegraphic signals were received from Glace Bay, Canada, over a distance of 6,500 km. (4,062 miles).

The wireless telephone experiments were continued on the third day, this time between two warships on the high seas, and the reception was consistently perfect over a distance of 30 km. Using wireless again on the fourth and last days successful telephone experiments were carried out, communications taking place with very limited energy between vessels on the high seas 70 km. (45 miles) apart. These experiments were repeated between two vessels situated at a distance of about 20 km. (16 miles) where land interfered between the communicating vessels, and in this case again excellent results were obtained.

On the last day radio-telephonic communication was constantly maintained for twelve hours, and the continuous working of the apparatus did not cause the slightest inconvenience. The apparatus employed in the experiments is of a new and most simple type, and it was Mr. Marconi's desire that it should first be used on the warships of the Italian Royal Navy.

Maritime Wireless Telegraphy.

EACH successive Atlantic liner launched at the Belfast works of Harland & Wolff has marked a distinct step, not only in size, but in strength and in those provisions necessary to ensure comfort to the passengers and the greatest degree of safety which is possible considering the elemental and other forces of nature. Indeed, it may be said that each vessel

17 ft. The draught of the vessel when afloat was 15 ft. 4½ in. forward and 25 ft. 7 in. aft. The vessel was afterwards berthed for completion at a deep-water wharf.

* * *

The *Britannic* is about 900 ft. long and 50,000 tons gross register; and in general features will be similar to the *Olympic*, with various improvements introduced as the

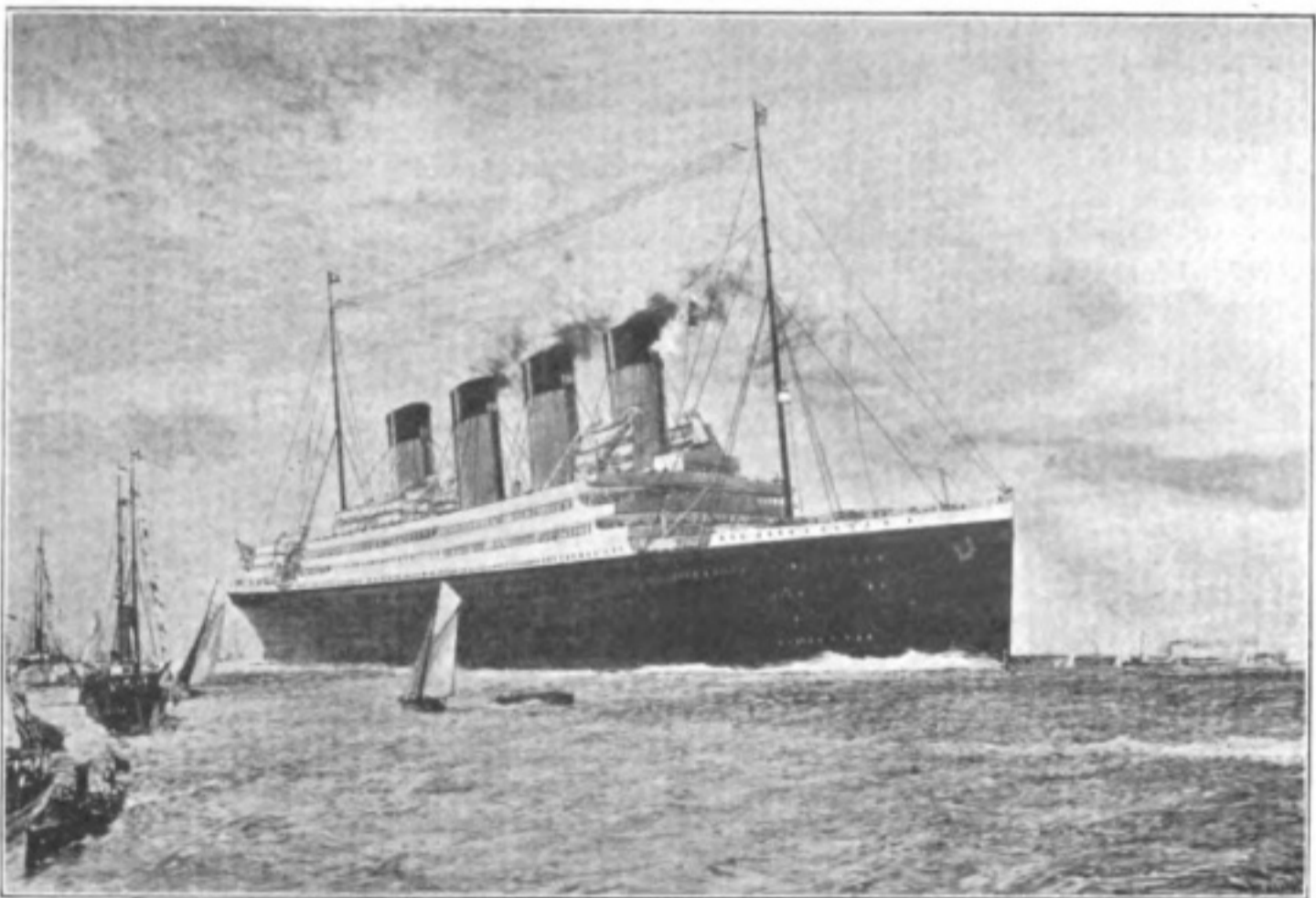

The White Star Liner "Britannic."

typified the highest achievement of her day in the practice of shipbuilding and marine engineering. The White Star liner *Britannic*, the latest of the ships, is in every respect an example of this periodic standard of progress. This vessel was successfully launched on February 26th. The pressure on the hydraulic ram of the trigger arrangement used for releasing the ship attained a maximum of 560 tons, and the time which expired from the beginning of movement of the ship until the vessel was afloat was 81 seconds, the maximum speed attained being 9½ knots. The stern dip was 31 ft., and the stem dip

result of the experience gained in that vessel, which has proved so popular in the service. Both in design and workmanship the element of strength has been kept steadily in view, and the most approved structural arrangements suggested by the latest experience have been adopted. There will be accommodation for over 2,500 passengers in all, besides a crew of 950. As some indication of the extent of the accommodation in this vessel, it may be remarked that there will be over 2,000 sidelights and windows in the ship. Full advantage is being taken of the enormous size and

spaciousness of the vessel in the arrangement of both public rooms and private cabins.

* * *

An important feature will be the arrangements for handling the boats. The vessel is fitted with electrically driven boat-lowering gear, by means of which a large number of boats can, one after the other, be put over the side of the vessel and lowered to the water-line in much less time than was possible under the old system of davits. One of the advantages of the new system is that the passengers take their places in the boats expeditiously and with safety before the boats are lifted from the deck of the vessel, and the gear is so constructed that the fully laden boats are lowered at a very considerable distance from the side of the ship, thus minimising risk in bad weather. Moreover, the whole of the boats on board can be lowered on either side of the vessel, whichever happens to be clear, and the gear has been kept so far inboard as to give a wide passage at either side of the ship for promenading and for marshalling the passengers in case of emergency.

* * *

The Marconi installation is a well-recognised feature of any modern vessel, and that on board the *Britannic* will be placed on the boat deck. There will be four parallel aerial wires 205 ft. above water-line extending between the masts fastened to light booms; from the aerials connecting wires will be led to the instruments in the house. The receiving apparatus will be placed in a sound-proof chamber in one corner of the cabin. An emergency set will also be provided.

* * *

The Board of Trade are holding an inquiry regarding the abandonment of the *Templemore* on fire in mid-Atlantic while on a voyage from Baltimore to Liverpool in September last.

Mr. Raphael Emanuel, the Marconi operator, in giving evidence, stated that he was satisfied with the position and conditions of his room on board the *Templemore*. He was there and able to attend to his duties up to the last moment. When the power in the engine room gave out he operated on the auxiliary set. The S.O.S. call was responded to by the *Arcadia*, and he asked that vessel to stand by until he had ascer-

tained from the master the position of the burning ship.

In reply to the Stipendiary Magistrate of Liverpool (Mr. Stuart Deacon), who presided over the inquiry, the witness said that his room was at the most convenient place, being on the lower bridge deck, and he had all that he wanted for the discharge of his duties.

The Stipendiary.—What hours do you keep?—There were two of us, and we each took six hours' watch right through day and night.

So one of you was continually on duty?—Yes.

So far as the fire was concerned, did it affect your installation at all?—Not for some time—not till about 1.15.

How did it affect you then?—The room became full of smoke.

Until you were inconvenienced by the smoke the fire didn't affect you at all?—No, not at all.

You seem to have been instrumental in saving the lives of these men. So far as you are concerned, everything on board this ship was satisfactory?—Yes, in every way.

* * *

Only a few months ago the steamship *Noordwyk* was fitted by the Société Anonyme Internationale de Télégraphie sans Fil with a $\frac{1}{2}$ -kw. and emergency wireless gear. Already it has proved of great assistance, for, a few days ago, she lost her screw and was obliged to signal for help. The message was picked up and assistance given by the British tug *Lady Brassey*. As soon as the *Lady Brassey* sent a wireless message to the *Noordwyk* that she was coming to the rescue the captain of that vessel sent a message to her owners stating what had occurred, that he expected help every moment, and all was well on board.

* * *

The *C. F. Tiergen* (Scandinavian American Line) has been re-named *Dwinsk* and sold to the Russian East Asiatic Co. The call letters have been changed to R D K.

* * *

The steamers *Malmberget* (Rederiaktiebolaget Lulea-Ofoten) and *Oklahoma* (Gulf Refining Co.) on which wireless was fitted, have been lost at sea.

D

CARTOON OF THE MONTH



Wireless Worries
Life in Tropical Countries

Contract News

Le Compañia Nacional de Telegrafia sin Hilos have almost completed the equipment of a 15-kw. installation on the new Spanish battleship *Espana*. This powerful apparatus is supplemented with a $\frac{1}{2}$ -kw. emergency set, and is worked by a generating plant entirely independent of the ship's power. The *Espana* is to be the eldest sister of two other battleships of similar construction. These will be named *Alfonso XIII.* and *Jaime I.*

The building of the *Alfonso XIII.* is progressing apace, but for the *Jaime I.* only the preliminaries have, as yet, been completed. They are being built by the Sociedad Española de Construcción Naval, at Ferrol, and will undoubtedly be the pride of the Spanish Navy, for they are modelled on the very latest design, are fitted with Parsons turbines, and have a motive force of 20,000 h.p.

Vessels fitted with Marconi Apparatus since the last issue of "The Wireless World":—

Name.	Owners.	Installation.	Call Letters.
<i>Khyber</i>	P. & O. Line	1½ kw. and emergency	MCE
<i>Pakowu</i>	" "	" "	MIQ
<i>Inca</i>	Pacific Steam Navigation Co.	" "	MIF
<i>Bandra</i>	British India Line	" "	MCH
<i>Takada</i>	" "	" "	MOB
<i>Indrabarrak</i>	Commonwealth and Dominion Line	" "	MOT
<i>Tokomaru</i>	Shaw, Savill and Albion	" "	MNF
<i>Marina</i>	Donaldson Line	" "	MNK
<i>San Eufemio</i>	Eagle Oil Transport Co.	" "	MPS
<i>Knight Bachelor</i>	Greenshields, Cowie & Co.	" "	MRE
<i>Montreal (Refit)</i>	Canadian Pacific Railway	" "	MLI
<i>Miami</i>	Elders and Fyffes	½ kw. and emergency	MLU
<i>Arucasera</i>	" "	" "	MLB
<i>Tortugero</i>	" "	" "	MMO
<i>Barranco</i>	" "	" "	MLI
<i>Espeintan</i>	" "	" "	MMI
<i>Chirripo</i>	" "	" "	MLP
<i>Manamoras</i>	" "	" "	MIS
<i>Kashung</i>	Ellerman and Bucknall Line	" "	MFP
<i>Don of Oqil</i>	C. Barrie & Sons	" "	MPU
<i>Ranger</i>	Liverpool Salvage Association	" "	MLD

Orders have been received during the past month to equip the following Vessels with Marconi Apparatus:—

Name of Vessel.	Owners.	Installation.	Call Letters.
<i>Melania</i>	The Anglo-Saxon Petroleum Co., Ltd.	1½ kw. and emergency	MTP
<i>Caseis</i>	" "	" "	MPO
<i>Denbighshire</i>	Royal Mail Steam "Packet Co."	" "	MPG
<i>Chandiere</i>	" "	" "	GDK
<i>Hororata</i>	New Zealand Shipping Co., Ltd.	" "	MRF
<i>Opawa</i>	" " " "	" "	MRG
<i>Whakatane</i>	" " " "	" "	MRI
<i>Hurunui</i>	" " " "	" "	GCQ
<i>Ovari</i>	" " " "	" "	MRM
<i>Bakia</i>	" " " "	" "	MRO
<i>Otabi</i>	" " " "	" "	MRP
<i>Kaikoura</i>	" " " "	" "	MRS
<i>Waimate</i>	" " " "	" "	MOS
<i>Eupion</i>	The Eupion Steamship Co., Ltd.	½ kw. and emergency	MKT
<i>Brodstone</i>	The Brodstone Steamship Co. and The Brodvale Steamship Co., Ltd. (Blue Star Line).	1½ kw. and emergency	MIS
<i>Brodvale</i>	" " " "	" "	MRB
<i>Purhonia</i>	Donaldson Line Ltd.	" "	MNS
<i>Kaitika</i>	" "	" "	MNI

Among the Operators

[This section is devoted to recording items of particular interest to wireless telegraph operators.]

High tribute was paid to the memory of Ferdinand J. Kuehn, the wireless operator of the ill-fated steamship *Monroe*, at a memorial service held on March 1st at the East Side Branch of the Young Men's Christian Association, New York. Mr. Kuehn, when the *Monroe* was run down by the *Nantucket* off the Virginia Capes, not only stuck to his post, sending forth calls for help, but gave up his



Photo Underwood
F. J. Kuehn.

life preserver to a woman and went to his death when the ship went down. That act was spoken of at the memorial service as one of the most heroic which history has recorded.

Mr. Kuehn was a graduate of Public School No. 40, and Mr. J. K. Van Denberg, Principal of that school, was one of those who paid a tribute to the memory of the young hero. He hoped Kuehn's act of heroism would prove an inspira-

tion to others, and referred to it as a milestone in the advance of humanity.

Mr. John Bottomley, Vice-President of the Marconi Wireless Company of America praised Kuehn as one of the army of wireless operators who never failed in their duty and who were deserving of the highest tribute which could be paid to them. There were brief addresses by others.

For indulging in unnecessary and unauthorised conversation by means of his wireless apparatus a wireless operator holding a Government licence operating on a steamship in the North Atlantic coasting trade has had his licence suspended for thirty days. A general warning was issued by the Secretary of Commerce (U.S.A.) on Feb. 25th to operators that the regulations governing radio communication must be complied with in all particulars and that future violations would not be leniently dealt with. This was the second offence of the operator whose licence was suspended, and on his first he was warned. Early in January he repeated the offence and was reported again. This is the second operator's licence that has been suspended by the Secretary of Commerce within the last two or three months and is equivalent to a fine amounting to a month's pay.

The office of the Rotterdam Inspectorate of La Société Anonyme Internationale de Télégraphie

sans Fil, of Brussels, has been transferred from No. 16 to No. 23a, Boompjes, Rotterdam.

A new depôt has been opened in Southampton in order to cope with the demand for a more efficient control of the ever-increasing number of ships fitted with wireless telegraphy in that port. Mr. J. R. Robinson has been placed in charge of this depôt as "Resident Inspector." He joined the Marconi Company's service in August, 1904, and has served on several steamers. He was appointed Resident Inspector at Valparaiso in August, 1911, and held that position for over two years, when he returned home at the end of 1913.

Mr. C. J. Close has ceased service with the Marconi International Marine Commerce Co. and the position he occupied as the Company's representative in Newcastle is being filled, *pro tem*, by Mr. H. Francis White.

A Government examination in Wireless Telegraphy was held at the Marconi House School during the week March 2nd-7th, resulting in the under-mentioned students securing First-Class Certificates for "Proficiency in Wireless Telegraphy":—

Messrs. D. W. Bone, G. Carruthers, G. J. Garner, W. A. Ings, A. V. McKiernan, F. A. Pales, J. Montgomerie, E. A. Simmons, G. Caine, D. G. Forman, A. C. Gillam, G. A. Kull, W. A. McDonald, H. J. Pavitt, S. W. Rudderham, S. A. Stockton, W. Dawson, H. T. E. Freeman, W. H. Heath, D. P. Leonard, A. J. W. Mitchell, M. Reidy, J. A. Kelly, H. Whittred.

Mr. Harold Cox, who joined the Marconi International Marine Communication Company during April, 1911, has obtained a Government appointment in Australia. Mr. Cox has served on many ships, including special duty on the Brazilian cruiser *January* (3 kw.) and the Japanese cruiser *Kongo* (25 kw.). He desires to take this opportunity of wishing "Good-bye and good luck" to the many excellent fellows he met in the Company.

Mr. H. Roffey, who was appointed to the Marconi Company's staff in April, 1911, has recently taken up a Government appointment in charge of the wireless station in the Fiji Islands. He sailed on the *Oceanic* on February 4th for Fiji, via New York and Vancouver, and will hold the above appointment for a period of three years.

The marriage took place on January 31st of Mr. W. J. Brown and Miss C. Barr. Mr. Brown was appointed to the Marconi Company in March, 1908. He has served on many ships, including the *Mauretania*, *Lusitania*, the Brazilian cruiser *Minas Geraes*, and the *Walmer Castle*. In October, 1913, he was appointed Travelling Inspector, and has since been attached to the Head Office staff. To commemorate the occasion he was presented with a handsome marble clock by his colleagues at Marconi House.

Mr. H. T. Sayer, who has been employed by the Rome Agency of the Marconi Company since December, 1912, has recently returned home and is now on leave.

Answers to Correspondents

BY OUR IRRESPONSIBLE EXPERT.

MACTAVISH (Glasgow).—Your question reminds us of the gentleman who inquired of the operator whether his message could not be sent cheaper by being transmitted with "plain aerial."

* * *

CONSTANT READER (Clapham).—With tight coupling of your transmitter you will have highly damped radiation and a double wave. In this wireless is analogous to a human being, who, when he is tight and highly damped, often sees double.

* * *

WOANCHU AVABERNANA (Benares).—We are glad to hear that THE WIRELESS WORLD is so widely read in India. There is no reason, however, for your posting your letter without a stamp and making us pay fourpence.

* * *

JONES (Carnarvon).—The long aerials at the new transatlantic station at Cefndu are necessary for the transmission of the extremely lengthy names of Welsh villages to be found in the vicinity. Question 2: There are three hundred and forty-nine distinct pronunciations of Cefndu in use at the present time in Marconi House. If you want to approximate to the true pronunciation, place your head under water and try to say "cabbage."

* * *

APPLICANT (Luton).—A course of instruction in wireless telegraphy embraces sending, receiving, electricity, magnetism, and heroism. This last subject embraces all that it is necessary for an operator to know concerning wrecks, attitude to lady passengers who interrupt during transmission of S.O.S. signals, how to take a flying leap from the Bradfield insulator as ship's funnel disappears beneath the waves, and other essentials.

* * *

SNOOQUES (Derby) writes: "It has occurred to me that with the erection of high-power stations for the Imperial chain, and having regard to the great efficiency of the Marconi system, it will no doubt happen that messages transmitted from, say,

England on high power will pass round both sides of the earth and meet at about Australia. Will this not cause some inconvenience?" Answer: A special meeting of our Technical Committee was held to consider your letter, and it was decided that the concussion will probably split the infinitives in the messages. We are consulting the Government, and tender you our best thanks for bringing the matter to our notice.

* * *

Rev. SMITH (Cambridge) writes: "Can I use a wooden bedstead to make a bedstead aerial?" Answer: You would probably find more damping with a wooden bedstead than with an iron one, but, if you take our advice, you will avoid bedstead aerials. Only recently an acquaintance of ours, after fixing up a receiving instrument of this type, found himself shot out of bed regularly every night at a quarter to twelve by Eiffel Tower signals; and an elderly enthusiast in Westminster Bridge Road who was getting into bed one night while the Admiralty were sending, short-circuited himself and died of heart failure. If you *do* decide to construct such an apparatus, we would suggest you sleep in rubber sheeting.

* * *

CHARLES (Westminster) writes: "Dear Sir,—Will you please advise me as to what will be my probable range with the following apparatus: Two bent 'phone diaphragms, a loose coupler that has come unstuck, three jam-jars covered with tin-foil, a thirteen-kilowatt transformer, two inductances wound on a lead pencil, an auto jigger, and a tango tight coupler. I may mention that my aerial is connected between the bedroom window and the clothes-line." Answer: If you connect the thirteen-kilowatt transformer across the mains and get your other apparatus thoroughly in tune, you will probably have a range of about a mile; or, in other words, you will not be able to come within a mile of the instruments owing to the smell of burning. Let us hear the result.

Amateurs' Experiences

An Experimental Wireless Station

By EARL C. HANSON (San Francisco).

THE climatic and atmospheric condition of the thousand miles of length of California, with the sea as one border and the mountains as another, is peculiarly adapted to the erection of wireless stations.

The writer, with the apparatus shown in the accompanying illustrations, has been able to send fifty miles in daytime and to hear the stations on the Pacific Coast.

The transmitting apparatus consists of a variable plate condenser, 1-kw. closed core 15,000-volt transformer with a variable primary switch to vary the power input, air-cooled oscillator, auto-transformer, and hot-wire meter. Since the new law came into effect an oscillation-transformer has been substituted for the auto-transformer. The closed oscillatory circuit is wired with copper ribbon, which lowers the high-frequency

resistance of the circuit and materially raises the efficiency of the apparatus.

The receiving apparatus, transmitting key, and necessary control switches are mounted on the operating table 8 feet from the transmitting set.

For receiving, a tuning inductance, oscillation transformer, variable and fixed condensers, telephone receivers, carborundum crystal detector, batteries and potentiometer are used.

The valve, silicon, galena, audion amplifier, and pericon detectors have been used; but, as an all-round detector, the carborundum detector is relied upon as a "stand-by."

No antenna switch is used, as a break system is provided which enables the operator to be "broken," or to overhear any interference while transmitting.

The antenna consists of six wires com-



The Author's Stations.

posed of a twisted cable of three sections of seven strands of No. 18 silicon bronze wires; each wire is 80 feet long and elevated forty feet above the ground and insulated by 18-inch electrose strain insulators. The "lead in" is made of a cable of eight cables, each of seven No. 18 silicon bronze wires, which pass through a hard rubber bushing into the station.

For an earth connection a 16-foot-deep hole was dug and zinc plates buried. These plates were in turn connected to 3,000 feet of No. 8 copper wire, buried 18 inches in the earth, and a large copper bus-bar led to the operating room and connected to the apparatus.

I take *THE WIRELESS WORLD* and took *THE MARCONIGRAPH* when you published it. Each month I wait anxiously for the time for my copy to come, and receive a great deal of pleasure and help from its contents.

[The writer of the foregoing article has sent us with his manuscript a covering letter which has interested us very much. He says: "Although I am 6,000 miles or more away from you I feel as though I was within a stone's throw of your office, for I have been a constant reader and admirer of your magazine and have told all my chums of your magazine and its work. . . . Personally I enjoy reading of the work of the boys in England, and anxiously await the arrival of my *WIRELESS WORLD*." Mr. Hanson's letter is typical of many hundreds of letters that have reached us from all quarters of the globe, all of them bearing testimony to the useful work which this magazine is performing and incidentally showing that it is playing no small part in encouraging and instructing amateurs all over the world and helping to co-ordinate and systematise their work.]

DETECTOR CRYSTALS.

THE correspondence on the subject of detector crystals has brought us the following interesting communication from Mr. J. S. V. Bickford, of Looe. He writes:

"My experience is confined to zincite and carborundum, and generally I can say that whilst a bad piece of carborundum is no good at all, a good piece runs a pericon (zincite bornite) very close.

"My detector is a double one; that is to

say, there are two separate detectors on one stand, with a switch putting either in circuit. I keep a zincite in one and carborundum in the other, and it is the carborundum which is always used, the zincite being kept as a stand-by for weak signals. I find that the zincite is always out of order when I switch on to it, and has to be touched up before it is any good, whilst the carborundum practically never varies at all unless it is touched.

"As to carborundum crystals, there is

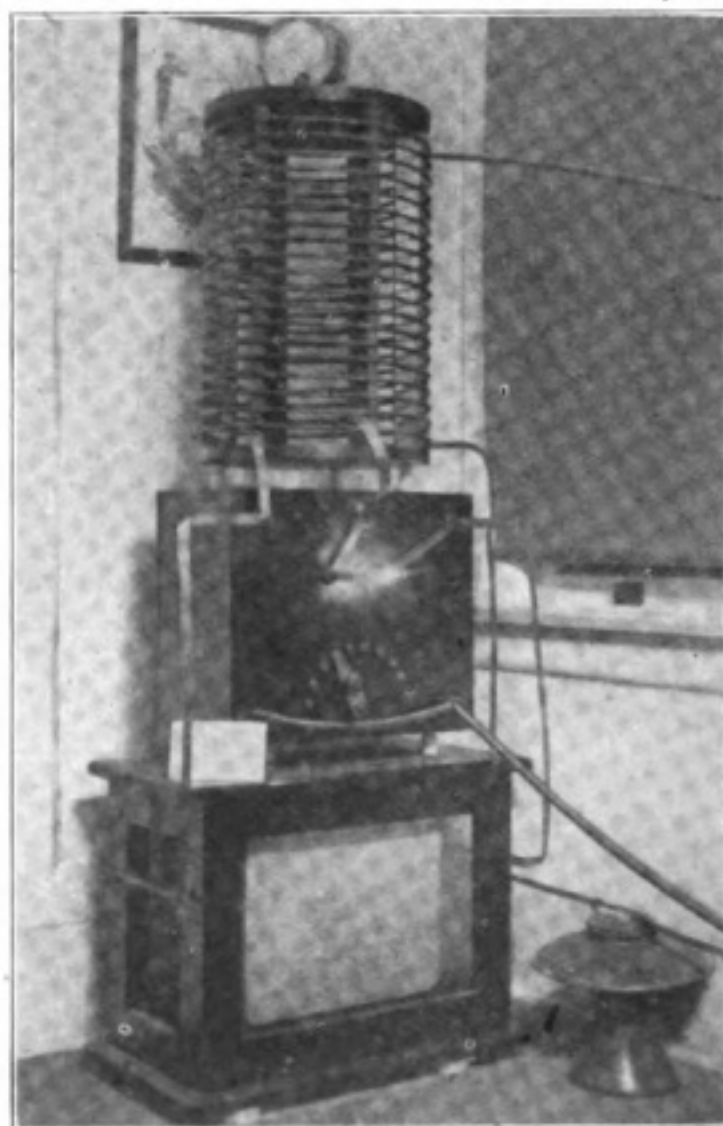

Transmitting Apparatus.

some mystery here. I have never yet found a carborundum crystal bought from one of the regular amateur supply houses of any use whatever. There are two ways known to me in which good crystals can be obtained.

"1. Go into any ironmonger's shop and buy up his show-case lump of carborundum crystals; as this is given to him he can usually be persuaded to sell it at a reasonable price. Break this up with a cold chisel and hammer, taking care to extract the big, well-formed, and well-defined crystals. Connect up all the dry cells about the piece in

series; there should be six or eight at least, bring one terminal to a piece of brass with a smooth face and the other to a voltmeter. To the other voltmeter terminal connect some 26-gauge wire. Then take the crystals one at a time and hold between the fingers together with the 26-gauge wire and press the crystal point on to the brass plate, watching the voltmeter. Set aside each crystal which shows a deflection on the voltmeter and mount in the detector, preferably in brass clamp screws. Probably one out of half a dozen will be good. A potentiometer is, of course, necessary.

"The mystery I have alluded to is this: I mounted six crystals as mentioned, but in Wood's metal. When tried, not one of them was of much good. I then put them aside and forgot about them for nearly two months. One night I put them in and tried them again; every single one was *quite* good. After that they slowly fell off, and to-day none of them are any use whatever.

The reason is a mystery to me, but I suspect the mounting.

The second way of getting a good crystal is to purchase a ready platinised carborundum crystal, which can be obtained for a

shilling each.* Platinised crystals must not be mounted in solder, as solder dissolves platinum about as quickly as water dissolves sugar. The great advantage of carborundum is that it does not vary and is quite unaffected by atmospheric, which would kill a zincite on the spot. Carborundum should be used with a flat piece of brass, iron or nickel plate, perhaps the latter is a shade better than the others.

"I incline to the view that zincite with a tellurium *point* is better than zincite bornite, but the former wants a potentiometer.

"A potentiometer with zincite bornite saves time, but the lower the potential at which it is best the better it is. For instance, if with one setting signals are loudest with 0.2 volt, whilst at another point they are stronger with 0.1 volt, then the best signals at the latter point will be better than the best signals at the former. It is best of all if it can be got to give best signals with no voltage, but this spot is always difficult to find, and seldom keeps its spot long.

"With strong signals, like Eiffel or M.P.D., carborundum is as good as anything provided the experimenter has a good piece; a bad piece would kill M.P.D."

* Further information regarding this will be supplied on application.—ED. W.W

The Amateur Handyman

A Magnetically Operated Detector.

TAKING crystal detectors generally there is a lack of nicety with regard to their fine adjustment. If these luxuries (for so they seem to be regarded) are provided, they are often disregarded by the user. I have often noticed that an experimenter invariably catches hold of the movable crystal cup with finger and thumb to make an adjustment. This is not good enough.

One often finds that experimenters have to readjust their crystals during sending operations. Much depends upon the particular design of detector—its wirings, etc.—whether it will form a closed circuit which will be excited by the sending current or not. Some short the detector "close up," as they

call it, others break both leads quite close up to the detector, and even then the crystal goes off. In many cases, under these conditions, one finds that the cutting off of the potentiometer current is sufficient to "knock out fancy crystals." I call them "fancy crystals" because they are not like, say, carborundum. "Fancy" or not, they will be the favourite among most experimenters for some time to come.

The first device I saw for completely guarding the crystals from powerful oscillations was of the following idea. On paper the idea seems totally unpractical. The top crystal cup was caused to be *lifted completely* from the lower one by a mechanical switch operated by hand. When ready to receive

the cup was lowered again in its position. It hit the mark every time and needed no adjustment throughout an evening's work. I am not at liberty to mention anything further of the matter—but it worked well in spite of its seeming weaknesses.

I have devised a detector—magnetically operated—which has in principle the same idea as in the last-named detector. It may, however, be easily constructed and the adjustment made a certainty. The idea will be seen in the accompanying diagram.

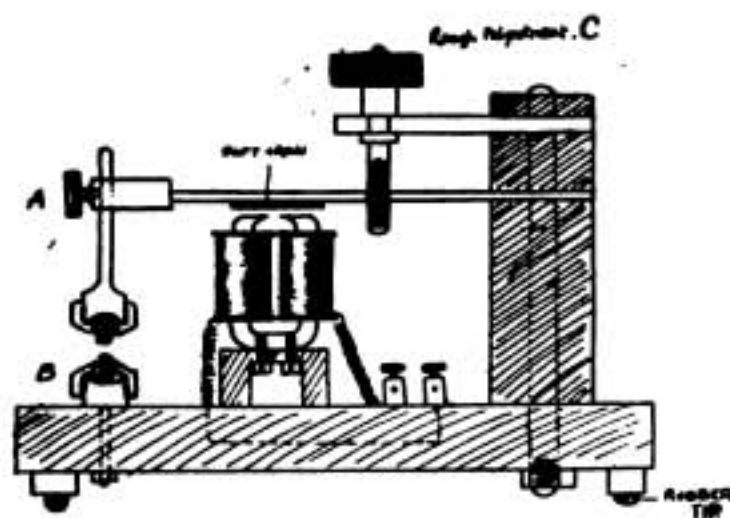

On the main bar of the detector is rivetted a soft iron armature, below which is fixed a small electromagnet. The whole is provided with a rough adjusting screw, as shown. The crystal cups are different from the usual design in that they have screw caps. The base is of ebonite, being fitted with rubber-tipped feet to absorb vibration.

The method of using the instrument is as follows: By means of the screw A the top cup is lowered to within a fraction of an inch of the lower cup B. By means of the rough adjustment C the crystals nearly touch. The electromagnet—being connected with a cell in series with a variable resistance—has its current now switched on, but with a high resistance in series. The resistance is now lowered by degrees until the detector is in a sensitive state. (We now find that the magnet is taking only a small fraction of an ampere.) Adjustment is easy, for the pressure is slowly and gradually applied. If it is necessary to cut out the detector whilst sending, more resistance should be put in, thus separating the crystals. To bring them back into a sensitive position is the work of a moment—by pulling back the slide of the rheostat to its original position. The only point to bear in mind is that the resistance

coil (which is of the sliding rheostat form) must be so arranged that current is not applied too suddenly—i.e., the windings must not be of too thick wire. However, ten minutes' acquaintance teaches all this, and it is worth something to have a "fancy" crystal always at concert pitch.

F. J. E. C.

THE TROUBLES OF JIMMY JONES

JONES for a month had been tireless
To finish his amateur wireless;
All he now had to do
Was to get the "sigs" thro';
He was "hot," though his study was fireless.

First he listened all day for Madrid,
Then he heard it, or thought that he did,
But 'twas baby next door,
Who was thumping the floor,
So the sum of his efforts was kid.

Nothing daunted, he tried for Poldhu,
Till a night bird struck up "Hitchy-Coo."
With a frenzied "Confound!"
He mixed heat, light, and sound
In a futile attempt to get through.

Next, in order to lessen mischance,
He "tuned" for time-signals from France,
But an organ came by
Playing "O Kill that Fly,"
And the 'phones on his ears did a dance.

Then he broke out in sardonic mirth,
He chortled for all he was worth.
He tugged and he twitched
His moustache—for he'd switched
His aerial lead to the earth!

H. G. E.

The Supreme Court-Martial of the Dockyard Division, sitting at Kiel, on March 9th, sentenced two wireless telegraphists to five years' and one month's imprisonment respectively for the betrayal of military secrets and bribery.

* * *

The German meteorological observatory at Cross Bay, Spitzbergen, has picked up a wireless time-signal from Eiffel Tower, 2,175 miles away, and has thus fixed its longitude with unprecedented accuracy. Its observations have included very accurate measurements of auroras.

Among the Wireless Societies

Bristol.—*Discussion on Detectors.*—A well-attended meeting of the Bristol Wireless Association, presided over by the Rev. W. P. Rigby, was held recently. Amongst those present as new members were Mr. Maurice Child, director of the London Telegraph Training College. It was announced that, thanks to the generosity of Mr. Child, the Association will be able to purchase some calibrating apparatus. Mr. A. C. Davies then contributed an interesting paper upon the subject of "Crystals," in which he touched upon their chemical composition and behaviour as detectors. A successful meeting was concluded by valuable advice from Mr. Child on general wireless topics and by "buzzer" practice that lasted for half an hour. Hon Secretaries: R. W. Cox, 16 Edgecumbe Road, Redland, and N. M. Driver, 13 Claremont Road, Bishopston.

* * *

Croydon.—*Modern Wireless.*—At the monthly meeting of the Croydon Wireless Society, held at the Croydon Polytechnic on March 7th, a lecture was delivered by Mr. P. W. Harris, of the Marconi Company, on "Modern Wireless Telegraphy," during the course of which he described in detail the instrument fitted on a ship station of the usual type installed by the Marconi Co.

* * *

Dublin.—*Interesting Tests.*—The usual weekly meeting of the Dublin Wireless Club was held on Wednesday, February 25th, at headquarters (St. Pancras, Harold's Cross Road). There was a very good attendance of members. During the evening tests were made with one of the members' home-made apparatus, and the results were entirely satisfactory, Clifden being received fairly strong without having to use any additional inductance. Signals were read from the usual stations, and messages received from some of the members.

On Wednesday, March 4th, the club met at their city premises, the Irish School of

Wireless, 11 Lower Sackville Street, where demonstrations on the Marconi set were given by Mr. P. K. Turner. Two wireless messages were received from members apologising for not being able to attend.

* * *

Liverpool.—*New Premises.*—At the fortnightly meeting of the Liverpool and District Wireless Association, held on February 24th, the chair was taken by Mr. Coulson, and several new members were elected. A member described an automatic change-over receiving and sending outfit, which was universally agreed to be an ideal set.

On March 10th the new club-room was formally opened, and was considered an unqualified success. It is intended to hold weekly meetings, but there is no reason why in the near future the club-room should not be open every evening for the benefit of the members. Instruments will be installed for testing wireless outfits, 'phones, detectors, etc. There will also be Morse practice sets for members. Refreshments can also be obtained on the premises.

* * *

London.—*The Design of Receiving Apparatus.*—A meeting of the Wireless Society of London was held on March 3rd, when it was announced that 25 new members had been elected, bringing the total membership of the Society to 225. We understand that the Postmaster-General has under consideration an application from the Society for a licence for a $\frac{1}{2}$ -kw. transmitting set which it is proposed to install at the Society's headquarters in Hatton Garden.

Mr. E. Russell Clarke opened an interesting discussion on the design of receiving apparatus with particular respect to the size of coils and the nature of their winding. He said that the question of the construction of receiving apparatus was an important

one, especially to those who used small aeri-als, where even more care was necessary than in the case of large aeri-als. The point to bear in mind was to avoid as much as possible the losses in the inductance coils, both those due to ohmic resistance and eddy to currents. There were several considerations which made it necessary to obtain the largest inductance with the least possible length of wire.

When measuring the inductance of a coil, and drawing a graph, it was found that the curve rose very rapidly up to a given distance, which was smaller than the diameter of the coil, and after that point the inductance rose in a straight line. It had been found that for a single-layer coil the best dimensions were obtained when the length of the coil did not exceed 0.4 times the diameter, and in the case of a flat spiral the hole should be half the diameter of the whole spiral. In order to obtain the largest quantity of wire on a small space, the usual way was to lap-wind two layers in the same space. One way to reduce ohmic loss in an inductance was to increase the size of the wire, but by using a big wire the eddy-current loss was run up at a considerable rate, and with short wave-lengths the eddy-current loss entirely overbalanced the ordinary ohmic loss. That difficulty was got over to some extent by Dolezelek, who suggested that the conductor should be divided into a number of insulated wires, which should be weaved so that none of them remained in the centre of the wire longer than the other; the result of this was to diminish very considerably the eddy-current loss. The latter increased with the frequency; therefore, it was a mistake to use large cable for short waves.

Mr. Clarke said that in the WIRELESS WORLD he had noticed an answer to a correspondent that if he wanted to get Clifden he had better use a thinner wire. In that regard, he said the winding of a coil for a long wave offered the very chance for using a big wire, because at that frequency it would give diminished ohmic resistance, and would not greatly increase the eddy-current loss. He gave a table of actual results, which showed that by taking a standard wire and building up a fairly big conductor with it a resistance would be obtained which was so low that the incoming signal would persist in the aerial and equally well persist in any secondary

circuit coupled with it, and consequently the energy in the receiving circuit would be built up through resonance to an extent which would enable one to couple far more loosely than would otherwise be the case. Moreover, the looser the coupling the finer the resonance, and thus discrimination with only 2 or 3 per cent. difference in wave-length was possible. Therefore, not only did one get an increased energy and loudness of signals by using an undamped circuit, but one also got a very largely increased sharpness of tuning and selectivity. He also gave a table which demonstrated the advantage of using subdivided wire. Regarding receiving apparatus, he thought it was essential to separate the receiving gear into two parts, having one short-wave receiving gear and one long-wave receiving gear. The most important reason for that was that if one had a long-wave receiving gear and only used a short length of the primary and a short length of the secondary for the short waves, there was the great liability of the other part resonating to other waves coming down the aerial that one did not want to hear. It was important in connecting up a short-wave transmitter to get the primary as near earth as possible, because the current was a minimum at the top of the aerial and a maximum near the earth. A mistake often made in the design of receiving transformers was that the primary was much too near the secondary, and in designing jiggers primary to secondary capacity should be avoided.

Mr. W. Duddell emphasised the importance of keeping down losses as much as possible, and he was inclined to think that in the larger jiggers it was wise to use no wire in the centre of them. Dielectric loss between the wires was especially marked with the larger currents. It was possible to measure the loss in an ordinary piece of flexible cord, which was measurable even at about 1,000 frequency, and that loss became larger in the larger currents unless one put air between the windings. For that reason he, personally, wound the coils spaced with about $\frac{1}{2}$ mm. of air between the successive turns.

The debate was continued till a late hour by Mr. Wilson Noble, Prof. Ernest Wilson, Mr. H. Rivers Moore, Mr. D. Broughton and Mr. Courcey, the latter emphasising the

necessity of avoiding dead ends of the coil, and suggested plugging out the unused sections.

It has been arranged to hold meetings of the Society on the last Tuesday in each month at the Institution of Electrical Engineers.

* * *

Manchester.—*New Premises.*—Owing to the greatly increased membership of the Manchester and District Wireless Club, a commodious and up-to-date club-room has been secured at 93, Market Street, Manchester, which will be opened on Saturday, April 4th, when it is expected that Mr. R. Harrison will deliver an address, entitled: "What is Electricity? its uses, etc." The meeting will commence at 3 p.m. Subscriptions to this Club are 5s. per annum and 2s. 6d. per annum for corresponding members. The Hon. Secretary is Mr. C. Heap, 15, Abbey Hey Lane, Hr. Openshaw.

* * *

Newcastle-on-Tyne.—*A Local Exhibition.*—The Newcastle-on-Tyne and District Amateur Wireless Association have now erected a large aerial at 29 Ridley Place, and have excellent club-rooms. The membership of the Association is just over thirty, but the Hon. Secretary, Mr. Chas. M. Denny, informs us that a larger number is expected. The entrance fee is 5s., with a subscription of 1s. per month; corresponding members, 5s. per annum only, with use of club-rooms and advice, etc, the one restriction being that they must live outside a 10-mile radius of Newcastle-on-Tyne. An opening exhibition and demonstration was arranged for March 21st, and promises of loans of apparatus, etc., have been received sufficient to warrant a good show being made.

* * *

Newport.—A successful meeting of the Newport and District Wireless Society was held at Stelvio (B.X.H.) on March 11th, when Mr. J. H. M. Wakefield, the acting vice-president, occupied the chair. There were about 30 members present. The Chairman

commented upon the very favourable report of the Society, and on its progress since the last meeting. Mr. C. H. Bailey read a Paper dealing with his wireless station, which was greatly appreciated. At the next meeting Mr. Wakefield will read a Paper on "Inductance as applied to wireless telegraphy."

* * *

North Middlesex.—*A New Society.*—The first meeting of the North Middlesex Wireless Club was held on March 9th at Shaftesbury Hall, Bowes Park Station, when members were enrolled, officers of the Club appointed, and a working committee formed. Mr. A. G. Arthur was elected President for the year, and in the course of his inaugural address urged all members to work for the good of the Club and to endeavour to increase the strength of the Club by getting new members. He also pointed out that those present were sufficient evidence of the need of such a club in North Middlesex. The Secretary, Mr. E. M. Savage, then put before the members the proposals with regard to the suggested working of the Club, entrance fee, subscription, etc., and explained that in fixing the subscription at 5s. per year, with a small entrance fee of 2s. 6d., it was hoped to get many members into the Club who might consider a larger subscription more than they wished to afford. Particulars of the Club can be obtained from the Secretary, Mr. E. M. Savage, "Nithsdale," Eversley Park Road, Winchmore Hill, London, N.

* * *

Nottingham.—*A Good Beginning.*—The inaugural meeting of the Nottingham and District Wireless Society was held on February 23rd, a good number of wireless enthusiasts being present. Several donations were received from gentlemen interested, and suitable premises will be taken as soon as possible, where the receiving and transmitting apparatus, which is already promised, will be installed. On the whole, the Society has made a very good start, and it is hoped that numerous other amateurs in the district will become members. Applications for membership should be made to J. H. Gill, 16 Premier Road, Nottingham.

QUESTIONS AND ANSWERS

Readers are invited to send questions on technical and general problems that arise in the course of their work or in their study. Such questions must be accompanied by the name and address of the writer, otherwise they will remain unanswered.

J. C. D. (Eltham).—(1) How can I receive wireless signals by means of kites? (2) Is it possible to communicate by wireless telephony from an aeroplane to the earth?

Answer.—(1) We do not see what there is to answer in this query. The kites merely take the place of masts, enabling a very long aerial wire to be hoisted more or less vertically. (2) We see no reason why wireless telephony over short distances should not be possible from aeroplanes. Wireless telegraphy is certainly possible; radio-telephone apparatus is, on the whole, less reliable and requires more adjustment, and is therefore less adapted to such work, but it is not by any means impossible to employ it.

F. G. W. (Liverpool).—(1) In the 1.5 kw. Marconi set, what is the ratio between the primary and secondary voltage, when the secondary is in series and in parallel? (2) What is the potential to which the transmitting condenser is charged, when using 600 metre wave and when using 300 metre wave.

Answer.—(1) Keeping the primaries in parallel in both cases, the ratios are 300:1 and 150:1, respectively. (2) Depends on the voltage of the direct-current mains, since the a.c. voltage produced by a rotary converter depends on this. If proper resonance is obtained in the low-frequency circuits, with a d.c. voltage of 100 volts, the maximum condenser-voltage is about 40,000 volts in the case of the 300 metre wave and about 20,000 volts in the case of the 600 metre wave. The above figures refer to the transformer used with the fixed discharger set.

J. P. M. (Havre) has experienced trouble with disturbances in his two (5,000 ohms) receivers, the phones give a continuous musical note caused by the network of underground electric mains, and he has asked how it is possible to avoid this trouble.

Answer.—The treatment of such trouble as yours varies according to the precise conditions. You might try, first, discarding the water-pipe as an earth and using a buried plate or wires running under your aerial and just buried in the ground a few inches down. If this is ineffectual, try earthing one side of your telephones; and also try cutting off both electric light leads from your apartments—probably when you tried before you only broke one lead by a single-pole switch. If this stops the trouble, you might have your interior wiring done with lead-covered cable, and earth the lead-covering. The last, and most interesting thing to try, is to *balance out* the noise. To do this you should set yourself deliberately to produce the noise in another circuit—for instance, by inducing from the lighting mains into a coil. Having thus produced a noise similar to that which is troubling your receiver, and being able to regulate the strength of it at will, you should then proceed to make one effect neutralise the other. If the objectionable noise is caused by an alternating current induced in your earth-lead, you might find it possible to induce an equal and opposite alternating current in the same earth-lead by your artificial circuit; or you might be able to bring about opposition in your telephone-circuit itself by including a coil in your telephone-leads and inducing an opposing current in this. The chief difficulty you will encounter is due to the fact that in order to oppose one alternating current by another the second must be

exactly similar to the first in every way, but of exactly opposite phase. Perhaps first of all you should try more thoroughly the plan of putting a condenser across the electric wires, as you have apparently tried this already with some success. Perhaps your condenser was not of large enough capacity.

G. J. W. (Hebburn).—This district is being changed over from d.c. at 230 volts to a.c. at 240 volts 40 frequency. At present I have been working with accumulators. How can I transmit using a.c.? Mr. Pope, in your July issue, made a $\frac{1}{4}$ kw. transformer to give 3,000 volts across the secondary. He used 200 v. at 60 frequency for the primary. By the usual rule this would only give a $\frac{3}{8}$ -in. spark, and the frequency is too low for wireless work. By using a large main condenser is the spark made crisp and long enough for wireless work?

Answer.—It would pay you to buy, ready-made, a transformer of the power you require, sending particulars of voltage and frequency to the makers. We do not know whether Mr. Pope omitted a cipher in the number representing his secondary voltage; even if he did not, if his low-frequency circuit was properly tuned to the alternating frequency, resonance would give a considerably higher value of potential-difference on his condenser than the 3,000 volts mentioned. Moreover he used a rotating discharger. We do not understand what you mean exactly by saying "and the frequency is far too low for wireless work." For years a 25 frequency used to work across the Atlantic.

H. C. (Devonport).—Loose coupled tuning inductance primary $2\frac{1}{4}$ in. diameter, 5 in. long, wound 23 D.S.C. tappings to switch. Secondary, 3 in. diameter, 5 in. long, wound 30 D.S.C. twenty-two tappings to switch. Can you tell why I never need to loosen the coupling; I hear Paris, Poldhu, Cleethorpes, Admiralty, and numerous coast stations; all these come through but with primary right in secondary. I have tried to get better results with loose coupling and varying inductance and condenser, but always with reverse effect. This being so, why is it always advised to make a loose coupled set? Every success to your splendid monthly.

Answer.—You do not give a diagram of connections, but we presume you have a considerable aerial-tuning-inductance in addition to your jigger-primary in order to tune the aerial circuit to the long waves. That is to say, the whole of your jigger-primary forms only a small proportion of the total inductance in your aerial-circuit; and since the coupling-coefficient is given by

$$k = \frac{M}{\sqrt{L_1 L_2}}$$

where M is the mutual induction, L_1 the self-induction of the aerial-circuit, and L_2 the self-induction of the secondary circuit, your coupling is very loose, even when the primary is right inside the secondary, because L_1 is so great compared with M . With the ideal jigger, you should be able to tighten the coupling bit by bit till the signals, which have been increasing in strength as the coupling tightens, begin to decrease, showing that the best coupling has been passed. The best coupling can be weakened when there is any interference, and this makes the circuit more selective though it weakens the signals slightly at the same time.

G. H. sends a neatly tabulated sheet of nine queries, many of which are beyond us. We summon up courage and attempt to tackle one or two of them.

(1) "What is the ratio between length of receiving aerial and transmitting aerial's length? Will it be some fraction, as $\frac{1}{2}$, $\frac{1}{3}$, etc., or in arithmetical or geometrical progression, or does it follow some harmonic scale? When we add a primary jigger to the aerial's length should their combined length have a similar ratio?"

An excellent condition for ordinary working is when the two aeriels are of equal length. But, after all, length is not of such importance as G. H. would appear to think; the important thing is that each of the two complete aerial-jigger-earth circuits should have their wave-lengths equal—i.e., that the $C \times L$ of the one should be equal to the $C \times L$ of the other.

(3) "Is the current induced in an aerial containing several wires in parallel a polyphase one; and if we supply an alternating current to the aerial will the electric waves impress themselves on such an aerial?"

In a composite aerial care should be taken that each wire is precisely the same as the rest of its fellows and is similarly connected; hence the phase in one wire is precisely the same as the phase in the others, and a polyphase current is not produced. If we supply an alternating current at an ordinary frequency to an aerial the electric waves will only be impressed on the latter if its natural time-period agrees with that of the impressed force—that is to say,

if $n = \frac{1}{2\pi\sqrt{CL}}$ where n is the number of alternations per second and C and L are the capacity and inductance of the aerial.

(5) "Can an aerial's capacity and inductance be balanced by placing a resistance and a condenser in parallel with the aerial?"

On second thoughts we must class this question among the ones which are beyond us. Really, it is too vaguely worded.

6, 7 and 8 are all concerned with inductively coupled circuits and the ratio of number of turns of primary to number of turns of secondary. G. H. evidently attaches an entirely fictitious importance to this matter of ratio, probably because he considers that it governs the ratio of transformation of voltage, as it does in the ordinary low-frequency transformer. In an oscillation transformer, where conditions of resonance hold, the case is entirely different, and the transformation-ratio depends on the ratio of the capacities in the two circuits.

We cannot help thinking that G. H. is trying to take too short a cut to the understanding of "Wireless" by applying the knowledge he has acquired in other lines without first mastering the elements of the new subject. We recommend him to go steadily through some standard book on "Wireless" theory, such as Dr. Fleming's "Elementary Manual." And, of course, he should read every word of our Instructional articles.

G. H. (St. Annes).—How much length of wire corresponds to a given inductance in centimetres? Suppose that the

(1) Inductance required in a circuit with .0006 condenser to respond to a 600-metre wave works out at 168,690 centimetres. What amount of wire does this represent in feet?

(2) What is the best rule for finding the inductance of a short coil whose length is 2 to 5 diameters?

(3) If a tuning coil has a copper cylinder sliding outside it will it cut off the inductance of all the turns it covers if it is slit down one side, or must it be whole? Can such an arrangement take the place of a slider?

(4) Can steam or water be used as the dielectric for small variable condensers? Its specific inductive capacity seems to be much larger than glass, or will it readily break down, due to electrolysis?

Answer.—The relation between the actual length l centimetres of a single straight wire of diameter d cm. and

its inductance to currents of infinitely high frequency is given by the formula:

$$L = 2l (2.303 \log_{10} \frac{4l}{d} - 1)$$

When the wire is wound on a circular former the matter becomes more complicated; the diameter of the former, and its relation to the axial length of the coil, having an important influence on the inductance.

L. Cohen's formula for a single-layer solenoid is:

$$L = 4\pi^2 n^2 \left(\frac{2a^4 + a^2 l^2}{\sqrt{4a^2 + l^2}} - 8a^3 \right)$$

where a is mean radius, n is number of turns per centimetre length, and l is axial length of coil in centimetres.

(2) The best way is to make it into a closed circuit with a known capacity, excite the circuit and find the wave-length by a wavemeter or by a "Locher wire" method. Or you can use the above formula.

(3) We suppose that you mean to keep the copper cylinder quite insulated, taking your leads off the ends of the coil as usual. In this case the cylinder will act as a slider so far as altering the inductance is concerned (provided that it is a continuous cylinder) and can be used for tuning purposes instead of a slider. Unluckily, however, a very appreciable amount of energy is used up in the cylinder, and signals will be weakened.

(4) Perfectly (chemically) pure water might be used as a dielectric for the purpose you mention. It would probably have to be prepared by synthesis to get it pure enough to avoid losses in the condenser due to dielectric leakage.

C. M. J. (Edinburgh).—I read in J. C. Hawkhead's "Handbook of Technical Instruction for Wireless Telegraphists" that the wave-length in metres

$$= 1884.96 \sqrt{C \text{ (mfs)} L \text{ (mhys)}}$$

but in R. P. Howgrave-Graham's "Wireless Telegraphy for Amateurs" there is the statement that the wave-length in metres

$$= 59.6 \sqrt{C \text{ (mfs)} L \text{ (mhys)}}$$

How can I reconcile these apparently conflicting statements?

Answer.—We do not know whether you have misread Mr. Howgrave-Graham's book, or whether the statement you refer to was printed in error; but in the form in which you give it it is certainly wrong. It might rightly have been put in the following form: Wave-length in metres = $59.6 \sqrt{CL}$ where \sqrt{CL} is Dr. Fleming's "Oscillation Constant"; but in this case C is in microfarads, and L is in centimetres of inductance, not in microhenries. The form in which the same relation is given by Mr. Hawkhead is correct and more convenient in some ways.

L. W. P. (Pomponne).—Referring to your reply to my inquiry in the November WIRELESS WORLD, I have tried a cheap coherer without success. Is it necessary in working (from the Eiffel Tower) over a distance of 30 miles that the coherer should be in vacuum?

Answer.—We hardly think your failure would be due to defects in the coherer, even though this is a cheap one, for your signals should be very powerful. It is more likely that the fault lies in your circuits or in your relay and in the adjustments generally. There should be no difficulty with a coherer under such conditions as you have, and we recommend you to persevere. So far as sensitivity is concerned, your coherer need not be in a vacuum, but it will soon deteriorate if it is not.

J. H. C.—(1) I have read in two books that for a magnetic detector circuit the telephones ought to be about 150 ohms in resistance. Is this absolutely necessary, or could I use my 2,000 ohms telephones without making a serious difference in the strength of signals?

(2) My aerial is at present a twin inverted L. As this gives me a greater wave-length than my licence allows, would I halve my wave-length by converting it into a T aerial?

Answer.—(1) The standard secondary winding of a magnetic has a resistance of about 150 ohms, and therefore gives the best results with telephones of that resistance. Your 2,000 ohms telephones would give very unsatisfactory results. But we see no reason why you should not use them effectively if you rewind the magnetic secondary with very fine wire (say No. 50) until its resistance is 2,000 ohms.

(2) You would not quite halve the wave-length, but very nearly.

AUDION (Timperley).—We do not know of any reliable formula for this; it is best determined experimentally.

J. S. (Bath) asks where he can find an exposition of the theory and design of receiving jiggers. He has two or three text-books which do not seem to help him; the only account of the theory of jiggers which he has come across "is in the very able series of articles appearing in THE WIRELESS WORLD." He asks because, although his receiving set works satisfactorily, he feels sure it could be improved. If he wants to go thoroughly into the subject of oscillation transformers he should buy Dr. Fleming's standard text-book; if he merely wishes to get the best practical arrangement, we cannot advise anything better than a careful study of our "Questions and Answers" columns for the last twelve months or so, picking out all the remarks on the subject of receivers. This should give him all the information he requires.

H. C. (Liverpool).—Apart from the suitability of your condenser, we must warn you that your 200 ohms telephones are not suitable for crystal detectors (see innumerable replies in past numbers). In any case, a glass plate condenser is not very suitable for receiving work unless a very small capacity is required; and the condenser you suggest would not be large enough to put across the telephones. Waxed paper would make a more suitable receiving condenser, though for a very small capacity variable condenser glass is excellent; as, for instance, in "Tinker's" article in the November, 1913, number. With regard to your second question, we regret that we can give no information about Government stations, whether home or foreign.

R. H. D. L. (Bungay) has a receiving jigger in which the secondary is wound on a drum (shallow compared with its diameter) which can rotate half inside the primary drum (8 in. diameter and 3 in. deep). In the position of maximum coupling—when the two coils are parallel—the edge of the secondary is just beginning to enter the primary. The primary is divided into 5 sections, the section nearest the secondary being subdivided into 24 parts. He says "I get good signals as long as most of these subdivisions are in; but if I use the next section, with only one or two turns of the subdivisions, signals are very poor although the same amount of inductance is in. In fact, the fewer turns of the subdivided section in use the weaker the signals. Why is this?"

The effect of changing from the turns nearest to the secondary to the turns further away is clearly to loosen the coupling.

He finds that if the secondary is wound with No. 30 wire (instead of the No. 22 used in the above case) he can get signals all right if it is wound on a smaller drum right inside the primary, but not if it is on the original drum. One obvious explanation of this is as follows: If his secondary circuit is in tune when the secondary winding is No. 22 wire it is highly improbable that his variable condenser has sufficient range to get to the same tune with the vastly greater inductance of the No. 30 coil; hence the latter requires the extremely tight coupling position inside the primary in order to allow signals to be forced on to it.

This explanation fails if R.H.D.L. has made sure that the No. 30 coil (on the inside former) is so much smaller in size that it has about the same inductance as the No. 22 drum; but, anyhow, we gather that when he failed to get signals on the No. 30 in the outside position he had filled up the original No. 22 former with the No. 30 wire, which would account for his not getting signals.

His third question is too complex to deal with in full; the result must be due to a change in the insulation of the former on which the wire is wound. In any case, overhanging turns should be avoided, if possible; with certain values of wave-length they may cause weakening of signals. With his plug arrangement it would not be difficult to arrange that the various sections were disconnected altogether when not in use.

A. I. H. (Fishguard).—What is the resistance of the lamps used on the marine switchboard of the Marconi emergency set? The candle-power is 50, and the E.M.F. used is 110 volts; so, if the wattage is three times the candle-power the amperage is 1.36, and the two in parallel would pass about 2.72 amps. But in the "Handbook" it is stated that about 4 amps. pass for charging. How is this?

Answer.—You are assuming a voltage of 110. If, as is generally the case on board ship, the voltage is lower (say 70, a very usual value) the amperes for the two 50 c.p. lamps would be, by your own calculation, just over 4. Thus the resistance of each lamp (when hot) would be about 35 ohms. For this rough calculation we are neglecting the extra 4 ohm resistance. It is stated in the Handbook that the motor is specified as for voltages from 80 to 110, but that it works satisfactorily at 60 or 130; and as the value of 4 amps for the current passed by the lamps is particularly mentioned as approximate, you can have no quarrel with these statements.

D. L. J. (Colwyn Bay) is troubled by the neighbouring electricity works causing noises in his receivers. The current generated is continuous, 220 volt; so it is not a matter of alternating-current induction. The noise must have to do with the frequency of the commutator-sections of the dynamos. We do not think that the use—which he suggests—of an electrolytic or magnetic detector in place of the crystal would help matters at all. We can only advise him to read our reply to J. P. M. in this number.

E. M. (Putney Heath) has been a reader of THE WIRELESS WORLD since its inception, and is now going to take up wireless as a hobby. As a preliminary, he asks what instruments are required for a receiving set. We should like to help him in his new enterprise, but really we cannot do better than advise him to study very carefully some of the articles from amateurs describing their own stations; M. F. G.'s, for instance, in the March, 1914, number. These articles, combined with the Instructional series, should give E. M. all the information he requires to start with.

D. W. M. (Wakefield).—I am making a wireless coil to transmit about six miles or more. I have an iron core wound with four layers 16 D.C.C. copper wire. It is 8½ in. by 1 in. diameter. Will this be of any use? If so, what amount of wire shall I want? Will number 32 be about right? What will be the best power to apply from batteries—i.e., what E.M.F. and what current?

Answer.—The core and primary winding should serve, if the winding is separated from core by, say, 2 layers of Empire cloth. The primary winding should be separated from the secondary by about 8 layers of the same cloth, or by mica ¼ in. thick. The secondary should be of smaller wire than you suggest—say No. 36; it should be D.S.C., and might with advantage be passed through melted paraffin-wax while it is being wound. You would require about 2 lb. of secondary wire. Use from 6 to 10 volts.

INSTRUCTION IN WIRELESS TELEGRAPHY

A NEW SERIES OF ARTICLES

THE March number of THE WIRELESS WORLD brought to an end the first course of instruction in Wireless Telegraphy, which this magazine conducted for the benefit of its readers. Although limited in its scope, we have been agreeably surprised to find that the series of articles has made far wider appeal than we had ventured to hope it would, and our one regret now is that we are unable to offer to all those who have studied the articles, and who wish to enter for the examination, the reward which their keen interest and industry certainly merit.

The first series of articles was designed with the object of instructing members of the Territorial Force, Cadet Corps, the Boys' Brigade, the Church Lads' Brigade, the Boy Scouts' Association, and kindred organisations in the principles of wireless telegraphy, as applied to its use in the field. To encourage the study of the articles we announced that at the end of the series we would hold examinations at convenient local centres, and the Marconi Company offered a number of valuable prizes to those who passed the examinations, in addition to certificates of proficiency. A large number of entries have already been received, and arrangements are now being made for the holding of the examination, concerning which a definite announcement will be made in the next issue of THE WIRELESS WORLD.

With the completion of the first course of instruction the question which many of our readers are properly asking is, What do we propose to do to satisfy the interest which that course has awakened? Having brought so many to the brook, we cannot withhold

from them the waters of knowledge of which they desire to partake. The first series of articles did not aim at more than the unfolding of the elementary principles of wireless telegraphy. It was intended to give an insight into the technical application of wireless telegraphy in the field and presupposed no previous knowledge of electricity on the part of the reader.

The main purpose was to encourage members of the great Citizen Army to study a subject which might at some future date add greatly to their efficiency, and to reward their diligence and proficiency by the gift of apparatus which would enable them when called upon in an emergency to operate wireless telegraph stations with advantage to their country.

The importance of this knowledge cannot be gainsaid; for instance, in actual warfare units equipped with wireless apparatus would receive their instructions long before those not so supplied, and in all probability the lack of well-arranged means of communication would upset the entire movement of the army. But, if wireless telegraphy is valuable to an army whose forces are intact, how much more valuable will it be to an army which has been divided by the enemy? Many instances can easily be recalled in which the loss or separation of a part of an army from the main body has had a disastrous effect upon the general organisation.

The first series of articles which we have published has done much to prepare the framework of the knowledge of wireless telegraphy that is required. Many, however, desire to go further and to supplement their preliminary training by more detailed

instruction, not only in the manipulation of apparatus, but in its actual construction.

That will be the aim of the second series of instructional articles which we have decided to publish in the present volume of *THE WIRELESS WORLD*, the first of which will appear in the May number.

The new series of articles will extend and amplify the first series, and is designed to appeal to an even wider circle of readers. The Territorial, the Cadet, the Boy Scout or the member of the Church Lads' Brigade, who has followed the first course should not fail to take up the second course, which he should have no difficulty in understanding. There may be some, however, who have not diligently studied the whole of the first course; and for the benefit of these, as well as for the general reader, we have decided to revise that series and to issue it in a cheap and handy form at an early date. Those who have no knowledge of electricity or who are just beginning to study wireless telegraphy with our new course should first master the contents of the elementary handbook.

The new course of instruction should be of great value to the large number of amateurs now interested in wireless telegraphy. It should appeal with great force to junior engineers and apprentices and to the younger members of technical societies and trade institutions, as well as to organised workers in various industries.

The second series will end in March, 1915, after which there will be examinations at convenient local centres all over the country. These examinations will be open to a wider public than it was possible to include in the first examination, which will be held shortly. In addition to members of the Territorial Force, Cadet Corps, Boys' Brigade, Church Lads' Brigade, Boy Scouts' Association, etc., it will be open to general readers. Prizes and first and second class certificates of proficiency will be awarded to successful candidates. Full conditions, however, will be announced at an early date.

Directory of Amateur Wireless Stations.

THE announcement in the December number of *THE WIRELESS WORLD*, that we proposed to publish a Directory of Amateur Wireless Stations has been received with satisfaction in amateur circles in this country, and has brought a generous response to our invitation to amateurs owning licensed stations to supply us with particulars of these stations for publication in the directory.

We feel, however, that we have not by any means heard from all the amateurs who possess a Post Office Licence, and we believe that many who are not connected with any wireless society have either overlooked our notice or have not yet taken the trouble to send us the particulars asked for. If there are any such amateurs, we would ask them to favour us with particulars of their stations at an early date, so that we may proceed with the preparation of the directory, which will then be complete in every respect.

We feel confident that in the compilation of this directory we can rely upon the assistance of the members of the amateur wireless societies, and others who are not associated with those organisations, and to whom the existence of a reliable directory will prove of inestimable value.

We shall be glad, therefore, if readers will send us, at an early date, the following particulars for inclusion in the directory:

Name and address.

Call-letters.

Whether the station is for transmitting and receiving, or receiving only.

Transmitting range, in miles.

Transmitting wave-length, in metres.

Receiving range.

Usual hours of working.

General remarks.

Secretaries of wireless associations and clubs will oblige by sending names of their officers, address of headquarters, call-letters and any other useful information.

This directory, when complete, will be distributed free of charge to our readers.

E

Wireless for Railways.

Opening up the Lackawanna.

THE uninterrupted success of the trials with wireless telegraphy which have been carried out by the American Marconi Company for the Delaware, Lackawanna and Western Railroad has led to a remarkable development. The achievement of the wireless during the recent severe storms in the United States has demonstrated that it is of as much importance to railways as it is to ships, and this has led to the President of the Lackawanna Railroad, Mr. W. H. Truesdale, issuing orders, on March 3rd, for the immediate expansion of his railways' wireless telegraph service. The following account, which is based largely upon reports in the leading New York papers, deserves the serious consideration of railway managers here as well as abroad.

An order was placed for three new stations to be installed along the Lackawanna's main line from Hoboken to Buffalo, and the first, at Hoboken, was put into emergency operation at 6 p.m. on March 3rd.

From the new Hoboken station that evening wireless was used in despatching fast freight trains after Mr. E. M. Rine, General Superintendent of the Lackawanna at Scranton, Penn., had reported by wireless that the trains would find the tracks open. He said trains would be able to get through if two locomotives were supplied for a load such as one locomotive could handle in ordinary weather.

While the dispatching of the fast freight trains through the storm zone was much appreciated by President Truesdale, the incident of the day which pleased him most was the report from the Lackawanna Limited train, which left New York at 10 o'clock for Buffalo. It sent exhaustive reports by wireless of the exact conditions throughout the whole storm zone as it proceeded on its way to Scranton. When the train arrived at Scranton, fifty-five minutes late, the officials there had a report on conditions in the storm zone that was quite complete.

A freight locomotive was immediately ordered to proceed with a gang of telegraph linemen to a point on the new Lackawanna cut-off, where a big repairing job awaited them.

Aid for other Lines.

This wireless service also greatly aided two other railways, the Erie and the New Jersey Central. Both called upon the Lackawanna to forward messages to New York after the telegraph systems along these lines had broken down.

The messages reported upon the conditions along the Erie and Jersey Central lines to Wilkesbarre. They were forwarded to Scranton by telephone and telegraph, after efforts to reach New York had failed. At Scranton the wireless station of the Lackawanna sent out the messages, which were received at the Marconi station on the roof of the Wanamaker Building in New York. The Erie and the New Jersey Central offices then received the reports by telephone from the Marconi station.

Until the opening of its own station in Hoboken on March 3rd the Lackawanna officials were compelled to depend upon the Wanamaker Building station both to send and receive messages to the company officials in Scranton and Binghamton. Besides the new station in Hoboken, it is now proposed to build a station in the heart of the present storm zone, probably at Port Morris, approximately half way between Hoboken and Scranton, and another station at Bath, N.Y., approximately half way between Binghamton and Buffalo.

The new stations have been found necessary to increase the efficiency of reports from moving trains.

Proves Value of Wireless.

In the opinion of President Truesdale the great storm of March 1st has proved beyond contradiction the value of wireless in modern railroading.

The following message, Mr. Truesdale believes, will become famous in the annals

of railway wireless as the message on which the system proved its value when all other means of communication had succumbed to the ravages of the storm. The message was received at the Wanamaker Building station in New York at 10 a.m. on Monday, March 2nd, after a night of anxious waiting and watching on the part of the Lackawanna officials, during which all that they knew was that many trains were out in the blizzard and all wires were down. The message brought definite information upon which to begin at once the search for trains whose location was made fairly definite by the wireless report. The message read :

SCRANTON, PENN.,
March 2nd, 1914.

President Truesdale,
Lackawanna, N.Y.

No wires working east of Slateford Junction since early last night. The telephone and telegraph companies claim to be in the same fix. Trains 7, 11, and 15, not received on the Morris and Essex division up to 9.30 o'clock this morning. Trains No. 8, 10, 12, and 14 got through to Scranton, where they are being held. Two freight engines are stalled in a drift at Paradise, the drift being from 10 to 20 feet high. Trackmen on the way to dig them out. Handicapped badly by lack of available men to shovel snow. Do not respond account severe cold. Train with two engines, two cars, and six passengers stalled on Ithaca branch. Most severe storm in history of this part of the country.

E. M. RINE, *Gen. Supt.*

Saving of Forty-Eight Hours.

To this message, and others which followed it next day, President Truesdale credited the saving of forty-eight hours in the time required to restore the road to normal conditions.

Early on the morning of March 3rd, after Mr. Truesdale had failed to receive wire communications from any point in the storm zone beyond Paterson, this wireless message from Scranton reached him :

SCRANTON, PENN.,

W. H. Truesdale. March 3rd, 1914.

Situation this morning improved eastward. The Morris and Essex division is in bad shape on account of 860 telegraph

poles down and no communication. We are operating single track between Cresco and Pocono Summit ; expect both tracks open by noon to day.

Trains doing well west of Pocono Summit. Snow conditions between Pocono Summit and Cresco, westward track, are bad. In the first cut east of Mount Pocono the snow is from 12 to 14 feet for distance of 1,000 feet, actual measurements. In second cut east of Mount Pocono, 15 feet deep for distance of 1,000 feet. This is most serious condition. For distance of 2,000 feet in cut just west of Paradise water tank, snow, actual measurements, 14 to 16 feet deep.

We started a train of perishable freight and poultry from Buffalo this morning and are adding to it cars of live poultry which were entered with a view of getting the train to Hoboken as early as possible.

E. M. RINE, *Gen. Supt.*

News of Wrecked Plow.

Shortly after Supt. Rine filed his message reporting on general conditions unexpected trouble occurred, and New York learned of it at once through this wireless message :

SCRANTON, March 3rd, 1914.

Truesdale, N.Y.

Since my previous wire this morning, in endeavouring to break snow drift in cut east of Mount Pocono, the Scranton snow plow was demolished. The plow was started on westward track at Pocono Summit and proceeded to this point, when accident occurred.

We are sending about 300 men to Mount Pocono to assist in clearing tracks, and have arranged to bring snow plow from Ithaca Branch to Mount Pocono and also snow plow from Syracuse division. The latter will be sent through to Port Morris via cut-off. On receipt of further particulars of situation will advise you.

E. M. RINE, *Superintendent.*

President Truesdale became anxious to know something about conditions on branch roads and how the Lackawanna Limited was proceeding. He sent a wireless message to Supt. Rine and received this answer :

SCRANTON, March 3rd, 2.40 p.m.

W. H. Truesdale : By 3 o'clock we shall have 500 men working between Mount

Pocono and Cresco, shovelling snow off westbound track. Shall have use of same this evening. Snow plow has opened Ithaca branch this morning. Buffalo and S. and U. divisions in good shape. Are not operating on Montrose branch, but have flanger (snow plow) working and expect to open by evening. Have started two fast freight trains from Scranton, two from Elmira, and four from Buffalo. Movement of slow freight and coal is restricted, but we hope to be able resume handling by to-morrow. No. 3 (Lackawanna Limited) reached Scranton fifty-five minutes late. E. M. RINE, *Superintendent*.

Mr. C. J. Phillips, the Lackawanna Superintendent at Hoboken, was so short of train crews in condition to go to work that he sent out three milk trains, carrying empties, with only one engine each instead of double-headers. He sent word ahead by wireless telegraphy. Station agents were thus on the look-out for the trains, with orders to send help.

Late on the afternoon of March 3rd, after all passenger trains had been reported as safely past Scranton, President Truesdale decided to start out the fast freight trains that had been held up at Hoboken. But first of all he asked Scranton how the tracks were for such a venture, and to his message came the following reply by wireless :

SCRANTON, *March 3rd, 5.45 p.m.*

Truesdale, N.Y. : All right ; start freight trains with loaded cars double head two engines with tonnage for one engine. Do not deliver any empty cars to Scranton division until you hear further from me. No objection to your handling empty cars on Morris and Essex division if you think track is properly flanged to ensure them holding rails. E. M. RINE, *Supt*

At President Truesdale's office it was said that the fast freight trains were sent out at least forty-eight hours earlier than the company would have ventured to send them out on its own belief that the road was clear.

AN AERO EXHIBITION.

There was much to interest the visitor at the Aero and Marine Exhibition recently held at Olympia ; though as regards actual novelties there were fewer than usual. What was most noticeable, however, was the distinct advance in the construction of the

models exhibited, which for finish and elegance could not be surpassed. In this respect, the Sopwith bat-boat and the elaborate river motor-launches should be mentioned. But perhaps the greatest public interest was centred on an exhibit in the stand of John Thornycroft & Sons. It was a motor-launch and was one of the most conspicuous in the building, chiefly by reason of the glistening copper serials of its wireless installation. The chief attraction of the boat was certainly the wireless set, which stood on a little mahogany cupboard and took up no appreciable room. That the inclusion of the apparatus in the scheme of the vessel was a good idea, the interest of the numerous visitors sufficiently testified, and many placed the 'phones on their ears to try to pick up any signals that might come their way. The stand of Messrs. Dixon Bros. and Hutchinson was particularly noticeable for their engines, which had been constructed for use in fixed and portable wireless telegraph stations. Space is limited, but a word must be spared for the exhibits of Messrs. Norris, Henty & Gardiner, who also showed some remarkably well-constructed engines, similar to a type which from time to time have been used in wireless telegraphy stations. Sound work is evidenced even to the tiniest bolt and screw, and the whole appearance of their machines suggests reliability and strength, although they are by no means cumbersome. There was much in the Aero Show to remind us that the art of aviation is to a large extent the art of attention to little things. Take, for instance, the wing of an aeroplane. Underneath the canvas covering is a skeleton which for complexity is sufficient to bewilder the cleverest intelligence. Every particle has to be fitted to a nicety, for something of the reliability of the machine depends on the careful adjustment of every bolt and screw. Therefore Messrs. Melhuish, Ltd., were well advised in providing a very complete display of small tools used in the manufacture of an aeroplane, including small drilling machines and lathes. In the same category must be placed the exhibit of Mr. Robert W. Coan, who showed aluminium castings of every description ; but perhaps the most interesting features of his stall were the specimens of repairs to broken aluminium castings. These were neither soldered nor welded, but were flawless in fitting and workmanship.



Reviews and their Uses.

THE human mind, though it is a wonderful machine, is not by any means a perfect one. Its fallibility intrudes itself into the writing of books just as much as into the ordinary affairs of everyday life, and in this particular field it has a good opportunity to make itself objectionable through the painful fact that *litera scripta manet*.

An author, once his first edition is put before the public, can only hope that his mind has behaved itself reasonably well; he waits for his readers to point out the places where it has misbehaved and welcomes any help which may enable him to improve the next edition. It is usually fruitless for him to reread what he has written in the hope of eliminating errors; for his own errors will generally pass unperceived, just as an error in totalling-up a column of figures will escape detection time and again until a new mind, coming fresh to the task, sees it at first glance.

To the author, therefore, a review which, instead of talking glibly about generalities, takes the trouble to point to specific errors and to give specific advice is a review to be welcomed. Such a one has lately appeared in the *Electrical Review*, dealing with the "Handbook for Wireless Telegraphists."

The author of the handbook has been for some time at the other end of the world, but

we take it upon ourselves with confidence to express his indebtedness to the critic who calls his attention to three or four points which require revision. As a large proportion of the readers of THE WIRELESS WORLD are also owners of the handbook, we think that we shall be satisfying their desires if we mention the various points in question.

After saying that "the appearance of the book under review . . . will be welcomed . . . by others besides those wireless operators for whom it is primarily intended as a handbook. It treats the matter in an eminently practical way . . ." the reviewer goes on:—

The text, in certain cases, is inclined to be loose in expression, as in the use of the term "resistance" where dielectric strength is intended, and in the statement that the permeability of iron decreases as the magnetic force increases.

We think that the first comment refers to one place only—on p. 99—where it is stated that "it takes a lower voltage to force a current through air than it does to force it through glass, so that, although glass offers an easier path for electrostatic lines of force, it offers a higher resistance to the passage of a current." This might better be put in the form:—

It takes a lower voltage to break down the insulation of air than to break down

* "Handbook of Technical Instruction for Wireless Telegraphists," by J. C. Hawkhead. London: The Marconi Press Agency. 3s. 6d.

the insulation of an equal thickness of glass, so that, although glass offers an easier path for the electrostatic lines of force, it is the stronger *insulator*.

The second comment refers to p. 43, where the statement "It is found that the permeability decreases as the magnetising force increases" should be modified by the addition of the words "beyond a certain point."

The review continues by referring to the description and sketch of Lodge's experiment with syntonised Leyden jars (p. 122). The error here is obvious; the "receiving" jar-circuit is shown interrupted by a spark-gap, so that until a spark occurs the circuit is not complete. Under such conditions no "building-up" effects can take place in this circuit unless the first surge is strong enough to break down the spark-gap insulation. In Lodge's experiment the "receiving" jar-circuit was permanently closed, and the jar itself had an "overflow path and air-gap"; the surgings set up in this closed circuit by the discharge of the "transmitting" jar-circuit—although at first far too feeble to "overflow" by breaking down the air-gap—gradually mounted up if the two circuits were accurately syntonised, until a spark took place at the overflow gap. To make Fig. 74 represent Lodge's experiment, therefore, the gap marked *B* should be short-circuited and the letter applied to a small "overflow" gap between the inside and outside coatings. Our friendly reviewer goes on to point out that Fig. 36 represents a balanced condition, in which no deflection of the galvanometer would be produced. The straight conductor shown should include a helix, near one end of which the magnet-pole is moved up and withdrawn, in line with the axis.

Finally, he says: "Attention is drawn to an omission on p. 234 in regard to a method of tuning the aerial with the aid of a wave-meter while using a very weak coupling of the transmitter, where the author fails to point out that unless the arrester gap is bridged the method is likely to fail." This bridging of the arrester gap is mentioned in connection with tuning by means of the buzzer, but not in connection with the particular process referred to; although since the book goes on to say that the tuning may be checked by means of the tuning-

lamp, and since the latter would not glow at all if the arrester were not either bridged or sparking properly, the omission would not appear to be of much moment.

Before we end, we may mention one or two more errors which have escaped the eye of this admirable critic. In Fig. 113 the condenser marked C_x is formed by the combination in parallel of both the condensers marked C_c in Figs. 111 and 112; it should therefore be marked $2C_x$.

On p. 175 the value of the high-frequency tuning inductance is given by an error to be 26 microhenries at its maximum, instead of .26 microhenry.

Finally, on p. 247 it is stated "The disc discharger may be adjusted so that a spark takes place at each half period." This is true for many types of disc-discharger sets, but in the particular set described, where the alternating frequency is mentioned as being 70 and the spark-frequency as being 560, it is clear that four sparks take place for every half-period. Also, in Fig. 154 on the same page, "Time" should be represented by π and not by $\pi/2$.

WIRELESS TELEGRAPHY: A HANDBOOK FOR THE USE OF OPERATORS AND STUDENTS. By W. H. Marchant. 241 pp. London: Whittaker & Co. 5s. net.; abroad, 5s. 4d.

The author opens with a brief explanation of electrical and mechanical phenomena, the value of which has probably been sacrificed through space considerations. He describes the action of different pieces of apparatus, and in his illustrations has included some representative types of apparatus. There is a short chapter on the interpretation of diagrams which should prove useful to students approaching the subject for the first time. At the end of the book are some abstracts from official regulations and instructions for both ship and shore stations.

A Reuter message from Ottawa announces that communication by wireless telegraphy has been established by the Canadian Government with the Port Nelson terminus of the Hudson Bay Railway. The Minister of Railways on February 23rd received from the chief engineer, Mr. McLachlan, the following message: "All well; comfortable, busy here."

Administrative Notes.

THE German Official Journal, No. 73, publishes a decree of the Chancellor of October 14th, 1913, modifying the regulations for the working of telegraph stations on foreign ships in German waters of October 12th, 1909. According to the revised regulations, wireless telegraph traffic of foreign ships in German waters and in German rivers is subject to the following :

Ships in German Waters.

(a) Foreign men-of-war shall be permitted to use their wireless telegraph apparatus on condition that the public coast stations and coast and ship stations of the German marine are not interfered with. In exchanging traffic with German or foreign wireless stations the rules laid down in the "Anweisung für den Funkentelegraphendienst" (Regulations for the wireless telegraph service) must be observed.

(b) Other foreign vessels are only permitted to use their wireless apparatus in accordance with the above-mentioned regulations, but when in German ports, roadsteads, river mouths, or inland waterways, the wireless apparatus shall only be used when written permission to do so has been obtained from the German postal authorities.

* * *

THE Telegraph Administration of the Republic of Columbia announce the opening of a station at Cartagena

Cartagena Station.

(75° 30' 00" long., 10° 40' 00" lat.). The station has a range of 600 miles during the daytime and 1,200 miles during the night. The following wave-lengths are employed : 600, 1,500, 2,000, 2,500 and 3,000, the first two being the normal wave-lengths. The station is open between the hours of 6 a.m. and midnight for general public correspondence, the rate being 0.50 frs. per word. We notice that the call letters C.T.G form part of the series reserved by the International Bureau for the Portuguese Administration. However, the Government of the Republic of Columbia have not yet adhered to the Convention, or,

at least, they have not made the declaration prescribed in the regulations annexed to the Convention.

* * *

THE Report for 1913 of the International Bureau, Berne, shows that at the end of the year there were 3,998 wireless telegraph (land and ship) stations in existence, according to the records of the Bureau. At the end of 1908 there were only 508 such stations in existence. During the following year 247 were added, bringing the total up to 755. In 1910, 1911, and 1912 there were increases of 462, 523 and 540 respectively, thus raising the total at the end of 1912 to 2,280 coast and ship stations. The most notable increase was that recorded last year, when no fewer than 1,718 stations were added, making 3,998 stations in all open at the end of 1913.

In the following table is given an analysis of these figures, showing the nature of services carried on at the stations.

	Public Service.	Restricted Public Service.	Official.	Private.	Special.	Total.
Coast Stations ...	288	27	136	7	25	483
Ship Stations ...	1,912	59	1,402	80	10	3,463
Land Stations ...	2,200	86	1,538	87	35	3,946
	—	20	30	—	2	52
Total... ..	2,200	106	1,568	87	37	3,998

* * *

An Ordinance regulating radiotelegraphy, under conditions similar to those of most other British Colonies and Protectorates, has been issued by the Commissioner of Wei-hai-wei, China.

* * *

The New Zealand Postmaster-General (Mr. R. H. Rhodes) stated recently that he was unable to grant concessions to amateurs which would allow of private wireless installations being erected. He had no doubt amateur stations did exist, in spite of the regulations.

The Imperial Wireless Chain.

Several questions were raised in the House of Commons during the past month regarding the Imperial Wireless

The British Station. Chain. Captain Norton, on behalf of the Postmaster-General, stated on March 2nd

that work on the English station, which is situated at Leafield, Oxfordshire, has already begun, and in connection with that station detailed specifications of the power, plant, and masts have been submitted by the Marconi Company. These have been generally approved, subject to certain reservations. The specifications of the wireless plant have not yet been settled.

As regards Egypt a change has been made in the original proposal, under which the station in Egypt will be

Egypt and India. a three-way station instead of a two-way one. Originally

the three-way station was to be in East Africa, but it was found impossible, at any rate without very large expenditure, to obtain a suitable site in the Protectorate for a three-way station, and, as the Marconi Company were willing to guarantee the maintenance of continuous and efficient communication between Egypt and India, the Postmaster-General decided to erect the three-way station in Egypt instead of East Africa. The site for this station has been purchased and the specifications of the power, plant, and masts have been generally approved. As a result of this change, the third station will be in India instead of in East Africa, and the Indian Government is now arranging for the provision of the site in the neighbourhood of Poona. The specifications for the Indian station cannot be finally settled until the site has been approved.

Under the present arrangement the East African station is necessary as a link to South Africa, and until the

Link with South Africa. agreement is ratified by South Africa neither the East

African nor the South African station can be proceeded with. The South African Government cannot bring the matter before Parliament now. Sites, however, for

both these stations have been provisionally selected, as is also the case in regard to the Straits Settlements Station.

Replying to a further question by Mr. W. Guinness, Captain Norton said the Marconi Company acquired the right to use Dr. Goldschmidt's wireless apparatus in September last.

Answering Mr. Faber on March 5th Mr. Hobhouse said that the decision to establish

Range of Station in Egypt.

a three-way wireless station in Egypt instead of in East Africa was arrived at in November last. It was intended that the three-way station to be erected in East Africa should have communication with the Imperial wireless stations in Egypt (distance 1,900 miles), in India (2,570 miles), and in South Africa (1,600 miles). The station about to be constructed in Egypt would communicate with stations in England (distant 1,950 miles), in India (2,560 miles), and in East Africa (1,900 miles). The question whether the rearrangement of the Egyptian and East African stations necessitated a further formal agreement with Marconi's Wireless Telegraph Company, supplementary to that of July 30, 1913, was considered by the Law Officers of the Crown, and they advised that the variation was a mere modification of the contract in one particular and did not affect its general scope and character, and that an exchange of letters would be sufficient. The Marconi Company had given a written guarantee, which would be regarded as most strictly binding, that continuous and efficient communication would be maintained between the stations in Egypt and India in accordance with Clause 7 of the Agreement of July 30 last.

On March 9 Mr. Hobhouse made a further statement which should allay any uncertainty regarding the contract

The Position with Regard to the Contract.

for the Imperial stations. He informed Mr. Nield that the second three stations of the Imperial wireless chain were included in the contract with the Marconi Company, and so far, therefore,

the Marconi Company held the contract for them. Under Clause 2 of the contract, however, the Postmaster-General had power to cancel the contract so far as it related to those three stations; and it was with this power in view that his predecessor issued a notice in the Press in November last that he would be prepared to consider applications to tender from any firms, companies, or contractors who were able, by means of practical demonstration, to satisfy him of the efficiency of their system. Tenders were not asked and none were sent in. Replies were received from the Universal Radio Syndicate (Poulsen system), the Société Française Radio Electrique (Béthenod system), and the Galletti Company; but their proposals were too indefinite and the date suggested for the demonstrations too distant to justify waiting. The companies were informed that the Post Office would be glad to witness demonstrations of the systems; but, as a matter of fact, no successful demonstration, even of an experimental character, had yet been given.

Patent Record.

The following patents have been applied for since we went to press with the January number:

1914.

3,371. February 9th. Francesco de Bernochi. System of apparatus for the wireless electrical operation at a distance of a type printing machine.

3,589. February 11th. Robert B. Ransford, for Compagnie Universelle de Télégraphie et de Teleph. sans fil. Alternating current machine and the like. ...

3,590. February 11th. Robert B. Ransford, for Compagnie Universelle de Télégraphie et de Teleph. sans fil. Alternating current machines, transformers and similar apparatus.

3,591. February 11th. Robert B. Ransford, for Compagnie Universelle de Télégraphie et de Teleph. sans fil. Method of regulating the length of electric waves in wireless telegraphy and telephony.

3,592 & 3,593. February 11th. Robert B. Ransford, for Compagnie Universelle de Télégraphie et de Teleph. sans fil. Wireless telegraph or telephone transmitters.

3,840. February 14th. William A. Benton and Walter C. Loones. Wireless telegraphic signal receiving apparatus.

3,963. February 16th. Dr. J. A. Fleming, F.R.S. Apparatus for generating H.F. oscillations for wireless telegraphy and telephony.

4,276. February 19th. Frank Herbert Spicer. Radio-telegraphic timepiece.

4,345. February 19th. Société Marius Latour et Cie. Transformation of frequency of H.F. alternating currents for wireless telegraphy and telephony.

4,664. February 23rd. Polyphos Elektrizitäts Gesellschaft M.B.H. Production of electric waves for wireless telegraphy, telephony and the like.

4,666. February 23rd. Harold Wade, for Harold Steele Mackaye, U.S.A. System of wireless telegraphy.

5,281. March 2nd. Henry Plunkett Dwyer. Wireless oscillator.

5,370. March 3rd. Harry Fothergill. Apparatus for radiating or receiving electromagnetic waves on aeroplanes, airships and the like.

5,535. March 4th. Gottlieb Leimbach. Wireless telegraphy.

5,718. March 6th. Wm. Theodore Ditcham. Spark gaps for radio-telegraphy and radio-telephony.

5,829. March 7th. Edward Howl and Frank Perry. Electrolytic detectors for use in wireless telegraphy and telephony.

5,934. March 9th. Signal Gesellschaft, M.B.H. Method of controlling mechanical forces by waves or other forms of energy propagated through a medium.

5,935. March 9th. Signal Gesellschaft, M.B.H. Receiving device for subaqueous sound signals.

6,171. March 11th. John Hays Hammond, Junr. Movable bodies, such as vessels, aircraft and road vehicles, controlled by radiant energy.

6,389. March 13th. Edouard Belin. Automatic telegraphic or radio-telegraphic transmitters.

Marconi Patents upheld in U.S.A.

According to a telegram received from New York, on March 18th, the action brought by the Marconi Wireless Telegraph Company of America against the National Electric Signalling Company (Fessenden's system) in the United States Circuit Court for infringement of Lodge's patent No. 609154 (corresponding to English patent No. 11575, of 1897, which has been

prolonged for seven years) and Marconi's patent No. 763772 (corresponding to English patent No. 7777, of 1900, which was upheld in the English courts a few years ago) ended on the 18th inst., in a judgment for the plaintiffs. The judgment, which thus corresponds with those which have been delivered in other countries, declares both patents to be valid and to be infringed by the defendants' system.

Action for Infringement.

In the action which Marconi's Wireless Telegraph Co. are bringing against the Helsby Wireless Telegraph Co. for infringement of the Marconi Patent No. 7777, of 1900, Mr. Courtney Terrell, on behalf of the Helsby Co., applied in Court to Mr. Justice Joyce, on February 23rd, under Section 31 of the Patents Act, 1907, for the appointment of an "assessor" to assist the Judge in trying the case. The application was granted. Section 31 of the Act referred to reads: "In an action or proceedings for infringement or revocation of a patent, the Court may, if it think fit, and shall on the request of either of the parties to the proceedings call in the aid of an assessor specially qualified, and try the case wholly or partially with his assistance; the action shall be tried without a jury unless the Court otherwise directs . . . The remuneration, if any, to be paid to an assessor under this section shall be determined by the Court or the Court of Appeal, as the case may be, and be paid as part of the expenses of the execution of the Act." Mr. J. Hunter Gray, on behalf of the Marconi Co., opposed the application on the grounds that no "specially qualified" assessor could be found. Mr. Justice Joyce, however, decided that an assessor should be appointed, and directed the parties to the action to agree on someone, or failing that to apply to him in Chambers. Mr. Terrell suggested that Lord Parker (Chairman of the P.O. Wireless Advisory Committee) might be asked to suggest someone who was qualified.

The Share Market.

LONDON, *March 23.*

The various Marconi issues have been without feature during the past month,

prices being governed by the position of stock markets generally.

The closing prices are:—Marconi Ordinary, £3 8s. 9d.—£3 11s. 3d.; Marconi Preference, £2 16s. 3d.—£2 18s. 9d.; Canadian Marconi, 9s.—10s.; Spanish & General Wireless Trust, 10s.—12s. 6d.; American Marconi, 18s. 9d.—£1 1s. 3d.; Marconi International, £1 8s. 9d.—£1 10s.

The annual report for 1913 of the Swansea Chamber of Commerce contained a statement regarding wireless telegraphy. As we have already stated in a previous issue, the Council of the Chamber suggested that a wireless telegraph station should be maintained by the Harbour Trustees at Mumbles Head. The report now issued states that "in response to a communication on the subject from the Trustees to the General Post Office, the secretary of the latter has suggested a personal interview with the Inspector of Wireless Telegraphy, and the Trustees having invited the Chamber to appoint a representative to take part in such an interview Mr. Moffat has undertaken to act in this capacity."

Commander Henry W. Hough, of the United States Navy, who has been in Paris conducting wireless communication tests between the Eiffel Tower and the Government wireless station at Arlington, Va., has returned to America, and expressed himself well satisfied with the results of the experiments in which he took part, and which we have already described in these columns. He has stated that on a good night, when weather conditions were favourable, he heard Arlington as plainly as if he had been speaking for a short distance over a telephone.

The new Post Office station at Fort George, Guernsey, is nearing completion. There is already an Admiralty station here, which was used by Post Office operators during the last telegraphic interruption. The new station is not to be open throughout the year, but it will be immediately available in the event of telegraphic interruption. The power house and station are constructed on the slope outside the ramparts of the citadel.

Positions of Operators

(March 14th.)

- Abbott, S. H. V., *Chik.*
 Adam, J. H. S., *Berrima.*
 Adams, F. W., *Persic.*
 Adams, G. E., *Minnetonka.*
 Adnitt, C. H. H., *Edinburgh Castle.*
 Akehurst, C. J., *Highland Laird.*
 Akerman, A. R., *La Negra.*
 Albrow, H. V., *John Pender.*
 Alderton, C. G., *Beacon Grange.*
 Alford, L. W. G., *Waimana.*
 Alichurch, H. P., *City of Bristol.*
 Allen, G. A., *Galeks.*
 Allison, W., sick leave.
 Allnutt, C. M., *City of London.*
 Allott, N. E., *Orita.*
 Allworth, H. P., *Isernia.*
 Alston, S. K., *Itasruco.*
 Alton, T. F., *Chaleur.*
 Ambler, F., *Orcoma.*
 Amott, F., *Maryland.*
 Anderson, G. A. L., London School.
 Anderson, G. D., *Elephanta.*
 Anderson, L. N., *Saxonia.*
 Andrews, A., *Philadelphian.*
 Angill, A. G., *Irishman.*
 Arbuckle, D., *Grampian.*
 Aris, B. F., *Waipara.*
 Arlaud, C., *Sardinia.*
 Armstrong, C. C., *Cufr.*
 Armstrong, S., *Magdalena.*
 Arnold, A. C., *Appam.*
 Arrowsmith, G., *Tarqua.*
 Atkinson, J., *Canada.*
 Atkinson, W. F., *La Correntina.*
 Atkinson, W. H., *Narragansett.*
 Auvache, J. E., *Medina.*
 Avery, F., *Tyrolia.*
 D'Avigdor, A. H. D., *Ultonia.*
 Bailey, F. M., *Arabic.*
 Bailey, H. H., *City of Baroda.*
 Bain, W. B., *Kelvinbank.*
 Baker, E. A., *Khica.*
 Baker, F. H., *Ortic.*
 Baker, J. R., *Orissa.*
 Balding, G., *Granitully Castle.*
 Baldon, C. T., *Oxfordshire.*
 Balfour, G. W., *Mauretania.*
 Ballard, A. E. R., unattached.
 Bamford, E., *Michigan (Warrens).*
 Bamford, J. B., *Dominion.*
 Banbury, W. C., *Derham Castle.*
 Band, H. J., *Star of Australia.*
 Barber, C. E., *Highland Brae.*
 Barber, W., *Den of Airtie.*
 Barker, L. T., *Matara.*
 Baron, C. E., *Huanchaco.*
 Barrell, W. S., *Oropesa.*
 Barron, T. G., *Baron Jedburgh.*
 Bartlett, C. H., *Matatura.*
 Baxter, B. O., *Moto.*
 Beamon, T., *Ascot.*
 Beardmore, G. A., *Caledonian (Leyland).*
 Beatson, F., *Walmer Castle.*
 Beckett, G. N., *Panaras.*
 Beckett, J., *Corinthian.*
 Belcher, H. F., *Armadale Castle.*
 Bellby, W., *Uranium.*
 Bell, A., *Highland Laird.*
 Bell, E., *Karema.*
 Bell, J. A., *Raeburn.*
 Bellhouse, G. L., *Megantic.*
 Belton, D., unattached.
 Bernard, R. A., *Kansas.*
 Beynon, A. R., *Kanasaka.*
 Biggings, J., *Canadian.*
 Bilton, W. W., *Hantonian.*
 Birch, A., *El Argentino.*
 Birtwistle, W., *Himalaya.*
 Blesard, J., *Magdalena.*
 Blight, W. T., *Mamari.*
 Bliss, W. E., *Carnarvonshire.*
 Blizzard, B. E., *Tara.*
 Blow, A. G., *Highland Laddie.*
 Bloxham, A. I. W. H., *Asturias.*
 Blundell, E. T., *Indrapura.*
 Bolleau, J. M., *Philadelphian.*
 Bolster, A., *Aronda.*
 Boon, N. A., *Bojota.*
 Boorne, E. V., unattached.
 Bower, A. B., *Berwick Castle.*
 Bowling, J. E. K., *China.*
 Bowman, H. A., *Welshman.*
 Boylan, J. A., *Garth Castle.*
 Boxer, H. R., *Bayano.*
 Bradfield, T., *Ekma.*
 Bradley, F. A., *Chignecto.*
 Brain, R. L., *Haverford.*
 Bramley, J. R. C., *Italia.*
 Bransby, A. H., *Highland Brigade.*
 Branton, S. V., *Pera.*
 Breen, J. J., sick leave.
 Bremner, J., *Barranca.*
 Brennan, J., *Empress of Britain.*
 Brett, C. H., *Limerick.*
 Brewer, C. H., *Calabria.*
 Bridges, W., *Derna.*
 Bright, A. E., *Baroda.*
 Brindle, F., *Kathiaear.*
 Brookes, J. F., *Miami.*
 Brown, A. C., *Galician.*
 Brown, A. H., *Demerara.*
 Brown, A. R., *Motagua.*
 Brown, J., *Californian.*
 Brown, J. A., *Tesota.*
 Brown, S. W., *San Eduardo.*
 Brown, Stanley W., *Dessado.*
 Browne, A., *California PSN.*
 Browne, C. W., *Alsation.*
 Bruton, A. F., *Derbyshire.*
 Bryan, H. F. B., *Sardinian.*
 Budge, J., *Callao Depot.*
 Bull, J. G., *Montrose.*
 Burgess, A. F. T., *Ucuyali.*
 Burgham, G. M., *Sumatra.*
 Burke, M. M., *Columbian.*
 Burnett, W. C., *Ruthenia.*
 Burnett, W. J. T., London School.
 Burrows, T. R., *Numidian.*
 Butterworth, J. M., *Lanfranc.*
 Buttle, J. G., *San Tirso.*
 Butler, J., *Icemia.*
 Caldwell, A. C., *Suevic.*
 Caldwell, J., *City of Paris.*
 Calver, F. N., *Mauretania.*
 Calver, G. H., unattached.
 Cameron, R. S., *Pardo.*
 Campbell, M. J., *San Urbano.*
 Camfield, J., *Bohemian.*
 Candy, W. H., *Empress of Britain.*
 Carey, J. P., *Drumree.*
 Carnaby, N. E., *Egypt.*
 Carruthers, G., London School.
 Carter, B. A., *Massilia.*
 Carter, W., *Chngres.*
 Cauvin, M. A. J., *Manxman.*
 Chadwick, J. G., *Adriatic.*
 Chapman, G. G., *Orama.*
 Chapman, T. J., *Neuralia.*
 Charles, E. E., *Royal Edward.*
 Chesterton, A. J., *Itapura.*
 Cheyne, J., *Manhattan.*
 Chick, C. A., *Llandoverly Castle.*
 Chick, O., *Mesaba.*
 Chick, W. H., *Potaro.*
 Child, L. J., *Orissa.*
 Church, G. R., *Minnetonka.*
 Church, T. M., *Etonian.*
 Clark, F., *Cawdor Castle.*
 Clark, J. W., *Delphic.*
 Clark, J. W. A., *Pathan.*
 Clark, L. B., on leave.
 Clark, P. S., *Assaye.*
 Clarke, A. H., *Nepesa.*
 Clarke, A. M., *Nankin.*
 Clarke, H. T., *Comris Castle.*
 Clarke, J. G., *Georgian.*
 Clarke, W. F., sick leave.
 Clarke, W. J., *Potaro.*
 Clarkson, G., *Crown of Toledo.*
 Cleary, L. B., *City of Glasgow.*
 Cleaver, W. W., *Arzila.*
 Cleverley, E. S., *Amazon.*
 Clifford, A. J., *City of Bombay.*
 Cobham, A., *Franconia.*
 Cocks, H., *Kingstonian.*
 Coffey, P. J., *San Gregorio.*
 Coldwell, G. A., *El Cordobes.*
 Coleman, T. H., *Gloucestershire.*
 Collier, F. R., sick leave.
 Condon, W., *Mount Royal.*
 Connell, J., *Liverpool Depot.*
 Cook, E. J., *Llanstephen Castle.*
 Cook, F., *Armenian.*
 Cook, G. E., *Athenic.*
 Cookson, V., *Sachem.*
 Cormack, D. R., *Scindia.*
 Cormack, W. L., *Gujurat.*
 Cottam, H. T., *Persia.*
 Cousens, E. C. N., *Nubia.*
 Cousens, W. T., *Clearway.*
 Cowhey, K. S., unattached.
 Cox, E. J., *Knight Templar.*
 Cox, L. H., *Eupion.*
 Cox, W. G., *Baltic.*
 Coysh, W. D., *California.*
 Craigie, J. A., *Michigan (Warrens).*
 Craven, W. M., *Themistocles.*
 Crawford, J. G., *Andorhina.*
 Crofts, A., *City of Durham.*
 Croke, L. G., *Mantua.*
 Crookes, W. D., *Oriana.*
 Crosby, S., *Arian.*
 Crossman, C. H. G., *City of Chester.*
 Cross, S. R., *Cornishman.*
 Cruess-Callaghan, S., *Koranna.*
 Cryan, W. J., unattached.
 Cunningham, J., *Luceric.*
 Outbush, H. E., *Karoo.*
 Dale-James, W. R., *Marmora.*
 Daly, D. G., *Trent.*
 Daly, R. H., *Alaunia.*
 Damen, O. G., *San Dunstano.*
 Daniels, J. H., *Missouri.*
 Darby, P. T., *Francis.*
 Darracott, R. B., *Alnwick Castle.*
 Davey, A. W., *Fllore.*
 Davies, F., *Caronia.*
 Davies, J. E., *Orduna.*
 Davies, J. I., *Mimiro.*
 Davies, W., *Liverpool Depot.*
 Davis, A. C. J., *Taroba.*
 Davis, G. E., *Desabla.*
 Davy, W. H. G., unattached.
 Dawson, B., *Canopic.*
 Dawson, R., *El Paraguayo.*
 Day, E. J., *Quilpus.*
 Dean, J. J., *Botanist.*
 Denison, P., *Den of Crombie.*
 Dennis, F. L., unattached.
 Devereux, S. H., *Royal George.*
 Dewey, G. H., *Lancastrian.*
 De Witt, D. T., *Barneson.*
 Dick, J., *Nisour.*
 Dicks, A. G., *Rangtira.*
 Dickinson, A., *Peru.*
 Dixon, E. W., *Namur.*
 Dods, L. A., *Carmania.*
 Doherty, P., *Moldavia.*
 Doddan, W. J., *Indian.*
 Donnegan, J. J., *Berwindmoor.*
 Driscoll, J. R., *Anglian.*
 Duncanson, J., *Goorkha.*

- Durston, W. J., *Cambrian*.
 Dyer, E. W., *Corinthian*.
 Earl, H. E., *Avon*.
 Earl, W. F., *Pardo*.
 Earle, H., *Huallaga*.
 Ebbetts, F. T., *Manora*.
 Eccles, P. B., *Appalachee*.
 Edwards, W. G., sick leave.
 Egan, M. B., *Gaika*.
 Elliott, B. S., *Empress of Asia*.
 Ellis, R. O., *Sicilia*.
 Emanuel, R., *Arava*.
 Emery, B. F., *Egra*.
 Empson, T. L., *Bankura*.
 Entwistle, A. M., *Aragon*.
 Erbach, E. W., *Morion*.
 Evans, A. W. N., *Hesperian*.
 Evans, C. F., *Perugia*.
 Evans, T. H., *Indora*.
 Fagg, G. K., *Andes*.
 Farman, A. H., unattached.
 Farmery, J. C., *Calypso*.
 Farrell, R. T., *Swazi*.
 Ferguson, R., *Empress of Ireland*.
 Findlay, J. M., *Whakarua*.
 Firman, A. R., *La Rosarina*.
 Firth, A., *Star of Ireland*.
 Firth, P. S., *Gaileo*.
 Fitzgerald, J. M., *Potomac*.
 Pitton, F., *Victorian (Leyland)*.
 Fletcher, L., *Carmania*.
 Fookes, F. T. J., *Francisco*.
 Foran, E., sick leave.
 Ford, H., *Empress of Ireland*.
 Foster, R. T., unattached.
 Fox, L. C., *Paparoa*.
 Fox, W., *Knight Companion*.
 Fowler, W., *Changuinola*.
 Foyle, H. J., *Kentucky*.
 Fraser, B., unattached.
 Fry, F. A., *Hubert*.
 Gadd, W. C., *Marere*.
 Gale, B., *Teutonic*.
 Gale, W., *Plassy*.
 Gallagher, H. J., *Dongola*.
 Garbutt, H. W., *Kia Ora*.
 Gardner, F. T., *Nigeria*.
 Gardner, E. S., *Oropesa*.
 Garrett, E. W., *Philadelphian (Leyland)*.
 Garwood, F. W., *Akobo*.
 Gascolgn, R. A., *Oriental*.
 Gibb, J., *Wayfarer*.
 Gibson, A., *Georgic*.
 Gilles, A. D., *Peru*.
 Giles, R. W., *Manzman*.
 Gill, C. J. A., *Cestrian*.
 Gillett, B. A., *Caribbean*.
 Golding, J. H., *Guildford Castle*.
 Goodsell, W. B., *San Valerio*.
 Gordon, C. S., unattached.
 Gornall, J., *Karina*.
 Graham, T., *Winifredian*.
 Graves, D., *Vandyck*.
 Graves, W. P., *Hypatia*.
 Gray, F., *Uranium*.
 Gray, J. H., *Carpathia*.
 Gray, W. F., *Mongolia*.
 Green, E. H., *Campanello*.
 Greene, A. L., *Highland Pride*.
 Greenstreet, P., *Whakarua*.
 Gregson, A. J., *Normannia*.
 Gregson, E. A., *Carthaginian*.
 Greig, A. F., *Campanello*.
 Gresham-Barber, K., *Macedonia*.
 Griffith, J. T. R., *Munster*.
 Griffiths, A., *Vauban*.
 Grover, A. P., *S. Y. Lysistrata*.
 Groves, W. G., *Zealandic*.
 Gullen, F., *Canadian*.
 Hagon, W. R., *Englishman*.
 Hague, W. J., *Luendes*.
 Haining, A. J., *Kildonan Castle*.
 Halcrow, A., *San Jeronimo*.
 Hall, H., *Caraguet*.
 Halliday, W. C., sick leave.
 Halsall, T. H., *Caledonia (Anchor)*.
 Hamlet, M. B. W., *Orita*.
 Hancock, L. A., *Palawan*.
 Hanson, A. E., *Bempton*.
 Harding, R., sick leave.
 Hardy, C. L., *Bovic*.
 Hardy, H. E., *S. Y. Doris*.
 Hardy, R. S., *Laurentic*.
 Harford, R., *Patuca*.
 Harlow, E., *St. George*.
 Harris, A. J., *Anglian*.
 Harris, C., *Royal George*.
 Harrop, T., *Danuba*.
 Hart, H. P. J., *City of Lincoln*.
 Hartigan, M. J., *Sardinian*.
 Hatfield, A. H., *Tunisian*.
 Hathaway, A. D., *Rimutaka*.
 Hawes, H., *Hydaspes*.
 Hawkes, G. E., *Letitia*.
 Henderson, W. C., *Jose de Larrinaga*.
 Hendry, A. O. R., *City of Naples*.
 Henry, R. J., *Mesaba*.
 Herbert, C. W., *Medic*.
 Herbert, T., *Sicilian*.
 Herd, H., *Corvican*.
 Hewitt, S., *German*.
 Hickling, W., *Berbice*.
 Hicks, W. J., *El Zorro*.
 Hill, A. E., *Otranto*.
 Hill, A. G., *Inverlay*.
 Hill, E. G., *Ghazee*.
 Hill, G. R., *Vauban*.
 Hindle, T., unattached.
 Hitchner, J. W., unattached.
 Hoare, H. R., *Corinthic*.
 Hobbs, P. B., *Abooso*.
 Hodge, T. H., *Chilka*.
 Hodgeson, W. H., *Chinkoa*.
 Holden, H., *Kandahar*.
 Holden, T. F., *City of Karachi*.
 Holker, N., *Saldanka*.
 Holland, E. J., *Barjora*.
 Holliday, P., *Demerara*.
 Holman, G. C., *Colonian*.
 Holmes, T. B., *Historian*.
 Hooley, T. E., *Star of India*.
 Hooper, P. H., *Galeka*.
 Hoppe, R. G., unattached.
 Horne, T., *Snafell & King Orry*.
 Hosking, L. G., *Palermo*.
 Horwood, H. J., *Alawania*.
 Howard, E., unattached.
 Howard, J. Q., *City of Birmingham*.
 Howard, W., *Hermione*.
 Howlett, W. J., *Manitou*.
 Huggins, W. T., *Ellenga*.
 Hughes, C. L., *Highland Harris*.
 Hughes, G. K., *Sagamore*.
 Hughes, L. E., *Olympic*.
 Hughes, W. J., *Andania*.
 Hugo, V. S., *Minneapolis*.
 Humphreys, E. H., *Wilcannia*.
 Hunt, P. G., *Drumcliffe*.
 Hunt, G., *Victoria*.
 Hunt, H. P., unattached.
 Hutchinson, W. E., *Highland Corrie*.
 Hunter, A. E., *Galeka*.
 Inder, W., *City of Lahore*.
 Ingle, G. W., *Indus*.
 Isherwood, T. P., *Afric*.
 Jacobs, A. G., *Ascanius*.
 James, F., *City of Poona*.
 James, R. C., *Kasenga*.
 James, R. H., *Royston Grange*.
 Jamieson, A. F., *Stephen*.
 Jeffries, A. H., *Leinster*.
 Jeffries, F., sick leave.
 John, W. L., *Mashobra*.
 Johnson, F., *Denis*.
 Johnson, W. A., *San Fraturno*.
 Johnston, M., *Kasama*.
 Jones, A. E., *India*.
 Jones, A. V. G., *Naneric*.
 Jones, C. E., *Engineer*.
 Jones, C. F., *Quillota*.
 Jones, H., *Monmouthshire*.
 Jones, J. P., *Numidian*.
 Jones, O., *Garth Castle*.
 Jones, R., *Columbia*.
 Jones, Richard, *El Uruguayo*.
 Jones, T. G., *Canopic*.
 Jones, W. A., *Canada*.
 Julius, A., *Eneas*.
 Keane, O. P., *Hawkes Bay*.
 Keen, F. L., *Saxonia*.
 Kelly, C., *Oceanic*.
 Kelly, K. C., *Norman*.
 Kett, H. S., *Galician*.
 Kinder, F. V., *Westmouth*.
 King, B., *Colorado*.
 King, R. B., *British Sun*.
 King, V. M., *Araguaya*.
 Kingsbury, A., *Makarini*.
 Kingsford, J. B., on leave.
 Knapman, W. H., *Simla*.
 Knox, T., *Preorian*.
 Lacock, E., *Scandinavian*.
 Lambert, E., *South Point*.
 Lambert, G. H., *Esmeraldas*.
 Lambert, L. J., *Carnaroonshire*.
 Langham, A. E., *Charles E. Harwood*.
 Langley, A., *Agadir*.
 Law, C., *Shenandoah*.
 Law, S., *Pannonia*.
 Lawson, A. L., *Araguaya*.
 Lawton, A. H., *Flamenco*.
 Lea, R. H., *Highland Enterprise*.
 Learman, E. E., *Highland Rover*.
 Leche, W. J., *Quernmore*.
 Ledger, F. H., *Highland Warrior*.
 Ledward, T. A., *Agula*.
 Lees, E. A., *Huayna*.
 Lees, J. H. D., *Commonwealth*.
 Lee, G., *Rowanmore*.
 Lee, R. A. C., *S. Y. Cassandra*.
 Lee, W., *Mexico*.
 Leech, H. S., *Cymric*.
 Leeds, K. F. N., *Calcutta, Depot*.
 Lefebure, H. H. R. A. C., *Baron Napier*.
 Leighton, L. H., *Narragansett*.
 Leith, R., *Lusitania*.
 Leith, S. A., *Cymric*.
 Lemon, S., *Andania*.
 Lever, G. H., *Marquette*.
 Lewington, W. H., *Gloucester Castle*.
 Lewis, W. T., *Laconia*.
 Lewis, S. P., *Buffalo*.
 Lewis, S. W., *Deana*.
 Lightfoot, H. J., *Darro*.
 Lindsay, M. J., *Demosthenes*.
 Lines, W. T., *Bovic*.
 Linnell, F. J., *Rotorua*.
 Lister, C., *Caribbean*.
 Litchfield, C. P., *Den of Ruthven*.
 Lithgow, W. H., *City of Colombo*.
 Little, H. T., *Exmouth II*.
 Lock, H. G. W., *Durham Castle*.
 Longton, C. E., *Letitia*.
 Lovelock, J. D., *Delaware*.
 Lovett, F. J., *Melford Hall*.
 Lovibond, R. A., *Parana*.
 Lucey, J., *Den of Glamis*.
 Lund, A. C., *Norman*.
 Lush, J. K., *Nestor*.
 Lyons, J., *Oronoa*.
 Lynch, G., unattached.
 Macdonald, J., *Marina*.
 Machan, J. W., *City of Corinth*.
 Mackenzie, C. F., *Itapuhy*.
 Mackintosh, J., *Bohemian*.
 Macleod, S. E. S., *Calabria*.
 Macrae, C., *Cedric*.
 Macrae, K., *Balmoral Castle*.
 Madgwick, G., *Isis*.
 Makin, A. E., *Matagua*.
 Maltby, P. B., *Virginian*.
 Mangan, D. D., *Sicilian*.
 Mares, A. H., *Castalia*.
 Marriott, J. E., *Dunluce Castle*.
 Marsh, J. E., *Welshman*.
 Marshall, W. P., *Scandinavian*.
 Martin, P. B., *Olympia*.
 Martin, S. F., *Syria*.
 Martlieu, J. E., *Briton*.
 Massey, C. T., unattached.
 Massey, W., *City of Dunkirk*.
 Masters, C. E. E., *Asturias*.
 Mather, J., *Campania*.
 Matthews, E. M., *Niceto de Larrinaga*.
 Matthews, W. C., *Esquimo*.
 Mattinson, E. V., *Pomeranian*.
 Mattock, P., *Victorian (Allan)*.
 Maudsley, C. V., *Caronia*.
 Maurice, J., *Guildford Castle*.
 Mauro, O. G., *Juin*.
 May, A. H., *Manitou*.
 May, P. B., *Armada Castle*.

- Maycock, T. C. C., *Star of Scotland*.
 Mayer, E. D., *Edinburgh Castle*.
 McCarthy, C. F., *Polemic*.
 McCarthy, C. J., *Nile (P. & O.)*.
 McCarthy, C. M., *Cassandra*.
 McCormack, G. N., *La Correntina*.
 McCormack, M., unattached.
 McCormick, D. C., *Sandon Hall*.
 McCreath, R. V., *Drumlanrig*.
 McCrohan, T., *Inoa*.
 McCutcheon, W. J., *Repentazon*.
 McEnery, T. C., *Imperial*.
 McGehee, W. J., *Alsatian*.
 McKenna, J. M., *Crofton Hall*.
 McLachlan, D., *Cheyenne*.
 McMillan, J., *Haverford*.
 Melling, H., *Denbigh Hall*.
 Meredith, M. W., *Italia*.
 Middleton, P. G., *Hesperian*.
 Miles, J. L., *Ilysses*.
 Miles, L. J., *Victorian (Allan)*.
 Miller, D., *Balantia*.
 Miller, W., *Aidan*.
 Miller, W., *Start Point*.
 Mills, L. C., *Englishman*.
 Mitchell, P., *Vadamore*.
 Mitchell, S. W., unattached.
 Mole, H., *Custodian*.
 Monsey, M., *Tritonia*.
 Montgomery, B. H., *Chaleur*.
 Moodle, T., on leave.
 Moody, J., *Balmoral Castle*.
 Moon, A. T., *Thongwa*.
 Moore, J. J., *Burutu*.
 Moores, J. H., *Calcutta Depot*.
 Morris, P., *Georgic*.
 Morgans, R. H., *Lackawanna*.
 Moriarty, D. J., *Matoppo*.
 Morris, T. P., *C. A. Canfield*.
 Morrison, L. D. G., *Barala*.
 Morrison, J. D., *California*.
 Morris, C. E., *Kalomo*.
 Morse, W. S., *Vandyck*.
 Moss, C. O., *Baltic*.
 Mountain, R. H., *Drina*.
 Mowe, F. H., *S. Y. Valiant*.
 Mulhall, J. P., *Caraquet*.
 Munday, B. A., unattached.
 Munroe, H., unattached.
 Murch, R. W. B., *Berwindvale*.
 Murphy, D., *Monmouthshire*.
 Murphy, E., *Pannonia*.
 Murphy, H. P., *Ortega*.
 Murphy, J., *Mantaro*.
 Murphy, W. F., *Takada*.
 Murray, T. W., *Ardeola*.
 Muschamp, T., *Briton*.
 Myron, G., unattached.
 Nailer, E. I. F., *Borderer*.
 Nash, R. H., *Cornishman*.
 Needs, W. A., *Nellore*.
 Nelson, C. H., *Winfredian*.
 Nethercoate, J. K., unattached.
 Newby, F. W., *Parana*.
 Newman, W., *Highland Watch*.
 News, L. S., *Canning*.
 Nicholas, W. G., *Columbia*.
 Nicholls, G. J. G., *Huntsman*.
 Nicholson, A., *Erinpora*.
 Nicholson, J., *Colonian*.
 Nightingale, F., *Bandra*.
 Nixon, C. S. C., *Dewa*.
 Nolan, J. J., *San Hilario*.
 Noble, H., *Palma*.
 Norwood, P. R., *Warwickshire*.
 Nowlan, C. F., unattached.
 Obey, W. C., *Runic*.
 O'Brien, G. W., *Marers*.
 O'Carroll, M. E., *Cassandra*.
 O'Connor, A. W., sick leave.
 O'Connor, J., *Iroquois*.
 O'Connor, P., *Principello*.
 O'Connor, P. J., *Ionian*.
 O'Connor, T., *Montfort*.
 O'Donnell, T. J., *Laurentic*.
 O'Halloran, T., *Californian*.
 O'Koeffe, P., *Kumara*.
 Oliver, F. G., unattached.
 Oliver, C. A., on leave.
 Oliver, H., *Arcadia*.
 O'Riordan, T., *Marengo*.
 Osborne, A. J., unattached.
 Osborne, A. E., *Sutherland Grange*.
 Osborne, J. Edward, *Cluny Castle*.
 Osborne, J. Edwin, *Ruapehu*.
 Osborne, R. F., *Orotava*.
 O'Sullivan, C. F., *Turcoman*.
 O'Sullivan, D., *Mount Temple*.
 O'Sullivan, J. P., unattached.
 Overall, E., *Marquette*.
 Owen, A. W., *Dakar*.
 Owen, R. M., *Carpentaria*.
 Owen, W., *Aaro*.
 Owen, L. L., *El Toro*.
 Packer, R. H., *S. Y. Iolanda*.
 Palmer, H. M., *Pakeha*.
 Pannett, W. E., *Menominee*.
 Parker, C. T., *Dover Castle*.
 Parker, E. P., unattached.
 Parkinson, W., *Kathamba*.
 Patrick, R. V., *Kildonan Castle*.
 Payne, J. H., *Peashawur*.
 Payne, T. A., *Arcadian*.
 Pearson, D. E., *Huasco*.
 Peever, F., *Tropic*.
 Penketh, G., *Cardiganshire*.
 Pennington, C. J., *Star of Victoria*.
 Penrose, H. E., *Trent*.
 Pepper, G. H., *Llanstephen Castle*.
 Perfect, A. E., *Inanda*.
 Perkins, H. J., *Palena*.
 Perkins, C. W., *Leicestershire*.
 Perlman, A., *Blamfontain*.
 Peterson, T. G., on leave.
 Pettingill, W., *Orava*.
 Phelan, N. J., *Orita*.
 Pink, Alfred, *City of York*.
 Pitchford, G. R. J. W., *City of Benares*.
 Pitkeathly, W., *Michigan (Red Star)*.
 Planterose, E. A., *Arabia*.
 Pollard, F. G., *Arlanza*.
 Ponsford, W. H., *Turakina*.
 Pope, H. W., *Crown Point*.
 Potts, A. S., *Cufic*.
 Potts, J. W., *Tomaswanda*.
 Power, W., *Cretic*.
 Preece, E., *Surat*.
 Preston, M. A., *California (P.S.N.)*.
 Proughton, A. J., *Acania*.
 Quinlan, J. F., *Orcoma*.
 Bailton, N., *Teutonic*.
 Ralphs, P. L., *San Isidoro*.
 Rapsey, C., *Patia*.
 Ratcliffe, L. G., *City of Calcutta*.
 Ratcliffe, T. C., *Avon*.
 Rattee, S. G., *Merion*.
 Raw, W., *Osterley*.
 Rawthorne, W., *Mechanician*.
 Rea, J., *Aracataca*.
 Redgate, H. J., *Kumara*.
 Reid, H. S., *Highland Loch*.
 Reid, S., *Haverford*.
 Reid, W. H. W., *Benalla*.
 Renshaw, P. J., *Ullonia*.
 Renshaw, R. W., *Lusitania*.
 Renwick, W. D. R., *Highland Heather*.
 Revell, J. L., *Dunluce Castle*.
 Reynolds, A. J., unattached.
 Reynolds, F. W. J., *Grantully Castle*.
 Rhodes, T., *Goorkha*.
 Ricci, R. E., *Tainui*.
 Rice, H. W., *Carmania*.
 Rice, P. F., *Indrabarrak*.
 Ridley, J. M., *Vitruvia*.
 Rivett, F. W., *City of Edinburgh*.
 Robb, T., *Toronto*.
 Roberts, D., *Laconia*.
 Roberts, G., *Virginian*.
 Roberts, M., *North Point*.
 Robertson, C., *Remuera*.
 Robertson, D., *Cardiganshire*.
 Robertson, J. K., *Sachem*.
 Robinson, F. V., *Highland Piper*.
 Robinson, L., *Glenetive*.
 Robinson, S., *Suveric*.
 Robson, E. W., *Cameronia*.
 Roden, C., *Walmer Castle*.
 Rodway, J. C., sick leave.
 Rookes, C. E., *Turcoman*.
 Rosney, P. J., *Drina*.
 Ross, W. M., *Pretorian*.
 Rowdon, W. A., *Dominion*.
 Rowlands, H., leave.
 Rowlatt, F. W., *Hilary*.
 Rundle, E. H., *Kumeric*.
 Rushforth, A., *Potosi*.
 Russ, E., *Cretic*.
 Rushton, F., *Carpathia*.
 Rushworth, F. B., *Sicilian*.
 Ryan, J., *Agadir*.
 Ryan, V. A., *Manhattan*.
 Ryan, W. C., *Montreal*.
 Salmon, J. B., *Highland Glen*.
 Salmon, J. L., *Empress of Russia*.
 Salter, T. H., *Asian*.
 Salway, R. L., *Minneowaska*.
 Sanders, C. T., *Arcadian*.
 Sanderson, L. T. N., *Somali*.
 Sandham, T. D., *Nyanza*.
 Sandon, W. E., *Star of India*.
 Sang, H. K., unattached.
 Saril, S. R., *Circassia*.
 Sayer, H. T., leave.
 Scales, C. W., *Atlantian*.
 Schanch, H. S., *Crofton Hall*.
 Schofield, A., *Guatemala*.
 Scott, M., unattached.
 Scott, R. C., on leave.
 Scully, E., *Napakoe*.
 Searl, C., *Empress of Asia*.
 Sedding, N., *Elmina*.
 Seddon, W., *Ingoma*.
 Seeney, H. W., *Berbice*.
 Sellars, G. H., *Caledonia (P. & O.)*.
 Sequeira, H. C., *Malda*.
 Sharp, E. W., *Angora*.
 Sharpe, C. H., *Ascania*.
 Sharpe, F., *West Point*.
 Sharpe, W. H., *Amazon*.
 Sharples, E., *Katuna*.
 Shatwell, E., *Dover Castle*.
 Shaw, A. H. H., *Armenian*.
 Shore, R. M., *Ozonian*.
 Shrimpton, E. T., on leave.
 Silvester, W. H., *Hull Trawler*.
 Simmons, H. F., *Pachitea*.
 Simmons, J. M., *Victoria*.
 Simpson, J. C., unattached.
 Simpson, T. A., *Orissa*.
 Sims, W. B., *Somali*.
 Sinclair, D. H., *Herbert G. Wylie*.
 Single, G., *Darro*.
 Skinner, J. S., *Andes*.
 Slater, F., *Iberian*.
 Sloggett, S. D., unattached.
 Smith, A. C., *Antillian*.
 Smith, A. F., *Intaba*.
 Smith, D. A., *Highland Heather*.
 Smith, F. J., *Oriana*.
 Smith, F. J. D., *Michigan (Red Star)*.
 Smith, H. F., *Ionic*.
 Smith, H. S., *Oruba*.
 Smith, L. J. G., *Arlanza*.
 Smith, P. S., *Celtic*.
 Smith, W., *Salmo*.
 Smith, W. H., *Inkosi*.
 Smythe, G. W., *Gascon*.
 Snow, H. C., *Christopher*.
 Snow, W. E., *Hyacinthus*.
 Snowden, H., *Kingstonian*.
 Soans, R. T., *Ionian*.
 Soar, R. A., *Dongola*.
 Solway, H. E., *Stephano*.
 Sotheran, A. W., *Banca*.
 Southam, B. W., *Otway*.
 Spence, R. S., *Devonian*.
 Spicer, S. W., unattached.
 Spiers, J., *San Ricardo*.
 Sproat, D. M., *City of Marseilles*.
 Sproat, H., *Mexico*.
 Spurgeon, W. P., *Geelong*.
 Standen, T. F., *Plasy*.
 Stanley, H. J., *Nore*.
 Stannard, C. E., *City of Norwich*.
 Stansbridge, S., *Adriatic*.
 Stansfeld, B. R., *Miltiades*.
 Starkey, J., *Kinfauns Castle*.
 Stephen, A. K., *Gascon*.
 Stephenson, J. A., *Highland Hope*.
 Stevenson, A., *Gaika*.
 Stevenson, P., *Niscaru*.
 Stevenson, J. L., *Hatumet*.
 Steward, E. H., *Victorian (Leyland)*.

Stewart, L. C., *Tunisian*.
 Stickland, A. G., *Murisi*.
 St. John, H. W., *Noosa*.
 Stocker, A., Canadian Cruiser *Margaret*.
 Stone, J. B., *Olympic*.
 Strong, R., *Walton Hall*.
 Stubbs, T. H., on leave.
 Studholme, J. J., *Patrician*.
 Sturdy, H., *Panama*.
 Styles, A. C., on leave.
 Summerlin, S. C., S.Y. *Alberta*.
 Summers, E. B., *Calabria*.
 Sutherland, D., unattached.
 Sutherland, W. G., *Herefordshire*.
 Sweetnam, R., *Delta*.
 Syme, W. A., *Orvieto*.
 Tamplin, L. H., *Danube*.
 Taylor, A., *Corsican*.
 Taylor, A., *Chignecto*.
 Taylor, A. W., *Cestrian*.
 Taylor, G. R. W., *Arzila*.
 Taylor, H. W., *San Lorenzo*.
 Taylor, R. F., *Seal*.
 Taylor, W., *Osiris*.
 Taylor, Wilfred, *Stonian*.
 Teahon, S., *Minneapolis*.
 Terranceau, E. G., *Norshana*.
 Thomas, G., *Cambrian*.
 Thomas, G. H., *Edward L. Doheny*.
 Thomas, H., *Itatinga*.
 Thomas, W., unattached.
 Thomas, W. H., *Musician*.
 Thomasson, F., *Franconia*.
 Thomasson, H., *Orotava*.
 Thompson, A., *Cevic*.
 Thompson, A. J., *Minnewaska*.
 Thompson, A. T., sick leave.
 Thompson, W. J., *Devanka*.
 Thomson, F. A., *Highland Scot*.
 Thomson, G., *Salastia*.
 Thomson, J., *Highland Watch*.
 Thomson, J. B., *Haverford*.
 Thomson, R., *Carthaginian*.
 Thorn, W. J., on leave.
 Thornton, J., *La Blanca*.
 Threlkeld, T. G., *Worcestershire*.
 Tilford, G. L., *Perugia*.

Timperley, J. H., *Kelvinia*.
 Tunbridge, A. O., *Galway Castle*.
 Turner, G. E., *Gloucester Castle*.
 Turner, J., *Salamis*.
 Tyler, G. E., *Sagamore*.
 Tyler, W. E., *Antony*.
 Underwood, H. G., *Karonga*.
 Utting, R. T., *Tongariro*.
 Veale, R., unattached.
 Vick, F. B. V., *Omrah*.
 Vincent, J., *Malta*.
 Vincent, L. B., *Bellana*.
 Waddoup, J. B., *Cameronia*.
 Wainwright, A. C. L., *Baron Erskine*.
 Wakeling, G. P., *Blyzia*.
 Walker, H. B., *Orduna*.
 Walker, S. R., *East Point*.
 Walker, T. R., *Anchises*.
 Wall, D. G., *Kenilworth Castle*.
 Wallace, W. W., *Roseric*.
 Wallworth, W. A., *Cedric*.
 Walsh, L., *Rappahannock*.
 Walsh, S. B., unattached.
 Ward, A., *Highland Harris*.
 Ward, H., *Galway Castle*.
 Ward, J. N., *Ceramic*.
 Warner, E. L., *Palaba*.
 Warner, N. B., *Georgian*.
 Warren, H. G., on leave.
 Wasley, J. G., *Eagle Point*.
 Waterworth, A., *Principello*.
 Watkins, L., *Lake Manitoba*.
 Watkinson, E. A., *Kenilworth Castle*.
 Watson, G. H., *Athenia*.
 Watts, B. O., *Aragon*.
 Webb, C. B. N., *Lancastrian*.
 Webb, W. A., unattached.
 Weller, C. A., *Ruakina*.
 Weller, E. S., *City of Delhi*.
 Wellington, C., *Antillian*.
 Weselby, A., *Kabings*.
 Wheeler, N. B. W. M., *Oceanic*.
 Whitaker, C. H., *Mendi*.
 Whitaker, H. A., *City of Madras*.
 White, A. G., *Kioto*.
 White, V., *Oruba*.
 Wickers, H. M., *Itacuera*.
 Wignall, R. M., *Orcoma*.

Wilcocks, A. E., unattached.
 Wilkins, A., *Hildebrand*.
 Wilkins, J., *Celtic*.
 Wilkings, D. A., *Maloja*.
 Wilkinson, E., *Atlantian*.
 Willett, F. W., *Kasembe*.
 Williams, A. C., *Orontes*.
 Williams, F. A., unattached.
 Williams, D. F., *Tagua*.
 Williams, G. H., *Royal Edward*.
 Williams, G. V., *Digby*.
 Williams, J., *Changuinola*.
 Williams, J. R. T., *Tokomaru*.
 Williams, J. T., *Deonian*.
 Williams, J. T., *Clement*.
 Williams, T. D., *Milwaukee*.
 Wills, H. C., *Malwa*.
 Wilson, H. O., *Limari*.
 Wilson, N. J., *Athenia*.
 Wingrave, D. W., *Ballantia*.
 Winsor, F., *Cocoonada*.
 Wood, C. B., *Aysen*.
 Wood, C. E., *C.S. Restorer*.
 Wood, D., *Columbian*.
 Wood, T. A., *Oslo*.
 Woodhouse, W. A., *Norseman*.
 Woods, F., *Swanmore*.
 Woods, L. J., *Oronsa*.
 Woodward, J. E., *Comanche*.
 Woolam, M. W., *Manchester City*.
 Woolley, L., *Kinfauns Castle*.
 Woolway, C. J., *Statesman*.
 Wright, E., *Brodstone*.
 Wright, F. M., *Menominee*.
 Wright, G. J., *Llandoverly Castle*.
 Wright, T. G., *Edavana*.
 Wroughton, E. N. M., *Marathon*.
 Wyard, L., *Oriana*.
 Wyatt, F. C., *Kenuta*.
 Wyatt, R. C., *Borneo*.
 Wyatt, A. W., *Mooltan*.
 Yates, A. L., *German*.
 Yelding, A. T., *Kafue*.
 Yelland, W. P., *Sunda*.
 Yorston, J. F., *Deseado*.
 Young, F. E., *Empress of Russia*.
 Young, J., *Galicia*.

Resignations

Breen, L., February 12th.
 Coster, E. J., February 28th.
 Cox, H., March 11th.
 Downes, C. N., March 14th.

Harrop, W. S., February 28th.
 Hunter, C. J., March 5th.
 Rawlins, A. S., March 3rd.
 Rockey, J. H., March 14th.

Rumbold, B. O., March 14th.
 Westlake, H. M., February 12th.

Additions to Operating Staff

Adams, G. E., February 17th.
 Bloxham, A. I. W. H., February 10th.
 Boylan, J. A., February 13th.
 Bryan, H. F. B., February 9th.
 Cauvin, M. A. J., February 26th.
 Cook, E. J., February 16th.
 Cross, S. R., February 9th.
 Daly, R. H., March 3rd.
 Fitton, F., February 9th.
 Fowler, W., February 9th.
 Gregson, E. A., February 18th.
 Harris, A. J., February 9th.
 Hawkes, G. E., February 18th.
 Hughes, W. J., February 9th.

Hunter, A. E., March 11th.
 Kelly, C., March 2nd.
 Lacock, T. J., February 9th.
 Lewington, W. H., February 19th.
 Lewis, W. T., February 27th.
 Lynch, G., February 27th.
 Makin, E. A., February 27th.
 May, A. H., February 26th.
 McCarthy, C. M. M., March 3rd.
 McCormack, M., February 27th.
 Morrison, J. D., February 9th.
 Newby, F. W., March 4th.
 Nicholas, W. G., February 18th.
 O'Connor, P. J., March 3rd.

Reid, S., February 27th.
 Robson, E. W., February 9th.
 Ross, W. M., February 9th.
 Russ, E., February 9th.
 Ryan, J., March 4th.
 Simpson, J. C., March 4th.
 Simpson, T. A., February 27th.
 Single, G., February 27th.
 Smith, F. J. D., February 26th.
 Stevenson, A., March 7th.
 Walker, R. S., March 11th.
 Webb, W. A., February 27th.
 Williams, F. A., February 27th.

Marconi Orchestral Society.

Band Contest.

To parody an ancient saying "Press and the Printer wait for no man," so it was impossible to include in last month's magazine a report of the concert which took place on February 21st. It was an important event, for the first of the annual contests between the orchestras of the Marconi Works, Chelmsford, and Marconi House, London, for a silver cup took place. The cup was presented by the Directors of the Marconi Co., and is a very beautiful specimen of the silversmith's art.

Great preparations had been made for the concert; the Lecture Hall had to be transformed into bandstand and auditorium, under the able supervision of Mr. Capellaire. The stage which was

White showed himself a clever and sympathetic conductor. He had the best of all gifts for his purpose, enthusiasm, and he inspired this quality into his players, so that any errors of technique which might be detected were compensated for in the vigorous and crisp interpretation of the music. Naturally enough, such qualities were seen to their best effect in the chorus, which evoked well-merited applause.

The Works Orchestra, under Mr. Ham, made an excellent impression by their version of the same music. It is marvellous to think of the variety of readings which may be drawn from the same notation, and the contrast between the playing of the two orchestras was very marked. Mr. Ham conducted at a much slower rate, thereby losing something of Mr. White's vitality, but as a compen-



THE MARCONI ORCHESTRAL SOCIETY.

Left to right (seated)—R. French ('Cello), J. Lewis (1st Violin), H. F. White (Conductor), A. S. Free (1st Violin), C. Haviland (2nd Violin), C. Marsh ('Cello); (standing) E. Hughes (Vocalist), F. E. Curnow (Pianist), R. D. C. Bailey (Drums), D. Bisset (Cornet), W. R. Cross, W. G. Baker (Cornet), A. Cappelaere (Stage Manager), E. A. Cummins (2nd Violin), H. Thomas (2nd Violin), E. Pilley (Vocalist), W. J. Everett (2nd Violin).

erected could comfortably accommodate the 44 members of the two orchestras which were to take part in the contest. The decorations were effective, a judicious use being made of laurel, while a golden harp marked with the initials of the Marconi Musical Society was included in the scheme.

It had been hoped that Mrs. Godfrey Isaacs, who had selected the test pieces, would act as judge, but unavoidable absence prevented her, and her place was taken by Mrs. Harmsworth, Mrs. Burton and Mr. Cameron, who sat with Mr. Godfrey Isaacs and Capt. Sankey behind a small table bearing the coveted trophy. The music to be played was taken from "Faust" and included the "Waltz," "Jewel Song" and the "Soldiers Chorus." The Marconi House Band opened the contest, and Mr. Frank H.

sating quality he brought out the full tone and the splendid orchestration and contrapuntal characteristics of the composer, while some of the crescendo passages were splendidly manipulated, and the climax was really beautiful.

After a short interval the second test pieces were played, but these were chosen by the competing bands themselves, and in the case of Marconi House band at least, it showed distinctly to their advantage. This excellent orchestra gave incidental music from "Monsieur Beaucaire," and whoever was responsible for choosing these pieces showed admirable judgment, which in a matter of this kind is half the battle. The music was sparkling and the effect on the audience was electric.

The Chelmsford orchestra replied with the over-

ture from "La Diademe" which tends more to the noisy side, but which brought out a good point of resourceful management and breadth of style; this also was well received, and the task was a difficult one for the judges.

While the momentous decision was being reached a short dramatic sketch entitled "Lights Out" was given by some members of the Marconi Musical Society. It was a dismally comic sketch of a poor unfortunate, who, smitten by the shafts of the Blind God, had proposed in the dark and knew not to whom. His part was well taken by Mr. Smart, while Mr. "Brandsby Williams," as his friend, with a *penchant* for a practical joke, gave him excellent support. Miss Atkins and Miss Dumas and a third lady of uncertain age, with a habit of rolling her eyes and a strong desire to remain *incognito*, ably played the feminine parts.

The remainder of the programme had considerably to be curtailed on account of time, but Mr. Edwards, from Chelmsford, gave an excellent recital; Mr. Tenning, a violin solo; and Mr. Hughes, a song. The concert ended with the massed bands playing "Nights of Gladness," Mr. White conducting.

This concluded, Mr. Isaacs rose to announce the decision of the judges in the musical contest. He expressed the kindest appreciation of the entertainment, explaining that the judges had attentively listened, had carefully considered the rival performers, and without fear or favour had come to the decision that the cup should be given to—he spoke the words carefully and deliberately, so that expectation stood a-tiptoe—Mr. White and the Marconi House orchestra. The announcement was received with vociferous applause, which testified that the decision was generally acceptable, though all present were bound to acknowledge that the contest had been exceptionally close.

When the applause had ceased, Mr. Mitchell, the manager of the Chelmsford Works, made an excellent speech, referring in generous terms to the House success, and expressing the desire that Chelmsford would meet London in many other competitions besides that of music, and promised that if matters could be arranged he would give something to back a sporting contest.

Marconi House Notes.

Football.

We regret to record that on Saturday, March 7th, a match was played which decided once and for all the chances of the Marconi team in the League competition. There is no longer any possibility of their being first in the contest, for they were beaten by the Oratory Brigade in an unequal contest by five goals to one. Better luck next year!

Rugby Football.

On Saturday, February 14th, a team from the Clifden Marconi Station played a match against the Galway University team at the Grammar School grounds. As the former were short of some players, they had to recruit from local clubs, hence the match was more or less a mixed one. Clifden forced matters with the 'Varsity, and on two occasions should have scored, Duffy being on the line when tackled. There was no score at the interval. Before the close D. Grant scored the only try of the game for Clifden, the kick for goal failing.

Cricket.

Enthusiasm in this section is increased tenfold by the generous promise of Mr. H. S. Saunders to

present a cup to the best all-round cricketer of the 1914 season. Batting, bowling, fielding and attendance will all be taken into consideration, and the Cricket Committee are at present drawing out a scheme for the awarding of points, so that a fair result can be arrived at.

Tennis.

Major Flood Page, Mr. Alfonso Marconi, and Mr. Geoghegan have very kindly promised to give a shield to the Tennis Section for annual competition between teams representing various departments of the Marconi and associated companies, these to include the Chelmsford works. The regulations for the competition will shortly be issued and "whips" are already busy in the various departments.

Literary and Debating Society.

On February 26th one of the most interesting debates of the season was held, with Captain Sankey in the chair. The subject was "Has Education increased human happiness?" Mr. Idden answered for the affirmative and made heavy demands on a natural optimism to support his argument. Mr. Ward argued the negative.

On March 12th the question discussed was "Is the increasing disregard for authority in the rising generation fraught with danger to the State?" Mr. H. W. Allen was in the chair. Mr. G. Green opened the discussion with a thoughtful, suggestive speech. A long and interesting debate followed.

Chess and Draughts Club.

A club to bear the above title, which sufficiently states its *raison d'être*, is in course of formation; but it is only in its initial stage. When further particulars are forthcoming they will be duly published.

Billiards.

Two billiard matches were recently played between members of the Staff of the Marconi Station, Clifden, Ireland, and members of the Clifden Town Hall Staff, the following being the scores:—

Played at Clifden Town Hall.

Marconi Team.		Clifden Town Hall Team.	
R. J. Henry	... 250	J. Hehir	... 177
H. J. Belcher	... 250	M. O'Connor	... 138
J. H. Norris	... 250	E. D. Moran	... 178
C. Rogers	... 195	H. Doyle...	... 250
P. H. Pettyfer	... 250	T. Joyce...	... 232
T. Webb	... 250	E. J. King	... 248
	1,445		1,223

Return played at Marconi Station.

Marconi Team.		Clifden Town Hall Team.	
R. J. Henry	... 250	J. Hehir	... 94
H. J. Belcher	... 250	M. O'Connor	... 129
C. H. Norris	... 250	E. D. Moran	... 236
J. Rogers	... 160	H. Doyle...	... 250
P. H. Pettyfer	... 250	T. Joyce...	... 241
T. Webb	... 250	E. J. King	... 192
	1,410		1,142

ADVERTISER (30) desires to take up Wireless Telegraphy as a profession; has considerable practical knowledge as an experimenter; could manage, control hands, or would travel, home or abroad. Box 1414, The WIRELESS WORLD, Marconi House, Strand, W.C.

BOOKS on Wireless Telegraphy, also all other Subjects: Secondhand at Half Prices, New 25% Discount, Catalogues Free. State Wants. Books sent on Approval. Books Bought. W. & G. FOYLE, 121-123 Charing Cross Road, London.