

# The WIRELESS & GRAMOPHONE TRADER

Incorporating "The WIRELESS and ALLIED TRADES REVIEW" "The RADIO TRADE JOURNAL" and "The WIRELESS DEALER"

VOL. XXIII. (NEW SERIES) No. 308.

July 12th, 1930.

8/- PER ANNUM, POST FREE.  
SINGLE COPIES 1/- EACH.

## DEMONSTRATE

### The Madrigal is its own Salesman

If a Madrigal receiver could use its own legs to get to the homes of people who don't like wireless in your neighbourhood; if it could demonstrate its marvellous melody, it would bring you more summer business than you've ever had before.

If YOU don't think it's 'different' to other sets—just listen to the Madrigal yourself and demonstrate for business' sake.

If you want us to help you to demonstrate, just send us a card.



Patent No. 317566

**THE MADRIGAL;** transportable anywhere in the home, verandah or garden, wherever there is an electric plug handy.

**NO AERIAL, NO EARTH** is needed for home station reception—therefore Madrigal is ideal for flat dwellers.

**GENEROUS TERMS** are available to back up your demonstration and make sales still easier.

Write for particulars and a supply of the Madrigal leaflets beautifully illustrated in full colours.



"Madrigal" Works,  
Purley Way,  
Croydon.

## AND IT'S SOLD!

# GREATER EFFICIENCY ON LESS CURRENT

**T**HERE is no valve being manufactured in Europe to-day that can show such wonderful characteristics in conjunction with great economy of current consumption as the Triotron Super Detector S.D.2.

➔ **SLOPE 1.7 mA/V**  
**MAG. FACTOR 21** ➔  
**FIL. CURRENT 0.14** ➔

The detector valve is the most important factor in long distance reception and the Triotron S.D.2 is the best detector that money can buy. No other factory in Europe has succeeded in achieving such a combination of steep slope, high magnification factor, and low current consumption.

Next time you are asked by your customers how they can improve the range of their sets advise them to use a Triotron S.D.2 in the detector stage and the results will delight them.

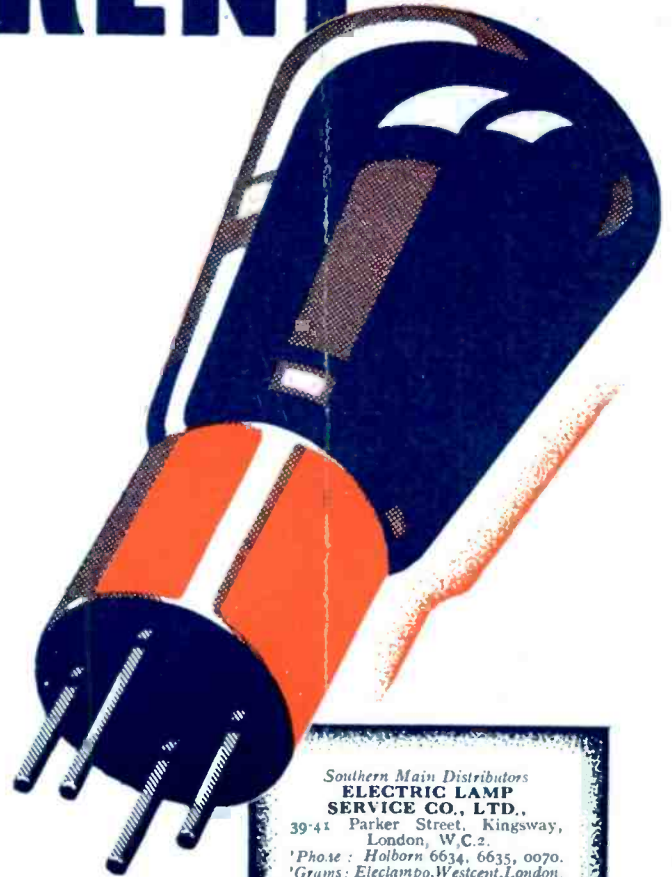

**TRIOTRON**  
THE ACE OF VALVES

Southern Main Distributors  
**ELECTRIC LAMP  
SERVICE CO., LTD.**  
39-41 Parker Street, Kingsway,  
London, W.C.2.  
Phone: Holborn 6634, 6635, 0070.  
Grams: Eleclampo, Westcent, London.

Northern Mains Distributors  
**CHORLTON METAL Co. Ltd.**  
18 Amber St., Shudehill, Manchester.  
Phone: Manchester Blackfriars 7637  
(Pl. Br. Ex.)  
Grams: Chorlnel, Manchester.

Main Distributors for Northern  
Ireland: Messrs. Sloan & Company,  
7, Corporation Street, Belfast.  
Telephone: Belfast 3020.

Main Distributors for Irish Free  
State: The Briscoe Importing Co.,  
Ltd., 9, Aston's Quay, Dublin.  
Telephone: Dublin 1351.

**TRIOTRON RADIO Co., Ltd.**  
91, Gt. Russell St., London, W.C.1.  
Phone: Museum 1908. Grams:  
Radiunited, Westcent, London. (Techni-  
cal & Overseas enquiries should be  
sent exclusively to the above address.)

# Do Justice

## to your customers' Batteries

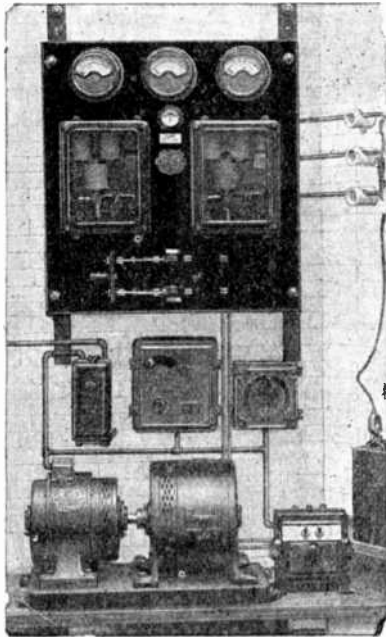

### NO HEAVY CASH OUTLAY

is necessary to secure Charging Apparatus. A simple deferred payment arrangement between you and us, enables equipment to be delivered without any security other than :: the plant supplied ::

—and to your own pocket by installing an

## EFFICIENT BATTERY CHARGING PLANT

Battery Charging should be a very valuable asset to any business. Make sure it is so to yours! If your plant is old-fashioned you are not fair either to your customers or to yourself. Let us show you the way to bigger profits. Our extensive range of apparatus, backed by a staff of specialists, enable us to offer you the equipment best suited to your particular requirements.

### A typical example of the PROFITS TO BE EARNED

CRYPTO TYPE B.3 .A.C. CHARGER (Constant Potential). Output: 8 and 16 volts 200 amps.

**PRICE £95 : 4 : 0 Nett Trade**  
or £23:16:0 down & 6 Monthly Instalments of £12:4:0

Will handle 1,000 2-volt cells per week (week taken as 72 hours. Calculate average capacity 30 act. A.H.)

Cost of charging at 3d. per unit     £2 7 0  
Income at 6d per cell     ..     £25 0 0

### WE SPECIALIZE IN CHARGING EQUIPMENT

—Let us tackle your problems—

Branches :  
Aberdeen, Belfast,  
Birmingham, Bristol,  
Cardiff, Dublin, Dundee,  
Glasgow, Leeds.

# Brown Brothers Limited

—Allied Companies—

THOMSON & BROWN BROTHERS Ltd.  
BROWN BROTHERS (Ireland) Ltd.

Wholesale only—Head Offices and Warehouses :  
GREAT EASTERN STREET, LONDON, E.C.2  
126 GEORGE STREET, EDINBURGH.

Branches :  
London (West End),  
14-15 Upper Marylebone  
Street, W.1 ; Manchester,  
Newcastle & Southampton

# SELL THESE SETS

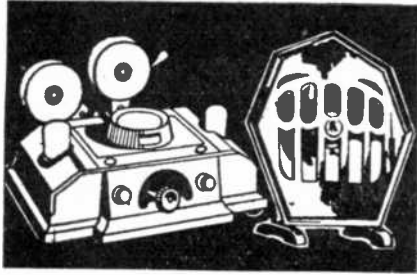

BROWNIE 2-VALVER

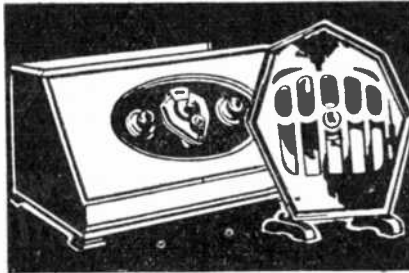

BROWNIE DOMINION 3

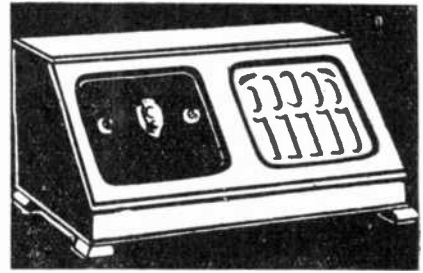

BROWNIE DOMINION CONSOLE

# AT THESE PRICES

**11'6** DOWN

**19'6** DOWN

**22'6** DOWN

Here's Brownie's tonic for summer sales—Deferred Payments. Not only does it make selling as easy as ABC—your customer can take a set home for only a fraction of the cash price—but you make an immediate *cash* profit on the sale. Let Brownie prove to you that genuine value is proof against seasonal trade depression — **DISPLAY AND DEMONSTRATE THESE SETS TO-DAY.**

**BROWNIE 2-VALVER.** Complete with speaker and all accessories, ready for listening-in. Royalty paid.

Cash Price £6 10. DEFERRED PAYMENTS

**11/6**

down

**BROWNIE DOMINION 3.** Complete with speaker and all accessories, ready for listening-in. Royalty paid.

Cash Price £10 15. DEFERRED PAYMENTS

**19/-**

down

**BROWNIE DOMINION CONSOLE.**

Complete with built-in speaker and all accessories, ready for listening-in. Royalty paid.

Cash Price £12 12. DEFERRED PAYMENTS

**22/-**

down

# BROWNIE

Send for striking window bill in colours to:

**BROWNIE WIRELESS CO. (G.B.) Ltd., Nelson Street Works, LONDON, N.W.1**

# The Radio you've waited for

*The new*  
**PICNIC  
 FIVE VALVE  
 PORTABLE**

The Edison Bell new Picnic Five is the same size as the previous model, but designed to meet the requirements occasioned by the change of wavelengths. It is selective and is fitted with an ultra low wave switch, giving an over-all range of 190-500 on the Low and 1,000-2,000 on the High.

The Set with the Ultra Low Wave Switch, in red, green, and blue, all gilt fittings, £17 17s. including Royalties.

A waterproof cover to protect the set when travelling can be supplied for 10/6 extra.

Send for Special Folder.

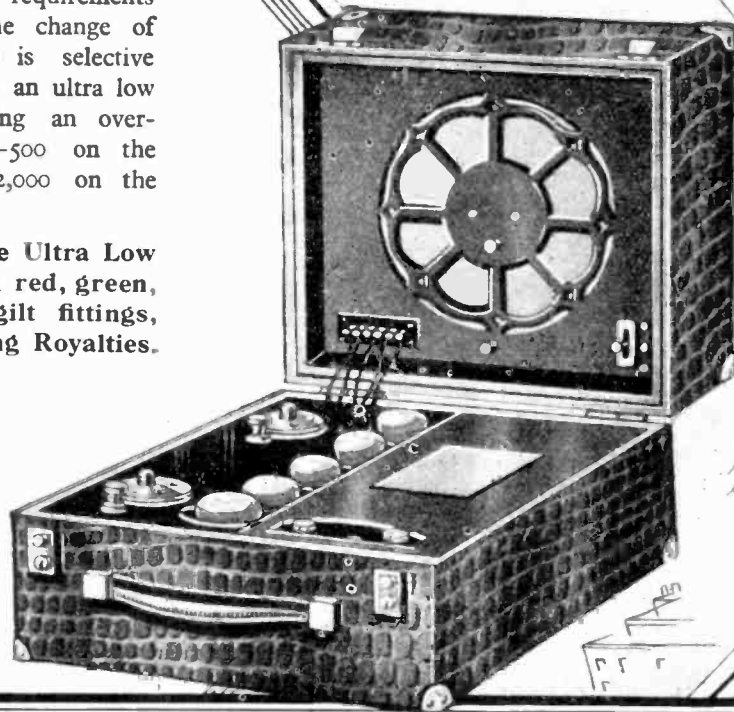

**EDISON BELL**  
**TRADE MARK**

EDISON BELL, LIMITED,

62, Glen gall Road, LONDON, S.E.15.

# The AEONIC

# ACCUMULATOR CHARGING BOARD

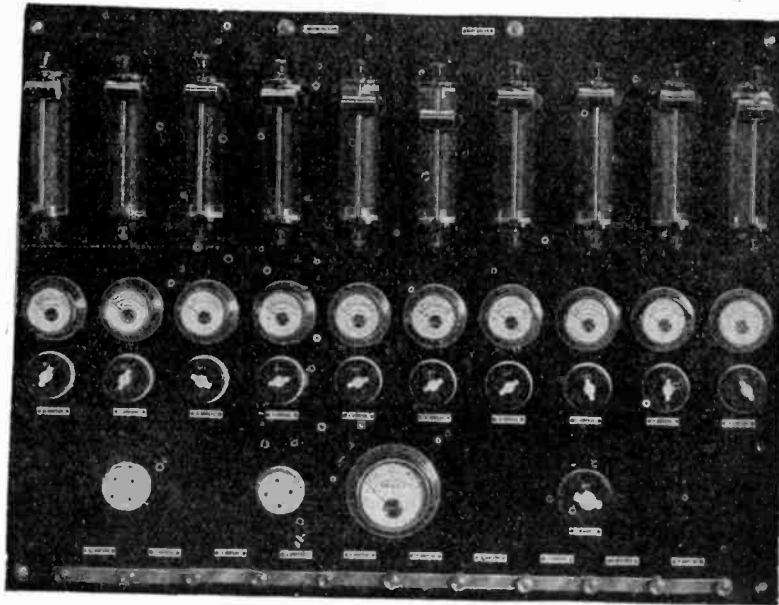

QUOTATIONS SENT FOR COMPLETE INSTALLATIONS FOR A.C. SUPPLY

SEND US YOUR ENQUIRIES

EVERYTHING ELECTRICAL

1 TO 10 AMPS  
50 . 100 . 250 V.  
D.C.

LIST PRICE  
**£24-0-0**

CAN BE SUPPLIED ON H.P. TERMS IN 12 MONTHLY INSTALLMENTS

### SPECIFICATION

Enamelled Slate Panel 27" x 36" x 1", mounted with 1 D.P. Main Terminal, 10 Sliding Resistances, 10 2 1/2" Moving Iron Circuit Ammeters, 10 Circuit Switches, 1 3 1/2" Moving Iron spring controlled Main Ammeter, 1 D.P. Main Switch and Fuses, 1 complete set of Circuit Terminals and Copper Links, complete with all back connections, small wiring, and Ivorine labels.

## THE FAMOUS SCREEN GRID IV



The 1930 Model of this famous set has been entirely re-designed, and is now the most up-to-date set on the market. It is constructed for either Mains or Battery use, and the Mains Unit, comprising H.T., G.B., and L.T. fits exactly into the Battery Compartment in place of the G.B. and H.T. Batteries.

Complete in brown hide Case, it forms a very handsome Set, with exceptionally good selectivity and tonal quality.

### PRICES

BATTERY MODEL - 19 GNS.  
MAINS MODEL  
A.C. or D.C. 26 GNS.

WE ARE NOW IN A POSITION TO SUPPLY AERIAL WIRE EITHER 7/22 OR 7/23

PRICES SENT ON APPLICATION

### BATTERIES

H.T.	108 v	-	-	-	-	13 . 6
	99 v	-	-	-	-	12 . 6
	66 v	-	-	-	-	8 . 3
G.B.	9 v	-	-	-	-	1 . 9

**AEONIC RADIO LTD., HORLEY, SURREY.**

Telephone : HORLEY 400

Telegrams : AMMETER, HORLEY

# GRAMOPHONES AND RADIO ALL ON ONE ACCOUNT

Many friends tell us . . .

that they consider it one of the greatest virtues of 'Poly' Service that it offers gramophones and radio goods all on one account. "So much easier"—"better in every way" they say.

Have you considered the great advantages 'Poly' Service offers you? Speed—for which our name is famous. Complete delivery—not merely half your order executed—and gramophones and radio goods all on one account.

May we send you our 300 page illustrated catalogue? You will see from it that we handle everything that matters in gramophones and radio.

DULCETTO - POLYPHON LIMITED.  
LONDON: 2-3 Newman Street, W.1.  
MANCHESTER: 31 Quay Street.  
GLASGOW: 27 Jamaica Street.

## ANNOUNCEMENT

The new season's range of Dulcetto Gramophones and Electric Amplifiers will shortly be ready, and the next issue of the "Wireless Trader" will contain advance trade information. Be sure to see it—and to ask our representative when he calls to let you examine the actual instruments.

We are also the largest wholesale distributors in Britain for COLUMBIA, PARLOPHONE, ZONOPHONE, REGAL, EDISON BELL, WINNER and RADIO Records and Accessories.

And can supply EVERY RADIO SET, VALVE, BATTERY, COMPONENT, ETC., that matters.



# DULCETTO POLYPHON LTD

# The Vital Link—

## CAV

## H.T. Radio Accumulators



*Price of 10-volt units:—*

M.101	2,500 milliamps	5/-
M.103	5,000 milliamps	6/3
M.105	10,000 milliamps	12/-

*Price of 30-volt groups  
with trays:—*

M.301	2,500 milliamps	18/9
M.303	5,000 milliamps	23/3
M.305	10,000 milliamps	42/-

The inability of an H.T. Battery to provide smooth, unstinted current will mar the performance of the most perfect radio receiver.

No other form of H.T. current supply equals the C.A.V. H.T. Accumulator. The demands of the small set and the multi-valve set are satisfied with equal ease. Current is delivered smoothly, constantly, without a ripple or a crackle to disturb the perfection of the broadcast.

It costs a few pence for recharging three or four times a year, and because of its long life proves not only the most efficient, but also the cheapest form of H.T. current available.

*Catalogue No. G.4. and Posters will be forwarded upon application.*

**CAVandervell & Co., Ltd.**  
ACTON, LONDON, W. 3.



# THE PORTABLE OF THE SEASON

The *NEW*

# Geisha

No. 3.

**OUTSTANDING IN:—**  
TONE  
VOLUME  
APPEARANCE  
NEW IDEAS.

CABINET IN BLUE OR BLACK WITH  
GILT EDGING IN EACH CASE.

PATENT STARTING AND  
STOPPING MOVEMENT.

CARRIES EIGHT 10" RE-  
CORDS IN DETACHABLE  
ALBUM.

PATENT SELF-CLOSING  
NEEDLE CUP.



RETAIL PRICE . . . . .

## £3/10/-

*Subject to usual Trade Discount.*

*Measurements—*  
HEIGHT 7 ins.  
LENGTH 16½ ins.  
WIDTH 12 ins.

**THERE'S BIG BUSINESS IN THE "GEISHA." A SAMPLE WILL CONVINCING YOU.  
SEND YOUR ORDER NOW.**

Manufacturers—C. GILBERT & Co. Ltd., Arundel St., Sheffield, and at South St., Hull.



# Still more *Power!*

**Here's new power! With the progress of radio, valves are required to do more—much more—for the modern circuit is designed to produce a better performance with fewer valve stages. That's a good reason for marketing the new Mullard power amplifier. More important still are the opportunities created for radio development by the tremendous possibilities of of this new valve.**

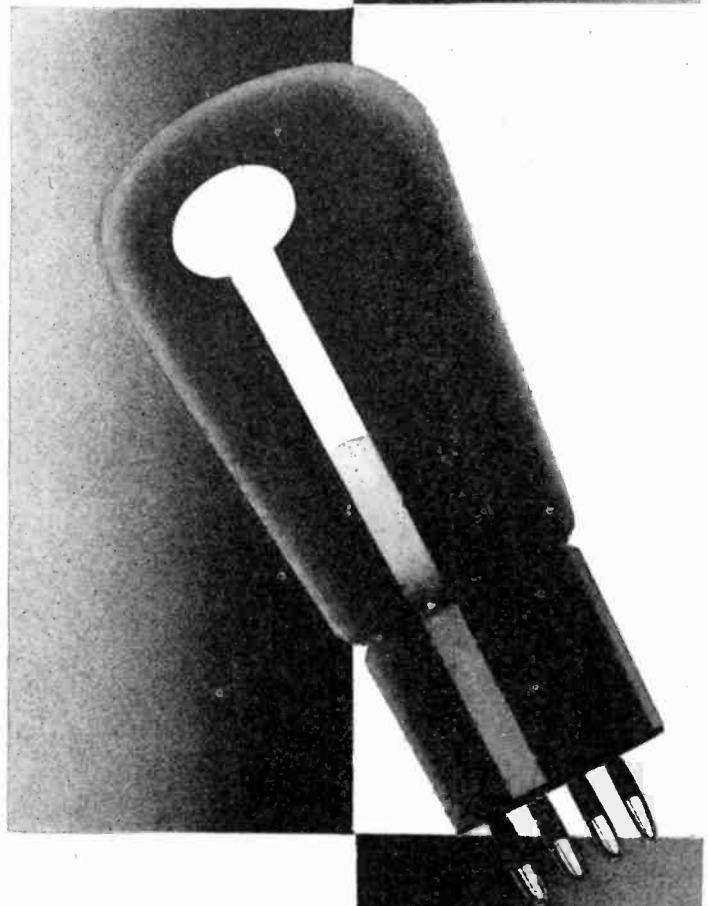

# Mullard

## *THE MASTER VALVE*

# P.M.

# 256<sup>A</sup>

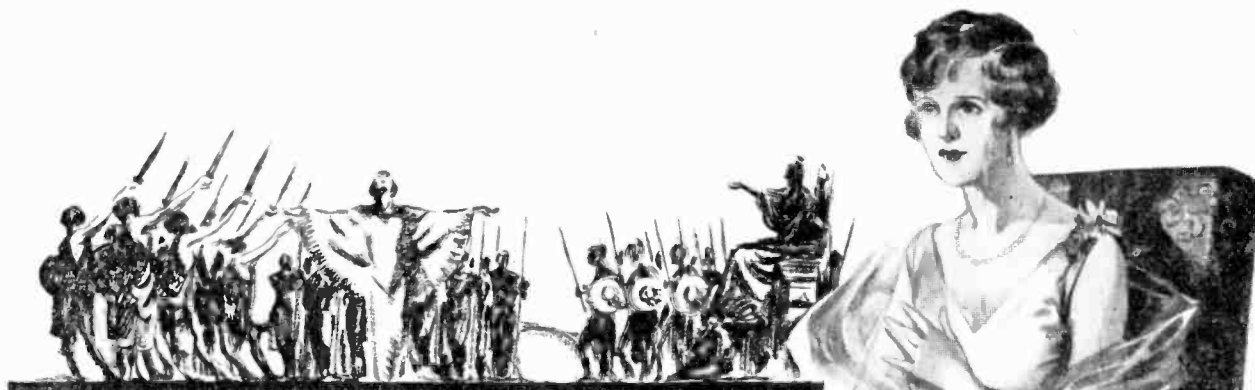

“A roll of drums, a fanfare of trumpets, and the orchestra sweeps into a grand triumphal march. From the distance the sound of a mighty concourse singing. It draws nearer, there is the tramp of many feet, and the victorious warriors march on to the stage. Magnificent, inspiring, it thrills you with its majesty until the final fall of the curtain and the tumultuous roar of applause. Then with a sigh of regret that the performance is over, you reach behind you for your cloak—and smile happily as you are reminded by its absence that you are in your armchair, that you are spared the trouble of the journey home, that your Pye Portable has brought the performance to you so perfectly and realistically that, for the moment, you imagined yourself actually in the distant opera house.”

**Another of the series of Pye Advertisements . . .**  
**The unseen actors come to life, the play becomes real, the listener is thrilled, when Pye Radio reproduces the programme. You cannot afford to ignore the sales which are being created by Pye Advertising. The public wants to see and hear Pye Radio. You must make a good display. You must have a Pye Portable always ready for demonstration. Re-dress your windows this week-end and show that you stock and sell Pye Radio.**



**PYE RADIO — MADE IN CAMBRIDGE**

PYE RADIO LTD., Sales Organisation, Paris House, Oxford Circus, London, W.1

# SPECIFIED



### IGRANIC "Q.M.B." SWITCHES

Can be used in many radio circuits. Completely enclosed in bakelite cases. Definite in action.

For L.T. Circuits Price 2/6  
" H.T. " " 3/6

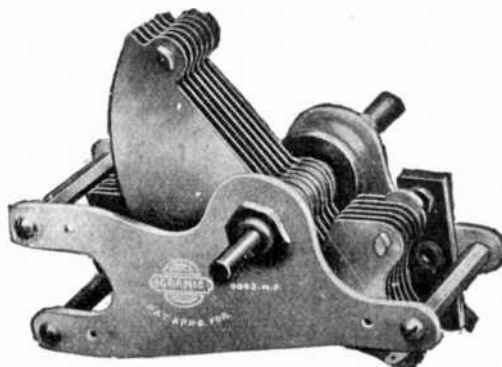

### IGRANIC "LOKVANE" CONDENSERS

Rigidly spaced vanes with double self-aligning bearings securing smooth turning and positive electrical contact.

.0005 Price 10/6; .0003 Price 9/6; .00015 Price 8/6

### IGRANIC MICRO CONDENSERS

*Panel Type.* This condenser has a maximum capacity of 38 mmfds. The vanes are of stout sheet brass and are protected by a transparent cover. The spindle is insulated to prevent hand capacity effects. Price 5/6

With 2 in. Combined Knob and Dial. " 6/-

### IGRANIC INDIGRAPH VERNIER KNOB AND DIAL

This is the auocrat of tuning knobs and dials. Its well finished mechanism and handsome appearance add beauty to any receiver, where appearance and performance are to be studied. Igranitic Indigraph Vernier Knobs and Dials are

## Specified by Experts

# IGRANIC

For utmost efficiency, set designers know that they can depend upon Igranitic components. They rely on you to stock Igranitic components, so that their readers may easily obtain the parts for which they have created a demand. Give set designers the support they deserve — stock IGRANIC.

Write to Dept. T.152 for full details of the Igranitic range.



Another "Halcyon" Triumph!



Price, complete with full equipment and including Marconi Royalties

55 GNS

or £8 down and 12 monthly payments of £4:12:6



This shows the Table Radio Gramophone fitted into the special RECORD PEDESTAL which is designed to match. It is perfectly finished in every way and holds a very considerable quantity of Gramophone Records. Price, Table Radio Gramophone complete with Pedestal

65 GNS

or £10 down and 12 monthly payments of £5:8:6

ALL-MAINS TABLE RADIO-GRAMOPHONE

The Halcyon Wireless Company, Ltd. have pleasure in announcing their latest achievement—the All-Mains Table Radio-Gramophone. This instrument, the result of many years experiment, gives perfect reproduction of both Radio and Gramophone, with that unrivalled purity of tone for which the name Halcyon has always been famous.

**SPECIFICATION:** Figured Walnut Cabinet, beautifully finished and fitted. Halcyon Special MOVING-COIL Speaker, giving perfect tonal quality at all frequencies. Four-valve Radio-Receiver with new and improved circuit employing "screened-grid" H.F. amplification and self-contained aerial. Extreme range and selectivity. Gramophone with electrically operated motor; 12 in. turntable; nickel-plated pick-up of unique design, specially matched for use with moving-coil speaker. Can be supplied for A.C. or D.C. Current.

GUARANTEED FOR ONE YEAR.

An Invitation!

Our many good friends in the Trade are cordially invited to see and hear this new Halcyon All-Mains Table Radio Gramophone in comfort at our

West End Trade Showrooms :

72 NEWMAN ST.

OXFORD STREET, W.1

where we have arranged a special advance display and at which the services of capable demonstrators will be available to answer any questions. May we have the pleasure of a visit from you?

Full Particulars, Descriptive Literature and Trade Terms on request from Dept. W.T.

THE HALCYON WIRELESS CO., LTD.

27a PEMBRIDGE VILLAS, NOTTING HILL GATE, W.11

Telephone: PARK 6541-2-3    Telegrams: HALCYON - WESTBOURNE - LONDON

Birmingham Service Depot: 6 Ryder St., Corporation St.

# DARIO VALVES

*Best way to all Stations!*

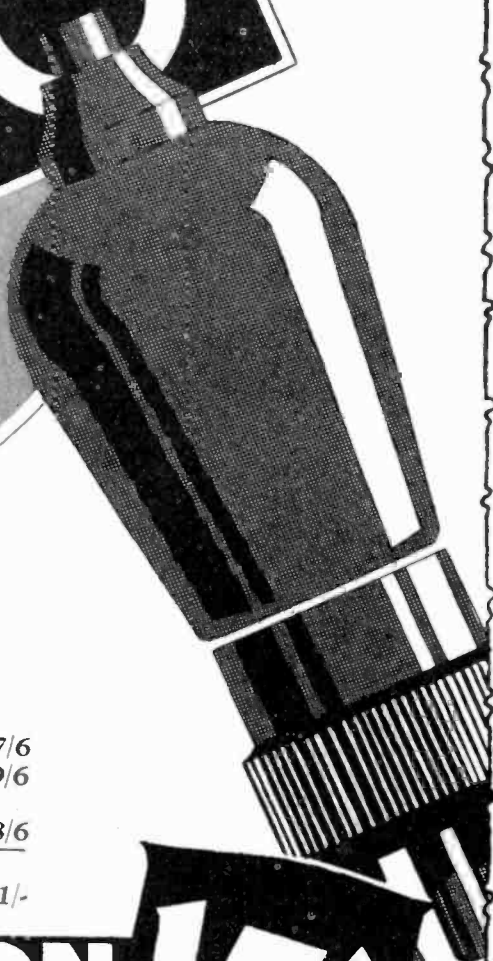

## DARIO VALVES

Bivolt or Forvolt

UNIVERSAL RESISTRON	} - 5/6	SUPER POWER	- 7/6
SUPER H.F.		HYPER POWER	- 9/6
SUPER DETECTOR	6/6	<i>Super Power</i> PENTODION	- 18/6
DARIO TRANSFORMER	- 5/-	DARIO Non-Microphonic VALVEHOLDER	- 1/-
Ratio 3-1 or 5-1			

# SCREENODION 15'6

*Write for supply of leaflets, together with showcards, to :*

**IMPEX ELECTRICAL LTD.,**  
Dept. W.T., 538, High Rd., Leytonstone, London, E.11

*Scottish Travelling Representative :*  
Mr. D. C. Fielding, Broomyknowes, Linlithgow, W. Lothian.

*Irish Free State Agents :* Burwoods of Cork.

**RADIO GRAMOPHONE CABINETS**  
**RADIO GRAMOPHONE CABINETS**  
**RADIO GRAMOPHONE CABINETS**  
**RADIO GRAMOPHONE CABINETS**  
**RADIO GRAMOPHONE CABINETS**  
**RADIO GRAMOPHONE CABINETS**  
**RADIO GRAMOPHONE CABINETS**

*Let the people who control the largest Factory that exists for this class of work quote you for the manufacture of this most important side of your business; your customers will certainly consider good Cabinet work, equally with your electrical and tonal results.*

*As we have secured for this year the orders and contracts for the largest and most influential Firms in the trade, we suggest, respectfully, that what is good enough for them is good enough for the whole industry.*

RADIO GRAMOPHONE CABINETS  
 RADIO GRAMOPHONE CABINETS  
 RADIO GRAMOPHONE CABINETS

RADIO GRAMOPHONE CABINETS

**D.M.D.**

**WOODWORK LTD.**

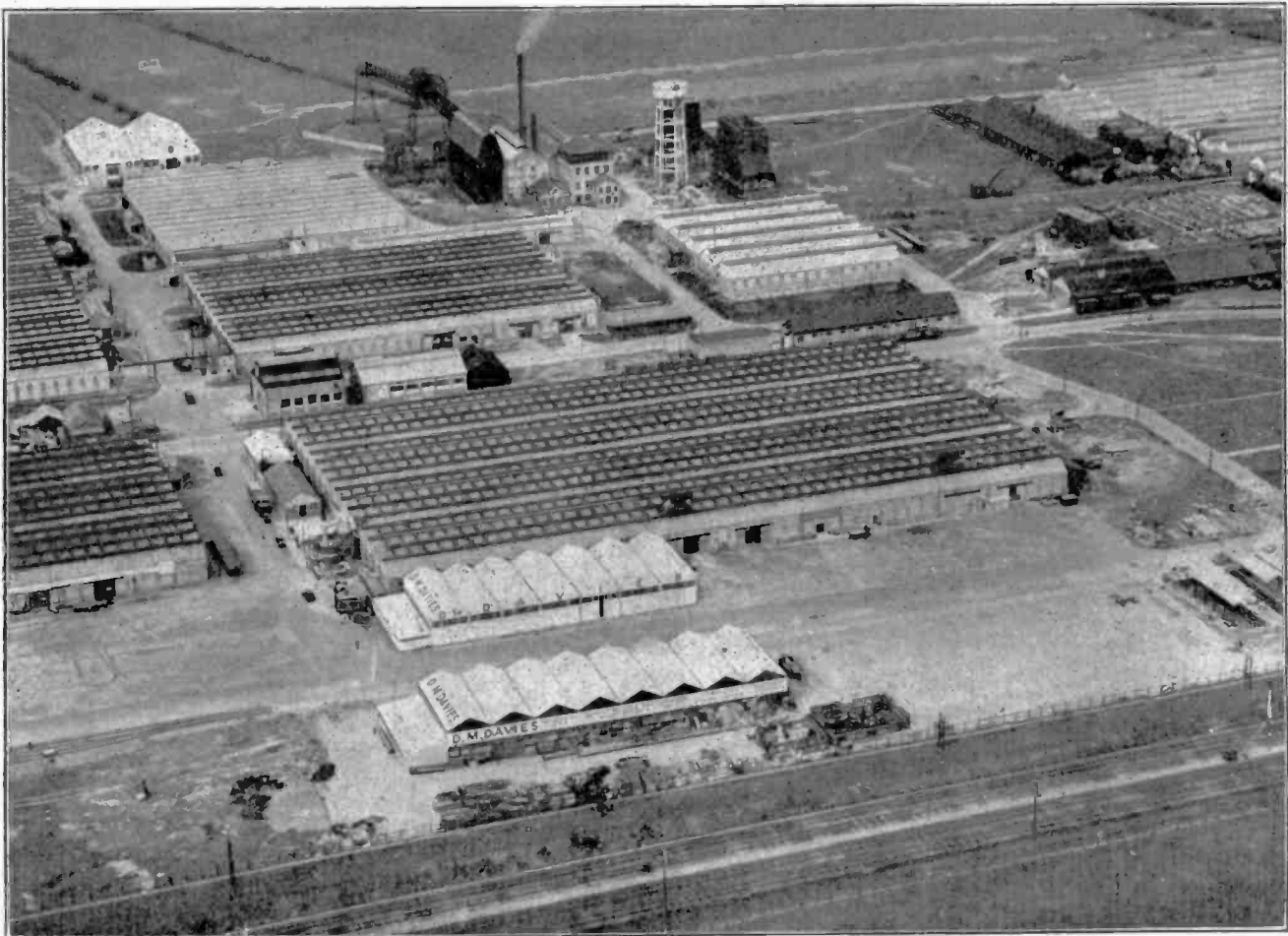

**D. M. DAVIES WOODWORK LTD.**  
**TRADING ESTATE, SLOUGH.**

'PHONE: SLOUGH 316.

ACRES OF FACTORIES.

OCEANS OF SERVICE.

# Manufacturers!

**W**HETHER your requirements are for plain or highly veneered cabinets, CAMCO can supply your needs. CAMCO cabinets have for over 10 years been adopted and used by Manufacturers who know that Cabinets designed and manufactured by CAMCO are better after all! Let us know your requirements; we shall be glad to submit exclusive designs for Portables, Radiograms, Loudspeaker, Pedestal Cabinets, etc.



**Radio Casework**  
Sets the World's Standard.



Carrington Manufacturing Co., Ltd.  
New Showrooms: 24 Hatton Garden, London, E.C.1  
Telephone: Holborn 8202.  
Factory: Camco Works, South Croydon.

5149

**TAKE NO MORE RISKS—SPECIFY "NEDAP" COMPONENTS**

TRADE MARK

N  
E  
D  
A  
P

**HIGH RESISTANCE**  
From 2,000-500,000 ohms.  
2 Terminals Retail 5/8 each  
3 do. Retail 6/- each

**VOLUME CONTROL**  
Plug Type or fitted 4 terminals.  
Retail Price 7/- each

**4-PIN VALVE HOLDER**  
Retail Price 1/- each  
Do. without Insulated Pins  
Retail Price 8½d. each

N  
E  
D  
A  
P

**SWITCH (2-pole change-over)**  
Anti-capacity guaranteed. Practical mounting with large terminals.  
Retail Price 5/- each  
Made also in 3, 4 and 5 pole, etc.

**ANTI-MICROPHONIC VALVE HOLDER**  
Special Phosphor Bronze Nickelled Springs.  
Retail Price 1/3 each

**5-PIN VALVE HOLDER**  
Retail Price 10d. each  
Do. with Insulated Pins  
Retail Price 1/3 each

N  
E  
D  
A  
P

ALL ARTICLES FIRST-CLASS BAKELITE AND FULLY GUARANTEED.  
MANUFACTURER:  
**NEDERLANDSCHE APPARATENFABRIEK "NAFA"**  
1e SCHINKELSTRAAT 30, AMSTERDAM.

ONLY WHOLESALERS AND MANUFACTURERS SUPPLIED.  
For trade discount and particulars apply Sole Agent for the United Kingdom:  
**E. ENDERLEIN** 16 CHARTERHOUSE STREET, LONDON, E.C.1





# Golden-voiced radio

Melodious! Full throated! Crystal clear! The reproduction given by the McMichael Super Range Portable Four reveals its sovereign supremacy in portable receivers. A wide choice of programmes combined with most beautiful tone and exceptional volume make the Super Range Four the Super-Portable.

## TESTIMONY that speaks volumes

Dear Sirs,

Thank you very much indeed for your letter of the 18th, enclosing price list, which we have received this morning.

Last night, between half-past ten and eleven, the undersigned had some friends in and they were listening to Rome. These friends gave the opinion that it was the sweetest wireless set they had ever heard, quite apart from the fact of it being a portable.

It happened that there was a woman singing with rather a Gall-Curci voice—a very beautiful voice—and there was no atmospherics and it came over most clearly.

Before this and after this, we roamed round several stations, and they were amazed at the clearness with which Rome—as we have told you—Budapest and several other stations came through. The visitors were amazed at the simplicity, the selectivity and the long range. As a matter of fact, the point of reception is only three quarters of a mile from the aerial of the Newcastle station SNO, and not in a particularly good place, being just on tram-lines, so that the large number of stations that came in so clearly reflect the highest possible credit on the McMICHAEL Four Portable.

Yours faithfully,

H. C. M.

Screened Grid Amplification.  
Single Dial Control.  
Easy Control of Volume.  
Lowest Possible Upkeep Cost.

Superlative Tonal Quality.  
Wide Range. High Selectivity.  
Fitted in handsome Suitcase with patent locking clips.

## The McMICHAEL 1930 SUPER RANGE PORTABLE FOUR

Owing to the high degree of selectivity in this, and our other Screened Grid Portable Receivers, we are able to guarantee complete selectivity between all main B.B.C. Stations under the new scheme of wavelengths, as proved by an actual test under the twin aeriels at Brookman's Park, when both programmes were received separately without interference, and in addition a number of other British and foreign stations.

This test was made on a standard "Super Range Four" receiver, under an Independent Press observer, and was repeated at half-mile intervals with similar results.

Sell more McMICHAEL Receivers by means of our special deferred payments on the Hire Purchase System. If you are not already stocking and demonstrating this popular Portable, write us or your Factors for terms, Showcards and attractive leaflets. The Receiver will prove a revelation to you.



### L.M<sup>C</sup>MICHAEL<sup>LTD</sup>

Manufacturers of Wireless and Scientific Apparatus  
**WEXHAM ROAD, SLOUGH, BUCKS.**  
Telephone: Slough 441-442. Telegrams: Radlether, Slough  
London Showrooms: 179 STRAND, W.C.2 (Tel.: Holborn 2466)

RETAIL PRICE **22 GNS.**

(Including all Equipment and Royalties)

**The Pye Portable**

The old favourite with an unchallengeable reputation! Completely portable, entirely self-contained incorporating a five-valve receiver, loud speaker, frame aerial, valves and batteries.

Complete with valves, batteries, royalties, concealed turntable and protective travelling cover.

**£19-19-0  
RETAIL**

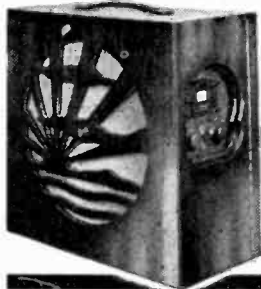

**big sellers  
right ahead  
of their class**

Order for  
immediate  
delivery  
from

**The Pye All-Electric Three**

The big advance in All-Electric Radio. Highly selective, amazingly powerful, reliable always and employing no batteries whatsoever—all the power being taken from the ordinary house A.C. mains.

Complete with full mains equipment, special mains valves and royalties.

**£25-0-0  
RETAIL**

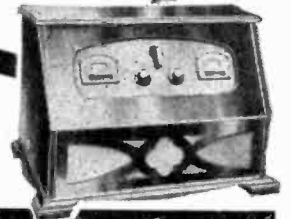

**L.E.S.  
DISTRIBUTORS, LTD.**

9, ST. MARTIN'S STREET, LEICESTER SQUARE, W.C.2

Telephone—Regent 7545.

Telegrams—"Electomar, Westrand, London"

**THE CORRECT  
CHARGING RATE—**

for Wireless Batteries — high and low tension — and also car starter batteries —  
**IS ALWAYS AT HAND**  
in a



FOUR CIRCUIT

**BATTERY CHARGING SET**

FOR A.C. MAINS

It will deal with about a thousand batteries a week and has no valves, electrolytes or moving parts—nothing to wear out or require periodical replacement.

**PRICE, ready for use, for standard voltages and frequencies—£40 nett. (Carriage paid in British Isles).**

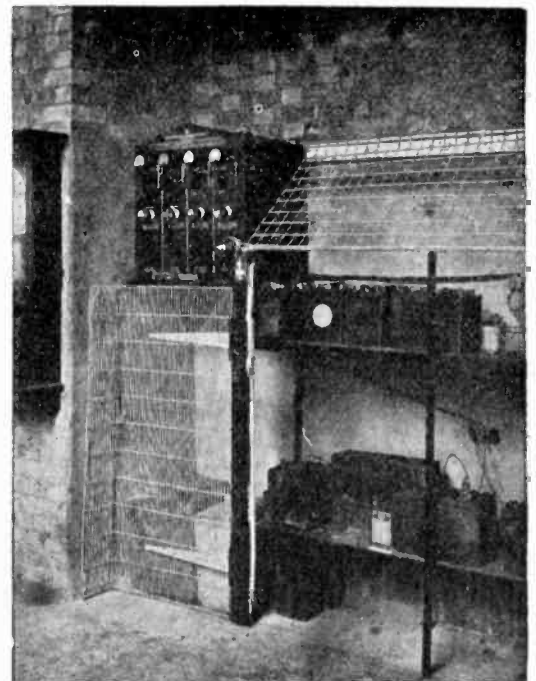

A Westinghouse 4-circuit Charger in service at Messrs. Whithers & Co's. Garage, Edgware Road, London.

High Efficiency. No Noise. No Interference with Wireless Reception.  
SEND FOR LEAFLET S.F.11e5. to—  
**The Westinghouse Brake & Saxby Signal Co., Ltd.** 81 York Road, London, N.1

# Announcing

## Philips Radio Trading Policy

**Season 1930-31**

As from the 1st September 1930 the Philips radio trading policy will be as follows:

**1** Only a limited number of carefully selected wholesalers will be invited to handle Philips Radio products.

**2** The retail trade discount will be 30%.

**3** Prices will be maintained by agreements with the selected wholesale suppliers, and by the rigorous use of a "stop list."

Philips rectifying valves coming within the scope of the B.R.V.M.A. agreements and regulations will continue to carry the discount rates fixed by the B.R.V.M.A.

Particular attention is drawn to the fact that factors' terms will be strictly limited to selected wholesalers under agreement with the Company.

# PHILIPS

## policy promises real

**P**HILIPS ADVERTISING LAST SEASON created a universal demand for Philips all-electric radio. National and local advertising on an even more extensive scale will be undertaken throughout the coming season and the public demand for Philips all-electric radio will be greater than ever. **Philips are determined to enforce price maintenance.**

**I**N ADDITION TO THE NEW SEASONS' ADVERTISING PROGRAMME a sales promotion department has been organized during the past six months to concentrate on radio dealers' own selling problems and to assist them in carrying through sales building ideas resulting from Philips experience in 50 countries of the world.

# sales promotion profits for retailers

## PHILIPS PUBLICITY AND SALES PROMOTION PROGRAMME FOR 1930-31 INCLUDES

**1** Continuous and striking Advertising by large spaces in National, Provincial and Local newspapers and magazines read by millions of possible buyers of Philips all-electric radio.

**2** Sales promotion plans to help dealers to link up with Philips national publicity, with sales promoters, distinct from representatives, in every area.

**3** Selling aids for dealers—better even than last year. Hire purchase terms, sales and service manuals, direct mailing pieces, window displays, posters, cut-outs, etc.

**4** Technical service organisation at each of Philips 13 branches to assist dealers with all their service problems.

# PHILIPS

## all-electric radio

PHILIPS ADVERTISING PROGRAMME FOR 1930/31  
without question will be  
THE BIGGEST EVER LAUNCHED IN THE TRADE



Dealers desirous of linking up with these plans for creating increased sales in their areas are invited to write immediately to:

**PHILIPS LAMPS LTD.,**  
Radio Department, 145, Charing Cross Road,  
LONDON, W.C.2, *and branches*

30, Handyside Arcade,  
Percy Street, New-  
castle-upon-Tyne.

16, Temple Street,  
Bristol.

25, Stanley Street,  
Liverpool.

Mappin Buildings,  
Norfolk Street,  
Sheffield.

Trivetts Square, Short  
Hill, Nottingham.

11, Womanby Street,  
Cardiff.

3, Lower Abbey Street,  
Dublin.

Philips House, Park  
Lane, Park Square,  
Leeds.

6/8, Cadogan Street,  
Glasgow, C.2.

62, Union Street,  
Plymouth.

14/16, Bridge Street,  
Manchester.

55, Cornwall Street,  
Birmingham.

16, Clarence Street,  
Belfast.

# PORTABLES ARE WANTED



You cannot go wrong if  
 you select your portables  
 from the Sunco range—

PORTABLES are past the experimental stage. We can show you many models, produced by leading makers, which you can sell to your customers, safe in the knowledge that Sunco Radio Service has tested them under all conditions.

We guarantee that every set in the Sunco range comes up to the high standard of efficiency that we demand. It is because we

have concentrated on Portables ever since they became a commercial proposition that this guarantee means so much to you.

Dealers who still have stocks of out-of-date receivers by makers who have now faded out of the picture will appreciate this. If you have not had a copy of our 224 page Radio Catalogue, send a postcard to-day.

## THE SUN ELECTRICAL CO. LTD

118-120 Charing Cross Rd., London, W.C.2

'Phone : Temple Bar 3500 (10 lines)

::

'Grams : " Secablis, Westcent, London "

LEEDS — 49-50, Park Place.

Branches :

NEWCASTLE-ON-TYNE — 112, Pilgrim Street.

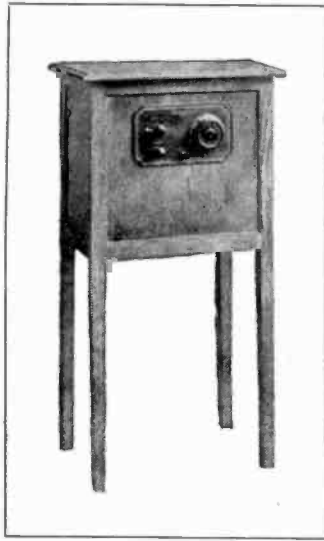

# “MONARCH”

## RECEIVERS THAT SELL

### The MONARCH III, Type “F”

This “Straight Three” floor model is in great demand. It is simple to operate, of attractive design, and gives the desired results in all districts. Ample room in cabinet for all batteries.

OAK Cabinet	.. ..	£6 17 6
MAHOGANY	.. ..	£7 7 0
		(Royalties extra)

**W.M. DIBBEN & SONS, LTD.**  
 ST. MARY'S ROAD SOUTHAMPTON.

LONG RANGE **POPULAR** SELECTIVE

Two Strong Selling Sets

### CABINET THREE

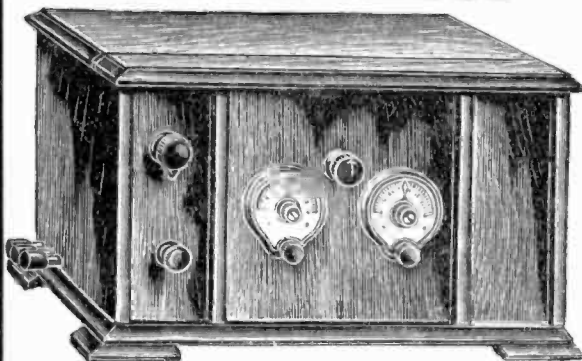

£5 : 15 : 6 (subject)

This set incorporates a unique device to sharpen tuning to any degree of selectivity. The Cabinet is designed to hold all the necessary batteries.

### REGIONAL THREE

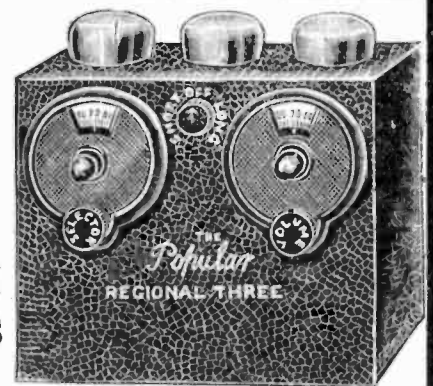

4 GUINEAS (subject)

FIXED  
 RETAIL  
 PRICES  
 INCLUDING  
 VALVES

FREE FROM  
 ROYALTIES

Completely screened. Cuts out Regional Stations as required, and brings in ALL EUROPE. Size only 7x6x3 in. Supplied in three finishes, Bronze, Gilt and Black. A unique proposition every Dealer should stock.

FULLY GUARANTEED  
 FOR ONE YEAR

Write for Details and Other Price Lists

**THE DANIPAD RUBBER Co., Ltd.,**  
 5 & 7, Market Street, Finsbury, London, E.C.2

Telephones: Bishopsgate 7322 & 7323

EFFICIENT

LOW PRICE



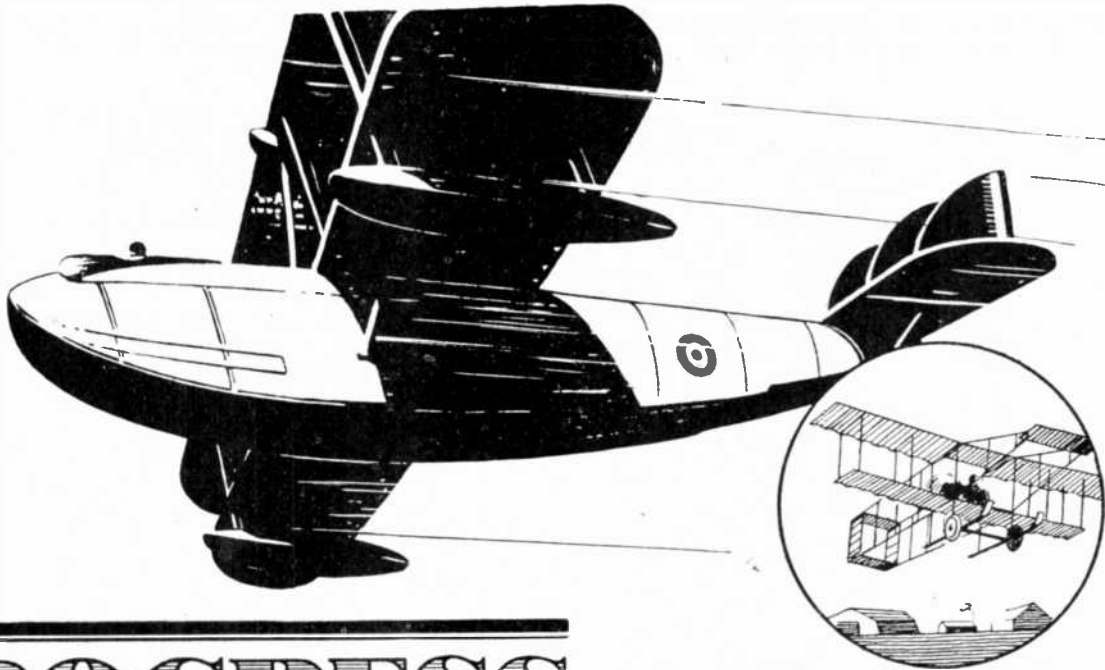

# PROGRESS

60%  
LONGER LIFE  
**What  
a life!**

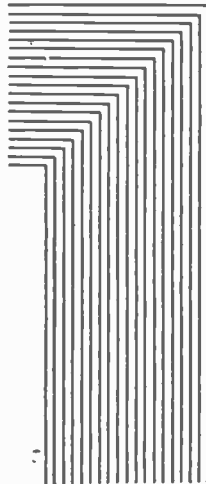

**PERTRIX LTD.**

Britannia House, Shaftesbury Avenue, London, W.C.2.

Please send me full particulars of the British Pertrix Patent Dry Battery, together with your Trade terms.

Name.....

Address.....

When you make use of Pertrix show cards, window bills and other sales aids, you reap the great advantage of increased battery sales.

The well-known fact that Pertrix batteries avoid corrosion and deterioration by using

## NO SAL - AMMONIAC

has converted thousands of listeners to Pertrix. By taking advantage of the assistance we offer you, you will keep your battery sales at a really profitable level.

Your business will progress rapidly if you stock Pertrix.

*Pertrix flash lamp batteries are also available.*

PRICES.							
Volts.	STANDARD. DISCHARGE 12 MILLIAMPS			GRID BIAS.			
	Size in inches.			s.	d.	s.	d.
	L.	B.	H.				
60	5 1/4	6 1/2	3 1/4	8	0	9	1 6
100	8 1/4	6 1/2	3 1/4	13	0	12	2 3
120	10 1/4	6 1/2	3 1/4	15	6	15	2 9

# PERTRIX

PATENT  
DRY BATTERY

PERTRIX, LTD. Britannia House, 233 Shaftesbury Avenue, W.C.2

# WATES STAR LOUD SPEAKER UNIT

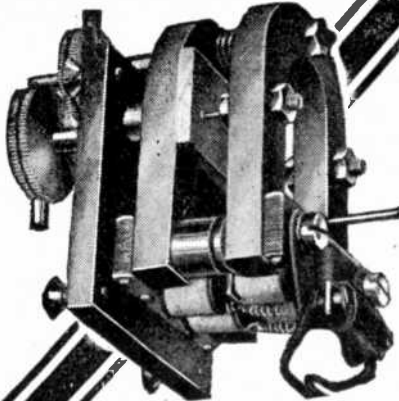

**SETS THE LEAD  
TO BRITISH MANUFACTURERS  
UNPRECEDENTED  
VALUE!**

The sensational reduction in price of the famous Wates Star Unit has been made in the confident anticipation that by bringing its price into line with the lowered purchasing ability of the public, they will reciprocate our gesture of goodwill by largely increased sales which will mean more profit for you.

**NEW REDUCED  
PRICE 30/-**  
FORMER PRICE 36/-

## WATES DOUBLE CONE CHASSIS

Carry the full Wates range and keep Summer turnover and profit up.

**PRICES**

Chassis with Universal Bracket instructions, screws and supporting leg ready for use.  
 12" Chassis .. .. . 11/8  
 14" Chassis .. .. . 12/6  
 Not fitted with supporting leg  
 20" Chassis .. .. . 17/6  
 Silk lined fret in polished wood  
 For 12" Chassis .. .. . 4/0  
 For 14" Chassis .. .. . 5/0

Cone Chassis complete in handsome cabinet fitted with Wates Star Unit Speaker ready for use.

14" in Oak .. .. . £3 10 0  
 In Mahogany .. .. . £3 15 0  
 20" in Oak .. .. . £4 10 0  
 In Mahogany .. .. . £4 15 0  
 Universal Bracket only with screws and full instructions .. .. . 2/0

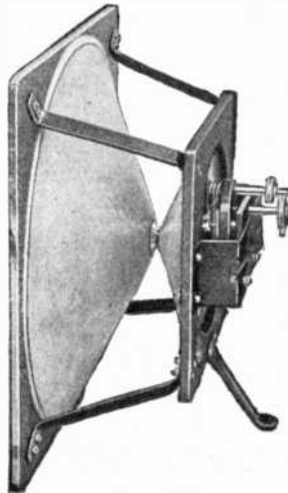

Write for full details and trade terms or Phone Temple Bar 6195-6.

**The STANDARD BATTERY Co.,**  
(DEPT. W.T.)

184/188, Shaftesbury Avenue, London, W.C.2.

The experience of over ten years successful business is behind all

# WEARITE COMPONENTS

and this is at your service, Mr. Manufacturer and Merchant. Below are illustrations of some of our lines.

Valve Holder for A.C. or 3-electrode valves.

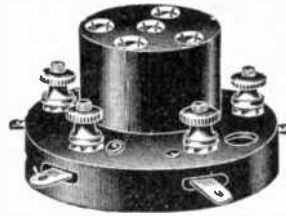

Rheostat Potentiometer or Volume Control.

Wearite Anti-capacity Switches, 1 to 6 way as used in most popular sets. Can be supplied lever controlled or ganged.

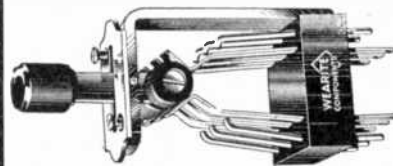

Miniature type A.C. Switches can now be supplied.

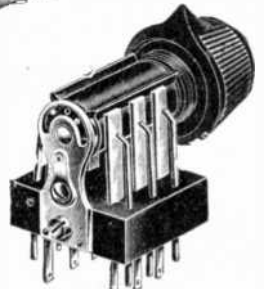

3-Point Wave-change Switch.



Write for free illustrated lists.

H.F. By-pass Unit .. .. .	4/6
Standard 6x6x6 1/2 Screening Box in heavy gauge aluminium, grey finish 6/6, polished .. .. .	7/6
Special Mains Transformer for "Orgola" H.T. Supply Unit ..	30/-

**WRIGHT & WEAIRE LTD.**

740, HIGH ROAD, TOTTENHAM, N.17.

Phone: Tottenham 3847/8.

# HOW TO MAKE BIG PROFITS ON ELIMINATOR SALES!

**30% + 10%**

**OUTPUT 20<sup>m</sup>/<sub>A</sub>**  
**INCREASED TO**  
**AT SAME RETAIL PRICES**

This increased output is a feature which will make Lissen Eliminators appeal to more people. The output is sufficient to cater for practically 90% of the valve sets in use. Think of the simplification of stock—the quick turnover—the constant stream of sales. Push Lissen Eliminators—they're worth stocking and worth selling, also they carry the generous Lissen discount of 30% and 10%.

There is big advertising behind the sales of Lissen Eliminators—advertising that makes Lissen the easiest, popular-priced eliminator for you to sell.

Remember this when arranging stock for the season—you need a *smaller* stock of Lissen to meet an assured *bigger* demand—and *there are always enquiries from our advertising* which no other eliminator will satisfy—and we hand these enquiries over to dealers we know are stocking.

# LISSEN

**ELIMINATORS PLUS BIG ADVERTISING THAT CREATES DEMAND**

**LISSEN LTD** Worplesdon Rd. Isleworth Middlesex



A.C.  
**60%**  
 Model A

D.C.  
**27/6**  
 Model A

**PROGRESS**  
 is not only  
**NECESSARY...**  
 .... it is  
**INEVITABLE**

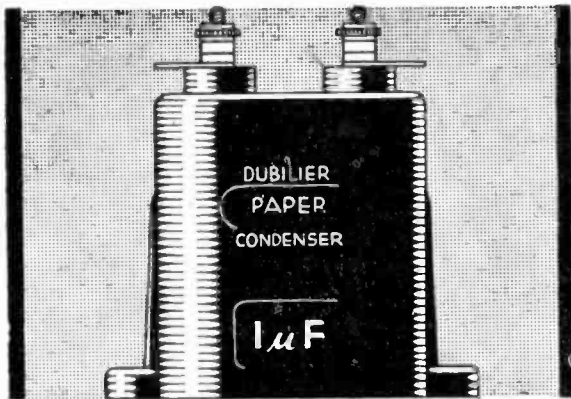

**T**HE unique research facilities of the leading condenser manufacturers of the country have been employed on a new process for producing PAPER CONDENSERS of all types, to give greatly increased life, reliable operation, and a guaranteed immunity from breakdown.

PARTICULARS WILL BE GLADLY SUPPLIED ON REQUEST

**DUBILIER**  
 RADIO PRODUCTS

DUBILIER CONDENSER CO. (1925), LTD.,  
 Ducon Works, Victoria Road, N. Acton, London, W.3

NEED NO ATTENTION  
 MORE VOLUME  
 GREATER SELECTIVITY

CHEAPER THAN DRY BATTERIES

for  
**PORTABLE OR TRANSPORTABLE RADIO RECEIVERS**  
 TANNOY PRODUCTS  
 1-7 DALTON ST. S.E. 27

**JUNR.**  
 FROM STOCK  
 TERMINALS, SCREWS,  
 NUTS ETC.

*Ralph Prideaux*  
 Junr.  
 101, Hatton Garden,  
 E.C.1

'PHONE: HOLBORN 6244

# Eloquent evidence

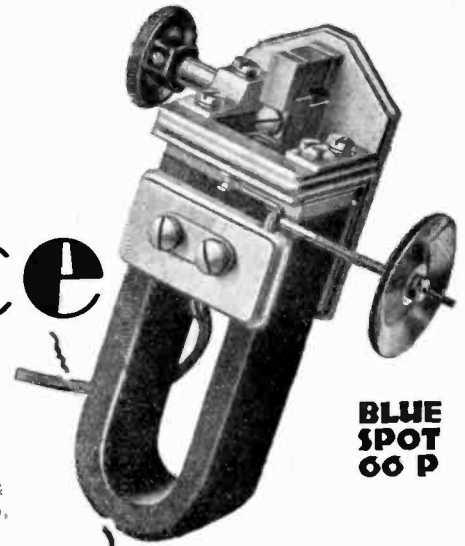

**BLUE SPOT 66 P**

**TEST RESULTS.**—Both units were sent to us mounted on Blue Spot Major chassis. They were fitted to 2 ft. square baffles, and compared with our large standard cabinet cone speaker. In each case the sensitivity was very good, the 66P being fully equal to the standard in this respect, while the 66R was noticeably more sensitive. In each case, too, the power-handling capabilities were above the average. The tone of the 66R was surprisingly good for a moving iron type of unit. There was a really prominent, clear bass, with a good high note response. The overall tone was rich, full, and well-balanced. Speech was inclined to be deep, but was very clear.

The smaller unit, the 66P, also gave an exceedingly good tone, though rather different from that of the 66R. The bass was almost as good as before, while the high notes were even more prominent. The middle register was not so much in evidence, the resultant tone being therefore rather less full, but extremely clear. Speech was very clear. Both units can be thoroughly recommended. Some people might prefer the tone of the smaller unit for its clarity, while others would choose the large unit for its richness. In both cases, however, the bass response is well above the average for units of this type.



**BLUE SPOT 66 R**

*"Wireless Trader,"*  
June 14

The above extract has not been "edited" in any way whatever and represents the complete test report. Such eloquent evidence speaks for itself.

## BLUE SPOT

- 66 P** A Better Unit retails at .. **27/6**
- 66 R** The Masterpiece retails at .. **35/6**

**F. A. HUGHES & COMPANY, LIMITED,**  
204-6, Great Portland Street, London, W.1

*Distributors for Northern England, Scotland and North Wales:*  
**H. C. RAWSON (SHEFFIELD & LONDON) LTD.,** 100, London Road, Sheffield;  
22, St. Mary's Parsonage, Manchester.

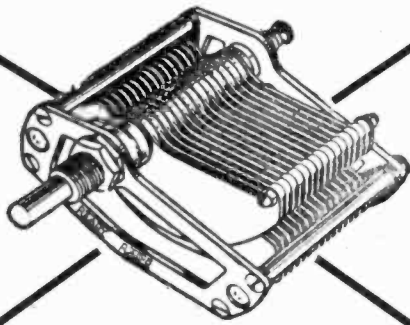

**SETMAKERS  
RETAILERS  
WHOLESALEERS**

**A VARIABLE  
CONDENSER**

**AT 4/6 .0003  
.0005**

Made at London Bridge, England.

**POPULAR WIRELESS SAYS:**  
The Ready Radio people are now manufacturing a Lo arithmetic condenser which retails at 4/6 in either .003 or .0045 mfd. maximum capacity. This will be good news for all constructors, and not only those whose pockets are lean, for the Ready Radio variable is cheap only as regards price.

Finally, the movement is consistently smooth. Altogether it is a distinctly commendable proposition.

**Ready Radio**

159, BOROUGH HIGH STREET  
LONDON BRIDGE - S.E.1

Telephone: HOP 5555. (Private Exchange)

# THURINGIA BATTERIES

Quality Unrivalled.  
Record Life in Use.  
Longest Guarantee.

Labelled to Instructions Gratis.  
Factors Enquiries Invited.  
Reduction in Price.

SOLE AGENTS:

**E. H. MAISNER & CO. LTD.**  
4 Attneave St., Farringdon Rd.,  
LONDON - - - W.C.1

OLDEST MANUFACTURERS,  
HUGO FALK,  
G.M.B.H.  
TABARZ



Sell him **PARMEKO**  
and he'll come again  
for more

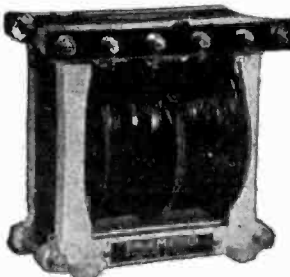

PARMEKO apparatus is so well designed, and so carefully constructed from the finest materials that it is practically laboratory apparatus — yet the price is no higher than for other apparatus.

No single choke, even, leaves our works without undergoing a searching test under working conditions, and receiving our guarantee of perfection in every part. Evidence of the success of this policy is found in the use of PARMEKO apparatus by some of the largest "Talkie" and Radio-Gramophone companies, which are in a position to choose the best, regardless of cost.

The PARMEKO range covers every normal requirement—there is a PARMEKO choke and transformer for every circuit featured in the technical press—but we specialise in making apparatus to specification. Simply let us know your customer's requirements and we will quote you by return.

Stocks are held at London and Leicester.  
Prices, terms and particulars of Wireless Mains Apparatus sent on application.

**PARTRIDGE & MEE LTD.**

74, New Oxford Street,  
LONDON, W.C.1

26, DOVER STREET,  
LEICESTER

# IOCO PANELS ARE IN GREAT DEMAND.



IOCO "Formapex" Wirelets Panels are of the highest grade, bakelite type, and are guaranteed to satisfy the most exacting demands of high frequency circuits, having exceptionally high surface resistivity and dielectric strength. Here are a few other points —

1. Can be easily drilled, tapped and machined.
2. Will not soften or warp with heat.
3. Are unaffected by dilute acids, alkalis or ozone.
4. Can be had in any thickness and any required dimensions up to 48" x 24".
5. Supplied BLACK or MAHOGANY.
6. Superior to Ebonite.

Send for Trade Terms.

The IOCO RUBBER & WATERPROOFING Co., Ltd.,  
Netherton Works, Anniesland,  
GLASGOW, W.3.

# "That's not the 17 guinea set?"

A REPRESENTATIVE of a well known battery manu-

facturer called at our factory a fortnight ago. He happened to be in the room while we were testing a Murphy Radio Portable. "Surely that's not the 17 guinea model?" he said. "If it is, it will give people something to think about."

I do not cite this incident in any boastful spirit, but to impress upon you that it is not really possible to do a good set justice in an advertisement. What we want is for you to see and hear a model for yourself.

**Fill in the coupon for a demonstration.**

*Frank Murphy*

B.Sc.,  
A.M.I.E.E.,  
A.I. Rad. E.,  
Chartered  
Elec. Engineer.

# MURPHY

# RADIO LTD

WELWYN GARDEN CITY, HERTS

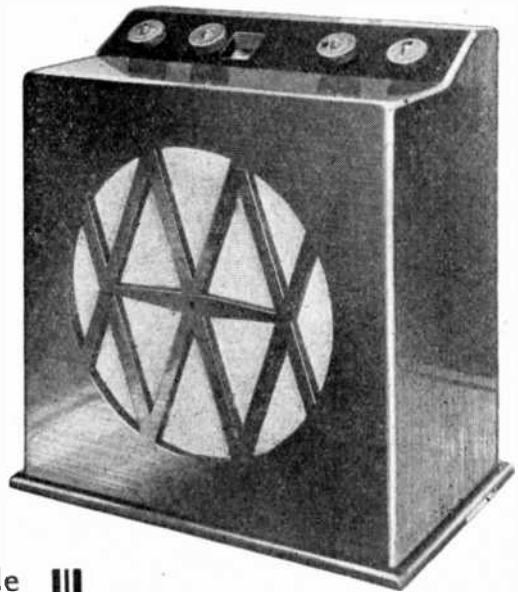

THE NEW MURPHY  
RADIO  
PORTABLE

MAKING  
WIRELESS  
SIMPLE  
MAKING  
WIRELESS  
SIMPLE  
MAKING  
WIRELESS  
SIMPLE  
MAKING  
WIRELESS  
SIMPLE

**4 - VALVE SCREENED GRID RECEIVER.**

**SINGLE TUNING CONTROL**— Completely Ganged Circuits CALIBRATED IN WAVELENGTHS. Fitted in beautiful Walnut Cabinet; weight 32 lbs. No aerial or earth required. 2-volt 23 A.H. unspillable Accumulator, mounted on acid-proof rack. 108-volt H.T. Battery 12 m/a rating. Average H.T. consumption 8-9 m/a. Gramophone Jack. External Loudspeaker Jack. External Aerial and Earth sockets. Excellent loudspeaker reproduction, giving very enjoyable music and particularly clear speech. Range and selectivity equal to, if not better than, any other portable set on the market.

**Price - - 17 Gns.**  
including valves, batteries, turntable and Royalties.

**C O U P O N**  
Murphy Radio, Ltd., Welwyn Garden City, Herts  
**MURPHY RADIO PORTABLE**  
Please send Particulars and Trade Terms  
Please send a Representative

NAME .....

ADDRESS .....

*Cross out line which does not apply.* W.T. July 12

# PROOF POSITIVE!

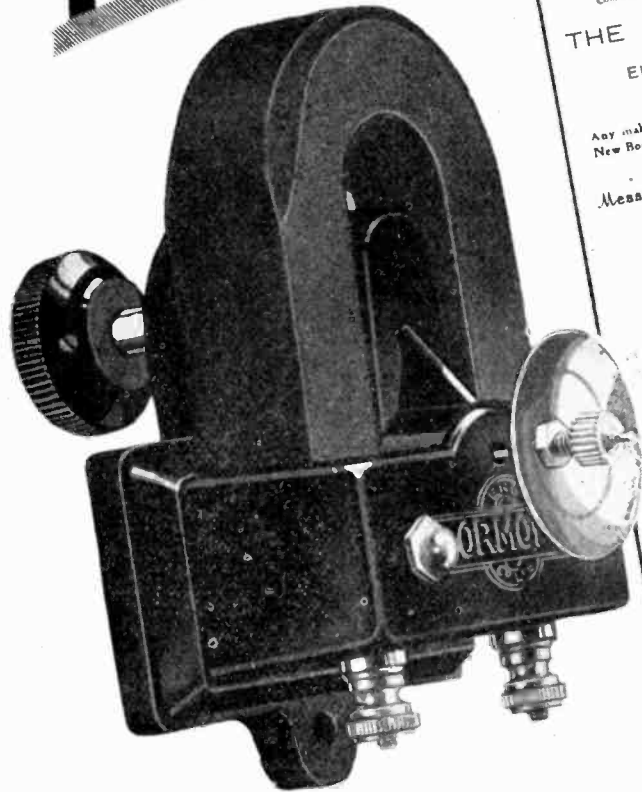

Noteworthy features are the very large Cobalt magnet used, and the beautifully polished bakelite cover which encases all working parts. The whole is finished in walnut-colour, whilst the terminals are heavily nickel-plated.

## 12'6



## The ORMOND 4 Pole Adjustable LOUDSPEAKER UNIT for PUNCH, POWER & PURITY!

THE ORMOND ENGINEERING CO., LTD., Ormond House, Rosebery Avenue, LONDON, E.C. 1 Telephone—Clerkenwell 5334/5/6 & 9344/5/6. Telegrams—"ORMONDENGI, SMITH."

Contractors to the Milled Metal Industry.  
**THE SCARBOROUGH MANUFACTURING COY.**  
(IN BURNETT, LATE OF COVENTRY)  
 ENGINEERS, BODY BUILDERS, SHEET METAL WORKERS, &c.  
 Offices, Works and Garage: FRIARS ENTRY, SCARBOROUGH.

Any make of Car or Motor Cycle supplied.  
 New Bodies and Body alterations a speciality.  
 Hoods, Windcreens, &c.

Garage, Spare, Patent, Oil, etc.  
 Mechanical Repairs to ALL MAKEHS of  
 EXPORT MOTORS.

Our Ref: H/B  
 Your Ref: WG/HM.

Messrs Ormond Engineering Co Ltd.,  
 Ormond House,  
 Rosebery Avenue,  
 London, E. C. 1.

21st, June 1930

Dear Sirs,

The Loudspeaker 4 Pole Unit which came to hand on the 17th has now been tested out, and although this is out of its cabinet and without a baffle board it has come above all our expectations.

Both ourselves and our customer consider it the Speaker Supreme, to be candid it is without a doubt the finest speaker we have heard.

When we say that we can hear the announcer breathing it is needless for us to add anything further, this adds another moneysworth to the already long list of your components.

If any of your satisfied customers wish for details of our construction of the cone Chassis (which may have helped us to get such wonderful results) we shall at any time be pleased to help them.

As this letter is quite unsolicited you are at liberty to make what use of it you wish.

Wishing you every success in meeting the public demands.

Yours faithfully,  
 For S.M.Co.,

*A Burnett*

Dear Sirs,

c/o 94 North Wall,  
 DUBLIN  
 Dec. 3rd 1929.

I have great pleasure in writing these few lines in appreciation of the pleasure I derive from using your Cone Loudspeaker Unit. I have one of your 4 Pole Units and without any exaggeration whatsoever, I can scarcely tell the difference of the actual Voice and Music are reproduced with a clarity that I am sure there is none to equal.

I have had various different kinds of Loudspeakers, but I can religiously say that up to the present I have never heard one to equal the one which I have; to tell you the real truth I am astonished and enraptured with it, and everyone that has heard it can verify this statement.

You are quite at liberty to use this as a true testimonial of the truth pertaining to your Cone Unit and I really have the greatest pleasure in recommending your Loudspeaker to anyone who wishes to purchase one of your Units and Chassis, which price is within the reach of the humblest.

Wishing You every success

I remain,

Yours faithfully,  
*H. L. Marshall*



*The only weekly Trade Journal circulating to Bona-Fide Wireless & Gramophone Traders.*

## EDITORIAL VIEWS.

### Coupons and Radio.

WHEN at the Music Trades Convention we heard a very lively discussion on the subject of coupon trading—whereby gramophones and records are available to the public in return for vouchers given away with cigarettes and tobacco—we could not dismiss a certain measure of satisfaction at the thought that the radio trade itself, as distinct from the gramophone side of the business, had so far been free from the attentions of the coupon enthusiasts. Unhappily our satisfaction has been short-lived.

Last Sunday's newspapers contained the first coupon offer of any considerable magnitude in which radio goods were involved, and while, as we propose to show, the particular case in question has points in favour of as well as against it, we want even thus early to address an earnest appeal to manufacturers generally not to permit any further extension of the coupon trading business into the radio field. Even if the manufacturer—as he may well do—goes into this avenue with the consciousness that he has done everything possible to remove features which are objectionable from the trader's point of view, we are still convinced that in the end the reputation of the maker himself, and the public attitude towards the radio industry and its merchandise as a whole, cannot be enhanced by these methods. There is inevitably a taint about the coupon trading business—and some of it sticks to the manufacturers, the goods, and, indeed, to the entire industry involved.

We make our appeal to every reputable manufacturer in the trade—well knowing that handsome orders from cigarette makers are not to be lightly turned away, but confident that we are asking makers to do something which eventually will increase rather than diminish their prosperity, as it must improve their standing in the eyes of the whole trade . . . and we shall be disappointed if our appeal falls upon deaf ears.

NOW let us examine in detail the offer which appeared last Sunday. A cigarette concern, noted for their coupon stunts, announced that 500 vouchers from their cigarettes will secure for the man in the street a self-contained cabinet type 2-valve set and speaker, with valves included and nothing to pay. "No other 2-valver," it is confidently claimed, "excels it for range, volume and quality of reproduction." It is further stated that the set is specially made by a famous valve- and set-making company (who are named) and carries their guarantee . . . the whole consignment free with £12 10s. od. worth of cigarettes!

Now here is the first undesirable feature of the offer. The radio manufacturers concerned are themselves selling a 2-valve set (without batteries and speaker) at the perfectly reasonable price of £5 10s., and we wonder how they view the implied suggestion that their proprietary instrument performs no better than one that is given away with a remarkably small quantity of cigarettes—which, incidentally, cost the public only a little more than the manufacturers' own receiver with the equipment necessary to operate it?

Several traders have already approached us on this question, and one

of the criticisms they advance is naturally that the coupon offer robs them of potential sales of complete receivers. Frankly, however, we are not deeply concerned on that score, and, in any event, such concern as might be felt over this aspect of the case is modified by the fact that, as distinct from some of the coupon offers affecting other trades, the set involved here is not a standard market line which traders themselves are offering for sale. Then, again, we believe that the average type of individual who will smoke a certain brand of cigarettes (probably to his own discomfort) and collect a host of coupons in order to obtain a free gift is not the man who, in the absence of such an opportunity, would have voluntarily purchased a receiver at the present time. The idea of buying a set would probably not have commended itself to him for a long time to come, whereas now it is possible that he will acquire sufficient appreciation of radio entertainment to become a worth-while prospect for a more ambitious instrument in a comparatively short time, in which case the trader would naturally benefit.

These points cover the average coupon collector, beyond whom there may conceivably be a proportion of people who had already made up their minds to secure a radio set (now or in the near future), but who will decide to "try" the coupon method first—no doubt arguing that the experiment will cost them nothing, and that if the free set proves unsatisfactory, they can still purchase a better one in the ordinary way. Here our sentiments are somewhat mixed. It is undoubtedly wrong that the trader should lose, even temporarily, this proportion of sales; but at the same time the people who were so near to purchasing should already have come under the influence of the trader's own propaganda—if, that is, he is doing his job properly. Even now it is not too late for the retailer to make capital by advancing the argument that satisfaction with a radio instrument can only be *permanently* assured when it is bought from a reputable distributor handling established goods and equipped for efficient customer service. The dealer obviously can do a great deal in this way to protect his own interests and business.

On the other hand—and this is a point which the manufacturers concerned will undoubtedly bring forward in justification of their action—coupon-owners of receivers may in the near future become quite useful customers for battery charging and renewals; and these, of course, will be in the main customers whom the trader would not normally have secured. At the same time, and even though the particular set in question carries a makers' guarantee, some traders will be called upon to give service on it, and here it seems that the makers are at the best placing themselves under an obligation to the retail trade.

It is thus not easy in the present instance to strike a balance between the probable losses and possible gains to the retailer; but, even if the latter occasionally predominate, we still feel that coupon business is definitely not in the best interests of the trade, and in the end probably more of a disadvantage than otherwise to those who indulge in it.

8th Year of Publication.  
Editorial, Advertisement and Publishing Offices:—  
**ST. BRIDE'S HOUSE, SALISBURY SQ.,  
FLEET STREET, LONDON, E.C.4.**

Telephone Numbers—  
CENTRAL 7713 (5 lines). CITY 4011 (4 lines).

Telegrams—  
"WIRELESTRA," FLEET, LONDON.

Branch Offices:

BIRMINGHAM: Central House, New Street. Telegrams: "Trapress, Birmingham." Telephone: Central 4026 and 4027.	MANCHESTER: 260, Deansgate. Telegrams: "Motrader, Manchester." Telephone: City 8970 (4 lines).
---	--

Annual Subscription Rates:  
United Kingdom, Canada and Newfoundland. All other Countries Abroad.

8/- Post free. 10/-

Published Every Saturday.

# Trade News

## Philips' New Distribution Policy.

### Limited Factorships, Basic Discounts and a "Stop List."

IT was announced this week that the new distribution system, which, as we exclusively reported two months ago, is being adopted by Philips Lamps, Ltd., will come into operation on September 18th next.

After that date only a limited number of factors from a carefully selected list will be invited to handle Philips' radio products, and every wholesaler who accepts the invitation will be bound by a close agreement to observe the manufacturers' terms of re-sale to the trade, and also to assist in the suppression of infringements of these terms among traders. The latter part of the factor's obligation will be operated by means of the rigorous use of a "Stop List," which, it may be pointed out, will be a "private" Philips instrument affecting solely their own goods. At the same time, it must be recorded that Philips have had the breadth of vision to register their prices for protection under the R.M.A. "Stop List" scheme, believing, no doubt, that any available additional safeguard to proper trading in their goods cannot be neglected.

Under the new Philips policy there will be two rigid rates of discount—one for the selected wholesalers, which will be given only to those actually on the list, and a flat 30 per cent. for traders. Philips will not, of course, refuse to supply other recognised factors than those who have agreements with them, but the discount in these other cases will be the same as that granted to dealers—namely 30 per cent. On this point it is also emphasised that Philips rectifying valves, which come under the B.R.V.M.A. regulations, will continue to carry the discount rates fixed by the Association.

Concurrently with this development will be launched the Sales Promotion department which Philips have been building up during the last six months. The function of this organisation will be solely to assist the dealer in marketing Philips goods, and, apart from a remarkably comprehensive programme of direct sales and publicity aids, it has resulted in the allocation of a specialist at every Philips branch throughout the country, whose only job is to help the dealers in his area to sell their goods. With his whole time devoted to the task, this specialist will be available for all Philips stockists.

Similarly each branch will have its own technical service organisation to assist dealers in their service problems, while special service manuals are also to be published for dealers' use.

It is a real pleasure for us to voice what will undoubtedly be general commendation of Philips' action in joining the ranks of determined price-maintenance manufacturers; and while, with Philips themselves, we recognise that in so restricting their wholesale distribution they are taking a big risk, we feel confident that their move in the interests of clean trading will bring adequate reward.

Finally, it is with very deep gratification that we acknowledge the tribute to our own influence in this direction which Philips Lamps paid us when revealing the details of the important step they are taking.

#### At a Colchester Show.

A correspondent writes: At an Empire Exhibition held at Colchester this week, there was an interesting stand by Shroshbery & Bakewell & Co., Ltd., radio and electrical engineers, who gave daily television demonstrations.

#### A New Mullard Scheme.

On the top of Selfridges—in the roof gardens—Mullards recently arranged an effective display in keeping with the surroundings.

A Mullard Orgola Senior radio-gramophone was installed in a gaily-striped tent, and this was coupled to a special amplifier capable of operating the twelve "Pure Music" speakers that were concealed throughout the gardens.

Thus the public who were enjoying the restful atmosphere of the roof gardens could enjoy gramophone music, and in addition, running commentaries were given on the open air mannequin parades. At intervals special announcements of attractions in the store were made by this means.

Besides being an effective publicity stunt, the idea opens up great possibilities for the use of P.A. equipment in large department stores.

#### Amplifiers at Church Services.

An instance of the many and increasing number of uses to which public address apparatus is put nowadays is afforded by a contract for P.A. work just received by the radio department of H. Binns, Son & Co., Ltd., of Middlesbrough.

At the request of the Ministry of the local Baptist Church Messrs. Binns installed amplifiers and speakers so that the church service on July 6th could be heard by a large gathering of people in the open air. A Marconiphone outfit was used, with a Marconi-Reisz microphone.

Such was the success of this relay that H. Binns, Son & Co., Ltd., have secured a contract for four consecutive Sunday evening broadcasts.

#### CIGARETTES AND A P.A. SHIP!

##### Portsmouth Dealer Supplies Equipment.

"Craven A" publicity is always effective and striking. The latest scheme adopted to boost these well-known cigarettes takes the form of a graceful white motor cruiser which, with "Craven A" boldly displayed along the side, is visiting several popular seaside resorts during the summer, and is broadcasting radio concerts.

The success of the whole venture is largely due to the effort of Mr. Ernest Wyatt, a well-known Portsmouth wireless dealer, who supplied the radio equipment. Being the Marconiphone agent in Portsmouth, Mr. Wyatt naturally used a Marconiphone outfit on the cruiser, which he has equipped with a special loud-speaker and amplifier having an audible range of two to three miles. Both broadcast and gramophone music are utilised in the concerts.

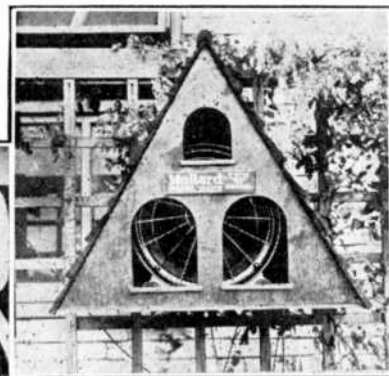

The above photograph shows how Mullard speakers were concealed on Selfridge's roof gardens. On the left is a view of a special window display staged at the same time at this London store.

# Canada Wants British Goods.

## Big Opportunities in the Dominion.

**A**LTHOUGH in the past little, if any, British radio business has been done with Canada, recent developments in the Dominion show great promise of possible increased trade in the future.

There exists in Canada at the present time a most definite desire to buy British goods, despite the intense competition from the United States. Canada, to put it baldly, is "fed up" with buying from America, from whom she receives little trade return, and is showing a distinct preference for British products, as was revealed by statements made at a recent meeting of the Overseas Trade Development Council by Sir William Clark, K.C.S.I., K.C.M.G., who is the High Commissioner in Canada for the British Government, and whose opinions, after his eighteen months' sojourn in the Dominion, are certainly authoritative.

In the first place, Sir William emphasised the bright prospects of future trade in Canada, where the economic situation is very sound. In fact, taking all things into consideration, there is probably no other country in the world showing such promise of early and rapid economic expansion.

At the present moment Canada takes some two-thirds of her total imports from U.S.A. and hardly one-sixth from Great Britain. Nevertheless, Sir William Clark is convinced that this disparity could easily be lessened if British exporters would only make appropriate efforts.

Throughout his extensive travels in Canada Sir William Clark found everywhere a growing desire to buy from the United Kingdom goods not yet produced in the Dominion itself. Increased preferences in the Budget, he said, were one expression of this desire, and British exporters will be foolish not to grasp the opportunity thus afforded them. The increased preferences cover a very wide range of headings in the tariff, and give every possible advantage to Great Britain.

Discussing methods of attack on the Canadian market Sir William said that there was still the competition from U.S.A.—enjoying geographical advantages—to be combated. There was also the remarkable growth in manufactures within Canada herself, to which our trade should be supplementary rather than competitive. In addition there was a factor which perhaps those who lived in a somewhat conservative country like the United Kingdom were apt to overlook, namely, the constantly changing demand arising from changes in conditions of living.

Careful consideration should be given to the marketing policies adopted; whether agencies should be appointed, branch factories erected, or marketing organisations established. The possibility of alliances with Canadian producers should not be forgotten.

Concluding, Sir William Clark again urged that every effort should be made to increase British trade with Canada. This could not be done without effort, but new tariffs were an invitation to make that effort.

We publish extracts from Sir William Clark's speech through the courtesy of the Department of Overseas Trade, and it is felt that radio manufacturers should now take this opening for gaining a long-awaited footing in North America.

### Longer Business Hours.

Under an order made by the Devon Town Council, the trading hours at Ilfracombe for wireless dealers and other traders have been extended to 10.30 p.m. on Saturdays, and to 10 p.m. on other days of the week, during July, August and September.

### National Accumulators at Wimbledon.

The loud-speaker installation at the Wimbledon Centre Court was equipped with batteries supplied by the National Accumulator Co., Ltd., 93, Great Portland Street, London, W.1.

### TELEVISION IN LONDON THEATRE.

#### Large Baird Screen to be Used.

In the near future a Baird television screen is to be installed in one of London's leading theatres, and this will be the first public demonstration of screen television ever given. The actual theatre has not yet been selected.

The equipment, we are informed by an official of the Baird Company, will be exactly similar to that described in our issue of July 5th. The screen will be about 2 ft. wide by 5 ft. high, and the demonstration will mark a tremendous step forward in the science of television.

#### Marconiphone's Second Sales Letter.

Dealers will learn with interest that the second Marconiphone sales development letter, entitled "A July Tonic!" has now been issued. It gives the broad outline of a useful scheme on lines recommended in our columns in the past for stimulating trade during the present period.

#### Brown Bros. and the Televised Play.

As we announced last week, the B.B.C.

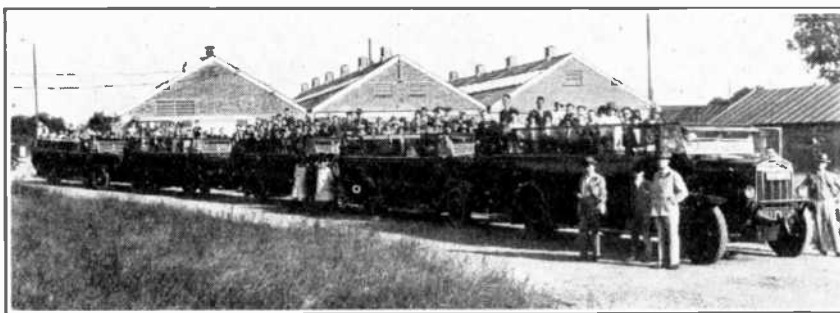

Off for the day. Some 200 of the McMichael employees setting out for Southend recently. The three main bays of the Slough works can be seen in the background.

### Trader's Music Recital.

The results of the effective poster reproduced in the columns of our June 21st issue, giving publicity to the wireless gramophone recital arranged by Mr. H. B. Hicking, of Albermarle Road, Beckenham, and the Marconiphone Co., Ltd., were completely successful.

After a short talk had been given by Mr. Youle, of the Marconiphone Co., stressing the advantages of radio in the home, a concert consisting of broadcast and gramophone music took place, and light refreshments were also served.

Demonstrations were then given, and general satisfaction was expressed by the audience at the performance of the apparatus.

### The German Radio Show.

For the first time the German Radio Exhibition will be run in connection with the Talking Machine and Record Exhibition. It will be held in six newly built halls in Berlin from August 22nd to August 31st.

In addition to the latest gramophone and radio products, there will be a special exhibit run conjointly between the German Post Office and the German National Broadcasting Co., showing the development of broadcasting in the Fatherland.

Any further information will be readily given by the Ausstellungs-, Messe- und Fremdenverkehrs-Am't der Stadt Berlin, Charlottenburg 9, Königin Elisabeth Str. 22.

are broadcasting a play for sound on 261 metres and for vision on 356 metres from 3.30 to 4.0 p.m. next Monday, July 14th. The title of the play is "The Man with the Flower in His Mouth."

Traders will doubtless be particularly interested in the announcement that Brown Bros., Ltd., are arranging to have a Baird Televisor operating in their showroom at Great Eastern Street, London, and at their branches. Dealers are cordially invited to attend.

### The McMichael Treasure Isle.

Those traders who listened to Mr. McMichael's account of a treasure hunt a short time ago will be interested to learn that this talk is to be given from Madrid and all Spanish stations in the near future.

The Treasure Island in the account is the small island of Alboran at the Eastern end of the Mediterranean.

### South-Western Shopping Week.

Arrangements have been made for the Plymouth and Devonport Shopping Festival to take place this year during the week beginning Monday, October 20th. The traders of the city are offering substantial prizes to the public in connection with the event.

At the suggestion of the local Chamber of Commerce the traders of Camborne are also meeting to consider the question of organising a shopping week.

## The War on "Noise."

### FURTHER DEVELOPMENTS IN KENT AND ESSEX.

**F**URTHER instances of the attacks made by local committees, associations, and the like upon alleged noisy loud-speakers have come to hand. At the Essex County Council at Chelmsford last week the Parliamentary Committee reported that, having received complaints of annoyance caused by loud-speakers, they had ascertained that, although a by-law had been allowed by the Secretary of State to one or two counties, it had not been allowed in respect of rural districts. The Committee had therefore submitted observations to the Home Office in the hope that the Council would be permitted to make a by-law applicable to the whole of the administrative county, with the exception of municipal boroughs. Councillor H. Chester, chairman of the Committee, said that he could not understand why a man should be subjected to "an intolerable nuisance" in rural areas, and yet could be protected from the same in urban areas. He hoped the Committee's representations would be successful. The Council endorsed the action of the Committee.

Last week we published a note dealing with the "noise nuisance" in Bromley, Kent, where the Council of the West Wickham Residents' Association have sent a letter to the Bromley Rural Council asking if a by-law could be passed to abate the disturbance caused by noisy loud-speakers.

At a meeting of this Council on July 3rd, the letter was read. The clerk said that the Rural Council had no jurisdiction in the matter. He was informed by the Kent County Council that they had not adopted a by-law to deal with loud-speakers, and that the ordinary street nuisance by-law did not apply unless the loud-speakers were actually in the street. The matter was referred to a committee for consideration.

The question of the offending speaker being actually in the street is also raised in our Court Case page this week, where a report upon a Stockport prosecution is given.

#### MUSIC IN PUBLIC HOUSES. Radio-Gramophones Allowed.

The misunderstanding which existed in regard to the installation of radio-gramophones in licensed houses at Portsmouth has now been put right by the Portsmouth Licensing Justices.

At a recent special transfer sessions, Mr. G. H. King, appearing on behalf of the Licensed Victuallers' and Beer Retailers' Associations, applied for music and singing licences in respect of over fifty public houses and well over 100 beer-houses in the City. He referred to the fact that permission had been already granted for the installation of wireless sets, but it had been found that this did not cover radio-gramophones, and it was now desired that the licence should apply to gramophone music as well. The application was granted.

Although a number of licensed houses in Portsmouth had ordered radio sets since the matter was last before the Licensing Justices, the installation had been deferred in many instances because radio-gramophones were desired. The permission now granted should give a good impetus to better-class sales.

#### Dealers Tie-up with Coventry Carnival.

In connection with a carnival recently held at Coventry, a special display was made at the establishment of H. Payne & Co., Jesson Street, who featured a 5-valve portable set priced at £8 8s.

Mr. H. Crane, 127, Far Gosford Street, in addition to exhibiting H.M.V. portable gramophones, made an excellent radio display.

#### Committee on Shop Assistants' Hours.

Many reasons were put forward by representatives of retail fruiterers that the restriction of shop assistants' hours would have an adverse effect on trade when the Select Committee met again, at the House of Commons, on July 4th, with Mr. Chas. Buxton, M.P., in the chair.

Mr. T. D. Matkin, secretary of the Retail Fruiterers' and Florists' Association, said the average number of hours worked in the shops was 56 per week. They were of opinion that it was not possible further to shorten the hours of trading, and still maintain an efficient service to the public. Any compulsory reduction of the present hours of labour would involve the engagement of further staff, which would in turn involve extra expense upon the trader. The Committee sat again on Wednesday, July 9th.

#### Marconi Company's Report.

The report of Marconi's Wireless Telegraph Co. for the two years ended December 31st last states that the net profit amounted to £796,235 (as compared with £430,471 for the year 1927). The balance brought forward was £23,777. The dividend on the 7 per cent. cumulative participating preference shares for the two years totals 29 per cent., of which 17 per cent. is in respect of 1928 and 12 per cent. of 1929. The dividend on the ordinary shares for the period under review is 35 per cent., of which 20 per cent. is in respect of 1928 and 15 per cent. of 1929. After allowing for these distributions there remains a balance of £38,966 to be carried forward. The whole of the debenture stock outstanding at December 31st, 1927 (with the exception of £19,416 redeemed in cash), has been converted into ordinary shares of the company. A meeting will be held on July 14th.

#### Another Wireless Exchange Fine.

By a coincidence, there was a second prosecution at Portsmouth last Monday (we published details of the first in our issue of June 21st) for tapping the distributing lines of a wireless exchange, when an electrical artificer was summoned for unlawfully diverting electricity. He appears to have stuck two needles into the wire, which ran nearby, connected some cotton covered wire to the needles and led this to a transformer and loud-speaker in his house. He was not, of course, a subscriber.

The Bench imposed a fine of £5.

#### RADIO AT PROVINCIAL SHOWS.

At the Staffordshire Agricultural Show held recently, a radio exhibit was staged just inside the main gate by Cy-Car-Mart, Cross Street, Burton. They displayed a comprehensive selection of all-electric and battery sets.

At the Sussex County Agricultural Show held at Hastings an interesting display was made by Butler's Radio Supplies, 16, Cambridge Road; 5, Hughenden Place, Hastings, and 8, King's Road, St. Leonards. They had a special Marconiphone display, and made a feature of the well-known Marconiphone portable receiver.

The firm also provided the music during the run of the show.

## PERSONALIA

#### A WEST COUNTRY WEDDING.

**T**HE wedding recently took place of Mr. John A. Uppington, West of England representative of Graham Amplion, Ltd., to Miss C. D. Stephen Evans, of Halberton, Tiverton, Devon. The ceremony was held at the bride's home, and Mr. S. J. Williams, of Kolster-Brandes, Ltd., was best man. Mr. Uppington wishes to thank, through the medium of our columns, his many friends in the trade for their presents and telegrams of congratulation.

Mr. and Mrs. Uppington intend residing in the West of England, their address



Mr. & Mrs. Uppington, photographed on the occasion of their recent wedding at Tiverton.

being "Cathalton," Lake Road, Henleaze, Bristol, which (to strike a more prosaic note), should be kept handy for reference by any traders desiring to get into touch with Mr. Uppington.

#### TWO MORE K-B CHANGES.

We hear that Mr. M. S. Barraclough who hitherto has been area manager at the Bristol depot of Kolster-Brandes, Ltd., has now been appointed manager of the K-B "Dual" motor department.

Mr. S. J. Williams, who was previously in charge of the "Dual" motor department, has taken up the position relinquished by Mr. Barraclough at Bristol.

# Revised I.E.E. Regulations for Mains Apparatus

*THE Institution of Electrical Engineers has just published some revised regulations concerning radio apparatus used in conjunction with the supply mains. By the courtesy of the I.E.E. we are able to give below certain extracts from the new regulations.*

**A** NEW supplement to the Regulations for the Electrical Equipment of Buildings, formulated by the Institution of Electrical Engineers, and dealing with mains-operated radio apparatus, has just been published. This supplement supersedes that dated June, 1928. Copies may be obtained on application to the Secretary of the Institution of Electrical Engineers, Savoy Place, Victoria Embankment, London, W.C.2.

According to Section 129, the regulations apply to radio receivers and valve amplifying apparatus for home use, business premises, public buildings and factories, but not to charging stations, for which there is a separate regulation, 60E. In addition, all receivers and amplifiers, not necessarily originally designed for mains use, but which are operated through any form of mains supply unit, come within the scope of the regulations.

As in the earlier regulations, the apparatus must be adequately protected by fuses on *both poles* of the supply circuit, and these must be *in addition* to any fuses which may be incorporated in the apparatus itself. The cable between the apparatus and the mains must also conform to certain regulations.

## The Container.

Regulation 133 deals with the cabinet, metal or moulded container of the apparatus, and states that the "inner structure" (which includes the components, wiring and screens) must be enclosed so as to prevent accidental contact with any part of it that is not metallically connected to the earth terminal of the apparatus. Further, all holes in the case must be made so as to avoid abrasion of the cables.

The case of a power unit must either be of metal or a non-ignitable insulating material, though the base may be of certain specified woods, or other material, covered with non-ignitable material. There is also a clause stating that the general rise in temperature of the air in the case must not exceed 75 degrees F. above room temperature.

For all apparatus other than power supply units, the case must be constructed so that the temperature rise of the air inside or any woodwork or other ignitable material does not exceed 60 deg. F. above room temperature. The permissible temperature rise has thus been considerably reduced in the new regulations. All external cases made of metal must be earthed, and an earthing terminal must be provided.

## Protection of Live Parts.

Regulation 134 deals with the protection of "live" parts. Any terminal, knob, control, metal part or end of a wire which is "live" must be guarded to prevent accidental contact under normal conditions of use. The mains switch (or connector) nearest the supply must be of the double pole type.

Battery chargers for charging a battery *in situ* must be designed so that the supply mains are isolated from the terminals of the radio set or amplifier. In the case of A.C., a double-wound mains transformer complies with this. A rectifier is regarded as a conductor, so that an auto-transformer and a rectifier do not comply with the regulation.

## The Isolation of Terminals.

Regulation 135 deals with the isolation of terminals, and is much fuller than the corresponding section in the previous supplement. The regulations are given in tabular form, and cannot be fully reproduced here, but the main points are mentioned below.

A.C. apparatus must be isolated by a double wound (separate primary and secondary winding) mains transformer complying with later regulations. The earth terminal of a set or power unit, in the case of A.C., must be connected to the part of the inner structure which is to be at earth potential. In the case of D.C. mains, the earth terminal must be isolated from the inner structure. The use of a suitable fixed condenser is suggested. Similar regulations apply to the earth terminal of a set used with a separate power unit.

The aerial terminal in A.C. sets must either be metallically

connected to the earth terminal (through a coil) or, if isolated from earth, it must also be isolated from the inner structure of the set. In D.C. sets, the aerial terminal must be isolated from the inner structure by means of a double wound H.F. transformer or by a condenser. The H.F. transformer must be insulated for 600 V D.C. (or twice the supply voltage, if this is greater), and the insulation resistance at 500 V D.C. must not be less than 2 MO.

H.T. terminals must be guarded according to Regulation 134. Loud-speaker terminals in the case of A.C. sets must be isolated from the inner structure, except in the case of a terminal which is at earth potential and is connected to the earth terminal of the apparatus, and in the case of built-in loud-speakers. In D.C. sets, however, the loud-speaker terminals must all be isolated from the inner structure by means of an output transformer or by condensers. In the case of headphones, a double-wound output transformer must be used in A.C. and D.C. sets, and the output terminals of this transformer must not be earthed.

Pick-up, microphone, and similar terminals must be isolated from the inner structure of D.C. sets. In A.C. sets they must also be isolated except when connected to the earth terminal. This would appear to indicate the necessity for a pick-up input transformer.

## Test Voltage of Condensers.

Regulation 136 deals with condensers, which must conform with British Standard Specification No. 271. For use in circuits where the voltage does not exceed 300, the D.C. test voltage must be 600, or such higher minimum test voltages as may be requisite to comply with later clauses. For D.C. mains apparatus the test voltage must be twice the supply voltage (or 600 V, whichever is the greater). On A.C. mains the test voltage must be at least *three* times the R.M.S. value of the alternating voltage applied to the terminals of the condenser. Any condenser connected through a rectifier to an alternating voltage is considered to be working at that voltage. Thus, if in an H.T. supply unit the mains transformer supplies a voltage of 300 R.M.S. to the rectifier, the test voltage of any condenser across the rectifier circuit must be at least 900 V. For condensers in loud-speaker filter circuits, the test voltage must be at least three times the D.C. voltage on the anode of the last valve or valves.

## Regulations for Transformers.

Transformers are dealt with in Regulation 137, which states, amongst other things, that every mains transformer must have its core earthed (except in special circumstances) and must be of the double-wound type, capable of withstanding 1,000 V (R.M.S.) A.C. between the windings and between windings and core. The insulation resistance after the voltage test must be at least 20 MO between windings, and between windings and core, the test voltage being 500 D.C. or twice the supply voltage if this is greater.

Similar regulations apply to output transformers, except that the pressure test must be carried out at 500 V A.C. or twice the supply voltage, if this is greater.

Finally, in Regulation 138, the insulation resistance tests are specified. There must be a resistance between isolated terminals of at least 2 MO at 500 V or twice the supply voltage. Between aerial and supply terminals, earth and supply terminals, and loud-speaker and supply terminals, there must be a similar minimum resistance. Batteries connected to radio apparatus and intended to be metallically connected to the supply mains must also have a resistance of 2 MO from earth, tested at 500 V or twice the supply voltage if this is greater.

This completes the new regulations, which mainly consist of an amplification of the older ones, doubtful points being cleared up. All manufacturers and dealers handling mains apparatus are recommended to secure a copy of the new regulations and make themselves *au fait* with them.

# PROVINCIAL TRADE NOTES

## Portables and Mains Units Sell in Bristol.

**A**N important radio store in Bristol has recently changed hands. The Broadmead Wireless Co., 61-62, Broadmead, Bristol, has passed from Mr. H. W. Smith, the founder, to Messrs. C. H. Gould, L. W. W. Davis, and B. J. Turner, and is now under the management of Mr. Turner. The Broadmead Wireless Co.'s premises are centrally situated in one of the main business thoroughfares. A full range of apparatus and accessories is stocked, and there is an efficient service department. Mr. Turner is, of course, well known locally as the Hon. Secretary of the Bristol Radio Traders' Association.

The general opinion seems to be that trade at the moment is very slack. Many of the smaller shops are finding sales few and far between, but the larger retail stores maintain summer business with the sale of portables and the usual replacements. The demand for mains units is fairly good just now, especially for the "Ekco" and "Regentone" portable models. Accumulator charging is a good standby for the trader who has a regular number of customers. Prices, however, continue to vary. The gramophone side is steady, with good sales of portables and records.

Recently the Bath Parks Committee decided not to allow gramophone recitals in the local parks. The decision arose through the action of the superintendent of Victoria Park in stopping a man giving a gramophone recital in aid of hospital funds, and his action was upheld.

## Colchester Dealers at an Empire Show.

**T**HE wireless trade was well represented at the Colchester Empire Exhibition, the first of its kind to be held in the Eastern Counties, from July 4th to 10th.

Shrosbery & Bakewell, Ltd., of Crouch Street, Colchester, who had a stand on which were displayed radio and gramophone lines, also gave some excellent demonstrations of television with a Baird televisor. These were most successful and were witnessed by large numbers of people.

The Mullard Wireless Service Co., Ltd., had a public address demonstration van at the show. It was equipped with a 600W amplifier, which supplied the whole of the musical programme throughout the exhibition and carnival grounds. The equipment was open to inspection by the public, and in order to help them to understand the operation of the equipment a large scale map of the grounds was exhibited.

Joslins, Ltd., of High Street, Colchester, and of Chelmsford, had a stand at which wireless had its place in the shape of "Gecophone," McMichael and Amplion portable receivers.

Mr. F. W. Straw, of St. John Street, and Short Wyre Street, Colchester, also displayed radio sets and components,

radio-gramophones, H.M.V., Columbia and Zonophone records, and portable and cabinet gramophones.

## Dull Trade in Edinburgh.

**N**OT for many years have sales in Edinburgh been at such a low ebb as at present. The general depression in trade and the spell of fine weather account for this. Moreover, owing to the scarcity of money, luxury trades—and some people consider that wireless comes under that category—are suffering. This time last year there was a boom in portables, but this summer, I am told, there is but a small turnover. All-mains sets and portables are the main stand-by. There is little sale for components, but servicing is keeping some traders fairly busy.

Mr. A. H. Baird, Lothian Street, finds the Burndept de-luxe portable and the Philips 3-valve all-mains set most in demand.

The portables which the Bell Radio Co., George Street, are selling, are the Burndept and the Marconiphone, and among all-mains sets, Pye and R.I. models.

Spensers (Scotland), Ltd., George Street, are also featuring the Burndept de-luxe portable.

Complaints continue locally regarding the few opportunities for set testing during the day. Daventry is usually broadcasting, but owing to local interference many traders cannot get satisfactory reception from that station, much completely spoiling the broadcasts. The potential purchaser blames the set and is not satisfied when the dealer explains that there are no local transmissions. When the new Scottish Regional Station is functioning a big

boom in trade is anticipated, but the date of the opening will not be for many months yet.

Mr. Lyon of the wireless department of Rossleigh, Ltd., Queensferry Street, does not share the general view that trade is dull just now, for he has no complaint to make about sales in recent weeks. He told me that in May of last year his sales were a record for that month, and this May he broke last year's record. April was a poor month and had been so for the last six years. His trade during recent weeks has been a general one. The Pye has been his best seller among portables, which, however, were down compared with last year. His best all-mains sets have been the Pye, Marconiphone, Burndept and Philips models, while the Burndept radio-gramophone and AC7 set have also found purchasers. The gramophone trade has been quiet recently, the principal turnover consisting of Edison Bell and Decca lines. Rossleigh, Ltd., are one of the few firms who advertise regularly in the local daily papers. Mr. Lyon considers the expenditure in this way well justified.

## Pye Portable Sells in Hereford.

**I**N Hereford and district wireless traders are continuing to give prominence to portable sets of popular makes, and striking window displays are to be seen this week. Their initiative is meeting with a good reward, and satisfactory sales are reported. Perhaps the outstanding seller at present is the Pye portable.

C. F. King, of Eign Street, have a riverside screen as an effective background to a fine selection of Marconiphone portables. Mr. Critchley here informed me that these sets were moving well, as were Pye portables. "We are ordering Pye's in half-dozens, and can sell them anyhow," he said.

A fair trade is being done in components, and traders who specialise in repairs have their engineers fully occupied with overhauls. Pertrix H.T. batteries are rapidly gaining in popularity.

Mr. C. Smith, proprietor of Smith's Wireless Stores, Church Street, combats the disadvantage of being in a side street by sustained advertising, and he always has original window displays. There is a comprehensive stock of complete sets and speakers within. Mr. Smith is doing good business with Pye portables.

Several excellent gramophone displays, particularly at Fred Preece's, Church Street; Hein's, Broad Street, and Turton's, St. Peter's Square, are worthy of note. Decca portable models are selling well, with H.M.V. machines a good second.

## Hull Mains Developments.

**R**ECENT developments in connection with the local mains supply, coupled with the gradual change over to A.C., is maintaining the sales of mains apparatus, the most popular units being the "Ekco" and "Regentone." The attention of the Corporation Water Supply



The front of Mullard's new premises at Bristol on the occasion of a recent special British-French Week.

# Frankness

Q Ever since the introduction of the AMPLION five valve all-mains receiver, the trade and public alike have agreed that for realism of reproduction, this set far surpasses anything hitherto produced.

Q Nevertheless, Graham Amplion realise that there are listeners who have been deterred from buying this receiver owing to the fact that it was not supplied in cabinet form.

Q Graham Amplion now offer their all-mains receiver in an attractive cabinet, the design and finish of which do no more than justice to the superlative performance of the set.

In accordance with their recently announced policy, Graham Amplion are not withholding the production of their newest models until the Radio Show, but are giving the trade the opportunity of handling such lines without delay.

# AMPLION

# AMPLION

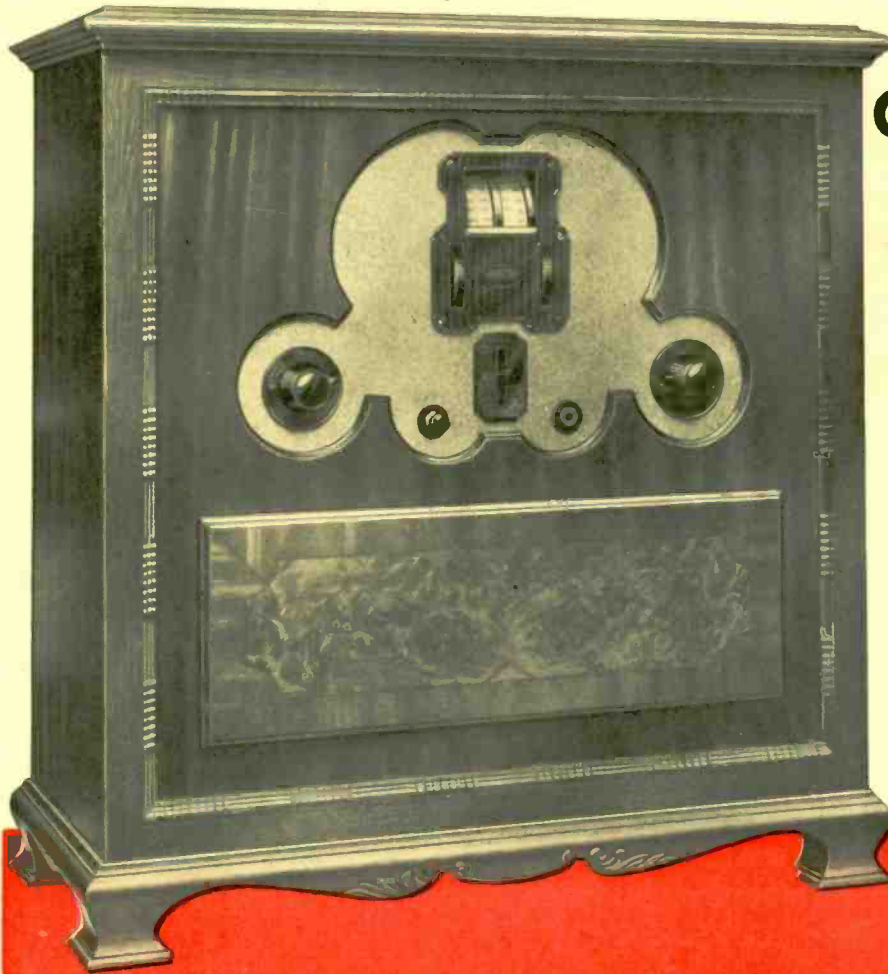

## A.C. MAINS CABINET SET

# £55

This cabinet model is the Amplion five valve all-mains receiver in its latest form.

Where difficulty is experienced in erecting an aerial, provision is made for using the house wiring as an aerial for the reception of local or powerful stations.

**A** most handsome cabinet set of distinct

design in mahogany with walnut panel.



# O N I

## CABINET RADIO TYPE A.C.50

OAK.. **£65**

MAH.. **£66**

By combining the Amplion all-mains receiver, and the largest "Lion" speaker type L.C.50 in one cabinet, reproduction is assured of a quality superior to that obtainable from any other combination set and speaker.

The house wiring may be used as an aerial for receiving nearby or powerful stations.



**Q** A really fine set and a famous

speaker in one handsome cabinet.

Read what a trader says:—

"For our part we have yet to handle a Portable giving equal results. It is certainly the best yet, and a credit to the name of Amplion."

Graham Amplion Ltd. wish to take this opportunity to thank the many members of the trade who have written to them on the subject of their Portable Set in a similar vein.

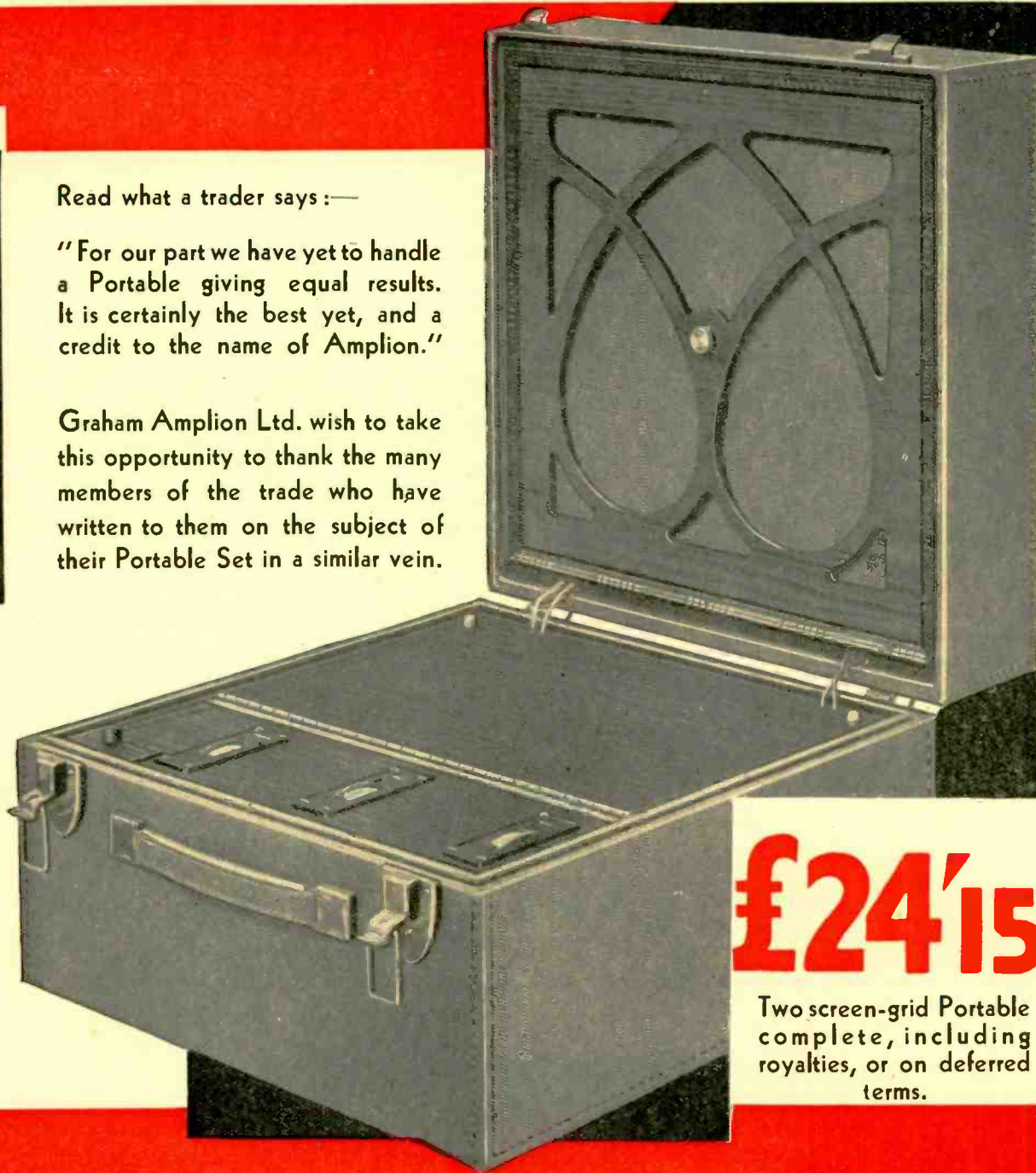

**£24'15**

Two screen-grid Portable complete, including royalties, or on deferred terms.

*A well-known dealer writes . . . .*

**"A CREDIT TO THE NAME OF**

**AMPLION"**

GRAHAM AMPLION LTD., Sales Offices and Demonstration Rooms, 26, Savile Row, W.1.

Works: SLOUGH.  
royds

Department has been drawn to the practice of using the water tap as an earth. In some cases chemical action has been set up, causing the department trouble from a repair standpoint, and it is forecast that in the near future listeners will be forbidden to use the water tap as an earth. In this event there will be a boom in earth tubes.

Wireless retailers in Hull have been served with a notice to the effect that if loud-speakers are used in their shops in such a manner as to cause annoyance to adjacent residents, or to cause crowds to assemble, a fine will be imposed.

The new Amplion portable set has been demonstrated in Hull, and has given excellent results. The demand for portable sets just now is, however, not very great.

Speakers are maintaining a steady sale, the new "Blue Spot" units, and the Undy and Farrand assemblies being most in request. A small but steady demand also exists for the Marconiphone A.C. moving-coil speaker.

### Liverpool Trader's Narrow Escape.

ALTHOUGH business is not too bright at the moment, some excellent displays are to be seen at many radio stores. Quite a considerable amount of activity is also apparent among local distributing houses.

S. Hathaway & Co. are now firmly established at their new premises, where there is plenty to interest traders who have time to call and look round. The building at the corner of Edge Lane and Beech Street is of imposing appearance, but gives one but a bare idea of its extent and contents. Offices, showroom, stores, delivery stations and garages are all on the same ground level, and there is an air of efficiency about them all. Especially is the delivery department notable, for here the complete fleet of vans can be loaded direct from the stores without any article having to be exposed to the weather. An extremely comprehensive stock is carried, and the firm's policy is to supply what is asked for, and not to give preference to any one line.

The ground floor includes also a battery repair shop, and ample space is provided for future extensions. Possibly, a certain

amount of manufacturing will be undertaken later, but everything now is for the trade. Both A.C. and D.C. electricity supplies are laid on.

In front of the premises is parking space for about thirty cars, a useful point for distant customers.

The premises are within ten minutes of Edgehill Goods Station. Incidentally, the new telephone number is Anfield 844.

At the G.E.C. showrooms in Church Alley, members of the radio department are always glad to show dealers the latest lines. For example, the M.C. speaker, which has been here for two months, is being demonstrated at different places in the district.

An entertainment equipment which is of particular interest comprises an electric gramophone, power amplifier and loud-speaker with baffle. This can be used on D.C. with a converter, which can be supplied by the company. A travelling van is visiting the trade at the present time. A 3-valve all-mains set is being pushed, and the department are proud of testimonials to its excellent performance in this district. The 4-valve screened-grid portable is increasing in local popularity.

The radio trade in Liverpool has been remarkably free from accidents, but a few days ago a great storm which swept the city brought down a hundredweight of metal from sixty feet above Mr. A. P. Bolton's private office at the Drury Radio Co. The office itself is roofed with glass. Some of the pieces of iron which fell through missed Mr. Bolton by inches, and many splinters of glass were found in his hair afterwards. Mr. Bolton was away from business later with shock. The counter department and stores in Drury Buildings are open as usual.

### Present Trade in Reading.

IN common with other parts of the country, trade in Reading during the past month or so, although fair for the time of the year, has been very quiet, and there is nothing which lends itself to comment. At Harris & Russell, Ltd., the wholesalers, of Blagrave Street, I was informed that the only thing which was really going strongly was the Pye portable. I learned, too, that "Blue Spot" units are achieving popularity, and there is a satisfactory trade in components for the new Mullard sets.

### Stockport Branch, W.R.A.

THE midsummer meeting of the Stockport branch of the W.R.A. was held last week at Aerial House (by kind permission of the Chairman, Mr. J. W. Heaps).

The first topic to be discussed was the suggestion of the National Council that the Association should take a stand at the Manchester Wireless Exhibition, and that the local branches should assist at the stand.

The general feeling of the branch was that the London Headquarters should make arrangements for a representative to attend the stand, as the local members were naturally busy on their own premises till late in the evening. It would therefore be impossible for local members to give their time to the Association's affairs at the Show.

It was reported that the National Secretaries of the Association had advised the branch of a special meeting to be held on July 9th to consider the proposed County Executives. Each branch had been invited to send a representative.

Mr. Harold Carter and Mr. Goostrey accepted nomination to attend, and were empowered to put forward the views of the

Mr. H. R. Henderson, of 24, Market Place, was in a quietly optimistic mood but the only thing he had to tell me was that there was an increasing demand for mains units, while all-mains sets are "catching on."

Whatever the state of trade in the town one must praise traders for the way they are boosting their goods. They cannot use one useful publicity method because the Chief Constable refuses to alter his decision made many months ago, in the days of raucous loud-speakers, not to allow wireless traders to broadcast music from their shop doors and windows.

### Yorks Dealers Discuss Window Displays.

DISCUSSING recently the relation of window displays to sales, a West Riding dealer told me that he could definitely trace increased sales of a particular line when he had featured that line prominently in the window. Another local trader gave an even more convincing instance of the value of window displays. Two years ago he made a feature of a special component manufactured by his firm, but for good reasons he had since dropped it. Imagine his surprise, therefore, when a customer who lives ten miles away recently asked for the special component, which he remembered having seen displayed so long ago when he had not the money to buy it!

Experience is proving that an increasing number of traders in the West Riding is being converted to the hire purchase system of trading. Many who were strongly opposed to it a short time ago are now in favour of it. The number of bad debts contracted up to the present is surprisingly small, doubtless due to the care taken in selecting customers.

When meeting various traders in this part of the country I often hear the complaint that southern manufacturers are not sufficiently acquainted with conditions in the north, and that the bulk of sets manufactured are designed for the south. This complaint was heard on two occasions in one town recently regarding portables. Many traders report a falling off in sales of these sets, but whether this is due to the fact that it is impossible to buy a set suitable for northern conditions, and at a reasonable price, or if it is another result of depression in the textile trade, I am not in a position to say.

Stockport branch as regards branch organisation in relation to the London Headquarters.

After various criticisms had been levelled against the attitude of Headquarters towards the branches and the organisation as regards the canvassing of new members, the discussion turned to the suggestion made in THE TRADER that manufacturers should invite traders to visit their works.

The Chairman (Mr. J. W. Heaps) said that such visits would be of great benefit to dealers as a whole. He pointed out that there were a number of important factories within the vicinity where a dozen or so retailers would probably be welcome. Such visits would be not only an outing, but a sound and practical means of gathering practical information.

Finally, it was decided that letters should be sent to the Ferranti and "Exide" works, asking for permission to go over these factories. Further, the Stockport members agreed that other Lancashire branches should be notified of the idea, with the view to a combined outing.



# SOUND- PROOF ROOMS

*are becoming essential for the radio-gramophone trader . . . . . but they*

## ARE NOT PROHIBITIVE IN COST.

**I**N the earlier days of the radio trade a large percentage of the average retailer's sales consisted of components and accessories, with only an occasional request for a complete set. Nowadays, however, as is well known, the reverse is the case, and the turnover from sales of receivers and reproducers is generally far greater than that from components, except, perhaps, in working class districts. Moreover, the radio receiver is now widely regarded, as is the gramophone, as a musical instrument, often on a similar footing to the domestic piano. Therefore, facilities should exist at the radio retailer's premises for the efficient demonstration of receiving sets and loud-speakers.

It is generally recognised among retailers that a well-equipped audition room is essential in the up-to-date wireless business, but in many cases the belief that such a "luxury" would necessarily be prohibitive in cost, or very difficult to accommodate within the confines of the average shop, has caused dealers to abandon the idea. That is a mistake—as this article endeavours to show.

When considering the erection of audition rooms the trader is fortunately spared the necessity of delving into the intricacies of acoustics—although the study is an interesting one for anyone interested in music, as the radio-gramophone trader should be—for sound transmission and sound insulation have recently received considerable attention from several firms who specialise in the construction of audition rooms. The result to-day is that there is a great variety of materials on the market suitable for panelling off sections of the shop as more or less sound-proof chambers.

It may be well to explain that the construction of sound-proof audition rooms is not necessarily a work involving big expense. Having decided upon the construction of one or more audition rooms, the trader must obviously make the work worth-while by choosing a material which has definite sound-proofing qualities, and the difference in price between sound-proof material and ordinary building boards is very slight. It will be understood, of course, that the term "sound-proof" is a relative one, for nothing short of a hermetically-sealed chamber can be sound-proof in the strict sense of the word. It is, however, usually sufficient if exterior sounds are reduced to a negligible degree.

Although it is important to use good sound-insulating materials, the method of construction is even more important than the material used. Before proceeding with the methods of construction, however, it will be as well to discuss a few elementary principles of sound insulation.

### *The Principles Involved.*

The elimination of noise resolves itself into two problems. The noise may originate in the structure of the shop, or it may enter from outside through windows and ventilators, or penetrate through the walls or partitions of the building.

Structure-borne sounds, such as those produced by motors and other machinery, cause vibration, and insulation can only be obtained by introducing padding or sound-absorbing materials in the path of the sound. For a shop in a large building which is given over to miscellaneous purposes, or for the wireless or gramophone section in a department store, this problem of structure-borne noises may become an acute one. Where structural alterations are out of the question, the use of a sound-absorbing material on the ceilings of the departments below, and between the floor-boards and the supporting joists of the floors above, will often prove an effective deterrent to structure-borne noises.

Air-borne or transmitted sounds include outside noises and the music which penetrates from one audition room to another, and these are the points more likely to affect the ordinary trader. The infiltration of outside noises may be reduced to negligible qualities by lining the ventilator ducts with sound-absorbing material, or by having a simple device to filter out a great proportion of the sound entering through open windows. These external sound waves may be direct, or may be reflected from the buildings opposite. Deep flat cornices over the windows should be lined with absorbent materials, and an arrangement of absorbent surfaces should be fitted to the portion of the window to be opened, so that while filtering out the greater part of the sound energy it permits of the free circulation of air.

Returning to the question of sound transmission within the building, we now find it necessary to consider jointly the most suitable means available of overcoming the trouble. Certain factors will be governed by the trader's own taste

while much will depend upon the size and character of the shop.

*Methods and Materials.*

Some traders have a marked preference for glass-fronted audition rooms. Now glass is a material with no absorbent capacity, and the result is that the sound produced inside such audition rooms is reverberated from wall to wall with resulting distortion and unnecessary loudness. These effects can be mitigated to some extent by the use of comfortably upholstered chairs and heavy carpets, for these have good sound-absorbing qualities. By themselves, they are not enough, however, and really satisfactory listening conditions can only be brought about by the use of a sound-corrective material on the ceiling.

One such material is called acoustic felt, and is composed of treated hair and asbestos fibre, obtainable in 1/2 in., 3/4 in., and 1 in. thicknesses, enclosed by a specially treated waterproof fabric called "oilcloth," which is perforated to allow of the full use of the sound-absorbing qualities of the felt. This material will eliminate practically all the energy accumulation caused by the multiple reflection of sound. It has, in fact, been likened to a blotting pad, for it absorbs superfluous sounds as a blotter absorbs ink, and with its corrective capacities it makes possible the use of ordinary hard-surfaced walls and floors for the remainder of the structure. There are certain limitations about this system of construction, however, for unless the dividing partitions are also suitably treated, the audition rooms are not entirely isolated from each other.

Where it is desired to have the panelling and walls of audition rooms carried out with a finish which blends with the general scheme of decoration in the rest of the premises—say a highly polished veneer—the use of a building board with its own decorative as well as sound-absorbing qualities is obviously precluded. In such circumstances, the introduction of a special felted material between the two sides of the partitions (see Fig. 1) will have the effect of isolating one audition room from another.

A good example of this method is afforded at the new premises of Alfred Imhof, Ltd., New Oxford Street, London. Here the architect has employed a felted matting of cured eel-grass, enclosed between two layers of strong kraft paper. These eel-grass fibres form a thick resilient cushion of small and irregular cells of dead air, and thus make an ideal muffler of noise. The walls of the audition rooms are decorated with a gaboon mahogany plywood.

There are twenty-six of these rooms, each fronted with glass panels. A view of this interior is shown in the first illustration, by courtesy of Huntley & Sparks, Ltd., De Burgh Road, London, S.W.10, who are specialists in sound-insulating and acoustical work.

Another material which is being effectively used as a sound-deadener, but which does not by itself present decorative possibilities, is one made

of compressed straw, reeds, rushes, marsh litter, papyrus, or similar vegetable fibres. This is produced in panels tightly bound by steel binding wires, and plastered on both surfaces. The second illustration shows partitions of this type in course of construction, reproduced by courtesy of Heat & Sound Insulation, Ltd., Craven House, Northumberland Avenue, London, W.C.2.

*The Trader's Best Scheme.*

For the trader who wishes to add audition rooms to an existing shop, with no constructional and the minimum of decorative alterations, a building-board, combining a finished appearance with sound-insulating qualities, will generally be preferable to either of the foregoing methods. These building boards are made up of fibrous plaster substances, felted together into panels of convenient sizes. An essential part of their structure from the sound-insulation point of view is the incorporation of innumerable dead air cells which prevent the passage of sound, for still air is one of the most effective sound insulators. Most of these materials have a natural tan colouring, which provides quite an attractive interior finish. If more decorative effects are desired, they can be treated with acoustical paint in stencil designs or one-colour applications.

The most effective method of using such materials as a means of isolating audition rooms is generally found to be in the form of double partitions with an air space between, so that the two surfaces are nowhere in direct contact except at the floor and ceiling, the air space nullifying to some extent the effects of vibration. These double partitions become more efficient barriers of sound, however, if another layer of the same material is placed loosely between them. This provides the maximum amount of sound-absorbing substance, and the loose partition nullifies the effects of the vibration set up in the fixed panels on either side by the sound produced in the audition rooms. The second diagram shows this method of construction in plan.

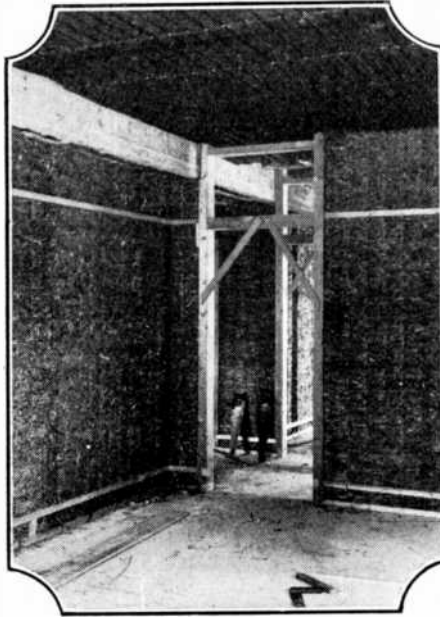

A sound-proof room in course of construction from a specially prepared material requiring an external finish.

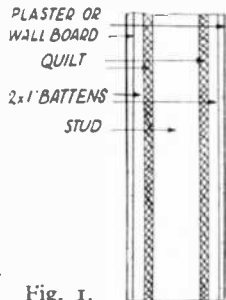

Fig. 1. How sound-absorbent felt is concealed in the wall or partitions.

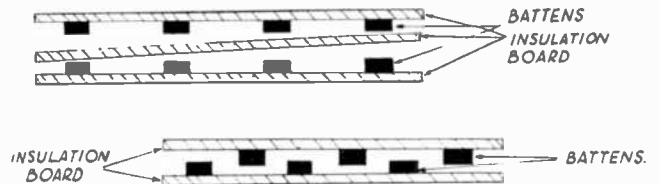

Fig. 2 (above). Plan of structure of double partition made from sound-insulating board, with a loose layer between the supports.

Fig. 3 (below). Plan of partition showing staggered arrangement of supporting studs.

A less expensive, although naturally somewhat less effective method than the one just described, but one which is probably more suitable for use in small shops where space is an important consideration, and where the panelling must be of the minimum thickness consistent with reasonable efficiency, is the construction of double partitions on the staggered stud principle, shown in the third diagram. It will be seen that the battens are so arranged that the panels are entirely separated by an air space which, as has already been said, is in itself an effective sound-deadener.

# IN THE COURTS.

## Another Mullard Valve Patent Injunction.

THE case of the Mullard Radio Valve Co., Ltd., against the London Radio Co. (Leeds), Ltd., came before Mr. Justice Eve in the Chancery Division on Friday last week. Mr. Corsellis said he had a motion by the plaintiffs for an injunction to restrain infringements of patents relating to various forms of wireless valves.

The parties had come to terms, and the defendants had agreed to treat the motion as the trial of the action, to consent to a perpetual injunction and to pay the plaintiffs £5 as damages and £10 towards costs. Defendants obtained their valves from importers, against whom two actions had been brought.

Counsel for defendants assented, and his lordship made an order in the terms agreed.

## ALLEGED "NOISE" IN STOCKPORT.

AT Stockport, last week, Abraham Hitner, managing director of The Universal Electric Supply Co., Princes Street, Stockport, was summoned under a local by-law for causing annoyance between May 24th and June 4th by the use of a loud-speaker at his firm's wireless shop. The case was the first of its kind heard by the Bench.

Police-Inspector Southern said that on May 24th a letter was sent to defendant, following a complaint of excessive noise from a loud-speaker, informing him that unless the noise were abated proceedings would be taken. On the following Monday defendant visited the police station and asked for the names of those who had complained, but witness refused to give them. At his request defendant was shown a copy of the by-laws, and later the loud-speaker was removed from the fanlight of the shop, and placed inside the premises. Cross-examined, witness admitted that it was part and parcel of defendant's trade to inform the public of the merits of his wares, which included loud-speakers. The by-law was made in 1903 when wireless was practically unknown.

A testing optician, who has premises opposite, said that the loud-speaker was operated throughout the afternoon of June 4th and prevented him carrying on his business in a proper way. Another witness said that the noise of the loud-speaker disturbed students at the School of Commerce, who were unable to concentrate. A local confectioner also complained. A police constable, who kept observation on the shop on June 4th, said that he called the manager's attention to the noise, and to the length of time the speaker had been operated. The manager replied that he was ordered to put it on. After the loud-speaker had been removed from the fanlight into the shop, the noise could be heard 50 yards away.

Mr. H. Finklestone, who defended, said this was a very important case. He contended that the by-law under which the proceedings were taken did not apply to loud-speakers, as it was made in 1903, when wireless had not been contemplated. The by-law stated: "No person shall sound or play upon any musical instrument." That surely could not apply to a loud-speaker. After the complaint was made the loud-speaker was removed into the shop, and thus, not being in a street or public place, did not transgress the by-law. The "noise" had to be within 100 yards of a dwelling place or office. Shops were not dwelling houses, and shopkeepers therefore had no right of complaint under this by-law.

A discussion then ensued between the clerk and Mr. Finklestone. The Bench, after considering the points of law raised, adjourned the case for a week pending their decision.

## HARD LABOUR FOR FALSE PRETENCES.

AT Ipswich recently John Collin Carter (17) painter, was indicted for obtaining between April 15th and May 3rd, from Mann, Egerton & Co., Ltd., two portable wireless sets, of the value of £40, by false pretences and with intent to defraud.

Mr. A. S. Leighton (instructed by Messrs. Marshall, Son & Fisk) prosecuted, and the prisoner pleaded guilty.

Mr. Leighton, having detailed the facts of the case, said that there were four previous convictions against the prisoner.

There were four warrants out against him, which he desired should be taken into consideration, for obtaining goods and money by false pretences, and there were three other offences in respect to which warrants had not been issued, which he also desired should be taken into consideration.

Detective-constable Leslie Green said the prisoner's real name was John Thomas Portier. He corroborated counsel's opening statement. The Recorder said he would do all he could to help the prisoner, but taking all the circumstances into consideration he would have to go to prison for seven months with hard labour.

## SOUTH LONDON THEFT CHARGE.

AT Tower Bridge Police Court before Mr. Oulton, Stanley Frederick Stanley Walsh (16), wireless engineer, of Pitt Street, Peckham, was charged with stealing a quantity of parts worth £11 12s. 6d., the property of his employers, the Reliance Manufacturing Co., between June 18th and 20th. He pleaded guilty.

Detective Philpot said accused was employed by the prosecutors as a wireless engineer from September, 1929, until last Saturday, when he was discharged through being slack. After he left, the apparatus mentioned in the charge was missed. He was seen and admitted taking the things. He said he wanted to make himself a set. Accused had never been in trouble before and had a good home.

Mr. Oulton: You will be remanded in custody for a week.

## A WINDING-UP PETITION.

A PETITION by the Mullard Wireless Service Co., Ltd., for the winding up of the Enterprise Manufacturing Co., Ltd., came before Mr. Justice Bennett in the Chancery Division on July 7th.

Mr. Stable, for the petitioning creditors, said their claim was for £691 12s. 4d. The petition was opposed by a large number of creditors, and it had stood over for the reason that an offer of £1,200 had been made for the goodwill and certain other assets of the company. The majority of the creditors seemed to think that that was an advantageous offer to accept. The petitioning creditors took the same view. The goodwill had now been sold for £1,200, which was about sufficient to pay off the debentures of the company. That, however, did not conclude the matter, because the rest of the assets, including the book debts, had not been sold. The position, therefore, was that the company had sold its goodwill and the right to use its name and so forth, and no one was left to get in the book debts, and the other assets, and distribute them among the unsecured creditors. In his opinion it was most desirable that the company should be wound up.

Mr. Turner, for the company, said the majority of the creditors were in favour of the sale of the goodwill, and it was assumed that the company would be wound up voluntarily. All the assets except the book debts had been sold. The committee of creditors had previously opposed a compulsory winding up.

Counsel for the committee of creditors said they were in disagreement. Some were in favour of a voluntary winding up and others a compulsory. The latter were in the majority.

His lordship: Do you oppose a winding-up order, Mr. Turner?

Mr. Turner said it seemed that a considerable number of creditors who opposed an order had changed their minds, and in those circumstances he could not oppose the order.

A gentleman who represented himself as the purchaser said that when he purchased the business the whole of the committee of creditors was present, and there was a tacit understanding that there would be a voluntary liquidation. He was carrying on the business, and he thought the goodwill would be damaged by a compulsory liquidation. It was not true that the majority of the creditors were in favour of a compulsory liquidation.

Mr. Turner suggested that the petition should stand over for a week in order that the views of the creditors might be ascertained. The company would agree to any voluntary liquidator nominated by the creditors.

His lordship directed the petition to stand over for a week, and said it would be unfair to the purchaser if the business was to be damaged by a winding-up order.



Perfect quality demands the best L.F. Valves, and remember—the first L.F. stage is as important as the output stage. Marconi Valves possess all the qualities needed for first L.F. stage efficiency—good magnification factor — low impedance — large grid base capable of handling a generous grid swing, so giving a magnificent undistorted output to the last valve. These are the famous Marconi Valves which will improve first L.F. stage performance. L.210, (2 Volt); L.410, (4 Volt); L.610, (6.Volt); M.L.4, (A.C. mains indirectly heated.)

**★ MARCONI VALVES**  
 are used by Imperial Airways—  
 The B. B. C. — Metropolitan  
 Police — Trinity House Lightships  
 and Beacon Stations — Croydon  
 Control Tower — etc., etc. They  
 are chosen for such vital functions  
 because of their unfailing  
 dependability.

---



---

# MARCONI VALVES

---



---



# This Oldham week-by-week purchase plan sells itself. . . .

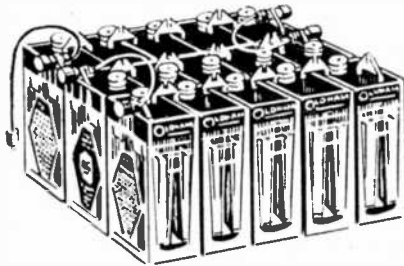
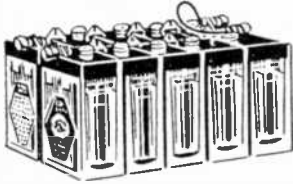
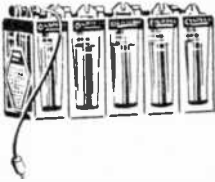

Back the Oldham unit-by-unit plan—explain that each unit can be brought into use immediately by connecting it to existing H.T. Batteries. Show your customers how to build up—at minimum cost—the finest source of H.T. current—an Oldham “Air-Spaced” H.T. Accumulator—how for 5/6 a week he gets 40 volts a month—and his reception improves as the Accumulator grows. This is a source of profit you cannot afford to miss.

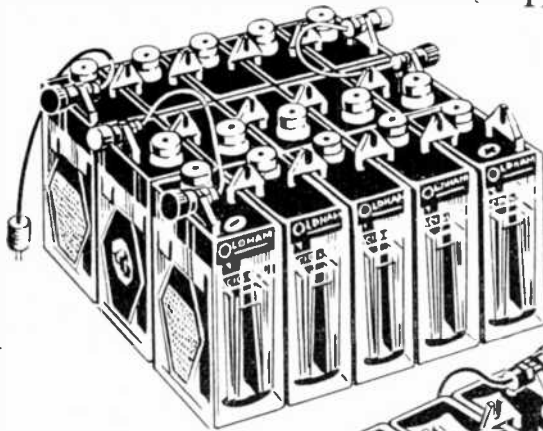

## OLDHAM

The Pioneers of “Air-Spaced”  
H.T. ACCUMULATORS

Standard 10-volt Unit  
Capacity 2,750 milliamps

**5/6**

Extra Large Capacity  
(5,500 milliamps)  
Per 10-volt Unit

**6/9**

OLDHAM & SON, LTD., Denton, Manchester.

Telephone: Denton 301 (4 lines).

London Office:

40 Wicklow Street, King's Cross, W.C.1

Telephone: Terminus 4446 (3 lines).

Glasgow: 200 St. Vincent Street.

Telephone: Central 4015.



# FROM ALL QUARTERS.

Notes and News for the Radio Exporter.

## Overseas Opportunities.

WE hear that an Indian radio firm of good standing, who already represent several well-known British manufacturers in the Punjab and North-West Frontier Provinces, are anxious to obtain additional agencies from reputable firms in this country. They tell us that, in their opinion, radio has a very bright future in India.

Communications from manufacturers interested in this opportunity should be sent to P. A. R., c/o The Editor, THE WIRELESS AND GRAMOPHONE TRADER, or to the firm's London agent, Mr. W. R. Everett, 63, Queen Victoria Street, E.C.4

The Commercial Secretary, H.M. Embassy, Istanbul, has forwarded to the Department of Overseas Trade a Report on the market for wireless sets and accessories in Turkey. A copy of the Report can be obtained by firms interested in the supply of wireless apparatus of British manufacture on application to the Department of Overseas Trade, 35, Old Queen Street, London, S.W.1. (Ref. B.X. 6496.)

## Notes from Paris.

From Our Own Correspondent.

THE Paris S.P.I.R. (Traders' and Manufacturers' Union) have long been criticised for their failure to admit foreign firms to their annual official Salon. They recently decided to open it to all countries granting reciprocal advantages to the French industry.

They accordingly enquired if the German Show Committee would allow their members to participate in the coming Berlin exhibition. The answer has been a polite, if indirect, negative, the S.P.I.R. being informed that the German wireless show would be "purely national." The Germans have thus automatically excluded themselves from the Paris Salon. Some of the Paris wireless papers cannot understand why "the powerful German industry refuses to face the French trade," and make a bid for such business as is obtainable here.

### French Trade Still Slow.

The trade outlook for some time has been far from bright. At least one firm of some importance has come to grief. This concern undertook business on the "sale or return" system, and advertised extensively. Other companies have been passing through crises also, but most have succeeded in pulling through.

### The Coming Salon: Cost of Stands.

A company has been formed by the members of the S.P.I.R. to assume full responsibility for the new show buildings that are being erected on a fine site in the Boulevard Raspail, on the left bank of the Seine. The annual official show will therefore no longer be crowded into the spare space of the Grand Palais at the height of the motor and cycle shows. There will be more scope for display—that is, for those who can afford it. The price of stands, indeed, is a sore point for the less important firms as it will not be less than 500 francs or £4 per square metre.

Despite inevitable complaints from certain quarters it is not easy to see how the S.P.I.R. could have done better, as there is no existing building sufficiently central and important for an international wireless show. Last year's experience of consecutive shows—an international followed by a national one—proved that there was really no alternative to a genuine international exhibition under the control of the S.P.I.R.—the only organisation that counts in the French wireless trade.

### The Honeycomb Coil Makers Win.

The Paris Court of Appeal recently pronounced a decision of considerable interest to the trade here. Some years ago, it will be remembered, the Standard Cables Co., in consequence of the refusal of the French manufacturers of honeycomb coils to recognise the validity of their claims to royalties on these components, made seizures in Paris and the provinces, and sought damages against all those who insisted that they had a perfect right to continue the production and sale of these coils.

The Paris makers formed themselves into a special union to fight against the plaintiffs' claims. The case excited some interest here, the "honeycomb" being held in high public esteem for its useful qualities.

The invention saw the light of day practically at the same time in America as in France. On January 10th, 1919, the Standard Co. obtained in U.S.A. a patent concerning the construction of "honeycombs" and deposited it in France on December 3rd, 1919. It seemed, therefore, as if America had secured the right of priority, for the French honeycomb coil patent had been taken out on March 3rd, 1919.

Both the Standard Co. and its opponents claimed legal priority. Counsel for the French makers argued that when the American patent was deposited in France no mention was made of the date and number of the patent taken out in America. The Court of Appeal then pronounced the American patent null and void in France, with costs against the plaintiffs.

### To Regulate Valve Prices.

Recently an agreement has been signed by the principal French valve manufacturers in order to prevent price cutting, I am informed. This agreement involves the creation of a central organisation to check and control all prices and discounts.

### Lyons International Show.

September 6th to 14th is the period definitely fixed for the Lyons International Wireless and Gramophone Exhibition, at the Lyons Fair Palace. Full particulars are obtainable from the Commissariat of the Show, rue Menestrier, Lyons.

## From Other Countries.

### Central European Market Not Saturated.

NEARLY 67 per cent. of the receivers in use in Czecho-Slovakia are crystal sets, according to *The British Export Gazette*. In the recently concluded arrangement for an exchange of programmes between the Czech transmitting towns of Prague, Brno, Bratislava, Moravska-Ostrava and Kosice, and Berlin, Vienna, Budapest, Warsaw and Belgrade, there is the promise of a substantial increase in the import of receivers by four of the other five countries concerned. Germany may be left out of account with its already vast radio industry. The scheme is of great importance to listeners in Austria, Hungary, Poland and Jugoslavia, and, though all the stations concerned lie within the scope of a crystal set, the business resulting will nevertheless be very substantial.

Czecho-Slovakia, it may be expected, will prove the most receptive market of the five for imported goods, for its registered listeners represent 2.4 per cent. of the population.

After Czecho-Slovakia, Poland would appear to offer most opportunities to British manufacturers, as an extremely efficient broadcasting service is now in operation there, and enthusiasm is increasing by leaps and bounds.

### American Export Trade Still Active.

A very active tone continues to prevail in the overseas trade in American wireless apparatus. Thus the shipments from the United States during April last attained a value of £285,953, bringing up the total for the first four months of the year to £1,142,516. The appended table shows the details of the four months' exports:—

AMERICAN WIRELESS EXPORTS.

	1930.	January to April, 1929.
Transmitting Sets and Parts .. .. .	99,728	61,861
Receiving Sets .. .. .	517,250	398,194
Valves .. .. .	157,810	110,805
Receiving Set Components .. .. .	187,057	185,592
Loud Speakers .. .. .	105,662	112,329
Other Receiving Set Accessories .. .. .	75,040	100,540
Totals .. .. .	£1,142,516	£969,847

# CORRESPONDENCE

The Editor is pleased to receive communications on matters of interest to the Trade. Letters intended for insertion must be accompanied by the name and address of the writer as a guarantee of good faith. No responsibility is taken by the Editor for opinions expressed by correspondents.

## A Dealer's Views on the Multi-Factor Problem.

To the Editor.

SIR,—I was very interested in your editorial on the subject of the multi-trade factor in a recent issue of THE TRADER, particularly because I went to some trouble in examining this question a few months ago.

It appears that there are at least four alternative policies for the wholesaler to adopt, and these can be conveniently described as under:

- (1) Open account for everyone.
- (2) Limited personal requirements supplies.
- (3) Half-discounts on "outside" goods.
- (4) Water-tight departments for each trade.

Under the first method anyone who has an account with a factor is supplied with everything that factor stocks or can obtain at trade terms. This, obviously, is the easiest system for the wholesaler to operate, but it undoubtedly must lead to trouble in the end. The anomaly at the present time is that while the motor dealers, the electricians and the rest take effective exception to the radio dealer being supplied with goods from their trades at re-sale terms, the poor radio dealer has to stand by and watch them buying their radio sets at the price he has to pay.

In the second system a trader would be supplied at a discount with goods outside his own industry for his personal use only, and not for re-sale or for gifts. In this way the garage-owner would buy his radio set at trade price, and the radio dealer would get retail discount on his tyres. This would probably be equitable enough if it were applied rigorously to both trades, and the practice of supplying "friends" by either party were properly prohibited.

The obvious disadvantage of the third method—whereby, for example, the motor trader would be given half-discount on a radio set purchased for his own use—lies in the fact that the supplier would get more profit from his dealings with those outside the ranks of the legitimate trade than he would from those who provide his regular turnover.

Finally, there is the absolutely water-tight system, which means that the wholesaler has to discriminate in accepting orders, and must refuse them, even from good customers, for goods in which that customer is not a recognised trader.

Considering the problem from all these angles, it seems that there are two questions which must be put to the multi-trade wholesalers, and to at least one of which every retailer is justified in expecting a frank reply. These are:

*Will the factor give equal treatment to every customer on his books? or*

*Will he declare the particular policy he intends to follow?*  
Edinburgh. ALEX. STEUART.

[Note.—There is sound reason in Mr. Steuart's arguments, and while the R.W.F. letter published below covers some of the points he raises, we would suggest that every wholesaler—however large—has nothing to lose, but much to gain, by giving a frank reply to one or other of the questions which are asked at the conclusion of this letter.—EDITOR.]

## The R.W.F. Replies.

To the Editor.

SIR,—We have seen the leading article in your issue of June 21st, and noted your invitation to this Federation to respond upon the point of equity advanced.

We cannot, of course, speak for all wholesalers: indeed, our experience is, and we have had occasion to call manu-

facturers' attention to the fact, that there do exist wholesalers dealing in a variety of goods, including radio, who appear to exercise little discrimination as to whether their customers are *bona fide* radio dealers or not.

So far as our members are concerned, they generally accept the ideas current in the trade that a radio dealer shall regularly carry a reasonable stock of wireless goods, make adequate display of these and be capable of giving proper service to the public. In this consideration it should always be borne in mind that the radio trade is young, and is, therefore, suffering from all the faults common to the period previous to adolescence. Those in it who have witnessed the growing-up process in somewhat older industries do not suffer the despair of your correspondent. They know from their experience that many of these disabilities disappear in time as a trade becomes more responsible and consolidated. Associations such as this Federation exist to hasten that time, and we can claim with a good deal of justification that in the short term of our existence we have been successful in enhancing a sense of responsibility amongst radio wholesalers.

An inevitable outcome of the youthful conditions referred to is that there exists among retailers, owing to that very process of growing-up, a number of what may be termed "border-line" cases. Although it is the custom immediately to upbraid manufacturers and wholesalers for supplying without proper enquiry such aspirants to a footing in our industry, our experience is that responsible firms in both categories expend considerable time and expense in investigating the *bona fides* of such.

My members do not profess to have an ironclad system preventing all illegitimate seekers after trade terms obtaining these, but they do claim that their defences are seldom penetrated more than once. As you may be aware, this Federation has a system of circulating amongst its members, contributed by them, the names of non-traders to whom they have declined terms, and many manufacturers have similar lists. The R.W.F. list is assuming formidable proportions, which provide sufficient evidence of the sincerity of my members in placing barriers in the way of the opportunist and the adventurer.

J. MACFARLANE, *Secretary*.

LONDON, W.C.1. RADIO WHOLESALERS' FEDERATION.

## Unsatisfactory Programmes.

To the Editor.

SIR,—I thoroughly endorse every word of the letter from "Sufferer" in the issue of THE TRADER for July 5th. Without exception every one of our customers complains of the programmes, and a great many tell us they only use their wireless for the news!

This town has a sea-front promenade many miles in length, with hundreds of beach huts along it. A walk along any portion at any time will reveal very many portable gramophones in use, but during the past two years the writer has not seen or heard a single portable wireless receiver. Your correspondent aptly states the reason for this state of affairs. We hope that now this vital matter has been brought up in THE TRADER it will not be dropped until some drastic alterations have been effected in the present type of programmes generally transmitted.

BOSCOMBE, HANTS.

"ANOTHER SUFFERER."

# Something Good Every Week —from HOUGHTONS



Houghtons Customers receive an *extra* service every week—HOUGHTONS RADIO NEWS.

It keeps them abreast of the market. New lines to sell, lines in demand, new developments—all are dealt with, in an easy-to-follow manner.

This unique service is enjoyed only by Houghton customers. Are you one?

Full details on request to Service Department, 88-89, High Holborn, London, W.C.1.

HOUGHTONS RADIO NEWS has a character all its own. That is why it is read, appreciated and acted upon.

# HOUGHTONS

*The National Wholesalers*

[(ENSIGN, LIMITED)]

HIGH HOLBORN • LONDON • W.C.1  
GLASGOW • MANCHESTER • LEEDS • NOTTINGHAM • SWANSEA • EXETER



The new Halcyon all-mains radio-gramophone shown complete with pedestal cabinet for storing records.

#### New Halcyon Lines Coming.

The Halcyon Wireless Co., Ltd., who, as stated elsewhere in this issue, have just opened new West End trade show-rooms at 72, Newman Street, London, W.1, are already in production with an entirely new mains-driven table radio-gramophone.

This instrument is built into a walnut table cabinet with a hinged lid and a fretted grille at the front concealing a moving coil loud-speaker. A 4-valve screened grid receiver is incorporated, working in conjunction with a frame aerial wound inside the lid. All the controls are grouped at the front of the motor board, which, in addition, carries the pick-up and the electrically-driven turntable.

The complete instrument is sold under a guarantee of one year at the inclusive price of 55 guineas. It is available for A.C. or D.C. mains and may also be obtained on H.P. terms. A pedestal cabinet which matches the set, and provides storage space for records is listed at 10 guineas extra.

A new Halcyon transportable receiver is available for delivery within about two days of receipt of order, and we understand that a large pedestal radio-gramophone will be announced shortly.

#### Condensers for Manufacturers.

Snap Switches, Ltd., of Bromley, Kent, a concern connected with Graham Farish, Ltd., who were responsible for the "Snap Three" receiver, are actively engaged on the production of a particularly comprehensive series of variable condensers for receiver manufacturers.

# INTRODUCING . . . THE LATEST

The condensers themselves are very compact and are available in a really extensive range of different designs to suit individual requirements.

Single or ganged models, with or without additional compensating condensers, are available, fitted with almost any type of drum or friction control, capable of adaptation into every form of receiver. Manufacturers who have not yet placed orders for condensers for their new apparatus are invited to get in touch with Snap Switches, Ltd.

#### The Wates Pick-up.

The Shaftesbury Radio Co., of Shaftesbury Avenue, London, W.C.2, join the ranks of pick-up manufacturers with the Wates "Star" instrument, which is supplied separately at 21s., or complete with a shaped and hinged carrying arm at 28s. 6d. If desired, the arm is obtainable separately at 7s. 6d.

#### Varley 300H L.F. Choke.

To meet the demand for an L.F. choke which may be used for choke feeding L.F. transformers following power grid detectors, Varley (Oliver Pell Control, Ltd.), of Kingsway House, 103, Kingsway, W.C.2, have designed and are shortly introducing a new 300 Henry L.F. choke.

This latest addition will be uniform in appearance with the existing range of Varley chokes, and it will be wound in sections and provided with four terminals, thereby giving it several different applications. The rated inductance with no D.C. flowing is, as stated above, 300 H, and 200 H when the winding is carrying 8mA, the normal value of anode current taken by a power detector valve. The D.C. resistance is 3,000  $\Omega$  and the choke is stated to remain inductive up to 800 cycles.

In view of the fact that power grid detectors are likely to be featured during the coming season, Varley anticipate a good demand for this new model, which will sell at 25s. Deliveries, we are told, will commence in about two weeks.

#### A New "Music Magnet."

We learn that, among other new season's lines which will be announced to the trade in the near future by the General Electric Co., Ltd., is a 4-valve version of the "Music Magnet" kit receiver, which, in its present 3-valve form, has been a particularly strong seller since it was originally introduced.

More detailed information regarding the new instrument will be available shortly.

#### K-B Price Revisions.

We are informed by Kolster-Brandes, of Sidcup, that the prices of some of their most popular sets are to be revised to the new prices which are given below. They will become effective on July 15th.

The reductions are K-B 103 oak with power valve, from £10 2s. 6d. to £9 5s. K-B 103 oak with pentode valve, from £10 15s. to £9 17s. 6d.

The increases are K-B 103 and K-B 156 portable sets, from £18 18s. to £19 19s. K-B 101 and K-B 100 three-valve electric sets from £17 10s. to £19 10s.

Corresponding revision will be made in the mahogany models of these particular sets.

#### The "Parmeko" L.F. Transformer.

A new L.F. transformer has recently been marketed by Partridge & Mee, Ltd., of 26, Dover Street, Leicester. This is of the unshrouded type and has sectionalised windings, the primary being so wound that its inductance is almost constant, irrespective of the value of the D.C. component. With no D.C. flowing, the primary inductance is rated at 86 H, while with 15 mA D.C. the rated value is given as 75 H. The specified ratio is 2 to 1, that is, with a primary D.C. resistance of 1,380  $\Omega$ , and a secondary resistance of 11,800  $\Omega$ .

The construction of this transformer is of the usual type, with the primary and secondary connections taken to small terminals mounted on ebonite strips at the top, and four lugs at the bottom for fixing purposes. The weight is 3 lbs., and the retail price £1 15s.

#### The "Lewcos" Programme.

Details of several of the new "Lewcos" lines that will be marketed for the 1930-31 season have just been released by the London Electric Wire Co. & Smiths.



Partridge & Mee's "Parmeko" L.F. transformer.

# SELLING LINES.

Ltd., of Church Road, London, E.10.

The well-known L.F.T 5 low frequency transformer will be supplemented by a 3-1 model known as the L.F.T3. A new L.F. choke will also make its appearance.

Among dual range coils several changes are to be noted. The screened types DRA1, DSP2, DSP3, DSG2 and DSG3, and the unscreened DURA, DUA, DUP and DUG units are discontinued, and will be replaced by an entirely new dual screened coil series, while an improved dual unscreened coil will be produced, mounted on bases with the standard six terminals. A corresponding 6-pin type will also be marketed. The "Q" type will be discontinued, as will the 6-pin "Q" coil.

As is general knowledge, "Lewcos" already list a fixed potentiometer. They will make an addition to this by marketing a range of potentiometers with tappings at  $\frac{1}{3}$  and  $\frac{1}{2}$  or  $\frac{2}{3}$  and  $\frac{1}{2}$  of the total resistance, and wire-wound resistances up to 50,000  $\Omega$  will be made.

Readers will remember that we published a test report upon the "Lewcos" wavetraps in our issue for June 21st, and it is therefore interesting to note that an additional model will be listed among the new season's goods. A feature of this wavetraps will be the provision of a switch allowing either the Regional or National wavelengths to be selected at will.

As yet, prices of these various new lines are not available, though we hope to publish them as soon as they are made known.

### "Wearite" 1930-1 Plans.

Many of the well-known "Wearite" lines will remain in the lists of Wright & Weaire, Ltd., during the coming season, though certain new products will appear in the autumn.

First we should mention the new dual range binowave coil units known as types D and E. Neatly mounted on ebonite bases, these are suitable for baseboard use, the change-over switch being arranged to protrude horizontally through a panel. The coils themselves—needless to say, of

the solenoid type—are mounted vertically side by side. The price for both types is 17s.

Next we come to an "Orgola" mains transformer suitable for use in the mains units described in *Radio for the Million*. It sells at 30s. for 40-100 cycle or 25 cycle mains.

No fewer than eleven quick-break switches appear among Wright & Weaire's new season's products. Especially suitable for mains work, and of various rotary and lever types, these retail at various prices from 2s. to 4s. according to pattern. Six new miniature rotary types will also be marketed between 3s. 3d. and 4s. 6d.

There are two new valve-holders, S1 at 1s. 3d. for 4 or 5-pin valves, and S3 at 1s. 6d. for 4-pin valves.

Priced at 20s., there will be an L.F. coupling unit known as LFC1, incorporating a ratio changing switch, while a collapsible aluminium screening box is also to be manufactured at 6s., or 7s. 6d. polished. In connection with screens we must mention the "Wearite" 10 ins. by 6 ins. aluminium screen which, fitted with an S.G. valve-holder, will retail at 4s. Other new lines will be a pre-set condenser, 00005 to 00035  $\mu\text{F}$ , priced at 3s. 6d., and a dial window knob. The latter, which we illustrate, is supplied, with a bracket, at 6d. There will also be a by-pass unit, BP1, at 4s. 6d.

Finally should be mentioned the very wide range of resistances of various types that Wright & Weaire, Ltd., propose to market. These consist of two more rheostats of 4  $\Omega$  and 7  $\Omega$  resistance, four new potentiometers, Q11, 15  $\Omega$ , at 2s.; Q12, 300  $\Omega$ , 2s. 6d.; Q13, 400  $\Omega$ , 2s. 6d.; and Q14, 400  $\Omega$ , with grid leak clips, 3s. Among volume controls will be the Q21, 25 MO; Q22, 5 MO; Q23, 1 MO, and Q24, 2 MO, all at 4s. All these variable resistances are for one-hole fixing, but can be supplied for base mounting at 3d. extra.

### A P.A. Trailer.

Of somewhat unusual, not to say novel design is the Carnival Music Reproducer recently developed by S. G. Brown, Ltd., of North Acton, London, W.3. This takes the form of a complete P.A. equipment with two loud-speakers, all contained in a neat two-wheeled balloon-tired trailer, suitable for towing behind the trader's car or van.

The installation consists of spring gramophone motors with twin turntables mounted on a neat desk with a drop flap, and cupboards on each side for

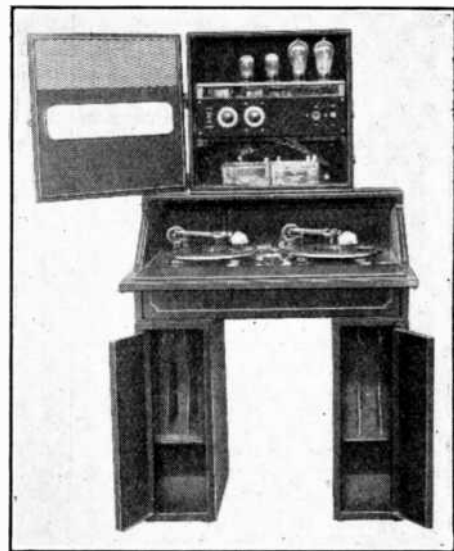

The control desk and amplifier which forms part of the Brown "Carnival" reproducer described below.

records. "Brown" pick-ups and pick-up arms are fitted, with a fader and volume control. Mounted above is a square cabinet containing the 3-stage 6-valve amplifier having an output of 16 W. The two speakers are of the "Super Cone" type. Inside the trailer is a petrol motor directly coupled to a generator supplying H.T. and L.T. current for the amplifier.

Although primarily designed for showmen, this interesting amplifier trailer should be of especial interest to traders who carry out P.A. work over a large area. Further particulars are available from S. G. Brown, Ltd.

### Cast Metal Name Plates.

McLeod & McLeod, of 329, High Holborn, London, W.C.1, have, for a considerable period, been supplying manufacturers of radio and electrical apparatus with chemically engraved aluminium and brass dials and name plates. They now announce that they are in a position to supply cast name plates in Ezett metal (white bronze and zinc bronze) and red metal (bronze). These can be manufactured in practically any shape or form in sizes up to 37 ft. 6 ins. by 24 ft. 6 ins. The Ezett metal plates are cheaper, but they cannot be curved or bent, and have a matt ground, whereas the red metal types can be manufactured curved, bent or domed, and have a polished ground.

One advantage of these plates is that there are no tool costs, except in cases where the quantity is very small or where they are required curved or bent.

We have received a sample Ezett metal plate, and there is no doubt that with its polished lettering and red and black matt grounds it looks exceedingly attractive, and would greatly enhance any manufacturer's goods.

There are great possibilities with this type of cast plate for escutcheons of all descriptions, and McLeod & McLeod are prepared to quote for any quantity against a blue-print.

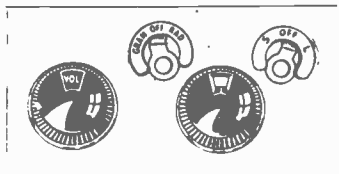

This unusually neat dial window knob is a new "Wearite" idea.

# LATEST RECORD REVIEWS

Below are reviewed selections from the August Zonophone supplement, a specially issued "Radio" record, and some July Goodson discs.

Dance numbers having vocal refrains are marked with an asterisk (\*)

British Zonophone Co., Ltd., Hayes, Middlesex.

## ZONOPHONE

10 IN., RED LABEL, 3S. 6D.

**G.O.91.—Stop Your Ticking, Jock and Sound Advice**, by Sir Harry Lauder, Scottish comedian, with orchestra.

The first is one of Lauder's most popular songs, and it is here re-recorded in a very jolly style. The second is also a bright affair, with amusing words. Sir Harry sings with his usual gusto, and the recording is excellent.

10 IN., GREEN LABEL, 2S. 6D.

**5614.—Old and New—Potpourri**, Parts 1 and 2 (arr. Finck), by The London Orchestra.

A selection of old-time ballads and musical comedy songs, with a sprinkling of one or two not quite so old, such as "I Love the Moon." The orchestra is of the dance type, aided by a cinema organ, and the recording is first-class. The disc should be a good seller as it is tuneful and bright.

**5618.—Watching My Dreams Go By and The Sacred Flame**, sung by Norman Blair, with orchestra.

Zonophone light vocal discs can always be relied upon, and this is no exception. The numbers themselves are of no particular importance, but they are both very well put over by Blair, who has the support of a first-class accompanying dance combination. The first number comes from the film "She Couldn't Say No" and the second from a film bearing the same name as the song.

**5619.—The Cuckoo in the Clock (Collins) and The Glow Worm (Lincke)**, by the International Novelty Quartette.

Two pieces of light music, the first being of the "novelty" type, and a very bright affair. The second is somewhat more dignified, but no less pleasant. In both cases a xylophone figures prominently, with, on the first side, a cello, piano and trumpet, while on the second side an accordion or similar instrument is heard. The recording is excellent, and the disc is most pleasant.

**5630.—Happy Feet (F.T.\*) and Harlem Madness (F.T.)**, both by the Rhythmic Eight.

A tip-top dance record played by the Rhythmic Eight in their best style. Both numbers have an inspiring rhythm and there are plenty of opportunities for the instrumentalists to shine individually. "Happy Feet"—a real winner—comes from the "King of Jazz," while "Harlem Madness" is played during a short theatre scene in the film "They Learned About Women."

**5634.—Eileen Alannah (Thomas) and Killarney (Balfé)**, by Herbert Wethmar, violin, with orchestra.

Two famous songs arranged for the violin, and played with plenty of feeling and excellent technique by the soloist.

The first piece is, of course, rather slow and mournful in melody, while the second is brighter. The accompaniment, which is very well done, is mainly by piano and cello, while the recording is excellent.

Edison Bell, Ltd., Glengall Road, London, S.E.15.

## RADIO

8 IN., IS. 3D.

**1352.—Amy and Meet Me in My Dreams To-night**, sung by Chris. Hall, with orchestra.

A specially-issued record of the number which has been composed in honour of Amy Johnson. It is presented with aeroplane and crowd effects and is well sung by Chris. Hall, who also makes a success of the waltz song on the reverse. This disc should be a good popular seller.

Goodson Gramophone Record Co., Ltd., 12, Old Burlington Street, London, W.1.

## GOODSON

10 IN., UNBREAKABLE, IS. 9D.

**212.—I Never Dream't You'd Fall in Love with Me (F.T.\*)**, by the University Syncopaters, and **Love Me, Dear (F.T.)**, by the Times Square Highlights.

These two numbers form quite an interesting contrast, the first being played in a steady, conventional sort of

style, and the second full of rhythm without being really hot. There is a short burst of double tempo in "Love Me, Dear." Both numbers are tuneful and the recording is generally quite good.

**213.—Why (F.T.\*)**, by the Astorian Dance Players, and **Without You Emaline (F.T.\*)**, by the Wolverine Peppercots.

"Why" is the distinctive and rather attractive number from "Sons o' Guns," coupled with "Without You Emaline," a slow number with a rather nasal chorus, but having some good instrumental work. The recording, however, is only fair on our pressing.

**214.—Song of the Dawn (F.T.\*)** by the Cosmopolitan Dance Players and **It Happened in Monterey (W.\*)** by the Metropolitan Dance Orchestra.

These two big numbers from Paul Whiteman's film "The King of Jazz" are well played, and certain to sell well. The recording is quite good.

**215.—The Free and Easy (F.T.\*)** by the High Hat Revellers and **Telling It to the Daisies (F.T.\*)**, by the Metropolitan Dance Orchestra.

"The Free and Easy" is a fast, hot dance number which causes quite a lot of amusement in Buster Keaton's first talkie which bears the same title. It is here managed quite well by an American combination. "Telling it to the Daisies" has not hitherto been issued over here, but it is good of its type. Satisfactory recording.

## GRAMOPHONE NOTES AND NEWS.

### A New Loud-speaker Test.

Cone diaphragms may now be subjected to visual tests while vibrating at any frequency within their range by a new method shown for the first time at the Royal Society conversazione held at Burlington House recently.

Intense interest was shown in this exhibit, which was arranged by the Gramophone Co., Ltd. Fellows and their guests saw an interrupted beam of light focussed on the diaphragm under investigation, and while the frequency of the vibrations was varied, they were brought into approximate synchronisation with the diaphragm vibrations.

A simple cone under test was seen to behave as a rigid piston only at low frequencies of the order of 50 cycles a second. Immediately the frequency was raised the diaphragm broke up into its characteristic nodes of one, two or more nodal diameters.

### Successful Belfast Carnival.

At a recent eight-day fête and carnival at Balmoral Show Grounds, Belfast, we are informed by a correspondent that Solomon and Peres, wholesale distributors

of Decca records, provided an installation by which music was relayed all over the grounds.

Five miles of wiring were used in the complicated equipment, and everyone who attended voted it to be a great success, both broadcast and record programmes being featured every day.

### Manchester Note.

S. Reisler & Co., of 10, Thorniley Brow, Shudehill, Manchester, musical instrument dealers, have, we learn, recently opened a branch at 42, Church Street, Sheffield, where Mr. Bernard Harrison is manager.

Messrs. Reisler are manufacturing gramophones under the name of "Rikoff," and are also factors of Homochord and Sterno records.

### "The Stein Song."

Many dealers are being besieged with enquiries regarding the manner in which the "Stein Song," admittedly the hit of the moment, received its somewhat curious title. Edison Bell have looked into the matter and produced the following interesting information of the subject.

Students at the Heidelberg University,

# THE BRAINS BEHIND

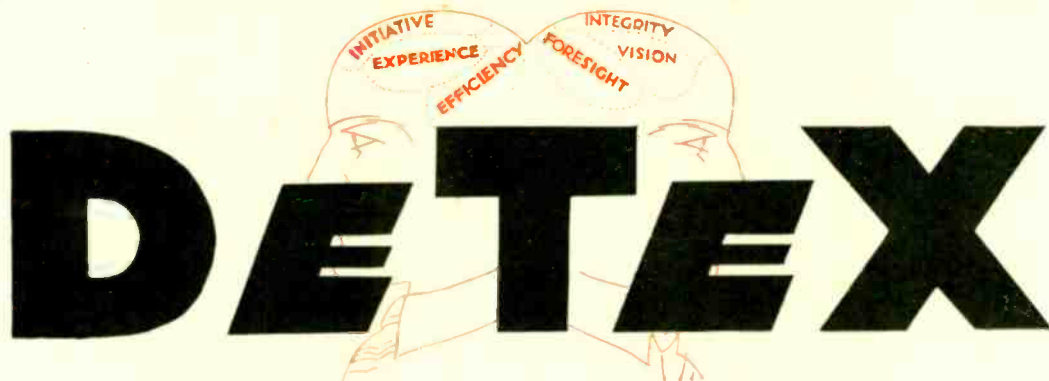

Many years have passed since **DETEX** marketed the first Portable Receiver. Through all the trials and vicissitudes that have beset the Radio Industry, the name and Reputation of **DETEX** have gone on increasing. Rivals have sprung up like mushrooms and gone down like ninepins, but backed by Brains that have been able to judge the requirements of the Public to a nicety and by men who believe in honest-to-goodness straightforward business dealings **DETEX** has emerged triumphant and now leads the world in the manufacture of PORTABLE RADIO. *Your customers will Demand Detex! See that you stock it!!*

LIBERAL TERMS

GNS. **8** GNS.

COMPLETE

12 months' guarantee

**DETEX**  
**PORTABLE RADIO**

161, Vauxhall Bridge Road,  
S.W.1

Telephone :

Victoria 1303 (6 lines).

Telegrams :

Detexacrys, Churton, London.





**COMING**

The word "COMING" is written in a large, bold, black, sans-serif font, slanted upwards from left to right. It is set against a background of several thick, horizontal, reddish-orange brushstrokes that also slant upwards, creating a sense of motion and excitement.



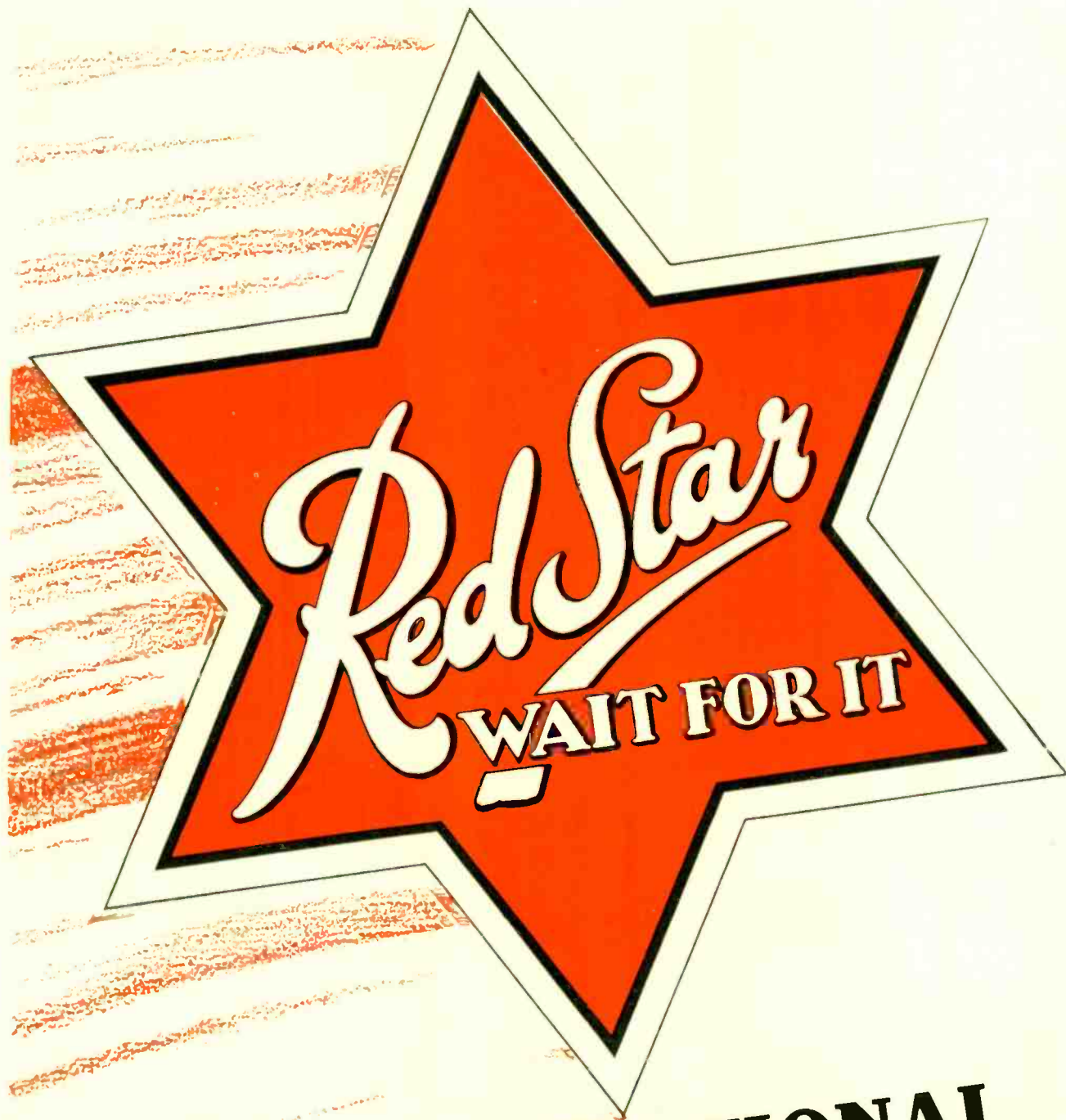

**A SENSATIONAL  
DEVELOPMENT IN  
THE RADIO WORLD**

**Definitely  
SUPERSEDES  
THE MOVING  
COIL SPEAKER**



**—and it's a  
“SILVER  
GHOST”!**

# Puts moving coil speakers in the background!

## THE NEW LAMPLUGH INDUCTOR SPEAKER.

This is the latest conception of the Inductor Principle invented by the American Radio Pioneer FARRAND, and is as great a step forward over present known types of Speakers—whether Balanced Armature or Moving Coil—as the original Cone was over the Horn type. It possesses all the advantages of a Moving Coil Speaker, has a better response at the lower frequencies, and has none of the disadvantages associated with the M.C. Type.

**ADVANTAGES.**—There is no moving coil to pick up field current. There is no field excitation coil, therefore no introduction of Hum from that source. There is no heat generated. Requires no Rectifier, Transformer, Smoothing Condenser associated with Moving Coil Speakers on A.C. operated Sets. Only a quarter of the weight of a M.C. Speaker.

**SET MANUFACTURERS** will realise at once the enormous saving in cost that the Lamplugh Inductor Dynamic offers without sacrifice in performance—which is indistinguishable from that of the Finest M.C. Speaker. It must not be confused with the many Balanced Armature Movements on the market at the moment designed to give Moving Coil effect by artificial methods.

There is nothing to get out of order: it is beautifully finished and of robust construction

**Chassis Complete £3 10**

**Cabinet Model £6 10**

# LAMPLUGH

**INDUCTOR  
DYNAMIC  
SPEAKER**



Send today for—  
Full details to:—

S. A. LAMPLUGH, LTD., KINGS ROAD, TYSELEY, BIRMINGHAM.

in Germany, have a custom concerning their "stein" or stone drinking flagons, a custom around which, it appears, a ritual was observed. The ceremony attaching to the "stein" has followed Heidelbergers everywhere, and in America, at the University of Maine, the "stein" has long been commemorated in song by a special chorus ballad. Over twenty years ago this song was in vogue on the other side of the Atlantic, and now it is enjoying a new lease of life.

#### A New Beckenham Shop.

We are informed that Mr. Lionel C. Ixer, of the Parade Music Stores, Clock House, Beckenham, has opened a new branch at 5, The Parade, Croydon Road, Elmers End Station, where he is stocking H.M.V. and Columbia gramophones and radio products. In addition to carrying several other well-known radio and

gramophone lines Mr. Ixer has a battery charging service.

#### "The King of Jazz."

In view of the fact that Paul Whiteman's film "The King of Jazz"—which continues to arouse immense interest in all circles—will in all probability have its premiere London presentation at the Regal Cinema, Marble Arch, it is fitting that a full selection of the musical numbers from the film has been recorded for Columbia by the Regal Cinema Orchestra, and organ.

The record—DX 72 (4s. 6d.)—is due for release in the August supplement.

#### The "Electrocolor" Needle.

Keith Prowse & Co., Ltd., announce the introduction of the "Electrocolor" gramophone needle, a companion to the "Burmese Colour Needle" which they handle.

Made by the inventor of the Burmese colour needle, "Electrocolors" are claimed to possess all the advantages of the "B.C.N." while reducing record wear and surface noise, having at the same time an extremely long life.

#### Mr. Jay Wilbur.

We learn that Mr. J. Wilbur has now left Dominion Gramophone Records Ltd., where he was musical director, to take up a similar position with the makers of Imperial records.

#### "Sons o' Guns" Musical Numbers.

The new Clayton and Waller musical production, "Sons o' Guns," which opened at the London Hippodrome recently contains several numbers possessing good sales possibilities in record form. "Why," "Cross Your Fingers," and "It's You I Love," are the titles, and all three have already been issued for sale by the leading companies.

## THEME SONGS.

#### "Not Damaged."

Featuring Lois Moran and Inez Courtney. "NOT Damaged" is not a musical talkie in the strict sense of the word, but I am mentioning it because of one number which is introduced in a party sequence. This is an excellent comedy item called, "Nothing's Going to Hold Us Down," first sung straight and then burlesqued. The singers are Inez Courtney and George Corcoran. The song has good dance possibilities.

#### "The Cuckoos."

Starring Bert Wheeler and Robert Woolsey. THOSE two comedians of "Rio Rita" fame, Bert Wheeler and Robert Woolsey, are the principals in "The Cuckoos," in which they have the action practically to themselves. The film is adapted from an American musical comedy called "The Ramblers."

So much of the action is of the non-sensical kind—to provide material for the two comedians—the love interest is almost nil. June Clyde and Hugh Trevor, the lovers, get few opportunities to do anything worth while, but they have a highly attractive duet in "I Love You so Much." This should develop into a decided hit.

Wheeler and Woolsey seldom let a chance pass to raise a laugh, and though some of the gagging and comedy is of the questionable variety, there is no mistaking their comedy talents. They have a couple of good numbers in "College Days" and "I'm a Gypsy."

Other tuneful numbers are "All Alone Monday" (which I do not think is entirely unknown over here), and "I'll Find You Wherever You Are."

#### "Cheer Up and Smile."

Featuring Dixie Lee, Arthur Lake and Jack Smith.

ANOTHER college picture on the lines of a previous Fox production, "Words and Music." Quite a pleasant little story of young love between a college youth (who afterwards becomes a radio singer) and a simple country maiden. One might say the whole production is a happy combination of boisterous spirits and noisy songs. There are some imposing scenes in the night club sequence. "Whispering" Jack

Smith has a principal part, and in addition, has most of the vocal work to do. His numbers are "Where Can You Be," "When You Look in My Eyes" and "You May Not Like It, But It's a Great Idea." There is also a good concerted number in "The Shindig," led by Dixie Lee.

#### "Night Work."

Featuring Eddie Quillan. "NIGHT Work" is an exceptionally light-hearted and simple film, which is admirably suited to the personality of Eddie Quillan, a pleasant youth with a very happy sense of humour that does not demand incredible situations to enable it to be effective.

Quillan takes the rôle of a window-dresser who falls in love with a nurse at an orphanage, and the story centres around the fact that he unwittingly agrees to adopt one of the children from the home. In order to support the boy, Quillan works at night as a waiter in a night club, thereby providing an excuse for several well-staged cabaret sequences, which, however, are of no interest musically.

The one song in the show, entitled "Deep in My Heart," is introduced in very artificial circumstances, and could quite well have been omitted. It is given as a duet by Eddie Quillan and Sally Starr, when they are sitting together in a garden. The continuity of film is interrupted, and a very unnatural atmosphere prevails owing to an accompaniment being provided by an unseen orchestra. The song itself, however, is quite a good number of its type.

#### "Women Everywhere."

Starring J. Harold Murray and Fifi Dorsay. THIS talkie is outstanding for the re-appearance on the screen of J. Harold Murray, who scored such a singing hit in the first talkie operetta, "Married in Hollywood." There is no mistaking that Murray has a voice that can't fail to charm, even though his songs are not always as brilliant as they might be.

"Women Everywhere" runs on musical comedy lines, the story telling of a sailor who is rescued from death for gun-running by a French cabaret singer,

Fifi Dorsay. Most of the scenes are laid in North Africa.

Apart from Murray, the cast is enhanced by the appearance of our own George Grossmith. As the café proprietor—and entertainer—he puts over a typical Grossmith performance, and with that lightness of touch that has made his stage work so delightful. He is heard in one song, "Bon Jour," in which he partners the fascinating Fifi Dorsay.

The theme song, "Beware of Love," comes over as an attractive and easy running waltz, while "Women Everywhere" and "Sailor Girl" are two good marching songs.

#### "Back Pay."

#### Starring Corinne Griffith.

"BACK Pay" is based on a Fannie Hurst story, with much of the story laid in the period of the late war. The producers are to be congratulated in their choice of a suitable theme song.

Corinne Griffith is heard singing several times throughout the picture, and the song is none other than the old favourite, "They Didn't Believe Me" (a Jerome Kern number). This song, you may remember, was highly popular during the war. It was selected by the producers in preference to a new theme song because it exactly fits the action. Will this lead to a revival of the old favourite?

#### Talkie Topics.

New theme songs issued by Feldman's this month are the following: "Watching My Dreams Go By" (from "She Couldn't Say No," featuring Winnie Lightner), "When You're Smiling" (from "The Girl from Woolworth's"), "Someone" and "You Baby Me—I'll Baby You."

The first of a series of All-British Radio Film Concerts was broadcast on 338 metres from Brussels recently.

"You're My Silver Lining of Love" from "The Devil's Maze" and "There's Nothing New in Love," from "High Treason" were played, and in addition to these two Gaumont-British film numbers, "By the Bend in the River" was also heard. This is featured in the Gaumont-Gainsborough talkie version of Ivor Novello's "Symphony in Two Flats."

# THE SELLING SIDE

## Holiday Season Advertising.

**D**URING the next six weeks or so the holiday season is at its height, and the seaside, in particular, is a subject of topical interest to practically everyone. The holiday theme is therefore, one of the best to employ in current advertising, and this week's continuation of our series of suggestions for the trader illustrates one method of handling the subject.

As always, it has to be remembered that few people are likely to incur the expenditure represented by a good portable wireless set for one purpose alone. To urge them to buy a portable for their holidays suggests far too limited a use for the set to make a worth-while impression. A far stronger appeal should result if, in addition to pointing out the immediate attractions of the set to the holiday-maker, the trader places adequate stress on its value at all other times of the year. The holiday then provides a reason for immediate buying—reinforced by the year-round attractions of ownership.

This is what has been aimed at in our own suggestion. Within the limits of this small space it naturally is impossible to tell the "story" in any detail, but the small illustration and the brief "copy" suggest something of the appeal, and a series of such advertisements will help to prepare the ground for the trader's other sales efforts.

Duplicate blocks of the illustration used in this specimen lay-out, which will enable readers to reproduce the advertisement above their own names and addresses, can be obtained at the price stated from our Publicity Department. Stereos of illustrations used in earlier examples are also still available.

## Agricultural Show Publicity.

**T**HE writer of this note has visited many agricultural shows this season, and in several cases has been pleased to note that wireless traders were making effective use of them.

There is little doubt of the value of these exhibits if they are well organised. The trader's local show attracts most of the worth-while "prospects" from the town itself and from the surrounding district, and enables him to get into closer contact with them than may often be possible from the shop. The large proportion of farmers and other country residents among the visitors is a further advantage, for this

class remains one of the most profitable from the wireless trade's viewpoint.

Traders who have booked space at shows yet to be held should remember that getting good results from the expenditure depends to a large extent on the employment of enterprising publicity methods. At few but the very smallest shows is it possible for the average visitor to see every stand, and the exhibit that does not seize attention is frequently missed altogether.

Loud-speaker demonstrations provide one of the most useful means of making the stand a centre of interest. Even a small exhibit will attract a crowd if a good demonstration is in progress—especially if the trader has the good luck to be relaying a broadcast dealing with an important event. A good example was provided at the Royal Counties Show at Reading, which opened on Derby Day. A wireless trader who had a stand at the show, made the most of this combination of events by announcing that the progress of the race could be followed on his stand, and big crowds gathered to listen.

In some cases the trader can secure good publicity at small cost by co-operating with an enterprising manufacturer. The latter may, for instance, be prepared to send down a man or a girl in special costume, to act as an attendant at the stand and to distribute publicity matter dealing with his specialities. It will be obvious that the number of such requests received will make it difficult for a maker to accede to them all, but the possibilities in this direction are worth exploring.

Good results can sometimes be achieved by co-operating with other exhibitors. At one of last year's

meetings, for instance, a trader loaned two good portable sets for use in the rest booths that were provided free for visitors. Cards attached to the sets acknowledged the trader's assistance, and pointed out that the attractions and advantages of these and other portable sets could be studied at first hand on Stand No. So-and-so.

Whenever possible, it is very sound policy to secure a new—or, at least, a little-known—set or accessory, for use as a "talking point." Admittedly, this is not always easy during the summer, but if it can be done good results will be achieved. In all preliminary publicity, the most can be made of the novelty to arouse curiosity, and many people will be attracted to the stand by the promise of "something new." Once their interest is aroused it is much easier to direct their attention to the exhibit generally.

## Make Your Shop Appeal to Women.

**I**N practically every trade it is being increasingly recognised that feminine appeal is highly important—whether the expected results are to be achieved directly or indirectly.

Wireless goods are among the few that, generally speaking, are not bought by women. It is an important fact, however, that although a man may place the order, a feminine voice has usually exercised considerable influence in arriving at a decision. Especially is this so now that wireless has ceased to be a purely masculine hobby, and is regarded as an asset to the amenities of the home.

The wise trader will recognise this "power behind the throne," and while retaining the essential character of his shop, and not endeavouring to imitate the methods of retailers whose customers are exclusively feminine, will ensure that his establishment is so run that it does not actively prejudice the woman shopper.

Lady customers, for instance, abhor untidiness in a shop. They notice any suggestion of slovenliness far more quickly than the average man, and a hint of dust and dirt on the floor, counter, shelves, and so forth, is fatal to a trader's goodwill. Even the competent wireless retailer is sometimes apt to overlook weaknesses of this kind, but he should remember that they are more than sufficient to outweigh his technical qualifications in the judgment of a proportion of customers.

One of the most practical hints that

## Away or at Home

nothing adds to the fun like portable wireless. Get your set in time for the holidays and make the most of summer joys. The widest choice is at:—

**WIRELESS SUPPLIES LTD.**  
Blank St., BATH



A further addition to our series of summer advertisements. Stereos can be obtained at 3s. 6d. each, or 3s. 10d. C.O.D.

can be given to the trader in this connection is that he should invite his wife—or some feminine member of his household—to visit the shop, and to give a frank report on the impressions received. An inspection of this kind may have valuable results, for the points noticed by the visitor will usually be those that will impress most other members of the opposite sex.

The trader will be told if his fittings and equipment have become dowdy, the general effect conveyed by his display methods, and whether the shop seems inviting to the passer-by hesitating at the door. Such details as worn linoleum are always suggestive of an unsuccessful business; if the trader has been postponing renewal under the impression that details of this kind are not obvious, he will speedily be disillusioned by a visit of inspection. The impressions received from the appearance and methods of the staff will also be informative.

In some ways this experiment may be temporarily depressing, for many of the features of which the trader is especially proud may pass unnoticed by the feminine visitor. By listening carefully to the opinions expressed, however, he will gain many new side-lights on his methods as viewed from the opposite side of the counter, and a process of adoption and adaptation will enable him to improve his business in many hitherto unsuspected directions.

#### Novel Display Stands.

FOR the trader who desires his window displays to maintain freshness and interest, fairly frequent changes of fittings and accessories are essential. It is not suggested that expensive equipment can be scrapped after a few months of use; but by making judicious additions to his fittings when occasion offers, and adopting as many new display ideas as are economically possible, even the "small" retailer can keep his shop-front from becoming stale and dull.

A good example of the type of moderately-priced accessories that help to give a novel touch to the window is the set of display stands illustrated on this page.

These stands are 12 inches high, and comprise a series of cut-out figures finished in colours. The uprights fit into a substantial base, while a narrow shelf is fitted to the top at a slight angle, enabling light goods to be displayed in an unusual and eye-catching style. The stands would carry some of the smaller type of loud speakers, as well as light accessories.

The chief advantage of such stands is the opportunity they offer for featuring goods that have a special selling value, or that the trader

desires to push for other reasons. Located in prominent positions in various parts of the display, they would infallibly catch the eye, and the attention attracted by the

accessory would be shared by the article displayed. The stands illustrated have been quite recently introduced by "Replicards," of Marlborough Road Works, Marlborough Road, N.19, a set of four different figures costing 18s. 6d. The use of oil colours for the finishing enables them to be washed without damaging them.

#### The Annual Overhaul.

THE opportunity offered to dealers, when customers are on holiday, of overhauling their receivers has been stressed so often that it need not be repeated here.

In the average family the radio set is used so continually that it is often impossible for the dealer to take it away for a general overhaul unless it has actually gone wrong, and the period when all the members of the household are away, therefore, is obviously the best time for a dealer to offer to bring a set up-to-date and ready for the winter season.

Several years have now passed since the B.B.C. first developed their "broadcasts to schools" service, and many schools are still using the same receiver and speaker to-day as they did when the service was first introduced. Here is a fine chance for the enterprising dealer to approach the principal and explain to him the important strides that have been made in set and speaker construction since the school receiver was obtained. Often it will be found that an order is given for the set to be modernised—or even replaced—during the holidays.

Again, from being rather a novelty for the pupils, the school broadcasts are now eagerly awaited in many schools, and offers for the installation of loud-speaker points in all the classrooms would in all probability be accepted after a short chat.

The installations in hospitals and other similar institutions also offer opportunities of a similar nature.

#### Stressing the Portable Appeal.

THE days on which portable radio sets or gramophones can be used in the open air are by no means over, and the trader who still "pushes"

Three of the novel display stands described in Col. 1

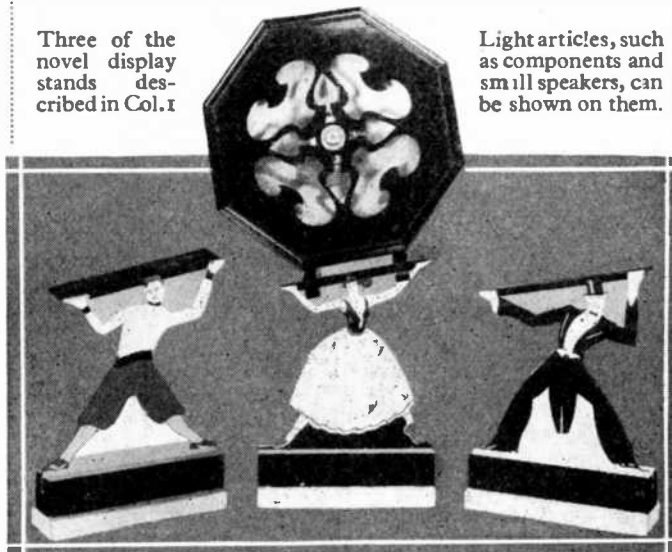

Light articles, such as components and small speakers, can be shown on them.

these in his window displays will be amply repaid.

One way of stressing the entertainment value of a portable is by including photographs of them in actual use in the window display.

Although many of the important photographic agencies will be able to supply prints if required, a vastly greater appeal would be made if local scenes are included, and—if possible—local notabilities.

One method of obtaining these is by asking the various customers who have bought portable radio sets or gramophones in the past year or so for the privilege of including in the window any photographs that they may have taken and in which the instrument actually appears. Often such photographs will include a view of some beauty spot quite well known to most people in the locality, thus making it of considerably greater interest.

If no really suitable prints can be obtained by these means, the trader might approach other tradesmen in the town, and lend one or two of them portables for the week-end in return for a good photograph of the sort in question. This would result in publicity both for the wireless trader and, say, for the butcher who co-operated with him.

When a variety of photographs has been obtained they should be mounted on a baize-covered board in the centre of the display, and the portables illustrated thereon can be ranged below. A suitable display-ticket describing the photographs and their origin would be all that was required to complete the appeal of the effort.

# SOME RECENT PATENTS.

The following abridgments of recently issued Patent Specifications have been made by "The Trader" technical staff. Permission to publish has been obtained from the Controller of His Majesty's Stationery Office. Copies of the Specifications in full can be obtained from the Patents Office, 25, Southampton Buildings, London, W.C.1, price 1/- each.

### A Folding Cone Diaphragm.

No. 324,302.—Folding cone diaphragms usually consist of three segmental pieces of stout paper, which are interhinged about their radial borders. Now with this form of diaphragm, the paper generally tends to sag at the interhinged edges, each segment tending to remain flat, so that instead of a cone, a distorted pyramid is formed. In this invention, an improved method of constructing such a cone is described.

The above disadvantages are overcome by hinging the segmental sheets together by means of a rule joint, which prevents the sheets from folding in one direction beyond a common plane. This joint is provided by extending the border portion A of one of each interhinged pair of sectors X-Y and X-Z beyond the line of hinging. The final free borders of the sectors can be arranged to interlock in one of several ways.

With this method, to assume the conical shape, it is claimed that the sheets must bend bodily instead of yielding at the hinged edges.

Specification accepted from P. Cassin.

### A Counter-balanced Pick-up Arm.

No. 324,032.—To enable the weight of an electric pick-up to be counter-balanced to any desired extent, an arm such as that shown may be used. A is the arm, which is composed of two members, fixed parallel to one another, and pivoted on a screw S, which in turn is attached to the end of a smaller arm B. The other end of B is rigidly fixed to a rod or tube R which is rotatably mounted in a suitable fitting on the motor board, so that A, B and R can be turned together about the point P.

As will be seen, the end of arm A opposite to the pick-up extends beyond the pivot, and it is here that weight is fitted. This weight is shown at W, and, as an alternative, arrangements may be made to fit weights of varying mass

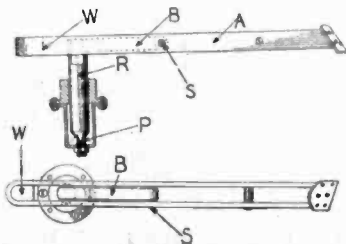

according to the counter-balancing effect desired.

Specification accepted from the British Electrical Reproduction Co., Ltd., and C. Berrage-Moulton.

### An Armature Driven Horn Speaker.

No. 324,095.—The object of this invention is to provide a horn loud-speaker

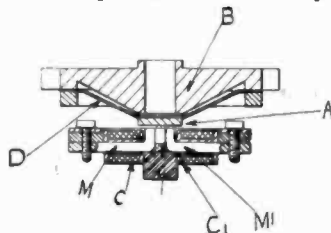

unit, whose vibrating assembly consists of an armature and a conical diaphragm, which are of the lightest possible construction.

The frusto-conical diaphragm D is clamped at its periphery by a base-plate B, and is preferably made of a hard phosphor-bronze. The armature A, which is a piece of iron having a suitable permeability, is attached to a flattened surface at the centre of the diaphragm. Behind this is placed an electro-magnetic unit of any known type, and as shown it consists of the coils C and C1, mounted on the pole pieces M and M1.

The base-plate B has a sound passage through its centre, and is shaped to correspond with the contour of the diaphragm, so that when in position, there is only a small air space between it and the diaphragm.

Specification accepted from A. E. Courtenay and F. S. Clifford.

### Strengthening Cone Diaphragms.

No. 309,555.—Many paper cone diaphragms are not rigid enough to vibrate as a whole at certain frequencies, and, to avoid this difficulty, it is proposed in this invention to attach to the outer surface of the cone a series of strengthening rings. These rings are flanged, and are attached with the flanges projecting at right angles to the axis of the cone. One ring, shown in the diagram at A,

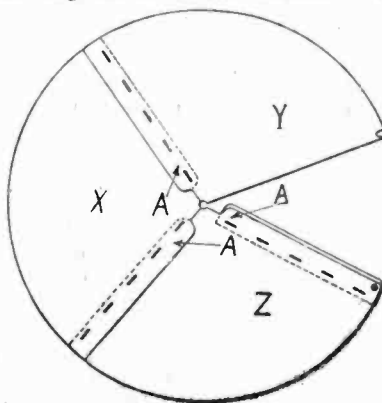

supports the diaphragm at its periphery, and the remaining rings are preferably disposed at varying intervals towards the apex.

As the tendency for the cone to distort becomes greater towards the edge the spacing between the flanges is therefore graded so that the distance between the ring A and the ring B is the smallest, and between C and the washer at the apex, the largest. With this method of grading maximum rigidity is secured without unduly increasing the weight of the diaphragm.

Specification accepted from The British Thomson-Houston Co., Ltd., assignees of W. B. Potter.

### Burndep Needle Armature Pick-up.

No. 324,943.—In this specification an invention is described which has for its object the provision of an electric gramophone pick-up in which the electrical impulses produced will follow more faithfully than usual the undulations of the record track. This is brought about by an arrangement which utilises the stylus or needle itself as the armature whose vibration serves to set up the flux variation needed to induce the electrical impulses.

The horse-shoe magnet M, has two pole tips P, which extend towards and nearly touch one another, and located symmetrically between the poles and attached to the mid-point of the magnet, is a central arm A of a magnetic material, adapted to hold a gramophone needle flexibly between the pole pieces. This arm holds the needle through the medium of a holder H which is equipped with a clamping screw S and which is enveloped in a sleeve of rubber D, thus being free to vibrate with the needle, the latter being normally in a position centrally between the pole pieces, and inside the coil L. The needle holder is held in position by an inverted cap C, which screws on to the central arm.

It will thus be seen that, as no part of the stylus holder is very distant from the axis of vibration, the rigid unit constituted by the needle and holder will have a very small moment of inertia about its axis of oscillation, which more or less coincides with the axis of the cross arm, and therefore there will be little tendency for the unit to resonate at a certain frequency.

The whole instrument is shielded and protected by a metal casing which is separated from the pick-up by pieces of damping rubber.

Specification accepted from Burndep Wireless (1928), Ltd., and H. D. Ridley.

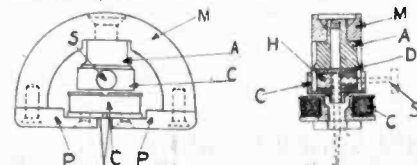

# COMMERCIAL INFORMATION

## GAZETTE.

**Symphony Gramophone & Radio (Foreign), Ltd.** Petition for winding-up was presented to the High Court of Justice on July 2nd, by the Darmstadter und Nationalbank Kommanditgesellschaft auf Aktien, 68-70, Behrenstrasse, Berlin. It will be heard at the Royal Courts of Justice, Strand, London, W.C.2, on July 14th, and those desiring to appear must give notice in writing not later than 1 p.m. to-day, July 12th, to Rehder & Higgs, 29, Mincing Lane, London, E.C.3, solicitors for the petitioners.

**Rissik Fraser & Co., Ltd.** Petition for winding-up was presented to the High Court of Justice on July 2nd, by the Barter Trading Corporation, Ltd., 14, Waterloo Place, London. It will be heard at the Royal Courts of Justice, Strand, London, W.C.2, on July 14th, and those desiring to appear must give notice in writing not later than 1 p.m. to-day, July 12th, to Slaughter & May, 18, Austin Friars, London, solicitors for the petitioners.

**Sphinx Electric, Ltd.** Petition for winding-up was presented to the High Court of Justice on July 1st, by Ceag, Ltd., Queens Road, Barnsley. It will be heard at the Royal Courts of Justice, Strand, London, W.C.2, on July 14th, and those desiring to appear must give notice in writing not later than 1 p.m. to-day, July 12th, to Clifford-Turner Hopton & Lawrence, 81-87, Gresham Street, London, E.C.2, solicitors for the petitioners.

**James Shoobred & Co., Ltd.** Petition for winding-up was presented to the High Court of Justice on July 1st, by Harris & Russell, Ltd., 91, Tottenham Court Road, London, creditors. It will be heard at the Royal Courts of Justice, Strand, London, W.C.2, on July 14th, and those desiring to appear must give notice in writing not later than 1 p.m. to-day, July 12th, to Lucien Fior, Commerce House, 72, Oxford Street, London, W.1, solicitor for the petitioners. At an extraordinary general meeting held on July 2nd, at Tottenham House, Tottenham Court Road, London, W.1, it was resolved that the company be wound up, and that Sir William McLintock, G.B.E., C.V.O., C.A., 71, Queen Street, London, E.C.4, be appointed liquidator.

**Duophone (Foreign), Ltd.** Petition for winding-up was presented to the High Court of Justice on July 1st, by Celebrity Gramophones, Ltd., 5, Budge Row, London, E.C.4, creditors. It will be heard at the Royal Courts of Justice, Strand, London, W.C.2, on July 14th, and those desiring to appear must give notice in writing not later than 1 p.m. to-day, July 12th, to Eves & O'Connor, 84-86, Chancery Lane, London, W.C.2, solicitors for the petitioners.

**Truphonic Radio, Ltd.** Petition for winding-up was presented to the High Court of Justice on July 2nd, by the said company, whose registered office is at Avenue House, Hanover Park, London, S.E.15. It will be heard at the Royal

Courts of Justice, Strand, London, W.C.2, on July 14th, and those desiring to appear must give notice in writing not later than 1 p.m. to-day, July 12th, to Ashurst, Morris, Crisp & Co., 17, Throgmorton Avenue, London, E.C.2, solicitors for the said company.

**Baird International Television, Ltd.** The order of the High Court of Justice, dated, May 19th, confirming the reduction of the company's capital from £700,000 to £600,000 was registered on June 25th by the Registrar of Companies.

**C. F. Young, Ltd.** At an extraordinary general meeting held at 3, Welford Road, Leicester, on June 25th, it was resolved that the company be wound up voluntarily and that Mr. Thomas F. Birch, C.A., of A. C. Palmer & Co., Court Chambers, Friar Lane, Leicester, be appointed liquidator.

**Dominion Gramophone Records (Foreign & Colonial), Ltd.** Meeting of creditors was held on July 9th, at Whitehall Room, Hotel Metropole, Northumberland Avenue, London, W.C.2.

**Peto-Scott Co., Ltd.** Meeting of unsecured creditors (other than those mentioned in paragraphs 1, 2 and 3 of the Scheme), will be held at the Hall of Incorporated Accountants, Astor House, Victoria Embankment, London, at 2.30 p.m., July 16th, to consider a scheme of arrangement to be made between the aforementioned creditors and the company. These unsecured creditors may vote in person or by proxy. In the latter case, forms of proxy, obtainable from the secretary of the company, 77, City Road, London, E.C., must be deposited with him by 12 noon, July 14th. The person appointed to act as proxy must be a like unsecured creditor of the company. Chairman of the meeting, appointed by the High Court of Justice, is Mr. E. J. Offord (Philips Lamps, Ltd., unsecured creditors), or failing him Mr. J. E. Saunders (Mullard Wireless Service Co., Ltd., unsecured creditors).

**Leo Taylor, Ltd.** (in voluntary liquidation). Creditors must send, on or before July 31st, their names and addresses (and of those of their solicitors, if any), together with particulars of their debts and claims, to William Latham, C.A., Union Bank Chambers, Lytham, the liquidator.

**Ramsbottom Electrical Heating & Lighting Co., Ltd.** Meeting of creditors will be held at 2.30 p.m., July 16th, at 52, Bolton Street, Ramsbottom, near Bury.

**Bordesley Electrical Accessories Co., Ltd.** 162, High Street, Bordesley, Birmingham. Meeting of creditors was held yesterday, July 11th, at the offices of Mr. Archibald Brown, Daimler House, Paradise Street, Birmingham.

## Receiving Order, Adjudication, First Meeting, and Public Examination.

**Britton, Joseph A.,** 362, Edgware Road, London, W., trading as **The Boleyn Gramophone Co.,** 31, Barking Road, London, E., gramophone and radio dealer.

Court: High Court of Justice. Date of petition and order: July 1st. Debtor's petition. First meeting: 11 a.m., July 15th, at Bankruptcy Buildings, Carey Street, London, W.C.2. Public examination: 11 a.m., August 12th, same place.

## Receiving Order & Adjudication.

**Dobson, Walter,** 17, Oak Lane, Manningham, Bradford, trading as **Stephen Dobson & Sons,** electrical engineer, etc. Court: Bradford. Date of petition and order: July 4th. Debtor's petition.

## Adjudication, First Meeting, and Public Examination.

**Spence, Herbert F.,** 2, Eureka Terrace, Honiton, lately trading at High Street, Honiton, carrying on business as **H. F. Spence & Sons,** electrical engineer, etc. Court: Exeter. Date of petition: June 12th. Date of order: June 30th. First meeting: 11.30 a.m., July 16th, at the Official Receiver's office, Exeter Bank Chambers, Broadgate, Exeter. Public examination: 10.30 a.m., August 14th, at the Castle, Exeter.

## Release of Trustees.

**Radcliffe, Harold H. D.,** 62, Islington Row, Birmingham, and **Haddleton, Frank,** 3, Lime Grove, Handsworth, Birmingham, trading in co-partnership as **City Electric Services,** 51, Islington Row, Birmingham, electrical engineers, etc. Court: Birmingham. Trustee: Clement Hoult, 191, Corporation Street, Birmingham, Official Receiver. Date of release: June 16th.

**Ranger, Gilbert A.,** 14, Hunton Road, Gravelly Hill, Birmingham, out of business, formerly residing and trading as **Terminus Garage** and **G. Ranger,** 1889, Pershore Road, Kings Norton, Birmingham, wireless dealer, etc. Court: Birmingham. Trustee: Clement Hoult, 191, Corporation Street, Birmingham, Official Receiver. Date of release: June 16th.

**Wilmington, Granville,** 74, Larch Street, Nelson, Lancs., trading at 75, Railway Street, Nelson, radio engineer, etc. Court: Burnley. Trustee: John W. Carter, District Bank Chambers, Blackburn, Official Receiver. Date of release: June 16th.

**Phillis, William J.,** 34, Morton Road, Leicester, trading at 87, Overton Road, Leicester, electrical engineer, etc. Court: Leicester. Trustee: Evan Barlow, 1, Berridge Street, Leicester, Official Receiver. Date of release: June 18th.

**Skipper, Sydney H.,** 35, Broad Bridge Street, Peterborough, trading as **S. H. Skipper & Co.,** electrical engineer, etc. Court: Peterborough. Trustee: Frederick H. Langmaid, 41, Sydney Street, Cambridge, Official Receiver. Date of release: June 16th.

## Intended Dividend.

**Peake, Ernest** (separate estate), 72, Harlow Road, Lidget Green, Bradford, trading in co-partnership with Chas. Armitage as **Armitage & Peake,** Pyramid Works, Coates Terrace, Manchester Road, Bradford, gramophone manufacturers, etc. Court: Bradford. Last day for proofs: July 23rd. Trustee: Cyril Wain,

and 8, Osborne Buildings, 91, Kirkgate, Bradford.

### Dividends.

**Jackson, John H.**, Dock House, Winsford, Cheshire, electrical engineer, etc. Court: Nantwich and Crewe. First and final dividend of 1s. 5d. in the £ payable on July 14th, at the Official Receiver's office, 12, Lonsdale Street, Stoke-upon-Trent.

**Shepherd, Cyril**, 69, Micklegate, previously 73, Acomb Road, formerly Coffee Yard, Stonegate, all York, radio engineer and wireless accessories dealer. Court: York. First and final dividend of 3s. 0½d. in the £ payable on July 17th, at the Official Receiver's offices, Duncombe Place, York.

### Dissolutions of Partnerships.

**Wheeldon, Charles E.**, and **Atherton, Clifford**, trading as **Wheeldon & Atherton**, 382, Moston Lane, Moston, Manchester, wireless and gramophone dealers, etc. Dissolved: July 3rd. Debts: C. E. Wheeldon, who continues the business.

**Ellison, Maurice, Hillman, Chas.**, and **Hillman, Edgar M.**, trading as **Ellison & Hillman**, 123-125, Albion Street, Leeds, wireless factors. Dissolved: December 31st, 1928. Debts: Chas. Hillman and E. M. Hillman, who continue the business as Hillman Bros.

### Receiverships (Appointment).

**Ambassador Talking Machine Co., Ltd.** A. H. Partridge of 3, Warwick Court, Gray's Inn, W.C.1, was appointed receiver and manager on June 19th, 1930, under powers contained in debenture dated June 12th, 1929.

**Clapton Rubber Co., Ltd.** M. Moustardier, of 69, Downs Road, E.5, was appointed Receiver on June 2nd, 1930, under powers contained in debenture dated January 8th, 1930.

### Mortgages and Charges.

**Campbell & Addison, Ltd.** Issue on June 20th, 1930, of £1,100 debentures, part of a series already registered.

**English Electric Co., Ltd.** Particulars filed of £750,000 debenture stock (inclusive of £450,936 outstanding under trust deed dated August 14th, 1923), authorised February 25th, and covered by trust deed dated June 17th, 1930, the amount of the present issue being £299,064. Property charged: The company's undertaking and property, present and future, including uncalled capital, and freehold and leasehold hereditaments in Bradford, Calverley, Preston, Ashton-upon-Ribble, Coventry, Bilton, Rugby, Shilton, Hough and Castlechurch. Trustees: Anglo-American Debenture Corporation, Ltd.

**General Wholesale Co., Ltd.** Debenture dated June 26th, 1930, to secure £500, charged on the company's undertaking and property, present and future, including uncalled capital. Holder: Mrs. V. McKenzie, Tullock Ard, Seaforth Road, Sunderland.

### Satisfactions.

*Note: Where the amount "originally secured" is stated, that is not necessarily the amount outstanding at the date of the satisfactions recorded below. There may have been previous partial satisfactions, registered or unregistered. The registration of Satisfactions is not compulsory.*

**Moon & Sons (Pianos), Ltd.** Satisfaction to the extent of £500 on April 4th,

1930, of debentures authorised June 16th, 1926, and registered June 29th, 1926. (According to the register of mortgages, the debentures registered June 29th, 1926, originally secured £30,000.)

**Mayfair Enterprises, Ltd.** Satisfaction in full on September 16th, 1929, of debenture for £1,000 dated July 10th, 1929, to the Earl of Rosse, and registered July 29th, 1929. (Notice filed June 28th, 1930.)

### County Court Judgments.

*The following returns have been received from the Registry of County Court Judgments, Treasury, Whitehall which purports to contain lists of judgments entered up in the respective County Courts of England and Wales, but no distinction is made on the register between actions for debts or damages or properly disputed cases; neither is it known which of the judgments remain unpaid at the present time; and it is probable that a large proportion of them have been settled between the parties or paid. It may also be observed that some of the judgments registered are against defendants in a representative capacity. The name given is that of the defendants; the amount is that for which judgment was given, and the date is that on which it was given.*

**Wireless Pictures (1928), Ltd.**, Dorland House, 14-16, Regent Street, London, W.1, manufacturers. Court: Westminster. £68 13s. 8d. May 12th.

**Jones, Clifford M.**, The Pavilion, Barmouth, Merioneth, wireless engineer. Court: Westminster. £31 9s. 8d. May 28th.

**Mainten Manufacturing Co., Ltd.**, 126, Portland Road, Hove, Sussex, wireless dealers. Court: Clerkenwell. £15 5s. 10d. May 22nd.

**Konchick, C.**, 52, George Street, Hull, wireless dealer. Court: Shoreditch. £91 1s. June 2nd.

**Parry & Co.**, 17, Promenade, Finchley, N.3, wireless dealers. Court: West London (Brompton). £18 11s. 6d. June 2nd.

**Dring, R.**, 257, Freeman Street, Grimsby wireless dealer. Court: Clerkenwell. £12 12s. 1d. May 23rd.

**Goodrick, W. R.**, 200, Lytham Road, Blackpool, wireless dealer. Court: Blackpool. £11 0s. 8d. June 4th.

**Smith & Powell**, 90, Bute Street, Cardiff, wireless engineers. Court: West London (Brompton). £12 1s. 5d. June 4th.

**Remond, W.**, 46, Wilson Street, Hammersmith, W.6, wireless dealer. Court: West London (Brompton). £73 9s. June 6th.

**Lester, Henry Gardiner**, (trading as Radio & Electrical Accessories Co.), 14, Endwood Court Road, Handsworth, Birmingham, wireless and electrical equipment factor. Court: Westminster. £26 11s. 11d. June 4th.

**Etherington, H.**, High Street, Haslemere, Surrey, wireless dealer. Court: Westminster. £27 19s. 9d. June 4th.

**Abbot, Mr.**, Bank Top, St. John's Crescent, Darlington, Durham, wireless dealer. Court: Halifax. £10 0s. 1d. June 13th.

### Bankruptcies.

**Dominion Gramophone Records, Ltd.**, Liverpool House, 15-17, Eldon Street, London.

Under a winding-up order made against this company on June 2nd, the statutory meetings of the creditors and of the shareholders were held on July 1st, at the Holborn Restaurant, London, W.C.

Mr. E. T. A. Phillips, Official Receiver, presiding. The chairman said that the company was incorporated as a public company on March 21st, 1928, to carry on business at Gt. Marlborough Street, London, W., with a factory at Luton and branches in Birmingham, Bristol, Glasgow, Leeds, Manchester, and Newcastle, as manufacturers of and dealers in gramophones, records, etc. Its nominal capital amounted to £150,000, divided into 200,000 10 per cent. participating preference shares of 10s. each, and 1,000,000 deferred shares of 1s. each. The whole of the capital had been issued for cash. The promoter of and vendor to the company was John Field, who, with a view to forming a company or companies, had acquired from the Cameo Record Corporation of America (of which J. E. Macpherson, who had acted as a director until January 7th last, was president) the sole and exclusive right licence of manufacturing records from matrices owned by the Cameo Corporation, and had agreed to buy from that corporation machinery and plant for record manufacture for £18,574, to be satisfied by the company when formed. On March 21st, 1928, Field agreed to sell to the company for £15,000, all his rights relating to the United Kingdom and the Irish Free State obtained from the Cameo Corporation, and he further agreed to apply for and to pay for 300,000 deferred shares. An agreement was also entered into on March 21st, 1928, for the Broadmount Investment Trust, Ltd., to issue the prospectus, and to underwrite the shares issued to the public. A prospectus was duly issued offering 200,000 shares (10 per cent. participating preference of 10s. each, and 200,000 deferred 1s. shares,) and the whole were applied for and allotted. The remaining 800,000 deferred were subscribed for by the vendor, and the directors and their friends.

The balance sheet disclosed a trading loss of £29,575 for the year ending March, 1929. The company had been in financial difficulties ever since, although debentures for £20,000 had been issued. The whole of its assets were charged by the debentures, and were valued at £45,000 if they could be sold as a going concern. They might not yield more than £5,000. The unsecured liabilities were estimated at £35,000.

The failure of the company was attributed to lack of capital, to alleged mismanagement, to extravagance, and to entering into unprofitable contracts, and to the theft of valuable machinery by an employee.

A difference of opinion arose with regard to the appointment of a liquidator, and the matter, it was intimated, would be referred to that court for decision.

**Andia, Ltd.**, 27, Old Bond Street, London, W.

In the compulsory liquidation of this company, which was formed to acquire inventions and patent rights relating to sound reproducing and amplifying apparatus, and to deal in goods connected therewith. The Official Receiver has now issued to the creditors and to the shareholders a summary of



# A FURTHER IMPORTANT NOTICE

BY THE MULLARD WIRELESS SERVICE CO., LTD.,  
AND THE MULLARD RADIO VALVE COMPANY, LTD.,

AS a result of the Legal Proceedings taken by  
The Mullard Radio Valve Company, Limited,  
against certain dealers for importing and/or selling  
Tungsram and Dario Radio Valves a

## PERPETUAL INJUNCTION

has been granted by The High Court of Justice  
against the London Radio Co. (Leeds) Limited of  
Leeds and Branches, under Letters Patent Nos.  
209730, 229622, 245146, 245147, 283941, 287958\* of  
the Mullard Radio Valve Company, Limited.

An order was also made for payment of

DAMAGES AND COSTS

## Warning

Anyone infringing the above-  
mentioned Letters Patent will  
render themselves liable to be  
proceeded against.

*The Mullard Radio Valve Company, Ltd.,  
Mullard House,  
Charing Cross Road,  
London, W.C.2.*



# 1,500 HELSEBY CONDENSERS

are being supplied weekly to one firm of Radio Manufacturers alone, for building into receiving sets. The Helsby Condenser has a reputation of 30 years' standing. Helsby made the first condensers under the original Mansbridge Patents.

**FOLLOW THE LEAD**  
you cannot go wrong

**Price - Quality**

and

**Delivery**

are

**Right**



Made for working pressures up to 600v. D.C.  
All Condensers packed in Attractive Cartons

Manufactured by:-

**BRITISH INSULATED CABLES LTD**

PRESCOT - LANCS.

Makers of PRESCOT and HELSEBY cables

Tel. No. PRESCOT, 171.

London Office: Surrey House, Embankment, W.C.2

Tel. No. TEMPLE BAR, 4793, 4, 5, and 6.



*It would be*  
**FATAL**  
*to lose*  
**CONTROL**

Barbed wire — trenches — dug-outs — a field set and a thin strand of wire. The difference between control and lack of control may spell life or death to an entire brigade. It's a far cry from No Man's Land to the comforts of your home. But even in your radio set . . . control plays a vital part . . . and it has been the privilege of CENTRALAB to furnish the volume controls of millions of radio receivers. Is your radio —CENTRALAB equipped?



This shows the exclusive rocking disc construction of Centralab volume control. "R" is the resistance. Contact disc "D" has only a rocking action on the resistance. Pressure arm "P" together with shaft and bushing is fully insulated.

Write for free Booklet, "Volume Controls, Voltage Controls—their uses."

**The Rothermel Corporation Ltd.**

24, Maddox St., London, W.1

'Phone : Mayfair 0578/9

Continental Sales Office:

27, QUAI DU COMMERCE, BRUSSELS, BELGIUM.

# Centralab



the statement of affairs, and this shows liabilities of £8,959, of which £8,806 are expected to rank, and net assets £358. A deficiency of £8,447 is accordingly disclosed with regard to the creditors, while in relation to the shareholders, the accounts show a total deficiency of £33,447. In his observations the Official Receiver reports that as a result of the statutory meetings of creditors and contributories the Senior Official Receiver remains the liquidator of the company.

**Daniel James Davies**, 36, Cambrian Street, Aberystwyth, Cardigan, lately Market Place, Newcastle-Emlyn, Cernarth, Carmarthenshire, wireless engineer.

The receiving order in this case was made on May 30th last on the debtor's own petition. The first meeting of creditors was held recently, and the case being a summary one, was left in the hands of the Official Receiver as trustee.

The following are creditors:—

Cadish, R., & Sons, London .. .. .	£24
Hobday Bros., Ltd., Wolverhampton ..	127
Murdoch Trading Co., London .. .. .	12
Brown Bros., London .. .. .	24

**Stanley Frederick Cooper, Ernest Charles Willis, and Royal Fisher**, trading as **The Merrington Gramophone Co.**, Harmony Works, Stringes Lane, Willenhall, Staffs, gramophone manufacturers.

The adjourned public examination of these debtors was held on June 30th at the County Court, Casen Street, Wolverhampton. No further questions were asked and the examination was closed.

**Harry George Edghill**, 13, Wembley Hill Road, Wembley, Middlesex, wireless engineer, etc.

The application for discharge herein was heard recently at the Court House, St. Albans. The receiving order had been made in February of this year. His honour granted the discharge, subject to a suspension for two months.

**Glanville Blackmore**, 62, Coventry Road, Market Harborough, Leicestershire, wireless engineer.

The receiving order in this case was made on June 13th last on the debtor's own petition, and the first meeting of creditors was held on June 27th at the Official Receiver's office, 1, Berridge Street, Leicester. The case being a summary one, was left in the hands of the Official Receiver as trustee.

The public examination of this debtor was held recently at the Castle, Leicester. The statement of affairs submitted disclosed a deficiency of £1,061. The debtor stated that he had to pay rates and taxes, and other traders sold wireless sets at prices with which it was impossible for him to compete. He attributed his failure to trade depression, competition, and cost of legal procedure. The examination was closed.

The following are creditors:—

Accumulators Elite, Halifax .. .. .	£10
Dibben & Sons, Ltd., Wm., Southampton ..	10
Edison Swan Electric Co., Ltd., Ponders End ..	57
Marconiphone Co., Ltd., Dagenham .. .. .	30
Mic Wireless Co., Ltd., Wellingborough ..	20
Mullard Wireless Service Co., Ltd., London ..	14
Pertrix, Ltd., London .. .. .	16
Philips Lamps, Ltd., London .. .. .	32
Radio Supply Co., Northampton .. .. .	57
Tungram Elect. Lamp Works, Ltd., London ..	13
Wilding Cole, Ltd., Birmingham .. .. .	21
Yesley Elect. Supplies Co., Ltd., London ..	36

**Maudslay Baynes**, lately trading with another as **Langham Radio**, wireless manufacturers, 96, Regent Street, London, W.

The order of adjudication in this case was made on November 20th last, and the firm's affairs came before Mr. Registrar Mellor in the London Bankruptcy Court on Friday of last week on the hearing of an application for discharge by the debtor Baynes.

Mr. E. Parke, Official Receiver, attended, and in reading his report on the application said that according to the trustee in bankruptcy, he had received, so far as the debtor's joint estate was concerned, five proofs of debt amounting to £11,804, of which he had admitted the petitioning creditor's (Marconi's Wireless Telegraph Co., Ltd) claim for £11,066. No joint assets were disclosed and nothing had been recovered. In evidence, the applicant had stated that he began business as a manufacturers' agent early in 1925 with a capital of £500. He dealt in wireless goods at 59-61, New Oxford Street, London, W. In 1926, he was joined by a partner, and they traded together as Langham Radio, but in March, 1927, he severed his connection with his partner, and taking over the assets and liabilities, continued the trading under the old style. In May, 1927, he gave an option to a Mr. Newman, who was at that time employed as a salesman, to buy the business for £2,000, but the option was not exercised. On his return to the business (after having been in a nursing home) in August, 1927, he gave Newman authority to sign cheques, and appointed him manager of the business, promising 50 per cent. of the profits, but stipulating that there should never be any question of a partnership.

The Official Receiver had been informed by a number of creditors who assented to the deed that they gave credit to Langham Radio in the belief that Newman was a partner, as evidenced by the notepaper, and in certain instances because Newman told them so or because he signed orders in that capacity. It was not disclosed to them that Newman was an undischarged bankrupt. Newman had admitted that he was an undischarged bankrupt, but his statements were at variance with those of the applicant. In particular, he said that he had a vague recollection that he informed the applicant that he was an undischarged bankrupt when he first joined the firm. He did not, however, know whether he was a partner, but thought that he was.

The Official Receiver opposed the application on the grounds that the applicant's assets were not of a value equal to 10s. in the £; that he had omitted to keep proper books of account; and that he had been guilty of misconduct in that he allowed Newman to hold himself out as a partner, and obtained credit for the business of Langham Radio, knowing that Newman was an undischarged bankrupt. Having heard counsel, His Honour decided to uphold the Official Receiver's report, and he suspended the applicant's discharge for two years and six months.

**John Gordon Wadsworth**, 10, Westfield Terrace, Higham Ferrers, Northampton-

shire, trading as the **Nene Road Electrical Company**, electrical engineer, etc.

The adjourned public examination of this debtor was held recently at the County Hall, Northampton. A statement of affairs submitted disclosed liabilities of £135 18s. 9d. and a deficiency of £125 18s. 9d. Questioned regarding a motor car which he possessed, the debtor stated that this had been bought for him by his father for use in his business, his father borrowing the money. He admitted that he had used the car for his own pleasure and had been in the habit of taking people for rides. In answer to further questions the debtor stated that he had been before a Court of Referees and was not receiving the dole. The case was again adjourned.

**Charles Kendrick**, 52, George Street, and 94, Bright Street, both Kingston-upon-Hull, wireless dealer, etc.

The first meeting of the creditors interested herein was held recently at the Official Receiver's Office, 37, Scale Lane, Hull, when a statement of affairs was submitted, disclosing liabilities of £1,978 3s. 10d., with assets amounting to £1,083 11s. 4d., thus leaving a deficiency of £894 12s. 6d. The debtor attributed his failure to "lack of capital, keen competition, cut prices, heavy overhead expenses, and illness of wife." Mr. E. Peter Dutton, of Victoria Chambers, Bowlalley Lane, Hull, was appointed trustee, with a committee of inspection.

**Cyril Morton Anderson**, trading as **The Robin Hood Electrical Co.**, 1556, Stratford Road, Hall Green, Birmingham, and at Back 330, Icknield Port Road, Birmingham, electrical contractor, etc.

The receiving order herein was made on the debtor's own petition recently, and according to the statement of affairs filed there are liabilities of £543 10s. 9d. and assets of £78 19s. 6d., thus leaving a deficiency of £464 11s. 3d. The debtor attributes his failure to bad trade due to keen competition, want of capital, damages for breach of contract, loss on patent battery charger, etc. He states that in December, 1927, he commenced business with a capital of £5, his savings, at 66, Primrose Lane, Hall Green, Birmingham, as "The Robin Hood Electrical Co.," doing sundry electrical work in his spare time. On July 27th, 1929, he commenced to trade as a motor engineer, stating that it was his intention to do repair work, but none of this business was undertaken. On February 1st, 1930, the debtor removed to 1556, Stratford Road, Hall Green, anticipating that the premises there would be more suitable for his electrical business. He states that owing to keen competition his hopes were not realised. On June 18th, 1927, the debtor patented a device for charging accumulators, and sold for £25 a quarter share of any profits derived from the sale thereof. All the businesses in which the debtor has been interested appear to have been unsuccessful, and he states that he has been able to continue only with the aid of the advances made and £100 alleged to have been advanced by his wife. The books kept consist of cash book, purchase and private ledgers, day book, invoice book, and stock book, but these date only from February 8th

last. He has never taken steps to ascertain his financial position or the result of his trading. In August, 1927, the debtor purchased the leasehold premises, 66, Primrose Lane, Hall Green, for £500, obtaining £475 on mortgage, and the balance of £25 is stated to have been advanced by his brother. These premises were let at a rental of £11s., when the debtor removed to his present residence. The first meeting of creditors was held recently; the case being a summary one was left in the hands of the Official Receiver as trustee.

### PETO SCOTT'S CREDITORS' SCHEME.

#### Committee Recommend Adoption of the Arrangement.

IN pursuance of an Order of the Court, a meeting of the creditors of the Peto Scott Co., Ltd., 77 City Road, E.C., and 62 High Holborn, London, W.C., will be held next Wednesday, July 16th, at the Hall of the Incorporated Accountants, Victoria Embankment, London, E.C., to consider a scheme of arrangement.

The scheme provides for the payment of preferential claims in full, while Mrs. Worthington and the British Radio Gramophone Co., Ltd., who are creditors for the aggregate amount of £14,718, will not participate in the proposed composition and will allow the amounts due to them to remain unpaid and without interest until first debentures to be created have been paid off. In addition, Associated Distributors, Ltd., and the Bankers' Commercial Security, Ltd., who are creditors for an aggregate amount of £15,500 in respect of current hire-purchase agreements financed by them on behalf of the company, will not take any steps to enforce payment of their claims against the company, nor participate in a proposed composition. In consideration of Associated Distributors, Ltd., continuing to finance the company's hire purchase agreement, they will have issued to them non-interest-bearing second debentures of £5,000, while a further £1,500 of such debentures will be issued to the Bankers' Commercial Security, Ltd., both as collateral security in respect of the company's contingent liability to them under H.P. agreements.

The scheme further proposes that all the remaining unsecured creditors of the company shall accept a composition of 5s. in the £ in full discharge of their claims. Mrs. A. M. Worthington and Associated Distributors, Ltd., will each advance to the company £2,000 on the security of first debentures, carrying interest at 7½ per cent. per annum.

At the recent meeting of the creditors of the company a statement of affairs was submitted which disclosed ranking liabilities of £29,274, against net assets of £12,941, and a committee was appointed. The committee has issued a circular to the creditors in which it is stated that the petition for the winding up of the company had been adjourned until July 30th to enable the creditors to consider the scheme of arrangement. The petitioning creditor, and other large creditors, have already agreed to accept the scheme. The committee thought that the scheme was one which should be accepted by the whole of the creditors.

#### Manufacturers' Lists, Please.

Hawnt & Co., wireless and electrical wholesalers, 11, Imperial Buildings, Dale End, Birmingham, are anxious to receive lists and terms from manufacturers.

#### Yorks. Music Firm's Branch.

A correspondent writes: Waddington & Sons, Ltd., the well-known Yorkshire firm of musical instrument dealers, have opened branch premises in New Square, Chesterfield, with a department for wireless goods and gramophones.

#### A Change of Name.

A change in the title of the well-known Wireless & Radio Trades Guardian Association, Ltd., should be noted. This Association, whose offices are at 78, New Oxford Street, London, W.1, have altered their name to the Radio & Gramophone Trades Guardian Association, Ltd.

#### A Halcyon Announcement.

It is announced that Mr. E. C. Green has been appointed London sales manager of the Halcyon Wireless Co., Ltd., while Mr. C. J. Close will be in charge of Halcyon's recently opened trade showrooms at 72, Newman Street, London, W.1.

#### The Show.

Whittingham Smith & Co., the manufacturers of "Portadyne" receivers, have been allotted Stand No. 132 at the forthcoming National Radio Exhibition. We regret that their name was omitted from the list of standholders published in our last issue.

#### Those Mailing Lists!

Some time ago—in September last, to be exact—the Lisenin Wireless Co. moved from Edgware Road, London, W., to 5, Central Buildings, High Street, Slough, but they inform us that they are still receiving a considerable amount of correspondence forwarded from their original London address.

Another case of out-of-date mailing lists has also come to hand. Mr. Charlie Roberts, wireless and gramophone dealer, moved some twelve months ago to more convenient premises named "Electra-ville," at West Ardsley, near Wakefield. Nevertheless, correspondence is still being sent to his old address at Fairfield Avenue.

Therefore, all you who read this, make sure that your mailing lists are up to date!

#### T. L. Castle Change their Discounts.

Manufacturers and others dealing with Messrs. T. L. Castle, of 2, Cricklewood Broadway, London, N.W.2 (the screw and small tool manufacturers) should note that several changes have been effected in discounts from the list prices of all stock sizes listed on pages 4-50 of their 1929 catalogue. These are as follow:—

Under 1 gross .. .. .	plus 25 per cent.
1 gross .. .. .	.. .. . nett
2 to 9 gross .. .. .	less 25 per cent.
10 to 49 gross .. .. .	less 40 per cent.
50 gross and more .. .. .	less 45 per cent. and 5 per cent.

Quantities of 2 gross and over may be made up of any number of sizes (minimum 1 gross of a size) and discount will be based upon the total quantity. Sizes listed at less than 5s. per gross can only be supplied in quantities of 1 gross or over. Special prices are quoted for 50 gross or more of a size.

#### Aeonic Changes.

We are informed by the receiver and manager of Aeonic Radio, Ltd., (in volun-

tary liquidation), that Messrs. D. G. Balette, G. Lawson-Thomas and I. Hillman are no longer representing the firm.

#### R.I.'s Northern Representatives.

Radio Instruments, Ltd., of Purley Way, Croydon, inform us that they have appointed J. D. Morrison & Co., of 10, Whitworth Street West, Manchester, as representatives for all R.I. products throughout the whole of the North of England, including the North Wales, Lancashire, Yorkshire and Newcastle areas. A wholesale showroom is being opened for the display and demonstration of the numerous lines carried.

If it is found necessary, stocking arrangements and additional showrooms will be opened in other centres covered by the agency.

#### Expansion in Cheshire.

The Deeside Radio Service tell us that, owing to rapidly increasing business, they have acquired a large shop at 16, Banks Road, West Kirby, Cheshire, into which they moved from 33, Grange Road, last Monday, July 7th. The new premises are equipped on up-to-date lines, and are excellently situated in a main thoroughfare.

### IMPORTANT NOTICE.

QUESTIONNAIRE forms in connection with the preparation of the 1931 edition of "The Wireless Trader' Year Book and Diary" have now been despatched throughout the trade, and we wish to make it clear that these should be completed and returned to us at once if all entries are to be correctly included.

Manufacturers and wholesalers who have not received or who have mislaid the form are requested to get in touch with us immediately, when a copy will be sent by return.

#### Edison Bell Holidays.

Edison Bell, Ltd., wish it to be known in the trade that their works at Glengall Road, London, S.E.15, will be closed entirely at 6 p.m., on Friday, July 25th, and will reopen on Monday, August 11th.

#### New Scottish Shops.

We learn that Mr. Alexander Aitchison has commenced business on his own account as a wireless specialist at 19, Elm Row, Galashiels.

It is announced that a new retail store has been opened at 18 Keptie Street, Arbroath, under the style of "Baker's Emporium." This includes a special department for radio sales.

Mrs. W. D. Renwick, we hear, has taken over new premises at 42 Northgate, Peebles.

#### Wholesalers Move.

We learn that the Manchester depot of Hardman & Co., Ltd., has been moved from 9-13, Miller Street, to 61, Bridge Street, where they are carrying large stocks of wireless and electrical goods.

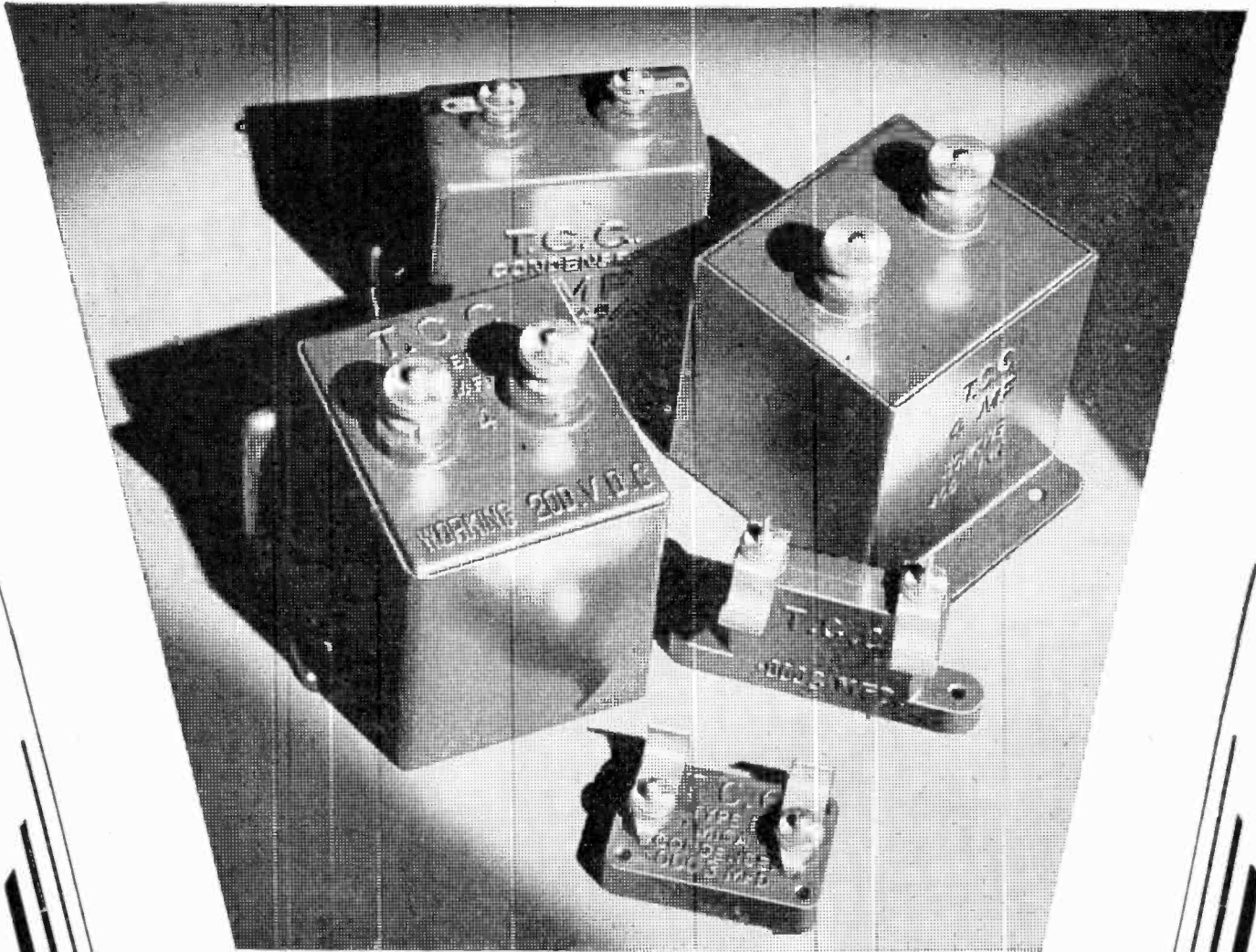

# T.C.C. might . .

.. well stand for.. "They—  
Command — Confidence,"  
—it is the initials of the  
Telegraph Condenser Co.,  
who have been making  
condensers—solely condenser—  
for a quarter  
of a century.

A condenser of proved  
merit — of absolute reli-  
ability. Stock T.C.C. "the  
condenser in the green  
case" — and, remember,  
it is a condenser with  
a guarantee.

TELEGRAPH CONDENSER CO., LTD.  
WALES FARM ROAD, N. ACTON.





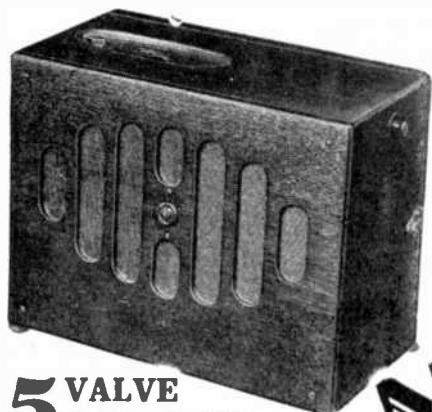

**12 GNS.**  
**OAK**

**THE RIGHT SETS FOR  
SUMMER SALES**

**—AT THE RIGHT PRICES.  
BACKED BY THE RIGHT  
SALES AND SERVICE  
ORGANISATION**

**5 VALVE  
PORTABLE**

**S**PEED up your summer sales by stocking *National* and *Symphony* portables. At greatly reduced prices the finest value in radio—for indoor or outdoor use. They are bringing big business to stockists throughout the country—get your share!

*Write to-day for full particulars of generous trade terms and free sales service to:—*

**NATIONAL**  
THE QUALITY PAIR  
WHICH SET THE HIGHEST  
STANDARD IN RADIO  
**SYMPHONY**

**13 GNS.**  
**MAHOAGANY**

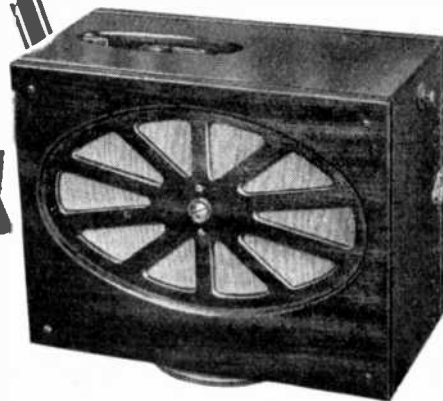

**5 VALVE  
PORTABLE**

**The BRITISH RADIOPHONE LTD.** Aldwych House, Aldwych, London, W.C.2 *Telephone: Holborn 6744*

**INDEX TO DISPLAYED ADVERTISEMENTS—Continued from Back Page.**

	PAGE		PAGE		PAGE
Kalisky, S. (Aldgate), Ltd. . . . .	48	Oldham & Son, Ltd. . . . .	36	Rigby & Woolfenden . . . . .	46
L. E. S. Distributors, Ltd. . . . .	16	Ormond Eng. Co., Ltd. . . . .	30	Rothermel Corporation Ltd., The . . . . .	44
Lamplugh S. A., Ltd. . . . .	42	Partridge & Mee, Ltd. . . . .	28	Standard Battery Co. . . . .	24
Lever, Er'c J. (Trix), Ltd. . . . .	47	Partridge, Wilson & Co. . . . .	50	Sun Electrical Co., Ltd., The . . . . .	21
Lissen, I td. . . . .	25	Pertrix, Ltd. . . . .	23	Tannoy Products . . . . .	26
Londor Metal Warehouses, Ltd. . . . .	48	Philips Lamps, Ltd. . . . .	17, 18, 19, 20	Telegraph Condenser Co., Ltd., The . . . . .	45
McMichael, L., Ltd. . . . .	15	Potter, E. . . . .	48	Triotron Valves . . . . .	Inside Front Cover
Maisier, E. H., & Co., Ltd. . . . .	28	Prideaux Junior, Ralph . . . . .	26	Vandervell, C. A., & Co., Ltd. . . . .	6
Marconiphone Co., Ltd., The . . . . .	35	Pye Radio, Ltd. . . . .	9	Westinghouse Brake & Saxby Signal Co., Ltd. . . . .	16
Muillard Wireless Service Co., Ltd. . . . .	8, 38, 43	Radio Instruments, Ltd. . . . .	Front Cover	Wingrove & Rogers, Ltd. . . . .	48
Mirphy Radio, Ltd. . . . .	29	Ready Radio Supplies . . . . .	28	Wright & Weaire, Ltd. . . . .	24
		Red Star Radio . . . . .	40, 41		

**Special Facilities for Readers**

IF you desire further particulars of several items advertised in this issue, place a tick against the names of the advertisers in the index above and overleaf, and forward the page to the "Trader Information Bureau," St. Bride's House, Salisbury Square, Fleet Street, London, E.C.4, who will see that your request is forwarded.

W.T. 12/7/30

Sign here.....

Address.....

INDEX TO DISPLAYED ADVERTISEMENTS.

(Continued on Page 49.)

	PAGE		PAGE		PAGE
Abingdon Wireless Supplies	40	Dibben, Wm., & Sons, Ltd.	22	Fonteyn & Co., Ltd.	48
Aeonic Radio, Ltd.	4	Dubilier Condenser Co. (1925), Ltd.	26	Francois, E. J.	40
Baker's "Selhurst" Radio	47	Dulcetto-Polyphon, Ltd.	5	Franklin Electric Co.	47
British Insulated Cables, Ltd.	44	East London Rubber Co.	Back Cover	Garnett Whiteley & Co., Ltd.	Inside Back Cover
British Radiophone, Ltd., The	49	Eastick, J. J., & Sons	48	Gilbert, C., & Co.	7
Brown Bros., Ltd.	1	Edison Bell, Ltd.	3	Graham Amplion, Ltd.	31, 32, 33, 34
Brownie Wireless Co. (Gt. Britain), Ltd.	2	Emkabe Radio Co., Ltd.	50	Gripso Co.	47
Carrington Mfg. Co., Ltd.	14	Enderlein, E.	14	Halcyon Wireless Co., Ltd., The	11
Concerton Radio & Electrical Co., The	48	Epoch Radio Mfg. Co., Ltd.	48	Hart Collins, Ltd.	50
Daly, H. C.	48	Exact Mfg. Co.	48	Houghtons	37
Danipad Rubber Co., Ltd.	22	Fielding, T., & Co., Ltd.	48	Hughes, F. A., & Co., Ltd.	27
Davies, D. M. (Woodwork), Ltd.	13			Igranic Electric Co., Ltd.	10
Dayzite, Ltd.	47			Impex Electrical, Ltd.	12
Detex, Ltd.	39			Ioco Rubber & Waterproofing Co., Ltd., The	28

To obtain particulars of several items advertised in this issue place a tick against the name of the advertiser in the index above and overleaf and sign coupon at foot of index on the previous page.

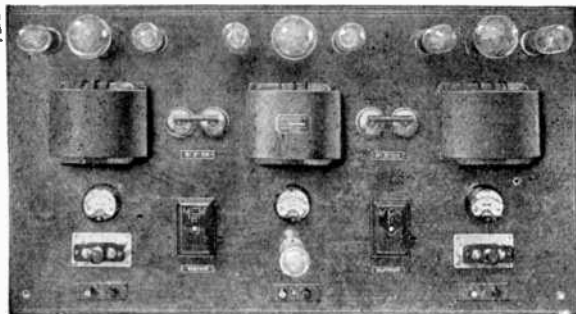

DAVENSET SERVICE STATION CHARGER  
Price £25 net.  
Max. D.C. Output 75 volts at 6 amperes

**DAVENSET**  
COMMERCIAL ACCUMULATOR CHARGERS  
AND RECTIFIERS FOR A.C. MAINS ARE  
THE PRESENT DAY EQUIPMENTS

BECAUSE THEY ARE

1. HIGHLY EFFICIENT.
2. SIMPLE TO OPERATE.
3. PERFECTLY SILENT.
4. NON-RADIATING.
5. REASONABLE IN PRICE.

e.g. from £8:8:0 net

TECHNICAL BOOK ISSUED FREE.

A 42-page copy of the 3rd Edition (reprinted April, 1929) of the booklet entitled "Commercial Accumulator Charging and the Efficiency of A.C. Rectifying Equipment," in which 7 models of Davenset Chargers are both described and illustrated, may be had on application to your usual wholesaler, or direct from the manufacturers FREE OF CHARGE. This offer applies to bona-fide traders only.

**PARTRIDGE, WILSON & CO.**  
LOUGHBOROUGH ROAD, LEICESTER



"ASTRA" DIAL

Accurate Geared Movement.  
Fast and Slow Motion.  
Fits any Condenser spindle.  
Fine Appearance



TYPE No. 1, 3 in. diam. 3/6  
TYPE No. 2, 4 in. diam. 5/-  
EMKABE RADIO CO., LTD., 47 Farringdon Road, London, E.C.1

Send for full LIST of Emkabe Components.

Your Passport

DON'T HESITATE to enter into conversation when anyone says "I believe in Passports."

Both you and your customer receive full satisfaction from the sale of a "Hart Collins" —

"PASSPORT" S.G.4 PORTABLE

Write for Prices and Terms.

HART COLLINS LTD.  
38a, BESSBOROUGH STREET, S.W.1.  
Telephone: Victoria 3738.





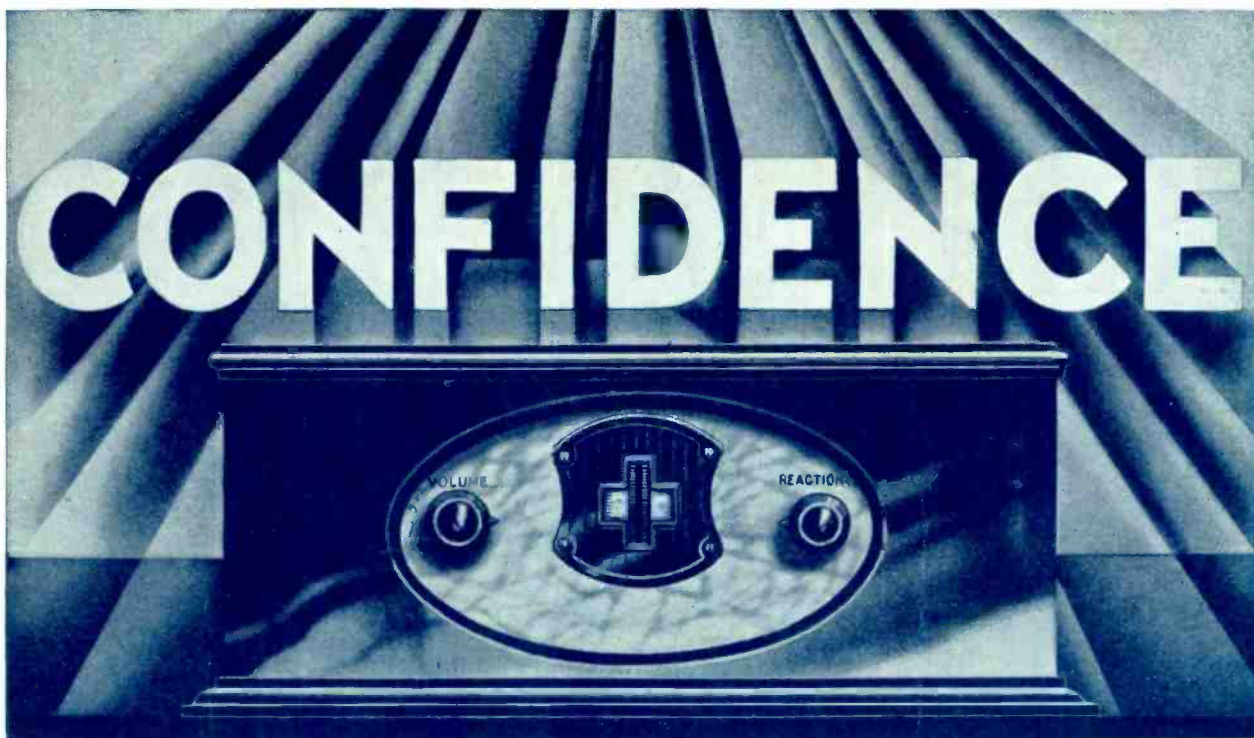

You can always be confident when selling a Lotus Set—confident that its appearance will impress the customer, and that its performance will satisfy even the most exacting ear.

The Lotus 3-valve S.G.P. All-Electric Receiver can be obtained in a polished Oak or Mahogany cabinet. The controls, including a dual drum dial, reaction and volume controls, are neatly and symmetrically arranged on a handsome panel. A feature of this set

is the ease with which stations can be tuned in or cut out.

Retail Price £21 cash, or £1 : 19 : 9 down and 11 similar monthly payments. Also available as Battery Model at £13 : 15 : 0, or £1 : 6 : 6 down and 11 similar monthly payments.

Another Lotus Set that you can stock with confidence is the Lotus 3-valve All-Electric Transportable, which retails at £25 : 4 : 0 or £2 : 7 : 0 down and 11 similar monthly payments.

Write for details.

# LOTUS ALL ELECTRIC RECEIVER

GARNETT, WHITELEY & CO., LTD., Lotus Works, Mill Lane, Liverpool

London Depot: 183 Old Street, E.C.2  
Telephone: Clerkenwell 2580

# RADIO

ALL ELECTRIC RADIO IS TROUBLE FREE  
E·L·R·CO. SERVICE IS TROUBLE FREE  
PLACE YOUR ORDER FOR MAINS  
RECEIVERS AND ELIMINATORS WITH US  
AND TAKE ADVANTAGE OF OUR LARGE  
STOCKS AND QUICK DELIVERY

EXCO POWER SUPPLY UNITS FOR PORTABLES

COMBINED H.T. UNIT and L.T.  
CHARGER. MODEL C.P.1 for A.C.  
MAINS. Size 9 by 5 by 3½ ins.

A switch enables 2, 4 or 6-volt accumulators to be charged when the receiver is not in use. H.T. tapplings for S.G. valves, variable tapping from 0-120 volts and fixed tapping of 120/150 volts (this tapping can be reduced to 100 volts). Approximate running costs 5s. 6d. per 1,000 hours, 11 watts, at 6d. per unit. For A.C. Mains (a) 200-250 volts, 40-100, cycles (b) 100-120 volts, 40-100 cycles. £6 - 0 - 0

PORTABLE H.T. UNIT FOR D.C.  
MAINS. MODEL 1V.20. Size 8½ by 4  
by 3½ ins.

H.T. tapping for S.G. valves, variable 0-120 and fixed 120/150 volts. Approximate running costs 2s. per 1,000 hours, 4 watts, at 6d. per unit. For 200-250 volt D.C. Mains only. £2 - 10 - 0

PORTABLE H.T. UNIT FOR A.C.  
MAINS. MODEL 1V.20. Size 9 by 5  
by 3½ ins.

H.T. tapping for S.G. valves, variable 0-120 and fixed 120/150 volts (this tapping can be reduced to 100 volts). Approximate running costs 3s. per 1,000 hours, 6 watts, at 6d. per unit. For A.C. Mains (a) 200-250 volts, 40-100 cycles, (b) 100-120 volts, 40-100 cycles. £4 - 12 - 6

SPECIAL STOCKISTS FOR PHILIPS MAINS

RECEIVERS 2 Valve Model 2515 for A.C. Mains £12 10 0.

3 Valve Model 2514 for A.C. Mains £23 0 0.

3 Valve Model 2524 for D.C. Mains £23 0 0. 4 Valve Model 2511

for A.C. Mains £37 10 0. Model 2007 Speakers £5 5 0. Model

2018 Moving Coil Speaker £14 14 0.

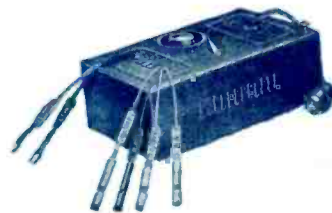

Model C.P.1



Model 1V20 for D.C. Mains.

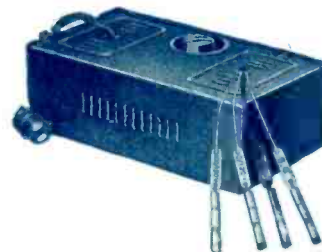

Model 1V20 for A.C. Mains.



# EAST LONDON RUBBER CO LONDON & SHEFFIELD