

The WIRELESS & GRAMOPHONE TRADER

Incorporating "The WIRELESS and ALLIED TRADES REVIEW" "The RADIO
TRADE JOURNAL" and "The WIRELESS DEALER"

VOL. XXII. (NEW SERIES) No. 303.

June 7th, 1930.

9/- PER ANNUM, POST FREE.
SINGLE COPIES 1/- EACH.

Columbia
TRADE MARK
MUSIC NOTES
RADIO



Columbia
TRADE MARK
MUSIC NOTES
RADIO

KEEPS FAITH

Columbia Portable Radio keeps faith with the user and dealer alike—reliable radio—made by the makers of Columbia gramophones and records who have over 30 years, reputation to uphold.

Columbia Portable Radio keeps faith with the original performance; produces honest, true-toned music at realistic volume.

£26-15-6

Model 303
All-Electric A.C. or
D.C. No Trickle
Charger! No Accumulator! No Battery!

£17 - 17

Model 303
Battery Driven. In
polished Oak
Cabinet. Wide
range of Stations.

Columbia RADIO

MADE BY—THE COLUMBIA GRAPHOPHONE CO., LTD.,
102-108, CLERKENWELL ROAD, LONDON, E.C. 1.

WESTINGHOUSE RECTIFIERS

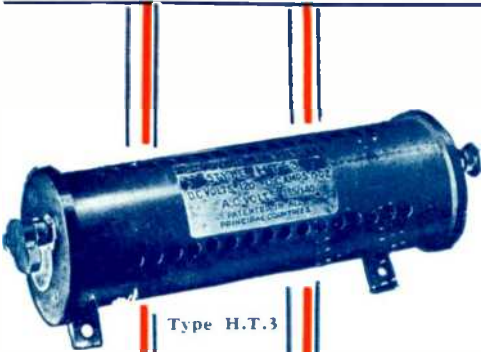

Type H.T.3



Type H.T.4



Type A.3

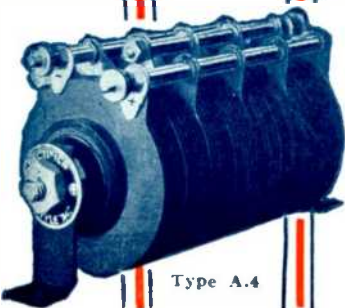

Type A.4

Supplies of our booklet "The All-Metal Way-1930" are available to all dealers for distribution to their customers. In this 32-page book are given suitable circuits, lists of recommended components, and complete and valuable information and instructions for the calculation, design and construction of every type of mains unit

FOR ALL TYPES OF MAINS EQUIPMENT — HIGH AND LOW TENSION BATTERY CHARGERS AND ELIMINATORS, or for supplying the pot windings of moving-coil speakers.



METAL RECTIFIERS

represent the most convenient and satisfactory means yet devised for obtaining direct current from an A.C. Supply, and are used in large quantities, on account of their reliability, durability and efficient performance, by the leading manufacturers.



THE



FOUR CIRCUIT BATTERY CHARGING SET

IS AN EQUIPMENT WHICH WILL APPEAL TO OWNERS OF BATTERY SERVICE STATIONS

It will charge simultaneously high and low tension wireless and car starter batteries at their CORRECT CHARGING RATE.

Requires no periodical replacements or attention.

Send for Leaflet S.F.11e5



Style R.G.C.1

The Westinghouse Brake & Saxby Signal Co., Ltd.,

82 York Road, King's Cross, London, N.1

Telephone: North 2415-6-7-8.

SUMMER SALES CAMPAIGN



Reprints of the
following pages



-available for
distribution to
your customers

Supplies of this supplement, with appropriate alterations to pages one and two, are available for distribution to your customers. Write to your Factor or direct to the Manufacturers

ALL-ELECTRIC RADIO

A.C. MODEL — the first

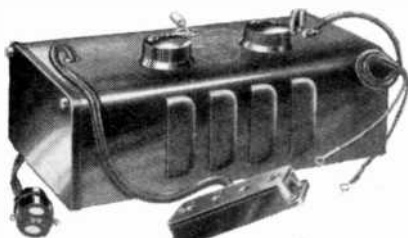

MODEL W.5.
Combined Model for A.C. Mains.
Size: 9" x 5" x 3 1/2".
Output: 120 volts at 15 m.a.
Tappings: H.T. 2 continuously variable
(one S.G.) and 1 power.
L.T.: Trickle Charger for 2-, 4- or
6-volt accumulators.

Price
£5 : 17 : 6

MODEL W.6. H.T. only, **£4 : 5 : 0**
*Either of the above models is available for 25
cycles at an increase in cost of 10%.
If supplied with "XTRA POINT" lampholder
and plug, 4/6 extra.*

D.C. MODEL — the only

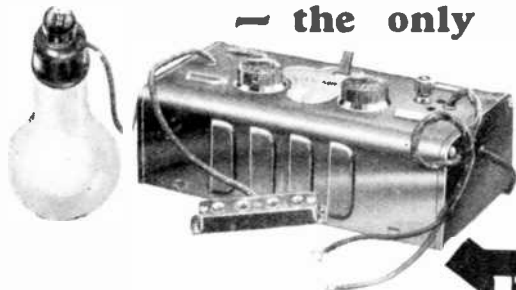

Combined Model for D.C. Mains.
Input voltage 200-250 volts.
Size: 9" x 5" x 3 1/2".
H.T. Output: 130 volts at 20 m.a.
H.T. Tappings: 2 continuously variable
(one S.G.) and 1 power.
L.T.: Trickle Charger for 2-,
4- or 6-volt accumulators.

Price
£4 : 5 : 0

H.T. only, **£2 : 15 : 0**

**IT FITS
IN
HERE**

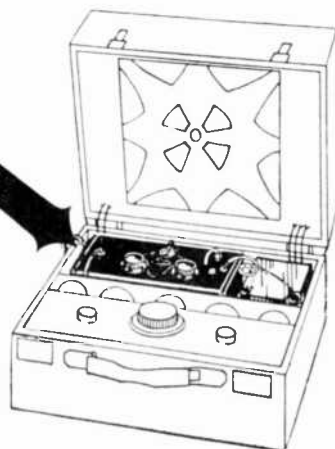

Most of your customers—owners of all types of battery-operated sets, including Portables—would not hesitate for one second to make their Sets "ALL-ELECTRIC" if they could be sure of really efficient results.

THIS BOOKLET WILL GIVE THEM CONFIDENCE

Letters from leading Portable Set Manufacturers state that the Regentone "Portable" Combined Units (A.C. and D.C.) give complete satisfaction when used with their Receivers.

Independent tests by a recognised authority on radio prove the entire suitability of Regentone Mains Units for all the well-known home-constructed circuits, large numbers of which have been built by your customers during the last year or two.

Think of your many customers who have bought a McMichael, a Pye, etc.—who have built an Osram Music Magnet or one of the Sets which Mr. James has tested—they'll all buy Regentone if they have electricity in their homes and you put this idea across properly.

Make full use of this sensational selling scheme and you cannot fail to increase your business.



READ WHAT M^c MICHAEL SAYS

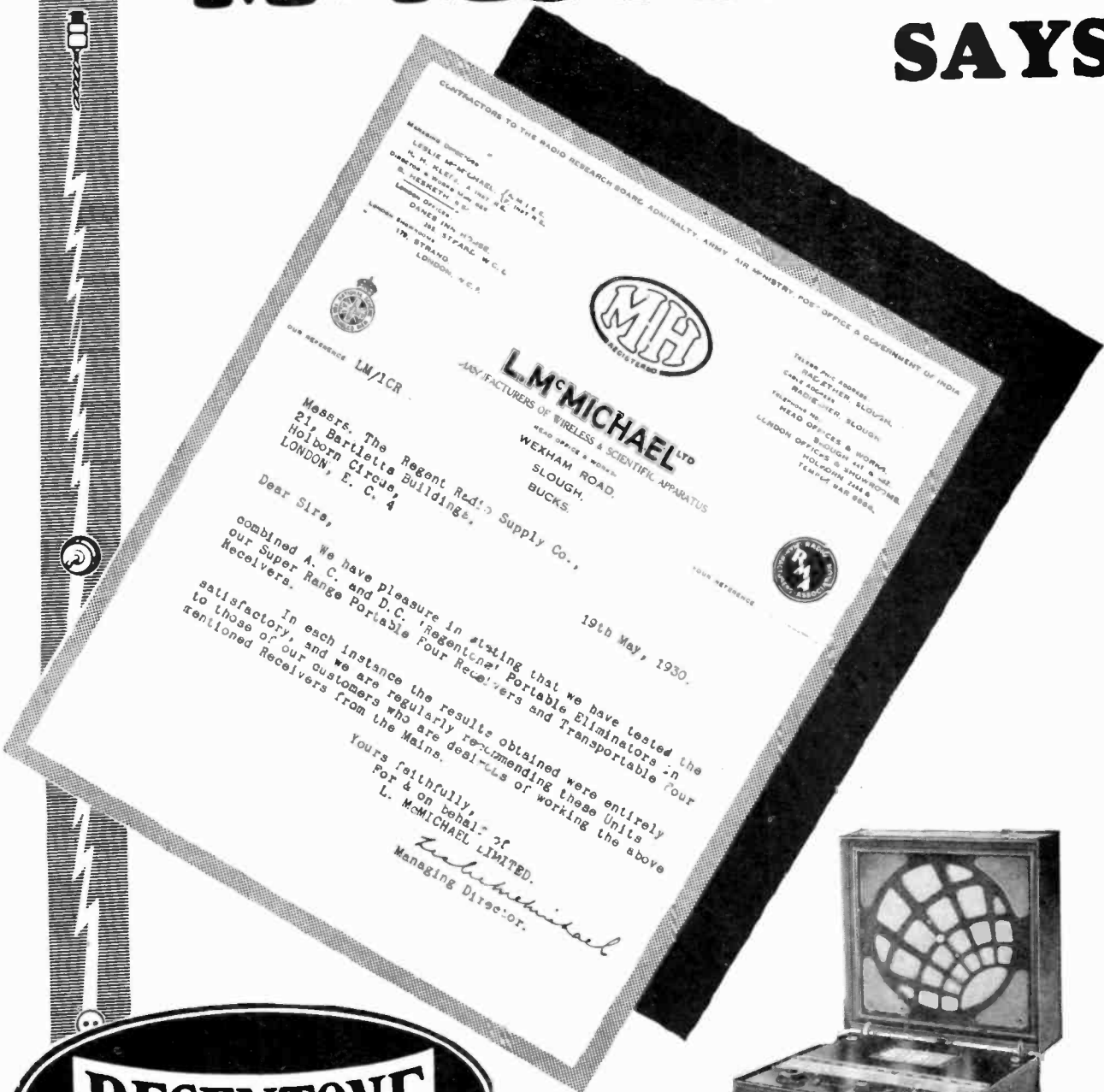

READ WHAT SELECTORS SAY

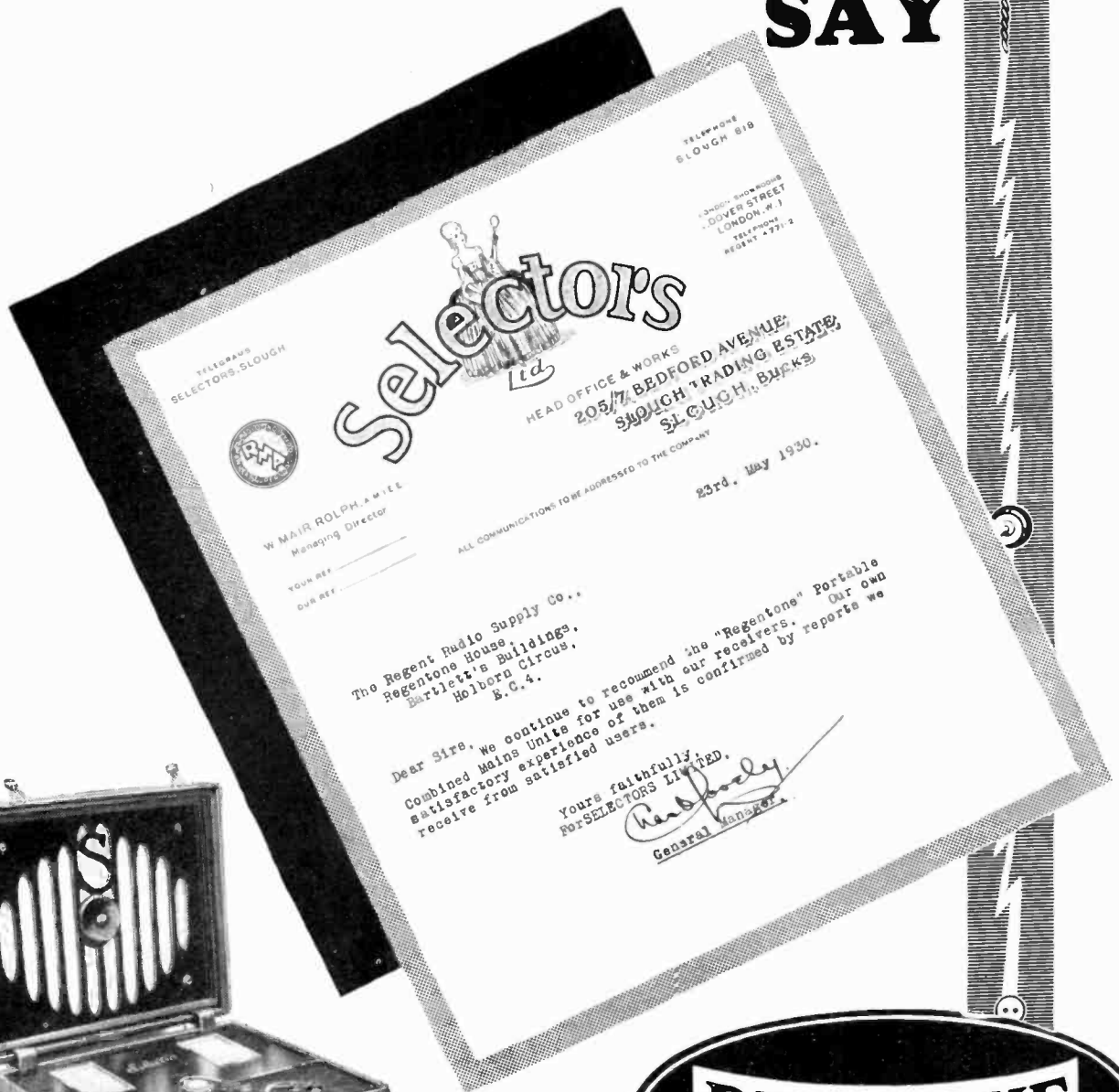

TELEGRAMS
SELECTORS, SLOUGH



Selectors Ltd

HEAD OFFICE & WORKS
205 1/2 BEDFORD AVENUE,
SLOUGH TRADING ESTATE,
SLOUGH, BUCKS.

TELEPHONE
SLOUGH 818

LONDON SHOWROOMS
1 COVER STREET
LONDON (W. 1)
TELEPHONE
REGENT 4771-2

W MAIR ROLPH, A.M.I.E.E.
Managing Director

YOUR REF. _____
OUR REF. _____

ALL COMMUNICATIONS TO BE ADDRESSED TO THE COMPANY

23rd. May 1930.

The Regent Radio Supply Co.,
Regentone House,
Bartlett's Buildings,
Holborn Circus,
E.C. 4.

Dear Sirs, We continue to recommend the "Regentone" Portable
Combined Mains Units for use with our receivers. Our own
satisfactory experience of them is confirmed by reports we
receive from satisfied users.

Yours faithfully,
For SELECTORS LIMITED,
Charles Dooly
General Manager



READ WHAT REES MACE SAYS

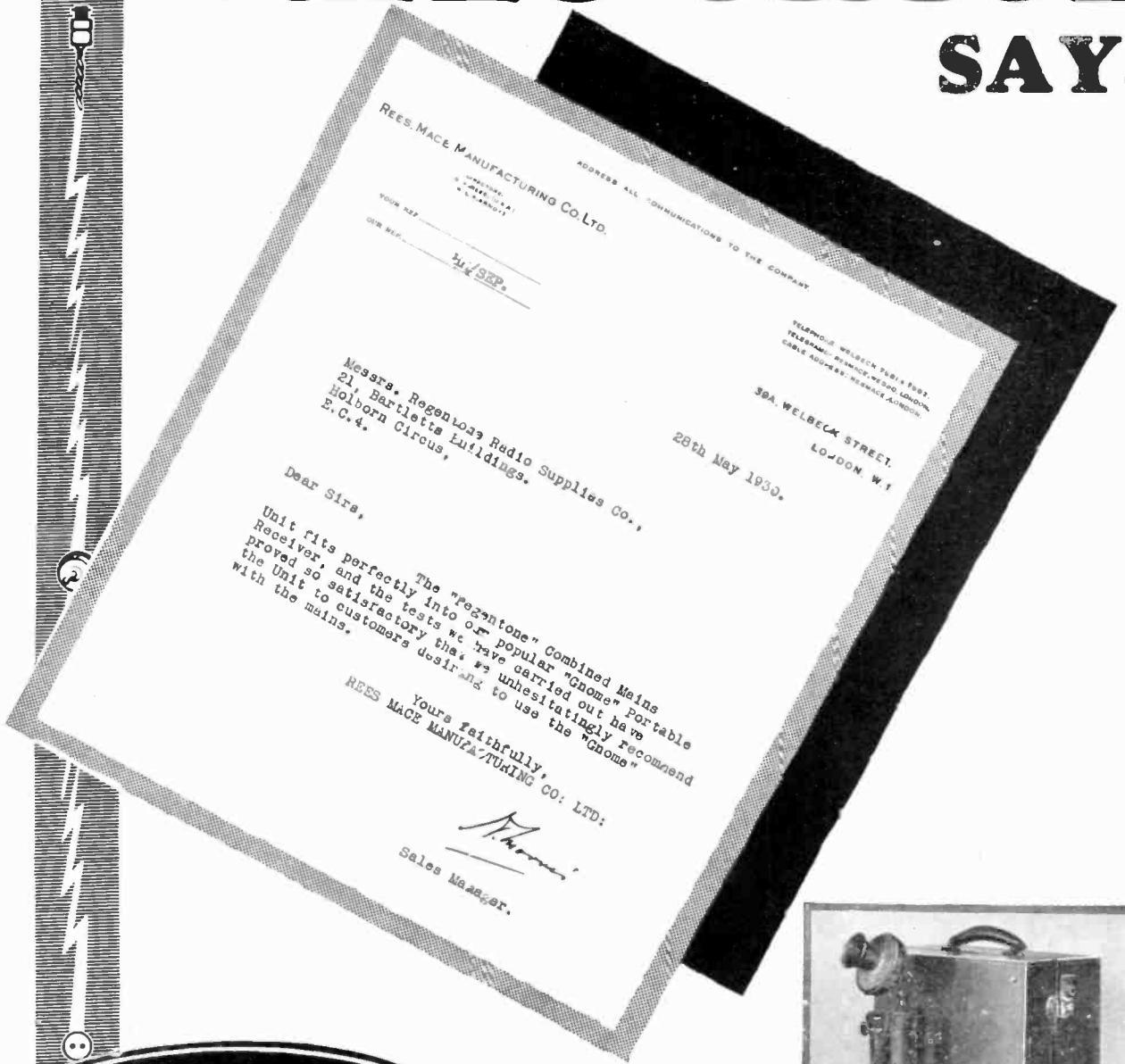

REES MACE MANUFACTURING CO. LTD.
ADDRESS ALL COMMUNICATIONS TO THE COMPANY
TELEPHONE: WELBECK PERIA PERIA
TELEGRAMS: REEMACE WELBECK LONDON
CABLE ADDRESS: REEMACE LONDON

38A, WELBECK STREET,
LONDON, W. 1

28th May 1930.

Messrs. Regentone Radio Supplies Co.,
21, Bartlett's Buildings,
Holborn Circus,
E. C. 4.

Dear Sirs,

The "Regentone" Combined Mains Receiver, and the tests we have carried out have proved so satisfactory that we unhesitatingly recommend the Unit to customers desiring to use the "Gnome" with the mains.

Yours faithfully,
REES MACE MANUFACTURING CO. LTD:

M. Mace
Sales Manager.



"UNIVERSAL APPLICATION"

(see letter)

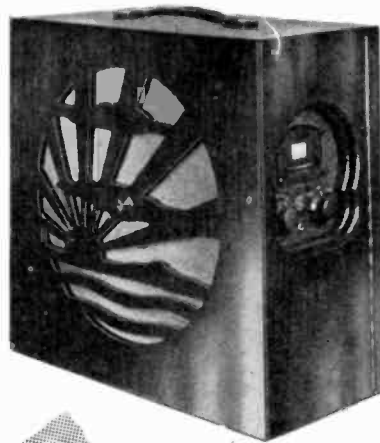

PYE PORTABLE

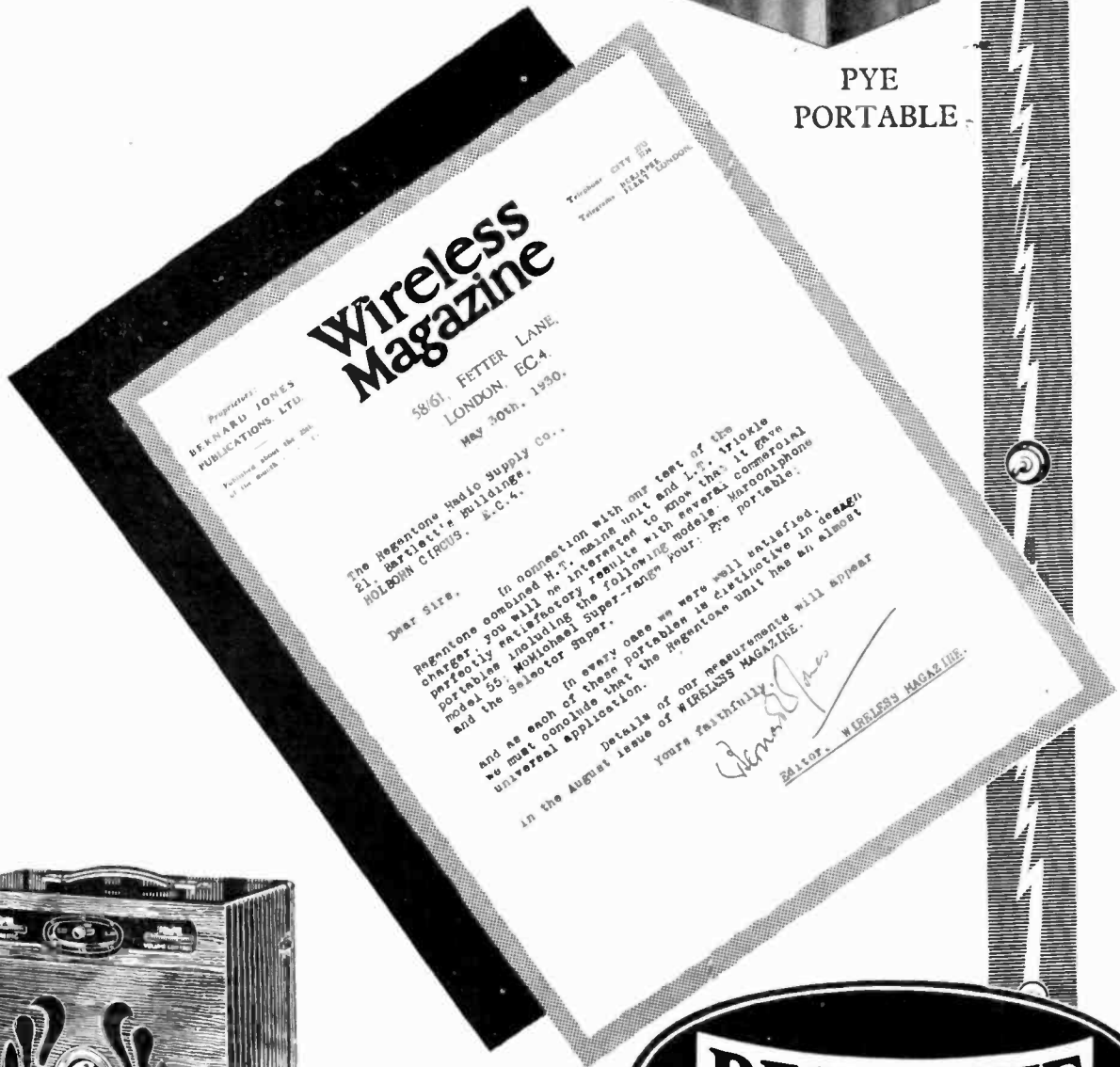

Wireless Magazine

Proprietors:
BERNARD JONES
PUBLICATIONS, LTD.
Published about the 25th
of the month

58/61, FETTER LANE,
LONDON, EC4.
May 30th, 1930.

Telephone: CITY 211
Telegrams: WIRELESS LONDON

The Regentone Radio Supply Co.,
21, Bartlett's Buildings,
HOLBORN CIRCUIS, E.C.4.

Dear Sirs,

In connection with our test of the
Regentone combined H.T. mains unit and L.P. triode
charger, you will be interested to know that it gave
perfectly satisfactory results with several commercial
portables including the following models: Marconiphones
model 55, Nivichal Super-range four, Pye portable
and the Selector Super.

In every case we were well satisfied,
and as each of these portables is distinctive in design
we must conclude that the Regentone unit has an almost
universal application.

Details of our measurements will appear
in the August issue of WIRELESS MAGAZINE.
Yours faithfully,
Bernard Jones
EDITOR, WIRELESS MAGAZINE.



MARCONIPHONE PORTABLE



—AND NOW

MULLARD



COSSOR

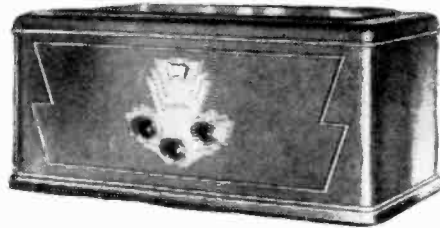

OSRAM



Mr. W. JAMES writes:

Messrs. Regent Radio Supply Co.,
Regentone House Buildings,
21, Berkeley Square, E.C.4.
Dear Sirs,

As requested, I have carried out tests with the "Regentone" A.C. and D.C. Combined Mains Units on a number of receivers, including all the well known manufacturers' kit sets. In all cases the reception, both for home and foreign stations, was commensally free from hum and foreign static, and owing to the higher voltage available, "push" and "pull" to the higher was better.

The facility with which the accumulator can be charged without disconnection, especially in the D.C. model, ought to prove a great convenience.

Yours faithfully,
W. James

4, Elliptop Way,
Stammore,
June 2nd, 1936.



So much for the Regentone "Portable" Combined Mains Units. Overleaf are given details of the complete range of Regentone Mains Units—all of them British Made and fully guaranteed for 12 months.

Regentone Mains Units have built up a reputation for efficiency, reliability, freedom from hum, and all-round excellent performance—under all conditions and in all parts of the world.

All Regentone A.C. Models incorporate Westinghouse Metal Rectifier.

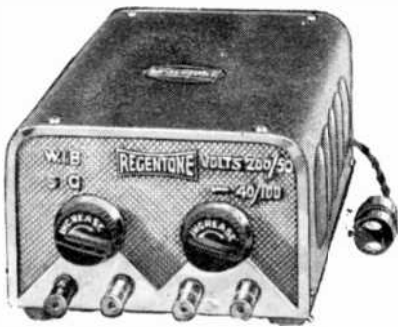

W. I. B., S.G.
£4 - 19 - 6



Half-amp Charger
£2 - 7 - 6

**REGENTONE
MAINS UNITS**

D.C. Models

Model	Size	Tappings	Smoothed Output	Price
D.C.1	8½ × 6 × 2½	1 Variable 1 Power	120 v. at 25 m.a.	£ s. d. 2 5 0
De Luxe	10½ × 6 × 4	1 Variable 0/140 S.G. 1 Variable 0/140 1 Power	160 v. at 50 m.a.	3 13 0
D.C. PORTABLE UNIT	8½ × 4 × 4	1 Variable. 1 Fixed (S.G.). 1 Power	120 v. at 18 m.a.	2 15 0
D.C. COMBINED UNIT	9 × 5 × 3½	2 Variable (1 S.G.). 1 Power	130 v. at 20 m.a. L.T. Trickle Charger for 2, 4 or 6 Volts.	4 5 0

A.C. MODELS

W.I.D.	8½ × 6 × 2½	1 Fixed at 60 volts 1 Fixed at 120 volts	120 v. at 15 m.a.	3 5 0
W.I.C.	8½ × 6 × 2½	1 Variable 0/120 (S.G.) 1 Fixed 120	120 v. at 18 m.a.	3 15 0
W.I.B., S.G.	10½ × 6 × 4	1 Variable 0/120 (S.G.) 1 Variable 0/120 1 Fixed 130/150	130 v. at 20 m.a.	4 19 6
With output for A.C. Valve heaters.	W.I.A.S.G.	1 Variable 0/150 1 Fixed (S.G.) 1 Fixed 90/120 1 Power	160 v. at 30 m.a.	6 18 6
	W.2.A.*	1 Variable 0/130 (S.G.) 1 Variable 0/150 1 Power	160 v. at 50 m.a.	7 15 0
	W.2.*	13 × 8½ × 6	3 Variable (S.G.)— 0 to full output 1 Power	200 v. at 100 m.a.
W.3.*	13 × 8½ × 6	1 Variable 0/180 1 Variable 0 180 1 Fixed 160/180. 1 Power	350 v. at 100 m.a.	17 10 0
W.4.A.	13 × 8½ × 6	2 Variable—0 to full output 1 Power	130 v. at 20 m.a. L.T. Charger—2, 4 or 6 volts at ½ amp.	7 10 0
W.4.*	13 × 8½ × 6	2 Variable (S.G.) 0 to full output 1 Power	160 v. at 50 m.a. L.T. Charger—2, 4 or 6 volts at 1 amp.	12 10 0
W.5. "PORTABLE" UNIT. COMBINED MODEL.	9 × 5 × 3½	2 Variable. 1 Power	120 v. at 15 m.a. L.T. Trickle Charger for 2, 4 or 6 volt acc.	5 17 6
W.6. "PORTABLE" UNIT. H.T. only.	8½ × 4 × 4	1 Variable. 1 Fixed (S.G.) 1 Power	120 v. at 18 m.a.	Model A.C. 4 5 0

All A.C. models are available, suitable for 25 cycle supply at an extra charge of 10s. each.
* A Regulator is fitted permitting half or full load from all tappings, thus ensuring against valve over-load.

Issued by
Regent Radio Supply Co.,
21, Bartlett's Buildings,
Holborn Circus, London,
E.C.4
Telephone: Central 8795
(3 lines).

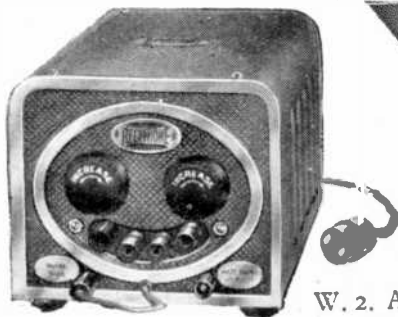

W. 2. A.
£7 - 15 - 0



W. I. C.
£3 - 15 - 0



FAMOUS "RADCROIX" POWER TRANSFORMERS

THEIR PERFORMANCE CANNOT BE EQUALLED AT ANYTHING APPROACHING THEIR PRICE

Sold Strictly on a Price-Maintained Basis

Outputs Guaranteed. Wiring Diagrams Free.

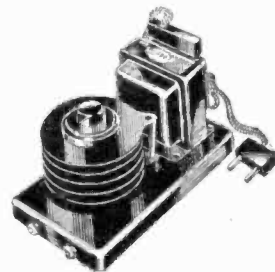
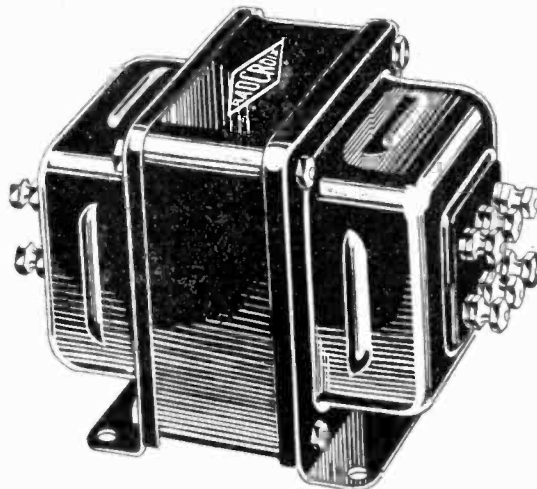
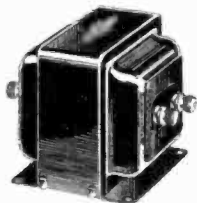

"Westinghouse" Transformer MXB2, 20 mA at 120 volts, 10/6

Power Transformer TMV2, 35 mA at 200 volts, 15/9.

Battery Charger employing "Westinghouse" Rectifier. No. 200 A2, 3 amps., 27/6.

"Radcroix" Power Transformers have the largest sale of any Power Transformers in Europe. They were first on the British market and have stood the test of time. A large number of Public Bodies have adopted them as standard. Their high efficiency and low prices have been recognised by Britain's largest manufacturers. Absolutely hum free and guaranteed for one year.

KEEP THIS LIST FOR REFERENCE

Transformer	Characteristics	Smoothed Output	Price	Remarks
TMV 2	200+200 v. 45 mA, 2+2 v. 1 amp.	45 mA at 160 v.	£ s. d. 0 15 9	For H.T. Supply
TPA2	200+200 v. 30 mA, 2.5+2.5 v. 1.6 amps	30 mA at 200 v.	0 17 0	For H.T. Supply
TPA4	300+300 v. 30 mA, 2.5+2.5 v. 1.6 amps	30 mA at 250 v.	0 17 6	For H.T. Supply
TPA6	400+400 v. 30 mA, 2.5+2.5 v. 1.6 amps	30 mA at 300 v.	0 18 0	For H.T. Supply
TPS2	400+400 v. 50 mA, 2.5+2.5 v. 1.6 amps	50 mA at 300 v.	1 5 0	For H.T. Supply
TPU5	450+450 v. 50 mA, 2.5+2.5 v. 1.6 amps	50 mA at 350 v.	2 0 0	For H.T. Supply
PX2	500+500 v. 120 mA, 3.75+3.75 v. at 2.4 amps	120 mA at 450 v.	2 10 0	For H.T. Supply
POWER UNITS (TRANSFORMERS AND CHOKES IN ONE UNIT)				
GP2	185 v. 20 mA, 2+2 v. 1 amp. Choke 50 henries 25 mA	20 mA at 120 v.	1 4 0	For H.T. Supply
GMV2	220+220 v. 45 mA, 2+2 v., 1 amp. Choke 50 henries 60 mA	45 mA at 185 v.	1 11 6	For H.T. Supply
FOR INDIRECTLY HEATED A.C. VALVES				
WAB2A	220 v. 20 mA, 2+2 v. 1 amp., 4 volts 3 amps.	20 mA at 190 v.	1 1 0	For H.T. and L.T. Supply for 3 A.C. Valves
WW4A	190+190 v. 45 mA, 2+2 v. 1 amp., 4 volts 4 amps	45 mA at 150 v.	1 10 0	For H.T. and L.T. Supply for 4 A.C. Valves
WWS2	210+210 v. 40 mA, 2.5+2.5 v. 1.6 amps, 4 volts 4 amps	40 mA at 200 v.	1 12 0	For H.T. and L.T. Supply for 4 A.C. Valves
WW6A	250+250 v. 50 mA, 2+2 v. 1 amp., 4 volts 4 amps	50 mA at 200 v.	1 15 0	For H.T. and L.T. Supply for 4 A.C. Valves
WX2	250+250 v. 50 mA, 2+2 v. 1 amp., 2+2 v. 4 amps. 5 v. 1 amp.	50 mA at 200 v.	2 5 0	For four 4 v. valves and two 5/6 v. valves in parallel.
FILAMENT HEATING TRANSFORMERS				
MA2B	2+2 v. 3 amps	4 volts 3 amps	0 7 6	For supplying L.T. current up to 3 indirectly-heated A.C. valves
MA2A	2+2 v. 5 amps	4 volts 5 amps	0 12 6	For supplying L.T. current up to 5 indirectly heated A.C. valves
BATTERY CHARGING TRANSFORMER				
TR2	1+1 v. 3 amps, 18+18 v. 2 amps	Approx. charging rate 2 amps	0 17 0	Valves used "Philip" 328 and 329
STEP-UP AND STEP-DOWN TRANSFORMER				
OTA	Ratio 1-2	35-42 volt amps	1 5 0	To use 200/250 v. units on 100/110 v. mains, or 100/110 v. units on 200/250 v. mains
OUTPUT TRANSFORMER				
TSr55	Ratio 25-1	—	0 17 0	For use in connecting low-resistance Moving-Coil Speakers to Amplifiers
TRANSFORMERS FOR "WESTINGHOUSE" METAL RECTIFIERS.				
MXB2	135 v. 40 mA	20 mA at 120 v.	0 10 0	For Rectifier HT3
MXB4	135 v. 60 mA	30 mA at 180 v.	0 12 0	For Rectifier HT4
Either of the above with 4 volt L.T. winding, Centre Tapped.				

One Year's Guarantee :: HANDSOME METAL COVERS FOR MAINS UNITS 7/6 EACH :: Trade Discount 30 per cent.

THE WHOLESALE WIRELESS COMPANY, 103, Farringdon Road, London, E.C.1

Telephone: Clerkenwell 5312

WINNERS

66P

66P - A BETTER UNIT

More Blue Spot units have been sold throughout the world than of any other make, and the opinion of the millions of satisfied Blue Spot listeners is the genesis of the world wide reputation of Blue Spot units and speakers.

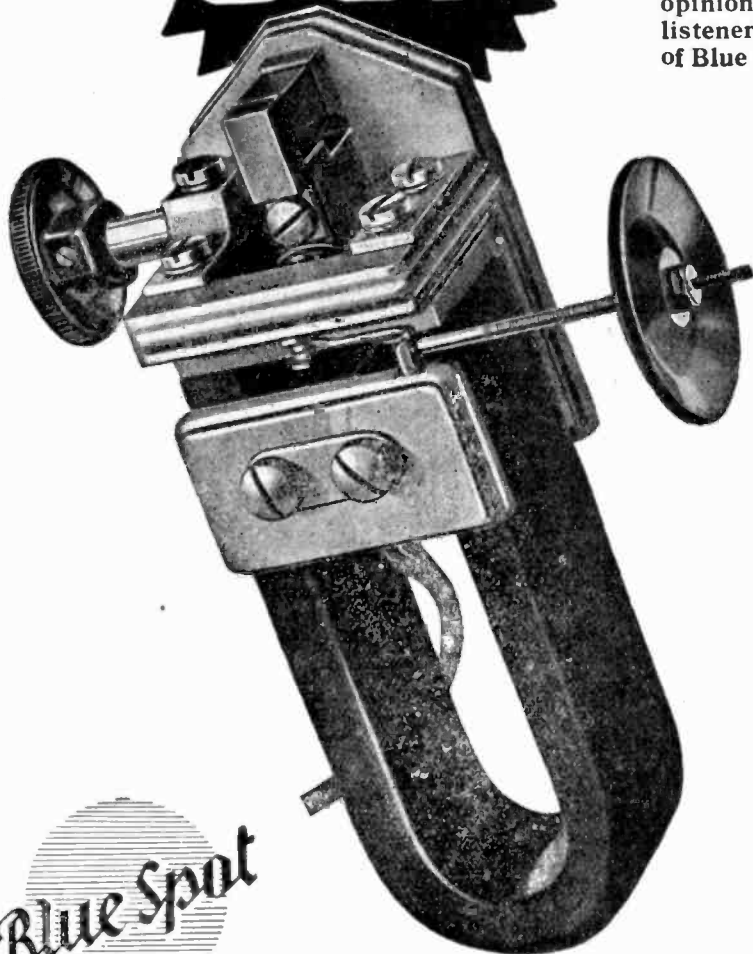

Here it is. The new 66P Unit! It is the logical development of the famous 66K Unit embodying among other improvements, all covered by patents and therefore only obtainable in Blue Spot products, an entirely new method of moving the anchor between the four poles. The precision of adjustment is so keen that it is now possible practically, to place the anchor the exact distance from the poles as is theoretically necessary to obtain the best effects as yielded by a magnetic unit under the best conditions.

The noticeable result of this increased sensitivity is the larger range of frequencies obtainable. In addition to the powerful reproduction of the bass register with its full beauty, the higher frequencies which largely determine the character of speech and music are also reproduced faithfully.

Blue Spot Power Unit Type 66P 27/6

Blue Spot Major Chassis Type 37P 15/-

Blue Spot Special Chassis Type 31P 10/6

Blue Spot Minor Chassis Type 28P... 9/-

Permissible D.C. Current 30 m/a

D.C. Resistance 1,000 ohms



F. A. HUGHES & CO., LIMITED

FROM THE START

66R—BLUE SPOT'S MASTERPIECE

66R

Improved receivers and valves have necessitated the production of a new and better loud speaker unit capable of handling enormous outputs without in any way detracting from the Blue Spot standard of reproduction.

The new Blue Spot Power Unit type 66R will handle enormous outputs without distortion or rattle, and in this respect the advantage of the patented adjustment obtainable only in Blue Spot products is appreciated more than ever. The powerful electric energies acting upon the anchor, energies that converted into acoustic frequencies cause at the bass notes even a sensible vibration of the furniture and the floor, would wear out by friction any link or weak construction of the part supporting the anchor. The patented adjustment of the Blue Spot Unit will never wear out, but will work with just the same exact precision as on its first day.

This is one of the advantages that guarantee you the wonderful brilliance and volume of this Blue Spot Unit. The 66R Unit stands a triumphant tribute to the painstaking care and ingenuity of the Blue Spot designers.

Blue Spot Power Unit
 Type 66R 35/-
 Blue Spot Major Chassis
 Type 37R 15/-
 Blue Spot Special
 Chassis Type 31R ... 10/6
 Permissible D.C.
 Current ... 50 m/a
 D.C. Resistance ... 500 ohms.

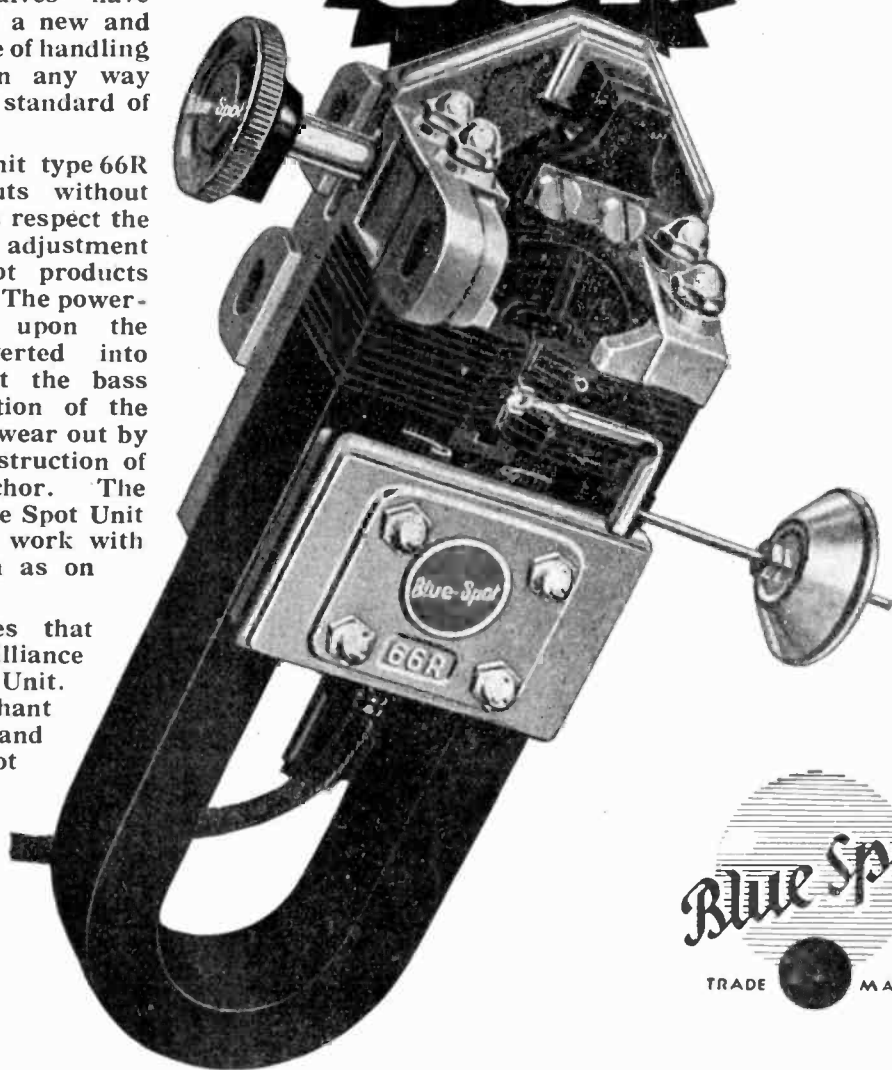

Blue Spot
 TRADE MARK

204-206 GREAT PORTLAND STREET . . . LONDON, W.1.

Phone: Museum 8630 (4 lines)

Distributors for Northern England, Scotland and North Wales: H. C. RAWSON (Sheffield and London), Ltd., 100, London Road, Sheffield, (Phone: Sheffield 26006) and 22, St. Mary's Parsonage, Manchester (Phone: Manchester City 3329).

Beethoven

the Portables that are Different



The **BEETHOVEN**
MINOR
price £10 - 10 - 0
inclusive

Stocked by all the leading
factors

OTHER MODELS

BEETHOVEN
SCREENED GRID SUPER 4 25 GNS
BEETHOVEN
Q.C.R. PORTABLE 21 GNS

MONTAGUE RADIO
INVENTIONS
& DEVELOPMENT Co. Ltd
117 REGENT ST., LONDON, W.1
TELEPHONE - - - REGENT 0730

TO RADIO MANUFACTURERS

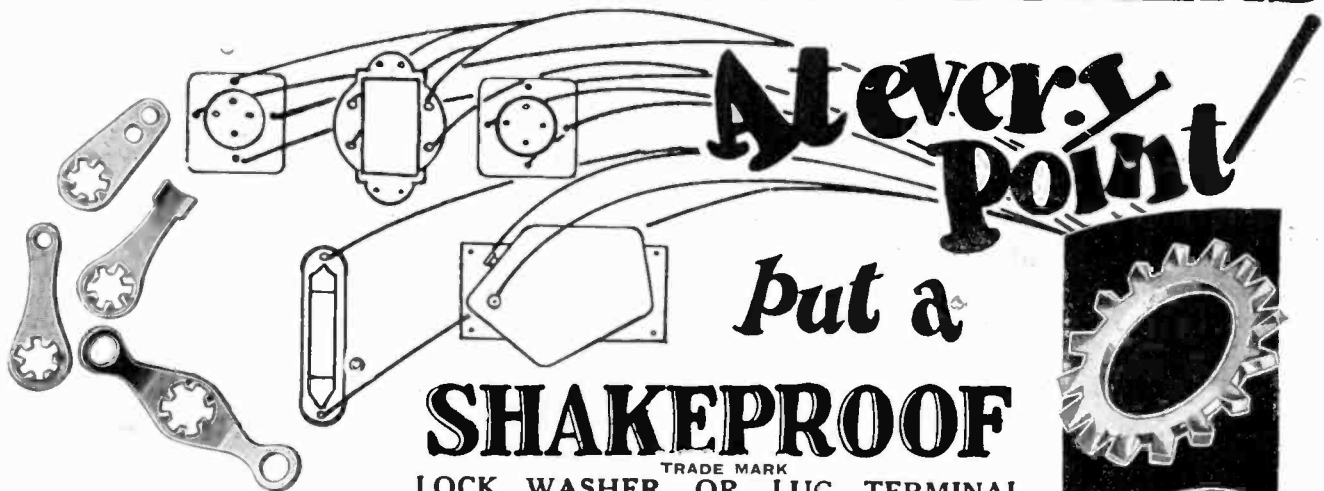

SHAKEPROOF Locking Terminals that combine Terminal and Lock Washer in one, cut out one operation and give a better connection with **ABSOLUTE SECURITY FROM VIBRATION.**

SEND FOR SAMPLES AND FOLDERS

SHAKEPROOF
TRADE MARK
LOCK WASHER OR LUG TERMINAL

MADE FROM TEMPERED STEEL OR PHOSPHOR BRONZE
A new Locking Principle with a twisted tooth form which grips both the nut and the component and *never comes loose.* All connections made permanent and vibration-proof with a better contact. Eliminate loose connections, save assembly time and servicing, and improve your product by adopting **SHAKEPROOF** Lock Washers and Terminals which are being standardised in the Radio Industries.

Now manufactured in Manchester by
BARBER & COLMAN Ltd.
MARSLAND ROAD, BROOKLANDS, MANCHESTER.

Phones: Sale 496 & 497 British Patent 194937 'Grams: "BARCOL" Sale
Sole Manufacturers and Distributors in Great Britain.



WASHERS in STEEL or PHOSPHOR - BRONZE (PATENTED)

Everything for the Wireless Retailer by this Service



Our service with eight great centres in the country has supplied the Retailer for the last fifteen years with all his needs. As wholesale suppliers, we have a duty to the retailer. And that is—to supply his every wireless need at lightning speed. You can rely on Electric Lamp Factors. Our stocks are complete and our staff is competent. It is the kind of service you need. Get to know how we can help you. Write for full particulars. Or, better still, let one of our representatives call and tell you all you want to know. A post-card will do.

SPECIALITIES

Receiving Sets, Loud Speakers, Batteries, Eliminator, Valves all makes.

E.L.F. SERVICE

ELECTRIC LAMP FACTORS LTD.

"Everything Electrical to Factor and Trade"

**Wholesale Distributors for
E.L.M.A. LAMPS
and
B.V.A. VALVES.**

LONDON: 41, Rathbone Place, W.1. Museum 8833	LIVERPOOL: 13, Stanley St., Central 2922.	BLACKPOOL: 18, Topping St. Blackpool 2666.	SOUTHPORT: 51, London St. Southport 3813	LEEDS: 5, York Place, Leeds 20951:	PORTSMOUTH: 47, Crosswell St., Portsmouth 2031	CHESTER: Leen Lane, Chester 598	PRESTON: 170, Corporati- on Street, Preston 10
---	---	--	--	--	--	---------------------------------------	---

WIRELESS NEEDS AT LIGHTNING SPEEDS!

To Show them is to Sell them
The quickest moving line in Records-

GOODSON WHITE DANCE RECORDS

NON-FLAM

SHOW GOODSON Records, in your window; invite your customers to hear them and see how quickly they sell! Goodson Records record all the big dance hits of the world's best orchestras. They are unbreakable, pliable and feather-weight. Their tone is a revelation! Your customers can buy two GOODSON Records for the price of one of most other records. They can take 50 instead of 10 ordinary records with their 'Portable' this summer. Sell them 50 instead of 10!

SEND NOW for free display material for GOODSON RECORDS, and ask for the current monthly list to put in your window.

Manufactured by

GOODSON GRAMOPHONE RECORD CO., LTD.,
 12, OLD BURLINGTON STREET, LONDON, W.1.

Telephone: Gerrard 1452-1453. Regent 4685.

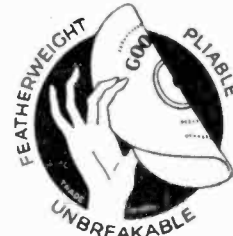

RETAIL PRICE

1/9
 10 INCH
 2 SIDES

C.F.H.7



**"EKCO-LECTRIC" S.G.P.3
 ALL-MAINS RECEIVER.**

For A.C. or D.C. Mains.

Employs Screened Grid, Detector and Pentode Valves, and covers from 200-2000 metres. Single Dial Control. Wonderful range and volume. Pick-up attachment.

PRICE £21-0-0 A.C. or D.C.

(Including Royalties)

Less Trade Discounts.

SEND NOW
 FOR 70-PAGE
 CATALOGUE

REPLENISH YOUR STOCKS AT RICHARDSONS!

Our stocks comprise:—

All the leading All-Mains Sets, Cabinet and Portable Gramophones, All the principal Loud Speakers, Radio Gramophones, etc., All the Components for the leading Constructor Sets. Mullard "ORGOLA," Cossor "MELODY MAKER," Osram "MUSICMAGNET"

250,000 Records of all kinds in stock.

RICHARDSONS

(JOSEPH RICHARDSON)

MANCHESTER
 24, ST. JOHN STREET,
 DEANSGATE.
 City 5718-9.

'Grams
 "TRUTONE."

LIVERPOOL
 24, PARK LANE.
 Bank 5443-4

THE PORTABLE OF THE SEASON

The *NEW*

Geisha

No. 3.

OUTSTANDING IN:—

**TONE
VOLUME
APPEARANCE
NEW IDEAS.**

CABINET IN BLUE OR BLACK WITH
GILT EDGING IN EACH CASE.

PATENT STARTING AND
STOPPING MOVEMENT.

CARRIES EIGHT 10" RE-
CORDS IN DETACHABLE
ALBUM.

PATENT SELF-CLOSING
NEEDLE CUP.



RETAIL PRICE

£3/10/-

Subject to usual Trade Discount.

Measurements—
HEIGHT 7 ins.
LENGTH 16½ ins.
WIDTH 12 ins.

**THERE'S BIG BUSINESS IN THE "GEISHA." A SAMPLE WILL CONVINCING YOU.
SEND YOUR ORDER NOW.**

Manufacturers—C. GILBERT & Co. Ltd., Arundel St., Sheffield, and at South St., Hull.





*Sent Carriage Paid on 7 days
Free Trial to any address
in the United Kingdom.*

"MONARCH" RECEIVERS ARE SELLING BEST

The MONARCH III, Type "T"

This "Straight Three" table model is in great demand.

It is simple to operate, of attractive design, and gives the desired results in all districts. Ample room in cabinet for all batteries.

PRICE **£5 5 0**

LIBERAL DISCOUNTS

(ROYALTY EXTRA)

W.M. DIBBEN & SONS, LTD.

ST. MARY'S ROAD SOUTHAMPTON



The "Royal," a Complete solid Oak Bedroom Suite

Is constructed of splendid quality seasoned Oak and finished in a warm shade of Dark Brown Oak (Fumed colour if desired) comprising a Fitted Wardrobe 3 ft. wide enclosed by an Oak panelled door. Dressing table 2 ft. wide with three roomy drawers surmounted by a Frameless adjustable toilet Mirror. 2 ft. Chest of Drawers, an excellent full panelled Bedstead to match fitted with a combination Spring Mattress 3 ft. or 2 ft. 6 in. wide. A strongly made Bedside table and Cane-seated Bedroom Chair. Complete for

14 Gns. nett.

Why not make this Catalogue your Silent Salesman. It costs you nothing. You can sell from its 617 full-sized illustrations and make some profit. Write for your copy to-day.

YOU CAN SELL FURNITURE — NOW.

also Portable Wireless
at a keen price.

The "Resselbell" (Regd.)

Four Valve Screened Grid
Suitcase Portable.

Entirely self-contained Receiver incorporating popular Resselbell loud-speaker. Finest hide or leather cases. Screened grid models require finer tuning, but bring in more distant stations.

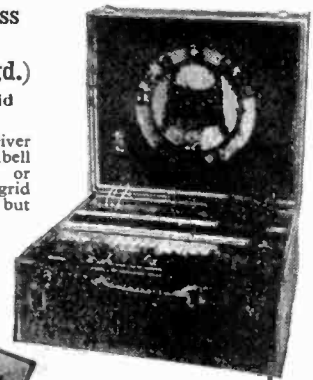

Circuit. The screened grid valve is choke coupled to a tuned grid detector, followed by two transformer coupled valves.

From £9 10s. od. nett.

The "Resselbell" (reg.) are popular and quick selling. They are well constructed and famed for their Tonal Purity, exceptional Range and great volume without distortion. The finest components have been incorporated in every model.



PORT OF LONDON CABINET WORKS, CUTLER STREET, LONDON, E.1

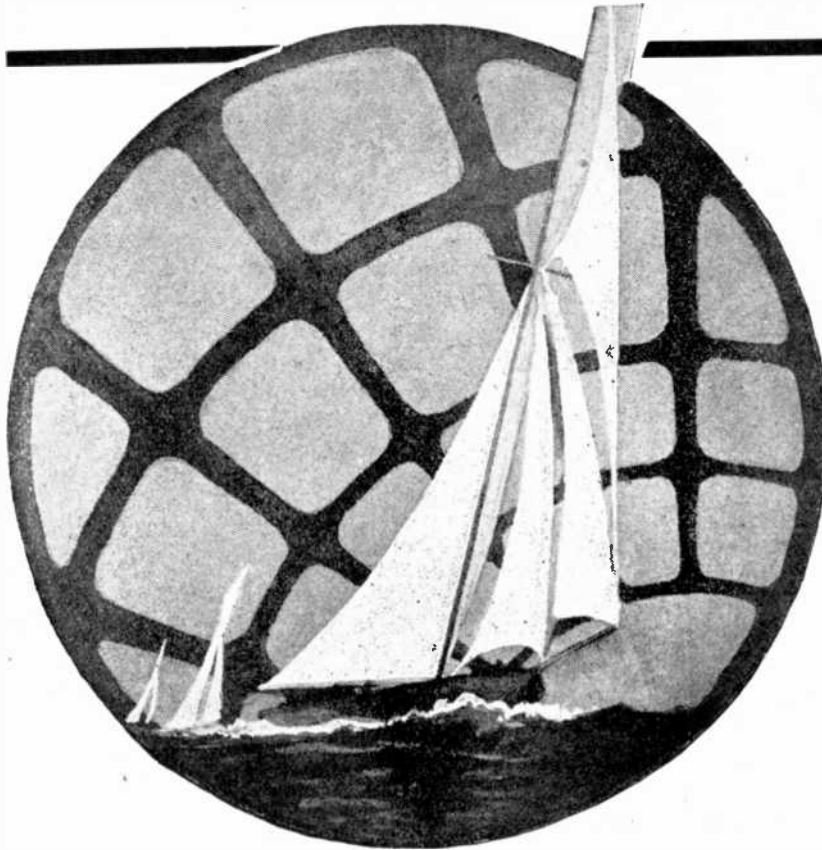

WELL AHEAD OF ITS RIVALS

Right in the forefront of radio—the McMichael Super Range Portable Four is paramount in its class. Not only for reception at exceptional loudspeaker strength of a far more than usual number of stations, but for the tonal quality of its reproduction this receiver proves easily supreme. A fine suitcase model which combines handsome appearance with unique convenience.

The McMICHAEL 1930 SUPER RANGE FOUR (TABLE MODEL)

A model for the home where an outdoor aerial and earth are not desirable. Comprises a handsome walnut cabinet on a directional turntable fitted with an exactly similar circuit to the Suitcase Portable. The whole is completely self-contained with Frame Aerial and Loudspeaker ready for immediate use. An additional aerial and earth may be attached to add to the normal and very remarkable range.

RETAIL PRICE 26 GNS.

(Including all equipment and Royalties)

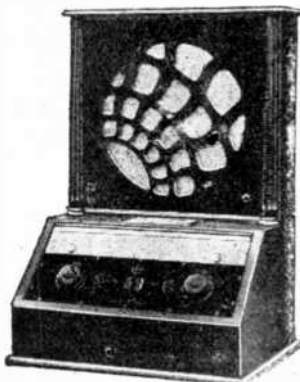

THE McMICHAEL 1930 SUPER RANGE PORTABLE FOUR

Incorporating the very latest improvements of radio science, this receiver is sparkling with selling points.

HERE ARE A FEW :—

Screened Grid Amplification. Single Dial Control.
Superlative Tonal Quality. Easy Control of Volume.
Lowest Possible Upkeep Cost. Wide Range.

High Selectivity.
Fitted in Handsome Suitcase with Patent Locking Clips.
In every way the McMichael Super Range Portable Four proves a most attractive proposition—good for prestige—and an effective aid to the production of increased business.

Owing to the high degree of selectivity in this and our other Screened Grid Portable Receivers, we are able to guarantee complete selectivity between all main B.B.C. stations under the new scheme of wavelengths, as proved by an actual test under the twin aeriols at Brookman's Park, when both programmes were received separately without interference, and in addition a number of other British and foreign stations.

This test was made on a standard "Super Range Four" Receiver, under an independent Press observer and was repeated at half-mile intervals with similar results.

Sell more McMichael Receivers by means of our special "Deferred Payments on Hire Purchase Terms" system and if you have not a demonstration set write for one. It will prove a revelation in your store. Write at once for full particulars.



L.M. MICHAEL LTD.

Manufacturers of Wireless and Scientific Apparatus
WEXHAM ROAD, SLOUGH, BUCKS.

Telephone: Slough 441-442. Telegrams: Radiether, Slough.
London Showrooms: 179, STRAND, W.C.2 (Telephone: Holborn 2466)

RETAIL PRICE : **22 GNS.**
(Including all equipment and Royalties)

D.C. to A.C.



The M-L D.C. to A.C. Rotary Transformer will operate an A.C. All-Electric Receiver from a D.C. Main.



Can be supplied to run from any voltage 12-250 V.D.C. 40 watt model £13 ; 85 watt model £19. Recommended and used by Philips Radio, Marconiphone, Burndep, Kolster-Brandes, M.P.A., Etc., Etc.

Write for Pamphlet 596/1 which gives full details.

THE M-L MAGNETO SYND. LTD.,
Radio Dept., COVENTRY.
Telephone : 5001.

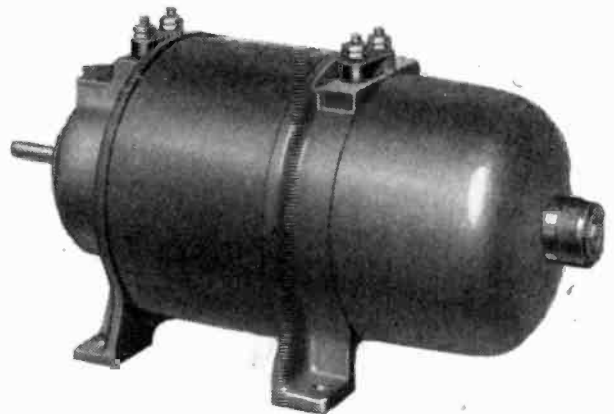

Godbolds

LONG RANGE **POPULAR** SELECTIVE

Two Strong Selling Sets

CABINET THREE

REGIONAL THREE



FIXED
RETAIL
PRICES
INCLUDING
VALVES
FREE FROM
ROYALTIES

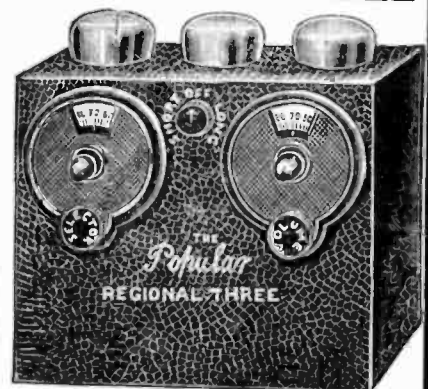

£5 : 15 : 6 (subject)

4 GUINEAS (subject)

This set incorporates a unique device to sharpen tuning to any degree of selectivity. The Cabinet is designed to hold all the necessary batteries.

Completely screened. Cuts out Regional Stations as required, and brings in ALL EUROPE. Size only 7x6x3 in. Supplied in three finishes, Bronze, Gilt and Black. A unique proposition every Dealer should stock.

FULLY GUARANTEED FOR ONE YEAR

Write for Details and Other Price Lists

THE DANIPAD RUBBER Co., Ltd.,
5 & 7, Market Street, Finsbury, London, E.C.2

Telephones: Bishopsgate 7322 & 7323

EFFICIENT

LOW PRICE

THE SUNCO MEN HAVE FOUND What you have been looking for!

Let them demonstrate ALL-MAINS PORTABLES to you—instruments too, that have a known performance. "The reflection of perfection" aptly describes these McMichael receivers both in regard to appearance and performance.

When they are fitted with the new Regentone combined H.T. and L.T. Portable eliminator they meet the ever growing demand for ALL-MAINS PORTABLE receivers. The makers are able to guarantee complete selectivity between all main B.B.C. stations under the new scheme of wavelengths—a claim which has been established by their recent test under the twin aerials at Brookman's Park.

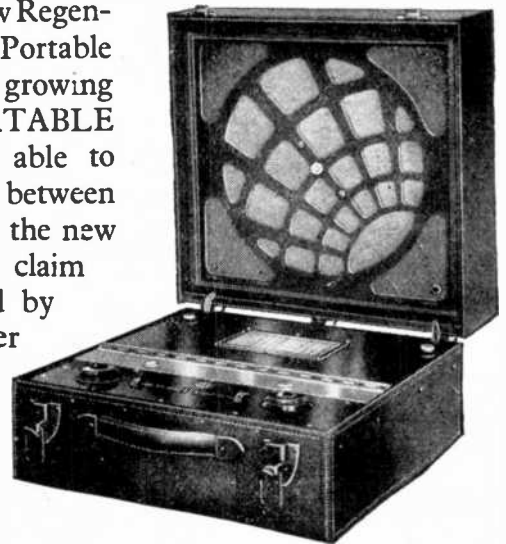

McMICHAEL SUPER RANGE TRANS-
PORTABLE FOUR
A receiver of unique design in Walnut cabinet.
PRICES
Battery Model - - - £27 - 6 - 0 (3)
A.C. Model - - - £32 - 0 - 6 (3)
D.C. Model - - - £30 - 8 - 0 (3)
(Royalties nett)

McMICHAEL SUPER RANGE PORTABLE
FOUR
A handsome suit-case model—one of the best sellers in the trade
PRICES
Battery Model - - - £23 - 2 - 0 (3)
A.C. Model - - - £27 - 16 - 6 (3)
D.C. Model - - - £26 - 4 - 0 (3)
(Royalties nett)

THE SUN ELECTRICAL CO. LTD.

Famous for service for over 30 years

Thirty years' unique experience of your markets have established for us a jealously guarded reputation for service. You will find in all your dealings with Sunco that the smallest order is executed with the same promptness, courtesy and intelligence that is shown to our largest customer. From Sunco you can obtain "everything electrical" in addition to all that is best in radio and we are confident that for price, quality, and above all, value, we are without a rival in the trade.

Phone :
Temple Bar 3500.
(10 lines)
Grams : "Secablist
Westcent, London."

BRANCHES
49-50 Park Place,
LEEDS.
112 Pilgrim Street,
NEWCASTLE-
ON-TYNE

118-120 Charing Cross Road London W.C.2

Efescaphone
**REGIONAL
 PORTABLE**
3 VALVE

Price £12.15.0
 H.P. terms £1 down and 12
 monthly payments of £1.0.7

**Breaks
 new
 ground**



This set has been specially designed for receiving the dual programmes from the Brookman's Park Station. It will separate the Regional from the National wavelength clear of interference, as close as one mile, and gives good loud-speaker strength within a radius of approximately 40 miles.

It serves a large population, and offers, therefore, a rich potential market to the enterprising dealer.

Its price—£12 15s. complete—is within the reach of households of quite modest means, while H.P. facilities are available, if required.

Only three Valves are employed, and Battery consumption and cost of upkeep generally is therefore much more economical than the average Portable Set.

The Efescaphone Regional Three is entirely self-contained and requires neither an Indoor nor Outdoor Aerial.

FALK STADELMANN & CO. LTD.
 83-93, FARRINGTON ROAD, LONDON, E.C. 1

REGISTERED

STALLOY

BRAND

TRANSFORMER LAMINATIONS of every description.



DIAPHRAGMS, CONE UNIT REEDS:

JOSEPH SANKEY & SONS L^{TD}.

Works : Bilston.

London Office : 168, Regent St., W. 1.

COMPARE THESE FIGURES WITH THOSE OF ANY OTHER 2-VOLT POWER VALVE

P 240



The goodness of a valve is determined by the highest amplification factor for the lowest anode impedance. This is expressed as mutual conductance, therefore the higher the mutual conductance the better the valve.

The mutual conductance of the Mazda P.240 is considerably higher than that of any other 2-volt power valve. It will operate a moving coil loud speaker with most satisfactory results.

Mazda valve sales are going up by leaps and bounds —are you getting your share of the big business?

THESE FIGURES PROVE IT . . .

Amplification Factor	7
Anode A.C. Resistance (ohms)	1,900
Mutual A.C. Conductance (MA/V)	3.7

MAZDA P. 240
PRICE 15/-



THE EDISON SWAN ELECTRIC CO., LTD.,
Radio Division,
1a, Newman Street, Oxford Street, W.1.
Showrooms in all the Principal Towns.

EDISWAN

The Amazing

MAZDA RADIO VALVES

With Mazda valves in all positions your set will give a performance many times better than before.

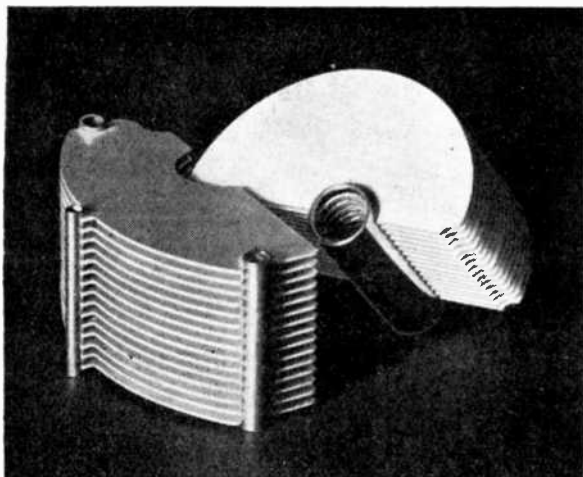

Pye Aluminium variable Condenser; standard in Pye Portable and All-Electric Receivers. (Photo by courtesy of Pye Radio Ltd., Cambridge and Paris House, Oxford Circus, W.1.)

SELL EASIER TUNING

Easy enough when the condenser vanes are of Aluminium, as in this example of a Pye condenser. Light in weight, and a quicker movement, Aluminium condensers readily sell at low prices. For boxes, panels, valve screens and cone chassis, Aluminium contributes low cost, attractive appearance, rustlessness, and durability.

Aluminium
THE BRITISH ALUMINIUM CO., LTD.
ALUMINIUM PRODUCERS. ADELAIDE HOUSE,
KING WILLIAM STREET, LONDON. E.C.4.

W.T. 7,6,30

THIS "THREE STAR" HEAVY CAPACITY H.T. BATTERY

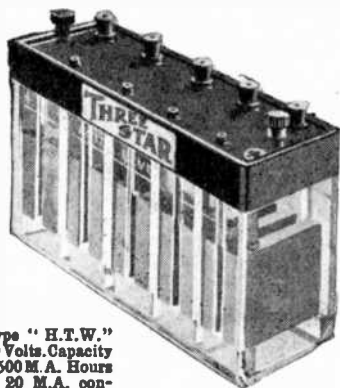

Type "H.T.W."
10 Volts. Capacity
6,500 M.A. Hours
at 20 M.A. con-
tinuous discharge

is manufactured under an entirely NEW PROCESS which enables it to give absolutely satisfactory service to users of modern high-power sets requiring heavy H.T. consumption. More and more customers are asking for this type, so stock up ready for the big Demand.

Crystal clear multiple glass container with 2-Volt tapings and insulated terminals. Price 6/9 per 10 Volts. Also supplied in polished Hard Wood Crate with carrying handles. 60 Volts 48/-

-AND THIS LINE IS A PROVED"SELLER

This type "H.T.X." has grown in popularity from its inception, and sales are well assured.

Type "H.T.X."
20 Volts. Capacity 2,500 M.A. 2-Volt Tappings. Price—10/- per 20 Volts; also supplied in Polished Hard Wood Crate with carrying handle, 60 Volts 37/6.



Complete illustrated list post free on application to the Manufacturers.

THREE STAR ACCUMULATORS Ltd.

Tottenham, N.17

Manufacturers



Magnavox
Dynamic
Speaker.

who are not familiar with the complete range of Rothermel parts should immediately write for a copy of our 68 page 1930 catalogue and supplementary sheets. Rothermel parts are used as a standard by the Country's foremost manufacturers of radio sets.

Magnavox Dynamic Speakers
Centralab Volume Controls
(Standard and manufacturers' types).
Centralab Faders and Constant Input Resistances.
Centralab Power Rheostats and Potentiometers.
Electrad Royalty Resistances (Standard and manufacturers' types).
Electrad Truvolt Fixed Resistances.
Electrad Truvolt Variable Resistances.
Electrad Loftin White Direct Coupled Amplifiers.
Frost Rheostats, Switches, Jacks, High Resistances.
Webster Pick-ups.
Orotone Automatic Non-Set Stop Tone Arms.
Green and Blue Flyer Induction Motors.
Mershon Electrolytic Condensers.
Aerovox Fixed Condensers.
Janette Rotary Converters.
A. C. Power Amplifiers.
Thordarson Transformers, Chokes and Power Compacts, Etc., Etc.

If it's a quality product — Rothermel's have it.

Write us for full details to-day.

Two New Items of Outstanding Interest

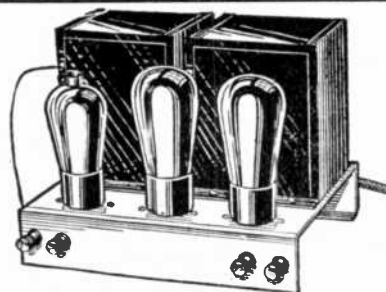

**ELECTRAD LOFTIN WHITE
DIRECT COUPLED AMPLIFIER**

110 or 220 v. A.C., complete with valves £12 : 5 : 0

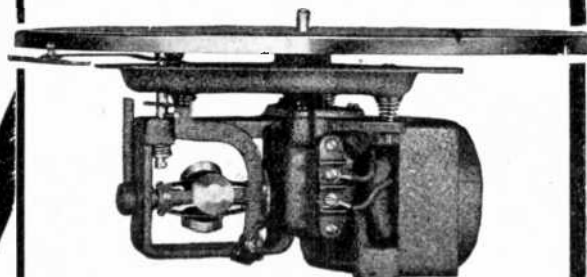

GREEN FLYER INDUCTION MOTOR

110 or 220 v., 10" Turntable, £3 : 15 : 0
110 or 220 v., 12" Turntable, £3 : 18 : 6

The Rothermel Corporation Ltd.

24, Maddox St., London, W.1.

Phone : Mayfair 0578/9.

CONTINENTAL SALES OFFICE :—27, Quai du Commerce, Brussels, Belgium.

Summer BOOM

FULL PARTICULARS
Of The Announcement
TO THE TRADE
Will Be In Next Week's Issue
WATCH

AEONIC

W.181. *An attractive Micro Dial with Central Vernier Knob* PRICE 7/6

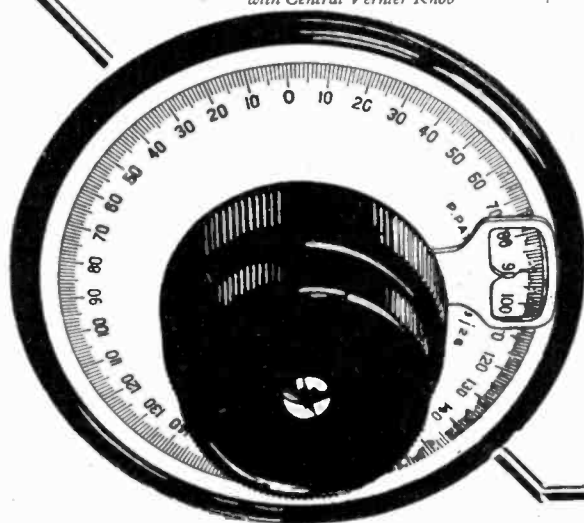

Utility DIALS
PAY BEST
— and why ?

“Utility” Components offer Super-quality—the best that money can buy—at prices keen enough to withstand any competition in the market. “Utility” Switches and Condensers are equally good, and fully Guaranteed—Stock them now, and the results will induce you to stock them always. Write for fully Illustrated up-to-date List.

WILKINS & WRIGHT LTD

HOLYHEAD RD., *Utility* BIRMINGHAM

Agents : London : E. R. Morton Ltd., 22 Bartlett's Buildings, Holborn Circus, E.C.1. Scottish : E. B. Hammond, 113 St. Vincent St., Glasgow

**Why Sell
FOREIGN VALVES ?
— BRITISH VALVES
are CHEAPER !**
BOLLINGTON

BRITISH MADE VALVES from 5/- All Ring Valves repaired at Half Price
The S.G.2 Screened Grid Valve, 2 volts, only 15/- each
Write for Catalogue now to

JUSTROLUX

Near
Macclesfield

one battery GIVEN AWAY Free!

To introduce AEONIC BATTERIES to the Trade we are GIVING AWAY, absolutely FREE, ONE AEONIC BATTERY of 108 volts to all purchasers of Batteries to the value of £5 (gross) and over, on all such orders received during the TWO WEEKS from the date of this advertisement.

AEONIC BATTERIES are of the highest possible quality, and are, in every way, equal to the most expensive standard Battery on the market.

The large extensions recently made to our Battery Plant has made not only this offer possible, but has placed us in a position to give IMMEDIATE delivery to the trade.

Write for trade terms and full particulars.

AEONIC

Aeonic Radio Ltd.,
Radio & Switchgear Manufacturers,
AEONIC WORKS, HORLEY, SURREY.

Telephone: Horley 400.

Telegrams: "Ammeter" Surrey.



VATEA—THE WONDER VALVE FOR ALL - MAINS SETS!

Vatea—the colloidal cathode valve—one of the best known valves on the Continent, and the valve that has met with such amazing success in so short a time in this country, announces here its series of 4-volt Indirectly Heated Valves for use with all-mains sets:

HV 4100 H.F. and Detector	-	9/6
UV 4100 Detector and Power Amplifier	-	10/6
SV 4100 Screened Grid	-	17/-
RV 4100 R.C. H.F. and Detector	-	9/6
TV 425 Pentode (Directly Heated)	-	19/6
Re 4100 Rectifying, Full Wave	-	12/6

For mains working there is nothing finer offered to the British public than these Vatea Colloidal Valves. Stock up now; make sure of your share of this profitable business.

Complete price list of Standard, Multiple Grid, Directly and Indirectly Heated Valves, on application to Abbey Radio, 47, Victoria Street, S.W.1, Sole Distributors.

There is **BIG** business for you in

VATEA

THE NEW VALVES
STYLE

ABBEY RADIO

47, Victoria Street, London, S.W.1
Telephone No.: Victoria 3914.

District Representatives wanted — applications invited.

HYDRA SURPASSES HYDRA

The new Hydra Condensers embody many outstanding improvements, most interesting of which, because of the simplicity and originality of the idea, is the arrangement of

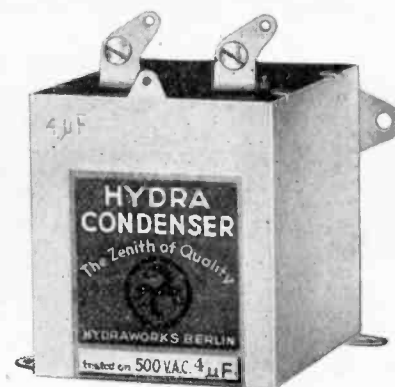

the 'fixing' and 'terminal' lugs. The condenser can be rigidly fixed in practically any position and the chance of a 'short' when connecting up is completely overcome. Full details of the new Hydra range will shortly be available in booklet form.

THE INSOL MOTOR THAT NEVER FAILS

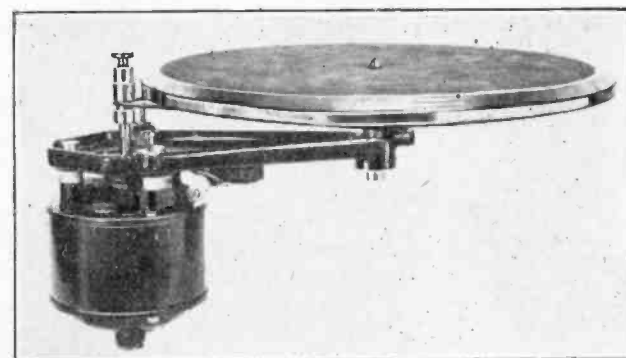

The Insol Motor is another Holzman Product of interest to the trade. Many manufacturers have standardized this motor and turntable which is noted for its silent running without excessive heating, and constant speed however fluctuating the mains. Retail at £6:0:0 Special terms to manufacturers.

LOUIS HOLZMAN, LTD.

37, NEWMAN STREET, LONDON, W.1

Telephone: Museum 2641.

We carry
LARGE STOCKS
 of



MAINS UNITS

Sell them with the 'Xtra-Point' Lampholder and Plug, 4s. 6d. extra.

SUPPLIES OF REPRINT OF THE REGENTONE
 SUPPLEMENT ON APPLICATION.

W. E. BEARDSALL & CO. LTD.

D.C. MODEL. Size 9" x 5" x 3 1/2".
 Input Voltage, 200-250 volts. H.T.
 Output, 130 volts at 20 m.a. H.T.
 Tappings, 2 continuously variable
 (one S.G.) and 1 Power. L.T.,
 Trickle Charger for 2-, 4- or 6-volt
 accumulators, without any altera-
 tion whatever to existing wiring.

PRICE £4 : 5 : 0

H.T. only £2 : 15 : 0

Northern Distributors of Regentone.
 Victoria Bridge, Manchester.

Telephone : Blackfriars 4255.

A.C. MODEL. Model W.5.
 Incorporates Westinghouse Metal
 Rectifiers on both H.T. and L.T.
 sides.

Size, 9" x 5" x 3 1/2". Output,
 120 Volts at 15 m.a. Tappings,
 H.T. 2 continuously variable
 (one S.G.) and 1 Power. L.T.,
 Trickle Charger for 2-, 4- or 6-volt
 Accumulators.

PRICE £5 : 17 : 6

Model W.6. H.T. only £4 : 5 : 0.
 Either of the above models is
 available for 25 cycles at an
 increase in cost of 10/-.

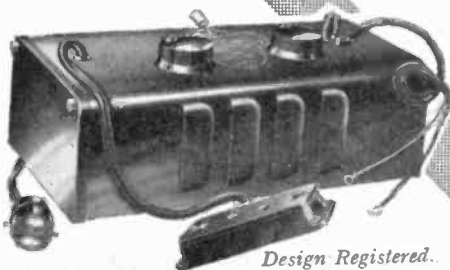

Design Registered.

MODEL.

Model W.5.

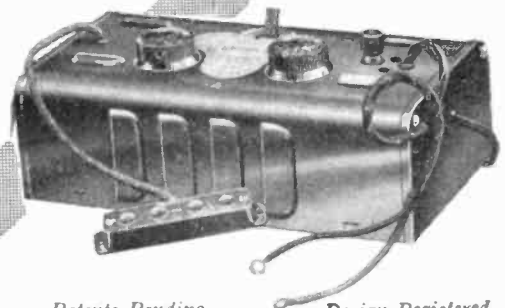

Patents Pending.

Design Registered.



'Charging' Profits

Give a complete service! Don't let your customers go elsewhere for charging. The Superflux U.C.1 illustrated is for 2-24 volt. accumulator at 3 amps. A.C. mains from 100v.-130v. or 200v.-240v.-40-60 cycles. A moving coil amperemeter always in circuit. Rectification obtained by Philips Valve No. 367.

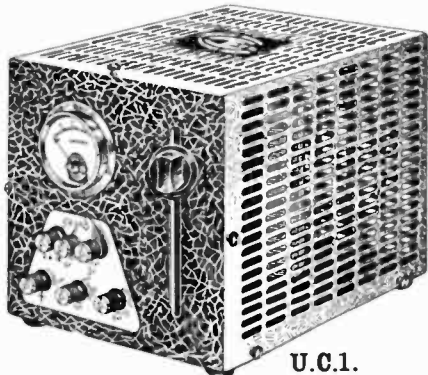

U.C.1.

SUPERFLUX CHARGERS

U.D.1.



U.D.1 Maximum capacity 80 volts at 2-6 amps for L.T. or ten 120 volt. H.T. Batteries at 1 amp. Input voltages 110/130 volt or 200/240 v. 50 cycles. Variable charging rate. Philips Valve No. 1029 protected by two fuses from overload.

PRICES : Valves For U.C.1, 25/- for U.D.1, 45/- less maker's discount

U.C.1 Without valve £7 - 0 - 0 less trade discount

U.D.1 " " £18 - 10 - 0 " " "

FONTEYN & CO., LTD.

2 to 6, BLANDFORD MEWS, BAKER STREET, W.1.
Telephone: Welbeck 4144 (4 lines). Wires: Fonteyn, London.

And at PARIS



**ENORMOUS
MAGNIFICATION
ABSOLUTE
STABILITY AND
EXCEPTIONAL
SENSITIVITY!**

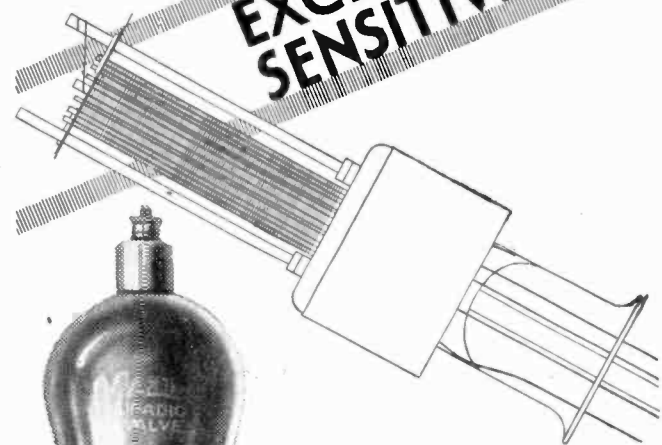

The Mazda A.C./S.G. will give a higher amplification than any other screened grid valve on the market—and with complete stability.

The reason is to be found in the unique duplex screen grid which, together with other exclusive features, reduces the anode/grid capacity to a remarkably low figure. This valve will definitely improve any S.G. all mains set not already fitted with one. Use Mazda valves in your next replacement job.

The Amazing

MAZDA

**PRICE
25/-**

RADIO VALVES



THE EDISON SWAN ELECTRIC CO., LTD.,
Radio Division,
1a, Newman Street, Oxford Street, W.1.
Showrooms in all the Principal Towns.

EDISWAN

V.44

**£8.6.8
FOR EVERY
ONE YOU SELL!**



**PRICE £25
A.C. OR D.C.**

And there's a model for every voltage and periodically.

Generous hire purchase terms are available.

£8 - 6 - 8 goes into your till every time you sell a Dubilier all-mains receiver—and there's no come-back. A Dubilier Set once sold stays sold. There's no bother about servicing—troubles simply don't exist. Dubilier Sets are guaranteed for one year, but all you are ever called upon to do is to sell your customers valve replacements if needed. Why not stock and demonstrate this profit bringing trouble-free line now?

DUBILIER

ALL ELECTRIC RADIO

DUBILIER CONDENSER CO. (1925) LTD., Ducon Works, Victoria Rd., N. Acton, London, W.3

The Acknowledged PIONEERS

with a full range of
D.C. and A.C.

All-from-the-Mains Receivers

GAM-BRELL

**TROUBLE-FREE
RADIO!**



*The Gam-brell Trans-
portable. This is all-
electric receiver which can
be easily carried from room
to room.*

*Several changes of pro-
gramme are assured. Price
Complete and ready for use:*

D.C. £29 A.C. £32

*The Gam-brell Radio
Gramophone. An excep-
tional instrument incorpo-
rating the marvellous Novotone
Compensator. Gives
realistic radio reception and
reproduces records with
astonishing vividness.
Novotone Model prices:—*

D.C. 69 Gns.

A.C. 80 Gns.



THE GAM-BRELL RANGE INCLUDES
TWO, THREE & FOUR-VALVE RECEIVERS

Prices from £13-15-0 to £39-15-0

Descriptive Illustrated Literature on request

GAMBRELL RADIO LTD.

Buckingham House, Buckingham Street,
Strand, London, W.C.2.

Telephone: Temple Bar 3213.

MADRIGAL HAS "GOT THERE" BY MUSICAL MERIT AND DEMONSTRATION

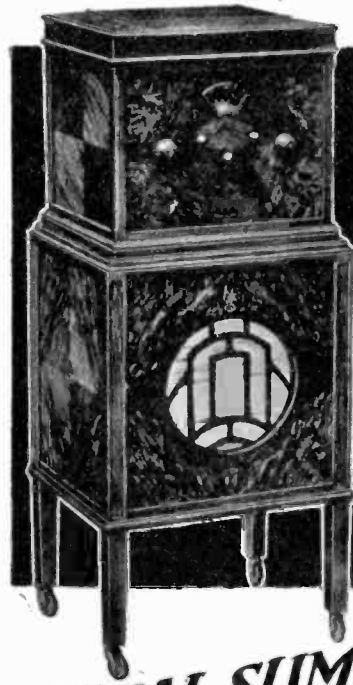

*Madrigal
cannot be
equalled
although
imitated.
It Sets the
standard of
Radio for
years to
come*

A REAL SUMMER SELLER

Transportable to wherever electric
light or power is available—in the
house or in the garden, and giving re-
production of unprecedented quality
"Madrigal" is first choice of those
who will have the pure unadulterated
best in speech, music and sound.

**NO AERIAL, NO EARTH, AND
POSITIVELY NO TROUBLE**

Most beautiful cabinet craft in walnut and mahogany

MOST ATTRACTIVE H.P. TERMS

"Madrigal" is now within reach of all on easiest of
easy terms—write for "Madrigal" leaflet and full par-
ticulars and enjoy your share of the Summer business

"Madrigal" Receiver only, in
walnut or mahogany, A.C. or D.C. £30-0-0

"Madrigal" complete Receiver and Pedestal
with coil-driven Speaker in walnut or
mahogany. Mounted on rubber-
tyred castors. For D.C. . . . £45-15-0

"Madrigal" complete Receiver £48-18-0
and Speaker. As above for A.C.

H.P. TERMS ON APPLICATION

12 HYDE ST., LONDON, W.C.1



I'VE TOLD THE WORLD!



It's simple. I'm not selling an obscure product to a doubtful market. Nothing is more certain than my methods. Daily I explain what a rectifier is—what it does and why it does it. What a vast multitude of potential buyers I have—the combined millions of newspaper circulation. But I can't teach you your business. I can only tell you that tens of thousands of all-electric radio owners have heard me and now demand Mullard when a rectifier valve is wanted.

MULLARD • RECTIFIER • VALVES

Advt. The Mullard Wireless Service Co. Ltd., Mullard House, Charing Cross Road, London, W.C.2

Arks.

THE RADIO EYE!

the dream of this
wonder age now
a solid fact...

Now seeing by Wireless is made possible for the average radio owner—the new Baird “Televisor” Home Reception Set brings Television home to countless enthusiasts. No longer will they be satisfied with just the voices of the entertainers—they will want to witness everything that takes place before the microphone.

The Baird “Televisor” Home Reception Set brings this wonderful advantage of actual reproduction from living objects and not just built up “still” pictures. The Baird instrument opens out new trading possibilities and will gain popularity because of its simplicity of operation and high efficiency.

Daily broadcasts of both sound and vision from the National and Regional Stations at Brookman's Park have been a feature since March 31st.

Special thought has been given to catering for the Home Constructor, and a KIT of BAIRD “TELEVISOR” BRANDED PARTS is now available.

Enquiries will be promptly dealt with, and prices will be forwarded to all interested. Ample “service” is arranged for.

BAIRD TELEVISION LTD.
133 LONG ACRE, LONDON, W.C.2

BAIRD TELEVISION

“TELEVISOR”
(Regd. Trade Mark)

for the home



The WIRELESS & GRAMOPHONE TRADER

SATURDAY,
JUNE 7TH, 1930.

The only weekly Trade Journal circulating to Bona-Fide Wireless & Gramophone Traders.

EDITORIAL VIEWS.

Selling Mains Equipment.

WE have found no-one yet who does not agree that the future of radio development and the industry's prosperity is very intimately bound up with the ever-expanding sale of mains-driven receivers and combination instruments. There are some, however, particularly among dealers, who appear to be regarding over-seriously the present obstacles to business in this direction.

The most important of these, of course, is the comparatively limited domestic use of electricity in this country, but even this circumstance, when examined more closely, has some of the elements of definite advantage. The vast majority of new houses, practically all of which are connected to the electricity mains, are being *bought* instead of rented, and this generally means that the owners are at least in moderately affluent circumstances. Then, again, outside this field, electricity is spreading only to those older homes where the occupants can afford the fairly heavy installation cost involved.

These two circumstances clearly show that the majority of those people whose homes are equipped to enable them to use mains-driven radio are also those who are best able to afford the more expensive apparatus required. And this general condition will continue in the future, since only a radical change in the policy of the supply companies, or State intervention on a really comprehensive scale, will bring about a rapid increase in the proportion of working-class homes that are wired with electric supply.

The market is therefore a very favourable one. Since the customer's ability to pay the price is always one of the main deciding factors in any sale, the dealer here starts with part of his job done, and in our opinion the remainder should be comparatively easy. It is apparent that mains-driven radio is more simple and fool-proof to handle than battery-operated apparatus, and there remains only one factor.

That is the question of safety. Early mains units, particularly, revealed pitfalls for the unwary or the non-technical user; but the general acceptance of the special safety regulations introduced by the Institute of Electrical Engineers has removed this obstacle to sales. The public, however, still need wider education on this score, and by following the lead given by manufacturers, and adding the influence of their own direct contact, dealers should reap a profitable reward.

The Music Trade and Wireless.

WE returned from last week's Music Trade Convention (to which some further space is devoted in this issue) with one impression standing out above all others. The distributing section of the music trade—whatever its hesitancy in early days—quite definitely now regards itself as the proper channel for the sale of radio instruments and radio-gramophones. (We imagine, although the subject was not specifically mentioned, that the still considerable component market is regarded rather less kindly.)

It is also noteworthy that the leaders of the music trade—and in this classification we include the gramophone industry—are keenly alive to the necessity of educating their dealers in the matter of radio technique generally and after-sales service particularly. In point of fact, the Music Trades School is already catering for dealers in this direction, while technical courses in various parts of the country have been arranged by leading gramophone firms.

We do not know what proportion of the music trade are recognising the technical obligations involved in the distribution of radio sets, and are taking advantage of these facilities. But in any event, the established radio dealer can rest assured that our manufacturers will not in these days continue long employing any dealer who fails him in the matter of service. It therefore comes down to the point that, in the end, existing traders will have to meet competition only from those music dealers who qualify in the proper way—and to that no-one can object.

This does mean, nevertheless, that every radio retailer must prepare himself to meet still more competition; But, bearing in mind that radio distributors of the present time have generally had years in which to establish themselves and build their reputations, we see no reason to fear the increasing interest that is being shown by the music trade.

Our final point is that we deprecate the talk that is sometimes heard of one or other of the two trades "absorbing" the second. Both of them, in our view, are too big for such a development ever to be realised. On the other hand, we do believe that their interests have so much in common, and their activities lie so much in the same direction, that they must inevitably march side by side, and, in the course of years, become more closely identified as kindred organisations.

8th Year of Publication.

Editorial, Advertisement and Publishing Offices:—
**ST. BRIDE'S HOUSE, SALISBURY SQ.,
FLEET STREET, LONDON, E.C.4.**

Telephone Numbers—

CENTRAL 7713 (5 lines). CITY 4011 (4 lines).

Telegrams—

"WIRELESTRA," FLEET, LONDON.

Branch Offices:

BIRMINGHAM: Central House, New Street.	MANCHESTER: 260, Deansgate.
Telegrams: "Trapress, Birmingham."	Telegrams: "Motrader, Manchester."
Telephone: Central 4026 and 4027.	Telephone: City 8970 (4 lines).

Annual Subscription Rates:

United Kingdom, Canada and Newfoundland. All other countries Abroad.

2/- Post free. 10/-

Published Every Saturday.

POWER FROM THE MAINS

Some notes on the principles of electric operation.

By The Technical Editor.

SINCE we published our mains issue last year, very little change has taken place in the principles of the utilisation of the electric mains for radio receivers, progress taking the form of refinements in the existing methods, together with improved components and valves. With the gradual replacement of D.C. supplies by the standard 230 V 50 cycle A.C. which will in time become universal in this country, D.C. apparatus is gradually giving way to A.C. Nevertheless, D.C. apparatus is still necessary in a large number of districts, and it still figures in most makers' catalogues.

D.C. and A.C.

It is hardly necessary to explain that mains apparatus intended for use on D.C. mains cannot be used for A.C., and vice-versa. In a D.C. supply, the voltage is unidirectional, that is, one terminal of the mains is always positive relative to the other. The voltage between the two terminals should also be constant, but unfortunately, owing to imperfections in the generators at the power station, there is always a certain slight fluctuation in voltage due to a commutator ripple superimposed on the steady D.C. If there were no such ripple, the construction of D.C. elimina-

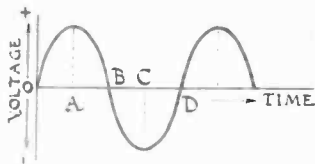

Fig. 1. The ideal A.C. wave form.

tors would be delightfully simple, as we should only require resistances to break down the voltage to the value required for the various parts of the circuit. As it is, "smoothing" circuits have to be employed to smooth out the ripple, which would otherwise cause an audible hum in the loud-speaker.

Some supplies are worse than others in this respect, and a unit which may give reproduction free from hum in one district may not be so successful in others. Most reputable manufacturers, however, employ smoothing circuits adequate for the worst examples of D.C. mains likely to be met in practice.

In A.C. supplies we have something entirely different. Here the voltage is not unidirectional, but varies in amount and changes in direction many times in each second. In Fig. 1, there is a graphical representation of a perfect A.C. supply. When we plot the voltage against the time, we get a curve which is symmetrical about the axis of time, and repeats itself at definite intervals. From the time O to A the voltage is rising in a positive direction, reaching its maximum at A. From A to B, the voltage is still positive, but is decreasing in value, until at B it is zero. From B to C the voltage increases again, but in a negative direction, while from C to D its negative value decreases. At D it commences the cycle all over again. The number of times it makes a complete cycle (*i.e.*, from O to D) in a second is known as the periodicity or frequency of the supply. In this country the periodicity is generally between 40 and 60 cycles per second.

Rectification of A.C.

It is quite obvious that before A.C. can be utilised for mains receivers it must generally be rendered unidirectional,

or "rectified." We say generally, because in some cases it is possible to utilise "raw" or unrectified A.C., for instance, to supply the heaters of A.C. valves.

Rectification can be performed in various ways, the chief of which are mentioned below. It should be pointed out that two types of rectification are possible, known as half wave and full wave. In Fig. 2, A represents the initial A.C. wave form. B shows the result of perfect half-wave rectification, in which the portions of the wave below the horizontal axis have been completely suppressed. C illustrates full-wave rectification, where the negative half of the wave is rendered positive instead of being suppressed. The result, therefore, is greater efficiency.

Types of Rectifier.

Any device which offers a higher resistance to the passage of a current in one direction than in the other will act as a rectifier, but it is obvious that for perfect rectification the conductivity in one direction must be zero. Otherwise, rectification will be incomplete.

Rectifiers used for wireless purposes are of several types, and come under the main headings of Electrolytic, Thermionic, Gas Conduction, Vibrating, Rotary and Dry Contact.

The wet electrolytic type, although originally one of the most popular, is now only used by a few firms, and we shall therefore not deal with it in detail here. The circuits used are similar to those of the dry contact type.

The gas conduction rectifiers include the well-known Tungar, the mercury arc and the helium types. Vibrating rectifiers are not very popular now, while the Rotary type is used mainly for heavy duty work, such as the H.T. supply to large amplifiers and transmitters.

The Thermionic Rectifier.

The Thermionic or valve type of rectifier utilises a heated filament as in an ordinary receiving valve, and one or two anodes. Its action depends on the fact that an electron stream will only flow between the filament and the anode when the latter is made positive relative to the former. The filament can be heated by "raw" A.C. obtained from one secondary winding of a mains transformer, while the voltage to be rectified is obtained from another secondary winding. Fig. 3A shows a simple form of half wave rectifier, and it should be noted that the filament heating winding

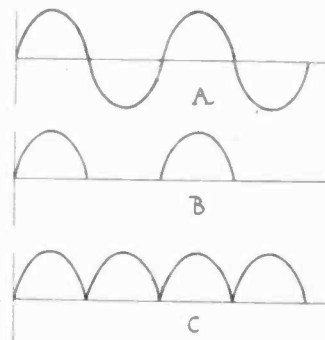

Fig. 2. Half and full wave rectification.

of the transformer is centre-tapped. At B, in Fig. 3, a full wave rectifying valve is shown, and it will be observed here that both secondary windings of the transformer are centre-tapped. On another page in this issue we give a list of the rectifying valves that are available, with their outputs. This type of rectifier is clean, noiseless and reliable, though its life depends on the life of its filament.

The gas conduction rectifier merely consists, in its simplest form, of a cathode and anode mounted in a bulb containing some helium or argon gas or mercury vapour. When a certain definite voltage is applied between the electrodes, the gas ionises, and acts as a unidirectional conductor. No filament is required for this type of rectifier, though in the mercury type a heater is sometimes employed. This latter type is generally used for rectifying A.C. for battery charging, while for H.T. supply the helium type, such as the Raytheon, is used.

Dry Contact Rectifiers.

Next we come to a type of rectifier which has become very popular in this country, namely, the dry contact rectifier. There are two main types, the copper oxide and the copper sulphide. An example of the former is the Westinghouse and of the latter, the Igranic-Elkon.

The copper oxide type contains a series of junctions between metallic copper and cuprous oxide. It consists of a number of copper washers, each with one surface oxidised, bolted up with lead washers and cooling fins into a compact and rigid unit. The rectification takes place not at the contact surface of two discs, but inside the surface at the junction of the metal and the copper oxide deposited thereon. Rectification is supposed to be due to a molecular film with the molecules so orientated that electrons can pass easily in one direction and not in the other. There is no decomposition of the metal or oxide, and the principle is entirely electronic.

In the sulphide type, aluminium or magnesium plates are in contact with a copper sulphide surface. Here the rectification is between the surface of the dissimilar plates,

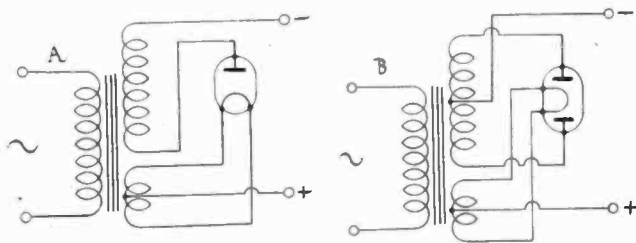

Fig. 3. Half and full-wave valve rectifier circuits.

and electrolytic conduction takes place, new chemical products being formed and converted back.

Dry contact rectifiers are used in circuits shown in Fig. 4. A is a simple half wave circuit, generally used only in the smallest types. B is the "centre tap" method, in which the applied A.C. voltage has to be twice that of the required output voltage. This gives full wave rectification. At C in Fig. 4, the full wave "bridge" method of rectification is shown, and this is undoubtedly the most popular circuit used at present. Here the secondary voltage of the input transformer is of the same order as the required output voltage. D shows an interesting circuit developed by Westinghouse, known as the "voltage doubling" circuit, which, like the bridge method, gives full wave rectification with an output voltage comparable with the input voltage, but with about half the current output of the bridge circuit. It is used for H.T. supply, and the large capacity condensers shown play an important part, and cannot be omitted.

A list of the types of metal rectifiers on the British market is given on another page.

Smoothing Circuits.

So much for rectifiers. After rectification we have a unidirectional supply, but of fluctuating voltage. This must be smoothed before it can be used to feed wireless sets, though it can be used for charging accumulators

just as D.C. straight from the mains can be used for charging purposes. The remarks about smoothing circuits will therefore apply to unsmoothed D.C. or rectified A.C.

The simplest form of smoothing circuit is shown in Fig. 5. The input is applied to the two terminals on the

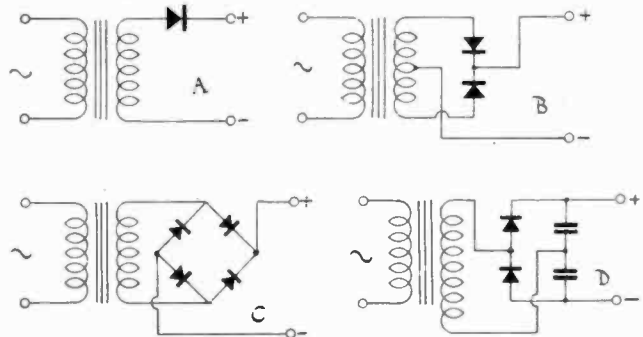

Fig. 4. Dry contact rectifier circuits.

left, while the smoothed output is taken from the terminals on the right. It will be observed that in series with the positive lead there is an iron cored choke. In some cases it may be necessary also to include a similar choke in the negative lead. The choke allows steady D.C. to pass with little hindrance, but it opposes any fluctuating voltage owing to its inductive impedance. The inductance of the choke should be as high as possible compatible with a low D.C. resistance and its ability to carry the requisite current without causing the core to be saturated.

Generally speaking, power chokes are heavy components, with large cores and windings. One firm, however, is now making a much smaller component for the same purpose, utilising a nickel-iron core, which has the same relation to the ordinary iron cored type as has the nickel-iron cored L.F. transformer to the ordinary L.F. transformer.

The other components in the smoothing circuit consist of large capacity condensers. The two shown in Fig. 5 have different functions, with which we have not space to deal here. Generally the condenser on the left will have a capacity of 2 to 4 μ F, while that on the right may be anything from 4 to 8 μ F. These condensers mainly act as smoothing devices by virtue of their storage or reservoir properties, though they also act as by-passes to some extent.

The fixed condensers used in mains units, besides having large capacities, must be capable of withstanding high voltages without strain or breakdown. For this reason they must be designed to withstand a test voltage of at least three times the peak voltage at which they will have to work in practice. This means that their dielectric must be thicker than with the ordinary 300 V test type, and hence they are larger and more expensive. Generally speaking, the test voltage should be 600-1,000 V.

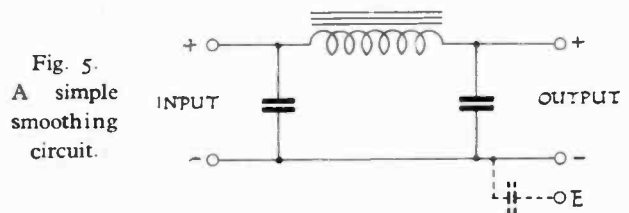

Fig. 5. A simple smoothing circuit.

It will be noted that another condenser is shown dotted in Fig. 5. This is connected between the negative terminal of the smoothed output and another terminal marked E. In the case of D.C. mains units, the earth lead must be disconnected from the receiver, and attached to terminal E

on the unit. This precaution against short circuiting the mains is not essential in A.C. sets, but it must not be omitted in D.C. receivers.

Having now smoothed our D.C. or rectified A.C., the output can be applied to the receiver, providing only one voltage is required. If, as in the case of H.T. supply, several different voltages are required, some sort of circuit incorporating resistances must be employed to break down the maximum voltage to the values required.

Regulating the Voltage.

In Fig. 6, two different methods of obtaining various output voltages are illustrated. The first, shown at A, utilises a potential divider connected across the output terminals. Tappings are taken to various points along the divider, while a by-pass condenser is connected between each tapping point and the negative output lead. This circuit has several advantages, but there is the serious disadvantage that part of the potential divider resistance is common to all the H.T. supplies to the set. The result

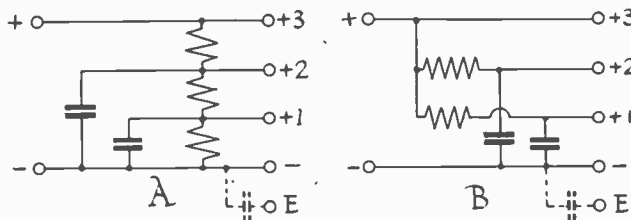

Fig. 6. Two forms of output circuit.

is that inter-stage coupling will be present, and this may result in incipient, if not actual, L.F. oscillation.

A circuit designed to eliminate the possibilities of this trouble is shown in Fig. 6 B. This is really the "anode feed" system applied in the mains unit instead of in the receiver itself. Separate series resistances are used for each tapping, and they may either be fixed or variable. The by-pass condensers have capacities of the order of $2 \mu\text{F}$.

L.T. Supply.

The above remarks have been directed mainly towards H.T. supply units, though some of the principles can be applied to the problem of L.T. supply. There are three alternatives as far as A.C. supply is concerned. We may use a "trickle charger" in conjunction with an accumulator, an L.T. supply unit, or special A.C. valves.

The trickle charger method is not to be despised. Usually a Westinghouse rectifier is employed, and the charging current is of the order of 0.5 A . On switching off the set, the charger is brought into action, and the accumulator is always kept fully charged. Provided that precautions are taken against over-charging, this method has very few disadvantages, and a smooth L.T. supply is assured.

Some people, however, desire to eliminate batteries at all costs. It is possible to provide an L.T. supply from special metal rectifiers, though the smoothing presents difficulties. Very large capacity condensers must be used, with a very low resistance choke capable of carrying a heavy current. Ordinary condensers would be far too costly and bulky, so use is made of a special type of electrolytic or dry contact cell to form what is known as an "electrolytic condenser." The gas film, or the film at the surfaces of contact, acts as a dielectric of infinitesimal thickness, and the result is an extremely high capacity, of the order of $1,000$ to $2,000 \mu\text{F}$. Unfortunately, these condensers have a very low breakdown voltage, though they are self-healing. In any case, in L.T. units the applied voltage is not very high.

We now come to A.C. valves. These are of two main types—the indirectly heated and the directly heated. Both can be used with "raw" A.C. which has previously been stepped down to the correct voltage by a suitable

transformer. An ordinary valve with a thin filament, cannot be thus used, since the emission would fluctuate with the applied A.C. voltage, producing a hum of the same frequency as that of the supply. The indirectly heated A.C. valve has a cathode in place of the filament to supply the electronic emission, and this cathode is kept at a red heat by a separate heater, which is close to, but not in contact with, the cathode. In this way a steady emission, unaffected by the A.C. heater supply, is obtained. Standard A.C. valves have a 5-pin base, the cathode connection being made to the centre pin. The two "filament" pins are connected to the heater. Special 5-pin valve-holders are, of course, necessary, and all the grid return leads of the circuit are taken to the fifth, or cathode terminal.

Directly heated A.C. valves are similar to ordinary D.C. types, except that they have special thick filaments, whose emission does not fluctuate with the A.C. input, but remains at a steady value. The grid return leads in the receiver must, however, be taken to a centre tapping on the secondary of the filament transformer, or, better still, to the slider of a potentiometer across the secondary.

It should be remarked here that certain ordinary D.C. valves with filaments taking 0.25 A or upwards can be run from raw A.C. This is particularly applicable to large power valves of the L.S. 5 A, P 650, D.O. 20, P 625 and similar types. Several manufacturers are selling their large power valves as directly heated A.C. types, and it is safe to say that these are probably being used more in this way, than with batteries. Naturally, 4 and 6 V types are the most popular for this purpose.

So much for L.T. supply from A.C. mains. Grid-bias can be obtained by dropping the required voltage from H.T. units across suitable resistances, or a special metal or valve rectifier with a separate smoothing circuit can be utilised.

L.T. from D.C. Mains.

L.T. supply from D.C. mains is rather difficult. The (large) excess voltage must be dropped across suitable resistances which have to carry the full L.T. current. This method is hardly economical, though some improvement is obtained by wiring the filaments of the valves in series. This is quite legitimate if the L.T. current consumption is the same for each valve. The voltages of the valves need not be the same—it is only the current that matters when the filaments are in series. Naturally, if ordinary battery types of valves are used, proper smoothing arrangements must be incorporated. A.C. types of valves can be employed on D.C., with their heaters in series, but as they consume 1.0 A , this method is even more uneconomical in running costs, though the smoothing circuit is not needed.

Rotary Transformers.

Reference should be made here to the small rotary transformers made to run from D.C. and to provide a high voltage D.C. output. These are very useful where low voltage D.C. mains are available, and where the only other method of obtaining a high voltage supply would be to use batteries, and charge them in sections. Also, D.C. to A.C. rotary machines are now available. These are useful for people who are at present on D.C. supplies, but wish to purchase an A.C. set or radio-gramophone. The output from the machines is 230 V 50 cycle A.C., which will operate any standard A.C. receiver or radio-gramophone. The machines are largely used by manufacturers, who can thus confine their production to A.C. receivers, fitting one of the rotary machines to enable them to be run from D.C. mains.

With this we must conclude our summary of the methods of utilising the supply mains for radio purposes. Other pages in this issue will be found to contain numerous examples of the apparatus embodying them.

NEWS ITEMS ROUND THE TRADE.

THE DERBY RESULT ON RAIL AND IN THE AIR.

A Triple Publicity Achievement by McMichaels.

THIS year L. McMichael, Ltd., of Wexham Road, Slough, were again successful in carrying out an interesting publicity "stunt" in connection with the broadcast Derby commentary and result. Standard McMichael Super Range Four portable receivers were installed in both the north and south bound "Flying Scotsman" expresses, in co-operation with the L.N.E.R., while, in addition, Mr. C. G. Allen, of L. McMichael, Ltd., flew from Paris to London in the afternoon Imperial Airways liner and received the results, also on a Super Range Four portable.

Both the train experiments were successful, the results coming through in the north bound train near Newcastle and in the south bound train near Doncaster.

Sets were installed in a restaurant car in each train, and as soon as the results were ascertained they were stamped on neat cards which had already been printed, and distributed to the passengers.

In both cases the sets behaved perfectly, and reception was clear, except for a certain amount of external interference, which, however, was not enough to spoil reception.

In the case of the 'plane reception, the results came through about 55 miles from Paris, the machine being at an altitude of 3,000 feet. The Super Range Four was fitted with eighteen pairs of head-phones, and all heard the results very plainly. There was no interference from the magnetos of the three engines. A photograph taken in the 'plane is reproduced below.

New Secretary of the U.W.T.A.

Owing to the retirement of Captain A. Barnett, who is going abroad, the hon. secretary of the Ulster Wireless Traders' Association is now Mr. D. J. Mullan, solicitor, 43, Chichester Street, Belfast.

At a recent U.W.T.A. social every good wish was expressed for Captain Barnett's success, and a presentation was made to him by the President, Mr. Robert Scott, of two cabin trunks.

Captain Barnett thanked the officers of the U.W.T.A. and every member individually for the support that had always been given to him.

A Varley Prizewinner.

It is of interest to note that the winner of the Varley all-electric receiver offered at the Ideal Home Exhibition is Mr. C. A. Baxter, of 21, Palmerston Road, Bowes Park, London, N.22. The winning number was 533.

Regulation of Prices Opposed.

Exeter and District Chamber of Commerce is requesting the local M.P.'s to oppose the provisions of the Consumers Council Bill, which gives power to the Board of Trade to regulate prices and charges, being of the opinion that these are against the interests of producers and consumers and likely to lead to a scarcity of commodities or a lowering of the standard of quality.

"Uncle Tom" Again.

"Uncle Tom" Payne, of Payne & Hornsby, Ltd., 7, St. Andrew's Buildings, Gallowgate, Newcastle, tells us that he has now successfully received the new television broadcast on 356 metres, using a 4-valve all-mains set.

Mr. Morgan's Accident.

We regret to record a rather serious accident having befallen Mr. Herbert T. Morgan, the popular hon. secretary of the South Wales branch of W.R.A., who is associated with his father, Mr. Dan Morgan, a pioneer wireless, motor cycle and cycle trader, in business at 218, Oxford Street, Swansea.

On May 27th, Mr. Herbert Morgan was found unconscious in the roadway at Sketty, Swansea, and it transpired that either he had fallen from a tramcar when dismantling—he had a used tram ticket in his hand—or had been knocked down by a passing car when dismantling. Two doctors on the scene caused his removal to Brunswick Nursing Home, where he remained until the week-end, when he was removed to his home. Mr. Morgan was then, at time of writing, still

suffering from severe brain concussion.

Traders will commiserate with Mr. Morgan and his parents, and wish him a speedy recovery from the effects of this accident.

It will be recalled that only recently we announced details of Mr. Morgan's forthcoming marriage to a well-known South Wales lady journalist.

The Radio Association.

We are informed that applications from many hundreds of districts have been received and filed for attention by the Radio Association, and they now announce that the scheme for the maintenance of listeners' sets will be put into operation from September 1st next. Those dealers who are finally selected to co-operate in their districts will receive a supply of literature and display matter during August.

It is stated that there are, however, many districts all over the country where the co-operation of a reputable trader is still required and interested dealers are invited to apply without delay on their trade notepaper for full details. Letters should be addressed to the General Secretary, Radio Association, 22-23 Laurence Pountney Lane, London, E.C.4.

And Now in Lancs!

An application to the Rawtenstall Corporation has been made by a firm of wireless engineers for permission to establish a broadcast relay service locally. The Corporation have offered no objection to the project.

Inventions Exhibition.

The sixth International Exhibition of Inventions will take place this year at the Central Hall, Westminster, S.W., from October 1st to October 11th inclusive.

League of Nations Transmitter.

An interesting development is revealed by the announcement that tenders are being invited until August 20th next for the construction and equipment of a wireless telegraphy and telephony station for the League of Nations. The station will be of the same type as the big short-wave stations constructed recently, and will consist primarily of a short-wave wireless transmission station with two transmitters, each of 20 kW, allowing the employment of any wavelength between 14 and 100 metres.

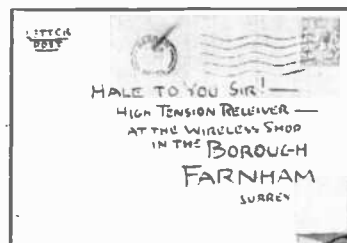

Facsimile reproductions of a coloured card sent to Hale, Ltd., the well-known Farnham dealers, by a customer. This novel testimonial was quite spontaneous.



Left : Mr. and Mrs. Bert Hinkler (nearest camera on right) listening in an air liner to the Derby broadcast on a McMichael portable.

ROUND-TABLE CONFERENCE AT THE MUSIC TRADE CONVENTION

*F*OLLOWING last week's report of the first days of the successful trade Convention organised in Blackpool, from May 26th to 30th, by the Federation of British Music Industries, we deal here with the closing stages. Much of interest to gramophone-wireless traders is dealt with here.

ON the business side, the last two days of the Convention were devoted mainly to the interests of the gramophone trade. Thursday morning's programme included a meeting of the Music Trades' Association, followed by a Dealers' Conference, and a meeting of the Association of Gramophone and Musical Instrument Manufacturers and Wholesale Dealers. These, however, were largely of a domestic nature.

On Friday three vitally interesting hours were spent in a round-table conference between gramophone manufacturers, factors and dealers on the subject of trading conditions in the gramophone industry generally.

The conference was a result of action taken by the Manchester Division of the Gramophone Dealers' Association. Supporting the idea, the Executive of the Association had sought to arrange a meeting of the three sections in London, but at the express desire of the manufacturers and factors, time was eventually allotted to it in the programme of the Convention at Blackpool.

The Dealers' Case.

The conference was opened by Mr. A. E. Hider, President of the Gramophone Dealers' Association, who outlined briefly the main points in the retailers' case. Referring to the fact that supplies—particularly of records—were undoubtedly going to people who ought not to have them, he said the G.D.A. felt that distributors in each district should have a voice in the opening of any new account.

Mr. Bainbridge, of the Manchester Division, followed with an outline of the circumstances which had led them to ask for this Conference. Reliable gramophone dealers, he said—those who had advertised, held recitals and generally done their task well—were seriously disturbed. Turnover was shrinking, and it was becoming increasingly difficult to make a net profit. Factors were in a similar position. Their record stocks were heavy, due to the increasing monthly output of the manufacturers, and to the fact that 25 per cent. to 50 per cent. of the records issued never sell—even once.

The large companies, the speaker continued, had just asked distributors for a return of their stocks of machines. Why did they not take the same course with records? The result would probably surprise them.

He attributed the present conditions to the decline in the gramophone boom of the past year or two and the "crazy" number of distributors in the field. Competition by too many people engaged in the trade, he said, could probably best be settled by a short, sharp price war, but that was impossible since dealers and factors generally had signed contracts to observe certain regulations laid down by the manufacturers.

Concluding, he said they had no fear of legitimate competition, but they did object to so many dealers in the field, and had called the conference to put forward a plea for the "rationalisation of distribution."

Mr. Bainbridge was followed by Mr. Hardy, of Stockport, who outlined the Association's scheme for remedying the present position. The scheme, he said, although the result of activity by dealers in the North-West, had been evolved by the best brains in the trade.

The first essential to success, Mr. Hardy said, was the registration of recognised dealers. Under the G.D.A.'s proposal, every gramophone dealer who was considered legitimate should be registered at once. Then in each district there should be formed local committees of dealers and factors to consider new applicants for trade recognition. Every proposed new dealer should pay an inspection fee, his premises should be examined, and, receiving a report, the committee would decide whether to admit the dealer to registration or not.

Further details in the scheme would provide for a central, impartial body to which all cases of dispute could be referred; there should be a ruling that any factor discovered supplying a non-registered dealer should himself be removed from the register; and there should be a provision ensuring that any factor introducing a new dealer should automatically get the first order, so that the wholesaler, in supporting the scheme, should not lose business.

General Discussion.

Several prominent gramophone dealers, together with representatives of well-known manufacturers and factors, took part in the broad discussion on the proposals which followed.

Mr E. E. Squire, of Ealing, in a well-balanced speech concurred with the view that the position was serious. Some dealers, he said, had been in the trade for 25 or 30 years; they had survived the early struggles and the past year or two had been extraordinarily fruitful; but there had been a sudden change, which was the cause of the present meeting. The trade was passing through a crisis, and dealers feared what might be ahead. Indeed, they had been told that factors themselves almost feared to look into the future.

There would come a time, he believed, when there would be no more gramophones in the present sense of the term, and what would happen then? Similarly the disc record might become obsolete, and they must provide a steady reserve against these possibilities.

The meeting was not called solely to criticise the manufacturer. There was no purpose in rowing; he desired to lay the



Gramophone Trade Personalities at the Convention.

facts before manufacturers, knowing that what is for the dealer's good is equally for the manufacturer's good.

Mr. A. E. Liedtke, British Manager of the Columbia Graphophone Co., Ltd., was the first manufacturer to comment on the arguments put forward by the dealers.

Mr. Liedtke felt that while the picture of contemporary trade conditions had been painted in somewhat lurid colours, there was a certain amount of truth in what had been said. At the same time, he believed that when times were bad there was more apprehension than was, perhaps, justified.

In his view good work could be done by dealers passing complaints, with details, to manufacturers. The latter would welcome the assistance.

He had his doubts about the practicability of the registration scheme, and thought at any rate that it should be further investigated by a sub-committee in London. He recommended them to try to find a workable solution on these lines, and also try the method of dealing with manufacturers he had suggested. But he urged them in any case not to be pessimistic.

After Mr. Hardy had commented that the method of laying complaints before manufacturers had been tried, without much success, Mr. A. T. Lack, of the Gramophone Co. (His Master's Voice), Hayes, supported Mr. Liedtke in his appeal.

He was confident that the trade had a glorious future. Commenting on Mr. Squire's reference to possible changes in the industry's merchandise, he said there had been many "revolutions" in the past, but he did not think dealers had much ground for complaint in connection with them. They always worked from the dealer's point of view, and progressed quietly in order not to prejudice the dealer's position.

The Factor's Position.

Two or three factors added their assurances that they desired to do everything possible to help the dealer. Mr. D. S. Bilantz, of Itonia Gramophones, Ltd., said they were all very anxious to do the right and fair thing. Mistakes did occur, he admitted, but most factors took a great deal of care with regard to whom they supplied and in opening new accounts.

"Frankly," he went on, "it is up to the manufacturers. We have rules laid down for us, and we have to do as we are told. A very serious point for us is that there has never been laid down a single unanimous definition of what really constitutes a gramophone dealer."

Later in the debate, Mr. Harry Bryan, of Selecta Gramophones, extended a similar message of willingness to help the trade, while dealers from various parts of the country warmly supported the action that had been taken by the G.D.A.

Mr. Ernest Marshall, of Sir Herbert Marshall & Sons, said the committee of the G.D.A. had known for long that the trade was running into trouble, and it was now absolutely necessary that they should have some method of control.

They all seriously felt that the three sections should get together and try to arrive at some basis as to who should and who should not be supplied.

Several more dealers, contributed interesting views to the discussion, and then Mr. Leslie Neck, of the Gramophone Co.'s English Branch, said they would gladly attend a further conference in London.

He showed the meeting that, in the meanwhile, His Master's Voice are doing much to help the dealer. In point of fact, their distributors were fewer now than they were formerly.

Finally, Mr. A. E. Ball, of Duck, Son & Pinker, Bath, marshalled the debate by suggesting that everyone admitted the dealers' right to an equal right with the other sections to a share in the control of the trade. He then proposed:—

"That at this meeting of dealers, factors and manufacturers . . . the dealers present strongly support the action suggested by the Manchester Division of the G.D.A., and in their opinion there must be a system of joint control, by the retail and wholesale trades, of the distribution of gramophone goods, and a further meeting should be held in London within one month from this date (May 30th)."

Mr. Ryalls, Birkenhead, who is chairman of the Liverpool Branch G.D.A., seconded the resolution, and, after a little further discussion, it was carried.

MARCONIPHONE COMPLETE THE JOB.

Setting the Seal on an Excellent Distribution Policy.

IT is by no means an exaggeration to say that the new sales policy instituted by the Marconiphone Co. is unique in ensuring practically ideal conditions for dealers who handle Marconiphone lines.

As we have already announced, the future policy of the company is to sell only through (a) agreement-holding retailers and (b) a limited number of wholesalers, who themselves will be under agreement to supply only on the manufacturers' terms and only to holders of the dealer's agreement. In addition, there is to be a standard dealers' discount of 33½ per cent.—except on Marconi valves, which, of course, still remain subject to B.R.V.M.A. regulations.

We have in recent issues published details of the two forms of agreement that are being used, and we have given them the unreserved commendation they merit. We have also dealt with the Dealer Training Scheme to be operated by the Marconiphone Service Dept., the courses for which will commence on June 16th.

The two agreements come into operation on September 1st, but traders who desire Marconiphone dealerships are requested to apply to the company before June 30th.

The Sales Development Department.

All of these schemes have now been co-ordinated and are to be supported by an entirely new Marconiphone department—the Sales Development Dept., under the control of Mr. G. W. Godfrey—which is the latest example of the thorough fashion in which the Marconiphone Co. are supporting their dealers.

The aim of this department is to place at the disposal of dealers every assistance in the sphere of sales ideas, in solving sales problems and in discovering further sales outlets. The department will also plan sales campaigns for individual dealers or on a national scale. When necessary personal visits to dealers can be made and practical help given to them in the course of their everyday business.

Mr. Godfrey was previously in the Engineering Dept. of the

G.P.O. until the war, when he joined the wireless branch of the R.E. Signals in France. After the Armistice, Mr. Godfrey handled a number of important jobs in sales and service organisation in Canada, and, coming back to this country, he was appointed Sales Engineer for Oldham & Son, Ltd. In 1925 he became associated with the Sterling Telephone & Electric Co., and then with the Marconiphone Co., Ltd.

As the Marconiphone "star" salesman, Mr. Godfrey will undoubtedly make this new departure a really "live" department, with the help of his assistant, Mr. F. Jones.

* * *

Marconiphone Sales Staff Convention.

A special opportunity was taken on Friday last week to acquaint all Marconiphone depot managers, representatives and sales staff with the company's new policy, on the occasion of a sales conference held at the Marconiphone headquarters, 210, Tottenham Court Road, London, W.1.

After the distribution scheme had been fully described by Mr. J. H. Williams (Sales Manager) and Mr. G. T. Beer (General Manager's Dept.), the meeting was adjourned for lunch, and in the afternoon the subjects and speakers were as follows:

Dealer Training in After-Sales Service—Mr. E. J. Emery (Service Manager).

The Sales Development Dept.—Mr. G. W. Godfrey.

Publicity and Dealer Co-operation—Mr. G. T. Freshwater (Publicity Manager).



Mr. G. W. Godfrey.

PROVINCIAL TRADE NOTES

Blackpool and Music Licences.

A QUESTION that was raised in a tour of Blackpool wireless traders was whether the sale of radio gramophones to hotels, boarding-houses, cafés, and so on, is affected by the operation of the music licence regulations. These, of course, are important in Blackpool, which is visited by multitudes of pleasure-seekers. It is readily apparent that the town could soon become a pandemonium if free-and-easy music facilities were permitted. There is, however, a feeling that in cafés, for example, a little more latitude would be appreciated by visitors. It would also be welcomed by radio traders.

Manufacturers and factors should note the new name of the business carried on by Mr. Hall at St. John's Walk, Blackpool. Mr. Hall, one of the wireless pioneers in this district, has been joined by Mr. R. W. Smith, and they are trading as G. D. Hall, Ltd. The firm have had a big run on valves for some time past. Sets sold have been mostly of the 3-valve type, with a few Philips' 4-valve receivers and their 5-guinea speaker.

Accumulators, "Regentone" eliminators and H.T. batteries have had a big run with Mr. Stanley Rhodes, 12, Coronation Street. In sets, 3-valve instruments here again have had the greatest popularity. The "Osram V" Music Magnet" kit has done especially well, but the component turnover is negligible.

Mr. H. Walton, at 2a, Caunce Street, runs the shop at one time held by the late Mr. W. A. Lyon, and has done very well with K.B. products. Sales of sets in the last 12 months have mostly been all-mains and straight 3-valves, with no pronounced demand for screened grid instruments. "Ekco" eliminators had a good run. Components in general are being cleared out, owing to the slackening demand. Portables have not yet become really popular, but inquiries have been received for radio-gramophones. Mullard valves are selling extremely well.

I found in Mr. W. Diggle, at 69, Adelaide Street, a pioneer in the radio trade—he has been in it since 1921—and one who has read every issue of THE TRADER since No. 1. He still has a big sale for sets of his own construction, from 3-valve up to super-hets. He has just taken up the Baird television, and has had good results, although Brookman's Park is 260 miles distant. He agrees that Manchester should have some local television transmissions.

Coventry Municipal Trading Trouble.

AN outstanding feature of trade in the rural districts of Warwickshire has been the great demand for all-mains receivers. In fact, in the smallest villages the popularity of the simple, completely mains-driven set is astonishing.

Although business is fair in Coventry one matter is exercising the minds of dealers, and causing no little concern.

I refer, of course, to the proposed Municipal Trading showroom. In a chat with Councillor C. Payne, the well-known local radio dealer and chairman of the Electric Light Committee, I was told that among the first articles to be affected by this scheme would be all-mains receivers. Councillor Payne said he was determined to fight the proposition tooth and nail, and looked to the local trade association to support him—which, without doubt, they will do.

The Coventry association, incidentally, continue successfully to combat trade evils, and can now claim to have diminished local price-cutting by over fifty per cent.

Pertrix Batteries in Hull.

SALES are once more engaging the attention of several retailers, but no great volume of business is reported. Price cutting by the London Radio Co. continues unabated, and many of the latest products are displayed in their window.

Pertrix H.T. batteries have sprung very quickly into favour, but deliveries even at this quiet time of the year are behind-hand. Portable sets are not so much in demand, but "Ekco" and "Regentone" eliminators are maintaining good sales, especially the new models for use in portable sets.

The Farrand inductor loud-speaker is considered to be a definite advance in speaker design and performance outside the moving-coil speaker class. The Marconiphone moving-coil instrument is also enjoying ready sales in this district.

The various new valves placed on the market during the last few weeks are now bringing the list of available valves up to embarrassing proportions from the standpoint of the trader. It is felt that the withdrawal of some of the older types would enable the trader to give better service to the public by reducing the number of valves he would have to stock.

Nottingham Portable Sales Increase.

THE outstanding feature of local trade just lately has been an increased demand for portable receivers, and this after one of the slackest periods ever known for this class of set.

According to Mr. Hought, the manager of T. Beadle's local wholesale depot, trade is slow in everything but portables, and of these the Pye is at present most in demand. There certainly is an improved call for eliminators, especially the "Regentone" portable model. "Ekco" mains units are also going well.

The chief price-cutter in Nottingham is still finding others keeping well within his own prices, and is therefore not having matters all his own way. One dealer in the district says he is determined to "give his opponent a run for his money," and as long as the price-cutting con-

tinued so long would he reduce his prices. This is a dangerous sentiment, with which all fair-play dealers will disagree.

Pearson Bros., Long Row, have been having a very busy time during the Central Nottingham by-election. Each of the three parties made good use of P.A. equipment for their meetings. Mr. Laurie Pearson supervised the P.A. arrangements which were of a highly satisfactory character.

Several of the leading retailers have lately been giving special displays of Philips sets, particularly the 3-valve all-electric and the new portable; while Messrs. Furse, Derby Road, have been doing the same on the wholesale side. The Philips all-mains 2-valve set is one of the most popular lines to be found in Nottingham's new housing estates, all of which are provided with A.C. mains.

J. S. Farr, in Parliament Street, have been featuring the Brown loud-speaker unit as a shop doorway exhibit. Its excellent reproduction naturally resulted in many enquiries being made.

The recent Command Performance broadcast gave a slight impetus to trade, and especially for renewals and battery charging. It is interesting to note how the battery collection and delivery system has grown in Nottingham. It is now the rule at most of the charging stations, whereas at one time it was the exception.

Portables in the West.

TRADE is slackening off a little in the West. Sales of portables, however, have kept up remarkably well in individual cases. The local manager at Bath of the Bristol Wireless Co. tells me that the present run is on 4-valve models, notably the McMichael "Super Range Portable Four." The Pye portable is also a strong seller, and considerable interest is being aroused by the new Philips portable. The use of electricity is spreading in both Bath and Bristol, and the demand for all-mains sets is likely to increase.

The Baird television set which F. H. Burris & Son, Bristol, are demonstrating, has attracted much attention locally, and is among the first in the district.

The "P.D. Speedy" motor boat, which Automobile Accessories (Bristol), Ltd., manufacturers of the well-known P.D. wireless receivers, are placing on the market, is priced at £98 10s. ready equipped for the water. This is an interesting proposition for wireless dealers who want a summer trade filip. Good discounts are offered, and valuable assistance will be rendered. Communications should be made direct to Automobile Accessories (Bristol), Ltd., Clifton Terrace, Bedminster, Bristol.

During the latter part of May many Bristol and Bath traders gave window displays of Lissen products, and in most cases they were very well arranged. Lissen batteries and the Lissen portable were prominently shown.

◆ ◆ ◆ THE NEW AMPLION PORTABLE

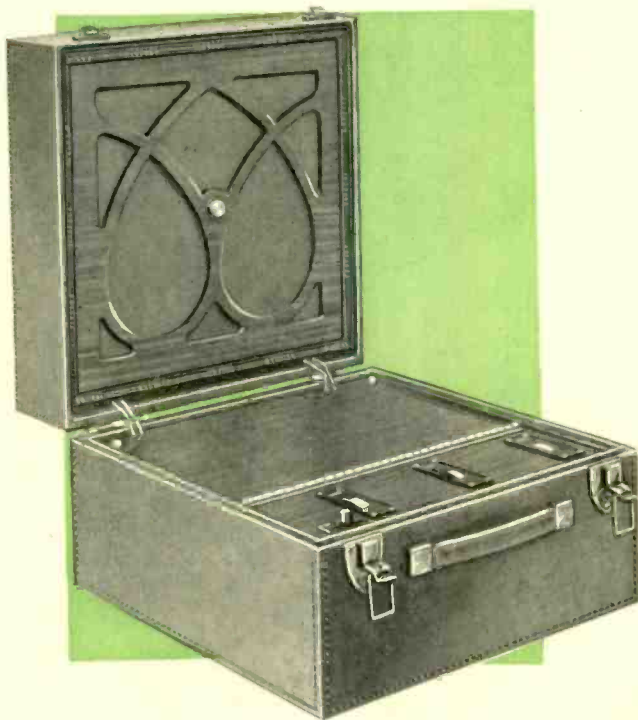

MEETS WITH UNQUALIFIED
SUCCESS

Cash List Price £24-15-0
Complete with all accessories and Royalties paid or on Deferred Terms

THE TWO OUTSTANDING AN OLD FRIEND

THE GUINEA

CONE

21'

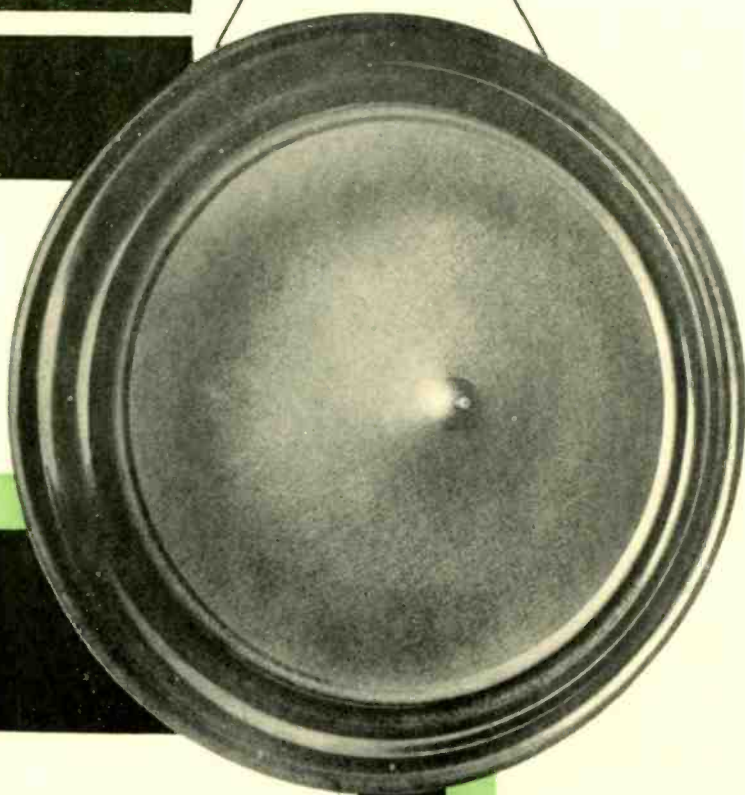

Nothing—not even the introduction of new popular lines—seems to affect the sales of A.C.2 Guinea-Cone Speaker. The trade is stocking them as of old; the public is buying them at a rate surprisingly rapid for this time of the year. The production is therefore being carried on at top speed to meet the sustained demand.

AMPLION

SELLING LINES

A NEW WINNER

THE TWO-GUINEA

CONE

£2-2-

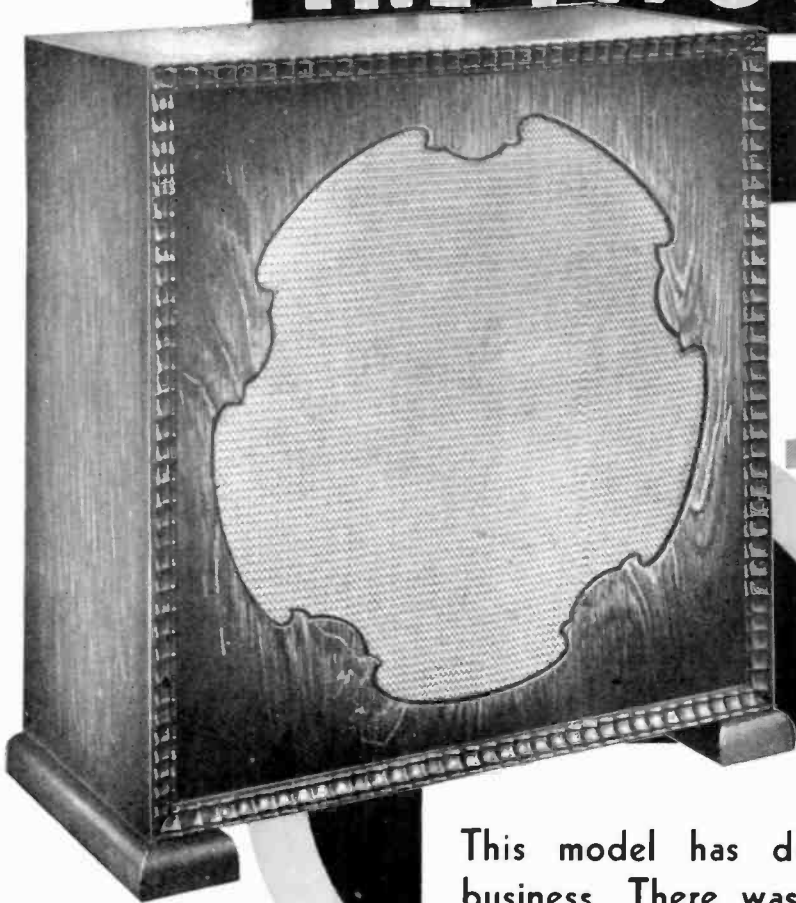

This model has definitely brought about NEW business. There was a demand for a junior Loud Speaker of superior quality and performance in creditable cabinet form. The A.C.8 Amplion Speaker fills that demand so fittingly and at a price which is so exactly right that real efforts have to be made to keep up with the required output.

AMPLION

THE AMPLION ELECTRAVOX

(GRAMOPHONE TRANSMITTER)

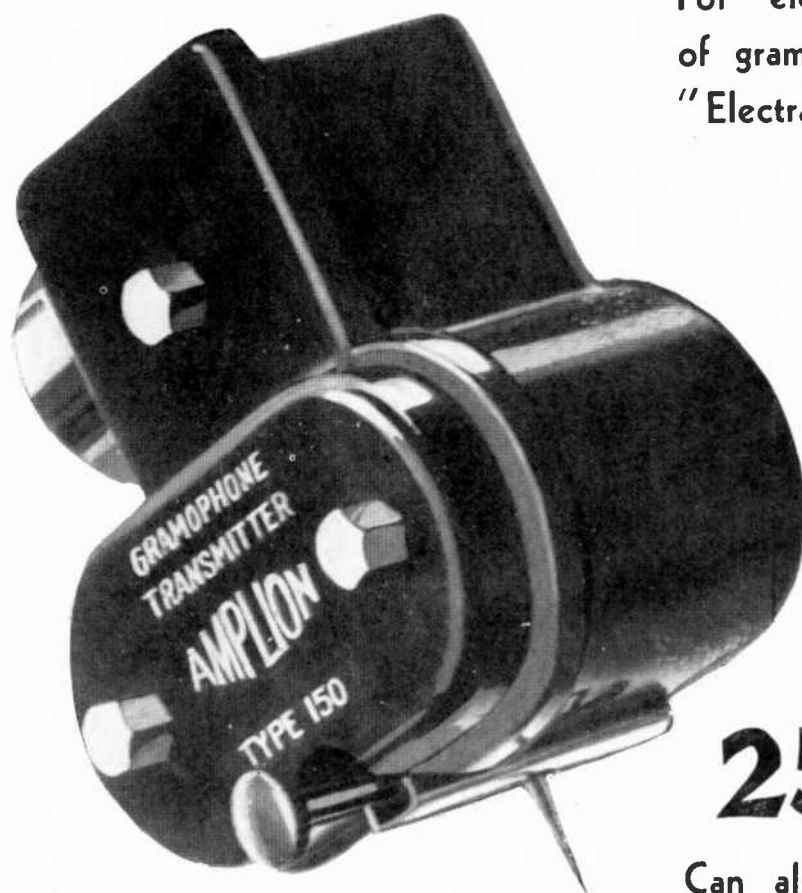

For electrical reproduction of gramophone music. The "Electravox" is extremely sensitive, and is capable of giving full undistorted reproduction, with freedom from needle scratch. Sells on quality, sensitivity, price, recommendation.

25/-

(Subject to
Standard
Discount)

Can also be supplied with
Volume Control, or mounted
on Tone Arm.

GRAHAM AMPLION LIMITED,
Sales Offices and Demonstration Rooms:
26, Savile Row, LONDON, W.1. *Works:* SLOUGH.

The Week's Court Cases.

Wireless Pictures Directors Prosecuted.

SUMMONSES under the new Companies Act, brought at the instance of the Board of Trade, were heard by Mr. Dummett at Marlborough Street on Monday, against Wireless Pictures (1928), Ltd., and the firm's directors—Captain F. E. Guest, Lt.-Col. Adrian Simpson, Mr. W. H. Lynas, Sir Nicholas Grattan-Doyle, and Sir Charles Bright. The company and the directors were summoned for not holding an annual general meeting of the company in the year 1929, and the directors, with the exception of Sir Charles Bright, were also summoned for not laying before the shareholders a profit and loss account since the incorporation of the company.

[Wireless Pictures, it will be recalled, were the company formed to develop and exploit in this country the Fultograph system of still picture transmission and reception by wire and radio. The B.B.C. completed a year of regular Fultograph broadcasts last October.]

Mr. Norman Birkett, K.C., appeared for the defendants, who pleaded guilty and asked for the case to be dealt with summarily.

Mr. H. D. Roome, for the Board of Trade, said that the whole of the directorate was summoned, and for their default they were liable to a fine of £50. On March 31st a letter was written by the company to the Board of Trade applying for an extension of time for holding the meeting, but in point of fact the time for holding the meeting had already expired. Application for extension was made on the grounds that there was an important contract pending which, in the considered opinion of the Board, would be seriously prejudiced if any disclosure was made. A period of five weeks was asked for, but it was refused. The five weeks elapsed, and it was found that no accounts had been laid before the shareholders. Sir Charles Bright was not a defendant in this summons, nor was the company, since the section under which the summonses were issued only affected directors.

Mr. Birkett, for the defence, submitted that the offence was a purely technical one. No shareholder was affected, but, on the other hand, deferring the annual meeting was to the shareholders' benefit.

The company was a pioneer concern, and the directors' hopes of a regular public service fell short of expectations. In July, 1929, the directors were in active negotiation with Central Press Photos, Ltd., and the purpose of a highly complex and technical contract was to provide a regular service of telegraphed pictures to newspapers. The negotiations were not completed in time for the annual meeting. At the same time there arose difficulties in connection with the overseas rights in the invention, and considerable delay occurred in America, with the result that the second part of the contract was not concluded until February last. Then it was found that their share list was in chaos. The matter was put openly to the Board of Trade, who would not grant the extension asked for. The directors desired him to say that they recognized that the law should be obeyed, and that they expressed very great regret at their breach of it. In future the matter would be perfectly regular. Mr. Dummett inquired how the annual meeting would have imperilled the contract?

Mr. Birkett said that with all the publicity attending the annual meeting a confession of failure on one contract might have affected the other contract, which had now been safely negotiated.

Mr. Dummett gave his judgment on Tuesday, and in commenting on the case he said: "I accept without any reservation that these men, in deliberately and knowingly breaking the law in these matters, did so with an honest motive. I give full weight to what has been said in mitigation; nevertheless, I feel it my duty to impose such fines as will indicate that in no circumstances can a breach of these sections be regarded lightly."

The following fines were inflicted: £10 and £5 costs on each of the summonses against the five directors, under section 112 of the Companies Act, and a further £10 and £5 costs in the case of the four directors summoned under section 123.

Thus the total which Captain Guest, Lieut.-Colonel Simpson, Mr. Lynas, and Sir Nicholas Grattan-Doyle had to pay was £30 each and Sir Charles Bright £15.

Mr. Dummett said that he accepted the plea made by Mr. Norman Birkett, K.C., on behalf of the company, that it was in a different position from the directors, and he dismissed the summonses under the Probation of Offenders' Act on payment of £5 costs.

DOMINION (FOREIGN) DIRECTORS FINED.

A SUMMONS under the same Act was heard on Tuesday at the Guildhall against the directors of Dominion Gramophones (Foreign and Colonial), Ltd. Mr. Roome again appeared for the Board of Trade and said that the summons was for failing to lay before a meeting of shareholders a profit and loss account within 18 months of the company's incorporation.

Fines of £50 each were imposed on the directors—Mr. G. R. Hall-Caine, Mr. Eric Woolbein and Mr. Henry Scott.

TRUPHONIC RADIO, LTD., AND DR. SPERO.

IN the King's Bench Division last week, before Mr. Justice Branson, Sir Albion Richardson, K.C., mentioned the action brought by Truphonic Radio, Ltd., of Hanover Park, Peckham, London, S.E., against Dr. George Ernest Spero, formerly of Lancaster Gate Terrace, London, W.

Sir Albion said that some time in the autumn of 1928 Dr. Spero, who was also a manufacturer of wireless sets, arranged to sell his business to a company called Truphonic, Ltd. Having sold it it was resold to a public company, the plaintiffs. The agreement from Truphonic, Ltd., to the plaintiffs was dated February 5th, 1929, and the first claim in the action arose in a paragraph in that agreement. A guarantee was given by Dr. Spero with regard to the book and other debts, and under clause 12 it was guaranteed that all book debts owing to the vendors in the business as at the date of the actual completion would provide a sum equal to such book debts, and within six months of the date he would pay to the purchasers the amount of any such book debts which would not have been received by the purchasers.

The first claim in the action was upon that guarantee. On the date of completion the book debts stood at £7,729 11s. 5d., but credit was given for certain sums which had come in, and this had reduced it to £7,139 9s. 10d. The writ in the action gave the claim as £6,369 13s. 10d., and he felt he could not ask for judgment against defendant beyond that amount.

The other action was simply a claim on a dishonoured cheque given by Dr. Spero for £4,000. The company also claimed alternatively for monies had and received by him to their use. On February 19th, unknown to the board of directors, defendant as managing director drew a cheque to his syndicate for £2,500 without any authority from the company, and on the same date he drew a cheque to himself on Truphonic, Ltd., for £2,000 of that £2,500 which he had placed to his own account. On February 25th Dr. Spero drew a cheque without any authority from the plaintiffs for £2,000, and directed the bank to place the proceeds of that cheque to his credit. He then gave plaintiffs a cheque for £4,000 to cover the two sums of £2,000 each, but this was not met.

Counsel added that Dr. Spero said he had a counter claim against the company for £20,000, but the claim proved to be absolutely fictitious. He was now in the United States and was outside the jurisdiction of the Court.

Mr. Justice Branson directed that judgment should be entered for the plaintiff company for £6,369 13s. 10d. in the first action, and for £4,000 with interest in respect of the cheque, with costs.

JUDGMENT AGAINST AEONIC RADIO, LTD.

A CLAIM by John Howitt & Son, printers, of Alfred Street Mills, Nottingham, against Aeon Radio, Ltd., wireless manufacturers, of Regent Street, London, W., for the sum of £105 in respect of work alleged to have been done to the defendant company's order, was upheld by Mr. Justice Humphreys in the King's Bench Division last week.

It was stated that Howitts prepared a quantity of advertising matter on the instructions of the wireless company.

Counsel for the defendants, after referring to the fact that the original instructions in connection with the matter were given to Howitts' early in January last, argued that, having regard to the agreement between the parties the issue of the writ in the action was premature.

His Lordship said that in his view the plaintiffs had acted quite properly, and he gave judgment in their favour for the full amount claimed with costs.

ALL- ELECTRIC RADIO

IN the following pages we have endeavoured to present a compact and comprehensive survey of mains apparatus at present on the British market. Valves and rectifiers are dealt with separately in another part of the issue. It should be noted that the letters "W.R." indicate the use of a Westinghouse Metal Rectifier. Commercial charging apparatus will be dealt with in our next issue.

Abingdon Wireless Supplies, 45, Stert Street, Abingdon, Berks.

GENERAL.

"Always" components for mains use are among the specialities of Abingdon Wireless Supplies. In addition to a comprehensive range of ordinary resistances the firm handle two wire-wound potential dividers, which are now wound with thicker wire than hitherto. The prices are 2s. and 1s. 8d. Another slight modification will shortly be made, in that the resistances will be improved by a coating of lacquer to prevent damage when the positions of the tapping clips are altered.

Aeonic Radio, Ltd., Aeonic Works, Horley, Surrey.

RECEIVERS.

All-Mains Two. This set utilises two valves in a straight detector-and-transformer-coupled L.F. circuit. Reinartz tuning is used, the long wave coil being shorted when the set is used on the medium waves, while a series aerial condenser can be used if desired. Grid bias is obtained by the voltage drop across a resistance in the negative H.T. lead. Valves: M.H.4 and P.410, with U.9 rectifier. Totally enclosed in an oak cabinet, the All-Mains Two is delivered ready for use. Price £12 15s.

All-Mains Four. The circuit used is of the S.G., detector and two L.F. type, R.C. and transformer coupling being employed in the L.F. stages, and a transformer coupled H.F. stage. Long and medium waves are covered, and a tapped coil and series condenser are incorporated. Separate resistances are connected in each cathode lead to supply bias. Valves: M.S.4, M.H.4, M.H.L.4,

P.625 (in last stage with separate filament winding on power transformer) and U.9 rectifier. One choke is connected in the H.T. feed to the P.625, and two chokes for the other three valves. In a walnut cabinet complete with "Blue-Spot" speaker, the set sells at 25 guineas.

RADIO-GRAMOPHONE.

Two resistance coupled L.F. stages are used in the 3-valve circuit employed. Valves: two A.C./H.L., A.C./P.1, and U.9 rectifier. A B.T.H. pick-up is used, with a G.E.C. electric motor and "Magnavox" M.C. speaker, the field current for the latter being obtained from a metal rectifier. In a mahogany cabinet, the instrument is ready for connecting to an

external aerial and earth. Price 48 guineas. A walnut cabinet is also available.

Appleton's, Hanover Place, Leeds.

RADIO-GRAMOPHONE.

The "Minster" radio-gramophone, made by this firm incorporates a Ferranti all-mains receiver employing three stages. It consists of an indirectly heated screen-grid valve transformer coupled to an indirectly heated detector, which is in turn transformer coupled to a 6-watt super power output valve.

The gramophone unit employs a motor of the induction type mounted on a metal unit plate with an automatic stop. A moving-coil speaker is incorporated.

An interesting feature is a safety device on the back of the instrument which disconnects the mains if the back is opened. Price in oak 60 guineas, in mahogany or walnut 63 guineas.

We understand that Appleton's also manufacture all-mains electric gramophones.

C. Creswick Atkinson, 35A, High Street, Bedford.

RECEIVER.

An entirely new addition to the range of "Nulli Secundus" receivers, and known as the "All-Mains Three." In outward appearance it resembles an ordinary dispatch case portable, but actually has the necessary mains equipment in the usual battery compartment. Red case of non-scratchable and waterproof material, with mahogany panels. Three-valve circuit with screened grid and pentode valves. Unusually good tone is claimed, this being possible by virtue of the extra H.T. which is available for the output valve.



Here is the Aeonic "All-mains 4" which incorporates a speaker above the receiver.

ALL - ELECTRIC RADIO

Cone speaker. Weight 25 lbs. Suitable for 100-250 V A.C. mains, no D.C. model being available. Price 28 guineas.

Baker's Selhurst Radio, 89, Selhurst Road, South Norwood, London, S.E.25.

RECEIVERS.

Baker's all-electric cabinet receiver for A.C. mains includes a moving-coil speaker. It incorporates indirectly heated valves; H.F.: parallel feed grid circuit; power detection; L.F.: either resistance or transformer coupling can be used by a change-over switch. The whole of the receiver and mains unit is entirely screened in aluminium casing.

The mains unit supplies 300 V 125 mA to the valves and speaker. The cabinet can be obtained in oak or mahogany.

The 3-valve model retails at £36, the 4-valve model, incorporating a further H.F. stage, at £40; and the 6-valve model, with an H.F. and a push-pull output stage, at £45. Mahogany cabinets cost £2 extra.

S. G. Brown, Ltd., Western Avenue, North Acton, London, W.3.

RECEIVERS.

Brown mains receivers are available in cabinet form with or without built-in speakers. The sets themselves are made for A.C. and D.C. mains, the D.C. models incorporating a special circuit which is stated to make them practically humless. Circuit in all models comprises S.G. stage, detector and power or pentode valve, the controls also being similar. The A.C. instruments make use of a mains unit which is incorporated in the cabinet and is fitted with a safety plug and fuse. The valves in these sets are of the indirectly-heated type, but those of the 1A series are chosen for the D.C. models, thereby

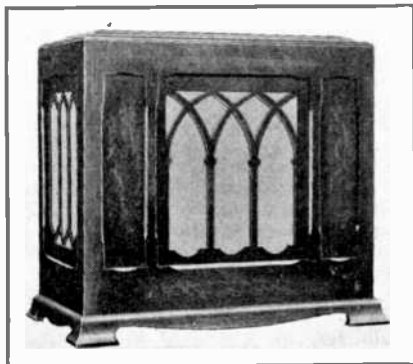

Bakers' all-electric cabinet receiver for A.C. mains, which incorporates a moving-coil speaker.

giving a slow current consumption. Dual wave coils are fitted, enabling both wave-ranges to be covered.

Prices: Type A.M. (A.C. or D.C.) with cabinet and self-contained speaker, £20 10s.; type B.M. (A.C. or D.C.) in table cabinet without speaker, £17 10s. All prices exclusive of valves.

A. F. Bulgin & Co., Ltd., 9-11, Cursitor Street, London, E.C.4.

GENERAL.

Unusual mains components, not easily obtainable elsewhere, are a speciality of Bulgin's. Two safety plugs and sockets should first be mentioned, a large type, carrying up to 5A, selling at 3s. 9d., and a

small model, non-reversible, suitable for 3 A load, being priced at 2s. 6d.

A. F. Bulgin produce several mains fuses and accessories. Among fuses—which are glass enclosed—a large number of ratings can be supplied, from 250 mA up to 5 A, in any length from ½ in. to 1½ ins. The stock types will fuse instantaneously at 50 per cent. overload, but if desired can be made to fuse at 100 per cent. overload. Price 6d. each. To take these fuses a flush panel mounting holder is made, in which the fuse can be replaced from the front. Price 2s. 6d., with a 1A fuse. A twin baseboard holder is also made. Price 2s. 6d., with two 1A fuses.

Among switches are the "Competa" S56 double pole type at 3s. 6d., and the "Competa" S54 one-hole fixing type taking up to 2 A, and retailing at 2s. 6d. Various other small components such as pilot lamps, etc., are listed.

Burndept Wireless (1928), Ltd., Blackheath, London, S.E.3.

RECEIVER.

"Universal Screened Five." Although it is supplied for use with batteries, this receiver can also be obtained as an all-mains A.C. receiver, in which form it has a larger cabinet. S.G.H.F., det., and one stage of R.C. coupled L.F., with two super power valves in push-pull in the output stage, Philips 506 rectifying valve, and W.R. for G.B. Wave ranges 220-560 metres, 900-2,100 metres, and also 16-38 metres. Two-speed dials with calibrated wavelength scales are fitted. Direct switch-over to gramophone pick-up by wave-change switch. Price, complete with valves, 39 guineas.

RADIO-GRAMOPHONE.

"A.C. Ethogram." Pedestal cabinet containing receiver, gramophone, mains units, speaker, and frame aerial. Though employing seven valves it is a five-stage receiver comprising 2 S.G. stages, anode bend detector, one R.C. coupled L.F.

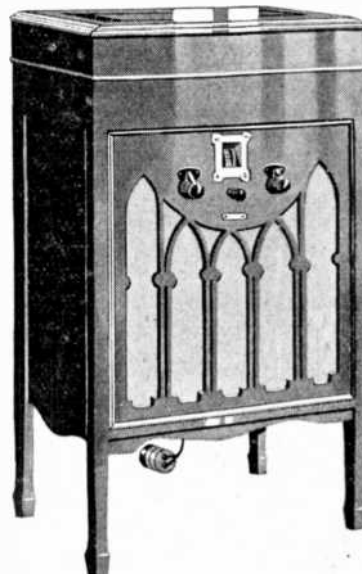

This handsome radio-gramophone, the Burndept "A.C. Ethogram," employs a 7-valve circuit.

stage, and two valves in push-pull in the output position. Philips 506 rectifying valve and W.R. for G.B. Can be fitted with R.K.M.C. speaker or linen diaphragm type. Combined wave-change and change-over switch for radio and gramophone. Induction electric motor and Burndept needle armature pick-up. Prices, including valves—in mahogany, £53 11s., in oak £52 10s., and with an M.C. speaker in oak £60 18s.

MAINS UNIT.

"Ethopower" H.T. and G.B. unit (W.R.). Enclosed in steel case. Tappings for S.G. valves and detector, and full voltage tapping for output valves. Maximum output, 150 V at 30 mA. Automatic G.B. adjustment. For voltages of 100-240 A.C., 40 to 100 cycles. Price £7 5s.

CHARGER.

L.T. type for A.C. mains (W.R.). For voltages of 100 to 240 A.C. Output .5 at 2, 4 or 6 V. Indicator lamp glows when in operation. Price, with spare lamp, £2 9s. 6d.

GENERAL.

All Burndept receivers can be supplied with the appropriate mains units and in each case the "Automatic Power Control" is recommended. This is a special type of relay which plugs into a lamp-holder and, when the switch on the receiver is turned on, it automatically causes the H.T. unit to be put into action. When the switch is switched off, it disconnects the unit, and, in conjunction with a battery charger, puts the L.T. accumulator on charge. Price £1 5s.

Burne Jones & Co., Ltd., Magnum House, 296, Borough High Street, London, S.E.1.

RECEIVERS.

This firm are now actively engaged in

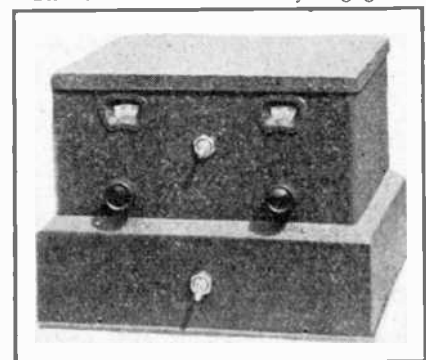

The "Magnum" A.C.2 all-mains receiver in a metal cabinet. This is marketed by Burne-Jones & Co., Ltd.

producing a range of A.C. mains receivers, including the "Magnum" A.C. 2-valve set, price complete, £12 10s., the "Magnum" transportable A.C. 3-valve model, the price of which is not yet fixed, and the "Magnum" band-pass 4-valve set. This model has 2 S.G., H.F., 1 detector, 1 power stage, and has provision for a pick-up. It is suitable for 110-250 V 40-100 cycles A.C. mains, and is priced complete at £30.

RADIO-GRAMOPHONES.

The "Magnagram" all-mains radio-gramophone is also in course of preparation. It is an upright cabinet model with

ALL - ELECTRIC RADIO

electrically-operated gramophone motor. The radio receiver will operate on a wave-band of 250-500 and 1,000-2,000 metres, and the speaker is of the cone type. The price has not yet been fixed.

Celestion, Ltd., 106, Victoria Street, London, S.W.1.

RADIO-GRAMOPHONES.

The "Senior" model incorporates the "Celestion-Johnson" moving-coil loud-speaker, and is stated to be capable of filling a large hall. Both A.C. or D.C. models are available, but if the D.C. supply is below 200 V, a rotary generator is fitted at extra cost. The prices are 120 guineas (oak), 122 guineas (mahogany) and 125 guineas (walnut).

The "Standard" radio-gramophone incorporates a "Celestrola" moving-coil speaker and a 2-stage amplifier. In all the Celestion models the radio units and amplifiers are completely screened. As in the case of the "Senior" model, D.C. or A.C. types are available. Prices: 85 guineas (oak), 86 guineas (mahogany), and 88 guineas (walnut).

ELECTRIC GRAMOPHONE.

Another Celestion production is the Celestion "Standard" electric gramophone selling at 75 guineas (oak), 76 guineas (mahogany), and 78 guineas (walnut). Available for A.C. or D.C. mains.

Clarith Reproducers, Ltd., East Street Mills, Leeds.

RECEIVER.

"Condor." This A.C. 3-valve set makes use of a S.G.—detector—one L.F. circuit, with a valve rectifier. A pick-up can be used with the "Condor" if desired. Price, in oak, £23, in table cabinet form.

RADIO-GRAMOPHONES.

"Vivid." Incorporating a S.G. circuit, the "Vivid" has a recessed, sloping panel closed by double doors. A spring motor is used. Price £33.

"Baby." This, one of the most popular Clarith lines, is available for D.C. or A.C. mains, the prices respectively being 59 guineas and 49 guineas. Oak, walnut or mahogany cabinets are available at these prices. The motor is electrically driven, while the M.C. speaker is situated behind a small circular grille below the vertical control panel.

"Baby-de-Luxe." This is a larger version of the "Baby," though there are several modifications and additions, the most important being that a screened-grid circuit is used. A drop-flap covers the vertical panel. Price, for A.C., £70.



H. Clarke's "Atlas" H.T. mains unit, model A.C. 16. A popular line.

"Console Grand." Designed primarily for use in halls, hotels, and so on, this machine is priced at £90, for A.C. mains.

H. Clarke & Co., (Manchester) Ltd., Atlas Works, Old Trafford, Manchester.

MAINS UNITS.

H. Clarke & Co., Ltd., make a very wide range of mains units which will be found suitable for practically all requirements.

The following are D.C. types for mains supply between 200 and 250 V: D.C.18—two fixed outputs of 60 and 120 V respectively; 15 mA. Price £1 17s. 6d. D.C.6.—four fixed outputs of 40, 60, 90 and 120 V; 20 mA. Price £3 5s. D.C.16—three outputs, 120 and 150 V, and a variable one from 0-100 V; 25 mA. Price £3 15s. D.C.50—four outputs; two variable 0/180 V each, two fixed 120 V and 200 V. Maximum output from 230 V mains at 200V terminal, 30 mA at 210 V; up to 60 mA at 180 V. Price £7 15s.

The following are A.C. models: A.C.72—suitable for mains supply between 200 and 250 V, 40/120 cycles, three outputs, one of 90 V, and two others varying from 60-80 V and 120-150 V; 15 mA (W.R.). Price £3 17s. 6d. A.C.73 is similar, but for mains between 100 and 125 V, 40/120 cycles.

A.C.16—suitable for mains supply between 200 and 250 V, 40/120 cycles. Three outputs, one variable 0/100 V, and two fixed at 120 and 150 V respectively; 25 mA. Price £4 10s. There are also similar models available for mains of different voltages.

A.C.56x—suitable for mains between 200 and 250 V, 40/120 cycles, three outputs, one variable 0/120 V, and two fixed at 60 V and 150 V, 50 mA (W.R.). Price £8 15s. There are again other models for different voltages.

A.C.38—suitable for mains between 200 and 250 V 40/120 cycles, three outputs, one fixed at 180 V, and two variable.



One of the Celestion reproducers, built into a very distinctive cabinet of high-class construction.

of 0/150 V each, 50 mA. Price £9 12s. 6d. A.C.39 is similar, but for mains between 100 and 125 V, 40/120 cycles.

A.C.50—the "Atlas" super model, suitable for mains between 200 and 250 V, 40/120 cycles; four outputs, two fixed at 120 V and 200 V, and two variable at 0/180 V; 50 mA. Price £12 17s. 6d. A.C.51 is similar, but for mains between 100 and 125 V, 40-120 cycles.

All-power A.C. units are also included in the "Atlas" range. The following models are available: A.C.84—three H.T. outputs, one variable from 0/100 V, and two fixed at 90 V and 120 V; 15 mA. Suitable for mains between 200 and 250 V, 40/120 cycles. The L.T. trickle charger provides current for a 2 V accumulator. Price £5 15s.

A.C.86—for mains between 200 and 250 V, 40/120 cycles, three H.T. outputs, one fixed at 150 V and two variable, 0/100 V and 0/120 V. It gives an output of 150 V at 30 mA. L.T. trickle charger caters for 2, 4 or 6 V accumulators. Price £8 15s.

GENERAL.

Among other products in the "Atlas" range which are also of interest are mains transformers in two types, the first, for mains between 200V and 250 V, 40/100 cycles, and the second for mains between 100 V and 125 V, 40/100 cycles, both retailing at £1 15s.

They have a centre-tapped H.T. secondary giving 180 V each side of the centre tapping, and up to 100 mA; also an L.T. secondary of 4 V up to 4 A.

E. K. Cole, Ltd., "Ekco" Works, London Road, Leigh-on-Sea.

RECEIVERS.

SGP3. Incorporating a 3-valve S.G. circuit with a pentode output stage, this receiver is available for A.C. mains of 100-120 V and 200-250 V, or for D.C. mains of 200-250 V. Long and medium waves are covered, and a volume control is fitted. There is provision for a pick-up. (W.R.). Price £21.

P2. In this set a 2-valve detector-and-pentode circuit is used, utilising A.C. mains voltages of 100-120, or 200-250 or D.C. mains voltages of 200-250. Long and medium waves are covered, while a pick-up can be used. (W.R.). Price £12 17s. 6d.

MAINS UNITS.

E. K. Cole, Ltd., produce a wide range of units for 200-250 V D.C. mains, and 100-120 V or 200-250 V A.C. mains. Several all-power instruments are also made, as well as special types for portable sets rectifier units, and one L.T. model.

Ten milliamperé range. D.C. mains. models: 1F.10 one 120 V tapping. Price 17s. 6d. 2F.10, two tappings, 60 V

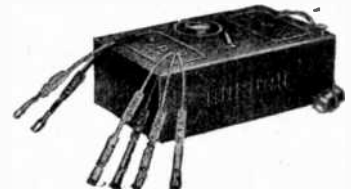

E. K. Cole's combined H.T. unit and trickle charger. This is the portable model C.P. 1, for A.C. mains.



Cossor

New Process

A.C. Mains Valves

**6 Types
Now
Available**

TO the long list of Cossor achievements is now added this series of New Process A.C. Mains Valves. Of the many strong reasons why it will pay you to sell them, the most important is that every one you sell will long be an audible testimonial for you.

For the New Process under which they are made ensures a fidelity of reproduction never before achieved with mains valves, and their Interlocked Construction System gives them such strength that they will break all records in valve longevity. Cossor New Process A.C. Mains Valves will let neither you nor your customers down.



Mains Valves

		Heater Amps.	Anode Volts	Impedance	Amp. Factor	Price
4-volt Indirectly Heated Cathode						
41 M.H.F.	H.F. or Detector	1 amp.	200 max.	14,000	32	15/-
41 M.L.F.	First L.F. Stage	1 amp.	" "	7,900	15	15/-
41 M.R.C.	R.C.C. or Detector	1 amp.	" "	20,000	35	15/-
41 M.P.	Normal Power Use	1 amp.	" "	5,000	13	17/6
41 M.X.P.	Extra Power	1 amp.	" "	2,000	6	25/-
41 M.S.G.	Screened Grid	1 amp.	" "	400,000	1,000.	25/-

Rectifying Valves

		Filament Amps.	Anode Volts	Output	Price
612 P.U.	Full Wave Rectifier	.4 amp.	250	50 m.a.	20/-
660 S.U.	Half Wave Rectifier	4.0 amp.	1000	150 m.a.	6/-
412 S.U.	Full Wave Rectifier	1.0 amp.	250	70 m.a.	20/-
412 S.U.	Half Wave Rectifier	1.0 amp.	250	70 m.a.	15/-
624 E.U.	Full Wave Rectifier	2.0 amp.	550	60 m.a.	20/-
825 B.U.	Full wave Rectifier	3.0 amp.	550	120 m.a.	22/6
44 S.U.	Half Wave Rectifier	.4 amp.	200	20 m.a.	15/-

A. C. Cossor Ltd.
Highbury Grove, London, N.5.

Depots at:

- | | | |
|--|--------------------------------------|--|
| BIRMINGHAM:
8 Temple Street. | BRISTOL:
14 Bath Street. | DUBLIN:
Corn Exchange Bldgs., Burgh Quay. |
| GLASGOW:
200 St. Vincent Street. | LEEDS:
4 Park Street. | LIVERPOOL:
42 Paradise Street. |
| MANCHESTER:
21 Bridge Street. | NEWCASTLE:
15 High Bridge. | SHEFFIELD:
Congo Buildings,
30 Trippett Lane. |

Cossor New Process A.C. Mains Valves are now ready for immediate delivery. Order now—and be ready for the demand Cossor advertising will create.



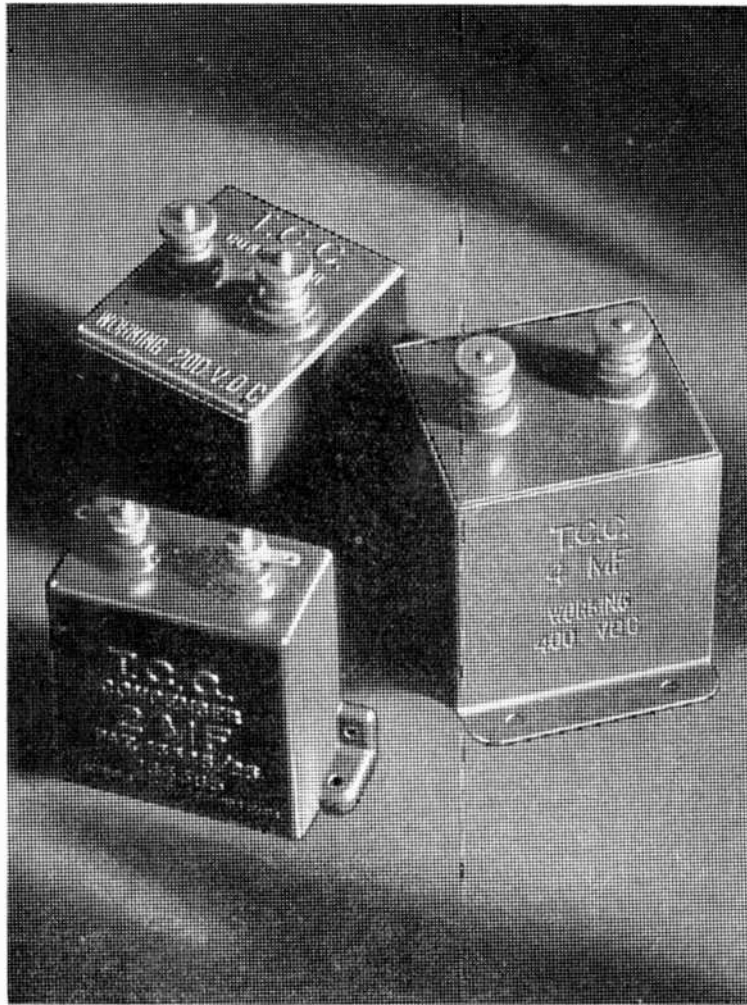

Tried and found . . dependable

Above is illustrated three condensers from the famous T.C.C. range . . .

2 M.F. 400v. D.C. working . . . 5/-
4 M.F. 400v. D.C. working . . . 8/6
4 M.F. 200v. D.C. working . . . 6/3

There is one certain way of making sure of quality before you buy—stock T.C.C. "the condenser in the green case." It is a condenser of proved merit—of absolute reliability, made by the Telegraph Condenser Co., who have been making condensers—solely condensers for over a quarter of a century. Sell T.C.C. and keep your customers satisfied.

TCC
CONDENSERS

ADVERTISEMENT OF THE TELEGRAPH CONDENSER
CO., LTD., WALES FARM ROAD, N. ACTON

ALL-ELECTRIC RADIO

and 120 V. A.C. mains model: 2A.10, two tapings, 60 V and 120 V. (W.R.) Price £3 10s.

Twenty milliampererange. 3F.20 Three tapings, S.G., 60 V and 120-150 V. Prices: D.C. £1 17s. 6d.; A.C. £3 19s. 6d. (W.R.).

Sixty milliampererange. 4T.60. Four tapings, S.G., 0-120 V, 120-150 V, and "power." Philips 505 valve rectifier in A.C. model. Prices: D.C. model £3 15s.; A.C. model £7 5s. 5T.60. Five tapings S.G., two 0-120 V, 120-150 V, and "power." Prices: D.C. model £4 15s.; A.C. model, £10 10s. (W.R.).

Portable range. IV.20. Output 20 mA. Three tapings, S.G., 0-120 V, and 120-150 V. Prices: D.C. model £2 10s.; A.C. model £4 12s. 6d. (W.R.).

CP1. Combined H.T. unit and L.T. charger. Output 20 mA. Three tapings, S.G., 0-120 V, 120-150 V. Price £6 (W.R.).

All-power units. CI.A. Output 60 mA. Four H.T. tapings, S.G., 0-120 V, 120-150 V and "power." L.T. 2-6 V up to 1 A. Seven G.B. tapings up to 21 V. Price £17 15s. (W.R.). Type C2A. Output 20 mA. Three H.T. tapings, S.G., 60 V and 120-150 V. L.T. 2-6 V up to .5 A in the A.C. model and up to .35 A in the D.C. unit. Five G.B. tapings up to 12 V. Prices: D.C. £5 17s. 6d.; A.C. £10 17s. 6d. (W.R.). Type ACV. Output 30 mA. Two tapings, 150 V and 80 V for H.T., raw A.C. L.T., 4 V at 2-4 A for indirectly heated valves, 6 V up to 1 A for directly heated valves. Five G.B. tapings up to—15 V. (W.R.). Price £6.

Low tension unit. LT1. Output 2-6 V at .3-1 A. Price £8 15s. (W.R.).

Rectifier units. These can be used in conjunction with existing D.C. units, in the event of a change-over in supply. They then function as effective A.C. mains units. R20. Output 20 mA at 200 V. Valve rectifier, Philips 373 or 505. Price £3 7s. 6d. R60. Output 60 mA at 200 V. Valve rectifier. Price £5.

CHARGER.

T500. Output 2-6 V at .5 A. This charger can be used for exciting the field of an M.C. speaker without using an accumulator. Price £2 12s. 6d. (W.R.).

GENERAL.

Control unit. Resistances and by-pass condensers are contained in this unit, which is to be used for decoupling purposes. Price £1 5s.

Isolating transformer. This is double wound with a 1-1 ratio. Price 15s.

Columbia Graphophone Co., Ltd., 102-108, Clerkenwell Road, London, E.C.1.

RADIO-GRAMOPHONES.

Model 302. Console cabinet available in oak, mahogany and walnut, the last two models having doors enclosing the front of the machine when not in use. The instrument makes use of the No. 304 3-screened-grid receiver, together with suitable electrically-driven turntable, pick-up and speaker. Volume, "brilliance" and tuning controls are mounted on the front panel, the main switch, etc., being located on the motor board. Available for 200-250 D.C. and 100-120 or 200-250 V, 40-60 cycles, A.C. mains. Prices: oak, 80 guineas; mahogany, 90 guineas; and walnut, 95 guineas.

ELECTRICAL GRAMOPHONES.

Model 250. An electrical reproducer of moderate size ready for use. Completely mains-driven, with Columbia pick-up, motor with automatic stop, volume and "brilliance" controls, pilot lamp and provision for storing records. All controls on motor-board, which is sunk and enclosed by lid. Price, in



The Columbia 5-valve all-electric receiver, incorporating 3 screened grid valves.

mahogany, 50 guineas (D.C.), and 53 guineas (A.C.).

Model 251. As above, but in walnut. Prices for D.C. and A.C. mains, 52 and 55 guineas respectively.

Model 400. A very powerful twin turntable installation for public and outdoor use. The turntables and amplifier are built in a single unit, which may be closed and locked. Separate generator units and speakers are available.

RECEIVERS.

Model 304. The well-known Columbia all-electric 5-valve receiver with three S.G. stages. It is completely screened and possesses four tuning circuits with ganged condensers operated by a single drum dial. This is calibrated in wavelengths and is set in a central escutcheon, below which are the wave-change and volume controls. The instrument has a table cabinet of walnut or mahogany, but does not, of course, incorporate a speaker. Suitable for 200-250 V D.C. and 100-125 or 200-250 V, 40-60 cycles A.C. Price £33.

MAINS UNITS.

Three units are made by Columbia for both D.C. and A.C. mains. They are intended for use with the two Columbia portables (303A and 303B), and list at 10 guineas each.

A. C. Cossor Ltd., Cossor Works, High-bury Grove, London, N.5.

RECEIVERS.

The 1930 Cossor "Melody Maker" is now available as an all-electric receiver. This is similar in appearance to the battery model, with the controls on an escutcheon plate at the front of the metal case. The kit of parts, including a factory-built and tested mains unit, and Cossor A.C. valves, is priced at £15, while, completely assembled, the receiver costs £17.

A new product of this firm is a 2-valve all-electric receiver specially designed for

the Regional Scheme. Plugs and sockets are provided for a pick-up. The set is supplied assembled and ready for immediate use at the price of 10 guineas. It is also available as a self-contained receiver with built-in speaker, in an oak cabinet, at £14 14s.

MAINS UNIT.

The Cossor mains unit is made in three models, for 200, 220, and 240 V A.C. respectively. Three H.T.+ tapings at 120 V, 90 V, and 60 V. Maximum output 20 mA at 120 V. 4 V raw A.C. supply for A.C. valves up to 4 A output. Cossor type 612B.U. full-wave rectifying valve. Price £5 15s. Without L.T. winding £4 15s.

(For valves, see page 276.)

Decca Gramophone Co., Ltd., 1-3, Brixton Road, London, S.W.9.

RADIO-GRAMOPHONES.

The Decca radio-gramophone model M.C.91 is made in two types, model A for A.C. mains between 200 and 250 V, 40 cycles and over, and Model B for mains between 110 and 130 V.

The circuit of the radio receiver comprises anode bend detector, with capacity controlled reaction, followed by one R.C. stage, transformer-coupled to a final super power valve. The set has a wave range of 200-2,000 metres.

Price, with moving-coil speaker and polished oak cabinet, 55 guineas, or in mahogany 60 guineas. These models are also available at the same prices for operation on D.C. 200-250 V.

The receiver in the model M.C.93 employs indirectly heated A.C. valves, consisting of screened grid, anode bend detector and 2 stages of L.F. amplification. It can be worked off A.C. mains between 100 and 250 V, and costs 95 guineas (oak) and 105 guineas (mahogany).



Here we show the compact Cossor 2-valve all-A.C. self-contained receiver.

or walnut), the latter types being available to order only.

ELECTRIC GRAMOPHONES.

Model M.C. 90A is for use on mains between 200 and 250 V, 40 cycles mains and M.C. 90B on mains between 110 and

ALL - ELECTRIC RADIO

130 V, 40 cycles. They incorporate a moving-coil loud-speaker and an induction electric motor. There is a 2-stage amplifier, and provision is made for the inclusion of a radio receiver. Price 45 guineas (oak) and 50 guineas (mahogany) supplied to order.

These electric gramophones can be supplied at the same prices for operation on D.C. of 200-250 V only.

Another electric gramophone in the Decca range is the M.C. 92, designed to work off A.C. mains between 100 and 250 V, 40 cycles or over. The pick-up is a B.T.H., and the amplifier employs resistance-capacity coupling. A moving-coil speaker is incorporated. The price in oak is 75 guineas, and mahogany or walnut models can be supplied for 85 guineas.

Dr. Nesper, Ltd., Colindale Avenue, Hendon, London, N.W.9.

MAINS UNIT.

H.T. supply unit for A.C. mains, incorporating a special selenium dry contact rectifier, and suitable for receivers consuming not more than 45 mA. Three H.T. tappings, the maximum being at 150 V, and also two G.B. tappings at 4½ and 12 V. Price £4 13s. 6d.

CHARGER.

Dr. Nesper "Tekade" L.T. trickle charger for A.C. mains. A selenium dry contact rectifier is embodied, and is designed to give a steady output of 35 A. It is made in two models, one for charging 2-4 V accumulators, and the other for 2, 4 or 6 V accumulators. Prices: 2-4 V model, 29s. 6d.; 2-6 V model, 38s. 6d.

Dubilier Condenser Co. (1925), Ltd., Victoria Road, North Acton, W.3.

RECEIVERS.

The A.C.2 model is a compact 2-valve all-electric receiver in a walnut cabinet, with provision for a gramophone pick-up, and other features, the price being £14 5s., plus royalty.

Models A.C.3 and D.C.3 all-electric receivers are A.C. and D.C. instruments both incorporating an S.G. H.F. stage, a detector, and a power valve in the output. Indirectly-heated valves are employed. In the A.C.3 valve rectification is used, while in the D.C. model, the valves are connected to the mains through a resistance unit, which drops the voltage to the value required to operate the heater elements. Tuning ranges of 230 to 600 metres and 750 to 2,000 metres are covered. Price, in both cases, £25.

MAINS UNITS.

Dubilier make four types of filter units which are, in themselves, complete H.T. supply units on D.C. mains. By the addition of some form of A.C. rectifier they can also be used with an A.C. supply.

Type A: Total output, 12-14 mA at 150 V. One "maximum" and one detector tapping. Price 28s. 6d. Type B: Total output, 30-40 mA at 180 V. One fixed "maximum" and six adjustable tappings. Price 47s. 6d. Type C: Total output, 40-50 mA at 180 V. One fixed "maximum" and six adjustable tappings. Price 72s. 6d. Type D: Total output, 50 mA at 150-180 V. One continuously variable, one fixed "maximum" and six other adjustable

tappings. Price 142s. 6d. Each of the above incorporates an earth protection condenser.

GENERAL.

In addition, the firm are well known for their wide range of condensers—Mansbridge, mica, electrolytic and other types, and also their wire-wound resistances, all of which are employed in many types of mains instruments.

Dulcetto-Polyphon, Ltd., 2-3, Newman Street, London, W.1.

RADIO-GRAMOPHONE.

One S.G. stage is incorporated in the 4-valve receiver used, while the output consists of two pentodes in parallel. Standard features include a volume control, "Novotone" tone compensator, electric motor, and scratch filter. Prices: D.C. model, for 200-250 V, £75; A.C. model, 100-250 V, 40-100 cycles, £80.

ELECTRIC GRAMOPHONES.

Model W50. Twin turntables, electrically driven, and two external M.C. speakers. Scratch filter and volume control. Price: £126 for A.C., and £141 for D.C., inclusive of converter.

Junior amplifier. Garrard electric motor, scratch filter, volume control. External M.C. speaker. Price 75 guineas, A.C. or D.C., with one speaker.

Dunhams, Ltd., Bellerophon Works, New Wharf Road, London, N.1.

Among the mains productions of Dunhams, Ltd., are a 2-valve all-electric set retailing at £12 12s., and a 3-valve receiver at £17 17s. Mains units for portables are also made, as well as a combined eliminator and charger.

J. Dyson & Co., Ltd., 5-7, Godwin Street, Bradford.

RECEIVERS.

Model OM, 3-valve all-A.C. set, with S.G., H.F., detector and super power valve. In grained walnut cabinet with provision for pick-up. Price £23 10s.

Model DM, 3-valve all-A.C., incorporating similar circuit to that of model OM. In transportable type oak cabinet, with built-in cone speaker. Provision for pick-up. Price £25 10s.

Model TM, 3-valve all-A.C. transportable receiver. Similar to model DM, with cone speaker and provision for pick-up. Price £27 10s.

Model MM, 2-valve all-A.C. receiver, with detector, and pentode output valve. Incorporates a wavetrap. In oak cabinet with provision for pick-up. Price £14 10s.

RADIO-GRAMOPHONE.

Model N, all-A.C. radio-gramophone. Improved model now available, with more expensive oak pedestal cabinet, and a moving-coil speaker. Price £65.

MAINS UNITS.

A wide range of "Godwinex" units for both A.C. and D.C. mains is produced by this firm.

The following are H.T. units for D.C. mains working:—Model DS with an output of 15 mA at 150 V, and tappings at maximum and 75 V. Price £1 7s. 6d. Model DSH. Output 15 mA at 150 V, tappings at maximum, 90 V and 75 V. Price £1 15s. Model DSV. Output 15 mA at 150 V, one maximum tapping, one at 75 V, and one variable from 0-150 V.

Price £1 17s. 6d. The above types are housed in oxydised copper sheet metal cases, while the following models are in special metal cases, with covers and base-plates of sheet steel, and end-plates of cast iron. Model DH. Output 25 mA at 150 V, fixed tappings at maximum and 75, and one variable tapping. Price £2 17s. 6d. Model DP. Output 50 mA at 200 V, fixed tappings at maximum, 150 V and 75 V, and one variable tapping. Price £3 10s.

The following are A.C. models:—Model AS, 20 mA at 120 V, tappings at maximum and 75 V. Price £3 12s. 6d. Model ASH, 20 mA at 120 V, tappings at maximum, 90 V and 75 V. Price £3 17s. 6d. Model ASV, 20 mA at 120 V, fixed tappings at maximum and 75 V, and one variable tapping. Price £4 7s. 6d. Model AH. 25 mA at 120 V, fixed tappings at maximum and 75 V, and one variable tapping. Valve rectification. Price £4 17s. 6d. Model AHW. 20 mA at 120 V, fixed tappings at maximum and 75 V, and one variable tapping (W.R.) Price £4 17s. 6d. Model AF. 50 mA at 200 V, fixed tappings at maximum and 75 V and two variable tappings. Valve rectification. Price £7 7s. 6d. Model AFW. 30 mA at 200 V, fixed tappings at maximum and 75 V, and two variable tappings. (W.R.) Price £7 17s. 6d.

Models PW and PWG are specially designed for portables, and each give an output of 20 mA at 120 V. There is one fixed tapping at 75 V and two variable tappings. Model PWG is different from PW in that it has four G.B. tappings at 1½, 3, 4½, and 9 V respectively. (W.R.) Prices: PW, £4 17s. 6d.; PWG, £5 7s. 6d.

This firm also produce rectifiers for operating existing D.C. units on A.C. mains. There are three models—AHR, with output of 15 mA at 150 V; AFRW, 30 mA at 200 V; and AFR with output of 50 mA at 200. The latter uses valve rectification and the former two models employ (W.R.) Prices: AHR, £3 5s.; AFR and AFRW, £4 10s. each.

Two all-mains A.C. units are made—the model AHM with an H.T. output of 20 mA at 120 V, a maximum L.T. output of ½ A at 6 V, and four G.B. tappings up to 9 V, and the model APM, very similar, but with an H.T. output of 30 mA at 200 V, an L.T. output of 6 V 1 A, and G.B. up to 25 V. Prices: AHM, £10 10s.; APM, £17 10s.

L.T. mains units for A.C. also feature in the firm's products. Model LTH gives a variable output of from 2 to 6 V at ½ A, and model LTP the same voltages at 1 A. Prices: LTH, £6 6s.; LTP, £7 7s.

CHARGERS.

Three types of L.T. battery chargers are listed, the first, model DTC, for D.C. mains, selling at £1 7s. 6d., the second, the A.C. model ATC, giving an output of ½ A at 2, 4 or 6 V, and lastly, the ATF, with an output of 1 A at 6 V. Prices: ATC, £2 7s. 6d.; ATF, £2 17s. 6d.

GENERAL.

In addition, this firm market G.B. units for attachment to existing mains units, mains transformers of all types, chokes, condensers and resistances.

ALL - ELECTRIC RADIO

Eagle Engineering Co., Ltd., Eagle Works, Warwick.

RECEIVER.

The Chakophone A.C. all-mains "Senior Two" standard receiver can be used on 200 and 250 V 40-100 cycle mains, and a special model can be supplied for 100-110 V 50 cycle mains at the same price, while another model for a 200 V 25 cycle supply is obtainable at an extra cost of 10s. Provision is made for a gramophone pick-up, and the output from the set is fed through a choke-filter feed system. Price, complete, £13. A D.C. model is also obtainable at the same price.

RADIO-GRAMOPHONE.

We are informed that the Eagle Engineering Co., Ltd., will shortly introduce an A.C. and D.C. radio-gramophone to retail at 30 guineas. It will incorporate a moving-coil speaker.

Edison Bell, Ltd., Edison Bell Works, Glengall Road, London, S.E.15.

RADIO-GRAMOPHONE.

The Edison Bell all-mains radio-gramophone can be run off A.C. or D.C. mains, and is equipped with moving-coil speaker, electric motor and specially designed pick-up.

The circuit of the radio set comprises screened-grid H.F., detector, 2 L.F., incorporating two super-power valves in parallel in the last stage. The radio receiver covers a range of 190-500 and 1,000-2,000 metres. When the instrument is required for D.C. mains a rotary convertor is supplied with a special smoothing circuit, the whole being enclosed in a separate cabinet so that it may be placed at any distance from the radio-gramophone. Price, in oak £65 (A.C.), £84 (D.C.); mahogany £68 10s. (A.C.), £87 10s. (D.C.); walnut £72 10s. (A.C.), and £91 10s. (D.C.).

MAINS UNIT.

A new product by Edison Bell is a combined H.T. and L.T. mains unit about the same size as a standard H.T. battery. The outputs are: special screened-grid, variable 0/150 V, two fixed at 100 V and 150 V respectively. The maximum output at 100 V is 50 mA; at 150 V, 30 mA. Provision is also made for supplying raw A.C. of 4 V 5 A for filament heating.

The unit is suitable for use on mains between 200 to 240 V, 60 cycles. Price, complete with Philips valve, £7 10s.

Edison Swan Electric Co., Ltd., 1A, Newman Street, London, W.1

RECEIVERS.

Ediswan Transportable A.C. mains, 100-110 V or 200-250 V. Circuit: 4-valve S.G. Balanced armature speaker. Long and medium waves are covered. There is provision for a pick-up and for an external aerial, earth, and speaker. Valves: "Mazda" AC/SG, two AC/HL, and AC/P. "Mazda" UU60/250 full wave rectifying valve. Price 30 guineas.

Ediswan 3-valve receiver. Utilising an S.G.—detector—pentode circuit, this set has a removable mains unit, and works off 100-110 V or 200-250 V A.C. mains, and 200-250 V D.C. mains. Long and medium waves are covered, and a pick-up can be used with the set. Valves: "Mazda" AC/SG, AC/HL and 425/PEN. Price 20 guineas.

MAINS UNITS.

Model BS, for A.C. mains, delivers 200 V at 20 mA, and has four H.T. tappings, two G.B. tappings, with automatic regulation proportional to plate current, and 4 V L.T. output at 5 A. "Mazda" U30/250 rectifying valve. Price £8; for 25 cycle mains, £10. Model BS for D.C. mains supplies H.T. S.G. voltage, and G.B. Price 5 guineas.

Model C, for A.C. mains, delivers H.T. (including S.G. voltage) L.T. at 4 V 5 A, and G.B. "Mazda" UU60/250 rectifying valve. Price 10 guineas, or for 25 cycle mains, £11 5s.

Model D, for A.C. mains, is a high-power unit. Among the several tappings one delivering 400 V, 70 mA, another 100 V, 100 mA for M.C., three G.B. tappings, and L.T. outputs of 4 V 4 A and 7.5-8 V 4 A. Rectifying valves: "Mazda" UU60/250 and two U75/300. Price £21.

D.C. mains unit for 100-250 V. Supplies H.T. and G.B. Price £9 2s. 6d.

L.T. unit for A.C. valves. Output 4 V 5 A. For 40-100 cycle mains 100-110 V

or 200-240 V. Price £2 10s. A special 25 cycle model is available at £4 2s. 6d. L.T. unit for D.C. mains. This is designed for running A.C. valves off D.C. supplies, and is fitted with a series diverter resistance. Price £1 17s. 6d. Diverter resistance of 16 O, 3s.

CHARGER.

Home accumulator charger for A.C. Utilises a gas discharge rectifier valve, and operates from 100-110, 200-220, 230-250 V 40-100 cycle mains. Output 2-12 V at 2 A. Price £2 17s. 6d., or £3 3s. for 25 cycle mains.

GENERAL.

Ediswan list a comprehensive range of mains transformers, including Type A, for A.C. valve filaments. This gives 4 V at 5 A. Price 30s. Type B gives H.T., G.B. and screened grid voltages. Price 34s. Types A and B are available in combined form, supplying H.T., S.G., L.T. and G.B. Price £1 17s. 6d., or for 25 cycles, £2 5s. Shrouded L.F. chokes: 20 H, 15s.; 100 H, £1. Unshrouded, 12s. 6d. and 18s. Resistances: (a) Wirewound. 20,000 O, carrying 15-20 mA, 11s.; 12,000 O, carrying 30-40 mA, 17s. 6d.; 1,000 O, carrying 50 mA, 11s. (b) Moulded conductive. Available in numerous values from 10,000 to 50,000 O at 1s. 2d. Moulded clip, 1s. 3d.

For valves, see page 279.

Electroset Radio Co., Rowington, Warwickshire.

RECEIVERS.

The Electroset Two, for A.C. mains, incorporates a loud-speaker and it can be worked off an outside aerial if desired. Provision is made for a gramophone pick-up. (W.R.) Price, in oak £14 5s., mahogany or walnut £14 10s.

The Electroset Three, also for A.C. mains, is a very compact instrument. (W.R.)



The Dubilier all-electric 3-valve receiver, type A.C. 3.

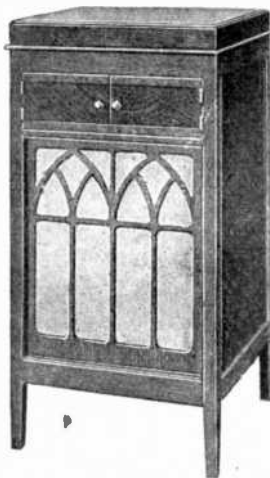

The Dyson "Godwinex" all-A.C. radio-gramophone which is now fitted with a moving-coil speaker.

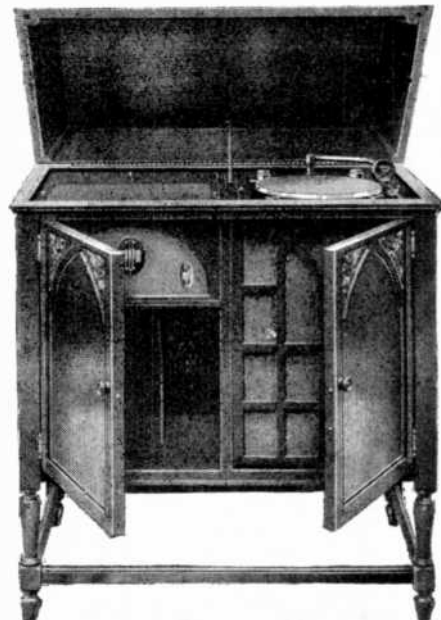

Edison Bell's all-mains radio-gramophone. A very handsome production.

ALL - ELECTRIC RADIO

Price, £18; without loud-speaker, £16 10s.

RADIO-GRAMOPHONE.

The Electroset 2-valve radio-gramophone is equipped with Osram valves, Blue Spot cone speaker, Harlie pick-up and Collaro motor. It is a very compact table model in mahogany, and is priced at 18 guineas. (W.R.)

MAINS UNIT.

A combined H.T. and L.T. unit, for A.C. mains, giving an H.T. output of 120 V, 20 mA, and 70 V for a detector tapping, and an L.T. output of 4 V 3 AH, is also made by the Electroset Radio Co., and sells at £4 complete. It can also be obtained for home constructors, without cabinet or switch, for £3 15s. (W.R.)

The Ellison Manufacturing Co., Ltd.,
Dragon Works, Harrogate.

MAINS UNITS.

The Ellison H.T. mains unit type P.1, A.C., for use in portable sets has two outputs, one giving 60-80 V, 1-3 mA, and another 120 V, 30 mA. Price, with valve, £6.

Type P.1, D.C., is a universal voltage model similar to the above model, but for D.C. mains from 100 V up to 250 V. Price £2 10s.

Type P.2, for A.C. mains (W.R.). Two outputs, one suitable for a detector valve, and the other 110 V at 15 mA. Suitable for straight 5-valve portable, and can be supplied at a slight extra charge for S.G. portables. Price £4 17s. 6d.

H.T. unit, type A.C.1, has 2 H.T. tappings, one giving 150 V, 125 V and 110 V, and the other suitable for a detector valve. For A.C. mains. Price, with valve, £3 15s.

H.T. unit, type A.C.2, for screened-grid sets. Three tappings, one giving a fixed voltage of 50-70 V for the detector, the second a variable voltage for the screen-grid, and the last a power stage output ranging from 110 V-200 V. For A.C. mains. Price, with valve, £4 10s.



The handsome "Melodyne" all-mains radio-gramophone marketed by A. H. Fellows & Son.

GENERAL

A full range of mains transformers is also listed: Output of 4 V from 200-250 V mains, £1 5s.; output of 4 V from 100 V mains, £1 2s. 6d.; output of 135 V, 20 mA, from 200-250 V or 100 V



Above is a view of the "Electroset" transportable radio-gramo. Below is the top of the cabinet with cover removed, showing turntable and pick-up.

mains, £1 (choke 10s. extra); output of 7.5 V, 3 A, 400 V 100 mA from 200-250 V or 100 V mains, £4.

All these transformers are for 50 cycle mains, transformers for 25 cycle supply can be obtained at a cost of 25 per cent. extra, and quotations for special transformers will be furnished on request.

The Elven Mains Receiver Co., 34, Church Street, Kensington, London, W.8.

A complete all-mains 2-valve set is made by this firm selling at £12 10s., or with Brown "Duckling" speaker, £14 5s. The 3-valve instrument in a similar cabinet sells at £16 10s. 6d., complete with "Duckling" speaker.

The all-mains (D.C. or A.C.) screen-grid four portable has provision for pick-up and extra loud-speakers. Price 27 guineas.

The all-mains screen-grid three retails at 20 guineas.

Erskine Silverbell Co., 189, Southfield Road, Chiswick, London, W.4.

RADIO GRAMOPHONES.

Four different models are available, all being similar in outward appearance, and housed in high-class cabinets of burr walnut.

The horizontal control board beneath the lid carries the electrically-driven turntable and pick-up, and also the radio tuning arrangements. The moving-coil speaker is mounted in the front of the cabinet. The instrument is entirely mains-driven, and the receiver portion is provided with a screened grid H.F. stage, but is intended for use in conjunction with an external aerial system. Two PX.650 valves are used in parallel in the output stage.

The model described above is known as the "Boudoir," and lists at £75 and £80 for D.C. and A.C. respectively. A third instrument, which is suitable for use on A.C. or D.C. is available at £80, and a fourth—the A.C. "Grand"—at £105. A smaller electrical reproducer is being manufactured to sell at £50, and this will

also be available in the near future in the form of a radio-gramophone.

Falk, Stadelmann & Co., Ltd., 83-93, Farringdon Road, London, E.C.1.

MAINS UNIT.

"Efesca" all-power unit for 100-110, or 200-250 V A.C. mains. Output 60 mA. Four H.T. tappings, four G.B. tappings, and L.T. at 4 V 6 A. Price £7 15s.

A. H. Fellows & Son, 119, Soho Road, Handsworth, Birmingham.

RADIO-GRAMOPHONE.

"Melodyne." Utilises AC/SG, AC/HL valves, with two P650 valves in parallel. Electric-motor and moving-coil speaker. Covers long and medium wavelengths, and is available for A.C. and D.C. mains.

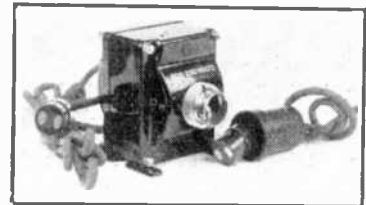

An interesting Ferranti product, the 2-1 step-up mains transformer.

Price £45 in oak, £47 5s. in mahogany.
Ferranti, Ltd., Hollinwood, Lancs.

RECEIVERS.

Model 31. Three valves, S.G., detector, transformer-coupled L.F., with P625 output valve. The H.F. and detector valves have indirectly heated cathodes. Both the long and medium wave bands are covered. Valve rectification is used, though G.B. is obtained through a metal rectifier. Price for 200-250 V, 40 cycle mains, £27 in oak, £28 in mahogany or walnut. A rejector unit, taking the form of a plinth on which the set is stood, costs £2 10s. extra. The receiver is also available in console form, incorporating an M.C. speaker. Price £53 in oak, £55 in walnut or mahogany.

MAINS UNITS.

Type BEM1, for 200-250 V, 40-100 cycle mains. Output 100 mA at 200 V. Five H.T. tappings. (W.R.) Price £16. A constructional A.C. unit is made at £14.

CHARGERS.

Permanent Trickle Charger. Five models are made, covering from 2 to 9 V, 5 to 1 A output, and available for 25 to 65 cycle mains of 100-130 V and 200-250 V pressure. (W.R.) Prices: 1A models 75s., 5A models 55s.

Motor Car Battery Charger, Model MCI. For 200-250 V, A.C. mains. Output up to 12 V at 3A. Price £11 18s. 6d.

GENERAL.

Safety box. Price 30s.

Moving-coil speakers for 200-250 V mains. Chassis models—type SA1 for A.C., price £11 15s.; type SD1 for D.C., price £5 17s. 6d.. Cabinet models: A.C. table model AT1, oak £8 16s., mahogany and walnut £19 14s. A.C. pedestal model AP1: Oak £22, mahogany and walnut £23 8s. D.C. table model DT1: Oak £12 18s. 6d., mahogany and walnut £13 10s. 6d. D.C. pedestal model DP1: Oak £16 2s. 6d., mahogany and walnut £17 10s. 6d.

Ferranti's also make a magnio-dynamic

Marconiphone's Famous All-Mains Models

Model
56

A 5-valve set of extraordinary liveliness which brings in the World's Broadcasting Stations one after another through a good loudspeaker with as much power and clarity as the local transmitter, yet in the case of the "local" it will tone down to the power of the most sedate small receiver. It enjoys a tremendous reputation for range, selectivity, power and ease of control.

Price for D.C. Mains - £32 7 0
" " A.C. Mains - £35 0 0

A powerful 4-valve circuit embodying the latest principles in All-Mains Radio design and providing splendid volume from both near and distant stations. Particularly economical in consumption and unusually round and full in tone. A remarkable instance of modern radio value.

Model
47

Price complete for A.C. Mains - £24 0 0

Model
39

One of the most popular 3-valve sets ever produced. Capable of bringing in many Continental Stations at excellent loudspeaker strength. As with the above sets this receiver is suitable also for gramophone pick-up which can be connected easily to this set. Its very reasonable price has placed this Receiver within the reach of every section of the public, especially when sold through the means of our Radio Purchase System.

Price for D.C. Mains - £17 15 0
" " A.C. Mains - £21 0 0



FIRST & FOREMOST IN RADIO

MARCONIPHONE MADE THE FIRST ALL-MAINS SETS AND STILL MAKE THE BEST — COMPARE THEM

The Marconiphone Co. Ltd. Radio House 210 Tottenham Court Road, W.1



Model
56

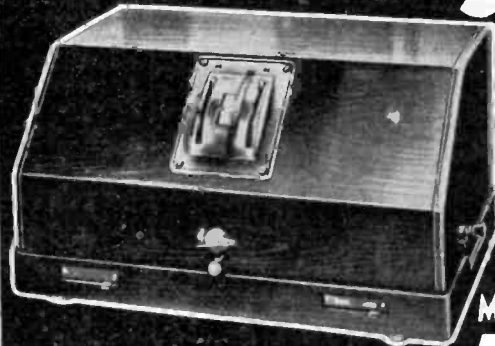

Model
47



Model
39

A FEW STRAIGHT WORDS about indirectly heated A.C. VALVES

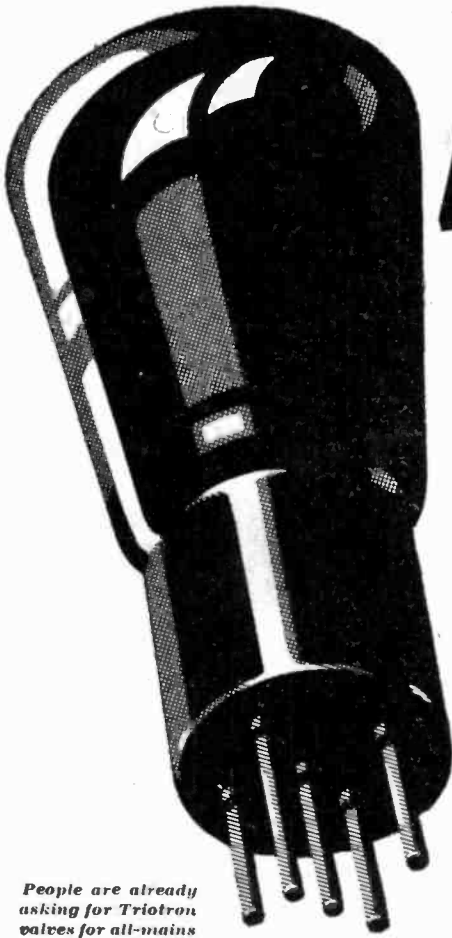

People are already asking for Triotron valves for all-mains sets. Don't lose business. Get your stock up-to-date without delay. Send your order to-day.

THEORETICALLY it should be easier to make an efficient A.C. Valve than a good Dark Emitter. It is easy for instance, to get Amplification, but in order to get music instead of noise the emitting coating must have properties which depend on the most subtle research in Micro Chemistry. The manufacture of the coating embodied in Triotron A.C. Valves is the secret of a scientific Master Mind. It cannot be analysed, it cannot be imitated.

REMEMBER: A.C. Valves work direct from the power supply. No amount of advertising, no amount of salesmanship can minimise the severity of this test and the drastic consequences of filament failure.

Do not experiment with your customers; give them the best that science has been able to produce.

Retail Prices protected by Limited Licence.

INDIRECTLY HEATED A.C. VALVES			RECTIFYING VALVES			
TYPES		RETAIL PRICE	TYPES		MAXIMUM D.C. OUTPUT	RETAIL PRICE
S.C.N.4	Screened Grid	Each 18/6				
S.N.4	Super Detector					
A.N.4	High Frequency	10/6	G.A.24	Full Wave	60 m/a	12/6
W.N.4	General Purpose	10/-	G.N.24	Full Wave	30 m/a	10/6
Y.N.4	Resistance Coupling	10/-	G.N.14	Half Wave	30 m/a	9/6
	Low Frequency and Power	10/6	<i>Full wave rectifier G.A.24 makes it possible to control the output H.T. voltage by the low tension voltage supplied to the filament.</i>			

TRIOTRON A.C. VALVES

Southern Main Distributors
**ELECTRIC LAMP
SERVICE CO., LTD.**
39-41, Parker Street, Kingsway,
London W.C.2.
Phone: Holborn 6634, 6635, 0070.
Grams: Eleclampo, Westcent, London.

Main Distributors for Northern Ireland: Messrs. Sloan & Company, 7, Corporation Street, Belfast. Telephone: Belfast 3020.

TRIOTRON RADIO CO., LTD.,
91, Gr. Russell Street, London,
Phone: Museum 1908. W.C.1.
Grams: Radiumited, Westcent, London
(Technical & Overseas enquiries should
be sent exclusively to the above
address.)

Northern Main Distributors
CHORLTON METAL CO. LTD.,
18, Amber Street, Shudehill,
Manchester.
Phone: Manchester, Blackfriars 7637
(Pte. Br. Ex.)
Grams: Chorimet, Manchester.

Main Distributors for Irish Free State: The Briscoe Importing Co., Ltd., 9 Aston's Quay, Dublin. Telephone: Dublin 1351.

TRIOTRON VALVES FOR BIGGER SALES

ALL - ELECTRIC RADIO

speaker, which, in chassis form, sells at £9 10s. It is also available as follows:—
 Table model MT1: Oak £16 11s., mahogany and walnut £17 9s. Magnodynamic pedestal model MP1: Oak £19 15s., mahogany and walnut £21 3s.
 Mains transformers. EM1, for use with Westinghouse rectifier type HT1 to give 200 V 100 mA output. Price 35s. EM3, for use with W.R. HT3 and HT4 to give

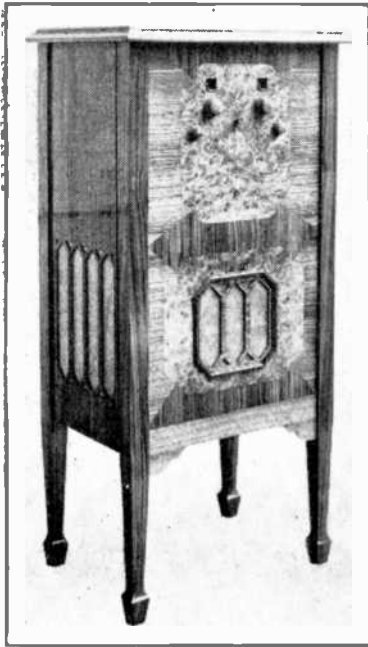

The Ferranti all-electric console receiver, incorporating a dynamic speaker. It is a fine looking instrument.

120 V 20 mA and 180 V 30 mA. Price 25s. EV2, for use with Marconi-Osram E8 or Mullard DW30 rectifying valves to give 200 V 80 mA. Price 47s. EV4 for use with U9 rectifying valve to give 250 V 50 mA. Price 32s. P9 for W.R. type A3 to give 9 V at 1 A. Price 27s. 6d. P10 to give 6 V, 3.2 A, 4 V, 4 A, and 45 V with W.R. type GB1. P11 is designed for use with 200-250 V A.C. mains sets to enable them to be operated from 100-130 V A.C. Price 42s. 6d.

A wide range of mains condensers is made, all being tested at three times their A.C. working voltage.

Anode feed units, a comparatively new development, have been produced by Ferranti, Ltd., for some time. A wide range is available. Among chokes the most recent addition is the B5, carrying up to 160 mA. It sells at 27s. 6d. Several others are also made.

Gambrell Radio, Ltd., Buckingham House, Buckingham St., Strand, London, W.C.2.

RECEIVERS.

The Gam-brell all-electric two-valve model is enclosed in a black crystalline cabinet, and retails at £13 15s. (D.C.) and £17 10s. (A.C.).

Comprising screen-grid, detector and pentode valves, the 3-valve model is stated to be very selective and easy to operate. It is contained in a black

crystalline cabinet, and costs £22 (D.C.) and £25 (A.C.). A handsome polished mahogany cabinet is retailed at 25s. extra.

The 4-valve type is fitted with a volume control and is instantly adaptable for reproducing gramophone records. It is contained in a mahogany cabinet and is suitable for use with a moving-coil speaker. Price £33 5s. (D.C.) and £39 15s. (A.C.). All the above prices include everything except loud-speaker and aerial.

The all-electric Gam-brell transportable employs screen-grid, detector and pentode valves, and is entirely self-contained. Provision for using a pick-up is included, and a Celestion loud-speaker. Price, in



This Gambrell all-electric transportable is available for either A.C. or D.C. mains working.

mahogany cabinet, £29 (D.C.) and £32 (A.C.).

RADIO-GRAMOPHONE.

The Gam-brell Novotone model radio-gramophone comprises a receiver with screen-grid, detector and two pentode valves in parallel; a moving-coil speaker, and a pick-up. The gramophone incorporates the well-known Novotone tone compensating device. Prices, for D.C., 69 guineas (oak), and 71 guineas (mahogany), for A.C., 80 guineas (oak) and 82 guineas (mahogany).

Garnett, Whiteley & Co., Ltd., Lotus Works, Mill Lane, Old Swan, Liverpool.

RECEIVERS.

The "Lotus" 3-valve S.G.P. all-electric receiver employs an S.G. H.F. stage, a detector, and a pentode power output valve. Tuning range, 200-500 metres and 1,000-2,000 metres. Available in oak or mahogany. Price £21, including valves. The "Lotus" 3-valve all-electric transportable receiver for A.C. mains is entirely self-contained, with built-in speaker. Mounted on a turntable, and has provision for external aerial and earth. Prices: in oak, £24 4s. in walnut or mahogany, £26 5s.

MAINS UNIT.

The "Lotus" all-mains unit for A.C. is contained in a metal case and can be used for the complete power supply for sets using indirectly heated valves or for the

H.T. supply of sets with ordinary valves. A variable G.B. supply is also provided. Price £7 7s.

GENERAL.

This firm make an all-mains version of their well-known remote-control system. A complete outfit for two rooms costs 47s. 6d., while the equipment for every additional room is priced at 7s. 6d.

General Electric Co., Ltd., Magnet House, Kingsway, London, W.C.2.

RECEIVERS.

The "Gecophone" 3-valve all-electric receiver employs an S.G. H.F. stage, a detector, and a super-power valve in the output, and is for use with A.C. mains. It is available in either oak or mahogany at £25. A 2-valve all-A.C. receiver, similar in appearance to the above, but on a smaller scale, is also listed by the G.E.C. This employs a detector and a power valve, and an "Osram" U5 valve is used for rectification purposes. Price £15, in oak or mahogany. The "Gecophone" 3-valve all-A.C. portable receiver is housed in a solid mahogany case, with the speaker built into the lid, together with the frame aerial. The circuit comprises an S.G. H.F. stage, a detector, and a pentode in the power stage, and, here again, a U5 valve is used for rectification. Price £28. A power amplifier for use with A.C. mains is another product of this firm. This employs two valves, and a U8 valve is used for rectification. Suitable for radio or pick-up. Price £25.

MAINS UNITS.

H.T. unit for A.C. mains. Outputs, 25 mA at 260 V, 30 mA at 240 V, and 40 mA at 200 V. Three tappings, one fixed at 200 V, and two variable. Utilises U5 rectifier valve. In metal case, finished in light brown crystalline enamel. Price £9. 20 mA type for A.C. mains. Output 20 mA at 140 V, tappings at 60 V and maximum, and one for S.G. valve. In same type of metal case as 40 mA type. Price £5 5s. H.T. unit for D.C. mains. Two tappings. Price £6 10s.

GENERAL.

Moving-coil speakers for both A.C. and

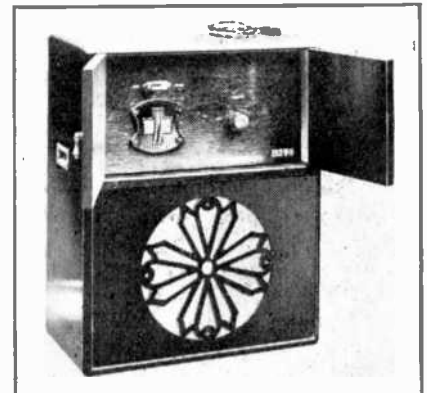

The "Lotus" 3-valve all-A.C. transportable receiver, made by Garnett, Whiteley & Co., Ltd.

D.C. mains are available, the former being priced at £10 guineas, and the D.C. model at £7.

ALL - ELECTRIC RADIO

Also, this firm supply various transformers, chokes, condensers and resistances for use in mains apparatus.

(For valves see page 276.)

Goodmans, 27, Farringdon Street, London, E.C.4.

GENERAL.

Goodmans' "Invincible" moving-coil speaker is made for D.C. mains at £5 9s. 6d. and for A.C. mains at £7 14s. 6d.

Fredk. J. Gordon & Co., Ltd., 92, Charlotte Street, London, W.1.

RECEIVERS.

Among the American products marketed by this firm are the Atwater Kent range of all-mains sets.

The No. 55 model, for A.C. mains, is of the screen-grid type and sells complete with valves and loud-speaker for £35.

Model No. 42, for A.C. mains, inclusive of valves and loud-speaker, sells at £20.

Both models can be obtained for D.C. mains at a slightly higher price.

Graham Amplion, Ltd., 25-26, Savile Row, London W.1.

RECEIVERS.

Standard Mains-Operated Set. The well-known 5-valve, 4-stage Amplion receiver incorporating a screened-grid stage and two super-power valves in the output position, with a rated dissipation of 10 watts. Completely enclosed in a crystalline-finished metal case with central drum pattern tuning condensers, calibrated in wavelengths. Selectivity and volume controls are fitted, together with suitable provision for the use of a pick-up. Wavelength ranges, 200-560 and 1,000-2,000 metres. Price, £50.

Model A.C.50. This recently introduced model is of the pedestal cabinet type combining the above-mentioned all-electric A.C. receiver and the senior "Lion" cone speaker, type L.C.50. Price £65 in oak and £66 in mahogany.

Model D.C.50. An even more recent model which is similar in general appearance to the A.C.50 but is for use on D.C. supplies. It incorporates the Amplion battery set working in conjunction with an all-mains unit for 200-250 V mains, the speaker being the L.14 14-inch "Lion" chassis. Price £50 in oak and £51 in mahogany. Both the A.C.50 and D.C.50 instruments make use of the house wiring as an aerial system.

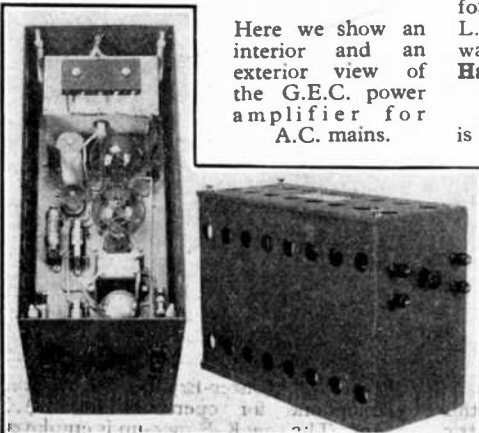

Here we show an interior and an exterior view of the G.E.C. power amplifier for A.C. mains.

RADIO-GRAMOPHONES.

Two models are made, also incorporating the standard Amplion receiver, in conjunction with a pick-up, electrically-operated turntable and necessary apparatus. Prices range from £120 to £150.

TRICKLE CHARGER.

Suitable for 2, 4 or 6 V accumulators and for use on 100-110, 200-220 or 225-250 V, 40-100 cycle A.C. mains. (W.R.) Provided with 3-way rotary switch giving "Off," "Set" and "Charge" positions. Price 52s. 6d.

The Gramophone Co., Ltd., Hayes, Middlesex.

RADIO AND ELECTRIC GRAMOPHONES

Model No. 600, the "Concert" model electric gramophone is for use in large halls, restaurants, etc. There are three units, the playing console, the amplifier and the loud-speaker. The loud-speaker is of the large diameter stretched diaphragm coil-driven type. Price, £250 (A.C.) or £285 (D.C.), including one loud-speaker. Extra speakers, £70 each.

Model 551 is the "Home" model electric gramophone, self-contained in a pedestal cabinet, with an induction motor, 2-stage 3-valve amplifier and moving-coil-speaker. There is a socket for plugging in the output of a radio set. Price, in walnut cabinet, 100 guineas (A.C. only). For D.C., a rotary converter must be used in addition.

Model 15, just introduced, is the automatic electrical reproducer, which combines the mechanism of the H.M.V. automatic gramophone with the reproducer as used in Model 551. The price is £200, £205 with distant control, or £215 with distant control and panelled doors to the cabinet (A.C. only).

Next, there is the Model 520 radio-gramophone, for home use on A.C. mains only. The radio side has an S.G. stage, detector and 2 L.F. stages. The tuning is ganged, and there is a variable aerial coupling device to vary the selectivity. On the gramophone side there is an induction motor, and No. 7A pick-up and arm. A moving-coil speaker is fitted. This machine is priced at £75 in oak (A.C. only).

GENERAL.

H.M.V. have also recently introduced a cabinet model moving-coil speaker containing its own rectifying equipment for use on A.C. mains. Known as the L.S.4, this speaker is housed in a walnut cabinet, and is sold at £16.

Halcyon Wireless Co., Ltd., 27A, Pembroke Villas, London, W.11.

A new all-mains transportable receiver is planned by the Halcyon Wireless Co. to be introduced to the market about July 1st.

An all-mains radio-gramophone is also being designed at the present time, and will be put on the market in a month.

Harris Williams (Manufacturers), Ltd., 5, New Zealand Avenue, London, E.C.1.

RECEIVERS.

All-electric A.C. set. Utilises external speaker and aerial system, the circuit, covering long, and medium waves, being a detector

and two transformer-coupled L.F. stages. 200-240 V mains. All-electric A.C. 3-valve transportable. Built-in speaker, but external aerial required. One R.C. and one transformer-coupled L.F. stages.

RADIO-GRAMOPHONES.

Three-valve model, with one R.C. and one transformer-coupled L.F. stage. Mullard speaker, "Truvox" pick-up.

Four-valve model, for A.C., with choke-coupled H.F. stage, Celestion speaker and "Truvox" pick-up.

Five-valve model, for A.C. two choke-coupled H.F. stages, M.C. speaker, B.T.H. pick-up. The two last-named instruments have self-contained frame aeriels, and pentode output stages.

Haw & Co., Ltd., 20, Cheapside, London, E.C.2.

MAINS UNITS.

Isomona mains unit half-wave type N.G. for A.C. mains between 100 V and 120 V or 200 V and 240 V, one tapping fixed at 150 V, one variable 0/100 V, regulating resistance for Philips 373 valve, 20 mA. Price £2 16s.

Full-wave rectifier type N.V. for A.C. mains between 100 V and 120 V or 200 V to 240 V, 50 to 100 cycles. G.B. tappings at 2, 4, 6, 8, 10, 12, 14 and 16 V. Detector resistance variable from 40-80 V. H.T. tappings at 100 V, 150 V and 200 V. For use with Philips 506 valve. 40-50 mA. Price £5 5s.

CHARGERS.

The Isomona trickle charger type T.R.1 charges 2, 4 or 6 V accumulators at 5 A. Price £1 10s.

Type T.R.2 charges 2, 4 or 6 V accumulators at 1.2 A. Price £1 15s.

GENERAL.

Haw & Co. also market a universal gramophone motor for A.C. or D.C. mains of 100/240 V. Price £5 5s.

F. C. Heayberd & Co., 10, Finsbury Street, London, E.C.2.

CHARGERS.

Model A.1 for A.C. Charges L.T. batteries and H.T. accumulators up to 40 V. Philips 328 rectifying valve. Price 55s.

Model A2 for A.C. Output 2-6 V at 1.4 A. Philips 451 rectifier. Price 42s. 6d.

Model A3, for A.C. Maximum output 20 V and 6 A. Philips 339 rectifying valve. Price £6 6s.

Model B1, for A.C. Charges H.T. accumulators 40-120 V at 100 mA. Philips 1002 rectifying valve. Price 55s.

Model AB4. A combination of Models A2 and B1, which will charge L.T. accumulators (up to 6 V) and H.T. accumulators separately or simultaneously. Price 85s. All these chargers can be supplied as kits if desired.

GENERAL.

A comprehensive range of mains transformers is produced by Heayberd, who feature particularly their type W14, which lists at 21s.

Louis Holzman, Ltd., 37, Newman Street London, W.1.

GENERAL.

This firm, who are agents for Hydra condensers, state that their filter type radio condensers have been tested at more

ALL - ELECTRIC RADIO

than double the working voltages. They are obtainable in capacities ranging from .001 to 10 μ F.

They also list the Insol gramophone motor A.C. model for running on mains between 100 V and 125 V or 200 V and 250 V, 25, 50 or 100 cycles. Price £6.



The A.C. 50 cabinet all-electric receiver produced by Graham Amplion. It is also available in D.C. form.

Ideas Development Syndicate, Ltd., 4, Golden Square, London, W.1.

RECEIVERS.

The I.D.S. 3-valve all A.C. receiver, "Table Model Type X1," incorporates a station selector which enables the local station to be easily tuned out. It utilises A.C. valves, and a rectifying valve of the full-wave type, while provision is made for a pick-up. Price 12 guineas.

"Portable Model Type X2" is a 5-valve receiver of the transportable type with a self-contained frame aerial, and cone speaker. A turntable and provision for a pick-up are two of its features. Two models are made, one for D.C. mains, and the other for A.C., the latter utilising a valve for rectification purposes. Prices: D.C. type, £16 16s.; A.C. type, £17 17s.

The only other all-mains receiver made by this firm is the "Console Model Type X3," which is a 4-valve receiver for use with A.C. mains. A pedestal cabinet, available in oak or mahogany, houses the receiver, and a cone speaker, and provision is made for a pick-up. A station selector, similar to that in the 3-valve table model, is incorporated, and a rectifying valve of the full-wave type is employed. Price £21 complete.

Igranic Electric Co., Ltd., 149, Queen Victoria Street, London, E.C.4.

RECEIVERS.

Igranic A.C.3 receiver. This is a 3-valve A.C. receiver employing one S.G. H.F. stage, a detector, and a pentode valve output stage. Four models are made, the first being a table instrument, which is obtainable, complete with supply unit, for £25 in mahogany and

£24 in oak; royalties £1 extra. The second model is a bureau cabinet, with the speaker housed beneath the set. This costs £38 in mahogany, and £35 in oak, royalties again being £1 extra. The remaining two models are radio-gramophones with self-contained speakers, supply units, frame aerials and "Phonovox" pick-ups. One, which has a spring motor, is priced at £45 10s. in mahogany, and £42 10s. in oak, while the other with an electric motor sells at £50 10s. and £47 10s. respectively. In each case £1 extra is charged for royalties.

The Igranic A.C.2. A 2-valve A.C. receiver, employing a detector, transformer-coupled to a pentode. Price £13, including royalties.

Besides several battery models of the "Neutrosonic Seven" receiver, there are three de luxe pedestal types for A.C. operation. The first consists of the receiver and a speaker housed in a pedestal cabinet, and costs £102 in oak and £105 in mahogany. The others are radio-gramophones, one, which is equipped with a spring motor, selling at £109 10s. in oak, and £112 10s. in mahogany, and the other, with an electric motor, at £114 10s. in oak, and £117 10s. in mahogany.

Igranic are well-known for their combined amplifiers and mains supply units, which are made in two types—5 and 12 W—listing at £12 10s. and £14 17s. 6d.

MAINS UNITS.

H.T. supply unit for A.C. mains. Output, 30 mA at 160 V; fixed tapplings at maximum and one variable tapping. Also L.T. output, 3 A at 4 V A.C. U.5 rectifying valve. Price £7 10s., including rectifier but excluding royalties.

L.T. supply unit for A.C. mains. Capable of supplying up to seven 4 or 6 V directly heated valves with smoothed D.C. current. Igranic-Elkon metal rectifier. Price £14, royalties extra.

CHARGER.

Igranic L.T. battery charger for A.C. mains. Output, 3 A at 6 V; metal rectifier. Price £5 10s., royalties extra.

GENERAL.

A new product is an A.C. filament transformer, giving 5 A at 4 V. The price is 29s. 6d. Then, of course, there is a number of components for mains working, including power transformers and chokes, mains switches, and the "Phonomotor," an induction type gramophone motor which is priced at £6 6s. Igranic also produce the "Igranophone" electrical reproducing equipments for use in theatres, dance halls and cinemas. The Igranic-Elkon dry contact metal rectifiers are dealt with elsewhere in this issue.

Itonia Gramophones, Ltd., 58, City Road, London, E.C.1.

RADIO-GRAMOPHONE.

This instrument utilises one S.G. stage, and R.C. and transformer coupled L.F. stages. It has a B.T.H. pick-up and motor. An Ultra air-chrome speaker is fitted, though a "Magnavox" M.C. speaker can be substituted for 5 guineas extra. Price 65 guineas for A.C. mains (200-250 and 100-120 V, 40-100 cycles), and 70 guineas for D.C. mains.

ELECTRIC GRAMOPHONE.

Available for A.C. mains only, this machine embodies a Garrard electric

motor and B.T.H. pick-up, with an air-chrome speaker. The amplifier is R.C. and transformer-coupled. Price 39 gns.

Junit Mfg. Co., Ltd., 2, Ravenscourt Square, London, W.6.

MAINS UNITS.

We learn that an interesting departure in the manufacturing policy of Junit will shortly take place, when the firm will announce the introduction of a series of new mains units for portable receivers.

It is not possible at the moment to give complete information regarding these new accessories, because they are not yet ready for release. We can state, however, that four models will be available, every one being smaller in size than an ordinary standard 100 V H.T. battery.

Kolster-Brandes, Ltd., 163, Great Portland Street, London, W.1.

RECEIVERS.

The K-B models 161 and 169 are designed for use on A.C. mains, and the circuit comprises screened-grid, detector and pentode. Provision is made for a gramophone pick-up. Model 161, price, including valves (for mains of 100-120 V, 40-60 cycles), £17 10s., and model 169 (for mains of 200-250 V, 40-60 cycles), £17 10s.

RADIO-GRAMOPHONES.

The K-B. 161 or 169 receiver is incorporated in the radio-gramophone, model 167 and 168. An electric motor is used, and a K-B pick-up. Separate volume controls are provided for radio and gramophone reproduction. Model 167 is for 100-120 V, 40-60 cycles, and model 168 for 200-250 V, 40-60 cycles A.C. mains. Both are priced at £49 10s.

K-B models 188 and 189 use an induction type motor, moving-coil speaker,

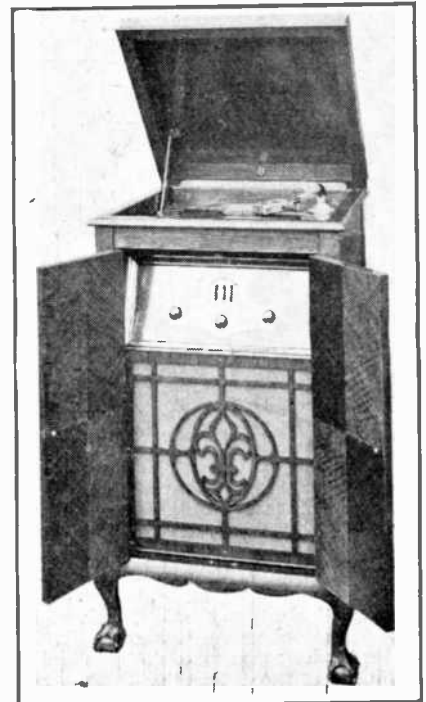

This is the Kolster-Brandes Super radio-gramophone for operation from A.C. mains. The new K-B pick-up is employed.

ALL - ELECTRIC RADIO

a radio receiver comprising a stage of H.F. amplification utilising a screen-grid valve and detector reaction. The output from the detector is passed to a two-stage L.F. power amplifying unit, employing two super power valves in the last stage. Model K-B 188 is designed for 100-120 V 40-60 cycles, and K.B.189 for 200-240 V 40-60 cycle A.C. mains. Price, for both models, £95.

ELECTRIC GRAMOPHONES.

The K-B electric gramophone incorporates an electric motor, and a 2-stage amplifier consisting of an indirectly-heated A.C. valve coupled to an output stage of two valves in parallel. Model K-B 130 is for 200-240 V 40-60 cycles, and K-B 154 for 100-120 V, 40-60 cycles.

S. A. Lamplugh, Ltd., Kings Road, Tyseley, Birmingham.

RECEIVERS.

"Silver Ghost" screened-grid three for A.C. This is a console model with a built-in balanced armature speaker. Indirectly heated valves. Price £27 10s.

"Silver Ghost" 2-valve A.C. set. Detector and one L.F., with indirectly heated valves. Price 15 guineas. A 3-valve model is available at £19 10s.

RADIO-GRAMOPHONE.

"Silver Ghost" 5-valve model, with self-contained aerial. Price £41 5s. for D.C., £43 10s. for A.C. 3-valve model requires an external aerial system, and derives H.T. only from the mains. Price

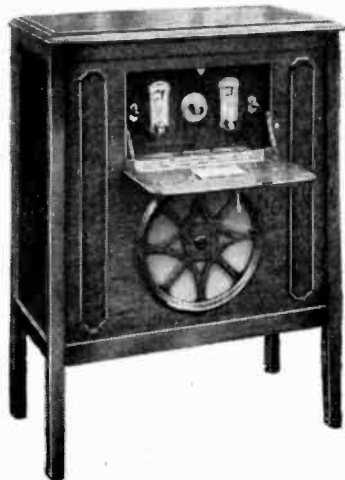

A Lamplugh product—the "Silver Ghost" all-mains 3-valve receiver.

£35 15s. for D.C., £38 for A.C. All-mains 3-valve instrument £46.

Eric J. Lever (Trix), Ltd., 8-9, Clerkenwell Green, London, E.C.1.

RECEIVERS.

"Trix" 2-valve portable for A.C. self-contained aerial and speaker. "Mazda" indirectly heated valves, and U5 full-wave valve rectifier. Weight 18 lbs. Price 15 guineas.

Although the "Trix" 4- and 5-valve portables are not strictly all-mains sets, they incorporate the patent "Trix" method of connecting up a mains unit through a plug-in adaptor.

E 16

MAINS UNITS.

A.C. model for H.T. Delivers 15 mA at 120 V with a half-wave rectifier or 25 mA with a full wave rectifier. Valve rectification. Price £3 17s. 6d. Combined H.T. unit and trickle charger. Output 120 V, 15 mA, with change-over switch to bring in the charger, which delivers .5 A at 2 V. Price £6 10s.

GENERAL.

"Trix" power amplifier. This all-mains amplifier is a 3-stage instrument with an LS6A output valve. The standard amplifier is for 200-250 V, 40-60 cycle mains, but can be supplied for 100-110 V at £4 extra. The average cost, including valves, etc., is £50.

Lissen, Ltd., Lissenum Works, Worples Road, Isleworth, Middlesex.

RECEIVERS.

The all-mains receiver for use on wavebands of 250-550 and 1,000-2,000 metres requires an outside aerial, and a grid bias battery must be used. The set is priced at £11 11s. for 200-250 V or 100-125 V A.C. mains.

RADIO-GRAMOPHONES.

2-valve baby radio-gramophone. Similar circuit to the above receiver, and an electric motor with automatic stop and volume control are fitted. Prices: Oak models, £23 2s. for A.C. mains of 200-250 V and 100-125 V; walnut models, £26 5s., 200-250 V and 100-125 V.

A D.C. model will be produced shortly. The 3-valve radio-gramophone incorporates moving-coil speaker, S.G., detector, pentode amplifier, volume control for radio and gramophone, with or without electric motor, Lissen needle armature pick-up. Prices, for any A.C. mains voltage, £52 10s. (oak pedestal cabinet), £54 10s. (oak console cabinet), £57 10s. (mahogany pedestal), and £62 (mahogany console). D.C. models for 200-250 V mains retail at £45 (oak pedestal), £50 (oak console), £47 (mahogany pedestal), and £54 10s. (mahogany console).

The 4-valve radio-gramophone is all-mains throughout, with moving-coil speaker, 2 screen-grid, detector, pentode, frame aerial, separate volume controls, and Lissen needle armature pick-up. For A.C. mains the prices are £63 (oak pedestal), £68 (oak console), £65 (mahogany pedestal), and £72 10s. (mahogany console). For D.C.: £55 10s. (oak pedestal), £60 10s. (oak console), £57 10s. (mahogany pedestal), and £65 (mahogany console).

MAINS UNITS.

A.C. types include model LN 734 for mains between 200 and 250 V, and LN 735 for mains between 100 and 125 V; both are priced at £3, and both have three fixed H.T. tapplings, 80 V 3 mA, 60 V 2 mA and 120-150 V 20 mA.

LN 736 is for mains between 200 and 250 V, and LN 737 for mains between 100 V and 125 V. Three tapplings, two variable, up to 150 V 2 mA, and one fixed at 150 V 20 mA. Both are priced at £3 15s.

The D.C. types are LN 544, for a mains voltage of 200-250 V. Three fixed H.T. tapplings: 80 V 3 mA, 60 V 2 mA, and 120-150 V 20 mA. LN 599 is for voltages of 100-150 V. Price £1 7s. 6d.

LN 549 has two variable H.T. tapplings:

0/150 V 2 mA, 2/150 V 2 mA, and one fixed at 120/150 V 20 mA; it is for mains between 200-250 V. LN 600 is for mains of 100-160 V. (For valves see page 276.)

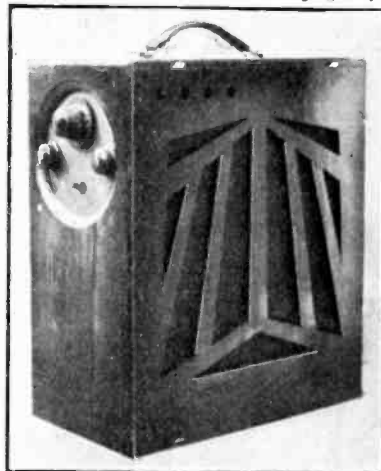

The Lissen 2-valve all-mains self-contained transportable—another very compact production.

Loewe Radio Co., Ltd., 4, Fountayne Road, Tottenham, London, N.15.

GENERAL.

While there is not an extensive range of Loewe mains apparatus on the markets at present, the few products there are should be of interest. A moving-coil speaker is made, and can be used with 110 or 200 V D.C. mains, or, with the addition of a Loewe rectifier unit, with A.C. supplies.

Quite recently Loewe introduced a range of power resistances, in two types, one capable of dissipating up to 5 W, and the other up to 1 W. The values of these resistances range from 1,000 Ω to 1 MΩ. For valves, see page 76.

"Loud Speaker" Co., Ltd., 2, Palmer Street, London, S.W.1.

RECEIVER.

"Enimains" 5-valve portable. There is space for a mains unit in place of the usual batteries, while provision is made for a pick-up and external speaker. Fitted with a D.C. unit and trickle charger the set weighs 31 lbs., and sells at 30 guineas, and with an A.C. unit 40 lbs., and 35 guineas.

Lowe's Empire Motor & Sidecar Co., Ltd., Empire Works, Birmingham.

GENERAL.

Lowe's specialise in the manufacture of any type of mains unit, and tell us that they are prepared to accept orders for any type of unit up to "talkie" installations. **M-L Magneto Syndicate, Ltd.,** Victoria Works, Coventry.

GENERAL.

Convertors, rotary transformers and motor generator sets are the speciality of this firm. First should be mentioned the BX, which, with a 6 V accumulator input, delivers 15 mA at 120 V and 150 V. Model C runs off 6 V or 12 V accumulators, or from D.C. mains of any voltage, and gives an output of 15 W up to 500 V.

Among rotary transformers the types E and F can be wound to run from a

ONE Order to
HOUGHTONS
secures ANY MAKE
of Mains Receiver
—at maker's terms

ONE ORDER . . .	} SAVES TIME	
ONE ACCOUNT		TROUBLE
ONE PAYMENT		MONEY

:: FREE Demonstrations of any Set for you and ::
 :: your customers at any HOUGHTON Branch ::

HOUGHTONS

The National Wholesalers

[ENSIGN, LIMITED]

HIGH HOLBORN · LONDON · W.C.1
 GLASGOW · MANCHESTER · LEEDS · NOTTINGHAM · SWANSEA · EXETER

From £500 to 50

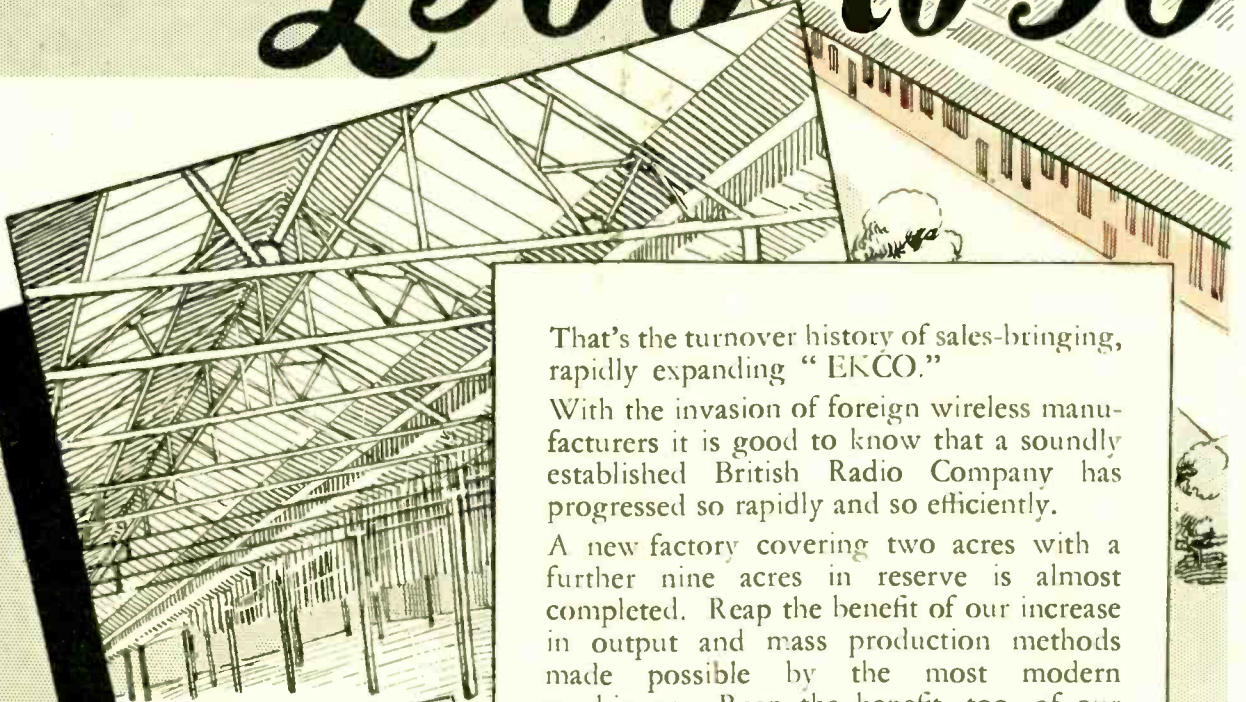

Above is shown an impression of the first "EKCO" Workshop. The other drawings are impressions of the new "EKCO" factory.

That's the turnover history of sales-bringing, rapidly expanding "EKCO."

With the invasion of foreign wireless manufacturers it is good to know that a soundly established British Radio Company has progressed so rapidly and so efficiently.

A new factory covering two acres with a further nine acres in reserve is almost completed. Reap the benefit of our increase in output and mass production methods made possible by the most modern machinery. Reap the benefit, too, of our consistent National Advertising and the Dealers' Co-operative Advertising Scheme that we have planned for you.

This summer "EKCO" specially introduced during May sound selling lines enabling you to turn summer sales-resistance into summer profits.

You must be assured that when you sell Electric Radio to-day that you sell the products of a manufacturer specialising and making solely Electric Radio in all its modern phases. Therefore: Sell "EKCO."

"EKCO" Pioneers &

0,000 in 5 Years!

TURN SUMMER-SALES RESISTANCE INTO SUMMER PROFITS!

These new "EKCO" summer lines are backed by a big national advertising campaign and dealers' co-operative scheme. Write for particulars of how to save yourself 50 per cent. of your advertising bill.

COMBINED H.T. UNIT and L.T. CHARGER.
MODEL C.P.1 for A.C. MAINS. Size 9 by 5 by 3½ ins.

A switch enables 2, 4 or 6-volt accumulators to be charged when the receiver is not in use. **H.T.** tapplings for S.G. valves, variable tapping from 0-120 volts and fixed tapping of 120/150 volts (this tapping can be reduced to 100 volts). Approximate running costs 5s. 6d. per 1,000 hours, 11 watts, at 6d. per unit. For A.C. Mains (a) 200-250 volts, 40-100 cycles, (b) 100-120 volts, 40-100 cycles. **£6-0-0**

PORTABLE H.T. UNIT FOR D.C. MAINS.
MODEL 1V.20. Size 8½ by 4 by 3½ ins.

H.T. tapping for S.G. valves, variable 0-120 and fixed 120/150 volts. Approximate running costs 2s. per 1,000 hours, 4 watts, at 6d. per unit. For 200-250 volt D.C. Mains only. **£2-10-0**

PORTABLE H.T. UNIT FOR A.C. MAINS.
MODEL 1V.20. Size 9 by 5 by 3½ ins.

H.T. tapping for S.G. valves, variable 0-120 and fixed 120/150 volts (this tapping can be reduced to 100 volts). Approximate running costs 3s. per 1,000 hours, 6 watts, at 6d. per unit. For A.C. Mains (a) 200-250 volts, 40-100 cycles, (b) 100-120 volts, 40-100 cycles. **£4-12-6**

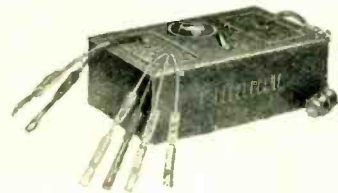

Model C.P.1.



Model 1V.20 for D.C. Mains.

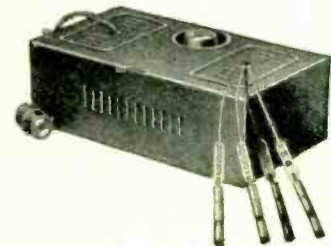

Model 1V.20 for A.C. Mains.

E. K. Cole, Ltd., Dept. F "EKCO" Works, Leigh-on-Sea.

Leaders of BRITISH "ALL-ELECTRIC" RADIO.

And yet And Marconiphone

**Free Training for
Marconiphone Dealers
Assistants in After-Sale**

**—"THE MASTERSTROKE
OF SALESMANSHIP"**

"Service after purchase presents the splendid opportunity for that masterstroke of salesmanship—the 'selling' of yourself and your firm as well as your merchandise to the customer. It is the opportunity for creating that intangible yet real form of advertising called 'goodwill,' whose value is so unquestioned that it is no longer considered as a mere asset, but rather a necessity for success."

**Other
Lead**

**& their
es Radio
Service**



THE SCHEME IN BRIEF!

- Course (A) Standard short full-time course of one week at our Dagenham Works.
- „ (B) Comprehensive three-week full-time course at our Dagenham Works.
- „ (C) Evening Classes of 16 lectures and practical demonstration at Radio House, Tottenham Court Road, London.

Apply for full details to

The MARCONIPHONE CO., LTD., Radio House, Tottenham Court Road, London, W.1

VARLEY PREPARE FOR

FACTORY ENLARGED FOR



Varley All-Electric 3-Valve Receivers. List Nos. AP3 (A.C.) and AP4 (D.C.) 25 GNS. (Marconi Royalty extra, each 20/-).



Working to utmost capacity in their big, newly extended factory, making sets as fast as they can, building up stocks to meet next season's huge demand, Varley are going right ahead to sweep the set market. Next season's Varley sales will be

For
RADIO
OLIVER PELL MANUFACTURE

Varley

Advertisement of Oliver Pell Control Ltd., Kingsway House, 103, Kingsway, London, W.C.2. Telephone: Holborn 5303.

NEW SEASON'S BIG DEMAND

INTENSIVE PRODUCTION



Varley All-Electric 2-Valve Receivers. List Nos. AP1 (A.C.) and AP2 (D.C.) 18 GNS. Marconi Royalty extra, each 15/-.

enormous. They've got the performance. They are a really sound proposition. There will be a huge demand.

Stock these "Radio for the Million" lines specified in the Mullard "High Power H.T. Supply Unit."

Two Varley Power Potentiometers—
1-10,000 ohms. Price 10/-
1-50,000 ohms. Price 10/6

One Varley Standard L.F. Chok. Price £1.
One Varley Dual L.F. Chok. Price £1-1-0.



Advertisement of Oliver Pell Control Ltd., Kingsway House, 103, Kingsway, London, W.C.2. Telephone: Holborn 5303.



SELL

ONCE again Philips, the pioneers of all-electric radio, have taken a decisive step. They are conducting a comprehensive National, Provincial and Magazine advertising campaign, with a view to increasing Summer Sales. Hitherto sales have slumped badly during the summer months, your profits

have dropped too, and these slack months have had an adverse effect on your balance for the year. Now at last a great manufacturer has had the courage to say radio is an all-the-year-round market.

So get in with the Philips Summer Sales Campaign and abolish the slack months.

Watch the Summer Sales Sign and ensure your share of the profits.

Write for your copy of the "Music from the Mains" poster. Philips All-electric Receiver Type 2514 (for A.C. Mains) and Type 2524 (for D.C. Mains) Price £23 0 0

Loudspeaker Type 2007	Price £5 5 0
Philips All-Electric Receiver Type 2515.	Price £12 10 0
Loudspeaker Type 2016	Price £2 10 0
Philips All-Electric Receiver Type 2511	Price £37 10 0
Moving-Coil Loudspeaker Type 2013	Price £14 14 0

Or on Easy Payment Terms.

You make practically the same profit immediately from a Hire Purchase Sale as from a cash order.

Philips All-Electric Receivers are made by the manufacturers of the famous Argenta electric lamps, commercial and industrial fittings, and neon signs.

PHILIPS

ALL-ELECTRIC

RADIO

PHILIPS LAMPS LTD., Philips House, 145 Charing Cross Rd., London, W.C.2

MUSIC FROM THE MAINS

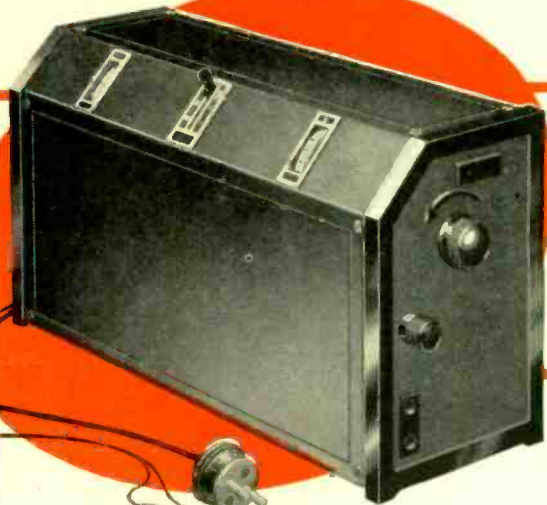

SET MANUFACTURERS— Here's the valve for you

You can save money—save costs on production if your valves cost you less. You can sell more sets at a lower price—reach a much wider market if your valves, besides costing less, are of better quality. Quality is the keynote of Tungram Valves—they have the famous Barium Filament. This quality costs twice as much in any other valve. Build Tungram into your sets—Tungram D.C. Valves for battery operated sets—Tungram A.C. Valves for all mains receivers—you won't sacrifice an atom of quality but your sets will cost less.



TUNGSRAM

BARIUM VALVES

TUNGSRAM ELECTRIC LAMP WORKS (GT. BRITAIN) LTD.

COMMERCE HOUSE, 72, OXFORD STREET,
LONDON, W.1.

Factories in Austria, Czechoslovakia, Hungary, Italy and Poland.

Branches: Belfast, Birmingham, Bristol, Cardiff, Glasgow, Leeds, Manchester, Newcastle, Nottingham.

BETTER SETS AT LOWER PRICES



MORE THAN THIRTY Set Manufacturers in Great Britain use TUNGSRAM BARIUM VALVES in their sets. TUNGSRAM Valves cannot be beaten for quality and efficiency.

The specialised knowledge of TUNGSRAM Technical Department is at your service. Write them for any information you require on circuits—positions of valves—which types of valves to use—any and every set problem on which the experience of a famous valve maker can be of value to you.

Let **BURNDEPT PORTABLES** carry you through the summer

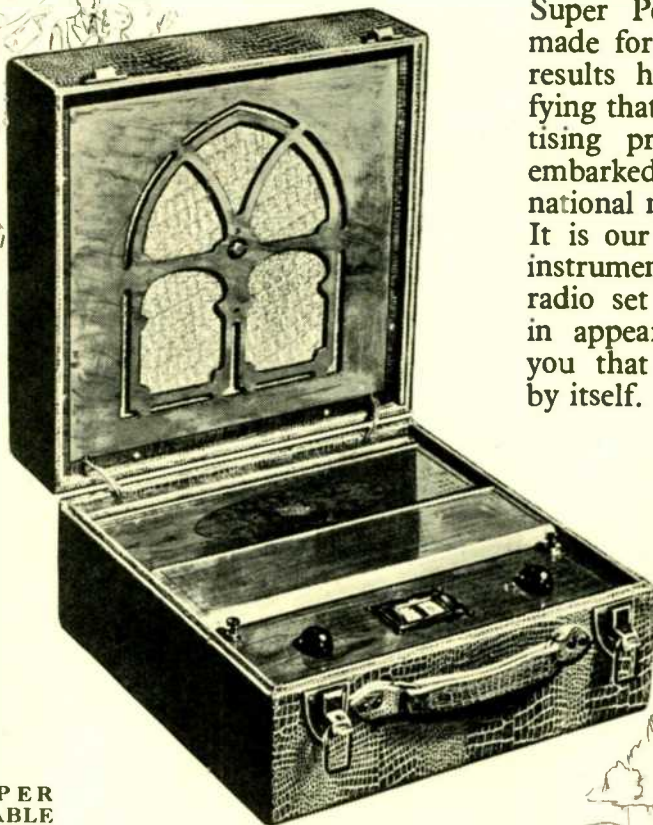

Deliveries of the "Burndept Super Portable" have been made for some weeks and the results have been so gratifying that an extensive advertising programme has been embarked upon in the great national newspapers.

It is our firm belief that this instrument is the best Portable radio set on the market, while in appearance we can assure you that it stands in a class by itself.



BURNDEPT SUPER SCREENED PORTABLE

has a crocodile grained polished hide case with loud-speaker grille and panels of superb polished walnut or mahogany finish as desired. Its construction is carried out with the most minute care.

Four valves are used, including a Screened Grid H.F. Stage with a super power valve in the output, and though economical in battery consumption, the quality of reproduction obtained with the balanced armature cone speaker is superb. Retails complete at £23-10-0, or £2 down and 12 monthly payments of £1-17-8.

BURNDEPT SCREENED PORTABLE

This receiver has a great number of the good points of the Super model, and is remarkable value. Retails complete at £19-19-0, or £1 down and 12 monthly payments of £1-13-2.

Order a demonstration model immediately and be ready to supply the demand. Display material and full particulars of the Burndept Hire Purchase System can be had on request.

Showrooms and Trade Counter : Roxburghe House, 283 Regent Street, London, W.1.
Scottish Depot : 28 Berkeley Street, Glasgow.

BURNDEPT WIRELESS (1928) LTD., Blackheath, London, S.E.3

THE WHOLE RANGE OF MELODY

THE EDISON BELL

**ALL MAINS
RADIO
GRAMOPHONE**



The Edison Bell All-Mains Radio Gramophone, as its name implies, has been developed to operate entirely from the ordinary lighting mains, requiring no batteries whatsoever. Cabinets are fitted with ample storage space for Records and are beautifully finished in Oak, Mahogany or Walnut. (A.C. or D.C. (Mains).

Ask for full particulars.

PRICE

	A.C.	D.C.
Oak	£65 0 0	£84 0 0
Mahogany	£68 10 0	£87 10 0
Walnut	£72 10 0	£91 10 0

Complete, Including Marconi Royalties

EDISON BELL, LIMITED

LONDON, S.E.15

OUR
**AUTOMATIC
 COIL
 WINDERS**

Wind without worry

Our Very Latest Productions

The "DOUGLAS" (hand-driven)

A new Machine possessing
 many novel features

(PATENTS APPLIED FOR IN ALL COUNTRIES)

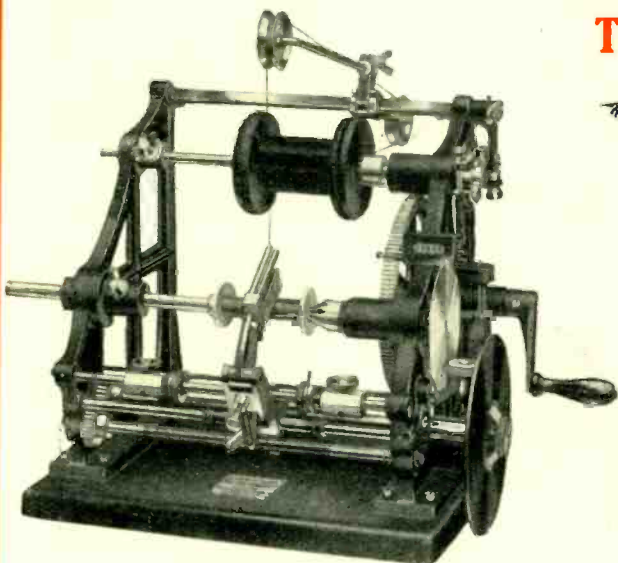

The "DOUGLAS" (hand-driven)

with attachment for the automatic insertion of
 paper, between each layer, every other layer, or
 at any intervals desired.

(PATENTS APPLIED FOR IN ALL COUNTRIES)

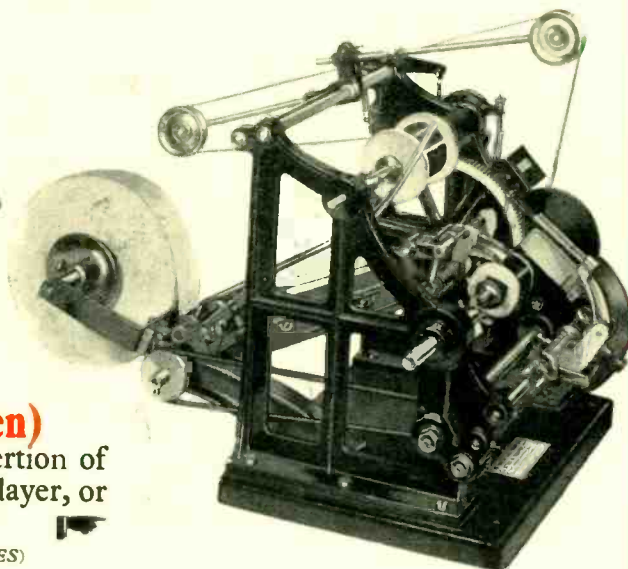

Write for Illustrated matter to

THE AUTOMATIC COIL WINDER & ELECTRICAL EQUIPMENT CO., LTD.,
 "Winder House," Douglas Street, London, S.W.1

Telephones: VICTORIA 3405/6

Telegrams: AUTOWINDA, SOWEST LONDON

ALSO MANUFACTURERS OF THE "AVOMETER"

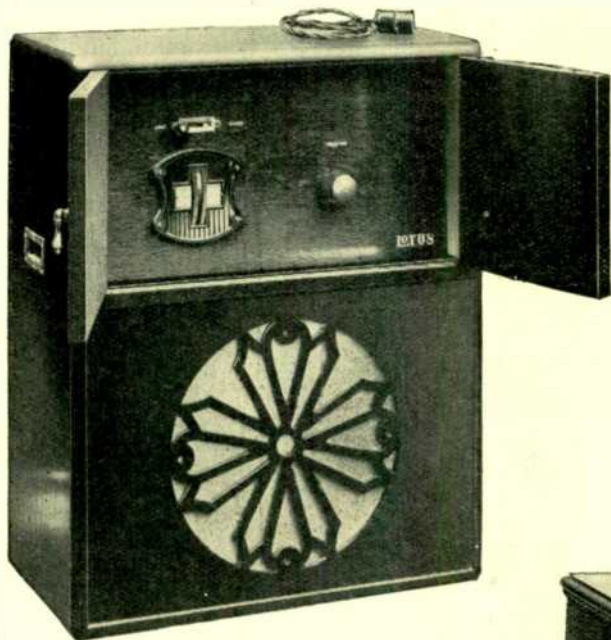

LOTUS 3-VALVE ALL-MAINS TRANSPORTABLE RECEIVER. Entirely self-contained—no aerial or earth—three valves only, yet giving the strength and clarity of five. Worked direct from the mains—no batteries needed. Fitted with turntable for directional reception.

Retail prices: Oak Cabinet, £25 4s. cash, or £22 7s. down and eleven equal monthly instalments. Mahogany or Walnut Cabinet, £26 5s. cash, or £22 9s. down and eleven equal monthly instalments.

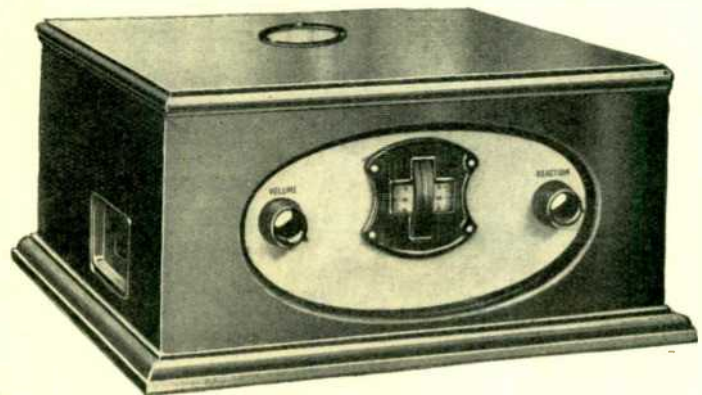

LOTUS 3-VALVE S.G.P. ALL-MAINS RECEIVER. Employs a Screened Grid H.F. Amplifier, a High Efficiency Detector and a Pentode Power Amplifier. No batteries required—a steady supply of power being obtained direct from the electric light mains at an infinitesimal cost.

In Oak or Mahogany: Retail Price £21 cash (complete with valves and Royalties paid), or £1 19s. 9d. down and eleven equal monthly instalments.

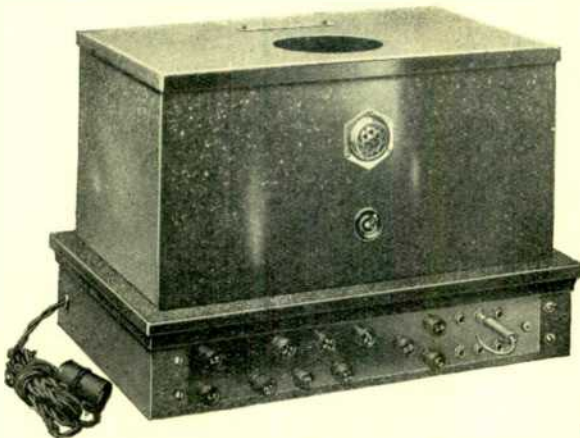

LOTUS ALL-MAINS UNIT FOR A.C. MAINS. Supplies complete power for non-battery sets. Acts as H.T. Eliminator for sets with battery-heated valves. In handsome metal case: Retail Price £7 7s. cash, or 14s. 6d. down and eleven equal monthly instalments.

Write for full particulars of Lotus All-Mains Remote Control System. Cost of complete outfit for two rooms, 47s. 6d.

LOTUS

ALL MAINS PRODUCTIONS

Garnett Whiteley & Co. Ltd., Lotus Works, Mill Lane, Liverpool
 London Depot: 183, Old Street, E.C.2

Telephone: CLERKENWELL 2550.



A.C or D.C

The new SELECTOR ELECTRIC "42"

THIS DEFERRED PAYMENT PLAN will help to maintain Summer Sales

Many of your customers would prefer to purchase a receiver of SELECTOR quality without paying the full price at once. Here is your opportunity to assist them.

THE ATTACHE "32"
£5 down, 12 monthly payments of £2-12-6

THE CABINET "32"
£5 down, 12 monthly payments of £2-12-6

THE ELECTRIC "42"
£7 down, 12 monthly payments of £3-8-0

THE ELECTRIC "55"
£8 down, 12 monthly payments of £4-10-6

**Get your profit immediately
and take no responsibility**

THE ELECTRIC "55" This model has already proved its popularity. It embodies a moving coil loud speaker of exceptional merit and like the "42" is entirely self-contained and highly selective. Price complete 55 guineas.

THE new SELECTOR ELECTRIC "42" is a completely self-contained receiver for operation off A.C. or D.C. mains.

Selectivity has been developed even to the degree of separating stations almost within sight of the aerial. Reproduction is superb and the quality and finish are of the usual high SELECTOR standard.

At 42 guineas complete this latest SELECTOR product has opened up a hitherto unexplored market.

Make a special feature of this receiver the demand for which is already being experienced.

Selector
Quality Supreme

SELECTORS LTD., 206 Bedford Avenue, Slough Trading Estate, Slough, Bucks.

'Phone : Slough 818. 'Grams : Selectors, Slough. London Office : 1 Dover Street, W.1 'Phone : Regent 4771.

ALL - ELECTRIC RADIC

12 V accumulator, or any voltage D.C. mains. Type E delivers up to 60 W at 600 V or 50 W at voltages between 600 and 1,000, while type F gives 100 W up to 600 V and 80 W between 600 and 1,000 V. Of particular interest are the several D.C.-to-A.C. rotary transformers enabling standard A.C. receivers to be operated from D.C. mains.



The Marconiphone Model 47, all-mains A.C. receiver—the only metal-cased set in the range.

Machines can be supplied which will give outputs of up to 85 W, while the M-L motor generator sets will run off A.C. or D.C. mains, giving L.T. and H.T. outputs of up to 170 W.

M.P.A. Wireless (1930), Ltd., 62, Conduit Street, London, W.1.

RECEIVERS.

Three-valve A.C. receiver. Utilises S.G.P. circuit, the first two valves being indirectly heated. Provision is made for a pick-up. Suitable for 100-110 V or 200-240 V mains, the set sells at 25 gns.

S.G. Transportable Four. This A.C. set has two transformer-coupled stages, and makes use of indirectly heated valves. An M.P.A. speaker is incorporated, and a pick-up can be used. For 100-110 V, 200-240 V mains, the Transportable Four sells at 33 guineas in art leather, 35 guineas in mahogany, and 36 guineas in walnut.

RADIO-GRAMOPHONE.

In addition to a self-contained M.C. speaker this instrument is supplied with an external cone speaker for use in a separate room. Indirectly heated valves are used, except the LS5A power valve, and D.C. and A.C. models are available for 100-110 V and 200-240 V mains. Price, oak or mahogany, 90 guineas.

L. McMichael, Ltd., Wexham Road, Slough.

RECEIVER.

The McMichael A.C. mains-driven screened Dimic Three is supplied with 1 H.F. screened valve, 1 A.C. heated detector and 1 A.C. heated power valve, and it is priced at 28 guineas complete. It is, of course, well known for its long-range possibilities.

Mains Radio Mfg. Co., 42, Green Lane, Thornton Heath, London, S.W.

RECEIVER.

"M.-R. Electric Transportable" for A.C. mains. Employs an S.G. H.F. stage, a detector, and a transformer coupled L.F. stage, all the valves being of the indirectly heated type. Full-

wave valve rectification. Incorporates a double linen diaphragm speaker beneath the receiver. Tuning range, 200-250 and 900-2,000 metres. Provision for pick-up. Price 28 guineas.

The Marconiphone Co., Ltd., 210-212, Tottenham Court Road, London, W.1.

RECEIVERS.

Model 47 is a 4-valve for use only on A.C. mains, and the circuit comprises a screened-grid valve, detector, and two R.C. stages. Marconi valves of the special A.C. mains type being used. Price, complete, £24.

In addition, Models 39 and 56 can be supplied for use on mains.

Model 39 is a 3-valve receiver supplied for A.C. with an H.T. and L.T. unit, price £21; also with a D.C. unit giving H.T., price £17 15s.

Model 56, a 5-valve set, with a combined H.T. and L.T. mains unit for A.C., price £35, and for D.C. with an H.T. unit only, £17 15s. The units used are described below.

MAINS UNITS.

Model A.M.7 is a combined instrument supplying H.T. up to 200 V 50 mA, with three intermediate tappings. The L.T. supply is 8 V and 4 V up to 3 A, and 6 V up to 1 A (L.T. outputs A.C.). Price, complete, £7 10s. This unit is incorporated in the A.C. types of Models 39 and 56 receivers.

Model A.C.7 supplies H.T. only, giving the same rated outputs as the A.M.7 unit described above. Price £6 10s.

Model D.C.7 supplies H.T. from D.C. mains, and is priced complete at £4. This unit is incorporated in Models 39 and 56 receivers when required for D.C. mains.

GENERAL.

A series of moving-coil speakers for mains use is also included in the Marconiphone range, among them being Model 120, drawing its field current direct from 100-250 V D.C. mains. Price £7 10s.

A similar speaker to the above, but for A.C. mains of 200-250 V, is Model 130. Price, complete with a U.9 rectifying valve, £12 12s.

Mic Wireless Co., White Horse Place, Market Street, Wellingborough.

The Mic Wireless Co., manufacturers of Zampa components, as is well known, concentrate on mains apparatus, and they now specialise in making all types of A.C. transformers, chokes and mains units (incorporating Westinghouse rectifiers) to the individual requirements of manufacturers, and thus it is difficult to state standard prices.

The company, however, would be glad to hear from manufacturers with a view to executing their special orders, for which purpose they are now well equipped.

Mullard Wireless Service Co., Ltd., Mullard House, Charing Cross Road, London, W.C.2.

MAINS UNITS.

P.M. H.T. unit. This is for A.C. mains, and sells at £5 5s. It has four tappings, and utilises full wave valve rectification.

GENERAL.

Mullard make a speciality of their P.M. filament transformer for supplying current to the heaters of A.C. valves. Six types

are produced, covering mains voltages of 100-260 V, and having a standard output of 5 A at 4 V. Price 32s. 6d.

A wide range of resistances is manufactured, as well as a potential divider in which the elements are sealed into a glass container. In addition, it should be noted that most of the well-known Mullard constructional sets can be mains driven. Further details appear in "Radio for the Million" for April, 1930.

Details of the Mullard A.C. valves and rectifiers are contained in tabular form on p. 276.

Neophone Engineering Co., 9-10, Little St. Andrew Street, London, W.C.2.

MAINS UNITS.

Neophone are concentrating especially on one A.C. and one D.C. unit. These are both rather similar in appearance, with the tappings brought out to a vertical panel. For 100 V D.C. mains the unit sells at £2 2s.; for 250 V D.C., at £3 3s.; and for A.C. mains at £4 10s. Rectifying valve extra.

Nottingham Radio Supplies, Sherwood Buildings, Nottingham.

RECEIVERS.

Four all-mains receivers are listed by this firm, two for A.C. and two for D.C. supplies. The 2-valve D.C. receiver, including valves, is priced at £11 10s., and the 3-valve D.C. receiver at £15.

For A.C. supplies, the 2-valve receiver lists at £12 10s. and the 3-valve model at £18. Royalties extra.

C. H. P. Nutter, 245, Selhurst Road, London, S.E.25.

RECEIVER.

Mains Three. Indirectly heated valves are employed throughout. There is one S.G. stage, with a detector, transformer-coupled to the output valve. Provision is made for the use of a pick-up. For A.C. mains of 200-250 V the "Mains Three," in an oak or mahogany cabinet, sells at £25 15s., with Amplion AB6 speaker.

Oldham & Son, Ltd., Hyde Road, Denton.

MAINS UNITS.

Oldham market a rather unusual form of A.C. mains H.T. supply, which they name the "H.T. Auto-Power Unit." It consists essentially of a 120 V H.T. accumulator built into a single unit with a suitable charger. Arrangements are made for the mains to be automatically switched off when a 5-pin H.T. plug from the set is inserted in the appropriate sockets. Price £5 18s. 6d.

Another model, which has an attachment for charging 2, 4 or 6 V L.T. accumulators, is priced at £6 18s. 6d.

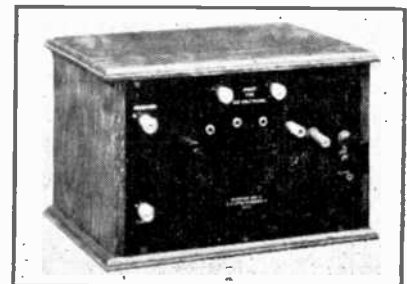

This is an A.C. H.T. mains unit marketed by the Neophone Engineering Co.

ALL - ELECTRIC RADIO

The "L.T. Auto-Power Unit" works on the same principle, but, of course, is only equipped with an L.T. accumulator. Three models are made for 2, 4 and 6 V supplies respectively, and in these the chargers give up to 9A output. Prices: 2 V, 45s.; 4 V, 58s. 6d.; 6 V, 65s. 6d. **Partridge & Mee, Ltd.**, 74, New Oxford Street, London, W.C.1.

MAINS UNITS.

"Junior" model. Output 120 V, 20 mA. Four tapings, giving 50, 70 and 100 V. Rectifier: U₄ valve. Price £4 15s.

"Senior" model. Output 120 V, 42 mA. Two H.T. tapings, one fixed, one variable. Rectifier: U₅ valve. Price £8 10s.

AC₃ model. Output 400 V, 50 mA. Two variable taps, 0-180 V. Rectifier: U₅ valve. Filament output 5 V 3 A, A.C. Price £13 10s.

AC₄ model. Output—H.T. 500 V, 100 mA, two variable tapings, 0-200 V. L.T. 5 V 3 A, A.C. Rectifiers: two U_{65/550} valves. Price £16 10s.

S₂ H.T. and L.T. model. Output—H.T. 140 V, 40 mA. Two variable tapings, 0-100 V, one fixed, 90 V. L.T. 4 V 4 A. Rectifier: U₅ valve. Price £9 10s.

H.T. and L.T. model. Output—H.T. 180 V, 40 mA, two variable tapings, 0-120 V. L.T.—2, 4 and 6 V at 1A, D.C. (W.R.). For H.T. rectification a U₅ valve is used, and all outputs are D.C., smoothed. A Ferranti voltmeter is fitted. Price £17 10s.

L.T. unit. Output—2, 4 or 6 V, 1 A (W.R.). Ferranti voltmeter.

Perfectavox, Ltd., Alexandra Works, Yeadon, Yorks.

RADIO-GRAMOPHONES.

All Perfectavox radio-gramophones are constructed in high-class and imposing pedestal cabinets, utilise electric gramophone motors, and are fitted with both

volume and brilliancy controls. All are for A.C., and have M.C. speakers. Special cabinets can be made to order.

Senior model, detector and 2 L.F. In oak, 80 guineas; veneered Queen Anne mahogany, 83 guineas. Senior S.G. model, S.G. detector and two L.F. stages. In lion oak, 100 guineas; veneered Queen Anne mahogany, 103 guineas; mahogany or burr walnut console, 120 guineas. These are for outside aerial systems.

Senior model with two S.G. stages has a rotatable frame aerial in the lid. In oak, it sells at 110 guineas; in mahogany, 68 guineas. Junior S.G. model, in oak, 65 guineas; mahogany, 68 guineas.

Philips Lamps, Ltd., 145, Charing Cross Road, London, W.C.2.

RECEIVERS.

All the Philips mains sets cover from 200-600 metres and 1000-2000 metres, except the 2511, which covers 200-600 and 800-2000 metres.

Type 2514. 3-valve set for A.C. supplies, utilises an S.G.P. circuit, and has provision for a pick-up. Valves: Mullard S 4 V, 154 V, PM 24, and Philips rectifying valve 506 K. Price £23.

Type 2511. 4-valve set for A.C. has two S.G. stages, and pentode output, with provision for a pick-up. Valves: Mullard S 4 V (5-pin), one 154 V (5-pin), one PM 24 A and Philips rectifying valve 506 K. Price £37 10s.

Type 2524. 3-valve set for D.C. This also has an S.G.P. circuit, with provision for a pick-up. Valves: Mullard PM 13, PM 4 DX, and PM 25, together with a Philips 1904 resistance lamp. Price £23.

Type 2515. 2-valve set for A.C. has a pentode output stage, and provision for a pick-up. Valves: Mullard 154 V (5-pin), PM 24 (5-pin) and Philips rectifying valve, 506 (large bulb). Price £12 10s. The 2502 general purpose receiver, and the 2802 model can both be used with mains units.

MAINS UNITS.

Type 3002 for A.C. Output 30 mA at 150 V. Six tapings. Price £5 10s.

Type 3009 for A.C. Output 22 mA at 150 V, and 20 V G.B. Four H.T. tapings, two adjustable and one fixed G.B. tapping. Price £5 15s.

Type 3005 for D.C. Two variable tapings. Price £3 17s. 6d.

CHARGERS.

Type 1017 trickle charger. Philips rectifier. A switch is fitted which, rotated in one direction, switches on both the H.T. and the L.T. accumulator, and in the other direction connects the accumulator

to the "charge" position when the receiver is not in use. Price £2 15s.

Type 1101 charging station rectifier, deals with up to sixty H.T. accumulator cells at 250 mA, and up to six L.T. accumulator cells at 2 A. Price £6 10s.

Type 300. Three outputs, 1-4 cells at 6 A, 5-7 cells at 3 A, and 1-4 cells at 3 A. Price £6 0s.

GENERAL.

Moving-coil speakers. Type 2013 (without step-down transformer), for use with 2511 receiver. Price 14 guineas. Type 2011 with step-down transformer. Price 15 guineas. Type 2048 unit without transformer, 8 guineas. With transformer (as type 2049), 9 guineas.

Type 4009 filament transformer for 100-260 V, 40-100 cycle mains. Output up to 5 A at 4 V. Price 29s. 6d.

In addition to the above apparatus Philips manufacture a comprehensive range of mains-driven power amplifiers, varying in size from a small 2-valve model for use with a pick-up to full-size instruments for public address and similar work. Prices are obtainable on application. **C. Haddon Poupard & Co., Ltd.**, Thermion Works, Ilford, Essex.

RECEIVERS.

The Thermion all-electric 3-valve set is designed for use with D.C. or A.C. mains, and is priced at 23 guineas.

The all-electric *de-luxe* model is capable of driving a moving-coil loud-speaker and lists at 31 guineas for D.C. or A.C.

RADIO-GRAMOPHONES.

Incorporating a moving-coil speaker, the Thermion radio-gramophone, type RG 1, is equipped with a Thermion super amplifier and electric motor. The D.C. model is priced at 69 guineas and that for A.C. mains at 84 guineas.

Model RG 2 is suitable for large halls, and incorporates a more powerful amplifier than that in RG 1. It sells at 77 guineas. (D.C.) and 95 guineas (A.C.).

For use in districts at a considerable distance from a broadcasting station, the firm market model RG 3, selling at 80 guineas (D.C.) and 100 guineas (A.C.).

MAINS UNITS.

H.T. supply units F. 1 (D.C.) and F. 2 (A.C.), are suitable for low power sets. Price with two outputs, F. 1, £2 19s. 6d., F. 2, £4 12s. 6d.

Models F. 3 (D.C.) and F. 4 (A.C.) have three outputs: one variable, 60-100 V 6 mA; two fixed at 140 V 12 mA, and 180 V 60 mA respectively. F. 3 sells at £5 15s. and F. 4 at £10 10s.

For powerful receivers there are the H.T. units, F. 5 (D.C.) and F. 6 (A.C.), with four outputs: two variable, 80-120 V 2 mA, and 60-150 V 6 mA; two fixed at 150 V 25 mA, and (A.C.) 400 V 120 mA, (D.C.) 200 V, respectively. Price: (F. 5) £8 8s., (F. 6) £18 18s.

The firm also list two L.T. units: F. 7 for D.C., and F. 8 for A.C. mains (W.R.). With outputs of 2-6 V, 0.35 A, they are priced at (F. 7) £7 7s., and (F. 8) £9 9s.

For more powerful receivers there are F. 9 (D.C.), F. 10 (A.C.) models, maximum output being 6 V 1.1 A. Complete with voltage regulator and voltmeter, they sell at £8 15s. (F. 9) and £10 17s. (F. 10).



The "Pantophase" reproducer which is a product of the Radio and Electro-Acoustic Development Co.



Completely enclosed in a metal case—the Partridge & Mee Senior H.T. unit for A.C. mains.

ALL - ELECTRIC RADIO

HL 1 is a combined H.T. and L.T. unit with the following outputs: (H.T.) one variable 60-100 V, one fixed at 120 V; (L.T.), 2.6 V .35 A. Price for D.C., £9 15s., for A.C., £15 15s. (W.R.)

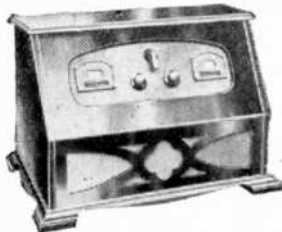

Neat and distinctive in appearance is the Pye 3-valve A.C. model, with its unusual cabinet.

Model HL 2 is supplied with voltage regulator and voltmeter. H.T. outputs: (variable) 80-120 V 2 mA, 60-150 V 6 mA; (fixed) 150 V 25 mA and 400 V 120 mA. L.T. outputs: 6 V 2 A. Price for D.C., £10 10s.; for A.C., £28 10s. (W.R.)

GENERAL.

The Thermion moving-coil loud-speaker can be supplied for field excitation by 100-250 V D.C. mains, or complete with rectifier for A.C. Price for D.C., £11 5s., and for A.C., £16 5s.

Pye Radio, Ltd., Paris House, Oxford Circus, London, W.1.

RECEIVERS.

Model No. 350/A.C.: 3-valve all-electric receiver consisting of screen-grid valve, transformer-coupled to anode bend detector, which is in turn transformer-coupled to a super power output valve. Provision for gramophone pick-up. Wave-length range: 200-500 and 580-2,260 metres. Price £25.

Model No. 275/A.C.: 2-valve all-electric receiver comprising a detector transformer-coupled to L.F. amplifier. Provision for gramophone pick-up. Wave-length range: 200-525 and 900-2,000 metres. Cone loud-speaker is incorporated in the set. Price £17 10s.

MAINS UNITS.

Mains units No. 924/5 (W.R.) are stated to be especially developed for use with Pye portables. They can also be used with "straight" 2- and 3-valve receivers. No. 924 can be used on mains from 200 and 250 V, and No. 925 on 100-110 V, 40-100 cycle supplies. Two outputs: one fixed at 122 V 15 mA, and one variable, 35-120 V 1.2 mA. Price £5.

No. 934 (W.R.) for A.C. mains between 220 and 250 V, 40-100 cycles. Outputs: 130 V, 20 mA, variable 30-120-V, 1.2-5 mA, 60 V (suitable for supplying the screen voltage to S.G. valves); for grid bias, 1.5 V, 2.3 V, 3.9 V, and 13-15 V. Price £7 10s.

For D.C. mains between 200 and 250 V, a similar model to 933 is No. 934, selling at £5 10s.

Radio and Electro-Acoustic Development Co., 9, Ward Road, Dundee.

RECEIVERS.

This firm produce a range of "Pantophase" receivers for A.C. or D.C. mains. The "Pantophase" 2-valve instrument employs a detector and a pentode output

valve, and is mainly intended for local station reception. Price, for A.C. or D.C., £13.

The 3-valve receiver has an S.G. H.F. stage followed by a detector, and a pentode in the output position. Wave-length ranges, 200-550 and 1,000-2,000 metres. Prices, for A.C. or D.C. mains, £23.

The "Pantophase Four" is a long range receiver, employing an S.G. valve, a detector and two L.F. stages, with a super power valve in the final position. Prices: for A.C., £33; for D.C., £31.

RADIO-GRAMOPHONE.

The "Pantophase Radio Concertgram" is available either in a solid mahogany or oak cabinet, and employs an S.G. stage and a detector before a powerful L.F. amplifier. It is equipped with a moving-coil speaker, and a volume control which is operative on both radio and pick-up. Prices: A.C. model, £71 8s.; D.C. model, £68 5s.

ELECTRICAL GRAMOPHONE.

The "Pantophase Concertgram" is an all-electric gramophone embodying a powerful amplifier and a moving-coil speaker. It is housed in a similar cabinet to that of the radio-gramophone described above. Prices: A.C. model, £50 8s.; D.C. model, £47 5s.

GENERAL.

Other products of this firm include all types of mains units and power transformers, and complete talking film and public address apparatus.

Radio Instruments, Ltd., 12, Hyde Street, New Oxford Street, London, W.C.1.

RECEIVERS.

The screen-grid 3-valve "Madrigal" receiver is the only all-mains receiver produced at the moment by R.I., Ltd. It is designed for operation from A.C. or D.C. mains, and is supplied in three forms—as a receiver only, price £30 (A.C. or D.C.); as a receiver mounted on a pedestal, £36 (A.C. or D.C.); as a receiver mounted on a pedestal and including a moving-coil speaker, £48 18s. (A.C.) and £45 15s. (D.C.). The cabinet work, which reaches a high standard of quality, is obtainable in walnut or mahogany.

We understand that a 4-valve receiver, on the lines of the above instrument, is shortly to be added to the R.I. range. Further particulars of this will be announced in the near future.

GENERAL.

R.I. metal rectifier transformers, approved for Westinghouse rectifiers of various types, are listed, each transformer being enclosed in a rectangular



The de-luxe instrument of the Philips series of receivers—the 4-valve model for A.C. mains.

metal case, and fitted with insulated terminals. The prices range from £1 1s. to £2 2s., according to type.

A universal power transformer for A.C. and rectifying valves is the No. EY4, selling at £2 7s. 6d. It is supplied for A.C. mains between 100 and 120 V or 200 and 250 V, 40/100 cycles.

No. EY5 is a heavy duty power transformer specially designed to provide the output necessary for operating moving-coil speakers. It has a tapped input, making it suitable for use on A.C. mains between 200 and 250 V or 100 and 120 V, 40-100 cycles. Completely enclosed in a strong metal case, it sells at £3 10s.

A small power transformer for half-wave rectification is designed for supplying suitable H.T. D.C. voltage after rectification and smoothing; also filament current for receivers up to three valves. It will work from A.C. mains between 100 and 120 V or 200 to 250 V, 40-100 cycles. Price £1 5s.

Among numerous other R.I. products in the mains field may be mentioned the R.I. moving-coil speaker, one type being for D.C. mains of 100-120 V or 200-240 V, and the A.C. model for mains of 100-120 V or 200-250 V, 40-100 cycles. Prices: A.C. (table model) £14, (pedestal model) 18 guineas; D.C. (table model) £11, (pedestal model) 15 guineas.

Radiovolt, Ltd., Kingston Road, Staines, Middlesex.

RECEIVERS.

The Radiovolt "Regal" 2-valve all-electric receiver for A.C. mains is a self-contained transportable, specially designed to meet the conditions existing under the complete Regional Scheme. It is housed in a dark brown leatherette-covered case, with the speaker below the receiver. The circuit comprises a detector and a pentode valve, and, it is stated, no aerial,

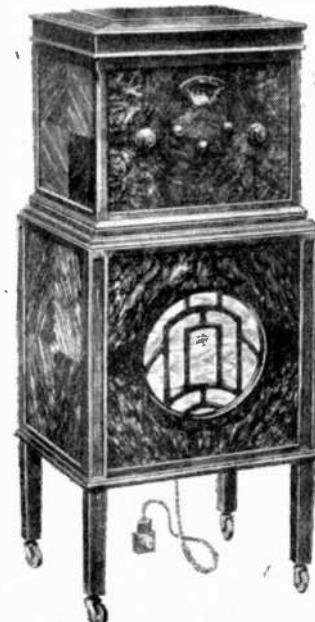

The "Madrigal" all-electric transportable receiver which incorporates a moving-coil speaker.

ALL - ELECTRIC RADIO

either external or frame, is required for its operation. (W.R.) Price £13 13s.

Radiovolt also market a 3-valve "Senior" A.C. receiver, similar in appearance to the 2-valve model. Price 19 gns. **Regent Radio Supply Co.,** Bartlett's Buildings, Holborn Circus, London, E.C.4.

RECEIVER.

Three-valve A.C. set. Utilises one S.G. stage, and A.C. valves. Covers long and medium waves, and has a pre-detector volume control. Pedestal model, £27 10s.; cabinet model £22 10s. (W.R.).

MAINS UNITS.

D.C. units for 220 V. Type DC 1. Output 120 V, 25 mA. Two tappings, one variable. Price £2 5s. D.C. de luxe Model. Output 160 V, 50 mA. Three tappings, two variable, 120 V, one fixed 160 V. Price £3 18s.

A.C. units, all for 240 V. All utilise Westinghouse rectifiers.

Model W 1 D. Output 120 V, 15 mA. Two tappings. Price £3 5s.

Model W 1 C. Output 120 V, 18 mA. Two tappings, one variable. Price £3 15s.

Model W 1 B.S.G. Output 130 V, 20 mA. Three tappings, two variable, 0-120 V. Price £4 19s. 6d.

Model W 1 A.S.G. Output 160 V 30 mA. Four H.T. tappings, one variable 0-150 V, one L.T. output; A.C., 4 V up to 4 A. Price £6 18s. 6d.

Model W 2 A. Output 160 V, 50 mA. Three H.T. tappings, two variable, and same L.T. as W 1 A.S.G. Price £7 15s.

Model W 2. Output 200 V, 100 mA. Four tappings, three variable and same L.T. as W 1 A.S.G. Price £12.

Model W 3. Output 350 V, 100 mA. Four tappings, two variable. Price £17 10s. or with L.T. output 6 V 3 A at £1 extra.

Combined H.T. units and L.T. charger. For A.C. mains, *Model W 4 A.* Output 130 V, 20 mA. Three tappings, two variable. Charger is suitable for 2-6 V accumulators, delivering up to .5 A. Price £7 10s. (W.R.). *Model W 4.* Output 160 V, 50 mA. Three tappings, two variable. Charger suitable for 2-6 V accumulator. Price £12 10s. (W.R.).

Combined H.T. unit and L.T. trickle charger. For portable sets. D.C. model: output 130 V 20 mA. Three tappings, two variable. Charger output 2-6 V, up to 1 A. Price £4 5s. H.T. only £2 15s. A.C. models for 40-100 cycles. *W 5.* Output 120 V 15 mA. Three tappings, two variable. Charger suitable for 2-6 V accumulators. Price £5 17s. 6d., or H.T. only (as *Model W 6*) £4 5s. For 25 cycles 10s. extra.

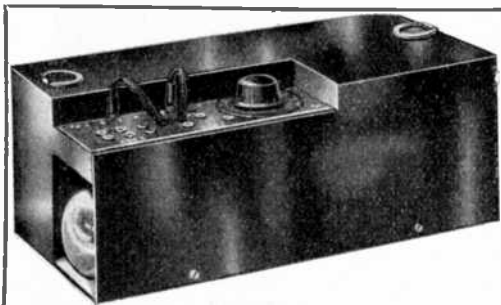

Rolls - Caydon produce this A.C. mains H.T. unit for replacing the battery in a portable.

Power Boxes. (Transformer and rectifier units). No. 1. Output 120 V, 20 mA, when smoothed. Price £2 10s. (W.R.). No. 2. Output 180 V, 30 mA, when smoothed. Price £3 10s. (W.R.). Each has L.T. output for A.C. valves of 4 V, 4 A.

Filter Compacts. (Smoothing units). No. 1. For power Box No. 1, £1 10s. No. 2. For Power Box No. 2, £2.

CHARGERS.

Suitable for 100-250 V, 40-100 cycle mains, these chargers utilise Westinghouse rectifiers. Half-amp type £2 2s. 6d. With L.T. coupler 5s. extra. One amp. charger with L.T. coupler £2 18s. 6d.

GENERAL.

Regent Radio produce numerous components, such as the "Regentstat" variable resistance at 7s. 9d., a variety of power transformers for H.T., L.T. A.C. valves and G.B. power smoothing chokes are also made.

Rolls Caydon Sales, Ltd. 77, Rochester Row, London, S.W.1.

RADIO-GRAMOPHONES.

The Rolls-Caydon "Table Grand" radio-gramophone is of the table cabinet type built in a walnut cabinet, and using an external aerial and earth. It employs an S.G. valve, a detector, and a pentode in the output stage, a cone-type speaker being incorporated. Tuning range 220-550 and 1000-2000 metres. Price 35 guineas.

The "T.R." radio-gramophone is housed in an upright walnut pedestal cabinet with a piano finish, and incorporates a moving-coil speaker. It is fitted with an electric gramophone motor. Tuning range 220-550 and 1000-2000 metres. Price 65 guineas.

MAINS UNITS.

The Rolls-Caydon H.T. mains unit for A.C. mains, is practically the same size as the ordinary H.T. battery and can, therefore, be fitted in nearly all Rolls-Caydon sets. It can also be used with any receiver of any make, not necessarily portable. Valve rectification is employed. Price 10 guineas complete with valve.

Rothermel Corporation, Ltd., 24-26 Maddox Street, London, W.1.

GENERAL.

In addition to the rectifying valves and B.L. metal rectifiers dealt with elsewhere in this issue, Rothermel are able to supply A.C. mains operated amplifiers and talkie equipment. Of particular interest is the "Orchestrope" automatic electric gramophone for A.C. mains, which will play 28 records automatically.

A wide range of the well-known "Magnavox" moving coil speakers for

A.C. and D.C. mains working is also listed, together with several induction type electric gramophone motors. The "Blue Flyer" at 6 guineas and the



The recently-introduced Regentone mains unit for incorporation in portable receivers.

"Green Flyer" at £3 15s. are examples of the latter products.

Three types of "Janette" rotary converters are marketed, together with a range of "Tobe" mains units and power condensers.

Among the smaller components are transformers, chokes, resistances, potentiometers and electrolytic condensers.

Runbaken Magneto Co., Tipping Street, Manchester.

CHARGERS.

Radio charger, for D.C. mains. Bayonet socket, and large ammeter. Price 30s. A.C. models. Type ACX, H.T. charging only, at 50-350 mA, 49s. 6d. Ammeter, 12s. 6d. Type ACX 2 for H.T. and L.T. charging at 50-350 mA and 2-3 A respectively, 95s. Ammeter, 15s. extra. Trickle charger, for 100-250 V, 40-90 cycle mains. Price, automatic type, 75s., non-automatic type, 55s. Meter 12s. 6d. extra.

Saxon Radio Co., Henry Street, Blackpool, Lancs.

RECEIVER.

The Saxon "All-Electric" 3-valve receiver for A.C. mains employs a detector and two L.F. stages, and is housed in a cabinet available in oak, walnut or mahogany. The power unit can be equipped with a valve or a Westinghouse rectifier. Tuning range 200-2,000 metres. Price 15 guineas. The kit of parts for this set, exclusive of valves and royalties is priced at £9 12s. 6d.

MAINS UNITS.

H.T. mains unit. Output 20 mA at 150 V or 50 mA at 120 V. One variable tapping giving from 40-50 V. Full-wave rectifying valve. Price 5 guineas. Kit of parts £4 5s.

"Energex" H.T. mains unit. Output 15 mA at 120 V specially built for receivers employing not more than three valves. Half-wave rectifying valve. Price, £3 12s. 6d., kit of parts £2 13s. 6d.

Selectors, Ltd., 206, Bedford Avenue, Slough, Bucks.

RECEIVERS.

Electric 55. This A.C. screened-grid set is contained in a mahogany cabinet with a built-in moving-coil speaker. Small

ALL - ELECTRIC RADIO

double doors enclose the control panel. Price 55 guineas, inclusive of self-contained frame aerial and pick-up plug.

Electric 42. This is also a screened-grid set with four valves, and is available for A.C. or D.C. mains. It incorporates a

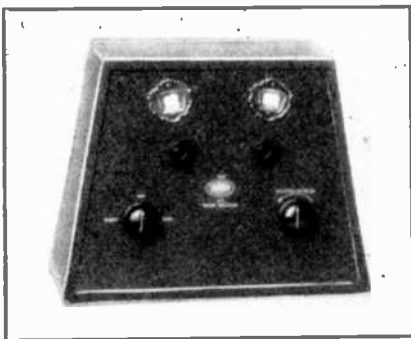

Here we show the new "Tannoy" model R. 3 all-A.C. receiver which is housed in a metal case.

built-in cone speaker with provision for the use of a second one externally. The aerial is also built-in. Price 42 guineas.

RADIO-GRAMOPHONE.

Selector-Vox all-electric console model for A.C. This instrument has twin turntables, and of course, a self-contained frame aerial. An S.G. stage and paralleled power valves are incorporated, with an M.C. speaker, making the instrument capable of supplying a large volume. Price 150 guineas.

Simmonds Bros., Shireland Road, Smethwick, Staffs.

RECEIVER.

The Berclif D.C.2 receiver is designed to work from D.C. mains of 200-250 V, the circuit comprising detector and pentode, with a 1 : 1 ratio output transformer. The standard model in oak costs £14 10s., and in mahogany £14 15s. complete.

In addition, it is of interest to note that Simmonds Bros. are prepared to supply the set in "chassis" form to traders, with or without their name on the panel. **Telegraph Condenser Co., Ltd.**, Wales Farm Road, London, W.3.

GENERAL.

As is well known, T.C.C. produce a large range of high-voltage condensers, and practically every requirement in connection with mains work can be met. Of especial interest are the T.C.C. electrolytic condensers for L.T. smoothing. One model has a capacity of 2,000µF and costs 15s., while a 4,000µF type sells at 27s. 6d.

It should be noted that T.C.C. now handle "Microfuses," which, though intended for radio receivers in general, are especially useful for mains sets.

Howard Thomas & Co., Ltd., 320, Regent Street, London, W.1.

RECEIVERS.

"Fada 25" is a walnut console model receiver with a built-in moving-coil speaker. It employs a S.G. H.F. stage, control being by a single illuminated dial calibrated in metres and kilo-cycles. A valve is used for rectification. For 100-240 V A.C. supply, price £48.

Another console model, the "Fada 42," also with moving-coil speaker, makes use of three S.G. H.F. stages. Price £48.

The "Fada 44" has the same type of chassis as the "42," but it is housed in a console cabinet with sliding doors. Price £54. The chassis only, of the "42" and "44" sets, is priced at £36, complete with M.C. speaker and valves.

The "Fada" range of receivers also includes several other console models and a table instrument in a metal case. All are for use with A.C. mains.

GENERAL.

A moving-coil speaker for use with A.C. mains is listed, this being housed in a walnut cabinet which also contains the power supply unit.

Tulsemere Manufacturing Co., 1-7, Dalton Street, West Norwood, London, S.E.27.

RECEIVERS.

The Tannoy A.C. mains 2-valve receiver, type R2, is housed in an art metal cabinet and operates entirely from the mains. Price, complete, 10 guineas.

The R3 model is similar to the above, but it incorporates an additional screened-grid H.F. valve, and is the latest addition to the Tannoy range. This set will operate a moving-coil speaker. Price 19 guineas.

The R4, forming part of the Tannoy radio-gramophone described below, has provision for a gramophone pick-up. Price 33 guineas.

RADIO-GRAMOPHONE.

The Tannoy radio-gramophone which, it will be recalled, was reported upon in a recent issue, is made in three models: 55 guineas (oak), 60 guineas (walnut or mahogany), and 65 guineas (de luxe model).

The firm also make public address amplifiers and gramophones for mains use from 50-80 guineas.

MAINS UNITS.

The Tannoy L.T. unit model L.W.A. with ammeter will supply a current of 2, 4 or 6 V at ½ A from A.C. mains, and is priced at £2 12s. 6d. (components £2 2s.), and without ammeter the price is £2 7s. 6d. (components £1 18s.). (W.R.) 1A models can be supplied for 7s. 6d. extra.

Among the H.T. units for A.C. mains is model 12C. This is suitable for the average 1-, 2-, or 3-valve set. The potential divider provides a variable voltage range (in steps of ten) for each valve, from 30-120 V at 10-15 mA. Price £2 17s. 6d. (components £2 7s. 6d.).

Model 16CH is capable of a heavier output, and provides a voltage range in ten steps up to 150 V at 20-25 mA. Price £3 15s. (components £3 2s. 6d.).

Model W8, for a receiver using two or more large power valves in the last stage. Ten tapings with a maximum of 200 V at 40-50 mA are provided. Price £5 15s. (components £4 17s. 6d.).

For portables there is the new H.T. unit type P2 for A.C. mains (W.R.). It has three tapings—one S.G., one variable, and one maximum, giving 120 V at 15-20 mA. The standard model is suitable for A.C. mains of 200-250 V, and can be varied by means of an insulated plug for mains of 200-220 V or 230-250 V. Price £3 15s.

For D.C. mains the firm produce a portable H.T. unit, model P.D.2. Price £1 17s. 6d.

The Tannoy combined H.T. and L.T. unit can be supplied for all standard A.C. mains voltages. Type H.L.1, giving an H.T. output of 150 V at 20-25 mA with ten intermediate tapings of approximately 12 V each; and an L.T. output of 2, 4 or 6 V at ½ A (W.R.), £6 10s.

Type H.L.2. H.T. output: 120 V at 10-15 mA, with ten intermediate tapings of 10 V each. L.T. output: 2, 4 or 6 V at ½ A (W.R.), £5 12s. 6d.

Type H.L.4. Specially designed for operating A.C. heated valves. H.T. output: 180 V at 20 mA. L.T. output: 4 V up to 3 A A.C., £4 4s.

Type H.L.8. For large amplifiers. H.T. output: 200 V at 40-50 mA, with ten intermediate tapings. L.T. output: 2, 4 or 6 V at ½ A (W.R.), £8 10s.

In each case a Westinghouse H.T. rectifier can be incorporated, instead of the Tannoy model, at extra cost.

CHARGER.

The Tannoy L.T. trickle charger, type L.W., charges at a rate of ½ A at 2, 4 or 6 V. Price £1 19s. 6d.

Varley (Oliver Pell Control, Ltd.), 103, Kingsway, London, W.C.2.

RECEIVERS.

All the Varley receivers and radio-gramophones this year are all-electric, and are made for A.C. mains of 100-120 V and 200-250 V, and also for 200-250 V D.C. mains. They are supplied in burr walnut cabinets specially designed by the makers.

The 2-valve instrument is primarily intended for the local and Regional stations, and for either A.C. or D.C. mains is priced at 16 guineas, royalty 15s. extra. The 3-valve model employs an S.G. H.F. stage, a detector, and an L.F. stage, and is capable of dealing with the more distant stations. Price, for A.C. or D.C., 25 guineas, plus 20s. royalty.

RADIO-GRAMOPHONES.

The Varley upright model radio-gramophone embodies a spring motor and a 2-valve amplifier arrangement, and is capable of a radio performance similar to that of the 2-valve receiver. It is supplied with a frame aerial, and a

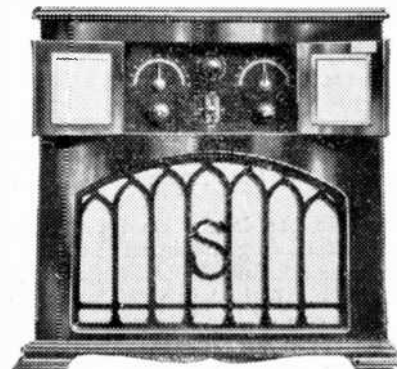

The Selector Model 42 A.C. mains portable receiver.

ALL - ELECTRIC RADIO

Varley pick-up and arm. Price, A.C. or D.C., 39 guineas, plus 28s. royalty.

A console model is listed, this employing an S.G. H.F. stage, a detector and L.F. stages, and utilising a self-contained aerial. A Garrard electric gramophone motor and a Varley pick-up and arm are fitted. Price for A.C. or D.C., 65 guineas; 40s. extra for royalty.

GENERAL.

In addition, Varley market an exceedingly complete range of power transformers, both H.T. and L.T., power chokes and potentiometers, wire wound resistances, and similar components of interest in connection with the construction of mains apparatus.

Ward & Goldstone, Ltd., Frederick Road, Pendleton, Manchester.

MAINS UNITS.

Model PA 2. 100-240 V. Four tappings. Valve rectification. Price £5, valve 15s. extra.

Model PX 2. Output 130 V at 25 mA. Four tappings. Price £5 15s., valve 15s. extra.

Model CP. Output 12 mA. Four tappings. Price £3 18s. 6d., including valve.

Model DW 2. Output 200 V, 80 mA. Four tappings. Price £6 17s. 6d., valve 20s. extra.

Constructional kits of mains units. Model KDW 2 for output of 200 V at 80 mA. Four tappings. Price £5 15s. 6d., rectifying valve £1 extra.

Model KPX 2. Output 25 mA. Four tappings. Price £5 1s. 6d., rectifying valve 15s. extra. Model KPA 2. Output 15 mA. Four tappings. Price £4 5s., rectifying valve 15s. extra. All the above seven units are for A.C. mains, above 40 cycles.

D.C. units. Model PN 2 for 200-240 V mains. Output 60 mA. Five tappings. Price £4 10s. Model DQ 2 for 110-250 V mains. Two tappings, 60 V, 120 V. Price £2. Model XL 2. One 100 V tapping. Price £1 1s.

All-mains units for A.C. Model AMU 1. Output 40 mA at 180 V, L.T. supply of 4 V 2 A raw A.C., and 6 V, 25 A. Centre tappings are provided for G.B. Price 6 guineas. Model AMU 2. Output 30 mA at 150 V and 4 V, 2-15 A. Price £7.

CHARGERS.

"Indispenso" standard model, for H.T. and L.T. charging from D.C. mains. Price 6s. "Indispenso" model de luxe, for H.T. and L.T. charging from D.C. mains. Price 22s. 6d., complete with ammeter.

Westinghouse Brake & Saxby Signal Co., Ltd., 82, York Road, King's Cross, N.

GENERAL.

This firm, of course, make the well-known Westinghouse metal rectifiers, of which a tabulated list is given on page 278. They also produce charging plant for use on A.C. mains, of which the most popular model, the four circuit R.G.C.1, was fully reviewed last week.

Wholesale Wireless Co., 103, Farringdon Road, London, E.C.1.

CHARGERS.

Three battery chargers are now being produced by this company. The first, No. 600 A 2 for A.C. mains between 200 and 250 V, 40/100 cycles, will charge 2, 4 or 6 V accumulator at .5 A (W.R.). Price £1 17s. 6d.

No. 200 A 2 charges 2, 4 or 6 V accumulators at .3 A, working on the same mains as model 600 A 2 (W.R.). Price £1 7s. 6d.

No. TRA 2a, incorporating two Philips valves, will charge 2, 4 or 6 V accumulators at 2 A, and is designed for A.C. mains between 200 and 250 V, 40/100 cycles. Price £2 7s.

GENERAL.

The firm market a wide range of kits of parts for power units (transformers and chokes in one unit), power transformers for indirectly heated A.C. valves, filament heating transformers, etc.,

The "Sensitite" 4-valve amplifier for radio or gramophone is another product. It will work from A.C. or D.C. mains, and it retails at £16.

Wright & Weaire, Ltd., 740, High Road, London, N.17.

GENERAL.

This well-known firm of component manufacturers produce several mains accessories, among which should be mentioned the universal mains transformer for 100-250 V A.C. mains, delivering 200-0-200 V, 100 mA, 5.5 V at 2 A, and 4 V, 5 A. A larger model, at 37s. 6d., gives 400-0-400 V, while "Wearite" produce a filament transformer giving 4 V, 5½ A. Price 25s.

A complete range of chokes is manufactured, carrying from 25 mA to 1.5 A, as well as a 20,000 O potential divider selling at 8s. There is also a push-pull output choke at £1 1s., and a centre-tapped resistance at 2s.

Other lines include rheostats, potentiometers and volume controls, while an A.C. valve-holder, at 1s. 3d., is another standard production.



A Ward & Goldstone production—the "Goltone" all-mains unit giving L.T. and H.T. output from A.C. mains is seen on the left, with the Varley 3-valve S.G. receiver, available for either A.C. or D.C. mains working on the right.



Selectors' Position.

WE have received the following letter from Selectors, Ltd., the well-known set-makers of Slough, and have been asked to give it prominence for the particular information of the firm's many friends in the trade.

To the Editor.

SIR,—It has lately been brought to our notice that rumours are being circulated to the effect that this company is in a bad financial position, and, in fact, is going into liquidation. Only last week we were questioned on this point by one of our biggest customers, who had received this information.

I am pleased to state that I am definitely able to contradict these inaccurate statements. We have recently found it necessary to enlarge our works; in fact, we have

increased them to 140 per cent. of what they were in January. We have already announced the introduction of two new models for next season, and our production programme for 1930 is three times that of 1929. We have reason to be perfectly satisfied with our position in every way.

You will agree that unfounded statements of the description mentioned are liable to be damaging in many ways, and immediate steps will be taken by us against any person or persons we find making them. We should much appreciate any assistance that is given us in tracing the source of these rumours.

SLOUGH.

SELECTORS LIMITED.

A. H. D. FREEMAN, Sales Manager.

LATEST RECORD REVIEWS

This week we review the June Columbia bulletin, a selection of the latest Polydor records, together with three specially issued Broadcast discs. Dance numbers having vocal refrains are marked with an asterisk ():*

The Columbia Graphophone Co., Ltd., 102-8, Clerkenwell Road, London, E.C.1.

COLUMBIA

12 IN., DARK BLUE LABEL, 4S. 6D.

DX 45.—A Country Girl—Selection (Monckton), Parts 1 and 2, by the London Theatre Orchestra.

A very satisfactory selection from Lionel Monckton's popular musical comedy. It contains numerous tunes well-known to the older generation, and, thanks to radio and the gramophone, quite familiar to young people. This selection is purely orchestral, and there are no vocal refrains. The playing is tasteful, and the recording is excellent. A tuneful record.

DX 47.—Old and New, Parts 1 and 2 (arr. Finck), by Herman Finck and his orchestra.

The sub-title of this disc is "A Potpourri of Popular Melodies," which is sufficiently descriptive, though we should add that the melodies include old ballads, musical comedy songs and classical numbers, and are arranged and played by that king of "arrangers," Herman Finck. His orchestra is of the "theatre" type, and gives a bright rendering, while the tone is crisp and clear. Another disc to swell the flood of "old time" releases.

DX 52.—Hermann Lohr—Vocal Gems, Parts 1 and 2, by the Columbia Light Opera Company, with piano.

Hermann Lohr wrote many tuneful ballads, such as "Where My Caravan Has Rested," "Little Grey Home in the West," and so forth, which have been, and still are, very popular. This is a vocal selection, with a piano accompaniment, containing seven of the best known. The soloists are excellent, and when the chorus comes in, it is to good effect. Recording very good, except for a slight lack of clarity towards the end of each side, which is hardly noticeable.

10 in., DARK BLUE LABEL, 3S.

DB 100.—Organ Imitations, Parts 1 and 2, Wurlitzer organ solos by Terence Casey.

A most remarkable record in which the Wurlitzer organ at the Regent Cinema, Brighton, takes the part in turn of a church organ, hurdy-gurdy, fair ground organ, steam organ, mouth organ (!) and cinema organ. In each case appropriate and well-known pieces are played, and Mr. Casey is to be congratulated on his imitative skill. A novel disc, which should sell well. Tone is excellent.

DB 101.—Home, Sweet Home (Bishop) and **The Old Folks at Home** (Foster), by Dora Labbette and Hubert Eisdell, with string quartet.

There must be many folk who relish

these hardy annuals. Dora Labbette and Hubert Eisdell sing very well together, and this disc is a good one. The voices blend well, and the recording of these and the string quartet is excellent. The latter supplies the requisite silky touch to the piece.

DB 102.—Bonnie Heilen Maggie and The Wedding of Sandy McKie, by Sandy MacFarlane, Scottish comedian, with orchestra.

Two songs composed and sung by this popular Scottish comedian. They are of the usual type, quite attractive, but not outstanding. The singing is excellent and there is the usual amusing "patter." The accompaniment is by a "theatre" type of orchestra.

DB 103.—Adoration (T.) and Destiny (W.), by Dinicu and his orchestra.

Both numbers—a tango and a waltz respectively—are given in a very polished and musicianly style by this well-known Columbia orchestra. A good record of its type, with fairly subdued recording.

DB 104.—Alice, Where Art Thou? and Cinderella Waltz, Compton Cinema organ solos by Pattman.

This was recorded in the Brixton Astoria by Pattman. Judging from the disc, this theatre is not ideal for recording purposes, as there is a certain lack of definition and clarity compared with other recent Columbia cinema organ discs. The second piece is composed by Pattman himself.

DB 105.—When Shadows Gather (Marshall) and **I Hear You Calling Me** (Marshall), by William Heseltine, tenor, with piano accompaniment.

Two favourite songs are happily combined on this disc; the second, of course, was immensely popular before the War. Heseltine manages them in a manner calculated to delight the hearts of many, and this, coupled with good recording, should render the disc a good seller. The recording is clear, with firm piano accompaniment.

DB 107.—Song of the Waterfall and Scent of the Jasmine (both by J. H. Squire), played by the J. H. Squire Celeste Octet.

Two more of J. H. Squire's compositions are here recorded. In character they are light and tuneful, the first exhibiting a rippling accompaniment in accordance with its title. The players give as good an account of themselves as usual, and the recording is first rate.

DB 109.—Goodbye to All That and The Shadow of a Rose, by Marie Burke, soprano, with orchestra.

The well-known artiste who made such a hit in "Show Boat" here gives us a popular song of the moment on the first side. She has a very clear-cut soprano voice, with an attractive quality. The orchestra is a bright little dance combination on the first side, but on the second it is more sedate. Quite good.

DB 112.—Song of the Condemned and The Song of the Blind Man, by Fields and Hall, duettists, with novelty accompaniment.

Fields and Hall are supposed to be very popular in America. These songs puzzle us—at first we thought they were intended to be humorous, but on second thoughts they appear to be serious. The first concerns two prisoners who talk to one another in their cells and then burst into a wailing chant about "those chains." The second is rather better—it is the song of a blind paper seller, who sings to some people who have bought papers from him. On the whole, it is maudlin sob-stuff, but it is certainly novel.

CB 56.—Wallah—Malaka—Lucy (6/8*) and There's Something about You That's Different (F.T.*), by Debroy Somers Band.

The first is a thoroughly absurd but at the same time amusing effort on the part of Leslie Sarony, who does the vocal work. It is a conventional sort of thing of its own peculiar type, but is played in a very rousing style.

The second number, which comes from the film "Song of Soho," has plenty of merit as a foxtrot and is managed exceedingly well by the band. First-class recording.

CB 61.—Watching My Dreams Go By (F.T.), by Merle Johnstone and his Ceco Couriers, and **There Will Never Be Another Mary (W.*)**, by Will Osborne and his Orchestra.

The Merle Johnston foxtrot comes from the film "She Couldn't Say No" and is a smooth type of number played in a straight but rather effective style. Some very good guitar work forms the chief feature of this side.

The waltz is from the Van and Schenck film "They Learned About Women." It is given in a deadly straight and slow style, the vocal solo by Will Osborne having an abundance of drawn-out sentiment which is reminiscent of the manner in which the song is treated in the film. Good recording.

CB 62.—The Stein Song (6/8*), and Moonshine is Better than Sunshine (F.T.*), by Jack Payne and his B.B.C. Dance Orchestra.

"The Stein Song" which is likely to be a big seller, is very much like a rousing Sousa march, although actually it is supposed to be the drinking song of the students at the University of Maine. The record will probably sell anyway, but there is no doubt that the band do not put as much pep and energy in their playing as they have during recent broadcasts of this number. The recording, too, is not quite so full and forward as usual. The accompanying foxtrot has a good melody, and although it is a little slow at the beginning, it warms up into a bright little number.

Keith Prowse & Co., Ltd., 159, New Bond Street, London, W.I.

POLYDOR

12 IN., PURPLE LABEL, 6S. 6D.

95325.—**Ballade in G Minor**, Parts 1 and 2 (Chopin), by Alexander Brailowsky, pianoforte.

Brailowsky gives us the delightful G Minor Chopin Ballade in this bulletin. His instrument is a Steinway grand, and the tone is, generally speaking, exceedingly good. The rendering is vigorous, and in places rather heavy handed, which results in a slight jumbling. On the whole, however, it is a noteworthy piano disc.

95328-95332.—**Carmen** (Bizet). Abridged opera by members of the Opéra Comique, Paris, with the orchestra of the "Association des Concerts Lamoureux," under Albert Wolff.

Here we have a very popular opera sung in French, and condensed on to five discs, and very well it is done, too. It has been skilfully abridged, and the five discs give an accurate "précis" of the whole opera. In places there is a certain amount of dialogue to give continuity. We shall not give details of the discs here, as they are fully set out in the bulletin. Most of the well-known songs and choruses are included. The solos and the recording generally are very clear. Some of the choruses naturally cause some needle hiss, but on a good machine the tone is very good indeed. We can thoroughly recommend this abridged version of the opera, albeit in French.

12 IN., BLACK LABEL, 6S. 6D.

66727.—**Carmen—Overture** (Bizet) and **Pelleas and Melisande—Sicilienne** (Fauré), by the Berlin Philharmonic Orchestra, under Albert Wolff.

This disc will probably be bought for the Carmen overture, or rather, Introduction to Act I. The second side appeals more to us, however. The delightful Sicilienne from Fauré's "Pelleas and Melisande" is in an even, flowing style, and is very sympathetically treated by Wolff, who is musical director of the Opéra Comique, at Paris. The first side, of course, belongs to the abridged version of Carmen, on 95328-95322. The recording is good, if not quite so crisp and clear as we have heard. There is a good spaciousness and plenty of bass.

10 IN., GREEN LABEL, 3S.

22914.—**Narcissus** (Nevin) and **Serenata** (Moskowski), by Ilja Livschakoff and his orchestra.

Two popular restaurant orchestra pieces, quite well rendered by a combination of this type. Both pieces are tuneful and well known. The playing is perhaps not so polished as that of some of the similar orchestras which record, but otherwise there is nothing to complain of. The recording in the main is good, with moderate volume.

22983.—**Auf fernen Straszen** (On Far-Away Highroads) (T.*) and **Nelken** (Carnations) (T.*), both by The Orquesta Tipica de Juan Llossas.

An unusually good record by this authentic tango combination who play both numbers in a beautifully polished stylish manner, the harmonised choruses being sung in Spanish. The first number is the better of the two. The recording is really excellent.

23036.—**Oh, Donna Clara** (T.*), by Paul Godwin's Dance Orchestra, and **Auf einer kleinen Bank im Park** (On a Bench in the Park) (T.*), by Ilja Livschakoff and his dance orchestra.

Two further tangos, played by ordinary dance combinations, the solo vocal

choruses both being sung, and sung very well, in German. Playing and recording again reach a high standard.

The Vocalion Gramophone Co., Ltd., Hayes, Middlesex.

BROADCAST

8 IN., 1S. 3D.

559.—**The Singing Lesson**, Parts 1 and 2, humorous sketch, by Sandy Powell.

This sketch, in which Sandy Powell is assisted by Frank Lorden, shows Sandy in the hands of a professor of singing. The humour is obvious and somewhat forced, and the artists bring forth their gags without any attempt to put them over with real force. Those who like this sort of thing will probably enjoy the disc. Good recording.

561.—**Singing in the Bathtub and I'm Following You**, sung by Billy Marlow, with orchestra.

A straightforward light vocal disc, pleasantly sung but rather lightly recorded on the first side. The reverse, however, is quite satisfactory in this respect. Both numbers are from well-known sound films, the first from "The Show of Shows," and the second from the Duncan Sisters' production, "It's a Great Life."

567.—**Ro-Ro-Rollin' Along** (F.T.*) and **The Stein Song** (6/8*), by the Riverside Dance Band.

These two numbers are likely to be certain sellers during the next few months, and live dealers will be well advised to order suitable stocks and start featuring the numbers right away. They are well played in a fairly straight style on this disc, with satisfactory recording. The choruses are solo and harmonised on the first and second sides respectively.

Hours Worked by Shop Assistants.

A FURTHER sitting of the Select Committee of the House of Commons on the question of shop assistants' hours was held on May 28th. The first witness called was Mr. A. G. Chamings, Chief Officer of the Public Control Department of the L.C.C. He dealt with the various provisions of the Acts relating to the closing hours of shops. Where frequent irregularities occurred, visits by a number of inspectors were instituted, and this means of detection had proved very effective. Complaints were also frequently received, which were fully investigated; about 2,000 complaints were received annually.

Questioned by members of the Committee, the witness said that if they had information that the law in relation to the weekly half holiday was being evaded, they took action immediately. They were mainly concerned with the closing of shops, although they made inquiries to see that an assistant did not work more than 74 hours a week. It was not their method to prosecute immediately, but to see that the law was obeyed, and in nearly every case, when attention was drawn to a breach, the law was complied with. He did not think there would be any enormous increase of staff necessary to deal with a Government provision of a 48-hour week for shop assistants.

Dr. T. H. C. Stevenson, of the General Register Office, gave evidence, and said that he dealt with the causes of mortality. He agreed that it was well known that physically weak people entered into the life of a shop assistant, as they were not strong enough for heavy work.

The third and last witness was Mr. Charles Findlater MacDonald, Chief Inspector under the Shops Act for Glasgow. He said that there was no doubt that as the result of closing orders and the 1928 Act, there had been considerable reduction in the working hours of assistants. The practice of the Department was to give a warning in the case of contraventions of the Acts

relating to the shop assistants' half holiday or meal times, and to avoid, if possible, bringing an assistant in conflict with his employer, and this had been found to be very satisfactory in most cases.

The Committee adjourned until June 18th.

Supplies to "Dabblers."

IN our issue of May 24th, we published an abridged version of a report, which had been supplied to us by the Organising Secretary, of the last Council meeting of the National Federation of Radio Retailers, and in it the following sentence appeared: "... a letter from Hirst, Ibbetson & Taylor, Ltd., was read in which that firm contended that the 'dabblers' concerned were entitled to trade terms, because they had some stock and did their business from a wooden shed in a back street."

Information has since come into our hands which shows that Hirst, Ibbetson & Taylor (who are, of course, the well-known Manchester factors) had made it plain to the N.F.R.R. that they granted trade terms in the case in question on stronger grounds than those outlined here. Not only had they told the Federation that they were satisfied with the retail and battery-charging business which was being carried on, but they had also referred to the endeavours that were being made to secure immediately shop premises on the street front. Moreover, we understand that other leading wholesalers were known to be supplying the people concerned, and it was therefore less than fair that Hirst, Ibbetson & Taylor alone were mentioned.

In any event we are informed that they had referred to the Radio Wholesalers' Federation the question of the status to be accorded to the firm in question, and had signified their willingness to abide by the R.W.F.'s decision.

Wait!!

for the New

JUNIT MAINS UNITS

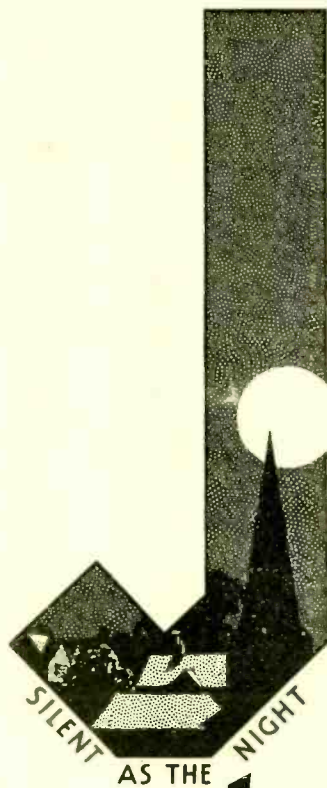

giving a higher voltage and a greater milli-ampere than any other mains unit of approximately the same size. Smaller than a 100 Volt H.T. Battery. Will be sold at competitive prices.

WATCH JUNIT!

Look for the next announcement!

EVERYTHING

The
G.E.C.
your guarantee

ELECTRICAL

Osram A.C. Mains Valves

SELL

these Osram A.C. Mains
Valves on proved service

Screen Grid Osram M.S. 4.
Detector .. Osram M.H. 4 or M.H.L. 4.
L.F. Osram M.H.L. 4 or M.L. 4.
Super Power Osram P.X. 4.

The **OSRAM**
M.S. 4
(Screen Grid)
for
CONTROLLED
High Frequency
Amplification

EXPERTS know that the true criterion of efficiency in a screen grid valve is *absence of self-capacity*—a very high amplification factor alone does not necessarily mean more distant stations.

The OSRAM M.S.4 has the lowest self-capacity in circuit of any screen grid valve—only 0.0025 micro-microfarad. This means that, actually, users get more range on their sets because the H.F. amplifier can easily be made perfectly stable.

The OSRAM M.S.4 improves the quality of the local station, due to absence of uncontrolled reaction effects, and makes station searching easy and sure.

PRICE 25/-

Made in England



Characteristics

Filament Volts	4.0
Filament Current	1.0 amp approx.
Amplification Factor	550
Impedance	500,000 ohms.
	(at screen volts 60)
Mutual Conductance	1.1
Anode Volts	200 max.



IMMENSE POWER

WITH PERFECT PURITY

Radio engineers throughout the world are realising that the true worth of a power valve lies in its permissible watts dissipation at the anode, this being a reliable guide to the useful power available to the loud-speaker.

The OSRAM P.X.4 is designed with characteristics so that, with an anode voltage of 200, the undistorted power output hitherto only obtainable by valves in the 400-volt class is possible. Users will not necessarily require all this power all the time, but the use of the OSRAM P.X.4 in the last stage of their A.C. sets or radio-gramophones means that the sudden loud passages can be handled by the loud-speaker with perfect purity—the piano will sound like a piano, and there will be no "cracked notes."

OSRAM Power Valves have for years been the choice of experts in sound reproduction.

OSRAM P.X.4
(Super Power)
for A.C. Mains sets & Radio Gramophones



Osram Valves

A.C. Mains

Characteristics

Filament Volts	4.0
Filament Current	0.6 amp. approx.
Anode Volts	200 max.
Anode dissipation	10 watts max.

MADE IN ENGLAND

PRICE 25/-

Instructions for use are contained in each carton

FOR ECONOMICAL WIRELESS



THE NEW TANNOY PORTABLE MODEL P.2.

... takes the place of the present H.T. Battery in PORTABLE, trans-
portable or practically any Radio receiver. For voltages from
200/250 A.C. PRICE £3. 15. 0 Complete.

THE NEW TANNOY TRICKLE CHARGER, L.W.

... a small very efficient charger incorporating Westinghouse rectifier
for 2, 4, or 6 volts at .5 amp. PRICE £1. 19. 6 Complete.

THE TANNOY THREE VALVE ALL MAINS RECEIVER. Type R.3.

... as yet the most attractive all mains receiver made, incorporating
screened grid, detector, and super power valves.

PRICE 19 Gns. Complete.

THE TANNOY R.2 RECEIVER.

... similar to the three valve in reproduction but incorporating only
two valves, yet capable of results equal to sets of a much larger size.

All these Models incorporate Westinghouse Metal Rectifier

THE TANNOY RADIO GRAMOPHONE.

... is a Reproducer for the connoisseur. Available in three styles ...
From 55 Gns.

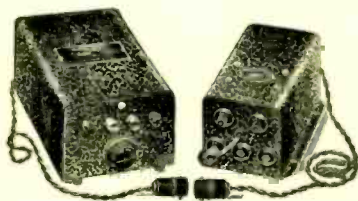

WRITE FOR BROCHURES DEALING
WITH ALL TANNOY PRODUCTS



TANNOY PRODUCTS,
1-7 DALTON STREET,
WEST NORWOOD, S.E.27.



DOES IT MAKE ANY IMPRESSION?

When your containers receive rough
handling do they "get the worst of it"
and burst at the most vital points?

NULLI SECUNDUS!

PRINTED GUMMED TAPE

will not only seal your packages effectively, but
will add considerably to their strength. It will
also act as a Travelling Advertisement, bringing
your name or speciality before an interested
public.

"The Gummed Tape Book" is bound to interest
you—Send for your copy NOW



ADVT. OF

SAMUEL JONES & CO., LTD., BRIDEWELL PLACE, LONDON, E.C.4.

Registered Trademark

TRADE NOTES & NEWS

A New Type of Valve-Pin.

Development that will affect Component Makers and Dealers.

THERE is news of first importance both to traders and to component manufacturers in the fact that the solid, cylindrical type of valve-pin used in some of the latest types of valves is eventually to be standardised by all B.R.V.M.A. members. We understand that a gradual change-over will take place from now on, and some of the valve manufacturers have already been acquainted with this development.

Even so, it seems to us that some general announcement to the trade should have been made by the B.R.V.M.A. Component manufacturers must plan their future valve-holder production with this new trend in mind, and in the same way it will affect the stocks of the dealer catering for the constructor market. Both would be materially assisted by some definite knowledge as to the time when the B.R.V.M.A. anticipate that the new pin will entirely replace the present types.

Bournemouth Studio as Showrooms.

It is stated that Mr. F. J. Bladen, lately with the Ecco Radio Co., has joined the staff of Lawrie & Co., of 95, Holdenhurst Road, Bournemouth, as the firm's representative in the Hants, Wilts and Dorset areas.

It is also interesting to note that Lawrie & Co., have taken over the B.B.C. Bournemouth broadcasting studio as a new showroom. This is nearly opposite their present premises.

A Climax Resignation.

We hear that Mr. R. J. O'Connell has resigned his position as Sales Manager of Climax Radio Electric, Ltd., and has now returned to Bernard Jones Publications, Ltd., as Advertisement Manager of *Amateur Wireless*.

A Change of Name.

We are informed by Ellison & Hillman, wholesalers, of 123-125, Albion Street, Leeds, that their Mr. Ellison is now devoting his interests entirely to the motor accessory side of the business.

The radio business is now known as Hillman Bros., at the same address.

A Leeds Note.

We are informed by Mr. A. E. Arundale, formerly in partnership with Mr. A. White, and trading as the Trebla Service Co., that he is now carrying on the business by himself under the same name as before, at 146, Town Street, Bramley, Leeds.

A.C. and D.C. on the Premises.

We learn that The Loud Speaker Co., Ltd., have recently moved from 38 to 2,

Palmer Street, Westminster, London, S.W.1, where they have audition rooms in which they can demonstrate to retailers either from D.C. or A.C. mains, a rotary converter having been specially installed.

The company are of the opinion that they are one of the first factors to be able to give such a service to retailers.

A Business Changes Hands.

Mr. J. H. Pougher, 8, Molegrave Road, Sutton, Surrey, has taken over the business of Vickery's, 79, Manor Road, Wallington and 927-9, Brighton Road,

shop at 4, Market Street, Otley, Yorks, and already report exceptionally good business. The manager here is Mr. A. Leach.

Messrs. Sayner hold H.M.V. and Columbia gramophone and radio agencies at all their depots and are also well known as the makers of the "Saynerphone" wireless set. They would be glad to receive advertising matter covering wireless and gramophones direct to their Otley shop.

It is learned that a fine modern store has just been opened in the central thoroughfare of Darwen Street, Blackburn, by James Mosley (1929), Ltd., wireless and gramophone specialists.

Kingstons', wireless dealers, have just lately opened premises at 13, Clifftown Road, Southend-on-Sea, with a special display of wireless sets and components.

Palmer & Riley, wholesale wireless and electrical factors, of Accrington, have opened branch showrooms in King Street, Blackburn.

A correspondent informs us that Gibsons, of 4, Queen Street, Exmouth, have opened a new branch at Tavistock

A new window-runner lately issued by E. K. Cole, Ltd., to feature their portable set mains units. Copies can be obtained on request.

Purley, who have in connection with their musical business a radio department.

New Premises.

A correspondent has written that Mr. Holdcroft, who has in connection with his musical business a radio department, has now opened new premises at 23, Pall Mall, Hanley.

A Yorkshire correspondent informs us that the enterprising firm of H. Sayner, Ltd., of Shipley and Saltaire, have just opened a branch wireless and gramophone

Road, Plymouth, where they are stocking wireless products only.

Showcards Available.

We are informed that the Dubilier Condenser Co. (1925), Ltd., of Ducon Works, Victoria Road, London, W.3, have available a supply of cut-outs relative to their all-electric radio receivers and also to the "Westminster" portable radio-gramophone, which the company will be pleased to supply to *bona fide* traders.

Change of Name.

Detex Distributors, Ltd., manufacturers of the well-known Detex portable receiver, have now deleted the word "Distributors" from their title, and will in the future be known as "Detex Ltd."

A Manchester Note.

Mr. Charles A. Houghton has asked us to announce that, until he can obtain larger and more suitable accommodation, he will be trading at 238, Manchester Road, Droylsden, Manchester, as the Ideal Battery Service.

The Best Window Display.

The first prize in the class for "Things to Use" at a shopping week window-dressing competition held at Maidenhead was awarded to S. Evans & Sons, Ltd., wireless dealers, King Street.



Two newly-appointed Ferranti representatives. Left: Mr. H. Benson Dare, of "Castleton," 52, Ceylon Place, Eastbourne, who will cover Essex, Middlesex, Surrey, Kent and Sussex. Right: Mr. Milbourne Wright, of 10, Avenue Gardens, Teddington, who will represent Ferranti, Ltd., in Hants, Wilts, Berks, Oxford and Bucks.



Which Mullard Rectifier Valves for what.

IMPORTANT A.C. APPARATUS IN WHICH MULLARD RECTIFIER VALVES MAY BE USED.

A.C. Sets and Radio Gramophones.	Mullard Rectifier Valve Type	A.C. Sets and Radio Gramophones.	Mullard Rectifier Valve Type
Burndept A.C.7	DW.2	Kolster Brandes 161	DW.2
„ Ethogram	DW.2	„ „ 169	DW.2
Columbia A.C. Set 304	DW.8	„ „ Radiogram	DW.2
Dubilier A.C. Mains Receivers ..	DU.1	Marconi 47	DU.2
Ediswan A.C. Mains Set	DW.2	Philips 2514	DW.2
Edison Bell All-Mains A.C. Radio- gram	DU.2	„ 2511	DW.2
Faraday A.C. Radio Gramophone ..	DW.30	„ 2515	DW.2
H.M.V. Radiogram 551	DW.15	Radio Recordian Radiogram ..	DW.30
Igranic A.C.2	DW.8	R.I. Madrigal	DU.1
„ A.C.3	DW.8	Selector All-Electric Type 42 ..	DW.2
„ All-Mains Neutrosomic ..	DW.8	Varley All-Electric 3	DW.8
Ferranti Model 31	DU.2	„ „ „ 2	DW.8
		„ „ „ Radiogram ..	DW.8
H.T. Units	Mullard Rectifier Valve Type	H.T. Units	Mullard Rectifier Valve Type
Atlas A.C.16	DU.2	Marconi AM.7	DW.8
„ A.C.17		„ AC.7	DW.8
Dyson AF	DW.8	Metro-Vick BS	DU.1
„ APM		„ „ C	DW.2
Ekco Rectifier Unit R.20	DU.10	„ „ G	DW.2
„ „ R.60	DU.4	Mullard	DW.2
Ekco H.T. Unit 4.T.60	DU.4	Philips 3009	DW.2
Goltone CP.2	DU.10	„ 3002	DW.2
„ AM/U.1	DU.10	Parmeko Senior	DW.8
„ AM/U.2	DU.2	„ A.C.3	DW.8
Igranic V.208	DU.2	„ A.C.4	DU.15 (2)

Dry Contact Rectifiers (continued from preceding pages).

Type.	Max. A.C. Input.	D.C. Output		Price.	Remarks.	
	Volts.	Volts.	Amps.			
BENWOOD LINZE. ROTHERMEL CORPORATION, LTD., 24-26, Maddox Street, London, W.1.						
B. 12	12-25	6	2	20s. od.	} Dry electrolytic rectifiers, L.T. types only.	
B. 16	14	7	2	22s. 6d.		
B. 24	21	10	2	26s. 6d.		
IGRANIC-ELKON. IGRANIC ELECTRIC CO., LTD., 149, Queen Victoria Street, E.C.4.						
M. 8	7	4.5	3	26s. od.	} "M" and "V" series, suitable for L.T. accumulator charging, L.T. supply units and field supply units for moving-coil speakers. These series, together with the E.B.H., are all full-wave, dry electrolytic rectifiers.	
M. 12	11	6	3	30s. od.		
M. 16	14.5	7.5	3	29s. od.		
M. 20	18	11	2.5	39s. od.		
M. 24	21	14	2.5	43s. od.		
M. 32	28	18.5	2.5	53s. od.		
M. 40	36	23	2.5	60s. od.		
M. 48	43	28	2.5	69s. od.		
V. 8	7	4.5	1.5	17s. 6d.		
V. 12	11	6	1.5	22s. 6d.		
V. 16	14.5	7.5	1.5	26s. od.		
V. 20	18	11	1.5	30s. od.		
V. 24	21	14	1.5	34s. od.		
E.B.H.	350-0-350	250	.06	37s. 6d.		Suitable for H.T. supply units.
WESTINGHOUSE. WESTINGHOUSE BRAKE and SANBY SIGNAL CO., LTD., 82, York Road, King's Cross, London, N.1.						
R.4.2.1	9	6	.5	27s. 6d.	} Suitable for L.T. trickle charging.	
R.4.2.2	9	6	1	45s. od.		
R.4.2.4	9	6	2	60s. od.		
R.4.2.2	18	12	1	60s. od.		
R.4.8.1	39	24	.5	60s. od.	} For L.T. mains units.	
A.3	14	9	2	23s. 6d.		
A.4	14	9	2	39s. 6d.	} Grid Bias model	
G.B.1	45	40	.05	17s. 6d.		
H.T.1	230	200	.1	75s. od.	} For H.T. mains units.	
H.T.2	400	350	.1	150s. od.		
H.T.3	135	120	.02	21s. od.		
H.T.4	135	180	.03	37s. 6d.		

All the above styles are electronic rectifiers, as distinct from the electrolytic types.

A NEW ANGLE IN SELLING MAINS POWER.

Regent Radio's Novel Scheme.

IT is more than encouraging to us to see the increasing number of manufacturers who are putting forward practical ideas, which are calculated both to enthuse the dealer into real attempts at summer radio selling, and also to provide the means whereby he can make those attempts successful. Several such schemes have been dealt with in our columns recently, and there are plenty of indications that they are being widely employed—to the benefit alike of dealers and of the manufacturers concerned.

The latest entrants into the field of forceful summer selling are the Regent Radio Supply Co., makers of the well-known "Regentone" mains supply units. Some time ago, it will be recalled, this firm introduced two special types of all-power mains supply units for use in portable receivers, and one type for H.T. supply only. The first two were designed physically to fit into the space normally occupied by the H.T. battery, and electrically to provide trickle-charging current for the accumulator, with rather better H.T. output than that usually available with a dry battery. These units are quite attractively priced, and are listed in our market review elsewhere.

Some time has been spent since their introduction in sensing the potential market for these productions, and in investigating the attitude towards them of leading portable set makers with whose sets they might be employed.

The reception which Regentone met in both cases was so encouraging that they are now launching a concentrated sales campaign, designed to put over to the public—through the dealer—the idea of electrifying the portable for home use, and thus, at one stroke, simplifying its domestic operation, improving its performance and conserving the batteries for use out of doors or in other places where mains supply is not available.

The scheme is based on the fact that several leading portable makers—including McMichael, Rees-Mace and Selectors—have satisfied themselves that the new Regentone units are entirely suitable for use with their sets, and are recommending them to all of their customers who desire to operate their portables from the mains. To these testimonies are added the views of two leading radio authorities, who have stated, after tests, that the units can be used satisfactorily with other well-known

portables and also with many of the popular manufacturers' kit sets, such as the Cossor, Mullard, Osram, and other products.

A special booklet has been prepared by Regent Radio, which contains reproductions of the letters they have received in this connection, and since the purpose of the publication is to drive home to the public in unquestionable manner that safety and satisfaction are assured when using these units—which is one of the most important tasks in selling mains radio at any time—it achieves its end with the minimum of effort and the entire absence of "puffy" claims on the part of the makers themselves.

Regentone feel that every owner of one of the portables named who is also connected to the light mains is a potential purchaser of one of their mains units, and they argue, quite soundly, that the man who can afford a fairly expensive portable can also afford the few extra pounds involved. This special booklet is, therefore, being put into the hands of the trade in very large quantities, and the co-operation of dealers is being sought in seeing that every likely prospect not only receives one but gives it the attention it deserves.

Obviously the dealer who sold the portables in the first place, and from local conditions knows where mains power is available, is the best possible person to see that the widest possible field is covered with the publication. Plentiful quantities will be available within the course of two or three days, and dealers are then invited to apply either to the Regent Radio Supply Co., 21, Bartlett's Buildings, Holborn Circus, London, E.C.4, or to their own wholesalers for sufficient quantities to meet their immediate requirements. Wholesalers, too, are desired to approach Regent immediately for bulk supplies.

Regentone are, of course, employing the same entirely novel appeal in their own advertising direct to the public, and if traders co-operate in the distribution of this booklet, there is every reason for believing that good sales will follow. The cream of the idea naturally lies in the fact that the sales arguments are at once authoritative and provided by interests in no way connected with Regent Radio themselves; and this undoubtedly sets a seal on its effectiveness.

COMMERCIAL INFORMATION

GAZETTE.

Fullotone Gramophones, Ltd. General meeting of members will be held at 11.45 a.m., July 8th, at 22, Queen Street, London, E.C.4, to have an account laid before them; also to receive the liquidator's report showing how the winding-up has been conducted and the property of the company disposed of; to hear the liquidator's explanation, and to determine by extraordinary resolution how the books, etc., of the company and of its liquidator shall be disposed of. Liquidator: A. B. Neil.

Kings Inventions (Electric), Ltd. At an extraordinary general meeting held on May 28th at 41, Castle Street, Liverpool, it was resolved that the company be wound up, and that Mr. Geo. H. Ashworth be appointed liquidator.

Receiving Orders, Adjudications, First Meetings and Public Examinations.

Atack, Handel A., 442, Borough Road, Birkenhead, wireless accessories dealer, etc. Court: Birkenhead. Date of petition and order: May 26th. Debtor's petition. First meeting was held yesterday at the Official Receiver's offices, Government Buildings, Victoria Street, Liverpool. Public examination: 10.30 a.m., July 2nd, at the Court House, Pilgrim Street, Birkenhead.

Dennis, Thomas H., 178, Denman Street, Nottingham, trading at 176, 178, 195, Denman Street, Nottingham, electrician, etc. Court: Nottingham. Date of petition and order: May 26th. Debtor's petition. First meeting was held yesterday at the Official Receiver's offices, 22, Regent Street, Park Row, Nottingham. Public examination: 10 a.m., July 3rd, at the County Court House, St. Peter's Gate, Nottingham.

Receiving Orders and Adjudications.

Hanson, Thomas S., 26, Nether Hall Road, Doncaster, electrical contractor, etc. Court: Sheffield. Date of petition and order: May 26th. Debtor's petition.

Davies, Daniel J., 36, Cambrian Street, Aberystwyth, late of Tegfan, Adpar, Llandyfriog, Cardigan, lately trading at Market Place, Newcastle-Emlyn, Cernarth, Carmarthen, wireless engineer. Court: Carmarthen. Date of petition and order: May 30th. Debtor's petition.

Winding-up Order.

"**K.N.**" **Electrical Products, Ltd.,** 5-7, Singer Street, London, E.C.2. Court: High Court of Justice. Date of petition: May 8th. Date of order: May 26th.

Application for Discharge.

Edghill, Harry G., 3, College Road, Harrow, trading at 13, Wembley Hill Road, Wembley, Middlesex, wireless engineer, etc. Court: St. Albans. Date fixed for hearing: 10.30 a.m., June 24th, at the Court House, St. Albans.

Intended Dividends.

Leach, John T., 1, Altar Villas, Riddlesden, nr. Keighley, Yorks., trading

as **Leach & Son,** 49-51, Cavendish Street, Keighley, gramophone dealer, etc. Court: Bradford. Last day for proofs: June 13th. Trustee: John O. Morris, 12, Duke Street, Bradford, Official Receiver.

Shepherd, Cyril, 69, Micklegate, previously 73, Acomb Road, and Coffee Yard, Stonegate, all York, radio engineer and wireless accessories dealer. Court: York. Last day for proofs: June 18th. Trustee: Donald S. Mackay, Duncombe Place, York, Official Receiver.

Bird, Sydney J., 6, Westbourne Street, Walsall, trading at 5, Her Majesty's Theatre Buildings, Townsend Bank, Walsall, gramophone dealer, etc. Court: Walsall. Last day for proofs: June 17th. Trustee: Samuel W. Page, Official Receiver's Office, 30, Lichfield Street, Wolverhampton.

Dividend.

Austin, Clifford, 20, Brownberrie Avenue, Horsforth, Leeds, trading as **C. Austin & Sons, and Austin's Accumulator & Radio Service,** at 97, Domestic Street, Leeds, musical instrument and wireless accessories dealer. Court: Leeds. First and final dividend of 3s. 6d. in the £ payable on June 20th, at the Official Receiver's office, 24, Bond Street, Leeds.

Dissolutions of Partnerships.

Thompson, Henry J., and Fox, Albert E., trading as **Thompson & Fox,** at 14, London Road, and 75, High Street, Sevenoaks, Kent, wireless and gramophone agents, etc. Dissolved: April 11th.

Arundale, Albert E., and Waite, Albert, trading as **The Trebla Service Co.,** 146, Town Street, Bramley, Leeds, and High Street, Upton, nr. Pontefract, wireless dealers, etc. Dissolved: May 21st. Debts: Albert E. Arundale.

Macey, Francis J., Roadfield Cottage, Shawville Gardens, Barkingside, Essex, and **Harvey, Irene I.,** 10, Queen's Avenue, Woodford Green, Essex, trading as **Fairlop Motor Works, Barkingside, Essex.** Dissolved: May 23rd. Debts: F. J. Macey, who continues the business.

Mortgages and Charges.

Central Wireless Co., Ltd.—Particulars filed of £300 debentures authorised by resolutions of May 1st and 2nd, 1930, charged on the company's undertaking and property, present and future, including uncalled capital, the amount of the present issue being £100.

Associated Wireless Co., Ltd. Two debentures dated May 1st and 16th, 1930, to secure £200 and £150 respectively, charged on the company's undertaking and property, present and future, including uncalled capital. Holder: Mrs. U. Bolsom, Ulman Lodge, Bridge Lane, Golders Green, N.W.

Duophone (Foreign), Ltd. Particulars filed of £30,000 debentures authorised April 28th, 1930, charged on the company's undertaking and property, present and future, including uncalled capital, the amount of the present issue being £595.

Satisfaction.

Note: Where the amount "originally secured" is stated, that is not necessarily the amount outstanding at the date of the satisfaction recorded below. There may have been previous partial satisfactions, registered or unregistered. The registration of Satisfactions is not compulsory.

J. Halden & Co., Ltd.—Satisfaction to the extent of £2,200 (being the full amount advanced) on May 12th, 1930, of mortgage dated September 1st, 1910, and registered September 10th, 1910.

Private Arrangement.

H. & R. W. Fairfield, trading as **Fairfield & Co.,** 27, 38, and 42, London Road, Leicester, wireless dealers, etc.

The creditors interested herein were called together recently, when a statement of affairs was submitted, which showed ranking liabilities of £5,143 8s. 3d., of which £4,895 13s. 1d. was due to unsecured creditors and £247 15s. 2d. to a partly secured creditor. The latter was the bank, who claimed £287 15s. 2d., and also held a life policy of the surrender value of £40. In addition, there was fully secured creditors for £578 19s. 3d., holding securities valued at £1,069. The net assets, including a surplus from fully secured creditors of £490 os. 9d., were £2,347 6s. 9d., or a deficiency of £2,796 1s. 6d.

It was reported that the business was originally commenced in 1914, when the joint capital was approximately £1,000. During the year to January 3rd, 1926, the turnover was £22,347, and in the following year it fell to £20,209. In the succeeding 12 months it was £19,708. During the year to January, 1929, sales still further declined to £14,215, while for the 12 months to January 3rd last, the turnover was £10,677. During the year to January, 1925, there was a profit earned of £1,049, and in the two following accounting periods the net profit was £135 and £283 respectively. During the last three years there had been losses ranging from £700 to £1,000 per annum. The deficiency was attributed to the losses on trading, together with the depreciation written off the assets in the statement of affairs.

No offer of a composition was submitted, and it was eventually decided that a committee should be appointed to consider the matter and to make recommendations to the general body of creditors as to the way the estate should be dealt with.

The creditors include:—

Brown, S. G., Ltd.	£56
Cole, S. Wilding	55
Celestion Radio Co.	53
Edison Swan Electric Co.	143
Mullard Wireless Service Co.	56
Philips Lamps, Ltd.	111
Symphony Radio & Gramophone Co.	87
Rothermel Corpn.	51
Hollington, R.	106
Yager, Ltd.	86
Inland Revenue	112

Bankruptcies.

Andia Ltd., 27, Old Bond Street, London, W.1.

The statutory meetings of the creditors

THERE'S A PROUD REPUTATION BEHIND EVERY ORMOND PRODUCTION!

Designed to carry out their work faultlessly and smoothly, Ormond components reveal in every detail the highest standard in construction and design.



Large Chassis and Cone. Constructed of aluminium, 16½ ins. in diameter. Screw holes are provided in outer ring for attaching to baffle board or cabinet. Price 11/8. Smaller model 11¼ in. diameter. Price 7/8

Select Unit. Can be connected for use as a selectivity unit or as a wave-trap. A really efficient unit produced to deal with the interference problem. Supplied in brown bakelite case, with full instructions. Price 7/6.

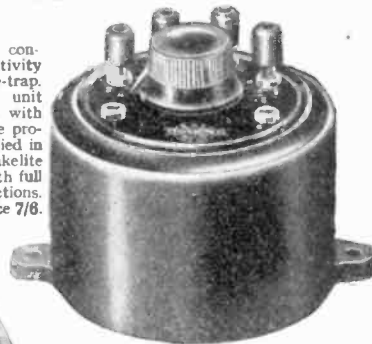

Radio Frequency Choke. High Inductance. Low Self-capacity. Impedance is constant up to 4,000 metres. Price 7/6

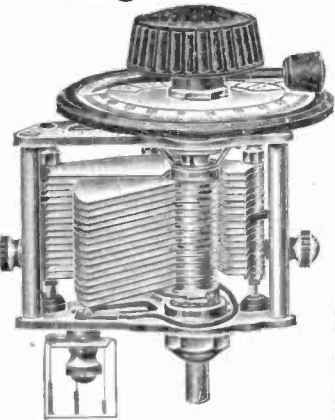

Small Logarithmic Condenser with Pointer Dial. Constructed mainly of Aluminium.

Cap.	Price
·00025	6/6
·00035	6/9
·0005	7/-



Three Electrode Fixed Condenser. Designed for use as the aerial coupling condenser. Insulation is provided between the vanes and capacity is approximately ·0001 each half. Price 1/-.

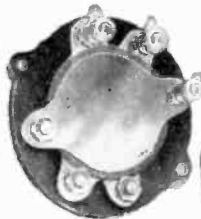

Three-Point Push-Pull Switch. May be mounted on a metal panel and insulated by means of the ebonite bush if necessary. Complete with knob, terminals and soldering tags. One hole fixing. Price 1/6. Two-point type, Price 1/3.

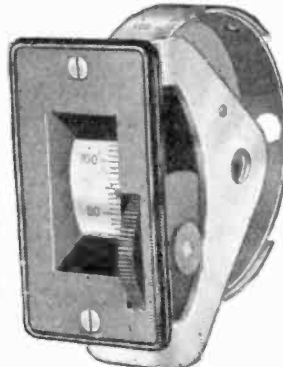

Ormond Drum Dial. No slip—no back lash. The control knob moves in the same direction as the dial. Available for either left- or right-hand mounting. Price 5/-.

Differential Condenser. Insulation is provided between fixed and moving vanes obviating all danger of short-circuiting. One-hole fixing. Ideal for use as a reaction control. Price 4/-.

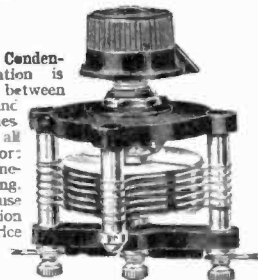

Single Coil Holder, Skeleton Type. Low loss. Anti-Capacity, spacing may be altered to suit different Types of Coils. Price 1/-.



The Ormond Ball-Bearing Turn-Table. Of extremely robust construction and heavily plated. A rubber ring is fitted to the base to ensure a perfectly smooth movement. 8 ins. in Diameter, Price 8/-, 7 ins. in Diameter, Price 5/-.

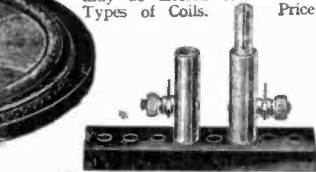

Fixed Condensers. May be secured either direct to valve sockets or supported on the wiring. Cap. ·0001, ·0002, ·0003, ·0005, Price 7d. each. Cap. ·001, 9d.; ·002, 1/-; ·006, 1/6; ·01, 1/9.



For Quality!

For Value!

THE ORMOND ENGINEERING CO., LIMITED,
 ORMOND HOUSE, Rosebery Avenue, LONDON, E.C.1.
 Phone: Clerkenwell 5334-5-6 & 9344 5/6. Telegrams: "Ormondengi, Smith."

SHEER SIMPLICITY —SHEER REALISM!

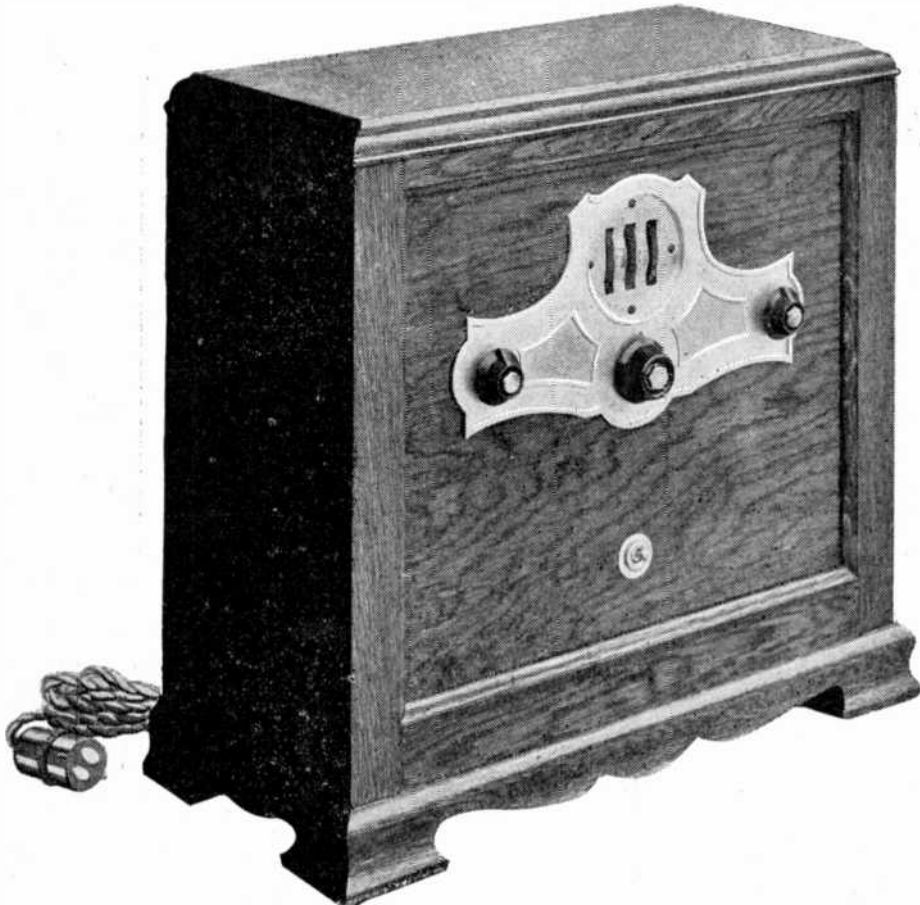

*See and Hear the K-B All-mains receiver.
First convince yourself—then your customers*

K-B 161 AND 169. THE KOLSTER-BRANDES ALL-ELECTRIC
THREE - VALVE SCREENED - GRID PENTODE RECEIVER

K-B 161. 100-120 v. A.C. K-B 169. 200-250 v. A.C. } 40-60 CYCLES

Including valves and royalties,

OAK CABINET £17-10 MAHOGANY CABINET £19-10

All K-B products costing £5 or more can be sold on simple Hire Purchase Terms.

Kolster Brandes

CRAY WORKS,



SIDCUP, KENT

and of the shareholders in the compulsory liquidation of this company were held recently at the Board of Trade Offices, 33, Carey Street, London, W.C., Mr. H. P. Naunton, Assistant Official Receiver, presiding.

The Chairman said that the winding-up order was made on April 7th on a creditor's petition. The company was registered in April, 1925, to acquire from the Marquis of Andia the registered trade mark "Andia" and certain inventions and patent rights relating to sound reproduction and amplifying apparatus, and to manufacture and deal in goods connected therewith. The nominal capital was £25,000, all of which had been issued for cash. The company was promoted by Carl Anton Lowenadler and Ernest Axel Martin Welin, who had acquired an option extending to April 30th, 1925, of an invention of the Marquis relating to loud-speaking apparatus for use in connection with gramophones and radio apparatus. In April, 1925, an agreement was completed between a Mr. Eller, as trustee on behalf of the company to be formed, and the Marquis, under which the latter granted to the company an exclusive licence to handle goods under the said patent in certain countries, the consideration being £11,500 payable in cash. On the same day it was agreed that the Marquis should be appointed technical adviser to the company and receive £1,000 and a commission on sales. Both agreements were adopted by the company in the general meeting. Towards the end of 1926 there was a complete change in the personnel of the board, and from that date the minute book referred to the patents as belonging to the Marquis. In July, 1927, the company assigned to a new company called Artandia Ltd., which was promoted by the Marquis, the licence rights of the patents and the trade mark "Andia" acquired under the agreement of April 27th, 1925, together with certain British registered designs. The company was to receive 5 per cent. of the net invoice price of all articles bought by Artandia Ltd. A clause appeared in the agreement that if the latter company should be ordered to be wound up, the rights assigned to it should revert to the company. On February 3rd last, Artandia Ltd. was ordered by the Court to be wound up. The Marquis, however, completed a separate agreement with Artandia Ltd., in July, 1927, selling to it all the British rights. It would probably be necessary to take counsel's opinion regarding the true position of the ownership of the patents. Accounts prepared at April 30th, 1926, the Chairman continued, showed a loss of £3,005, and an account dated December 31st, 1926, disclosed a further loss of £133, with stock of the value of £830, the whole of which was sold to Artandia Ltd. No further business was then transacted until the latter part of last year. The Official Receiver understood that it was the intention of the Marquis to promote a further company to take over the business of the company and the patents. With that object he proposed to revive the business of Andia Ltd., but he met with difficulty in obtaining the registration of the company. The failure of the com-

pany was attributed to lack of capital and to bad management.

The statement of affairs filed in the liquidation showed liabilities of £8,959, of which £8,806 are expected to rank, and net assets of £356, with a total deficiency of £33,447 with regard to the shareholders. Of the liabilities, £7,094 was stated to be owing to the Marquis. The meetings resulted in the liquidation remaining in the Official Receiver's hands.

Harold Rowles Smith, trading as **Smith's**, 22, Westgate, Elland, Yorkshire, gramophone dealer, etc.

The first meeting of creditors herein was held recently at the Official Receiver's office, 12, Duke Street, Bradford. According to the statement of affairs filed there were gross liabilities of £792 16s. 11d., with a deficiency of £477 os. 10d. The matter remained in the hands of the Official Receiver as trustee.

Donal William Morphy, wireless apparatus manufacturer, late of 4/5, Dorset Mews North, Upper Gloucester Place, London, N.W.

The affairs of this debtor, who was adjudged a bankrupt on January 15th with ranking liabilities estimated at £3,799, came before Mr. Registrar Mellor in the London Bankruptcy Court, on May 23rd, on the hearing of his application for an order of discharge.

The Official Receiver said that the assets, which were estimated by the debtor at £419, were expected to realise, in all, £344. In evidence the debtor had stated that he began business in 1928 in equal partnership with another person as manufacturers of wireless apparatus at the above address. They traded as the Royal Radio Co. In December, 1928, however, the partnership was dissolved, because Morphy was unable to agree with his partner regarding the conduct of the business, which had not been a success. His partner received £300 when he retired. The debtor took over the assets and liabilities of the business and continued trading alone until January of last year, when, being in financial difficulties, he filed his petition. He attributed his insolvency to lack of capital and general adverse trading conditions. He stated that a full set of books of account had been kept throughout, although they were not completely written up after December last. There was no record in them of the loans he had received from his father, who had lent him £100 in June, 1928, £300 in the following December, and £1,000 between May, 1929, and the date of the receiving order. All this money, except the first loan, he had used for his business. When the partnership was dissolved the business was solvent without taking into consideration his father's loan of £100 in June, 1928, but the payment of the £300 to his partner, so the debtor said, made him insolvent, and he knew that at the time. According to his balance sheet of July 31st last, there was then a deficiency of £596, and he admitted that his personal assets did not exceed £200. He realised his insolvency, but continued to trade, and had since incurred all the trade debts returned in his statement of affairs. The Official Receiver opposed the application on the grounds that the debtor's

assets were not of a value equal to ros. in the £; that he had omitted to keep proper books of account; and that he had continued to trade knowing he was insolvent.

Counsel on behalf of the debtor challenged the last two findings, and said that the debtor's father, to whom three-eighths of the liabilities were due, was prepared to withdraw his claim. His Honour upheld the Official Receiver's report, and decided to suspend the debtor's discharge for six months.

County Court Judgments.

The following returns have been received from the Registry of County Court Judgments, Treasury, Whitehall, which purports to contain lists of judgments entered up in the respective County Courts of England and Wales, but no distinction is made on the register between actions for debts or damages or properly disputed cases; neither is it known which of the judgments remain unpaid at the present time; and it is probable that a large proportion of them have been settled between the parties or paid. It may also be observed that some of the judgments registered are against defendants in a representative capacity. The name given is that of the defendant; the amount is that for which judgment was given, and the date is that on which it was given.

Alfred, Richard, c/o Edison Illuminating Ltd., 55, Victoria Street, London, S.W.1, wireless dealer. Court: Westminster. £21 14s. 8d. April 2nd.

Owen, Charles, 103, Manor Road, Fleetwood, Lancs., wireless engineer. Court: Blackpool. £12 19s. April 23rd.

Woodward, R., High Street, Lyndhurst, Hants., wireless dealer. Court: Torquay. £10 9s. 6d. April 29th.

Kaplan, H., 37, Lisle Street, London, W., wireless dealer. Court: Whitechapel. £10 2s. April 30th.

Trower, J., 51, Green Lane Road, Leicester, wireless dealer. Court: Birmingham. £18 4s. 7d. April 30th.

Blackmore, G., 62, Coventry Road, Market Harborough, wireless dealer. Court: Birmingham. £29 1s. 1d. April 2nd.

Midland Electric & Wireless Co., 133, Sutton Road, Erdington, electrical engineers. Court: Birmingham. £11 5s. 7d. April 10th.

J. D. Wireless Co., 195, Breck Road, Liverpool, electrical engineers. Court: Bloomsbury. £13 14s. 6d. May 2nd.

Chalkwell Electric & Radio Stores, 2, Nelson Rd., Leigh-on-Sea, wireless dealers. Court: Westminster. £17. April 8th.

Hunt, A. E., Maldon Road, Great Totham, Essex, wireless dealer. Court: Westminster. £16 11s. 5d. April 8th.

Brosan, Rudolph, 267, High Road, Willesden Green, wireless dealer. Court: Nottingham. £11 8s. 8d. May 1st.

Kelsall Wireless Service, Kelsall Hill, near Chester, wireless dealers. Court: Westminster. £10 17s. 9d., April 14th.

Martin, Thomas, G., (trading as **Beehive Radio & Electrical Stores**), 4, Chaucer Gardens, Beehive Lane, Ilford, Essex, wireless dealers. Court: Westminster. £25 17s. 11d. April 14th.

Wireless Pictures (1928), Ltd., Dorland House, 14-16 Regent Street, London, W.1, wireless dealers. Court: Westminster. £14 14s. 10d. April 14th.

Sworder, C. J., Wireless Depot, High Street, Crowthorne, wireless engineer. Court: Croydon. £24 6s. 5d. April 30th.

London Wireless Co., 32, London Road, Derby, wireless dealers. Court: Salford. £11 5s. 7d. May 6th.

Pye, F., 57, Handsworth Road, Blackpool, Lancs., wireless factor. Court: Blackpool. £18 13s. 5d. May 2nd.

Edwards, G. J., 236, Central Market, Cardiff, Glam., clock and wireless dealer. Court: Greenwich. £17 7s. 6d. May 1st.

Electradio Co., Ltd., 25, Westbourne Grove, London, W.2, wireless dealers. Court: Wandsworth. £13 9s. 8d. May 5th.

Turnock, George, 41, High Street,

Aston, Birmingham, wireless dealer. Court: Birmingham. £21 8s. 7d. April 8th.

Thomas, Robert, 20, The Grove, Villa Road, Handsworth, wireless dealer. Court: Birmingham. £13 18s. 6d. May 5th.

Gartside, Henry (trading as **H. Taylor & Co.**), 24, The Arcade, Waterfoot, Rossendale, Lancs., wireless dealer. Court: Preston. £13 17s. 5d. May 2nd.

Cross & Co., 32, Church Street, Baldock,

Herts., wireless dealers. Court: Clerkenwell. £18 14s. 0d. April 29th.

Cycle & Wireless Depot., 119-125, Upper Commercial Street, Batley, Yorks., wireless and cycle dealers. Court: Clerkenwell. £16 15s. 5d. April 30th.

Gartside, Henry, 24 the Arcade, Waterfoot, Lancs., wireless dealer. Court: Clerkenwell. £22 6s. 4d. April 25th.

"EXIDE" ANNUAL MEETING.

Continued Prosperity.

THE thirty-ninth Annual General Meeting of the shareholders of the Chloride Electrical Storage Co., Ltd., was held at Clifton Junction on Monday, Mr. W. S. Naylor presiding.

Before proceeding with the ordinary business, the meeting placed on record its deep regret at the death of Mr. Wm. Bannister, who had been associated with the company as a director since 1895, and who had officiated as chairman of the board from September, 1902 until his death in October, 1929.

The chairman, continuing, said that the company was in the position of being able to report a continuance of development and prosperity, and that, as a consequence of additional business, the profits for the year showed a satisfactory increase.

"You will have observed from the accounts," said Mr. Naylor, "that the directors are able to report a profit for the year under review of £287,612, and that the available balance is £300,875."

Mr. Naylor then went on to deal at some length with the general activities and interests of the company. He pointed out the variety of fields into which the storage battery now enters and the new avenues of business which were continually developing, and also had a few words to say on the subject of the works, and the employees and the employees' benefit and pension funds.

Regarding the future, Mr. Naylor said that the battery business seemed to be in a state of continual change. Not so many years ago it meant business in large batteries for supply stations and country mansions. Then came train lighting, submarines, motor cars, electric vehicles, wireless, etc. In recent times it looked as if the stationary battery business were doomed by reason of the spread of alternating current. We have not stood idly watching this development, which by the newness of the engineering problems involved introduces new risks of interruption of the supply. Without wishing to exaggerate these risks it is obvious that they open out a new field for the emergency battery.

It seems natural to suppose that wireless sets in the near future will be operated from the electric supply, instead of from a storage battery. So far we have not suffered from the development of the mains set. Our wireless business is still one of our principle lines, and we are doing an increasing business in batteries for portable wireless sets.

Finally, Mr. Naylor turned to a proposal to double the company's ordinary

capital by the issue of a 100 per cent. share bonus. "In talking of the future," he said, "I am definitely hopeful, but I do not want to give the impression that we expect to pay 30 per cent. upon the increased capital next year. The directors have considered that from all points of view it would be better for the share capital more nearly to approximate to the amount of capital employed in the

EVER READY ANNUAL MEETING.

Substantial Increase in Sales.

THE ordinary annual general meeting of the Ever Ready Co. (G.B.), Ltd., was held on Monday at the Holloway Works of the Company.

Mr. Magnus Goodfellow, who presided, opened his speech by saying that the results had been obtained in the face of greater competition than ever.

"The sales for the year," he said, show an increase of 22½ per cent. over the sales of the previous year, and the increase in profit, amounting to £34,388, would have been at least proportionate to the increase in sales but for the fall in the values of materials and commodities during February and March, which necessitated our writing down stocks to the lower market values on March 31st. Our low stock values and the lower prices at which we have been able to purchase our materials for the coming year have enabled us to effect reductions in price of a number of our products.

"On examining the balance-sheet and comparing it with the balance-sheet as at March 31st, 1929, you will observe that the amounts receivable from shareholders, amounting to £225,746, have been paid, making our issued capital £742,800 fully paid. The loan from the company's bankers as at March 31st, 1929, has been repaid, and the only liability we have, therefore, apart from our liability to shareholders, is the item of sundry creditors, amounting to £66,516. The expenditure during the year amounted to £1,363 3s. 1d., and the capital sum remaining amounts to £2,784 11s. 7d.

"The reserves have been increased by the sum of £30,000, which has been allocated as to £5,000 to the contingencies reserve and as to £25,000 to dividend equalization reserve.

"The balance on profit and loss account to be carried forward after payment of the dividend amounts to £34,000—roughly £3,300 more than it was a year ago.

business, and for the earnings to bear a relation to the capital more nearly in accordance with fact than appeared from our last capitalisation. I hope our business and our profits may continue to grow, and that you will have reason to be as satisfied in the future as you have been in the past with your dividends, but you must expect and be satisfied to start off next year with a more modest rate of dividend than the one it is proposed to pay this year."

The report and accounts were unanimously adopted.

"Turning to the credit side of the balance-sheet, goodwill, etc., stands at the original purchase price. Trade investments at cost, £209,000, show a small decrease of some £1,500. As you are aware, the bulk of this investment is in Lissen, Ltd. We have during the past two years obtained a fair yield on this investment, amounting to 10 per cent. gross in each year, and considerable surplus profits have been left in the business for the purpose of providing for expansion and development."

After dealing at some length with the subject of subsidiary companies, Mr. Goodfellow passed on to trading conditions. He stated that it appears to be generally accepted that the present worldwide trade depression may continue during the coming year and may even grow worse than it is at present. The cause of the depression appeared to be excessive production, and lower consumption.

During the four months ended on March 31st last the general trade position did not prevent the expansion of the Ever Ready Co. and for the two months ended May 31st to date the sales were greater than they were for the two months ended May 31st a year ago.

Mr. Goodfellow paid a tribute to the work of the staff and finally moved that the accounts be adopted, which was carried *nem con.*

Final dividends of 5 per cent. on the Preference shares (making the maximum of 10 per cent. for the year) and 25 per cent. on the Ordinary shares (making 35 per cent. for the year) were declared, and the retiring director and the auditors were re-elected.

An extraordinary general meeting was then held for the purpose of increasing the capital of the company to £1,000,000 by the creation of 1,000,000 Ordinary shares of 5s. each to rank *pari passu* with the existing Ordinary shares. This proposal was approved and carried.

256A

THE "PAPER"

PERFORMANCE THAT IS PRACTICAL

PM 256A

A
marvellous
new
Mullard
6 volt
Power Valve

Price 15/-

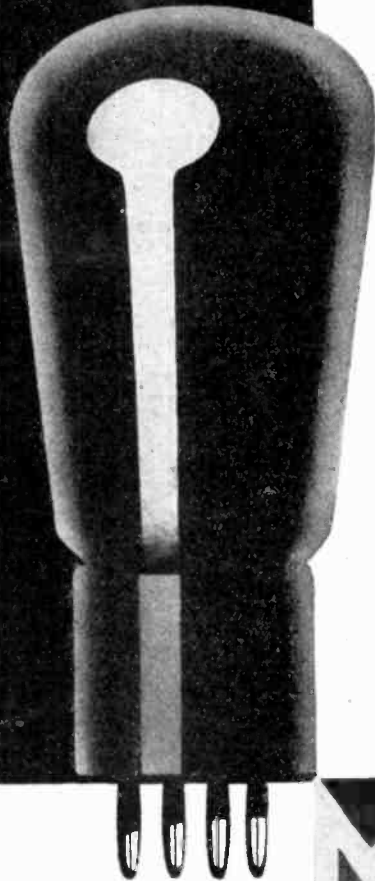

POWER VALVE

MULLARD

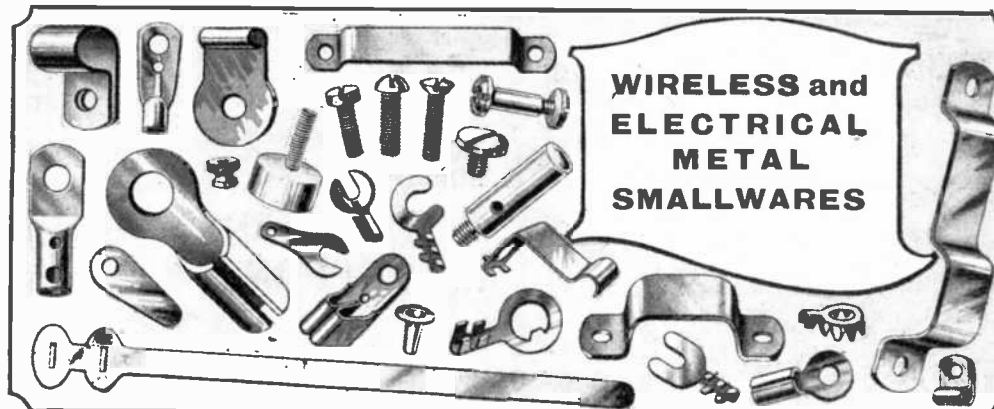

**WIRELESS and
ELECTRICAL
METAL
SMALLWARES**

WITH PLEASURE !

We shall be pleased to receive enquiries for any of the goods illustrated or for any other Pressed, Stamped, or Turned Metal Work used in the Electrical Trades. To customer's own specification.

**F. DOWLER & SONS,
WAINWRIGHT STREET,
ASTON, BIRMINGHAM.**
**Phone : East 1349. *Grams : Dowler B'ham*
LONDON OFFICE :—
66, Basinghall St., E.C.

**MAKERS of
MAINS
SETS!...**



Wireless amateurs and others who are making mains sets and Eliminators will want LOEWE RADIO Paper Condensers, Sturdily constructed. They can be relied upon to maintain a consistently high performance. Write for full details. Also supplied with screw terminals and soldering tags.



Retail Price From

1/2 ★
EACH

**Paper IN METAL CASES
CONDENSERS**

Made in a complete range of values. For example:
1 mf. tested to 500v. D.C. 1/2 each. } Retail Prices
" " " 700v. D.C. 1/3 each. }
" " " 1000v. D.C. 1/4 each. }
" " " 1500v. D.C. 2/1 each. }

Complete range and prices on request.
SPECIAL NETT PRICES TO MANUFACTURERS.

THE LOEWE RADIO COMPANY, LIMITED.

4, Fountayne Road, Tottenham, N.15. Phone: Tottenham 3911/2.

MOULDINGS

of Guaranteed Accuracy

in

BAKELITE AND EBONITE

Ebonite Sheet, Rods & Tubes

UNITED EBONITE MANUFACTURERS LTD.

Phone:— **Seven Kings 2171/3** **Chadwell Heath, ESSEX**

In Your Interests

and for all those engaged bona-fide in the Wireless, Radio & Allied Industries

A non-profit Association to protect and assist legitimate manufacturers and traders to regulate credit conditions and report on the status of persons or concerns requiring credit.

Annual Subscriptions:—

SEND FOR PARTICULARS **£2 - 2 - 0** JOIN NOW

THE WIRELESS & RADIO TRADES GUARDIAN ASSOCIATION LTD.

(By Guarantee)

78 NEW OXFORD STREET, LONDON, W.C.1

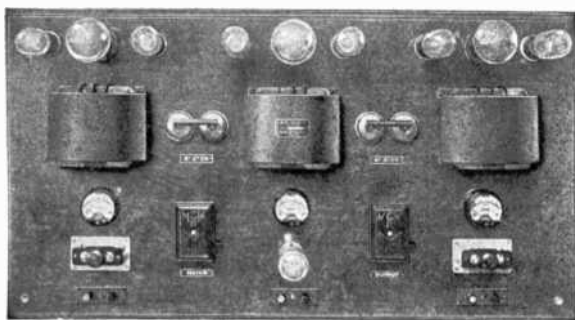

DAVENSET SERVICE STATION CHARGER

Price £25 net.

Max. D.C. Output 75 volts at 6 amperes

DAVENSET

COMMERCIAL ACCUMULATOR CHARGERS AND RECTIFIERS FOR A.C. MAINS ARE THE PRESENT DAY EQUIPMENTS

BECAUSE THEY ARE

1. HIGHLY EFFICIENT.
 2. SIMPLE TO OPERATE.
 3. PERFECTLY SILENT.
 4. NON-RADIATING.
 5. REASONABLE IN PRICE.
- e.g. from **£8 : 8 : 0 net**

TECHNICAL BOOK ISSUED FREE.

A 49-page copy of the 3rd Edition (reprinted April, 1930) of the booklet entitled "Commercial Accumulator Charging and the Efficiency of A.C. Rectifying Equipment," in which 7 models of DAVENSET Chargers are both described and illustrated, may be had on application to your usual wholesaler, or direct from the manufacturers **FREE OF CHARGE.** This offer applies to bona-fide traders only.

PARTRIDGE, WILSON & CO.

LOUGHBOROUGH ROAD, LEICESTER

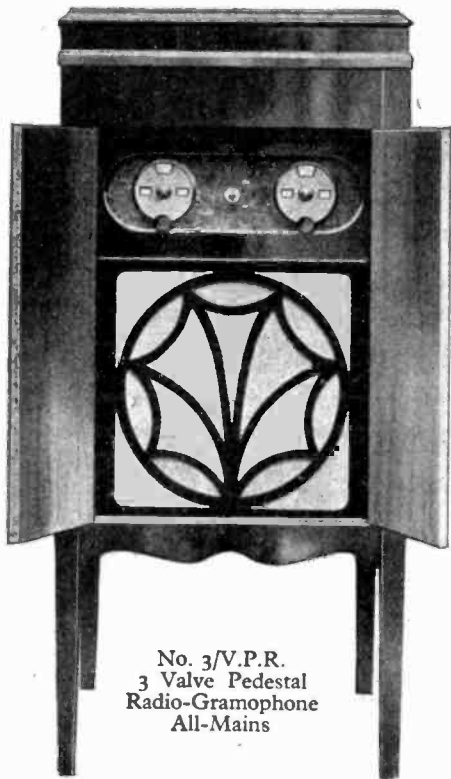

No. 3/V.P.R.
3 Valve Pedestal
Radio-Gramophone
All-Mains

THERE IS A BIG DEMAND for ALL-MAINS RECEIVERS & RADIO-GRAMOPHONES

We manufacture for the trade only all the latest types of Pedestal, Table and Transportable models at remarkably low prices.

Ask for our illustrated catalogue of all types of Receivers, Suitcase Portables, Table Models, Screened Grid Sets and Portable Radio-Gramophones.

Wholesale Factors are asked to kindly communicate at once for full particulars

HARRIS WILLIAMS (MFTRS.) LTD.
5, New Zealand Avenue, Barbican, London, E.C.1
Telephone : National 5594. Telegrams : Elegaslite, London

FREE EXCHANGE OF STOCKS

WE will alter free of charge the title of any slow selling engravings on Belling-Lee products which you have in stock. This is a normal part of our service, and if you wish to make use of it, just write to us giving particulars of stock and quantities.

Altering engravings to your specification, packed in new cartons and returned to you post FREE. If you return to us your stocks of Belling-Lee Shrouded Plugs and Sockets, we will exchange them for an improved type, FREE.

We offer you a specialised service second to none.

BELLING-LEE

Advertisement of BELLING & LEE, LTD.,
Queensway Works, Ponders End, Middlesex.

THURINGIA BATTERIES



4.5 VOLTS

Quality Unrivalled.
Record Life in Use.
Longest Guarantee.

*Labelled to Instructions Gratis.
Factors Enquiries Invited.
Reduction in Price.*

SOLE AGENTS:
E. H. MAISNER & CO. LTD.
4 Attneave St., Farringdon Rd.,
LONDON - - - W.C.1

OLDEST MANUFACTURERS,
HUGO FALK,
G.M.B.H.,
TABARZ



66 VOLT H.T.

SEL-EZI for SERVICE!

WE ARE THE SOLE LONDON AND SOUTHERN AGENTS FOR TELSEN TRANSFORMERS AND CAN GIVE IMMEDIATE DELIVERY OF ALL MODELS.

Orders received by First Post are delivered to London and Suburbs the same day.



SEL-EZI, LTD.

6 Greek Street, London, W.1

Phone: Regent 666t.

SIMPLIFY YOUR ACCUMULATOR CHARGING

By using any of the following you can tell at a glance when your customer's accumulator was left, when it is being called for, and how much it will be, etc. No further book-keeping is needed.

ACCUMULATOR CHARGING TAGS
printed in 3 sections, 1 to be attached to accumulator, 1 to file for reference, 1 for customer. 5/9 per 1,000

ACCUMULATOR CHARGING PADS
100 leaves in duplicate. 1/6 per Pad

BOOKS OF 100 LEAVES
in triplicate with your name on each leaf. 21/6 12 Books

TRANSPARENT LABELS
for fixing permanently to accumulators 10/6 per 100
printed with your name and address

Send for Free Samples to:

BURALL BROS.

THE PATENT LABEL FACTORY, WISBECH.

Postage on small Orders 9d. extra in U.K. only All Foreign orders must include sufficient to cover cost of postage



Transfers

AN artistic transfer will be an invaluable addition to your sets and components, and will provide a permanent advertisement. Our transfers are designed specially for this purpose — write for particulars.

THE BRITISH TRANSFER PRINTING CO., LTD.,
Quinton Works, Coventry.
and at 6 Upper Thames Street, London, E.C.4.

"FONATEX" FABRIC GAUZE

The perfect fabric for gramophones, speakers, etc.

Write for samples and prices

ASHTON & CO. (Estd. 1787), LTD.
45, Chorlton Street, Manchester.

BECOL EBONITE is RELIABLE

LOW LOSS FORMERS Eleven Sizes SHEET PANELS TO SIZE

STOCK BECOL EBONITE AND SATISFY CUSTOMERS

Look for Trade Mark. Sole makers:

The British Ebonite Co., Ltd., Hanwell,
LONDON, W.7

THE "BABY" THEY'LL BUY



Behind each "ISO" Baby 75 (2 1/2") is a big demand—a demand that is solely due to the exceptional quality and extremely low price. The friction drive of the Baby 75 dial is pleasingly smooth and reliable and entirely devoid of backlash. Specially strengthened scale. In Black or Brown 2/4 each retail. Full range of ISO Products on request.

"ISO" BABY 75 "ISO" DIALS

HAW & CO., LTD., 20 Cheapside, London, E.C.2
Phone: CITY 9510. Grams: "Hawcom, Cent."

LISENIN

POSITIVE GRIP TERMINALS (Patented)

Stocked by all Members of RADIO WHOLESALERS FEDERATION

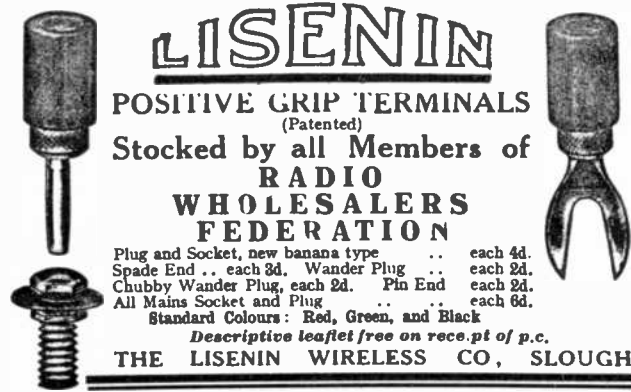

Plug and Socket, new banana type ..	each 4d.
Spade End .. each 3d.	Wander Plug .. each 2d.
Chubby Wander Plug, each 2d.	Pin End .. each 2d.
All Mains Socket and Plug ..	each 6d.

Standard Colours: Red, Green, and Black

Descriptive leaflet free on receipt of p.c.

THE LISENIN WIRELESS CO, SLOUGH

PARFAIT

THE PERFECT EBONITE PANEL ONE QUALITY ONLY THE BEST

SUPPLIED IN SIX FINISHES

Matt	Semi-Polished Mahogany	Highly Polished Black
Cube Surface	Highly Polished Mahogany	Semi-Polished Black

Send for price list and generous trade terms

H. B. POTTER & Co., Ltd., Station Buildings, ROCHDALE.

PATENTS

STANDARD TELEPHONES & CABLES LIMITED

beg to announce that they are the owners of more than 60 patents relating to wireless broadcast receiving sets.

These include amongst many others:

Superheterodyne, Push - Pull Split Loop, Hartley Oscillator, Mains Receivers, Free Grid Bias, Gang Condensers, Volume control with Constant Impedance, Folded Exponential Horns and (In conjunction with Electrical Research Products Inc.) Combined Gramophone and Radio.

AND THAT they are willing to grant licences under these patents and future inventions of their own and their associated companies to approved British Manufacturers, who are invited to apply for further particulars and conditions to:

STANDARD TELEPHONES & CABLES, Room 717, Bush House, Aldwych, W.C. 2

TO MANUFACTURERS of Wireless Sets and Appliances

WE SOLICIT

Your Enquiries for
SISTOFLEX SLEEVING

ESSELLITE connecting WIRES
PANELS AND SHEETS
in **EBONITE** and **LEBAKITE** in Various
Beautiful Designs

FOR YOUR NEW PRODUCTS

We guarantee **FIRST CLASS QUALITIES**
AND KEEN COMPETITIVE PRICES

Wholesale Only

SPICERS LIMITED

Insulation and Wireless Dept.

19 NEW BRIDGE STREET, LONDON, E.C. 4
Phone: City 6251. Private Exchange: 49. Grams: 'Nykoping, Ltd, London.'



High Voltage

**SWITCHES
PLUGS
FUSES
ADAPTORS
LAMPS
CHOKES
RESISTORS
METERS
CONDENSERS
ETC.**

Samples on Application.

FOR, MAINS FITTINGS OF EVERY DESCRIPTION



Brilliant cut glass, Ruby, Blue, Green or Opal Lenses fitted in artistic mounts as illustrated. They constitute excellent signal Lamps for Mains Receivers and Gramophones, the illuminating lamp being fed from the heater windings of the transformer. All sizes can be supplied, from 1/2 inch dia. up to 1 1/2 inch dia.

Catalogues on application to

A. F. BULGIN & CO., LTD.

9-10-11, Cursitor Street, Chancery Lane, London, E.C.4

FERRANTI
THE ALL-MAINS SPECIALISTS,

HAVE NOW COMPLETED ARRANGEMENTS FOR THE SUPPLY OF THE

FERRANTI
All-Electric Receiver

AND

FERRANTI
Electro Dynamic Speaker

ON HIRE PURCHASE TERMS

FULL PARTICULARS ON REQUEST.

FERRANTI LTD. HOLLINWOOD LANCASHIRE

PREPAID PARAGRAPH ADVERTISEMENTS.

SCALE OF CHARGES.

AUCTIONEERS' & OFFICIAL ANNOUNCEMENTS.—Advertisements under this heading are inserted at a charge of 11s. per single column inch.

TRADE & MISCELLANEOUS.—3s. for 12 words and 3d. for each additional word.

SITUATIONS VACANT & WANTED.—2s. for 12 words and 2d. for each additional word

SERIES DISCOUNTS.—On contracts for consecutive insertions the above rates are subject to discounts as follow: 13 insertions 5 per cent., 26 insertions 10 per cent., and 52 insertions 15 per cent.

BOX NUMBERS.—If replies are sent to the office of the publishers, 6d. extra per insertion is charged to cover cost of forwarding them. The Box Office address is counted as six words and charged accordingly.

PRESS DAY.—Copy should reach us not later than first post Tuesday Morning, four days before publication, and should be addressed to The Advertisement Manager, St. Bride's House, Salisbury Square, Fleet Street, London, E.C.4. Phone: Central 7713 (9 lines.)

COPY FOR ADVERTISEMENTS is subject to the approval of the Proprietors, who retain the liberty to withhold any advertisement which they regard as unsuitable for publication in this journal. The Proprietors are not responsible for clerical or printers' errors, although every care is taken to avoid mistakes.

NOTE.—The insertion of an advertisement ordinarily constitutes acknowledgment of the remittance, but for remittances covering contracts for 13 insertions or more a receipt will be sent.

ORDERS AND CHEQUES should be made payable to THE TRADER PUBLISHING CO., LTD., and crossed "and Co." Treasury Notes, being untraceable if lost in transit, should not be sent as remittances.

ALL ADVERTISEMENTS MUST BE PREPAID.

DEPOSIT SYSTEM.

To facilitate business between advertisers and unknown or distant readers, we have a "Deposit Department." The buyer sends us the money, and we advise both parties of its receipt. The seller then sends the goods carriage paid to the buyer, who must within three days of receiving them either accept them or return them carriage paid. If he accepts them we forward his money to the seller; if he rejects them we return his money when advised by the seller that the goods have come to hand. We cannot, however, accept any liability in a dispute. Our charges payable by the buyer for this service are:—

1/- on transactions up to £5.

2/6 " " between £5 and £20.

5/- " " £20 and £50.

And thereafter 6d. for every £5 or part thereof.

AUCTIONS.

23, ST. HELEN'S STREET, IPSWICH.
HERBT. WRIGHT & WARD

Will sell by Auction, on THURSDAY, June 12th, 1930, at ELEVEN o'clock a.m. By direction of Lionel Ensor, Esq., the liquidator of Cooks Wireless Co., Ltd. (In Voluntary Liquidation)

The Whole of the STOCK-IN-TRADE

of a Wholesale Wireless Factor comprising a large quantity of Wireless Fittings, Valves, Condensers, Accumulators, Batteries.

FOUR RADIO GRAMOPHONES

Ten Receivers, Gramophone Amplifier, Eight Portable Sets, Loud Speakers, etc. Catalogues, price 3d. each, from the Auctioneers, 21 and 23, Princes Street, Ipswich. (977)

L 4

CLIX PRICES REDUCED

The charge of ½d. per unit for Engraved Insulators has now been cancelled on the following lines:—

CLIX PIN TERMINALS
CLIX PARALLEL PLUGS
CLIX RING TERMINALS
CLIX HOOK TERMINALS
CLIX-LOX WANDER PLUGS
CLIX FIT-ALL SPADE TERMINALS
CLIX SPRINGSREW WANDER PLUGS

All the above-mentioned lines are now supplied with either Engraved or Plain Insulators at the same price.



Prov. Pat.
Regd. Design

Illustrated list on request

LECTRO LINX LTD.

254 Vauxhall Bridge Rd., Victoria, S.W.1

Telephone: Vic 3541

FEEL THE SNAP OF IT!

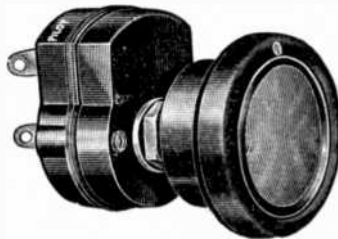

THE PILOT QUICK ACTION SWITCH

It will handle 3 amperes at 220 volts Especially suitable for Mains Sets.

Also all Lines manufactured by THE PILOT RADIO AND TUBE CORPORATION of NEW YORK, the largest Manufacturers of Wireless Parts in the World.

Write for Catalogues to:

THOMAS A. ROWLEY LTD.

59 Skinner Lane, Birmingham

Sole Agents for Great Britain and Ireland.

Agents for Portsmouth and District:

J. J. EASTICKS, Commercial Road.

Scottish Distributors:

MICHAEL BLACK, 184, West George St., Glasgow, C.2

Re CELEBRITONE LTD.

(In Voluntary Liquidation).

By Order of the Joint Liquidators, Charles Latham, Esq., F.L.A.A., and Eric F. Wilkins, Esq., A.C.A.

Messrs.

FULLER HALL & FOULSHAM are instructed to offer for SALE by AUCTION ON THE PREMISES situate on the CHASE ESTATE, PARK ROYAL ROAD, WILLESDEN, N.W., on TUESDAY, JUNE 24TH, 1930, at 11 o'clock precisely, FIRSTLY, the

GOODWILL OF THE BUSINESS of CELEBRITONE, LTD., including the Patents, and immediately afterwards in Lots in detail the Stock of

GRAMOPHONE and WIRELESS ACCESSORIES, including:—

CINEMA, DOUBLE CLUB and SINGLE GRAMOPHONES. SIMPLEX PROJECTOR. Gramophone Motors. Oak and Walnut Cabinets. CRYPTO DC/AC CONVERTERS up to 200/240 volts. Philips Chargers, Kuprox Trickle Chargers. CRYPTO MOTORS and GENERATORS up to 110/240 volts. M.L. GENERATORS. WESTINGHOUSE RECTIFIERS. Variable and Non-Variable ELIMINATORS. 4- to 12-VALVE AMPLIFIERS. MOVING COIL LOUD SPEAKERS by Brown and others. FERRANTI TRANSFORMERS, Valves by Mullard and others. Accumulators, H.T. Batteries, Fixed and Variable Condensers, Grid Leaks, Frame Aerials, Switches, Plugs and Sockets, Large quantities of D.S.C., D.C.C. and enamelled Copper Wire and the

ENGINEERS' MACHINE TOOLS comprising Capstan and other Lathes; DRILLING MACHINES, Grinders, GUILLOTINE, Screw Fly Presses, ELECTRIC MOTORS UP TO 15 H.P. Benches. 25-CWT. MORRIS MOTOR VAN, OFFICE FURNITURE and other effects.

Catalogues (when ready) may be obtained of:—

CHARLES LATHAM, ESQ.,

Certified Accountant,

78, New Oxford Street, W.C.1

ERIC F. WILKINS, ESQ.,

Chartered Accountant,

8, Queen Street, E.C.4

and of

Messrs. FULLER HALL & FOULSHAM,

Auctioneers,

125, High Holborn, W.C.1

DOZ.
"ORGOLA" M III Panels, new, 20/-
 do. M II 12/9, M III Screens, 14/-
 New Midget S.L.F. Condensers, 21/-
 COMPRESSION Condensers, 10/6
 DUAL COILS 30/-, P/P Switches, 5/3
(Up-to-date plant at your service)
A. E. ANDREWS & CO., "OBO,"
 17 TOLLINGTON PARK, N.4

EMKABE
 QUALITY
DIALS and CONDENSERS
Precision Instruments for Set Manufacturers
EMKABE RADIO CO. LTD.
 47 Farringdon Road, London, E.C.1

Sell 'HOLDFAST' Now!
EXTENSION UNIT
 The best extension unit for every type of balanced armatures. Post price 1/-. Special price for large quantities.
DAYZITE LTD.
 17, Lisle St., Leicester Square, London, W.C.

NSF
CONDENSERS
 EXCEPTIONAL QUANTITY TERMS TO MANUFACTURERS
Geo. Becker Ltd.
 39, GRAFTON ST. W. 1
 Museum 7430

EPOCH
 MOVING COIL SPEAKERS
 Write for new booklet — 19 models
EPOCH RADIO MANUFACTURING CO., LTD.,
 8 Farringdon Ave., London, E.C.4. Phone: Central 1971

ASHTON PERFECT AERIAL SPREADERS
 Fit any Pole Any length Aerial.
 Trade 9/8 Pair
 8-10, Bull's Head Yard Manchester.

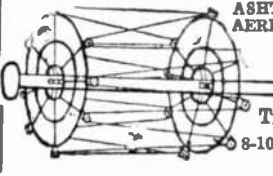

ELEX
SPADES, PINS HOOKS & EYES
 2D series. 6 colours. 2d. each.
 Write for List W. 66
J. J. Eastick & Sons
 118 Bunhill Row London. E.C.1



C.F. Radio Controller
 finds faults in your set
 Write for Illustrated Leaflet to
FONTEYN & CO. LTD.
 2 to 6, Blandford Mews, Baker St., W.1

BUSINESS FOR SALE.
FOR immediate sale—established electrical and radio business with double-fronted lock-up shop in prominent position, Thames Valley district.—Full particulars Box No. 1113, WIRELESS TRADER Office. (B.2)

BUSINESS REQUIRED.
REQUIRED, good-class Retail Radio and Gramophone business, in good locality.—Write, giving full particulars, turnover, profits, etc., to Box 1066, WIRELESS TRADER Office.

FOR SALE.
NATIONAL cash register. Recently overhauled. In excellent condition. Adds and prints total on strip. Send for full details to F. Milton, 54, Merritt Road, Brockley, S.E.4. (970)

MISCELLANEOUS.
LOUND-SPEAKERS, headphones and transformers. Trade repairs.—Howell, 91, Morley Hill, Enfield, Middlesex. (H7)

FORTY lines and every one a seller. Send for lists now and keep busy.—A. J. Hewitt, 21, South Street, Greenwich, S.E.10. (H4)

PATENTS.
PATENTS obtained, trade marks and designs registered at home and abroad. Gee & Co., patent and trade mark agents, trade mark advisers to THE WIRELESS TRADER, H. T. P. Gee, Member Radio Society, Great Britain, A.M.Inst. Radio Engineers, 52-54, Chancery Lane, Holborn, W.C.2. Telephone: Holborn 1525.

THE owner of British Patent No. 272887 for electrical amplifying systems is desirous of entering into negotiations with one or more firms in Great Britain for the purpose of exploiting the above invention, either by the grant of a licence or licences to manufacture on royalty. Enquiries should be addressed to Messrs. Abel & Imray, 30, Southampton Buildings, London, W.C.2. (972)

SITUATIONS VACANT.
REPRESENTATIVE with own car for Midlands and North for ebonite, sets and components by leading manufacturers.—Box 1135, WIRELESS TRADER Office. (978)

REQUIRED by leading radio manufacturers, representative having a thorough knowledge of the radio industry with connection among the leading wholesalers throughout the country.—Reply, giving full details of past career, together with age, whether married or single, and salary required, to Box No. 1138, WIRELESS TRADER Office. (973)

TRAVELLER wanted for radio, records and gramophones. Expenses and commission. To represent well-known firm holding important factorships. Man possessing car preferred.—Box No. 1137, WIRELESS TRADER Office. (974)

TWO MORE NEW LINES OFFERED FOR DELIVERY FROM STOCK :—



Best obtainable Workmanship, N.P. (1/2 actual size)

(2) MIDGET WANDER PLUGS & SOCKETS



UNIVERSAL SPADE TERMINAL (PATENT)
UNIVERSAL TERMINALS { Red and Black Engraved 30 Wordings

ALSO :—
 B.A. Screws, Nuts and Washers, Brass and N.P.—General Stamping (Spades and Soldering Tags, etc.)—Brass and N.P. Terminals—Red and Black Insulated Spades, Pins, Wander Plugs, etc.

E. J. FRANCOIS,
 89, Clerkenwell Road, London, E.C.1
 Telephone: Holborn 6055

TURNED SPECIAL PARTS to SAMPLE or SKETCH

£1,000 RESEARCH LABORATORY

WE HAVE FOR DISPOSAL the whole of a Research Laboratory fitted for Electrical and Radio Test Work of every description at a cost of £1,000. Suitable for the development department of an enterprising manufacturer or a college.

For full particulars apply
LESLIE DIXON & CO.,
 218 Upper Thames St., London, E.C.4
 City 0191

"ALWAYS" CONSTANT RESISTANCES

They Look well, Sell well, WORK well, and show you a decent profit. Send to-day for List and then let us have your Trial order

Manufacturers, increase your efficiency and reduce costs by using "ALWAYS" in your Receivers.

Trade Terms and Lists on request.
 Large Stocks Quick Deliveries.

ABINGDON WIRELESS SUPPLIES
 ABINGDON - - - BERKS.

SITUATIONS WANTED.

FULLY qualified radio engineer desires responsible post. Full knowledge of circuits, designing and service work. Eight years' experience. Capable of supervising staff. Highest references.—Box No. 1136, WIRELESS TRADER Office. (976)

LANCASHIRE salesman, 7 years sales and technical, handling exclusively one of radio's biggest lines, requires additional first-class lines, (excluding receivers and loudspeakers) on part expenses and commission basis.—Box No. 1146, WIRELESS TRADER Office. (980)

WANTED.

MANUFACTURERS' discontinued stocks wanted. Any quantities.—Box No. 947, WIRELESS TRADER Office. (C9)

WANTED, all types of electrical and wireless apparatus; purchased for cash; large quantities only.—T. W. Thompson & Co., 17, Strutton Ground, S.W.1.

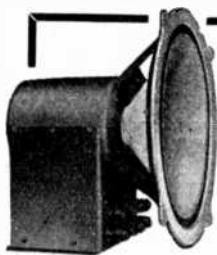

"THE MUSIC LOVER'S CHOICE"

Radio-Gramophone music and speech reproduced with amazing and uncanny realism. The most efficient speaker money can buy.

SEND TO-DAY FOR OUR FREE 36-PAGE BOOK-LET "8OUND ADVICE."

BAKER'S Selhurst RADIO

Offices: 89 Selhurst Road, S. Norwood, S.E.25
Works: 42 Cherry Orchard Road, E. Croydon

Send Your Orders to:—

T. FIELDING & Co. Ltd

The EAST ANGLIAN RADIO FACTORS
King St., GT. YARMOUTH

Factors of all the best known makes of Radio Components

EXACT TUNERS

THOUSANDS IN USE
STOCKED BY ALL THE LEADING FACTORS
THE EXACT MANUFACTURING CO.
Croft Works, Priory Street,
COVENTRY, England.

Wanted—continued.

WANTED, constant potential battery charger, capacity 200 amps. Suitable charging H.T. and L.T. car and radio batteries. Mains 400 V 50 periods 3 phase.—Box No. 1117, WIRELESS TRADER Office. (R4)

ALL-ELECTRIC gramophone for demonstrating records. D.C. 230 volts. Moving coil speaker. Give full particulars and price.—Walker's, 298, Conway Street, Birkenhead. (975)

WANTED. Two National cash registers. Must be in good condition and ring up to £1 or 30s.—Send full particulars to Box No. 1139, WIRELESS TRADER Office. (971)

WANTED. One valve voltmeter, one 1,000 V megger, one set frequency records, one capacity and inductance bridge with 1,000 cycle oscillator and standard condenser box.—Box No. 1142, WIRELESS TRADER Office. (979)

We solicit your enquiries for **METAL CABINETS** Eliminator Boxes, Transformer Cases, etc. We can supply any colour in Crystalline finish.
C. HOUNSLOW & CO.,
Sheet Metal Workers,
96a, Coleridge Street, Hove, Brighton.

Retails at **The "SOPRANIST" ACCUMULATOR TESTER**
Tests all kinds of Lead-Sulphuric Acid Batteries.
Efficient, Simple, Handy
Sole Dis.
S. KALISKY (Aldgate) LD.
Aldgate High St., London, E.C. and
16 Withy Grove, Manchester.

6d. ALL BEADS FULLY CHARGED
MULTIPLE BEAD FLOAT HALF DISCHARGE
ALL BEADS SINK RECHARGE
SETS OF 12 CELLS
Mansrs: Veechler Co., WILSON.

ELITE
RANGE OF COMPONENTS

INDUCTANCE COILS.

60 x	-	-	-	each	2/4
250 x	-	-	-	"	4/-
Titan Coils	-	-	-	-	12/6
Dual Range, 6 pin	-	-	-	-	6/-
H. F. Chokes, 200 to 2,000 metres	-	-	-	-	3/6
Binocular, ditto	-	-	-	-	3/6
L. F. Transformers, 3-1 and 5-1	-	-	-	-	6/6
Double Reading Voltmeters	-	-	-	-	5/6
Spring Aerials	-	-	-	each	9d.

TRADE DISCOUNT 33 1/3%

THE BEAVER ELECTRICAL SUPPLY COMPANY
5, GREAT CHAPEL STREET, W.1.

A 'Sound' Proposition

The 'LIMIT' Soundbox is an unqualified success. Its popularity is due to the priceless tone that hides behind its modest cost. In its ability to reproduce the high and low Registers with life-like purity, the 'LIMIT' is the last word in Sound-box design.

Pat. No. 311025.

10/6
IN SILK-LINED CASE.

LIMIT
TRADE MARK.

Bayonet, H.M.V., Continental and Columbia Fittings.

Ask your Dealer to Demonstrate.

LIMIT ENGINEERING CO., LTD.
ALBION STREET :: KING'S CROSS, N.1

A BIG SELLER THE WHOLE YEAR ROUND

"GOLTONE" ALL-MAINS UNIT

To operate from the electric light supply (A.C. only). Enables the Radio Receiver to be converted to an "ALL-MAINS" set, thus saving the inconvenience and expense of Accumulator Charging and H.T. Battery Renewals.

ADDS VOLUME, SELECTIVITY & RANGE
Suitable for Mullard, Cossor and Screened Grid Valve Circuits. *Plug in, that's all.*

Price £6 6s. (subject)
Pamphlet with full particulars on request.

New Radio Catalogue now ready sent to Trade on application.



INDEX TO DISPLAYED ADVERTISEMENTS—Continued from Back Page.

	PAGE		PAGE		PAGE
Gilbert, C., & Co.	15	M. L. Magneto Co.	18	Selectors, Ltd.	54
Goodson Records	14	McMichael, L., Ltd.	17	Spicers, Ltd.	66
Graham Amplion, Ltd. 33, 34, 35, 36		Maisner, E. H., & Co., Ltd.	64	Standard Telephones & Cables, Ltd.	66
Harris, Williams (Mfrs.), Ltd.	64	Marconiphone Co., Ltd., The 38, 42, 43		Sun Electrical Co., Ltd., The	19
Haw & Co., Ltd.	65	Montague Radio Inventions & Development Co., Ltd.	12	Telegraph Condenser Co., Ltd., The 37A	
Heayberd, F. C., & Co.	71	Mullard Wireless Service Co., Ltd. 31, 59, 62		Telsen Electric Co., Ltd. Inside Back Cover	
Holzman, Louis	26	Ormond Eng. Co., Ltd.	60	Three Star Accumulators, Ltd.	22
Houghtons	39	Partridge, Wilson & Co.	63	Triotron Valves	38A
Hounslow, C., & Co.	69	Philips Radio	46, 47	Tulsemere Mfg. Co.	58
Hughes, F. A., & Co., Ltd.	10, 11	Port of London Cabinet Works	16	Tungsum Electric Lamp Works (Gt. Britain), Ltd.	48, 49
Jones, Samuel, & Co., Ltd.	58	Potter, H. B., & Co., Ltd.	65	United Ebonite Mfrs., Ltd.	63
Junit Mfg. Co., Ltd.	55	Radio Instruments, Ltd.	30	Varley (Oliver Pell Control, Ltd.) 44, 45	
Kalisky, S. (Aldgate), Ltd.	69	Regent Radio Supply Co. 1, 2, 3, 4, 5, 6, 7, 8		Ward & Goldstone, Ltd.	70
Kolster-Brandes	61	Richardsons	14	Westinghouse Brake & Saxby Signal Co., Ltd.	Inside Front Cover
Lectro Linx, Ltd.	67	Rothermel Corporation, Ltd., The	23	Wholesale Wireless Co., Ltd.	9
Limit Eng. Co., Ltd.	69	Rowley, Thomas A., Ltd.	67	Wilkins & Wright, Ltd.	24
Lisenin Wireless Co., The	65	Sankey, Joseph, & Sons, Ltd.	20	Wingrove & Rogers, Ltd.	71
Loewe Radio Co., Ltd., The	63	Sel-Ezi Wireless Supply Co., Ltd.	65	Wireless & Radio Trades Guardians Association, Ltd., The	63
Lustrolux, Ltd.	24				

Special Facilities for Readers

IF you desire further particulars of several items advertised in this issue, place a tick against the names of the advertisers in the index above and overleaf, and forward the page to the "Trader Information Bureau," St. Bride's House, Salisbury Square, Fleet Street, London, E.C.4, who will see that your request is forwarded.

W.T. 7/6/30

→ Sign here

Address

INDEX TO DISPLAYED ADVERTISEMENTS.

(Continued on Page 70.)

PAGE	PAGE	PAGE
Abbey Radio 26	British Transfer Printing Co., Ltd. 65	Dowler, F., & Sons 63
Abingdon Wireless Supplies 68	Bulgin, A. F., & Co. 66	Dubilier Condenser Co. (1925), Ltd. 29
Aeonic Radio, Ltd. 24, 25	Burall Bros. 65	Eastick, J. J., & Sons 68
Andrews, A. E., & Co. 68	Burndept Wireless (1928), Ltd. 50	Edison Bell, Ltd. 51
Ashton & Co. (Est. 1878), Ltd. 65	Cole, E. K., Ltd. 40, 41	Edison Swan Electric Co., Ltd. 21, 28
Ashton, Harold, A.M.I.E.E. 68	Columbia Graphophone Co., Ltd. Front Cover	Electric Lamp Factors 13
Automatic Coil Winder & Electrical Equipment Co., Ltd. 52	Concerton Radio & Electrical Co., The Back Cover	Emkabe Radio Co., Ltd. 68
Baird Television Development Co., Ltd. 32	Cossor, A. C., Ltd. 37	Epoch Radio Mfg. Co., Ltd. 68
Baker's "Selhurst" Radio 69	Danipad Rubber Co., Ltd. 18	Exact Mfg. Co. 69
Barber & Colman, Ltd. 12	Dayzite, Ltd. 68	Falk Stadelmann & Co., Ltd. 20
Beardsall, W. E., & Co., Ltd. 27	Dibben, Wm., & Sons, Ltd. 16	Ferranti, Ltd. 66
Beaver Electrical Supply Co. 69	Dixon, L., & Co. 68	Fielding, T., & Co., Ltd. 69
Becker, George, Ltd. 68		Fonteyn & Co., Ltd. 28, 68
Belling & Lee, Ltd. 64		Francois, E. J. 68
British Aluminium Co., Ltd. 22		Gambrell Radio, Ltd. 30
British Ebonite Co., Ltd., The 65		Garnett Whiteley & Co., Ltd. 53
		General Electric Co., Ltd. 56, 57

To obtain particulars of several items advertised in this issue place a tick against the name of the advertiser in the index above and overleaf and sign coupon at foot of index on the previous page.



ADVANCE INFORMATION

Manufacturers and Traders are invited to apply now for details of several

NEW POLAR CONDENSERS

which will shortly be available

WINGROVE & ROGERS LTD.

188-189, STRAND, LONDON, W.C. 2.

Polar Works: Mill Lane, Old Swan, Liverpool.

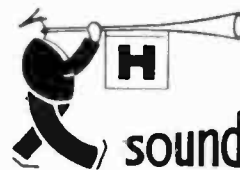

sound the ADVANCE - of SALES!

Now that most people owning a wireless receiver are realising that a mains unit is far in advance of batteries, the wary dealer will make components for mains units one of the chief items of his stocks. Then with the coming of the autumn he will be prepared to give advice and to sell to his customers

with



POWER TRANSFORMERS

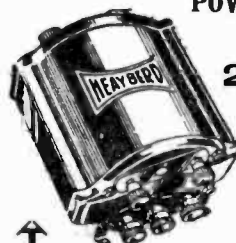

21/- The type illustrated is W.14, a power transformer for use with a Westinghouse metal rectifier for mains of 200-250v. 50 cycles.

F. C. HEAYBERD & CO.
10 FINSBURY ST., E.C.
Telephone: Clerkenwell 7216

BIG L.S.D FOR THE WIRELESS DEALER IN THESE TRANSFORMERS

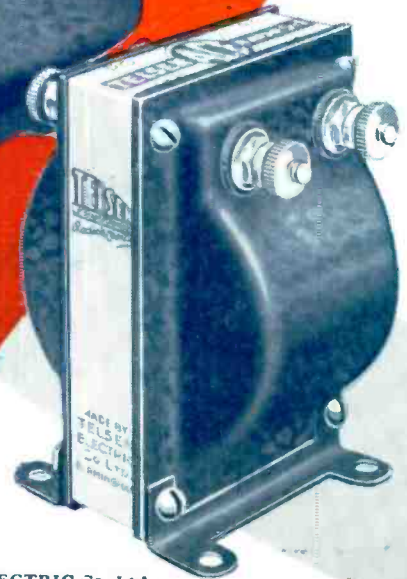
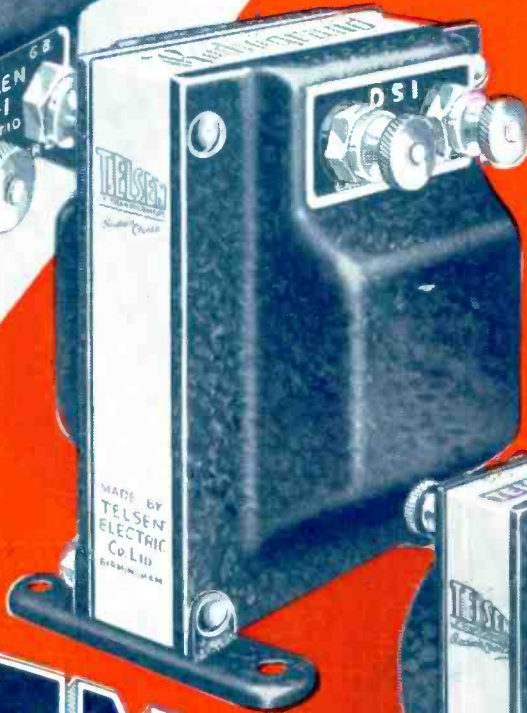
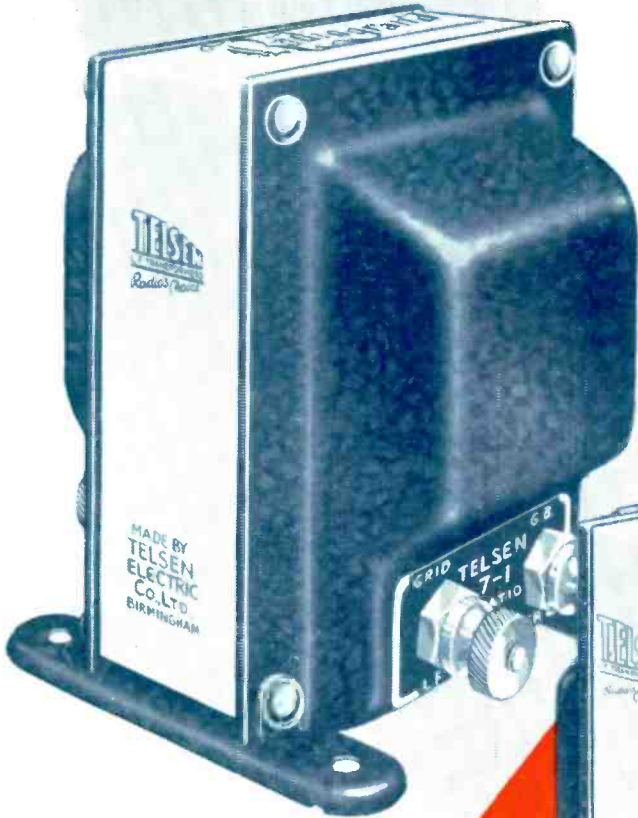

The Telsens range of Transformers offer one of the best investments any dealer can stock: always ready sellers, their "Sales Curve" is consistent throughout the season. Made in three models: "Radiogrand" 7-1 ratio Super Transformer 17 6, "Radiogrand" Standard Model 12 6, and the Telsens "Ace" 8 6, both made in ratios 5-1 and 3-1.

TELSENS

TRANSFORMERS

TELSENS ELECTRIC Co. Ltd.
BIRMINGHAM

are you watching

—the growth in popularity of the valve that really does improve reception—FOTOS, the Concert Valve? How more and more people ask for FOTOS every day?

There's a selling proposition for you! A cheaper valve—but a valve masterpiece!

And the Big Discounts that are offered! How they swell a Trader's Profits, to be sure!



fotos
CONCERT VALVES
Trade Mark
 THE HEART OF EVERY SET-

5'6

GENERAL
 PURPOSE
 & POWER

Super Power 7/6
Screened Grid 15/6
Pentode 18/6

Stock FOTOS and swell your profits

CONCERTON RADIO & ELECTRICAL CO. LTD.
 256/7 Bank Chambers, 329 High Holborn, W.C.1
 Telephone : Holborn 8667

