

WHAT NEW IDEAS SHALL WE SEE THIS SEASON?

Wireless Magazine

1-

AUGUST
1934

PAUL D. TYERS
designs a
PORTABLE
on "COMMERCIAL"
lines for the
AMATEUR



so in this Issue
Tracing and Curing Hum
UNIVERSAL TESTER
made from Bits and Pieces

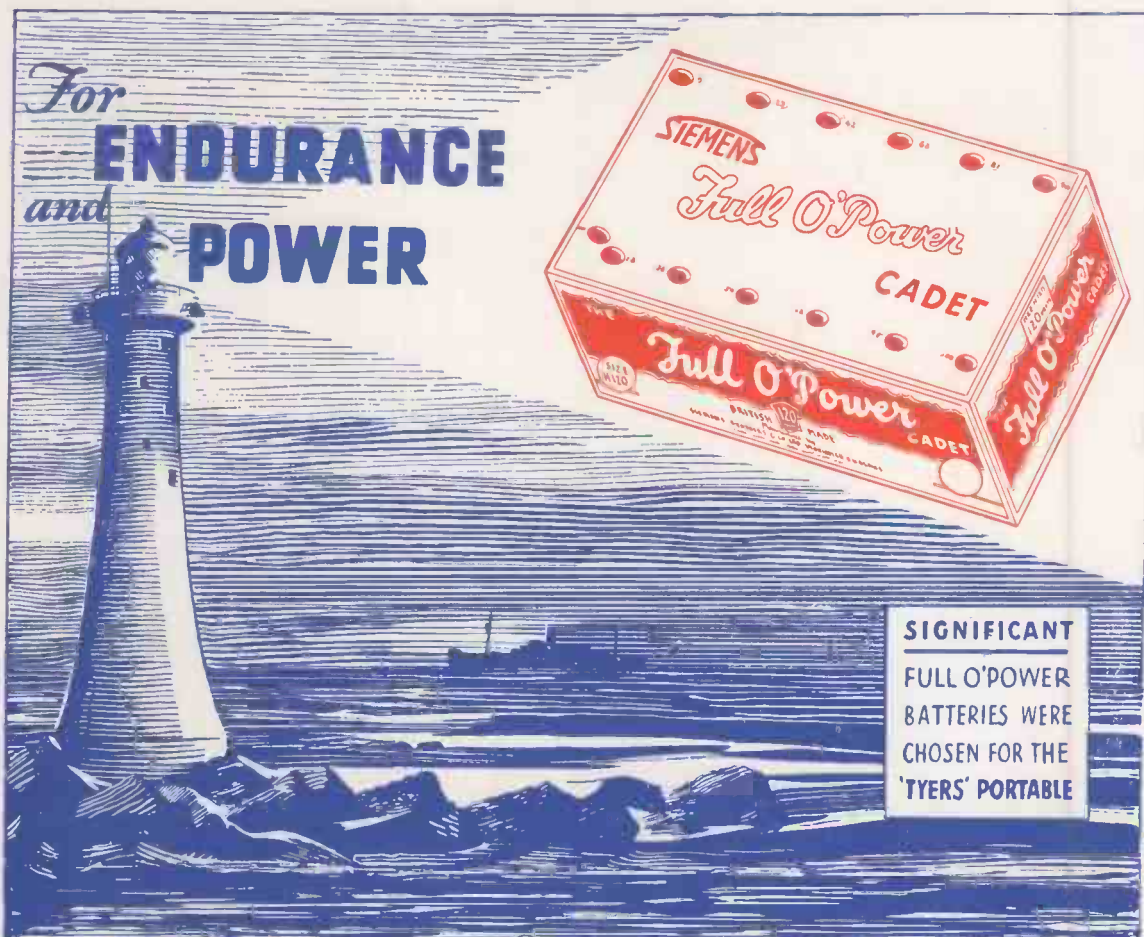

For
ENDURANCE
and
POWER

SIGNIFICANT
FULL O'POWER
BATTERIES WERE
CHOSEN FOR THE
'TYERS' PORTABLE

FULL O'POWER

RADIO BATTERIES

BRITISH MADE BY **SIEMENS**

A user writes :—

Lennoxton, Glasgow.

"I bought a Full O'Power which has outlasted all other makes of H.T. Batteries I have used in the past; naturally I have bought another of the same type"

(signed) Ernest A.

★ Write for Booklet 667 containing up-to-date BATTERY information

Editor-in-Chief:
BERNARD E. JONES

Technical Editor:
J. H. REYNER
B.Sc. (Hons.), A.M.I.E.E.

Radiovision Editor:
H. CORBISHLEY

Wireless Magazine

The Best Shillingworth in Radio

Vol. XX : AUGUST 1934 : No. 115

Editor:
D. SISSON RELPH

Research Consultants:
W. JAMES and
PERCY W. HARRIS

Assistant Editor:
T. F. HENN

Published by BERNARD JONES PUBLICATIONS, LTD., 58/61 Fetter Lane, London, E.C.4. Telephone: Central 4341 (four lines). Telegrams: "Beejabee, Fleet. London." Subscription: Great Britain and abroad, 15s. 6d. a year, post paid (Canada only, 13s. 6d.). Next issue published on Wednesday, August 29.

A Lively Autumn!

AFTER a quiet summer in home-construction, there is coming a lively autumn. For the quietness we have to thank, with individual degrees of ingratitude, the tropical weather, the absence of outstanding technical developments, the competition of the manufactured set, and so forth. For much of the promised liveliness, we are in a position to give credit to an old contributor of "Wireless Magazine" and "Amateur Wireless," to wit Paul D. Tyers, who was writing for the amateur as far back as 1922 and between whom and ourselves there has always been more or less close contact.

Paul Tyers has been for some time one of the best-known set-designers in the radio trade. "Wireless Magazine" readers will remember him for his experiments and development work in connection with the iron-core coil. He has some real novelties in hand, as to which we can say but little at the moment except as regards his new portable, a simple set intended for the amateur, but reflecting current commercial practice. We describe it fully in our pages this month.

It uses one stage of ordinary screen-grid amplification, a detector and two low-frequency stages, the output being so arranged that either a pentode or a power valve can be used. While the layout is in a class by itself, the construction is kept simple. I may tell you that this portable has taken months to design, Paul D. Tyers being of the careful, studious type that takes nothing for granted.

This portable is the most important set of its kind introduced for a long time. Other sets which he is designing for us will, in a still more remarkable way, actually improve on commercial practice.

It is difficult to believe that the Radio Exhibition at Olympia is close upon us; but there, nowadays we hold our Show in the summer instead of the autumn! Before the publication of our next issue, the Radio Show of 1934 will have come and gone, and in a special article in this issue we point to some of the new ideas we shall see this season and deal in particular with technical improvements.

Marcus Scroggie makes, with "bits and pieces," a universal tester, which will enable the constructor to match his own coils and condensers for ganging, test the efficiency of components, and in addition measure capacity, inductance, and wavelength. He describes this very useful instrument, worth a great deal to every constructor and experimenter and costing but very little, in a well-illustrated article in our pages this month.

A short-wave two-valver, using A.C./D.C. mains valves and the latest type of short-wave coil, is what many hundreds of readers seem to need. The "W.M." Band-spread Short-waver described in this issue gives a good performance on all wavelengths and can be used without alteration on either A.C. or D.C. mains.

Percy Harris has been taking a radio-equipped car about the country and now tells us how the outfit behaved during a run round the hills and valleys of Surrey and Sussex. Some of his results seem to be contrary to what might have been expected.

"I.B.U.—The Radio League of Nations," an article by Alan Hunter, offers an insight into the exact powers and functions of the International Broadcasting Union, which recently met in London for its annual general conference and deals with some of the members, including Arthur Burrows, the Secretary-general of the I.B.U., and Raymond Braillard, the man who checks the wavelengths at the famous Brussels station.

The Crossley Radio Corporation of America now have the most powerful broadcasting station in the world, you will learn from an article in our pages. It must be very different from the little station I was driven out to visit in 1926. I had spent some time in the Crossley studio near Cincinnati and was then taken out over miles of country road in a car to Harrison, where in a deserted part of the country the Crossley people had their 5-kilowatt station. Just one-hundredth part of the power of the new giant, but in those days described as being "relatively powerful."
B. E. J.

FOR THE CONSTRUCTOR

- THE TYERS PORTABLE. Designed by Paul D. Tyers .. 12
"W.M." BAND - SPREAD SHORT - WAYER. Designed by the "W.M." Technical Staff .. 69

TECHNICAL FEATURES

- WHAT NEW IDEAS SHALL WE SEE THIS SEASON? By the "W.M." Technical Staff .. 26
MAKING AND USING A UNIVERSAL TESTER. By Marcus G. Scroggie, B.Sc., A.M.I.E.E. .. 43
HOW TO TRACE AND CURE HUM. By S. Rutherford Wilkins .. 52
OUR TESTS OF THE NEW SETS. By the "W.M." Set Selection Bureau .. 55
HALCYON BATTERY THREE-VALVER .. 56
H.M.V. MODEL 542 AUTORADIOGRAM .. 57
EKCO BATTERY FOUR, MODEL B54 .. 58
UNIVERSAL ALL-WAVE SUPER-HET .. 59
MARCONIPHONE MODEL 262 A.C. SUPER-HET .. 60
TESTS OF NEW APPARATUS .. 83
USING THE NEW VALVES. By the "W.M." Technical Staff .. 85

Contents

GENERAL ARTICLES

- GUIDE TO THE WORLD'S BROADCASTERS. By Jay Coote .. 2
WORLD'S BROADCAST WAVELENGTHS .. 4
LATEST VALVE LISTS FOR THE ASKING. By Fetter Lane .. 8
VALVES IN THE MAKING .. 11
I.B.U.—THE RADIO LEAGUE OF NATIONS. By Alan Hunter .. 19
SHOULD AMATEUR TRANSMITTING BE ENCOURAGED? By Kenneth Jowers .. 22
AUTOMATIC S O S FOR THE YACHTSMAN. By Malcolm Harvey .. 24
A WARNING TO THE B.B.C. By Whitaker-Wilson .. 31
MY EXPERIENCES WITH CAR RADIO. By Percy W. Harris, M.Inst.Rad.E. .. 33
FORTY SEASONS OF "PROM" CONCERTS. By Whitaker-Wilson .. 37
AMERICA'S NEW 500-KILOWATT GIANT. By Lionel Merdler .. 38

- WIRELESS JOBS MADE EASY FOR MR. EVERY-MAN. By R. W. Hallows, M.A. .. 40
NEW EGYPTIAN BROADCASTING STUDIOS .. 42
RADIO MEDLEY. A Radio Fan's Causerie, by BM/PRESS .. 49
RECORDING—AND HOW YOU CAN DO IT AT HOME. By Frank Charnley .. 61
PROGRAMME NOTES AND NEWS. By T. F. Henn .. 66
WHAT I THINK OF THE "W.M." RADIOGRAM SUPER. By T. F. Henn .. 76
ON THE CREST OF THE WAVES. By Jay Coote .. 90
NEWS FROM ALL PARTS .. 92
THE "W.M." EMPIRE SHORT-WAYER IN FIJI .. 93
COUPONS: INDEX TO ADVERTISERS .. 96

TELEVISION SECTION

- THE CONSTRUCTION OF TELEVISION RECEIVERS. By H. Corbishley .. 79

GRAMO-RADIO ARTICLES

- CHOOSING YOUR RECORDS. By Whitaker-Wilson .. 74
ADDITIONAL RECORDS REVIEWED. By Chopstick .. 75

A PORTABLE DESIGNED ON "COMMERCIAL" LINES—See page 12.

Registered at the General Post Office for transmission by Canadian Magazine Post

Postage on this issue 3d, (inland and abroad)

Guide to the World's Broadcasters

Specially Compiled for "Wireless Magazine" by JAY COOTE

(Revised)
Metres : 240.2 **JUAN-LES-PINS** **Kilocycles :**
Power : 0.8 kw. **(France)** **1,249**

Distance from London: Approximately 640 miles.
Standard Time: Greenwich Mean Time (France adopts British Summer Time).
Announcer: Man.
Call: "Allo! Allo! Ici le Poste de Nice, Cannes, Juan-les-Pins. Emissions de la Societe Radio Cote d'Azur."
Abbreviated Call: 'Ici Radio Cote d'Azur, Juan-les-Pins.'
Main Daily Programme: B.S.T. 1230-1400, concert (1300 news); 2000, news, etc.; 2015 (Tuesdays), English lesson (Fridays) Esperanto; 2030-2200, concert or relay (2100 news).
 Usually closes down at 2200, but on Sundays concert in English is given at 2230, followed by dance music until midnight.
 Frequent relays are made from the Casino at Monte Carlo.
 Closes down with usual French good-night greetings, followed by *La Marseillaise*.

(Revised)
Metres : 437.3 **BELGRADE** **Kilocycles :**
Power : 2.5 kw. **(Yugoslavia)** **686**

Distance from London: Approximately 1,055 miles.
Standard Time: Central European (coincides with British Summer Time).
Announcer: Woman.
Call: "Ovde Radio Beograd" (phon.: "Bay-owe-grard").
Interval Signal: Musical box (first bars of Serbian folk song).
Main Daily Programme: B.S.T. 0900 (Thursdays), church service; 0925 (Sundays), physical exercises; 1100, concert or records; 1205, concert; 1630 (Sundays, 1600), concert; 1830 (Wednesdays), French lesson; 1900, concert or talk; 2000, main evening programme; 2200, time signal, news, sport, etc., followed by concert or relay (dance music on Sundays and Tuesdays).
 Closes down at 2300 (Mondays, Tuesdays, Wednesdays, Fridays) and 2330 (Sundays, Thursdays, Saturdays) with the words, "Ovde Radio Beograd zeli svima svime; Laku noc" ("Belgrade wishes all its listeners good-night"), followed by injunction to earth the aerial. Frequently exchanges programmes with Zagreb, 276 metres.

(Revised)
Metres : 531 **ATHLONE** **Kilocycles :**
Power : 60 kw. **(Irish Free State)** **565**

Distance from London: Approximately 358 miles.
Standard Time: Greenwich Mean Time (Irish Free State adopts British Summer Time).
Announcers: Man and woman.
Call (in Gaelic and English): "Se Seo Radio, Ath Luain, Atha Cliath, agus Corcaige" ("These are the Athlone, Dublin, and Cork broadcasting stations calling").
Main Daily Programme: B.S.T. 1300 (Sundays), records (silent on Sunday till 2030, time signal, concert); 1330, time signal, weather, news, records; 1800, talks, etc.; 1900 (Mondays and Wednesdays), Irish lesson (Thursdays French); 1930 (approximately), main evening programme; 2200 (except Sundays), variety; 2230, time signal, weather, news, etc.
 Closes down at approximately 2300 with good-night greetings in Gaelic and English, followed by Irish Free State Anthem.
Relays: Cork, 241.9 metres (1,240 kilocycles), 1 kilowatt; Dublin, 222.6 metres (1,348 kilocycles), 1 kilowatt.

(Revised)
Metres : 1,807 **LAHTI** **Kilocycles :**
Power : 40 kw. **(Finland)** **166**

Distance from London: Approximately 1,130 miles.
Standard Time: Eastern European (British Summer Time plus 1 hour).
Announcers: Man and woman.
Call (for Finnish transmissions): "Huomio! Huomio! Taala Suomen Helsinki, Lahti, Viipuri." For Swedish broadcasts: "Giv akt! Giv akt! her Finlandsrundradio Helsingfors, Lahti, Viborg."
Interval Signal: Musical box melody.
Main Daily Programme: B.S.T. 0900 (Sundays) church service; 1100, concert or records; 1700 (Sundays), records; 1750, time signal and news in Finnish and Swedish, followed by talks, etc.; 2000, main evening programme; 2045, news in Finnish and Swedish, followed by relay of concert (except Saturdays).
 Closes down at approximately 2200 with greetings in Finnish and Swedish.

(Revised) **W2XAD** **W2XAF:**
19.56 metres; SCHENECTADY **31.48 metres ;**
15,330 kilo- **9,530 kilo-**
cycles ; 20 kw. (New York, U.S.A.) cycles ; 40 kw.

Distance from London: Approximately 3,050 miles.
Standard Time: British Summer Time less 5 hours (America adopts Summer Time).
Announcer: Man.
Call: "This is the N.B.C. programme. Your station is WGY, or short-wave station W2XAD/W2XAF, at Schenectady, transmitting on 15,330 (or 9,530) kilocycles."
Interval Signal: Three notes on xylophone-like instrument.
Times of Transmission: B.S.T. 2100-2200, Sundays, Mondays, Wednesdays, and Fridays (W2XAD); 0045-0400, daily (W2XAF).
 Relays programmes from WGY, Schenectady, which is linked up with WEAF, New York, of the N.B.C. (National Broadcasting Company of America) "Red" network.
 Closes down with the words: "Good-night to you all, ladies and gentlemen."

(Revised) **HBL : 31.27** **HBP : 38.48**
metres ; 9,595 metres ; **RADIO NATIONS** **metres ; 7,797**
kilocycles ; **(Switzerland)** **kilocycles ;**
18 kw. **20 kw.**

Distance from London: Approximately 470 miles.
Standard Time: Central European (coincides with British Summer Time).
Announcer: Man.
Languages Used: French, Spanish, and English.
Call: "This is the wireless station of the Information Department of the Secretariat of the League of Nations at Geneva, Switzerland." Also given in French and Spanish.
Times of Transmission: B.S.T. 2330-0015 (Saturday-Sunday morning only), broadcasts relating to the activities of the League of Nations. S.B. on both wavelengths.
 Stations are also used for telegraphy transmissions to the Far East, U.S.A., and South America.

Metres : 45.31 **RIOBAMBA (PRADO)** **Kilocycles :**
Power : 0.2 kw. **(Ecuador)** **6,620**

Distance from London: Approximately 5,000 miles.
Standard Time: British Summer Time less 6 hours.
Announcer: Man.
Languages Used: Spanish and English.
Call: "Aqui Estacion el Prado, Riobamba, Ecuador."
Times of Transmission: B.S.T. 0300-0540 (Fridays only), news bulletins, concerts, gramophone records, etc.
 Broadcasts open and close with Ecuador National Anthem.
 Transmissions also given occasionally on 19.47 metres (15,410 kilocycles), from 2300 B.S.T.

(Revised)
Metres : 49.5 **NAIROBI, VQ7LO** **Kilocycles :**
Power : 0.5 kw. **(Kenya Colony)** **6,060**

Distance from London: Approximately 4,300 miles.
Standard Time: British Summer Time plus 1 hour 30 minutes.
Announcer: Man.
Call: "This is VQ7LO, the Nairobi station of the East African Broadcasting Company, calling."
Times of Transmission: B.S.T. 0900-1000 (Tuesdays), 1400-1500 (Thursdays), 1700-2000 daily (Saturdays till 2100).
 Broadcasts consist of news bulletins, market reports, American and English music, book reviews, etc., and occasional relays are made of the Daventry Empire programme and Big Ben chimes.
 Closes down with good-night greetings and *God Save the King*.



WIDEN YOUR CHOICE OF PROGRAMMES

No matter what type of Receiver you use—Battery or All-Electric (A.C. or D.C.)—there is a Cossor Screened Grid Valve to suit it. By fitting one of these highly efficient valves you can considerably widen your choice of programmes.

Because Cossor S.G. Valves have negligible inter-electrode capacity they permit exceptionally high effective amplification, and this means increased range. To fit a Cossor Screened Grid Valve, therefore, is a simple way of improving performance.



COSSOR SCREENED GRID VALVES

Cossor 2-volt Screened Grid Valves

Type	Fila-ment Amps.	Anode Volts	Imped.	Amp. Factor	Mutual Conduc-tance m.a./v.	Price
*215 S.G.	-15	120-150	300,000	330	1-10	15/6
*220 S.G.	-2	120-150	200,000	320	1-60	15/6
*220 V.S.G.	-2	120-150	110,000	—	1-60	15/6
*220 V.S.	-2	120-150	400,000	—	1-60	15/6

Cossor A.C. Mains Screened Grid Valves

Type	Purpose	Imped.	Amp. Factor	Mutual Conduc-tance m.a./v.	Price
*†MSG-HA	Super H.F. Amp'n.	500,000	1,000	2-0	17/6
*†1MSG	Super H.F. Amp'n.	400,000	1,000	2-5	17/6
*†MSG-LA	Super H.F. Amp'n.	200,000	750	3-75	17/6
*†MVSG	Variable-Mu S.G.	200,000	—	2-5	17/6

The above Valves have Indirectly Heated Cathode, 4 Volts, 1 Amp

Cossor D.C. Mains Screened Grid Valve

*†DVSG	Variable-Mu S.G.	—	—	2-5	17/6
--------	------------------	---	---	-----	------

The above Valves have Indirectly Heated Cathode, 16 Volts, 0.25 Amp.

*These Valves available with or without Metallised Bulbs.

† Characteristics measured at -1's grid volts

** Stocked with Metallised Bulb only

FREE! 72-page WIRELESS BOOK

From cover to cover this Cossor 72-page Wireless Book is packed full of useful and interesting information—latest circuits—explanations of technical terms—how a superhet works, etc. Send at once for free copy. Please use the coupon

USE THE COUPON

To A. C. COSSOR LTD.,
Melody Dept., Highbury
Grove, London, N.5.

Name

Please send me free of charge,
a copy of the Cossor 72-page
Wireless Book.

Address.....

B.V.33

W. MAG. 8/34

Mention of the "Wireless Magazine" will ensure prompt attention



BROADCAST WAVELENGTHS

Stations best received in the British Isles are indicated in bold type

Note: Names in brackets are those of stations relayed

Wave-length	Name of Station	Dial Readings	Country	Wave-length	Name of Station	Dial Readings	Country
12.30	Bowmanville		Canada	31.35	Millis W1XAZ (WBZ)		United States
13.92	East Pittsburgh		U.S.A.	31.38	Zeesen DJA		Germany
13.97	Daventry GSH		Great Britain	31.41	Jeloy LCL		Norway
14.49	Buenos Aires LSY		Argentina	31.48	Schenectady W2XAF (WGY)		United States
14.58	Bandoeng PMB		Java	31.545	Daventry (Empire) GSB		Great Britain
15.5	Bandoeng PMA		Java	31.55	Melbourne VK3ME		Victoria
15.92	Bandoeng PLE		Java	31.55	Caracas YV3BC		Venezuela
16.36	Lawrenceville (N.J.) WLA		United States	31.58	Rio de Janeiro PSA		Brazil
16.38	Rugby GAS		Great Britain	31.71	New Brunswick WKJ		United States
16.5	Drummondville (CFA8)		Canada	31.9	Bandoeng PLV		Java
16.56	Bandoeng PMC		Java	32.71	Lawrenceville WNA		United States
16.56	Buenos Aires LSY3		Argentina	32.79	Maracay YVQ		Venezuela
16.81	Bandoeng PLF		Java	32.88	Szokesfehervar HAT4		Hungary
16.85	Kootwijk PCV		Holland	33.26	Rugby GCS		Great Britain
16.86	Daventry Empire GSG		Great Britain	33.59	Rocky Point (N.J.) WEC		United States
16.878	Boundbrook W3XAL (WJZ)		United States	34.68	London VE9BY		Canada
16.88	Eindhoven PHI		Holland	36.65	Rio de Janeiro PSK (PRÁ3)		Brazil
16.89	Königswusterhausen DJE		Germany	37.04	Quito HCJB		Ecuador
17.05	Transatlantic liners			37.33	Rabat (CNR)		Morocco
19.56	Schenectady W2XAD (WGY)		United States	37.41	Suva VPD		Fiji Isles
19.61	La Paz CP4		Bolivia	38.07	Tokio JIAA		Japan
19.63	New York W2XE (WABC)		United States	38.47	Radio Nations HBP		Switzerland
19.67	Coytesville N.J. W1XAL (WEEI)		United States	38.65	Kootwijk PDM		Holland
19.67	Tashkent (Rim)		U.S.S.R.	39.34	Tashkent RIM		U.S.S.R.
19.68	Radio Colonial FYA		France	39.76	Moscow RKI		U.S.S.R.
19.72	Saxonburg W8XK (KDKA)		United States	39.82	Riobamba PRADO		Ecuador
19.93	W8XK, Saxonburg (KDKA)		United States	39.89	Moscow RKI		U.S.S.R.
19.737	Zeesen DJB		Germany	40.3	Radio Nations HBQ		Switzerland
19.815	Daventry (Empire) GSF		Great Britain	40.5	Bogota HJ3ABB		Colombia
19.84	Rome (Vatican) HVJ		Italy	40.54	Rocky Point WEN		U.S.A.
19.88	Moscow (RKI)		U.S.S.R.	41.1	Amateur band		
20.27	Rocky Point WQV		United States	41.55	Bogota HKE		Colombia
20.31	Rocky Point N.Y. (WEB)		United States	41.6	Las Palmas EA8AB		Canary Isles
20.97	Amateur band			41.67	Singapore VS1AB		Sts. Sett'l'mts.
21.43	Cairo SUV		Egypt	41.84	Grenada YN6RD		Nicaragua
21.53	Rocky Point WIK		United States	41.9	Manizales HJ4ABB		Colombia
21.58	Rocky Point WQP		United States	42.92	Jeloy		Norway
21.605	Rocky Point WQT		United States	43	Madrid EA4AQ		Spain
21.83	Drummondville CJAS		Canada	43.86	Budapest HAT2		Hungary
22.26	Rocky Point WAJ		United States	44.61	Rocky Point WQO		United States
22.48	Santa Rita YVQ		Venezuela	44.96	Maracay YVQ		Venezuela
22.68	Liners			45	Constantine FM8KR		Tunis
22.684	Zeesen (DHB)		Germany	45	Guatemala City		S. America
23.39	Radio Maroc (Rabat) CNR		Morocco	45.02	Guayaquil HC2RL		Ecuador
24.41	Rugby GBU		Great Britain	45.38	Moscow RW72		U.S.S.R.
24.9	Kootwijk PDV		Holland	46.53	Barranquilla (HJ1ABB)		Colombia
25	Moscow RNE		U.S.S.R.	46.69	Boundbrook W3XL (WJZ)		United States
25.25	Radio Colonial, Paris (FYA)		France	46.7	Boston W1XAL		United States
25.25	Saxonburg (Pa.) W8XK (KDKA)		United States	47	Cali HJ5ABB		Colombia
25.28	Daventry (Empire) GSE		Great Britain	47.5	S. Domingo HIZ		Dominican R.
25.34	Wayne W2XE (WABC)		United States	47.8	Domingo H1AA		Dominican R.
25.4	Rome ZRO		Italy	48.75	Winnipeg CJRO		Canada
25.45	Boston W1XAL (WEEI)		United States	48.78	Caracas YV3BC		Venezuela
25.51	Zeesen DJD		Germany	48.86	Saxonburg (Pa.) W8XK (KDKA)		United States
25.532	Daventry (Empire) GSD		Great Britain	49	Moscow (RKK)		U.S.S.R.
25.58	Winnipeg (CJRX)		Canada	49	Johannesburg ZTJ		South Africa
25.63	Radio Coloniale FYA		France	49.02	Wayne W2XE (WABC)		United States
26.83	Funchal CT3AQ		Madeira	49.08	Caracas YVIBC		Venezuela
27.65	Nauen DFL		Germany	49.1	Halifax VE9HX (CHNS)		Canada
27.86	Rugby GBP		Great Britain	49.18	Boundbrook W3XAL (WJZ)		United States
27.88	Marapicu PSG		Brazil	49.22	Chicago W9XF (WENR)		United States
28.28	Rocky Point (N.J.) WEA		United States	49.26	Bowmanville VE9GW (CRCT)		Canada
28.5	Sydney VLK		N.S. Wales	49.3	St. John VE9BJ (CFBL)		N. Brunswick
28.98	Buenos Aires LSX		Brazil	49.34	La Paz CP5		Bolivia
29.03	Bermuda ZFD		West Indies	49.34	Chicago W9XAA (WCFL)		United States
29.04	Ruyselede (ORK)		Belgium	49.39	Maracaibo V5BMO		Venezuela
29.16	Zeesen (DIQ)		Germany	49.4	Vienna OER2		Austria
29.35	Marapicu PSH		Brazil	49.43	Vancouver VE9CS (CKFC)		Brit. Columbia
29.59	Leopoldville OPM		Belgian Congo	49.47	Nairobi VQ7LO		Kenya Colony
29.64	Marapicu PSI		Brazil	49.5	Philadelphia W4XAU (WCAU)		United States
29.84	Abu Zabel, Cairo SUV		Egypt	49.5	Cincinnati W8XAL (WLW)		United States
30	Radio Excelsior LR5		Argentina	49.586	Daventry (Empire) GSA		Great Britain
30.1	Rome IRS		Italy	49.6	Bogota HJ3ABI		Colombia
30.4	Lawrenceville WON		United States	49.67	Boston W1XAL (WEED)		United States
30.4	Tokio JIAA		Japan	49.83	Zeesen DJC		Germany
30.43	Madrid EAQ		Spain	49.9	Singapore ZHI		F.M. States
30.77	Lawrenceville WOF		United States	49.92	Havana COC		Cuba
30.9	Rugby GCA		Great Britain	49.96	Drummondville VE9DN		
31.3	Daventry (Empire) GSC		Great Britain		(CFCF)		Canada
31.08	Nauen DGU		Germany	49.97	Caracas YV2BC		Venezuela
31.23	Mexico City XETE		Mexico	50.8	Barcelona EA3AB		Spain
31.25	Lisbon CT1AA		Portugal		Moscow RNE		U.S.S.R.
31.26	Radio Nations HBL		Switzerland	50.26	Rome (Vatican) HVJ		Italy
31.28	Philadelphia W3XAU (WCAU)		United States	50.26	Vatican		Rome
31.28	Sydney VK2ME		N.S. Wales	50.42	Domingo HIX		Dominican R.

(Continued on page 6)

There's more than a big name behind **G.E.C.** RADIO



● Your search for the supreme radio receiver at Radiolympia this year will inevitably take you to the G.E.C. Stand. And although you will admire the superb cabinet work and attractive appearance of all the G.E.C. sets, remember that there is more than this behind them. For every G.E.C. set has been designed in the finest electrical and Radio research Laboratories in the country—by men responsible for some of the greatest achievements in radio.

G.E.C. A.C./D.C. MAINS THREE

HIRE PURCHASE TERMS

Deposit 13/- and twelve monthly payments of 13/-

£7-15

A "universal" mains receiver for both A.C. and D.C. supplies, providing exceptional quality and power with reasonable range and with flexibility of operation. Built-in energised moving coil speaker with 2-watts output. Illuminated tuning control. Connections for low-impedance extension speaker. OSRAM VALVES. Lustrous moulded Bakelite cabinet.

For A.C. Mains 200/250 volts, 40/100 cycles, and D.C. Mains 200/250 volts.
MADE IN ENGLAND

SEE THE COMPLETE NEW RANGE AT RADIOLYMPIA

G.E.C. THE SETS WITH THE BIG NAME BEHIND THEM

Advt. of The General Electric Co. Ltd., Magnet House, Kingsway, London, W.C.2

WORLD'S BROADCAST WAVELENGTHS Continued from page 4

Wave-length	Name of Stations	Dial Readings	Country	Wave-length	Name of Station	Dial Readings	Country
50.6	Medellin HJ4ABE		Colombia	309.9	Grenoble PTT		France
56.9	Königswusterhausen (DTG)		Germany	312.8	Poste Parisien, Paris		France
57.03	Rocky Point WQN		United States	315.8	Breslau		Germany
58.03	Bandoeng PMY		Java		Goteborg		Sweden
58.31	Prague		Czechoslovakia	318.8	Algiers		North Africa
60.3	Rugby GBC		Great Britain	321.9	Brussels (2)		Belgium
62.5	Long Island (N.J.) W2X		United States	325.4	Brno		Czechoslovakia
62.55	London		Ontario	328.6	Radio Toulouse		France
65.93	Rocky Point WAD		United States	331.9	Limoges PTT		France
68.18	Moscow (RFCK)		U.S.S.R.	331.9	Hamburg		Germany
69.44	Rugby GDB		Great Britain	335.2	Helsinki		Finland
70.2	Khabarovsk RV15		U.S.S.R.	338.6	Graz		Austria
73	Quito (HCJB)		Ecuador	342.1	London Regional		Great Britain
76	Maracay (YV11AM)		Venezuela	345.6	Poznan		Poland
80	Lisbon CTICT		Portugal	349.2	Strasbourg		France
84.5	Berlin D4AGE		Germany	352.9	Bergen		Norway
84.67	Mozambique CR7AA		East Africa		Valencia		Spain
85.9	Boston W1XAL		United States	356.7	Berlin		Germany
203.5	Plymouth		Great Britain	360.6	Moscow (4)		U.S.S.R.
204.7	Bournemouth		Great Britain	362.8	Radio LL Paris		France
204.7	Pecs		Hungary	364.5	Bucharest		Roumania
206	Fecamp		France	368.6	Milan		Italy
208.6	Miskolcz		Hungary	373.1	Scottish Regional		Great Britain
209.9	Beziere		France		Salonika		Greece
209.9	Newcastle		Great Britain	377.4	Lvov		Poland
211.3	Tampere		Finland		Barcelona (EAJ1)		Spain
214	Sofia		Bulgaria	382.2	Leipzig		Germany
215.4	Radio Lyon		France	386.6	Toulouse PTT		France
216.8	Warsaw No. 2		Poland	391.1	Midland Regional		Great Britain
218.2	Basle, Berne		Switzerland	395.8	Katowice		Poland
219.6	Lorun		Poland	400.5	Marseilles PTT		France
221.1	Turin (2)		Italy	405.4	Munich		Germany
	Dublin		Irish F. State		Seville		Spain
222.6	Bordeaux S.O.		France	410.4	Tallinn		Estonia
	Königsberg		Germany		Madrid (España)		Spain
	Milan (2)		Italy	415.5	Kiev		U.S.S.R.
224	Montpellier		France	420.8	Rome		Italy
	Lodz		Poland	426.1	Stockholm		Sweden
	Hanover		Germany	431.7	Paris PTT		France
	Bremen		Germany	437.3	Belgrade		Yugoslavia
225.6	Flensburg		Germany	443.1	Sottens		Switzerland
	Stettin		Germany	449.1	North Regional		Great Britain
	Magdeburg		Germany	455.9	Langenberg		Germany
230.2	Danzig		Germany	463	Lyons PTT		France
	Linz		Austria	470.2	Prague (1)		Czechoslovakia
231.8	Salzburg		Austria	476.9	Trondheim		Norway
	Dornbirn		Austria	483.9	Brussels (1)		Belgium
233.5	Aberdeen		Great Britain	491.8	Florence		Italy
	Dresden		Germany	499.2	Sundsvall		Sweden
235.1	Stavanger		Norway		Rabat		Morocco
236.8	Nurnberg		Germany	506.8	Vienna		Austria
238.5	San Sebastian		Spain		Agen		France
	Rome (3)		Italy	514.6	Riga		Latvia
240.2	Juan-les-Pins		France	522.6	Mühlacker		Germany
241.9	Cork		Irish F. State	531	Athlone		Irish F. State
243.7	Gleiwitz		Germany	539.6	Beromunster		Switzerland
245.5	Trieste		Italy	549.5	Budapest		Hungary
247.3	Lille PTT		France	559.7	Wilno		Poland
249.2	Prague Strasnice (2)		Czechoslovakia		Bolzano		Italy
	Frankfurt-am-Main		Germany		Viipuri		Finland
	Trier		Germany	569.3	Ljubljana		Yugoslavia
251	Freiburg-im-Breisgau		Germany		Innsbruck		Austria
	Cassel		Germany	578	Hamar		Norway
	Kaiserlautern		Germany	696	Oulu		Finland
253.2	Kharkov (2)		U.S.S.R.	726	Boden		Sweden
255.1	Copenhagen		Denmark	748	Moscow		U.S.S.R.
257.1	Monte Ceneri		Switzerland		Geneva		Switzerland
259.1	Moravska-Ostrava		Czechoslovakia	765	Ostersund		Sweden
261.1	London National		Great Britain	824	Smolensk		U.S.S.R.
	West National		Great Britain	845	Furnark		Norway
263.2	Turin (1)		Italy	1,107	Moscow (2)		U.S.S.R.
265.3	Horby		Sweden	1,145	Madona		Latvia
267.4	Belfast		N. Ireland	1,181	Oslo		Norway
	Nyiregyhaza		Hungary	1,224	Leningrad		U.S.S.R.
269.5	Kosice		Czechoslovakia	1,250	Vienna (Exp.)		Austria
	Radio Vitus (Paris)		France	1,261	Kalundborg		Denmark
271.7	Naples		Italy	1,304	Luxembourg		Luxembourg
274	Madrid EAJ7		Spain		Reykjavik		Iceland
276.2	Falun		Sweden	1,345	Kharkov		U.S.S.R.
	Zagreb		Yugoslavia		Warsaw		Poland
278.6	Bordeaux PTT		France	1,389	Motala		Sweden
280.9	Tiraspol		U.S.S.R.	1,395	Eiffel Tower		France
283.3	Bari		Italy	1,442	Minsk		U.S.S.R.
285.7	Scottish National		Great Britain	1,500	Daventry National		Great Britain
	Leningrad (2)		U.S.S.R.	1,550	Ankara		Turkey
288.6	Rennes PTT		France	1,571	Deutschlandsender		Germany
	Königsberg		Germany	1,621	Istanbul		Turkey
291	Parade		Portugal	1,648	Radio Paris		France
293.5	Barcelona (EAJ15)		Spain	1,724	Moscow No. 1		U.S.S.R.
296.2	North National		Great Britain	1,807	Lahti		Finland
298.8	Bratislava		Czechoslovakia		Kootwijk		Holland
301.5	Hilversum		Holland	1,875	Huizen		Holland
304.3	Genoa		Italy		Brasov		Roumania
	Cracow		Poland		Kaunas		Lithuania
307.1	West Regional		Great Britain	1,935			

A.C./D.C.

RECEIVERS

equipped with a Westinghouse Metal Rectifier are more simple, reliable and safe.

There can be no high anode to cathode voltages, and . . . the metal rectifier lasts for ever.

If you built the "Universal Merrymaker" you can make it into an even more reliable receiver by converting to metal rectification. Blueprints and complete instructions are available, price 6d. post free.



METAL RECTIFIERS

The Westinghouse Brake & Saxby Signal Co., Ltd.
82 York Road, King's Cross, London, N.1

CONSISTENCY

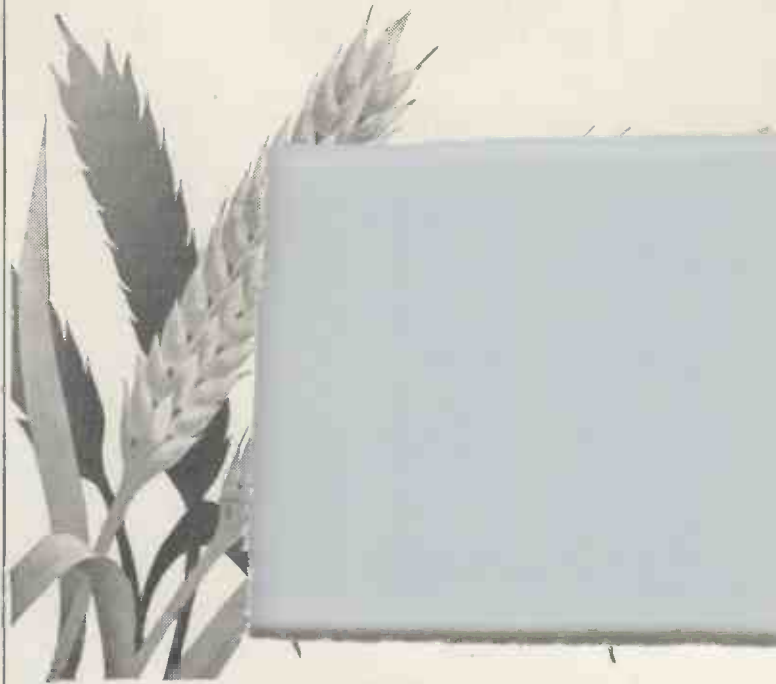

Corn and Condensers—what a curious combination! Yet, just as corn is a living symbol that nature never fails man—so the T.M.C. HYDRA mark on a condenser is a warrant of consistent, good performance. This unfailing consistency is only possible because T.M.C. HYDRA condensers are made from the finest raw materials, with up-to-date plant under the strictest scientific control, to tolerance figures of the narrowest margin.

Take advantage of these new standards in condenser production. Equip your set with T.M.C. HYDRA condensers—it will be better for your set and better for your pocket. They are made in all standard capacities.

Write to the Distributors if you have any difficulty in obtaining supplies.



T.M.C.

BRITISH MADE

HYDRA

CONDENSERS

Price List from Distributors:

T.M.C.-HARWELL (SALES) LTD

NOTE NEW ADDRESS:—

Britannia House, 233 Shaftesbury Avenue

(a few doors from New Oxford Street) London, W.C.2

Telephone: Temple Bar 0055 (3 lines)

Made by TELEPHONE MANUFACTURING Co.Ltd.



FREE!

Just send us a postcard

IN order that anyone you know who is interested in wireless but is not yet a reader of "Wireless Magazine" may become acquainted with it, a complimentary copy will be sent to him gratis and post free, if you will kindly send your request on a postcard, giving both your own and your friend's address.

To the Publisher,
"Wireless Magazine," (C.2.)
58-61 Fetter Lane, E.C.4.

Better service results from mentioning "Wireless Magazine" when writing to advertisers

Latest Valve Lists for the Asking

FETTER LANE'S REVIEW OF THE LATEST CATALOGUES

MARCONIPHONE and Osram appear to specialise in battery-valve gear, although for the mains-set merchant there are new valves in plenty.

X21—that's a nice intriguing designation for a new valve. It cloaks the identity of the battery pentagrid, and is to be used in all modern super-hets this year.

For the first time the battery super-het will be really free from tags. Their handbooks are worth getting for the details of this new valve alone, not counting the MX40, a mains version battery double-diode-triode, and a special output valve, giving 1,000 milliwatts, without any intermediate low-frequency stage.

Now about the Marconiphone and Osram VP21, a high-frequency pentode that runs from a 2-volt accumulator. This valve, when used as a detector, will load a super-power valve with only resistance-capacity coupling. Don't forget that a high-frequency pentode gives more amplification as a detector than a triode valve, and at the same time saves the expense of a low-frequency transformer.

A card will bring both Marconiphone and Osram booklets. **405**

NOW I will let you into a secret. At the Exhibition the Mullard Company will show their universal valves. These valves will make mains transformers almost obsolete.

They have eight-pin bases, with a special guide on the side of the valve, so that it is impossible to plug it in the wrong way round and burn out the heater.

"W.M." AT OLYMPIA

The tenth National Radio Exhibition will be held at Olympia from August 14 to August 24. Do not fail to pay "W.M." a visit at Stand No. 10. Here you will meet members of the Technical Staff who will willingly give advice

YOU MUST VISIT STAND No. 10

If you are on D.C. mains and use these valves in your set and with only moderate smoothing, hum is unnoticeable. Should at any time the supply be changed to A.C., remember that the set need not be altered if you use universal valves, for they work on either types of supply.

You can find out all about these valves without waiting for Olympia for the Mullard guide, free on request, is unusually complete and gives full technical data. **406**

AS quality will be one of the most important features of this season's sets, the Cossor people have brought out a number of new valves to help the constructor to this end. A double-diode is their first step in this direction, and there are several new mains pentodes as well.

Being set makers, Cossors do know what the constructor wants. They have a valve for every purpose, including a complete D.C. range, which gives as good results as their A.C. counterparts. The Cossor booklet gives some large-scale curves and is well worth having for the technical data which is given. You can get this also through my free service. **407**

WITH all these American midget and other receivers using American valves, I had an idea there would be a shortage of valves for replacement purposes. Tungstram apparently have the same idea, for they have brought out a complete range of valves for use in American receivers.

This range is a very complete one, and includes 2A7 and 6A7 pentagrids, mains rectifiers and super-power output valves.

They also have a range of universal valves with 20-volt .2-ampere heaters for A.C./D.C. sets. Tungstram valves will now be made in this country for the first time, so write and see just what they are including in their first all-British programme. **408**

BY this time next month the Exhibition will have made it necessary for me to turn out many precious catalogues I have carefully hoarded for the last year. Some of the new lists have already arrived, but they are mostly from valve makers. I wonder why that is? As most sets are designed round the valves, the valve makers have to decide their programme early in the year. Hence the early lists.

Perhaps it would be a good idea to tell you about the contents of some of these catalogues before they are filed away. Most of them are full of good things.

The Mazda people seem to like bringing out multi-electrode valves with awe-inspiring bases. Their booklet shows the connections for double-diode-triodes, triode-pentode frequency-changers with nine-pin bases, and a host of other valves.

If you are interested in set construction or have an idea that your present set would be better with new valves, get their booklet, for it tells you everything you will want to know. It even gives complete receiver circuits using some of the new valves, so that you can get the very best from your own set.

Should you like to know how to add automatic volume control or add class-B output or make a power amplifier for public-address work, this booklet tells you all about it.

404

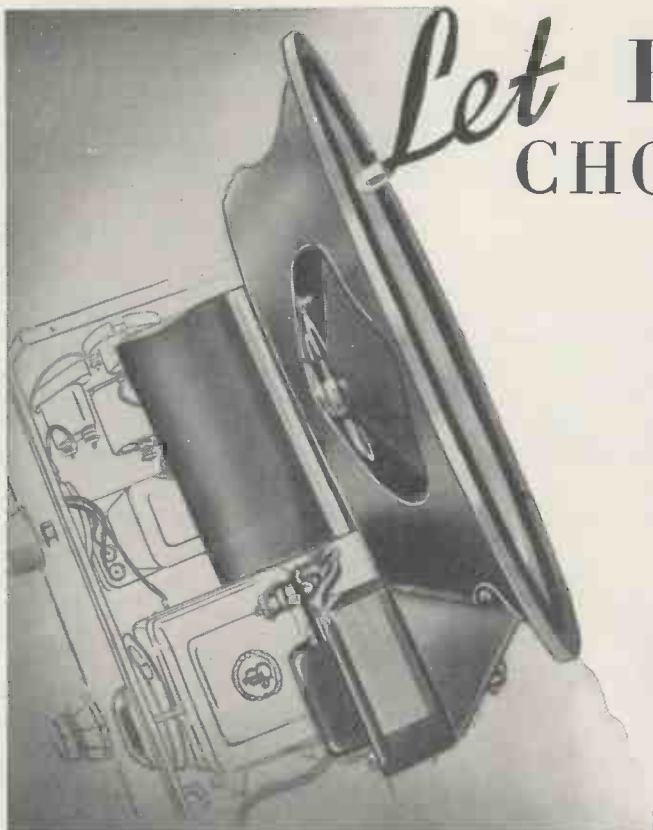

Let **PAUL TYERS'**
CHOICE *be* **YOURS**

It is significant that Mr. Tyers has chosen a Gramphian speaker for incorporation in what must be the outstanding portable of the year.

Quite apart from its excellent performance, which worthily upholds the Gramphian reputation, its low weight and the extreme permanence of its permanent magnet are without doubt features which are of paramount importance to the designer of any portable set.

... But why gild the lily? Mr. Tyers has specified Gramphian—surely the best testimonial a speaker could wish for.

Using the new NIAL Magnet 32/6.

GRAMPHIAN REPRODUCERS

GRAMPHIAN REPRODUCERS LTD., KEW GARDENS, SURREY



SIMPLICITY in OPERATION QUALITY in REPRODUCTION

EIGHT RECORDS CHANGED AUTOMATICALLY

The 'Garrard' Automatic Record Changing Unit is supplied absolutely complete and will satisfy the most exacting clientèle. Note these exclusive features:

- Plays automatically eight 10 in. or 12 in. records of any make.
- Stops and switches off the current as the last one is played.
- Repeats or rejects any desired record when knob is turned to 'repeat' or 'reject' position.
- Complete with Pick-up and Arm A.C. £10. D.C. £10 : 17 : 6.

GARRARD

AUTOMATIC RECORD CHANGER

Remember that the new Garrard Radio-Gram Unit modernises Radio Sets to Radio-Grams. Write for full particulars.

Garrard Engineering & Manufacturing Co. Ltd.
Swindon, Wilts. 17 Grafton St. W.1

Phone—Swindon 534 & 535 (2 lines)

Phone—Regent 7596

When replying to advertisements, please mention "Wireless Magazine"

● A Radiogram with the performance of an instrument costing twice as much, or more . . . in your own home . . . for five shillings a week!

AN AMAZING TRIUMPH

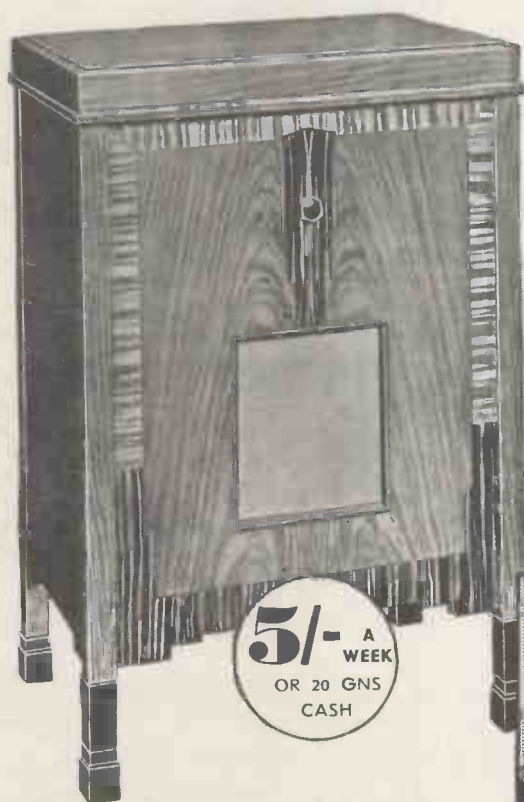

5/- A WEEK
OR 20 GNS CASH

It is not possible to convey how beautiful the tone of this instrument is. It must be *heard* to be believed. No instrument comparable to it has ever been offered at a price as low as this. Musicians and music critics have all acclaimed it: in the opinion of many, it equals in every way the performance of instruments costing twice as much, or more. 20 guineas for a gramophone?—that has been a usual price for a good instrument. 20 guineas for a radio?—that has been a reasonable price for a good model. But 20 guineas for an instrument that combines the best of both!—obtainable at the rate of only 5/- a week! There has never been value to equal this before! For the Five-Forty Radiogram combines in a single cabinet the latest type of “His Master’s Voice” electrical gramophone and an “His Master’s Voice” superhet five-valve radio set of astonishing range, sensitivity, selectivity and power. And both instruments possess the quality of tone that only the older-than radio experience of “His Master’s Voice” can give. You *must* hear it. Hear both radio and records. Listen to the tone. Your own ear will tell you how accurate the reproduction of this instrument is.



1,000 BANDSMEN ON PARADE!
Hear this amazing record of the Aldershot Tattoo. Listen to it played on this instrument. It will give you some idea of the almost incredible perfection of modern methods of recording and reproduction and of the boundless pleasure this radiogram holds in store.

Tannhäuser, Grand March—Pilgrims' Chorus—Massed Bands of the ALDERSHOT COMMAND. C2670 4/-.

“HIS MASTER’S VOICE” ALL - ELECTRIC SUPERHET FIVE - FORTY RADIOGRAM
A.C. Model, 20 guineas; D.C. Model, 21 guineas. Or a small deposit and 5/- a week.

With automatic record change
The Five-Forty-Two is the same instrument as the Five-Forty, but it will play and change eight full-sized records, automatically, without attention. The price of the Five-Forty-Two is 27 guineas, or a small deposit and 27/6 a month.

“HIS MASTER’S VOICE”

Write for special illustrated leaflets to: The Gramophone Company, Ltd., 108C Clerkenwell Road, London, E.C.1

When replying to advertisements, please mention “Wireless Magazine”

Valves in the Making

(Right) The wire leads and stays are mounted in this machine which pinches the glass foot of the valve round the platinum leads

(Below) The finished foot is then passed into the hands of a skilled worker who puts it in a machine which bends and clips the stays for the valve system

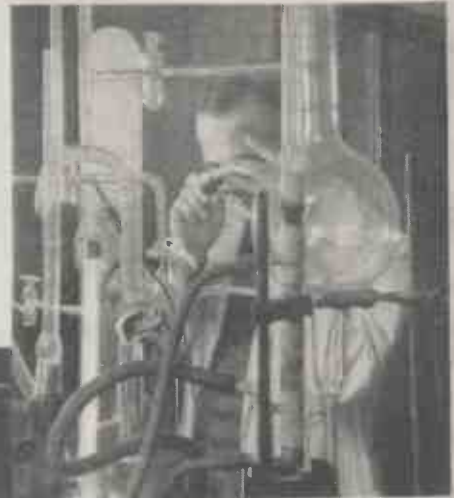

(Above) A scientist putting helium gas, used in rectifiers, through a spectroscope test
(Below) The intricate inside works of the valve are electrically welded to ensure rigidity

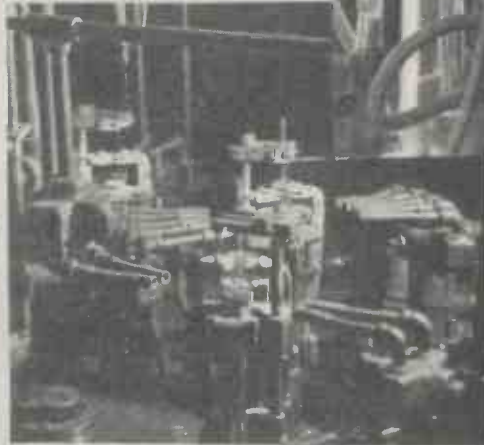

(Bottom, left) The finished valve is then evacuated by means of this machine. The sealed valves are fitted with bases and then go to the ageing rack for the final tests before leaving the factory

(Bottom, right) The finished inside of a valve is put in this machine; the glass bulb is put in place, which is melted on to the glass foot

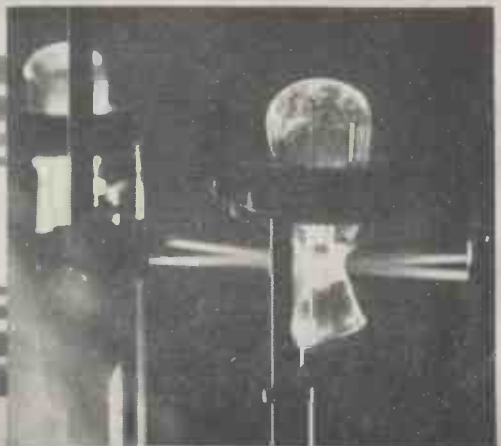
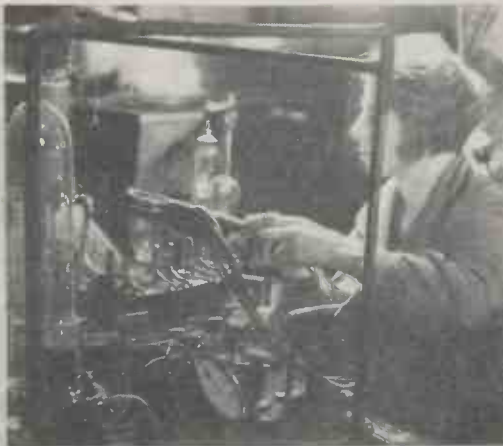



A corner of Paul Tyers' laboratory, showing the array of gear which is used for super-het measurements

FOR years Paul Tyers has been actively engaged in research work and the design of components and sets for the radio trade. His laboratory, on which he has spent many thousands of pounds, is equipped with every essential piece of apparatus necessary for this work.

To give readers of "Wireless Magazine" an opportunity of profiting by his research, we have arranged for him to produce a number of sets reflecting current commercial practice for description in our pages. These sets will be designed and described in such a way that they can easily be built at home by the amateur.

The popular impression of a radio research laboratory is that of a vast array of meters and test instruments housed in neat boxes. Admittedly, they are an important part, but actually they represent a small proportion of the laboratory's gear.

However simple a problem may appear at the outset, its solution may frequently lead into many side tracks and



Paul D. Tyers, who will be designing a number of first-rate sets for "Wireless Magazine" readers this season

It gives us great pleasure to announce that we have arranged for Paul D. Tyers to produce a number of sets for "W.M." during the coming season. His first set, a four-valve battery-operated portable, appears this month. Paul D. Tyers is one of the best-known set and component designers in the radio trade and his sets for "W.M." will therefore reflect current commercial practice

byways. The efficient laboratory, of which that of Paul Tyers is a fine example, provides facilities for the production of experimental models on the lines of production types.

Thus the perfect lab must have a fully equipped machine shop in miniature, with lathes, drills, milling machines and a countless assortment of tools of all descriptions, as well as measuring microscopes and electric furnaces.

For example, Paul Tyers believes that windings not produced on production machines are quite useless, and therefore he has in his laboratory a machine which can wind self-supporting or paper-interleaved coils and which will handle the finest gauge wire for small transformer bobbins.

Long before the final assembly of a set or component is done, measurements of the performance have to be made.

The measurements must be accurate and they are of such a diverse nature that really expensive equipment is necessary. Again, the laboratory must have its reference library with a large assortment of standard text books on all branches of pure and applied science and engineering, files of technical publications, and by no means a small record of patents.

It is this type of laboratory that will produce some outstanding designs for "Wireless Magazine" this coming season. These sets will cause a sensation in the constructor world.



(Left) A member of Paul Tyers' staff making final adjustments to a super-het chassis in the laboratory



(Right) Measuring the size of various iron dusts with an accuracy of .001 of a millimetre

Here we present full constructional details of the first of a series of sets reflecting current commercial practice that are to be designed for "W.M." by Paul D. Tyers. This month he describes the design of a simple four-valve portable set using a single stage of high-frequency amplification, detector and two low-frequency stages. A notable feature is that the anode current taken by the four valves is only 7 milliamperes



The TYERS PORTABLE

Designed for "W.M." by PAUL D. TYERS

IF one uses a large number of highly efficient modern valves and takes no account of the necessary anode current, it is then an exceedingly easy matter to build a highly efficient portable receiver. If the super-het principle is employed the problem is further simplified.

Number of Valves

A receiver of this type, while having practical and technical interest, is not altogether an economic proposition. Accordingly, one must of necessity use the minimum number of valves to keep the operating current as low as possible.

Reducing the number of valves immediately necessitates operating them at the highest possible stage gain, as otherwise there will be insufficient sensitivity and the general output will be low.

Here the first complication arises, because as soon as one endeavours to increase the stage

gain, so the tendency for instability rises at an alarming rate.

One of the easiest ways of stabilising a set is to connect it to a good earth. In a portable set, of course, this is entirely impossible. Accordingly, one has to make a compromise, and in making this compromise the greatest care and attention is needed in dealing with every individual detail. Two inches of wire in the wrong place will easily cut down the effective overall efficiency of a set to nearly half.

It is not surprising, therefore, that the performance of portable receivers varies so tremendously.

I should not consider it sound practice to suggest that the home constructor builds his set to limits bordering on the edge of instability owing to exceedingly high overall gain. It is possible, however, by operating at a fairly good efficiency to produce a receiver which will give very good programme strength from all the main stations without difficulty in handling or the necessity of incorporating elaborate screening.

Always a Success

At the same time it is possible to obtain this performance with the total anode current well within the capabilities of a small high-tension battery.

Commercial receivers which have been built on these lines have always proved successful, and it is such a receiver which I have designed for the home constructor. Moreover, the portable has the advantage that it can be operated with ordinary

valves. Actually, use is made of a standard type of screen-grid valve, two valves of the H.L. class, and a small power or pentode valve.

It is always true that the circuit is only half the secret of the success of any receiver, the design and arrangement of the components being equally important as well.

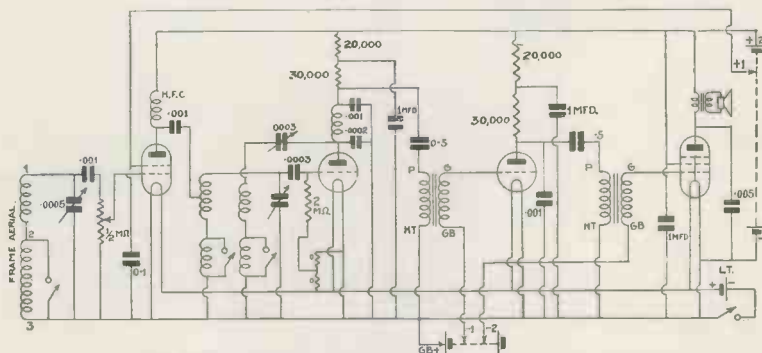

CIRCUIT OF THE TYERS PORTABLE

The circuit, as you can see, is extremely simple. The valve combination consists of an ordinary screen-grid high-frequency amplifier, triode detector and two low-frequency amplifiers with a pentode or power output

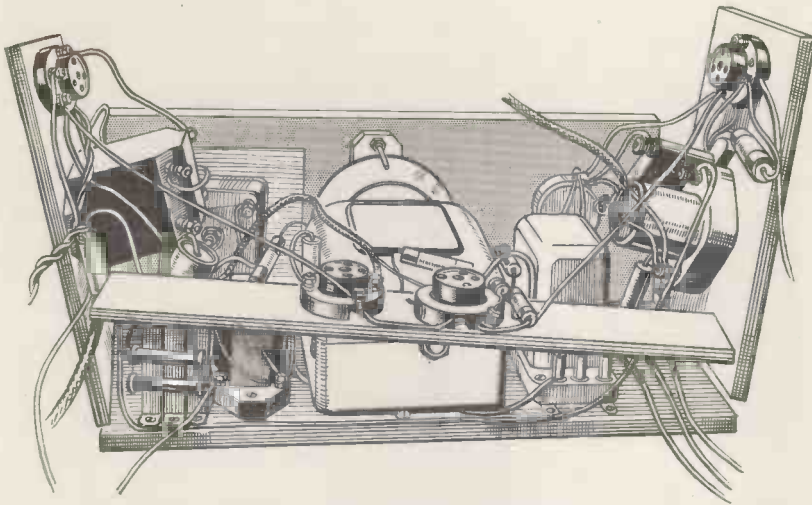

MOST CONVENIENT WAY OF WIRING

This drawing shows clearly the layout of the various components. Constructors will find that wiring is best done with the two end pieces and the valve platform supported at the angle shown in this drawing

In the case of a portable receiver the circuit becomes almost of minor importance. It is as well, however, to study the circuit in some detail, as there are several important points which must be fully understood.

Unusual Volume Control

First of all, I must explain why I have used what appears to be a most unorthodox form of volume control, and one which might be criticised as lowering the efficiency.

Why not use a variable-mu valve instead of an ordinary screen grid? In the first place, a variable-mu valve must be fitted with some form of variable-bias control, and this is generally obtained from a bias battery, which is subjected to the load of the necessary potentiometer. The use of this involves switching and the more frequent replacement of batteries. The grid return invariably requires de-coupling, which adds to the expense and complication of wiring.

Stage-gain Question

Most important, however, is the fact that it is far easier to obtain a higher gain from a standard type of screen-grid valve than from a variable-mu.

The primary function of a variable-mu valve is to enable a very loud signal to be dealt with without overloading and causing cross modulation.

This is only likely to occur in a portable set on the local station, because it must be remembered that the voltage produced across the frame aerial is far smaller than that

occurring in an aerial set. Generally speaking, then, it is only necessary to reduce the gain on the local station.

An obvious method is to use a potentiometer, and this is actually what I do in this particular receiver.

Once again, I may be criticised for daring to shunt a tuned circuit with a potentiometer which will increase the damping and flatten the tuning. This reasoning cannot be applied to a frame aerial.

A frame aerial is already encased in wood, leather or fabric, and in addition it has in the centre a veritable mass of metal in the form of a loud-speaker. The efficiency, then, is not so extraordinarily high, and the presence of a .5-megohm in parallel makes so little difference that it is hardly measurable.

Another point to be remembered is that there is liable to be a certain amount of feed-back from stray

high-frequency fields, and all this tends to nullify the effect of shunt resistances. In fact, if we made the high-frequency resistance of the frame-aerial circuit too low we should complicate the matching and the stability. Accordingly, I feel that our .5-megohm resistance is fully justified.

The inter-valve coupling, that is, the choke-fed iron-core coil with capacity reaction, calls for no comment, except that the choke in the anode circuit must be a good one.

High-frequency Filter

The remainder of the circuit is entirely straightforward, consisting of two resistance-fed transformers.

A word, however, must be said about the high-frequency filter. It is most important to filter out all traces of high frequency from the detector output. If this exists there will be instability and reaction howl, overlap and general inefficiency, because it will not be possible to use critical reaction.

Starting Instability

It is also vitally important that no high-frequency currents get into the loud-speaker leads as this will couple the frame aerial and start immediate instability. For this reason there is a shunt by-pass condenser on the output and screened leads are used for the loud-speaker.

The success of any portable receiver depends largely upon the precautions taken with the screening and the total elimination of what I may best term loop circuits carrying high-frequency currents. For this reason the set should be built with screened chokes and a screened tuning coil.

Certain connecting leads must also

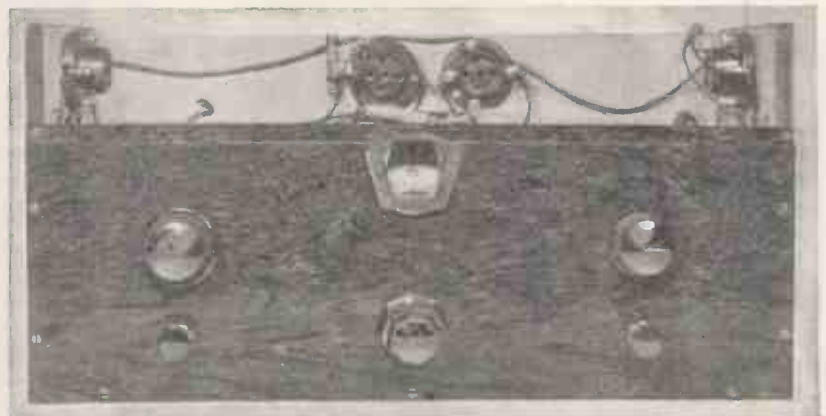

SHOWING THE MAIN CONTROLS

On the left is the volume control, above the wave-change switch, and on the right is the reaction above the on-off switch. The main tuner, with trimmer, is in the centre

be screened, and the necessity for this is largely increased by the desirability for a symmetrical panel layout.

This results in placing certain controls much farther away from their associated circuits than is really desirable. This deficiency, however, can be overcome quite satisfactorily in practice by using a screened lead, which is earthed to the chassis.

Problem of Space

Another problem arising in portable-set design is the fact that the whole receiver is far more compact and, as some of the components are not in their correct logical positions, stray fields have a far greater effect. By studying the photographs and the diagrams it will be seen, however, that the whole four-valve receiver has been compressed into a space measuring only about 15 in. by 5 in. by 5 in.

I believe that many home constructors build their sets by screwing all the components into position and then wiring them up. Such a

procedure is never adopted in a commercially built receiver.

There are several reasons for this. In the first place, the set has to be as compact as possible to save space, and in turn save production cost. Accordingly, there is no room to place many of the wires between the very compactly arranged components.

As the home constructor is building a portable set he must of necessity use the same tightly packed arrangement. As a result, the set is preferably wired on exactly the same lines as a factory-built receiver.

In this particular set the arrangement is actually by no means complicated, and it will be seen by studying the drawings that the components are arranged in groups on different parts of the metallised-wood chassis.



PLAIN BUT ATTRACTIVE

This view of the finished portable shows at once the extreme neatness of the finished job. The case can be obtained in black or with a walnut finish

When the components are screwed in their correct positions the various parts of the chassis can be assembled without any difficulty, but before this is done it is easier to wire up each section.

Chassis Material

The set can be built up either on an aluminium or other metal chassis, or, alternatively, it can be built up on a metal-sprayed wooden frame, such as Metaplex. This type of chassis is actually shown in the photographs. Metallised wood is easier to work than sheet metal.

In building the set the majority of the components are fixed on the three sides of the chassis and the ebonite panel separately. When the panel layout is finished the leads are then soldered to their respective points. Unless the leads are fixed to the panel components first of all, it will be impossible to make the connections afterwards as there will be no room.

Valve Mountings

It will be noted that the valve holders are arranged in two groups, the first and fourth valves being carried horizontally on the sides of the chassis. The second and third valves are mounted vertically on a valve platform. In a factory-built set this valve platform would be wired separately and the various leads would be joined up to the main chassis after assembly.

This may prove a little difficult to

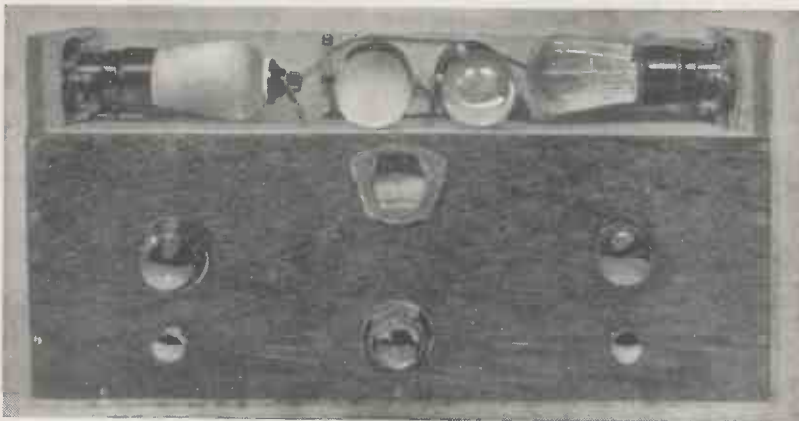

WITH THE VALVES IN POSITION

A front view showing the set with the valves in position. From left to right they are the screen-grid, detector, first low-frequency amplifier and output valve. Note the screening between the valve platform and the set

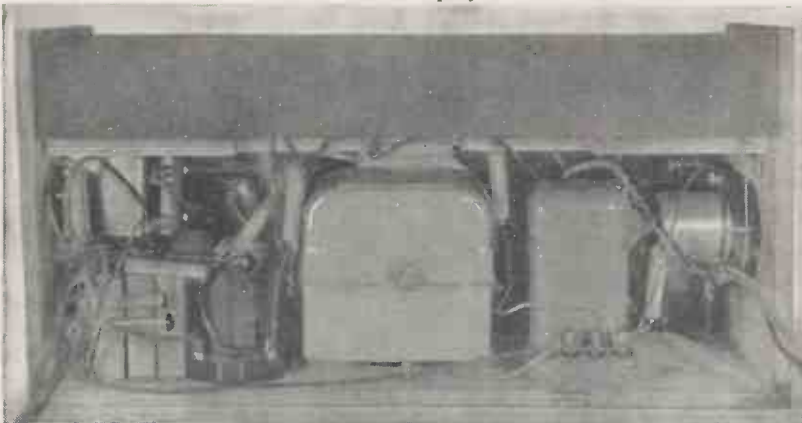

LOOKING AT THE SET FROM THE BACK

An unusual view of the Tyers Portable set chassis showing the compact nature of the assembly. It is very typical of current commercial practice

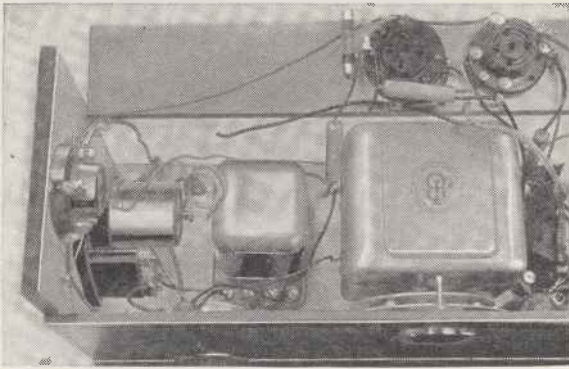

CLOSE-UP OF THE HIGH-FREQUENCY SIDE
 Showing the layout of the high-frequency side of the set. On the left is the screen-grid valve holder and moving right, the high-frequency choke, iron-core coil and variable condenser

those who are not too familiar with wiring, and an alternative method is to rest the valve platform on some convenient support so that it is at the right height, arranging it at right angles to its final position. It can then be wired up with the rest of the chassis and simply swung into position for final assembly.

back completely to zero in the minimum position. If no measuring instruments are available the position of the contact arm on the element should be carefully inspected.

If it does not quite go to zero the stop can be bent slightly with a pair of pliers, so that no resistance

It is very important to make little alteration in the layout, as otherwise there may be considerable feedback and inadequate de-coupling.

There are one or two points which require careful attention in wiring.

Before wiring the volume control it is essential to see that it goes

remains in the circuit whatever. Any resistance left in the circuit will reduce the sensitivity of the whole receiver.

When connecting the tubular condensers into position, make quite sure that the outer foil, which is usually stamped on one end cap, is connected to the earth or low-potential side. If you use a metal-sprayed wood chassis, be careful to bond each section by soldering at the corners.

Excellent Stability

The partial screening used in the set is sufficient to give excellent stability, but it will be found necessary to insert a small piece of metal foil at the back of the reaction condenser to eliminate any hand capacity effects.

Many reaction condensers have a live spindle; that is, a spindle which is connected to one element, and this, of course, means that the fixing bush is also alive. In this particular

Third-scale Layout and

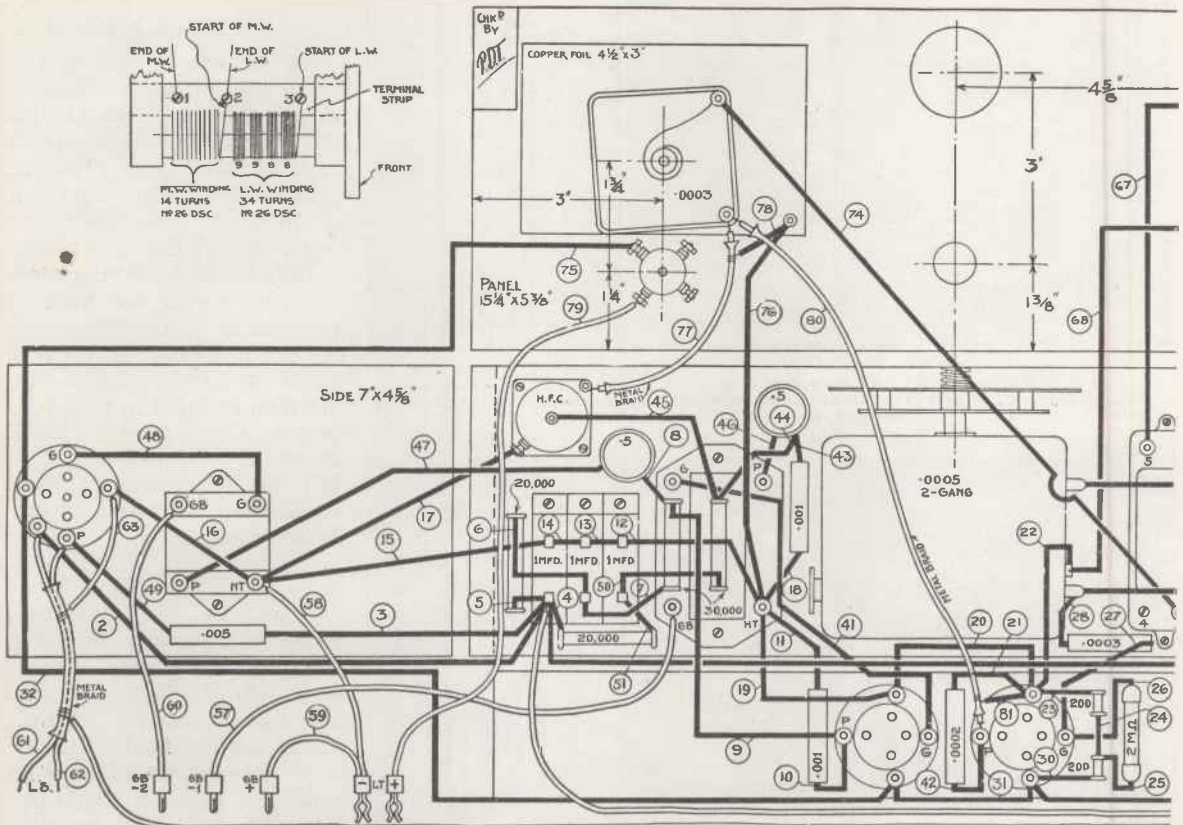

YOU CAN GET A BLUEPRINT FOR HALF-PRICE!

If desired, a full-size blueprint of the Tyers Portable can be obtained for half price, that is 9d., post paid, if the coupon to be found on the last page is used before August 31. Address your application to the "Wireless Magazine" Blueprint Dept., 58/61 Fetter Lane, London, E.C.4. Ask for No. WM367

circuit the spindle will not be at earth potential, and accordingly the screening plate which goes behind the condenser *must be insulated* from the condenser fixing bush.

If possible, it is preferable to use a condenser having a spindle not connected to either set of vanes, because on the medium waveband the capacity effect between the hand and the spindle, inside the knob, is sufficient to affect reaction.

Points to Watch

A very important point in building a portable set is to see that all metal areas, which are nominally at earth potential, are properly bonded. Every screened lead must have the screen properly earthed to the chassis. It may even be found advisable to earth a lead at more than one point if it is of any appreciable length. The negative filament should be earthed to the chassis at several points.

There are a few minor points worthy of consideration in the

actual arrangement of components. It will be noted that the two high-frequency chokes are different types, and the same can be said of the low-frequency transformers. This is intentional, because it frequently happens that when identical chokes or transformers are used such a practice tends to produce instability owing to the similarity of the constants.

The most difficult part of building a portable receiver lies in the final adjustment. Provided the layout has been followed fairly accurately and the wiring is correct, there should be no sign of any instability.

The first thing that will be noted is an almost complete absence of any gain and general flatness and deadness throughout. This is quite normal, and will be due to the fact

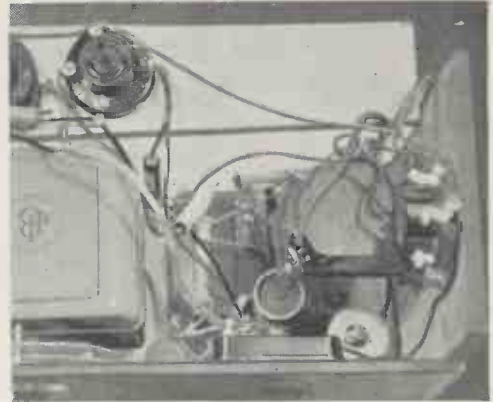

LOW-FREQUENCY ARRANGEMENT
The components on this side are packed rather tightly. One low-frequency transformer, it will be noticed, is mounted on the side

that the set is not properly ganged and matched.

The condenser used in this set is fitted with a concentric trimmer on the aerial section giving a wide variation. Accordingly, the need for accurate matching of the inductances is not so great. At the same time the signal strength will be small unless the two tuned circuits are matched.

Down to 200 Metres

It appears that one of the most desirable characteristics of a portable set is its ability to receive Radio Normandie (Fécamp). It should come in about 4 or 5 degrees on the dial with the trimmer on the high-frequency section near the minimum.

Assuming that this station has been found satisfactorily, the position of the concentric trimmer should be adjusted on the aerial section. If this is nearly at maximum or minimum one turn should be removed or added to the medium-wave frame.

Checking the Matching

The matching should then be checked at various points on the medium waveband until maximum signal strength is obtained on any station with the concentric trimmer not quite at maximum or minimum.

Fine adjustment of the matching of both the medium and long waveband frame aerials can be obtained by slight movement of the turns. Spacing the turns close together increases the inductance, and it is equivalent in effect to adding part of a turn to the frame. Conversely, spacing the turns apart decreases the inductance and is equivalent to removing part of a turn.

When the frames have been accurately matched the turns should

Wiring Diagram

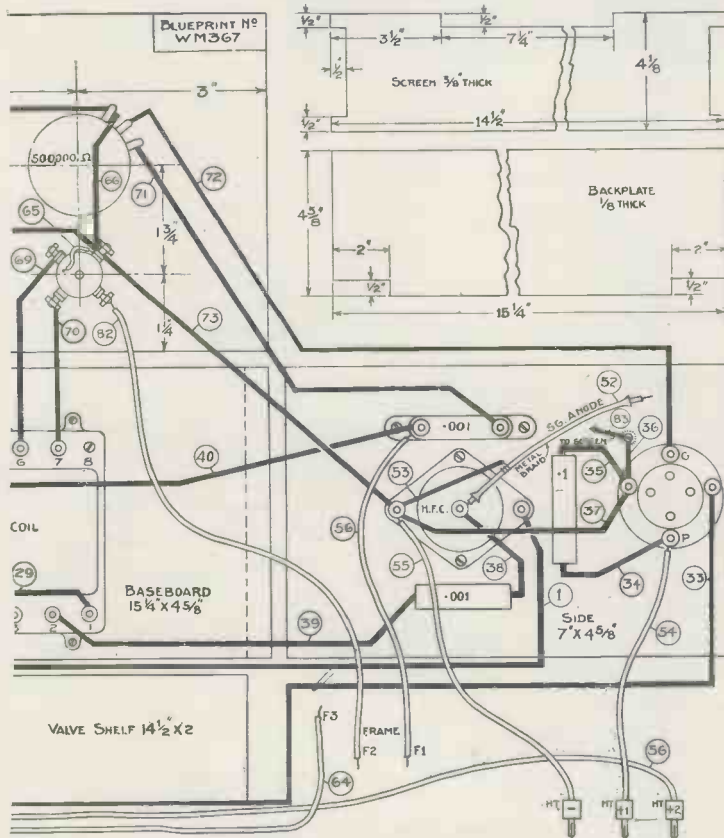

NUMBERED FOR EASY ASSEMBLY

There is no need for us to remind readers that a "W.M." blueprint shows the position of every wire numbered in the best order of assembly. Incidentally a blueprint can be used as a template and this will greatly simplify construction



WITH THE SCREEN REMOVED
This view shows clearly the layout of the Tyers Portable. If the construction is attempted as shown by the drawing on page 14, there should be no difficulty whatsoever. A metallised-wood screen fits between the valve holders and the rest of the set

be anchored with some form of varnish to prevent them slipping

Similar tests should be carried out on the long waveband, but all alterations should be made by varying the turns on the long-wave section only.

Smooth Reaction

If the set is properly adjusted it will be possible to bring the reaction control right up to the point of oscillation without any sudden click or any form of overlap. At the same time there should be no low-frequency howl. If such exists it will be a somewhat difficult matter to cure the trouble, and the causes are many and varied.

It will be noted that the grid leak does not return directly to the filament, but goes to a potentiometer consisting of two fixed resistances. By using two of unequal value it is obvious that the junction point will not be about 1-volt positive with respect to the negative filament, but slightly less if the

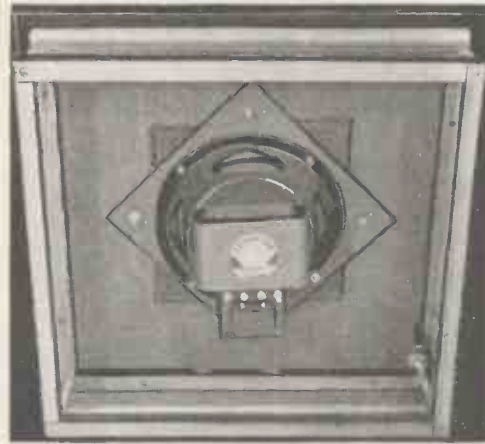

FRAME-AERIAL ASSEMBLY
The frame aerial is wound round a frame fitted to the loud-speaker baffle. Details of the windings are given on the wiring plan on page 16

smaller resistance is connected to the negative side.

This may help considerably in reducing reaction overlap, but this is largely controlled by the constants of the detector valve.

If there is very little overlap but

definite howl, some form of feedback is likely, and a careful check of the position of all the wires should be made, and in particular the position and connections of the various screened leads, to see that all the points are electrically bonded together.

Using Other Valves

It is quite possible that the set may be built to use a valve other than the Mullard PM12A. If this is the case, some alteration will be necessary both to the screen voltage and the grid potential.

The .5-megohm potentiometer is taken directly to the negative filament. If, however, a valve is used which requires a small negative bias, the lower end of the potentiometer should be taken to a suitable bias voltage; a small fixed condenser being connected between the end of the potentiometer and the negative filament.

Performance

The whole performance of the set depends very largely upon the satisfactory operation of the screen-

grid valve.

If the set has been properly built it will enable all the main stations on both wavebands to be received without any difficulty, and the set will have an excellent daylight performance.

COMPONENTS NEEDED FOR THE TYERS PORTABLE

CHASSIS		£ s. d.	PANEL		£ s. d.	COPPER FOIL		£ s. d.			
1—Peto-Scott Metaplex to specification	4	3	1—Telsen anti-microphonic, type 4-pin	8	Copper foil 4½ in. by 3 in., say	1	2				
CHOKES, HIGH-FREQUENCY			PLUGS, TERMINALS, ETC.			TRANSFORMERS, LOW-FREQUENCY					
1—Telsen screened, type Standard	3	6	1—Peto-Scott ebonite, 15¼ in. by 5 in.	3	6	1—Lissen type Torex	5	6			
1—Varley Nicore, type BP26	4	6	6—Belling-Lee wander plugs, H.T.+1, H.T.+2, H.T.+7, G.B.—1, G.B.—2, G.B.+ (or Clix, Ealex)			1	0				
COILS			2—Belling-Lee spade terminals, marked: L.T.+ L.T.— (or Clix, Ealex)			4		1—Varley Nicoret, type DP21	7	6	
1—Wearite, type Universal	5	0	RESISTANCES, FIXED			ACCESSORIES					
CONDENSERS, FIXED			2—Eric 1/8-watt type, values 200-ohm			1—Siemens 120-volt high-tension type Cadet			11	0	
7—T.M.C. Hydra, type tubular: values .0002-, .0003-, .001- (3), .005-, 1-microfarad	4	6	5—Eric 1-watt type, values 20,000-ohm (2), 30,000-ohm (2), 2-megohm			1—Siemens 4.5-volt grid-bias, type Cadet			1	0	
1—T.C.C., type 34, value .001-microfarad	1	6	RESISTANCES, VARIABLE			1—Smiths 2-volt accumulator, type 2PJ9B			12	6	
2—T.C.C., type tubular, value .5-microfarad	4	0	1—Claude Lyons 500,000-ohm, type ST500			CABINET					
3—T.C.C., type 65, value 1-microfarad (or Dubilier, T.M.C. Hydra)	6	0	SUNDRIES			1—Kebtex, type PDT			1	5	0
CONDENSERS, VARIABLE			4 ft. screened sleeving, say			LOUD-SPEAKER					
1—J.B. two-gang .0005-microfarad, type Unitune with cover	17	6	Round tinned copper wire, No. 20 gauge, for connecting, say			1—Grampian, type MPM			1	12	6
1—Telsen .0003-microfarad reaction, type W354 (or Lissen, Ormond)	2	6	Oiled sleeving, say			VALVES					
HOLDERS, VALVE			6 yd. thin flex, say			1—Mullard PM12A (metallised)			15	6	
3—Telsen solid type, 4-pin (2), 5-pin (1)	1	8				1—Cossor 210HL (metallised)			7	0	
						1—Cossor 210HL			7	0	
						1—Cossor 220PA (triode) 8s. 9d. or Cossor 220HPT (pentode)			16	6	

The prices mentioned are those for the parts used in the original set; the prices of alternatives as indicated in the brackets may be either higher or lower.

WHILE the lounge of the Dorchester Hotel was teeming with broadcasting officials from all over Europe—not to mention those from America and Cuba—I gained an insight into the workings of the I.B.U. that is, I think, worth passing on.

The International Broadcasting Union—I.B.U., for short—is the English name for *Union Internationale de Radiodiffusion*, which has its offices at Geneva, Switzerland, with Arthur ("Uncle Arthur") Burrows as its Secretary-General.

To most listeners the I.B.U.'s job is to hatch out the wavelength plans. Listeners of several years' experience will easily recall the successive introductions of the Geneva Plan, the Prague Plan, and most recently, the Lucerne-Plan.

While it is true that the formulation of plans for the smooth working



This photograph of Arthur Burrows (Uncle Arthur of the good old days), was taken in his office at Geneva

I.B.U.—The Radio League of Nations

The great work accomplished by the International Broadcasting Union during its ten years existence and its proposed solution to the congestion on the long waveband are authoritatively dealt with in this special article by ALAN HUNTER

of the broadcasters of Europe and near Asia is a vital part of the Union's work, it is by no means the whole of it.

In the hundred and one aspects of broadcasting that have to be handled internationally the hand of the Union is always to be found. If you like, it is the centre of a sort of Radio League of Nations. The parallel is not too far-fetched.

Just as the real League's influence depends for the effective ratification of its recommendations on the individual nations, so the I.B.U.'s suggestions can never be compelled unless the participating delegates can get the backing of their individual governments.

This fundamental limitation of the Union is often overlooked when

listeners condemn it for the lack of co-ordination among broadcasters—or more particularly for the breakdown in the wavelength allocations.

As it happens, the really important proposals are usually referred to plenipotentiary delegates—to delegates who can speak with the backing of governments or of their official departments.

Thus the Prague and Lucerne Plans were put through with the backing of most of the important European Governments, though there were sufficient dissentients to cause the Lucerne Plan at least partially to break down—especially on the long waves.

Before we see what the latest meeting has accomplished in this vexed matter, it might be as well to touch upon the work of the Union.

Entering now upon its tenth year of activity since its formation in London, the Union can claim to be one of the most successful of the multiplicity of international organisations that have come into existence since the war.

Without some such organisation, the situation in Europe's ether would long since have become impossible.

Amidst the extreme nationalism rampant today, the Union has to tread warily. That it has brought about something like a corporate feeling among Europe's broadcasters speaks volumes for the diplomatic abilities of the Union's delegates.

If it had a motto, the I.B.U. would probably align itself with the B.B.C.'s "Nation Shall Speak Peace Unto Nation."

Anyway, it tries to steer clear of all political questions, and to keep right down to its job of acting as a clearing house for the various broadcasting organisations.

Quite apart from the friendly relations it has managed to establish between European broadcasters, the Union has forged links with the broadcasters of other continents, notably the U.S.A., Japan, and Australia. Recently, too, New Zealand was made an associate member.

To handle the policy and finances of the Union, a general assembly of representatives of all member states meets annually, choosing a different



CENTRE OF THE I.B.U.'S TECHNICAL WORK
Some of the apparatus used at the now famous Brussels Checking Station where the wavelengths of all European stations are checked for accuracy

country each year. This year, for example, it was held in London. Next year the Assembly will meet in Poland.

When the Assembly meets it elects a council. Under the able presidency of Vice-Admiral Sir Charles Carpendale, this council studies all the outstanding problems of the ether. Twenty-five countries are now represented.

In order to expedite the work of the council a sort of cabinet is formed, known as the bureau. It consists of the president, three vice-presidents and the delegate of the council.

As is usual in international conferences, the work of the Union is split up into various expert commissions.

At the recent London meeting, for example, there were four different commissions at work: the Legal Commission, under M. Le Dr. Sourek, Czechoslovakia; Programme (also known as *Rapprochement*) Commission, under M. Dubois, Holland; Relay Commission, under M. S. de Chamiec, Poland; and the very important Technical Commission, under the indefatigable M. Raymond Braillard, Belgium.

You must not imagine that these broadcasting delegates met in London without official notice. Such is the growing influence of the Union that at this meeting representatives of the European Telegraph and Post Office administrations and of the Berne Bureau of Inter-

national Telecommunications Union were in attendance.

So, after many years of meeting at all sorts of European centres, such as Berlin, Brussels, Geneva, Lausanne, Paris, Prague, and Rome, the I.B.U. came back to the land of its birth in March, 1925 —its president in all that time once again taking the chair.

Just stop to think for a moment of the amazing development that has taken place in European broadcasting between that inaugural meeting in 1925 and the June 12 meeting of this year.

At the beginning of the period it was estimated that the total radiated power of all the broadcasters at any moment was 80 kilowatts. The relatively advanced state of broadcasting in this country is shown by the fact that we accounted for 43 kilowatts of that energy.

Now compare those figures with, say, April 1, 1934, the first day of the Union's tenth year of activity. Altogether the 250 European zone stations radiated 4,250 kilowatts. An almost incredible increase!

So far, though, you may still not

be clear exactly what is the function of the Union. I can best tell you by quoting Arthur Burrows himself.

"The Union acts largely as a study centre; the offices at Geneva and Brussels are executive organs and clearing houses of information useful to broadcasting development."

The work is split up by the Geneva and Brussels offices. At Geneva, where Arthur Burrows holds sway, non-technical data is dealt with.

On the technical side—necessarily more spectacular from our point of view—reigns the great Braillard. This genial Belgian is not merely the president of the Technical Commission. He is the director of the world-famous Brussels Checking Station—the station that puts wavelength wanderers "on the spot."

Here, again, it would be wrong to imagine that all the work centres on wavelength adjustment. The Technical Commission wages a ceaseless war on electrical interference.

Most recently, it took part in the Paris Conference comprising a mixed



RESPONSIBLE FOR THE LUCERNE PLAN
Raymond Braillard, President of the I.B.U. Technical Commission (left), with two other members of the I.B.U. On the right is Herr Gless who presided over the committee responsible for the formation of the Lucerne Plan

committee of the International Electro-technical Commission. Hopes were expressed that the delegates would find a basic method of measuring electrical interference, as a necessary prelude to the recommendation of legislation to the administrations of Europe.

Spade work, pains-taking analysis of detailed technicalities—yet the I.B.U. Technical Commission cheerfully faces up to it.

Nightly checks of wavelengths are part of the routine work of the Brussels station, which, like the I.B.U. itself, has grown vastly in importance since it was first set up in the annexe of a small garage.

Extraordinary accuracy is now obtained from the checking instruments. The present accuracy for normal types of broadcasting stations is from 1 to 2 parts in 100,000, while for the very latest stations with great stability of working the accuracy of the measurements reaches the amazing figure of 1 part in 1,000,000.

Every night no less than 80 precision measurements are taken—all for accuracy of nearer than 1 cycle. This work is, of course, more than justified by the greatly increased number of stations working on common wavelengths, where absolute accuracy is essential to avoid mutual interference.

To those who so painstakingly worked out the Lucerne Plan that came into action on January 15 of this year it must be exceedingly trying to find that many unauthorised stations are completely ruining the long waves.

As a matter of fact, this was one of the knotty points discussed by the Technical Commission as part of the I.B.U.'s 60 hours of conferences in London.

According to the *communiqué* issued at the close of the meetings, the general situation on long waves had been appreciably improved by the partial application of the Union's revised suggestions. Still further improvement would be possible, the Union concludes, if everyone carries out in full the proposals enunciated at Geneva.

Protests by certain administrations, notably those concerned with Huizen, Kaunas, Brasov and Oslo had been considered. The protests were to the effect that, even under the Geneva revision of the Lucerne Plan, their wavelength allocations were not good enough to ensure a proper national service.

This being so, a catch-as-catch-can policy has tended to develop, with the result that there were still many bad examples of mutual wavelength clashing.

Apart from the

decision to re-examine the position brought about by the unauthorised stations on long waves, the Union seems to have resigned itself to interference up there until such time as it can manage to obtain a widening of the long waveband embracing sufficient wavelengths for broadcasting.

Medium-wave reception is in a much better condition. Such interference as still exists has been put down to clearly tabulated causes. Insufficient synchronisation, use of arbitrary non-Lucerne wavelengths, instability of working of common-wave stations—these are the root causes.



I.B.U. DELEGATES AT THE B.B.C.

During their recent London meeting, delegates of the I.B.U. took the opportunity of inspecting Broadcasting House. Here they are seen watching an engineer at work in the control room, which is on the top floor of the building

[Fox photo

This is, of course, quite outside the Union's province, but it shows which way the wind is blowing. Fearing, perhaps, to subject its powers to too great a test, the Union must perforce go on advising and hoping the broadcasters will see reason and fall into line.

In its report the Union recommends the various governments to enforce measures to overcome these troubles, as by the avoidance of over-modulation, suppression of harmonics, and the implicit following of the agreed wavelength allocations of the now-famous Lucerne.

Although nothing definite was done about wavelengths at the London meeting, there is no doubt that the delegates were drawn more closely together by the extremely lavish entertainments arranged for them.

In the Dorchester lounge, where I met so many of these foreign broadcasters during the hectic June 12 to 20 period, they were all enthusiastic over the B.B.C., its Broadcasting House, Droitwich, and the twin regional centres.

Arthur Burrows told me that the meeting had improved the morale of the Union.

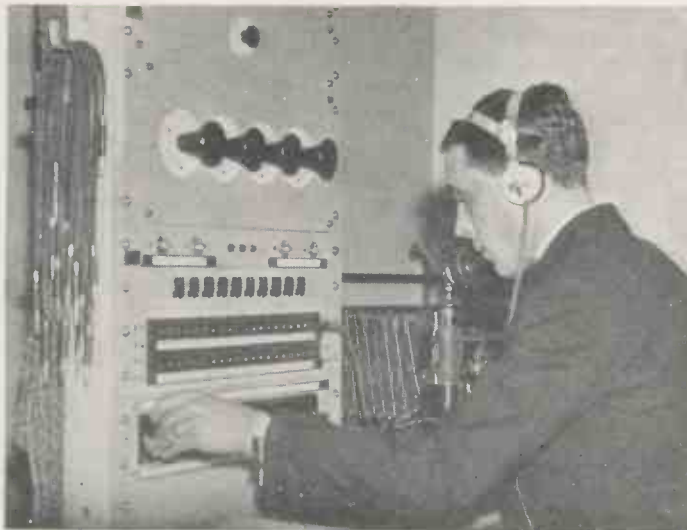

B.B.C.'S OWN CHECKING STATION

The B.B.C. has its own experimental station at Tatsfield, Surrey, for checking up the wavelengths of its own and foreign broadcasters. It works in conjunction with the I.B.U. station at Brussels



Marconiphone photo
A scene in the judging ring at the International Horse Show. The Marconi operator with the 5-metre transmitter on his back is seen on the right

Should Amateur Transmitting Be Encouraged?

By Kenneth Jowers

AMONGST my mail these days are a number of letters either telling me I am a menace to the peace of the country or thanking me for trying to help the amateur get on the air.

One poor fellow is quite worried because his neighbour has made a transmitter from a circuit given some time ago in "W.M." He tells me that his reception is always being interfered with.

Simple Remedy

It may be useful to know that the genuine amateur does not transmit during broadcasting hours unless he is quite sure that he will not cause interference to broadcast listeners. If a listener happens to be next door to an unreasonable "ham" the remedy is quite simple—a card to the Post Office will put a stop to it.

Other correspondents realise that amateurs do a great deal of good and their services in time of war would be invaluable. I understand that the radio strength of the navy is well below normal and in event of war it would be impossible to find sufficient naval operators. There can be no question that the amateur would come to the rescue in a case like this.

If you are contemplating getting a transmitting licence, don't apply for the full licence right away. An

artificial licence will be quite as useful until the gear is all adjusted and ready to connect to the aerial. An A.A. licence is quite easy to obtain as the main obstacle—the morse test—does not arise.

This licence will enable you to build the complete transmitter, make all the required tests to obtain the most efficient circuit without upsetting all the neighbourhood. Then you can start worrying about the morse test and the full licence.

A useful morse code practice unit can be made up very simply, as shown in Fig. 1. With a little help and some patience, it will not be long before you can do the requisite twelve words a minute.

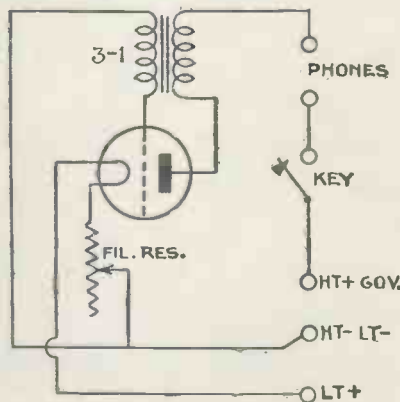

Fig. 1. A circuit of a unit—made up from odd parts—which will be found useful for practising morse code

This unit consists of a standard inter-valve transformer, a pair of headphones and 20-ohm filament resistance. The circuit shows the connections—all very simple. A small high-tension battery of 60 volts will be ample, while the key can be obtained from an army-disposal place for a few shillings.

R. D. Everard, of Standon, has sent me an interesting letter and a report showing that he has made some exceptional bags. He has heard KAY, Manilla, 20.03 metres, testing with J1AA, Tokio, on several occasions about midnight. Another good bag was TGF, Guatemala City, 20.71 metres, calling WNC. He has "veries" from Poona, 33.41 metres, and has heard VUB, Bombay, 31.36 metres; JVH, Japan, 14,600 kilocycles, and XGR Shanghai, on 26 metres.

English "Hams"

Amongst the amateurs he reports W5YH, Texas; W4PW, W9EEL, W9FQU, W5CCB, W5ZS, W4EF, W8AFM, W9BRX and W10XDA, the schooner *Mark*. He goes on to ask why it is that the English "hams" who ask for reports never acknowledge them. Well, I am not quite sure of that, but I should say that the reports wanted are from genuine DX listeners, and as the

number of reports sometimes runs into hundreds the matter of postage is no small one.

Fred. L. Seufert, of Bloomfield, New Jersey, the operator of W2AOG, has sent me an interesting letter about his station. His transmitter circuit is quite interesting. The first valve is a crystal oscillator with a wavelength of 80 metres, followed by a double to 40 metres, two buffer stages and a type 204A power amplifier.

Welcome Reports

The speech amplifier—fed by a condenser microphone—consists of two stages and an 845 modulator. The modulator feeds into the final buffer stage and not into the power amplifier, as is generally the rule over this side.

His station is heard very well by English listeners whose reports are welcomed. Beside contacting with almost every country in the world, he also worked the Byrd Expedition some time back.

♦ ♦ ♦

A number of readers have heard the test broadcasts of the new Bombay station, VUB, on 31.36 metres. The average signal strength appears to be R6 with little fading. This station is best heard between 1730 and 1845 on weekdays.

♦ ♦ ♦

Francis Beane, of Ridgewell, Essex, reports reception of a number of DX stations, including Prade, Ecuador, on 19.47 metres at R6, Nashaki, Japan, on 20.54 metres, also R6, and PLE, Bandoeng, Java, on 15.93 metres at R8.

Jeloy Queries

He also queries the frequencies used by Jeloy. There are a number of different frequencies supposed to be used by this transmitter. But they don't tally with those given by the station authorities in a letter to Mr. Beane. According to this letter they may use any of the following frequencies—9,540, 6,130, 4,930, 4,100—which are equal to wavelengths of 31.45, 48.94, 60.98 and 73.17 metres. Any further information about this station will be appreciated.

Jack Wilson, of Newmains, finds that the conditions on the 20-metre band are deteriorating. Amongst the stations heard recently were the reliable ones such as K4SA, LAIG, of Norway, CM2WV of Cuba and VE2CA of Canada. In addition to these were W3BC, W9USA, W2BC, W2CZL and W5BSC, to quote only the more important ones.

♦ ♦ ♦

Quite a number of the American "hams" seem to be migrating to outlandish spots, for the summer. I mentioned last week that W9BHT would be away for a time and in a letter just to hand from W. A. Clemenson, I find that W2EDW and a few friends are also going to the wilds of South Jersey.

They will be cut off from civilisation except for a small 30-50-watt transmitter and a receiver they are taking for experiments. Several call signs will be used, including W2DHW, W2DEU, W2EJB, W2CVM, W2FXA, W1HHL and W2GHQ.

If any English listener should hear transmissions with these call signs, please send a report for it will be appreciated and all letters will be acknowledged with a QSL card.

♦ ♦ ♦

The national field-day contests were more successful than ever this year. Twenty-two pairs of stations were in operation and the whole idea was to see how amateurs could maintain Empire communication in an emergency.

A Bristol station running entirely from Exide batteries communicated with no less than sixty-two stations,

including a portable station at Cairo.

The ultra-short waves have again proved their worth, but in an entirely unexpected manner. At the International Horse Show the judges used to stand in the middle of the ring and after careful deliberation send the results to an announcer by messenger boy. As the messenger had to run some 250 yards the results were somewhat delayed.

This year the Marconiphone Co. fitted up a 5-metre transmitter to the back of a man standing near

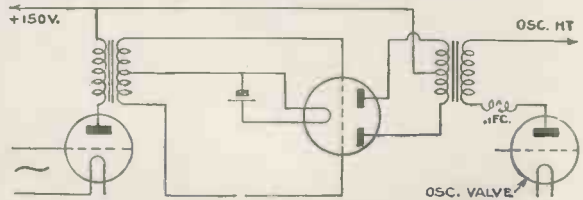

Fig. 2. A circuit for building up a simple class-B modulator. High tension of 150 volts will be sufficient for good results

the judges. He was able to obtain the results without delay, transmit the information to the announcer, who, with a microphone in front of him, was able to speak to the whole of the huge crowd without effort.

Flash-lamp Current

The power from the transmitter was less than 3 watts or about equal to the current taken by a flash-lamp bulb, and an aerial 3 ft. in length was found to be sufficient.

♦ ♦ ♦

Every evening the English amateur stations 50C and 2A0 are on the air using the 40-metre band. The frequency of 50C is 7,062 kilocycles and 2A0, 7,100 kilocycles. The first-named station is situated at Kidwelly and the second station is at Eastbourne. If anyone over 200 miles away from either station should pick up the transmissions, please drop me a card. The approximate transmission times are 10.30 p.m. onwards.

♦ ♦ ♦

Many readers have asked me to describe a class-B modulator. Well, Fig. 2 is a simple circuit I can recommend. High tension of 150 volts will be ample, while the oscillator valve can be of the PM2DX or 220PA type. It is quite easy to build.



W3QV, of Roslyn, Pennsylvania, is operated by Bradley Martin, who has worked all continents with his 20-metre 'phone equipment. This station, which also works on 40, 80, and 160 metres is well heard here



Amateurs need have no fears of losing their bearings in a fog at sea now that a simple and cheap form of direction-finder has been introduced. This photograph shows the yacht, "Frixos," built by John I. Thornycroft, Ltd., for Mediterranean use

HOW often have you read in the newspapers that so-and-so, with a small party of friends, left for a short trip in the English Channel and has not returned to port. It is feared that the vessel met bad weather and has capsized. The yacht did not carry radio transmitting gear.

It is not often that we see such tragic news items in our papers, but that does not hide the fact that there is a certain amount of danger involved in sea travel, especially in the case of a yachting party where, in nine cases out of ten, the persons aboard have not had a deal of nautical experience.

The law compels vessels over a certain tonnage to carry efficient wireless gear in the charge of a certified operator, but it makes no provision for small boats, which obviously are in much greater danger should the weather become foggy or if a strong sea blows up.

Another point is that, up till now, transmitting gear, no matter how small, has always been expensive and well out of the reach of the average man. Even so, certain Post Office regulations have forbidden an uncertified man to use transmitting gear.

Before any amateur yachtsman can take a transmitter on his yacht, he must obtain the sanction of the Postmaster-General. To get a licence he must be able to read and send the morse code at a rate of not less than twelve words a minute. Even then, obtaining a licence is not an easy job.

Can you imagine such men as doctors and stock-brokers studiously swatting dots and dashes and tying themselves up into awful tangles? I am afraid not!

If a yacht gets put on the missing list it means that ships in the area concerned are asked to keep a sharp lookout for wreckage, and lifeboats and coastguards all help in the search.

Anyway, it does seem that all this trouble and bother with its consequent loss of life is to be removed, thanks to the ingenuity of a British firm of set makers.

Automatic

By Malcolm Harvey

The set, which has just been marketed, is called the SOS emergency transmitter and costs about £20 complete with all equipment. It has been designed so that

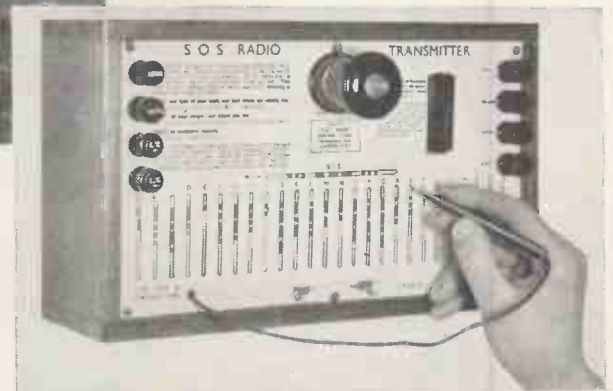

The control panel of the SOS transmitter. Across the bottom is the row of strips each representing a letter of the alphabet. The pencil is drawn across the desired letter which is automatically sent out in morse code

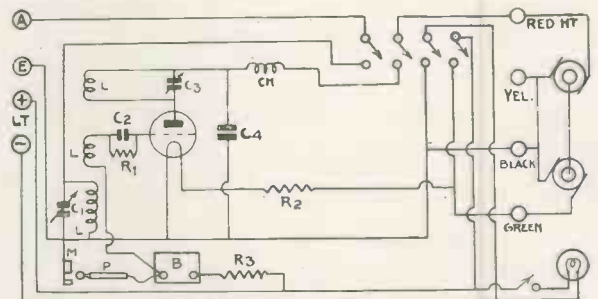

This is a skeleton diagram of the circuit used in the SOS automatic transmitter. As you can see, it is very simple and embraces the Hartley-oscillator principle

the operator need have no knowledge of the morse code or radio principles.

The set, which is contained in a stout wooden case, makes use of a Hartley oscillator circuit. A single switch brings the whole transmitter into operation and morse code is transmitted by drawing a special pencil across a number of slots each representing different letters.

To send the distress message, the pencil is drawn across the letters S, O and S specially provided at the top. These letters will be transmitted in perfect morse and should be picked up by ships within a radius of 50 miles or so. Any coastal station in the vicinity will also hear the transmission, so that help would be sent in a very short while.

SOS for the Yachtsman

But let me tell you of the brighter side. The whole morse code in alphabetical order is shown on the front of the transmitter. To send a message all one has to do is to draw the pencil across the required letters and the whole job is done.

Another feature of having this simple gear is that a companion receiver can be obtained to hear the replies to your messages. Remember that the transmitter is for sending out messages only, not for receiving.

The Postmaster-General has decided that telegrams can be handed in at the ordinary post office for transmission to yachts at sea via the nearest coast station.

If, for example, you were somewhere in the North Sea, a telegram could be sent through the telephony station in that area. The message would be broadcast twice during the first five minutes of the regular transmissions on a wavelength of 177.5 metres—the wavelength used for radio telephony to ships.

As the SOS receiver is already pre-tuned to this wavelength, all messages sent out would automatically be received.

Think how useful this would be for a doctor, taking a week-end off, should he be wanted in an emergency. It does mean that no matter where you may be, you are no longer isolated from the rest of the world.

With the transmitter, a list of direction-finding stations



Hythe lifeboat has been permanently fitted with a wireless set specially designed for use in an open boat by G. S. Woodman. To stand up to the elements of the sea, the set has been built into a watertight metal container

around the coast of England, France, Holland, Germany and Norway is given, together with their call signs.

As the operator cannot, as a general rule, understand morse code, an ingenious idea has been thought out to overcome this snag.

A little oscillator for use with the receiver can be supplied with a number of blank scales cut out to represent dots and dashes. You fit in, for example, the scale marked "Cromer," draw the metal pencil across the scale and a perfect reproduction of the Cromer station's call sign will be heard. After hearing the call once or twice it can be memorised, then when the station sends out a call, you will be able to pick up the message quite easily.

Another useful accessory by SOS Radio is a direction finder, which will enable the yachtsman to obtain directional bearings on coast stations in the vicinity.

The direction finder is collapsible and is supplied complete with compass in the top. Actually, the finder is a highly directional frame aerial and is plugged into the receiving set.

A pair of headphones are worn and the frame aerial rotated until the coast-station signal reaches the minimum point. The reading on the compass is then taken and the bearing marked. A second reading is then taken from another coast station and again marked on a map; the two lines are joined up and the point of intersection is the position of the yacht.

In storms, fog or loss of direction, this finder is invaluable. It is by no means complicated. This gear is manufactured by the SOS Radio Co. and will certainly be interesting to small yacht owners.



Marconiphone photo

No sign of trouble here! These two yachting enthusiasts are just setting off for a day's cruise in the Channel and are taking a Marconiphone portable to while away the time

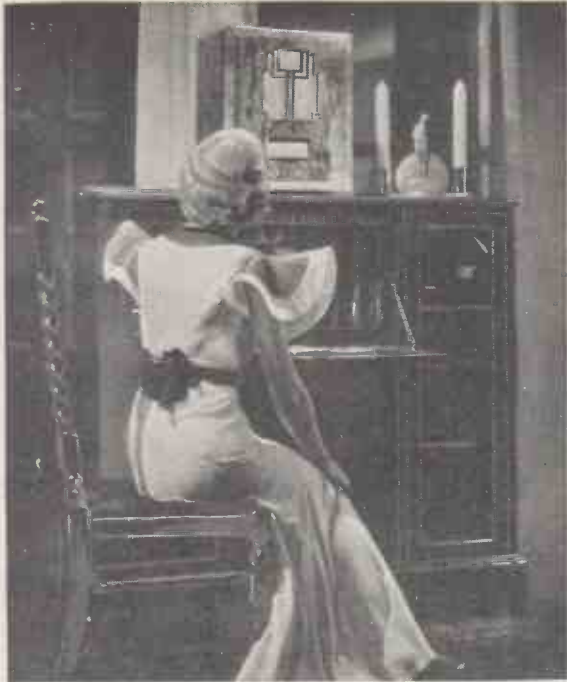

An ideal home set, the Marconiphone model 282 will be continued during the coming season

What New Ideas Shall We See This Season?

By the "W.M." Technical Staff

The National Radio Exhibition will be held at Olympia from August 14 to August 24. Every keen radio enthusiast should make a point of visiting the show and seeing the improvements made during the past year—in particular, the new stripped components for the constructor. In this article we outline the many new ideas and improvements that have been announced for the coming season

FOR years the pessimists have cried out loudly that radio developments have come to a full stop, but strangely enough these people have found that as each exhibition time arrives new ideas of really practical value make themselves known.

Many Developments

The truth of the matter is that there are so many developments nowadays that it takes all one's time to keep pace with them. When Olympia opens its doors on August 14 many new ideas will come into public life for the first time.

First of all let us see what the valve makers have done, for valves are the starting point of set design.

Many of the commercially made receivers to be shown at Olympia are built round the new valves.

The most important valve that has made its appearance recently is the pentagrid. This valve has made the four-valve super-het a reliable proposition.

It has been said that the four-valve super-het would give way to five- or six-valve super-hets on account of poor self-adjusting volume control, heavy background noise, and bad daylight range.

This year the four-valve super-het will still be a marketable proposition, and will still have four valve holders, but the four valves used will be

equivalent to seven or eight of the three-electrode type.

A typical 1934-5 four-valve super will have a triode pentode as the first valve, a high-frequency pentode as the second, a double-diode-triode or a triple-diode-pentode as the



A handsome new loud-speaker in a rather ornamental cabinet just released by the General Electric people



The new battery-operated Pup, by K.B., has a neat clock-face dial

third, and a steep-slope pentode as the fourth.

Most of the sets designed for the home constructor will follow these lines, for component manufacturers intend to make good use of the constructor market, and will have suitable components available.

Set makers have realised that the

public is not particular over the set's price *within reason*. Two or three pounds spent wisely on putting the finishing touches to a good set—including better cabinet work, more stringent final testing, and useful accessories, such as visual tuning and noise suppression—will put the industry on a better footing.

The large seven-valve super-hets of last year are still available at slightly lower prices, but the tendency is for this season's large supers to have at least eight or even more valves, and to give a miniature public-address output with really good quality.

Interference Question

As these large super-het are rather prone to pick up local interference, they have been carefully designed to minimise this trouble. A

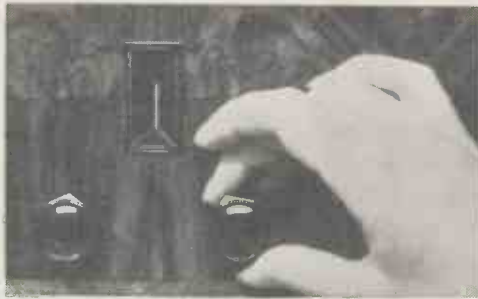

Showing the new fluid-light device fitted by H.M.V. to simplify the art of tuning

degree of selectivity can be obtained, the limit being determined by the user's idea of quality.

In practice the greater the selectivity, the greater the loss of high notes in the reproduction. By increasing the coupling, the high-note response can be improved so that the reproduction is as good as that given by the best straight set.

This idea can be utilised by the home constructor for intermediate-frequency coils with variable coupling will be available from such firms as Colvern and Goltone.

The feature of the new commercial sets is the number of useful accessories—we think they are past the luxury stage—now fitted as standard. Such ideas as tuning by the fluid light, favoured by the Gramophone Co., the contracting arrow device introduced by the Marconiphone Co., or Kolster-Brandes' neon-gas indicator, consisting of a neon tube that glows when a station is tuned in, will make tuning easy for all.

R.G.D., Pye, and other manufacturers favour metre tuning. This accessory consists of a sensitive milliammeter (uncalibrated), the set being correctly tuned when the needle on the sets panel shows the maximum reading.

New sets will have a host of small semi-adjustable controls on the back of the set chassis. The non-technical reader need not get "windy," for these knobs *should* and probably will be adjusted by the



The much talked-about piezo-electric crystal pick-up recently marketed by Rothermel. It is claimed to give an amazing frequency response

local dealer when the set is installed.

There are a few new models having such controls intended for the user. The new Burndept super-het has a booster control on the intermediate-frequency stage to increase or decrease the sensitivity as required. Many other sets have incorporated this idea, which is really a stage-gain control.

Straight Sets Return

These are but few of the many gadgets that will adorn the 1934-5 sets. No doubt many set makers have fancy stunts up their sleeves which they are keeping dark until the doors of Olympia open.

Super-hets are not having it all their own way this coming season. We have often hinted in the introduction to our set tests that we expected a sudden return to popularity of the straight set.

These straight sets are making an unobtrusive return this season. Thousands of listeners have never got away from the idea that they are quite capable of standing up to



Made by Kingsway Radio, this loud-speaker of unusual looks can be obtained in a variety of colours

good example is the new Kolster-Brandes eight-valve super-het for A.C. mains working. This set gives an output of 5.5 watts, uses twin loud-speakers, automatic tone compensation, automatic volume control, neon-light tuning indicator, and an entirely new idea of selectivity control.

New Selectivity Control

This new control takes the form of an intermediate-frequency coil, the coupling of the primary and secondary being externally controlled. The effect of this is to enable the user to increase or decrease the selectivity according to his particular requirements. A high



This handsome console receiver, with only the volume control on the front, is a new season's G.E.C. product



An attractive combination. The McMichael Twin Supervox with an attractive Bowyer-Lowe-A.E.D. playing desk

present-day ether conditions and, at the same time, capable of giving better quality than super-hets. That, of course, is a matter of opinion.

There will be several makes of set with three high-frequency stages, still more with two high-frequency stages, and sets with just a single high-frequency stage will be confined mostly to the battery market.

We are sure that the most popular battery set, commercially made, will be the four-valve class-B table model with all batteries and moving-coil loud-speaker in the one cabinet. It will cost about £7 or £8.

Before we leave the question of the

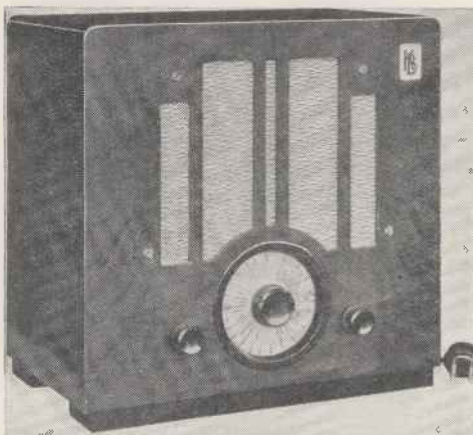

The new Kolster-Brandes five-valve A.C./D.C. super-het has rather a "Continental" appearance

trend of commercial sets in favour of component developments, just a few words about individual sets of proven ability that are being maintained, and in some cases re-introduced by public demand.

For instance, there will be the five- or six-valve A.C. transportable with self-contained frame aerial. Such designs will be marketed by H.M.V., Pye, and Portadyne.

Twin loud-speakers, another idea having a great public backing, will grace the sets of McMichael, Burndept, R.G.D., and Drummer.

We think we are perfectly justified in saying that the K.B. Pup was a set that sold in thousands. K.B.'s are re-introducing it. The 1934-5 Pup has all the latest—a moving-coil loud-speaker, a

These will convert a table set into a really efficient radiogram without any untidy wires around the set corner of the room.

Ideas for the Constructor

Construction at home is going to be a big feature of the new season's radio. Many component makers have realised that the constructor does not want fancy-looking parts at equally fancy prices.

The constructor wants parts that work well and are reasonably priced. He is quite prepared to pay a fair price.

For the first time, we believe, certain manufacturers are producing components without fancy cases. We call them stripped components.

Most of these components will be supplied with soldering tags and without moulded cases and the superfluous bits and pieces that put up the cost without doing any real good.

Foremost in this revolutionary idea are Goltone, who have a most ambitious programme. With some of their components home construction will really go ahead. High-frequency chokes with plain, uncovered bobbins, inductances for noise suppression, intermediate-frequency transformers having that



Specially designed for car-radio use, a new set just marketed by Baker's Selhurst Radio, Ltd.

clock-face gold-finished dial, four aerial tappings, and an improved cabinet.

A striking introduction in this year's sets will be a large number of all-wave types. Hitherto they have been made by two or three firms, but this year such notable concerns as K.B., G.E.C., Stratton, and Philco are marketing sets with provision for the short waves as well as the medium and long.

The striking feature of new radio gramophones will be their low price. It will be possible to buy a straight radiogram for mains working for as little as twelve guineas.

There is no need to buy a radio gramophone just because you want to make use of a pick-up. Bowyer Lowe and the Gramophone Co. are providing playing desks of striking design.

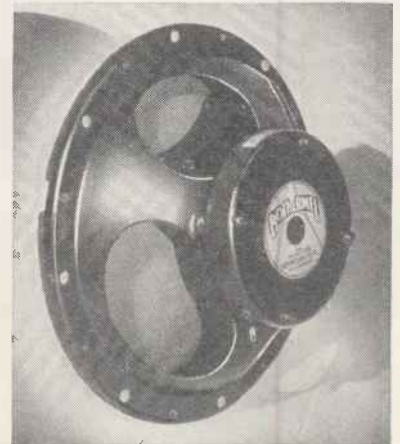

A wide frequency range is claimed for the piezo-electric crystal loud-speaker introduced by Rothermel

all-important variable selectivity device, filters for tone correction for use when too much top has been cut off through very selective high-frequency stages, are but a few of the new components for the home constructor.

For the real home builder there

will be metal coil cans and blank formers, so the making of coils at home will no longer present any difficulties. Iron-core coils in the stripped type will be shown for the first time, and for those who have ideas about an all-wave set there will be several coil units that tune from 15 to 2,000 metres.

The construction of all-wave sets will be very popular after this exhibition, for the constructor and the component maker have both realised that short waves do offer definite entertainment.

For Short-wave Fans

Steatite and other special insulators have made it possible for the efficiency of short-wave components to be increased out of all recognition. Another point is that the components designed for colonial use can be supplied in this country.

The number of special condensers,

coils and Stratton Steatite valve holders and high-frequency chokes.

There are to be some special variable condensers with two .0005- and two .00015-microfarad sections on the same spindle, so that the tuning of an all-wave set will not present any difficulties as the correct value of condenser can be used on each waveband.

Making a radio gramophone always arouses a lot of interest if the components can be obtained at a reason-



McMichael are continuing to market their popular Mains Super-het—a real deluxe receiver

The Mazda people have brought out their first needle-armature pick-up for which great things are claimed in the way of frequency response.

Crystal Loud-speakers

The crystal idea has also been adapted to loud-speakers and microphones. One little point that will cause loud cheers among the constructors is that the new volume controls and, in fact, most of the components generally fitted to a wooden panel, will have long spindles. No more drilling out the back of the woodwork because the spindle is too short.

The feminine touch can be seen



Portedyne's new PB6 battery super-het favours square lines and a clock-face dial

able price. A step in the right direction is the introduction of a combined gramophone motor and pick-up for £3 2s. 6d. for A.C. mains. This motor—a Garrard—is of the induction type and will not cause any interference on radio. It is not mounted on the usual metal plate, but is ready for mounting in a cabinet and includes automatic stopping and starting apparatus.

Several pick-ups of new design will interest home constructors. One of the most interesting pick-ups will be shown by Rothermel, who have done away with the usual type of armature by using the Rochelle Salts Crystals. This pick-up gives remarkable quality with minimum record wear.



Garrard's new electric gramophone motor has a pick-up attached by a small metal plate

coils and high-frequency chokes to be shown by many manufacturers represents a definite advance in this field. It will now be possible to build a good all-wave set with such components as the Wearite Mycalex



Those who require large public-address volume should see the new Parmeko gramophone amplifiers



H.M.V. will be continuing their Portable Fluid-light Six—an ideal set for home and outdoor use



Typical of the new battery-set designs, the Cossor model 435B is a four-valver with class-B output

in the design of many loud-speakers, particularly the Daedalia, which is obtainable in all colours and looks a cross between a table lamp and a headlight from a motor-car.

Quite a number of manufacturers are showing small loud-speakers for use as an external type with receivers that already have an internal one.

Loud-speakers

The General Electric Co. have two excellent models that harmonise with their own radio sets, but they can be used for other purposes and are particularly suitable for use as extension loud-speakers.

Varley have a complete range of specially-designed coils for the battery and mains pentagrids, the octode and heptode, so that highly efficient sets will be made by the home set builder this coming autumn.

Permeability Tuners

A coil that has been talked about for a long while is the semi-permeability tuner. The Varley version of this tuner is a simple iron-core coil that can be adjusted to give either a high or low inductance.

The idea of this is that some constructors may want to hear stations below 200 metres, while others want to go right up above 600 metres. With this coil they are both satisfied.

For the first time a three-gang permeability tuner will be seen, so that at last a set can be made without tuning condensers and at the same

time use at least one high-frequency stage. There is much to recommend this type of tuner, for selectivity and quality obtainable are maintained at a constant level.

As the heptode frequency-changer will appear in most of the super-hets, it is quite right that there should be a suitable heptode tuning pack available. C.A.C. have produced a model in the form of a condenser pack with all of the coils for a heptode properly ganged with the condensers.

The idea of having a separate amplifier for the gramophone pick-up is growing in popularity. Hartley-Turner have a high-power kit having an almost perfect response curve.

This kit, although a highly efficient piece of apparatus, can be assembled at home.

There will be no reason whatever for not equipping the car with



A handy-size 2-volt accumulator made by Smith's of Cricklewood

radio after this exhibition. A complete range of car radio sets and components for the home set builder will be available. Converters running from the car accumulator enable the set to be as efficient as the normal mains-driven job.

Catkin and midget valves, special condensers, aeri-

als, earth plates, noise suppressors, remote controls and all the gear wanted for the car radio are ready for constructors.

Do not for a moment think that car radio is only for the man with a converter. Excellent battery-operated sets with three high-frequency stages will

be shown by Lissen and others. Test gear will receive more than usual attention this year, for radio fans know how important it is. Many new test meters have been designed by Ferranti, Weston, and others.

A welcome line will be the introduction of a universal Avominor by Automatic Coil Winder people.

While these notes are being written comes the news that the Varley people have now evolved an excellent four-gang permeability tuner.

This unit is the improved version of the single tuner introduced last year. By an ingenious method of construction they have been able to vary the inductance of the coil by moving a soft iron core in and out of the coil field.

Gradual Variation

This core has been so designed that a very gradual variation is obtained with only a low-g geared tuning drive. It is claimed that this type of unit gives perfect inductance-to-capacity ratio so that the sensitivity and selectivity are always of the highest order.

It is very likely that permeability tuners will, in the near future, take the place of tuning condensers in simple sets for they undoubtedly offer many advantages in addition to the saving of space.

Generators and converters for supplying high tension will be a feature of this Exhibition.

As there is a shortage of good D.C. receivers and a glut of A.C. models, the sale of D.C. to A.C. converters has increased by leaps and bounds.

It is now possible by the aid of a converter to run an A.C.

Continued on page 65.



The Cossor three-electrode neon-tuning indicator



A boon to the deaf. The Multitone deaf-aid set with a distributing panel for use in schools and institutions

BROADCASTING is no longer young. No longer a wayward child to be petted and pampered and excused for its misdemeanours. It has grown up. Perhaps we have grown up with it.

I have been looking carefully through the summer programmes and have found much I remember that pleased me at the time. Also plenty that produced the reverse effect. Also I have read a good deal of criticism with the major portion of which I have found myself in profound disagreement. Too much has been made of unimportant details.

It is not my purpose here to rake up reminiscences of bygone productions. It is better to let them be bygones and forget all about them.



Keystone photo

Dramatic producers operating one of the control panels at Broadcasting House. John Watt is standing behind the microphone

A Warning to the B.B.C.!

By WHITAKER-WILSON

Instead, I propose to look at the programmes as a whole. As nobody at Broadcasting House considers the service perfect there is no need for me to suggest it is or it is not.

It is typically English of us to declare there is "nothing on the wireless tonight" or any other night. We all do it. Probably one of the reasons is that we pay so little for the excellence of what we do receive. Still, there it is, and it is a factor in the situation. The B.B.C. thinks so, at all events.

It is well known at Broadcasting House that by far the larger proportion of the programmes passes without comment. Only those items which please—or else irritate—are written about.

I have always held the view that on one wavelength should be a continuous stream of light orchestral music varied with songs and instrumental solos. It might begin at eight in the morning and continue until midnight. Unannounced, except by the artists. Just left to take care of itself.

Such a method would have a satisfactory result because it would supply the needs of those quaint souls who allow wireless to form a noisy background to their lives but who really listen to nothing.

Furthermore, it would have the advantage of clearing the other wavelengths for more and still more productions of an outstanding type. I am convinced these are necessary.

The programmes would cost the B.B.C. a good deal more, of course, but an extra sixpence on each licence—half a guinea instead of half a sovereign—would go a long way towards covering the extra outlay.

Until such time as this is possible something should be done about the service as it is.

Light entertainment is obviously the first consideration merely because it is the reason for most people having sets at all.

There has been a great improvement in all departments of it recently. This is probably due to its having been produced by five or six men whose views do not agree in the matter of the value of humour.

All I see necessary is a tightening up so far as the comedians themselves are concerned. There are still far too many silly lines, as distinct from really funny lines, allowed to go through.

Another fault is in permitting singers with harsh and displeasing voices to sing comedy songs. Singers, who would be almost thrown out of Broadcasting House if they attempted to sing before members of the *serious-music* department, are accepted and allowed to do their vilest in vaudeville.

There should be a standard, even in vaudeville singing. Vocal faults of the most elementary character are passed by. It needs a little pluck on the part of the producers, but something should be done.

Still, on the whole, light entertainment is in a fairly healthy condition. That it appeals to the majority is not to be denied.

On the serious side things are not quite so healthy. The good is *very* good and gaining favour in consequence, but there is much that is not so good.

The plays are successful, particularly biographical and historical plays. There is every evidence of it. People are responding to plays about real people rather than about people made to appear real. There was one—quite short—recently about Carlyle which caught the fancy of many of my friends.

Then there was the Lord Lovat trial. Howard Rose produced the play so perfectly that he even surprised himself. The response was considerable. People liked it because it sounded as though the whole trial had been given, whereas about thirty-nine hours were cut out of it. It succeeded because it gave a real impression.

I am certain we are up against this in most plays. Either we must leave the real and go headlong into fantasy or else be headstrong the other way and keep down to hard facts. Both are acceptable. It is the go-between which gets criticised.

Serious music is in quite a good way. The only exception is in the production of hyper-modern music. It appeals to such a small majority that to spend much money on its performance is merely placing emphasis in the wrong place.

It is no good raking up that £800 over *Wozzeck* again, except that there is a warning in the criticism it brought forth. There was no sense in broadcasting it. Sung in German because the plot would not bear translating; hideously cacophonous. Valueless.

Extremes of this kind fail. They fail because nobody can make anything of them. Wireless conditions will never be good enough for anybody to enjoy ultra-modern works.

The answer at Broadcasting House has always been that it is expedient to try everything. Perhaps we can all try something once. That, in fact, is just what most of us have done with these modern works. Once and only once.

There is a very high and a very long perch at Portland Place and far too many Directors of This and That are sitting on it, preening their feathers.

That is not meant rudely at all. Neither is it a

sweeping statement. It is a fact. Warnings have been given in every journal, which takes notice of broadcasting, but the attitude of the B.B.C. has been—quite sincerely so—a determination to try everything out in the musical line.

If they would only accept the fact that there are many musical works containing much worth hearing *so long as the hearing is actual and not by wireless*, they would not make the mistake of thinking that *everything* they hear and like is sure to be a success through a microphone.

Then there is the spoken word. The talks, on the whole, are a success. I think there is proof of it. The trouble is that the majority of the talkers—readers, in other words—kill their talks outright by inability to put them over.

This is recognised at Broadcasting House, but nothing has been done about it. The *In Town Tonight* series has been illuminating in this respect. Amusing also. People have been asked to talk on every conceivable subject. Most of them have been unconscious comedians over it. I have had more amusement out of them on a Saturday evening than I have had subsequently out of the vaudeville.

In their case it does not matter. In serious talks it does; very much. These things should be produced. If Howard Rose or Val Gielgud were asked to "produce" these talkers and make them read their

papers intelligently, the scripts would be a mass of inflection marks, but the result would be amazing.

The whole success of any programme lies in its presentation. If the B.B.C. needs proof of this—I imagine it does nothing of the kind—it has only to turn to its statistics regarding the Sunday night appeals. Who gets the most money? *The*

PAY US A VISIT AT RADIOLYMPIA!

The tenth National Radio Exhibition will be held at Olympia, London, from Tuesday, August 14, until Friday, August 24. Everybody who can possibly get along should visit Olympia this year. There will be many new developments to interest the constructor. You must, of course, pay a visit to the "Wireless Magazine" stand, where there will be plenty to interest the amateur

man or woman who presents the appeal most appealingly.

The success of broadcasting in general lies in perfect presentation of suitable material. It does *not* lie in enforcing things, whether they are liked or not.

I hope the B.B.C. will drop the twenty-four-hour clock system. It is so manifestly absurd, because the

programmes do not continue for twenty-four hours.

A programme at 8 o'clock must be in the evening, because it obviously cannot be in the morning, at least as yet. There is no intelligent use for anything but the twelve-hour system, except for railway timetables.

All those perches at Broadcasting House need to be broken up and the perchers asked to lie on the ground and keep their ears to it. Rather a mixed metaphor, but there is a deal of truth in it.



Keystone photo

GIVING A BROADCAST TALK

Gerald Heard giving one of his science-made-easy talks in a B.B.C. talks studio. As you can see, everything is provided for the comfort of the speaker, including a special rack on which the written talk can be supported.

Percy Harris has fitted an up-to-date super-het car-radio outfit to his car and in this article he gives his experiences of local-station reception whilst motoring in Surrey and Sussex. Incidentally he explodes the fallacy that listeners living on the tops of hills get better reception than those tucked away in valleys. The photographs illustrating this article were taken by the author



Percy Harris covered many miles of the countryside in his car, observing the variations in signal strength from London Regional

My Experiences with Car Radio

By PERCY W. HARRIS, M.Inst.Rad.E.

THE experimenter who desires to get at the true facts about radio is faced with many difficulties. It is a science in which practically nothing can be taken for granted and one in which numerous erroneous ideas have been prevalent for so long, that they have come to be accepted as facts.

Many people who have written on the subject have been pure theorists, and altogether it is very difficult to get together a sufficient collection of facts based on experiments to form a solid foundation for a practical working theory.

Take, for example, the question of the range of a station. Elementary articles and text books depict the site of a station as a dot and round it draw a number of concentric circles showing how the waves spread outwards equally in all directions, gradually falling off in strength as the circumference of the wave-front increases.

Signal strength, we are told, falls off as the square of the distance for this reason. From this it would appear that receiving sets situated at equal distances from a transmitting station would all receive signals of about equal strength, so that if a man writes in to say that he is perhaps sixty miles from, shall we say, North Regional, he expects the Query Department to tell him with certainty what kind of a signal he is going to get.

In the last ten years I have designed a very large number of receiving sets for home construction, and as a consequence have

had considerable correspondence with readers all over the country, thousands of whom have very kindly written to tell me the results they have obtained. In this way I have collected a good deal of data on the subject of receiving conditions in all sorts of places.

Predicting Conditions

This has taught me how hopeless it is to attempt to predict conditions in any given place merely by consulting a map. At least, I now know this: signals do *not* come in at equal strength at equal distances from a station, and the same set used on the same size and shape of aerial in two different parts of the same town may give results entirely different.

There is a common fallacy that high up on a hill is the best place to erect a receiving set, and that the man (or woman) in the valley must put up with weak signals. Often the reverse is true.

Contrasted Reception

My correspondence has shown me that in some places quite distant from a transmitting station signals come in regularly and well, at a strength several times greater than anyone would have anticipated, while in other districts quite close to a transmitting station results are consistently poor.

There are one or two places in the country where receiving conditions are so very good that almost any set behaves like a "super" receiver, thereby misleading the user of the set into thinking that he



HOW THE SET IS CONTROLLED

The remote control unit of the author's car radio is fitted to the steering column of the car. Note the key for "locking up" the gear



GOOD RESULTS NEAR LIPHOOK
On this delightful common near Liphook, Surrey, Percy Harris found reception better than in places much nearer London Regional

is the owner or discoverer of some particularly efficient circuit.

In other districts the best set available works like a "dud," making the user lose all faith in the designers of sets for home construction, and in most of the manufacturers, too!

Car-radio Efficiency

Motor-car radio has now reached a high point of efficiency, and so, when I bought a new car recently, I had it fitted with one of the latest types of super-het of sufficient sensitivity to enable me to collect a good deal of data bearing on the subject of receiving conditions.

The controls of the set are fastened to the steering column and consist of a small illuminated dial, a manual volume control, a tuning control, an on-and-off switch, and a lock (this last accessory is essential if you leave the car in a public garage).

Separate Loud-speaker

The set itself is fastened underneath the faciaboard, the moving-coil loud-speaker, which is separate, is also fastened to the faciaboard, while a motor-generator for high tension is screwed underneath the floorboards at the back of the car.

The current supply comes from the car accumulator, the six-volt current supplying the valve heaters and also the motor of the generator. The aerial is built into the roof, and the car chassis itself is used as the earth.

The set works very well indeed—so well, in fact, that I should now



OUT-OF-THE-WAY POSITION
The loud-speaker and set chassis of the author's Philco Transitone outfit are fixed right underneath the faciaboard of the car

miss it badly if it were taken out of the car.

Let me say at once that you will not find a great deal of conclusive information in this article, because my researches are by no means completed, but if they stimulate thought and remove even a few misconceptions the facts given will justify their publication.

I have already made tests north and south of the Thames and as far west as Salisbury. The present notes concern some recent week-end tests in Surrey and Sussex. The photographs reproduced are to show the kind of country concerned and the map shows the route followed.

The observations began on the Guildford-Godalming road, the set being tuned to London Regional. It should be noted at the outset that, as the receiver is fitted with a good measure of automatic volume control, substantial changes of volume heard must represent much bigger changes

in field strength. This is confirmed by listening to the background noise, which is at a minimum with a minimum magnification and at a maximum when the set is "all out."

No notice was taken of changes of signal strength due to such obvious causes as passing under a railway bridge, running close to a tall building, or passing a high, corrugated iron fence.

The volume was set so as to be pleasant in a quiet-running car for all four occupants, the programme being orchestral music followed by a talk, and again orchestral music.

Up a Steep Hill

The road from Guildford to Godalming runs first of all up a steep hill from the bottom of Guildford High Street, and on descending the other side once more rises and falls after which it remains fairly flat to Godalming. The observations began at the beginning of a flat portion, and signal strength was considered to be rather on the low side having regard to the position of the manual volume control knob.

No variations other than those easily taken care of by the automatic volume control occurred up to Godalming, but towards Milford a steady increase of signal strength was noticed, and round about the Milford area London Regional was obviously much stronger than anywhere from the beginning of the observation.

On the Shalford Road

On another occasion we left Guildford by the Shalford road, beginning our observations at Shalford, where signals were set to be about the same strength as those referred to on the previous test. For a few miles results were of medium intensity until we turned to the right and went along a side road towards the main Guildford-Godalming road. Almost immediately signals improved considerably—so much so, in fact, that the manual volume control had to be altered to reduce the overpowering effect.

I stopped and looked around to see whether there was any characteristic of the landscape which would suggest what was occurring.

The country was fairly flat with no rise near, but a glance at any map will show that there was rising ground between us and London Regional. We had apparently passed the screening effect of the rather hilly country at Guildford.

Signal Variations

For about a mile or so along this road the signals remained loud and then gradually fell off again to the level previously observed, and on joining the main Godalming road they appeared to be about the same as during the previous observations referred to at the beginning of this article.

The good field strength at Milford was once more noted, and turning to the left we took the Haslemere-Midhurst-Chichester road, which is as hilly as it is picturesque and frequently runs into dips and cuttings and heavily wooded valleys, the general direction being south.

Astonishment!

We expected to get poor results on this road, particularly in the valleys and cuttings, but to my astonishment and that of my passengers the best signals seemed to be in the deep narrow valleys and, frequently, at the top of the hills where one would think the best results would be obtained, signals were reduced to such a point that the background noise—brought up, of course, by the increased amplification due to the automatic volume control—became quite predominant.

Here I first noticed something resembling regularity in the rise and fall of signals. The speedometer of

the car is of a standard pattern and shows tenths of a mile on the trip mechanism. I noticed one reduction as the figure was turning over on the tenths scale and another the next time the figure changed.

This caused me to watch the trip mechanism and see whether the changes of figure coincided in any way with the changes of field strength and for many miles there was a rough coincidence between the two—that is to say, there was a periodic reduction of signal strength at every tenth of a mile.

Haslemere, which is situated in very hilly country, seemed a poor spot for reception until we had gone beyond it, where a long winding road up the side of a hill began to cross the South Downs. Here, as we rose, the signal strength again improved considerably, and all the way up the hill we obtained fine volume.

The hill was between us and the sea, and therefore the hillside up which we were proceeding was facing towards Brookman's Park.

This set me thinking about the possible effect of reflection from hillsides, and for the rest of the afternoon I particularly observed conditions of reception when there was high ground behind us when we were looking in the direction of the station being received. Gene-

rally speaking, signals were better under such conditions.

Once we had crossed this range of hills signals fell off considerably and remained weak as we descended the other side towards Fernhurst and Midhurst. Here and there signals dropped to practically zero, although there was nothing round us to suggest this—notably at one point near Fernhurst and again near Midhurst.

Stationary Observations

Just before reaching Chichester we turned to the right in a hairpin bend along a road leading to Petersfield, and after a mile or so pulled off the road into a field for tea and sundry stationary observations. The country here was very beautiful, and only gently undulating with no high ground near us. Signals from London Regional were better, but were no longer as good as on the other side of the South Downs.

As now we had the Downs at the



**CLOSE-UP OF THE PHILCO
REMOTE CONTROL**

Here you can see clearly how the controls are arranged for the Philco Transitone car-radio set. The tuning scale calibrated in kilocycles is illuminated from below



WHERE UNUSUALLY GOOD RECEPTION WAS OBTAINED

It was on this road leading from Shalford to Godalming that the signals suddenly increased fourfold. You will notice that the road is quite flat

back of us looking towards the sea it occurred to me that observations on Poste Parisien might be interesting, having in mind my reflection theory from high ground, and on turning to this station on the dial I was not surprised to find that it came in much louder than London Regional.

When we started moving again we kept observation on Poste Parisien for some time, finding, as might be expected, that signal strength fell off



"A LONG WINDING ROAD UP THE SIDE OF A HILL"

One of the delightful spots visited by Percy Harris when he was collecting observations for this article. Listeners with portable sets may like to try their hand at tracing variations in the strength of reception.

considerably on re-crossing the South Downs. So far as London Regional was concerned, it should be observed that we were returning on a different route, but the same general effects were noted: signals often being very good in valleys and poor on high ground, with frequent increases when there was a hill surface behind us and we were proceeding towards Brookman's Park.

No Evening Work

Observations ceased as evening came on, for my experience shows that there was so much fading towards evening as to make such observations useless.

I do not pretend to have discovered much in a run such as this, and, of course, to formulate theories a good deal of further observation—and that repeated at frequent intervals—would be necessary, but from what is written above you will see the hopelessness of attempting to say what receiving conditions will be like at a given spot merely by looking at the map.

"Dead-spot" Areas

Frequently along a straight road with no obvious obstruction or high ground near by, houses a mile apart or less will be situated in totally different receiving conditions.

One of the most puzzling phenomena is the "dead-spot" area—usually very small—where signals fall to practically nothing, and these tests (and others made before and since) have confirmed the theory I have held for some time (based on correspondence with readers) that

high ground is *not* by any means always the best for receiving, and that a man in a valley may get very much better results than one on the top of a near-by hill.

It is all very puzzling, and those readers who already have car radio installed will find it very interesting to make observations such as those given here.

Since the experiments here described were made, I have conducted numerous other tests, all leading me to the conclusion that obvious geographical configurations cannot alone account for the variations in strength.

While it is true that the presence of a steep hill close to the receiver and between it and the transmitter seems invariably to cut down the signals to a low value, I can find no rhyme or reason in the way in open country signals drop suddenly to extremely low values for small areas only, nor in the corresponding increases to abnormal values, except if we assume interference between ground and reflected waves.

Solving a Mystery

In such an assumption the weak areas would be places where the reflected wave tends to cancel out the ground wave and similarly the strong areas would correspond to places where one wave adds to the effect of the other.

Some support to this theory is given by the results obtained in the lane, where there were periodic variations at approximately each tenth of a mile.

Quality, too, varies. Nowadays we can assume quite safely that, at least so far as the medium-wave British stations are concerned, the quality at the transmitter is practically perfect.

Now quality of reception will occasionally go right "off" during these tests. From the clear-cut well-balanced reproduction it will suddenly pass to muffled, distorted sound, and in a few minutes return to excellent quality.

This is independent of signal strength variation. This result is not a new one and has been observed before, but our travelling receiver makes it more evident. High-speed fading is the probable cause, plus interaction of two waves fading differentially.

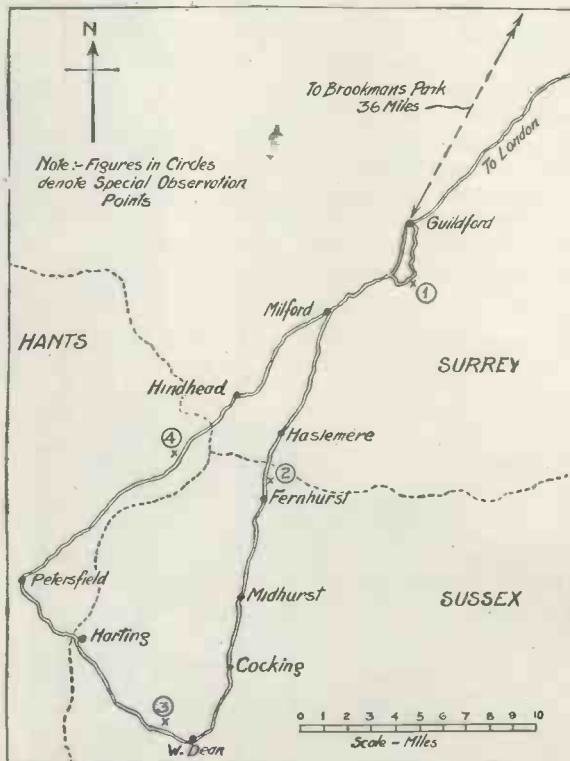

WHERE THE OBSERVATIONS WERE MADE

A map showing the route taken by the author for the special purpose of finding the effect of local surroundings on strength of reception. The route, to the south-west of London, is in the counties of Surrey and Sussex

AUGUST 11 will see the opening of Sir Henry Wood's fortieth season of Promenade Concerts. He founded them and built them up to what they are—a unique series of classical concerts, the like of which are not to be found anywhere else in the world.

I have known Sir Henry personally for at least twenty-five out of those forty years. I remember him when his hair and beard were jet-black, but I cannot say I remember a time when he was more active than he is now. He has amazing virility.

He is a slogger. Lady Wood once told me she tried to draw the line of letting him spend hours studying the score of Handel's *Messiah* before a concert, considering he conducted it



Sir Henry Wood at his home at Chorleywood, Herts, enjoying a game of bagatelle. Besides being an eminent musician, Sir Henry is very fond of painting

Forty Seasons of “Prom” Concerts

All Conducted by Sir Henry Wood

when he was twelve. Sir Henry's view is definitely that he intends to refresh his memory and note places where mistakes have been made in previous years. He is the most conscientious musician of my acquaintance.

Sir Henry does not actually conduct the Prom rehearsals. He generally asks Charles Woodhouse, his principal violin, to do so for him. Sir Henry presides over the whole proceeding, and spends his time with a score in one or other of the galleries, interrupting when he considers it necessary, but more often giving



Sir Henry Wood will conduct the fortieth season of Proms which begin at Queen's Hall on August 11. This photograph of Sir Henry with his daughter, Tatiana, was taken at Chorleywood

his observations at the end of a movement or work.

He gets his results this way. Rather than be amongst his players and actively engaged in conducting, he likes to listen to the effect from a distance, following every bar closely with a score. He is the only conductor of my knowledge who rehearses in this manner, but I see his point of view.

Looking back on the Proms—I have attended them for more than twenty years—one thing impresses me deeply. When they first began, forty years ago, they were happy-go-lucky sort of affairs compared with what they are now.

There was always a rattle of coffee cups, Sir Henry told me; also the audience was none too attentive. Nowadays it would be more than anyone dare do to strike a match, let alone rattle a cup and saucer. Gradually Sir Henry has put the screw on until the Proms are as strictly carried out as the B.B.C. Symphony Concerts—with the exception that smoking is still allowed.

Sir Henry Wood is quite one of the liveliest men I know. I have never yet caught him in a dull mood. He has always plenty to talk about. In his country home at Chorleywood he is delightful. Just a refined country gentleman with refined tastes and pursuits.

He was once faced with a big decision. Should he be an artist or a musician? He must have known he could easily be either one or the other. His pictures, of which many specimens hang in his house, are just as individualistic as his conducting. In a sense they reflect his thoughts on Art as a whole.

Naturally he is keenly looking forward to his fortieth season at Queen's Hall which opens on August 11. Many of the concerts will be broadcast.

Guest-conductors from foreign lands come over for the B.B.C. Symphony Concerts. They are very welcome, as most of them have found out, but only Sir Henry may conduct the Proms. In forty years he has never missed one so far as I am aware. *Whitaker-Wilson.*

America's New 500-kilowatt

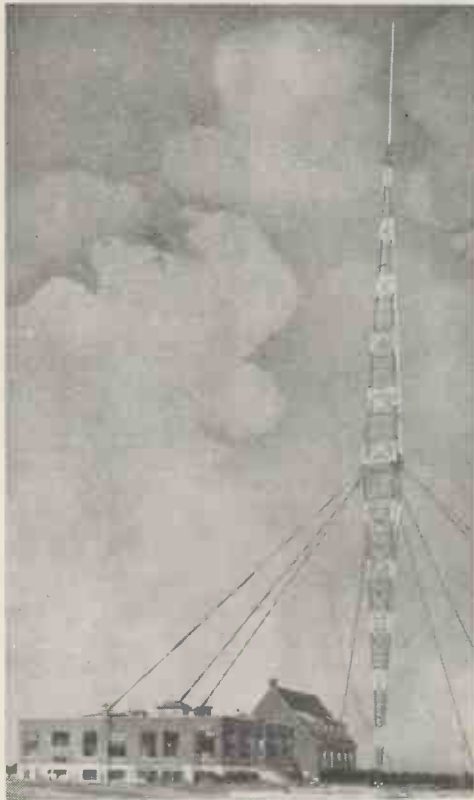

WLW'S MAST AERIAL

The huge 831-ft. aerial mast of WLW is itself the radiator. It is supported by huge steel stays and rests on two porcelain insulators

AND now 500 kilowatts—the world's largest transmitter. The Americans jealously watching the growth of European broadcasting stations have jumped from a maximum power of 50 kilowatts to an aerial carrier power of 500 kilowatts.

In the early days of broadcasting, with the old 2LO transmitter working at just over 1 kilowatt, the United States easily surpassed the rest of the world in transmission power. We in England listened with envy to tales of 25- and 50-kilowatt broadcasters in the States.

With increasing congestion in Europe, however, power went up and up until 50 kilowatts became quite commonplace, and Russia reached close to the present American high-power figure. That the claim of the American engineers is justified can be appreciated when the following description is read.

Five years ago the technical staff of the Crosley Radio Corporation

began working on the design of a 500-kilowatt station, and a year ago the final plans were passed to the Federal Radio Commission for approval. Meetings of the leading radio engineers were called and the transmitter design, departing radically from accepted practice, soon developed into an engineer's picnic.

It was decided that the new equipment should have a peak power of 2,000 kilowatts, and this meant the design of very special equipment embodying many novel features.

The Radio Corporation of America, which was connected with Marconi's in the early days, secured the contract for the installation. The location was fixed at Cincinnati, about 500 miles west of New York. The radio amplifier has twelve R.C.A. 100-kilowatt valves divided into three units of four valves each.

In each unit the valves are operated in a push-pull parallel arrangement and each unit also has its own grid- and plate-tuned circuits.

This has been done to ensure stability, especially as each unit is individually neutralized. The valves are operated as class-C amplifiers, which is, of course, much more efficient than the class B of the ordinary home receiver.

Perhaps the most remarkable feature of this installation is that high-power modulation is used and the final audio output consists of eight 100-kilowatt valves, divided into two units of four valves each.

These valves are operated in push-pull parallel from a class-B amplifier of unprecedented size. The amplifier is capable of giving over 400 kilowatts of undistorted audio power. Direct current is blocked out of the modulation transformer by a 500-microfarad condenser.

The total filament current is 4,300 amperes and three 75-horsepower motors are required. The plate-current rectifier supplies 100 amperes at 12,000 volts.

Special hot-cathode mercury-



PUTTING A 100-KILOWATT VALVE IN ITS HOLDER!

Joseph A. Chambers, chief engineer of WLW, putting one of the 100,000-watt water-cooled transmitting valves into position. The transmitting plant at WLW is the largest in the world

Giant

Here our special American correspondent, LIONEL MERDLER, tells all about WLW, the new 500-kilowatt transmitter erected at Cincinnati, U.S.A., which has just been put into regular service. This ether giant fulfils the ideals of Powel Crosley, jun., president of the Crosley Corporation.



MAIN TRANSMITTING HALL

Here is the main transmitting hall at WLW. Two engineers are seen at the entrance to one of the valve cabinets handling a huge transmitting valve



SWITCHING ON FOR THE FIRST TIME

Powel Crosley, jun., founder and president of the Crosley Radio Corporation, pressing the switch which put WLW on the air for its first official broadcast

vapour rectifiers were developed for this installation by the General Electric Company. At 100 per cent. modulation the peak voltage on the radio-frequency valves is 24,000 volts.

A tremendous problem was presented with the design of class-B transformers to give 400 kilowatts output. As is well known, the plate current varies with input and plate current variations at 400 kilowatts can well be imagined. One engineer stated that the power just comes through in large gobs when a speaker is at the microphone.

This means that many strange and queer conditions with regard to power supply had to be met. The entire power supply system had to have a very low reactance and a 260-microfarad condenser was required for smoothing.

The electric supply company concerned was forced to lay down a special sub-station and special power lines were required to bring in the power.

One disadvantage of the above conditions was that in the event of a short circuit a terrible destructive power would be released, so that special high-speed circuit breakers had to be developed. These break 100,000 amperes in one-twelfth of a second.

The problem of taking 500 kilowatts of radio-frequency power to the aerials was overcome by the use of a concentric-type transmission line; hitherto confined to short-wave work. This line was designed after the aerial had been erected and actual measurements taken on the spot.

The aerial tower, in conformity with the most advanced American practice, constitutes the aerial itself and stands 831 ft. high and its foundations go over 70 ft. below the ground level.

The total weight of this aerial—136 tons—is entirely supported on two apparently fragile porcelain cones. Both, however, are capable of sustaining a pressure of more than 3,000,000 lbs.

It may interest some listeners to know that the total cost of the station was over \$400,000, or £80,000 at the present rate of exchange. The operating frequency is 428 metres and the call sign WLW.

In view of this high power a statement by Powel Crosley, jun., president of the operating company, is significant. He says: "The early belief that an increase in power causes interference with other broadcasting stations has been definitely disproved over a period of years through the many power increases of WLW."

He further stated that there should be two types of broadcasting station—first, one covering a local area; and, second, one or more stations powerful enough to deliver satisfactory signal strength to places remote from local broadcasting stations.

It would appear, too, that this is the consensus of opinion in Great Britain and Europe; especially in view of the new high-powered Droitwich transmitter of the B.B.C., which is opening in August or September of this year.



Wireless Jobs Made Easy for Mr. Everyman

by R.W. Hallows, M.A.

PLYWOOD is one of the most useful materials in the home workshop. It is difficult to better it for baseboards, chassis and panels, and it can be used very effectively for making even complete cabinets. The metal-sprayed plywoods known as Metaplex and Plymax are also most useful for many wireless purposes since they enable connections to "earth" to be made in the easiest possible way.

Not everyone knows perhaps that plywood is available with a considerable variety of veneers—such as maple, oak, mahogany, walnut, teak, and rosewood—and also in different thicknesses.

It is built up as a rule of layers about $\frac{1}{2}$ in. in thickness. Thus 3-ply has a total thickness of $\frac{3}{8}$ in., 5-ply of $\frac{5}{8}$ in., 7-ply of $\frac{7}{8}$ in., 9-ply of $\frac{9}{8}$ in., and so on.

Any woodshop is sure to carry a good stock of plywood. If you haven't a woodshop in your locality, builders, cabinet makers, or joiners can generally supply what you want.

Working Plywood

There is only real difficulty about working plywood, and that is the tendency, unless proper precautions are taken, for pieces of one or other of the outer layers to split off. If you bear in mind the hints that follow and will act upon them you won't find trouble in dealing with plywood of any kind.

First as regards cutting out: always keep your plywood with the veneer uppermost whilst you are sawing. It is on the underside that

the wood is most likely to split since the teeth of the saw tend to pull the lowest layer away from its moorings as they force their way through it.

You can make quite sure of preserving *both* of the outer layers intact if you care to take one further precaution. Fix your plywood firmly, either screwing it down or using clamps, to a piece of scrap wood and saw right through both plywood and scrap.

Sharp Saws Essential

For plywood it is essential that the saw used shall be really sharp

and not of too coarse a kind. Any carpenter will set and sharpen a saw for you for a trifle, and you will be delighted with the way in which it cuts after he has finished with it. Don't forget to tell him, by the way, that you want the saw set for plywood cutting. You can use an ordinary fret saw for cutting thin plywood and you will probably find it easier to handle than the ordinary carpenter's saw. You must remember that a little extra care *must* be taken.

A Sawing Tip

By the way, there is one tip about sawing which applies to woods of all kinds. What kind of an angle does your saw make with the work when you are cutting wood? Look at Fig. 1. In one case the angle of the saw is correct; in the other it is wrong. Decide for yourself which you think is which before reading any further.

The position shown at B is that in which the amateur's saw is often to be seen when he is making a cut. It is wrong; the saw is too nearly vertical. Watch a professional

at work and you will see that his saw is held much more sloping, unless he has some reason for a nearly up and down movement in doing a particular job.

Use your saw as shown at A in Fig. 1, and you will find the work much easier. Your arm can move more freely, and since the teeth of the saw clear themselves better they are not nearly so likely to tear the wood, nor is there any difficulty in making the saw keep to the ruled guide lines.

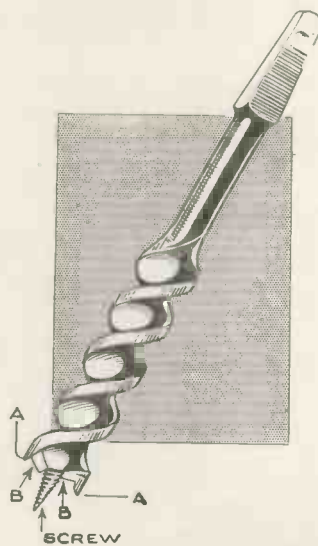

USEFUL TOOL
FOR WOODWORK

Fig. 2.—The auger bit is the best of all tools for making really large holes in any kind of wood

Something About Drilling

I expect that before now you've found yourself up against a problem or two when engaged in drilling holes in wood—and particularly in plywood. So long as it is only a matter of small holes the business is fairly plain sailing, for you can run a fine twist drill through without any untoward results.

But it is not so easy when you come to 1/4-in., 3/8-in., or bigger holes for the spindles that pass through a panel.

With plain wood the trouble is that the drill wants to tear its way

Those Large Holes

Similar precautions will prevent the splitting off of the lowest layer of plywood.

So far we have considered the use of drills really designed for metal work for making holes in either plywood or plain wood. You will get far better results if for large holes you use not a drill but an auger bit such as that illustrated in Fig. 2. Auger bits are not expensive, and, after all, for wireless work two will be sufficient to tackle almost any job. The sizes I suggest are 1/4-in. and 3/8-in.

The auger bit is a most ingenious tool. The central screw seen in Fig. 2 pulls it down and keeps the cutters tightly against the work. The cutters are of two different kinds. The purpose of those marked A A is to scribe out a circle corresponding to the diameter of the hole. The clean cut that they make, provided that they are sharp, prevents any tendency to tearing or "whiskers." The second set of cutters, B B, removes the wood from within the circumferential cut.

Use a Pad

There is one mistake frequently made by users of auger bits. They don't realise that the screw *must* have something to bite into so that it can pull the bit down on to the work.

Suppose you are drilling a piece of wood 1/4-in. thick. The screw protrudes a good way beyond the cutters, and unless you have a "pad" of soft wood underneath it cannot possibly pull the tool in as it should. Always use such a pad when working with an auger bit.

When using this tool there is no need to make the preliminary countersunk cup recommended above. The circumferential cutters do all that is necessary. But you must *not* run the bit straight through from one side to the other, or you will make a mess of the underside hole.

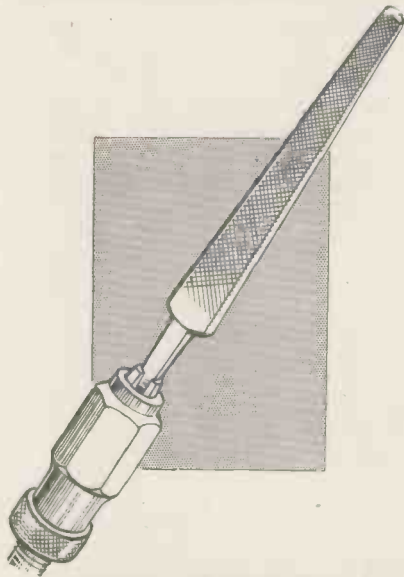

IMPROVED "D" BIT
Fig. 3.—This handy tool can be made out of a half-round file with its tang clamped centrally into the chuck of a brace

out on the underside, splitting the surface and leaving fibrous whiskery rags when soft wood is being worked.

This kind of thing is easily avoided. Having carefully marked the drilling centre, make a preliminary pilot hole right through with a small drill. So long as this drill is sharp there will not be any tearing.

Now take a rosehead countersink and with it make a good "cup" on each side of the wood. The big drill will tackle the work readily now. If it show any signs of binding turn the crank *backwards* instead of forwards. Don't take the drill right through from one side to the other, but when it is nearly through turn the work over and finish off from the underside. All this takes much longer to describe than it does to carry out.

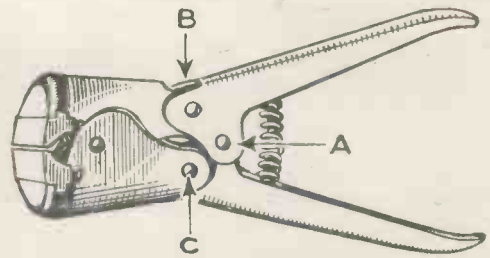

CUTTERS FOR ALL RADIO WORK
Fig. 4.—These toggle cutters will tackle any stiff wireless job. As you can see, the pliers are double-jointed and very strong

When you are rather more than half-way through, turn the work over and finish the hole from the other side. You will then achieve a perfectly clean-cut hole with no rags, splits, or whiskers.

An Improved "D" Bit

Some time ago I mentioned that most useful tool the tapered "D" bit, the purpose of which is to enlarge holes already made with drill or auger. If you haven't a "D" bit you can easily improvise one as shown in Fig. 3 from an ancient half-round file. You will find that

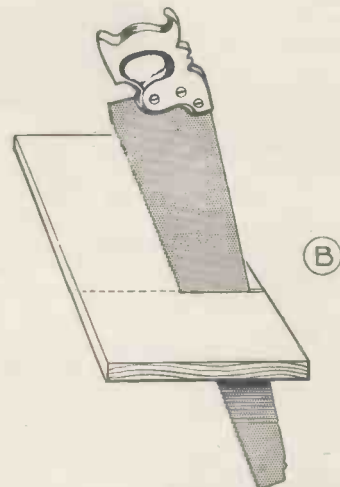
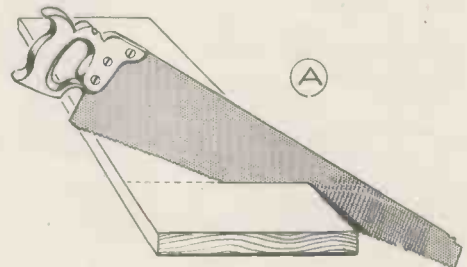

HOW DO YOU SAW WOOD?
Fig. 1.—In one of these drawings the sawing angle is correct; in the other, it is wrong. How do you saw? Make up your mind, and then read the text



A PAINFUL TOOL TO USE!

Fig. 5.—If you use this type of cutter, take special care not to let the handles pinch the palm of your hand when clinching them

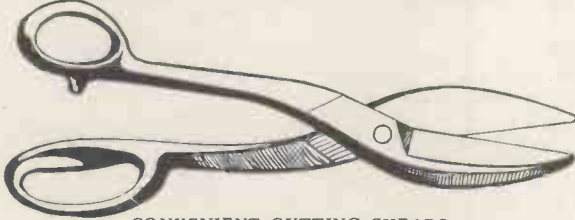

CONVENIENT CUTTING SHEARS

Fig. 6.—These shears will tackle any snipping job and will not pinch the palm of your hand should you be in a hurry!

with a little manoeuvring its tang can be clamped centrally into the chuck of the brace.

Once that is done you have a very handy enlarger.

Suppose that your biggest drill is $\frac{3}{8}$ -in., and that you want to make a $\frac{1}{2}$ -in. hole for a switch or some other component with a large bush. Put the drill through first of all, then mount the half-round file in your brace. Go to work steadily and after a few turns try the bush in the hole from the side at which the file has entered.

As soon as it will go about half-way in, turn the work over and continue from the other side. In this way you will soon make a clean-cut hole enlarged to just the right size.

Something Like Cutters

The other day I bought myself a pair of toggle cutters like those illustrated in Fig. 4, and after using them I think that they are about the best of all kinds of cutters or nippers for wireless work.

These pliers are double-jointed. The handles are pivoted on the pin marked A in Fig. 4 and the jaws on the two pins B and C. The result of this double-jointed arrangement is that a comparatively light squeeze on the

handles applies enormous force to the jaws. With a pair of six-inch toggles you can cut a brass 4 B.A. screw almost as if it were made of cheese! They are equally good for wire of all kinds. As their price is only eighteenpence or so they form an inexpensive addition to the tool kit and one that you will, I am sure, find well worth while. You can obtain these pliers from any good

Once Bitten

tool shop, but should you have any difficulty drop me a line to the "Wireless Magazine" offices at 58-61 Fetter Lane, London, E.C.4.

I expect you have discovered by sad experience that tin shears can be quite painful tools to use. The

trouble is that the ends of the handles are curved inwards, as shown in Fig. 5. In a thoughtless moment you give a good squeeze when cutting some tough piece of sheet metal—and next minute they have bitten you in that very painful spot, the palm of the hand.

Professional tinsmiths use them without trouble, but then they serve seven years' apprenticeship!

Another evil point about shears of the ordinary pattern is that whereas you and I can close them easily enough to make a cut we don't find it half as simple to open them again for the next one.

Personally, I find that shears of the kind illustrated in Fig. 6 are much more convenient for cutting sheet metal and far less apt to produce untoward results than the ordinary type. Certainly they will tackle any snipping job that is likely to come one's way in wireless construction, and if they do cost a shilling or two more than the others I think that the freedom from punctured palms that they confer makes them well worth the extra.



New Egyptian Broadcasting Studios

Egyptian State Broadcasting was officially inaugurated on May 31 in the presence of many notable officials of the country. These photographs show the two studios that have been built at Cairo. At the top is the modernly decorated studio No. 1 and below studio No. 2, which, as you can see, is fitted with special gear for the broadcasting of gramophone records



Making and Using a Universal Tester

By MARCUS G. SCROGGIE,
B.Sc., A.M.I.E.E.

Here we present an authoritative article showing how a simple piece of test apparatus can be made at home with a few ordinary components. It will enable the constructor to match coils and condensers accurately for ganging purposes, test the efficiency of components and make useful measurements of capacity, inductance and wavelength.



MANY experimenters would like to be able to test the quality of their components, match coils and condensers for ganging, measure inductance, capacity, and wavelength, and carry out many other tests, but are afraid of the vast sums of money that would have to be spent on the necessary apparatus, or of the expert knowledge that would have to be acquired.

Ordinary Components

There is no need for this. I am describing quite a simple piece of gear that can easily be made up from a few ordinary components—most of which are probably lying about already—and it is almost as good as a complete radio laboratory, such is its versatility.

Its scope is quite distinct from that of the many "universal" test sets of the voltmeter-milliammeter type, which are electrical instruments not necessarily used for radio at all. The apparatus to be described is for the more characteristically radio

work, for which practically no equipment is sold except at very high prices.

In essence this gear consists of little more than a valve with batteries (or A.C. transformer), to which may be added a few coils and tuning condensers, according to the things it is required to do.

The valve acts as a dynatron oscillator, and in case that puts any readers upon unfamiliar ground we had better begin with a little explanation of how a dynatron works. Those who don't care, so long as it *does* work, may skip the next paragraph or so.

An oscillator of any sort is a generator of alternating-current power. If resistance is added, it absorbs some of the power; and too much resistance may cause the oscillations to cease altogether. Getting down still further to fundamentals; a resistance is something that requires an increased voltage to force a bigger current through it (which is a loose way of stating Ohm's Law).

So if one were to draw a graph of current against voltage, it would be something like Fig. 1, which, being a straight line, expresses a constant resistance. The resistance of the path from filament to anode of an ordinary valve is not constant, and has the familiar shape of Fig. 2. But although the slope of the line (and hence the resistance that it represents) varies from point to point, it is always true that greater current necessitates greater voltage.

Downward Curve

Now look at Fig. 3. This is a curve of a typical screen-grid valve. It has a rather remarkable feature over part of its course: the curve actually slopes *downward*, which can only mean that the resistance is *negative*. Now if ordinary positive resistance drains power out of an oscillating circuit, negative resistance must surely put more power into it.

In fact, it may even keep it oscillating without the need for any other source of power such as a reaction

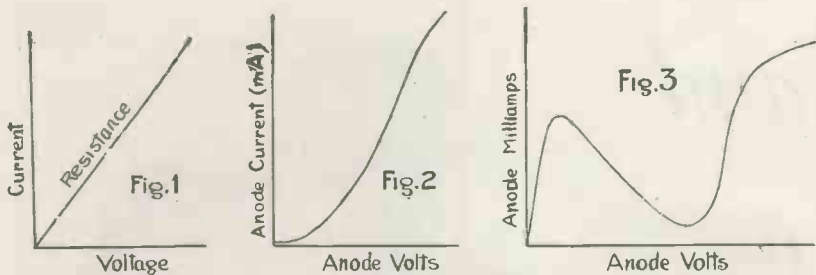

Fig. 1 shows a graph of current against voltage which, being a straight line, expresses a constant resistance. In Fig. 2 is shown the resistance of the path from filament to anode of an ordinary valve; this is not constant. Fig. 3 shows the curve of a typical screen-grid valve

coil system. This is very useful, because it means that if we have any sort of coil or transformer, high- or low-frequency, we can make it oscillate without any reaction coil or other complications.

Just how very useful it is will appear shortly. Meanwhile, the important point to notice is that the anode voltage, instead of being greater than the screen voltage as in the normal method of using screen-grid valves, must be less, in order to work on the negative resistance part.

Suitable Valve

Valves differ very much in their suitability as dynatron oscillators. Probably the best of all is the Mazda AC/S2. Being an A.C. valve, one naturally thinks it must be driven from an A.C. power unit. But there is no compulsion about this.

As a matter of fact, a complete A.C. drive for this solitary valve is rather a luxury and, as the consumption is very small, it will probably be found more economical to use a battery. There are quite a number of possibilities, and the choice from among them depends mainly on what happens to be available:—

Five Methods

- (a) Batteries for both high and low tension. This method is very satisfactory so far as results are concerned, but 1 ampere at 4 volts is likely to be rather inconvenient unless one happens to have a big 4-volt accumulator.
- (b) Battery high tension and A.C. transformer for low tension. The latter can be bought quite cheaply (for example, the Heayberd type 723, 12s. 6d.) and does away with the need for charging, while 100-volt tapped high-tension batteries are also quite economical for supplying a milliamper or two.
- (c) All A.C., using a metal rectifier for

high tension. This has the advantage of giving a constant supply at next to no running expense, but the first cost is fairly high, and it is not so easy to vary the high-tension voltages.

- (d) "Raw" A.C. for high tension, using just a transformer with no rectifier or smoother. This gives a rough-sounding oscillation, which, however, has certain advantages of its own.
- (e) If no A.C. is available, and a heavy low-tension current is impracticable, one must fall back on a battery valve. The Mazda S215B is about the best, but not nearly so good a dynatron as the A.C. valve.

The set is so simple that there is really no need to describe the layout in detail. The appropriate circuit diagrams in Fig. 4 (a) to 4 (e) should provide enough information to enable any experimenter to carry out the job in the way most convenient to him.

The three unspecified fixed condensers are not indispensable in (a), (b), and (e), but are very desirable to provide a good low-impedance path for oscillatory currents. They can be almost any capacity from 0.1 microfarad upwards.

It is worth while taking some care to select a really good grid-bias potentiometer, because many of the applications of the oscillator depend on being able to adjust the bias very closely and reliably.

A wire-wound type is practically essential, and it should *not* be logarithmic or any fancy winding. A suitable potentiometer is made by Burndep, Ltd., at 8s. 6d. Although the scale of the potentiometer is useful as a comparative indicator of bias, it is better still to be able to measure the voltage exactly; terminals vv are recommended for connecting a voltmeter, which should be of the 1,000 ohms per volt type.

The switch s is quite essential; if it is not opened after use the battery will run down through the potentiometer. The dotted connection from the heater is optional. Terminals x₁ x₂ are the points for connecting the coil in which oscillation is to be set up. As a tuning condenser and other things are usually connected as well, it is a good idea to use multiple terminals.

Points to Watch

Some care should be taken to make a short lead from the anode of the valve, and to mount the terminal or terminals on good quality ebonite or other "low-loss" material, and not close to other metal parts. Suitable material can be obtained from Wright & Weaire, Ltd.

Having put together the oscillator, one can proceed to give it a preliminary trial. Connect an ordinary tuning condenser and a coil—preferably medium-wave—in parallel across x₁ x₂. Put the whole affair close to the receiver, which should either be oscillating (if that is

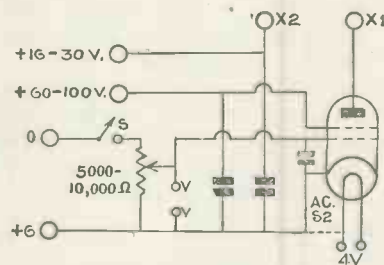

Fig. 4 (a).—A circuit for the Universal tester, using a Mazda AC/S2 valve, with batteries for both high and low tension

possible) or receiving some station, preferably *not* the local.

Operating the Unit

Set the bias potentiometer near zero—the position at which cathode and grid are together—and swing the oscillator tuning condenser around. If all is well, and the coil is suitable for tuning to the wavelength at which the receiver is working; a whistle will be heard when the oscillator "beats" with the receiver or broadcast-station oscillation. Without loss of time, increase the bias until it is as great as possible without stopping oscillation altogether.

The reason for the hurry is that the AC/S2 takes rather a heavy screen current with zero bias, and if run like that for long its dynatron capabilities are liable to suffer

severely; to say nothing of the waste of the battery.

Failure may just possibly be due to the valve being unsuitable for dynatron use; this can be so even although it functions perfectly in normal use. But it is far more likely that there is some circuit fault, or else excessive loss in the coil or condenser.

Using ordinary components there should not be the slightest difficulty and, assuming that a successful test has shown the oscillator itself to be in order, one can consider various accessories for making the instrument useful for a multitude of purposes.

"Laboratory" Condenser

As many of the purposes include the need for a variable condenser, and the accuracy and goodness of some of them depend mainly on the goodness of the condenser, it is worth considering getting a "laboratory-grade" condenser.

There is hardly any limit to what one can pay for (and get) in beauty and precision of condenser workmanship. Perhaps even the cheapest (£4 or so) is rather too much of a luxury for amateur work, but anyone who is tempted to go in for the thing thoroughly would be well advised to have a really good variable condenser which can be relied upon to hold its calibration.

One can do very useful work, however, with an ordinary tuning

condenser costing a few shillings. Pick the best you can get hold of, noticing particularly that the vanes are spaced evenly and not warped, and that the bearings are not of the type which are likely to let the spindle shift endwise.

Another good feature is a low-minimum capacity, which is obtained when the moving vanes are allowed to come quite clear of the fixed. The maximum capacity is the usual .0005 microfarad. The condenser should be mounted on a panel and fitted with a pointer and scale.

The well-known Burndep Etho-vernier dial is particularly suitable, because it gives fast and slow motion, full vision, and a replaceable paper scale on which calibrations can be marked, as well as a permanent engraved scale from 0 to 100. But it requires reasonable care and accuracy in fitting if it is to be a success.

The terminals should be mounted so that they come just opposite the x_1 x_2 terminals of the oscillator; the fixed vanes of the condenser go to x_1 . If there is any hand-capacity effect, it can be cured by a tin or copper foil screen lining the panel and connected to the moving vanes terminal. To be very sure of it, you can screen the whole box.

Alternatively, the condenser may be mounted together with the rest of the oscillator, but there should be a removable link, or something of the sort, to enable the condenser to be disconnected from x_1 .

Fig. 5 shows a suggested layout. A set of plug-in coils is a very useful acquisition that can be picked up quite cheaply from second-hand dealers, for this type of coil has become obsolete for broadcast reception.

Short-wave plug-in coils are still listed by some firms, such as Igranic and Stratton (Eddystone). Whatever is done about coils, they should be far enough away not to be influenced by movements of the hand in working the condenser, but not so far away as to need long leads between them and the condenser and valve.

Now for things that can be done with it. Obviously if a coil is plugged in, or otherwise connected, we have an oscillating wavemeter. The

band of wavelengths covered by any coil is, of course, determined by the inductance of the coil. Each coil can have its separate scale for fitting over the condenser dial; but if only two wavebands are wanted it is rather more convenient to mark them both on one scale.

Calibration is not now the troublesome problem it once was, for there are so many identifiable broadcast

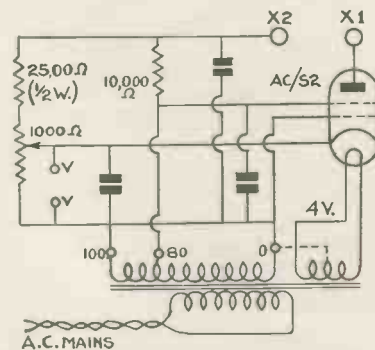

Fig. 4 (d).—Another method using rough A.C. for high tension. This gives a rough sounding oscillation which has certain useful advantages

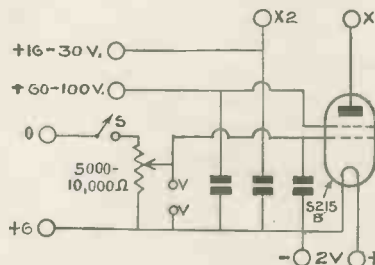

Fig. 4 (e).—If A.C. mains are not available this circuit using a Mazda S215B battery valve can be tried

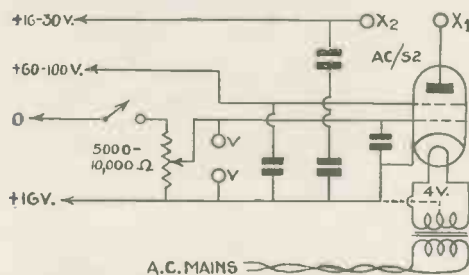

Fig. 4 (b).—Another circuit you can try with batteries for high tension and an A.C. transformer for providing low tension

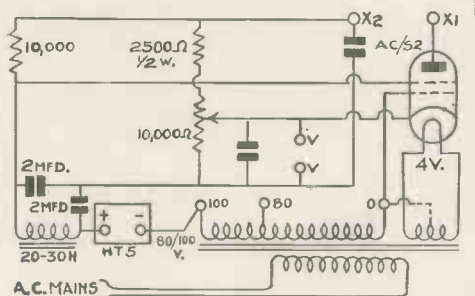

Fig. 4 (c).—In this case the tester derives all its power from A.C. mains; a metal rectifier is used for providing high tension

stations to provide points all over the scale. Suppose, for example, you want to cover medium- and long-wave broadcast bands. With a .0005-microfarad condenser there is no difficulty in doing this; the coils should be about 160 microhenries and 2,200 microhenries respectively.

Preliminary Test

If the inductances are not definitely known to be suitable, a preliminary test is needed to find out. Put the prospective wavemeter near the receiver, and work about with the condensers of each until a whistle is heard. To get this, the receiver must either be oscillating or receiving a station.

If the receiver is near the middle of its scale—tuned to London Regional, for example—and the wavemeter condenser is right at the top end, the inductance of the coil

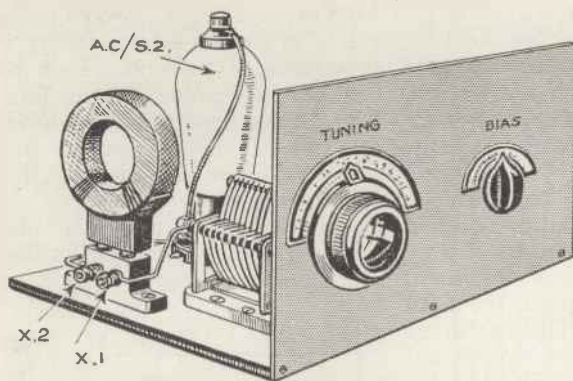

Fig. 5.—A suggested layout with the two controls fitted on one panel. The plug-in coil should be fixed so that it is not influenced by the hand rotating the variable condenser

is too low, and *vice versa*. It should be adjusted by adding or removing turns until the wavemeter covers the whole band properly. The same should be done for the long-wave coil, and any others.

Now we are ready for the calibration proper. Tune in a known station on the receiver, and "find it" on the wavemeter. Adjust the bias until the wavemeter signal is just on the point of stopping. Then carefully adjust the condenser until the whistle reaches the silent point, from which the note rises which ever way the condenser is tuned.

Exact Dial Reading

Note the exact dial reading on the engraved condenser scale. Now repeat this for a number of other stations, spread as well over the scale as possible.

The next thing is to draw a calibration curve. Mark a piece of squared paper with a scale 0-100 along the foot (or 0-180 if the condenser is so marked); and an appropriate wavelength scale up the side (Fig. 6). Follow along the horizontal lines from the wavelengths of the stations tuned in, until they meet the vertical lines rising from the scale readings at which the wavemeter was exactly in tune with each station; and mark the intersections with a small cross.

Drawing the Curve

If all has been properly done, the crosses will all lie so that a smooth curve can be drawn through the centres of them. If a cross is obviously off the curve, some mistake has been made in the reading or perhaps its wavelength has been changed. Use an up-to-date list.

Now it is possible to transfer exact wavelength points from the

chart to the paper scale. Mark the cardinal points—200, 300, 400, etc., metres—prominently; then fill in the tens, etc., with a longer mark for the fifties.

The value of the result will depend very largely on the care that has been expended on the calibration. When experimenting, and particularly when trying out a new set, a wavemeter is a

priceless possession, for it enables one to know where one is in wavelength, instead of depending exclusively on broadcast reception.

When dealing with the types of supply it was mentioned that type (d) has advantages for some purposes. As the oscillation is modulated it can be heard on a receiver even although there is no receiver oscillation or reception of a station.

When there is another oscillation present in the receiver, the whistle is not of the pure clear type obtained by the other methods; but besides the rough low-pitched hum it is possible to distinguish a sort of broken whistle mixed up with it, which enables it to be adjusted to the "silent" point; in this case, the point of lowest pitch.

It is quite possible to adapt circuits (b) or (c) to give a modulated signal when required, by modifying it as in Fig. 7. The 3-henry choke can be obtained from Varley. Unlike the circuit Fig. 4 (c) this arrangement gives a loud, high-pitched note.

Actual wavelength measurements are best made when the receiver is in an oscillating (or receiving) condition, and with an unmodulated wavemeter; because of the greater precision of the silent point adjustment.

Also, the wavemeter should be a foot or so away if its accuracy is not to be impaired by coupling it to a tuned receiver circuit.

The foregoing explanation of how the wavelength of the dynatron oscillator is adjusted to be the same as that of a received station, or of the oscillation of the receiver itself, will come in useful for most of the other applications.

The thing to understand clearly is that unless there is another oscillation present in the receiver,

generated either by itself or by some external source such as a broadcasting station, it is impossible to get the whistle which permits of very exact equalisation of wavelength by tuning to the silent point; and impossible to get any wavemeter signal at all unless the latter is modulated as described. This whistle process will in future be assumed when instruction is given to set the wavemeter to the receiver or *vice versa*.

Matching Possibilities

It is this ability to adjust two sets of oscillations to the same wavelength with such accuracy—actually a few parts in 100,000—that makes it possible to compare coils and condensers with great accuracy for ganging purposes.

Although it is possible to tune to



SUITABLE VERNIER DIAL
This Burndept Eshovernier dial is particularly suitable for incorporation in this tester. Calibrations can be marked on the paper scale provided

the same wavelength with a coil of considerably different inductance, by means of a correspondingly different capacity, that won't do for ganging. Both coils and condensers must be matched to within a fraction of 1 per cent.

Testing a Ganged Condenser

And that is where the dynatron oscillator is useful. Suppose you have difficulty in ganging, and you want to find out whether coils or condenser are to blame, and put them right. Test the gang condenser first. If it is not convenient to remove the condenser entirely, place the chassis on which it is mounted so that the high-potential terminals—those that go to anodes or grids—are close to the x_1 terminal on the dynatron.

The earthed side of the condenser, which is common to all sections, goes to the "earthable" x_2 terminal. Now attach a short flexible lead to

x_1 , with a crocodile clip, so that it can be connected to each of the gang condenser sections in turn with the least possible disturbance of the circuit capacity.

The condenser sections must, of course, be disconnected from all else. Plug in a coil such that when the gang condenser is all out, and the dynatron condenser (which is in parallel with it) is approximately all in, the dynatron oscillation can be heard on a receiver. Do not forget to adjust the bias so that oscillation is almost stopping.

Each Section in Turn

Clip on to each section of the gang in turn, and adjust the trimmers to keep the signal dead in tune with the receiver in every case. The initial capacity of each section is now exactly equal. Then turn the gang condenser round, perhaps 10 or 15 degrees. That puts the signal right off the receiver, but it can be brought back again by adjusting the dynatron condenser to a slightly lower capacity. Again clip on to the remaining gang-condenser sections.

If each of these has increased its capacity by the same amount as the first, the signal should be dead in tune every time; which means that the whistle is at the silent point. Generally a condenser is not quite so perfectly matched as that, and a whistle note will be heard.

If the note is within the reach of a star soprano there is no need to worry. And one can tolerate even a bit more. But if it is a very high note or, worse still, out of audibility altogether, the matching is not good enough.

Position of Trimmers

Test the capacity in the same way at intervals all around the scale. An alternative, and rather fairer, system is to adjust the trimmers when the gang is half in. That can be regarded as the standard by which the other settings are judged. If you have infinite patience you will try to adjust a mis-matched condenser. If you have not, you will get the makers to replace it with a good one.

But perhaps the condenser is O.K. Unplug the dynatron coil, and connect the crocodile clip to each coil in turn, having also the gang condenser sections in circuit, at their all-out position. With the dynatron condenser also at minimum

setting, the signal will be near the lower end of the waveband.

Pick it up on a receiver, and move the clip from coil to coil, adjusting the trimmers to keep in tune. Although each circuit is now adjusted to the same wavelength it does not necessarily follow that the coils are all matched.

To test that, tune the receiver to the top end of the waveband, and move the dynatron condenser over to follow it. If the dynatron is still in tune when clipped to each coil in turn, then the coils are matched. The amount of mis-matching can be judged from the departure of the signal from the silent point, as before.

A lot of nonsensical advertising is issued by the makers of coils and condensers, who are pretty safe in assuming that their customers are not in a position to check their statements. One cannot tell the "goodness" of a coil by looking at it, or even by applying a simple meter to it.

Generally a good deal of elaborate apparatus and calculation are required. But the dynatron oscillator, just as it stands, enables one to make reliable comparisons of coils, etc.

By going into the thing more thoroughly it is possible to go so far as to measure the actual high-frequency resistance in ohms, or the so-called "magnification." Sticking to what we have got, however, it is delightfully simple to compare one coil with another for selectivity and amplification. A great advantage of the dynatron system is that a

totally screened coil can be tested, and compared with the same coil un-screened.

All that is needed is to connect it across x_1 x_2 ; tune it with the dynatron condenser to the wavelength at which the test is to be made, and note the point on the bias scale at which the dynatron just stops oscillating (or, better still, the bias voltage across VV).

Testing Coil Amplification

If another coil tested in the same way needs a larger negative bias to stop oscillation, the amplification obtainable with the coil is greater. And *vice versa*. If the coil is very bad, it may not be possible to get oscillation at all, even with zero bias.

When comparing one with another in this way it is essential that the operating voltages of the dynatron, and the valve itself, should be kept quite unchanged (apart from the bias). Moreover, the same coil may show a greater amplifying power at some other wavelength.

Measuring Selectivity

Air-core coils usually fall off considerably as the wavelength increases, while good iron-core coils are practically constant. Provided that two coils have the same inductance, and consequently the same tuning capacity, the bias voltage is a measure also of the selectivity. Most broadcast coils now have very nearly the same inductances, so in effect one measures both things at once.

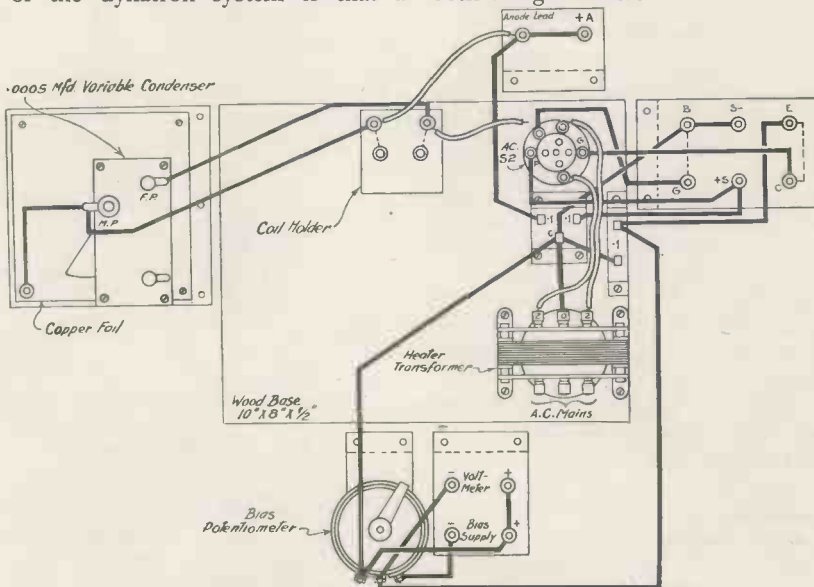

WIRING GUIDE THAT WILL BE FOUND USEFUL

Here we reproduce a layout and wiring guide of a universal tester used by the author. Every component is marked and constructors should find no difficulty whatsoever in building an efficient tester on these lines

Strictly speaking, it is not only the coil that decides the goodness of a tuned circuit; the condenser is an equal partner in the business. But the sources of loss are usually mainly in the coil, and the imperfection of the condenser is often left out of consideration.

That is all right provided that the

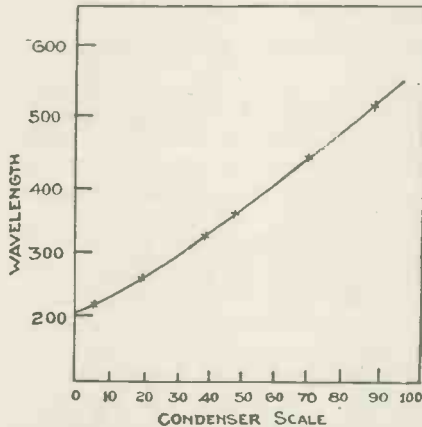

Fig. 6.—The wavelength calibration scale should present no trouble; it is drawn on squared graph paper. The condenser scale should be marked from 0 to 100 or 180, according to the condenser used

condenser is of sound construction, and the coil is not too good. But if the coil itself is very good, as are some of the iron-core models, the residual condenser loss may be appreciable.

And, of course, a condenser with solid dielectric usually throws quite a lot of loss into the circuit, having the two-fold effect of spoiling selectivity and amplification.

Comparison Test

By plugging a coil in the dynatron circuit—preferably a good low-loss coil—any variable condenser, or fixed condenser not exceeding .0005 microfarad, can be compared with the standard simply by substituting it and noting whether it shifts the bias voltage at which oscillation just stops.

The better the coil, the more sensitive is this test. Any really appreciable decrease in bias voltage points to a definitely inferior condenser.

Very few people know how to test high-frequency chokes properly. Although a high-frequency choke is a coil, it behaves under working conditions as a high resistance in parallel with a small condenser. The ideal would be infinite resistance and no capacity—in other words, nobody would be able to tell it was there so far as high-frequency currents were

concerned. Its function is to convey D.C. without passing high-frequency current.

In some of the places where high-frequency chokes are used they are effectively in parallel with a tuned circuit, and therefore any parallel resistance and capacity are decidedly objectionable. A really good specimen is as high as a megohm and as low as 1 micro-microfarad. Bad makes on the market register 20,000 ohms and 12 or 15 micro-microfarads at some wavelengths.

A good test is to set up the dynatron oscillator at its critical bias, with as good a coil as possible. Then connect the high-frequency choke with short leads to x_1 , x_2 . In all probability the dynatron will stop oscillating. Bring it back to the just-oscillating condition by adjusting bias; and it will be found to be slightly different in wavelength.

Restore this by adjusting the tuning condenser. Now a perfect choke would necessitate neither of these adjustments.

The approach to perfection can be judged by the smallness of them. A good choke produces an almost microscopic change, at whatever wavelength it is tested. And it must be remembered that the bad points have usually come and gone within a few metres, so it must be tested at a great many points all over the scale.

Once you have grasped the substitution idea that underlies all these tests you will be

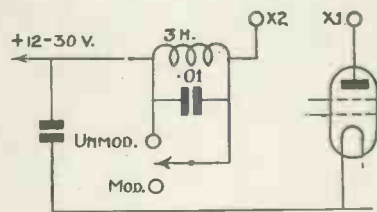

Fig. 7.—A modulated signal can be obtained from Fig. 4 (b) and (c) if this modification is used

able to think of others. If you have any coils or condensers of known inductance or capacity, you can compare others with them, and thus know where you are.

You can compare similar-shaped

samples of insulating material; making them into small condensers by squashing them between metal plates and testing them as described for condensers. The badness of the

What "W.M." Offers

This month we again present our readers with a fine varied issue. "Wireless Magazine" prides itself on the fact that it gives its readers authoritative articles on every radio subject. This fine standard will be maintained and, of course, improved upon as months go by.

Next month's issue will contain informative and helpful articles on the new season's productions. Don't forget the date. . . .

Wednesday, August 29

material is indicated by the bias shift. In fact, it is possible to find out all the sources of inefficiency in the high-frequency circuits.

Low-frequency Oscillator

Quite a different use for the dynatron is as a low-frequency oscillator. If instead of a high-frequency tuning coil one uses a coil of much higher inductance and a larger condenser, the oscillation is of such low frequency as to be audible.

This can easily be tried with any odd low-frequency or output transformers that happen to be about. A step-down output transformer is a good thing to use; in fact, a 25 : 1 ratio is suitable, for the output from the secondary is then about equivalent to that from a gramophone pick-up, and can be applied to the

gramophone terminals or sockets of a receiver. Various notes can be got by using different condensers across the primary (Fig. 8).

Constant Output Signal

With a fixed anode voltage and transformer ratio, the output signal is roughly constant no matter what else is varied; so this gives a means of checking the response of the receiver at various frequencies.

One could go on at considerably greater length describing the uses to which a dynatron oscillator can be put. No doubt the foregoing will be enough to demonstrate that every serious experimenter should have one.

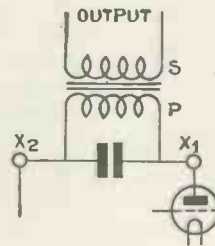

Fig. 8.—A low-frequency transformer in place of the coil will enable the tester to be used as a low-frequency oscillator

Radio Medley

A Radio Fan's Causerie
Conducted by BM/PRESS

Radio Homes of the Future

HOW times change! It is not so many years ago that all technical people told us how important it was to keep the aerial and its downlead well away from conducting material in order to avoid capacity losses, etc. We used most carefully to hold the lead-in wire away from the side of the house in order to conserve every millivolt of signal energy.

And what happens now? We fling up an aerial any old how—and get results that a few years ago we could have proved (on paper) were impossible!

All this is brought to my mind by the fact that I have just heard that the builders of a new housing estate in a district that I know very well are not overlooking radio. Every house has at least one room specially wired for radio; in other words, an aerial is built internally into the roof, the lead-in wire brought invisibly down through the house in the course of building, and a four-point socket provided for aerial-earth and mains connections.

So when you go into one of these new houses you just place the set in the proper room, plug in the aerial, earth, and mains plugs—and there you are! What a change in ten years!

The Earth Problem

As a matter of fact, the earth problem is nowadays very much more troublesome than the aerial problem, especially for flat-dwellers, like myself. I can very easily run a wire round the picture rail of two rooms and get a total length of about 40 ft. of aerial, but where am I to fix up my earth connection?

In one room I have solved the problem by hiding under the carpet a sheet of copper measuring about 4 ft. by 2 ft. 6 in. and using it as a counterpoise. It works very well with the average mains set.

But by my bedside I have installed a mains two-valver



REAL RADIO OUT OF DOORS!

L.N.A. photo

Note the business-like looking aerial attached to this army car, which is equipped for radio transmission and reception. A dispatch rider is passing in a message for transmission by the "car-radio"

to listen to dance music when I get into bed; this set is not entirely hum-free—and I have no more copper plates. Not that I think a copper plate would be suitable in this case; the hum is such that a good firm connection to the water system is indicated.

And that is where I come unstuck. If I am to make contact with the water supply I shall have to run wires all over the place, a procedure that does not attract me at all. So, in the meantime, I am putting up with a trifle more hum than is really pleasant.

When Experts Differ!

I have just come across an amusing incident which shows how difficult it is to know whom to believe when you are hearing about something of which you have had no actual first-hand experience.

A well-known radio journalist recently had a particular make of car-radio installed on his car, and a few days afterwards he took another well-known radio journalist out for a run.

Writing about his impressions, the second journalist praised the effects of self-adjusting volume control on reception generally; the owner of the car, talking to me



H.M.V. photo **A SUMMER-TIME IDEA FOR YOUR ROCK GARDEN**
An amusing garden setting for a portable radio set. But should gnomes play cards while listening-in at the bottom of your garden?

a few days before his passenger's notes were published, told me how over-rated self-adjusting volume control is and how disappointing it was on his particular set!

Of course, it all depends upon what you really expect before you try out such a modern development as S.A.V.C.!

Interference with Radio Sets

Quite a lot of work is being done behind the scenes, I believe, over the question of electrical gear and the interference that it causes with radio receivers.

But I was surprised the other day when a hint was dropped from a responsible quarter that within a short time every car on the road might have to be fitted with spark-plug interference suppressors in order to avoid interference with radio sets in buildings and other cars.

On the short waves such interference is an acute cause of discomfort on the part of the listener. Kenneth Jowers—one of the keenest short-wave fans I have yet run across—told me the other day that he was seriously thinking of moving because of the interference caused to his reception by passing motor-cars.

And, of course, if and when high-definition television does come on the ultra-short waves, then the problem will have to be solved. Or the transmitting authorities may be faced with libel actions by indignant artists who object to be sent out as cubists!

Do Radio Sets Last Too Long?

That is an extraordinary question to ask, you will say to yourself, and what is the fellow driving at? Well, I really mean that—do sets last too long? The question occurred to me recently when visiting a relative who has had a well-known make of portable set (with an additional trickle charger) in use for close on five years.

He tells me that he is perfectly satisfied with his results and sees no reason for changing to a new set.

The trouble is that your ears soon get used to a certain standard of quality and unless you go about a lot and hear more up-to-date sets belonging to other people you do not realise the advances that have been made. Going into a shop and hearing a set is not the same as listening in an ordinary household, where the atmosphere is so much different.

With an old car you are not long in doubt regarding its mechanical deficiencies—and as you go on driving it the whole machine does get steadily and quite perceptibly worse.

Not so with a radio set, however. Your valves last, if you are at all lucky, anything up to five years; and your ear, by that time, has become so accustomed to what may really be rotten quality that you feel no need for changing to a more modern receiver.

In fact, I suppose that most ordinary listeners only

change their sets for two reasons—firstly, because owing to the wavelength alterations they may be forced to have better selectivity if they are to cut out the "locals" and hear anything at all without interference and, secondly, because something really serious goes wrong with the set and they get fed up with putting it right every few weeks. There are, I suppose, a few husbands who have to buy a new set every year to match up with the wife's latest furnishing scheme, but these people are few and far between.

But I do not think that the latter happens very often nowadays so it is not easy to persuade a satisfied listener that he would really get a great deal more enjoyment out of radio if he scrapped his set of three or four years ago and invested in a modern production.

Try it on some of your friends—particularly those who buy and do not build for themselves—and see how difficult it is!



THEY KNOW HOW TO USE RADIO IN ITALY Biagini photo
Another summer-time radio scene. This picture comes from Italy where they obviously know how to live joyously

B.B.C. Theatre at Olympia

I understand that this year the B.B.C. will again stage a theatrical show at Olympia during the run of the Radio Exhibition (Thursday, August 16, to Saturday, August 25). As before, seats will only be bookable on the day of the performance—so if you are going to get a seat you must arrive at Olympia early in the morning.

Last year I never got near the B.B.C. theatre at Olympia. But still, I have had the advantage from time to time of attending actual studio performances, so perhaps I did not miss much—and somebody was able to get a seat who had never seen an actual broadcast.

Every year for at least three years people have said that the Exhibition attendance will drop off "this time"; but each time the prophecies have proved to be incorrect. Still, I am one of those who think that the show should be held later in the year when there are fewer open-air distractions. However interested you may be in radio, you do not want to swelter indoors.

But, of course, being a keen radio fan you will go to Olympia if you possibly can, no matter what the temperature may be!

Too Much Dance Music

I do not often discuss programme topics in these notes, because the truth is that I am much more interested in "radio" than in "listening." But I should like to join forces with those who want an occasional alternative to the late-night dance music.

Often I get home late and sit down for a quiet read. I automatically switch my set on, but I feel very much inclined to switch it off when the dance bands start.

While reading, I like a background of quiet music; but the rhythm of dance bands is not a good background for reading and I am sure that many others find the same. What is wanted is a

programme of good light music from the Nationals from 10.30 p.m. to midnight.

I know that there are plenty of foreign stations, but I am unlucky with them as a rule. I get up and tune in what seems to be a reasonable programme and then, after I have sat down again for three minutes, the music comes to an end and a long-winded talk starts!

We ought to be able to get all that we want in the way of radio entertainment from our own British stations.

Things I Should Like to Know

When are some of our tuning-condenser manufacturers going to produce some sensible slow-motion dials for short-wave work?

When will somebody develop a universal type of switch with plug-and-socket connections for quick experimenting?

When will time switches be fitted as a standard to



Marconi photo
WHERE RADIO MEANS WORK INSTEAD OF PLEASURE
Every listener likes to see a professional radio man at work. Here is the operator at work in the radio cabin of the s.s. "Strathnaver"



H.M.V. photo
PASSING AWAY AN ODD HALF-HOUR WITH RADIO
This attractive picture shows one of the latest super-hets fitted with fluid-light tuning and self-adjusting volume control

radio sets and when will somebody produce a compact and reasonably priced time switch that can be built into a home-constructed set?

When shall we have a turntable that can be screwed to the bottom of a portable cabinet without any difficulty?

Isn't a reduction in valve prices long overdue?

When are some of the component manufacturers going to get down to the production of "stripped" components to save constructors' money?

Isn't it time that somebody designed a really good frame aerial that can be manufactured and sold at a reasonable price?

When will the international broadcasting authorities produce a really foolproof system of station identification calls that all listeners will be able to recognise?

BM/PRESS.

London, W.C.1.



Keystone photo

A B.B.C. engineer at work tracing a fault in one of the dramatic-control panels at Broadcasting House

ONE of the most awkward problems experienced with wireless sets is to trace and cure unwanted hum. A few words on the way such hum is caused and various methods of curing it should be of great assistance to amateurs.

Hum is seldom experienced with battery sets and when it is, it can usually be traced to direct pick-up or low-frequency instability. In mains sets, however, hum is nearly always present in some degree or other. Usually it is derived from the source of supply.

High-pitched Hum

If the mains supply is direct current, the hum experienced is usually more high-pitched and variant than with alternating-current mains. The original cause can usually be traced to slight deficiencies in the generating system, such as variations in the speed of the motor generator which superimposes a ripple voltage on the steady D.C. supply (Fig. 1).

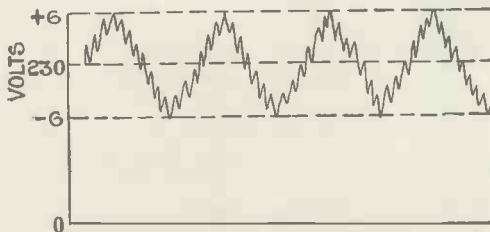

VISUAL INDICATION OF D.C. RIPPLE
Fig. 1.—This diagram shows the wave-form of the type of ripple experienced on D.C. mains

How to Trace and Cure Hum

By S. RUTHERFORD WILKINS

With the introduction of indirectly-heated D.C. mains valves with their high-voltage heaters, the problem of D.C.-mains set design has been simplified, but unless special precautions are taken, slight hum may be caused by induction from the heaters into the cathode circuits of the valves.

This is more noticeable as the voltage across the heater rises. That is to say, you should expect to notice more hum from this source when 40-volt .1-ampere valves are used than if 10-volt .4-ampere valves were employed.

In order to minimise interference from this source, the series train of heaters should always be arranged so that one end of the detector heater is returned to high-tension negative.

Besides the more ordinary super-imposed ripple, trouble is frequently experienced in D.C. mains sets from various extraneous sources, such as stray high-frequency voltages picked up by the mains leads. This is due to poor screening.

This type of interference is remedied by putting a simple high-frequency filter between the mains and the input to the set as shown in Fig. 2. Be careful when building such a filter, however, to see that the chokes are wound with heavy wire in order to carry the full D.C. current taken by the set.

With A.C. mains very little trouble is experienced from this source because the set is isolated from the mains by means of the mains transformer. Moreover most modern transformers have a high-frequency screen fitted between the primary and secondary windings

to prevent interference from this source.

In A.C. mains sets hum is usually caused in the process of rectification; the frequency of the interference is either equal to or twice that of a mains supply in normal types of rectifier circuits.

The reason for this will be under-

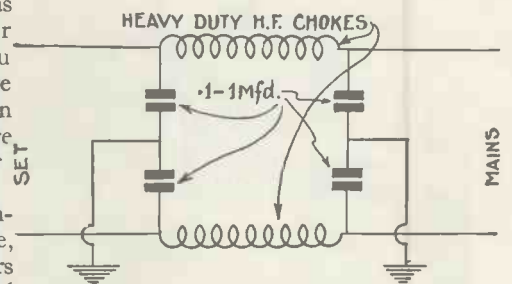

SIMPLE HIGH-FREQUENCY FILTER

Fig. 2.—A circuit for a filter for stopping high-frequency interference from getting through from the mains supply

stood from Fig. 3. Presuming that 50-cycle mains are used, the predominant hum will have a frequency of 50 cycles if half-wave rectification is used, and 100 cycles with full-wave rectification. In modern receivers full-wave rectification is generally used because the current delivered is more nearly constant and for large

outputs the design of the transformer is simplified. This is because there is no D.C. saturation, as the D.C. current magnetisations in the two halves of the secondary are equal and opposing.

Electrical Network

To prevent hum due to the pulsating voltage delivered from the rectifier, or ripple derived from D.C. mains, the high-tension supply is passed through an electrical network or, as it is more commonly called, a filter. This consists of an arrangement of one or more inductances in series and condensers in parallel with the high-tension input.

Such filters, known as the series-inductance type or parallel-condenser type according to the way the filter starts, are shown in Fig. 4.

The series-inductance type of

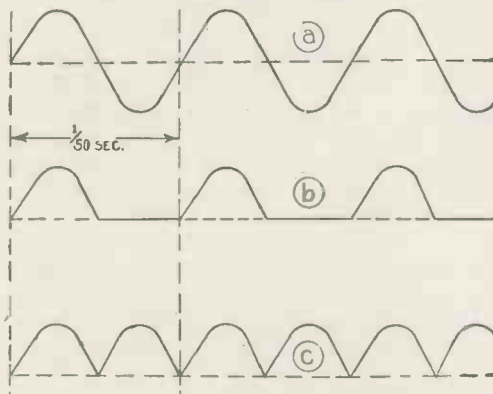

50- AND 100-CYCLE HUM FROM THE MAINS
Fig. 3.—These wave-form diagrams show how a 50-cycle A.C. voltage (a) when rectified by half-wave method produces a hum (b) with 50 pulsations; and (c) shows the output having 100 pulsations per second when full-wave rectification is used

filter is generally used as a smoothing system in high-power installations because the ratio of average to peak current is higher than with the shunt-condenser type. The series-inductance filter should also be used when following a polyphase rectifier circuit.

Shunt-condenser Filter

In low-power installations, such as broadcast receivers and amplifiers, the shunt-condenser filter is more commonly used. In this case the ratio of average to peak current is certainly less than with the series-inductance type of filter, but the A.C. voltage component across the filter input is also much smaller.

Thus considerably less ambitious chokes are needed for smoothing purposes. The levelling action of the condenser directly following the

rectifier—usually known as the reservoir condenser—on the pulsating voltage produced, can be followed from Fig. 5.

The further smoothing action of the low-frequency choke, and the condenser C_2 will give in most cases a perfectly hum-free output. Care must be taken to see that the choke is sufficiently heavily built not to saturate at full load.

If 8-microfarad condensers are used, a 20-henry choke will generally be sufficient. Be sure, however, that this inductance is obtained when the choke is carrying the full current taken by the set.

Another type of filter not already mentioned is one which employs a resonance circuit. Such filters are particularly effective on A.C. mains sets, when the major portion of the hum is at a certain known frequency.

Examples of this type of circuit are shown in Fig. 6, (a) and (b). In Fig. 6(a), L_1C_1 is a parallel resonant circuit tuned to the note of the hum and acts as a stopper circuit at that frequency.

Fig. 6(b) shows a series resonance circuit which shorts the unwanted frequency to earth. In general 6(b) is more easy to adjust than 6(a) because there is no D.C. current flowing through the choke L_1 . Its inductance, therefore,

does not alter with the load on the rectifier. This makes it easier to determine the value of C_1 required to tune the resonant circuit to the hum frequency.

As, however, there is bound to be a small amount of A.C. current in the choke, it is really necessary to make provision for varying either C_1 or L_1 until resonance is obtained.

Although the modern A.C. valve with its indirectly heated cathode is very free from hum, it is really necessary to earth the centre point of the heater. This cannot actually take place and an equivalent operation is usually carried out by earthing or connecting the centre tap of the heater winding on the

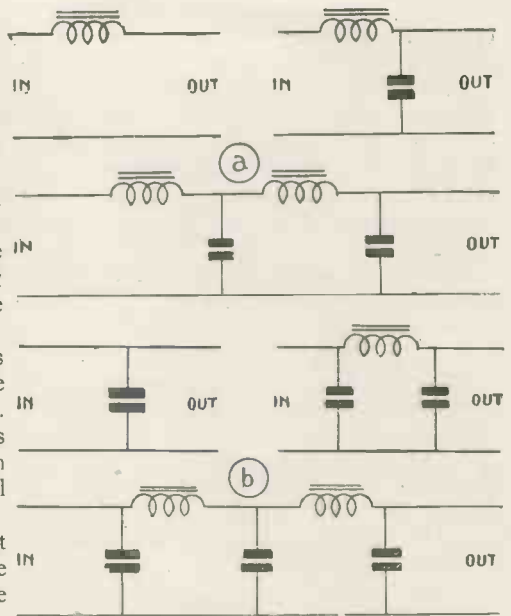

TWO SMOOTHING SYSTEMS

Fig. 4(a).—This shows various types of filters having a series-inductance input and Fig. 4(b) shows similar filters employing shunt-capacity input

mains transformer to a high-tension negative point in the circuit.

Electrical Centre

Should this tap be inaccurately placed, that is not at the electrical centre of the winding, it is quite possible that hum will result. If it is impossible to get the centre tap adjusted, hum from this point can usually be cured by removing the connection to the centre tapping on the heater winding and connecting it instead to the centre point of a 20 or 30-ohm resistance connected across the heater winding.

It often happens that although adequate smoothing is provided in a

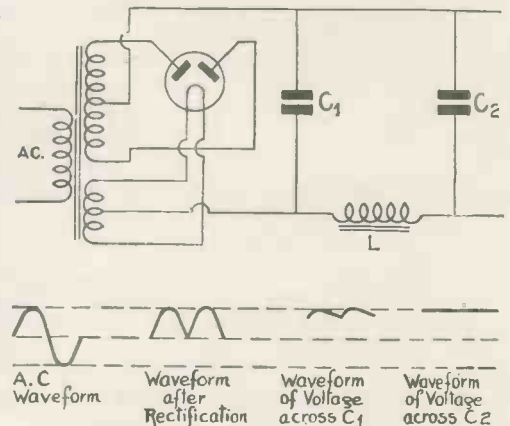

ACTION OF THE FILTER

Fig. 5.—An explanatory diagram showing the process of rectification and smoothing in a simple full-wave rectifier arrangement

set a persistent hum results which cannot be cured by additional filter circuits.

In this case, direct pick-up by induction can be suspected. The cause for this can usually be traced to a low-frequency transformer or other inductive component in the low-frequency stages of the set picking up hum by magnetic induction from the mains transformer or smoothing-choke windings.

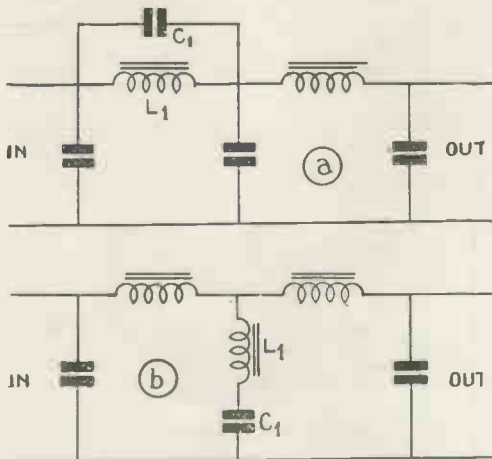

SMOOTHING AND RESONANT CIRCUIT
 Fig. 6.—Two forms of filter employing a circuit L_1C_1 resonating to the frequency of the hum. They are particularly effective on A.C. mains

Trouble from this source indicates bad component layout, and to cure this, the offending transformer, choke or other component should be orientated so that the axis of its windings is at right angles to that of the mains-transformer windings.

Earthed Cores

In this position pick-up will be at a minimum. In any case the cores of all low-frequency chokes and transformers should be earthed to minimise stray induction of this description. High-frequency chokes are particularly liable to interference through induction, and hum from this source is especially noticeable when the choke is in the diode circuit of a double-diode-triode or included as a reaction choke in the anode circuit of the detector.

This trouble is cured in a similar manner to the above by orientating the choke until the interference is at the minimum.

I came across a peculiar case of low-frequency induction the other day caused by a large A.C. energised moving-coil loud-speaker. Interference was occurring between the magnetic field around the loud-

speaker and some of the components in the set fitted just above the loud-speaker.

This hum, however, was simply eliminated by earthing the iron case of the loud-speaker and its rectifier.

Modulation hum is a very annoying form of interference, particularly because it is rather hard to trace. It is distinguishable in that it is only noticeable when a broadcast station is transmitting a carrier wave, and is therefore heard during quiet or silent passages of a programme. Directly the station transmitter shuts down the hum is no longer heard. The cause of this is that high-frequency is getting through the set into the rectifier circuit and is being modulated by the 50-cycle ripple present.

It is cured by putting two small condensers having a capacity of .01 to .05 microfarad in series across the high-tension secondary winding of the mains transformer with the junction of these condensers connected to the centre tap of the high-tension winding. If it is awkward to get to the secondary winding, two 1-microfarad condensers connected across the mains input winding with the centre tap

earthed will often cure the trouble.

Hum caused by direct pick-up on to the wiring of the set is usually traced to the grid lead of the detector or the gramophone pick-up leads. It may be that this is caused by slight instability due to the capacity between the leads, and it can often be cured by putting low-capacity screening on one of them. This will have very little effect, however, on low-frequency pick-up.

In this case the wires should be moved until they are out of the field that is causing interference.

Loud Hum

If a loud hum is experienced in a set employing bass compensation, especially in the type of compensation where a resonant circuit is used, slight adjustment of the resonant frequency of this circuit will often cure the trouble.

This is because the action of the compensating circuit is greatly to increase the amplification of the set at the resonant frequency, and if by any chance this frequency coincides with that of the hum, any slight residual hum will naturally be amplified to a large extent.

As a last precaution, be sure that you have a good low-resistance earth. I know that this has been emphasised before, but it is essential to attend to this very important point.

New Use for the Cathode-ray Tube

A NEW use for the cathode-ray tube has recently been invented by an American scientist, Allen B. Dumont.

His invention is called the Cathautograph, and enables the transmitting operator's handwriting to be seen on a cathode-ray tube within the distant receiving Cathautograph as a brilliant glowing stream of letters just like a miniature neon sign.

In practice, the transmitting operator writes with a pencil, stylus shaped, attached by pivots to two variable resistances concealed within the instrument, and as the stylus moves up and down and backwards and forwards, the motion is communicated by means of the pivots to the two resistances and the voltage of the current passing through the resistances is, of course, varied.

These currents now travel to the two sets of deflecting plates within the receiving cathode-ray tube, and

direct and control the flight of the electron stream emanating from the base of the tube. Thus a perfect duplicate of the handwriting of the transmitting operator is seen.

Pencil Movements

If the operator's pencil moves upwards, more current is supplied to the top deflecting plate of the receiving tube and taken from the bottom plate. If his pencil moves to the left, the pivots move over the resistances and supply more current to the left plate and take some from the right.

The higher the voltage applied to a deflecting plate, the higher the degree of attraction it has for the electron stream.

It is claimed that as many as ten words can be written before the first letter begins to fade on the phosphorescent screen of the receiving tube.

G. R. Wilding.

AMONG the receivers we have tested this month are types to suit most of our readers. Although the number of readers interested in battery sets is comparatively small, the exceptional results obtained on the new Ekco battery four—a straight set—is likely to revive the old controversy of straight versus super.

The short waves are slowly, but surely, coming into their own, so that the more far-seeing manufacturers have been quick to realise that a short waveband on the family set is a great attraction.

Universal High Voltage Radio, who specialise in family and all-wave receivers, supplied us with one of the best sets of the month, covering all wavebands and suitable for any mains, A.C. or D.C.

In this issue is reviewed the cheapest British automatic record-changer radio gramophone, a product of the Gramophone Co. A receiver designed by the Marconiphone Co. to overcome the problem of inter-



World Wide photo
Set makers say that cabinet designs for the 1934-5 season will be more modern than ever. This 1933 specimen embodies a radio gramophone, electric clock and cocktail bar

Our Tests of the New Sets

By the "W.M." Set Selection Bureau

ference and poor daylight range is also put through its paces.

Finally we have tested a battery receiver suitable for the reader who is particular about the initial cost as well as running costs. The Halcyon model 301 is the first set introduced by the new Halcyon Company. The report tells you all about it.

Although the weather is distinctly "summery," we must not lose sight of the fact that in less than three weeks' time we shall all be perspiring at Olympia at the 1934 Radio Exhibition.

What will be the surprise this year? Will it be television, a new design in radio sets, a new portable?

This year, set manufacturers have been particularly silent about their future plans. We do feel that there will be a return to the straight set, instead of every set maker keeping to super-hets as if they were the only sets worth having.

So far, we know of several makers who will be showing receivers with three high-frequency stages. This departure will be welcomed, for set buyers are beginning to realise that the cheap super-het is not too

efficient. Poor daylight range, bad whistles, a nasty background behind every weak programme are but few of the faults that are all too prevalent with poor "supers."

Manufacturers have told us that there is not a good battery frequency-changer available, so that the return of the straight set with battery high-frequency pentodes with specially designed coils is almost a certainty.

So far the high-frequency pentode has been held back through the scarcity of suitable coils.

That a boom in home construction is coming is obvious even to the most disinterested listener. The component maker has neglected the home constructor in favour of the set maker for far too long.

Component prices have been much too high—deliberately so—but now that set makers are making their own components, the component manufacturers are looking round to see how they can increase sales.

The solution is to bring down the prices to a more reasonable level. Then they will have a waiting market of constructors ready to buy.

FREE ADVICE TO PROSPECTIVE SET BUYERS

To make the most of this free advice service, we ask you to answer the following questions:—

- (1) The maximum price you wish to pay, and whether you are prepared to exceed this if there is no suitable set at your desired price.
- (2) The locality in which the set will be installed.
- (3) The stations required, that is, locals only or a selection of foreigners.
- (4) Whether you want an entirely self-contained set or one with external aerial and earth.
- (5) Whether battery or mains driven. If the latter, whether A.C. or D.C.

A stamped-addressed envelope for our reply is your only expense. Address your inquiry to Set Selection Bureau, "Wireless Magazine," 58-61 Fetter Lane, E.C.4. Tell your friends about this useful service, exclusive to "W.M."



"This new set is in a horizontal walnut cabinet. . . . The receiver is on the left-hand side with the loud-speaker behind an attractive grille on the right"

WE tested the new Halcyon three-valver with more than usual interest, for we had our first experience of receivers bearing the name Halcyon way back in 1923. Although the new battery three bears little resemblance to those early receivers, there is still one feature that is as noticeable; that is the excellent cabinet finish.

This new set is in a horizontal walnut cabinet, 23 in. in length, 10 in. in depth, and 11 in. high. The receiver is on the left-hand side with the loud-speaker behind an attractive grille on the right.

There are only three simple controls, and operating could not be simpler. These control knobs all match the cabinet finish, making the whole outfit look very attractive.

The left-hand knob controls a combined wave-change, gramophone, and on-off switch. You cannot be confused as to the position of the switch for the knob is clearly calibrated.

The centre knob is, of course, for tuning, while on the right is a combined volume-reaction control.

All wavelengths between 290 and 550 metres on medium waves and 750 and 2,000 metres on long waves are marked on the tuning scale. You can see from this that stations such as Radio Normandie, Aberdeen and Plymouth can easily be tuned in.

Selectivity is obtained by the use of three sharply tuned circuits, two coupling the first valve to the aerial and the other between the detector and high-frequency valves.

A screened-grid valve is used in the first position, and as this valve has a variable grid base, its characteristics enable the stage gain to be controlled.

As a detector, Halcyon use the new Osram L21 triode which gives a high output with good quality. An output pentode giving about 400 milliwatts feeds into a large permanent-magnet loud-speaker which together give really good quality. A notable feature is the absence of box resonance.

Ample space is left for the high-tension battery of 144 volts to be fitted inside the cabinet alongside the accumulator. This accumulator is held in place by means of a metal support so that it cannot possibly move and spill the acid.

Halcyon Battery Three-valver

On test with a 50-ft. aerial and 40 miles from the local station, we found the selectivity ample for all normal needs. Care, however, must be taken to adjust the trimmer as indicated in the instruction booklet, when results will be very good indeed.

On the long waves we were able to tune-in Croydon, Oslo, Kalundborg, Luxembourg, Warsaw and Motala during the early part of the evening. Berlin was blotted out by Daventry although Radio Paris was quite clear.

As we expected, the medium waves yielded more stations at even greater strength. The first programme heard was Radio Normandie, which came in at great strength at lunch time.

Breakfast programmes from Hilversum were heard



"Ample space is left for the high-tension battery of 144 volts to be fitted inside the cabinet alongside the accumulator"

with only a short length of wire across the room, which speaks well for the efficiency of the high-frequency circuit. The average selectivity was about 13 kilocycles, so that we were able to hear stations at every four degrees or so on the dial.

There is a growing feeling that the ordinary three with the screen-grid, detector and output sequence is not capable of giving good results under modern ether conditions. This is by no means true!

A little care and patience on the part of the set user in handling the controls will make all the difference between good and bad results.

In an ordinary evening we logged all the British Regionals and seven or eight foreigners whilst it was broad daylight. When it was quite dark we had no trouble in logging a further twenty programmes at real entertainment value. We can confidently recommend

this receiver to the non-technical user for the controls are so very simple. There are no minor adjustments to be made and most of the stations can be tuned-in on one knob.

It is without question a handsome piece of furniture, but at the same time a radio ornament that really does behave extremely well.

The model 301 is good value for money and all who are interested in battery sets we advise to consider the latest Halcyon product.

BRIEF SPECIFICATION

MAKERS: Halcyon Radio, Ltd.

MODEL: 301.

PRICE: £8 19s. 6d.

VALVE SPECIFICATION: Band-pass coupling to a variable- μ high-frequency stage (Osram VS24), triode detector (Osram L21), transformer coupled to a pentode output valve (Osram PT2).

POWER SUPPLY: Dry batteries and low-tension accumulator.

TYPE: Table battery set.

REMARKS: A neat horizontal type of cabinet. Well worth its price!

H.M.V. Model 542 Autoradiogram

AT twenty-seven guineas this new automatic radio gramophone is certainly value for money. It has all the finer points usually associated with H.M.V. products at an exceptionally low figure, well within the reach of nearly every listener.

Cabinet work is of the highest quality; controls are all simple to operate, while the circuit embodies every worth-while refinement.

All these points, with others too numerous to mention, go to make one of the best radio bargains available today. The illustrations fail to convey the excellence of the cabinet work, particularly the inlaid veneer, which contrasts with the remainder of the woodwork.

In the front of the cabinet is a single knob beneath the lock and key. This knob is for adjusting the volume from the gramophone pick-up, so that there is absolutely no need to raise the lid when the pick-up is in operation.

On the right-hand side of the motorboard is the major control panel. It consists of four knobs, grouped round a wide vision tuning scale. From top to bottom we have the master switch, combining wave-change, gramophone, and on-off switches.

Then comes the tuner, tone control, and volume control. The tone control, incidentally, works on both radio and gramophone. On radio it cuts out the bulk of the whistles, while on the gramophone it reduces



"Cabinet work is of the highest quality; controls are all simple to operate. . . . One of the best radio bargains available today"

A tuning scale is provided, showing the wavelengths of the more important European stations. This, by the way, is a far better idea than calibrating the tuning scale in station names.

The circuit consists of a sharply tuned band-pass filter, feeding into a combined detector-oscillator. It is this circuit which accounts for the lack of second-channel interference and the high degree of selectivity. Following this is a single intermediate-frequency stage, coupled to a power-grid triode detector.

The output pentode gives approximately 2.5 watts at good quality. When the receiver is first switched on an impression of tremendous power is obtained. Continental stations can be tuned-in with the greatest of ease with the volume control in the half-way position.

We were impressed with the remarkable absence of background noise.

Provision has been made for a gramophone pick-up, external loud-speakers, and hum neutralising by means of a special variable resistance. The receiver can also be tuned up to obtain the maximum results by means of a pre-set condenser in series with the first tuned circuit.

For those readers who, for some reason or other, cannot erect an external aerial, a mains-aerial attachment has been provided. With this we received some twenty or thirty stations under normal conditions.

The gramophone side works particularly well and the volume is sufficient for quite a large number of people to dance to.

Quality is equally as good on the gramophone as on the radio. Altogether, this receiver, besides being the cheapest automatic radio gramophone on the market, is particularly suitable for flats or where space is limited.



"On the right-hand side of the motorboard is the major control panel. It consists of four knobs grouped round a wide-vision tuning scale"

needle scratch to a negligible quantity.

One is immediately impressed with the easy-to-read tuning scale, which is illuminated from beneath. There are two sets of wavelengths—on the right-hand side the medium waves and on the left-hand side the long waves.

A hair-line pointer moves up and down so that it is quite an easy matter to determine the wavelength to which the receiver is tuned.

BRIEF SPECIFICATION

MAKERS : The Gramophone Co., Ltd.

MODEL : 542 A.C.Auto.

PRICE : £28 7s.

VALVE COMBINATION : Screen-grid oscillator-detector, (Marconi MS4B), single variable- μ intermediate-frequency stage (Marconi VMS4), power-grid triode detector (Marconi MH4), pentode output (Marconi MPT4), and valve rectifier (Marconi U12).

POWER SUPPLY : A.C. mains 200-250 volts, 40-60 cycles.

TYPE : Compact radio gramophone.

REMARKS : Especially good value for money, excellent selectivity and good quality.



"It is similar in appearance to the standard range of Ekco receivers and is housed in their now famous moulded bakelite cabinet"

WE have just completed our tests on one of the cheapest four-valve battery sets of the year. The Ekco four-valve model B54. It is similar in appearance to the standard range of Ekco receivers and is housed in their now famous moulded bakelite cabinet.

There are two models; an inexpensive one at ten guineas with a walnut-finish cabinet, and the super model with a black cabinet and chromium-plated fittings for ten and a half guineas.

Station selection is by means of an oversized dial which causes a light beam to appear behind the name of the station to which the receiver is tuned. As almost every European station is calibrated on the tuning scale it is an extremely simple matter to tell from where the programme to which you are listening originates.

Another point about this tuning scale is that it can be removed in a matter of moments and a new one put in its place. This is not of great importance just now, but if and when there is another change in wavelengths, similar to the Lucerne Plan, it will save a lot of bother.

There are three control knobs horizontally spaced at the base of the cabinet. These are so arranged to give a symmetrical appearance. On the extreme left is the selectivity control which, when used in conjunction with the volume control in the centre, will enable stations only separated by a few kilocycles to be

received without interference.

On the extreme right is the combined wave-change and on-off switch. The chassis is unusually compact. Looking from the back, on the left-hand side is the first valve, a Mullard SP2 high-frequency pentode.

Then comes the detector valve, a Mazda H2, followed by a Mazda L2 used as a driver and finally the Mazda class-B output valve. On the chassis is an ebonite inset into which is fitted the aerial and earth sockets and the two sockets for the gramophone pick-up. It is essential to remove the gramophone pick-up when the set is used for radio reproduction. The receiver is supplied complete with a 130-volt combined high-tension and grid-bias battery and a non-spillable low-tension accumulator.

It is not possible to estimate the actual anode current as this varies according to the volume. With the maximum output of between 1,200 and 1,400 milliwatts the anode current rises to as much as 14 milliamperes, but decreases to about 8 milliamperes when the volume is reduced to normal room strength.

Actually, when the receiver is running at full volume the high-tension battery should last about 250 hours, which is about three months normal use.

Our first test of this receiver was in London on a short indoor aerial and poor earth connection. Under these conditions selectivity was of the highest order, and quality—always a high spot with Ekco receivers—was exceptionally good.

Ekco Battery Four Model B54

BRIEF SPECIFICATION

MAKERS : E. K. Cole, Ltd.

MODEL : B54.

PRICE : £10 10s. in walnut finish; £11 0s. 6d. in black and chromium.

VALVE SPECIFICATION : High-frequency stage (Mullard SP2), triode detector (Mazda H2), triode driver to class-B stage (Mazda L2) and biased type of class-B output valve (Mazda PD220).

POWER SUPPLY : Internally fitted dry batteries and accumulator.

TYPE : Table consolette.

REMARKS : A cheap receiver that gives almost super-het performance!

In fact we were of the opinion that the quality of the B54 was almost as good as from the A.C. model 64, and that is saying a great deal.

Of course, the volume level is



"The receiver is supplied complete with a 130-volt combined high-tension, and grid-bias battery and a non-spillable low-tension accumulator"

lower, but altogether the receiver's quality is very close to that of a mains-driven set.

Our laboratories, forty miles north of London, were selected as being the best position for our second test. There we used an aerial of 60 ft. By adjusting the selectivity control we were able to tune out the local National station so that only three channels were lost on either side. This is a good performance when one considers that we were only twenty-five miles from Brookman's Park and in an exceptionally good position for radio reception.

Universal All-wave Super-het Eight

BRIEF SPECIFICATION

MAKERS: Universal High-voltage Radio Co., Ltd.

MODEL: Universal Super-het Eight.

PRICE: As a complete receiver £26 5s. In kit form, complete with valves, £16 16s.

VALVE COMBINATION: Variable- μ high-frequency stage (Ostar-Ganz MS18), screen-grid first detector (Ostar-Ganz SE25), triode oscillator (Ostar-Ganz A520), single variable- μ intermediate-frequency stage (Ostar-Ganz MS18), Westector for second detection and separate Westector for automatic volume control, buffer low-frequency stage (Ostar-Ganz A520), transformer coupled to power pentode (Ostar-Ganz M43), and valve rectifier (Ostar-Ganz NG100).

POWER SUPPLY: A.C. mains 110-260 volts, any frequency and any voltage; D.C. mains from 110-260 volts.

TYPE: Upright table console.

REMARKS: The first universal all-mains, all-wave super-het.

MANY amazing developments which were only hinted at during the last radio exhibition are at last finding their way into the more advanced commercial receivers.

Foremost in this respect is the Universal Super-het Eight, a receiver that embodies automatic volume control, visual tuning, tone correction, cold second detection, all-wave tuning, and all-mains working among other points.

This receiver is well ahead of the majority of commercial receivers on the market at the present time. The circuit consists of a pre-first detector stage using a variable- μ screen-grid stage followed by a triode oscillator and a screen-grid valve with a fixed grid base as a first detector.

In the single intermediate-frequency stage another variable- μ screen-grid valve is used, and this valve, in addition to the valve in the pre-high-frequency stage, is A. V. C. controlled. The second detector is a half-wave Westector, while a second Westector of the WX6 type is used to provide automatic volume control voltage.

The output valve is a power pentode giving

3,000 milliwatts, which is preceded by a buffer low-frequency stage.

In addition to these valves there is a special rectifier consisting of two separate electrode systems, each giving 200 volts at 100 milliamperes.

One half of the output from the rectifier is used to feed the valves in the receiver, while the other half energises the loud-speaker field. So you can see that the receiver does not suffer from inadequate high tension. Consequently, the quality is of the highest, while the volume is enough to fill a large hall.

The eighth valve, which we have not yet mentioned, is used on short-wave reception only. It is a screen-grid, working as an autodyne combined oscillator-detector, and converts the receiver into a powerful short-wave super-het.

In spite of the large chassis, the cabinet—made of light walnut—is not bulky. It is of the upright table type with all of the controls—except



"In spite of the large chassis the cabinet—made of light walnut—is not bulky. It is of the upright table type"

two, which are mounted one either side of the loud-speaker fret—grouped beneath the tuning scale.

All wavelengths between 200 and 2,000 metres are calibrated on the tuning scale and there is a separate tuner—on the right of the loud-speaker fret—for the short waves. With this receiver it is possible to tune in short-wave stations on wavelengths between 12 and 190 metres from all parts of the world.

The receiver is suitable for almost any supply mains, either A.C. or D.C., so that it is particularly suitable for use abroad. It is one of the few English sets that can be exported with any hope of competing with the receivers of American design.

All the valves are of the high-voltage type, so that they can run directly from the mains without breakdown resistance or mains transformer.

On test the results amply justified the elaborate specification. Selectivity was a little better than 9 kilocycles over both medium and long wavebands, so that most of the European stations could be heard without interference.

It is not an exaggeration to claim that 90 to 100 stations can be heard most evenings. During the day and after midnight we had no difficulty in tuning several American stations on the short waves. With a little patience on our part, Sydney and one or two Japanese stations were also heard at reasonable strength on the speaker.

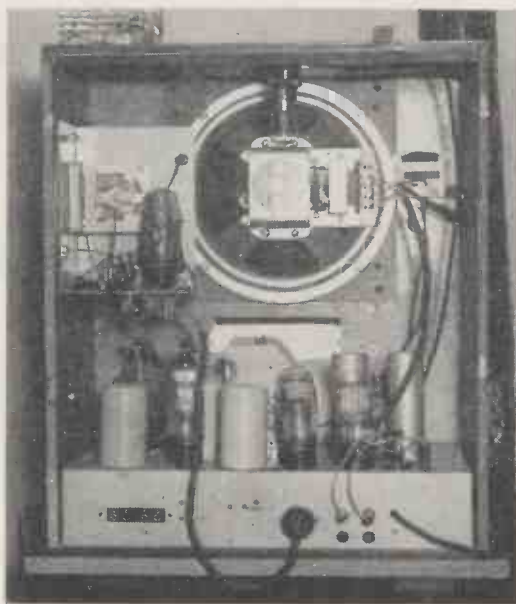

"Many of the amazing developments, which were only hinted at during the last radio exhibition, are at last finding their way into the more advanced commercial receivers"

Marconiphone Model 262 A.C. Super-het



"The cabinet is of solid walnut with the control knobs and fret design all harmonising so that the effect is a dignified piece of furniture"

OF all the different types of receivers available to the general public, there are comparatively few that stand out in popularity.

The battery three is one type, the super-het seven is another; but the most popular is the almost self-contained four-valve super-het.

A good example of this class is the Marconiphone Lucerne Special, model 262, an A.C. mains set that has set a standard for price and performance. When it was first introduced at the unheard low price of twelve guineas it was said that at the price it could not be efficient or, if it was, it couldn't last.

Well, so far, it has proved to be above the average in efficiency, cheap to run, and with a guarantee behind it that really means something. There is no need to stress the efficiency of Marconiphone service.

The cabinet is of solid walnut with the control knobs and fret all harmonising so the effect is a dignified piece of furniture.

These controls are of the usual type. A tuner, tone and volume control, with a special combined wave-change, gramophone and on-off switch. They are grouped together beneath the escutcheon at the base of the cabinet.

Owing to the supposed

unstable condition of the Lucerne Plan, the tuning scale has not been calibrated in station names, only wavelengths. This is quite a good idea for a further change in wavelength allocations will not necessitate a new scale. A tuning card is provided, giving wavelengths of the more important European stations and their approximate positions on the tuning scale.

There is no need to say very much about the circuit. Briefly, there are four receiving valves and a full-wave rectifier. The first

valve is a combined oscillator-detector followed by a single intermediate-frequency stage and a triode second detector. The output valve is a power pentode that gives good quality up to the maximum output of 2.5 watts.

A gadget to reduce hum—should there be any—and gramophone pick-up sockets are also provided. So as to obtain the best results when the receiver is installed, a small pre-set condenser in series with the aerial should be adjusted.

One of the many important points that we noted during our tests was

the entire absence of hum or background noise of any kind; even the usual mains clicks heard were very few and far between.

Except on the weakest stations, background hiss was negligible. During the daytime range was phenomenal and, due to the low noise level, far more stations than one would normally expect were tuned in on the loud-speaker.

The average selectivity was found

BRIEF SPECIFICATION

MAKERS: Marconiphone Co., Ltd.

MODEL: 262.

PRICE: £12 12s.

VALVE SPECIFICATION: Combined detector-oscillator (Marconi MS4B), single variable intermediate-frequency stage (Marconi VMS4), triode detector (Marconi MH4), power pentode output (Marconi MPT4) and full-wave valve rectifier (Marconi U12).

POWER SUPPLY: A.C. mains 200-250 volts, 40-60 cycles. (D.C. model available).

TYPE: Table super-het.

REMARKS: A receiver designed to give efficient results under the Lucerne Plan.

to be in the region of 9 kilocycles, which means in practice that all of the stations included in the Lucerne Plan can be received without any interference.

Results on the long waveband are as good in daylight as after dark, some ten stations are always available. Of course, the medium waveband is much better after dark, but even so an average of ten stations can be heard most times of the day. This is not a colossal number, but remember that it means many alternative programmes to those provided by the B.B.C.

The family man should be able to tune in over forty stations at night with only a moderate aerial. Using an indoor aerial the only difference we found was that the background noise level rose slightly.

For twelve guineas the model 262 cannot be bettered. It is a set that will give long service without any trouble and at the same time it will not be out of date next season.

In fact, we have reason to believe that set prices, generally, will tend to rise rather than fall.



"There is no need to say much about the circuit. There are four receiving valves and a full-wave rectifier"

Because in the early days of its development the results were not entirely satisfactory, home recording was not taken up permanently with any enthusiasm by many experimenters. But today the position is quite different and the equipment for this purpose that is now being offered by a number of firms is of a high order of merit. It is now possible to make records at home that in most respects are as satisfactory as the commercial article



H.M.V. photo

RECORDING— and How You Can Do It at Home

By FRANK CHARNLEY

There is also the aspect of recording the voices of other members of the family, or music played by them, and this has an appeal all its own. The satisfaction obtained from this, however, will depend upon whether or not the amateur possesses a room suitable to use as a studio, and can obtain a microphone having a good frequency characteristic.

Home recording might, therefore, be divided into two main types, (1) recording from a wireless receiver, and (2) recording direct from a microphone and amplifier.

Broadcast Recording

It will be assumed that in the first place the amateur proposes to record certain items from the broadcast programmes because, providing a sufficiently powerful undistorted output is available from the wireless receiver, the preliminary experiments are simplified.

This is due to the fact that the experimenter has not got to bother about a microphone, the balance of the subject, or acoustical problems

D OUBTLESS, at some time or other, many readers, having listened to a particularly appealing broadcast item, have had the impulse to shout encore. Many others have wished that it had been possible to preserve for future listening some particularly attractive item and, as a consolation, have hied them to a gramophone shop to buy a record as closely as possible resembling that which they have heard over the air.

Immense Appeal

For these reasons alone the possibility of making one's own gramophone records is immensely appealing, and having once mastered the technique involved, and obtained one or two good records, it will be found that the process is as fascinating, or even more so, than taking photographs.

Also, when once the initial equipment has been acquired, the running costs in-

involved are not heavy—scarcely more than the constant maintenance of an efficient photographic outfit, so that, although of course expense is always a deciding factor, this need not deter the enthusiast from building his own library of broadcast records.

Once built, this will afford hours of enjoyable home entertainment during the winter months. Needless to say, such records should not be played in public, nor for gain or profit, as it is conceivable that questions of copyright may be involved in many of the items heard from wireless stations over the ether.

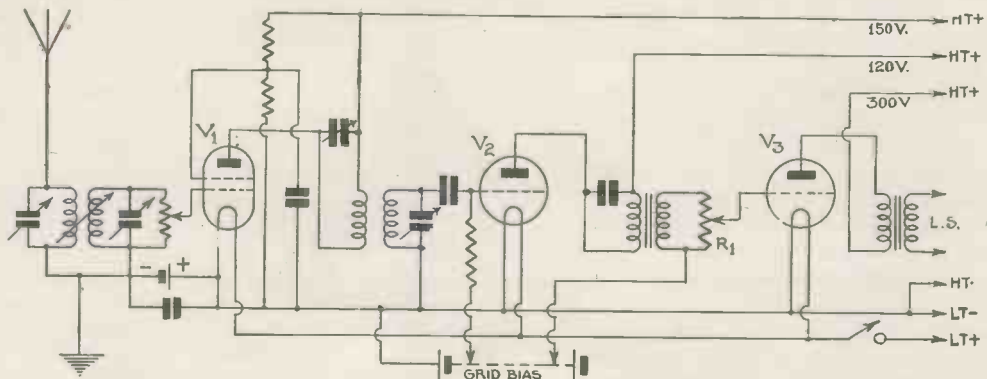

Fig. 1.—Common type of receiver circuit, which can be used for recording if the output valve is one of those listed in the table on page 64

which, at the outset, may be troublesome. The subjects of balance, etc., will be dealt with later in this article.

The essentials of a really efficient home-recording outfit are:

(a) A good power amplifier for supplying undistorted power to operate the cutter head;

(b) A cutter head which holds the tool or cutter responsible for making

not convey to the operator the exact degree of volume going to the cutter, and, whilst the arrangement depicted is not the very best which can be used, nevertheless it is helpful to serve as a visual indicator of maximum peak values.

The arrangement is a valve rectifier, in the anode circuit of which is arranged a milliammeter to indicate

conjunction with the volume control R_1 , which is used to reduce the volume when the needle is in danger of exceeding the safety mark, which will be determined by experiment when all the gear is erected. R_3 is used to limit the input to V_4 to suitable proportions and when once "set" should remain in that position.

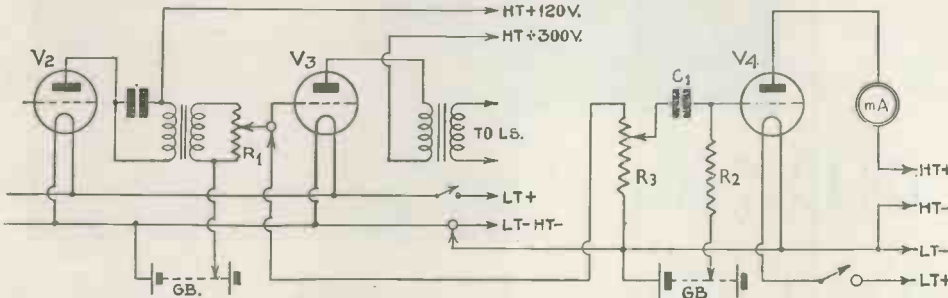

Fig. 2.—A refinement is the use of a volume indicator

Note the following component characteristics: C_1 , 4 microfarads, 400 volts A.C. test; R_2 , 2 megohms; V_4 , 10,000-12,000 ohms impedance; G.B., 15 volts; and R_3 , 500,000-ohm potentiometer to adjust the input to V_4 and then left fixed

Actually, considering the amplifier before the cutter head is rather like considering the cart before the horse, for practically the output of the amplifier must be suitable to match the impedance of the cutter head selected for recording purposes.

In this case we have referred to it in the first instance in order to

the cut or markings on the recording blank, which, when traversed by a gramophone pick-up, reproduces the speech or music recorded;

(c) A fairly strong clockwork or electric motor with turntable running at seventy-eight revolutions per minute, and

(d) An arrangement whereby the cutter is guided so as to form a continuous spiral track on the recording blank.

If home recording direct from a microphone is required, a high-grade microphone should also be obtained, and it will be necessary to make small modifications to the existing amplifier in order to accommodate this.

First Essential

Most readers have the first essential, a good power amplifier for supplying the programme to the cutter head, and any amplifier which is capable of delivering from about 3 to 5 watts to a loud-speaker is usually suitable, although in certain cases slight modifications may be necessary.

Dealing with a simple case, the circuit of Fig. 1 shows a common type of receiver circuit, the output valve of which may be either of those shown in table 1, that is capable of passing 3 to 5 watts to the loud-speaker without distortion.

A refinement useful to include in the circuit for recording purposes is as shown in Fig. 2. The object of this is to serve as a volume indicator whilst making a record, for listening by loud-speaker or telephones does

changes of anode current due to variations of voltage on the grid. This milliammeter should be of a good grade, to obtain the best results, and have a scale reading of 0 to 5 milliamperes. A valve having a passably straight anode-current characteristic with various values of grid voltage should be selected for this purpose, and the grid is biased negatively by means of the grid-bias battery until the anode current is at zero value, or nearly so.

This adjustment is made when no signals are being received and when the indicator is connected into circuit, incoming speech or music causes movements of the milliammeter needle in an upward direction, according to the intensity of the voltage on the grid of the valve.

A little practice will soon enable the operator to know the maximum deflection of the needle permissible without spoiling the record and causing distortion.

The volume indicator is used in

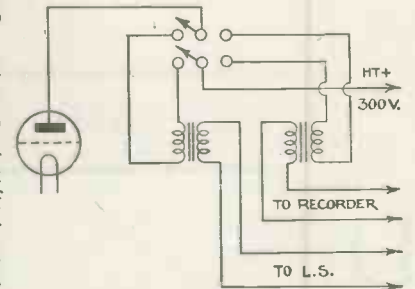

Fig. 3.—Switching arrangement to change over from loud-speaker transformer to recording transformer

show what modifications may be called for in this part of the existing equipment, and to enable the amateur to determine whether or not his equipment is reasonably suitable for use for recording work.

Before the amplifier is entirely suitable, it will possibly be necessary to have a special impedance-matching transformer made to match the cutter head to the power-output stage. Any of the well-known manufacturers of transformers for special requirements will make such a transformer if they are provided with data regarding the impedance of the cutter head and the power valve; the former can be obtained from the manufacturers and the latter from the valve data sheet.

Matching Essential

It might be said right away that recording will not be satisfactory unless this impedance-matching has taken place, for the ordinary loud-speaker step-down transformer may be quite unsatisfactory.

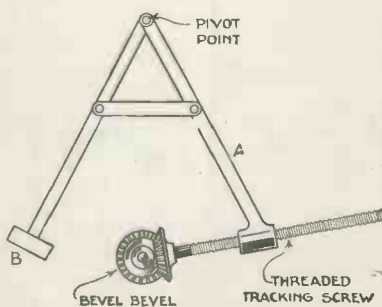

Fig. 4.—Arrangement of thread-tracking device to drive cutting head

If this transformer is obtained, some sort of switching arrangement to change over from the loud-speaker to the recording transformer and vice versa will be necessary, and this is shown in Fig. 3.

We will now consider the gear actually constituting the recorder. This is obtainable in two general forms, one being a cutter head and thread tracking gear suitable to mount on a standard gramophone motor and turntable, and the other constituting a complete recording unit, including motor, turntable, and cutter head with thread tracking device.

Complete Equipments

The first is, of course, the cheaper, and very good complete equipment can be obtained from certain firms at prices ranging from about £4. The latter may cost from £10 to as much as £40 to £80, depending, of course, upon the use to which it has to be put, and the number of refinements embodied in the design.

Dealing with the essentials of the home recorder, we will first of all consider the cutter head. This consists of an electromagnet, usually of high resistance, enclosed in a suitable container for attaching to a carrier bar.

In appearance it frequently resembles a rather heavily built gramophone pick-up and, indeed, a well-designed gramophone pick-up can be used for the purpose.

However, instead of inserting a play-back needle in the needle-holder, a specially shaped cutting tool of steel or even a sapphire or diamond cutting tool is inserted in the place usually accommodating the needle.

The principle is simple. It is well known that in the gramophone pick-up the vibrations of the needle passing over the recorded surface generate minute quantities of current in the magnet windings, and these should be

as nearly as possible perfect reproductions of the sounds recorded on the disc or record. These are then amplified and passed to the loud-speaker.

In recording work, the voltage variations from the microphone or detector valve are amplified, and after they have been raised to a sufficiently high level, they pass around the magnet windings. In so doing, they cause the cutting tool to vibrate in sympathy, and providing the power is high enough, and the surface upon which it rests is soft enough, minute marks are made on the disc.

As the disc, carried by the turntable, revolves, these marks are imprinted in a groove cut by the sharp edge of the cutting tool, the weight of the complete cutter head being sufficient to drive the point of the tool into this disc and cut a continuous groove carrying the modulation or marks.

It will be evident that if the cutter head were not guided in some way, the groove would become just a short path to the edge or centre of the disc, so that a method to guide it so that

it makes a continuously spiral track has to be evolved.

In the home-recording outfit this consists of a thread tracking driving mechanism usually attached to the turntable in such a way that, as the latter revolves, a threaded boss is forced to travel along a threaded rod.

To this boss is attached a lever A (Fig. 4) which is fixed firmly to the pivot of the bar carrying the cutter head B and as the boss travels along the threaded tracking shaft, the cutter head is forced to move slightly to the centre of the recording disc or blank.

Number of Grooves

According to the number of threads per inch on this shaft, the number of grooves cut per inch on the recording surface is determined. If the speed of the turntable is constant and the number of threads per inch on the tracking shaft increased, the resultant record will play longer. Home-recording outfits to cut from about 50 to 120 threads per inch at 78 r.p.m. are available.

The cutting edges of cutting tools may take various shapes, according to the ideas of the makers. Fig. 5 illustrates one or two examples, and there are probably others. In practice the tool is so arranged in the holder that the spoon-shaped or nearly flat edge is directed against the direction of rotation of the turntable.

When cutting the groove, this part of the



COMPLETE RECORDING MACHINE FOR HOME USE
This latest Parmeko production is intended for serious recording work. Both 10-in. and 12-in. records can be made, playing respectively for about three minutes and four minutes

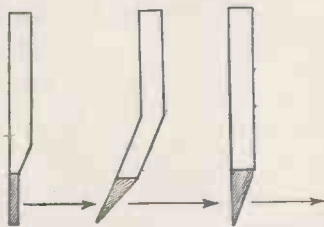

Fig. 5.—Examples of the cutting edges of cutting tools for recording



Columbia photo
"BLANK" FOR A COMMERCIAL RECORD
Note the glass-like surface of this wax blank, ready for recording. Most home-recording outfits use aluminium blanks



H.M.V. photo
PERMANENT RECORD OF HIS MAJESTY'S VOICE
 Workers at the Hayes factory inspecting the first pressing of a new record made by His Majesty the King, which was broadcast the same evening by the B.B.C.

tool should be at right angles to the surface of the record which is being cut. Therefore, if the cutter head presents any angle other than a right angle to the surface being cut, a specially shaped cutter should be obtained so as to make allowance for that angle and allow the cutting portion to itself take up a right angle.

Re-pointing Cutters

Cutters can be re-pointed or polished after use for use again; in fact, the writer prefers to use re-pointed tools to new ones. A simple method of re-conditioning a cutter is to hold it in a hand or pin-vice and to polish the surface constituting the shape of the tool with an emery stick. A fine surface stone can also be used for the purpose.

Blank discs for recording purposes take various main forms. There is an ordinary aluminium alloy disc, upon the surface of which the record is made. Quite good results are obtainable from such discs, but the power required to operate the cutter is fairly high, and a fairly powerful motor is necessary to drive the turntable.

Making Copies

The resultant record has to be played with a fibre or Burmese colour needle for best results, but can be processed; that is, copies can be made from it providing that it has not been played.

There is also a disc consisting of an aluminium, copper, or zinc metal plate, coated with a special cellulose

recording surface. These discs are capable of giving very good "silent background" results and can be played immediately with a "trailing" needle. This needle is a type which has a spear-shaped tip bent so as to trail along the record and not dig into the fibre.

Another type is a metal disc coated with a chemical mixture, which, after the record is cut, is baked in an oven. The resultant records have the advantage that they are very tough, and will wear a considerable time. If properly baked, it is not possible to scratch them even with a hard metal edge.

The satisfactory cutting of a record depends upon these factors:—

- (1) A sufficiently powerful undistorted output from the amplifier.
- (2) The proper depth of cut by the cutting tool.
- (3) The exercise of care to ensure that the cutting tool does not cut too "big," that is, does not break down the walls of the grooves.



H.M.V. photo
FAMOUS TENOR IN THE STUDIO
 Beniamino Gigli, considered to be the world's finest tenor, making a record at the H.M.V. Studios in London

(4) A sharp cutting tool suitable for the type of blank used and the number of grooves cut per inch of surface.

Of these, (1) has already been dealt with in a general way. Satisfactory recording will depend upon careful observation of the peak-value indicator used in conjunction with the amplifier. The best method to adopt for consistency is first to adjust the receiver until a suitable value of rectified current is shown by a milliammeter inserted in the anode circuit of the detector valve.

Use of the Loud-speaker

This can be determined by listening to the loud-speaker while adjustments are being made, and noting what value of rectified current produces the most pleasing results without signs of distortion due to overloading of the rectifier.

The effect of varying the peak-value indicating meter (Fig. 2) can then be observed, and whether distortion is evident when this is at its maximum.

As regards (2), the procedure is to fade out the programme to a minimum volume by means of R_1 (Fig. 2) and put a recording blank on the

Table I.—Suitable Output Valves

Cossor.—41MXP, 680XP, 620T, 660T, or DP.
Eta.—GW402.
Ferranti.—LP4.
Marconi and Osram.—PX4, LS6A, PX25, or DA60.
Mazda.—AC/P1, PP3/250, or PP5/400.
Mullard.—AC/044, DO24, DO26, DO60, DO75, or DO25.
Six Sixty.—SSHV4/1, or SSHV6/5.
Triotron.—K435/10, K480, or K450/50.
Tungsram.—P4100.

turntable. Set this in motion and slowly and carefully lower the cutter head until the cutting tool is on the surface of the blank—the whole weight of the cutter head being unrestrained and bearing on the disc. A groove will be cut and the cutter head should be lifted.

Next, stop the turntable and examine the groove under a strong magnifying glass and ascertain that the width of the groove is approximately equal to the width of the

ridge or wall of the grooves. If it is too wide and the walls are consequently thin, an arrangement will be found on the cutter-head mechanism whereby the depth of the cut (or the weight of the cutter head) can be varied.

Depth of the Groove

Decreasing the weight of the cutter head will make the groove more shallow, and increasing its weight will deepen the cut. Another short sample cut should then be taken, and if, after visual examination, this is found satisfactory, the turntable may be started again and the programme faded on to the cutter head.

We will now deal with (3). For the first experiments it would be advisable *only* to undertake short bands of recordings for periods of about three-quarters of a minute, and to examine each band through the magnifying glass to ascertain the action of the cutter in the groove.

Broken-down Grooves

It may be found that the modulation as shown by the indentations in the walls of the groove has been too great, with resultant bad distortion of the grooves, which may be broken down. If in doubt as to the effect of this, play the record through a pick-up and hear the result.

If there is no obvious distortion, it is satisfactory and the maximum peak value as shown by the meter (Fig. 2) should be noted for future use. If distortion appears, volume should be reduced by the aid of the volume control R_p , when the deflection of the needle will not be so great.

An hour or two spent in these experiments will soon enable the operator to ascertain the best adjustments to the amplifier necessary to obtain a satisfactory record.

It should be remembered, however, that if a disc is under-recorded, background noise will increase, due to the fact that amplification has to be increased in order to bring up the volume to suitable proportions.

Finally, as regards (4), it is essential that the cutting tool should be of a satisfactory shape and thickness, and should be kept sharp. Blunt or improperly shaped cutting tools will cause serious background noises. Further, distortion may be



Columbia photo

SEVENTY RECORDS AN HOUR!

That is the rate at which a man can press discs; a pressure of 60 tons is used and the labels are put on at the same time that the impression is made

introduced by using the wrong shape of cutter and the advice of the makers of the cutter head should be observed as to the best shape of cutter to use with their particular products.

(A further article will appear dealing with the question of the use of a microphone for recording purposes.)

WHAT NEW IDEAS SHALL WE SEE THIS SEASON?

Continued from page 30

mains receiver from a 12-volt accumulator, while quite large battery sets can be operated from a 6-volt accumulator to give the input to the converter. The converter will also supply the filament voltage as well.

Self-contained Converters

Similar converters which will give 250 volts, 50 milliamperes will be available for running car-radio sets. These units, which are entirely self-contained and include ample filtering, are noiseless in operation and can be bolted to the dash or under the running-board. They certainly solve the problem of high tension for car-radio sets.

Country people without power supply will find such converters of great use, for they will now be able to scrap their high-tension batteries. Incidentally with a converter a large output valve can be used, taking up to 75 milliamperes or so.

For constructors going abroad into hot climates there will be a special display of fixed condensers that have been filled with a special high melting-point wax. T.C.C. and Dubilier are making a special feature of such condensers as they



Two Goltone stripped high-frequency chokes which will save the amateur considerable expense



A stripped iron-core coil—one of many stripped components for the amateur, by Ward & Goldstone

can be used in the worst tropical climates without fear of the wax melting.

These condensers coupled with some of the vacuum resistances and steel-case low-frequency chokes and transformers will ensure that all-wave sets going abroad will stand up to the extreme temperature and humidity conditions.



Columbia photo
Wearing their old school ties—of course—the Western Brothers appear frequently in broadcast vaudeville shows

PROGRAMME NOTES and NEWS

By T. F. HENN

I VISITED Broadcasting House on a sweltering July day to get details—if available—of the shows at Radiolympia this year. I know it was hot because the B.B.C. had allowed their page boys to roam about the building in open-neck cricket shirts. Not like the austere B.B.C., is it?

To get down to this Radiolympia business. At the time of writing, details are rather in the air. Whether the B.B.C. or the Radio Manufacturers Association is producing the "gigantic" variety shows I told you about last month is still a question that it is impossible to answer.

I gathered that although the B.B.C. is playing a very large part in producing the shows, it is the R.M.A. that is responsible. You remember that the shows were run entirely by the B.B.C. last year.

casts, for they will be featured in the programmes.

Among the artists will be Henry Hall and his band, and—to quote the words of a B.B.C. official—"twenty-four attractive blondes." If you can't go to the show, you will have plenty of opportunities of hearing Radiolympia at home. In the first week of the show, two concerts will be broadcast, and three in the second week.

A trip to Olympia will be well worth your while this year!

As you no doubt have read in the papers, the B.B.C.'s revenue is increasing by leaps and bounds. They intend to spend a lot of this money on the light side of the programmes. Quite right, too!

One of the first steps taken was to prepare plans for the formation of a new orchestra, which will make its debut sometime in September or October. The main work of the new band will be to accompany variety broadcasts, so leaving the official Theatre Orchestra free for more solo concerts.

Few authoritative details are known, but it is certain that the new band will consist of a dozen or fifteen players, so chosen as to be capable of augmentation should the occasion arise.

By the way, talking about B.B.C. bands reminds me that the Wireless Military Band celebrates its tenth anniversary in July. It has had



The popular violinist-leader of the B.B.C. Theatre Orchestra, Montague Brearley. He frequently conducts the band



Jack Payne—still a great favourite—will be heard with his band for a week when the official B.B.C. band is on holiday

B. Walton O'Donnell as conductor since the early months of 1927. I have been very critical about the choice of music played by the band in past notes, and I still think it is inclined to be a little highbrow.

However, that is a fault common with the B.B.C. generally, and I offer the band my congratulations.

One point about highbrow music comes to my mind. On Sunday evenings we always have highbrow music on one wavelength and light music on the other. I do not grumble at that. But I am getting tired of hearing hotel orchestras nearly every week.

They play remarkably well, of course, but why not have them, say, once a fortnight. I notice that



Uncle Andre Charlot is busy preparing another of his popular hours for broadcasting in August



A well-known musician, Percy Bush appears in the role of conductor of his own orchestra

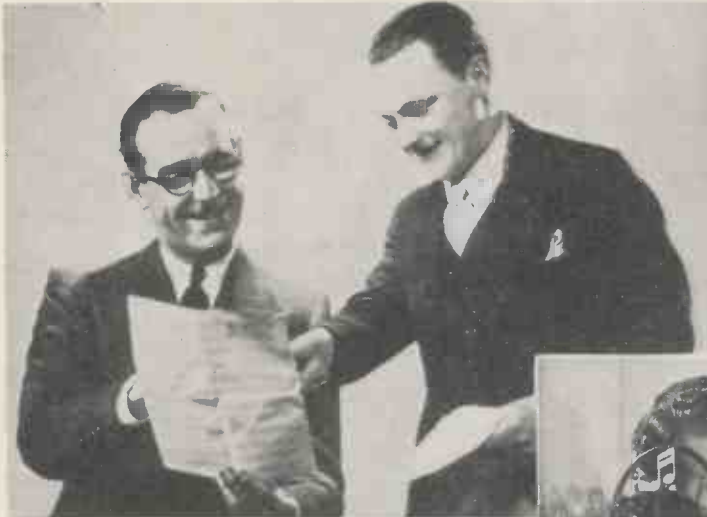

Leslies Holmes and Sarony were responsible for a fine broadcast recently. Leslie Holmes is on the left

the Grenadier Guards Band is down to play on the Sunday evening, August 5. Let us have more military and brass bands on Sunday nights!

I am writing these notes towards the end of July; the evening is hot and close. The weather will probably be the same in August when some hundreds of people will flock to Queen's Hall and pay two shillings for the privilege of standing on the floor of the hall to see Sir Henry Wood conduct the B.B.C. Orchestra in the fortieth season of Promenade Concerts.

Frankly, as much as I appreciate hearing music in the flesh, I shall be quite content to hear some of the Proms comfortably in my own home. Sir Henry Wood will arrive back from America three or four days before the season starts and will superintend the final rehearsals.

The same scheme for giving certain nights entirely to music of certain composers, as

has been done in previous years, will continue. Monday will be Wagner night; Wednesday, Bach and Brahms; Friday, Beethoven; and Saturdays will be popular night except for one special concert of the works of Richard Strauss in honour of this composer's seventieth birthday.

Tuesday and Thursday will see one-night concerts of music by Liszt, Vaughan Williams, Sibelius, Delius, two to Tchaikovsky, four to Haydn and Mozart, and some miscellaneous, including some Russian composers.

The Delius concert is not by way of a



Columbia photo

A fine photograph of Les Allen, vocalist of the B.B.C. Dance Band, with Mrs. Allen and their son, Norman, recording the latest hit, "Little Man, You've Had a Busy Day," for Columbia



It is rumoured, mind you, that Norman Long, the man with a smile, a song and a piano, will be one of the artists at Radiolympia this year

memorial concert. You will remember that Delius, the blind British composer, died recently at his French home at Grez-sur-Loing. His greatest hobby, during the last years of his life, besides composing music, was listening to broadcast concerts.

A fitting memorial concert to this blind genius will be included in the 1934-5 season of B.B.C. Symphony Concerts. The B.B.C. has chosen Sir Thomas Beecham to conduct the concert. Sir Thomas is one of the few conductors who know how to interpret Delius' works. He was a life-long friend of Delius.

Now for special concerts for August which may or may not be worth noting.

July 28 will see a relay of Leonard Henry's show from the Pier at Worthing, Sussex. I hear that Leonard is having a good time and is getting a rousing reception on the pier. I saw a photograph of him cheerfully knocking a punchball about with the Eight Step Sisters. He is a real live wire! In the relay you will hear these eight lassies and Beryl Orde, the brilliant mimic.

Coming to more serious items. On August 23 the Continental landlines will be brought into use for a relay from Salzburg of the Vienna Philharmonic Orchestra under Toscanini, playing a concert of works by Brahms, Mozart and Beethoven.

The relay will be heard in the National programme from 8.15 to 8.50 p.m., and from 9.5 to 9.45 p.m. It is a great pity, but I suppose it is unavoidable, that this concert clashes with the Delius Prom. on the Regional wavelengths. It's a pity for two reasons. Serious music, people will have to miss one concert and the bulk of listeners, who like light material, will have to go ether searching or switch off. Alternatives like this should be avoided.

Earlier in the month will be a relay of Acts 1 and 3 of Wagner's opera, *The Valkyries*, from the Wagner Memorial Theatre at Bayreuth. The first act will be heard in the National programme beginning at 3.55 p.m. and the second in the Regional from 8.25 to 9.40 p.m. Opera in August, even from Bayreuth, is not very tempting.

Also in August is a relay on the seventh of part of the Tidworth Tattoo, forty minutes of Harold Ramsay's Band on August 21, and two new broadcast musical shows.

Plans are already being made for the broadcast of the launching ceremony, to be performed by Her Majesty the Queen, of the Cunarder 534 from Clydebank this autumn. As far as we know, the date fixed is September 26, but I understand it is only tentative.

It will be the most thrilling outside broadcast we have had for a long while. We shall hear the actual christening, then the great roar and cheers as the 65,000-ton ship slides into the river. Of course, she will not be ready for her first voyage for many months after the launching ceremony.



Nat Gonella plays the dual rôle of trumpeter and vocalist. He frequently broadcasts



A very popular variety artist who makes frequent appearances in broadcast vaudeville shows—Jane Carr



Edward Clark often conducts the B.B.C. Orchestra in relays from the Concert Hall in Broadcasting House

Here we present constructional details of a highly efficient short-wave two-valver using the new A.C./D.C. valves. It can be used on any mains without any alteration whatsoever. The design incorporates band-spread tuning which makes short-wave tuning as easy as that of the ordinary broadcast sets. Another feature is that signals can be changed over from loud-speaker to headphones, or vice versa, by means of a simple plug and jack



The "W.M." Band-spread Short-waver

By the "W.M." Technical Staff

THERE are two very special features about this two-valve short-wave set: it is a universal mains receiver and it also makes use of the latest band-spread system for easy tuning. Let us consider these points separately and in the order just mentioned.

Universal high-voltage valves are employed and these can be operated direct from A.C. or D.C. mains at any voltage between 110 and 260 volts, although mains of the 200-

260-volt type will give better results than the 110-volt variety. As all the filaments operate at the high voltage of the mains, there is no need for a mains transformer; this not only saves expense, but it also means that the set will work on A.C. mains of any frequency without difficulty.

Thus, practically wherever there are electric mains installed, this set can be put into operation without any trouble. No circuit alteration is necessary when changing

over from A.C. to D.C. or vice versa.

Another point to note in this connection is that the set is absolutely hum-free, even when headphones are used. That is a matter of great importance with a short-wave set, where distant stations may come in at very poor strength and any trace of mains interference may result from bad wiring, so to get the best results the original wiring should be followed as closely as possible from the photographs and third-scale layout reproduced in these pages.

Band-spread Described

So much for the mains arrangements until we go into actual constructional details; now let us look into the band-spread feature of the receiver.

It is well known that tuning on the short waves is very much sharper than on the medium and long waves. For this reason it is essential to use slow-motion dials with a low-reduction gear. Even so, though, it is very easy to pass right through stations by turning the dial too quickly.

Simple Tuning

Band-spread tuning has been developed to overcome this difficulty.

The obvious way to make the tuning simple on short waves is to decrease the size of the tuning condenser until a point is reached where the variation capacity from minimum to maximum is so small

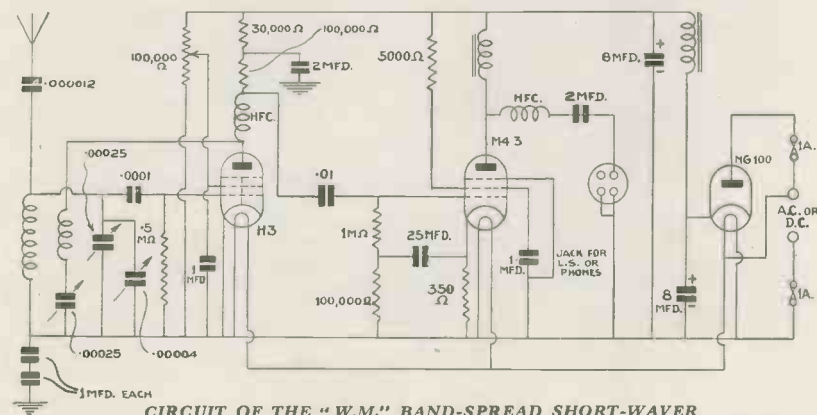

CIRCUIT OF THE "W.M." BAND-SPREAD SHORT-WAVER
This is quite a simple circuit. The valve combination consists of a high-frequency pentode as detector and a pentode output. A rectifier is in use a/c mains

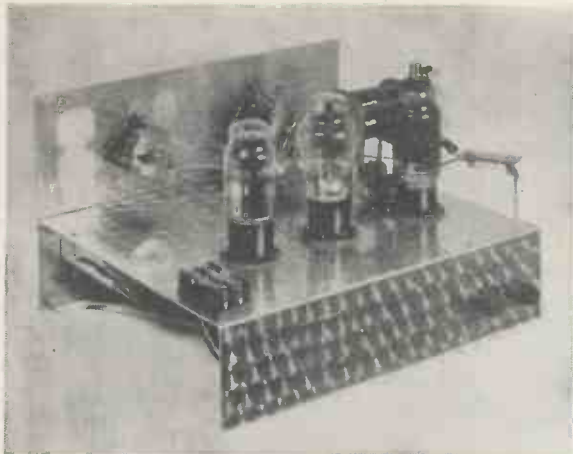

CLEAN AND NEAT LAYOUT

A back view of the new "W.M." short-waver showing the clean and simple layout adopted on the top of the chassis

that the waveband covered is reduced to 1 or 2 metres.

This is an excellent idea in theory for with a band-spread of 2 or 3 metres over a 180-degree travel of the tuning condenser, it would make short-wave tuning much easier than tuning a normal broadcast set.

Used by Amateurs

The difficulty is that with such narrow band tuning, about a dozen plug-in short-wave coils would be wanted to cover the 12 to 100-metre band.

A way of overcoming this has been developed and used by the amateurs who go in for real short-wave reception. A normal .00025-microfarad tuning condenser is connected in parallel with the grid coil in the normal way. Again, in parallel with the tuning condenser, is a small 40-micro-microfarad (or .00004-microfarad) midget condenser. This is for band-spreading.

Band-spread in Practice

In practice, the idea is to tune in to one of the normal commercial bands, such as 16, 19 or 25 metres on the main tuning condenser. The 25-metre band, for example, spreads between 24 metres up to 26, so that the dozen or so powerful stations that one normally wants to hear are all jammed in about 2 degrees on the dial.

Although the stations can be separated, or at least some of them can, tuning is not easy and, what is more, 2 degrees among 180 makes it difficult for the inexperienced

listener to find the particular band he wants.

After the main tuning condenser has been adjusted so that it brings in the middle of the 25-metre band, it is then forgotten. The midget band-spread condenser is then used for tuning and the two degrees that represent the 24- to 26-metre band are spread over 180 degrees so

firmed broadcast listener to tune in some of the more powerful short-wave stations. Even the most heavy-handed amateur cannot possibly fail to pick up a good percentage of the stations that are always on the air.

Not Conventional

So you see, you must not consider this set as being a conventional two-valve short-waver, which the amateur may think will present many difficulties. Think of it more as a simple broadcast set that will bring in American, South African, Australian and, in fact, stations from all over the world.

The circuit is worth more than a casual glance. First of all the aerial is coupled to the grid coil through a very small fixed condenser of .000012-microfarad, so that the coupling between the aerial and coil is as loose as possible. This makes quite sure that the receiver will oscillate over all wavebands, even with a heavily damped aerial.

New Coils

We specially chose the tuning coil because it represents the latest development in short-wave coils, being wound on special material with a high degree of insulation.

This material is called Micalex and has been used for the first time in radio. It enables the tuning coils to be rigid and yet to be of exceptionally low capacity and

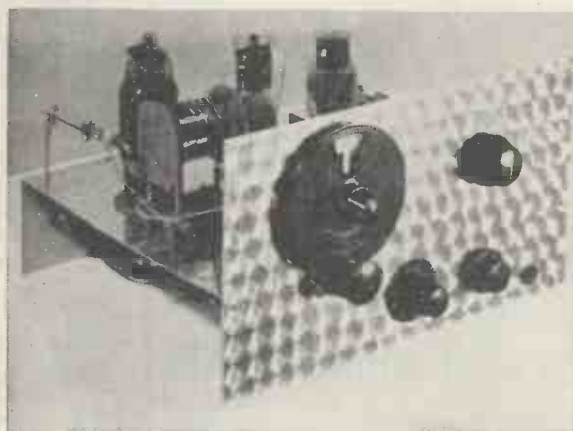

UNUSUAL PANEL LAYOUT

Symmetrical layout has been sacrificed for the sake of efficiency. The set has been thoroughly tested and works well

that reception of these stations is ridiculously simple.

We feel that this new idea in short-wave tuning will enable the con-

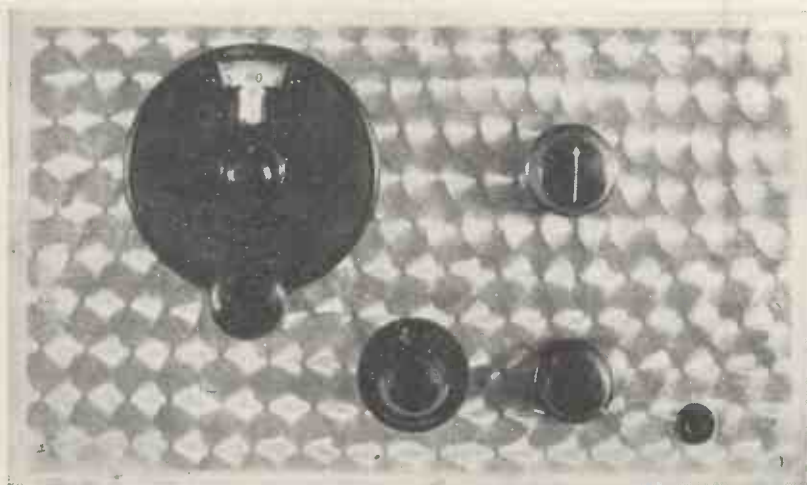

LAYOUT OF THE PANEL CONTROLS

The big vernier dial is the main tuner, and to its right is the band-spread condenser knob. At the bottom, from left to right, are the reaction and volume controls and a jack for using headphones and loud-speaker switching

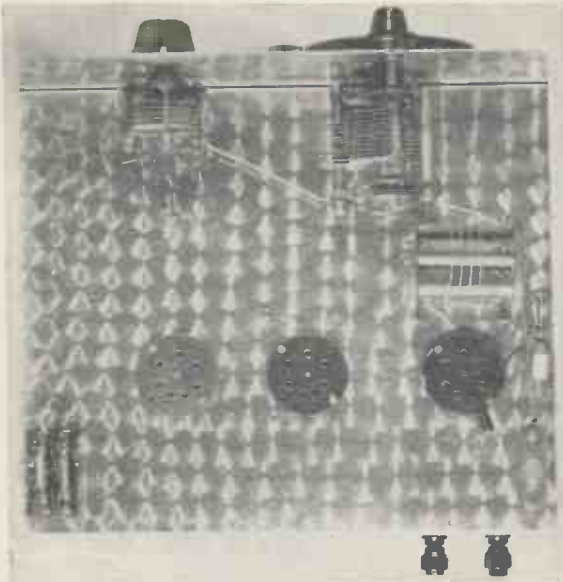

PLAN VIEW OF THE UPPER SIDE

There are few components fixed to the top side. Note carefully the position of the coil and tuning condenser on the right-hand side of the chassis

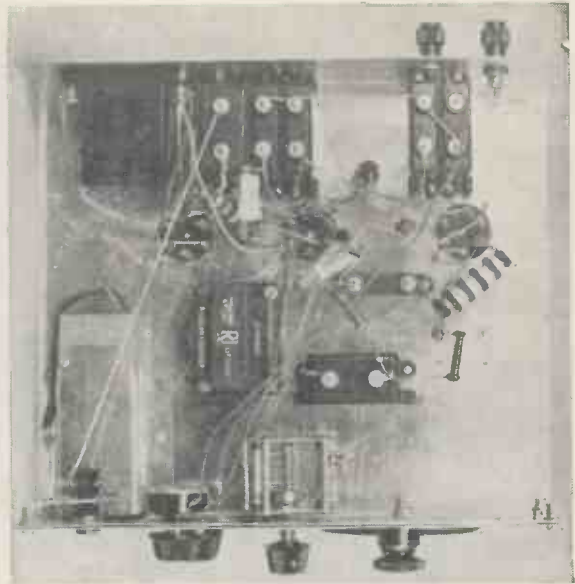

PLAN VIEW OF THE UNDERSIDE

Here a symmetrical layout has been adopted for simplicity and efficiency. High-frequency chokes and fixed resistances are suspended in the wiring

without loss. Naturally the efficiency of a receiver using these coils is very greatly increased.

Although in theory a high-frequency pentode used as a detector is better as an anode-bend detector, we discovered in actual practice that anode-bend detection means rough reaction, so that the overall gain was comparatively low.

Smooth Reaction

By changing over to leaky-grid detection we obtained smooth reaction, so although the system was not quite so efficient, the output was greater than with anode bend. The reason for this is quite clear. With

leaky-grid rectification the reaction can be pushed to the final limit.

No bias is wanted on the first valve, the cathode being joined directly to earth. In the anode circuit of the high-frequency pentode, we found that the maximum anode resistance that could be used to give maximum amplification with stability was 100,000 ohms and this in conjunction with a 30,000-ohm decoupling resistance and a 2-microfarad by-pass condenser gave perfect stability with a high degree of amplification.

You will notice that there is no low-frequency transformer. There are several reasons for this. The

high-frequency pentode gives infinitely more amplification with resistance coupling than with a transformer, because the impedance of the resistance-capacity unit is almost equal to the impedance of the valve.

3-watt Output

Anyway, the high-frequency pentode worked under these conditions fully loads an output pentode to give 3 watts, which should be enough volume for anybody.

Incidentally, without a low-frequency transformer in circuit the amount of hum pick-up is considerably reduced, while for the home constructor there will be less possibility of hum pick-up due to poor wiring.

As a further guard against instability, the grid circuit of the output pentode has been de-coupled very thoroughly. With all the precautions we have taken instability cannot happen.

Circuit Details

Bias for the pentode valve is obtained automatically by means of a 350-ohm resistance in the cathode lead. Notice how this is by-passed by means of a 25-microfarad electrolytic condenser.

The output circuit of the pentode valve is interesting. First of all there is choke filter arrangement with a large 2-microfarad condenser so that no D.C. voltage can reach the headphones. Secondly, should there be the slightest possibility of high-

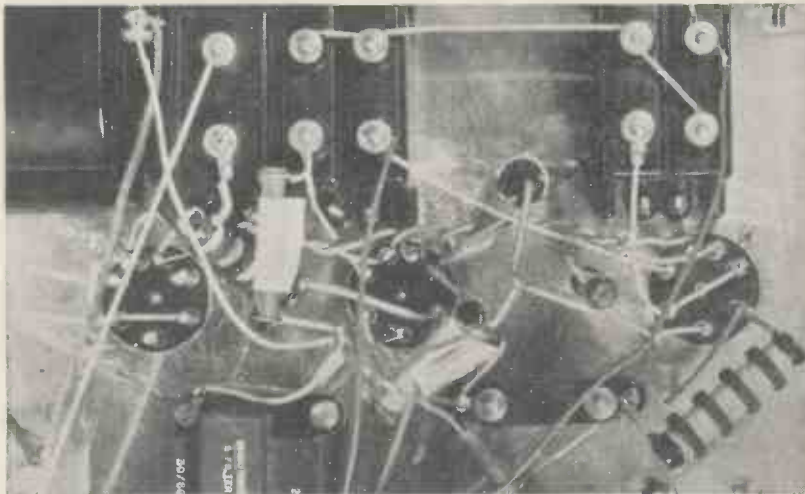

HOW THE VALVES ARE WIRED UP

This close-up photograph shows very clearly the wiring of the pins of the three valve holders. This photograph should be used in conjunction with the wiring plan on page 72

stray capacities, and the effect of the metal chassis. The small coil tunes between 12 and 25 metres. The second coil tunes between 22 and 50 and the third between 48 and 160. These wavebands cover all normal needs.

The Next Best Thing

The construction is simple, but even though we supply a third-scale wiring plan in these pages, it is a great advantage to have a full-scale blueprint, which is the next best thing to having the original receiver in front of you. A full-scale blueprint No. WM368 can be obtained from the Blueprint Department, "Wireless Magazine," 58-61 Fetter Lane, London, E.C.4, for 6d., if the coupon on the last page is used before August 31.

One of the first points to remember is that there are three components that must be isolated from the panel by means of ebonite bushes. These components are the 100,000-ohm variable potentiometer,

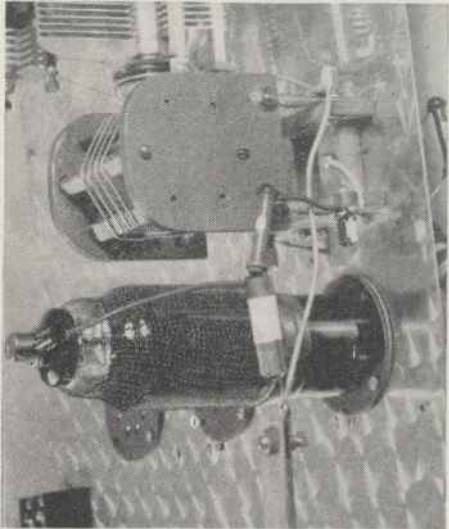

WIRING TO THE COIL
An interesting photo showing the wiring to the coil and high-frequency-pentode detector

frequency current getting through into the headphone leads, a high-frequency choke is included in the anode of the pentode valve to stop it.

In addition to the low-frequency choke acting as an impedance in the anode of the output valve, it also in a measure provides a little smoothing. The mains smoothing is carried out by means of another low-frequency choke by-passed on either side by means of an 8-microfarad 500-volt electrolytic condenser test.

A'most Hum-free

With this amount of smoothing the hum level is of a low order, even when using headphones on low wavelengths.

As this set has been on short-wave tests for a long while, all the little points found useful have been included, so that the short-wave fan will

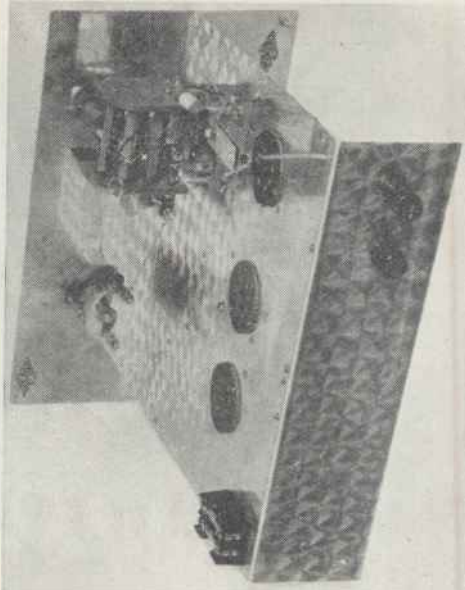

TWO TERMINALS ON THE BACK
The two terminals on the back of the chassis are for the aerial and earth. The loud-speaker is connected to the jack on the underside of the chassis

Third-scale Layout and Wiring Diagram

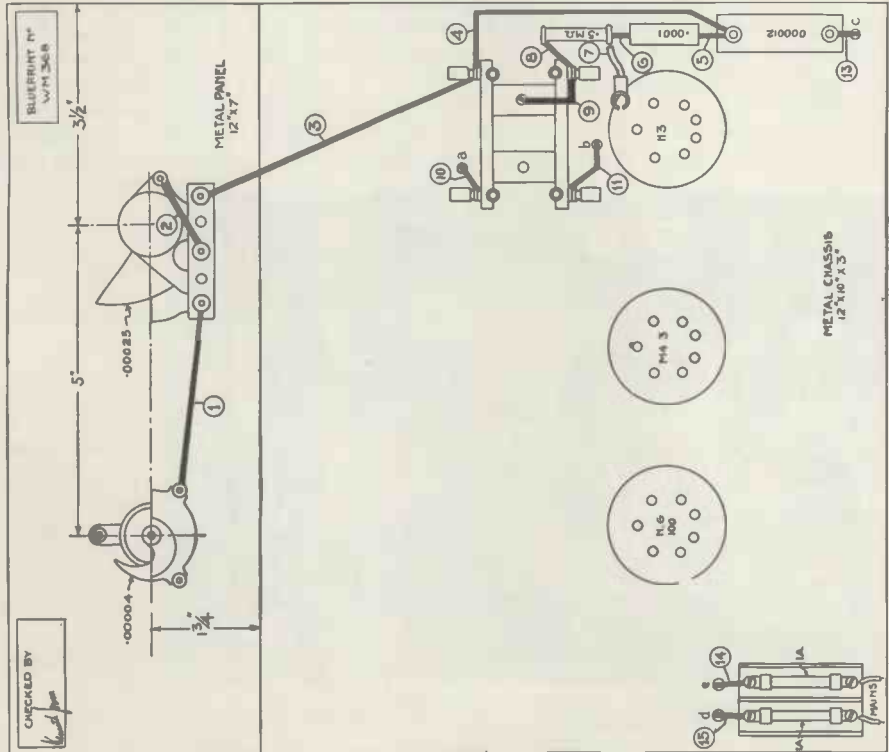

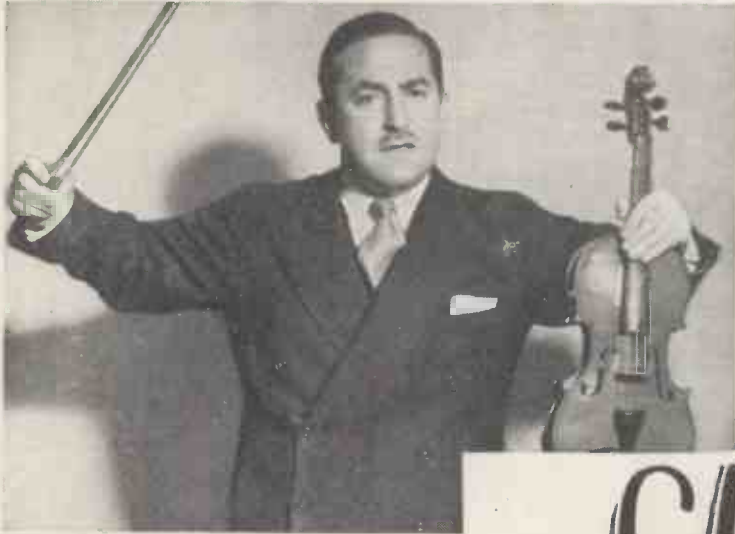

H.M.V. photo

No doubt the greatest master of light music presentation in the world, Marek Weber, has recorded for H.M.V.

I WANT to talk about a Parlophone record which has caught my fancy (RO20246, 4s.). It is Richard Tauber singing German folk-songs. The songs are lovely, and you will agree with me that the way he sings them *must* be the only way. Strong words, but I invite you to try to disprove them. I have been charmed by Tauber's magnificent phrasing. By the way, Parlophone have issued a series of these discs.

While on the subject of Parlophone records, I recommend E11254 (4s.), not for the same reason, of course. It is a sea-shanty medley, with a splendid male-voice chorus with orchestra. Very jolly, with a good sea breeze blowing through the whole record.

There are also a couple of intermezzi played by the Dajos Bela Orchestra which are quite worth hearing (R1861, 2s. 6d.). I like the orchestra, which is of the novelty type.

Amongst the H.M.V. I find an attractive operatic record by the tenor, Beniamino Gigli: part of *Pagliacci* and an aria of Gwladano new to me. Gigli has robust tone, but is not without expression. A fine record for testing your machine (DA1312, 6s.).

Bach lovers amongst you may like to know his *Musical Offerings* have been recorded by the Italian Trio. There is no space for me to tell you how old J. S. B. came to make these musical offerings, but I do want to say that you will find them light in the listening sense, so to speak, *not highbrow!* (DB2168-9, 6s. each.)

H.M.V. DB2195 is the *Merry*

Wives of Windsor overture, played by the B.B.C. Orchestra under Dr. Adrian Boult—a double-sider, of course. The overture makes nice light music and I think I ought to say I think the recording outstanding. Some amazing bass tone has just come through the loud-speaker.

Changing the orchestra to the London Symphony and the conductor to Lawrence Collingwood, Elgar's *Dream Children* is my next item on DB2147 (6s.). Some very delicate shadows in this work, which is one for your calmer moments. Personally I think it a perfectly lovely work.

Less expensive, but certainly not less

Choosing Your Records

New Record Releases Critically Reviewed

By WHITAKER-WILSON

expressive, is Auber's *Fra Diavolo*, by the London Philharmonic Orchestra under John Barbirolli. I was very much taken with this, not having heard it before. Absolutely light music all through. It should prove popular now it is recorded (H.M.V. C2644, 4s.).

The Aldershot Tattoo record is out (C2670). The massed bands playing an arrangement of Wagner ought to appeal to many record buyers.

There is also a smaller disc (B8188, 2s. 6d.) for marches by the massed drums and fifes.

You simply *must* get Columbia DX586—the Western Brothers. They are simply top-notch!

I am attracted to Columbia DX585 (4s.), because Harold Williams and Malcolm McEachern (Mr. Jetsam) sing together. They are splendid!

Columbia DB1390 for Lionel Tertis playing *Songs My Mother Taught Me* and a German love song on the viola is fine. He is a great artist.

Quite good, though not brilliant, is a monologue by William McCulloch, called *When I Appeared Before the King* (Columbia DB1394, 2s. 6d.).



B.I.P. photo

A tenor everyone knows—Richard Tauber has recorded German folk music for Parlophone. He is seen here as Franz Schubert in the B.I.P. film "Lilac Time"

Two nice Regal-Zonophone discs. MR1307 (1s. 6d.) is by the Commodore Orchestra, and MR1306 is a selection by the grand massed bands at Leicester Music Festival, conducted by James Oliver.

To conclude. Some Deccas, all of which have my recommendation. DE7028 is a violin record by Enrica Morini and is remarkable for the production of clear tone. F5001 is another of Reilly and Comfort's successes. Another which attracted me was F3996, because I liked Alfredo Campoli and his Orchestra. These Decca records are especially good in tone. I consider them remarkably cheap.

If you want a really good Marek Weber record—almost above his own excellent and unvarying standard—let me recommend you to get H.M.V. B6490, which will cost you half a crown. It is a tango and waltz, *Café in Vienna and One Life, One Love*. You will not be disappointed. This is the first I have heard of Marek for some



Sweet music is an art in which Geraldito excels. He has recorded a delightful medley for Columbia this month



A scene in the Trusound recording studio with Howard Godfrey and his Waldorf Hotel Orchestra. His latest disc is reviewed by Whitaker-Wilson

time. What surprises me is the tenor who sings the refrains. He might sing opera anywhere. How much better than the eternal crooning!

I have had a letter from Howard Godfrey who sends me one of those nice bendable records—you know, the Trusound type. Do you know, I think the makers are quite justified in calling these records by such a name. I was amazed at the quality and the recording. I am now wondering when all firms will give up heavy discs and take to these lightweights. Godfrey plays well.

Additional Records Reviewed

By CHOPSTICK

LIGHT SONGS

(a) Arlene, (b) Butterfingers, Reilly and Comfort, 1s. 6d.

DECCA F5001

These famous American duet-tists used to be heard often with Ambrose in the Saturday-night Mayfair Hotel days. I haven't come across a disc by them for some time. This was a real treat. They sing as charmingly as ever, but there is a little too much orchestral interlude for my liking. Both numbers are of the croony-ballad type.

LIGHT INSTRUMENTAL

Medley by Harry Roy and His Tiger-Ragamuffins, 2s. 6d.

PARLO R1859

If you like real snappy piano playing, try this. These lads know how to put over breezy pianisms. Here are the contents of their medley: "Happy Feet," "I Got Rhythm," "Everybody Loves My Baby," "Rain," and two or three other tunes.

★(a) Let's Fall in Love, (b) Love Is Love, Anywhere, Carroll Gibbons and His Boy Friends, 2s. 6d.

COL DB1397

Carroll has been good in his time, but here he excels every-

thing he has done before. His (a) is a masterpiece of arrangement. I have put this disc in the light instrumental section. Do not be mistaken; it is not a dance record. I recommend this to anyone who has an ear for pleasant light music. You must make a point of hearing it.

★Soft Nights and Sweet Music, with Austen Croom-Johnson, 2s. 6d.

H.M.V. B8190

I happened to try this record late in the evening, and I was surprised how much I enjoyed it. This idea of Croom-Johnson's of hunting up old tunes and arranging them for a small orchestra and playing them in a dreamy way does make one appreciate the value of old dance tunes. In this disc, for example, he includes "Sweet and Lovely," "Sleepy Time Down South," and "The Song is Ended," and gives them a new lease of life with his charming manner of presentation. I hope H.M.V. will continue this series.

World of Romance, Geraldo and His Sweet Music, 4s.

COL DX584

This disc will find a ready market. You probably remember Geraldo's hour's non-stop broadcast, which he is to repeat in August. It is real light music played in such a way as to appeal to

everyone. He mixes up such tunes as Dvorak's "Humoresque," "Two Guitars," "Simple Aveu," "Poeme," "My Song Goes Round the World," and "Valse Bluette" to make a delightful 12-in. medley.

DANCE MUSIC

(a) In Other Words, We're Through (slow f.), (b) Now That We're Sweethearts Again (f.), Billy Merrin and His Commanders, 1s. 6d.

REGAL-ZONO MR1315

Two well-recorded dance tunes. You cannot go wrong with a Billy Merrin record, that is if you want a disc especially for dancing. The recording is good, with the rhythm heavily marked. His slow fox-trot is a little fast, but is worth having. This band seems to improve with every fresh hearing.

(a) Little Man, You've Had a Busy Day (f.), (b) The Show is Over (f.), Billy Cotton and His Band, 1s. 6d.

REGAL-ZONO MR1313

(a) has just become the great craze of the moment; everyone is asking to hear it. Cotton's version is as straightforward as is possible to get. Personally I feel that a number of this sort requires rather a sorrowful treatment to get the best out of it. I much prefer his (b), which is in real Billy Cotton style. It has plenty of round tone and a pleasant vocal duet. This disc is worth having.

(a) That's Love (f.), (b) Go to Sleep (slow f.), Billy Merrin and His Commanders, 1s. 6d.

REGAL-ZONO MR1284

I have great admiration for the tune (b). With perhaps one or two notable exceptions, it is the best we have had this year. Merrin's version, perhaps a little tactless in parts, is on the whole acceptable. His fault is that he tries to get too many variations. His guitar interludes are his strongest point. Still, a good disc.

★(a) Tick Tock Town (f.), (b) Little Man, You've Had a Busy Day (slow f.), Ambrose and His Orch., 2s.

BRUNS 1790

(a) is a novelty type of number and is very well produced. The honours of the disc go to (b) for being the best "Little Man" presentation I have heard. It is difficult to beat Ambrose at this kind of tune. He plays it as a slow fox-trot and a touch of pathos is given to the vocal by Elsie Carlisle.

(a) Troublesome Trumpet (f.), (b) The Beat O' My Heart (f.), Harry Roy and His Orch., 2s. 6d.

PARLO R1857

This does not need any recommendation. His (a) is a superb example of dance-band ragging. The trumpet does all sorts of weird things and, of course, the rhythm is perfect. (b) is a quieter type of tune, put over with all Harry Roy's best showmanship.



(Above) A view of the completed amplifier and mains section. The fuses are incorporated in the mains transformer. The two low-frequency valves are seen on the extreme left and the output triodes between the two transformers

(Right) A view of the radio unit and amplifier in the radiogram cabinet. Note that the amplifier is mounted on its side behind the loud-speaker



the entire absence of background noise there was an equally complete absence of hum. I do not mean that the hum was slight; *there was no hum in any shape or form.*

It was rather late that evening to get a fair impression of the long-wave performance. The following morning in daylight I went the rounds and found that at least a dozen came in as well as could be wished. A good medium-wave feat in the morning was the reception of Hilversum at terrific strength with volume control only just on.

Criticism

I have, however, one criticism. There was a perceptible falling off in signal strength towards the bottom of both wavebands. I do not hide this fact. It was not caused by ganging because I took special precaution to check this up on a wavelength of about 300 metres.

This is a technical fault, but it does not matter practically. The enormous reserve of volume, I found, was sufficient to take up this falling off in signal strength a dozen times if necessary.

It was at this point of the test that I noticed the real quality of reception. In the first place there was no trace of background noise; a bold statement but very true.

About Quality

The quality is best summed up as being quite as good as would be normally expected from a "straight" set with a 5-watt output. One other point about quality. Besides

COMPONENTS NEEDED FOR THE "W.M." RADIOGRAM SUPER

		£	s.	d.			£	s.	d.					
CHASSIS					RESISTANCE, VARIABLE									
1—Peto-Scott aluminium 16 in. by 12 in. by 3 in.	7	6			1—Claude Lyons 5,000-ohm (or Ferranti) ...	5	6							
CHOKES, HIGH-FREQUENCY					SUNDRIES									
2—Wearite, type HFS (or Goltone)	9	0			2—Bulgin flush-mounting mains plugs and sockets, type P20 ...	4	0							
COILS					Round tinned copper wire, No. 20 gauge, for connecting, say ...									
1—Set Wearite, type GN4 ...	2	0	0			Oiled sleeving, say ...	1	3						
CONDENSERS, FIXED					3 yds. thin flex, say ...					3				
5—British Radiophone, type tubular, values: .00005-, .0001- (2), .0003-, .0005-microfarad (or T.M.C. Hydra, Telsen) ...	2	6			TRANSFORMERS, LOW-FREQUENCY									
1—T.M.C. Hydra, type tubular, value .05-microfarad ...	1	0			1—Ferranti, type AF5c ...	1	14	0						
10—T.M.C. Hydra, type 25, values: 1- (6), 1- (2), 2-, 4-microfarad (Dubilier, T.C.C.) ...	1	1	6			1—Ferranti, type OPM6c ...	1	6	6					
1—T.M.C. Hydra, type 40, block comprising 1- (3), 1-microfarad (1) ...	5	0			TRANSFORMER, MAINS									
CONDENSERS, VARIABLE					1—Sound Sales, type 25M ...					2	2	6		
1—Polar four-gang .0005-microfarad, type Star Minor, complete with semi-circular slow-motion drive ...	1	10	9			ACCESSORIES								
HOLDERS, VALVE					CABINET									
6—Clix, type chassis-mounting, four-pin (2), seven-pin (4) ...	5	4			1—Peto-Scott, type Adaptagram de Luxe ...	6	10	0						
RESISTANCES, FIXED					GRAMOPHONE MOTOR AND PICK-UP									
19—Erie, values: 250- (2), 300-, 1,000-, 5,000-, 10,000-, 15,000-, 20,000- (3), 25,000-, 30,000-ohm (2), ¼- (3), ½-, 1-, 2-megohm (or B.A.T., Telsen) ...	19	0			1—Garrard, type 202A with volume control ...	4	6	9						
RESISTANCES, VARIABLE					HOLDERS, FUSE									
1—Claude Lyons 1,000-ohm, type M1 ...	5	6			1—Bulgin twin, type F14, complete with 1-ampere fuses ...	2	3							
1—Claude Lyons ½-megohm, type ST500 ...	6	6			LOUD-SPEAKER									
SUNDRIES					1—Magnavox permanent-magnet, type 252 ...					3	3	0		
1—British Radiogram 1½ in. metal mounting bracket ...	4	4			VALVES									
					2—Mazda AC/VP1 (pre-high-frequency and intermediate-frequency amplifiers) ...					1	15	0		
					1—Ferranti VHT4 (Detector-oscillator) ...					1	0	0		
					1—Marconi MHD4 (second detector) ...					15	6			
					1—Marconi MH4 (tone-corrector valve) ...					13	6			
					1—Marconi MHL4 (low-frequency amplifier) ...					13	6			
					2—Marconi PX4 (output valves) ...					1	13	0		
					1—Ferranti R4 (rectifier) ...					15	6			

The prices mentioned are those for the parts used in the original set; the prices of alternatives as indicated in the brackets may be either higher or lower

HOME TELEVISION SECTION

The Construction of Television Receivers

By H. CORBISHLEY

THE amateur who decides to build a television receiver has now a fairly wide choice of types, though no doubt the selection will really depend upon the amount he is prepared to spend on the apparatus. Additionally there is considerable variation possible in each type so there is plenty of scope for ingenuity of design and layout.

There are, however, several pitfalls to avoid and it is proposed in this article to give a brief survey of the practical construction of scanners of the mechanical type and indicate the best lines upon which to proceed.

The three types of scanner available to the amateur at present are the disc, the mirror screw and the mirror drum and these are mentioned in order of simplicity and, incidentally, cost. The construction of the disc machine is simplicity itself unless one attempts to make the actual disc. This is really quite a difficult task; although well within the scope of the careful worker it is advised that this component should be purchased.

Discs are made in various sizes and until recently the 20-in. disc was the most popular but it is now appreciated that a diameter of 16 in. is better on account of the possibility of making the receiver less cumbersome and also the fact that the smaller disc requires less power to drive it.

A point to note is that the disc should be flexible and this means that the metal should be thin. The reason for this is that it is essential that when the disc is running it should be quite flat.

Experience has shown that this is only possible with a thin disc

which will straighten out owing to centrifugal force when running at a fairly high speed. Lightness is also a desirable feature, so aluminium of No. 32 gauge will be found the best material.

Vibration and want of balance are very undesirable. There is no difficulty about the latter provided that the disc is accurately cut and that the motor is well balanced both mechanically and electrically. Vibration may be kept at a minimum by keeping the centre of gravity low and mounting the disc upon a substantial base.

Driving the Disc

Not only will vibration spoil the picture but the noise produced will be found rather disconcerting. Until recently it has been the general practice to mount the disc directly upon the spindle of the motor and support the latter on a platform. This arrangement makes for simple construction,

but the more recent idea of mounting the disc upon separate bearings with the motor on the baseboard and driving by a rubber belt has much to commend it from various points of view.

It is always desirable to include some sort of mechanical filter in the driving arrangement and a rubber belt drive fills this bill very simply and efficiently; another important advantage of indirect drive is that a step-down ratio is easily obtainable between motor and scanner which will enable the motor to be run at a higher and more efficient speed. The speed of the disc must be 750 revolutions per minute and small motors run most efficiently at from 2,000 to 3,000 revolutions per minute.

At these speeds they are less subject to variation so it will be obvious that by arranging a step-up drive there will be better prospect of keeping the scanner speed steady. The belt used must of course be of

The usual practice is to mount the disc screen on the motor shaft, but it can be equally well driven by a belt as shown above, this will make for steadier running and a more efficient motor

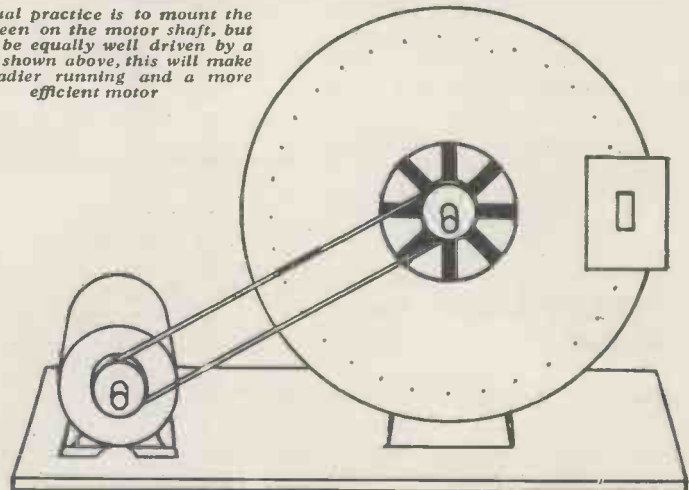

the jointless variety, such as are used for small cinema machines are very suitable.

Critical control of speed is absolutely essential and experience has shown that a combination of

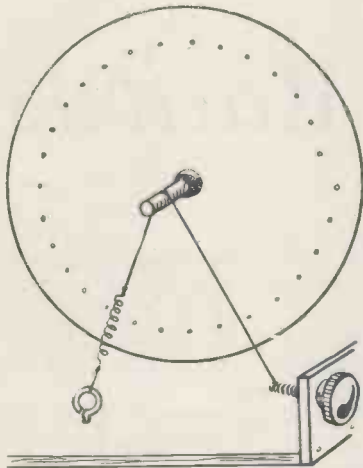

A simple mechanical brake for control of disc speed where no synchronising gear is fitted

electrical and mechanical control is better than relying upon either one or the other. Mechanical control gives quicker response than electrical, so it is desirable to be able to obtain the approximate speed by the use of resistances and then have a simple mechanical brake that can be applied or released quickly.

The electrical control should consist of two resistances, one of a fixed type and the other of a variable type. The approximate speed is first obtained with the fixed resistance and the variable in the midway position which will allow of either increasing or decreasing the speed, the setting being determined with the mechanical brake half way on.

The mechanical brake is a very simple device and can consist of a spring-tensioned piece of string

**The ABC of
Cathode-ray Television
"TELEVISION" for
August . . . 1/-**

passed over the motor or disc spindle. It is not much use making this controllable by means of a screw, for the action is not quick enough. It is preferable to be

able to place a finger on the cord and regulate the braking action instantly; practically constant control of speed is essential unless synchronising gear is fitted.

It is questionable whether it is worth while fitting a synchroniser to the more simple type of television receiver, because it means another output stage and the output must be fairly considerable if it is to work efficiently. This increases the cost very consider-

ably, to such an extent in fact that it would probably be a better proposition to go to a little more cost and obtain screen projection by means of a mirror drum.

The Mirror-screw Receiver

The mirror-screw receiver is a distinctly more difficult type for the amateur to construct and operate. In the first place, the flat-plate mirrors have to be assembled and this calls for a considerable amount of painstaking work. Then, again, owing to the

TELEVISION MADE EASY—

A Special Section for the Beginner in the August issue of
"TELEVISION" 1/-

ably, to such an extent in fact that it would probably be a better proposition to go to a little more cost and obtain screen projection by means of a mirror drum.

It should be borne in mind that the disc receiver is a very simple type which enables the television broadcasts to be received using the average wireless set for the reception of the signals and it is rather questionable whether it is worth while attempting anything more ambitious with this type.

It is essential, of course, that the field of illumination of the neon lamp should exactly coincide with the horizontal diameter of the disc; incorrect positioning of the

small diameter of the mirror assembly it is a rather difficult matter to maintain the screw at the correct speed, and in addition a greater value of light is required if a bright picture is to be obtained.

The advantages of this type of scanner are that a larger picture is obtainable than with the disc and the entire apparatus is much more compact.

Mirror plates, end pieces and the central boss are available, but not complete screws, so the amateur who decides to construct this type of apparatus has no alternative but to assemble the screw from the component parts.

If the assembly is to be accurate

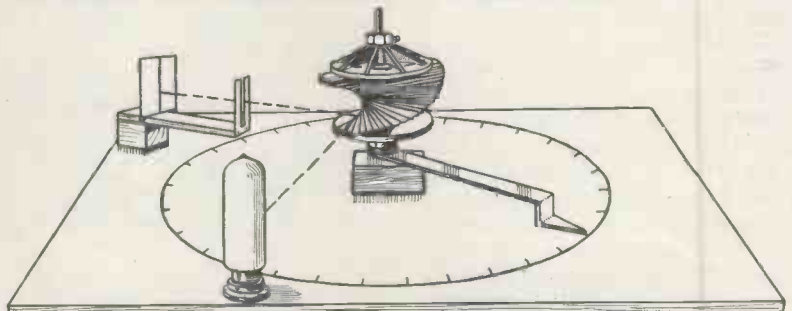

This diagram shows how the mirrors of a mirror screw are adjusted

lamp is a very common fault and the result is that the picture has a distorted appearance.

If a beehive type of neon lamp is used, then all but the space occupied by the scanning field should be masked out; the best way to do this is first to coat the bulb with aluminium paint and then over this put a layer of black paint and when dry, scrape off an

some such arrangement as shown by the diagram will be necessary. The parts of the screw, roughly assembled, are mounted on a vertical spindle fixed in the base-board. The size of the latter must be not less than 2 ft. square and on it is drawn a circle divided into thirty parts.

To the screw assembly is fixed a pointer so that the former can be

moved $12\frac{1}{2}$ degrees as each mirror is set. An ordinary tubular incandescent lamp, which is masked out with the exception of a thin line, is arranged so that the line of light is thrown upon the mirrors and then reflected through a slit in a piece of metal and on to a card with a vertical line drawn upon it.

The procedure will be obvious; the light reflected from the lowest mirror is picked up on the screen and this mirror is lightly secured with a touch of Durofix cement. The pointer is then moved 1 degree of the scale and the second mirror adjusted and fixed, and so on until the assembly is complete.

It will be evident that the optical leverage obtained by the use of a long pointer and the fairly long distance that the reflected beam must travel enables a great degree of accuracy to be secured.

Lamps for Mirror Screw

The simplest type of lamp for use with the mirror screw is the flat-plate neon masked out so that only a line is left, and with this the provision of light is just as

simple as in the case of the disc receiver. Better illumination, though, can be secured by the use of a positive-column mercury-vapour lamp.

There are unfortunately some additional difficulties in the use of this type of lamp, however. For one thing, the striking voltage is rather high and so some special method is required for starting the lamp up. A convenient way is to use a 5-to-1 transformer so that a momentarily high potential can be supplied to the lamp. The primary of this transformer is momentarily connected to the mains.

Also, the running potential of the mercury-vapour lamp is somewhat high—about 450 volts—and this means that this voltage must be available in the last stage of the amplifier. The current requirements are approximately 25 milliamps, so it will be clear that an amplifier of the class used for mirror-drum reception will be necessary if this type of illumination is to be used and this will add to the cost of the entire equipment very considerably.



Making final adjustments to the mirror screw

Taking complication and cost into account, the amateur would perhaps be well advised to use the neon lamp in conjunction with mirror-screw apparatus and be content with a picture which, though inferior to that obtainable with a mercury vapour lamp, will be an improvement upon that provided by the disc machine.

Points in Construction of Mirror-drum Apparatus

The best class of apparatus at present available is undoubtedly the mirror-drum as this gives screen projection and it is a fairly simple matter to obtain pictures measuring about 9 in. by 4 in.; moreover, the colour of the pictures is ordinary black and white tone.

BE MODERN!
Take up Television
 Simple explanatory articles for
 the beginner in the August
 issue of
"TELEVISION" - 1/-

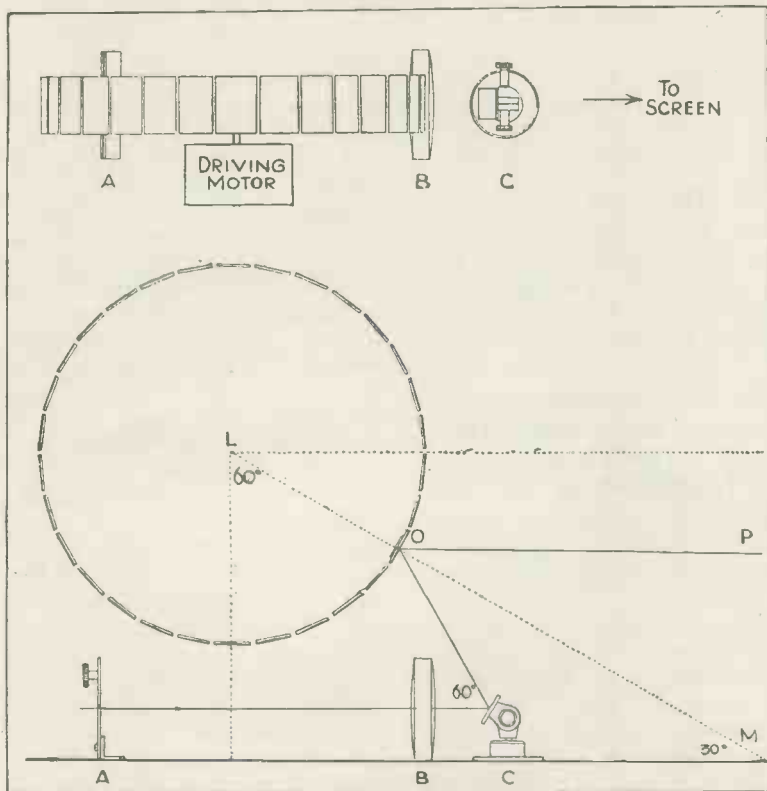

A diagram showing the elementary principles involved in setting up mirror-drum projectors

adding to the difficulty of construction and operation. It is advisable to keep the layout upon the simplest lines and use the minimum of reflecting surfaces and lenses; apart from the increased difficulty of setting up, mirrors and lenses absorb a certain amount of light and reduce the brightness.

The diagram shows the elementary principles involved in constructing a television projector of

tance is measured from the point *o* in the diagram, and it may be pointed out that the multiplier suggested can be used for any 30-mirrored drum.

The next step is to position the reflecting mirror *c* so that it directs a ray from the light source at an angle of 60 deg. from the horizontal on to the point of intersection between the line *op* and the line *LM*. If a universal angle

vapour lamp which also is modulated directly and is similar in many respects to the crater point.

If an ordinary incandescent lamp is used this is placed just to the left of the aperture *A*, a condensing lens being placed between the aperture and lamp. The crater point lamp simplifies the construction considerably, but with this type it is not possible to get quite the same degree of illumination as when a Kerr cell is used in conjunction with an ordinary lamp. The crater-point lamp can be worked quite satisfactorily from an amplifier of average power. The lamp is mounted behind the aperture (which, by the way, is now reduced so that only a small spot is visible on the screen) so that the spot projected on to the screen is evenly illuminated. The crater point lamp can be connected directly in the anode circuit of the output valve from the amplifier, or it may be biased separately and fed in the usual way.

SPECIAL ARTICLES FOR THE BEGINNER APPEAR IN THE AUGUST ISSUE OF "TELEVISION"

the mirror-drum type. It will be noticed that definite angles are given, but it must not be imagined that these are the only ones which can be employed.

Motor-spindle Height

The first matter to settle is the height of the motor spindle above the baseboard, and for a start it is suggested that the size of the picture be limited to about 10 inches high. In the average room this will be found quite large enough for comfortably watching the television. Obtain a piece of drawing paper, therefore, and mark a point 5 inches above the base line. This line carried horizontally to the screen gives the centre of the picture. Next draw a line *LM* at an angle of 30 degrees as from the baseboard so that it intersects the picture centre line. Now measure the radius of the mirror drum and from the point of intersection *o*, this radius should be marked off along the line *LM* and will, in this way, give the point *L* which is the position of the motor spindle height from the baseboard.

Motor Support

Now arrange to support the motor (and synchronising gear) so that the mirror drum is on the right-hand side when looking direct from the screen, as shown in the plan view. It will be obvious that one of the factors which decides the size of the picture is the distance of the screen from the mirror drum. In the case under consideration it is suggested that the height of the picture required, 10 in., be multiplied by 2.3523 in., giving a measurement of 23.523 in. or approximately 23½ in. This dis-

mirror stand is used it will be possible to adjust easily these reflected light spot so that it takes up its correct position on the screen. The light system is placed under the drum and directed via this reflecting mirror so as to economise in space. Now take the lens *B* and the mask *A*, the latter being preferably adjustable, and place a light behind the mask with the aperture fully open. Then position the lens so as to focus this aperture on the screen set up about 30 in. from it. This will enable the approximate distance from the mask to the lens to be determined, it being borne in mind that the best position for the lens *B* is as close to the reflecting mirror *C* as possible without cutting off the light ray reflected on to the drum.

The Light Source

The next matter to settle is the type of light source which it is proposed to use. For mirror-drum apparatus it is possible to use an ordinary incandescent lamp of the

An Experimental Mirror-drum Transmitter. Full Details in "TELEVISION" - 1/-

bunched filament variety, and in conjunction with this a Kerr cell, which in actual fact is a light valve which will modulate the constant light from the lamp.

Alternatively it is possible to use a special type of neon lamp termed the crater point, and this light is modulated directly, so that no accessory apparatus in the form of a light valve is required. Still another alternative is a mercury-

Projection Screens

Screens of ground glass may be employed, and with this, although the illumination is good, the angle of vision is somewhat limited. It is quite satisfactory for individual experimental use, but when it is desired to allow several people to look-in at once, a wider angle of vision is desirable. Screens for this purpose can be made from various kinds of material, among which may be mentioned tracing linen, oiled cartridge paper, a mixture of resin and ether thinly spread on glass, while even a ball of putty dabbed evenly on glass will provide a good screen. Another method is to warm a sheet of glass and spread a thin, even coating of paraffin wax on the surface, and then allow this to cool.

It may be mentioned while on this question of screens that when used in a darkened room their basis can be white, but if they are to be used in daylight or a normally lighted room, they should be a fairly deep grey, but of coarse grain to allow the light to come through. This latter point is desirable because if the screen were of light material the black tones of the picture would be barely visible, owing to the surface reflecting the light in the room.

TESTS OF NEW APPARATUS

Cossor Tuning Indicator :: Ferranti Potentiometer and Switch :: Benjamin Transfeeda :: W.B. 9-pin Valve Holder :: Ohmic Low-frequency Transformer :: Rothermel Piezo-electric Pick-up

COSSOR TUNING INDICATOR

APPARATUS : Tuning indicator.
MAKERS : A. C. Cossor, Ltd.
PRICE : 4s. 6d.

WITH a simple set tuning is comparatively easy. The knob is turned until the loudest signal is obtained. With a receiver incorporating automatic level control, however, the process is not so simple because the strength of the station does not vary as the tuning knob is rotated over quite a large arc.

Good quality is only obtained when the receiver is *dead in tune*, which is rather difficult to find.

The Cossor tuning indicator is designed to overcome this difficulty. It consists of a special form of neon lamp having three electrodes. Two of these operate in the normal way and are kept at such a voltage that they just glow.

The voltage on the third electrode is supplied from a resistance in the anode circuit of one or more of the high-frequency or intermediate-frequency valves. If these valves are controlled by the automatic level control, the anode current will vary, and hence the voltage applied to the indicator.

This third electrode is in the form of a long stem, and the glow mounts up the stem according to the voltage applied. In practice, therefore, as one tunes a station in, the column of light mounts higher and higher, and all one has to do

is to tune to the greatest height.

The device is simple to use and can easily be adapted to an existing set. It takes between 2 and 4 milliamperes, so that its principal application is to mains receivers, though it may be used with battery sets if the extra current consumption can be tolerated.

FERRANTI POTENTIOMETER AND SWITCH

APPARATUS : Combined potentiometer and switch.
MAKERS : Ferranti, Ltd.
PRICE : 4s. 6d.

THIS latest Ferranti product is both neat and effective. It is built up from stampings of metal and bakelite sheet, and is only 1 in. deep behind the panel, including the switch and tags. The diameter is 1½ in.

The resistance element is of the usual carbon-treated paper, contact being effected by a small circular shoe which not only gives good contact, but serves to distribute the pressure and minimise the wear on the track.

The switch is of the usual quick-acting variety and operates smoothly and easily.

The resistance of the sample submitted was rated at 50,000 ohms, and was found on test to be slightly over this figure. The makers claim a dissipation of 25 watt, and the resistance was found to withstand this quite satisfactorily.

One-hole fixing is provided, and there



The Ferranti combined potentiometer and switch is quite shallow and has soldering lugs

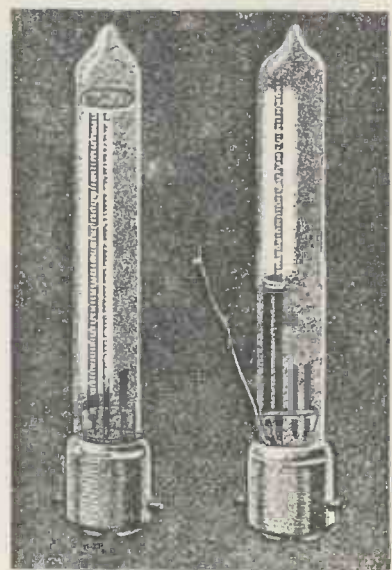

Two views of the Cossor tuning indicator. The neon glow is clearly seen at the top of the right-hand drawing

is a convenient flat on the spindle to assist the fitting of the knob.

BENJAMIN TRANSFEEDA

APPARATUS : Coupling unit.
MAKERS : Benjamin Electric, Ltd.
PRICE : 7s. 6d.

THE original Transfeeda coupling unit introduced by Benjamin met with well-merited success. Readers will remember that it comprised a small low-frequency transformer of a high-permeability core together with the necessary components for parallel feeding the transformer so that the anode current does not go through the windings.

The new Transfeeda employs an improved method of winding whereby the effective step-up is increased while, in addition, a high-



A new valve holder by W.B. for use with the new 9-pin valves

voltage feed condenser has been incorporated so that the unit can be used in mains sets generating several hundred volts when switching on.

The condenser has a value of .25 microfarad, and the feed resistor is 50,000 ohms with a tap at 30,000 ohms to suit different valves.

The whole unit is located on a moulded base with a sprayed-metal cover. It is fitted with the well-known Benjamin one-piece terminals and makes a very neat assembly.

We found on test that the reproduction was satisfactory. The effective step-up is very uniform from 60 to 6,000 cycles, the average value being practically 3:1.

A slight rise given in the treble will be particularly useful in modern selective sets, which have a tendency to cut off the top notes owing to sharp tuning.

W.B. 9-PIN VALVE HOLDER

APPARATUS: Side-contact valve holder.
MAKERS: Whiteley Electrical Radio Co., Ltd.
PRICE: 2s. 3d.

THE new Mullard universal valves are provided with a distinctly new form of base. The contacts are located at the side, it being claimed that with the multi-contact bases now in vogue, satisfactory contact is impossible with the older forms of base.

This new W.B. valve holder is designed for the side-contact valves. In appearance it is generally similar to a normal base except that instead of the customary sockets there is a series of springs.

These contact springs are housed in recesses in the side of the moulding and thus locate accurately with the pips on the valve. There is a play

of rather more than 1/16 in. on the springs so that there is ample compensation for minor variations in the valves.

We tested the fit with a number of samples and found that it was good and firm in every case.

The particular model submitted was for baseboard mounting, and was fitted with terminals, but there is a similar model available for chassis mounting with soldering tags projecting on the underside.

OHMIC TRANSFORMER

APPARATUS: Low-frequency transformer.
MAKERS: Ohmic Accessories

PRICE: 7s. 6d.

THIS is an inexpensive low-frequency transformer for those who require good average quality. It is con-

ventional in construction, the primary and secondary being overwound and the whole assembly located in a brown bakelite moulding. The dimensions are 2 3/4 in. by 1 3/4 in. by 2 3/4 in. high. Terminals are provided at the four corners.

On test we found that the transformer gave an effective step-up of about 2.5 to 1 over the middle registers, falling off somewhat in the bass, as one would expect.

The upper frequencies were well maintained even with a 40-microfarad condenser connected across the secondary to duplicate the Miller effect of the last valve in the receiver.

An Invitation to Component Manufacturers

Component makers are invited to submit new apparatus for test and report in these columns. We would like to point out that we cannot guarantee to return apparatus in a sound condition. Apparatus is frequently dismantled for test purposes. Samples should be addressed to the Editor and marked: "For Test."

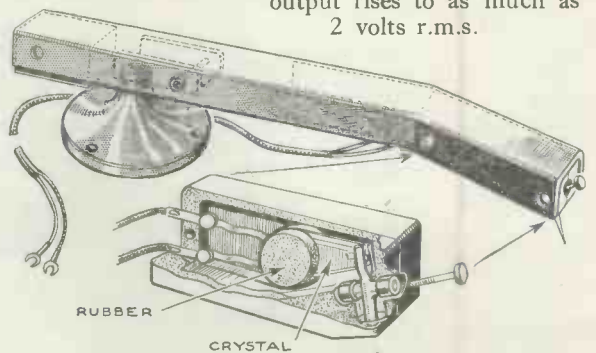

A drawing showing the construction of the new Rothermel piezo-electric pick-up. The crystal support is seen clearly in the lower sketch

ROTHERMEL PIEZO-ELECTRIC PICK-UP

APPARATUS: Piezo-electric crystal pick-up.
MAKERS: R. A. Rothermel, Ltd.
PRICE: £2 2s.

THIS new pick-up, just introduced by Rothermel, makes use of the electrical properties of Rochelle salt crystals. An advantage of this new pick-up is that the crystal element is so flexible that when coupled to a light stylus chuck or needle holder, little damping is required.

The result of this is that the pick-up gives a uniform response over a wide frequency band. It will handle the maximum amplitudes obtained from a normal gramophone record with a weight of only 1.5 oz. on the pick-up head.

A further interesting point is that the arm, which has a black crystalline



A cheap and efficient low-frequency transformer just marketed by Ohmic Accessories

finish, is counterbalanced to prevent record wear.

On test we found the reproduction extremely realistic and this was specially noticeable in the bass notes. From our measurements we noted that there is a marked freedom from peaks in the response, while the output rises to as much as 2 volts r.m.s.

Using the New Valves

During the past months we have seen an almost complete revolution in valve design. Nowadays it is almost a strange occurrence for one of the valves in the high-frequency end of the set to have less than seven pins. In this article the "W.M." Technical Staff explains the uses for the new valves and emphasise that they will make a vast improvement if used in an existing set.



Mullard's new high-frequency pentode. This has an eight-contact base, but no valve pins. The heater voltage is 13

THIS year has seen more improvements in valve design than ever before in a single year. As the majority of the modern sets are designed around the valves it means there are hosts of ideas to be used if you want to get the best from your set.

Not Expensive

Perhaps it may be that your set does sound in trim, but go and listen to one of the latest commercial sets and then you will realise just how much out of date your set is, although it may only have been made a year or two ago.

Don't run away with the idea that to use a new valve will run you into a lot of money. The gain in the intermediate-frequency or high-frequency stages can be increased several hundred times without costing a penny more than the bare price of the valve and perhaps a valve holder.

Easy A.V.C.

Automatic volume control, so that you can cut out the fading on those foreign stations to which you all listen on Sundays, can be embodied for the cost of a double-diode-triode valve, with a few odd resistances and a couple of condensers out of the spare-parts box.

Battery sets that give about half-a-watt output are now very old

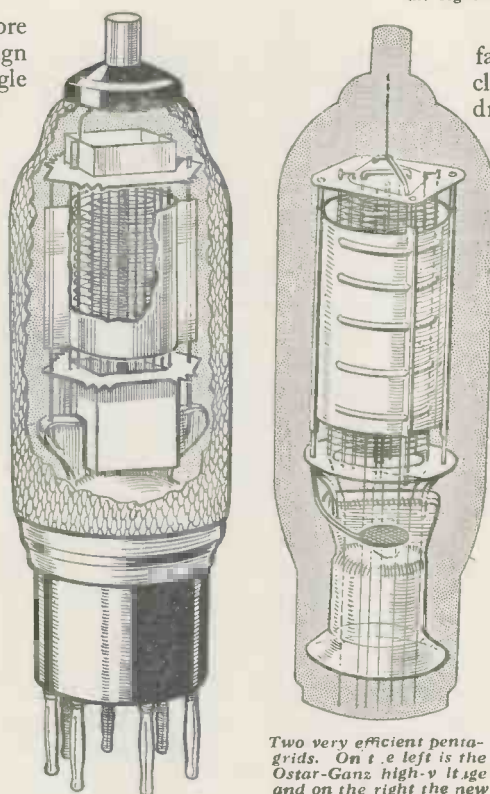

Two very efficient pentagrids. On the left is the Ostar-Ganz high-voltage and on the right the new Cosmor 41MPG

fashioned. No, don't think we mean class-B amplification and an additional driver stage. A valve called the QP21 will give 1,100 milliwatts when loaded by the detector valve.

Low Anode Current

The anode current will probably be lower than it was with the old triode valve and remember you have over double the output.

This idea will again only run you into the cost of a new valve, two fixed resistances, and a seven-pin valve holder.

Anyone who with D.C. mains still grumbles about poor results, hum, small output, or any of the other troubles associated with D.C. mains sets, should know better.

This year we have tried several valves that are quite as good as the A.C. mains types and are suitable for either A.C. or D.C. supplies without alteration.

Do you realise that it is cheaper and better to make your set for A.C. and D.C. mains than to make it only for one source of supply?

For example, Ostar-Ganz valves do not want any mains transformer and can be used on any mains, while Mullards, with their Universal 13-volt heater valves, have almost made the mains transformer obsolete.

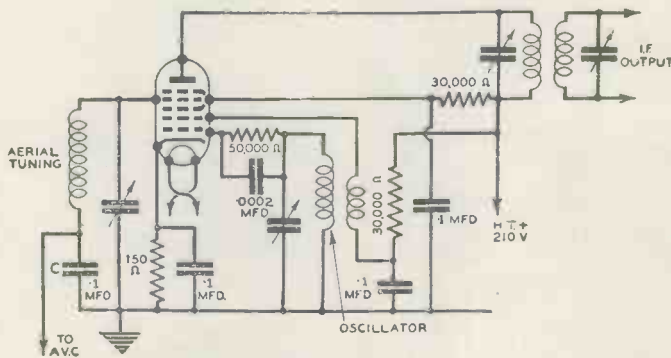

Fig. 1.—Here is a circuit evolved by Cosmor for their new pentagrid valve

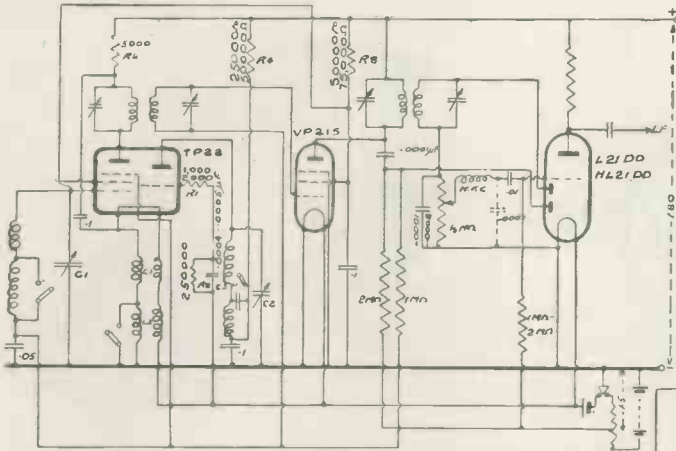

Fig. 2.—This circuit, evolved by Mazda, is for a super-het using the new triode pentode, high-frequency pentode and a double-diode-triode

With all these new valves it is small wonder that the receivers for the home constructor have never before reached such a high standard.

Take advantage of these new ideas while you may. Now is the time for alterations, not in the winter when the set cannot be spared as the rest of the family want it.

Efficient Detector-oscillators

This winter, second-channel interference and simple station jamming will be worse than ever, for most of the stations seem to be increasing their power. The only way to cure this trouble in your super-het is to have an efficient detector-oscillator stage—one that will not re-radiate, and upset your neighbours. It will also reduce the strength of second-channel whistles to a minimum.

The valve for the job is the new pentagrid frequency-changer made by most manufacturers. The Cossor 41MPG is a good example and works well with the circuit, shown in Fig. 1, developed by the makers. Any super-het will be improved out of all recognition with this valve in circuit. The component values are quite normal while coils are obtainable from most makers.

Two Valves in One

There is no need to get worried by this valve. It may look awesome, but really it is only a plain triode and a screen-grid valve in the same bulb.

The whole idea is that the external coupling coil between the oscillator and first-detector portion is omitted. All coupling is carried out internally by means of mixing the electron streams of both sections of the valve.

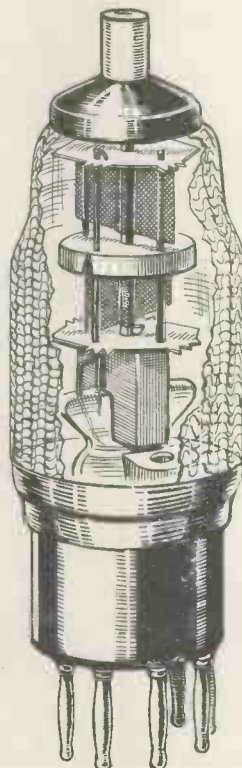

In this way the efficiency remains constant at all frequencies and does not vary on different stations as would happen if a coil was used.

There are one or two variations of this valve. For those on D.C. mains, or who wish to use a high-voltage valve, the Ostar-Ganz people have evolved a valve and a special circuit that is really good.

On Wavelengths Down to 10 Metres

This circuit, shown in Fig. 3, will work well on wavelengths down to 10 metres.

The Mazda people are quite sure that the only way for perfect first detection and oscillation is by

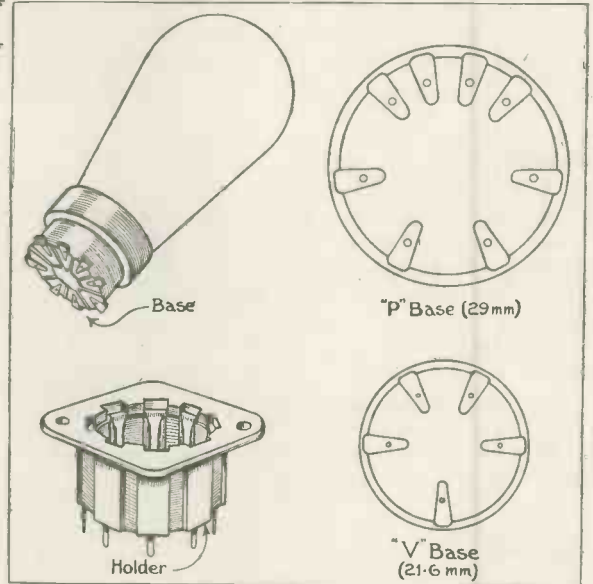

The connections for the Mullard universal valves are strange at first sight. Here you see the connections for all types except the double diode which uses the "V" base



Two good examples of double diodes. (Left) The Ostar-Ganz with a 200-volt heater and (right) the Mullard with a 13-volt heater

using a triode pentode valve with a special circuit of their own design. We certainly do agree that a home-built set on the lines of the circuit shown in Fig. 2 would give very satisfactory results.

The circuit shown is the nucleus of a really fine super-het. All you have to do to complete it is to add a low-frequency stage or stages. It is for battery operation which makes it even more interesting.

Do you realise that with this set and an output pentode of the Pen220A type you will have a super-het with a triode-pentode oscillator-detector, a variable-mu pentode as an intermediate-frequency

Continued on page 88

Varley

(Proprietors Oliver Pell Control Ltd.)

FOR THE TYERS PORTABLE

No hum or instability—a screening cover is fitted to prevent undesirable coupling. A very high inductance is obtained through Varley's special core material . . . an extremely efficient choke.

Varley Nicore
H.F. Choke.
B.P.26 - 4/6



Advertisement of Varley (Oliver Pell Control Ltd.), Bloomfield Road, Woolwich. Telephone: Woolwich 2345.

There's no mystery about

T.C.C. SUPREMACY



IT'S HERE



"We're Fluxite and Solder, the reliable pair; Famous for Soldering, known everywhere! To make good reception a foregone conclusion; Use Fluxite and Solder—no fear of 'confusion'!"

See that Fluxite and Solder are always by you—in the house—garage—workshop—anywhere where simple, speedy soldering is needed.

ALL MECHANICS WILL HAVE FLUXITE
IT SIMPLIFIES ALL SOLDERING

All Ironmongers sell Fluxite in tins: 4d. 1d., 1s. 4d., and 2s. 8d. Ask to see the FLUXITE POCKET SOLDERING SET—complete with full instructions—7s. 6d. Ask also for our leaflet on HARDENING STEEL with Fluxite.

FLUXITE LTD., Dept. 332,
Dragon Works, Bermondsey St., S.E.1

FOR ALL REPAIRS!



INVARIABLY T.C.C. . . . first in the designer's specification, used in all the best commercial receivers, your own dealer's recommendation . . . There's no mystery about this insistence on T.C.C. when you realise that every important condenser development has found its birth in the T.C.C. laboratories. The B.B.C., the world's Broadcast Stations, all use T.C.C. No mystery here either . . . **DEPENDABILITY.** That is the keynote. Take the ever popular Type 50 for 200v. D.C. Working, a paper condenser . . . but what paper! the finest linen tissue, and the foil, the best obtainable. The whole hermetically sealed, proof against climatic changes. And then, tested and tested again, to be sure. That is how T.C.C. have attained Supremacy, thoroughness throughout. It's the same with every type too . . . Built for a special job and guaranteed to do it without fuss or complaint. Use T.C.C. and be sure.

T.C.C.

ALL-BRITISH CONDENSERS

The Telegraph Condenser Co. Ltd.,
Wales Farm Road, North Acton, W.3

amplifier, a double-diode-triode second detector feeding an output valve that gives 1,000 milliwatts?

The quality will be perfect, for the second detector is a diode, which feeds into a triode all enclosed in the same bulb. A second diode gives automatic-volume-control voltage, which works on both the first detector and the intermediate-frequency amplifier, so that almost perfect control is obtained.

Fine Battery Circuit

So with a four-valve circuit of this kind we have the equivalent of at least seven valves and in actual operation the performance is equal to many mains-driven sets.

This disposes once and for all of the fallacy that a battery set must always give a mediocre performance. Now with these very modern battery valves and special coils the home constructor can make his *ideal* set.

Talking about quality, the double-diodes are certainly coming into favour. These special valves are quite small inside and have been designed for use as rectifiers and automatic-volume-control valves. With the modern highly efficient valves and even more powerful transmitting stations, almost every kind of valve detector, such as leaky-grid and anode-bend, will overload on some of the strong signals.

Perfect Quality and Rectification

As quality is of primary importance these days, a double-diode has been brought out to handle an average input of about 200 volts. This makes quite sure that the most powerful receiver can be used quite close to a local

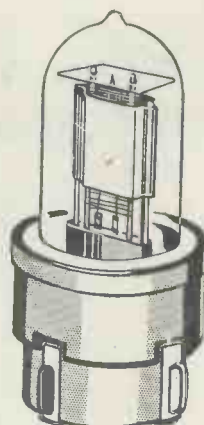

On the left is the first seven-pin catkin, the Osram VMP 4/K, a high-frequency pentode (Right) is a drawing of a new Marconi-Osram midget battery valve

Although the output from a diode is low they will, in the majority of instances, load a steep-slope pentode valve to give an output over 2 watts.

Side-contact Range

Mullard are so keen on this type of valve that they have introduced it into their universal range. All the valves in this range have side contacts and no valve pins, and this, coupled with the fact that the valves are already of small dimensions, now enables them to be comparable with some of the new midget valves.

Midget valves brought out by the Marconiphone and Osram people earlier in the year are quite interesting, and are especially useful in hiker's sets and small portables. The police first discovered these useful little valves and later the deaf-set makers took them up.

Regional and still give good quality and perfect rectification.

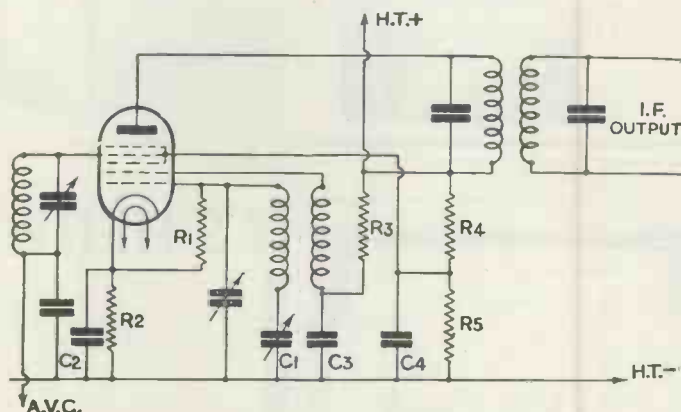

Fig. 3.—This circuit is a good one for the Ostar-Ganz pentagrid. It is quite conventional and is for use with standard coils

UNIVERSAL

A.C./D.C. RECEIVERS—RADIOGRAMS—AMPLIFIERS

We claim, and the "Wireless Magazine" and other well-known radio publications confirm, by "tests," that our Universal A.C./D.C. Receivers always give outstanding performance, also that they are well ahead of the majority of present-day receivers. Suitable for any supply mains, A.C. or D.C. and all wavelengths between 200 and 2,000 metres. Besides being perfect for the home market, these receivers are particularly suitable for the Colonies and other overseas markets.

UNIVERSAL A.C./D.C. RECEIVERS
 UNIVERSAL "HIGHMU" 4 £11 11 0
 UNIVERSAL "SUPER" 5 £15 15 0
 UNIVERSAL "SUPER-HET" 8 £28 5 0

(This model covers 12 to 2,000 metres).
 See Test Report on page 59.

UNIVERSAL A.C./D.C. RADIOGRAMS
 All above receiver models supplied as combined radiograms and receivers.
 Prices on request.

BE SURE TO READ ALL ABOUT THE "WIRELESS MAGAZINE" TEST REPORT ON OUR UNIVERSAL A.C./D.C. 8-VALVE SUPER. SEE PAGE 59 OF THIS ISSUE.

All inquiries to:—

UNIVERSAL HIGH VOLTAGE RADIO, LTD.,
 28-29, SOUTHAMPTON STREET, STRAND, LONDON, W.C.2.

Telephone: Temple Bar 4985.

UNIVERSAL A.C./D.C. AMPLIFIERS
 Giving 4 to 10 watts output.

Single Output £6 6 0
 Double Output £10 10 0

UNIVERSAL A.C./D.C. SHORT-WAVE ADAPTOR
 Covering wavelengths between 12 and 85 metres. Complete with 2 valves and rectifier.

All ready to plug into any mains set £8 6 0

OSTAR-GANZ

UNIVERSAL HIGH VOLTAGE MAINS VALVES

The Ostar-Ganz range are the only Universal Valves that can be wired in Parallel. There's no wider, finer, or more up-to-date range available. Remember that Ostar-Ganz Valves work equally as well on either D.C. or A.C. supply without alteration, and they do not require transformers, barretter lamps or breakdown resistances. They work off the full mains voltage. Full details of range on request.

OSTAR-GANZ VALVES SPECIFIED FOR THE "W.M." BAND-SPREAD SHORT-WAVER

For full description of this exceptionally fine UNIVERSAL A.C./D.C. Receiver, see pages 69-73.

UNIVERSAL A.C./D.C. KITS

With these kits it is easy to build Universal A.C./D.C. receivers, etc., which work off any mains supply without alteration.

RECEIVER KITS

Highmu 3 £6 0 0
 Highmu 4 £8 10 0
 5-Valve Super £11 11 0
 3-Valve Super-Het £16 16 0

AMPLIFIER KITS

4-5 Watt Output £5 5 0
 6-8 Watt Output £8 8 0
 Full-size layouts and all instructions with every kit.

EUGEN J. FORBAT

28-29, SOUTHAMPTON STREET, STRAND, LONDON, W.C.2.

Telephone: Temple Bar 8608.

ALL WAVE RADIO ON YOUR EXISTING SET

If you are missing all the short wave stations why not fit the Unit Radio S.W. Converter and hear stations you have never heard before.

For use with any type of receiver, Mains or Battery, straight or super-het, no extra batteries required. Wave range 16-100 metres with one change of coil. Send for Illustrated Leaflet

DE-LUXE MODEL 39/6 CASH or C.O.D.
Sent for 5/- down

UNIT RADIO, 12 Pulteney Street
Barnsbury, London, N.1. Telephone Terminus 5382

NEVER AGAIN WILL YOU BE ABLE TO BUY OSBORN CABINETS

AT 50% OFF LIST PRICE TO MAKE ROOM FOR OUR EXHIBITION MODELS, A CATALOGUE OF WHICH IS NOW READY, POST FREE.

THIS IS OUR SENSATIONAL OFFER. ONLY 600 TO BE SOLD

Call at our showrooms:

21, Essex Road, SLINGTON. (Adjoining Collins' Music Hall.)

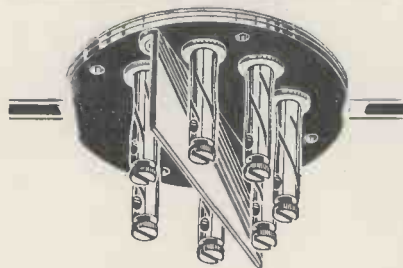

CLIX

CONTINENTAL TYPE
Chassis Mounting Valveholders

7-Pin Screened Type 1/8 each
SPECIFIED FOR THE

"W.M." BAND SPREAD SHORT-WAVE SET

In the July issue of "Wireless Magazine" Clix Chassis Mounting Valveholders

Specified for the

"W.M." RADIOGRAM SUPER

4-Pin 8d. 5-Pin 9d. 7-Pin 1/-

Clix are invariably specified wherever the modern chassis method of construction is used

LECTRO LINX LTD.

79a, Rochester Row, London, S.W.1

AMATEUR WIRELESS
3d. EVERY WEDNESDAY

WEARITE COMPONENTS

again in the
'Star' Specifications
for the **TYERS PORTABLE**

One WEARITE Universal Iron Core Coil Type I.C.S.6 (Screened) 7/6

for the

W.M. RADIO-GRAM SUPER

One Wearite G.N.4 Coil Unit (Aerial, pair Band Pass and Oscillator) 40/- complete

Two Wearite H.F. Chokes, Type H.F.S. 4/6 each

for the

BAND - SPREAD SHORT - WAVE

One Set Wearite 3 S.W. Coils 5/6 per coil

One Wearite Special S.W. Coil Holder base 2/6 complete

Two Wearite Special S.W. H.F. Chokes 1/6 each

SEND FOR THE WEARITE BOOKLET

Here is THE UNIVERSAL COIL . . .

Tunes 180 - 550 and 850 - 1950 metres

Specially designed to cover the Lucerne Plan. One Type of Coil suitable for H.F. Aerial and Band Pass Tuning.

PRICE PER COIL **5/-**



WEARITE COMPONENTS

COUPON

To MESSRS. WRIGHT & WEAIRE, LTD., 740 High Road, Tottenham, London, N.17.

Please send me a copy of your booklet No. M.12, together with details of your Universal Coils and "L.P." (Lucerne Plan) Circuits, particulars of your Class "B" Components (and Circuits) & also H.T. Power Packs with circuits

NAME

ADDRESS

W.M. 8/34.....



About Resistors!
Have you realised that half the Radio Industry is an **ERIE** Advertisement?



WHY IS IT that every leading manufacturer uses Erie Resistors and nearly every designer specifies them? It is because of the quality of Eries, because of their greater stability and unvarying accuracy. Eries are specially impregnated to prevent breakdown. That's exclusive! You always need the safety of Eries.

Specified this month for the

"TYERS PORTABLE" and 31 Eries Specified for the **"W.M." Radiogram Super**



RESISTORS

1/2 PER WATT in all values Each Resistor hand-tested, colour coded, labelled and Guaranteed.

Ask definitely for Erie Resistors. Helpful Colour Code Chart post free.

RADIO RESISTOR CO.
1 Golden Sq., Piccadilly Circus, London, W.1.

5277

Mention of the "Wireless Magazine" will ensure prompt attention

ON THE CREST OF THE WAVES

Radio News From All the World

:: By JAY COOTE

ARGENTINE REPUBLIC

THE breakdown of the North-South American Radio Conference in the early part of the year has led the owners of broadcasting stations in the Republics of Argentine and Uruguay to consider the establishment of the Union Sud-Americana de Radio-difusion, on the lines of the International Broadcasting Union.

The seat will be at Montevideo and the first meeting to take place will allot the wavelengths to be used by the interested concerns.

Although Chile is not a member, it is presumed that special channels will be reserved for her stations. It is also hoped that Brazil and Mexico may be induced to interest themselves in this association.

EGYPT

The new 20-kilowatt Cairo station was formally opened on May 31 and started its regular daily programmes on Sunday, June 3.

It is situated close to the commercial transmitters at Abu Zabal, about twenty miles to the north-east of Cairo, and works on 483.9 metres, a channel shared with Brussels (No. 1). The programmes are relayed by cable to a smaller station at Ras-el-Tin (Alexandria), where they are re-broadcast on 267.4 metres (5 kilowatts).

FRANCE

Notwithstanding the fact that the Wireless Bill has granted full powers to the State for the establishment of a broadcasting network, the number of private transmitters has not been curtailed. Some difficulty has, therefore, arisen in allocating wavelengths to all stations.

Radio LL (Paris), which has on various occasions usurped channels in the broadcast band, has now been ordered definitely to work on 209.9 metres. Radio Agen, although supposed to operate on an international common wave in the lower portion of the band, still broadcasts regular transmissions on 514.3 metres.

Radio Toulouse, which has been authorised to use its new high-power station, completed some months ago at the Chateau de St. Agnan, has exchanged wavelengths with Limoges PTT to avoid interference. They are now to be heard respectively on 327.7 metres and 335.2 metres. With the granting of the State authority, Radio Toulouse is now permitted to utilise the telephony network for its relays of outside broadcasts.

Work on the high-power station at La Brague, on the French Riviera, which is destined to ensure a service to Mentone, Monaco, Nice, Cannes, and Juan-les-Pins, has progressed so satisfactorily that it is expected the station may start testing in August. It will be formally opened in October.

HOLLAND

The Dutch Government is placing a proposal before its Parliament for an early adoption of Greenwich Mean Time. So far, Holland, although on the same meridian as Belgium, has worked to Amsterdam local time, a difference of some twenty minutes. It is thought Greenwich Mean Time would be welcomed not only by Dutch radio listeners, but also by the shipping, railway and aviation services.

ITALY

One of the main difficulties experienced in the past by studios anxious to broadcast to a number of foreign countries has been the choice of the language. Esperanto, although understood by a large number of people today, does not appear to have solved the problem.

For this reason the E.I.A.R., Rome, has decided to carry out, in a tentative manner, a number of transmissions in Latin, as it is thought that by this method a larger number of listeners may be reached.

LUXEMBOURG

There is a strong possibility that the power of this transmitter may be considerably increased by the end of

the year. The studio is fast developing its series of publicity programmes destined to different European states. Special hours are now devoted to entertainments sponsored by French, Belgian, and German firms, in addition to those provided by English concerns and which have become a regular feature of the Sunday broadcasts.

In view of the fact that increased income is obtainable if the sphere of the transmissions is widened, plans are being discussed for doubling the output power of the existing station in the near future. Luxembourg will then be a 400-kilowatt.

POLAND

In view of the success achieved by the Katowice letter-box hour, during which answers to foreign correspondents are broadcast in the French language, the studio is seriously considering the idea of devoting another evening of the week to answers *via* microphone for the benefit of listeners in Great Britain. These will be transmitted in English.

ROMANIA

In addition to the 120-kilowatt station at Lakihegy, programmes have been broadcast regionally by the old 3-kilowatt Budapest transmitter on the Island of Csepel. This second station is to be replaced by a 20-kilowatt, in order that a more extended area may be covered.

Budapest 2, according to the Lucerne Plan, was given the 1,321-kilocycle channel that has since been monopolised by the Magyarovar relay. The alternative regional transmission is now heard on 845 metres (355 kilocycles).

SYRIA

At the request of the French High Commissioner of the Republic of Lebanon (Syria), a British wireless company is studying the question of installing a broadcasting station at Beyrouth on the lines of the plant recently brought into operation at Cairo (Egypt).



IMMEDIATE DELIVERY

PETO-SCOTT HAS IT FIRST

... send to Peto-Scott for the latest in Radio. Everything new at **OLYMPIA** for **CASH, C.O.D. or EASIWAY**

IMPORTANT Miscellaneous Components, Parts, Kits, Finished Receivers or Accessories for Cash or C.O.D. or H.P. on our own system of Easy Payments. Send us a list of your wants. We will quote you by return. C.O.D. orders value over 1/- sent carriage and post charges paid (GREAT BRITAIN ONLY). OVERSEAS CUSTOMERS CAN SEND TO US WITH CONFIDENCE. We carry a special export staff and save all delay. We pay half carriage—packed free. Send full value plus sufficient for half carriage. Any surplus refunded immediately. Hire Purchase Terms are NOT available to Irish or Overseas customers.

PILOT AUTHOR KIT EXACT TO SPECIFICATION

TYERS PORTABLE

KIT "A" Author's Kit of First Specified parts, less Valves and Cabinet. Cash or C.O.D. Carriage Paid, £4/15/0.

Yours for **8/9** and 11 monthly payments of 8/8.

KIT "B" As Kit "A" but with set of Specified Valves. Cash or C.O.D. Carriage Paid, £6/13/3. Or 12 monthly payments of 12/3.

KIT "C" As Kit "A" but with Valves & Cabinet, less Speaker. Cash or C.O.D. Carriage Paid, £7/18/3. Or 12 monthly payments of 14/6.

If Peto-Scott Midget Permanent Magnet Speaker required add £1/2/6 to above cash prices or 2/1 to deposit and each monthly payment.

W.M. BAND-SPREAD SHORT-WAVER

KIT "A" Author's Kit of First Specified parts, less Valves. Cash or C.O.D. Carriage Paid, £6/15/0.

Yours for **12/3** and 11 monthly payments of 12/3.

KIT "B" As Kit "A" but with set of 3 Ostarganz Valves as specified. Cash or C.O.D. Carriage Paid £9/18/6.

Yours for **18/3** and 11 monthly payments of 18/3.

KIT-BITS You pay the Postman. We pay Post Charges on all Orders over 10/-. GREAT BRITAIN ONLY.

- 1 Peto-Scott aluminium chassis, 12 in. by 10 in. by 3 in., as specified ... 7 0
- 1 Peto-Scott aluminium panel, 12 in. by 7 in., as specified... ... 3 0

NEW 1935 ADAPTAGRAM

By the courtesy of the Editor of "Wireless Magazine" advance particulars of the **PETO-SCOTT 1935 ADAPTAGRAM** are appearing in page 93 of this issue. Models in Walnut, Oak, or Mahogany. Cash or C.O.D. 63/-. (Carriage and Packing 2/6 extra. SEND FOR LISTS.

YOURS FOR 8/3
Balance in 11 monthly payments of 5/9

PETO-SCOTT Co., Ltd. 77 CITY ROAD, LONDON, E.C.1. Telephone Clerkenwell 9406/7. West End Showrooms: 62 HIGH HOLBORN, W.C.1. Telephone Holborn 3245.

TELEVISION MADE EASY for the BEGINNER!

The August issue of TELEVISION, out to-day, price 1/-, contains a special section dealing with Television for the beginner. The following are some of the other contents of the AUGUST issue :—

- THE ABC OF CATHODE RAY TELEVISION.
- AN EXPERIMENTAL MIRROR DRUM TRANSMITTER.
- A NEW SYNCHRONISING SYSTEM.
- ADJUSTING AND OPERATING A CATHODE RAY RECEIVER.
- HOW TO IMPROVE THE RUNNING OF TELEVISION MOTORS, ETC., ETC.

On Sale **TO-DAY**

TELEVISION
AUGUST ISSUE - Price 1/-



This is one of Pye Radio's handsome new sets. It is the battery-operated super-het portable, model SP/B. It is on the lines of the Cambridge cabinets

News From All Parts

het battery set as their only means of keeping abreast with happenings in the rest of the world.

By the way, the General Electric Company have so much confidence in the future of wireless that they have

added 28,000 square ft. of floor space to their already huge works at Coventry. The total floor area of the Coventry works is now no less than 733,160 square ft. The works stand in an estate of 150 acres.

In the June issue of "Wireless Magazine" we published an article by Morton Barr entitled "New Ideas in Easy Tuning." We have since received a letter from Mr. James P. McGloin, of 7 Castlewood Park, Dublin, who points out that he is the inventor of the band-type tuning scale illustrated in Fig. 1 of the article.

British Radiophone, Ltd., the makers of the well-known Radiopak tuning unit, are introducing three exceptionally interesting sets at the forthcoming radio exhibition. One is a miniature five-valve super-het, called the Radiophone Bantam, which will be supplied complete with aerial. It needs no direct connection to earth.

Radiophone will supply a vibrator unit for use with this set so that it can be used on cars, provided, of course, that the car has been fitted with the usual suppressors.

The Bantam will cost in the neighbourhood of ten guineas, excluding the vibrator unit.

The other sets are an eight-valver covering both short, medium and long waves, and another, called the Empire, for short and medium wavebands only. Further information may be obtained from the makers at Aldwych House, Aldwych, London, W.C.2.

YOU remember that last month we told you all about Leonard Henry's vaudeville appearance on Worthing Pier. Now we understand that part of a performance is to be broadcast on July 28.

By the way, at that time the Post Office detector vans will be searching valiantly for wireless pirates in the Worthing, Brighton, Hastings, and Eastbourne areas.

Leonard Henry is making the most of their visit, and has written a skit, "Wireless Pirates and how to catch 'em," which it is hoped to include in the broadcast. Other artists in this show are the Eight Step Sisters, Beryl Orde, and Patrick Colbert.

Can you imagine sailing in uncharted seas in the Antarctic with only a radio set as a link with the rest of the world?

The British Graham-Land Expedition, which is shortly sailing on a cruise covering approximately 1,500 miles of un-surveyed coast line at the back of the Weddell Sea in the Antarctic, is taking a G.E.C. super-

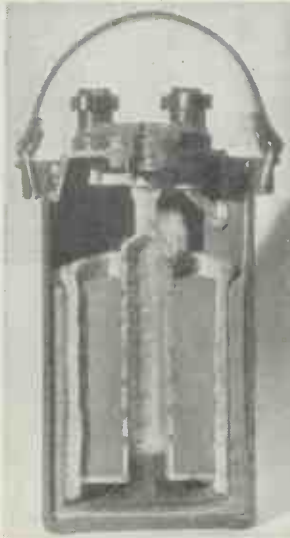

Showing the internal arrangement of the Block plateless accumulator

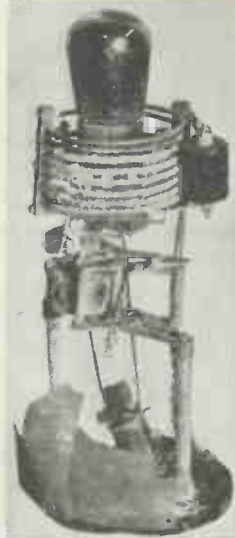

This six-year-old Philips transmitting valve was "caught" in a trawler's nets

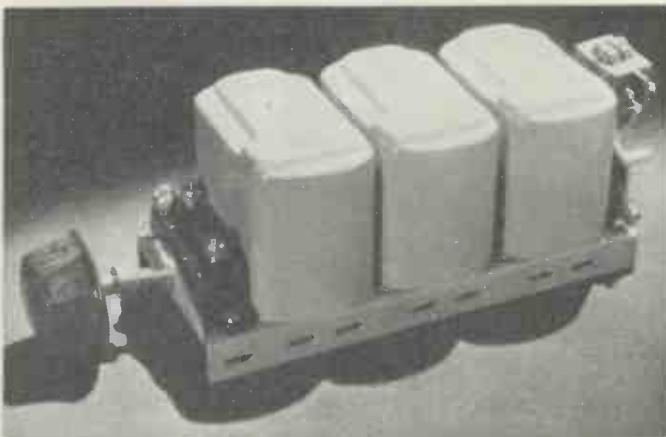

These are the new Colvern Ferrocart coils. They have identical characteristics with the previous types, but have greater mechanical strength and attractive new metal covers

Kolster-Brandes, Ltd., are making a feature of A.C./D.C. sets in their new season's programme. No fewer than four universal-mains sets will be marketed. These include two four-valve super-hets, one with a self-contained aerial, and a six-valver. Kolster Brandes are introducing a car-radio set later in the season.

Ultra Electric, Ltd., of Erskine Road, London, N.W.3, are also featuring an A.C./D.C. two-valver having exceptionally attractive lines. The set is contained in a horizontal cabinet with a large clock-face tuning dial almost as large as the loud-speaker fret. The price of this set is £8 15s.

Supplies are now available of six mains valves recently announced by High Vacuum Valve Co., Ltd., of 113-117 Farringdon Road, London, E.C.1. The range includes an

AC/HL, screen-grids, pentode, and a full-wave rectifier rated to give 120 milliamperes at 350 volts. The price of the rectifier is 12s. 6d.

The B.B.C.'s new 150-kilowatt station at Droitwich has begun its unofficial tests on 1,500 metres. This new ether giant will be officially opened on September 6.

The Peto-Scott Co., Ltd., of 77 City Road, London, E.C.1, have just introduced a 1935 version of their famous Adaptagram cabinet, which we have illustrated in these pages. The new cabinet is constructed of inlaid walnut with tastefully contrasted inlays of Macassar ebony. The square loud-speaker opening on the front is bound with chromium.

The cabinet is normally supplied with a plain front as shown in the illustration, but it can be obtained
(Continued on page 96)

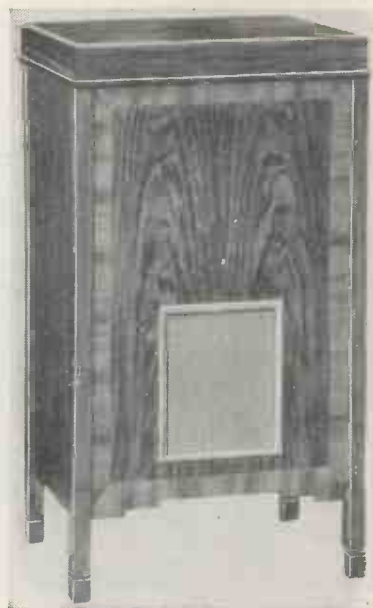

Peto-Scott's new Adaptagram cabinet has a chromium-plated band round the loud-speaker fret

The "W.M." Empire Short-waver in Fiji

You will not have any doubts about the thrills of short-wave listening after you read this letter, which tells in enthusiastic terms of the performance of the "W.M." Empire Short-waver in the Fiji Islands. This set, which was described in the June, 1933, issue of "Wireless Magazine," is a battery-operated four-valver

To The Editor.

Dear Sir,—I am writing, after nearly a year of delay, to redeem my promise to you of a full report on the Empire Short-waver, published in "W.M.," March, 1933. A series of setbacks partially delayed this report.

On unpacking the parts it was found that all the 1- and 2-microfarad fixed condensers had oozed from their bakelite cases—they were of the type with terminals fitted into the case. As nothing is obtainable here a two months' delay ensued, when these were replaced by a make completely enclosed by the moulding.

All should now have been plain sailing, but the fates decided not to let it be too easy, for in the preliminary tests of the completed receiver the beautiful little safety connector of those two little bright boys, Belling & Lee, slipped as it

was being fitted to the top of the valve and safely connected itself to the terminal of the detector-grid condenser—not the harmless end, but the coil end, and so to earth.

Before I could snatch it off I had the agony of seeing Wearite's charming little short-wave choke sizzling with blue smoke. More delay whilst suitable wire was being obtained to rewind said choke.

However, all's well that ends well, as I did eventually get the set going.

The Empire Short-waver is definitely the best straight short-wave set I have ever used, and results compare very favourably with six- and eight-valve super-hets, mostly of American origin, that I have heard here.

Some of them can produce a stronger signal, but I've got them all beaten for clear signals, which to my mind is preferable to extra "punch" in short-wave work.

I will not weary you with a list of stations received as this includes all the American and South American regulars and "umpteenth periodicals." The acid test here is reception from Daventry.

GSB on 31.5 metres is my best for good reception, though GSD on 25.5 metres is occasionally useful, though I seldom find the latter a

good alternative when GSB is not up to standard.

GSB is tuned in direct on the loud-speaker (Amplion PM22), and is nearly always able to pleasantly load it. This is subject, of course, to the usual short-wave vagaries of fading.

Recently conditions have improved regarding signal strength, and for the last three months the news given out in the 6 p.m. transmission has become quite a local institution.

Transmissions from the Byrd Antarctic Expedition are frequently received, and about a month ago on the occasion of the Byrd transmission given out by GSB, I was able to pick up the same programme from six different stations.

I originally received it from GSB, and on ascertaining what it was, searched round and was able to tune it in from Buenos Aires, then direct from the expedition, and later from two North American stations and also from Sydney.

I am very pleased with the set, and so far have not come across anything else that tempts me.

"W.M." still finds me here regularly every month.

With best wishes for your continued success.

Edward Vautier.

YOU CANNOT GO WRONG IF YOU USE A



FULL-SIZE BLUEPRINT

Each blueprint shows the position of each component and every wire and makes construction a simple matter. Copies of "Wireless Magazine" and of "Amateur Wireless" containing descriptions of most of these sets can be obtained at 1s. 3d. and 4d., respectively, post paid. Index letters "A.W." refer to "Amateur Wireless" sets and "W.M." to "Wireless Magazine" sets. Send, preferably, a postal order (stamps over sixpence unacceptable) to "Wireless Magazine," Blueprint Dept., 58-61 Fetter Lane, London, E.C.4.

And here are over 50 more to choose from—
CRYSTAL SET (6d.)

- 1931 Crystal Set AW308
- 4 Statlon Crystal Set AW427

- ONE-VALVE SETS (1s. each)**
- Easy to Build One AW304
 - Portable Short-wave One AW354
 - B.B.C. One-valver AW387
 - Short-wave One-valver AW429

- TWO-VALVE SETS (1s. each)**
- A Two for 7 Metres (D, Trans) WM295
 - A.C. Quality Gem (D, Trans) WM312
 - The Companionette (D, Pen-A.C./D.C.) WM358

★ **SPECIAL HALF-PRICE OFFER**

Blueprints of the following "Wireless Magazine" sets described in this issue are obtainable at the special price, given below, if the coupon on last page is used before Aug. 31, 1934.

- Tyers Portable (SG, D., 2 L.F., WM367 9d.
- "W.M." Band-spread Short-waver (A.C./D.C) (D, Pen). WM368 ... 6d.

- "A.W." Iron-core Two (D, Trans) AW395
- "A.W." Iron-core Two with Q.P.P. AW396
- Big Power Melody Two, with Lucerne Coils (SG, Trans) AW338A
- B.B.C. National Two, with Lucerne Coils (D, Trans) AW377A
- Lucerne Minor (Det, Pen) AW426
- Home Station A.C. 2 (D, Pen) AW374
- B.B.C. National Two (D, Trans) AW377
- Melody Ranger Two (D, Trans) AW388
- Consolelectric Two (D, Pen) A.C. AW403
- Lucerne Minor (D, Pen) AW426

THREE-VALVE SETS (1s. each)

- C.B. Three (D, LF, Class-B) WM333
- Duo-tuned Three (SG, D, Pen) WM341
- A.C. Transportable (SG, D, Pen) WM347
- All-wave Three (D, 2LF) WM348
- "W.M." 1934 Standard Three (S.G., Det, Pen) WM351
- Emigrator (A.C. set : 14-500m.) (S.G., D, Pen) WM352
- £3 3s. Three (SG, D, Trans) WM354
- Heptode Super Three (A.C. Super-het) WM359
- Iron-core Band-pass Three (SG, D, QP 21) WM362
- £6 6s. A.C./D.C. Three (SG, D, Pen) WM364
- All-wave Battery Three (SG, D, Pen) WM365
- James Push-push Three (SG, D, Q.P.P.) (1/6) AW378
- Everybody's Home Radiogram (SG, D, Trans) AW381
- Home-lover's New All-electric 3 for A.C. mains (SG, D, Trans) AW383
- Our Up-to-the-Minute Three (SG, Westector, LF, Trans) AW384
- Class-B Three (D, Trans, class B) AW386
- A.C. Trilodyne (SG, D, Pen) AW399
- Home-built Coll Three (SG, D, Trans) AW404

- Fan and Family Three (D, 2LF) AW410
- £5. 5s. S.G.3 (SG, D, Trans) AW412
- 39/- Lucerne Ranger (SG, D, Trans) AW422
- Penta-guester (S.G., D, Pen) AW431

FOUR-VALVE SETS (1s. 6d. each)

- Calibrator (SG, D, RC, Trans) WM300
- Table Quad (SG, D, RC, Trans) WM303
- "Words and Music" Radiogram (2 SG, D, Trans) WM307
- "Words and Music" Radiogram de Luxe (SG, D, RC, Q.P.P.) WM307a
- Home Short-waver (SG, D, RC, Trans) WM311
- Empire Short-waver (SG, D, RC, Trans) WM313
- Calibrator de Luxe (SG, D, RC, Trans) WM316
- All-metal Four (2 SG, D, Pen-A. C. Mains) WM329
- Self-contained Four (SG, D, LF, Class B) WM331
- All-progress Four (Battery Super-het) WM335
- Merrymaker Super (A.C. Super-het) WM345
- 1934 A.C. Quadrydne (2SG, D, Pen) WM349
- Lucerne Straight Four (SG, D, LF, Trans) WM350
- Universal Merrymaker (A.C./D.C. Super-het) WM356
- "A.C. Melody Ranger" (SG, D, RC, Trans) AW380
- "A.W." Ideal Four (2SG, D, Pen) AW402
- 2 H.F. Four (2 SG, D, Trans) AW421
- Lucerne Major (256 SG, Trans) AW433

FIVE-VALVE SETS (1s. 6d. each)

- New Class-B Five (SG, D, LF, Class-B) WM340
- Class-B Quadrydne (2 SG, D, LF, Class-B) WM344
- James Short-wave Super (Super-het) AW328
- Simple Super (Super-het) AW340
- The Etherdne (Super-het) AW406
- 1934 Century Super (Battery super-het) AW413

SIX-VALVE SETS (1s. 6d. each)

- 1932 Super 60 (Super-het) WM269
- 1932 A.C. Super 60 (A.C. Super-het) WM272
- "W.M." D.C. (Super-het) WM321
- James Class-B Super (Super-het with iron-cored coils) WM326
- Welcome Portable with class-B output stage WM325
- Connoisseurs' Super (A.C. Super-het) WM334
- James Super Straight Six (2 SG, D, LF, Push-pull) WM339
- Lucerne Super (battery super-het) WM355

SEVEN-VALVE SETS (1s. 6d. each)

- Super Senior (Super-het) WM256
- Seventy-seven Super (A.C. Super-het) WM305
- Q.P.P. Super 60 (Super-het) WM319

EIGHT VALVE SET (1s. 6d.)

- "W.M." Radiogram Super (A.C. Super-het) WM366

PORTABLES (1s. 6d. each)

- Town and Country Four (SG, D, RC, Trans) WM282
- Everybody's Portable (five-valve Super-het) WM291
- Welcome Portable (six-valve Super-het) WM322
- Spectrum Portable (SG, D, QP21) WM357
- "Two H.F." Portable (2SG, D, QP21) WM363
- General-purpose Portable (SG, D, RC, Trans) AW351

AMPLIFIERS (1s. each)

- 10-watt A.C. Amplifier WM360
- 10-watt D.C. Amplifier WM361
- Universal Push-pull Amplifier AW300
- "A.W." Record Player (LF, Push-pull) AW317
- Battery-operated Amplifier AW362
- "A.W.'s" Push-push Amplifier AW 376
- Class-B Gramophone Amplifier AW391
- Universal A.C. Amplifier (3-valve) AW411
- Five Q.P.P. Output Circuits AW315

MISCELLANEOUS (1s. each)

- A.C. Short-wave Converter WM353
- "A.W." Trickle Charger AW352
- Experimenters' D.C. Mains Unit AW430
- Experimenters' A.C. Mains Unit AW432
- Add-on Band-pass Unit AW359
- Plug-in Short-wave Adaptor AW382

You can always rest assured that if you build your set with a "W.M." full-size blueprint, it will work first time and work well!

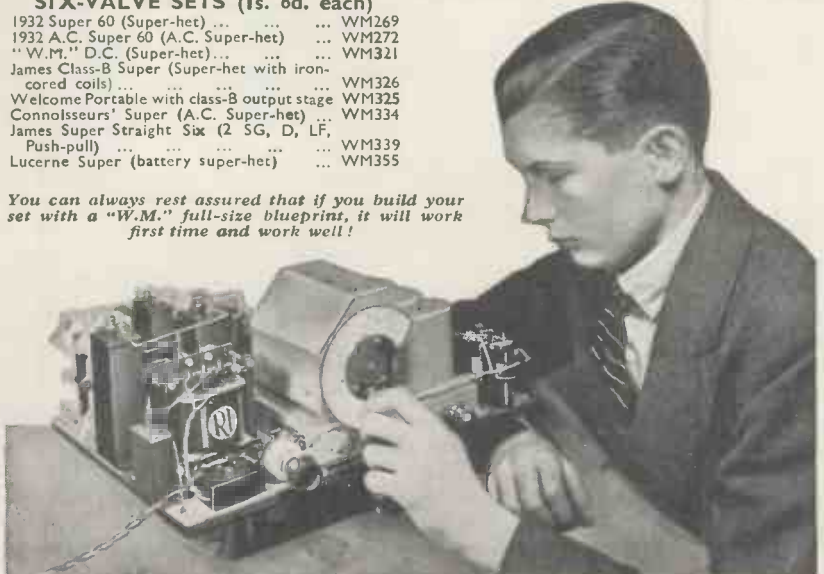

It comes out every Friday —the twopenny paper the family will enjoy too!

Every Friday RADIO PICTORIAL reveals in pictures and in words the home life of popular broadcasters. Scores of lifelike photographs of the favourites you listen to, thrilling fiction, clever humour, a corner for the children, a splendid feature for the wife, etc., etc. RADIO PICTORIAL puts you in intimate touch with the human side of broadcasting and adds greatly to your enjoyment of listening-in. A great twopennyworth!

**GET YOUR NEWSAGENT TO DELIVER
"RADIO PICTORIAL" EVERY FRIDAY**

RADIO PICTORIAL

**ON SALE AT ALL
BOOKSTALLS and
NEWSAGENTS**

Price 2^D.

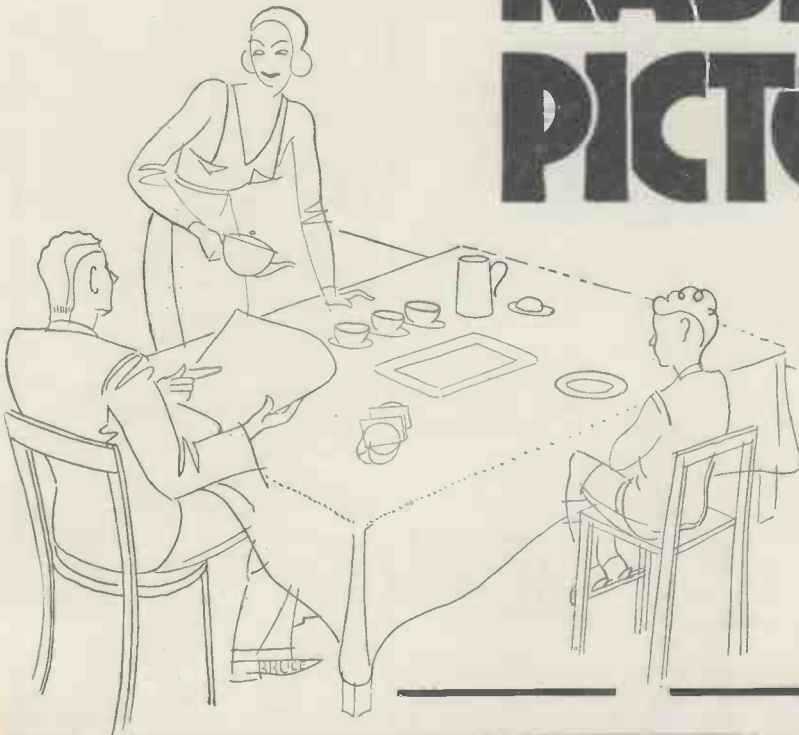

BLUEPRINT COUPON

Valid only until Aug. 31,
1934 (or until Sept. 30,
1934, for overseas readers)

FOR ONE BLUEPRINT ONLY

If you want a full-size blueprint of any ONE of the sets constructionally described in this issue for half price, cut out the above coupon and send it, together with a postal order, to Blueprint Department, WIRELESS MAGAZINE, 58-61 Fetter Lane, London, E.C.4.

This coupon is valid for a blueprint of any ONE only of the following sets at the prices indicated:—

TYERS PORTABLE (page 13), No. WM367, price 9d., post paid.

"W.M." BAND-SPREAD SHORT-WAVER (page 69), No. WM368, price 6d., post paid.

INFORMATION COUPON

Valid only until Aug. 31,
1934 (or until Sept. 30,
1934, for overseas readers)

If you want to ask any questions, cut out the above coupon and send it, together with a postal order for 1s. and stamped addressed envelope, to the Information Bureau, WIRELESS MAGAZINE, 58-61 Fetter Lane, London, E.C.4.

Note that not more than two questions may be asked at a time and that queries should be written on one side of the paper only.

Under no circumstances can questions be answered personally or by telephone. All inquiries must be made by letter so that every reader gets exactly the same treatment.

Alterations to blueprints or special designs cannot be undertaken: nor can readers' sets or components be tested.

If you want advice on buying a set, a stamped addressed envelope only (without coupon or fee) should be sent to the Set Selection Bureau, WIRELESS MAGAZINE, 58-61 Fetter Lane, London, E.C.4.

NEWS FROM ALL PARTS

(Continued from page 93)

vignetted to take standard-size panels at no extra charge.

There are three models, and the model A costs only £3 3s. Incidentally, it can be obtained in oak or mahogany at no extra charge.

We get several requests from readers for the names of firms who supply complete kits of parts of "W.M." sets. There is no need for us to remind regular readers but we mention it for the benefit of new subscribers that Peto-Scott Pilot Author kits are supplied with the exact parts specified by the designer down to the last screw and bolt.

On page 92 you will see a quaint looking piece of apparatus illustrated in the centre. This is a Philips transmitting valve which was picked up in the nets of a Padstow trawler about 30 miles off Trevose Head in the Bristol Channel.

Markings on the cap of this valve show that it was made in France in 1925 by the Philips Radio Co. The trawler people returned the valve to Philips, who tried it and found that it still "burns."

It is believed that the valve may have been part of the short-wave automatic-beacon transmitter of a buoy or lightship, which had either foundered or had been sunk in a collision.

By the way, let us remind you once again that you must pay a visit to the "W.M." stand at Olympia this year.

"Songs of the Shows," "Old Time Music Hall," and "In Town Tonight" will all draw you to the great variety theatre, but don't forget to pay a visit to STAND No. 10. We look forward to your company.

The employment curve is likely to take a sharp rise in the Tottenham district of London in the very near future. Not far from the Hotspur's football ground, a big new British valve factory has come into being. It is the factory of the British Tungsram Radio Works, Ltd., where in future all Tungsram valves will be made.

A large amount of unique machinery has already been installed and some "trial trips" have been made.

INDEX TO ADVERTISERS

	Page
A	
Automatic Coil Winder and Electrical Equipment Co., Ltd.
B	
British Blue Spot Co., Ltd.	..
Bulgin A. F. & Co., Ltd.	..
Burne Jones & Co., Ltd.	..
C	
Columbia Graphophone Co., Ltd.
Cossor, A. C. & Co., Ltd.	3
D	
Dubilier Co., Ltd.
E	
Edge Radio, Ltd.
F	
Ferranti, Ltd.
Fluxite, Ltd.	87
Forbat, Eugene, Ltd.	88
G	
General Electric Co., Ltd.	5
Gramophone Co., Ltd.	10
Garrard Eng. Co., Ltd.	9
Grampian Reproducers Ltd.	9
J	
Jackson Bros., Ltd.	7
K	
Kehtex Radio
L	
Lectro-Linx, Ltd.,	89
O	
Osborn, Chas.	89
P	
Partridge & Mee, Ltd.
Peto-Scott Co., Ltd.	91
Pifco, Ltd.
R	
"Radio Pictorial"	95
Radio Resistors	89
S	
Siemens Bros.	Cover ii
Smith (M/A), Ltd.	Cover iv
Stratton & Co.
T	
Telegraph Condenser Co., Ltd.	87
Telephone Manufacturing Co., Ltd.	7
"Television"	91
U	
Universal High-Voltage Radio Unit Radio	88 89
V	
Varley	87
W	
Westinghouse Brake & Saxby Signal Co., Ltd.	7
Wright & Weaire, Ltd.	89

Join the CONSTRUCTOR CRUSADERS TO-DAY!

MEMBERSHIP of the "Amateur Wireless" Constructor Crusaders is open to everybody who is seriously interested in the home building of radio sets. There are no fiddling rules and regulations, but, on the other hand, members of this fellowship will receive a number of valuable privileges. Constructor Crusaders will each receive a full-size photographic blueprint of the four special sets that will be released during the 1934-1935 season.

Further, however, every Constructor Crusader will be given the full advantage of free technical advice by the "Amateur Wireless" Technical Staff on the building and operation of each of these four special receivers.

To focus this great interest so that Constructor Crusaders can exchange ideas, make suggestions for the help of fellow constructors—and, if necessary, air their grouses—we shall devote at least one page of "Amateur Wireless" every week from now on to a special Constructor Crusaders' Corner, which will be open to every member. Only serious set-builders are wanted as Constructor Crusaders. We want to encourage the constructor to tell us of his own particular needs so that we can do our best to meet them.

That is why we want to organise the constructor interest that is so very much alive all over the country into a definite channel. We want constructors to say what types of sets they want; why they like one type in preference to another; where certain circuits have not come up to their expectations; and where they think improvements can be made.

This week's issue of "Amateur Wireless," Price 3d., contains a membership application form. Get a copy now and enrol to-day.

**Our Great New
Scheme for Home
Set-builders**

will provide

FREE Full-size
Blueprints

FREE Technical
Advice

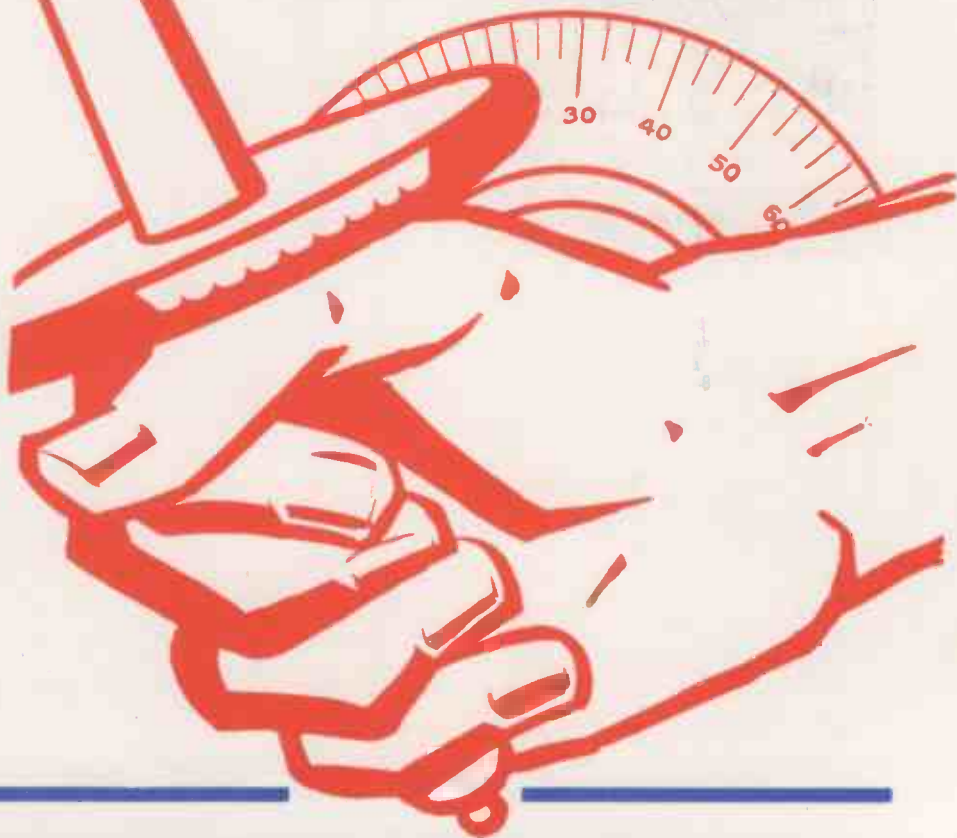

See us at

OLYMPIA

'ANODEX' DRY BATTERIES

We are not the oldest firm in the industry, nor yet the largest, but we can justifiably claim to be the most progressive. Smith's Accumulators and "Anodex" Dry Batteries have achieved a meteoric rise to popularity. And while we are continually increasing our resources—introducing new lines—and seeking new ways in which to help the Trader, we take every opportunity of improving our products to the mutual benefit of our stockists and public.



WRITE FOR FREE ILLUSTRATED FOLDER



Many additional features are included in the newly-designed range of SMITH'S ACCUMULATORS, ensuring even greater efficiency and convenience in use. Attention is drawn to the large non-interchangeable coloured terminals, grease cups preventing corrosion, ebonite separators, charging device, panel for owner's name, charge dates, etc., and non-slip metal carrier.



SMITH'S ACCUMULATORS

S. SMITH & SONS, (Motor Accessories) LTD.
CRICKLEWOOD, LONDON, N.W.2.