

TWO SUPERS: SHORT-WAVE *and* FRAME-AERIAL

Wireless Magazine

THE BEST SHILLINGSWORTH IN RADIO

NOVEMBER 1932



MODERN
LOUD SPEAKERS
SPECIAL SUPPLEMENT
INSIDE

OTHER CONTENTS

Why Not An Epilogue for Everyman?
The Screen-grid Valve As Detector
Percy Harris on the Variable Resistance
New Screen-grid Four

IN THE HANDS OF RADIO EXPERTS



The leading electric wire manufacturers for over fifty years, Lewcos have been in the van of radio progress from the commencement. Lewcos Components are indispensable for perfect reception. Write for leaflets and please quote reference numbers.

COMPONENTS OF EVERY DESCRIPTION		Leaflet Ref. Nos.
L.F. and H.F. Transformers	R76
L.F. and H.F. Chokes	R76 & 78
Potentiometers	R79 & 81
Band-pass Filters	R73a
Spaghetti Resistances	R78
		Glazite Connecting Wire

Lewcos

REGD

LEWCOS RADIO PRODUCTS FOR BETTER RECEPTION

THE LONDON ELECTRIC WIRE COMPANY AND SMITHS LIMITED, CHURCH ROAD, LEYTON, LONDON, E.10

Editor:

BERNARD E. JONES

Technical Editor:

J. H. REYNER,
B.Sc. (Hons.), A.M.I.E.E.

Wireless Magazine

The Best Shillingworth in Radio

Vol. XVI :: NOVEMBER, 1932 :: No. 94

Assistant Editor:

D. SISSON RELPH

Research Consultant:

W. JAMES

Published by BERNARD JONES PUBLICATIONS, LTD., publishers of "Wireless Magazine" and "Amateur Wireless." Editorial and Advertisement Offices: 58-61 Fetter Lane, London, E.C.4. Telephone: City 3733, 3744. Telegrams: "Benzapee, Fleet, London." Subscription: Great Britain and abroad, 13s. 6d. a year post free (Canada only, 13s. 6d.). Next issue published on Wednesday, November 23

As the Editor Sees It

MY introduction to the month's contents is too often a mere catalogue of titles, but please tell me what I am to do in my restricted space when I sit down to talk about such an issue as the November "Wireless Magazine"?

Surely you will agree that I am giving you most of the radio writers that matter and that between them they put up a thoroughly bright, varied, and useful issue.

Frankly, I do not know who or what should have pride of place in my introduction, but I can at any rate say that my 16-page supplement—"Modern Loud-speakers"—is an item of outstanding importance. In it Noel Bonavia-Hunt reviews the four main types of loud-speaker and my Technical Staff describes a dual-speaker amplifier—in other words, an amplifier feeding two speakers, one good in the bass and the other in the top registers. This is the latest idea for obtaining naturalness of reproduction.

For a moment I will leave the technical contents and have a word about an article by Whitaker-Wilson on the Epilogues. While it is undoubtedly controversial, and none the worse for that, I think every reader will ponder over the suggestion made by the author, who wants to see broadcasting "completely catholic, by which I mean universal. I want," he says, "to see the epilogues what they should be—wonderful, impelling afterthoughts for Everyman's Sunday."

Another feature of strong broadcasting interest is J. Godchaux Abraham's "The Lure of the Ether," in which he explains, chiefly for the benefit of the new reader, just what the ether can give in the way of entertainment. He makes the point that "it is seldom we register disappointment, for at any time during the day or night the ether can furnish many kinds of recreation. . . . We have the world at our elbow."

Now for some of our technical articles. Early in our

pages F. E. Henderson, an acknowledged authority in the valve industry, comments on the fashion of extending the use of the screen-grid valve and points out that many new receivers utilise this valve as a detector; in his article he explains authoritatively and in detail how the screen-grid functions in that capacity.

P. Wilson continues his discussion on the subject of automatic volume control. With his help we hope soon to be in a position to present readers with a set in which such control is incorporated as the chief feature. Mr. Wilson is also responsible for an extremely informative article in our Gramo-Radio Section, with regard to which I may say that no man knows more than he of the relation between the needle and the gramophone record, and I doubt whether any authority on the subject can express himself so well.

It is seldom that "Wireless Magazine" includes a set designed by a newcomer, but in this issue W. G. Hill is responsible for a set, the "W.M." Short-wave Super, which he and ourselves have been discussing for some time. Mr. Hill has had great experience in radio-set design and has produced a short-wave super-het that undoubtedly has great possibilities. The idea behind the design is to obviate most of the "trickiness" associated with the operation of a short-wave receiver.

The Calibrator, described last month, became immediately popular, it being at once recognised that the new tuning unit definitely avoids most of the troubles associated with ganging. To the readers who have written asking for an A.C. version, we can only say that they must watch for an early announcement.

There is easily a dozen other features to which I should like to pay the courtesy of brief mention, but I must resist the temptation. Just turn over the pages for yourselves. I am sure they will please you,

B. E. J.

MODERN LOUD-SPEAKERS

(16-page Supplement after page 456)

INTRODUCTION	Page One
P'S AND Q'S OF THE FOUR TYPES. By Noel Bonavia-Hunt, M.A.	Page Two
CONTROLLING THE TONE	Page Seven
A DUAL-SPEAKER AMPLIFIER. By the "W.M." Technical Staff.	Page Eight
MATCHING THE LOAD. By P. K. Turner, M.I.E.E.	Page Eleven
NOTES, HINTS AND TIPS	Page Sixteen

FOR THE CONSTRUCTOR

THE EASYTUNE 60 ON A FRAME AERIAL. By J. H. Reyner, B.Sc., A.M.I.E.E.	478
THE TABLE QUAD. By the "W.M." Technical Staff	489
THE PROSPERITY THREE: Further Notes for the Constructor	497
A SET WITHOUT GANGING TROUBLES: More About the Calibrator	503
THE "W.M." SHORT-WAVE SUPER. By W. G. Hill	508

GENERAL ARTICLES

GUIDE TO THE WORLD'S BROADCASTERS. By Jay Cooté	436
WORLD'S BROADCAST WAVELENGTHS	444

Contents

RADIO MEDLEY. By BM/PRESS	453
ON THE CREST OF THE WAVES. By Jay Cooté	456
THE EPILOGUES. By Whitaker-Wilson	460
THE LURE OF THE ETHER. By J. Godchaux Abraham	465
CONCERNING PATENTS. By Our Legal Correspondent	468
THE "O.B." IN AUSTRALIA. By C. Danvers-Walker	475
STORIES OF THE OPERAS: Damnation of Faust	477
THE B.B.C. AT CLAPHAM. By Kenneth Ulyett	482
SOME FAMOUS "W.M." SETS	484
BROADCAST MUSIC OF THE MONTH. By T. F. Henn	494
HIGH-SELECTIVITY RECEIVERS	502
THOUGHTS OF AN ANNOUNCER. By George Macaulay	505
NEWS OF THE SHORT WAVES	507
IN FA OUR O - FRAME AERIALS	526
POINTS ROM HERE AND THERE	526
NOTE AND JOTTINGS	530
THE WIRELESS ZOO: The Tele-monkey	536
IN TUNE WITH THE TRADE. By Fetter Lane	528
BLUEPRINT AND INFORMATION COUPONS	552
INDEX TO ADVERTISERS	552
VALVES TO USE IN YOUR SET	428

TECHNICAL FEATURES

THE SCREEN-GRID VALVE AS DETECTOR. By F. E. Henderson, A.M.I.E.E.	457
AUTOMATIC VOLUME CONTROL—2. By P. Wilson, M.A.	462 and 530
WE TEST BEFORE YOU BUY. By the "W.M." Set Selection Bureau	469
STATION MASTER THREE (KIT SET)	470
H.M.V. SUPER-HET SIX PORTABLE	471
ATLAS A.C. TWO-VALVER	472
COSSOR MELODY MAKER—MODEL 335	473
LOTUS BAND-PASS A.C. 3	474
FILLING YOUR ACCUMULATOR	483
HIGH-FREQUENCY STABILITY	483
THE VARIABLE RESISTANCE. By Percy W. Harris, M.Inst.Rad.E.	485
RADIO IN REVIEW. By Morton Barr	488
NOTES ON GANG TUNING. By W. James	500
COIL DOPES AND THEIR EFFECTS	506
TESTS OF NEW APPARATUS	526
IMPROVEMENTS THAT MATTER. By Alan Hunter	532
CURING MAN-MADE STATIC I	538
TESTS OF NEW APPARATUS	546

GRAMO-RADIO SECTION

THE NEEDLE AND THE RECORD—3. By P. Wilson, M.A.	514
CHOOSING YOUR RECORDS. By Whitaker-Wilson and Chopstick	522
SPECIAL CHRISTMAS RECORDS	524

Registered at the General Post Office for transmission by Canadian Magazine Post

Postage on this issue, 3s. 1. (inland and abroad)



AMPLION M.C.22 PERMANENT MAGNET

The Amplion M.C.22 looks a good job, and when you come to hear it (as you certainly should do before deciding), you will find that it lives up to its appearances—and its name.

It is sensitive, it can handle great volume if necessary, and it has a truly universal input transformer. Try it on a two-valve battery set, or an all-mains super-het, and the quality will be the same, sweet and pure. People listen when the Amplion speaks.

PRICE 39/6



AMPLION PICK-UP AND ARM

The finest pick-up. Handsome bakelite, smooth movement, no tracking wear, wide range of volume control; and perfect reproduction. PRICE 25/-

AMPLION

AMPLION (1932) LTD., 82/84 ROSOMAN STREET, LONDON, E.C.1
CLERKENWELL 5440-1

OSBORN RADIO CABINETS

"MADE BY CRAFTSMEN FOR PARTICULAR PEOPLE"

MODEL No. 234. Beautiful Queen Anne style. Radio-Gramophone Cabinet, 3 ft. 3 in. high by 2 ft. 6 in. wide by 1 ft. 6 in. deep. Takes panel 19 in. by 12 in., or smaller. Ample room for any type of gramophone motor and largest H.T. and L.T. batteries made. Storage for 35 Records each side of set. If you desire larger panel space, this Cabinet takes panel 27 in. long by omitting Records storage.



MODEL No. 234

PRICES

Machined ready to assemble, Oak, £3 10s.; Mahogany, £3 15s.; Walnut, £4 10s. Assembled Ready to Polish, Oak, £4 10s.; Mahogany, £4 15s.; Walnut, £5 10s. Assembled and Polished, Oak, £5 10s.; Mahogany, £6 5s.; Walnut, £7 5s. All Models Carriage Paid.

OSBORN SUPER ACOUSTIC Baffle Board. Prevents 90 per cent. of speaker scree. Guaranteed no vibration even when attached to powerful Moving-coil. Any size hole cut FREE. 18 by 18, 3s.; 24 by 24, 5s.; 30 by 30, 8s.; 36 by 36, 11s. 3d. Carriage paid U.K. SEND FOR FREE SAMPLE!

STANDS 117 & 118 BLOCK "S"

Scottish National Radio Exhibition, Edinburgh, Waverley Market - October 12-22.

SEND FOR FREE CATALOGUE of LATEST MODELS

CHAS. A. OSBORN (Dept. W.M.)

THE REGENT WORKS, ARLINGTON STREET, LONDON, N.1. Telephone Clerkenwell 5095. And at 21 Essex Road, Islington, N.1. (9 minutes from Essex Road Tube Station.) Telephone Clerkenwell 5634.

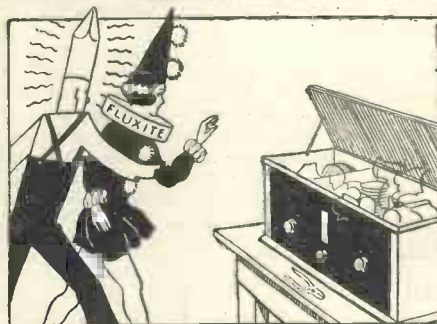

"We're Fluxite and Solder, The reliable pair, Famous for Soldering—Known everywhere!"

Wherever there's Wireless—There you'll find US, We SOLDER ALL CONNECTIONS Without any fuss!"

See that Fluxite and Solder are always by you—in the house, garage, workshop—anywhere where simple, speedy, soldering is needed. They cost so little, but will make scores of everyday articles last years longer! For Pots, Pans, Silver, and Brassware; RADIO; odd jobs in the garage—there's always something useful for Fluxite and Solder to do.

All Hardware and Ironmongery Stores sell Fluxite in tins, 8d., 1/4 and 2/6.

NEW "JUNIOR" SIZE, 4d. per tin
FLUXITE SOLDERING SET
Simple to use and lasts for years in constant use. Contains special "small-space" soldering iron with non-heating metal handle; pocket blow-lamp, Fluxite, Solder, etc.; and full instructions.
COMPLETE, 7/6 or LAMP only 2/6

FLUXITE LTD.,
(Dept. 332)
ROTHERHITHE, S.E.16.

ANOTHER USE FOR FLUXITE
Hardening Tools and Case Hardening. Ask for Leaflet on improved method.

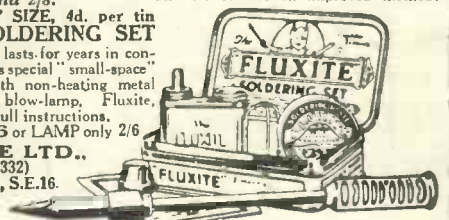

ALL MECHANICS WILL HAVE

FLUXITE

IT SIMPLIFIES ALL SOLDERING

Mention of the "Wireless Magazine" will ensure prompt attention

HERE ARE THE COILS YOU WILL NEED—

Specified for the "Prosperity Three" Battery Model, A.C. Model and D.C. Model.

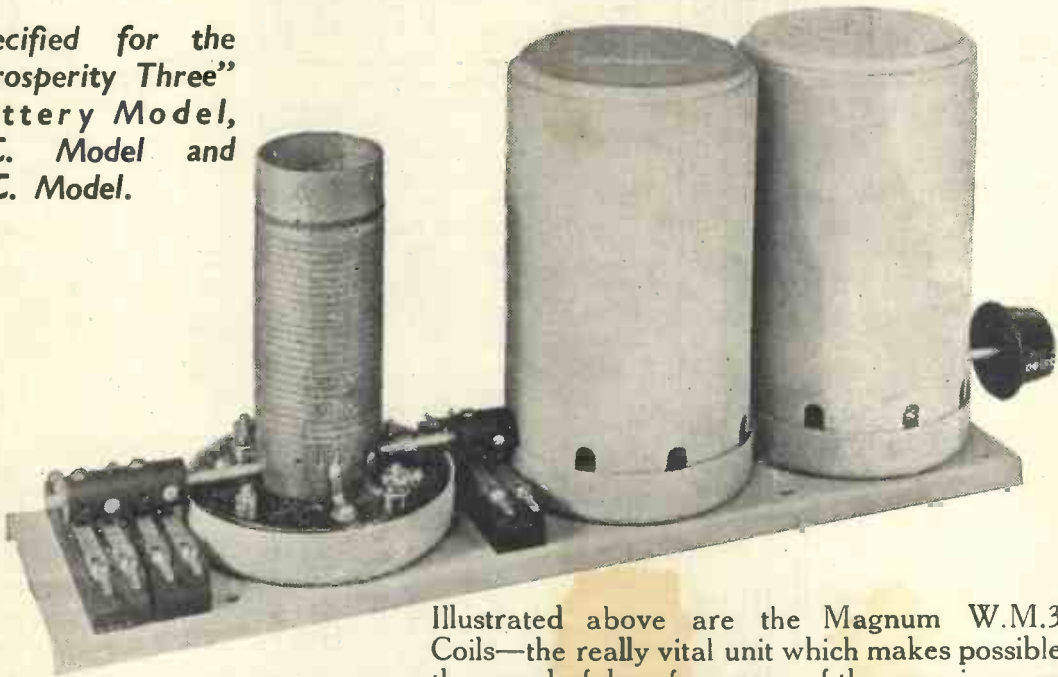

Illustrated above are the Magnum W.M.3 Coils—the really vital unit which makes possible the wonderful performance of the amazing new "Prosperity Three." No wonder they are specified for all three models! They enable you to cover the entire range of broadcast wavelengths from the ultra short waves to 2,000 metres by the operation of a single switch! They are extraordinarily selective, and are built with that care and thoroughness which is typical of all "Magnum" components. Send for your coils to-day. Per set **30/-** Complete with switch and baseboard

OTHER FAMOUS MAGNUM COMPONENTS

MAGNUM 25 megohm Variable Resistance has been specified for "Dual Speaker Amplifier"
Price 3/6

MAGNUM SHORT-WAVE CONVERTOR for both A.C. Mains and Battery Sets. Price, including coil 40/80 metres, cord and plug, 39/6. Extra coil if required, 18/40 metres, 3/- (not suitable where S.G. Detector is used). Model T for sets using British Valves. Model T.A. for sets using American Valves.

STENODE—The set that is years ahead. A brochure fully describing the latest Burne-Jones "Stenode" is now available, free on request.

MAGNUM W.M.3. COILS

BURNE-JONES & CO., LTD., MAGNUM HOUSE

296, Borough High Street, London, S.E.1

Telephone: Hop 6257 & 6258

Scottish Agent :—Mr. Ross Wallace, 54 Gordon Street, Glasgow, C.1

Advertisers like to know you "saw it in the 'Wireless Magazine'"

VALVES TO USE IN YOUR SET

Characteristics of All the Most Important British Types

Make	Type	Impedance	Amplification Factor	Mutual Conductance	Anode Current at 120 volts	Make	Type	Impedance	Amplification Factor	Mutual Conductance	Anode Current at 120 volts	Make	Type	Impedance	Amplification Factor	Mutual Conductance	Anode Current at 120 volts
2-volt Three-electrode Valves						2-volt Variable-mu Valves						6-volt Three-electrode Valves					
Mazda	H210	59,000	47	.8	5	Lissen	SG2V	350,000	—	1.7	—	Mazda	H607	90,000	40	.45	1.0
Lissen	H210	50,000	35	.7	1.0	Mazda	S215VM	350,000	700	2.0	—	Mazda	H610	66,000	40	.6	1.0
Cossor	210RC	50,000	40	.8	5	Mazda	S215B	334,000	700	2.1	—	Lissen	H610	60,000	40	.66	1.0
Osram	H210	50,000	35	0.7	1.0	Cossor	220VSG	110,000	—	1.6	—	Osram	H610	60,000	42	.66	.35
Six-Sixty	210RC	45,400	50	1.1	1.0	Osram	VS2	—	—	1.25	—	Osram	H610	60,000	40	.7	1.0
Lissen	H2	45,000	50	1.1	2.0	Marconi	VS2	—	—	1.25	—	Six-Sixty	6075RC	58,000	40	.7	.75
Mazda	H2	45,000	50	1.1	—	Six-Sixty	215VSG	—	—	1.25	—	Cossor	610RC	50,000	40	.8	.75
Mullard	PM1A	41,600	50	1.2	.75							Mullard	PM5B	49,000	40	.85	1.0
Marconi	H2	35,000	35	1.0	1.0							Marconi	HL610	30,000	30	1.0	1.0
Osram	H2	35,000	35	1.0	1.0							Osram	HL610	30,000	30	1.0	1.0
Six-Sixty	210HF	25,000	19	.75	1.0							Lissen	HL610	21,000	25	1.2	2.5
Osram	HL210	23,000	20	.87	1.5							Cossor	610HF	20,000	20	1.0	1.75
Marconi	HL210	23,000	20	.87	1.5							Mazda	HL610	20,000	22	1.1	1.8
Mullard	PM1HF	22,500	18	.8	1.0							Mullard	PM5D	20,000	26	1.3	1.0
Cossor	210HL	22,000	24	1.1	1.75							Six-Sixty	607H	15,200	17	1.1	2.0
Lissen	H. 2	22,000	35	1.6	3.0							Mullard	PM5X	14,700	17.5	1.2	1.6
Mazda	HL2	21,000	31	1.5	—							Six-Sixty	610D	9,200	18.5	2.0	2.0
Lissen	HL210	20,000	20	1.0	2.2							Mullard	PM6D	9,000	18	2.0	2.0
Mullard	PM1HL	20,000	28	1.4	1.2							Lissen	L610	8,000	16	2.0	2.0
Six-Sixty	210HL	20,000	26	1.3	1.0							Cossor	610LF	7,500	15	2.0	3.4
Mazda	HL210	18,500	26	1.4	3.0							Marconi	L610	7,500	15	2.0	3.0
Marconi	HL2	18,000	27	1.5	1.0							Osram	L610	7,500	15	2.0	3.0
Osram	HL2	18,000	27	1.5	1.0							Mullard	PM6	3,500	8	2.25	7.0
Cossor	210HF	15,800	24	1.5	2.2							Cossor	610P	3,500	8	2.28	8.0
Cossor	210D	13,000	15	1.15	2.5							Marconi	P610	3,500	8	2.28	6.0
Six-Sixty	210LF	12,500	10.6	.85	2.5							Osram	P610	3,500	8	2.28	6.0
Mullard	PM1LF	12,000	11	.9	2.6							Six-Sixty	610P	3,400	7.8	2.3	8.0
Osram	L210	12,000	11	.92	2.0							Lissen	P610	3,200	8	2.5	6.0
Marconi	L210	12,000	11	.92	2.0							Cossor	625P	2,500	7	2.8	13.0
Mullard	PM2DX	12,000	18	1.5	2.0							Lissen	P625	2,500	7.5	3.0	8.0
Six-Sixty	210D	10,000	18	1.6	2.0							Marconi	P625	2,400	6	2.5	11.0
Cossor	2101F	10,000	14	1.4	3.0							Osram	P625	2,400	6	2.5	11.0
Lissen	L210	10,000	12	1.2	3.0							Cossor	610XP	2,000	5	2.5	15.0
Lissen	L2	10,000	20	2.0	3.0							Mullard	PM256	1,850	6	3.25	8.0
Mazda	L2	10,000	19	1.9	3.0							Six-Sixty	625SP	1,780	5.8	3.25	8.0
Marconi	P215	5,000	7	1.4	6.0							Marconi	P625A	1,600	3.7	2.3	2.0
Osram	P215	5,000	7	1.4	6.0							Osram	P625A	1,600	3.7	2.3	16.0
Six-Sixty	220P	4,800	7.2	1.5	5.0							Lissen	P625A	1,500	4.5	3.0	12.0
Mullard	PM2	4,400	7.5	1.7	5.0							Six-Sixty	625SPA	1,500	3.9	2.6	20.0
Lissen	P220	4,000	7	1.75	5.0							Mullard	PM256A	1,400	3.6	2.6	20.0
Cossor	220P	4,000	9	2.25	6.0							Mazda	P650	1,300	3.5	2.7	30.0
Cossor	215P	4,000	9	2.25	5.0												
Cossor	220PA	4,000	16	4.0	5.5												
Marconi	LP2	3,900	15	3.85	6.0												
Osram	LP2	3,900	15	3.85	6.0												
Mazda	P220	3,700	12.5	3.4	11.0												
Six-Sixty	220PA	3,700	13	3.5	6.0												
Mullard	PM2A	3,600	12.5	3.5	6.5												
Lissen	LP2	3,500	12.0	3.5	9.0												
Marconi	P240	2,500	4	1.6	12.0												
Osram	P2	2,150	7.5	3.5	12.0												
Six-Sixty	220SP	2,060	7	3.4	13.5												
Mullard	PM202	2,000	7	3.7	18.0												
Mazda	P240	1,900	7	3.7	18.0												
Mullard	PM252	1,900	7	3.7	14.0												
Six-Sixty	2405P	1,900	6.6	3.5	14.0												
Mazda	P220A	1,850	6.5	3.5	13.0												
Lissen	P220A	1,700	6	3.5	12.0												
Lissen	P2X40	1,500	4.5	3.0	14.0												
Cossor	230XP	1,500	4.5	3.0	15.0												
Lissen	P240A	1,000	5.0	5.0	20.0												
2-volt Double-grid Valves						4-volt Three-electrode Valves						6-volt Screen-grid Valves					
Marconi	DG2	3,750	4.5	1.2	—	Marconi	H410	60,000	40	.66	.5	Six-Sixty	SS6075SC	210,000	190	.9	—
Osram	DG2	3,750	4.5	1.2	—	Osram	H410	60,000	40	.66	.35	Cossor	610SG	200,000	200	1.0	—
Cossor	210DG	3,400	2.7	.8	—	Lissen	H410	60,000	40	.66	1.0	Mullard	PM16	200,000	200	1.0	—
Mullard	PM1DG	—	—	—	—	Six-Sixty	4075RC	58,000	37	.64	.55	Osram	S610	200,000	210	1.05	4.0
Six-Sixty	210DG	—	—	—	—	Mullard	PM3A	55,000	38	.66	.3	Marconi	S610	200,000	210	1.05	4.0
						Cossor	410RC	50,000	40	.8	.6						
						Lissen	HLD410	21,000	25	1.2	2.5						
						Marconi	HL410	20,800	25	1.2	2.5						
						Osram	HL410	20,800	25	1.2	1.25						
						Cossor	410HF	20,000	22	1.1	1.0						
						Mullard	PM3	13,000	14	1.05	2.0						
						Six-Sixty	4075HF	12,500	13.5	1.1	3.0						
						Cossor	410LF	10,000	17	1.7	2.5						
						Lissen	L410	8,500	15	1.8	3.5						
						Marconi	L410	8,500	15	1.77	3.0						
						Osram	L410	8,500	15	1.77	3.0						
						Mullard	PM4DX	7,500	15	2.0	2.0						
						Six-Sixty	410D	7,250	14.5	2.0	4.0						
						Marconi	P410	5,000	7.5	1.5	6.0						
						Osram	P410	5,000	7.5	1.5	6.0						
						Six-Sixty	410P	4,100	7.8	1.9	7.5						
						Cossor	410P	4,000	8	2.0	8.0						
						Mullard	PM4	4,000	8	2.0	7.5						
						Lissen	P410	4,000	8	2.0	7.0						
						Marconi	P425	2,300	4.5	1.95	14.0						
						Mullard	PM254	2,150	6.5	3.0	9.0						
						Six-Sixty	420SP	2,150	6.5	3.0	10.0						
						Marconi	P415	2,080	5.0	2.4	14.0						
						Osram	P415	2,080	5.0	2.4	14.0						
						Mazda	425XP	2,000	7	3.5	13.0						
						Lissen	P425	1,500	4.5	3.0	28.0						
						Cossor	415XP	1,500	4.5	3.0	15.0						
						Osram	PX25	1,265	9.5	7.5	—						
						Cossor	4XP	1,200	4.8	4.0	18.0						
						Marconi	PX4	830	5	6.0	35.0						
						Osram	PX4	830	5	6.0	35.0						
2-volt Screen-grid Valves						4-volt Screen-grid Valves											

NOW -

PENTODE PERFORMANCE AT

POWER-VALVE CONSUMPTION

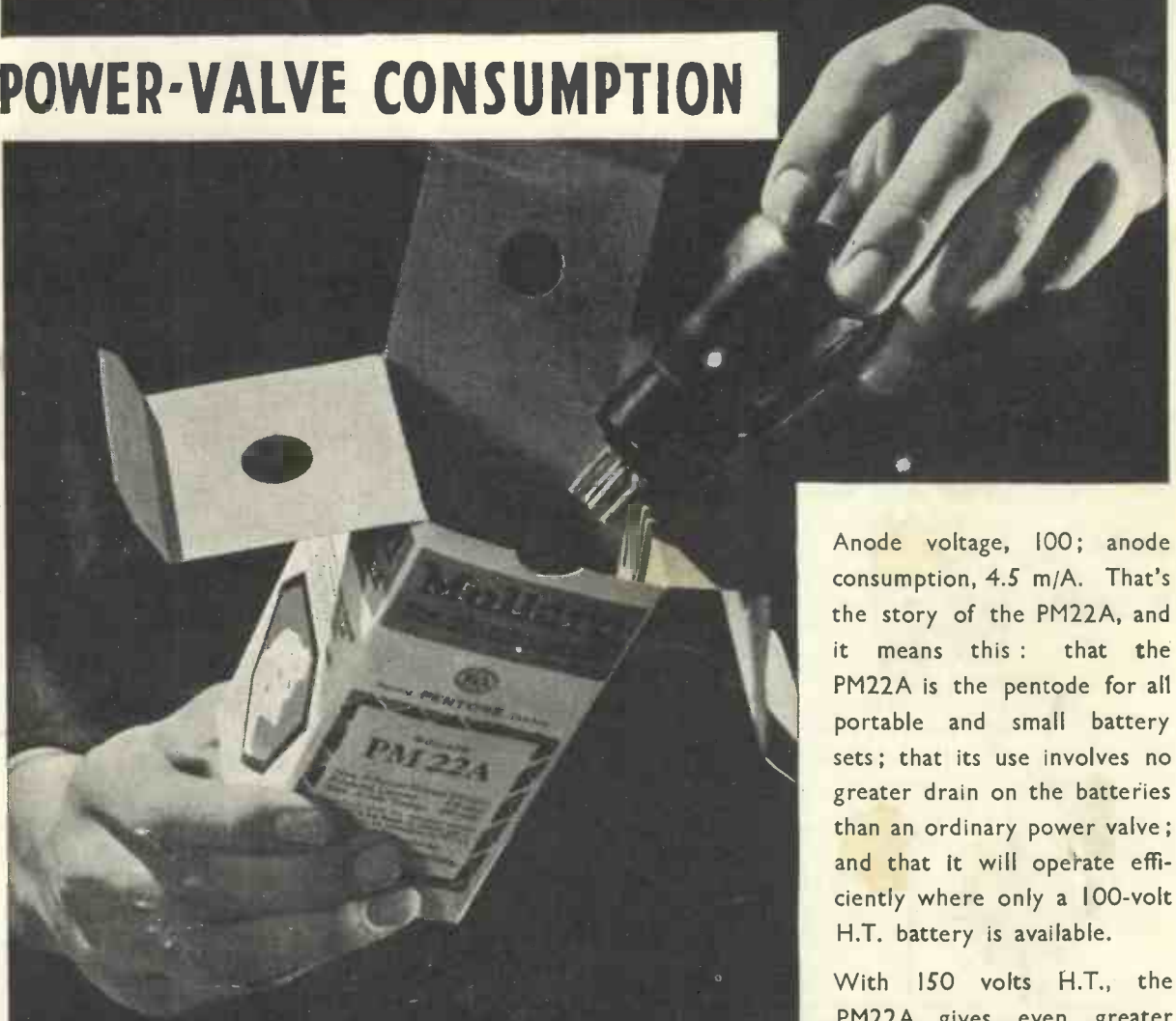

Anode voltage, 100; anode consumption, 4.5 m/A. That's the story of the PM22A, and it means this: that the PM22A is the pentode for all portable and small battery sets; that its use involves no greater drain on the batteries than an ordinary power valve; and that it will operate efficiently where only a 100-volt H.T. battery is available.

With 150 volts H.T., the PM22A gives even greater output, but is still extremely economical in H.T. consumption.

Price 17/6

Made in England.

Mullard
THE · MASTER · VALVE

Adv. The Mullard Wireless Service Co., Ltd., Mullard House, Charing Cross Road, London, W.C.2. ARKS

Better service results from mentioning "Wireless Magazine" when writing to advertisers

Proof!



of their
LONG LIFE

Tests carried out have proved that the life of Dubilier Metallised Resistances is practically limitless. Thousands of hours of service have failed to alter their value even by as little as 1%. You cannot buy a better Resistance than Dubilier. Their special method of manufacture, exhaustive testing and proved performance is a guarantee that they will never fail you.

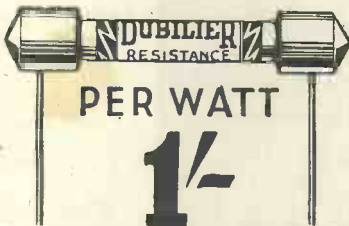
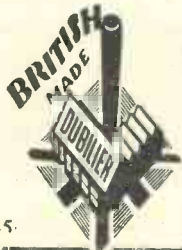

DUBILIER

Metallised
RESISTANCES

DUBILIER CONDENSER CO. (1925) LTD.
Ducon Works, Victoria Road, North Acton, W.3

The Speaker SPECIFIED

for the Wireless Magazine
"TABLE QUAD"



—but judge for Yourself

Many of the designers of the latest receivers say definitely, "The MoToR Minor Moving Coil for perfect reproduction." The rich, pure tone of this speaker has made it widely recommended. But please judge it for yourself. Hear it at your dealer's and you will admit that the most emphatic assertion that this speaker is different is an under-statement after all.

MOTOR

MINOR

P.M. MOVING COIL

Complete with Baffle Board & Transformer

39/6

In attractive leatherette baffle case **45/6**



If you have any difficulty in obtaining, please send us the address of your nearest dealer. Ask also for complete list of MoToR Speakers.

TEKADE RADIO & ELECTRIC CO. LTD.
147 Farringdon Road, London, E.C.1

When replying to advertisements, please mention "Wireless Magazine"

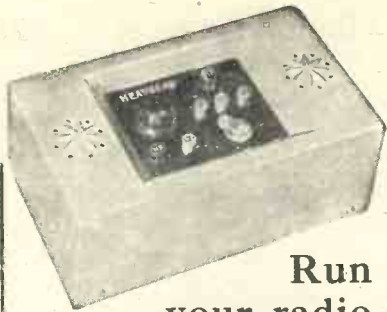

Run your radio from the Mains

Get your power from the mains with a Heayberd Mains Unit and be sure of a constant, silent, and steady H.T. and L.T. supply for your receiver. Heayberd are specialists in Mains Equipment and can supply you with Complete Mains Units, Assembled Mains Kits, or Un-assembled Mains Kits. The Mains Unit illustrated above is Model D.120—output, 20 m/A at 120 v., 2 v. 3 amp. Trickle Charger; three H.T. tappings, S.G., 60-120 v. var., 100 v. and 120 v. fixed. Supplied in modern bronze-finished metal case. Incorporating Heayberd Transformer, Choke, and Westinghouse Rectifier. Price, 85/-. Size, 8 in. by 5 in. by 4½ in. Send coupon NOW for 1933 Catalogue of Mains Equipment.

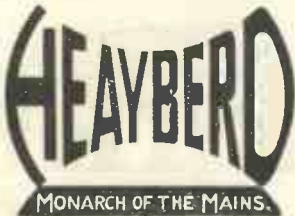

I enclose 3d. stamps for 1933 Catalogue, packed with Technical Tips and Circuit Diagrams.

M.....

Address.....

W.M.N.

F. C. HEAYBERD & CO.,
10, Finsbury St., London, E.C.2

One minute from Moorgate Underground Station.

The ACME of CRAFTSMANSHIP
High Grade Radio Gramophone CABINET

of exclusive modern design, with record wells, hand-made and polished, on Queen Anne legs.
Figured Oak
Figured Walnut
Figured Mahogany
Remarkable Values
Illustrated Catalogue

Free.
Cabinets made to order a speciality
GILBERT
CABINET MAKER,
SWINDON Estimates Free Estd. 1866



Read what J. H. REYNER says about FILT!



24th September, 1932.

Messrs. Graham Farish Ltd.

Dear Sirs,

I have been much interested in the Filt Percolative Earth which you have submitted for test. The importance of a good earth connection is often overlooked, although attention to this point is repaid by improved signal strength and less liability to interference from external sources, particularly with Mains receivers.

A low electrical resistance is the first essential, and you appear to have gone to the root of the matter by providing an earth bowl filled with chemicals which firstly attract the moisture from the surrounding soil and then saturate it with salts of high electrical conductivity.

My tests indicate that the device is both simple and effective and that the earth resistance is definitely lower than is obtained by the usual methods.

I imagine that in the majority of cases the installation of the Filt Earth will give a definite improvement in results.

Yours faithfully,

(Signed), J. H. REYNER.

GRAHAM - FARISH

FILT
PERCOLATIVE EARTH



Obtainable from your radio dealer or post free from the sole manufacturers.

GRAHAM FARISH LTD.,
197 Masons Hill, Bromley, Kent



J. H. Reyner, B.Sc., A.C.G.I.,
D.I.C., A.M.I.E.E., M.Inst.R.E.,
Consulting Radio Engineer. The
well-known designer of many
famous sets described in the
foremost wireless publications.

SPECIFIED for the Wireless Magazine "TABLE QUAD"

The PERFECT Transformer for every Set

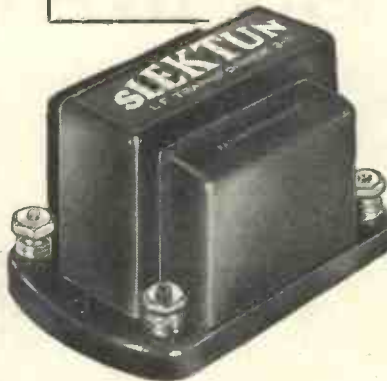

Greater purity of reproduction is at once obtained by fitting a Sлектun Super Transformer to your set. Deepest bass and highest notes are brought out richly and clearly—a real difference is obtained at a moderate cost.

Guaranteed for 3 Years

8'6 RATIOS
2:1, 3:1,
4:1, 5:1.

At all good Dealers

SLEKTUN PRODUCTS, Ltd.

21 Douglas St., Westminster, S.W.1.

SLEKTUN

SUPER TRANSFORMER

Please mention "Wireless Magazine" when corresponding with advertisers

VALVES TO USE IN YOUR SET — Continued from p. 428

Make	Type	Impedance	Amplification Factor	Mutual Conductance	Anode Current at 120 volts	Make	Type	Impedance	Amplification Factor	Mutual Conductance	Anode Current at 120 volts	Make	Type	Impedance	Amplification Factor	Mutual Conductance	Anode Current at 120 volts						
A.C. Three-electrode Valves—Continued						A.C. Variable-mu Valves						Filament Current .25 Ampere											
Cossor	4IMP	2,500	18.7	7.5	10.0	Lissen	AC/SGV	300,000	—	—	—	Marconi	DH	10,800	40	3.7	—						
Mullard	AC064	2,000	6	3.0	15.0	Cossor	MVSG	200,000	—	2.5	7.8	Osram	DH	10,800	40	3.7	4.0						
Cossor	4IMXP	1,500	11.2	7.5	23.0	Marconi	VMS4	—	—	2.4	—	Marconi	DL	2,660	12	4.5	11.0						
Mazda	AC/P1	1,450	5.4	3.7	—	Mazda	AC/SGVM	—	—	—	—	Osram	DL	2,660	12	4.5	11.0						
Six-Sixty	HV4/I	1,450	6.3	3.0	14.0	Mazda	AC/SLVM	—	—	—	—	Filament Current .5 Ampere											
Marconi	PX25	1,265	9.5	7.5	—	Mullard	MM4V	—	—	—	—	Mazda	DC/HL	13,000	35	2.7	—						
Osram	PX25	1,265	9.5	7.5	—	Osram	VMS4	—	—	2.4	—	Mazda	DS/P	2,220	10	4.5	—						
Mullard	O54V	1,250	5	4.0	25.0	A.C. Pentode Valves						D.C. Screen-grid Valves											
Mullard	AC044	1,150	4	3.5	17.0	Marconi	PT4	42,000	120	2.85	—	Mazda	DC2SG	—	11,200	2.0	—						
Micromesh	PA1	1,050	12.6	12.0	35.0	Osram	PT4	42,000	120	2.85	—	Filament Current .1 Ampere											
A.C. Double-grid Valves						Marconi	MPT4	33,000	100	3.0	—	Filament Current .25 Ampere											
Cossor	41MDG	40,000	10	.25	—	Osram	MPT4	33,000	100	3.0	—	Osram	DS	550,000	500	1.1	3.0						
A.C. Screen-grid Valves						Marconi	MP.Pen.A	—	4.0	9.0	—	Marconi	DS	540,000	500	1.1	3.0						
Six-Sixty	4SGAC	1,000,000	1,000	1.0	1.5	Cossor	MS.Pen.A	—	4.0	30.0	—	Osram	DSB	350,000	1,120	3.2	3.4						
Mullard	S4V	909,000	1,000	1.1	—	Mazda	AC/Pen.	—	2.5	—	—	Marconi	DSB	350,000	1,120	3.2	3.4						
Mazda	AC/SG	630,000	1,700	3.0	5.0	Six-Sixty	SS4Pen.AC	—	3.0	—	—	Filament Current .5 Ampere											
Mazda	ACS2	600,000	3,000	5.0	—	Mullard	Pen.4V	—	3.0	—	—	Mazda	DSCG	—	1,000	2.75	—						
Marconi	MS4	500,000	550	1.1	2.2	Cossor	AC/PT	—	2.6	—	—	Marconi	VDS	—	—	2.4	—						
Osram	MS4	500,000	550	1.1	2.2	Cossor	PT41B	—	2.25	30.0	—	Osram	VDS	—	—	2.4	—						
Six-Sixty	4XSGAC	485,000	1,600	3.0	—	Mullard	PM24A	—	2.0	15.0	—	D.C. Pentode Valves											
Mullard	S4VA	—	1,000	2.0	1.5	Mullard	PM24B	—	2.1	—	—	Filament Current .2 Ampere											
Cossor	41MSG	400,000	1,000	2.5	2.0	Mullard	PM24C	—	2.1	—	—	Mazda	DC/2Pen.	—	—	2.5	—						
Marconi	MS4B	350,000	1,120	3.2	3.2	Mullard	PM24M	—	3.0	—	—	Filament Current .25 Ampere											
Osram	MS4B	350,000	1,120	3.2	3.2	D.C. Three-electrode Valves						Marconi	DPT	30,000	90	3.0	10.0						
Lissen	AC/SG	340,000	1,100	3.25	—	Filament Current .1 Ampere						Osram	DPT	30,000	90	3.0	10.0						
Six-Sixty	SS4MMAC	300,000	900	3.0	—	Mazda	DC3HL	11,700	35	3.0	—	Filament Current .5 Ampere											
Mullard	S4VB	257,000	750	2.5	4.0	Mazda	DC2P	2,650	10	3.75	—	Mazda	DC/Pen.	—	—	3.5	—						
Cossor	MSG/HA	209,000	780	2.0	2.0																		
Cossor	MSGLA	200,000	750	3.75	5.5																		
Six-Sixty	4YSGAC	—	900	3.5	—																		

● SPECIAL CHRISTMAS NUMBER OF "W.M." NEXT MONTH
 Make Certain of Getting Your Copy on Wednesday, November 23.

A FREE COPY OF THE WIRELESS MAGAZINE

THE interest and pleasure which you derive from the "Wireless Magazine" will be greatly enhanced if you can discuss its monthly articles with a friend who is also familiar with its contents.

In order that anyone you know who is interested in wireless but is not yet a reader of "Wireless Magazine" may become acquainted with it, a complimentary copy will be sent to him gratis

and post free, if you will kindly complete the attached coupon, or if you do not wish to mutilate your copy, send your request on a postcard.

THE "WIRELESS MAGAZINE" IS "THE BEST SHILLINGSWORTH IN RADIO." Tells you every month all you want to know about recent progress in Radio Design. Look out for the Dec- issue on Wednesday, Nov. 23.



POST THIS COUPON NOW

LOOK FOR "EDDY" IN YOUR DEALER'S WINDOW



FACTS YOU SHOULD KNOW.. ABOUT THE MAZDA PENTODES



The output stage in portable battery-driven receivers has always presented a problem to the designer on account of the limited H.T. supply available.

THE MAZDA PEN 220 has solved this problem as, owing to its extreme sensitivity, ample volume can be obtained with only 4 M/a anode consumption. The Pen 220 has, in addition, rapidly gained favour in the case of standard battery-operated receivers where economical H.T. consumption is an important consideration.

THE PEN 220A is a high-power output pentode suitable for driving a large moving-coil speaker. It should be used in conjunction with an eliminator.

THE PEN 425 for receivers operating on anode voltages above 150.

THE AC/PEN, the finest all-mains power pentode, sensitive enough to operate a loud speaker direct from aerial input.

Full details of these and other useful Mazda types will be found in the Mazda catalogue, sent FREE on request.

Mazda valves are fitted by all the leading receiver manufacturers. All good radio dealers stock them.

The amazing
MAZDA
THE
BRITISH
VALVES

**EDISWAN RADIO
100% BRITISH—Designed by British Engineers**

The Edison Swan Electric Co. Ltd.



155 Charing Cross Rd. London. W.C.2

Mazda Radio Valves are manufactured in Great Britain for

The British Thomson-Houston Co. Ltd., London and Rugby.

V167

There is news in the "Wireless Magazine" advertisements

A BETTER ACCUMULATOR— BASED ON A NEW PRINCIPLE

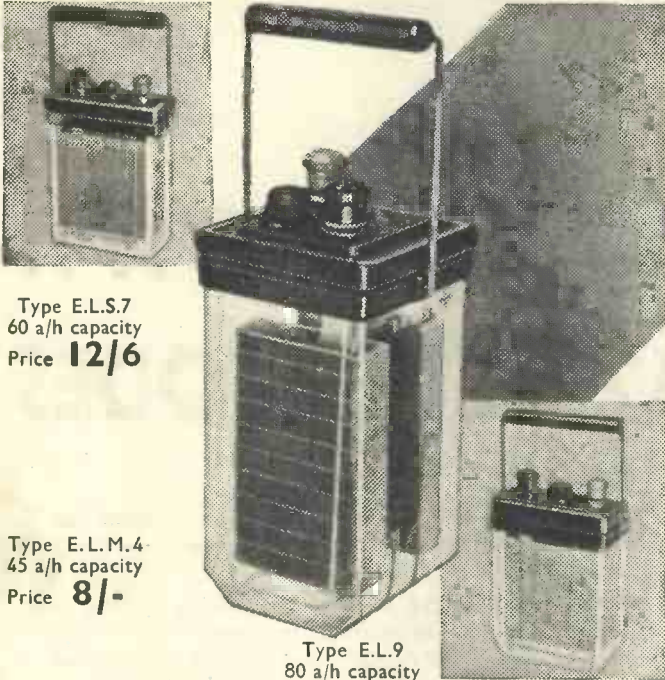

Type E.L.S.7
60 a/h capacity
Price 12/6

Type E.L.M.4
45 a/h capacity
Price 8/-

Type E.L.9
80 a/h capacity
Price 12/3

yet you pay no more for it

"Balanced capacity"—an entirely new development in accumulator design—is the outcome of three years' ceaseless research in the Ediswan laboratories. Briefly it means that positive and negative elements are in accurate electrical balance making very rapid charge and very slow discharge rates equally practicable without damage to the elements. Careful tests show that the new Ediswan accumulator outlasts every other accumulator of similar capacity.

Outside as well as inside, the new Ediswan accumulator is a tribute to the quality of Ediswan workmanship. The glass containers are British made with moulded ebonite lids, screwed vents, non-corrodible and non-interchangeable connectors and a carrier which fits beneath a moulded projection of the glass container. In the E.L.S. types a "grease-cup" on pillar prevents "acid-creep" . . . See them at your radio dealer's.

EDISWAN *EXTRA LIFE* ACCUMULATORS



THE EDISON SWAN ELECTRIC CO. LTD.
155 CHARING CROSS ROAD, LONDON, W.C.2.

B.183

CHOSEN BY THE EXPERTS for "THE CALIBRATOR" This New STENIBAC CABINET

Model No. 19. A Radio-Gramophone Cabinet, 3 ft. 3 in. high, 2 ft. 2 in. wide, 1 ft. 4 in. deep. Will take a baseboard 24 in. by 18 in., or smaller. The Top Panel above the Fret we will cut to your specification. Should you be using an ebonite panel, a paper pattern must be forwarded. Will accommodate any type of Gramophone Motor, Hand-polished Oak, Mahogany, Walnut.

PRICES

OAK	£4 10s.
MAHOGANY .. .	£4 15s.
WALNUT	£5 0s.

"First in their Class"

STAND No. 9
Block "B"
Scottish National Radio
Exhibition, Edinburgh,
Waverley Market,
October 12-22.

WRITE TO-DAY
FOR FREE CAT.
ALOGUE OF LATEST
MODELS POST FREE.



Model
No. 19

STENIBAC LTD., (Dept. W.M.), 303, ESSEX RD.,
ISLINGTON, LONDON, N.I.
PHONE: GLISSOLD 8056

DAVENSET

**TRANSFORMERS for the Mains &
"WIRELESS MAGAZINE" SETS**



The long practical experience of the makers of the famous Davenset Charging Equipment is now available in a range of Mains Transformers and Chokes. The home set constructor will find in Davenset Transformers thoroughly reliable and sound

equipment of the highest quality and most original design which will make a material contribution to the success of his set.

Illustration shows the DAVENSET Class "A" Shell-Type Transformer.

NOTE: The Dual-speaker Amplifier, described in this issue, definitely specifies the incorporation of List No.17 DAVENSET TRANSFORMER. Price 47/6.

FREE to all interested, a copy of "Mains Transformers and Power Smoothing Chokes for Radio and Industrial Purposes."

PARTRIDGE, WILSON & CO.

Dept. 31, Davenset Works, Leicester.
Scottish Branch: 200 Vincent Street, Glasgow, C.2.

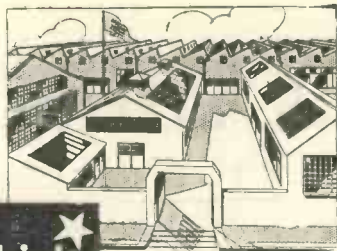

★ This is our new Factory where the famous **PERMAG** Moving Coil Speakers (as illustrated) are being made in thousands

-note the beautiful cabinet—as illustrated, fitted with the little magic **TONE CONTROL** knob which gives instant response at the touch of your finger-

THE BAKER "PERMAG" with TONE - CONTROL



THE BAKER "PERMAG" WITH TONE-CONTROL



Complete with beautiful Cabinet—as illustrated—Tapped Transformer AND TONE CONTROL

49/6

The Chassis only, complete with Transformer.

38/6

The Speaker that is selling in THOUSANDS

Made only by The Pioneer Manufacturers of Moving Coil Speakers

BAKER'S 'Selhurst' RADIO

★ NEW FACTORY 75 & 77, SUSSEX ROAD, CROYDON, SURREY.

'PHONE: CROYDON 1618

Why

throw away 2! worth of H.T.

- when your H.T. Battery runs down?



WHEN you throw away an old H.T. Battery there is still power left in it—power you cannot use—its voltage is too low to work your set. You are compelled to waste this energy—energy for which you have already paid.

The Lively 'O' H.T. Accumulator eliminates waste. It is full of life and vitality right up to the time when it is ready for recharging (3 or 4 times a year). Its "air-spaced" cells are proof against electrical leakage. Its voltage is constant. Get the best out of your set with the smooth, unvarying H.T. supply ensured by the Lively 'O.' Your Dealer stocks it.

TWO TYPES:

Standard 10 volt unit capacity 2,750 milliamps **5/6**

Extra large capacity 5,500 milliamps (10 volt unit). **6/9**

Oldham & Son Ltd., Denton, Manchester. Est. 1865, and at London, Glasgow, Belfast and Dublin.

The

Lively 'O'

H.T. ACCUMULATOR

PUT THE LIVELY 'O' INTO YOUR RADIO

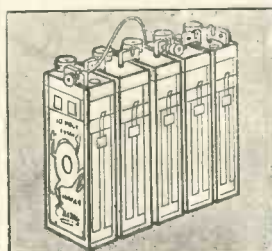

You will get prompt replies by mentioning "Wireless Magazine"

GUIDE TO THE WORLD'S BROADCASTERS

Specially Compiled for "Wireless Magazine" by JAY COOTE

Metres : 20.64 **RADIO NATIONS (PRANGINS)** **Kilo-**
40.3 *Switzerland* **cycles :**
14,538
7,444

Distance from London: Approximately 470 miles.
Standard Time: Central European (Greenwich Mean Time PLUS 1 hour).
Announcer: Man.
Languages Used: French, English, and Spanish.
Call: "Ici Genève, poste radiophonique de la Société des Nations."
At intervals: "Ici Radio Nations."
Times of Transmission: A special broadcast relating to the activities of the League of Nations is given every Sunday night in French (G.M.T. 22.00), in English (22.15), and in Spanish (22.30). Transmissions are also made occasionally on 15.43 metres and on other wavelengths.

Metres : 26.83 **FUNCHAL (CT3AQ)** **Kilocycles :**
Power : .05 kw. *Madeira* **11,181**

Distance from London: Approximately 1,590 miles.
Standard Time: Greenwich Mean Time LESS 1 hour.
Announcer: Man.
Call: "This is CT3AQ, amateur experimental station at Funchal, Madeira." Calls are made in Portuguese, French, and English.
Times of Transmission: G.M.T. 22.00 to 23.30 (Tuesday and Thursday), 15.30 to 17.00 (Sunday). Concerts mainly consist of gramophone records of Portuguese melodies.

Metres : 48.95 **MARACAIBO (YV11 BMO)** **Kilo-**
Power : *Venezuela* **cycles :**
.25 kw. **6,127**

Distance from London: Approximately 4,250 miles.
Standard Time: Greenwich Mean Time LESS 4 hours.
Announcer: Man.
Call: "Aqui Estacion radiotelefonica de Maracaibo, La Voz de Lago."
Standard Transmissions: Daily, G.M.T. 01.00 to 03.00 and 05.00 to 07.00 (irregular).
The station is mainly used for the transmission of news bulletins, publicity broadcasts, and short sponsored concerts.

Metres : 50 **ANTANANARIVO (FUI)** **Kilocycles :**
Power : *Madagascar* **6,000**
.5 kw.

Distance from London: Approximately 5,760 miles.
Standard Time: Greenwich Mean Time PLUS 3 hours.
Announcer: Man.
Call: "Ici station française de radiodiffusion Coloniale et Equatoriale." Between items: "Ici Radio Tananarive."
Times of Transmission: Daily (except Monday, Wednesday, and Sunday), G.M.T. 09.00 to 09.15, 18.00 to 17.00, 19.00 to 21.00 (Sunday only), 18.30 to 20.00 (Wednesday only). The programme usually consists of short news bulletins and gramophone records. Closes down with the playing of "La Marseillaise" and usual French greetings.

Metres : 206 **ANTWERP** **Kilocycles :**
Power : 4 kw. *Belgium* **1,460**

Distance from London: Approximately 200 miles.
Standard Time: Greenwich Mean Time (Belgium adopts British Summer Time).
Announcer: Man. Flemish and French languages used.
Call: "Hallo! Hier Antwerpen; ici Anvers, Radio Eglise du Christ."
Sunday broadcasts only. G.M.T. 10.00, talk and sermon; 10.45, sacred music; 11.30, sacred service, etc.
Closes down with greetings in both the Flemish and French languages, followed by "La Brabanconne" (Belgian National Anthem).

Metres : 227.4 **FLENSBURG** **Kilocycles :**
Power : .5 kw. *Germany* **1,319**

Distance from London: Approximately 435 miles.
Standard Time: Central European (Greenwich Mean Time PLUS 1 hour).
Announcers: Man and woman.
Language: German only used.
Opening Signal: When own studio, FL in morse (. . . — . . .).
Interval Signal: Metronome or gong; if latter, two notes repeated four times in ten seconds. When relaying Hamburg, HA in morse (. . . — . . .).
Call: "Hier die Norddeutsche Sender Hamburg, Kiel, Hannover, Bremen, und Flensburg."
Usually relays the Hamburg programme.
Closes down with the usual German good-night greetings, followed by the National Anthem, "Deutschland über Alles."
Associated Transmitters: Kiel, 232.2 metres (1,292 kilocycles), .25 kilowatt; Bremen, 266.7 metres (1,124.9 kilocycles), .25 kilowatt; Hamburg, 372 metres (806 kilocycles), .5 kilowatt; Hanover, 566 metres (530 kilocycles), .25 kilowatt.

Metres : 279.4 **BRATISLAVA** **Kilocycles :**
Power : 14 kw. *Czechoslovakia* **1,073.6**

Distance from London: Approximately 800 miles.
Standard Time: Central European (Greenwich Mean Time PLUS 1 hour).
Announcers: Man and woman.
General and Interval Call: "Hallo! Hallo! Radio Journal Bratislava."
Opening Signal: One note, A (oscillating valve).
Interval Signal: Bells: C, E, G, G.
Relays programmes from Prague and exchanges broadcasts with Brno and Moravska-Ostrava.
Closes down with greetings in Czech and German, followed by "Dobru Noc" (Good night).

Metres : 293.6 **KOSICE** **Kilocycles :**
Power : 2.6 kw. *Czechoslovakia* **1,022**

Distance from London: Approximately 962 miles.
Standard Time: Central European (Greenwich Mean Time PLUS 1 hour).
Announcers: Man and woman.
Languages Used: Czech, Slovene, Magyar, and German.
Call: "Hallo! Hallo! Radio Journal Kosice" (phon.: "Kosh-ect-say").
Interval Signal: Metronome (eighty beats per minute).
Main Daily Programmes: Relays broadcasts from Prague, Bratislava, and Moravska-Ostrava; when own programme, at G.M.T. 17.00 and at 21.50 (gramophone records).
Time Signals: Striking of a bell at G.M.T. 19.00 and at 22.00, when chimes are relayed from Ludmilla Cathedral, Prague (if at end of programme).
Closes down with the words: "Halo! Radio Journal Kosice . . . dobru noc" (good night).

"Amazing to those who know the difficulties of combining selectivity with high quality"

The Ferranti 7-valve Super-Heterodyne has received praise from all sections of the Press. The following brief extract is quoted because it refers to a problem which is known to all listeners who take a technical interest in radio.

“Selectivity is certainly wonderful, and what is more amazing to those who know the difficulties of combining selectivity with high quality, the standard of reproduction is astonishingly good.”

Every detail of the Ferranti Super-Heterodyne has been designed to meet the exacting standards of “those who know.” Examine it—test it—and you will agree that this is the greatest of all the super-hets.

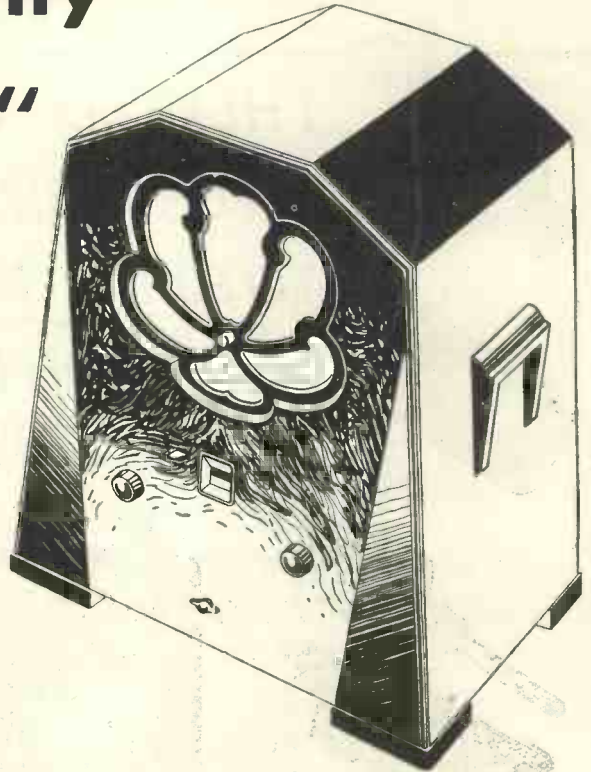

The design incorporates the most modern features, including INITIAL H.F. AMPLIFICATION, preventing interference with other sets; VARIABLE MU VALVES, providing the best form of volume control, GANGED CONDENSERS, giving one knob tuning; BAND PASS COUPLING, ensuring high selectivity without loss of high notes; MOVING COIL SPEAKER, for high quality reproduction; TONE CONTROL, to provide sharp or mellow tone at will; ILLUMINATED WAVELENGTH SCALE, giving instant station identification; AUTOMATIC MAINS AERIAL DEVICE, enabling the Receiver to be moved easily from room to room and used wherever an A.C. light or power socket is available; and provision is made for GRAMOPHONE PICK-UP.

STANDARD MODEL, as illustrated and described in specification, with wave-length indicator,

22 GUINEAS
or Deposit 42/- and 12 Monthly Payments of 38/6.

STATION DIAL MODEL, with illuminated Station Dial

23 GUINEAS
or Deposit 43/- and 12 Monthly Payments of 40/4.

CLOCK MODEL, incorporating Ferranti Electric Clock and Station Dial— for time controlled frequencies only—

25 GUINEAS
or Deposit 45/- and 12 Monthly Payments of 44/-.

FERRANTI 7-VALVE SUPER-HET

Suitable only for 200/250 volts A.C. supplies having frequencies between 40 and 100 cycles.

Ask your dealer for literature, or write to

FERRANTI LTD., HOLLINWOOD, LANCS. AND BUSH HOUSE, LONDON, W.C.2

Speedy replies result from mentioning "Wireless Magazine"

From 6^d . . .
 . . . to 37/6

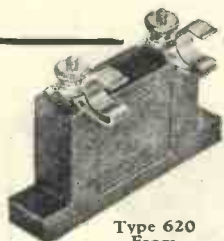

Type 620
From
1/3 to 3/-



Type 610
From
1/3 to 3/-

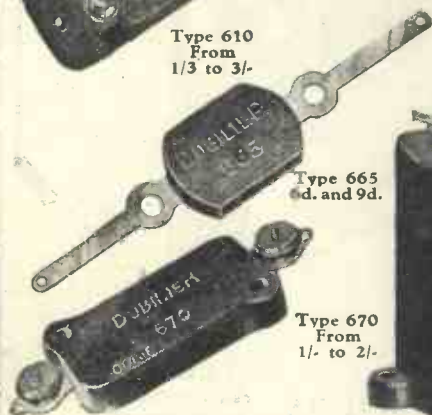

Type 665
6d. and 9d.

Type 670
From
1/- to 2/-

THERE IS A
 TYPE AND SIZE
 TO SUIT EVERY
 REQUIREMENT

Type B.775
From
3/- to 37/6



For those who want condensers occupying only a fraction of the space of the ordinary type, yet containing the finest materials and workmanship, there are the Dubilier Types 610, 620, 665 and 670 Mica Condensers for receivers, while for power amplifiers and transmitters there are the Types B770/1/2 and B775/6/7.

No matter whether a Dubilier Condenser is large or small, it is the most up-to-date in design and contains the finest materials it is possible to obtain. On every Dubilier Condenser rests the Dubilier reputation for Dependability. You may be sure that Dubilier will never let you down.

Have you seen the new Dubilier Components Booklet, "Choosing your Condensers and Resistances"? Ask your dealer for a copy or write direct to us.

DUBILIER
 MICA
 CONDENSERS

DUBILIER CONDENSER CO. (1925) LTD.
 Ducon Works, Victoria Road, North Acton, W.3



Build your eliminator with a metal rectifier and ensure years of service without the annoyance of breakdown or falling off in output.
 Prices from 12/6.

Full particulars, circuits and prices are given in the new and enlarged 1933 edition of "The All-Metal Way." Post the coupon now, with 3d. in stamps and get a copy.

WESTINGHOUSE
 METAL RECTIFIERS

THE WESTINGHOUSE BRAKE AND SAXBY SIGNAL CO., LTD.
 82 York Road, King's Cross, London, N.1.

Westinghouse Publicity, 82 York Road, King's Cross, London, N.1.
 Please send me a copy of your 44-page booklet "THE ALL-METAL WAY, 1933" for which I enclose 3d. in stamps.

NAME
 ADDRESS

W.M. 1/11/32

**START RIGHT —
 FINISH RIGHT —
 USE**



The Wearite
 STICK-ON
 SELECTIVITY
 CONTROL
 LEAD-IN
 Price .. 1/-
 with anchoring
 block 1/6

The Wearite
 NO TOOL
 EARTH TUBE
 Price .. 3/6
 complete

WEARITE
 COMPONENTS

THE efficiency of a set is the efficiency of its EARTH-AERIAL System. Start right and use the new Wearite Selectivity Control Aerial Lead-in. It requires no tools to instal—it fits any window, and more than that gives you additional control over the selectivity of your receiver. A bad earth means flat tuning—get the best from your set by using the WEARITE earth tube—it is fixed in a minute—without spanner or screwdriver—just a match and you have a perfect soldered joint. To use Wearite throughout is the first step to better results. On page 443 is a coupon which will bring you the latest Wearite Booklet—fill it in and post now.

WRIGHT & WEARE LTD.,
 740 HIGH ROAD, TOTTENHAM,
 N.17

Telephone: Tottenham 3847/8 and 3015

PARMEKO EFFICIENCY WITH RELIABILITY



NMTO High Voltage Transformer

The success of Parmeko Mains Transformers and Chokes lies in the fact that they are both efficient and reliable. The Design is in every case well thought out, and the greatest care is taken in manufacture and in the selection of the various materials used.

Parmeko manufacture all types of Transformers and Chokes from the smallest to the largest, and in a large variety of frames and terminal assemblies.

Illustrated on the left is a type NMTO High Voltage Transformer having outputs of 1,000-0-1,000 volts at 80 m.a., 10 volts at 2 amps., 4 volts C.T. 2 amps., and 4 volts C.T. 4 amps.

We shall be pleased to send you further particulars.

PARTRIDGE & MEE LIMITED,
 LEICESTER, AYLESTONE 487.
 74, New Oxford Street, LONDON, W.C.1.
 MUSEUM 5070.

BETTER—CAMCO CABINETS for Your Wireless!

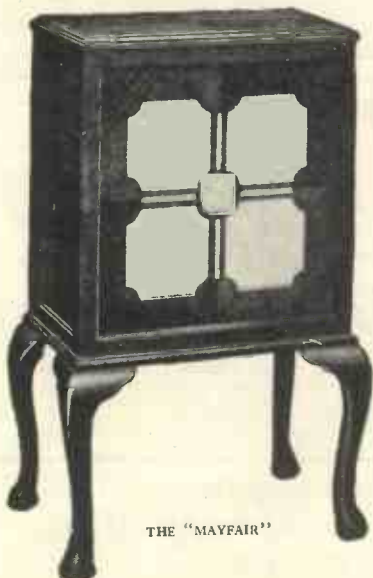

THE "MAYFAIR"

THE CAMCO "MAYFAIR" CABINET FOR DUAL SPEAKERS

The "Mayfair" pedestal cabinet is just what is wanted for Dual or other speakers. Behind the fret there is a stout baffle board (20 in. by 20 in.) which can be drilled to meet your requirements. This handsome cabinet is designed to avoid resonance and is suitable for all makes of speakers. With space for amplifiers, etc. Price, including Baffle Board, £5 10s.

THE CAMCO "EMPIRE" CABINET

An unusually attractive cabinet for only 35s. Suitable for set and speaker it can be used for mains or battery models. The "Empire" is supplied with or without stool. Price 35s. walnut or mahogany. Stool, 25s. extra.

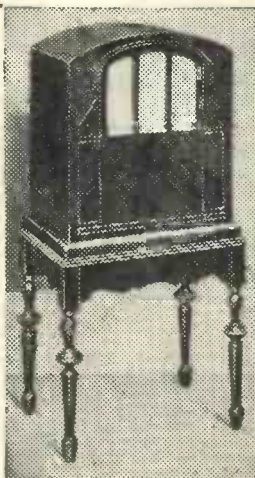

THE "EMPIRE"



THE "GRESHAM"

THE CAMCO "GRESHAM" CABINET

This entirely new Radiogram cabinet is not only designed on sound acoustical lines, but is a very handsome piece of furniture of which you will be justly proud. Sufficient room has been allowed to house batteries or eliminators as well as set and speaker. Price, including baffle board, shelf, and motor board, £6.

Post in 4d. envelope

Carrington Mfg. Co., Ltd.,
 24 Hatten Garden,
 London, E.C.1

'Phone: Holborn 8202 Works: South Croydon

Name.....

Address.....

3W.M.....

These are only a few of the many Camco Cabinets. See them at our Showrooms open 9.15 to 5.45 (Saturdays 12.30) or send coupon for FREE Copy of our New Camco Catalogue.

Advertisers like to know whence the business comes—please mention "W.M."

GUIDE TO WORLD'S BROADCASTERS — Cont. from p. 436

Metres : 304.9 **BORDEAUX -LAFAYETTE** **Kilocycles : 983.9**
Power : 13 kw. *France*

Distance from London: Approximately 402 miles.
Standard Time: Greenwich Mean Time (France adopts British Summer Time).
Announcer: Man.
Language: French only.
Call: "Allo! Allo! Ici le poste de radiodiffusion des Postes et Telegraphes de Bordeaux-Lafayette. Between items: "Ici Bordeaux Lafayette P.T.T."
 No special interval signal, but at times a gong is struck at the end of the programme.
Main Daily Transmissions: Frequently relays broadcasts from Paris P.T.T. (Ecole Supérieure). G.M.T. 20.00, main evening entertainment; 21.00, studio concert or relay of programme from other State-owned provincial transmitter.
 Closes down with the usual French good-night greetings, followed by "La Marseillaise."

Metres : 307 **ZAGREB** **Kilocycles : 977**
Power : .75 kw. *Yugoslavia*

Distance from London: Approximately 830 miles.
Standard Time: Central European (Greenwich Mean Time PLUS 1 hour).
Announcer: Woman.
Opening and Interval Signal: Metronome, about 106 beats per minute, a low-pitched dull tone, as of a hammer striking wood.
Call: "Hallo! Radio Zagreb."
Languages Used: Serbo-Croatian and German (in announcements).
Main Daily Programmes: G.M.T. 17.00, gramophone records; 18.20, talks; 19.00, main evening entertainments; 21.30, news and relay of dance music from local restaurant or cabaret.
 Exchanges programmes with Belgrade and Ljubljana and also relays international concerts from Berlia, Budapest, Prague, Vienna, and Warsaw.
 Closes down with the words, "Radio Zagreb zeli svima laku noc" (Radio Zagreb wishes everyone good night), followed by a melody, "Ljepa Nasa" (Croatian anthem).

Metres : 318.8 **SOFIA** **Kilocycles : 941**
Power : 1 kw. *Bulgaria*

Distance from London: Approximately 1,255 miles.
Standard Time: Eastern European (Greenwich Mean Time PLUS 2 hours).
Announcer: Man.
Call: "Hallo! Hallo! Radio Rodno."
Language Used: Bulgarian (Slavonic).
Interval Signal: Gong and metronome.
Main Daily Programmes: G.M.T. 06.30, sacred service (Sunday); 10.30, concert; 11.00, news, dance music; 18.00, talks; 19.30, concert (Thursday and Saturday only); 20.00 or 21.00, dance music (Friday and Saturday only).

Metres : 325 **BRESLAU** **Kilocycles : 923**
Power : 60 kw. *Germany*

Distance from London: Approximately 743 miles.
Standard Time: Central European (Greenwich Mean Time PLUS 1 hour).
Announcer: Man.
Language: German only.
Call: "Achtung! Achtung! Hier die Schlesische Rundfunksender Breslau und Gleiwitz" (phon.: "Braze-low oond Gly-veets").
Interval Signal: Metronome: 200 beats per minute.
Main Daily Programme: G.M.T. 05.15, physical exercises (from Berlin), concert; 07.15, concert (Sunday); 08.00, relay of sacred service (Sunday); then continuous broadcast on weekdays until 18.30, concert, talks, and main evening entertainment; 22.15, dance music relayed from Berlin.
 Closes down as other German stations with the playing of the "Deutschlandslid" (Haydn's hymn: "Austria").
Relay: Gleiwitz: 253 metres (1,184 kilocycles), 5 kilowatts.

Metres : 394 **BUCHAREST** **Kilocycles : 761**
Power : 12 kw.* *Roumania*

Distance from London: Approximately 1,300 miles.
Standard Time: Eastern European (Greenwich Mean Time PLUS 2 hours).
Announcer: Woman.
Call (phon.): "Atent-see-oon-aye ah-eetch-ee rah-dee-owe Book-oo-recht-ee." Announcements are usually made in the Roumanian language, but also occasionally in French, German, and Italian.
Interval Signal: Metronome (160 beats per minute).
Main Daily Programme: G.M.T. 09.15, Children's Hour, sacred service (Sunday); 11.45, news, gramophone records; 17.00, news, weather, concert; 19.00, main evening entertainment; 20.15, dance music, news, weather.
 Closes down with good-night greetings (in Roumanian), "Buna seara tuturoi," repeated in several languages and followed by the National Anthem ("Traiasca Regel"), a gramophone record.
 * A high-power transmitter is in course of construction.

Metres : 416 **RABAT** **Kilocycles : 721**
Power : 6 kw. *Morocco, N. Africa*

Distance from London: Approximately 1,260 miles.
Standard Time: Greenwich Mean Time.
Announcers: Man and woman.
Opening Call: "Allo! Allo! Ici le poste de radiodiffusion de l'Office Cherifien de Radio Maroc à Rabat." Between items: "Ici Radio Maroc."
Interval Signal: Metronome (sixty beats per minute).
Language Used: French generally, but when Oriental concerts are broadcast announcements are also made in Arabic.
Main Daily Programme: G.M.T. 13.30, concert; 17.00, gramophone records; 20.30, news and concert; 23.00, concert or records. Occasionally direct relays are carried out of foreign transmissions or of Paris P.T.T. through Radio Coloniale (Pontoise).
 The Radio Maroc broadcasts are also relayed on 23.39 metres (day wave) and on 32.26 metres (night wave); also on certain days through Casablanca (CN8MC) on 48 metres.
 Closes down with usual French good-night greetings followed by "La Marseillaise."

Metres : 1,000 **LENINGRAD** **Kilocycles : 300**
Power : 100 kw. *U.S.S.R.*

Distance from London: Approximately 1,308 miles.
Standard Time: Central European (G.M.T. PLUS 2 hours).
Announcers: Man and woman.
Opening Call (phon.): "Sloo-schah-eet-ee-yay Leningrads-kye-ya rah-dee-owe ves-schah-tell-nigh-ya stan-see-ya na-vol-neigh tea-sat-schah may-trough" ("Attention. Leningrad radio station speaking on 1,000 metres").
Opening and Interval Signal: Strokes of hammer on anvil.
Time Signal: Three notes on a trumpet at G.M.T. 21.00.
Main Daily Programme: G.M.T. 03.15, physical exercises, then continuous broadcast throughout day until 16.00, weather, news; 17.00, concert or relay from Radio Theatre; 19.30, relay of foreign stations (Tuesday); 20.00, English lesson (Tuesday); 21.00, late concert (Tuesday, Friday). Late concerts from 22.00 are also frequently given for night workers.
Good Night (phon.): "Dos-wee-dan-ee-ya" (twice) "spak-oy-knee notch-ee" ("Good-bye. Good night").

CORRECTIONS and AMENDMENTS

The following alterations should be made to the panels published in previous issues of "Wireless Magazine."

Rome (3RO) now works regularly on 25.4 metres (11,810 kilocycles).
Madrid (EAO), usually heard on 30.4 metres (9,868 kilocycles), also works on 15.20 metres (19,750 kilocycles).
Johannesburg (ZTJ) has reduced its wavelength to 49.2 metres (6,097.5 kilocycles).
Chi-Hoa (Saigon). Broadcasts of wireless entertainments have been suspended.
Madrid (EAJ7) now working on 424.3 metres (707 kilocycles).
Cologne (Germany). The relay station on 227.4 metres (1,319 kilocycles), has been closed down. All programmes are broadcast through the Langenberg high-power station.
Frankfurt-am-Main. The power of the transmitter will shortly be 17 kilowatts and the wavelength 259.3 metres (1,158.5 kilocycles).
Grenoble is now working on 568 metres (530 kilocycles).
Milan. The power of the new transmitter is 50 kilowatts.
Naples is now working on 318.8 metres (941 kilocycles).
Palermo has raised its wavelength to 542 metres (554 kilocycles).

Look out for the fine Christmas number of "Wireless Magazine" on Wednesday, November 23. It will contain all the regular features and many other articles of interest to every listener. To make certain of getting a copy, order from your newsagent in advance

The New MADRIGAL ELECTRIC RECEIVER

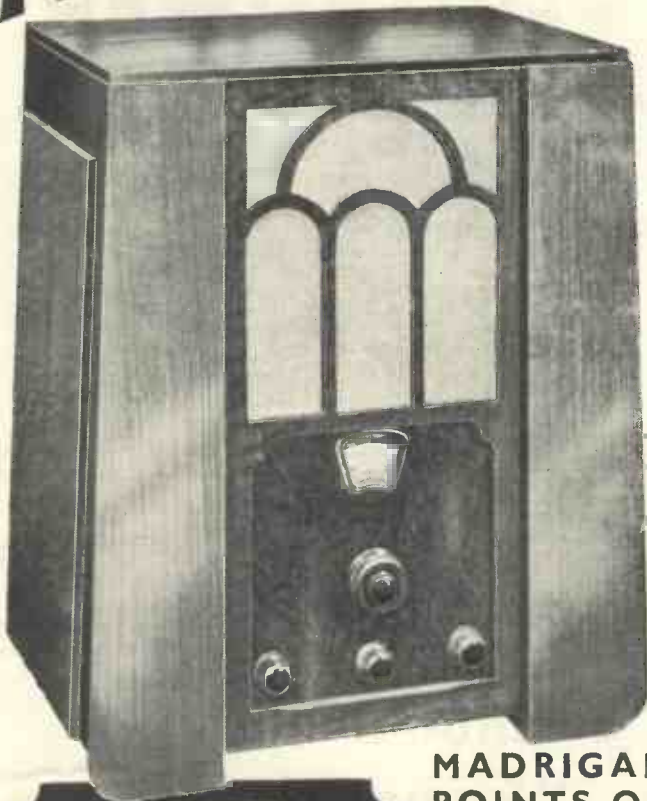

THE SET THAT THRIVES on COMPARISON

R.I. have astounded the radio world with the new "Madrigal," which, for the first time in Radio History, combines quality in every essential detail with low prices that compare favourably with any receiver of the ordinary mass production type.

For the past ten years R.I. have produced sets admittedly best and more advanced in design, and covering all radio and electrical developments likely to affect receivers in the near future of each successive year.

Quality of reproduction of their receivers has always been acknowledged as superior to any, and reliability is proven by the vast numbers of R.I. veteran sets that are still going strong—many have never even needed valve replacements.

This year the "Madrigal" enters into a new phase of appeal—that of popular price: a remarkable achievement by the makers, considering that the same high quality and serviceability of the original is fully retained.



**A REAL ENGINEERING
RELIABLE JOB**

List No. AY 30. A.C. Mains only. 100/150v.
or 200/250v. 40/100 cycles.
HANDSOME FIGURED WALNUT CASE.

MADRIGAL POINTS OF ADVANTAGE

- 1 Special screened grid pentode circuit.
- 2 Beautiful musical and speech reproduction.
- 3 A child can operate—absolutely safe.
- 4 Ideal for flat dwellers, brings in over twenty stations without aerial or earth.
- 5 Single knob tuning. Illuminated dial calibrated in wavelengths.
- 6 Latest chrome steel loud speaker.
- 7 Four point control switch.
- 8 Gramophone connections.

Price Including
Valves and Royalties
(25 cycles 21/-
extra.)

17
GNS.

Ask us or
your dealer for
Madrigal and
Super Hel.
Brochures—
free on request



Every Radio
Enthusiast
should have
the R.I. Cata-
logue—free
from your
dealer or us

Adv. of Radio Instruments Ltd., Croydon, Surrey. 'Phone: Thornton Heath 3211

Speedy replies result from mentioning "Wireless Magazine"

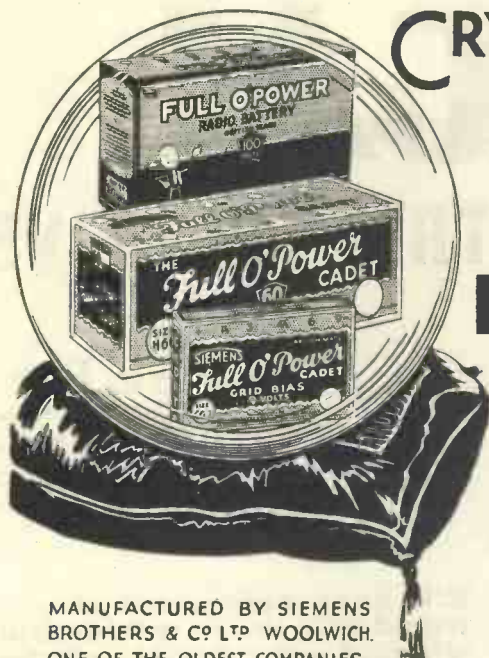

CRYSTAL CLEAR RECEPTION IS ASSURED WITH **SIEMENS** **FULL O'POWER**

Never before have batteries possessed such Sustained Power, Long Life & the vitality that produces unequalled purity & volume of tone as that supplied by "FULL O'POWER" the batteries with the one piece pure zinc cells

Buy
Full O'Power
by **SIEMENS**

MANUFACTURED BY SIEMENS BROTHERS & CO LTD WOOLWICH. ONE OF THE OLDEST COMPANIES IN THE ELECTRICAL INDUSTRY WHO HAVE BEEN MAKING BATTERIES FOR OVER 60 YEARS

FROM YOUR DEALER TO-DAY

Advt. of SIEMENS ELECTRIC LAMPS AND SUPPLIES LIMITED, 38/39, Upper Thames Street, London, E.C.4.



R & A Type "40" is the designer's choice for the "Easytune 60"

Yet again the incomparable Type "40" is the premier choice. The designer of the "Easytune 60" described in this issue recommends it above all others, because of its ability to *faithfully* reproduce speech and music. If you want the best this set can give, you need an R. & A. Type "40."

WIRELESS WORLD Test Report states: "The design is ingenious and the workmanship thorough . . . of more than average sensitivity . . . speech, which is exceptionally good, even by comparison with moving-coil instruments, provides more than sufficient volume for normal requirements . . . performance and workmanship . . . bear all the marks of a thoroughbred and at the very reasonable price of 16/6 it stands in a class by itself."

The R. & A. TYPE "50" has the same unit as the TYPE "40," but is of smaller dimensions and has a somewhat reduced bass response. Price 15/-
Complete in cabinet, 40/-

CHASSIS
16/6

COMPLETE IN CABINET
41/6

Your dealer can supply. Refuse so-called substitutes. There is no substitute for R. & A. REPRODUCERS & AMPLIFIERS, LTD., WOLVERHAMPTON

Advertisers like to know you "saw it in the 'Wireless Magazine'"

R. & A. BANTAM P.M. MOVING COIL REPRODUCER is an alternative to the Type "40" for those who desire true moving coil performance. It is complete with 3 ratio Transformer.

27'6

Complete in Cabinet
52/6

Write for copy of new Leaflet.



RADIOPAK

TRADE MARK

THE ONLY COMPLETE BAND-PASS TUNER

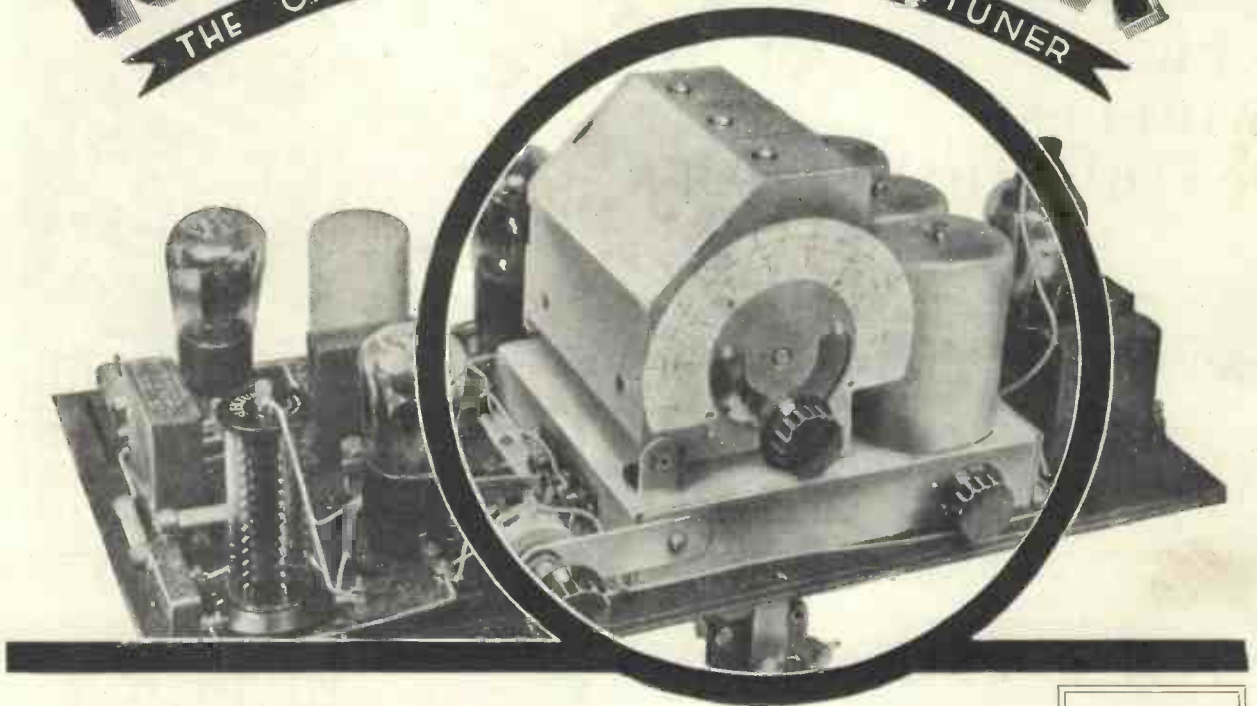

specified for the

“CALIBRATOR”

PRICE COMPLETE

£3

THE band-pass “Radiopak” simplifies set construction as well as it simplifies selectivity. No development in modern component design is so important as this to the amateur constructor. Revolutionary in conception and design, neat, compact and robust, above all the “Radiopak” is efficient.

Consisting of screened coils, ganged condenser with drive, combined volume control and on-off power switch, mounted neatly on a metal chassis, the “Radiopak” needs only the addition of valves, low frequency circuit, loud-speaker, and batteries or mains unit to form a complete receiver.

Because the coils and condenser are matched with the highest possible degree of accuracy before leaving our factory, *all ganging difficulty is eliminated*, and each unit is supplied with a tuning scale calibrated in wavelengths.

Width along front of base board 9 $\frac{1}{8}$ in.
 Depth 6 in.
 Height 6 $\frac{1}{2}$ in.

Specified for the “Calibrator.”

Band-pass ‘Radiopak’

Type 535A/50,000 - £3

Extra Reaction Knob - - - 6d.

Supplied with full-size fixing template.

BRITISH RADIOPHONE LTD., ALDWYCH HOUSE, ALDWYCH, LONDON, W.C.2

Telephone: HOLBORN 6744

Advertisers take more interest when you mention “Wireless Magazine”

Tune in
on
this



NEW WIRELESS INSTRUCTION

The I.C.S. Wireless Courses cover every phase of wireless work, from the requirements of the youth who wishes to make wireless engineering his career to the man who wants to construct a broadcasting set for his home, and, at the same time, to know how and why it operates and how to locate any faults that may develop.

No branch of industry has ever progressed as rapidly as wireless and the rate of progress is increasing. Only by knowing thoroughly the basic principles can pace be kept with it. Our Instruction includes American developments and practice in addition to British. It is a modern education in radio, covering every department of the industry, and gives an outline of the principles and possibilities of television.

OUR COURSES

Included in the I.C.S. range are Courses dealing with the Installing of radio sets and, in particular, with their Servicing, which to-day intimately concerns every wireless dealer and his employees. The Operating Course is vital to mastery of operating and transmitting.

There is also a Course for the wireless salesman. This, in addition to inculcating the art of salesmanship, provides that knowledge which enables the salesman to hold his own with the most technical of his clients.

We will be pleased to send you details of any or all of these subjects. Just mark and post the coupon, or write in any other way—the information you require will be forwarded at once.

—YOU MAY USE THIS COUPON—

International Correspondence Schools, Ltd.,
Dept. 89, International Buildings,
Kingsway, London, W.C.2.

Without cost, or obligation, please send me full information about

THE I.C.S. RADIO COURSES

Name..... Age.....

Address

**USED
UNIVERSALLY**
The World's
Standard for
Eight Years—
Still the Best

"B" TYPE TERMINAL.
Insulated non-rotating name.
36 permanent white letterings.
Price 6d. each.

"R" TYPE TERMINAL.
Non-removable rotating head.
Now 2½d.

**BELLING-LEE
TERMINALS**

Advert. of Belling & Lee, Ltd. Cambridge Arterial Road, Enfield, Middlesex.

TUNEWELL VOLUME CONTROL
Increases power of reception. Losses much less than with ordinary types. Logarithmically wound with double-silk-covered wire. Paper laid between windings.

Type V. All sizes up to 50,000 ohms., 5/6.
From 50,000 to 100,000 ohms., 7/6.
Type P. Variable Resistance or Potentiometer. Equal resistance between studs. Max. Dissipation 3 watts, 5/6.

The NEW
**TUNEWELL
COMPONENTS**
give you
SUPER-RADIO
at Lower
Cost!

**TUNEWELL
L.F. CHOKE**
S20/50 Price 12/6
**SPECIFIED
for the
CALIBRATOR**

TUNEWELL WIRE-WOUND ANODE RESISTANCES
All values from 10,000 to 100,000 ohms. 3/6 each.
Bakelite Holder (for vertical or horizontal mounting) 1/6

★
Ask also for
Brochure of the
TUNEWELL ALL-ELECTRIC RADIO-GRAMOPHONE TUNEWELL'S latest success!

The standard of quality achieved by the new TUNEWELL Components has hitherto been approached only by the highest priced products, but by careful design and lowering our profits, TUNEWELL have removed the old price-bar to Quality Radio.

Send the coupon now for the TUNEWELL "Guide to Super-Radio"—an interesting folder you will keep for reference. It includes 8 Blue Prints (Band Pass All Mains 3, Kit Eliminator, etc.) and details of the new range of TUNEWELL Components.

8 FREE Blue Prints

To Tunewell Radio Ltd., 54 Station Road, London, N.11.

Name.....
Address.....
My nearest dealer is..... W.M.4

First and foremost - QUALITY

In the radio receiver, probably more than in any other product, Quality is of supreme importance. For a radio to give—and continue giving—perfect satisfaction, it must exemplify Quality from the first to the last detail of its construction. McMichael realised this fact from the very first—so that, through twelve years of successful radio manufacture their name has been associated with the best in radio. Every McMichael receiver exemplifies the Quality ideal.

The McMICHAEL DUPLEX FOUR MAINS TRANSPORTABLE.

The cabinet of this McMichael receiver is, alone, a veritable triumph of craftsmanship. Within this cabinet the set is entirely self-contained, so that it is easily transportable and may be operated wherever a suitable mains socket or plug is available. Neither aerial nor earth are necessary, although for operation in remote districts, these may be applied. Contained in the receiver is a Moving Coil Loud-speaker, the reproduction from which is quite exceptional—no less than sheer delight.

The circuit employed is similar to that already made famous in the Duplex Four battery models, except for the "mains" adaptation.

Indicating on the Duplex Scale, this circuit includes the latest refinements in design, and gives maximum range and selectivity with a minimum of controls.

Provision is made for applying a gramophone pick-up, and an external additional loud-speaker or 'speakers.

PRICE 21 Gns. (Including all Royalties)

Deferred Payments may be arranged.

You are cordially invited to visit our London Showrooms, 179 Strand, W.C.2, where demonstrations of this, and any other of our models will gladly be given. McMichael Wireless Products are stocked by all reputable dealers.

Telephone :
SLOUGH
441-442.

L. McMICHAEL LTD
Manufacturers of Wireless and Scientific Apparatus
WEXHAM ROAD, SLOUGH, BUCKS.

Telegrams :
RADIETHER
SLOUGH

London Showrooms : 179 STRAND, W.C.2. Telephone : Temple Bar 6938.

The
**McMICHAEL
DUPLEX
FOUR
MAINS
TRANSPORTABLE**
(For Alternating Current only)



ALL BRITISH —BUILT AT OUR WORKS AT SLOUGH AND EMBODYING THE EXPERIENCE OF TWELVE YEARS' SUCCESSFUL RADIO MANUFACTURE.

SPECIFIED for the "PROSPERITY THREE" SETS

THESE BRITISH-MADE RESISTANCES HAVE ALL THE QUALITIES YOU DEMAND!

OUR "B.A.T." TRADE MARK IS ALL THAT THE SLOGAN IMPLIES: "BEST-AFTER-TEST"

ALL-BRITISH

PERMANENT

STURDY

QUIET

MOISTURE-PROOF

B.A.T. BEST-AFTER-TEST

FIXED RESISTORS

- 1-Watt - 10½d.
- 2-Watts - - 1/9
- 3-Watts - - 2/9
- 5-Watts - - 4/0

"OHMS' LAW WITHOUT TEARS."

Send to-day for your free and post-free copy of our 2-colour, "Copyright," 16-page Art Booklet. Not a "Catalogue," but simple illustrations, with valuable circuits and "ABC," concerning the "mysteries" of Ohms, Volts, Amperes and Watts Dissipation. The Edition is limited.

● No matter what are the features you demand in the Resistors you use, you will find every requirement fulfilled in "B.A.T." (Best-After-Test) Resistors.

Their entirely new process of manufacture ensures that "B.A.T." Resistors are noiseless in operation, permanent in resistance value, and give really perfect voltage regulation. They are sturdily constructed and are definitely proof against surface flaking and the troubles it can cause. Perfect electrical connections are assured, the stout wire leads being heavily soldered to the resistor ends.

"B.A.T." (Best-after-Test) resistors are definitely guaranteed to be 100% British and are also guaranteed to be non-capacitative and non-inductive.

There are no finer Resistors made than "B.A.T.," a fact substantiated by their widespread use by the leading British Radio Manufacturers.

CLAUDE LYONS LTD.

76, Oldhall St., Liverpool. 40, Buckingham Gate, S.W.1

Advertisers like to know you saw it in the "Wireless Magazine"

BROADCAST WAVELENGTHS

Continued from page 444

Wave-length	Name of Station	Dial Readings	Country	Wave-length	Name of Station	Dial Readings	Country
62.5	Deal Beach WOO		United States	355.8	London Regional		Great Britain
62.56	London (Ont.) VE9BY		Canada	358	Moscow		U.S.S.R.
65.0	Kuala Lumpur VS2A		F.M.S.	360.5	Mühlacker		Germany
67.65	Doerberitz DFK		Germany	363.3	Algiers		North Africa
70.2	Khabarovsk RV15		U.S.S.R.	365.5	Bergen		Norway
76.0	Paris 8PCR		France	366.1	Seville		Spain
79.5	Salisbury ZEA		South Africa	367.6	Frederikstaad		Norway
80.0	Rome		Italy		Helsinki		Finland
81.45	Utrecht		Holland	368.1	Bolzano		Italy
88.3	Rugby G6RX		Great Britain		Kharkov		U.S.S.R.
92.31	Doerberitz		Germany	369.3	Radio LL, Paris		France
198.5	Riga		Latvia	372	Hamburg		Germany
207.3	Franchimont		Belgium	376.4	Scottish Regional		Great Britain
208.3	Antwerp		Belgium	378	Moscow Regional		U.S.S.R.
208.7	Budapest		Hungary	380.7	Lvov		Poland
210	Magyazovar		Hungary	385	Radio Toulouse		France
210.1	Liege		Belgium	385	Stalino		U.S.S.R.
211.3	Newcastle		Great Britain	389.6	Frankfurt		Germany
214.2	Warsaw (No. 2)		Poland		Archangel		U.S.S.R.
214.3	Aberdeen		Great Britain	394	Bucharest		Roumania
216	Chatelineau		Belgium	398.9	Midland Regional		Great Britain
217	Konigsberg		Germany	403	Sottens		Switzerland
217.1	Brussels (Conference)		Belgium	408	Katowice		Poland
218	Salzburg		Austria	411	Madrid (EAJ5)		Spain
219.6	Binche		Belgium		Athlone		Irish Free State
220	Beziere		France	413	Dublin		Irish Free State
222.9	Cork		Irish Free State	416	Radio Maroc		North Africa
225.2	Fécamp		France	419.5	Berlin		Germany
227.4	Flensburg		Germany	424.3	Madrid EAJ7		Spain
230.3	Radio Wallonia		Belgium	431.5	Belgrade		Yugoslavia
230.6	Malmö		Sweden	435.4	Stockholm		Sweden
232.2	Kiel		Germany	441	Rome		Italy
235	Lodz		Poland	447.1	Paris PTT		France
235.5	Kristianssand		Norway	449.4	Odessa		U.S.S.R.
237.2	Bordeaux-Sud-Ouest		France		Danzig		Danzig
239	Nurnberg		Germany	453.2	Klagenfurt		Austria
240.6	Stavanger		Norway		Porsgrund		Norway
241.3	Liege Experimental		Belgium	456.6	San Sebastian		Spain
242	Belfast		Ireland	459.4	Beromuenster		Switzerland
244.1	Basle		Switzerland	465.8	Tartu		Estonia
	Radio Schaerbeek		Belgium		Lyons PTT		France
245.9	Linz		Austria	472.4	Langenberg		Germany
	Berne		Switzerland	476	Sebastopol		U.S.S.R.
247.7	Trieste		Italy	480	North Regional		Great Britain
249.6	Prague (No. 2)		Czechoslovakia	488.6	Prague		Czechoslovakia
249.8	Juan-les-Pins		France	493.4	Trondheim		Norway
252.3	Barcelona EAJ15		Spain	500.8	Florence		Italy
253.1	Gleiwitz		Germany	502.4	Nini Novgorod		U.S.S.R.
255	Toulouse PTT		France	509	Brussels No. 1		Belgium
257	Horby		Sweden	518	Vienna		Austria
259.3	Leipsig		Germany	525	Riga		Latvia
261.6	London National		Great Britain	527	Palermo		Italy
263.8	Moravska Ostrava		Czechoslovakia	533	Munich		Germany
265.4	Lille		France	542	Sundsvall		Sweden
266.7	Bremen		Germany	550	Budapest		Hungary
266.8	Valencia		Spain	559.7	Kaiserslautern		Germany
270	Bari		Italy		Augsberg		Germany
271	Cointe-Liege		Belgium	563	Wilno		Poland
271.4	Rennes		France	566	Hanover		Germany
273.6	Turin		Italy	568.5	Grenoble		France
276.5	Heilsberg		Germany	569.3	Freiburg		Germany
279.3	Bratislava		Czechoslovakia	574.7	Ljubjana		Yugoslavia
281	Copenhagen		Denmark	644	Kazan		U.S.S.R.
282.2	Lisbon C'T1AA		Portugal	720	Moscow PTT		U.S.S.R.
	Berlin		Germany	748	Ostersund		Sweden
283.6	Magdeburg		Germany	760	Geneva		Switzerland
	Stettin		Germany	824.2	Sverdlovsk		U.S.S.R.
2	Montpellier		France	849	Rostov (Don)		U.S.S.R.
286.3	Radio Lyons		France	882	Saratov		U.S.S.R.
	Bournemouth		Great Britain	937.5	Kharkov		U.S.S.R.
	Scottish National		Great Britain	967.7	Alma Ata		U.S.S.R.
	Plymouth		Great Britain	1,000	Leningrad		U.S.S.R.
	Swansea		Great Britain	1,035	Kiev		U.S.S.R.
291	Viipuri		Finland	1,071.2	Tiflis		U.S.S.R.
	Tampere		Finland	1,071.4	Scheveningen-Haven		Holland
293	Kosice		France	1,083	Oslo		Norway
293.7	Limoges PTT		Czechoslovakia	1,106	Minsk		U.S.S.R.
296.1	Hilversum		Holland	1,116	Moscow (Popoff)		U.S.S.R.
298.8	Tallinn		Estonia	1,153.8	Kalundborg		Denmark
301.5	North National		Great Britain	1,171.5	Taschkent		U.S.S.R.
304.9	Bordeaux PTT		France	1,191	Luxemburg		Luxemburg
307	Zagreb		Yugoslavia		Reykjavik		Iceland
307.1	Falun		Sweden	1,200	Istanbul		Turkey
308.9	Radio Vitus		France	1,229.5	Boden		Sweden
309.9	Cardiff		Great Britain	1,260	Novosibirsk		U.S.S.R.
312.8	Genoa		Italy	1,304	Moscow (Trades Union)		U.S.S.R.
	Cracow		Poland	1,348	Motala		Sweden
315	Marseilles		France	1,380	Bakou		U.S.S.R.
318.8	Naples		Italy	1,411.8	Warsaw		Poland
	Sofia		Bulgaria	1,445.7	Paris (Eiffel Tower)		France
319.7	Dresden		Germany	1,481	Moscow (Komintern)		U.S.S.R.
321.9	Goteborg		Sweden	1,538	Ankara		Turkey
325	Breslau		Germany	1,554.4	Davenport National		Great Britain
328.2	Poste Parisien		France	1,600	Irkutsk		U.S.S.R.
331.4	Milan		Italy	1,635	Königswusterhausen		Germany
335	Poznan		Poland	1,725	Radio Paris		France
338.2	Brussels (No. 2)		Belgium	1,796	Lahti		Finland
342.1	Brno		Czechoslovakia	1,875	Huizen		Holland
345.2	Strasbourg		France	1,935	Kunas		Lithuania
348.8	Barcelona EAJ1		Spain	2,525	Königswusterhausen		Germany
351	Leningrad		U.S.S.R.	2,900	Königswusterhausen		Germany
352.1	Graz		Austria	4,000	Königswusterhausen		Germany

EVERYTHING **The G.E.C.** ELECTRICAL
your guarantee

LATEST DEVELOPMENTS



OSRAM 2-VOLT SCREEN-GRID BATTERY VALVES with the WEMBLEY FILAMENT

VS.2 (Metallized or Clear) PRICE 16/6

A new variable mu. valve with outstanding characteristics—long range, improved selectivity, adequate volume control, with only a 9-volt grid bias battery.

MUTUAL CONDUCTANCE 1.25 ma/volt at Ea 150, Esg 70, Eg. 0.
at Eg-9 0.05 ma/volt.

S.22 (Metallized or Clear) PRICE 16/6

The high slope screen grid valve to improve the reception of any three valve Kit set. Replace your old screen-grid valve with an OSRAM S.22.—A tonic to any set with single stage screen-grid.

MUTUAL CONDUCTANCE 1.75 ma/volt at Ea 150, Esg 75, Eg. 0.

S.21 (Metallized or Clear) PRICE 16/6

The screen-grid valve with new automatic OSRAM cushion springing and special non-microphonic construction. Designed for range with stability. A sensitive detector valve with entire absence of microphonics.

MUTUAL CONDUCTANCE 1.1 ma/volt at Ea 150, Esg 70, Eg. 0.

OSRAM 2-volt Valves with the WEMBLEY FILAMENT

PRICES

		PRICE
VS.2	Variable Mu. Screen Grid	16/6
S.22	High slope Screen Grid	16/6
S.21	Medium slope Screen Grid	16/6
H.2	High amplification Det. and RC.	7/6
HL.2	The non-microphonic Detector	7/6
LP.2	L.F. and Small Power	8/9
P.2	Super Power	12/6
PT.2	Economy Power Pentode	17/6

The OSRAM VS.2, S.22, S.21, H.2, HL.2 can be supplied either metallized or clear.

Osram Valves

MADE IN ENGLAND

Write for the OSRAM Wireless Guide (1932 Edition) Sent Post Free on request.

Sold by all Wireless Dealers

EXTRA QUALITY WITHOUT EXTRA COST

Advt. of The General Electric Co. Ltd., Magnet House, Kingsway, London, W.C.2

Mention of the "Wireless Magazine" will ensure prompt attention

RECTATONE

L.F. TRANSFORMER



over
1,000
cycles
— a
rising
curve

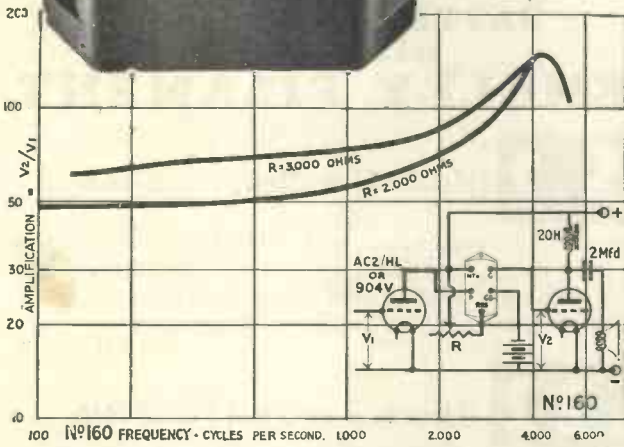

The above curve shows the increased amplification of high notes which can be obtained. The Rectatone can of course be used after any detector valve, suitable adjustment of the compensating resistance producing the above characteristics.

1. HAS a rising response curve from 1,000 to 4,500 cycles.
2. Balances any form of sound reproduction.
3. Restores a weakened treble to its correct value.
4. Gives a variable compensation and therefore complete control of tone correction.
5. Gives the required tone-correction without an extra L.F. stage.
6. Becomes at will and instantly a normal straight-line transformer.

The ideal L.F. coupling for selective sets. Particularly useful where the same L.F. amplifier is used for radio and gramophone reproduction.

15%
RATIO 7 : 1

The degree of compensation is variable and may be suited to the particular tuning circuits in use or employed to correct deficiencies due to the loud-speaker or to the acoustics of the room.



POST THIS
COUPON
TO-DAY

To Messrs. Varley, Kingsway House, 103 Kingsway, London, W.C.2
Please send me, FREE and post free, the

"BOOK of the RECTATONE"

Date.....

Name.....

Address.....

W.M.2

MAKE YOUR SET MAINS OPERATED

"ATLAS"
POWER
costs less
than ONE
PENNY
A WEEK



10/-
DOWN
AND BALANCE
IN EASY
MONTHLY
PAYMENTS

There is no cheaper radio power than H.T. and L.T. from the mains with an "ATLAS" Unit. Make your battery receiver mains-operated in a few minutes without alteration to set or valves. Put an end to dry battery expenses and charging inconveniences now. Ask your dealer for a demonstration to-day and insist on "ATLAS," the Olympia Ballot winners. A.C. Models from 52/6 with Westinghouse Rectifier. D.C. Models from 39/6.

**"CLARKE'S
ATLAS"
MAINS UNITS**

H. CLARKE & CO., (M/cr) LTD., Patricroft, Manchester

London Office: Bush House, W.C.2.

Scottish Distributors: The G.E.S. Co., Ltd., 38 Oswald Street, Glasgow.

Messrs. H. Clarke & Co. (M/cr) Ltd., George Street, Patricroft, Manchester.

Please send me a copy of Folder No. 68.

Name

Address

33/11/.

Please mention "Wireless Magazine" when corresponding with advertisers

BETTER THAN MAINS

and Cheaper than dry batteries

Available to all in town or country, C.A.V. Rechargeable High-Tension Accumulators provide the most perfect form of H.T. obtainable. They are quite silent in operation and produce none of the annoying crackling and humming noises so common with dry batteries and mains.

With recharging costing about 3/- per 120 volts three times a year, they actually cost less than dry batteries and if you have D.C. mains you can charge them yourself at a fraction of this cost. Our maintenance Booklet shows you how to do it.

To greatly improve reception and reduce running costs, therefore, change over to C.A.V. Rechargeable H.T. Accumulators at the first opportunity.

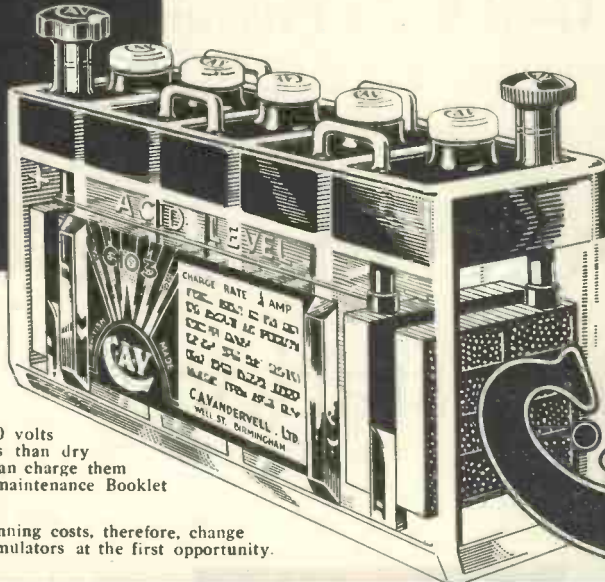

Send for free maintenance Booklet containing charging circuit diagrams and useful information on the charging and care of C.A.V. Radio Accumulators. Send a post-card to

Department 1.3.
C. A. VANDERVELL LTD.,
WELL STREET, BIRMINGHAM.

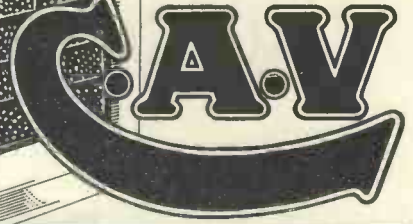

RECHARGEABLE H.T. ACCUMULATORS

INSTANTLY CONVERT YOUR RADIO TO A RADIOGRAM *without Cabinet or Mounting*



BY ATTACHING UNIVOLT TO YOUR SET

Connected in an instant, Univolt reproduces electrically all recorded music through your Radio with full, clear, beautiful volume... giving the performance of an expensive Radiogramophone at the least possible cost. Absolutely self-contained—only 2 in. high to top of turntable. Solid walnut-grained bakelite Case. Silent and uniform running, free from Radio Interference. No overheating. Simple Voltage Adjustment. Minimum Current Consumption. Speed Control (70 to 90 r.p.m.). Invisible Rubber Insulated Feet. On-off Switch. Flex and Plug-in Adaptor, Univolt Super Pick-up with perfect tracking, Swivel Head, Weight-adjustable Arm, and a sensitivity and frequency response hitherto never attained. Square Law Volume Control. Automatic Start and Stop. Terminals to connect to Radio. Univolt is needed in every home where there is Radio.

Send for fully descriptive leaflet.

FULLY GUARANTEED 2 YEARS

Standard Unit For A.C. Mains. As described above, complete with pick-up equipment. **5/2**
Junior Unit For A.C. Mains. As described, but less pick-up and brake equipment. **3/2**
Universal Model for A.C. and D.C. Mains 15/-. Extra in each case.

Send Direct to

F. PARKER-WOOD
51/52, Fenchurch Street, London, E.C.3. Royal 4014.

CLIX CHEAPEST PERFECT CONTACT

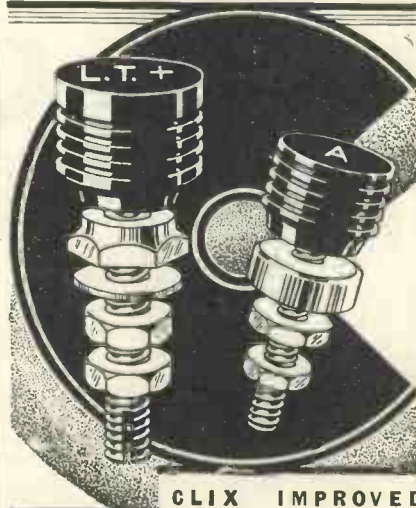

Prices:
Type B, with hexagonal shoulder **4d.**
Type A **2 1/2d.**
Folder 'w' free.

CLIX "Master" Plugs and Spade Terminals Specified for the 'TABLE QUAD'
LECTRO LINX, LTD.
256 Vauxhall Bridge Road :: S.W.1.

CLIX IMPROVED PANEL TERMINALS FOR CONSTRUCTORS

From the "T. & R. Bulletin" (Official organ of the Radio Society of Great Britain)
"What we particularly like about this is the fact that the body is provided with a hexagon shoulder so that it can be held with a spanner while the nuts behind are made tight."

CLIX terminals are more robust; completely insulated, non-removable heads. Red or black. Full range of easily read markings.

WHY NOT?

FIT A **LIMIT** RELIANCE PICK-UP AND CARRIER in the RADIO-GRAM YOU ARE MAKING

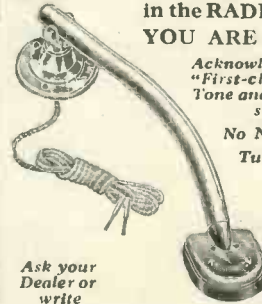

Acknowledged to be "First-class" in value, Tone and Workmanship

No Needle Screw Turnover Head Arm Incorporates a Rest

15/6 each

Ask your Dealer or write

LIMIT RADIO LTD., 15/29 Windsor St., N.1

RADIO SUPPLIES

Send your list of Radio needs for our quotation. Kits, Parts, Sets, etc. Everything in Radio stocked. Prompt delivery; seven days' approval. Catalogue free. Taylex and Standard Wet H.T. replacements stocked. **B. TAYLOR, 57 Stindley Road, STOCKWELL, LONDON**

BUY

Amateur Wireless

3d. Weekly

Better service results from mentioning "Wireless Magazine" when writing to advertisers

TO-NIGHT!

47 Good Radio Programmes "on the Air"



how to increase your choice of stations

Every night the great European stations pour out a wealth of entertainment. Are you one of the thousands of people whose worn-out or inefficient valves prevent them from enjoying it?

Increase the range of your Set—get a wider choice of programmes—with Cossor Screened Grid Valves. Due to their abnormally low inter-electrode capacity and unique construction, including the famous Mica Bridge, Cossor S.G. Valves will definitely increase the range of any well-designed Receiver.

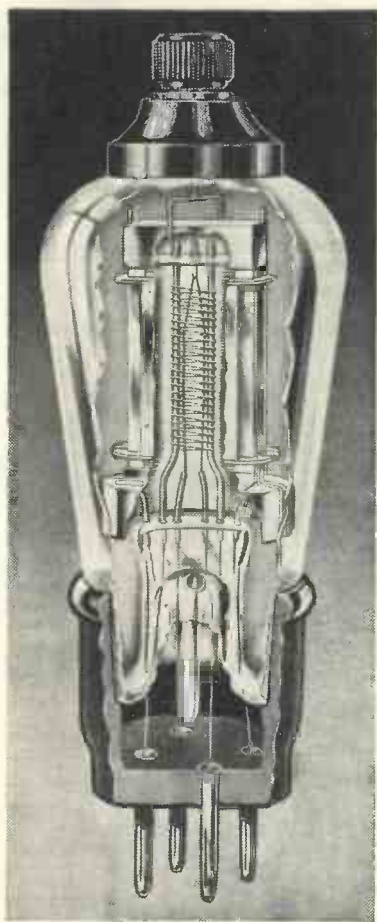

Send for a free copy of the 40-page Cossor Valve and Wireless Book which contains a wealth of interesting and useful information including Radio Definitions—Useful Circuits—List of Stations, etc., etc. Please use the Coupon.

COSSOR SCREENED GRID VALVES



To A. C. COSSOR LTD., Melody Department, Highbury Grove, London, N 5.

Please send me, free of charge, a copy of the 40-page Cossor Valve and Wireless Book B.17.

Name.....

Address.....

W.M. 11/32

A. C. Cossor Ltd., Highbury Grove, London, N.5. Depots at Birmingham Bristol, Glasgow, Leeds, Liverpool, Manchester, Newcastle, Sheffield, Belfast and Dublin.

When replying to advertisements, please mention "Wireless Magazine"

RADIO

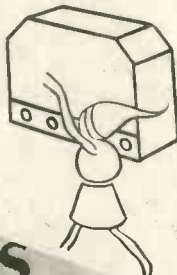
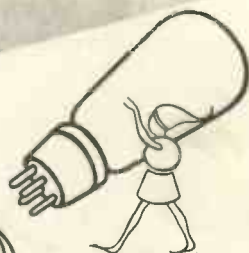
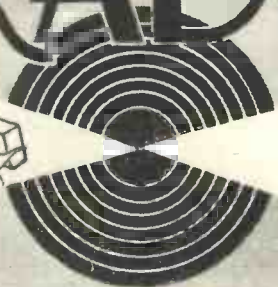

MEDLEY

By
BM/PRESS

A Radio Fan's Causerie

THERE is still considerable controversy as to whether a mains rectifying valve in an A.C. set should be included in the name of the set or not. Personally, I am dead against the practice, which I consider to be misleading.

It is true that a rectifying valve is just as much a valve as is a screen-grid type, but I cannot bring myself to regard it as a true part of the *basic* circuit; it is something additional to the main scheme of the set in which it is used.

You have a very good illustration in the case of the Prosperity series of sets recently described in these pages. There are three Prosperity's—one for batteries, one for A.C. mains, and the third for D.C. mains. In each case the circuit is basically the same.

It so happens that the A.C. Prosperity Three makes use of a Westinghouse rectifier, so it still remains a "three." But should a valve rectifier have been used would it not have been ridiculous to call it a four-valve receiver?

Bordering on the Ludicrous

It is obvious, I think, that to call the Prosperity Three for A.C. mains a four-valver because it is built with a valve rectifier instead of a metal rectifier borders on the ludicrous.

And what are you going to do about D.C. mains sets, where for an equal number of valves you can reasonably expect a performance

comparable with an A.C. receiver? Imagine a radio salesman trying to explain to a perplexed customer that a four-valve A.C. set is no better really than a three-valve D.C. model because one of the valves is a mains rectifier!

The argument has been advanced that in the case of a super-het the oscillator should not be included in the number of valves because it does not actually detect or amplify the incoming signal.

Comparing Super-hets

The point to remember is that this difficulty applies only to super-hets, which all have an oscillator of some kind. It is quite fair to compare a five-valve *super-het* with a six-valve *super-het*, in my opinion, *unless* the sixth valve in the latter case is a mains rectifier.

This practice originated in America, where nearly every set is for A.C. mains operation and where, apparently, metal rectifiers are few and far between. Over here the rectifier was first included in the designation of sets to meet the competition of imported American receivers.

But while probably half the sets made use a metal rectifier—and while D.C. sets are still manufactured—I shall stick to the point of view that the A.C. mains-rectifying valve should not be included when totaling up the number of valves in a receiver.

Philco in Britain

Philco is a name that must be known to every listener. Now the largest makers of sets in the world—jumping from twenty-sixth to first place in the United States in two years—Philco sets are now being produced in England.

Rather than start a works of their own, with all the attendant difficulties of coping with new labour and factory conditions in a strange country, Philco looked round for a manufacturer who could undertake the job for them.

They found what they wanted in Standard Telephones and Cables, Ltd., and the production of Philco sets is now in full swing at New Southgate and Hendon.

Three Thousand a Week

I recently had the opportunity of visiting the Standard Telephone works and seeing Philco sets actually in production. By the beginning of November it is expected that 3,300 sets a week will be turned out.

An interesting point is that sets for test after the assembly has been completed are passed down a belt conveyor, so that there is no waiting and no walking about. The actual tests are very complete and one gets the impression from seeing the factories that Philco sets are good.

So quick were Standard Telephones and Cables in getting down to the job, said Mr. Carleton Dyer, the managing director of Philco, that

RADIO MEDLEY—Continued



RADIO TO RELIEVE MONOTONY

George McErlaine, who is 72 years old, lives by himself on a tiny island in Lough Beg (Ireland). He exists by bird shooting and fishing, and his only entertainment is a radio set

production has started a year before it was expected. As a result it was found impossible to get valves made to the Philco specifications in time for this season's receivers, which are being equipped with American types. By next season it is hoped that valves for Philco sets will be produced over here.

Colour Code

Visitors to the Radio Exhibition must have been struck by the fact that the resistances in many commercial sets were coloured. Now this colouring is not an attempt on the part of set makers to brighten radio, but is a definite code to avoid the necessity of looking closely at a resistance to determine its resistance value.

The official R.M.A. colour code is now used by a number of resistance manufacturers, and such resistances are becoming available to the public, so it will be useful if I indicate here how the code is arranged.

Ten colours are used altogether and up to three can appear on any one resistance. The BODY is coloured to represent the FIRST FIGURE of the resistance value; ONE END (or tip, if you prefer it) is coloured to show the SECOND FIGURE; and a

DOT, usually somewhere about the centre of the body of the resistance, represents the number of CIPHERS or noughts.

Here is the code of body colours representing the first figure: Black = 0, brown = 1, red = 2, orange = 3, yellow = 4, green = 5, blue = 6, purple = 7, grey = 8, and white = 9.

The same colours are used for the ends of the resistances, but corresponding to the second figure.

Ciphers or noughts are shown by dots of the following colours: None = black, 0 = brown, 00 = red, 000 = orange, 0000 = yellow, 00000 = green, and 000000 = blue. It will be seen that this arrangement is based on the first set of figures—two ciphers = red, for instance.

In A Resistance Factory

The thing that has led me to the subject of fixed resistances, or resis-

tors as they are being called nowadays, was a visit to another factory—to be exact, the works of Erie Resistor, Ltd., at Cricklewood, where I was shown round by Mr. Rod Weese, who is a Canadian.

In Commercial Sets

More than 60 per cent. of the sets shown at Olympia, Mr. Weese told me, were equipped with Erie resistors which, although not supplied to the constructor up till now, have nevertheless become quite well known among amateurs generally.

A company has recently been formed for the retail distribution of Erie resistors to the public; it is called the

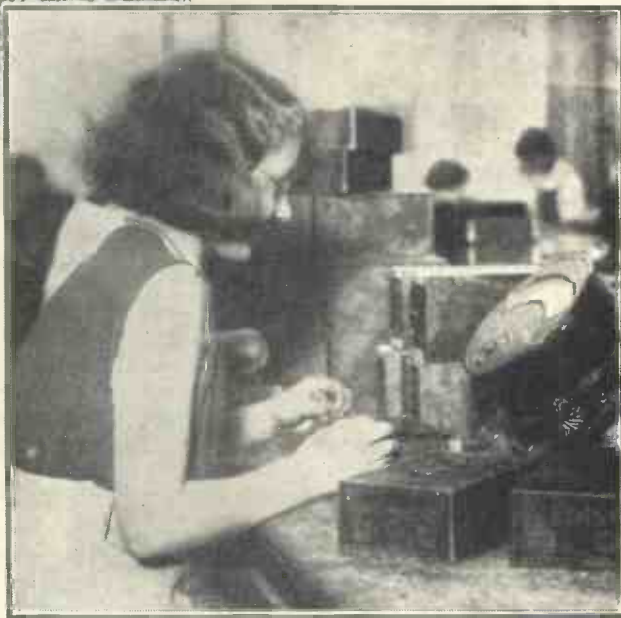

TESTING THE "JUICE" SUPPLY

One of the workers employed in the manufacture of Edlswan high-tension batteries. Every care is taken to produce a first-class product

Radio Resistor Co., and the address is 1 Golden Square, London, W.1.

Erie resistors are of the composition type and have wire ends. The body material is a special mixture of carbon and other materials, mixed in the proper proportions to give the required resistance. In other words, for a given wattage all resistances are the same size, a 250,000-ohm model being no larger than a 5,000-ohm job.

Molten copper is sprayed on to the tips of the resistance elements and the wire ends are then soldered on; it is practically impossible to pull them off and it is also practically impossible to break the resistances.

CONDUCTED BY BM/PRESS

The operations that are carried out at Cricklewood are drying, impregnating, grading, and colour coding. Drying the resistances is, I gathered from Mr. Weese, the secret of success. Resistors are passed in racks through a constant-temperature oven for three-quarters of an hour, which process effectively drives out all the moisture.

Progressive Cooling

The impregnating bath is so arranged that the wax becomes progressively cooler as the resistances pass through it, the necessary gas jets being thermostatically controlled.

Grading is done by means of sensitive galvanometers, the resistance values being read off on special ground-glass scales with ink markings.

Some manufacturers have peculiar requirements in the way of tolerances and a scale is prepared to meet any special case. For instance, one maker may want a tolerance of only plus 5 per cent. but minus 10 per cent., and so on.

I found the Erie factory one of the most interesting I have visited for a long time and I was really astonished at the care that is taken with the production of what is to most of us a very insignificant component.

At Manchester

I took the opportunity of running up to Manchester for a day to have a



MOLLISON'S PLANE—AND HIS RADIOGRAM

As announced in our last issue, Mrs. Mollison (Amy Johnson) recently bought a C.A.C. radio-gramophone kit to present to her husband on his return from America. Here is Mollison's plane on the C.A.C. van that formed part of the convoy travelling from London to the Manchester Exhibition

look round the Northern Radio Show. I have not been to it in previous years. (By the way, I have been to Manchester just for the day about four times in the past two years and not on one occasion yet have I seen it raining there!)

The show itself is very compact and homely after the recent effort at Olympia; it was also very bright and it was good to have daylight instead of artificial light only.

There was some criticism among manufacturers I spoke to on the score of the admission charge, which was 1s. 6d. As there are no side shows or demonstration rooms at

the Manchester Exhibition, it was felt that the price of admission was too high to attract many casual visitors and that only the really keen people rushed to get there. On the whole, though, I believe the attendances were good.

My Correspondents

At this time of the year my correspondence increases enormously and I should like to take the opportunity of again reminding readers that they need only address their letters "BM/PRESS, London, W.C.1" for them to reach me in perfect safety.

London, W.C.1. BM/PRESS.

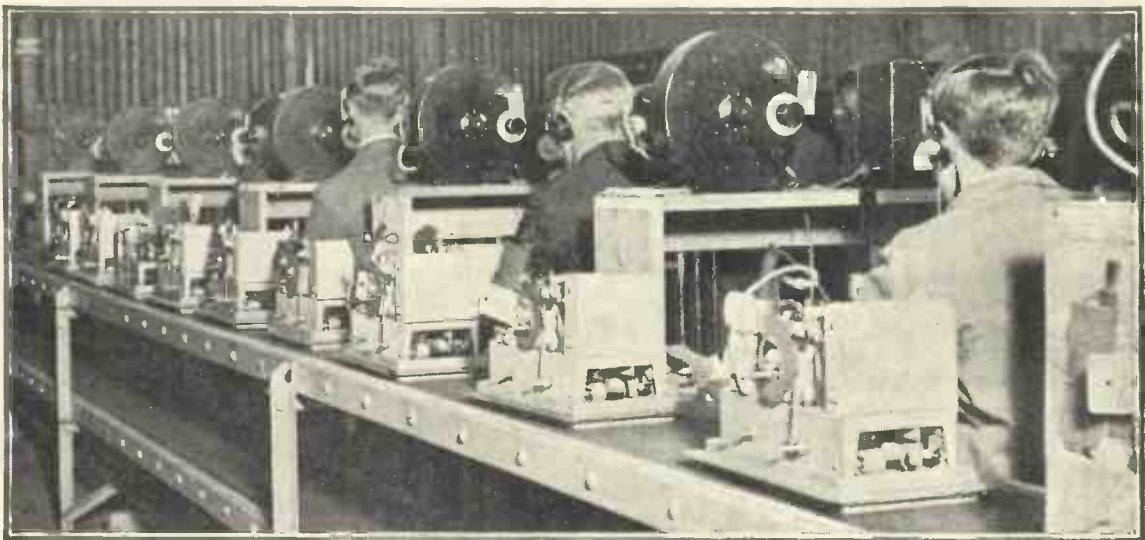

COMING DOWN THE LINE FOR FINAL TEST

This photograph shows how Philco sets are passed down a conveyor-belt system to the operators who give the final tests before dispatch

ON THE CREST OF THE WAVES

RADIO NEWS FROM ALL EUROPE :: By JAY COOTE

CZECHOSLOVAKIA

MAURICE CHEVALIER, the well-known film star, who recently toured the Continent, was paid the equivalent of £840 for the one evening's recital of songs he gave at Prague. As a law exists in Czechoslovakia making it illegal to export money from the country the organisers of this special concert were sued by the State finance department for contravening the currency regulations. It was contended that the French artist's voice was an illegal import.

EGYPT

According to a report from Italy, a high-power transmitter of the "Coltano" type is to be erected to the order of the Egyptian government at Alexandria. The station will be so constructed that it can be used for wireless telegraphy and telephony on long, medium and short waves. Work is to be started before the end of this year.

GERMANY

Following the launch of the high-power transmitters at Breslau and Gleiwitz, work is to be started immediately on the "super" station at Berlin to take over the duties of the broadcaster situated at Witzleben. In the near future a start will also be made on the new Hamburg transmitter. The reconstruction of the Hanover relay has already been put in hand; when completed it will work on 227.4 metres in common with Bremen and Flensburg. The rated power is 1.5 kilowatts (aerial).

HOLLAND

Photo cells are now used on the Dutch railways for the control of ventilation in passenger trains when passing through long tunnels. When steam and smoke obscure the lights a relay is set in action by means of a cell and by this means revolving fans are brought into operation to supply fresh air to the carriages.

During the coming winter a series of concerts in which artists of international repute are taking part will be broadcast from the Hilversum

station. On these special nights, for the benefit of foreign listeners, all announcements will be made in the Dutch, French, German and English languages.

Contrary to the custom prevailing in Great Britain, where SOS messages are usually held over until the broadcast of the news bulletin, in Holland, in view of the urgency of such communications, the programme may be interrupted at any moment to send them out. As a rule they are heard between two items of the entertainment. In the same way, should it be found that an urgent telegram cannot be delivered the text is handed over by telephone to the broadcasting station for transmission through the microphone.

ITALY

As the Scala Opera House at Milan, owing to heavy losses incurred during the past two seasons, was threatened with a deficit likely to affect its future existence, the E.I.A.R. has come to its rescue by promising to grant an annual subsidy in exchange for increased facilities in the relay of operatic performances to the North Italian group of transmitters.

LATVIA

As the geographical position of Riga has been deemed unfavourable for the broadcast of wireless programmes, a second transmitter is in course of construction at Aiviekste, near Madona. The power of the station will be roughly 15 kilowatts at the start, but provision has been made for an increase to 50 kilowatts should this be judged necessary to provide an adequate service to the entire country. There is also a possibility that a wavelength in the neighbourhood of 800 metres may be used. To ensure good reception to listeners in the Latvian capital it is suggested that the present station should reduce its wavelength to 198.5 metres, a channel in which tests have already been made with satisfactory results.

LITHUANIA

Kovno (Kaunas), the sole transmitter owned by Lithuania, will shortly have its power increased. Up to the present it has been working on less than 7 kilowatts. With the reconstruction of the station the engineers hope to double and even treble its output.

MOROCCO

Notwithstanding the fact that Radio Rabat has now been working for over two years, less than 5,000 licensed listeners registered in the French protectorate up till April of this year.

RUSSIA

The U.S.S.R. stations have suspended their broadcasts of propaganda likely to give offence to the authorities of neighbouring countries and are now confining their international talks to minute descriptions of conditions of living under Soviet rule. It appears that little has been gained by the exposition of Bolshevik tenets, in which the Moscow (Trades Union) station specialised, and that an endeavour is now being made to co-operate more closely with other European states. It is reported that special cables are being laid to connect up the principal Russian cities with the Polish and Lithuanian frontiers with a view to linking up these centres for the interchange of broadcast concerts.

SWITZERLAND

The 20-kilowatt short-wave station at Prangins (near Geneva) is regularly taken over by the League of Nations every Sunday evening for the broadcast of an account of the League's activities. This transmission takes place between 10 and 10.45 p.m. G.M.T., the first fifteen minutes being devoted to a French communique. This is followed by a special report in English, followed by similar matter given out in the Spanish language. The wavelengths used for these broadcasts are 40.3 metres and 20.64 metres. At a later date a programme for European listeners may be transmitted on a higher wavelength.

MODERN LOUD-SPEAKERS

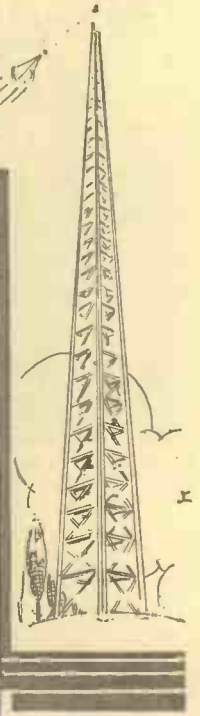

The photograph on the left shows the giant "searchlight" type of loud-speaker installed on the roof of the Marconiphone building in Tottenham Court Road, London

IN preparing this supplement we have as far as possible included articles that will answer most of the questions the listener wants to ask about modern loud-speakers. There is no attempt to go into the details of construction or operation, but the material here presented will give the reader a good idea of the present state of the loud-speaker art.

For instance, Noel Bonavia-Hunt, an acknowledged authority on reproduction, discusses the respective merits of the four main types of loud-speaker in general use—the balanced-armature, the inductor, the moving-coil and the electrostatic. His article cannot fail to appeal to

all those who take the slightest interest in the question of radio reproduction.

Designers have in most cases given up the attempt to produce a loud-speaker that will give an even response over the entire range of musical frequencies. The latest idea is to use two reproducers, one to give good bass response and the other to supply the requisite amount of treble; in this way it is sought to obtain an effectively level response over a wide frequency range.

Such a compensated loud-speaker combination naturally requires a really good amplifier for the best results. To this end the "W.M." Technical Staff has produced a special amplifier. It contains three valves and has a substantially level

frequency response curve. Moreover, it gives sufficient output to drive the two loud-speakers at really good volume. The Dual-speaker Amplifier will appeal to many keen people who want absolutely tip-top reproduction—whether from radio or from records.

It is well known that for the best results the loud-speaker must be matched to the last valve of the set with which it is used by means of an output transformer. P. K. Turner in his article explains that a general rule of thumb is not really good enough, and he gives in detail a method of calculating the best characteristics for an output transformer for any given conditions.

P'S AND Q'S OF THE FOUR TYPES, by Noel Bonavia-Hunt, M.A.—Page Two. **THE DUAL-SPEAKER AMPLIFIER**, by the "W.M." Technical Staff—Page Eight. **MATCHING THE LOAD**, by P. K. Turner, M.I.E.E.—Page Eleven. **NOTES, HINTS AND TIPS**—Page Sixteen



By
Noel Bonavia-Hunt,
M.A.

P's and Q's of the FOUR TYPES

There are four types of loud-speaker now in general use—the balanced-armature, the inductor, the moving-coil and the electrostatic reproducer respectively. In these notes an authority discusses the advantages and disadvantages of each type

IF there is one occupation which proves more than usually attractive to wireless and gramophone enthusiasts it is that of listening to and comparing various types of loud-speaker working on a common amplifier.

correction has been interposed between it and the first low-frequency valve to compensate for the treble and bass deficiencies in the recording.

In the case of a wireless set, we shall be content with one that is capable of giving us undistorted reception of the local station. Now all that remains for consideration is the loud-speaker. If the result is bad, blame can reasonably be thrown on the last link and the reason for the bad result must be traced.

A good loud-speaker may popularly be described as reproducing the musical band of frequencies in proper balance. A well-defined treble, a clear and pronounced bass, a middle register that dovetails neatly at one end into the bass and at the other into the treble, no objectionable resonances or discoloration—these are the main points which a critic should be on the look-out for.

And then, of course, we prefer a sensitive loud-speaker, or at least one that does not compel us to overload the last valve in order to get adequate volume. A sensitive loud-speaker, on the other hand, must be capable of handling reasonably large inputs without “blasting.”

Have we exhausted our requirements? Not quite. There is the important question of “transients” (explosive sounds) which are so badly treated by many loud-speakers (and amplifiers, too).

If transients can be reproduced with some approximation to the

original we have travelled considerably along the path to realism, though it must not be forgotten that the ground is by no means covered even when we have done this.

No “Explosives”

It is possible to listen to a musical item which is quite innocent of these “explosives”! It so happens, however, that a loud-speaker which is good in respect of transients is also good in many other respects.

Let us review the three principal types of loud-speaker in modern use, pointing out their vices and their virtues:



A well-made balanced-armature unit and cone is the Geophone model shown here. Gold silk for the loud-speaker fret is supplied

Assuming that the amplifier is really good, with each stage working well within its capacity, and with a wide frequency response, one need not be unduly anxious about this particular link in the chain.

If we are listening to a gramophone record we must also assume that the pick-up is as good as the amplifier and that some efficient form of tone

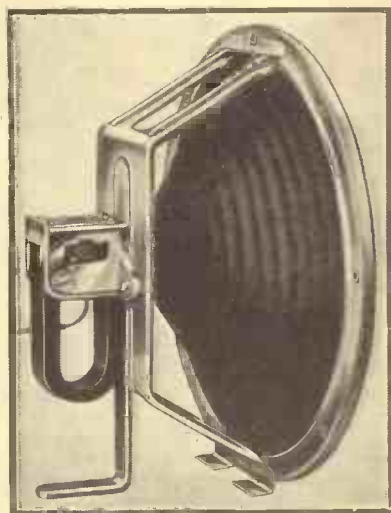

This is the Blue Spot 100U inductor loud-speaker, which is suitable for use with power or pentode output valves

1.—The balanced-armature reed-driven diaphragm is still extremely popular. It is cheap and sensitive to small inputs, and these two qualifications offer attractions which the owner of a small battery set cannot afford to ignore.

Distortion

In all loud-speakers of this class, however, with the exception of the Lion and the Beverley, the relationship between the electromotive force and the amplitude of the movement is not linear, and this results in distorted wave-forms. By employing a compensating mechanism between the reed and the diaphragm this non-linear characteristic can be eliminated.

But, no matter how clever the designer may be, he is confronted by the apparently insoluble problem of securing the proper reproduction of the lower frequencies (below 100 cycles) and also of the higher frequencies (above 4,500 cycles) free from resonances.

Transients, however, are really quite well handled since the reed itself, which need not be more than

battery-set owners. It is very sensitive, delivers quite a remarkable bass (so much so that a large baffle is unnecessary) and, like the reed type, has the great advantage of a permanent magnet system.

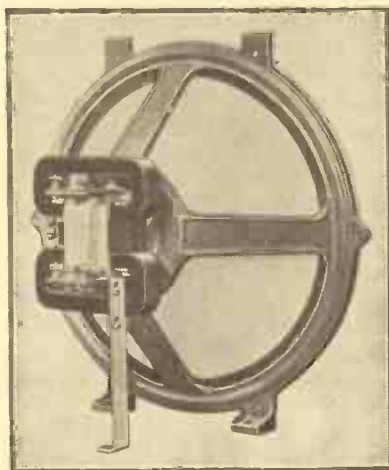

The Gecophone inductor loud-speaker chassis has alternative tappings which permit its use with any type of super-power output valve

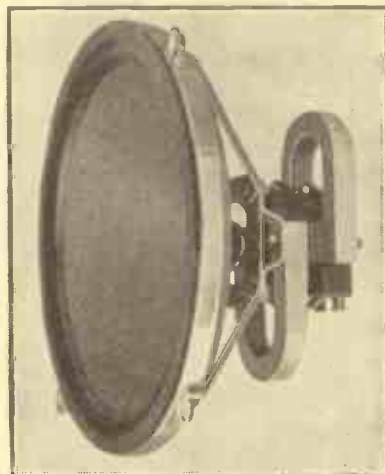

Results comparable with those of a moving coil can be obtained with an inductor. This is the Ferranti model, its resistance being 5,000 ohms

The best types offer a high-note response up to 5,500 cycles devoid of obvious resonances, and there is no doubt that these loud-speakers exhibit their more favourable characteristics when linked to a comparatively low wattage amplifier, though it is true that they will stand up to quite large inputs.

The fact is, the bass is by no means free from resonance and becomes "boomy" and even excessive when the input is derived from a high wattage super-power valve. Further, the high-note response is too limited to counter-balance the excessive bass, and the overall effect is "low pitched."

I must, however, honestly confess that by using a small amplifier it is possible to reproduce speech with almost uncanny realism, providing the baffle (whether of the cabinet or screen type) is carefully designed.

Transients in this loud-speaker are not as good as one could wish, but this is only what is to be expected from a heavily damped movement and a relatively weak field magnet.

3.—The moving-coil loud-speaker is generally admitted to be the best yet devised by human ingenuity for reproducing the original sounds. I say "generally admitted," as there are still one or two experts who frankly dislike this type of loud-speaker.

The principal charge brought against it is its failure to attack

type is considered greatly superior to that of any mass moving system in which the "time constant" is supposed to present a serious problem.

Imaginary Defect

In my opinion, this particular defect exists largely in the imagination of these critics, since it is easily possible to design a moving-coil system that will reproduce transients as faithfully as any reed can do.

Another charge levelled at the moving-coil loud-speaker is its proneness to resonances, especially in the neighbourhood of 100 and 2,000



A moisture-proof diaphragm is one of the main features of the Celestion permanent-magnet reproducer type PPM9. A universal matching output transformer is supplied

$\frac{1}{2}$ to $\frac{3}{4}$ in. in length, functions independently of the diaphragm and is not impeded by mass movement.

2.—The inductor moving-iron loud-speaker provides many features of interest. Had it arrived three or four years ago it would, despite its rather high price, have achieved a phenomenal popularity among



The cheapest loud-speaker in the Blue Spot range is the 66KC chassis. The balanced-armature unit incorporated is the popular 66K

P'S AND Q'S OF THE FOUR TYPES—Cont.

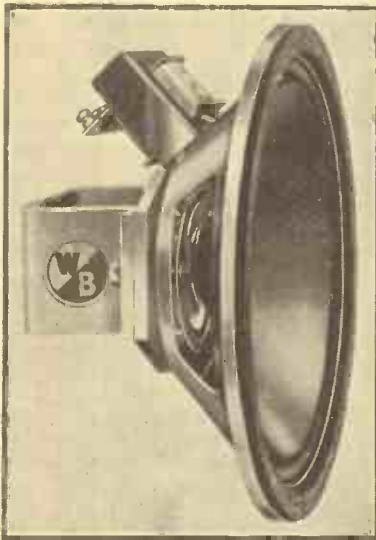

The PMS Mansfield model is the latest reproducer to be added to the W.B. range. The resistance of the speech coil is only $2\frac{1}{2}$ ohms

cycles respectively. Careful design can palliate these resonances considerably, and the moving-coil possesses no monopoly in this respect.

Lack of Sensitivity

Thirdly, the moving-coil is criticised for its lack of sensitivity to small inputs unless a very powerful field magnet is employed, and this makes it unpopular with battery-set owners. Further, it is objected that if a high wattage field is supplied from A.C. mains the frequency of the latter is impressed on the moving-coil, and attempts to eliminate this hum have mostly failed.

This defect is mainly a source of disturbance to certain highly sensitive listeners who find themselves unable to tolerate the very slightest suspicion of background noise even with the ear placed right close up against the loud-speaker diaphragm.

Complete Cure

The substitution of accumulators for energising the magnet or else of a permanent magnet in place of the electromagnet will provide a complete cure, but both possess obvious disadvantages of their own.

The "9,000-line" permanent-magnet loud-speaker is the most efficient of its kind yet devised, but it is a costly affair and is really not capable of reproducing the extreme ends of the musical scale with the

same efficiency as the powerful electromagnetic system.

It is when an actual comparison is made between the moving-coil and all other types of loud-speaker that one realises the superiority of the former. It must not be forgotten that the frequency range of a well-designed moving-coil is easily greater than that of any other system, and this feature alone weights the scales very heavily in its favour.

An organist, for instance, can

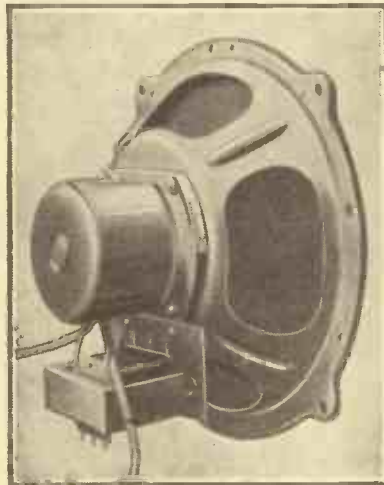

A moving-coil loud-speaker which has been specially designed for use in A.C. receivers where it can be used as a smoothing choke the Epoch type E7

hardly be expected to wax enthusiastic over a loud-speaker that fails to reproduce in due proportion the pedal passages of an organ item!

The tympanist and the double bass player, too, deserve some consideration when an orchestral item is transmitted. And at the same time, since the response curve of the ear is asymmetrical, a good bass register should be counterbalanced by a good treble, so as to secure the correct proportions throughout the spectrum.

And this leads me to mention the moving-coil logarithmic-horn loud-speaker. The diaphragm is quite small and very light, and in consequence the mass to be moved is reduced to a practical minimum. The long exponential horn serves as an effective load, with the result that the efficiency of the system is as high as 33 per cent. Transients are excellent, as one might expect, and there is a good high-note response.

But what about the lower frequencies? The small diaphragm is incapable of re-creating fundamental waves below 100 cycles in due pro-

portion: in fact, the fall-off is very evident. No matter how long the horn is, the lower notes will refuse to come.

Lower Wave-forms

The reason is simple: a 2-in. diameter diaphragm cannot be arranged to form part of a system designed to reproduce the lower wave-forms. In the reproduction of speech, and of such complex sounds as the bowing and plucking of stringed instruments, this type of loud-speaker is really excellent.

For home use it is obvious that a very long horn is out of the question, and the majority of moving-coil enthusiasts are compelled to choose the large diaphragm loud-speaker, either housed in a cabinet or mounted on a baffle board.



The Igranic permanent-magnet moving-coil loud-speaker has a specially designed magnet system which is claimed to minimise losses

There can be no question that the most important factor in the success and efficiency of the large diaphragm is a strong field magnet. Although it cannot apparently increase the flux density in the gap beyond a definite point, the fact holds good that the higher the density the better chance the loud-speaker has of doing its job.

The "attack" is improved, the low- and high-note response is increased, and the sensitivity is greater. In a word, the *velocity* of the movement is increased, there being a magnification of both applied and back e.m.f.

Now the question arises—should the paper diaphragm or cone (which is the shape we are compelled to adopt after trying out every con-

BALANCED-ARMATURES AND INDUCTORS

ceivable formation of diaphragm) be permitted absolute freedom of movement and, if not, how far shall restraint be placed upon it?

Question of Suspension

Absolute freedom is impossible, as there must of necessity be some kind of suspension at both the base and the edge of the cone in order to preserve an axial, piston-like motion. But there are some who argue that the diaphragm should be as free as possible.

What *is* required is that it should be in a state of equilibrium (just as the air particles may be said to be before displacement). This means that there should be no bias in either direction due to any method of centring, or suspension employed. Further, it is well known that too much restraint produces resonances, and there is no doubt that a number of commercial loud-speakers are blameworthy in this respect.

On the other hand, there is a degree of freedom which involves the formation of the smaller wave-forms during the execution of wide amplitudes, that is, before the diaphragm has had time to complete a single excursion forward or backward.

Solving the Difficulty

Hence, if we can so arrange matters that the cone is free to oscillate to and fro with an amplitude of $\frac{1}{8}$ in. in a gap approximately $\frac{3}{32}$ in. without fouling the polepieces, we shall have probably solved the difficulty fairly well.

It will be found that the size of diaphragm employed will considerably affect the issue of our experiment. A small cone of $4\frac{1}{2}$ to 6 in.

diameter is incapable even on a large baffle board of reproducing very low notes if allowed sufficient axial freedom to obviate pronounced resonances.

A larger cone of 9 to 12 in. diameter, owing to the fact that it displaces a larger mass of air, can be allowed to execute smaller amplitudes with greater freedom; also the heavier weight itself introduces a steadying effect on the diaphragm and therefore admits of a relaxation of the methods of restraint commonly in use.



One of the most popular of this year's moving-coil reproducers is the Rola type F7. The matching transformer is for either power or pentode output valves

The best type of peripheral suspension I have yet seen is the "bellows surround," devised by C. Berrage-Moulton, B.Sc., by means of which, with its quasi-pneumatic effect, an excellent compromise between freedom and restraint is effected, and undue lateral motion is prevented.

As regards centring devices, I do not favour the outside type because it biases the movement of the coil in the return direction, making the pull

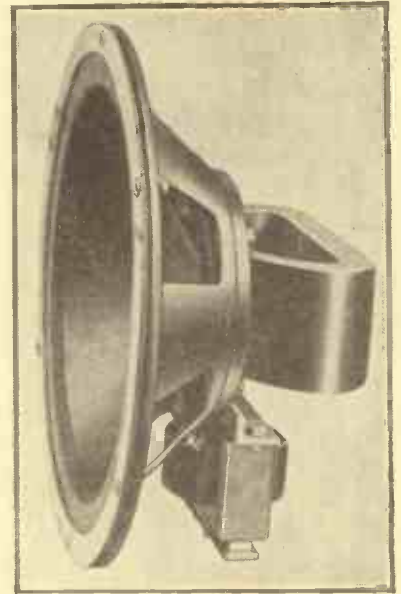

This is the new Gecophone permanent-magnet reproducer. A multi-ratio input transformer is supplied. It can be obtained in a matt-walnut cabinet

stronger than the push. The wheel-shaped linen device, due to Arthur Baker of moving-coil loud-speaker fame, is the best from all points of view. It is fitted to the inside of the coil former in the approved manner and allows just the axial latitude that is wanted.

I prefer to fit on either side, behind and in front of the device, after centring the coil in the gap, a soft rubber pad or disc about three-fourths the diameter of the coil former with the object of preventing excessive excursions of the cone and of preserving the curvilinear outline of the linen radial strips during motion.

Reduced Resonance

In this way, by utilising with proper care a method similar to that which I have suggested for pick-up damping, in which the linear relationship between current and amplitude is maintained, the cone and coil assembly can be arranged to vibrate in a satisfactory manner with resonances considerably reduced.

The frequency response of a loud-speaker is, as already noticed, a very important point. The difficulty arises when it is desired to reproduce very high and very low notes. The ideal response would range from 23 to 10,000 cycles. What is of greater moment is that the reproduction shall show the correct harmonic pro-



The Sonochorde permanent-magnet moving-coil reproducer made by the Rothermel Corporation, Ltd. A new method of suspension is claimed to give permanent alignment of the speech coil

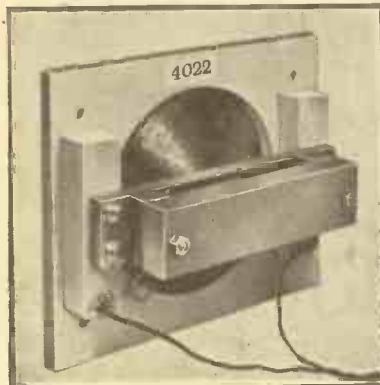

This is the Lanchester Bob moving-coil reproducer, which utilises the bar type of permanent magnet. A cabinet model is obtainable

P'S AND Q'S OF THE FOUR TYPES—Cont.



The senior R.K. permanent-magnet moving-coil reproducer made by B.T.H. is fitted with an 8-in. corrugated diaphragm and the impedance of the coil is 15 ohms

portion of the original, in which the various frequencies and amplitudes all fit in their right places.

Could one be confronted with a loud-speaker wholly devoid of resonances and capable of reproducing the complexities of sound with real fidelity to the harmonic proportion of the original, even though its frequency range were limited to a band of 64 to 5,500 cycles, the result would be a positive delight—if not a revelation.

A response range from 30 to 8,200 cycles is easily obtainable from a large diaphragm of 12 to 14 in. properly suspended and operated by a suitable speech coil fed by a first-class amplifier.

Associated Overtones

The lowest note produced by the organ in the Royal Albert Hall has a frequency of 16.3 cycles, obtained from the 32-foot pedal stop. The fundamental frequency of this note is not actually heard, but merely creates an "effect" on the ear through its associated overtones. The lowest frequency which the ear can determine as such is that produced by the 23-cycle note of this stop, so that we need not suffer from a fit of mental depression because our loud-speaker happens to cut off at 30 cycles!

The highest note in this organ has a

frequency of 8,352 cycles, the overtones of which are inaudible to the average ear. So here again a cut-off at 8,200 cycles is hardly a serious matter. Superb quality of reproduction is possible with such a range.

Much ink has been spilt over the coil controversy. Space forbids my writing at length on this subject. Suffice it to say that it is entirely a question of design. A high-resistance coil is relatively heavy and requires a proportionately heavy diaphragm to

required wattage, but one is consoled by the reflection that the thicker wire necessitated makes for greater durability.

Resonant Peaks

I do not agree with those who argue that the ideal coil would weigh no more than the proverbial feather; for too light a coil produces nasty resonant peaks in the upper register, the damping of which neatly removes the very advantages of employing such a coil.

In all the problems of dealing with moving-coil loud-speaker design there seems to be a Scylla and a Charybdis, and we are for ever running up against the one or the other!

The best results from any one system are obtained by steering a middle course, and if any one system is used there can be no doubt as to the superiority of the moving-coil for all general purposes. But having admitted as much, one does feel the necessity of exploring the path to realism more fully.

Two Crying Needs

To secure real efficiency in the upper register without impurity, and to harness those elusive transients—these are the two most crying needs of to-day in loud-speaker design. Fortunately, I am able to conclude this article on an optimistic note.

There has recently been introduced on the market an "electrostatic" loud-speaker called the Primustatic, which supplies the above needs in a striking manner. It readily



The Ferranti type M1 permanent-magnet loud-speaker is claimed to give almost perfect reproduction. As can be seen, it is particularly "clean" in appearance

balance it. The low-resistance coil can be made considerably lighter and wound on a smaller former, so that the whole assembly can be reduced in mass. This is an obvious advantage when, for instance, permanent magnets are employed.

Very thin wire in this case must be avoided since it cannot carry the



The Baker Permag is supplied complete with a matching transformer and cabinet. This back view shows the unusual shape of magnet used. There are many other types in the range



The new Amplion permanent-magnet reproducer is claimed to handle inputs up to 6 watts. The large magnet used is of 1/2-in. chrome steel and weighs 6 1/2 lb.

MOVING-COILS AND ELECTROSTATICS

responds to frequencies up to at least 15,000 cycles, is remarkably free from resonances, and is capable of handling transients with extraordinary efficiency.

When the announcer turns over a page of his notes or when cymbals suddenly crash out, then it is that the



One of the range of R. and A. loud-speakers. This is a well-made balanced-armature model of particular value for use with battery sets

superiority of this condenser loud-speaker in its reproduction of the minuter impulses is brought vividly home.

There is no need to scrap the moving-coil, with its splendid bass and middle register. All one has to do is to combine this with the electrostatic loud-speaker, so that each system, with its own peculiar

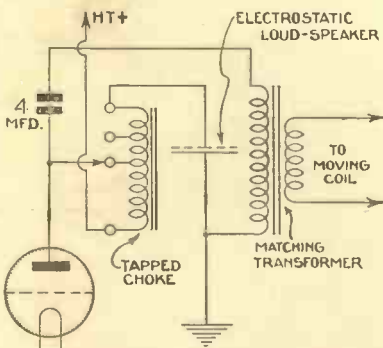

Special output arrangement for using an electrostatic loud-speaker in conjunction with a moving-coil reproducer — an ideal combination

advantages, may contribute its quota to the general effect. And this is a simple matter; for the electrostatic loud-speaker has neither coil nor magnet and can be operated in conjunction with a coil drive without in any way affecting the individual

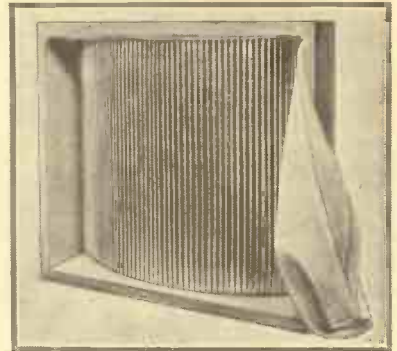
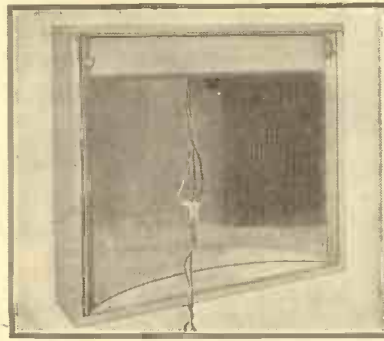

Two views of the Primustatic loud-speaker, which is excellent for use in conjunction with a moving-coil reproducer. It has an amazing response to transients and marks a very definite advance in loud-speaker design

performance of the latter.

A tapped choke is necessary for matching the loud-speaker to the output valve, and a suitable circuit for connecting the two loud-speakers to the ordinary amplifier is given here.

By itself, the electrostatic system exhibits a decrement in the lower register, but in its reproduction of the higher frequencies and its amazing response to transients it marks a very definite advance in loud-speaker design.

Controlling the Tone

TONE is often differentiated from quality by the non-technical user and there is some justification for this. The tone of a loud-speaker refers to the relative balance of high, middle and low frequencies, and different users have different preferences.

The modern tendency, therefore, is to employ a loud-speaker which, with its associated output valve, delivers an excess of both bass and treble, and then to provide a suitable adjustment by which the user can regulate the proportion of both. The ideal system would be to provide either two controls or a composite arrangement whereby the response at either end of the scale could be cut down independently to any desired extent.

Nearly as good results can be obtained, however, with much simpler arrangements. One of the most common consists of a simple cutting off of the upper frequencies. For this purpose a condenser of about .02-microfarad is connected in series with a variable resistance of about 25,000 ohms across the loud-speaker. With all resistance in series the capacity has little effect, and the loud-speaker gives its normal performance. As the resistance is reduced more and more of the high-

frequency currents are shunted by the condenser, while with no resistance at all the condenser is connected directly across the loud-speaker, and practically all the upper frequencies are cut off.

Bass Unaltered

This arrangement, however, leaves the bass unaltered, and if this is excessive a similar device must be used to cut down the low notes. In this instance a small low-frequency choke is used instead of a condenser, since this shunts the loud-speaker at low frequencies, but has little effect on the upper notes. Since few loud-speakers give too much bass this system is little used.

Low-resistance Choke

The choke used should be about 25 henry and should have a really low resistance if it is to be effective.

If one wants to go a step farther, both controls may be incorporated at once. The ends of the low-frequency choke and the fixed condenser are connected to the outers of a 50,000-ohm potentiometer and the moving arm is connected to the loud-speaker. Movement of the slide then provides a smooth graduation from boomy tone to shrill reproduction.

A Dual-speaker Amplifier



The latest method of obtaining absolute purity of reproduction is to use two loud-speakers of different characteristics, one having a larger diaphragm than the other. In these pages the "Wireless Magazine" Technical Staff describes the construction of an A.C. amplifier for driving such a pair of loud-speakers

ASSUMING that an amplifier has a level response curve, to obtain a loud-speaker suitable to use with this would be rather an expensive proposition.

be rather expensive to be used solely for the reproduction of gramophone records. An ingenious switching arrangement has been introduced so that a pick-up, or the output of an

existing radio receiver, can be amplified at will.

With Christmas approaching, this is surely an ideal party equipment, particularly if it is used to supply music for dancing in conjunction with a gramophone pick-up and microphone.

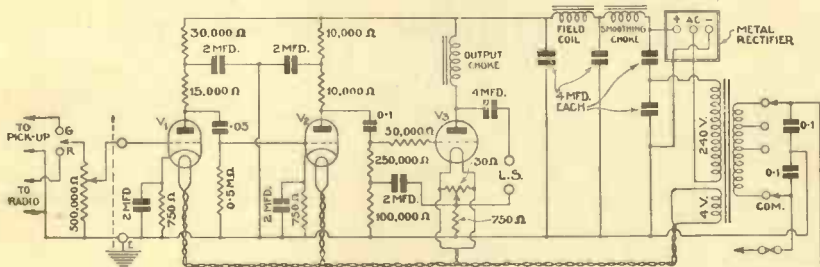

CIRCUIT OF THE DUAL-SPEAKER AMPLIFIER

The circuit arrangement consists of two resistance-coupled low-frequency stages feeding into a PX4 output valve. A.C. is rectified to D.C. by means of a metal rectifier

Realistic Output

The main thought throughout has been to obtain a realistic output and, at the same time, to keep the cost within reasonable limits. To this end, it was decided to use resistance-capacity coupling throughout. Theoretically, this method of coupling gives straight-line amplification. After exhaustive tests, metallised and

The introduction of dual-matched loud-speakers has disclosed a totally different viewpoint. Instead of having to pay between ten and fifteen guineas for a loud-speaker capable of reproducing faithfully both the bottom and the upper registers, for between £4 and £5 can be obtained a pair of loud-speakers so arranged that one deals competently with the lower register, and the other with the higher frequencies up to 6,000 or 7,000 cycles. With an arrangement of this kind one is able, for quite a reasonable sum, to obtain a sensibly level response, and the general effect is extremely realistic.

Raising the Standard

We believe that the Dual-speaker Amplifier is one of the first of its kind, and will do much to raise the standard of reproduction. It is well realised that such an amplifier would

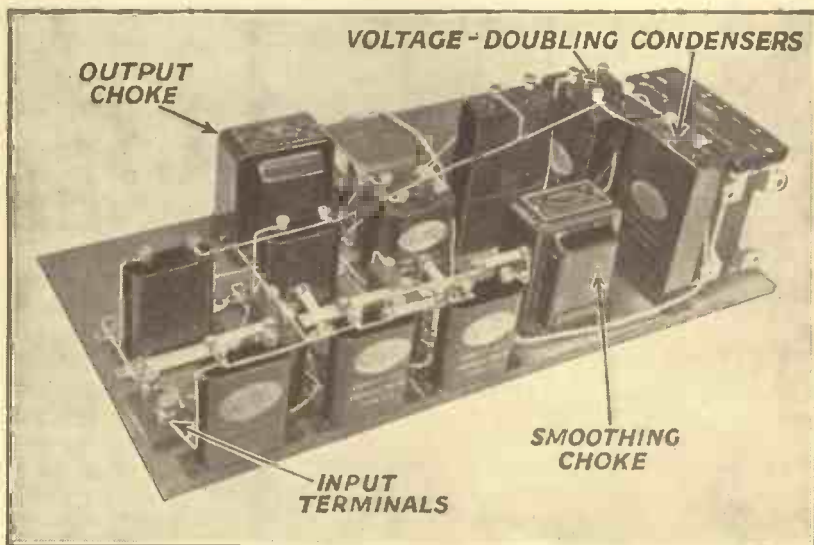

COMPACT BUT STRAIGHTFORWARD LAYOUT

There is nothing complicated about the construction of the Dual-speaker Amplifier as this photograph shows clearly. The input terminals, shown on the left, are connected to the input controls fitted to the cabinet

strip resistances were chosen, as these were found to be practically unbreakable when used correctly.

In modern apparatus of this type it is essential that it should be entirely mains driven and, at the same time, be suitable for working on practically any A.C. voltage. Supply voltages are usually between 200 and 250 volts, so the primary of the mains transformer has been tapped accordingly.

Unusual Supplies

For unusual voltages an auto-transformer can be used so that the amplifier need not be altered in any way.

Metal rectifiers are acknowledged as being completely trouble-free, and the Westinghouse H.T.9 is used to provide the necessary high-tension supply. When used on the voltage-

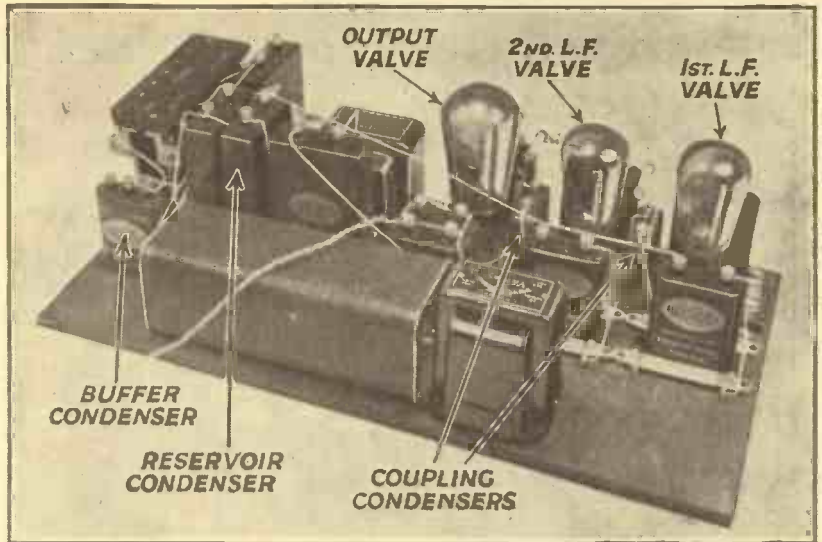

READY FOR FIXING IN THE CABINET

Here is a photograph of the amplifier with the valves inserted ready for connecting up inside the cabinet. The mains transformer is tapped for various voltages.

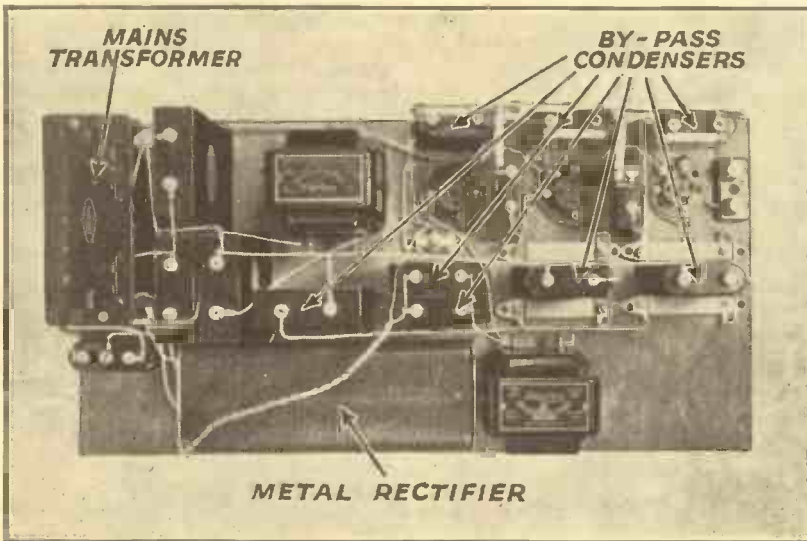

This photograph shows quite clearly how the components are arranged on the baseboard. Construction should present no difficulty even to the beginner

doubler system, the direct-current output from this unit is a little over 300 volts, which will allow for any voltage drop due to grid-bias requirements and choke resistance, etc., while still providing 250 volts for the anode of the PX4 output valve.

Variation in components and differences in the supply are sometimes inclined to cause hum; to counteract this, the smoothing used is unusually com-

plete. To reduce expense it was decided to include the field of the loud-speaker to assist smoothing and, at the same time, this could be energised automatically. The anode current of the PX4 is approximately 48 milliamperes, which is the current required by the Rola loud-speaker used.

Avoiding Mains Hum

Another small point which helps to make the performance of the amplifier such a success is the inclusion of a 30-ohm centre-tapped resistance across the filament supply for the output valve. This resistance can be adjusted so that the exact electrical centre of the 4-volt winding can be found, which will cancel out the last trace of ripple. Although a minor

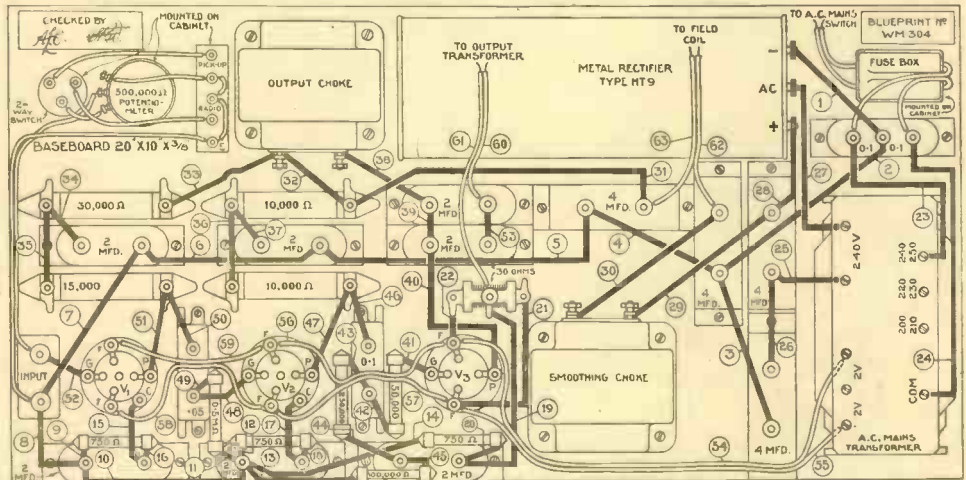

QUARTER-SCALE LAYOUT AND WIRING DIAGRAM

A full-size blueprint can be obtained for half price (that is, 6d., post free), if the coupon on the last page is used by November 30. Ask for No. WM304. When wiring, start with wire No. 1 and continue in numerical order until the set is completely wired up

A DUAL-SPEAKER AMPLIFIER—Continued

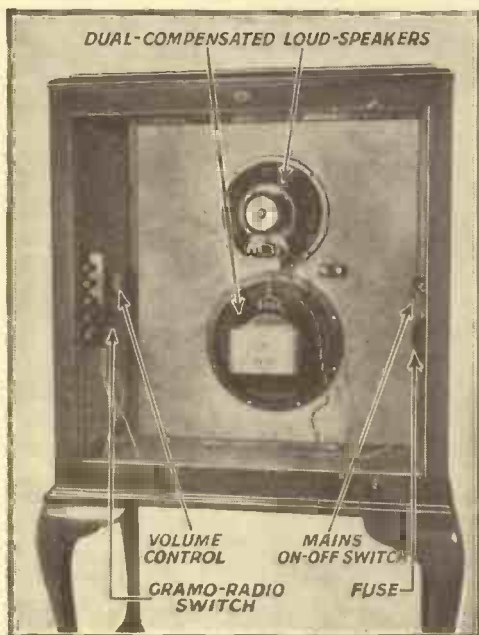

ARRANGEMENT OF THE CONTROLS

This photograph shows the cabinet with the dual loud-speakers and sundry controls ready to receive the amplifier. The connecting wires are clearly shown in the blueprint

detail, it is rather important to see that the heater leads are carefully twisted, as failure to do this may introduce hum into the circuit.

Finally, a total smoothing of 16 microfarads is used in the mains section so that with a 100-milliampere constant-inductance choke, and the loud-speaker field, every vestige of A.C. ripple is completely suppressed.

The PX4 power valve gives a little

over 2,000 milliwatts when operated with an anode voltage of 250 volts and 34 volts negative grid bias, the average anode current being 48 milliamperes.

A 20-henry choke (at 100 milliamperes) is included in the output circuit, obviating any possibility of saturation, and, by using this choke-filter output circuit, the input transformer, which is usually built into the loud-speaker, is safeguarded from saturation of the primary and breakdown.

It will be seen that every point has been carefully considered so that the reproduction will meet the requirements of the most fastidious.

We will review the various technical aspects of the circuit. The

500,000-ohm volume control was chosen for two distinct reasons; when used with a pick-up there is no possibility of any high-note cut-off, and if coupled to a radio receiver, it is used not only as a volume control, but as a grid leak in a resistance-capacity coupling unit.

The first low-frequency valve is an Osram MHL4 handling an input of at least 6 volts. As .5 volt input will fully load the PX4, there is no possibility of distortion in this section of the circuit. A low value of anode resistance has been chosen purposely to reduce high-note attenuation; incidentally this reduces the overall amplification in this stage, thus precluding any possibility of the second MHL4 being overloaded.

Use with a Radio Set

As radio may be used, complete decoupling has been provided so that there is little possibility of high-frequency currents penetrating into the output stage. Not only is the anode circuit of the first low-frequency valve decoupled, but the

(Continued on page Sixteen)



A COMPLETE GRAMOPHONE ATTACHMENT
A Simpson electric motor, pick-up and volume control are the principle parts of this attachment known as the Ad-a-gram. This conveniently constructed unit is suitable for the Dual-speaker Amplifier

COMPONENTS NEEDED FOR THE DUAL-SPEAKER AMPLIFIER

CHOKE, LOW-FREQUENCY

- 1—Varley constant inductance, type DP12, 17s. 6d. (or Ferranti, Heayberd).
- 1—Varley standard, type DP10, 15s. (or Ferranti, Heayberd).

CONDENSERS, FIXED

- 1—T.C.C. .05-microfarad, type 40, 1s. 9d. (or Dubilier).
- 1—T.C.C. .1-microfarad, type 50, 1s. 10d. (or Dubilier).
- 1—Ferranti .1-1-microfarad, type C3C, 3s. (or Peak, Dubilier).
- 7—Ferranti 2-microfarad, type C2, £1 2s. 9d. (or Peak, Dubilier).
- 4—Ferranti 4-microfarad, type C6, 1,050-volt D.C. test, £1 12s. (or Peak, Dubilier).

FUSE

- 1—Belling-Lee baseboard-mounting, type 1033, 2s. 6d. (or M.K., Bulgin).

HOLDERS, VALVE

- 1—Telsen four-pin, 9d. (or W.B., Lotus).
- 2—Telsen five-pin, 2s. (or W.B., Lotus).

METAL RECTIFIER

- 1—Westinghouse, type HT9, £1 1s.

RESISTANCES, FIXED

- 3—Dubilier 750-ohm 1-watt metallised, 3s. (or Erie, Claude Lyons).
- 2—Colverstat 10,000-ohm strip, 3s. 6d. (or Erie, Claude Lyons).
- 1—Colverstat 15,000-ohm strip, 1s. 9d. (or Erie, Claude Lyons).
- 1—Colverstat 30,000-ohm strip, 2s. 3d. (or Erie, Claude Lyons).
- 1—Dubilier 50,000-ohm 1-watt metallised, 1s. (or Erie, Claude Lyons).
- 1—Dubilier 100,000-ohm 1-watt metallised, 1s. (or Erie, Claude Lyons).
- 1—Dubilier 250,000-ohm 1-watt metallised, 1s. (or Erie, Claude Lyons).
- 1—Erie Dubilier 500,000-ohm 1-watt metallised, 1s. (or Erie, Claude Lyons).

RESISTANCES, VARIABLE

- 1—Claude Lyons 30-ohm Humdinger, 2s. 6d.
- 1—Wearite 5-megohm potentiometer, type Q21, 4s. (or Magnum, Igranico).

SUNDRIES

- Tinned-copper wire for connecting (Lewcos).
- Lengths of oiled-cotton sleeving (Lewcos).

Length of rubber-covered flex (Lewcos).

- 1—5½ in. by 2 in. terminal strip.
- 1—20 in. by 10 in. wooden baseboard.

SWITCHES

- 1—Bulgin rotary change-over, type S86, 1s.9d. (or Tunewell, Benjamin).
- 1—Bulgin double-pole mains, type S56, with escutcheon, 4s.

TERMINALS

- 2—Lissen terminal blocks, 2s. (or Belling-Lee).
- 5—Belling-Lee terminals, marked: Input (2), Pick-up (2), and Earth, 1s. 3d. (or Ealex, Clix).

TRANSFORMER, MAINS

- 1—Davenset, type No. 12, £2 7s. 6d.

ACCESSORIES

CABINET

- 1—Camco Mayfair, £5 5s.

LOUD-SPEAKERS

- 1—Pair of Rola dual-balanced, types F6 and F7, for use with PX4 output valve, £4 12s. 6d.

VALVES

- 2—Marconi MHL4, £1 7s. (or Osram MHL4).
- 1—Marconi PX4, 17s. 6d. (or Osram PX4).

The prices mentioned are those for the parts used in the original set; the prices of alternatives as indicated in the brackets may be either higher or lower

MATCHING THE LOAD

By
P.K. TURNER,
M.I.E.E.

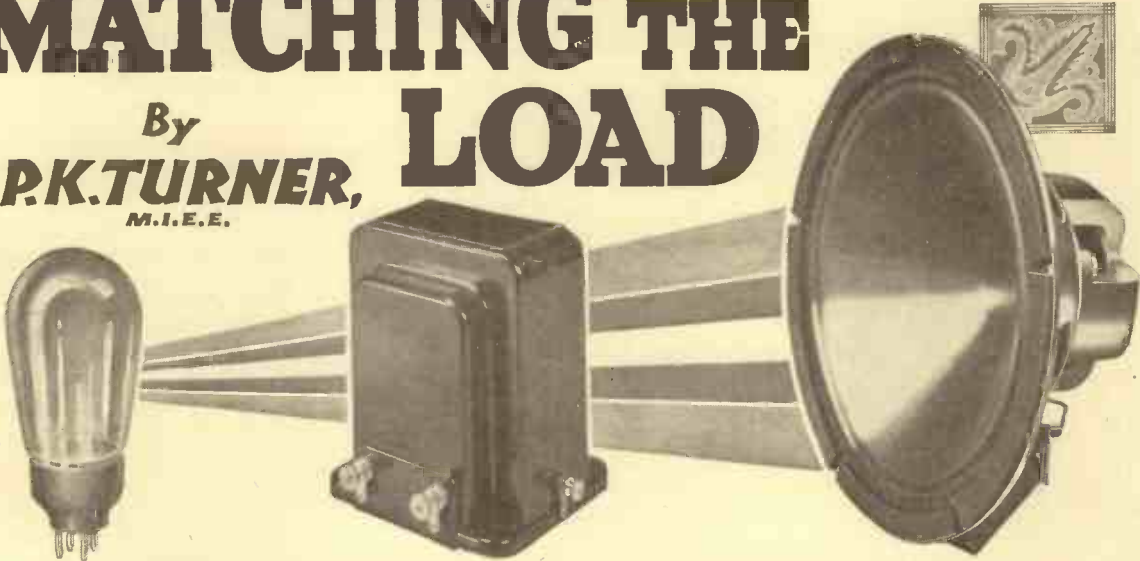

However good your loud-speaker it will not give the best results unless it is properly matched to the output valve of the set with which it is used. In these notes one of the leading radio authorities deals with the whole problem

NOT long ago I sold one of my loud-speakers. I didn't sell an output transformer with it, for the purchaser had a multi-ratio transformer of his own. A few days later, he expressed some disappointment with the results. The loud-speaker, he said, only gave a surprisingly small volume, considering that he was using a large power valve, and working it right up to the point where distortion began.

So I went to see about it. I found that he had set the transformer ratio so that the loud-speaker behaved like a resistance of twice the valve impedance—as he said, that is the standard value that everyone advises. None the less, by adjustment of the grid bias and the transformer ratio, I at once got a very great increase of volume before the valve began to distort.

Now why was this? Because that "standard" value is not a safe guide at all. Matching the load to the valve is not so simple. But at the same time it is not really at all difficult, and it is well worth learning; so here goes for an explanation of it.

Typical Conditions

First of all, I want to avoid the difficulties introduced by the transformer, so to start with we will consider the circuit of Fig. 1, which shows, in a slightly unusual form, a valve—in this case a PX4—fed with high-tension through a large

choke, and connected to a loud-speaker (shown as the resistance R) through a large condenser. As will be shown later, if the high-tension is 180 volts and the bias 20 volts, the current from the battery will be 45 milliamperes.

I am going to imagine that the choke is a perfect one, that is, it has negligible D.C. resistance, but so high an inductance that it simply won't allow a sudden change of current. As the D.C. resistance is

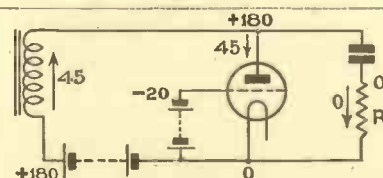

Fig. 1.—Conditions in typical power-valve circuit with output choke, corresponding to point A of Fig. 3.

negligible, there will be no volts loss in it, so that there will be 180 volts on the valve, and the top plate of the condenser will also be at this voltage.

Also, there is no current in R, so both ends of it will be at the same voltage, and so the bottom plate of the condenser will be at 0 volts. There is therefore 180 volts across the condenser—and remember that it is the property of a large condenser that it can receive a short sudden "surge" of current with only a negligible change of voltage across it.

Thus Fig. 1 now shows all the

voltages and currents in the circuit.

Increased Grid Bias

Now suppose that just for an instant the grid bias is increased to 30 volts, and that we want to find the current and volts in the anode circuit during that instant. It can be found from the valve curves that if there were no choke or load, the current would drop from 45 to 12 milliamperes. But in the circuit of Fig. 1 it *can't* do that. The choke, as explained, keeps the battery current at 45 milliamperes, neither more nor less.

What happens, then? The valve *does* take less, but the surplus goes through the condenser and load. We can't find what are the actual currents in any obvious way, even if we know the load resistance: but we can do the opposite; if we assume a current in the load we can easily find out what change of bias caused it.

Thus, suppose there were 10 milliamperes in the load, which is 2,000 ohms. Then there must be 20 volts across it by Ohm's Law, so the bottom plate of the condenser must be at +20 volts, and its top plate therefore at $180 + 20 = 200$ volts. Also, if there is 45 milliamperes going up through the choke and 10 down through the load, there must be 35 milliamperes through the valve. So the condition of the valve at this instant is: anode volts 200, current 35 milliamperes. (Fig. 2

MATCHING THE LOAD—Continued

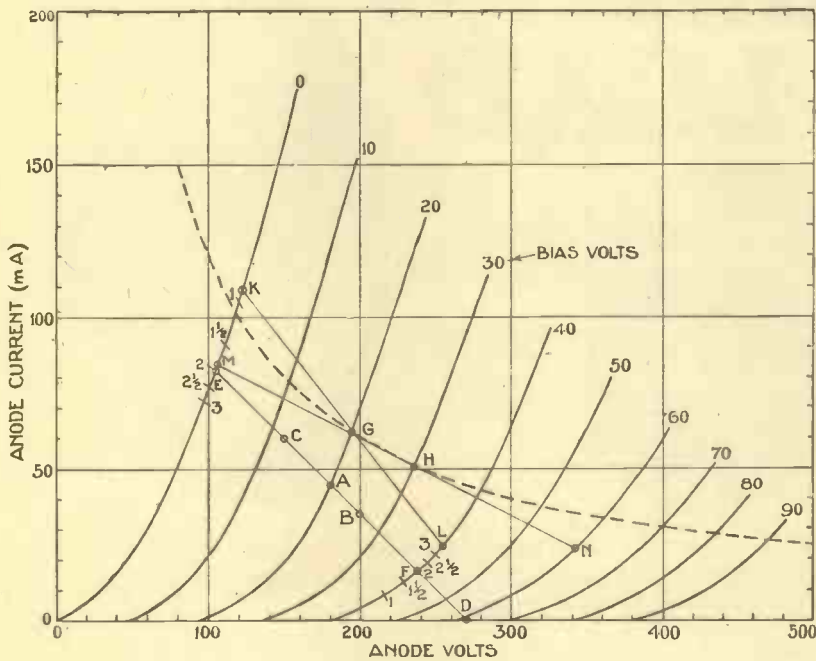

Fig. 3.—Typical valve curve-sheet, in this case for a PX4 power valve

shows the currents and voltages.) Now look at the valve curve-sheet, Fig. 3. Our original state was anode 180 volts, bias 20 volts, current 45 milliamperes—point A. During the instant of increased bias, we have just found: anode 200 volts, current 35 milliamperes, or point B, corresponding to 26 volts bias. Now work out in the same way some other cases. I will give just one example.

An Example

Suppose the current at some instant is 15 milliamperes up through the load. The top end of the load will be 30 volts below 0, or —30 volts, and the voltages and currents will be as Fig. 4, that is, anode 150 volts, current 60 milliamperes, point C on the curve-sheet.

If you work out several such cases, you will notice two things. First, all the points so found on the curve-sheet lie on a straight line—the line actually shown through A, B, and C. Second, the change in the anode volts and current in the valve are, exactly, the instantaneous volts and current in the load. So that if we can find an easy way of drawing this line, then for a given change of grid volts we can at once find out the instantaneous load conditions.

Luckily, this is quite easily done. The point A is 180 volts, 45 milliamperes on the scales of the curve. Work out the volts required to drive this 45 milliamperes through the load. In this case it is

$$\frac{45}{1,000} \times 2,000 = 90 \text{ volts.}$$

Add to this the value of the volts for point A: 180 + 90 = 270. Then the line required is got by joining A to 270 volts on the bottom scale (point D).

If now we want to solve our original problem, of what happens when the bias is increased from 20 to 30 volts for an instant, we have only to see where the 30-volt bias curve cuts the load line. It is at 212 volts, 29 milliamperes. Point A was 180 volts, 45 milliamperes, and the differences are 32 volts, 16 milliamperes, which are the instantaneous volts and current on the

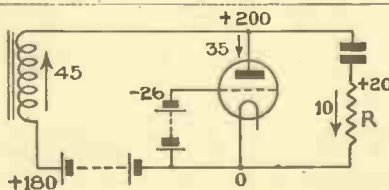

Fig. 2.—Another set of conditions for the valve of Fig. 1, corresponding to point B of Fig. 3

load. So the first problem is completely solved. If the load is a pure resistance, and we know what its resistance is, we can draw the "load line" at once, and find what instantaneous current and voltages are produced by any sudden change of grid bias.

Audio-frequency on the Grid

Now suppose that, in addition to the steady bias from the grid battery in Figs. 1 and 2, we have an audio-frequency voltage on the grid. I assume that my readers already realise that the maximum instantaneous grid voltage must not exceed the bias, to avoid grid current which would introduce distortion.

What we shall have will be that the momentary grid voltage will continually vary on either side of its original 20 volts. If the audio-frequency input is 20 volts amplitude (the maximum safe amount on account of grid current), then the grid volts will continually vary between 0 and 40 volts, and the conditions in the load will be given in turn by all the points on the load line between E and F.

This enables us to find quite easily the power in the load. Remember that the power in milliwatts is the product of the volts and

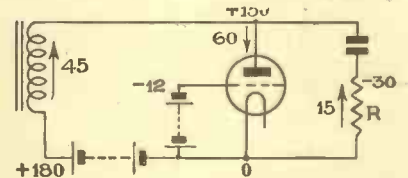

Fig. 4.—Third set of conditions for valve of Fig. 1, corresponding to point C of Fig. 3

the milliamperes. Both are varying all the time; but there is an easy formula which gives what is called the "effective" power—a sort of average, which gives a true indication of the useful power actually available.

First we find the maximum "swing" of the volts and current between the extremes reached. These extremes are (point F) 238 volts, 16 milliamperes, and (point E) 104 volts, 83 milliamperes, and the swings are 134 volts, 67 milliamperes. Multiply these two together and divide by 8, and we get the effective power. In this case it is 1,120 milliwatts. The product of swings

ABC OF THE OUTPUT TRANSFORMER

is always to be divided by 8.

Now suppose we try a different load. I have marked on the curve-sheet, Fig. 3, where various load-lines cut the curves for 0 and 40 volts bias. They are marked 1, 1½, 2, 2½, 3, and correspond to 1,000, 1,500, 2,000, 2,500, and 3,000 ohms. If we do as I have just described in each case, we find that the " swings " are, beginning with the 1,000-ohm case, 97, 120, 134, 145, and 153 volts, and 97, 67, 80, 67, 58, and 51 milliamperes, leading to powers as in this little table :—

Load Resistance in ohms	Output Power in milliwatts
1,000	1,170
1,500	1,200
2,000	1,120
2,500	1,050
3,000	980

So that if the input is kept up to the maximum permissible one of 40 volts swing, the output power is a maximum for a load of about 1,500 ohms. Is this twice the anode impedance? Not on your life!

Working Conditions

We find the anode impedance under working conditions like this : First take an equal increase and decrease of current from A, and find, on the valve curve through A, the corresponding voltages. Thus, take 55 and 35 milliamperes (that is, 10 milliamperes up and down), and we get 189 and 170 volts. Find the differences : they are 19 volts and 20 milliamperes. Divide the volts difference by the current difference, and we have the anode impedance : in this case it is :—

$$\frac{19}{20} \times 1,000 = 950 \text{ ohms.}$$

(We multiply by 1,000, because the 20 was milliamperes and not amperes.)

Maximum Power

Thus we see that in this particular case the maximum power is got from a load of about one and a half times the anode impedance.

But this is not all the story. This is the maximum power for 40 volts grid swing in each case; but we have paid no attention to the amount of distortion set up. Now a full investigation of the distortion is

much too complicated an affair for us to undertake. But there is a very simple approximation which is quite sound for such cases as this, though it will not do for pentodes, or any other case where there is third harmonic distortion.

If we assume that all the distortion is caused by setting up a second harmonic, then we can find it thus : Work out, not only the total swing of current or voltage in the load, but the change from point A in each direction. Thus in the 2,000-ohm case, the current change is from 45 to 83 milliamperes one way, and 45 to 16 milliamperes the other way, or values of 38 and 29. Find the ratio of these two. It is 38/29, or 1.31. Then look at the curve of Fig. 5. This gives, for a ratio of 1.31, a distortion of about 7 per cent.

If we similarly work out the cases for the other loads, we find :—

Load Resistance in ohms	Distortion for Maximum Input
1,000	12%
1,500	8½%
2,000	7%
2,500	5%
3,000	4%

We all know that it is common practice to talk of so many milliwatts of "undistorted output." This is nonsense, strictly speaking, for there will practically always be some distortion. But it is found that, under the best conditions, distortion up to 5 per cent. is not perceptible,

An Approximation

To make a full and accurate calculation, we should have to work out, for each load-line, how much input would give 5 per cent. distortion, and what would be the output power. But usually we can dodge this very laborious job by an approximation. We can assume that the reduction in power is proportional to the reduction in distortion. Thus, for the 1,000-ohm case, we have 1,170 milliwatts with 12 per cent. distortion, or

$$\frac{1,170}{12} \times 5 = 490 \text{ milliwatts for 5 per cent. distortion.}$$

If all the cases are reduced to 5 per cent. distortion, we get the following table :—

Load Resistance in ohms.	Output Power in milliwatts for 5 per cent. Distortion.
1,000	490
1,500	700
2,000	800
2,500	1,050
3,000	980 (for 4 per cent.)

(Note that for 3,000 ohms, we can't increase the input to raise its 4 per cent. distortion to 5 per cent., for then we should run into grid current.)

Let us bring together all the above results, together with those for some other distortion limit—say 7 per cent.—in one table :—

Load.	INPUT 40 VOLTS		DISTORTION 5%		DISTORTION 7%	
	Power	Distortion	Power	Input needed	Power	Input needed
1,000	1,170	12	490	25	690	31
1,500	1,200	8½	700	30	990	36
2,000	1,120	7	800	35	1,120	40
2,500	1,050	5	1,050	40	1,050	40
3,000	980	4	980	40	980	40

while with a lower quality generally, rather more may be allowed. So let us take it that we will call 5 per cent. "undistorted."

Obviously, the lower values of load resistance, though they give more power for maximum input, cause distortion. So that for undistorted output they must be used with a smaller grid swing. This will reduce the output power, so that it is not at all sure that they will give more power for the same distortion limit.

The figures in the 5 per cent. and 7 per cent. distortion columns are found as follows : The output powers are found, as already shown, by multiplying the maximum powers by the ratio of the 5 per cent. or 7 per cent. to the distortion given at maximum power—thus for a 1,500-ohm load at 7 per cent. distortion, the maximum power for 1,500 ohms is 1,200 milliwatts at 8½ per cent. distortion, so we have

$$1,200 \times \frac{7}{8\frac{1}{2}} = 990 \text{ milliwatts.}$$

MATCHING THE LOAD—Continued

For the required input swings, we multiply the maximum input (in this case 40 volts) by the square root of the ratio. Thus, for the same case,

$$40 \times \sqrt{\frac{7}{8\frac{1}{2}}} = 40 \times \sqrt{.825} = 40 \times .91 = 36 \text{ volts approx.}$$

No "Best" Load

We now see the really important point: even for a fixed anode voltage and bias, there is *no* best load for everybody. If we want absolute maximum power, and are not critical as to quality, we get it by a 1,500-ohm load in the above case, or about one and a half times the anode impedance; and this gives 1,200 milliwatts. If we want no perceptible distortion, the best load is 2,500 ohms—over two and a half times the anode impedance—and we only get 1,050 milliwatts.

But up to now, everything has been based on one definite set of conditions: 180 volts anode, 20 volts bias, giving 45 milliamperes. What happens for other settings? Well, the reader ought to work this out for himself. It is good practice for a job that every wireless amateur *must* be able to do unless he is to

follow blindly someone else's designs. But without wearying you all (and myself too) with repeated examples, I can give you some general pointers.

If the anode current is raised, by using less bias or more anode volts, the best output will tend to show for smaller loads; while if the anode current is kept about the same, while both anode and grid volts are increased, we shall find that bigger load resistances are best.

In either case, sooner or later we come up against the dotted curve in Fig. 3. This is the "safe watts line." At our original point A, the D.C. power into the valve was 180 volts, 45 milliamperes, or 8.1 watts. Now this valve is rated to stand 12 watts, and the dotted curve passes through all the points corresponding to that D.C. power—200 volts 60 milliamperes, 300 volts 40 milliamperes, and so on.

Now it is an important fact to remember that although most valves don't mind a rather higher anode voltage than their rated maximum—in spite of what their makers say—they will *not* stand more than their rated watts without shortened life. So that, although 250 volts anode, 67 milliamperes, 30 volts bias, would be a very nice working condition for

the valve in Fig. 3, it would not be safe.

Now it is a golden rule that the more D.C. watts go into a valve, the more we can get out of it; so that where there is plenty of D.C. power (as from a mains unit), we always work up to the dotted line. Consider two cases of this kind, points G and H. One is 20 volts bias, 195 volts anode, 62 milliamperes, and the other 30 volts bias, 236 volts anode, 51 milliamperes. Both take the same D.C. power, but they call for quite different loads.

Five per cent. Distortion

I will not go into all the possibilities; but take the one case of a 5 per cent. distortion limit. I find that the best load lines for this are KL and MN. Point G calls for 1,600 ohms, and gives 1,400 milliwatts of power, while point H calls for no less than 3,900 ohms, and then gives 1,810 milliwatts, or 39 per cent. more power than point G for the same distortion.

In fact it is almost invariably the case that *the highest voltage you can get*, with bias to keep the current down to within the safe watts limit, will give the maximum output for a small distortion, provided the load resistance is kept up to the right value. This condition usually calls for more audio-frequency input—in our last case 60 volts swing instead of 40 volts—but if the set has a volume control there is usually little difficulty about that.

Note one point: I have said that the working point must not be above the dotted line. This only applies to the *steady* condition, in the absence of audio-frequency input. For example, it does not matter that the line GK goes above the dotted curve, since point G itself is not above it.

Optimum Ratio

I have now done the first part of my task. I have shown that there is no *fixed* ratio of load to valve impedance which is the best for all purposes. The optimum ratio depends on:—

- (1) Whether actual maximum output is required, or
- (2) Whether we want maximum output for a definite distortion limit; and
- (3) What is the voltage and current setting adopted.

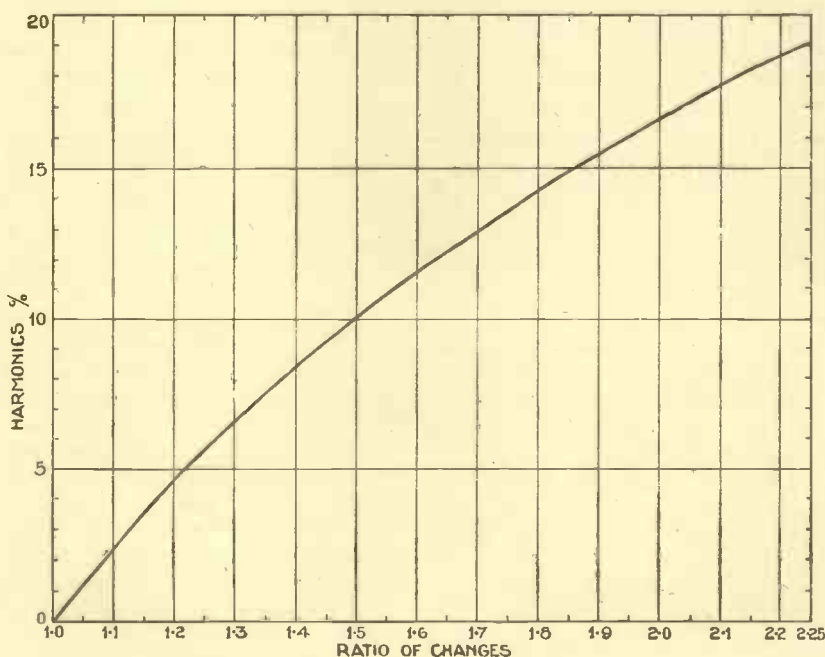

Fig. 5.—Curve showing percentage of harmonic distortion for various ratios of anode-current change

MAXIMUM LOUD-SPEAKER OUTPUT

By altering the latter, we can often make the valve suit a given load if we can't alter the load to suit the valve, and I have shown how the reader may work out the best conditions for his own particular cases.

It remains to find out what *is* the load in practice, and how we can alter it if we wish.

Up to now, I have considered the load as just a resistance, and have said nothing as to the effects of frequency. But, as everyone knows, a loud-speaker is not like that. A moving-iron loud-speaker has inductance as well as resistance, an electrostatic behaves mainly as a condenser, and a moving-coil one may behave as a pure resistance, a condenser, or an inductance, according to frequency.

Question of Frequency

It is possible, by a method something like that already described, to draw the load-line—a curve in this case—for a complex load like a loud-speaker, for *any given frequency*. But in practice it is not easy. Luckily, however, an easy approximation can be made, though still only for any fixed frequency.

If we draw a load-line corresponding to the total *impedance* of the loud-speaker at that frequency, we can use that line as already described, to get the best conditions. We can still compare different arrangements for the best power and least distortion, but the actual power will in all cases be less than that worked out from the curves.

A Difficulty

But there is one great difficulty. Suppose we find that the best condition is a load of 3,000 ohms, but we also know that the impedance of the loud-speaker varies, being 500 ohms at 50 cycles, and getting bigger as frequency increases. Then the loud-speaker would get most power at say 1,000 cycles, where its impedance is 3,000 ohms. If we altered the valve setting so that it gave maximum power for 2,000 ohms, then the loud-speaker would get most power at say 800 cycles, at which frequency it had that impedance.

What it comes to is that a loud-speaker of varying impedance cannot be arranged for maximum power at all frequencies. But we must also

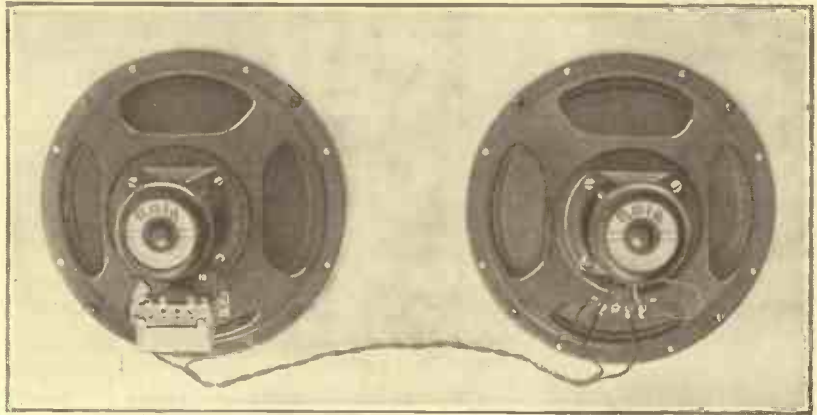

USING TWO LOUD-SPEAKERS FROM THE SAME OUTPUT
Two Rola moving-coil loud-speakers being used in parallel, an interesting set of conditions for calculation

remember that such a loud-speaker varies in its own efficiency at various frequencies. We should arrange to give it most electrical power just where its own efficiency is least, so as to level up the final *sound power* as much as possible.

In the case of moving-iron speakers and electrostatics this is only to be done by experiment, and for moving-coils it is usually done that way, though here there is a greater possibility of calculation. After the experiments, one can say definitely: "For the best balance between bass and treble, this loud-speaker should be treated as (so many) ohms."

Actually, most moving-iron loud-speakers are best treated as 4,000 ohms, except inductors, which are often better if treated as 2,000. Electrostatics vary, but 4,000 ohms will suit many of them. Moving-coil loud-speakers also vary, but if you have no definite reason to do otherwise, it is usually satisfactory to treat them as twice the D.C. resistance of their coil (*moving coil*, of course, not pot coil).

Now comes the last problem. We find, say, that the best load for a given valve setting is 3,000 ohms. But our loud-speaker is best treated as 4,000. What is to be done?

Well, if the difference is not very great, as in the above case, it may be best to alter the valve settings, as already described, till they fit the speaker. But often—almost always with the moving-coil loud-speaker—this can't be done. In such cases we use a transformer, and the rule is simple. For example, to make a 10-ohm loud-speaker behave like 2,000 ohms, divide one by the other:

$$\frac{2,000}{10} = 200.$$

Then take the square root of the result, and you have the correct transformer ratio. In this case it is 14/1.

When I described the A-P-A, I said "the transformer should be such that the loud-speaker behaves like 8,000 to 10,000 ohms in the anode circuit." I find that my own loud-speakers are best treated as 4 ohms. $9,000/4 = 2,250$, and the square root of this is about 47, so I use a 47/1 transformer.

Primary Inductance

There is one other point about the transformer: its primary inductance. We all know that if the primary inductance of any transformer, intervalve or output, is too small, there is a loss of bass. But it is not quite so widely known that in an output transformer too large an inductance may cause loss of treble, owing to the magnetic leakage which exists in all transformers.

A proper calculation of the best inductance is too complicated to describe here, and it calls for a knowledge of the leakage, which the user generally hasn't got. But, as a rough guide, get a transformer whose primary is 5 to 7 henries for every 1,000 ohms of the valve anode impedance (this does not apply to pentodes). Thus for the PX4 we have been discussing, we found an impedance at point A of 950 ohms. so we should ask for an output transformer of the correct ratio to suit the loud-speaker, and of 5 to 7 henries primary inductance.

NOTES, HINTS AND TIPS

NEVER put your moving-coil loud-speaker near a fire or radiator. In time the heat tends to dry the material of the cone and gives rise to peaks and resonances in the reproduction of the upper

moving-coil loud-speaker will faithfully reproduce all that is put into it. Owing to its improved low- and high-frequency response, it will often show up distortion that another type of loud-speaker will mask.

is not an unusual event these days. However, there is one model which has recently been marketed by Slektun Products, Ltd., which deserves special mention.

It was designed by P. K. Turner and H. A. Hartley with the object of producing an almost perfect reproducer.

The major claim for this new instrument, which can be obtained for use with D.C. or A.C. mains, is that it reproduces from 40 to 10,000 cycles without perceptible resonances if it is used in a properly constructed cabinet or a large baffle.

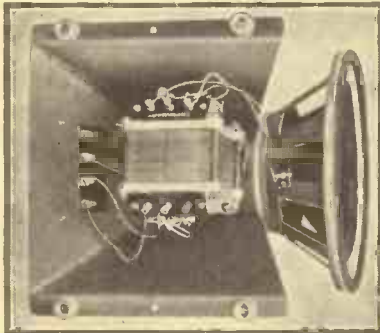

These are two photographs of the new Slektun moving-coil loud-speaker which was designed by P. K. Turner and H. A. Hartley. It is claimed that the response is almost level from 30 to 8,000 cycles. Each output transformer is specially wound for the user's requirements

register. This applies particularly to the type of loud-speaker which is fitted with a light thin paper cone with the object of giving adequate high-note response.

Although moving-coil loud-speakers are capable of giving better

When using the field coil of an energised moving-coil loud-speaker as a smoothing choke in an A.C. mains unit, it is advisable not to include the coil directly after the rectifier.

Another fairly small low-frequency choke with its associated by-pass condenser should be inserted between the rectifier and the loud-speaker field, otherwise a 50-cycle ripple will be induced from the field winding into the speech coil, thus giving rise to a hum in the reproduction.

A new moving-coil loud-speaker

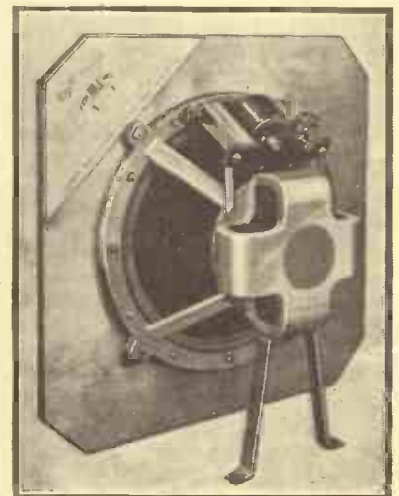

A well-made permanent-magnet reproducer is that made by Edison Bell, Ltd. Two models for use with power and pentode valves are obtainable



One of the small class of permanent-magnet moving-coil loud-speakers is the Motor minor. A matching transformer is seen fitted to the chassis

quality of reproduction than the balanced-armature or horn type, the simple replacement of a moving-coil reproducer for the horn or cone type which is at present used with a set will often give disappointing results. Remember that the

THE DUAL-SPEAKER AMPLIFIER—Cont. from Page Ten grid circuit of the PX4 is dealt with in a similar manner. Two .01-microfarad condensers across the primary of the mains transformer also assist in suppressing any stray high-frequency currents that may be receivable through the mains supply.

Perhaps it would be as well to give a few details as to the assembly of the various accessories. On the left-hand side of the cabinet is the mains on-off switch and directly beneath this the twin fuses. On the right-hand side of the cabinet is placed the volume control and the switch for changing over from radio to gramophone.

The loud-speaker terminals are

mounted directly on the baffle and the output of the amplifier is taken directly to these and from there to the primary of the loud-speaker transformer.

There are five terminals situated at the rear of the cabinet, one of which is taken to earth, two are used for connecting to the pick-up and the other two for connecting to the radio. If the radio receiver is already earthed there will be no need to use both the terminals, but only to connect one terminal to one side of a small fixed condenser of approximately .01-microfarad, the other side being taken to the anode of the last valve in the radio section.

THE SCREEN-GRID VALVE AS DETECTOR

By
F.E. HENDERSON,
A.M.I.E.E.

A special article by an authority in the valve world that will be read with interest by all who like simple experimental work

DURING the past few years we have heard a very great deal about screen-grid valves of all sorts, makes and characteristics, and it may be safely said that there can hardly be a modern receiver employing high-frequency amplification which does not utilise the properties of the screen-grid valve.

Amplifying Action

The way in which the screen-grid valve works as an amplifier has been described many times and most amateurs are now familiar with the peculiar type of characteristic shown by the screen-grid (or tetrode) valve when compared with an ordinary triode, but up to the present this class of valve appears to have been employed practically wholly as an amplifier of high-frequency signals.

Now there appears a tendency to extend the use of this variety of tetrode to include the detector position in a set, and many receivers are now appearing on the market which utilise a screen-grid detector.

It will be of interest, therefore, to have a look at this type of valve and its characteristics for a few moments with particular reference to how it operates in the detector socket.

It should first be realised that every detector valve, apart from a simple diode rectifier, is in effect both a rectifier and amplifier in one bulb. Thus, in an anode-bend rectifier use is made of the curvature of the anode-

current characteristic to rectify the high-frequency signal, and of the straight part of this characteristic (if any) to deal with the de-modulated signal voltage for passing on to the output circuit.

In the grid-leak detector, which is more commonly employed, rectification is effected wholly in the grid circuit, the de-modulated signal being applied to the anode circuit which, in effect, becomes an audio-frequency amplifier.

It is not the purpose of this article to discuss the relative merits

of anode-bend and leaky-grid rectification, but owing to the well-known disability of the anode-bend detector to rectify highly-modulated carrier waves of radio

frequency without distortion, and the more universal use of the leaky-grid rectifier in consequence, we shall consider the screen-grid valve as applied to the leaky-grid method of detection.

Input Voltage

Perhaps it is not generally realised that with any valve working as a detector the load resistance and the input signal voltage applied is as important, if not more important, than with a loud-speaker power valve if distortion is to be avoided; also the effect of different degrees of

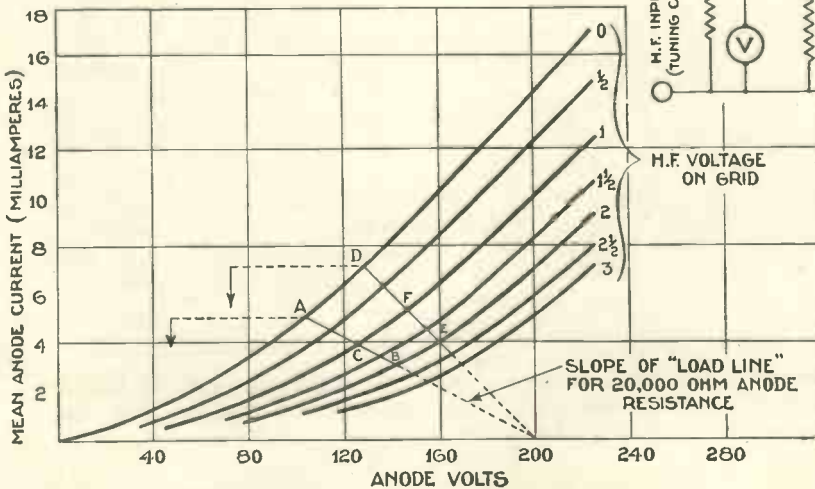

Fig. 1.—Set of anode current/anode voltage curves for a triode (MH4) working as detector. Typical connections for a leaky-grid circuit are shown

THE S.G. VALVE AS DETECTOR—Cont.

modulation on the carrier wave must be considered.

Fig. 1 shows a set of anode current/anode voltage curves for an ordinary triode working as a detector, the curves being drawn for different values of high-frequency signal voltage applied to the grid circuit.

Unequal Spacing

It will be seen that the distances between the sets of curves are not evenly spaced, the curves widening out when a certain signal voltage is applied and crowding together again as the signal voltage is increased.

Now let us consider the effect of introducing some form of loading into the anode circuit, which may take the form either of a pure resistance or of a transformer or choke. As with a power valve, the

This cuts the valve curves, and where it cuts them indicates the change in anode current for any given signal voltage applied to the grid circuit. It will also give the actual applied anode voltage at any moment.

For this particular load line and valve it will be apparent that the least distortion will be obtained for a drop in mean anode current from A to C milliamperes as shown.

Suppose that the value of anode resistance were decreased by half, giving the straight line cutting the curves at D and E, it will be seen that the anode current can now be allowed to fall from D to F for the same percentage absence of distortion.

allowed to drop on tuning-in the signal is also fairly critical. It depends on the load resistance and is usually about 20% of the "no signal" anode current.

Now let us look at similar characteristics for a screen-grid valve. As with triodes, there is an optimum value of "tuning-in" drop in anode current. Fig. 2 shows the drop permissible with different values of load resistance. Fig. 2 shows the anode current/anode voltage curves for the screen-grid valve taken out for a number of values of applied high-frequency voltage to the grid input circuit.

On drawing the load line in the same way as for a triode it will be at once seen that there is a very much more restricted area available with-

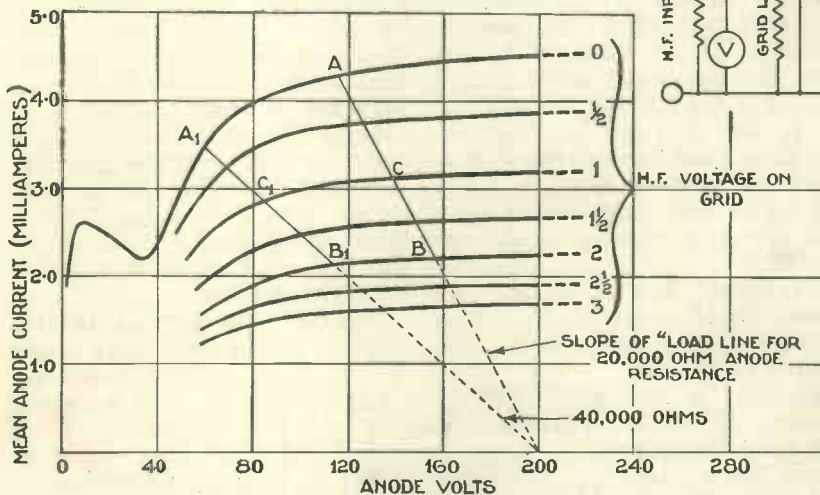
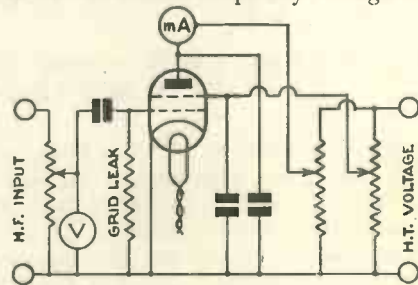

Fig. 2.—Set of anode current/anode voltage curves for a screen-grid valve (MS4) working as detector. Typical detector connections are also shown



in which various values of load resistance can be applied without the risk of distortion.

When dealing with triodes it is common practice to look up the published figure for internal resistance, or impedance, and double this for a suitable load resistance in the anode circuit. What happens when this rule is applied to screen-grid valves?

Triode Impedances

With this class of valve the rated internal resistance, or impedance, is usually of a very high value compared with that of a triode. For instance, a triode normally used for detector purposes may have an impedance of approximately 10,000 ohms, whereas rated figures for impedance on screen-grid valves vary from 200,000 to 500,000 ohms.

An anode resistance or loading of such a value would not only entirely upset the correct relationship between anode and screen voltage, but would introduce serious distortion.

Anode Resistance

On referring again to Fig. 2 we may assume that the load line AC refers to an anode resistance of, say, 20,000 ohms. From the shape of the curves any value of anode load resistance below 20,000 ohms will

introduction of a resistance into the anode circuit causes a certain voltage drop across the resistance when current flows through it, and the amount of the voltage drop will vary according to the anode current.

This can be shown diagrammatically by drawing what is known as the "load line" across our set of characteristic curves. Suppose the anode resistance is 20,000 ohms and the high-tension supply voltage 200 volts. By Ohm's Law the current flowing through a resistance of 20,000 ohms with a voltage drop of 200 equals 10 milliamperes ($i = \frac{E}{R}$), and thence by drawing a straight line connecting 200 volts and 10 milliamperes on the curve the slope of the load line can be obtained.

tion, but it could be shown also that with a lower value of anode load resistance the output available from the valve is reduced.

There is a best value of load resistance which, for a given drop in anode current, on tuning-in the desired signal with the least distortion will at the same time give the best output from the valve. If care is taken to avoid overload by some form of pre-detector volume control, very high values of load resistance may be employed without danger of distortion, in spite of the fact that such resistance might exceed the optimum value for best detector output. For complete absence of distortion, the value by which the anode current may be

A CHANCE FOR EXPERIMENTERS

be quite suitable from the point of view of distortion, but lower values will naturally give less voltage output.

If we attempt to use higher values than 20,000 ohms for the particular valve in question, the load line, $A_1 C_1 B_1$, cutting the family of curves at a more oblique angle, will obviously give rise to quite uneven distribution of current change for the high-frequency voltage applied to the grid and bad distortion will result.

Hence for a given screen-grid voltage there is a definite critical optimum value of anode load resistance. The lower the screen voltage the larger can be made the anode resistance for a given applied high-tension voltage.

Decreased Strength

On the other hand, as the screen voltage is reduced, the radio-frequency signal strength which the grid can accept without the valve being overloaded is decreased.

When using a screen-grid valve as a detector, therefore, it is necessary to effect a compromise between screen voltage and load resistance such that the valve will accept a reasonably large radio-frequency signal without overload, but, at the same time, to choose a load resistance which will enable us to obtain full

advantage from the higher voltage amplification afforded by the screen-grid valve.

Fig. 3 shows the anode current/grid voltage curves of the screen-grid valve for two different screen voltages, indicating limitation of input by reduction of screen voltage, and Fig. 4 the corresponding anode current/anode voltage curves for the same valve for two different screen voltages, indicating the limitation of load resistance by a high screen voltage.

Having taken the above precautions, however, there is no doubt that the screen-grid valve offers a distinct advantage over the triode as a detector, chiefly owing to its higher efficiency as a voltage amplifier, but also in a very large degree to its much lower anode-grid interelectrode capacity, which reduces the damping on the tuned-grid circuit and therefore materially im-

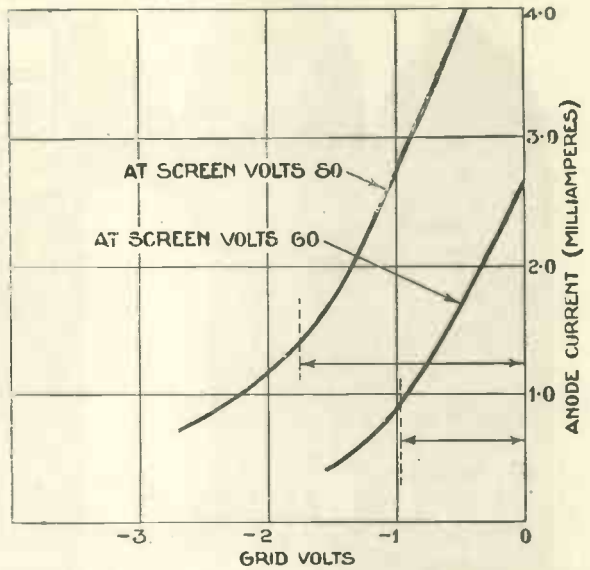

Fig. 3.—How a low screen voltage limits the grid signal input

proves the selectivity of the receiver.

One of the biggest disadvantages of a triode valve—particularly one with high amplification—is that the effect of interelectrode capacity between anode and grid “throws back” on to the grid circuit any change in loading which occurs in the anode circuit.

This makes accurate “ganging” over the whole of the wavelength scale extremely difficult.

Avoiding “Throw-back”

The use of a screen-grid valve as detector, with its attendant low anode-grid capacity, avoids this “throw-back” effect, and enables accurate ganging of pre-detector tuned circuits to be done so as to hold good over a wide band of wavelengths. This naturally makes for improved selectivity.

The selectivity being such an important factor in radio receivers of modern design, the possibility of utilising the screen-grid as a detector valve is of the greatest interest and importance to designers.

[Two recent sets to be described in “Wireless Magazine” have made use of a screen-grid valve as detector. The first set to be described with this innovation was the Easytune 60, the one-knob super-het receiver published in the May issue. After that the Screen-grid Two, a “detector and power” combination, was described in the July number.—Ed.]

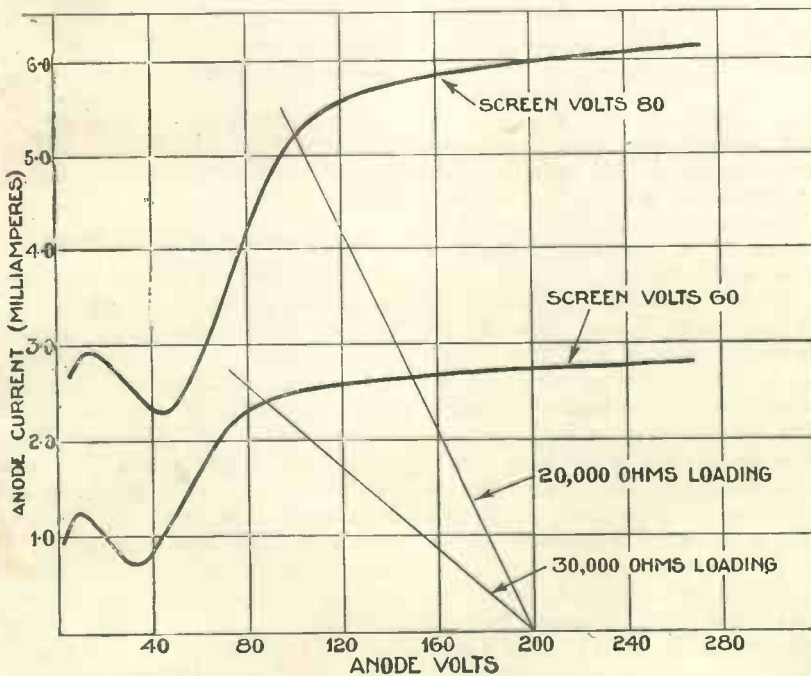

Fig. 4.—How a high screen voltage limits anode (load) resistance and voltage output

The EPILOGUES

By WHITAKER-WILSON



RELIGIOUS STUDIO AT BROADCASTING HOUSE
This photograph shows the special studio used for religious broadcasts—and the Epilogues—at Broadcasting House

NO one seems to be quite certain how the idea of the epilogues arose, excepting that, in the early days of broadcasting, Sunday evening seems to have been treated in a special manner almost unconsciously.

The announcer generally bade his listeners a lingering good-night; perhaps somebody would read a verse or two of attractive poetry, or sing an aria from an oratorio.

A Great Thought

Thus was gradually evolved one of the really great thoughts of broadcasting—the epilogue, the afterthought for Sunday—but immediately the thought took definite shape and was allowed to enter a nursery where the nurses were adherents of organised religion, it suffered eclipse.

In attempting to persuade the Director-General to consider the form of the epilogues afresh, I am going to begin by stating that I believe it to be a fact that general satisfaction has been expressed about them as they are; that I also recognise the epilogues to be amongst the most popular features of broadcasting; and that I know thousands

of listeners have

of listeners have written to say so. That would, surely, seem a good reason for allowing them to remain as they are. There are generally two sides to any question, particularly if it be in any sense a religious question. Who are these people who have written in such great numbers to express satisfaction at the present form of the epilogues?

I think if I state definitely that they are composed entirely of people interested in organised religion, who are either members of the Church of England, some branch of Non-conformity, are Christian Scientists, or even Roman Catholics, I shall not be far wrong. I say "even Roman Catholics" quite dispassionately; Romanists do not generally take great interest in anything not strictly their own. At all events, my point is that the supporters of the epilogues are those interested in organised religion of some kind.

In case it should be thought at Broadcasting House that I am writing this article as a "free lance" (in the sense that I am not a member of any one of these bodies and therefore have an axe to grind) I may as well say at once that I have been a church organist since I was thirteen, a matter of over thirty years, and that I am what is generally known as an Anglo-Catholic.

That is being perfectly frank, but I feel that my case would be considerably weakened if I led the B.B.C. to suppose I was against anything definitely connected with organised

religion and was seeking to alter things on that account.

Naturally, I have no figures before me upon which to base a calculation, but it does not strain my imagination in the least to conclude that the epilogues, however popular they may be amongst adherents to the Christian faith as expressed in the various churches, have little or no weight with listeners as a whole.

Form Unchanged

The form of the epilogues has seldom varied. Probably the B.B.C. understands from its correspondents that a metrical psalm—appreciated because of the fascinating system of pointing in use—followed by a reading of scripture, a well-known hymn, and a more or less cryptic Biblical sentence at the end, is just what is wanted.

As I have already suggested, the epilogues began with a great thought—a thought almost of cosmic magnitude. I have also suggested that the moment the conception was narrowed to come strictly within the limitation imposed by any (or all) of the churches—which naturally meant that they should be definitely "sacred" in composition—the epilogues fell in value in the broader sense.

When Things Were Different

If "sacred" epilogues were attractive to twenty million listeners, nothing could be more ideal. In the early Stuart period they might have been of far greater and far wider appeal than they are now. This, however, is 1932, not 1632, and things have altered. There may be an argument advanced by churchmen that, even so, it is a poor excuse for not broadcasting a church-like epilogue at the conclusion of Sunday, the churchman's day.

Such an argument cannot stand. The British Broadcasting Corporation does not exist entirely, or even

mainly, for matters of religion. It exists for a combined service of religion, education, and entertainment. Neither will it do to suggest that on *one* day in the week church ideas must come first.

Minority Appeal

The fact remains that anything suggestive of the churches or organised religion only appeals to a minority. Nobody can dispute that fact. It *is* a fact, and there is nothing further to be said. No amount of religious broadcasting is going to make listeners keep their sets going if they are not interested. They will simply switch off.

Some will say "Why trouble?" But that sort of answer gets us nowhere. If we adopted that attitude nothing would be done to improve broadcasting at all.

My object, ever since I took up radio criticism, has been to attempt to disturb the B.B.C. whenever and wherever I have felt it necessary. This broadcasting has come to stay; it is a great power. I want to see it completely catholic, by which I mean universal. I want to see the epilogues what they should be—wonderful, impelling afterthoughts for Everyman's Sunday.

There is one way—and only one, as far as I can see—to make the epilogues worth Everyman's while; it is to spend something on them. Rather crude to say so quite so bluntly, but I am not inclined to mince matters. The epilogues will never succeed until they become the great surprise item of the week. They will never succeed while they are entirely "sacred."

Something Mid-way

On the other hand, they will never be of real use if they are entirely "secular." I am not sure that *secular* is the opposite of *sacred*, which latter word I have been compelled to use for the want of a better. I hope, however, that my meaning is clear.

A surprise item is wanted each week. These epilogues require writing—and *properly* writing—in the first instance. After that they need some one who can command a public to take part in them.

If music is used—either as a background or in the more direct sense—it should be of the best. All really good music is in a sense sacred or religious.

Some fine prose, specially written by someone able to write on a high plane, spoken by a man like Henry Ainley (who can arrest anyone's attention by his voice alone), would do much to attract new listeners to the epilogues.

It may be thought at Broadcasting House that it is impolitic to disturb the present arrangement because church people are so conservative. Having lived my life close to the Church, so to speak, and having gone through years of fighting against narrow-mindedness in every shape and form in order to effect reforms in music in the churches with which I have been connected, I think I can understand the Director-General's attitude should he conclude that it *is* unwise to change if only for the sake of those whom the epilogues please and to whom they are of help.

Giving him this point, I appeal directly to Sir John Reith to make use of the regional scheme, and to allow an *alternative* epilogue to be broadcast on Sunday evenings.

In the September issue of "Wireless Magazine" Whitaker-Wilson contributed a well-reasoned article in support of a change in Sunday programme policy. This month he goes a stage further and discusses the desirability of changing the form of the Epilogues.

Sunday programmes are of vital importance to all listeners, for Sunday is the only day of the week when most people can listen-in at any time *should there be anything to attract their interest.*

It is sometimes said that it is a waste of time to criticise the B.B.C. or to make suggestions. But the officials at Broadcasting House follow criticisms and suggestions very carefully, although it is often difficult to say whether or not they have any effect.

By constant pressure of opinion there is no doubt that the time will come when the B.B.C. will be forced to make a change in its attitude to certain aspects of Sunday broadcasts.

Surely there can be no argument against *that*?

Will he consider an alternative epilogue on a high level in the literary sense, full of thoughts to arrest every thinking person, spoken by a perfect voice? Will he allow some of the best singers—anonymously, if he prefers it—to sing something suitable?

Sir John has only to ask in order to receive some fine English lyrics

which can be given to composers to set specially for the purpose.

To bring about a real catholic epilogue will mean a conference of the best brains at the B.B.C. There are plenty of artistically-minded men at Broadcasting House. I could name several of my acquaintance.

I maintain that until the epilogues are made the subject of serious thought at the B.B.C., and the help of the best writers and composers called in, they will retain their limited appeal.

Hymns and Scripture

If the regional scheme be used, those who wish can *still* have the hymns they know by heart and the scriptural passages they know equally well. They are satisfied now and will remain satisfied.

The majority has never been satisfied, though it has probably not taken the trouble to say so. To the majority the epilogues mean nothing at present.

I want Sir John to issue an appeal for specially-written epilogues to be sent in, or, if he thinks that to be a dangerous proceeding, to approach some of our writers with the idea of getting specimens sent up to Broadcasting House. It will obviously take some time and thought to evolve the real thing.

I have thus approached Sir John personally because I know he has much to do with the policy of Sunday broadcasting. I wish to suggest to him that the real afterthought of Sunday—so far as the majority of listeners is concerned—is not born yet.

A Great Chance

The date of its birth is the hour he asks for specially-written epilogues on a high literary level with thoughts that must arrest every thinking man and woman in these islands.

For the non-thinking person he cannot cater. If the non-thinker is *really* the Man-in-the-Street, of whom we hear so much, for whom we pass most of our laws, and for whom we have to write down so distractingly—then the Man-in-the-Street must be told that he cannot always be considered.

I ask Sir John to use the alternative programmes, and to have (on one side) an epilogue to be the *Churchman's Moment*, on the other an epilogue to be *Everyman's Moment*.

Automatic Volume Control

This month we are able to present the second part of an important article on automatic volume control by P. WILSON, M.A. The first part of this article appeared in October

SO far I have confined my illustrations to a receiver which employs an anode-bend detector. What can be done with the more popular grid-leak detector?

Let us consider what is happening to the currents in the conventional circuit shown in Fig. 5. If we connect a milliammeter in the anode circuit, or the anode-feed circuit, of a grid detector we find that the high-tension current *decreases* as a signal is tuned in, which is the exact opposite of what happens in the case of an anode-bend detector.

This decrease of current will cause a decreased drop of voltage across a resistor connected in the lead between the anode and H.T. +, and we might try to make use of this to effect our object in varying the bias to the high-frequency valve. If we did we should come up against much the same sort of snags as with the anode-bend detector.

Cause of Decrease

But we can do better than this by thinking out what is responsible for the decreased anode current. It is due to the fact that when the signal on the grid is increased more of the electrons emitted by the cathode proceed to the grid and appear in the form of grid current and so fewer of them reach the anode and appear as anode current.

Remember that the grid detector functions because of its grid-current characteristic.

This increased grid current flows through the grid leak and therefore causes a drop of voltage between the two ends of the leak. How about making use of this?

With the conventional circuit shown in Fig. 5 it is not easy, but by putting the leak and condenser at the foot of the grid coil instead

more hopeful arrangement because then one end of the grid leak is at cathode potential and since the *negative* electrons are flowing through it from the grid to the cathode, the other end is negative with respect to the cathode.

The shifting of the grid leak and condenser does not affect the operation of the valve as a grid detector; but we have obtained a negative potential relative to the cathode of the grid detector, that is to the earth line of the set.

This is very promising for feeding back to the grid circuit of the high-frequency valve. We have the distinct advantage, too, that the screen-grid valve can be given a permanent bias, either fixed or variable.

Thus we can have a manual control of volume operating on the bias of a variable-mu screen-grid valve as well as an automatic control. Fig. 6 shows a tentative arrangement.

Everything seems O.K., but let us pause awhile and look about for snags. First of all, look at the

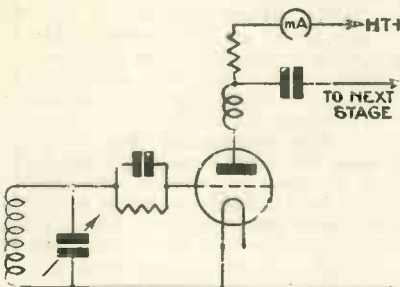

Fig. 5.—Conventional leaky-grid detector circuit with milliammeter

grid circuit of the variable-mu valve. The only path for high-frequency signal voltages between grid and cathode is through the grid leak and condenser of the detector stage. Oh, horror! We must put in a by-pass condenser *c* (Fig. 7). Worse and worse!

This by-pass condenser would in effect be in parallel with the grid leak and condenser of the detector stage and would therefore upset all the rectification process. There is a resistance *R* in series with it in the

cathode of the variable-mu valve, it is true, but this resistance cannot be very large if the potential of the cathode is to be kept at a reasonable value.

Evidently we must dissociate the by-pass condenser from the grid leak somehow. Obviously, we need a resistance R_1 in the lead feeding back to the grid circuit and this resistance must have a value several times as big as the grid leak.

In this case, the circuit in parallel with the grid leak-condenser rectifying elements will be the resistance R_1 , the condenser *c*, and the part *R* of the cathode potentiometer between the slider and earth. If R_1 is very large, therefore, the effect on the rectifier will be negligible.

Moreover, since no direct current will actually flow through it, this resistance R_1 will not in any way upset our automatic-bias arrangements. Hence we are led to Fig. 7.

A Workable Arrangement

Here we have an arrangement which will actually work. And it is both simple and cheap. But we have not yet reached our El Dorado. We have still to consider the possible range of control and how that is governed by the range of input signal which a grid detector will stand before it begins to overload.

The sad fact is that this is small for our present purpose. The variable voltage available for feeding back for the purpose of automatic bias depends both on the size of the grid leak and the amount of variation in the grid current. If we use a large value of grid leak (say 2 megohms) we must have a larger grid condenser and the combination is not good for quality. If we use a .0001-microfarad condenser and a .25- or .5-megohm leak we reduce our voltage variation (for a given grid current) and therefore our range of control.

On the other hand, the amount of variation of grid current is governed by the strength of the signal we can put on the grid. The permissible amount can be increased by increasing the high-tension voltage, but this also means a large current

flowing through the valve and therefore a shorter life.

This is the fundamental objection I have always had to the so-called power-grid detector and long before I ever seriously thought of applying automatic volume control (that is, before the variable- μ valve became available) I had cheerfully accepted the only means I knew of avoiding it.

Lost Amplification

This means was simply to put no volts on the anode at all: that is, to use the valve as a diode detector. The disadvantage of this was that one lost the amplification of the valve and therefore had to make up for it later by using at least one low-frequency stage apart from the output stage.

With modern output valves which require a relatively low grid-voltage input this criticism has not the same force. But I preferred a large grid swing on the output stage, and I was prepared to make this sacrifice because although an extra valve was necessary the extra valve was biased as a low-frequency amplifier and its emission was not severely taxed, while the diode took no high-tension at all and therefore had no emission worth talking about.

Stability and No Hum

The life of the two valves was therefore considerably more than double that of a single valve used as a power-grid detector. Moreover, the absence of high-tension on the detector considerably simplified the problem of stability and avoidance of hum.

What was the initial cost of an extra valve compared with these solid gains? Its cost was easily counterbalanced by the simplification of the smoothing arrangements.

I am now an enthusiastic diodist, or should I say "diodem" or

"diodalist"? Anyway, I would not dream nowadays of using anything but a diode detector except as the first detector or frequency changer of a super-het where a detector arranged so as to operate with decidedly square-law characteristics seems to be essential.

A diode detector will handle very large input signals without overloading, and it will rectify them with a freedom from distortion greater than any other type of detector that I know.

Its characteristics as a detector are to all intents and purposes linear, and for this reason one may safely include a tone-corrector in the following low-frequency stages with out fear of over-accentuating harmonic distortion—a very real danger where a detector is used which is not linear in its characteristics.

Used as second detector in a super-het a diode has also a distinct advantage in avoiding any reflected load on to the grid-tuning coil which would upset the band-pass effect and cause the receiver to tune with double and dissimilar humps.

Certainly it provides a very satisfactory means of automatic volume control, especially if two other refinements are incorporated. Percy Harris, who handled many forms of automatic volume control during his stay in America, told me when he saw mine the other day that it has as wide a range of control as any he has come across.

The fundamental circuit arrangement is that of Fig. 7, the detector being operated as a diode, but the refinements improved the operation so much that I immediately broke my vows never to take out another patent and made the necessary application.

I have already mentioned the troubles that attend the modification of the values of the grid leak and condenser.

In a super-het many of these troubles immediately disappear if we substitute an acceptor circuit, that is a tuned circuit consisting of a choke and a condenser in series, for the grid condenser. For we can tune this acceptor circuit to the intermediate frequency, so giving it a very low impedance value to that frequency and at the same time a high impedance value to audio frequencies.

Trouble Obviated

In other words, it will act at once both as a by-pass for the inter-

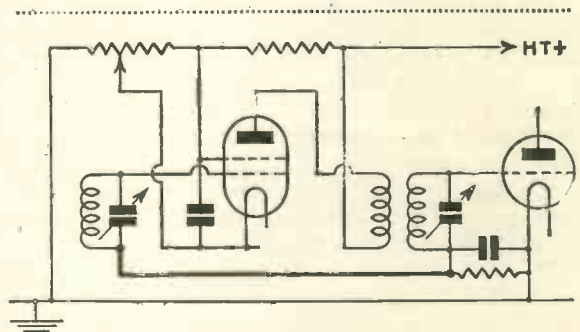

Fig. 6.—Variable- μ screen-grid valve with manual volume control as well as automatic control

mediate frequency and as a block to audio frequencies. In these circumstances not only is a higher value of grid leak permissible, but also much of the trouble one normally experiences in keeping the intermediate frequency out of the low-frequency stages is obviated. For this, however, it is essential that the acceptor circuit should be accurately tuned.

In a super-het, since the intermediate frequency is fixed once and for all, this need occasion no heart-burning, for the tuning, when once done, requires no adjustment in the operation of the receiver.

Tuning Indicator

In addition to this device, I also use the anode of the diode for another purpose, namely, as a tuning indicator. I connect up the anode (MH4 valve) to about 50 volts high-tension and put a milliammeter (0—2 milliamperes) in the high-tension lead.

In order to avoid any troubles due to reflected anode load on to the grid circuit I make that load small by by-passing the anode to the cathode through a 2-microfarad condenser. This arrangement also appears to have the advantage of

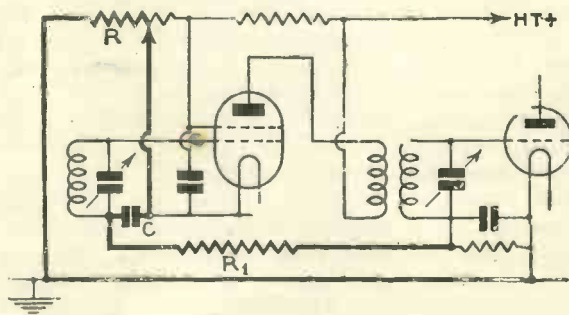

Fig. 7.—Similar to Fig. 6, with the addition of a by-pass condenser C

AUTOMATIC VOLUME CONTROL—Cont.

improving the sensitivity both of the automatic volume control and of the valve as a rectifier.

When I tried it first of all I rather expected to find that I had overlooked some snag, but I haven't come across any.

The tuning indicator, of course, is given by the fact that when a station is tuned in the anode current as shown by the meter falls from 1.9 milliamperes to .7-.9 milliamperes.

Strength of Signals

The meter reading also gives some indication of the strength of the signal being fed to the detector and if it wobbles at all on a distant station it indicates a failure of the automatic volume control fully to correct for a fade.

In view of this the following observations are a convincing testimony to this form of control:—

1.—After dusk the reading given by all the leading foreign stations is not .1 milliamperes different from that of London Regional.

from the station to which the set is tuned. One can still use the frame to cut out interference.

4.—Altering the bias on the variable- μ intermediate-frequency valves by as much as 12 volts, by means of the manual volume control operating in the cathode circuit, makes no difference either to the meter reading or to the volume level. The difference is automatically compensated. Probably an even greater change would be compensated, but up to the time of writing this article I haven't had the opportunity to change the potentiometer for one of higher resistance value.

5.—I can set the manual control at zero, leaving no cathode bias, without sending the set into oscillation and without increasing the volume level. Again, the automatic control makes full compensation.

This last feature is not altogether a desirable one since it must mean that one is not getting the full value of the amplification of the receiver

two intermediate-frequency stages you will see that the use of the automatic volume control has in itself introduced no real complications.

There are several subtleties in the design of a completely satisfactory automatic volume control into which I cannot very well enter here. Those who are interested in the subject will find many suggestive hints in the paper by D. D. Israel published in the *Proceedings of the (American) Institute of Radio Engineers* for March, 1932.

Selectivity and Noise

Before I conclude, however, I should retrieve my promise and indicate why it is that selectivity is apparently decreased and why noise is increased between stations.

The former feature is simply due to the fact that when the set is tuned a short way from the resonance point of a station the input signal to the set is decreased. The automatic volume control therefore takes charge and puts up the amplification so that to the ear it seems as though the station were spreading itself over a wider range of the dial. When one is accurately tuned in, of course, the fringes are not amplified to the same extent, for the amplification is then automatically reduced. The real selectivity, therefore, is just the same as with a manual control.

Desirable Addition

For these reasons (though they are not the only ones) a sensitive tuning indicator, such as that I have already described, is a very desirable addition to a receiver. It is remarkable what a difference may be made in the quality of the reproduction if one tunes the oscillator to a point which is a little way from the exact resonance point.

The second feature is due to a similar cause. When the set is not tuned to a station the signal applied to the second detector is very small, the bias fed back by the automatic control is therefore small and the intermediate-frequency valves work at their maximum sensitivity.

Outside noises are therefore amplified to the maximum and valve noise is at its greatest. As soon as a station is tuned in, however, the amplification is automatically reduced and the noises cease to intrude themselves.

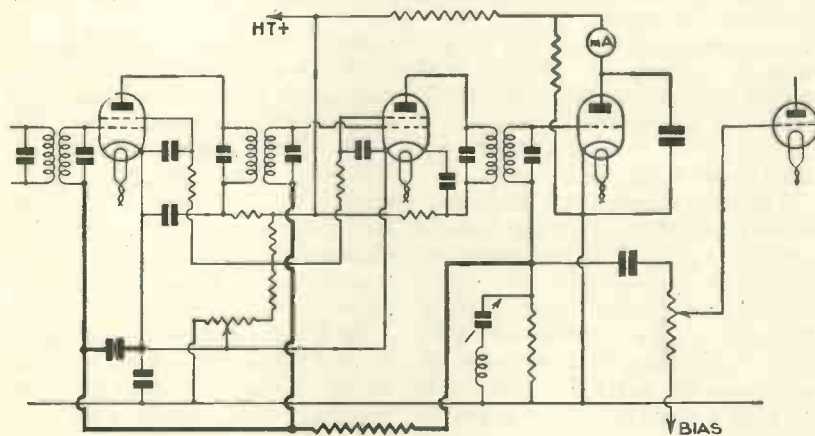

Fig. 8.—Automatic volume control applied to the intermediate-frequency stages of a super-het; it has introduced no complications

2.—The pointer remains quite steady for all powerful stations, whereas if I disconnect the automatic volume control it oscillates to and fro right up to the 1.9 milliamperes (no signal) reading.

3.—Turning my frame aerial from maximum to minimum on London Regional makes no difference whatever to the reading or to the volume. This does not mean, however, that the directional properties of the frame are lost; they are unaffected. But the automatic volume control compensates for loss of input signal

on a weak broadcasting station.

From the listening point of view this does not worry me at all, but it is a challenge to one's ingenuity, so I propose to make an alteration in the cathode-bias arrangements which will be such (I hope) that the automatic control will only begin to function after a certain minimum signal strength is reached.

Fig. 8 shows the circuit I am at present using for the intermediate-frequency stages and the second detector. If you compare it with that for an ordinary super-het with

The LURE of the ETHER

By J. GODCHAUX

ABRAHAMS

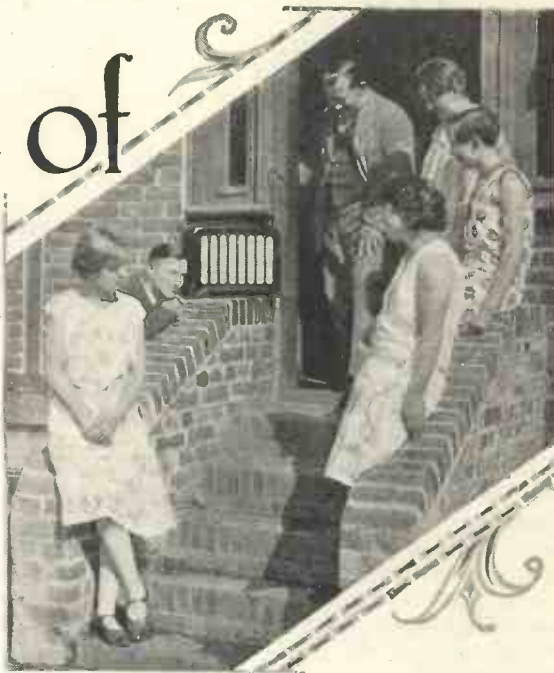

IF you have once possessed a wireless receiver you will never again, at any time, be without one. I cannot recall an instance of an acquaintance or friend telling me that he had done away with his radio set without expressing his intention to replace it.

On the contrary, and invariably, I have heard people say: "Oh, by the way, you know that old receiver of mine; well, I've just bought a new one." Or: "I'm making that four-valver you spoke about a few days ago."

Striving for Better Things

It has always been a case of striving for better reproduction of the home broadcasts or of securing a circuit which would give its owner a greater range of programmes.

More than once on the approach of my holidays I have decided to give listening a rest during that period and within a day or so of my arrival at the seaside or country resort where I intended to spend a number of thoroughly lazy and uneventful days I have found myself hurrying round to the local wireless dealer to borrow some kind of a set—in fact, anything which would bring in the home and foreign transmissions.

It is the lure of the ether!

Out of Touch with the World

Without these little valves I feel just as out of touch with the world at large as the average man does when he finds he cannot buy an evening paper. Radio has so become part and parcel of our daily life that it is now classed as a necessity; it is no longer a luxury, but fills a long-felt want.

Broadcast programmes, as everyone must know from experience,

constitute the cheapest form of entertainment and as such, especially in these times of stress, appeal to the majority of the community.

Fortunately for us, the same urge has induced many Continental cities to erect high-power transmitters—stations capable of radiating wireless programmes far beyond the country's frontiers—and thus millions of listeners are able to enjoy entertainments from an ever-growing number of foreign centres.

With the modern receiver, even of a comparatively simple and inexpensive type, it is possible for the average stay-at-home to tune-in broadcasts from transmitters ranging over the greater part of Europe; we can roam from Oslo to Palermo, from Leningrad to Barcelona, from Warsaw to Paris.

We can cross the Continent in the space of a few seconds, calling a halt at many places on the way and thus sample the best entertainments the different nations have to offer.

But the mere fact of flitting from place to place affords little satis-

This article, although intended primarily to show the beginner what a wealth of entertainment modern broadcasting offers, will appeal to all listeners. It points out what particular types of programmes some of the better known broadcasting stations most consistently favour—it will remind you to what transmitters to tune your set when you want opera, symphony concerts, dance music or gramophone records

faction either to the dial-twiddler or to the members of his household—to whom he fancies he is demonstrating his receiver; on the contrary, there is nothing more irritating than to hear snippets or snatches of music or talks, however distant their origin may be.

Many owners of sets err in this respect; it is the best way to acquire unpopularity in one's own household or circle of friends.

Simple Manipulation

Possibly this kind of game was excusable in the early days of broadcasting when the receiver was still looked upon with awe as a "magic box of tricks" which the exhibitor could show off to his friends as a new toy; to-day, however, the average instrument is of such simple manipulation that the merest tyro can secure some radio entertainment by simply pushing over a switch.

The inner mystery of the captured transmission impresses the onlooker no longer; familiarity with wireless has developed in us a blasé complex; to-day we ask more from our receivers than just the reproduction of signals emitted by some more or less distant station. We expect our sets to supply every kind of entertainment when we turn to them in our leisure hours.

And in this respect, in view of the development broadcasting has taken during the past two or three years,

THE LURE OF THE ETHER—Cont.

it is seldom we register disappointment, for at any time during the day or night the ether can and will furnish many kinds of recreation, be it vocal or orchestral concerts, organ recitals, vaudeville, cabaret turns, operatic performances, or interesting talks.

We have the world at our elbow and from our armchairs are able to pick and choose at our own sweet will excerpts from the best programmes offered to us by the old world's leading studios.

Controlled Selection

If, however, broadcasts are to be enjoyed some method should control this selection. It is obvious that the same rule applies to the home as to the Continental stations; all of them throughout the day must cater for a variety of individual tastes if in the course of the week the greater part of the community is to declare itself satisfied.

Programmes which are appreciated by one class of listeners will not appeal to another, and consequently the studios strive to strike a happy medium by incorporating in their regular schedule of broadcasts features drawn from every field of amusement.

It is this infinite variety which enables us to compile our daily programme to suit our individual taste and the number of broadcasts at our disposal will easily demonstrate how simply, by judicious selection, we can make up a time-table showing us at what particular hour we can tune-in any desired item.

Personally, I scan the published programmes every morning and jot down in my diary the broadcasts to which I feel I should like to listen.

Musical Programmes

Music in every conceivable form, throughout the ages, has appealed to all nations and it is obvious that until television has become general, transmissions of music must essentially make up the bulk of most radio programmes. (In Germany alone, between 60 and 65 per cent. of the time on the air is devoted to musical entertainment, the balance being taken up by literature and talks of various kinds.)

For the present, at least, radio studios possess no option; they are restricted to music or the spoken

word, but these fields are still so vast that there is little likelihood of their showing any signs of exhaustion in the near future.

Just as individual tastes differ, so do nations differ in regard to their entertainments, and we may turn to specified countries for particular forms of broadcasts.

Italy is rightly associated with grand opera; it is the land of the tenor, the soprano, and the baritone; and on most evenings if we swing our condensers round to the settings of Rome or Milan we shall secure a relay of some of the best operatic performances Europe can offer to us.

Rome, Milan, Naples, Trieste, Genoa, Turin—each in turn is drawn into the net for the benefit of the general listening public. In respect of singers and orchestra there is little to differentiate between them.

As it is seldom possible to gather from the advanced programmes the title of the work to be broadcast it is wise to tune-in to one or other of the main stations towards 7.45 p.m. G.M.T. as the performances are timed to start at 9 p.m. G.M.T. (Central European Time is one hour in *advance* of our clocks.)

German stations, also, may be relied upon to give us excellent operatic performances (Berlin, by the way, possesses four opera houses). Here we register the advantage that on special nights the relay is taken by several transmitters, thus giving us the choice of three or four channels for our reception.

Munich, Dresden, Frankfurt-am-

Main, Stuttgart, Hamburg, and Cologne are all regular contributors to these programmes. Make a note that except for Wagner's "Ring," 7 p.m. G.M.T. is the time at which the curtain habitually rises.

In the same way Copenhagen, Stockholm, and Oslo may be visited now and again for broadcasts from their local opera houses, as also Budapest and Warsaw.

From France there are few transmissions of this description, but the P.T.T. stations have now concluded arrangements and we may capture performances at regular intervals through Eiffel Tower and Radio Strasbourg. Later, when the chain of provincial PTT stations has been opened more channels for these broadcasts will be placed at our disposal.

Symphony Concerts

In regard to broadcast symphony concerts, it would be invidious to pick out any particular foreign city as most of them boast of subsidised state or municipal orchestras which can be "roped in" to provide entertainment for the listening community. Chief amongst these are Warsaw, Prague, Berlin, Vienna, Stuttgart, Copenhagen, Amsterdam, Rome, and Zurich.

For dance music we may turn almost nightly to Berlin or any German stations; to Copenhagen via Kalundborg for visits to the Nimb. Wivel, Industrie Restaurants, and Palace Hotel, all of which possess bands of outstanding merit; or to Budapest for its Tzigany orchestras.



BROADCASTING A SPORTING EVENT

On the right can be seen the commentator at the microphone of a German sports stadium. Running commentaries are a popular feature of modern radio

RADIO FOR YOUR PLEASURE

Brussels, also, during the season takes us over to its coastal Kursaals at Ostend or Knocke, or to the popular resorts in the Belgian capital. From Holland (Hilversum) we may expect broadcasts from English and foreign bands touring the Continent, the former enjoying considerable popularity amongst Dutch dance enthusiasts.

Music-hall Turns

Variety, or music-hall turns as presented to the foreigner, cannot greatly interest the British listener except in the case of performances by such artists as animal impersonators, players of quaint instruments, or of the hundred-and-one noise producers so frequently heard in our new non-stop programmes.

To appreciate French, German or other foreign humour it is essential that one should be absolute master of the particular language; even in these circumstances the jokes cracked may be purely of a local character or idiomatic and consequently only understood by a restricted minority.

But most European stations, and in particular the French and Belgian, devote a number of hours every week to the broadcast of gramophone records and you will notice that the greater part of these are of British or American origin.

Radio Toulouse, between the hours of 8 p.m. and midnight, appears to pour out a steady flow of canned music of every description; Poste Parisien, in a lesser degree, follows this example, and both the Brussels stations contribute their quota to the ether every day.

"Hot" Dance Music

The later issues of gramophone records may be picked up from Hilversum and on Saturday nights, as a late transmission, Cologne (Langenberg) offers, under the title "Masters of Jazz," dance records, usually of the variety termed "hot."

If I have left Radio Paris until one of the last it is because this station during the past year has greatly developed its publicity "stunts," consisting mainly of concerts sponsored by British concerns who advertise their wares via ether.

On Sundays, in particular, Paris offers a light alternative to the fare provided by the B.B.C. studios. As the titles of every item are given out

by both French and English announcers, these broadcasts have achieved considerable success in the British Isles.

Then, again, we find Radio Normandie (Fécamp), a privately owned 10-kilowatt near The Havre which, whilst devoting its programmes during the day to its local subscribers, makes a special appeal to Great Britain from 8 p.m. onwards; in fact, on Saturdays and Sundays these English concerts are carried on until 3 a.m.!

Perhaps a few words regarding some special transmissions may prove equally useful to the early and late bird. Many German stations are on the air before 7 a.m.; Königswusterhausen may be captured at 4.45 a.m. with a weather bulletin. On Sundays at 5.20 a.m. a concert broadcast from one of the Transatlantic liners in port at Hamburg or Bremen is taken by the German stations.

Hilversum also opens up before breakfast time on Sundays, namely at 6.55 a.m., and on weekdays usually favours its listeners with a gramophone recital at 7.40 a.m., followed by Radio Paris five minutes later.

At midnight, when the B.B.C. stations have signed off, it is often possible to enjoy a further hour's transmission from some European centre.

Although Berlin and the other German stations, for the purpose of effecting economy, have somewhat curtailed their programmes and now close down, with few exceptions, at 11 p.m., on two nights weekly concerts are given at midnight which are relayed to the Zeesen short-waver and destined to German nationals dwelling in other parts of the globe.

Madrid and Barcelona, and on some nights, Algiers, may be discovered working until 1 a.m. and occasionally you may tune in Radio Maroc (Rabat), or an Italian studio which has extended its activities. Also Katowice, with its "Answers to



IN A NEW TALKIE

Miss Molly Lamont, the British film star, and the Marconiphone model 535 both appear in a new B.I.P. film entitled "Double Trouble." We hope that there will not be any double trouble!

most of Foreign Correspondents" by microphone on Wednesdays and Fridays, may be heard well after midnight.

Although in view of the difference in time most of the Russian stations bid their listeners good-night at 10 p.m., if you turn to Moscow (Old Komintern) or to its Trades' Unions colleague after that hour you will find them busy dictating news bulletins for the guidance of provincial newspapers and you may pick them up again at 4 a.m. (it is then 7 a.m. in the Soviet capital) when they start their morning duties.

No Complete Blanks

There is at all times, somewhere, somehow, some entertainment to be culled from the ether; at no time is it possible for the owner of a wireless set in good working order to draw a complete blank.

A short scend, possibly a simple twirl of the condenser dial, may bring in some item of interest, something with which to while away a leisure hour. Listening to the voices of the night is one of the most fascinating pastimes discovered; it is the lure of the ether.

CONCERNING PATENTS

NEW RULES FOR INVENTORS

THE technical side of wireless offers such a wide scope to those of an inventive turn of mind that there are probably few keen amateurs who have not, at one time or other, at least played with the idea of taking out a patent.

Some of the numerous wireless patents already in force are earning big fortunes—whilst others are a drug on the market! But there are still fresh worlds to conquer for those who can find the way!

New Regulations

Would-be inventors should, however, note that certain important changes are about to be made in the regulations under which patents are issued, as well as in the laws which govern the use of a patent after it had been granted.

These are set out in a new Patent Act, which comes into force on November 1.

It should be borne in mind that every invention on which a patent is based must be novel, in the sense that it has not been previously used or even described in any publication. This, of course, is a point which is not easy to verify, though every application before being accepted is first subjected by the Patent Office to a search which covers all similar British patents issued during the preceding fifty years.

Strict though this test may be, it is obviously not sufficient to guarantee *absolute* novelty, since there are many other possible sources of information, such as foreign patents, text books, the proceedings of various learned societies, and a host of other technical journals and periodicals.

Extension of Search

One of the most important changes to be brought about by the new Act is the gradual extension of the official search to cover all such documents as those mentioned above.

It will, of course, take some considerable time to accumulate and index all the material necessary to make such an investigation really complete, but a start is to be made

By Our Legal Correspondent

at once, and then gradually extended until the desired object is achieved.

In the long run this will be a distinct advantage to the inventor, because, although his patent may be more difficult to obtain in the first place, it will certainly be a more valuable document once it is issued. One of the defects of the present system is that an inventor is never quite certain that he can safely take his patent into Court in order to sue for infringement, because there is always a danger of running up against some previously unsuspected "anticipation."

The Courts insist on novelty in the strict sense before they will hold a patent valid. The Patent Office has for many years helped the inventor in this direction, but only so far as prior British patents were concerned, leaving him to shoulder the risk of possible disclosure elsewhere. To reduce this danger as far as is humanly possible, it is now proposed to make the official search practically a "world-wide" one.

The charge to be made for this service is an extra stamp fee of £1 payable when filing the Complete Specification. The cost of a Provisional Specification remains at £1, and all other charges are left unaltered.

The usual time allowed for following-up a Provisional with a Complete Specification was nine months, but is now extended to a year. The time for acceptance is similarly increased from 15 to 18 months, whilst 21 months is allowed between the date on which an application is first filed and the issue of the sealed Letters Patent.

Other provisions of the new Act are intended to protect the public against the improper use of patents. For instance it is laid down that a patent may be revoked if it can be shown, amongst other things:—

That the invention is not useful.

That it is obvious and does not involve any real inventive step.

That the patent specification does not clearly set out the scope of the monopoly claimed.

That the patent specification does not describe the best method of carrying-out the invention known to the inventor at the time when he filed his application at the Patent Office.

These provisions are all to the good, since they help to prevent the exploitation of the public by bogus patents.

Prior Publication

The Comptroller of the Patent Office is also given power to refuse to grant a patent where the alleged invention has been wholly described in a prior publication, or where it is so obviously contrary to accepted scientific principles as to be merely frivolous.

This may seem at first sight to be a perfectly obvious proceeding, but as a matter of fact it has not previously been possible to prevent the issue of such patents, which is the reason why one hears of patents being granted for a "perpetual motor," and also why certain wireless patents have been granted though they are obviously unworkable.

One danger in such a case is, of course, that the Patent Office may refuse some really revolutionary discovery which does at first sight appear to conflict with accepted scientific principles, but which eventually turns out to be true.

Benefit of Doubt

However, this is not likely to occur in practice because where there is any reasonable doubt the inventor would be given the benefit of it.

Finally the new Act makes provision for the setting-up of a special Appeal Tribunal to hear and decide disputes between the inventor and the Comptroller of the Patent Office when these arise. The Tribunal is to consist of a Judge of the High Court to be nominated by the Lord Chancellor.

We Test Before You Buy

By the "W.M." Set Selection Bureau

DO WE WANT MIDGET CABINETS ?

NEARLY all the popular sets of the new season are of the table type, the set chassis and the loud-speaker being contained in a "midget" cabinet.

The question we shall decide this season is whether the small size of the cabinets does justice to our reproduction needs. It is almost without question that real bass note reproduction cannot be obtained with a small baffle area such as these cabinets offer to the moving-coil loud-speakers they contain.

Perhaps more objectionable than the absence of real bass is the presence of resonance, a reiteration of a definite low frequency caused by the enclosed nature of the cabinet. The "boominess" of the midget cabinet is its great drawback.

So far as we can see, there has been no attempt at scientific elimination of the resonance, as by filling the space inside the cabinet with slag

wool. The only thing that has been done in some of the sets is to leave the back off.

With modern metal chassis, having enclosed tuning condensers and coils, the resulting accumulation of dust inside the cabinet is not very harmful, and the quality is certainly free from resonant bass.

BETTER TUNING SCALES

NOW that radio is becoming more stabilised in general technique, the makers are turning more to the details, such as improvements in the tuning scales. This year's crop of sets is notable for immensely better tuning arrangements, and many ingenious ideas have been exploited to make station logging the "joy for ever" that it should be.

The simple idea of lighting up the back of the scale with a bulb fed from the filament transformer (in mains sets) has been widely developed. One device that particularly intrigued us at the Show consists in a moving beam of light over the tuning scale. Other sets have two bulbs, so that only one set of calibrations is illuminated at a time.

Very few sets are without wavelength calibrations, and it should be remembered that even the cheaper battery sets with scales marked in degrees probably have a good list of calibrations given in their instruction booklets.

We need hardly warn our readers against the type of set that has its

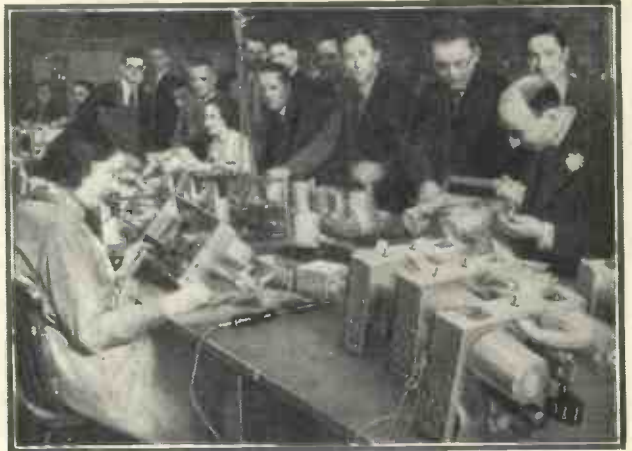

PUTTING ON THE FINISHING TOUCHES

A busy corner in the works of Kolster Brandes, Ltd., at Sidcup. A group of dealers is watching the final work to the chassis of a popular mains set

scale marked in stations only. As an auxiliary to wavelength calibrations the positions of a few of the powerful foreigners are naturally useful, but if the scale is in stations only, there is no knowing where you are in a few weeks, after the usual half a dozen station changes have come into force.

KIT SETS SCORE AGAIN

ANYONE who thinks the battery market is neglected should be shown this year's selection of kit sets. There are several outstanding kits available, incorporating the very latest ideas in set design, and enabling really good results to be obtained for a moderate outlay.

This year the kits are more than ever "professional" in their finished appearance. This is due to the almost universal use of metal chassis, with gang condensers and screened-tuning coils.

One of the most outstanding improvements in the kits relates to the control of volume. This year it is much easier to cut down the volume of the locals to a reasonable degree, so that overloading is avoided.

FREE ADVICE TO PROSPECTIVE SET BUYERS

To take advantage of this service it is necessary only to mention (1) the maximum price and whether this is for a complete installation or the bare set; (2) where the set will be used; (3) what particular stations are desired; (4) whether a self-contained set with or without aerial, or an ordinary set with external accessories, is preferred; and (5), in the case of mains-driven sets, whether the mains are A.C. or D.C.

A stamped-addressed envelope for reply is the only expense. Address your inquiry to Set Selection Bureau, "Wireless Magazine," 58-61 Fetter Lane, E.C.4. There is no need to send any coupon, but it is essential to give the information detailed above on one side of the paper only. Tell your friends about this useful service.



Station Master Three (Kit Set)

TYPICAL of this year's practice in kit sets is the design of the Station Master three-valver, which in a finished form we recently tested and found excellent in operation.

Using a well laid-out metal chassis as a basis, the makers have produced four distinct models of the Station Master, for battery or A.C. mains

something of the circuit. In the Station Master is a thoroughly up-to-date three-valve sequence of screen-grid, detector and power.

The aerial is coupled to the screen-grid valve by means of a variable aperiodic coil—controlled from the front of the set—giving an unusual though very effective control of selectivity.

The screen-grid valve is coupled to the detector by a modified tuned-anode arrangement. The anode of the screen-grid goes to a tap on the coil to improve the interval selectivity.

The section of the two-gang condenser associated with the anode tuning is connected in series with a 1-microfarad fixed condenser so that the moving plates can be earthed.

Low values of grid leak and condenser have been employed to prevent frequency distortion. The detector has reaction by the

A NUTSHELL SPECIFICATION

MAKERS: United Radio Manufacturers, Ltd.

PRICE: £7 10s., including components, valves, cabinet and Celestion loud-speaker.

VALVE COMBINATION: Screen-grid (Mullard PM12), detector (Mullard PM1H), and power (Mullard PM2A).

POWER SUPPLY: Self-contained batteries.

POWER CONSUMPTION: 12 milli-amperes anode current.

TYPE: Kit set in table cabinet with loud-speaker.

REMARKS: A well-designed three-valve kit, giving a flexible performance.



A CLEAN LAYOUT

An interior photograph showing the clean layout adopted by the designers. The batteries are accommodated on the shelf behind the loud-speaker

operation, in simple cabinets or console table cabinets with self-contained loud-speakers.

We tested the battery console table, which, in addition to taking the set in the lower part of the cabinet, accommodates a moving-iron loud-speaker and batteries in the upper part.

The finished job needs only an aerial and an earth to complete the installation. In appearance the set we tested is attractive in its veneered-walnut cabinet. The controls are mounted in very convenient positions on the front, and the batteries are accessibly placed inside.

Kit-set builders like to know

differential method, but there is no high-frequency choke in the detector-anode circuit.

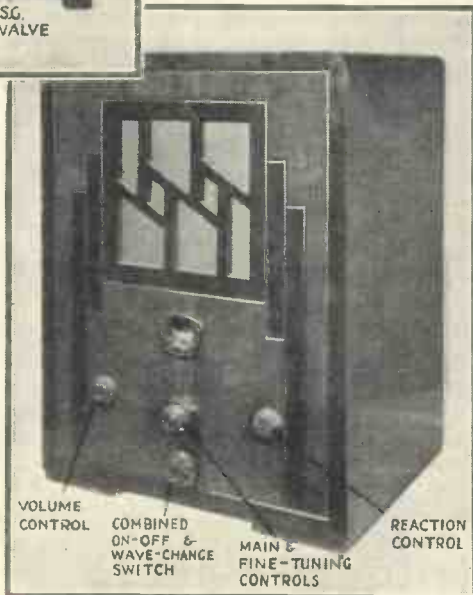

NEAT APPEARANCE

The Station Master Three kit set is assembled in a modern walnut-veneered cabinet. The loud-speaker incorporated is of the balanced-armature type

This simple though effective circuit has been used to great advantage in a metal chassis, with well-designed coils for aerial and anode, and one of the latest two-gang condensers to tune them.

This condenser has an aerial trimmer—worked by a small knob super-imposed on the main tuning knob. Once set, this auxiliary control does not have to be moved.

The mounting of the coils and the condenser on the cadmium-plated steel chassis should prove a simple job. Due to the rigidity of the chassis the rest of the component fixing would undoubtedly be accurately carried out.

Only eight wires are needed to join up the assembled parts—a marvel of simplification! The battery cable simplifies the external connections.

Results on Test

On test the set behaved well. We liked the good action of the rotary wave-change and on-off switch. The reaction is smooth. The selectivity is easily controlled by the knob on the left working the aperiodic aerial coil. Tuning is simple, and once the trimmer knob has been adjusted signals come in with clean separation.

With moderate aerial coupling the selectivity is exceptional for two tuned circuits. We got Scottish Regional clear of London Regional and Heilsberg clear of London National.

Although the dial is marked in degrees the makers provide some useful calibrations in their booklet, and these are a great help in finding foreigners. We got most stations within two or three degrees of the numbers in the list.



H.M.V. Super-het Six Portable

THIS is the first battery-operated set that has borne the famous "dog" label of the H.M.V. factory. It is in many ways an outstanding contribution to the very difficult task of meeting present-day reception conditions for listeners who have no electric-light supply at their disposal.

and quality, is more limited than in a mains-operated set, who can blame the H.M.V. engineers? Such limitations are inherent in the design of battery portables, and set buyers presumably realise the facts.

THE SET IN BRIEF
MAKER: The Gramophone Co., Ltd.
PRICE: £17 17s.
VALVE COMBINATION: Six-valve super-het sequence, consisting of first stage of high-frequency (Marconi S21), oscillator valve (Marconi HL2), first detector (Marconi S21), intermediate-frequency amplifying valve (Marconi S21), second detector (Marconi HL2) and pentode output valve (Marconi PT2).
POWER SUPPLY: Batteries, comprising 120-volt high-tension and 2-volt accumulator.
POWER CONSUMPTION: Anode current was 14 milliamperes.
TYPE: Self-contained portable in upright table cabinet.
REMARKS: Recommended for great range and high degree of selectivity.

For a portable the performance is, on all counts, staggering. It certainly makes you readjust ideas on selectivity and range. The powerful super-het sequence of valves meets all reception needs, both long and medium waves yielding on test all the stations that could possibly be wanted.

There is a handsome walnut cabinet, with a sunken escutcheon for the very simple controls. The way the knobs have been arranged is a marvel of ingenuity.

With this six-valve super-het portable the listener confined to battery operation can enjoy the full benefits of the latest high-frequency amplification technique, for this set has, in spite of its small frame aerial, an unlimited range of reception.

If the power, in terms of volume

There are only two main controls, volume on the left and tuning on the right.

Cunningly let into the outer rings controlling volume and tuning are knobs for wave-change, on-off and trimming. When we remember that this is a super-het the simplicity of control is all the more praiseworthy.

The tuning dial is carefully calibrated in medium and long wavelengths, the ranges being from 200 to 500 and 1,000 to 2,000 metres. The dial revolves past pointers.

The set chassis is contained in the top of the cabinet, with ample room below for the moving-iron loud-speaker and the batteries. Grid bias is automatic.

We found the total anode-current consumption was 14 milliamperes, which is really not excessive for a six-valver using a pentode output.

Enough output can be obtained to give satisfactory volume in most homes, but the volume control must be kept well down for local stations and powerful foreign-

ers. Quality, as might be expected, lacks real bass, but there is quite a pleasing amount of balance.

Perhaps the most gratifying point in the performance is the constant action on both wavebands. The super-het ganging remains accurate at all settings of the tuning dial. With the aerial-tuning trimmer correctly worked an amazing performance can be obtained.

Added to the inherently large amount of selectivity of the super-het sequence is the frame aerial, which enables Zeesen on the long waves (to give an outstanding example) to be tuned in quite clear of the powerful stations on each side of it.

Clearing the Locals

Although we were not able to clear Mühlacker of London Regional on the medium waveband many stations usually swamped by the locals were brought in clear of all trace of adjacent signals.

The weight of the portable is thirty-four pounds, which is on the heavy side, but to make the transport as easy as possible there is a neat Packawa handle let into the top of the cabinet.

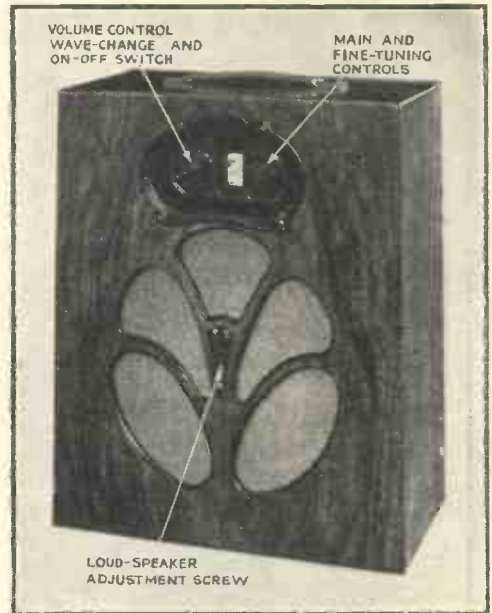

VERY NEAT APPEARANCE
 The appearance of the H.M.V. super-het is certainly commendable. Note the switches fitted to the outside of the control knobs

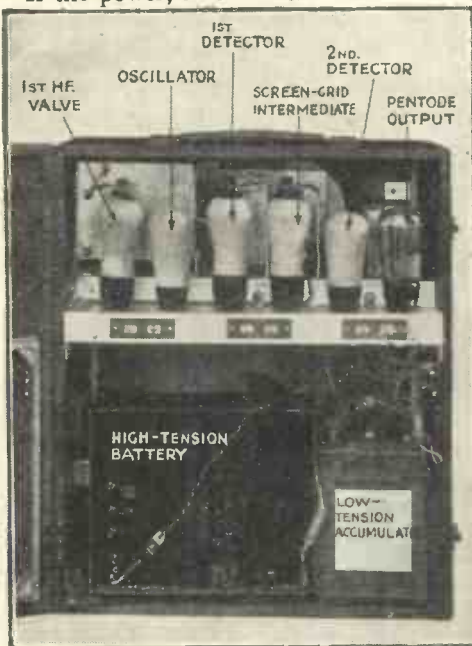

THE WORKS DISCLOSED
 Here is an inside view showing the layout of the compact chassis and batteries. Provision is made for adding a pick-up



Atlas A.C. Two-valver



CONSOLE TWO-VALVER

This is the Atlas two-valve console for A.C. mains operation. It gives excellent results

FOR enjoyable local-station reception, provided you live within, say, fifty miles of a regional centre, and can erect some form of external aerial, the two-valver—especially the mains type—is more than adequate.

We say this once again after our highly satisfactory experiences with the new Atlas set. This little newcomer to the British radio market has many points of appeal, not least of which is its very moderate price.

The circuit, as might be expected, is perfectly "straight," though there are detailed refinements, such as the use of a large single-layer winding of stranded wire for the medium-wave coil. This is responsible for the very sensitive results that have been obtained on test. Further, the reaction is delightfully smooth on the medium waves, if a little "fierce" on the long.

Low values of grid leak and condenser have been chosen for the detector valve to ensure good quality. This asset has been still further enhanced by the use of a resistance-fed transformer between the detector and the power valve.

The two valves are fed with their high tension and grid bias from a metal rectifier arranged in a novel

way. This rectifier also feeds the moving-coil loud-speaker. Before putting the set on test we noted how simple was the adaptation of the mains transformer for our mains voltage. By the way, the A.C. models are designed to cover the unusually wide periodicity range of 40 to 20 cycles.

We were immediately impressed with the quality of the reproduction. The moving-coil loud-speaker has no pronounced resonances, and in spite of the small size of the cabinet there is very little box resonance.

The result is a rather exceptional freedom from "woofiness"—speech having a clarity all too rare these days. The music can be reproduced with great volume, not the slightest sign of distortion being noted even during the loud passages.

The power valve matches up very well through the output transformer with the moving-coil loud-speaker.

Using the standard test aerial we obtained full loud-speaker reception at 20 miles from Brookman's Park. This reception was obtained without

recourse to the reaction control, which was left at minimum.

The two London stations were separated completely on the A2 connection for the aerial. With A1 louder signals were obtained but there was some mutual interference.

On long waves Radio Paris came through at fair loud-speaker strength with reaction pushed to the limit. It was clear of Daventry, which was

THE SET IN BRIEF

MAKER: H. Clarke and Co. (Manchester), Ltd.

PRICE: £10 10s.

VALVE COMBINATION: Detector (Cossor MH4) and transformer-coupled power valve (Cossor MP4). Metal rectifier.

POWER SUPPLY: A.C. mains from 200 to 260 volts.

TYPE: Self-contained table set, needing only an external aerial and earth. Mains aerial provided.

REMARKS: A sensitive little set giving better quality than is usual for its type.

a strong signal with a slight application of reaction.

Mains hum is very slight and cannot be heard at all when the set is tuned to a programme. With the mains aerial the locals were brought in at fair strength, though some reaction had to be used to make up for the poor signal pick-up of the mains conduit.

The quality certainly justifies the use of a gramophone pick-up for the reproduction of gramophone records. Sockets are provided at the back for the pick-up, but an external volume control is needed.

The large tuning scale is commendable in such a small set. It is marked in degrees, which is quite a satisfactory method for a set limited to a few stations. Actually, when conditions are anything like favourable, this set will pick up at least a dozen foreigners on the medium waves.

We must emphasise, though, that to get really good strength from distant stations an efficient aerial and earth are required with this little two-valve receiver.

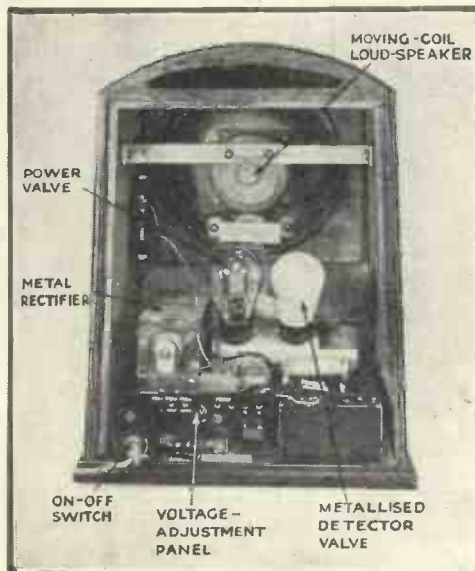

WITH THE BACK OFF

An interior view showing the general arrangement. The loud-speaker is of the permanent-magnet moving-coil type



Cossor Melody Maker, Model 335 (Kit Set)

THIS year's Cossor kit three-valver is a worthy successor to the long line of Melody Makers we have tested during the past several years. Although a straight set in every sense of the term, this kit represents the latest ideas in design. Its good results are due entirely to the very careful thought that has been put into the arrangement of the three valves. An outstanding feature is the use of a battery-type variable-mu screen-grid valve.

As might be expected, these valves take the sequence of screen-grid, detector, and power. The team of Cossor valves used in this kit work nobly together.

We could hardly wish for a better interpretation of the valve circuit used with this kit. The basis of the design is a metal chassis, on the upper part of which are fitted the two screened coils for aerial and intervalve tuning; countersunk under the chassis are the three valve

from the right-hand side of the cabinet.

Apart from one or two large fixed condensers, all the remaining components are fitted underneath the metal chassis, so that the finished set has a remarkably clean appearance.

A point of importance in this kit is the retention of the two-dial tuning system. There are, that is to say, two separate tuning condensers for the aerial and intervalve coils. Well, in a simple kit we are not sure a gang condenser is absolutely essential, or even desirable.

From the point of view of simplicity of control, one-knob tuning is obviously preferable, but this set has the advantage that, though there are two knobs to turn, the dial settings keep extremely well "in step."

Once you have got used to the dual control, the logging of stations is very easy, as we proved on test. London National came in at 30 on each dial, London Regional at 56 and North Regional at 84. The fact that Brussels No. 1 came in with both dials at 89 degrees proved that the dials keep in step all the way up the wavelength range.

In the top of the cabinet housing the metal chassis is the balanced-armature loud-speaker, with a generous size of diaphragm and a solid unit to drive it. There is an adjustment on the back of the unit.

Besides the tuning knobs this kit has three other front controls. On the left is the reaction, which works smoothly and builds up

foreigners like a charm, and on the right is the screen-grid volume control, which cuts down the distant stations to a whisper and the locals to reasonable strength.

Between these controls is the fila-

ment on-off switch, with the wave-change switch, as mentioned, on the side.

We were impressed with the separating powers of this kit. It got Sötens clear of Midland Regional, and Langenberg clear of North Regional. It also got Scottish Regional clear of London Regional,

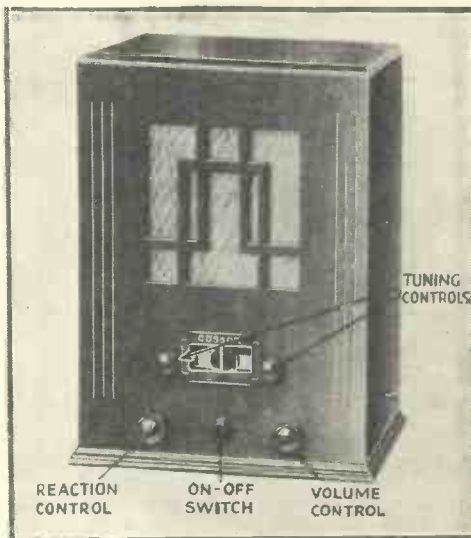

IN A HANDSOME CABINET

The appearance of this year's Cossor kit is really handsome. A balanced-armature loud-speaker is fitted in the cabinet

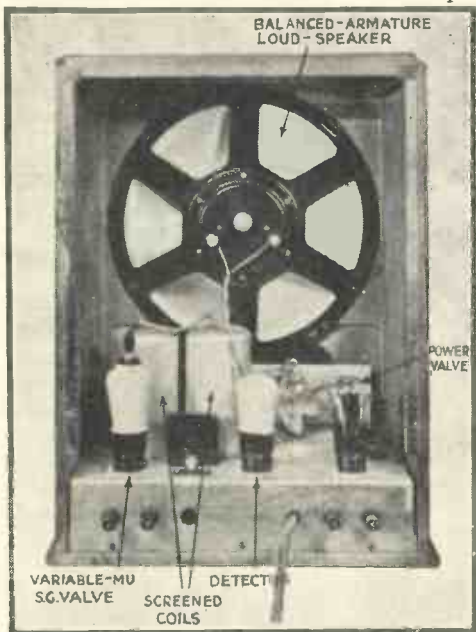

A WELL-DESIGNED THREE

An inside view of the finished set showing the disposition of the components and valves

holders, in a line at the back.

The coils are, of course, dual-range. The wave-range switching is done with a rod running through the coil bases underneath the chassis. This rod ends in a knob projecting

DETAILS IN BRIEF

MAKER: A. C. Cossor, Ltd.
 PRICE: £7 17s. 6d.
 VALVE COMBINATION: Screen grid (Cossor 220VSG), detector (Cossor 210HL), and power (Cossor 220P).
 POWER SUPPLY: Batteries connected externally.
 POWER CONSUMPTION: 14 milli-amperes at 120 volts.
 TYPE: Kit set of table cabinet type, with self-contained moving-iron loud-speaker.
 REMARKS: A well-designed kit set making good use of the variable-mu valve.

which is rather good for two tuned circuits.

There is plenty of power in the set. During daylight, we heard Brussels No. 1, Langenberg, and Huizen at fair strength and at night thirty-five stations on the medium waveband were easily logged within the hour.

The long waves gave Paris at great strength, quite clear of Daventry. There is no "break-through" at the bottom of the long-wave tuning.

Quality is quite satisfactory for a moving-iron loud-speaker.

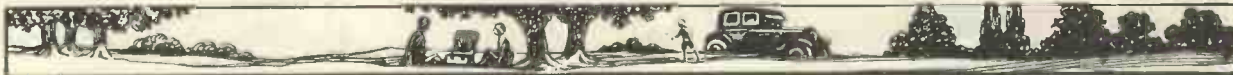

Lotus Band-pass A.C.3



VOLUME CONTROL
COMBINED WAVE-CHANGE AND ON-OFF SWITCH
TUNING CONTROL
REACTION CONTROL

AN ATTRACTIVE SET

The Lotus Band-pass Three for A.C. mains operation is housed in a neatly designed cabinet. Every control is marked

FOR average use the three-valve is still supreme. This state of affairs is not surprising when such a good performance can be obtained as we noted during the tests of the Lotus set.

Here is an A.C.-mains set that provides, above all, a welcome flexibility of control, enabling the last ounce of performance to be obtained without any very critical operation. Band-pass tuning is employed, which means that selectivity in the aerial circuit is adequate for modern conditions.

All the latest ideas have been incorporated. For example, the screen-grid valve is a variable- μ , which provides a smooth variation of volume control and avoids the troubles of cross modulation that used to be so common with the older type of screen-grid valve.

The variable- μ valve is coupled to a power-grid detector by the improved system of tuned-anode coupling—improved because the moving plates of the tuning condenser are connected to earth, thus enabling the intervalve tuning to be ganged with the band-pass aerial tuning.

Although the tuning is thus reduced to one-knob control, nothing has been sacrificed in sensitivity, thanks to the accuracy of the ganging made possible by fitting a small trimmer control at the back of the set.

We found that once this trimmer had been properly adjusted to give the loudest signals at around 300 metres, the ganging remained good over the whole of the two wavebands, except at the very lowest settings.

The power-grid detector is fed to the pentode output valve through the usual transformer, and all three valves get their high tension from a metal rectifier. All valves have indirectly-heated filaments, and grid bias is obtained by cathode resistances.

An electrolytic condenser is used in the output of the smoothing circuit. We can say that mains

hum is negligible. By the way, the field winding of the moving-coil loud-speaker is connected in the mains output to act as a smoothing choke.

On test we were very agreeably impressed with the general liveliness of this set. First we noted how, when the medium waves were switched in, only the medium-wave calibrations

BRIEF SPECIFICATION

MAKER: Lotus Radio, Ltd.

PRICE: £16 16s.

VALVE COMBINATION: Screen-grid (ACSG/VM Mazda), detector (Mullard 904V) and pentode output (Osram MPT4) with metal rectifier for supplying anode current.

POWER SUPPLY: A.C. mains from 200 to 260 volts.

TYPE: Self-contained table set needing only aerial and earth to complete installation. Mains-aerial connection.

REMARKS: A lively band-pass set giving good-quality output.

were illuminated, and on switching over to the long waves how only the long-wave markings were illuminated. This is done with two bulbs behind the scale, the appropriate one coming into action as required. A simple yet effective idea.

Sensitivity is such that half a dozen foreigners were easily tuned in on an indoor aerial during broad daylight. Even on the mains aerial Brussels No. 1 came in at fair strength. Long waves were equally good. Here the band-pass action showed up well, as Zeesen was almost clear of Davenport and Radio Paris.

Both the London stations were tuned out within 20 metres. Adjacent foreigners came in clear of each other.

Quality on the Magnavox loud-speaker will please the great majority of listeners. It works well with the MPT4 pentode valve, giving crisp speech and a satisfactory balance with music. Great volume can be obtained without distress. The quality does not deteriorate at the minimum settings of the volume control, a result of using the variable- μ type of valve.

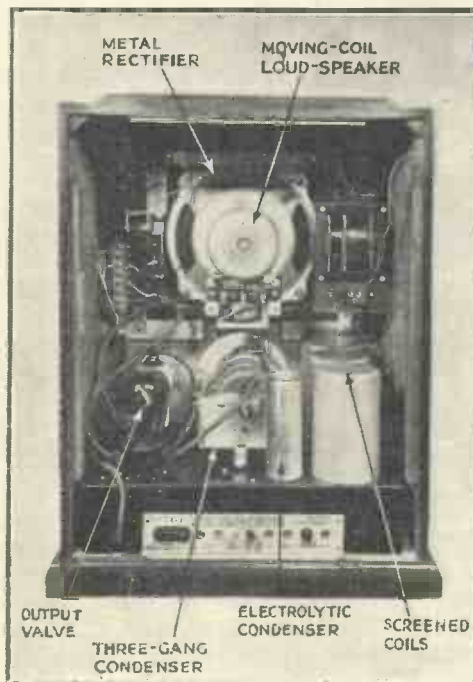

METAL RECTIFIER
MOVING-COIL LOUD-SPEAKER
OUTPUT VALVE
THREE-GANG CONDENSER
ELECTROLYTIC CONDENSER
SCREENED COILS

AN INTERIOR VIEW

The inside of the Lotus A.C.3, showing the disposition of the various parts. Provision is made for using a pick-up and mains aerial





A view of Sydney Harbour Bridge, New South Wales

Last month C. DANVERS-WALKER, who was talks manager and announcer at the station 3LO, Melbourne, until his recent return to England, discussed general broadcasting conditions in the Commonwealth. This month he has something to say about outside broadcasts that have been put over "down under"

NOT so very long ago I was asked to prepare for the programme manager of the Melbourne station a list of novelty broadcasts; he wanted about six of these to cover about as many weeks, each to last for fifteen to twenty minutes.

Preliminary Work

The preliminary work that has to be done in obtaining an attractive group is difficult. Few people realise the amount of work that is entailed before the microphone eventually gets "on location"; there are numerous details to be tackled, such as the co-operation of the person or persons concerned; application for the use of the telephone line, or if there is none, the use of some nearby circuit; the synchronising of times to fit in with the rest of the programme; acoustic problems; and several other factors.

However, the programme manager ultimately got a list comprising some novel features; if I remember rightly they were in this order:—

A broadcast from the railway workshops at Newport.

An informal evening in an Oriental shop in the Chinese quarter.

From the underground tunnels carrying the telephone and telegraph cables.

From an aeroplane in flight.

Mock Fire Call

A mock call at the Central fire station.

From the bridge of a liner.

I might add here that the broadcasting of novelty items did not end with this list. There always has been and always will be an eagerness for the unusual, so that when

any topicality suggests a transmission of something "out-of-the-ordinary," or upon the arrival of the Christmas and Easter holidays, then the microphone makes a tour of such places as the mail-sorting rooms at the G.P.O., and the kitchens where the hot-cross buns are being baked in the ovens.

It might be gathered that the job of an "O.B." man is not altogether unpleasant, but let me assure you that there are moments when one would willingly sacrifice the box of cigars and the hot-cross buns to be suddenly transported to the comfort and solace of one's own home.

There is a human story attached to every one of these broadcasts, and this seems all the more so when I come to reflect on the various incidents surrounding many of them.

In the case of the little social

gathering in the Chinese quarter, I had the assistance of the Chinese interpreter to the Customs Department, who made things very much easier when the negotiations with the owner of the shop were in their early stages.

With true Oriental caution, the consent was not forthcoming until a full and very close investigation had been made into the reason for our wanting to broadcast the proceedings, which entailed a visit to the studios and control room by the owner and his family.

Final Consent

As soon as each member was assured that the experiment was not being done with any derogatory motives, we had their entire consent and approval.

When the stage was finally set on



COMMENTARY FROM A RAILWAY WORKSHOP

A novel outside broadcast was carried out from the railway workshops at Newport, near Melbourne. The commentator and the microphone are seen on the left

THE "O.B." IN AUSTRALIA—Cont.



BROADCASTING AN EARLY-MORNING DIP

Here you see the engineers and a swimmer getting ready for the broadcast of a before-breakfast swim at the St. Kilda Baths, near Melbourne

the night of the broadcast, we had a shop full of curious and excited Chinese who were only too eager to assist in the novelty; in fact, they were a little too keen. I had my work cut out trying to keep them quiet as the time drew near for us to receive the "go ahead" signal from the station control room.

When the cue came at last, the excitement that had been written on their faces changed to awe as they waited for the fateful signal to speak their allotted pieces.

It was very gratifying to see with what interest and intelligence they went about their work. The "sing-song" was, to our Western (or should I say Southern?) ears, a "howling" success, and when it came to the supper of shark-fin soup, dim sims, and I forget what else, the microphone was completely forgotten, which no doubt gave the broadcast the required amount of intimacy.

Early-morning Swimmers

Another "O.B." which comes to my mind (although not included in my list) is the instance when a broadcast was made of the early-morning swimmers performing their exercises at one of the seaside resorts in Melbourne.

There are certain people who, with clock-like regularity, take an early morning dip in the baths at St. Kilda, and when winter comes these hardy annuals receive quite a

the deep-throated but school-boyish exclamations as the swimmers floundered in the icy water, must have been a revelation.

From the surprise item I must turn to two matters of importance which occurred in Australia comparatively recently.

The first was when Australian National Airways lost one of their air-liners during a bad storm one afternoon in March of last year. The incident may be recalled by the reader when I say that the plane, with its passengers and crew, was never found.

The part that wireless took in this disaster was by no means a small one. I was instructed to locate myself on the scene of operations and to communicate with the studio at appointed intervals throughout the days and nights that that eventful



BROADCAST OF MOCK CALL FROM FIRE STATION

Listeners in Australia have had the thrill of hearing the preliminaries associated with a fire call. This is the alarm board at the station

lot of publicity in the papers. It occurred to us that a novelty might be introduced in the early-morning section of our programme by giving those who were still in the throes of morning drowsiness a little diversion.

While the sun was still low in the sky, the outside control operator and myself wended our way along the platform around the sides of the baths and quietly connected the equipment. The psychological effect on those who were still heavy with sleep when they heard through their loud-speakers the deep intaking of breath, the splash of water, and

but fruitless quest was being carried out.

The field of search was, to a large extent, governed by the reports that came through from numerous listeners in reply to the broadcast SOS messages from Australian National Airways.

For a portion of that tragic week I was in the mountainous country fifty miles north and north-east of the city, the vicinity whence the last authentic reports had come.

To try to convey a picture of that country is practically impossible; strikingly beautiful, but hopeless country for a plane to be lost in, it

A SPECIAL ARTICLE

gave one the feeling of utter despair when on such a mission.

The tall green gum trees rising to 50 ft. in height were growing in thick profusion, surrounded with undergrowth taller than any man and as thick as jungle growth. The ranges themselves were dense walls where one precipitous slope gave way to another. And over such country the search went on by land and air, by day and night for days on end, until the utter hopelessness of ever finding the plane was gradually felt.

End-of-day Reports

Every night when the various groups of men, some five hundred strong, returned from a fifteen-hour day in the bush, I would collect the news from each country town by telephone and, after making up a report, phone it through to the studio.

Later on it was felt that if any sign of the air-liner was to be found it would come from the searchers in the air, so I returned to Melbourne and made my headquarters at the aerodrome.

The search plane, laden with observers equipped with powerful field-glasses and in the expert hands of Air Commodore Kingsford Smith

or J. A. Mollison, would zig-zag its way over the mountains and valleys in search of some small piece of evidence that would lead to the scene of the disaster, only to return later with the same story, to fill up, and cover another sector.

Shortly before leaving for England, I was sent up to Sydney to assist in the broadcast of the Harbour Bridge celebrations. It was a week of wonderful pageantry and sensational incidents, so full, in fact, of movement and colour that the time was really too short to tell the story.

The ribbon-slashing incident was, of course, a most difficult and delicate matter to handle, but the description was diplomatically dealt with—fortunately it did not fall to my lot to give this commentary.

I think sufficient has been said to show that the Commonwealth is very much alive to the value of the novelty broadcast and the "O.B." Many seeming novelties are only the natural consequence of some topicality which it is the duty of any wireless authority to broadcast, and therefore cannot be claimed as enterprise on their part, but the part that the "unusual" plays in the programmes generally is undoubtedly a big one.



READY FOR A FLIGHT AT MELBOURNE AERODROME

An engineer of the 3LO outside-broadcast department and the pilot off for a flight. Unusual stunts are heard very frequently in the Australian programmes

Stories of the Operas

DAMNATION OF FAUST (Berlioz)

CHARACTERS

MARGUERITE.....Soprano
FAUST.....Tenor
MEPHISTOPHELES.....Bass
BRANDER.....Bass
Time: 18th century. Place: German town.

IN the first act Faust is supposed to be on the plains of Hungary. He sings introspectively of solitude and nature. Peasants dance and sing, and there is a march past to the stirring Rákóczy March, the national air of Hungary.

The next scene shows Faust in his study about to take poison, when suddenly the walls part and disclose a church interior. The congregation is singing an Easter Anthem. After this there is a change of scene to Auerbach's cellar in Leipzig, where there is a revel of students and soldiers. Brander sings the "Song of the Rat," whose death is grieved over mockingly, the chorus ending with a satirical Amen in fugal form. Mephistopheles then entertains the revellers with "The Song of the Flea," which causes great merriment.

The next scene discovers Faust asleep on the banks of the Elbe. Here follows the attractive "Dance of the Sylphs." This ballet is followed by a chorus of soldiers and students, singing in Latin.

Faust enters Marguerite's pavilion, a somewhat different treatment of this part of the story when compared with Gounod's setting. There is a love duet which becomes a trio when Mephistopheles urges Faust to depart. Marguerite is now alone. Overcome by remorse, she swoons at the window.

The scene succeeding this is a mountain gorge. Faust sings a fine song here ("Nature immense, unfathomable and proud"). Then follows the famous "Ride to Hell," and finally the redemption of Marguerite, whom angels welcome in the softly lighted heavens above the town in which the story has been enacted.

The Faust legend has attracted many musicians, but the only famous settings are those by Berlioz, Gounod and Boito, who calls his opera "Mephistopheles." Gounod's setting is now easily the most popular of the three.

From the B.B.C. point of view the setting by Berlioz might easily supplant that by Gounod. There are some clumsy operatic adaptations, it is true; nevertheless, a good broadcast version of Berlioz, adapted carefully for the needs of the microphone, and (above all), sung in good English, might meet with great success.

Whitaker-Wilson.



The Easytune 60 on A Frame Aerial

By J. H. REYNER, B.Sc., A.M.I.E.E.

EVERY regular reader of "Wireless Magazine" will remember the interest that was aroused by the publication of a design for a one-knob super-het receiver in the May issue. That set—called the Easytune 60—was arranged for use on an open or plain wire aerial.

Our Technical Editor recently took the original model of the Easytune 60 and tried out the possibilities of getting the one-knob tuning effect when a frame aerial was substituted for the ordinary type. These experiments were attended with reasonable success and in these pages we are able to give details for converting the original Easytune 60 design for use with a frame aerial.

Two special points should be noted. The loading coil is suitable only for use with

the particular make of frame aerial specified and the gang condenser need only be of the two-gang type. However, those who desire to convert existing Easytune 60's can use the three-gang model originally specified.

No claim is made that the Easytune 60 used with a frame aerial will give the same results as when it is employed with an aerial of the usual type, but nevertheless results are quite satisfactory.

As J. H. Reyner points out, much better results would be assured by the use of a special oscillator coil, but that method would lead to complications. The method of loading the frame aerial to match up with a standard oscillator will, we think, meet with the approval of all who are at all interested in this conversion scheme.

despite the much sharper tuning of the frame aerial as against the outside aerial and the results were quite promising.

Not the Best Solution

On looking into the matter more closely, however, it was felt that this was not the best solution of the problem.

In the first place it involved the production of a special oscillator coil and this would have had to be factory produced since a matching of at least 1 per cent. is essential for correct working. Secondly, the oscillator would have had to be different

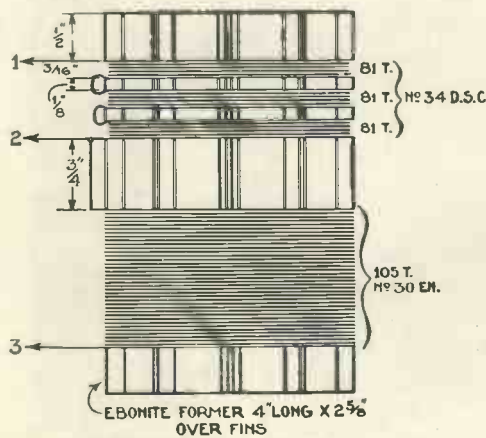

This diagram shows how the dual-range loading coil is made. A ribbed ebonite former is used and the winding can be easily done at home

THERE are many people who want to use super-het sets with frame aerials, and who also would like to avail themselves of single-control tuning. So far the receivers published in this category have been intended for use on an outside aerial, but there is no insuperable difficulty in operating a frame-aerial receiver with a single control.

Series of Experiments

In order to investigate the question the Easytune 60, described in the May issue of "Wireless Magazine," was taken as a basis and a series of

experiments conducted around this receiver.

It was found that with a given aerial it was possible to design an oscillator with which the matching over the whole of the wavelength scale was very close indeed, being less than 1 degree out. This was

for every type of frame aerial and this would tend to produce complications. After some consideration it was decided to adopt a different procedure.

The special oscillator designed by Lewcos for use in the Easytune 60 was taken as the basis. This oscillator, of course, is already on the market and is supplied accurately matched to a standard. The next step was to match the inductance of the set to suit that of the oscillator instead of working the other way round as with the previous test.

Parallel Coil

At first this would appear impossible, but actually it can be done by the introduction of a coil across the frame. If this coil is correctly designed, the combined inductance of the frame and the additional coil will match with the oscillator to give the necessary tracking.

This method proved reasonably satisfactory, although unfortunately the results were not as good as with the original system. However, when the final model was made up it was found that a number of stations could be received without any difficulty by the simple rotation of the one tuning control.

To allow of the variations in tracking a small trimmer condenser is mounted on the panel; this allows any given station to be brought up to maximum signal strength. I had

hoped to be able to avoid using such a trimmer but, within the limitations imposed by the consideration mentioned, it was not possible, and in any case its use is a very simple one.

The bulk of the stations are found without trouble on the main tuning dial and in a few cases further adjustment of the trimmer is not required.

The additional coil, which is connected across the frame aerial, is

mounted in a screened container to prevent interaction with the frame and the rest of the receiver. It is of simple construction and consists of an ordinary dual-wave arrangement on which the long-wave section is short-circuited when receiving on the medium-wave band.

The particular coil described with this set has been designed for use with the Lewcos frame aerial and the construction of the coil is quite

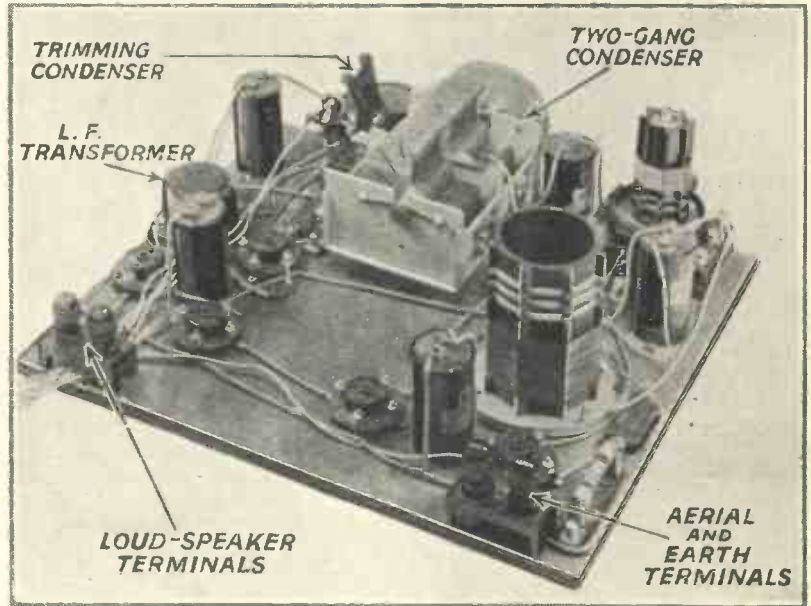

REAL SUPER-HET SIMPLICITY—AND ONLY ONE KNOB TO TUNE!
Here is the original Easytune 60 adapted for use with a frame aerial. The conversion is quite simple and inexpensive

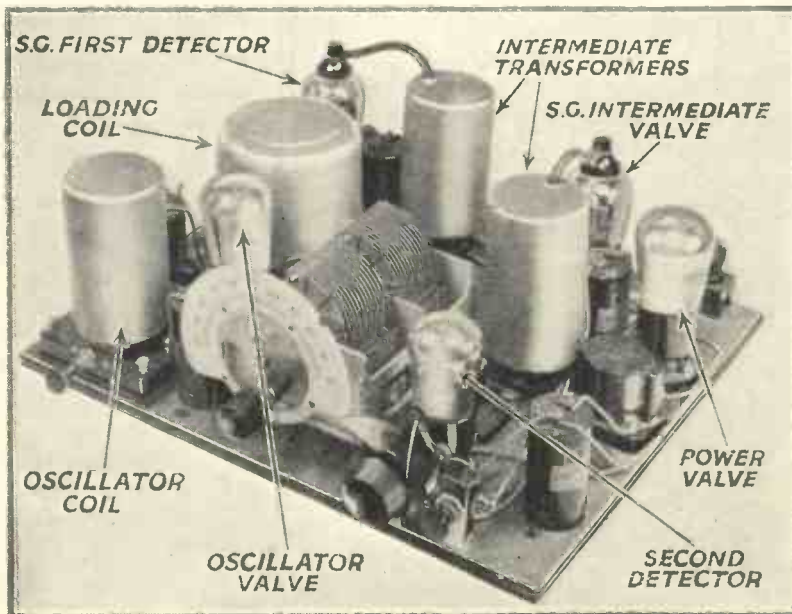

COMPLETED SET ALL READY FOR USE

Every coil is properly screened and excellent results are obtained. In this view the gang condenser is shown without its cover

simple, so that the reader may make it himself if he wishes.

A further advantage of the method is that the inductance of this coil is not by any means as critical as that of the special oscillator used in the first set, so that minor variations are quite possible without destroying the performance of the receiver.

Screen-grid Detector

The circuit finally adopted, therefore, is shown on page 481. The frame aerial with its compensating coil is connected to the first detector valve, which is of the screen-grid type.

The necessary mixing of the incoming signal with the local oscillation is obtained in the anode circuit, not because there is any need for special non-radiating properties with this circuit (as there is in the case of a receiver designed for use on an outside aerial), but because it was desired to depart as little as possible from the arrangement recently

THE EASYTUNE 60 ON A FRAME—Cont.

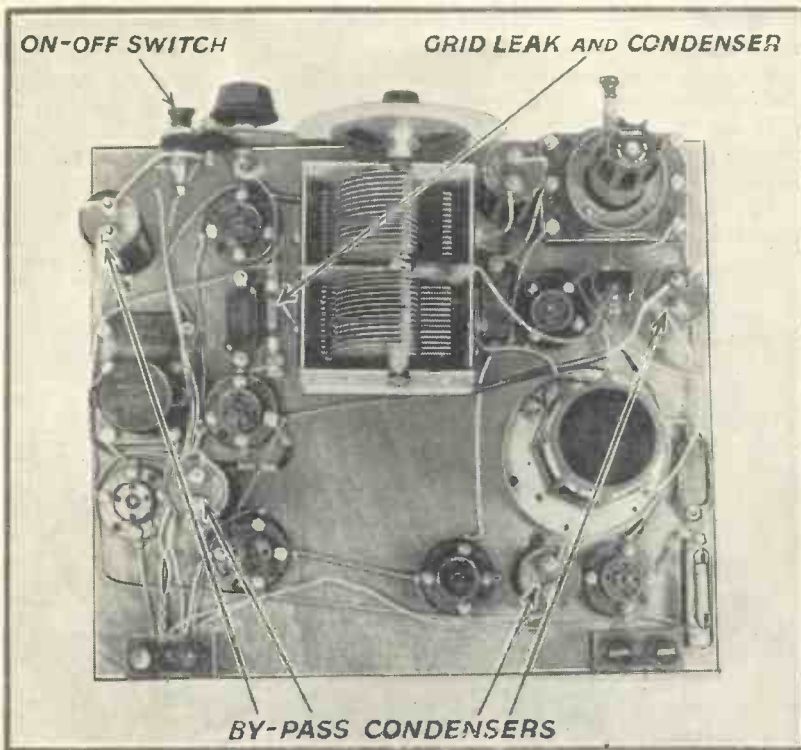

WITHIN THE CAPABILITIES OF ANY CONSTRUCTOR

This plan view of the Easytune 60 adapted for use with a frame aerial shows how simple is the construction

obtained by rotating the frame aerial into a suitable position.

In most cases the signal strength can be cut down to nothing by merely moving the frame round, and this was considered quite sufficient for ordinary purposes.

Trimming Condenser

In place of the volume control there is a small .0002-microfarad condenser which is connected in parallel with the frame tuning condenser, in parallel with the usual trimmer condenser.

This trimmer condenser is normally operated around the middle position and, as pointed out earlier in the article, is just to bring up the stations to their maximum volume.

Owing to the omission of the band-pass filter, it is only necessary to use a two-gang instead of a three-gang, as is required for a receiver with external aerial.

It should be emphasised, however, that this condenser is of the special super-het type in which the front set of fixed plates is specially shaped so that the tune of the oscillator may line up with the tune

of the first detector over the whole of the wavelength range. The British Radiophone condenser used in this circuit is a standard one, easily obtainable from dealers.

The operation of the receiver is straight-forward.

Valves to Use

Insert the following valves in the set :

A good screen-grid valve for the first detector and the intermediate amplifier. A good low-frequency or detector valve should be included in the oscillator socket (v_2), an HL valve for the second detector, and a good power valve in the last socket.

Owing to the fact that only one intermediate stage is used, it is important to have a high-gain screen-grid valve for the intermediate

adopted in the Easytune 60.

The local oscillation is generated by a separate valve as many experiments have shown that this is really the only satisfactory method.

From the first detector the signals are led to the intermediate amplifier in which only one stage of screen-grid amplification is used and the output from this feeds to the second detector and thence through a low-frequency stage on to the output valve.

The volume control which was used on the original circuit has been discarded. In the first place the signals are not quite as strong as on an outdoor aerial so that the need for a volume control is not so great. Secondly, quite a simple volume control is easily

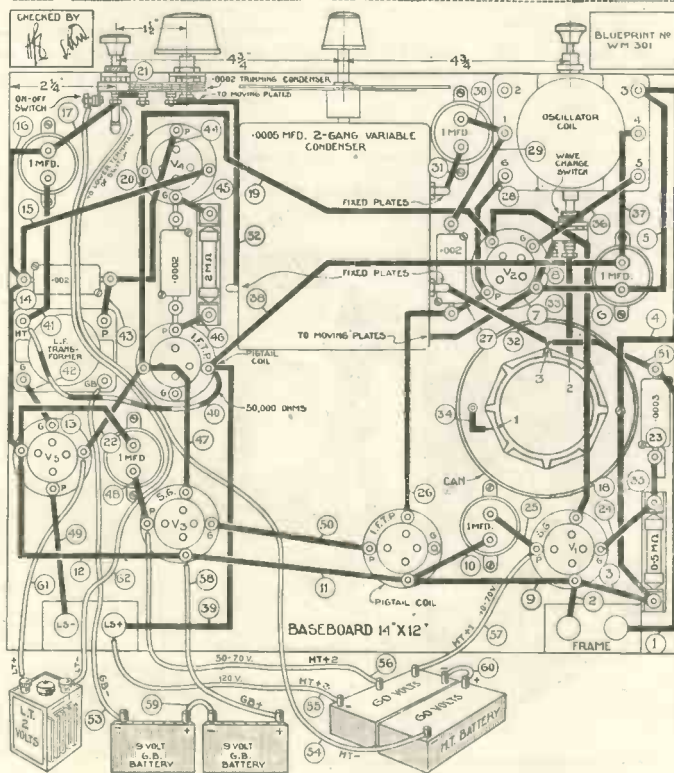

If desired, a full-size blueprint can be obtained for half price, that is, 9d., post free, if the coupon on the last page is used by November 30

AN INTERESTING ADAPTATION

stage, and the best available valve should be used. The Marconi S22 is recommended.

Connect up the low-tension leads to the accumulator and the high-tension leads as follows: H.T.+1 goes to between 40 and 60 volts: H.T.+2 is the screen-grid feed to the intermediate-frequency stages and requires 50 to 70 volts, as specified by the makers. H.T.+3 is connected to the whole high-tension battery.

Grid-bias Connections

There are only two bias leads which are connected to the grid battery in the ordinary way. The positive lead is connected to the positive socket and the negative lead to the voltage recommended by the makers for the particular valve used.

In connection with the batteries, it may be mentioned that best results are obtained if the batteries are kept quite close to the set and the connecting leads are relatively short.

When the receiver was first tried out very annoying whistles were obtained on some stations. These were subsequently found to be due to pick-up on the battery leads, as the receiver was being tested on a common high-tension battery used for supplying a number of points throughout the laboratory.

All the Difference

Disconnecting the receiver from this common supply, which has rather lengthy leads, and using quite short connections made all the difference in the world.

Having connected up the bat-

COMPONENTS NEEDED FOR THE FRAME-AERIAL VERSION OF THE EASYTUNE 60

COILS

- 1—Lewcos oscillator, type TOS/G, 8s. 6d.
- 2—Lewcos intermediate band-pass filters, type IFTP, £1 1s.
- Parts for home-made coil, comprising:—
- 1—Colvern aluminium coil screen and base, type CCS, 3s. 6d.
- 1—Becol former, ref. No. 16, 4 in. in length, 1s. 4d.
- 1 oz. No. 34 d.s.c. wire.
- 1 oz. No. 30 enamelled wire.

CONDENSERS, FIXED

- 1—Dubilier .0002-microfarad, type 670, 1s. (or T.C.C., Telsen).
- 1—Dubilier .0003-microfarad, type 670, 1s. (or T.C.C., Telsen).
- 2—Dubilier .002-microfarad, type 670, 2s. 6d. (or T.C.C., Telsen).
- 5—Dubilier 1-microfarad, type 9200, 13s. 9d. (or T.C.C., Peak).

CONDENSERS, VARIABLE

- 1—British Radiophone 2-gang super-het .0005-microfarad, type 423, 17s.
- 1—Polar Compax .0002-microfarad, 2s. 6d.

DIAL, SLOW-MOTION

- 1—British Radiophone disc drive assembly, 5s.

FRAME AERIAL

- 1—Lewcos dual-range, £1 7s. 6d.

HOLDERS, GRID-LEAK

- 2—Readi-Rad, 1s. (or Bulgin, Telsen).

HOLDERS, VALVE

- 7—W.B. four-pin miniature type, 4s. 8d. (or Lotus, Clix).

PLUGS AND TERMINALS

- 10—Belling-Lee wander plugs, marked: H.T.+3, H.T.+2, H.T.+1, H.T.+1, H.T.—(2), G.B.+ (2), G.B.—(2), 1s. 8d. (or Clix, Eelex).
- 2—Belling-Lee spade terminals, marked: L.T.+1, L.T.—, 4d. (or Clix, Eelex).

- 4—Belling-Lee terminals, type B, marked: Aerial, Earth, L.S.—, L.S.—, 2s. (or Clix, Eelex).

RESISTANCES, FIXED

- 1—Bulgin 50,000-ohm spaghetti, 1s. 6d. (or Magnum, Lewcos).
- 1—Edison Bell .5-megohm, 1s. (or Lissen, Telsen).
- 1—Edison Bell 2-megohm, 1s. (or Lissen, Telsen).

SUNDRIES

- Tinned-copper wire for connecting (Lewcos).
- Lengths of oiled-cotton sleeving (Lewcos).
- Lengths of rubber-covered flex (Lewcos).
- 2—Belling-Lee terminal blocks, 1s. 4d. (or Sovereign, Junit).
- 1—Aluminium bracket for mounting switch (Wearite).

SWITCHES

- 1—Readi-Rad on-off, 10d. (or W.B., Bulgin).
- 1—Readi-Rad three-point, 1s. 3d. (or W.B., Bulgin).

TRANSFORMER, LOW-FREQUENCY

- 1—Lewcos, type LFT6, 10s. (or Ferranti AFB, R.I. Hypermite).

ACCESSORIES

BATTERIES

- 2—Ever Ready 60-volt, type HP60, £1 10s.
- 2—Ever Ready 9-volt grid-bias, Winner type, 2s.
- 1—Ever Ready 2-volt accumulator, type 2127, 13s. 6d.

LOUD-SPEAKER

- 1—R. & A. cabinet cone, type 40, £2 (or Amplion, W.B.).

VALVES

- 2—Osram S22, £1 13s. (or Marconi).
- 2—Osram HL2, 14s. (or Marconi).
- 1—Osram P2, 12s. (or Marconi).

The prices mentioned are those for the parts used in the original set; the prices of alternatives as indicated in the brackets may be either higher or lower

teries and inspected the valves, tune-in the set as follows:

Set the trimmer of the oscillator condenser (nearest the panel) in the mid position, and the trimmer on the other condenser practically all out. The auxiliary (.0002) trimmer should be approximately in the mid position. Now rotate the tuning knob and quite a number of stations will be heard right away.

A small adjustment on the auxiliary trimmer will bring it up to maximum strength with a possible slight re-tune on the gang condenser. After this the trimmer may be left set, when quite a number of stations should be found without difficulty.

Remember that a full-size blueprint can be obtained for half price, that is 9d. post free, if coupon on last page is used by November 30.

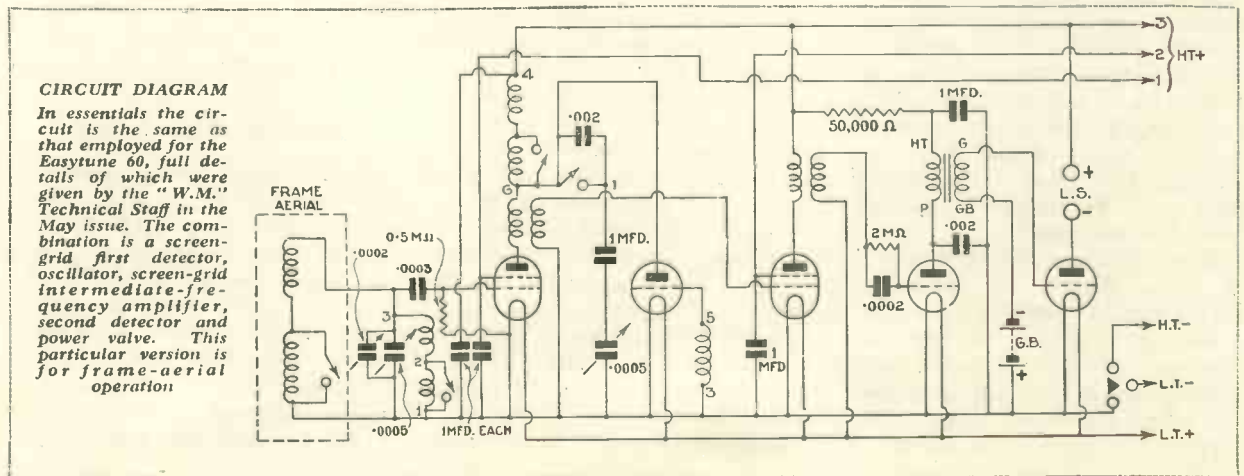

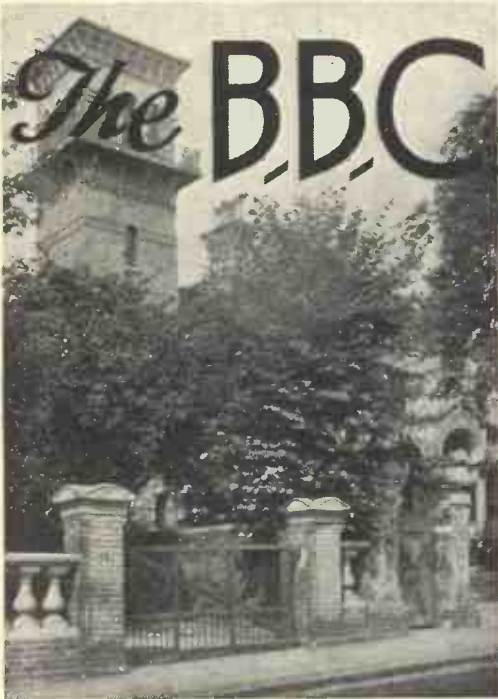

B.B.C.'S RESEARCH DEPARTMENT
The gate on the right is the entrance to the Clapham house used by the B.B.C. for special research work

The B.B.C. AT CLAPHAM

The B.B.C., in order to devote more time to research and special work in connection with short waves and television, has taken over a new research station in South London, which is here described by KENNETH ULLYETT.

the suburb to boast the new research station.

Perhaps there is a "quality" about the wireless waves on this side of the Metropolis!

A house in Nightingale Lane which was, until recently, a nurses' home, has been opened up as a new research depart-

matters for guesswork rather than slide-rule calculation. Rooms were chosen where they could best be converted into studios, drapings were hung up and composition board was tacked in place to keep out the sound. The resulting echo (or reverberation period, as the B.B.C. experts will have it) was taken for granted.

Advance Calculations

When the B.B.C. studios for Broadcasting House were designed, Mr. Noel Ashbridge, in conjunction with the programme officials, realised that it would be necessary to have studios with the reverberation periods calculated in advance.

They would have to say: "This studio is for talks; therefore it must have an echo period of x seconds; to get this reverberation period it must be decorated with y pounds of curtaining and z square feet of panelling."

You would say that this sort of calculation would be outside the bounds of possibility, but the Clapham engineers were asked to face the problem and within a few weeks the bare rooms of Broadcasting House were being made to sound intolerable with the howls of a special sound-reflection measurer which the Clapham experts had made up.

Breaking New Ground

At first their results were disappointing—hardly to be wondered at, for they were breaking new ground. After weeks of trying, and after building a special wall in the Children's Hour studio of Broadcasting House, to prove some complicated formula (the wall was a failure and had to be scrapped) they began to get good results.

After a month they realised that

ment. The mysterious house of Nightingale Lane will not, I hope, become the Mecca of sightseers. In spite of a large aerial, and a brass plate with the letters "B.B.C." on it, the house has not yet taken on any unusual aspect.

It rather reminds me of that big house which H.M.V. took over last year in St. John's Wood, and converted into one of the finest gramophone recording and studio centres in the country. They both, from the outside, look just like—well, houses.

Now, what is Clapham doing, you will want to know. At the present moment it is habited by young men who, as a Claphamite succinctly puts it, "wear horn-rimmed spectacles and a thoughtful air."

These experts are engaged on all kinds of research work which the B.B.C. now has to tackle in connection with the 7-metre broadcasts from the roof of Broadcasting House, the television programmes given in the late-evening broadcasts, and the testing of studio acoustics for the constantly changing studio design.

To give you an idea of the value of Clapham, I must take you back a bit into the early history of Broadcasting House.

Studio acoustics were then

ARE you a Claphamite? If so, be prepared to bud the suburban pride! If you are unacquainted with the amenities of this part of South London, then be prepared to learn.

Clapham and the B.B.C. are becoming almost synonymous. For some years now the quiet respectability of Clapham has hidden a B.B.C. hive of industry in the shape of the equipment and transport headquarters of the Corporation.

Valuable Work

Technical *wallahs* of Broadcasting House who have found the purified washed and frozen air in the B.B.C. building not compatible with their scientific research have hibernated in one of those dear old Victorian houses which comprise, I regret to say, a large part of this end of South London and Clapham has been unaware of the great deal of valuable work which the engineers have done behind closed doors.

Now I hear that the headquarters in Kings Avenue are inadequate for the research work which Mr. Noel Ashbridge and his worthies are planning for the new season and, for some reason which the auctioneers and estate agents can best explain, Clapham has again been chosen as

it was possible to calculate exactly, in advance, the acoustics of a room and to say just how many pounds (and in some cases, tons) of decorative material would be needed to produce any required reverberation period.

The sound-reflecting measuring apparatus which the Clapham engineers used in the Broadcasting House tests is kept as a standard and when studios have to be redecorated (or when new ones are built, as in Birmingham) it can be brought into use for checking up the echo.

The Clapham engineers are not always hunting echoes, though.

Ultra Short-wave Work

They are at work on ultra-short-wave receivers for use in checking up the polar diagram of the 7-metre broadcaster on the top of Broadcasting House. These receivers, which may be *un fait accompli* by the time this article is at press, tune from 6 to 8.5 metres and will be erected at various points within the optical range of the transmitter on the roof.

A B.B.C. official tells me that the normal optical range of the 7-metre transmitter extends to about Hampstead, the Crystal Palace, the Tower of London, and Kensington in the north, south, east, and west directions, respectively, and the Clapham people will therefore have a busy time installing the ten special receivers and checking up the local field strength.

While Robb, Birkenshaw, and the others have been busy with the television broadcasts at London, the engineering section has not yet been able to get any official television check receivers erected.

As a matter of fact, there is only one television check receiver in Broadcasting House, although at the request of the Press a machine is being fitted into one of the listening rooms.

Original Check Televisors

The Clapham research station expects to be kept busy in connection with the official television check receivers, for it is quite probable that these will not be of the standard mirror-drum type used by television amateurs.

Broadcasting House is full of all kinds of technical novelties which are the result of the Clapham research. They deal in everything from superhets to echo hunting.

Filling Your Accumulator

PERIODICALLY one's low-tension accumulator should be "topped up." This is done by adding a little distilled water or, if this is not available, boiled water may be used.

The purpose of this is to allow for the evaporation of the water due to atmospheric changes and also partly due to charging of the cells.

Distilled or boiled water is used because tap water usually contains a certain percentage of lime or similar salt, and these are affected by the acid in the electrolyte of the accumulator, causing a white deposit to be formed on the plates and thus preventing their proper working.

This deposit must not be confused with the very tenacious deposit known as sulphate, which sets in all over the surface of the plates if the accumulator is allowed to run down too far. When the accumulator is fully discharged it is in a very weak state and the material of the plates is attacked by the acid with the formation of white sulphate.

Therefore one should be careful not to allow the accumulator to remain in a run-down condition for long.

Acid should not be used when

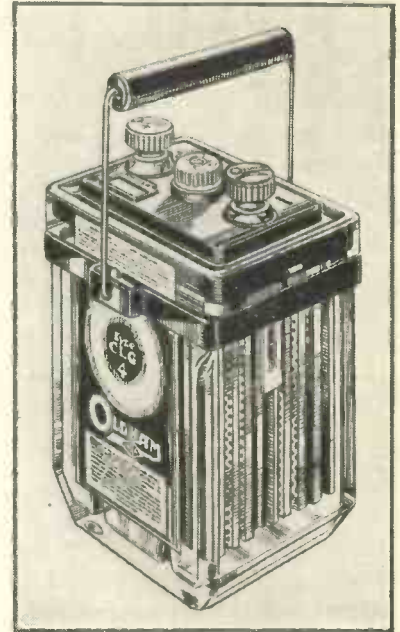

GLASS CONTAINER
One of the well-known range of Oldham glass-cell accumulators. Topping-up is done by unscrewing the vent plug and removing it

topping up a battery, as it is only the water which evaporates and therefore water only should be added in order to bring up the level to the required value. F. L.

High-frequency Stability

ONE occasionally experiences difficulty in making a set stable, particularly where an efficient high-frequency valve is being used. Sometimes, although the coils are screened and the circuit layout appears perfectly satisfactory, one finds that instability sets in towards the bottom of the tuning scale.

Sometimes this is found to be due to the reaction circuit and one of the first tests to be applied is to disconnect the reaction condenser altogether. If the condenser is of the differential type it is only necessary to disconnect the lead between the reaction coil and the condenser, leaving the remainder of the condenser still connected in circuit.

If this does not cure the fault then the difficulty is probably due to the layout. Try connecting the wiring differently. Connections to low-tension negative, for example,

can often be made in various ways, and in some cases the current may have to go quite a long way round to get to its ultimate point. While this does not matter with direct currents, it is very important for high-frequency currents.

"Close" Connections

Generally speaking connections to low-tension negative or high-tension negative, or the connections of by-pass condensers, should be taken as close as possible to the apparatus with which they are associated. Often the disconnection of a lead from one point and its reconnection to another which is apparently the same and is, in fact, connected to the first point by a fairly long length of wire, will make all the difference to the stability of the set.

J. H. Reyner.

SOME FAMOUS "W.M." SETS

Here are reports from five enthusiastic readers who are getting good results from their "W.M." sets. When sending your report remember that half a guinea is paid for every photograph of a home-built "W.M." set reproduced in these pages

FIVE RECEIVERS

Colchester (Essex). — I have recently built five sets of your design:

(1) *Super 60*.—This did all you claimed for it and more. I can get more than sixty stations clear.

(2) *Super Senior*.—This eclipsed the above set on only a 12-ft. indoor aerial. I can get any station you like. This is the best set I have built. Quality and volume are wonderful.

(3) *Double Band-pass Three*.—This is good for a three, but, of course, does not come up to the above sets. Quality is good, but selectivity is poor after using the Super 60 and Super Senior.

(4) *Ideal Home Super*.—This, after some minor trouble, is good in selectivity and very fair quality. But, in my opinion, does not compare with the Super 60 or Super Senior.

(5) *The Easytune 60*.—This is my latest venture, and is the only set built from your magazine that I cannot manage. On the long waves I can get all worth while, but most signals on the upper part have a spread of ten degrees. Quality good.

[This reader has not ganged his receiver correctly.—Ed.]

EVERYBODY'S PORTABLE

(July, 1932)

Framlingham (Suffolk).—This summer I decided to build Everybody's Portable and take it to Wales on my holiday, where I am now writing this letter. I am pleased to say that it is much more efficient than you claimed in your too-modest description and test report in the

July "W.M." You logged thirty-four stations during your test in the park. I went round the dial once on its maiden trip and logged forty-six stations, which could be found with perfect ease. The complete log is now fifty-seven stations. The performance of this set is remarkable. I like it because it works just the same in Wales as it did during its four days' test in Suffolk before I started my holiday.

NEW ECONOMY THREE

(December, 1931)

Ilford (Essex).—I feel I must write and tell you of the wonderful success I have made of the New Economy Three. It is a marvellous set with heaps of reserve power. Using an Octron SG2, Mazda HL2 (detector), and Mazda P220 in the power stage, and an indoor aerial 14 ft. high (which goes up through the ceiling to the top room, and is not even insulated from floor to ceiling), the following stations were logged: London National and Regional, Mid-



"The best I have ever built" is the opinion of a Gateshead reader who has added P. K. Turner's Economy Push-pull Amplifier to the Easytune 60. It certainly looks a good job!

land Regional, North Regional, Langenberg, Stockholm, Radio Toulouse, Hamburg, Mühlacker, Bordeaux-Lafayette, Hilversum, Heilsberg, Vienna, Berlin, Madrid, Fécamp, and Prague on the medium waveband; and Daventry, Radio Paris, Eiffel Tower, Warsaw, Moscow, Huizen, and Leningrad on the long. A remarkable achievement!

SUPER 60

(March, 1931)

Port Louis, Mauritius (Africa).—You may be interested to get a report of your famous Super 60 from overseas, such as Mauritius, which is situated thousands of miles from the principal broadcasting stations. The reception of wireless stations is bad here. I have used a plug-in coil holder and have joined to it an outdoor aerial and earth for the reception of medium waves. With a 40-turn coil I have logged the following stations, all very loud on the loud-speaker: Bombay, Colombo, Nairobi, Durban, Johannesburg, Reunion, Rome, and a few others not identified.

On the ultra-short waves I put in a 4-turn coil and received the following stations on the loud-speaker: Chelmsford, Rome, Amsterdam, Johannesburg, Nairobi, Berlin, Moscow, Vatican, Java, and Schenectady, U.S.A. I hope to get still more. The set works admirably with indoor or frame aerial and the selectivity is excellent. I can separate Nairobi and Johannesburg on 50 metres by half a degree on the oscillator dial without any interference. I consider my Super 60 to be an excellent set and the results I have obtained are above my expectations.

1932 A.C. SUPER 60

(February, 1932)

Transvaal (South Africa).

—I am using a "W.M." double-diaphragm loud-speaker with my set. For purity, volume, and selectivity it beats all commercial sets I have heard. I have no proper outside aerial—only a short length of wire across the backyard about 10 ft. off the ground, and on a good night I get about a dozen European stations at fair loud-speaker strength. Rome is especially strong, sometimes coming in as loud as the local station, which is only thirty miles away from here. I get better results from the "W.M." set than from a commercial set.

The Variable Resistance



By PERCY W. HARRIS, M.Inst.Rad.E.

LAST month we discussed fixed resistors and their place in radio sets. We saw how important it is to choose them with an eye on the current which they will be required to pass and how various constructions suit various purposes.

This month I want to talk about variable resistances—and much that was written about the fixed resistor is equally applicable to them.

First Use for Variables

It is interesting to notice that the first use of variable resistances in wireless sets has long since been abandoned. A variable filament resistance was an essential part of every well-built receiver when valves first came to be used, owing to the fact that the voltage at which the filament operated was very critical and filaments themselves were abnormally fragile. Taking anything from .75 ampere to 1 ampere for each valve, they worked at a critical temperature, there being very little electron emission below this point and complete destruction of the filament just above it! The filaments were made of tungsten wire that had to be run white hot to give any emission at all—and what you *did* get was very poor!

Controlling Temperature

However, we are not here discussing valves but merely the means of controlling the temperature we had to use.

First of all, these resistances consisted of coils of wire wound round the edge of a circular former and frequently supported by some solid material inside the coil, the resistance being of about 5 ohms, and a slider serving as the variable contact.

If you refer back to my last month's article you will find I gave a simple way of calculating voltage and so forth, and you will find that with a current of 1 ampere a variable resistance of 5 ohms will give you a big variation of voltage. It was the custom to use a 6-volt accumulator and the valve worked generally at about 3.5 to 3.8 volts on the filament. This meant that we had to drop just over a couple of volts in the resistance, which was easily done by this method.

After a while valves were improved and we had a series of dull-emitters working with .25 ampere, at various odd filament voltages. The ohmic value of the variable resistance was thereupon increased and later when valves of .1-ampere consumption came along the values had to be made still higher, for, as you will have found from the simple calculations we discussed last month, the smaller the filament current the larger the resistance has to be to drop a given number of volts.

A tenth of an ampere, for example, through the whole of a 5-ohm

resistance can only drop .5 volt, whereas .1 ampere through 30 ohms can drop 3 volts.

Soon, however, the inconvenience and danger of leaving the control of filament voltage to the person operating the set came to be realised and valves are now made to work at accumulator voltages (2, 4, or 6 volts) so as to obviate the need of these resistances.

Limit of Reaction

In these first days when high-frequency amplification was almost non-existent (at least the amplification obtainable was so low as to be almost negligible) we all had to run our sets to the very limit of reaction to obtain any distant stations.

In a well-designed reaction receiver the set gradually slides into oscillation, the transmission from the stable to the oscillating state being almost imperceptible, and the magnification obtainable in this last state being very high.

Variable Grid Leaks

A crudely designed reaction set "plopped" into oscillation without passing through this last very valuable critical stage, so everything was done that could be done to get critical reaction. It was discovered, for example, that making the grid leak variable enabled a very fine control to be obtained in some circumstances, for the grid leak exercises a damping effect and reaction was controllable in this way.

All kinds of variable grid leaks were made, most of them very erratic in their behaviour, but it will pay us to consider a few of them in view of the importance of variable resistors in modern work.

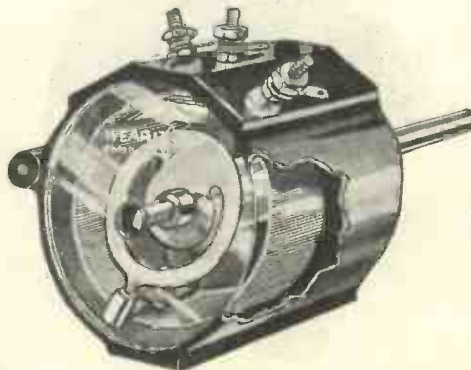

SUITABLE FOR GANGING

The latest type of Wearlite wire-wound potentiometer, which is so arranged that two or more can be actuated from a single knob on the panel

THE VARIABLE RESISTANCE—Continued

One of the first type consisted of an ebonite tube with a terminal at one end and a brass collar at the other through which ran a threaded rod terminating on the outside in a moulded knob. The interior of the tube was filled with a kind of blacking, a sticky and messy paste containing carbon and other substances.

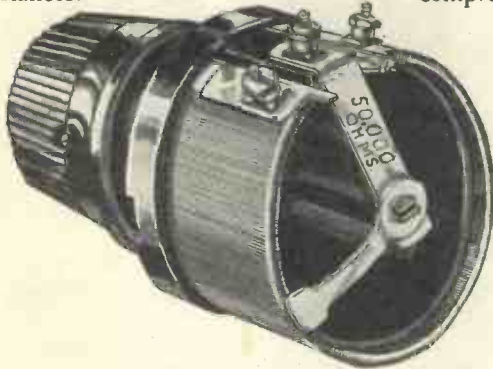

SIMPLE RUBBING CONTACT
A simple type of wire-wound resistance made by Colvern. The contact is of the rubbing type, the arm being made of springy material.

The resistance of this paste was fairly constant throughout its length and the idea was to screw the rod in and out so as to vary the distance in the paste between the end of the rod and the opposite electrode, the shorter the path the lower being the resistance.

The idea was a good one, but it worked out very badly in practice, for the paste had an awkward habit of squelching out in hot weather; varying its resistance with temperature; drying up; or failing in some other way.

Pellets in a Tube

Another type consisted of series of pellets of some carbonaceous material, the resistance of the pellets varying with pressure. A similar tube was used, but instead of sliding a rod in and out of a sticky mess by turning a knob the pellets were more or less compressed. These, too, were good when they were new, but soon failed and became noisy.

The first really reliable variable resistance of the compression type originated in America and was known as the Bradleystat. In this a very large number of discs of carbon were placed under varying compression.

Later another carbon type, made on an entirely different principle and also American, arrived under the name of the Clarostat. This

resistance has remained popular for many years and large numbers are still sold for all kinds of purposes.

The Clarostat consists of a container in which a special powdered carbon is mixed with finely powdered mica. Any carbon-powder arrangement will vary its resistance on compression, the tighter the compression the lower being the resistance, but the trouble is to arrange such devices to regain their high-resistance or loose state.

In the Clarostat the powdered mica acts like millions of tiny springs and the whole mass is, so to speak, elastic and easily regains the uncompressed state when the knob is released. The composition of the powder determines the resistance of a given unit and a very wide range is obtainable.

We must now consider the wire-wound type of variable resistances. These, as I have pointed out earlier in this article, were the original variable resistances used for filament control, and it is very easy to make them when the variation of resistance is only a few ohms or a few hundred ohms.

In such circumstances we wind the coil of wire, bend it in a circle, or slightly less than a circle, and arrange for a slider to rub over the turns, one terminal of the device being connected to the slider and the other to one end of the coil.

It follows that as the slider moves further away from the end which is

used as a terminal more and more turns of wire are included in circuit, and therefore more and more resistance is obtained.

The real trouble begins with high resistances, when we find that to obtain a given maximum resistance value either the coil has to be very long, and thus the whole arrangement unwieldy, or else if we wish to get the resistance into a convenient space the wire becomes unduly thin.

Ingenious Arrangements

Even the best high-resistance wires are liable to give trouble in very high values of variable resistances, and a number of ingenious arrangements have been adopted to overcome this.

The chief trouble arises from the danger of wearing or breaking the fine wire by the friction of the slider. One method of overcoming this difficulty is to make the slider run, not along the wire itself, but over a number of studs connected to the coil at intervals.

If, for example, our resistance coil has a thousand turns we can connect a stud at every hundred turns, the slider then running over ten studs. The disadvantage of this arrangement is that it makes the resistance variable in rather large jumps, whereas when the slider is running over the wire itself the resistance is almost continuously variable.

Pressure Contact

A very ingenious solution of this problem has recently been marketed in a variable resistance in which a circular plate of metal is made to roll along the coil of wire, establishing contact by pressure at various places rather than sliding along it. It is difficult to explain this in words, but you know what happens when you drop a saucepan lid on the floor and it performs a circular movement without actually rotating before it settles down.

A similar effect is obtained in this new resistance, the disc of metal being supported in the middle at an angle, touching the wire at one point only. Which point it touches is determined by the rotation of a roller upon it.

A compromise between the stud method and the rubbing-contact method has been arrived at in some

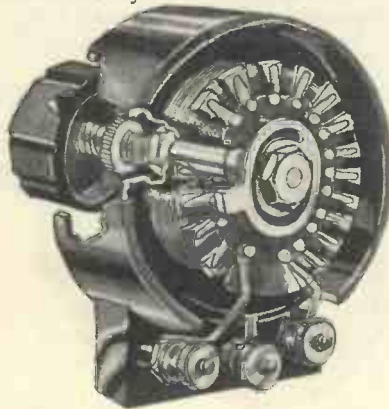

TAPPED RESISTANCE ELEMENT
In the Tunewell potentiometer the resistance is tapped off in sections by means of studs and a rotary switch. The resistance is not continuously variable.

HOW IT IS MADE AND USED

resistors where a heavier wire than usual is adopted. Instead of the wire being wound on a circular former, which would make it very long, it has been wound on a wide strip, the strip being bent round in a circle.

Use of Thicker Wire

The slider then rubs along the edge of the strip, making contact with the successive turns, and while there is a bigger variation of resistance per turn (owing to the length of the loop) the whole device is reasonably compact and there is not much trouble in wear owing to the thicker wire used.

With the development of high-resistance compounds of the carbon type a number of variable resistances have been produced in which the slider is made to rub over the surface of a curved piece of this high-resistance material, one terminal being joined as before to the slider

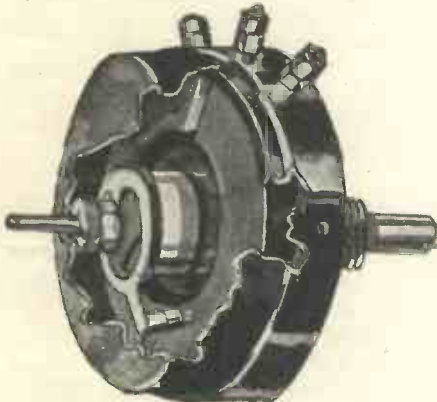

COMPOSITION ELEMENT

This Varley potentiometer has the resistance element and contact made of a composition. The motion is extraordinarily smooth

and the other to one end of the resistance material.

If the resistance is low these components are quite simple to make, but when the total resistance is high there is some difficulty with the actual contact between the slider and the material, uniformity being difficult to obtain.

Rolling Metal Disc

Sometimes the material used at the end of the slider is identical with that used as the resistance medium, and a good contact is established without too much wear. In other cases the rolling metal disc is used very successfully, this being the method adopted in the well-known

Centralab variable resistances.

There is one form of variable resistance which on the one hand overcomes the difficulty of the rubbing contact over thin wire, and on the other the wearing effect of the rubbing contact on a composition material. This is made by taking a rod of the moulded material and bending it into a circle or almost a circle, the composition and size of the former being such that at its full length gives the maximum resistance required.

This former is then wound round with fairly thick wire, using well-spaced turns, or the wire coil can be moulded into the material, so long as it projects slightly.

If left in this form the coil would, of course, short-circuit the resistance material, but instead a sawcut is now made so as to sever every turn, giving us, instead of a continuous winding, a series of disconnected metal loops in thorough contact with the resistance material.

The slider can now rub freely over these disconnected loops, giving intimate contact with the resistance at that point, but avoiding any frictional wear on the relatively soft material.

Such resistances are not strictly continuous, but go in steps—the number of steps, of course, depending upon the number of turns or loops.

So far I have treated all of these resistances as simple two-terminal affairs, but it is obvious that identical principles are applied to the construction of potentiometers having three terminals. In this case terminals are fixed to each end of the resistance coil or material, the slider forming the third terminal. High-resistance potentiometers have numerous uses in modern radio, a typical application being the volume control used with gramophone pick-up.

Just as in choosing fixed resistors we must bear in mind the dissipation of power required, so in the variable type we must have similar considerations in mind. If, for example, we are using a variable resistance in an

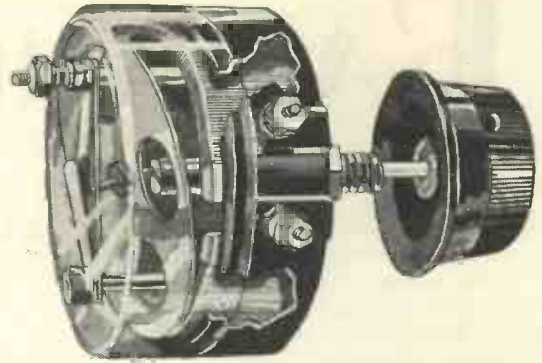

PRESSURE CONTACT

The new Lewcos potentiometer has a metal plate that bears on the resistance element without any circular motion. It is excellent value for money

automatic grid-bias circuit it must be remembered that the resistance has to carry the whole plate current of the valve it is used to bias, which may be very heavy.

Possible Injury to Valves

Such resistances must be well made, not only in their resistance element, but also in the contact between the slider and the resistance element. If the slider tends to jump turns and does not establish good contact, it may momentarily break the circuit, giving not only an ear-splitting noise, but even injuring the valve.

If it is desired to have a variable resistance for such biasing purposes it is much better to use the type where the contact can only be adjusted by unscrewing the clip, sliding it along and screwing it tight again.

There is no need to have a resistance continuously variable by means of a knob, as once the correct resistance has been found for a particular valve it will not be changed and there is no risk of instability of contact.

Question of Self-capacity

Another important point to be borne in mind is the self-capacity of variable resistors, which may rise to a very high figure, particularly in some of the power resistors which are made to dissipate a good deal of heat.

As it is not unusual to wind the wire on the metal former with quite a thin insulation, the self-capacity of such a resistance may well be high enough to give a serious shunting effect on the higher audio-frequencies, while on the radio side the capacity may virtually short-circuit the resistance.

RADIO in REVIEW

Automatic Sets :: "Silent" Tuning :: A Cure for Fading :: The Electric Atom

THE idea of bringing in any desired station simply by operating a switch or pushing a button seems to have a definite attraction for some listeners—judging by the amount of attention given to sets which "featured" this method of tuning at Olympia.

Some of the interest shown was, no doubt, due to a genuine appreciation of the advantages of "automatic" tuning, though many visitors were probably prompted more by curiosity as to how it was done.

Semi-fixed Condensers

In the switch-operated type, the aerial and high-frequency circuits are built up around a number of semi-fixed condensers, and the desired station is brought in by selecting the appropriate condenser. The switch is, of course, arranged so that the change-over from one condenser to another takes place simultaneously in all the high-frequency circuits.

Push-button tuning is based on quite a different principle. The high-frequency circuits of the set are all ganged to a common-control shaft in the usual way, but a selector device is inserted between the shaft and the control buttons, so that as each button is operated the shaft is rotated into a definite position corresponding to the desired station. In other words, it is really a simplified method of adjusting the tuning condensers to certain pre-selected settings.

Problems for the Designer

Whether or not such automatic methods of tuning will ever come into general favour remains to be seen, but there is no doubt that the simplified control of a modern high-powered set is beginning to present some nice problems to the designer—in spite of recent improvements in ganging, and in mounting and marking the tuning dial.

For instance, a really high-powered receiver simply "blasts" when it is "tuned through" the local station. Of course one can use a local-

By MORTON BARR

distance switch; and the variable-mu valve also helps, but by itself it is not sufficient to keep the volume steady under these circumstances.

This problem of cutting-out unnecessary "noise," when tuning, was first seriously tackled in America where high-powered sets are the rule rather than the exception. And where, in consequence, listeners soon began to object and to press the manufacturers to find a remedy.

One solution which is already in use consists in arranging the loud-speaker so that it is normally disconnected from the output valve, though the connection is automatically restored whenever a signal comes in. As one rotates the dial, the loud-speaker remains silent except at the settings which bring in a definite carrier wave.

The switching in and out of the loud-speaker is effected by means of a relay which is operated automatically by the incoming signal. The arrangement makes it quite impossible for the set to reproduce loud crackles and other disagreeable atmospherics in the process of searching. A special rectifier valve is used to provide a control bias which varies in strength with the incoming signal, so that the volume is kept at a constant level even when passing through the local station.

Automatic volume control introduces another tuning difficulty, because once a programme is heard in the loud-speaker it remains at constant strength in spite of further slight movements of the tuning dial.

But unless the dial setting is dead accurate, it is quite likely to cause a certain amount of distortion, so to overcome this defect a "visual" tuning indicator is provided in the form of a small neon lamp, which glows only when the circuits are exactly in resonance with the incoming signal.

♦ ♦ ♦
Much has been said of the merits

of the variable-mu valve as a means for automatically regulating signal strength, and so reducing the effects of fading, but a still better solution would be to tackle the problem at the transmitting end.

As is well known, fading is largely due to the presence of the so-called space wave, which when reflected back from the Heaviside layer "interferes" with the ground wave and at times practically wipes it out.

Eliminating Space Wave

If the space wave could be eliminated in transmission and the whole of the radiation concentrated into an earthbound wave most of the trouble would disappear. Experiments are now being made along these lines, and successful results have been obtained by using six or seven vertical aerials arranged around a central aerial at a distance of half the transmitted wavelength.

♦ ♦ ♦
The electron was first identified by J. J. Thomson in 1897, shortly after the discovery of radioactivity by Becquerel and of X-rays by Rontgen. As soon as its true significance became clear, most of the existing conceptions of electricity went into the melting pot.

For instance, instead of referring to two different kinds of electricity, one positive and the other negative, we now regard a body as negatively charged when it holds an excess of electrons, and "positively" charged when it is short of its proper quota.

Newly Discovered "Neutron"

In his presidential address to the British Association, Sir Alfred Ewing drew an interesting picture of the newly discovered "neutron," which is formed when an electron gets into really close association with a proton.

Close bound as they are in space, the two particles are separated electrically by a potential difference measured in millions of volts. This highly charged miniature condenser is the real seat of the atomic energy which scientists hope may one day be harnessed to do useful work.



Designed by
the "Wireless
Magazine"
Technical Staff

In the following pages the "Wireless Magazine" Technical Staff presents full constructional and operating details of a particularly efficient and straightforward four-valve receiver that uses the latest components. It is a type of set that has always enjoyed considerable popularity and this model incorporates all the latest ideas

THERE is nothing "stuntish" about the Table Quad. It is just a straightforward and honest-to-goodness four-valver built with the most modern components; it works well, is simple and reasonably cheap to build, and should give months of enjoyable radio entertainment without any trouble.

Cost Repaid

Although the three-valve combination is still the most popular type of set with the man-in-the-street, there is no doubt that a fourth valve well repays its cost for those who want reception of foreign stations.

The fourth valve gives that little extra bit of punch that is needed to bring many Continental stations up to real programme value.

The valve combination of the Table Quad is one high-frequency stage, a leaky-grid detector, a resistance-coupled intermediate low-frequency amplifier and a transformer-

coupled three-electrode output valve.

The aerial input circuit is arranged on the band-pass principle for the sake of selectivity, while the grid circuit of the detector valve is also tuned. Thus a three-gang condenser can be utilised to give one-knob control.

Perhaps the most interesting feature of the Table Quad is the new type of tuning coil it utilises. These coils are of small dimensions, but they are claimed to have great efficiency through the special nature of their design.

For instance, the high-frequency resistance of the medium-wave

winding is claimed to be only 9.5 ohms, while the long-wave portions have a resistance of 55.5 ohms. These are figures that compare very favourably with the values obtained for good low-loss solenoid windings, and are all the more commendable in view of the low price of the coils.

Control of Selectivity

Not only have the coils a fairly high inherent degree of selectivity, but they are also provided with tappings so that the selectivity can be further controlled by the user for the best possible results under his particular conditions.

This feature will be found of very great benefit for winter listening, especially if the operator wants to get a good bag of foreigners.

Apart from the actual windings, there are two other features of interest about these new coils. The dual-wave switch is of a very substantial type and should give no trouble in use.

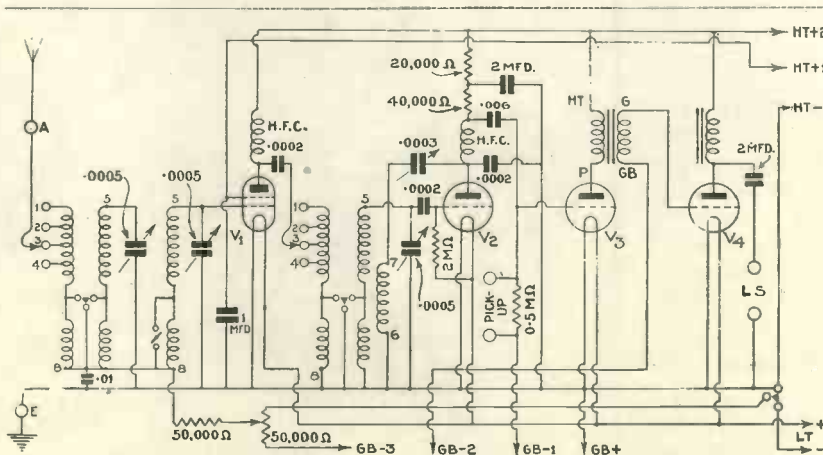

FOUR-VALVE CIRCUIT FOR POWER AND RANGE
The combination employed in the Table Quad is a variable- μ stage, a leaky-grid detector, a resistance-coupled low-frequency amplifier, and a transformer-coupled power valve

THE TABLE QUAD—Continued



SIMPLE CONTROLS

After a few minutes practice any member of the family will be able to manipulate the controls of the Table Quad with fruitful results

The contacts are of gold-silver and have a slight wiping action that should keep them quite clean even after prolonged use and exposure to the atmosphere.

Colour Code

The second point is the special colour code employed to differentiate between coils of various types. For instance, the first band-pass coil is coloured green, the second band-pass coil is yellow and the high-frequency coupling coil is blue. The screens are finished off in these colours, so the constructor will have no difficulty about recognising which coil is which.

When the screen is removed from any one of these coils and the winding is exposed to view it will be seen that there is a coloured cardboard disc fixed to the top of the former. This disc, which is the same colour as the screen in each case, carries a diagram of the coil windings and the actual connections at the base, which are numbered in the usual way.

Welcome Innovation

This feature is of considerable utility to the experimenter who may want to use the coils in another set at some later date. Experienced constructors will know how coil-connection details get mislaid in the usual

way and will welcome this permanent method of indicating the connections.

The coils are all matched to a standard and can therefore be used with any good make of gang condenser if it is desired to produce a set with one-knob control.

In this set we have used a well-known make of condenser. The Polar Tub was probably the first attempt on the part of a British radio manufacturer to make a really substantial ganged instrument and this firm's new three-gang model is even better designed and produced than previous examples from the same factory. With this condenser there will be no troubles about ganging the set up.

The circuit is arranged for the use of a variable-mu type of valve in the first stage. This, as is becoming appreciated by constructors very rapidly, results in much better reception of the local station and less mush on foreign stations.

No set can be called really up to date now unless it does incorporate a variable-mu valve for high-frequency amplification, although the

ordinary screen-type still has its uses, of course, in some special circumstances.

Such is the demand for battery variable-mu valves that there is still a shortage of one or two makes, so if you intend to build the Table Quad it will be just as well to order the variable-mu valve from your dealer at once and avoid any possibility of delay. Some manufacturers have ample supplies, of course.

Straight-forward Circuit

As far as the actual circuit arrangement goes, there is little to be said. Everything is quite straightforward and easily followed by the experienced hand.

Wherever necessary, devices have been provided to prevent any possibility of instability and in practice it will be found that the set is not at all inclined to "go up the loop" in spite of its general liveliness.

Resistance Coupling

The resistance-capacity coupling between the detector and the first low-frequency valve has been made with separate components for the benefit of those who already have the necessary materials and also for the benefit of those who like to try different values of resistance and capacity for the coupling.

Two terminals are provided across the grid-leak for the connection of a gramophone pick-up if required.

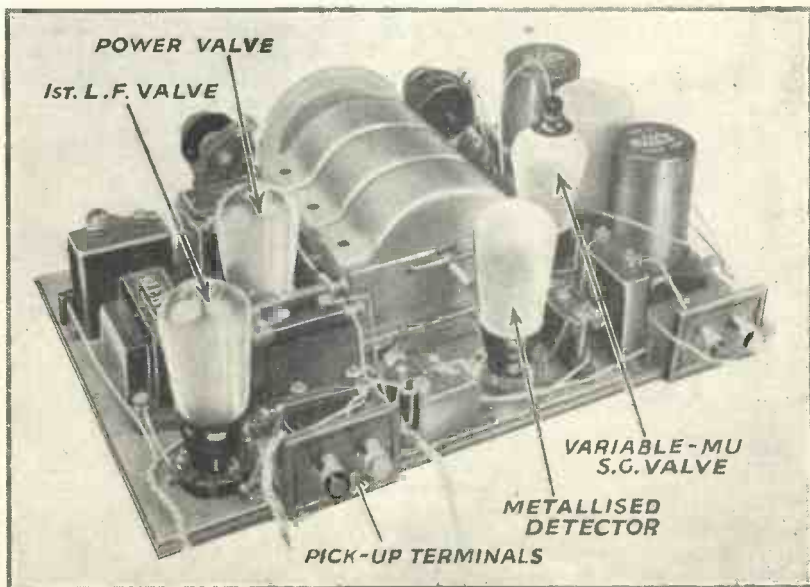

AN UP-TO-DATE FOUR-VALVER TO BE PROUD OF!
This photograph of the Table Quad shows how well it has been designed. Not only is the appearance attractive, but the performance is all that can be desired

THE TABLE QUAD—Continued

What You Can Expect from the Table Quad

THE chief advantage of the Table Quad over a three-valver is that the strength of foreign stations is much better. The log given at the end of this report is the result of a two hours' test. Every station listed was heard at good loudspeaker strength—not a whisper—and definitely identified.

For Use Anywhere

The test was made in London, but experience indicates that the set is suitable for use almost anywhere in the country. Its selectivity and range are decidedly better than with most sets employing a similar circuit. I am sure the log would have been doubled had the set been on test for a week!

Selectivity is the point which matters most nowadays. With the Table Quad the variableappings on the first band-pass and tuned-grid coils enable the user to adjust the degree of selectivity to suit his local conditions.

In my case I found that at 20 miles from a regional station the two maximumappings on the coils gave adequate selectivity. Scottish Regional was heard entirely free of interference from London Regional, the strongest

station in my part of the globe.

A good selectivity test is the ability of a set to separate Poste Parisien from Breslau, two "super" stations just below London Regional. This was an easy task for the Table Quad. Likewise Langenberg and Prague were separated from North Regional, and Rome and Stockholm were clear also.

A splendid performance on the long waveband is one of the outstanding features of the Table Quad. Sensitivity was such that over a dozen signals were heard, many of them identified. The unidentified stations were probably a few of the Russian "giants," which swarm on this waveband.

Königswusterhausen

The separation of Königswusterhausen from Daventry is a feat which should not be expected with a set of this kind. However, the German station was almost clear, there being only a slight sideband twitter from Daventry.

You will notice from the dial readings that this set covers a wide wave range. Newcastle and Aberdeen listeners will have no trouble with their local stations.

A. Brock Lea.

LIST OF STATIONS RECEIVED

LONG WAVEBAND

Stations	Reading	Stations	Reading
Oslo	32	Daventry National	113
Kalundborg	53	Königswusterhausen	125
Motala	82	Radio Paris	137
Warsaw	94	Huizen	157
Eiffel Tower	102		

MEDIUM WAVEBAND

Trieste	25	Toulouse	91
Leipzig	30	Bucharest	94
London National	32	Midland Regional	97
Bari	37	Sottens	100
Heilsberg	41	Katowice	103
Scottish National	43	Stockholm	114
Hilversum	49	Rome	117
North National	53	Beromunster	127
Goteborg	61	Langenberg	133
Breslau	63	North Regional	137
Poste Parisien	65	Prague	142
Milan	68	Brussels	153
London Regional	78	Vienna	158
Scottish Regional	87	Budapest	174
Lvov	89		

the rest in proper numerical order

If each number is crossed through on the blueprint as the corresponding connection on the set is completed there will be no possibility of making a mistake.

Front of Cabinet

The assembly of the actual base-board layout of the Table Quad is very simple, but care must be taken in marking out the positions of the holes on the front of the cabinet for the control spindles.

As there are five controls, five spindle holes are needed in the front of the cabinet; an additional hole is also needed for the condenser escutcheon.

On page 491 is reproduced a diagram showing the positions and sizes of the holes required. The vertical measurements are taken from the top edge of the bottom of the cabinet. The best way of marking out the front of the case is to stand the cabinet on a perfectly flat table and add the distance x to the dimensions given.

A Variable Quantity

It will be appreciated that x (the distance from the table to the top edge of the raised bottom of the cabinet) may vary as from one model to the other, and the distance should be measured off by the constructor.

We must emphasise one point about the "gramo" side of this receiver. If a pick-up is connected to the two terminals provided, records can be reproduced electrically. No arrangement is made, however, to switch out the variable-mu and detector valves, which are not needed for record reproduction, of course.

This means that the volume control must be turned to its minimum position to prevent the possibility of radio transmissions from breaking through the causing interference.

Reduced Consumption

Putting the volume control to minimum also means that the anode current of the variable-mu valve is reduced to a negligible quantity and the only drain on the source of high tension is the 1 or 2 milliamperes taken by the detector.

Those who want to save as much current as possible when the Table

SCORES OF STATIONS ON ONE KNOB

Quad is being used for gramophone-record reproduction can fit an additional switch to cut the variable-mu and detector valves right out of circuit.

This switch can be inserted in the lead No. 13. Just break this lead and connect the two ends so formed to a standard type of on-off switch, which can be mounted in any convenient position.

Such a switch was not incorporated in the original design because the set is not presented as a complete radio gramophone and those who only want to reproduce records occasionally will not mind the drain on their high-tension batteries for, of course, no more current is consumed when the set is used for record reproduction than when it is used for radio reception.

Operating the Set

The actual operation of the set will not prove difficult, the only part that needs any kind of skill at all being the preliminary ganging. The trimmers on the particular gang condenser used in the original set are very accessible and can easily be adjusted by means of a screwdriver.

The best thing is to place the tapping pins on the first band-pass and aerial coils in the sockets

COMPONENTS NEEDED FOR THE "ABLE QUAD"

CHOKE, LOW-FREQUENCY
 1—Varley Nichoke II, type DP23, 10s. 6d. (or Bulgin, Tunewell).

CHOKES, HIGH-FREQUENCY
 1—Telsen binocular, type W74, 5s. (or R.I.)
 1—Ready Radio Standard, 1s. 6d. (or Igranic).

COILS
 1—Set of Formo coils, comprising: 1 pair of band-pass, types 82c and 83c, and 1 anode coil, type 61c, £1 2s. 6d.

CONDENSERS, FIXED
 2—T.C.C. .0002-microfarad, type 34, 3s. (or Lissen, Telsen).
 1—T.C.C. .0002-microfarad, SP type, 2s. 4d. (or Lissen, Telsen).
 1—T.C.C. .000-microfarad, type 34, 2s. 6d. (or Dubilier).
 1—T.C.C. .01-microfarad, type 34, 3s. (or Dubilier).
 1—T.C.C. 1-microfarad, type 50, 2s. 10d. (or Lissen, Telsen).
 2—T.C.C. 2-microfarad, type 50, 7s. 8d. (or Lissen, Telsen).

CONDENSERS, VARIABLE
 1—Polar .0005-microfarad three-gang, Star type, £1 5s. 6d. (or J.B., Utility).
 1—Telsen .0003-microfarad, type W188, 2s. (or Ready Radio, Polar).

HOLDERS, VALVE
 4—W.B. four-pin, miniature type, 2s. 8d. (or Lotus, Benjamin).

PLUGS AND TERMINALS
 7—Belling-Lee wander plugs, marked: H.T.—2, H.T.—1, H.T.—, G.B.—, G.B.—1, G.B.—2, G.B.—3, 1s. 2d. (or Clix, Ealex).
 2—Belling-Lee spade terminals, marked: L.T.—, L.T.—, 4d. (or Clix, Ealex).
 4—Belling-Lee terminals, marked: Aerial, Earth, L.S. (2), 1s. (or Clix, Ealex).

RESISTANCES, FIXED
 1—Graham Farish 20,000-ohm Ohmite, 1s. 6d. (or Claude Lyons, Eerie).
 1—Graham Farish 40,000-ohm Ohmite, 1s. 6d. (or Claude Lyons, Eerie).

1—Graham Farish 50,000-ohm Ohmite, 1s. 6d. (or Claude Lyons, Eerie).
 1—Graham Farish .5-megohm Ohmite, 1s. 6d. (or Claude Lyons, Eerie).
 1—Telsen 2-megohm grid leak, 1s. (or Dubilier).

RESISTANCES, VARIABLE
 1—Varley 50,000-ohm potentiometer, type CP 159, 6s. (or Lewcos, Colvern).

SUNDRIES
 Tinned-copper wire for connecting (Lewcos).
 Lengths of oiled-cotton sleeving (Lewcos).
 Length of rubber-covered flex (Lewcos).
 2—Sovereign terminal blocks, 1s. (or Lissen, Belling-Lee).

SWITCH
 1—Bulgin three-point, type S39, 1s. (or W.B., Telsen).

TRANSFORMER, LOW-FREQUENCY
 1—Slektun, ratio 1 to 5, 8s. 6d. (or Ferranti AF3, Lissen Hypernik).

ACCESSORIES

BATTERIES
 1—Lissen 120-volt high-tension, type LN539, 11s. (or Siemens, Pertrix).
 1—Lissen 9-volt grid-bias, 1s. (or Siemens, Pertrix).
 1—Smith 2-volt accumulator, type 2-RGC-9, 12s. 6d. (or Siemens, Pertrix).

CABINET
 1—Camco Empire in walnut or mahogany, £1 15s.

EARTH
 1—Fill earth connector, 2s. 6d.

LOUD-SPEAKER
 1—Motor Minor permanent-magnet moving-coil, £1 19s. 6d.

VALVES
 1—Cossor 220VSG metallised, 16s. 6d. (or Mullard PM12V).
 1—Mazda HL210 metallised, 7s. (or Six Sixty 210HL, Cossor 210HL).
 1—Mazda L210, 7s. (or Six Sixty 210LF, Cossor 210LF).
 1—Mazda P220, 8s. 9d. (or Six Sixty 220P, Cossor 220P).

The prices mentioned are those for the parts used in the original set: the prices of alternatives as indicated in the brackets may be either higher or lower.

numbered 1 on the coil bases, these being the positions that give the

greatest sensitivity (and the least selectivity, incidentally). Then adjust the middle trimmer to about its mid-way setting and turn the main knob until a station is picked up at reasonable strength.

Increasing Selectivity

The back trimmer should next be carefully adjusted until the best results are obtained, the front trimmer being adjusted last. If it is found that the No. 1 tapping position on the two coils is not sufficiently selective the tapings should be made to points No. 2, 3 or 4, the last giving the best degree of selectivity.

Need for Reganging

Alteration of the tapping points will mean in some cases that the set will have to be reganged, but this is not always necessary for the difference introduced is so small, sometimes, as to be negligible.

It is only in places within a very few miles of a powerful broadcasting station that any higher tapping than No. 1 will have to be made on the coils. The degree of
(Continued on page 548)

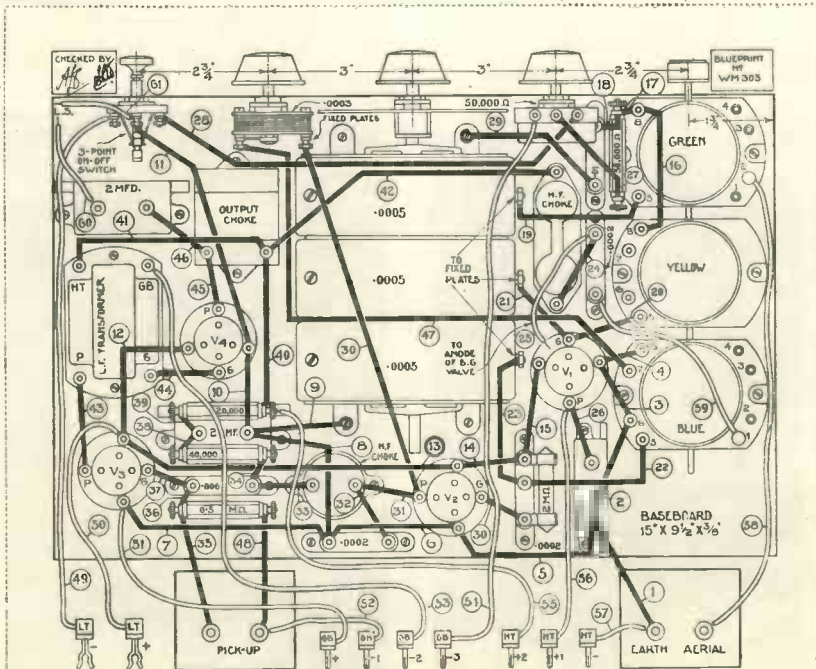

QUARTER-SCALE LAYOUT AND WIRING DIAGRAM

If desired a full-size blueprint can be obtained for half price, that is 6d., post free, if the coupon on the last page is used by November 30. Ask for No. WM 303.

Broadcast Music of the Month

REVIEWED BY T. F. HENN

IT occurred to me the other day to compare the programmes of 1932 with past years. On doing so I was astonished at the similarity between them. Every week at the appointed time we have been given, for example, a cinema-organ recital by an organist whose name has been widely known solely through the medium of radio publicity.

It seems that unless some revolution or earthquake occurs we shall continue to hear this organist's performances week by week *ad*

We are assured of an interesting broadcast in the future. Whitaker-Wilson is to give a Bach recital when the organ in the Concert Hall studio at Broadcasting House is completed.

I am going to take the opportunity of clearing up a point which must be mystifying listeners. "The concert to-night is given by the B.B.C. Orchestra, Section C, conducted, etc.," is what is heard almost every night. How much simpler it would be if instead of "Section C," the announcer said that the B.B.C. orchestra performing consisted of thirty-six players.

The full B.B.C. orchestra of 115 players, which is known as Section A, can be divided into smaller orchestras, each complete in itself and capable of providing the type of music comparable with its size. Sections B and C consist of seventy-nine

and thirty-six players respectively, and sections D and E of sixty-eight and forty-seven players.

Studio symphony concerts are given by sections B and D, while the lighter types of orchestral programmes are played by sections C and E.

The Theatre Orchestra

The Theatre Orchestra is an entirely separate organisation. You may have noticed that Leslie Woodgate, who has been the conductor since its inception, has recently handed over to Stanford Robinson, late chorus master of the National Chorus.

Leslie Woodgate has been transferred to the administrative side of the music department. His services in this department will, I believe, be of great value.

Dr. Adrian Boult has relieved Stanford Robinson of the control of



A famous German soprano, Elisabeth Schumann is renowned for her rendering of German folk songs. She will broadcast from London on November 16

infinitum. If you care to spend a week going round the different cinemas, you will be amazed at the various styles of the organists.

There is better talent available, not only in cinema-organ music, but for other fixed feature programmes as well. Originality in programme compilation is the only weak point in our broadcasting system.



Dennis Noble will sing the solo part in William Walton's "Balthazar's Feast" when it is broadcast in a symphony concert on November 2



One of the leading British composers of the day is Sir Granville Bantock. One of his compositions will be performed at the Queen's Hall shortly

the National Chorus which, by the way, is now called the B.B.C. Chorus. Sheer personality and hard work on the part of Dr. Boult have raised the standard of the big orchestra almost to perfection, and it will be interesting to watch the progress of his work with the B.B.C. Chorus.

Stanford Robinson will continue to act as conductor of the Wireless Singers.

Rumours have been current that several other changes are likely, but I have been told on good authority that there will be no other changes affecting musical leaders.

We shall hear some remarkably fine concerts on Wednesday evenings during November. Elisabeth Schumann, the famous soprano; Pablo Casals, the world's greatest 'cellist; and Albert Sammons and Arthur Catterall, both violinists, are the outstanding soloists.

A Great Event

Casals's interpretation of Haydn's *Concerto in D, for Violincello and Orchestra* will be one of the great events in the coming season.

The B.B.C. Chorus will be making its first appearance this season at the concert on November 2, when William Walton's *Belshazzar's Feast*, for mixed chorus, baritone, solo and orchestra, will be performed. Harold Samuel, the famous pianist, will be playing the solo part in the

Concerto No. 1 in D minor by Bach at this concert.

If you want to hear something particularly interesting, you should make a point of listening to Stravinsky's *Le Sacre du Printemps* (The Rite of Spring) which Ernest Ansermet, the famous Swiss musician, is conducting on November 16. Anser-

The Kutcher String Quartet—Samuel Kutcher, Raymond Jeremy, Frederick Grinke and Douglas Cameron—is one of the finest string quartets broadcasting. Samuel Kutcher, the leader, was one of the earliest classical musicians to broadcast



met has done a vast amount of work in popularising Stravinsky's compositions and is recognised as the finest conductor of them.

This concert will open with Weber's famous overture to *Der Freischutz* (The Marksman) and Elisabeth Schumann will be singing three songs by Mahler.

Do not forget to listen to Pablo Casals on November 23. Dvorak's beautiful *Symphony No. 5, in E minor*, better known as the New World Symphony, will also be included in the programme.

These Wednesday evening concerts are outstanding events in the London musical season. They are

relayed from the Queen's Hall and begin promptly at 8.15 p.m.

The season of Sunday evening orchestral concerts opens on October 23, the first concert being conducted by Dr. Boult. The orchestra will be Section B. The rumour has been current that these concerts are to be performed in the new Concert Hall Studio at Broadcasting House, but No. 10, the wharf studio down by the river, has been chosen after all.

Concert Hall Studio

Mind you, the Concert Hall Studio is being put to good use and nearly all the general orchestral concerts are being performed there. The full orchestra of 115 members has rehearsed in the Concert Hall, but the resultant noise is hardly pleasing enough to warrant sending out invitations for an audience.

An orchestra such as section B or D is best suited for the Concert Hall. Members of the general public are being admitted to this studio for a series of chamber-music concerts this winter. The first was on October 15, and the admission prices range from 7s. 6d. to 2s.

You should certainly take the



Dr. Adrian Boult, musical director of the B.B.C., is conducting eleven of the Wednesday-evening series of symphony concerts this season



An early broadcaster and opera singer, Muriel Brunskill has been heard in recent radio programmes. She is well known for her operatic roles

BROADCAST MUSIC—Continued



Albert Sammons, the celebrated English violinist, will be heard in the first of the Elgar Celebration concerts on November 30

opportunity of visiting Broadcasting House and seeing the fine Concert Hall. Plans for admitting listeners to ordinary orchestral concerts have not yet been passed. I am wondering if the idea of having an audience for chamber-music programmes only is to prevent a massed attack by listeners on the pay boxes at Broadcasting House.

Guy Fawkes night will be celebrated by a show of fireworks in one of the studios at Broadcasting House. This is official! Ashley Sterne, the humorous writer, has written a burlesque entitled "Fireworks" which should on no

same evening.

The sequence of wonderful weekends we have all enjoyed this summer will be continued until November 3, when Mark Lubbock is producing the first show since he has been on the permanent staff of the B.B.C. Harry Pepper has also been put on the permanent staff. Both of these men have done

account be missed. Jack Payne and the boys will prepare the atmosphere by a broadcast of dance music on the

a great deal for broadcasting in their time.

A Wonderful Weekend, a joint effort on the part of both Harry Pepper and Mark Lubbock, will be broadcast on November 3. The show is billed as a comedy with music.

Mark Lubbock is still remembered for his two plays, *The King Can Do No Wrong* and *Fame in a Night*, both of which attracted considerable attention some months ago. Harry Pepper is well known for his pianistic art and the recent revival of the White Coon's Concert Party.



A clever pianist who has been often heard in the programmes, Harriet Cohen. She will be playing in forthcoming broadcast concerts

The B.B.C. Celebrates its tenth birthday on November 13 and plans are well advanced for suitable festivities. In addition to a tour of the twenty-two studios at Broadcasting House, listeners are to hear a broadcast version of Dumas' great play *The Three Musketeers*. Owing to its great length, the play will be spread over two nights.



Ernest Ansermet, the famous Swiss conductor, is noted for his work with the Russian Ballet and for popularising the compositions of Stravinsky



A great pianist known for his interpretation of Bach's works, Harold Samuel has composed several operettas and a comic opera



A splendid baritone singer, Arthur Cramer frequently broadcasts in the programmes. He received a great ovation during the last Schumann night at the "Proms"

THE PROSPERITY THREE

Further Notes
for the
Constructor

By the
"Wireless Magazine
Technical Staff



THREE VERSIONS—for Batteries, A.C. and D.C. Mains
THREE WAVE RANGES—Short, Medium and Long

THIS is the third time we have had something to say about the Prosperity Three series of receivers, which were first described in the September issue of "Wireless Magazine."

We make no excuse for so consistently bringing these sets—there is one for batteries, another for A.C. mains, and a third for D.C. mains—to the attention of our readers. As three-valvers, the Prosperity series of sets represent the latest and best in modern radio technique.

Variable-mu Valves

Each set has a variable-mu valve for high-frequency amplification, a leaky-grid detector and a transformer-coupled pentode. The particular types of moving-coil loudspeaker recommended were only specified after careful consideration; if the sets are built according to the "Wireless Magazine" instructions, and with the specified parts we know that they will give excellent results

from every point of view—especially is the quality good.

An outstanding feature of the series is the fact that not only have the sets one-knob tuning, but they are also arranged so that reception can be obtained on the short waves as well as on the medium and long waves by the operation of a single wave-change switch.

It will be realised from this brief description of the Prosperity sets that they are outstanding in design from every point of view. Wherever they are used they are certain to give good results. Hints for successful short-wave reception were given in last

month's issue and we are looking forward to a large number of reports from readers in the course of the next few weeks.

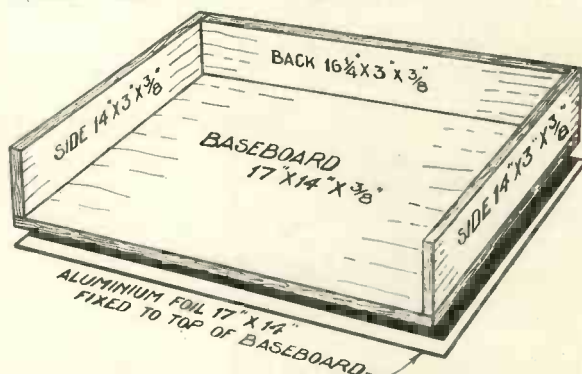

DIMENSIONS OF THE BASEBOARD-CHASSIS
Details necessary for the construction of the baseboard-chassis needed for all three versions of the Prosperity Three

Here we are going into a number of details about points that have been raised by prospective constructors, many of them being of general interest.

Many people have asked whether ordinary screen-grid valves can be used in place of the variable-mu types specified. The answer is "No." The variable-mu type of valve needs special grid-bias arrangements and these have been incorporated in the Prosperity series of sets.

To use an ordinary type of screen-grid valve would necessitate considerable alteration to the layouts and could only be accom-

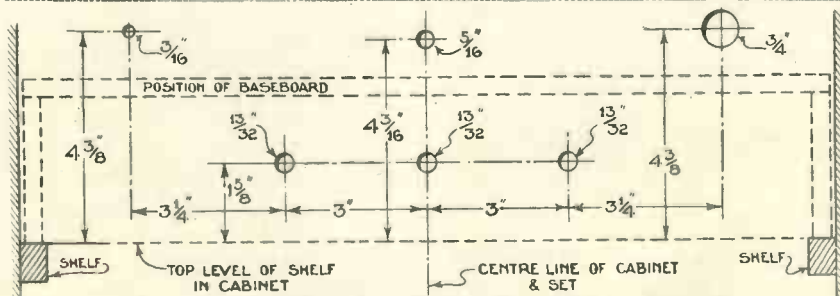

POSITIONS OF CONTROL SPINDLES ON FRONT OF CABINET
This diagram shows the positions and sizes of the holes to be drilled in the front of the cabinet for any version of the Prosperity Three

THE PROSPERITY THREE—Continued

PARTS COMMON TO ALL THREE VERSIONS

CHOKES, HIGH-FREQUENCY

- 1—Wearite standard, type HFO, 6s. 6d.
- 1—Wearite screened, type HFP, 3s. 6d.

CHOKE, LOW-FREQUENCY

- 1—Igranite, type C40, 12s. 6d.

COILS

- 1—Magnum three-coil assembly, type WMS, £1 10s.

CONDENSERS, FIXED

- 2—Dubilier .0002-microfarad, type 670, 2s. (or Telsen, T.C.C.).
- 1—Dubilier .000-microfarad, type 670, 1s. 6d. (or Telsen, T.C.C.).
- 1—Dubilier 1-microfarad, type 9200, 2s. 9d. (or Telsen, T.C.C.).
- 3—Dubilier 2-microfarad, type 9200, 11s. 3d. (or Telsen, T.C.C.).

CONDENSERS, VARIABLE

- 1—Utility .0005-microfarad two-gang, type W314/2, 17s.
- 1—Utility .0003-microfarad reaction, type W320, 4s.

- 1—Utility .0002-microfarad short-wave, type W187, 6s. 6d.

- 1—Peto-Scott neutralising, 3s. 6d.

- 1—Sovereign preset, .0003-microfarad max., type J, 1s. 3d. (or Porro, Igranite).

- 1—Utility non-insulated coupler, 1s.

- 1—Bulgin 4-in. condenser extension spindle, type BH2, 1s. 9d.

DIAL, SLOW-MOTION

- 1—Utility SL full-aperture, type W/317, 7s. 6d.

HOLDER, VALVE

- 1—W.B. five-pin, miniature type, 8d. (Benjamin, Lotus).

RESISTANCE, FIXED

- 1—Claude Lyons 20,000-ohm, 1-watt type, 10½d.

RESISTANCES, VARIABLE

- 1—Lissen 400-ohm baseboard potentiometer, type LN140, 1s. 6d. (or Igranite).
- 1—Wearite 100,000-ohm potentiometer (type QVC) combined with switch (type G40), 7s. 6d.

SUNDRIES

- Tinned copper wire for connecting (Lewcos).
- Lengths of oiled-cotton sleeving (Lewcos).
- Lengths of rubber-covered flex (Lewcos).
- 1—Packet of Goltone shielded wire, 9d.
- 1—Peto-Scott baseboard-chassis assembly, with foil, 3s. 6d.
- 5—Wearite aluminium brackets, 1s. 3d.
- 3—Lissen terminal blocks, marked: A and E, L.S., P.U., 3s. (or Belling-Lee).
- 1—Pair Ericsson headphones, 12s. 6d.
- 1—Belling-Lee insulated anode connector, 4d.

TRANSFORMER, LOW-FREQUENCY

- 1—Lissen Hypernik, 12s. 6d.

ACCESSORIES

CABINET

- 1—Camco Gresham radiogram, £0.

PICK-UP

- 1—Marconiphone, type K17, £2 2s.

EXTRA PARTS NEEDED FOR THE BATTERY VERSION

HOLDERS, VALVE

- 2—W.B. four-pin, miniature type, 1s. 4d. (or Benjamin, Lotus).

PLUGS AND TERMINALS

- 8—Belling-Lee wander plugs, marked: H.T.+2, H.T.+1, H.T.—, G.B.+ (2), G.B.—1, G.B.—2, G.B.—3, 1s. 4d. (or Clix, Ealex).
- 2—Belling-Lee spade terminals, marked: L.T.—, L.T.—, 4d. (or Clix, Ealex).

RESISTANCES, FIXED

- 1—Claude Lyons 5,000-ohm, 1-watt type, 10½d.
- 1—Lissen 3-megohm grid leak with wire ends, 6d. (or Dubilier).

RESISTANCE, VARIABLE

- 1—Wearite 50,000-ohm potentiometer (type QVC) combined with switch (type G40), 6s. 6d.

SUNDRIES

- 2—Pairs Bulgin grid-battery clips, type No. 5, 4d.
- 1—2.5-volt flashlamp bulb for dial.

SWITCH

- 1—Becker on-off, type 460, 1s. 10d.

ACCESSORIES

BATTERIES

- 1—*Pertrix 150-volt super-power high-tension, type 301, £1 11s. (or Ever Ready).
- 1—Pertrix 15-volt grid-bias, type 262, 2s. 3d. (or Ever Ready).

- 1—Pertrix 9-volt grid-bias, type 260, 1s. 3d. (or Ever Ready.)

- 1—Pertrix 2-volt accumulator, type PLB2, 12s. 6d. (or Ever Ready.)

- (* Or Atlas AC188 unit for A.C. mains, £6.)

GRAMOPHONE MOTOR

- 1—Garrard No. 30 clockwork with 12-in. turntable, £1 10s.

LOUD-SPEAKER

- 1—Rothermel Sonochorde type PMP £1 12s. 6d.

VALVES

- 1—Cossor 220VSG, 16s. 6d.
- 1—Cossor HL2 metallised, 7s.
- 1—Cossor 220PT, 17s. 6d.

EXTRA PARTS NEEDED FOR A.C. VERSION

CONDENSERS, FIXED

- 1—Dubilier .0001-microfarad, type 670, 1s. (or Telsen, T.C.C.).
- 1—Dubilier 1-microfarad, type 9200, 2s. 9d. (or Telsen, T.C.C.).
- 1—Peak 2-microfarad, 1,500-volt test, 3s. 9d.
- 3—Peak 4-microfarad, 1,500-volt test, £1 0s. 3d.
- 1—Dubilier 8-microfarad dry electrolytic, 450-volt D.C. working, 5s. 6d. (or T.C.C.).

HOLDERS, VALVE

- 2—W.B. five-pin, miniature type, 1s. 4d. (or Benjamin, Lotus).

METAL RECTIFIER

- 1—Westinghouse type HT8, 18s. 6d.

RESISTANCES, FIXED

- 1—Claude Lyons 200-ohm, 1-watt type, 10½d.
- 1—Claude Lyons 400-ohm, 1-watt type, 10½d.
- 1—Claude Lyons 8,000-ohm, 1-watt type, 10½d.
- 1—Claude Lyons 20,000-ohm, 1-watt type, 10½d.
- 1—Claude Lyons 50,000-ohm, 1-watt type, 10½d.
- 1—Lissen 1-megohm grid leak with wire ends, 6d. (or Dubilier).

RESISTANCE, VARIABLE

- 1—Wearite 15,000-ohm potentiometer (type QVC), 4s. 6d.

SWITCH

- 1—Becker double-pole type 462, 2s. 3d.

SUNDRIES

- 1—4.5-volt flashlamp bulb.

TRANSFORMER, MAINS

- 1—Sound Sales, type H8 shielded super, £1 5s.

ACCESSORIES

GRAMOPHONE MOTOR

- 1—Garrard No. 201 induction with automatic stop, £4 17s. 6d.

LOUD-SPEAKER

- 1—Rothermel Sonochorde, D.C. type with 2,500-ohm winding, £1 5s.

VALVES

- 1—Mullard MM4V metallised, 19s.
- 1—Mullard 904V metallised, 13s. 6d.
- 1—Mullard Pen4V, £1.

EXTRA PARTS NEEDED FOR THE D.C. VERSION

CHOKE, LOW-FREQUENCY

- 1—Atlas type CPT (for smoothing), £1 1s.

CONDENSERS, FIXED

- 1—Dubilier .0001-microfarad, type 670, 1s. (or Telsen, T.C.C.).
- 1—Dubilier 1-microfarad, type 9200, 2s. 9d. (or Telsen, T.C.C.).
- 1—Dubilier 2-microfarad, type 9200, 3s. 9d. (or Telsen, T.C.C.).
- 2—Dubilier 8-microfarad dry electrolytic, 450-volt D.C. working, 11s. (or T.C.C.).

FUSE

- 1—Belling-Lee double fuse and holder, 2s. 6d.

HOLDERS, VALVE

- 2—W.B. five-pin, miniature type, 1s. 4d. (or Benjamin, Lotus).

RESISTANCES, FIXED

- 1—Bulgin universal D.C. mains resistance, type B, 18s. 6d.
- 1—Claude Lyons 300-ohm, 1-watt type, 10½d.
- 1—Claude Lyons 5,000-ohm, 1-watt type, 10½d.
- 1—Claude Lyons 20,000-ohm, 1-watt type, 10½d.
- 1—Claude Lyons 40,000-ohm, 1-watt type, 10½d.
- 1—Lissen 1-megohm grid leak with wire ends, 6d. (or Dubilier).

RESISTANCE, VARIABLE

- 1—Wearite 15,000-ohm potentiometer (type QVC), 4s. 6d.

SUNDRIES

- 1—4.5-volt flashlamp bulb.
- 1—4.5-volt flashlamp battery.
- 1—On-off switch for pilot lamp.

SWITCH

- 1—Becker double-pole type, 462, 2s. 3d.

ACCESSORIES

GRAMOPHONE MOTOR

- 1—Garrard standard universal with automatic switch, £5 15s.

LOUD-SPEAKER

- 1—Rothermel Sonochorde D.C. model with 2,500-ohm winding, £1 5s.

VALVES

- 1—Osram VDS, 19s.
- 1—Osram DH, 13s. 6d.
- 1—Osram DPT, £1

The prices mentioned are those for the parts used in the original set; the prices of alternatives as indicated in the brackets may be either higher or lower.

Constructors are reminded that, as is the case with all "W.M." sets, full-size blueprints are available. Address your application to "Wireless Magazine" Blueprint Dept., 58-61 Fetter Lane, London, E.C.4. Ask for No. WM296 if you intend to build the battery set; No. WM297 for the A.C. version; and No. WM298 for the D.C. version. In each case the price of a blueprint, which is sent post-free, is 1s.

FOR BATTERIES, A.C. AND D.C.

plished at the sacrifice of much efficiency. Since the sets were first described in these pages a number of alternative types of variable-mu valve have made their appearance on the market. Only one make of valve was specified for each set originally, but now a number of alternatives are available.

The point has been raised as to whether A.C. valves can be used in the D.C. version of the Prosperity Three as there are "mains" type. The trouble is that A.C. valves take 1 ampere each through their heaters, while the D.C. valves specified take only .25 ampere. The mains resistance is designed specially to limit the current taken from the mains to .25 ampere.

Question of Expense

It would, of course, be an expensive matter to use 1-ampere valves in a D.C. set for (assuming the mains to be of 200 volts) the consumption would be 200 watts. In the case of .25-ampere valves the consumption (for the filament circuit, that is) is only 50 watts. It follows, therefore, that the D.C. version of the Prosperity Three costs no more to run than the average electric-light bulb.

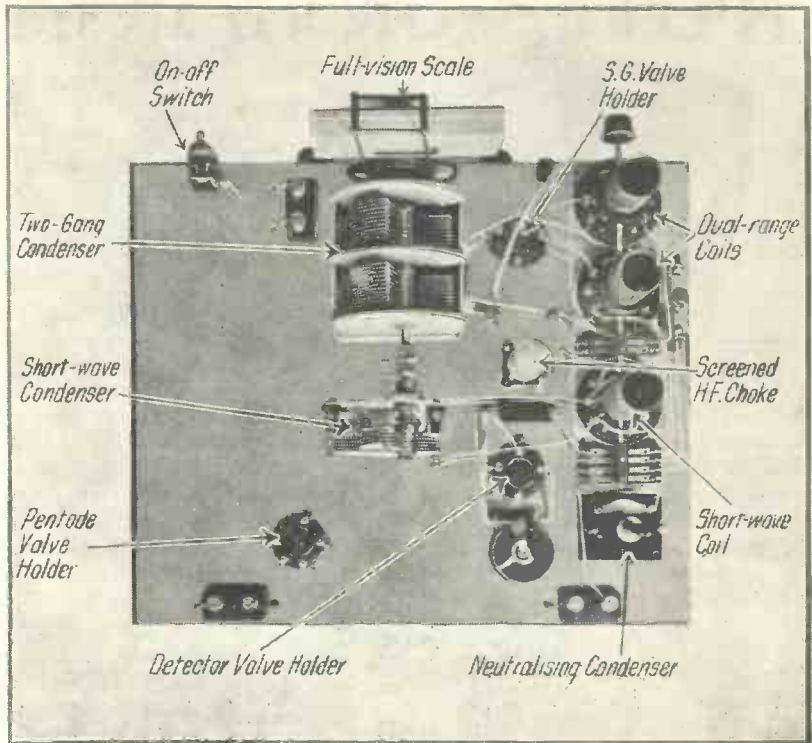

SIMPLE LAYOUT OF BATTERY SET

A top-of-baseboard view of the battery version of the Prosperity Three. Note the neat appearance of this layout, which is also electrically efficient

There are two other points to note about the D.C. version. In the first place no mains of a voltage lower than 200 will be suitable.

The second point is concerned with the pilot light for the tuning condenser. In the A.C. and battery versions the pilot lamp is wired in parallel with the valve filaments and is automatically switched on when the set is switched on. Things are not so simple with the D.C. set, however, and actually no pilot lamp was shown in the blueprint of this model.

In the D.C. set the valve filaments are run in series and the pilot lamp could only be put into the circuit if its current and voltage characteristics were the same as those of the valves. Unfortunately, no such lamp is available, and the only solution to the problem is to use a separate bulb, battery and switch for lighting up the condenser scale. Suitable parts for this purpose are listed under "Sundries" in the specification for the D.C. version.

In response to numerous requests we reproduce on page 497 a diagram that shows the positions of the holes that must be drilled in the front of the cabinet for any one of the Prosperity sets to allow the spindles to project through.

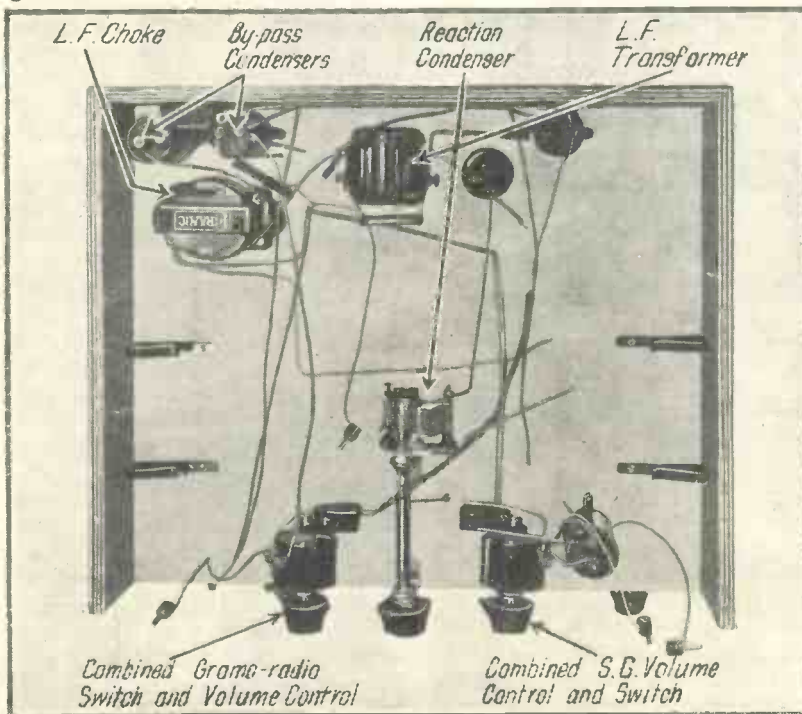

UNDERNEATH THE BASEBOARD-CHASSIS

Here you see the under side of the baseboard-chassis, the set being the battery version of the Prosperity Three. This form of construction is particularly efficient

NOTES ON GANG TUNING

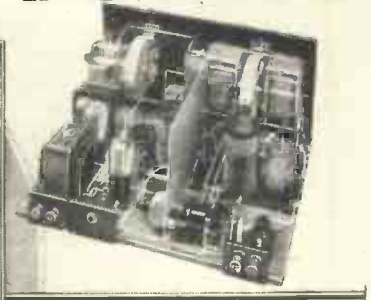
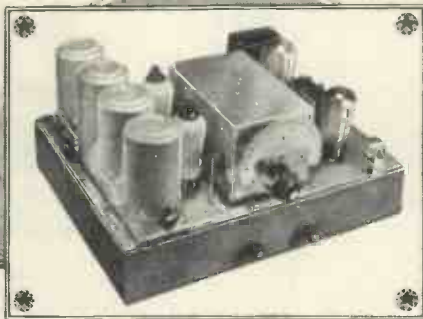

Special Article

by W. JAMES

RECEIVERS having adjustable tuning circuits may be arranged to have a separately controlled condenser for each circuit or the condensers may be mechanically coupled and operated through one knob.

A few years ago, separate tuning condensers were always used. Popu-

lar sets had two neutralised stages and therefore three tuned circuits. The coils were wound to the same specification and the tuning condensers were also made at least to look alike.

lar sets had two neutralised stages and therefore three tuned circuits. The coils were wound to the same specification and the tuning condensers were also made at least to look alike.

lar sets had two neutralised stages and therefore three tuned circuits. The coils were wound to the same specification and the tuning condensers were also made at least to look alike.

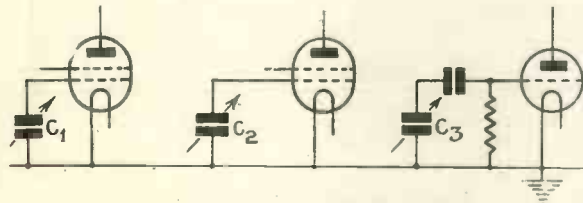

Fig. 1.—The three sections of a gang condenser connected to two screen-grid valves and a detector

The result was that the readings of the dials of the condensers varied a little as the set was tuned over the wavelength band.

Thus the condenser used to tune the coil having the aerial connected to it often read several degrees below the others at the low-wavelength end of the scale and read about the same as the others at the top end.

Circuits Not Alike

The condenser used to tune the coil joined to the detector would usually differ in its reading by various amounts from the others according to the wavelength. Obviously the circuits were not alike.

Perhaps one coil had a little greater inductance than another. The capacity of one condenser at, say, 50 degrees, might have been below that of the rest and, at 90 degrees a little

greater, and so on. Then again, there would be differences in the circuits.

Let us, therefore, look a little more closely into this problem of ganging the tuning of, say, three circuits, using screen-grid valves, of course, and the usual detector.

We have first to see that the circuit is one that can be ganged. True, it is possible to couple the sections of the gang condenser with insulating sleeves or bushes, but present-day condensers have the moving vanes of each section fitted to a metal shaft.

Often a metal chassis is used to carry the parts of the set, and so it is convenient to arrange that all moving vanes are earthed, joined to low-tension negative, to the cathodes of A.C. mains valves or to some other point of fixed potential not much removed from earth.

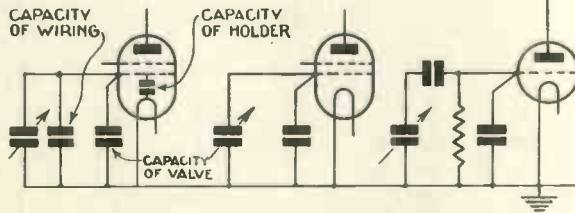

Fig. 2.—Additional capacities due to wiring, screen-grid valve and holder in a ganged circuit

We can therefore represent the three sections of the gang tuning condenser as in Fig. 1, with two screen-grid valves and the detector.

Obviously the three sections should be alike, that is, the sections should have equal values of capacity as far as possible when tested with the

dial in any position.

In practice, the sections are not identical. You might set the dial at 15 degrees and find C_1 to have a capacity 5 per cent. above C_2 and 2 per cent. below C_3 . At 30 degrees the capacities might be nearly enough alike, with perhaps a reasonable difference at the other testing points. The makers adjust the sections and arrange that the errors are less than a certain amount.

Positions of Plates

It does not follow, though, that the adjustments hold good for a period of a few years. In fact, there is always the chance that the plates may change their positions slightly.

Wear may take place in the bearings and so on. The result is that the gang condenser may not be accurate permanently.

However, let us assume just now that the sections are well matched. A glance at Fig. 1 will show that there are other factors to be considered before we consider the coils. First

are the valve holders, then the valves and the wiring. These elements have capacity and Fig. 2 shows the extra condensers. It is quite unlikely that all the extra condensers have equal capacities. True, the capacity of the connecting wires to each

condenser might be equal, but joined to C_1 is the first screen-grid valve. Joined to C_2 is the second screen-grid valve and the first.

The next condenser, C_3 , has connected to it the anode of the second screen-grid valve and the grid circuit of the detector. If we draw the

coils, as in Fig. 3, we shall see the anode-circuit capacities.

It is clear that the total stray capacity in each circuit is not likely to amount to the same value in each case. In practice, they seldom do, as the capacity added to C_3 is usually very different from that added to C_2 .

To make matters worse, the aerial must be connected. An aerial has capacity and, according to how it is

the purpose of making the circuit right, but if the circuit capacities added to the trimmer in each case are made alike, the condenser will show the same measured capacity (with the slight errors mentioned above due to the sections) for each circuit. The coils and switches have capacity and so have any other parts that may be used in the circuits connected to the condensers.

If the act of tuning does not alter the stray capacities, then balancing may be effected by adjusting the trimmers.

To show that tuning may affect the stray capacity, let us consider Fig. 4, which is a reaction circuit from the detector. It is clear that the capacity added to the detector-grid circuit will vary with the setting of the reaction coil is coupled to the grid coil.

Careful design will reduce the effect, but cannot remove it. The use of a volume control in another part of the circuit might also throw the tuning of the gang condenser out.

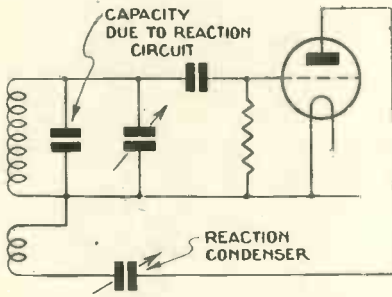

Fig. 4.—Reaction circuit with the stray capacity it introduces

coupled, will increase the stray capacity across C_1 .

If the aerial is joined to a tap on the aerial-grid coil, the capacity added to the circuit will be less than when the aerial is joined to the top of the coil. In order to minimise the effect, the aerial may be joined to a tap so that about one-third of the coil is between the aerial and earth.

Series Condenser

A fixed condenser of .0001-microfarad capacity may be used in the aerial wire to the coil still further to reduce the capacity thrown across the condenser C_1 .

These stray capacities naturally affect the accuracy of the tuning. To get over this difficulty, the sections are provided with small auxiliary condensers, called trimmers. They are set to make the fixed and stray capacities equal.

One trimmer may have to be set to have a larger capacity than the rest for

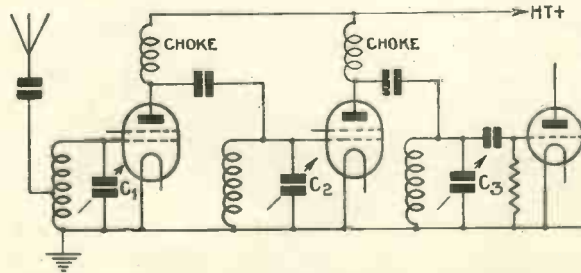

Fig. 7.—Circuit with plain tuned-grid coils in a screen-grid valve circuit

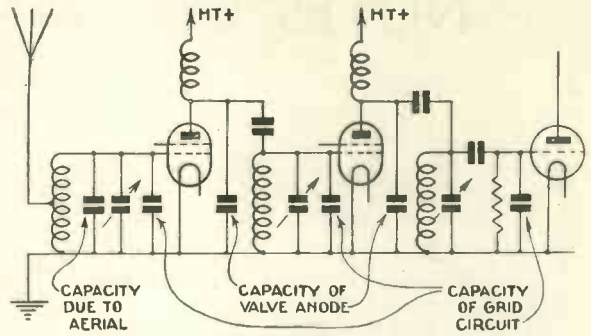

Fig. 3.—Other capacity effects are introduced by the aerial, anode, and grid circuits

the valve is across C_1 , the first section of the tuning condenser. But when the contact is moved,

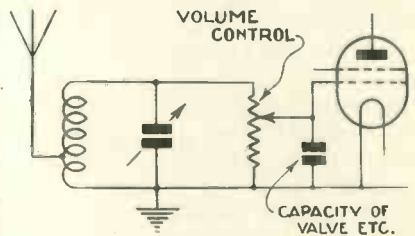

Fig. 6.—Complications may be introduced by a volume control

there is across C_1 a resistance in series with the capacity of the valve, and so the circuit is put out of balance.

In spite of these difficulties, however, the capacity side of the problem can be so arranged that the results are, from a commercial point of view, at least, quite good. Changing a valve is, of course, likely to upset the circuit and re-trimming is necessary. A change in the aerial ought not to affect the tuning. If it does, the aerial circuit is of poor design.

The coils used in the circuit will be adjusted to have equal values of inductance. Coils are shielded and switches are used. The shielding may upset the results if the metal covers of the coils do not fit properly and make good contact with earth.

Effect of Coil Can

A coil might have an inductance of 210 microhenries without shielding and the addition of the shield may reduce the inductance to 200 microhenries. Changing the position of the shield will alter the inductance and it is therefore important to see that coil covers are firmly fixed and then the coil is tested for accuracy.

When there is a long-wave section

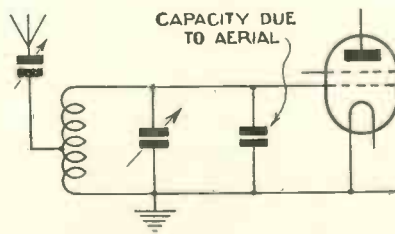

Fig. 5.—Effect of adjustable capacity in aerial circuit

It would not be advisable to use an adjustable condenser in the aerial circuit as in Fig. 5, for example, as the capacity thrown across the tuning section C_1 would vary with changes in the volume-control condenser.

There is another control which is also difficult (Fig. 6). A potentiometer is used here.

When the sliding contact is at the top, the full capacity of

NOTES ON GANG TUNING—Cont.

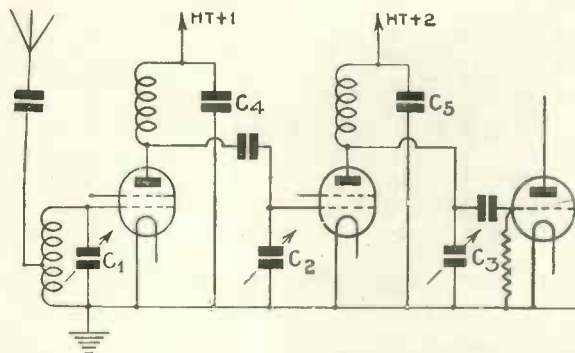

Fig. 8.—Popular anode-circuit arrangement for screen-grid valve sequence

close to the medium-wave section in the same shielding box, the switching may easily be the cause of trouble. If the long-wave part is short-circuited, for example, the inductance of the medium-wave coil may be different from when the coil is not short-circuited, but connected to switch contacts making a high resistance contact.

Use of Plain Coils

Plain coils are often used, joined as in Fig. 7. Here the anode current of the two screen-grid valves passes through high-frequency chokes and the tuning circuits are coupled through fixed condensers.

The chokes have inductance and capacity and these amounts must be allowed for, if necessary. But usually the self-capacity of a choke is so low that it is negligible and the inductance is so high that the effective

inductance of the tuning circuits is not materially lowered.

With poor chokes, however, the tuning may be upset and it is necessary to be careful how and where the chokes are fitted in position.

Metal near a choke may increase its capacity and the wiring to it can easily add to the capacity.

A different and fairly popular circuit is that of Fig. 8. The anode current for the screen-grid valves passes through the coils themselves.

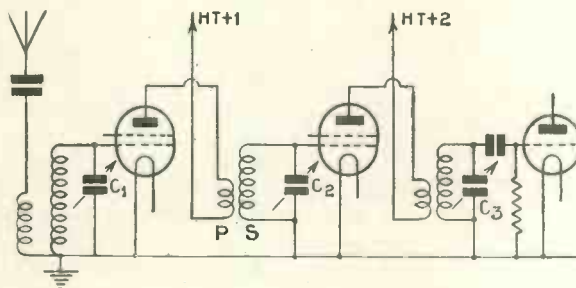

Fig. 9.—A safe circuit with tuned high-frequency transformers

It is interesting to note how the tuning circuit is completed. Fixed condensers C_4 and C_5 are used between the tops of the coils and the bottoms

of the tuning condensers. These are in the high-frequency circuits. Usual values are 1 microfarad non-inductive.

Need for Good Spacing

As the high-tension is across the sections C_2 and C_3 of the tuning condenser, it must have well-spaced vanes. As a safeguard a fixed condenser may be joined between the anode of the screen-grid valve and the section of the tuning condenser C_2 , another one being joined to C_3 .

These fixed condensers will tend to reduce the net capacity across the coils and must, therefore, be large; 1-microfarad condensers are usually fitted. With high-frequency transformers, the tuning will be easier, as the stray capacities are likely to be less.

Transformers are shown in Fig. 9. This circuit is a particularly safe one, no high tension being applied to the tuning condensers. The coils are a little more difficult to construct than the plain coils, but the results are usually better.

The primary coils can be adjusted to suit the valves and this circuit is one I recommend. There will be the least ganging difficulty.

High-selectivity Receivers

KEEN amateurs will be interested in the latest publication of the Department of Scientific and Industrial Research, of which the Radio Research Board is a branch.

Tone Correction

The book referred to is entitled "A Theoretical and Experimental Investigation of High-selectivity Tone-corrected Receiving Circuits." It gives in detail the Radio Research Board's opinion of the Stenode type of circuit.

This publication is a résumé of a report made by a special committee

of the Radio Research Board set up in April, 1931, to examine and report on the properties of very highly selective receivers. The scope of the report can best be indicated by the following quotation from the preface:

The Committee has confined its attention to receivers in which high selectivity is attained by the use of radio-frequency circuits of exceptionally low decrement, combined with audio-frequency tone correction, and to answering in this connection the two following questions:—

- (i) Is the performance of such receivers consistent with hitherto accepted theory?
- (ii) What are the advantages or dis-

advantages of such receivers in relation to the practical problem of discriminating between wanted and unwanted wireless transmissions?

Three Main Parts

This report is divided into three parts, dealing respectively with Generalised Theory of Selective Reception, Experimental Investigation of Retroactive Coil Circuits, and the Application of Quartz Crystals to Selective Reception.

The price is 1s. 3d., and copies are obtainable from H.M. Stationery Office, at Adastral House, Kingsway, London, W.C.2.

A Set without Ganging Troubles



More about the CALIBRATOR

Last month the "Wireless Magazine" Technical Staff gave full constructional and operating details for building the Calibrator, a new type of screen-grid four-valver with a revolutionary tuning system that definitely does away with the usual ganging troubles

IMMEDIATELY on publication of "Wireless Magazine" last month there was a rush to get the main component needed for the Calibrator, the four-valve screen-grid receiver that has no ganging troubles.

Basis of the Set

The basis of this fine set is a new type of tuning unit made by the British Radiophone people and called the Radiopak. It consists of one of the well-known British Radiophone three-gang condensers and a set of dual-range coils that are actually matched up with the condenser in the factory.

All the operator has to do in the way of trimming is to make very slight alterations to allow for the

capacities of different valves and the wiring of the receiver.

Because the coils and condenser are accurately matched up in production by the makers, it is possible to calibrate the dial directly in wavelengths. That is one of the most outstanding features of the Calibrator from the user's point of view; it is possible to tune the set directly to the wanted station provided its wavelength is known—and there will be no trouble about that if one of the "W.M." Station Finders is used.

The Calibrator was designed as a complete radio gramophone; its neat and handsome appearance when completed is evident from the photograph reproduced on this page. It will be seen that there are four

control knobs, one above the other in the centre and one at either side.

The top knob in the centre is the main tuning control, and, as already explained, it is just turned round until the pointer is opposite the desired wavelength marking. Below the main tuning control is the knob of the reaction condenser.



Two views of the Calibrator, the construction of which was fully described in the previous issue

The knob on the left is for controlling volume. Actually it adjusts the grid bias on the variable-mu valve used for high-frequency amplification. The control of volume when gramophone records are being reproduced is accomplished with a separate potentiometer supplied in

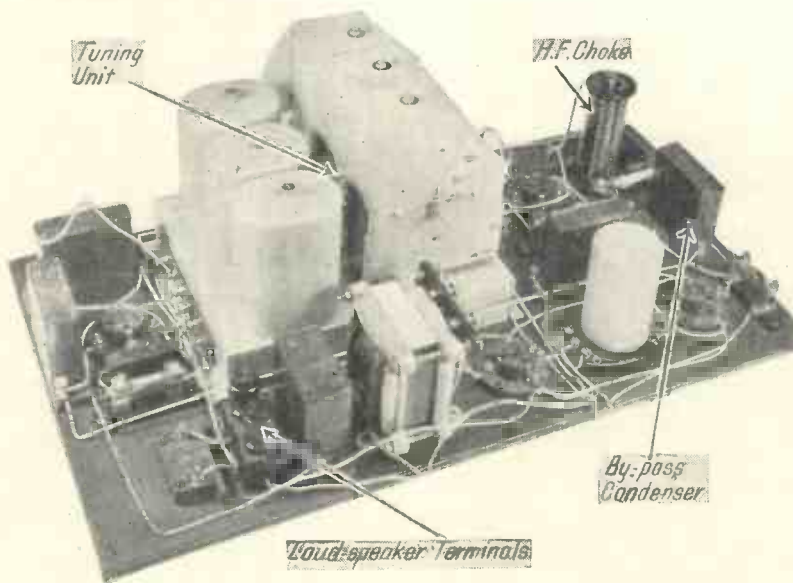

A SET WITHOUT GANGING TROUBLES—Cont.

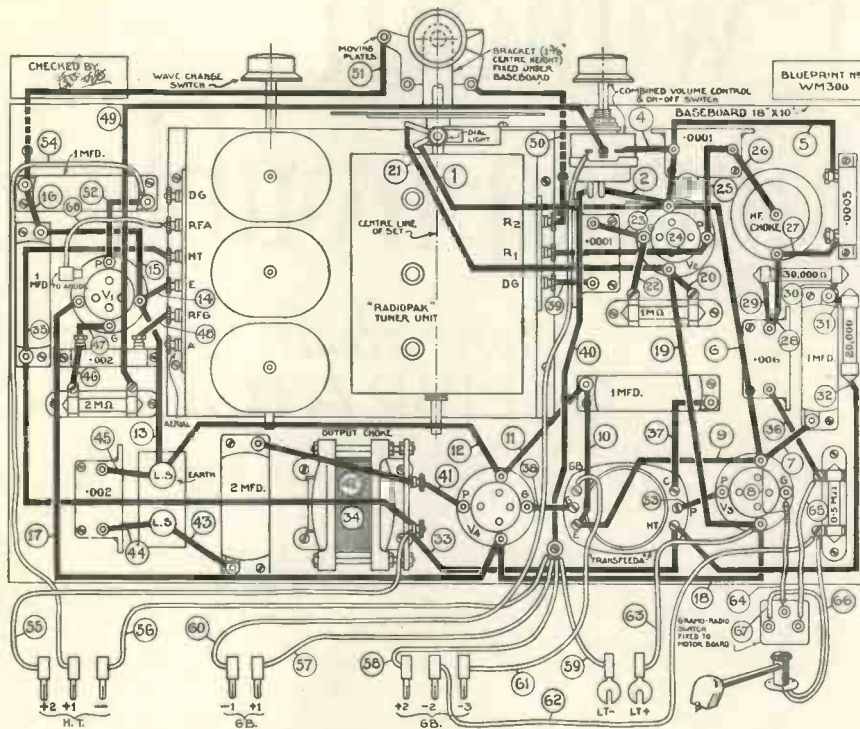

QUARTER-SCALE LAYOUT AND WIRING DIAGRAM

If desired a full-size blueprint can be obtained; the price is 1s. 6d., post free. Each wire is numbered separately in the best order of assembly

one unit with the pick-up specified. On the right of the set is the wave-change switch, which is, of course, manipulated in the ordinary way for medium and long-wave reception.

Although the Calibrator represents the latest advance in radio technique the cost of construction is quite moderate when the high quality of the parts is taken into account.

Good Value for Money

The cost of the parts for the bare set is a little less than £6 10s., while the four valves account for another £2 2s. 6d. It will thus be seen that the Calibrator is by no means expensive—and as a complete radio gramophone it is a fine instrument that will give the user untold pleasure.

Full constructional details were published in the October issue of "Wireless Magazine"; copies can be obtained for 1s. 3d. each, post free, on application to the Publisher. Of course, full-size blueprints are available; one of these will be sent post free for 1s. 6d. Address your application to "Wireless Magazine" Blueprint Dept., 58/61 Fetter Lane, London, E.C.4, and quote No.

WM300. A copy will be sent by return of post.

It was evident from the test report published last month (the tests were actually made some weeks before Summer Time came to an end, of course) that the Calibrator has great possibilities. During the winter months there is no doubt that it will prove itself to be an ideal set for long-distance reception.

Simple Operation

Remember that it does not need a skilled operator to get good results from this "Wireless Magazine" design. There is only one knob to tune and the dial is calibrated in wave-lengths.

Already we have many requests for an A.C. version of the Calibrator. The "Wireless Magazine" Technical Staff is at present engaged on that problem and we shall have an interesting announcement to make in an early issue.

COMPONENTS NEEDED FOR THE CALIBRATOR

CHOKE, HIGH-FREQUENCY

- 1—Slektun, standard type, 4s. (or Golton, Lewcos).

CHOKE, LOW-FREQUENCY

- 1—Tunewell, type S20/25, 12s. 6d. (or Bulgin, Ferranti).

CONDENSERS, FIXED

- 2—Telsen .0001-microfarad, type W240, 2s. (or T.C.C., Dubilier).
- 1—Telsen .0005-microfarad, type W244, 1s. (or T.C.C., Dubilier).
- 2—Telsen .002-microfarad, type W246, 2s. (or T.C.C., Dubilier).
- 1—Telsen .006-microfarad, type W247, 1s. 3d. (or T.C.C., Dubilier).
- 4—Telsen 1-microfarad, 500-volt test type, 9s. (or T.C.C., Dubilier).
- 1—Telsen 2-microfarad, 500-volt test type, 3s. (or T.C.C., Dubilier).

CONDENSER, VARIABLE

- 1—Polar Compax .0005-microfarad, 2s. 9d.
- 1—British Radiophone knob for above, 6d.

HOLDERS, GRID-LEAK

- 3—Bulgin, type G6, 1s. 6d. (or Telsen, Lissen).

HOLDERS, VALVE

- 4—Telsen four-pin, solid type, 3s. (or W.B., Lotus).

PLUGS AND TERMINALS

- 8—Belling-Lee wander plugs, marked: H.T.+2, H.T.+1, H.T.—, G.B.+ (two), G.B.—1, G.B.—2, G.B.—3, 1s. 4d.
- 2—Belling-Lee spade terminals, marked: L.T.+ , L.T.—, 4d. (or Clix, Belex).
- 2—Belling-Lee terminals, type B, marked: L.S., 1s.

RESISTANCES, FIXED

- 1—Dubilier 20,000-ohm metallised, 1-watt type, 1s. (or Claude Lyons).
- 1—Dubilier 30,000-ohm metallised, 1-watt type, 1s. (or Claude Lyons).
- 1—Lissen .5-megohm grid leak, 6d. (or Telsen, Dubilier).
- 1—Lissen 1-megohm grid leak, 6d. (or Telsen, Dubilier).
- 1—Lissen 2-megohm grid leak, 6d. (or Telsen, Dubilier).

SUNDRIES

- Tinned-copper wire for connecting (Lewcos).
- Length of insulated sleeving (Lewcos).
- Length of rubber-covered flex (Lewcos).
- 1—Belling-Lee terminal block, 8d.
- Length of Goltone shielded cable, 9d.
- 1—2.5-volt flashlamp bulb.
- 1—Bracket for mounting reaction condenser (Wearite).

SWITCH

- 1—Tunewell radio-gram, 1s. 9d.

TRANSFORMER, LOW-FREQUENCY

- 1—Benjamin Transtee, 11s. 6d.

TUNING UNIT

- 1—British Radiophone Radiopak, £3.

ACCESSORIES

BATTERIES

- 1—Ediswan 120-volt super-capacity high-tension type 69728, £1 5s. (or Pertrix, Siemens).
- 2—Ediswan 18-volt grid-bias, type 60805, 4s. (or Pertrix, Siemens).
- 1—C.A.V. 2-volt accumulator, type 2AG0, 12s. 6d. (or Lissen, Exide).

CABINET

- 1—Stenbac radio-gramophone, model 19, in mahogany, £4 15s.

GRAMOPHONE MOTOR

- 1—Cabaret double-spring clockwork, £1 15s.

LOUD-SPEAKER

- 1—Ormond permanent-magnet moving-coil, type R/475, £1 18s. 6d.

PICK-UP

- 1—Harlie, model 36, with volume control, £1 7s. 6d.

VALVES

- 1—Mullard PM12V, 16s. 6d. (or Cossor 220VSG, Marconi VS2).
- 1—Mullard PMLHL, 7s. (or Cossor 210HL, Marconi HL2).
- 1—Mullard PM2DX, 7s. (or Cossor 210LF, Marconi HL2).
- 1—Mullard PM202, 12s. (or Cossor 220P, Marconi P2).

The prices mentioned are those for the parts used in the original set; the prices of alternatives as indicated in the brackets may be either higher or lower

Thoughts of An Announcer



By George Macaulay

IN the studio a red light suddenly glowed, silent and sinister. The studio cat was deposited outside with a dignity only a wireless announcer could have achieved. Then, turning from little things to great, the announcer cleared his throat very softly and addressed the ear of the great British public.

As I watched him I began to wonder what the announcer thought about as he announced.

Like the youth in Excelsior :
His brow was sad, his eye beneath
Flashed like a falchion from its sheath.

Mesmerised !

In fact, he seemed to quell the microphone with a single glance. When I stood before it I had been literally unable to face that basilisk eye, and it had mesmerised me like the eye of a snake all the time I was talking.

The announcer, however, having dealt with the microphone, fixed calm, possibly unseeing eyes on the heavily curtained studio walls. His thoughts were far away.

Judging from his expression those thoughts were very high and very noble. I would have given the price of a wireless licence for them.

The announcer waited in dignified silence. My mind went back to the odd occasion on which I had broadcast before. I remembered that as I faced the microphone one thought had come into my mind and throbbed through my brain as I read my talk with glassy eye and dry tongue.

I had thought over and over again that never would I allow Mrs. Bottomley, the charlady (as she insists on being called) to use a "catch 'em alive-o" trap again. I knew what the mice felt like.

But obviously such a thought was beneath the announcer. Did he meditate, I wondered, on the dignity and nobility of his office, he on whose trim tones the ears of the million hung? Did he, from announcing the falls of kings, the suicides of millionaires, the increase in the income tax or the disappearance of Samuel Smelley from his home at 302 The Promenade, Wigan, come to regard himself as the deity who originated and distributed these various lots?

Or did he take a somewhat lower

view and regard himself as a modern Mercury of the gods, as the Hand that was continually writing on other people's walls? Or did he merely wonder what his wife would have for supper that night and whether she would burn it again?

An Old Tomato Tin

An announcer friend of mine once told me that it was a custom of his to take into the studio with him an old tomato tin (of all things) and place it behind the microphone when he announced. I have often wondered whether he did this to control his wandering thoughts.

Perhaps the contrast between the inanimate, mundane tin and the thousands of quivering ears into which his words trickled as honey or hissed as boiling oil, was a help to this too-imaginative announcer.

Or maybe my announcer friend found the old tin reminiscent of all that is slovenly, of *al fresco* meals and people who eat off their knives and drop their aitches, and thus made it a spur to still further heights of immaculate pronunciation.

The idea might be developed further. Why not a series of common objects in the studio to control the wandering thoughts of the announcer? There must be times when the continual pursuit of a dignified enunciation reacts badly on the nerves and then it would be a positive relief to announce to a wilting sardine tin the impending performance

A New Bill Sykes

*The burglar's plans had all gone right,
And by his torch's shaded light*

He stowed away his haul.

*The house was empty, as he knew,
No dog, nor even cat to mew :*

He tip-toed through the hall.

*But, as he softly passed one room,
All of a sudden through the gloom*

*A voice rang loud and clear—
"Hands up, or I will fire !" it said.*

*The burglar dropped his "swag" and fled,
Propelled by frenzied fear !*

*But, though the household was away,
He did not know a murder play*

*Was broadcast that same night,
And people very oft forget*

*For these had left their wireless set
Turned on—and hence his fear !*

LESLIE M. OYLER.

THOUGHTS OF AN ANNOUNCER—Cont.

of a Tschaikevsky symphony, or to inform an ex-Heinz baked beans can in silken tones that Colonel Noseblood will now give his talk on "Armies I Ambushed and Why."

And imagine how helpful it would be to gaze at an old salt cellar what time one announces that a depression over the Channel is filling up! And there may be times during the 'Children's Hour' when only the presence of a friendly old bottle could save the announcer from hopeless lunacy.

Low Humming Noise

I have, on occasions, distinctly heard an announcer think. You know that low humming noise that sometimes upsets the reception when the announcer in a hurry suddenly drops a stitch during the racing news? That noise, I am inclined to believe, is the noise of the announcer thinking.

The same noise was often noticeable when the news was full of Japanese politicians and Chinese bandits, and I believe I have also heard it on the rare occasions when I have listened in to the fat stock prices.

But it must be very pleasant to be an announcer and not have to think whether one's tie is straight, one's hair unbrushed or that little reminiscence of egg on the waistcoat really noticeable—that is until the days of television come upon us.

On the other hand an announcer may often be wondering, with great inward troublings of the spirit, whether the click of his false teeth is really audible or whether the fact that he has adenoids is evident to many of his listeners. And imagine the plight of an announcer whose boots squeaked!

By Rule of Thumb

The thoughts of an announcer as he announces may not be confined to himself or to the studio, however. His thoughts, wandering away from a task he does by rule of thumb, may allow the poor man to get really worked up over such points as the possibility of cousin Perce from Godmanchester coming to stay the week end, or the studio engineer's horrible habit of chewing gum.

The announcer's voice is often so impersonal that one feels that literally

any thought may be concealed in his mind. At such times he is probably engaged in spotting the notes and beams in the eyes of the wretched broadcasters who await his bidding.

There are times when the inflexion of his voice leads one inevitably to believe that he is thinking to himself as he announces that the Week's Good Cause has got odd socks on or that the barber has dealt very ill this morning with that mole on the back of Recipes for Housewives' neck.

I was recalled from my reverie by

the voice of the announcer informing the world that the station was now closing down until 5.30 p.m. The red lamp ceased to intimidate us. Hurriedly the announcer strode to the door, opened it and glanced anxiously up and down the corridor.

Climax!

"Kitty!" he called. Then he turned to me. "I've been thinking all the afternoon that she never had her saucer of Cow and Gate at the usual time," he explained.

Coil Dopes and Their Effects

IT is very often convenient when making a coil to give the completed winding a light coating of some form of dope. This serves to hold the wires in position, and not only makes the arrangement mechanically strong, but also ensures that the turns shall not move under normal conditions. Consequently the inductance of the coil is kept constant.

Solenoid Coils

Rather peculiar effects had been observed during some experiments, and tests were made to find out the exact effect of one or two forms of dope. A number of simple solenoid coils were wound upon 1½-in. formers with No. 32 d.s.c. wire. The first coil was wound on a plain Paxolin former; the high-frequency resistance was measured and found to be 7.15 ohms.

The same coil was then coated with a proprietary blend of cellulose dope of the type often used for stiffening linen-type loud-speaker diaphragms. This had the effect of sending the high-frequency resistance up to 21.7 ohms.

This enormous increase accounted for the unpleasant effects which had been observed during the former experiments. Another blend of cellulose dope was tried and found

The next issue of "Wireless Magazine"—that is the number dated December—will be on sale at every bookstall and newsagents throughout the country on Wednesday, November 23. Order now in order to make certain of getting a copy!

to have nothing like so serious an effect, raising the resistance only to just over 9 ohms, an increase of 26 per cent. While this is not so serious it is an appreciable extra loss.

After experiments with various forms of dope it was found that simple shellac gave the most satisfactory results. Shellac can be obtained readily dissolved in methylated spirits and a light application of this dope is quite sufficient to hold the coil rigid. A coil treated in this way was found to have a resistance of 7.55 ohms only, an increase of a little over 5 per cent, which is a very much more satisfactory state of affairs.

As a matter of interest, coils were also wound on ebonite tubes. A plain ebonite tube with an undoped winding gave a resistance of 5.95 ohms, while a coil on a ribbed former having an overall diameter of 1½ in. outside the ribs, had an even lower resistance—4.85 ohms.

Small-diameter Former

These figures are rather interesting and indicate that even with a small-diameter former quite an efficient coil can be constructed. They also show that the idea of a low-loss construction is still worth considering even with the small coils so popular to-day.

After all, a reduction of resistance from 7.15 to 4.85 ohms is very appreciable, amounting to over 30 per cent.

All the coils in the tests were matched to an inductance of 185 microhenries, the resistance being measured at a frequency of 750 kilocycles.

J. H. Reyner.

NEWS of the SHORT WAVES

THE rush of new short-wave stations to come on the air seems rather to have fallen off lately. This has, no doubt, been in some measure due to the business depression, and we have to take into account the fact that short-wave transmitters, or rather the running and upkeep of these transmitters, is actually a very different affair from that of a normal broadcast transmitter.

Experiment and Research

Short-wave stations are, as a rule, either erected by some company with a view to conducting experiments and research (and in this case the listener cannot reasonably expect a very regular service), or else they are run by some broadcast corporation for distant reception by listeners who will in all probability not pay anything at all towards the upkeep of the station.

In this case, the listener has to rely to some extent on governmental generosity (!) or some form of radio publicity. However, conditions will undoubtedly change with the course of time for short waves are gaining more recognition in official quarters day by day.

Short waves have, up to the present time, been responsible for some extraordinary results in the way of freaks and stunts. Take the transmitters themselves for a start. We have the Empire State transmitter in New York, on the top of the world's highest building.

Portable Gear

Then there are the portable positively one-man power transmitters which are transported in a small case on the back, whilst the wearer walks about and commentates on exciting events; transmitters used in submarines at the bottom of the ocean; and aeroplane transmitters, by means of which a person flying in an aero-

plane somewhere over the United States spoke to a person in London without much difficulty.

Then short-wave receivers are used in boats or launches for commentating on the boat races.

Many of these transmitters of the types just mentioned are only operated on short waves because of the fact that there is no room for them anywhere else in the radio spectrum and *not* in order to take advantage of the properties of short waves.

Small transmitters of these types would, no doubt, operate just as well on medium and longer waves as they are not required to cover much dis-

metres during the latter part of the autumn and winter of last year, has hardly appeared at all.

The signs are hopeful, therefore, that we shall continue to obtain good reception of the Transatlantic stations through the winter months of this year.

Vagaries of "Tiny Waves"

However, I am no prophet and knowing as we do how the "tiny waves," as some American journalists seem to prefer to call them, are apt to change their mind any minute, I shall refuse to be alarmed if all is dead below 25 metres by the time you are reading this.

A further hopeful sign is that, at the time of writing, things around 49 metres seem quite lively and W3XAL on this band has been romping in louder than W2XAD on some nights just recently.

Short-wave super-het converters are, without doubt, considerably more satisfactory than adaptors of the plain tuner type, provided a really powerful high-frequency stage is available for use as the intermediate-frequency amplifier.

Two Tuning Points

Convertors of this type have one or two characteristics of their own which do not appear in the tuner type—some of them in the form of disadvantages, but none being really objectionable. The most annoying feature is probably the fact that stations will generally come in at two different places on the dial. The actual space on the dial between the two settings depends, of course, on the intermediate frequency and the higher the frequency the wider apart the two settings will be. The effect begins to be rather more annoying as the received wavelength decreases.

In the case of the average type of
(Continued on page 512)

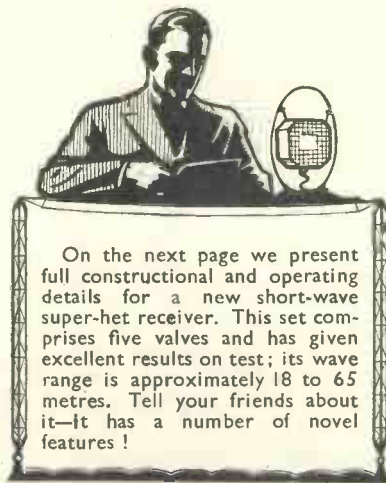

tance as a rule, but the fact is that there just isn't room for them to operate anywhere else.

We have had a good run of short-wave reception, particularly of the Transatlantic stations, during the last few months.

I think that on the whole reception conditions, as far as the short-wave broadcasters are concerned, have been rather better than during the corresponding period of last year and, up to the present time, the "blanket," which came on the ether below 25

Specially Designed
for "W.M." by
W.G. HILL



THE "W.M." SHORT-WAVE SUPER

Constructional details of a new and simply-built receiver for short-wave working. Five valves are employed, but ease of control is an outstanding feature

HERE are details of a super-het embodying a novel method of employing a screen-grid valve as detector-oscillator (as in the autodyne method of reception), the control grid and the anode being

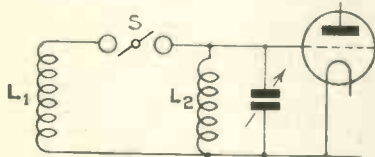

Fig. 1.—Arrangement of coil switching

employed as a means of producing the local source of oscillation, and the screen being used solely for the purpose of transferring the beat-difference energy.

It has been the effort of the writer to produce a short-wave receiver that gives good results and that does not require the manipulative skill of the short-wave expert to produce results.

A Difficult Task

It has always been a difficult task for the novice or even the person with a good knowledge of ultra high-frequency circuits to operate a receiver covering the waveband from, say, 20 to 60 metres, even with sets designed specifically for this waveband, owing to the multiplicity of controls or due to the critical adjustment of those controls.

In the receiver described here every effort has been made to reduce the controls and, above all, to make those controls definite.

In a short-wave receiver good

results depend entirely upon the use of good components; for instance, the coils must be good from the point of view of rigidity, reasonably low loss, and, above all, have been really designed.

The condensers must be good. There must be no sign of series resistance of a varying nature present, such as there will be if the collector system has no permanence of contact, or the loosening of vane washers due to ageing. These failings are very evident in condensers that have indefinite bearings or badly machined parts, and the reader is well advised to use the condensers specified.

In the case of the coil, if insufficient attention is paid to the design for its particular purpose, there is little doubt that absorption and/or erratic reaction effects present themselves, both of which make the reception of short-wave signals a tedious task.

With regard to the varying series resistance of the condenser, the affect of this is evident from the noises heard in the loud-speaker with the rotation of the condenser. Nothing is more annoying than to have sounds resembling a machine-gun party practicing on a biscuit tin emitted from the loud-speaker at a volume much greater than the signal behind it.

It is better to have a condenser of a reasonably high resistance so long as that resistance is permanent. To neglect to follow this advice means at the ultra high frequencies intermittent disappearances of the signal and an introduction to the noises mentioned above.

The coil specified for this receiver has had special attention paid to the design from the point of view of obtaining a more or less even amplitude of oscillation over the range of wavelengths employed, first by employing the parallel method of inductance change, that is, instead of the switch short-circuiting a section of the winding as is usually done, the switch parallels the two windings and the resultant inductance is the product of $\frac{L_1 L_2}{L_1 + L_2}$, which is a value less than the smaller.

Increased Efficiency

This method of reducing inductance is very suitable for the ultra high-frequency range and reduces the possibility of "dead-end" and absorption effects.

Special attention has been paid to the method of applying the reaction

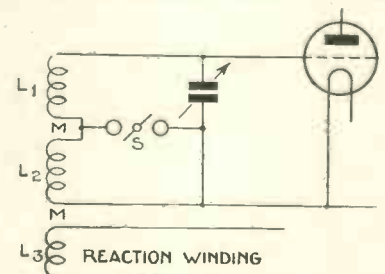

Fig. 2.—Usual reaction arrangement

winding, so that the value of coupling between the tuning coil and reaction coil is large in comparison to its self-inductance.

As mentioned above, the coils are arranged so that by a switch they

can be paralleled: Fig. 1 indicates how this is brought about.

The inductance L_2 is in circuit permanently for the lower-frequency range and paralleled with L_1 , which is the smaller inductance, for the higher-frequency range.

Usual Reaction Method

The usual method of locating the reaction coil is to wind a separate coil remote from the two windings L_1 , L_2 which in many cases are two coils in series having a switch to cut out or short-circuit the lower-frequency coil as in Fig. 2.

It will be seen that the value of coupling will depend upon the values of $(L_1 L_2 + 2M)$ and L_3 , and the coaxial position of them. With such a coil the value of L_3 has to be large enough to bring about reaction

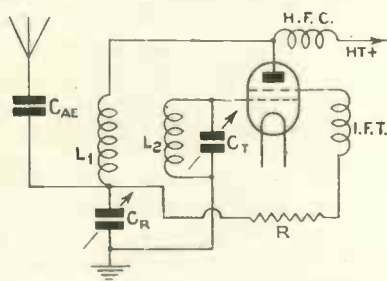

Fig. 4.—Circuit arrangement of the detector valve

at the maximum setting of the tuning condenser with the switch open, and invariably the inductance of this coil is too great for the minimum setting of the condenser with the switch closed, the result being that the erratic reaction and absorption effect mentioned earlier is the result.

Getting back to the parallel method employed in the coil recommended

for this receiver, the reaction coil is wound between the turns of the lower-frequency coil. It will be appreciated that by doing this the self-inductance of the coil will be small by virtue of the turn to turn screening by the lower-frequency coil, but the mutual inductance between those two windings will be large.

As the mutual inductance is a function of the self-inductance of these two coils it will be seen that M will automatically adjust itself when the switch is connected.

The danger of reaction-coil resonances is considerably lessened by virtue of the small value of its self-inductance; evidence of the value of this is that the writer did not find it necessary to readjust the reaction condenser once over the entire range from 18 to 65 metres. Of course, readjustment for better signals can be made if necessary.

It appears to be general practice to couple the aerial system by an aperiodic coupling coil, or a tapping, or a small series condenser directly to the grid.

Coupling by one of these methods means encouraging trouble by introducing aerial damping, which necessitates the continual use of the reaction condenser, or absorption by the aerial system, due to fundamental or harmonic vibration which brings about erratic behaviour as regards the setting of the reaction condenser.

The method of coupling employed in this receiver is to use a small limiting-capacity condenser to the high-potential terminal of the reaction condenser: it is considered by the writer that the impedance of the reaction condenser is of sufficiently

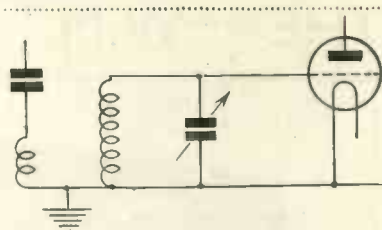

Fig. 3a.—A common method of coupling

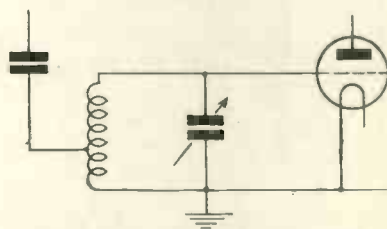

Fig. 3b.—Another common method of coupling

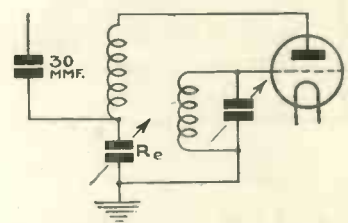
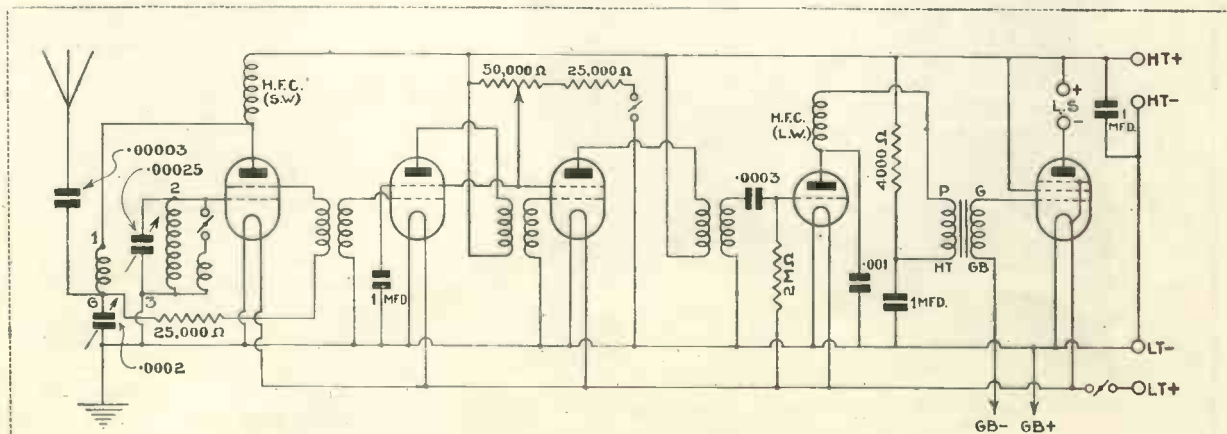

Fig. 3c.—Method of coupling used by the author

high order to give ample coupling when employed on this type of receiver.

It will be seen that the aerial capacity is complementary to the reaction condenser, and if the 30-micromicrofarad limiting condenser is omitted, then a non-oscillatory condition of the valve would not be obtained if the aerial capacity is of sufficiently large order to bring about oscillation at the maximum setting of the main tuning condenser.

The advantage of this method of coupling is that the aerial capacity is



CIRCUIT OF FIVE-VALVE SHORT-WAVE SUPER-HET RECEIVER

The circuit comprises a combined screen-grid detector-oscillator, two screen-grid intermediate-frequency amplifiers, second detector, and transformer-coupled pentode

THE "W.M." SHORT-WAVE SUPER—Cont.

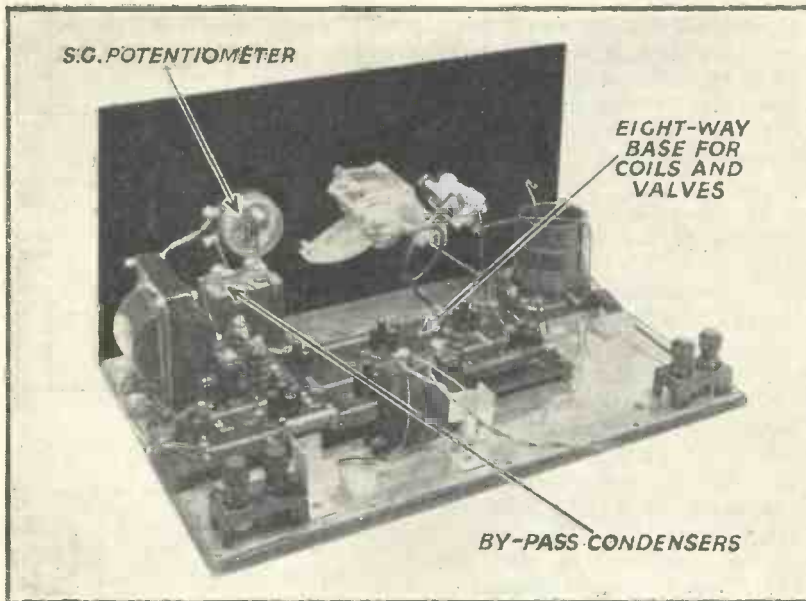

SIMPLE CONSTRUCTION WITH EIGHT-WAY BASE

This view shows the simple nature of the construction. A combined coil and valve base as used in the Super 60 is employed, but one holder has a fifth pin for the pentode

not reflected across the main tuning condenser, but across the reaction condenser, and in consequence the tuning range of the oscillatory circuit is not interfered with to the same extent as by inductively or capacitatively coupling to the oscillatory circuit inductance.

The writer used aerials of 300 micromicrofarads to 50 micromicrofarads with only a degree or two difference on the main tuning con-

denser. The diagrams of Fig. 3 show the usual methods of coupling and the coupling employed in the present receiver, A and B being the usual methods and C the method described.

As evidence that the coupling is sufficient, the receiver was tested for a period of fourteen consecutive days by an independent listener, W2XAD (New York) being the test station. The report was that the news items were received each evening between

9.30 and 10 p.m. Even if the conditions were good for short-wave reception from that station, the test proved the coupling was sufficient.

The object of employing the screen of the valve as the anode of the intermediate-frequency signal was to isolate as far as possible the local-oscillation main current from passing through the intermediate-frequency transformer primary.

Less Background Noise

It was considered that by doing this the background noises due to atmospherics would be lessened, and to some extent the object has been achieved, but to what extent it is difficult to say, except that from results obtained (that is, programmes from ten countries) it is presumed that the gain is greater than the loss.

The circuit arrangement of the detector valve will explain the arrangement (Fig. 4). In this circuit C_A is the aerial limiting capacity of 30 micromicrofarads; C_B is the reaction condenser; C_T is the main tuning condenser; L_1 is the reaction coil; L_2 is the oscillatory circuit coil; R is a resistance of 25,000 ohms to give added potential to anode to encourage oscillation; IFT is the intermediate-frequency transformer primary; and HFC is a short-wave high-frequency choke. The wave-change switch has been omitted.

The radio-frequency choke must be good, for unless this unit successfully chokes high-frequency currents from 15×10^9 cycles per second to above the limits of the range of the receiver, the detector oscillator will not oscillate.

Standard I.F. Amplifier

The intermediate-frequency amplifier is standard, except that a pentode is used in the last stage.

It will be appreciated by many short-wave enthusiasts that to be able to substitute valves of various manufacture and different values of mutual conductance in a receiver designed for the ultra high-frequencies and to be sure of results is certainly encouraging.

During tests, various makes of valves were employed with intermediate-frequency transformers of different manufacture, each having varying degrees of efficiency, and it was found that by a combination of valves having high values of mutual

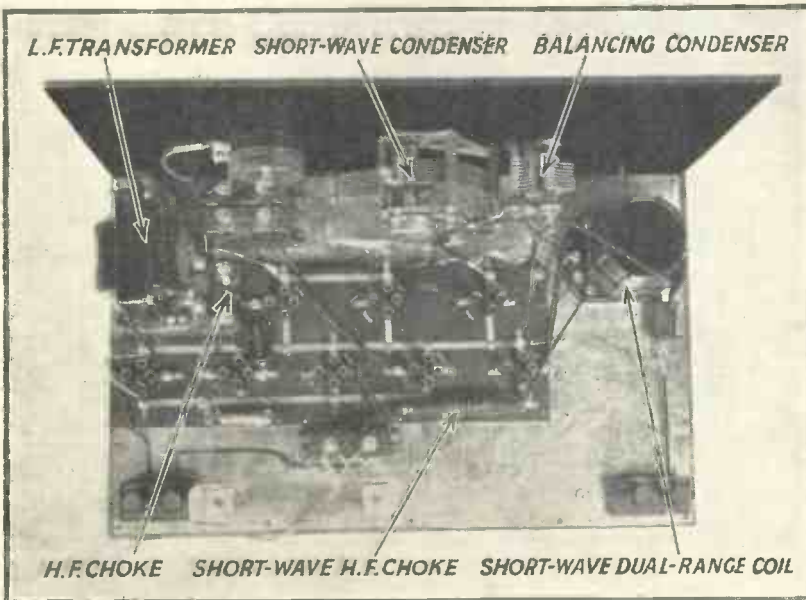

A RECEIVER FOR REALLY LONG-RANGE RECEPTION

This special photographic plan view shows clearly the disposition of the parts on the panel and baseboard. A full-size blueprint is available, of course

A POWERFUL BATTERY RECEIVER

conductance and transformers of lower percentage of efficiency and *vice versa*, the results were more or less consistent.

Of course, the best results were obtained when using the high mutual-conductance valves and transformers having a good degree of efficiency.

No Danger of Instability

Even when using valves and transformers to give the best results there is no danger of intermediate-frequency instability.

When constructing a receiver of any description it is always best to make the leads as short as possible. The question of making the wiring a pretty picture should be a secondary consideration.

This advice is given presuming the reader is alive to the fact that anode and grid wires should be separated or crossed at right angles to reduce as far as possible the inductive and

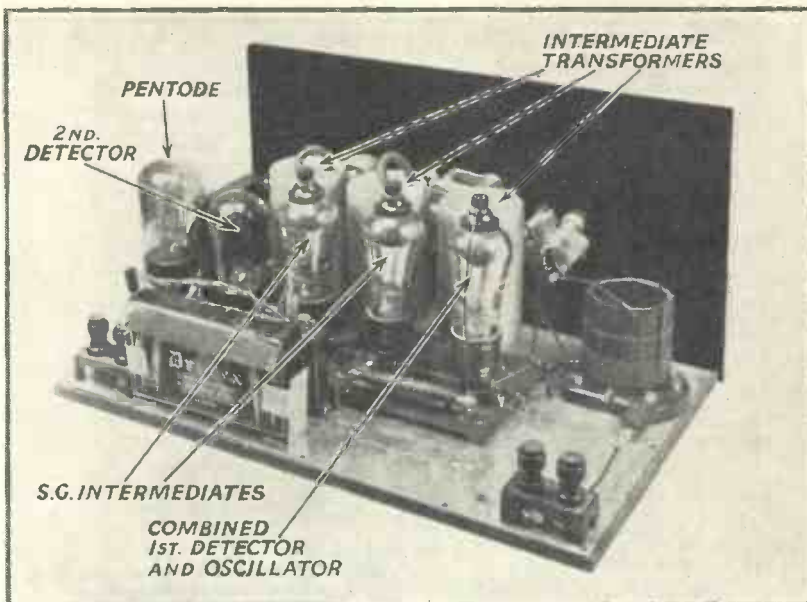

COMpletely Assembled and Ready for Use
Another view of the "W.M." Short-wave Super, a receiver designed especially for short-wave reception on wavelengths from 18 to 65 metres

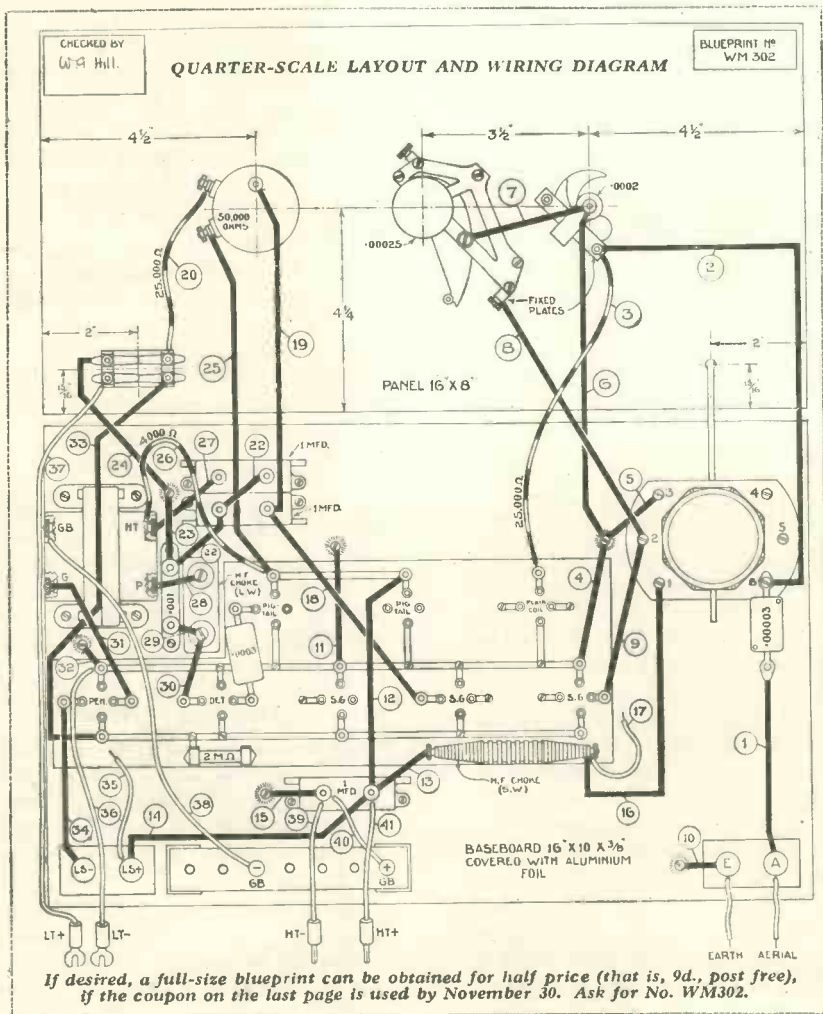

capacitive coupling between these high-potential points.

The advice given above is most advisable when constructing a receiver for the ultra high-frequency range. The point of short leads must be considered to the limit in order to get as much of the inductance of the circuit in the oscillatory circuit itself.

Stray Capacities

It must be appreciated that all the leads associated with the signal-frequency circuit have an added effect to the total inductance of tuning system, and therefore they must be short, not only from the point of view of reducing the danger of capacity effects from wire to wire, but also from a more important aspect—that is the greater the inductance that is localised in the grid circuit of the detector valve the greater will be the voltage variations across the grid-filament points of the detector valve, the result being increased efficiency.

Where a long lead is absolutely necessary it is far better to run this lead close to the screen, the object being to reduce the inductance and introduce capacity, for it will be appreciated that the total inductance of the oscillatory system, at frequencies as employed on this type of receiver, is only of the order (on the highest-frequency switch position) of

THE "W.M." SHORT-WAVE SUPER—Cont.

COMPONENTS NEEDED FOR THE "W.M."
SHORT-WAVE SUPER**CHOKES, HIGH-FREQUENCY**

- 1—Wearite short-wave, type HF8, 3s. 6d.
- 1—Watmel, type DX3, 4s.

COILS

- 1—Colvern dual-range short-wave aerial, type B.H., 8s. 6d.
- 1—Wearite super-het intermediate without pigtail, type OT1, 10s. 6d.
- 2—Wearite super-het intermediate with pigtail, type OT2, £1 1s.

CONDENSERS, FIXED

- 1—T.C.C. .00003-microfarad, type M, 1s.
- 1—T.C.C. .0003-microfarad, type M, 1s. (or Dubilier, Lissen).
- 1—T.C.C. .001-microfarad, type 34, 1s. 10d. (or Dubilier, Lissen).
- 3—T.C.C. 1-microfarad, type 50, 2s. 10d. (or Dubilier, Lissen).

CONDENSERS, VARIABLE

- 1—J.B. .00025-microfarad short-wave with slow-motion dial, type 1067, 12s. 6d.
- 1—J.B. .0002-microfarad reaction, 4s. 3d.

EBONITE

- 1—Becol 16 in. by 8 in. panel, 5s. 11d. (or Peto Scott, Permcol).

HOLDER, COMBINED COIL AND VALVE

- 1—Wearite eight-way base with five-pin output holder, 7s.

PLUGS AND TERMINALS

- 4—Clix Vicegrip wander plugs, marked: H.T.—, H.T.—, G.B.—, G.B.—, 6d. (or Belling-Lee, Eelex).
- 2—Clix spade terminals, marked: L.T.—, L.T.—, 4d. (or Belling-Lee, Eelex).
- 4—Belling-Lee terminals, type B, marked: Aerial, Earth, L.S.—, L.S.—, 2s. (or Eelex).

RESISTANCES, FIXED

- 1—Tunewell 4,000-ohm spaghetti, 1s. (or Lewcos, Bulgin).
- 2—Tunewell 25,000-ohm spaghetti, 2s. 8d. (or Lewcos, Bulgin).

The prices mentioned are those for the parts used in the original set; the prices of alternatives as indicated in the brackets may be either higher or lower

- 1—Lissen 2-megohm grid leak, 6d. (or Dubilier, Graham Farish).

RESISTANCE, VARIABLE

- 1—Lewcos 50,000-ohm potentiometer, 3s. (or Wearite, Colvern).

SUNDRIES

- Tinned-copper wire for connecting (Lewcos)
- Lengths of insulated sleeving (Lewcos).
- Length of rubber-covered flex (Lewcos).
- 1—pair of Bulgin panel brackets, type No. 1, 6d.
- 2—Belling-Lee terminal blocks, 1s. 4d. (or Lissen).
- 1—sheet of Parex aluminium foil, 1s. (or Peto Scott, Scott Sessions).

SWITCH

- 1—Colvern on-off, type S1, 1s. 3d.

TRANSFORMER, LOW-FREQUENCY

- 1—Ferranti AF3, £1 5s. (or Varley Nicore 1, Lissen Hypernik).

ACCESSORIES**BATTERIES**

- 1—Drydex 120-volt, green triangle type, 16s. 9d. (or Lissen, Siemens).
- 1—Drydex 9-volt grid-bias, green triangle type, 1s. 6d. (or Lissen, Siemens).
- 1—Exide 2-volt accumulator, type 1-CZG5, 14s. 6d. (or Lissen, Siemens).

CABINET

- 1—Pickett standard American type in oak, 16s. 6d.

LOUD-SPEAKER

- 1—Blue-Spot cabinet cone, type 44B, £2 12s. 6d.

VALVES

- 1—Osram S21, 16s. 6d. (or Marconi S21).
- 2—Osram S22, £1 13s. (or Marconi S22).
- 1—Osram HL2, 7s. (or Marconi HL2).
- 1—Osram PT2, 17s. 6d. (or Marconi PT2).

view, is well known by the hardened short-wave enthusiast.

Make the earth lead as short as possible. See that connection to the wire or plate that is buried is definite, that is, it should be well soldered; a twisted wire connection is not a connection, but a small condenser as soon as the two wires become oxidised. See the earth plate is in earth that is naturally damp. To follow this advice means reduction of de-tuning effect due to body capacities.

To operate the set, insert the valves; connect the aerial and earth; connect the batteries and loud-speaker; switch on; rotate the reaction condenser sufficiently to encourage oscillation of the first valve; and rotate the intermediate-frequency sensitivity control to bring about maximum sensitivity on this side of the receiver. Finally, rotate the main tuning condenser and in will come the stations.

Concluding Hint

In conclusion, here is one additional hint: See that anode and filament supplies are constant, that is, there must be no sign of hunting on the part of the high- or low-tension battery supplies when subjected to the load of the valves.

As an example of the importance of this advice, at one stage during the development of the receiver an extraordinary amount of fading was experienced. This fading was traced to a local source, an erratic high-tension unit.

1 microhenry and to add, say, 10 micromicrofarads or even 20 micromicrofarads to the tuning condenser is not so serious as introducing perhaps 30 per cent. inductance to the tuning circuit inductance, but external to the tuning circuit proper.

Concerning the making of joints in the tuning system: It may be considered very elemental by some readers to give the following advice, but nevertheless it is necessary to impress upon the minds of newcomers to the short-wave field that a medium-wave or a long-wave joint (or, at least, joints which do not show their weaknesses on those ranges) is not good enough for the ultra high-frequency range.

Low-resistance Joints

All points of contact must be definite and of as low resistance as possible. Each nut must be tightened with pliers; the fingers are not good enough. If this advice is not followed it will not be long before the receiver begins to lose its efficiency, owing to loosening of nuts due to vibration or other causes.

The reader is advised to make as

many points of the whole system earthy as possible, the object being to reduce the possibility of ultra high-frequency potential differences making themselves manifest in the supply batteries.

The difficulty of getting a good earth, or at least of making the earth terminal of the receiver zero potential from the incoming signal point of

NEWS OF THE SHORT WAVES Cont. from page 507

broadcast receiver, where the intermediate-frequency amplifier will in all probability be set to somewhere just above the point where Daventry normally comes in—call it about 160 kilocycles—a short-wave station at 50 metres will probably come in at two dial settings about twenty degrees apart and a station on 20 metres will probably be only two or three degrees apart for its two dial settings.

If a super-het receiver is being specially designed for short-wave reception only, it is sometimes just as well to use a rather high intermediate frequency. A setting somewhere near the top of the broadcast band—550

kilocycles—will be found quite useful although, of course, the actual amplification obtained will generally not be so high as when the lower intermediate frequency is used.

Annoying Effect

Another annoying effect which is often present with this type of short-wave receiver or converter is that when a station has been tuned-in and the reaction control slackened off, a background of morse may probably be heard. This effect is due to the fact that the intermediate frequency is beating with two received signals.

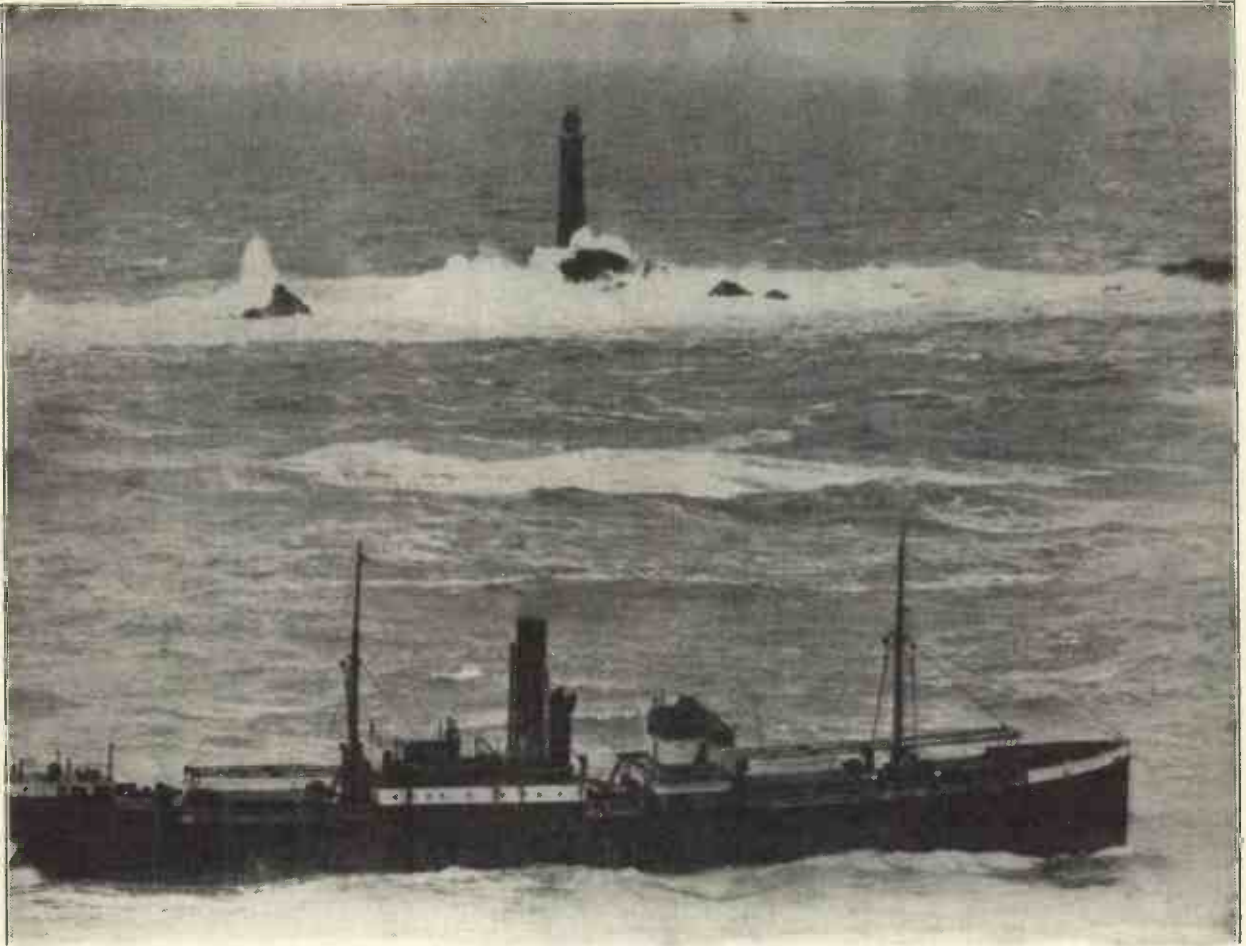

Beacon Stations trust to MARCONI VALVES

DAY in day out the beacon station must rap out its Morse, every half hour in fair weather, continuously in fog. Human life and the safety of the vessels in its vicinity depend on that message. The Beacon is an invisible lighthouse and it must never fail. Trinity House dare not risk a faulty valve. That is why they—and the Coastal Authorities of most maritime nations use Marconi Valves. *When lives may depend on a valve they chose Marconi.*

MARCONI A.C. MAINS VALVES

There is a type to give very best results in every position of the A.C. all-electric receiver. Each is constructed to the very latest standards of durable efficiency, a high mutual conductance being combined with long life and silent operation. This is the curve for Marconi M.H.4. a

general purpose type. Note how steep is the slope, despite the length and straightness of the working position.

MARCONI A.C. SERIES

* VMS4	Variable-Mu S.G.	19/.
* MS4B	S.G. (Single Stages)	19/.
* MS.4.	S.G. (Multi Stages)	19/.
* MH.4.	General Purpose	13/6
* MHL.4.	General Purpose and L.F.	13/6
ML.4.	L.F. and Power	15/.
PX.4.	Super Power	17/6
PT.4.	Pentode (Directly heated)	20/.
MPT.4.	Pentode (Indirectly heated)	20/.

* Available metallised, if desired.

WHAT IS THE PURPOSE? —

WE HAVE THE VALVE!

Ask your local dealer or write direct to The Marconiphone Company, Radio House, Tottenham Court Road, London,

W.I. for the Marconi Valve Folder which gives curves, facts and figures for all types of Valves.

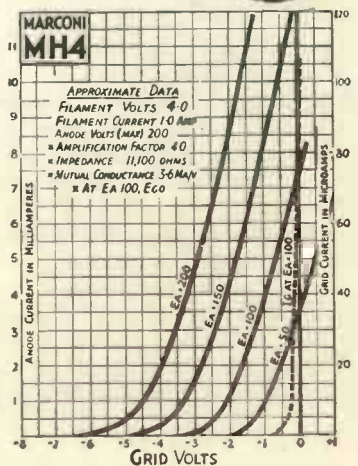



An H.M.V. radio gramophone is the centre of attraction

A Special Section for Those Interested in Electrical Record Reproduction

The Needle and the Record

By P. WILSON, M.A.

This is the third of a series of articles by one of the best-known authorities in the gramophone world

WHEN the model groove is pulled by hand under the tinfoil-mounted needle point, as illustrated in Fig. 1, the up-and-down motion is clearly seen and the effect of increasing or decreasing the needle angle becomes obvious.

But there are also one or two other points of interest to be observed. The first is that when the lifting is very marked, that is, when the needle passes a place of sharp curvature in the groove, the tinfoil shudders and squeaks. This corresponds to needle chatter in actual playing conditions.

One is, therefore, led to the conclusion that needle chatter is at any rate largely due to vertical motion, though I think it can also be demonstrated with equal assurance that the transverse damping of the

pick-up is also important from this point of view.

A discussion of this aspect I will reserve until later. It should be noted at this stage, however, that the shuddering must also mean that the needle and the pick-up are suffering from what one may call "shock excitation" by analogy with a not dissimilar effect produced on a wireless aerial by a strong atmospheric.

This means that if the pick-up happens to have any marked, or inadequately damped, mechanical resonances they will be strongly excited at any difficult passage and the reproduction will consequently become coarse and fuddled, with a probability of a background whistle, which will ring through the ears.

This is a not uncommon feature of record reproduction; it is most noticeable, perhaps, when a vigorous, dramatic tenor is singing, for then one has a fairly simple combination of sounds which cannot mask the whistle.

Some of the Alessandro Valente records, for example, exhibit the phenomenon in a marked degree.

At one time I thought it was entirely due to recording; but as I have been able to eliminate it by taking precautions to minimise this shock excitation, I am now satisfied with the foregoing explanation.

A Few Years Ago

In this event, however, how is it that the effect was more marked with the records made a few years ago than it is with those of the present day? Here again the models give us the necessary information.

The difference is due to the difference in shape of the cross-section of the groove. At one time the cross-section was almost V-shaped, with the bottom of the V rounded off; now it is more U-shaped, with the bottom of the U practically semicircular. There is no question that the modern shape is much the better. (Fig. 2)

(Continued on page 516)

A BATTERY SET BECOMES A BETTER SET WHEN ELECTRIFIED WITH REGENTONE

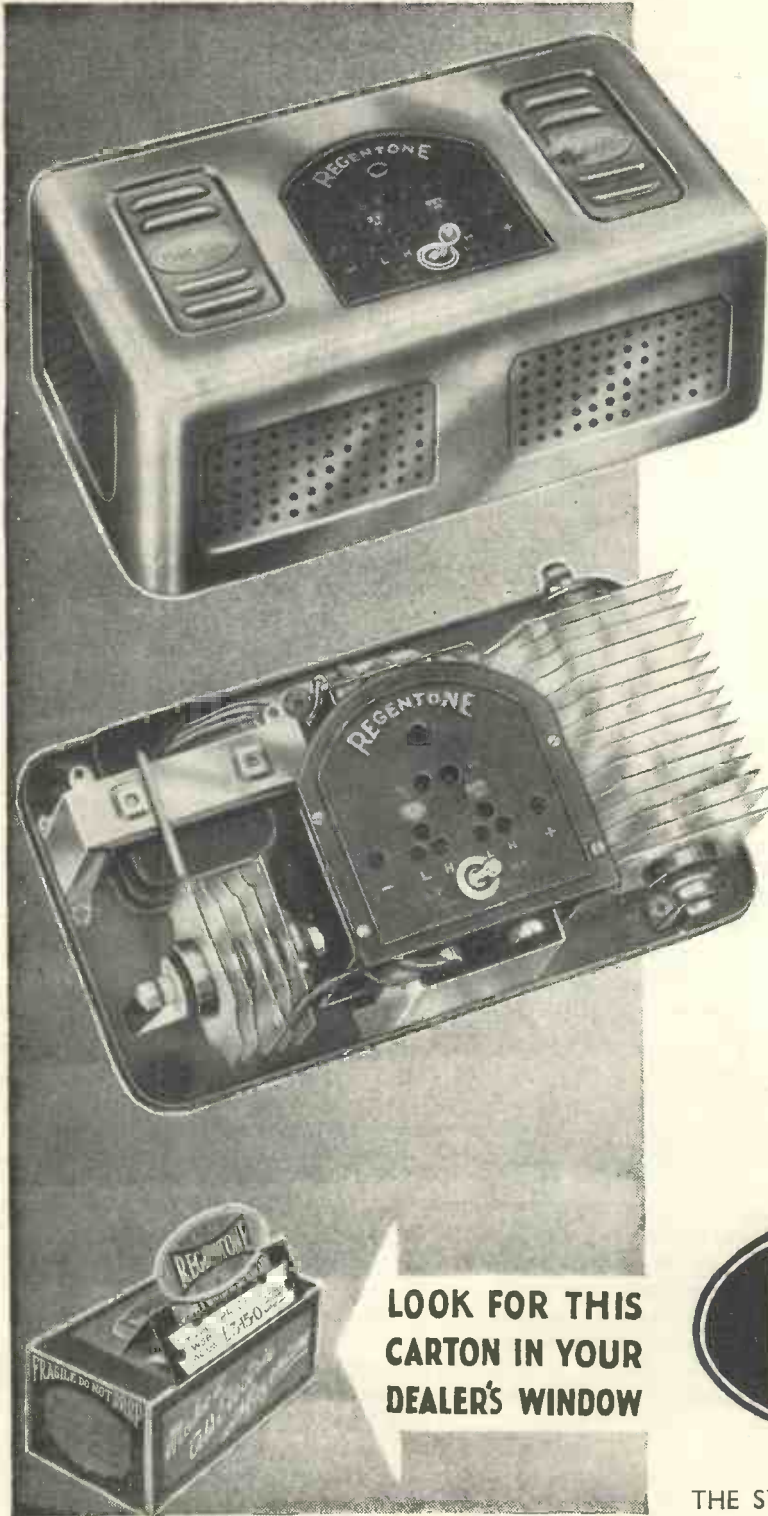

An all-electric receiver is constant in efficiency of output, because the supply of power never varies.

If you have a battery set or a battery kit set, why not enjoy the advantages of All-Electric Radio in the cheapest way possible?

Join up a REGENTONE Mains Unit in the same manner as a dry battery, connect to the electric supply socket, and your set becomes permanently powered by the mains at a cost not exceeding 6d. per month. Regentone mains units cost from 39/6, or 8/- down.

SIX STAR FEATURES COMMON TO ALL REGENTONE MAINS UNITS

- ★ Seven voltage tapings.
- ★ Line voltage output regulator.
- ★ Solid drawn steel case.
- ★ High capacity smoothing.
- ★ One efficiency only.
- ★ Price determines current output.



THE SYMBOL OF INDIVIDUAL CRAFTSMANSHIP

LOOK FOR THIS
CARTON IN YOUR
DEALER'S WINDOW

REGENTONE LIMITED, Regentone House, 21, Bartlett's Buildings, E.C.4. Tel. : Central 8745 (5 lines).
Irish Free State Distributors : Kelly & Shield, Ltd., 47, Fleet Street, Dublin.

THE NEEDLE AND THE RECORD—Cont. from page 514

The up-and-down motion of the needle point is much more pronounced when a V groove is used than with a U groove. The difference is very marked when models of the two grooves are pulled under the needle models.

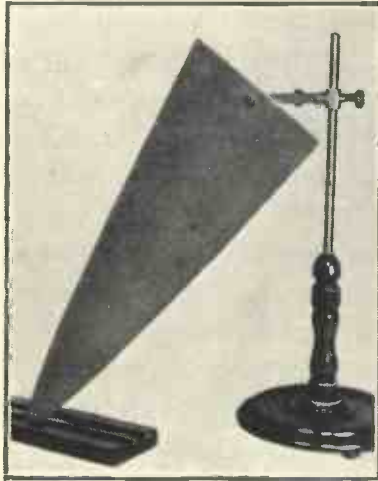

Fig. 1.—By drawing the record model under the needle point at different speeds the actual motion of the needle may be studied

It is fortunate, too, that nowadays the cross-section of the groove has been almost standardised in shape, at any rate with the leading makes of record. This used to be one of our difficulties in the old days. It defeated every attempt one made to devise a permanent needle.

The groove shape not only varied as between different makes of record; there was no semblance of consistency between records produced in the same factory.

Importance of Consistency

Some of us have urged in season and out of season the importance of consistency in this particular respect, but in the days of which I am speaking the empiricist experts of the gramophone companies were apt to regard amateurs with ideas as cranks and outsiders. We have changed all that.

This consistency in groove cross-section is fundamental to the solution of the problem at which I hinted at the end of my last article.

I pointed out that if we could use a needle point with its axis at right angles to the record surface there would be no up-and-down motion

and I instanced the fibre needle as an example of the way in which the thing could be done.

Just examine a fibre needle carefully and you will see that when the shank is sloping at about 60 degrees to the record, thereby avoiding the needle-drag to which I referred earlier, the actual point enters the groove vertically. (Fig. 3)

At first sight, however, it has one grave disability: the point does not by any means fill the groove or even make a good surface contact with it, and therefore it is not a particularly good medium for the transmission of forces varying in intensity and in frequency.

Fortunately the fact that a fibre needle has a hard shell overcomes this disability to a large extent. For in practice the point of the needle flexes, so that the needle actually rides with the shell bent underneath.

The hard shell of a fibre needle is thus a vital part of its structure and in using fibre needles it is important to acquire the knack of placing the needle in the groove in such a way that the shell is bent under the point and rests on the bottom of the groove. If it is bent the other way the point will tend to split and break off.

So much for the use of fibre needles. I have given the explanation here not because I would like to see everyone using them, though as I have said before I usually do

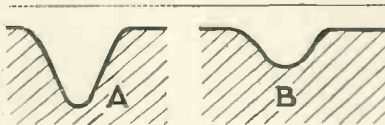

Fig. 2.—Shape of cross-section of record grooves, (a) old V-shape groove and (b) modern U-shape groove. Both are greatly enlarged

myself, but because the explanation leads directly to an understanding of the requirements that must be met if we are to have a permanent needle which will not give rise to vertical motion in the groove, to needle chatter, and to undue record wear.

With the introduction of automatic record-changing mechanisms there is great need for such a needle as this. And I see no good reason

now why such a needle should not be produced.

There may be some snags which I have overlooked, though I think this very unlikely, and there may be some difficulty in actually making a needle to fulfil the requirements. But these requirements do not seem to me to be specially exacting. Let us look at them a little more closely.

Hard Point

The first requirement is that the actual point should be made of a hard material which will not wear down so as to alter its shape readily. That presents no difficulty with hill-and-dale records; Edison used a diamond stylus and Pathé's used a sapphire.

Even glass would not be unsuitable, provided it were handled with care and not dropped.

The next requirement is that the point should enter the groove with its axis vertical or, rather, that the portion of the stylus actually in the groove and below the top surface of the record should be symmetrical about a vertical axis.

With a V-shaped groove this meant that the point would have had to be conical with the axis of the cone vertical.

This would be rather awkward, because only at one particular and exact setting of the pick-up on the carrying arm would the condition be fulfilled; at other settings the axis of the conical point would be sloping as with an ordinary steel needle.

Ball-pointed Needle

With a U-shaped groove of semi-circular curvature, however, this difficulty does not arise, for in these circumstances the needle can be ball-pointed, and the ball, being symmetrical about any central axis, will enter the groove vertically whatever the needle angle may be.

The third requirement is that the point must be such as to make good contact with the groove from the beginning. This is the most difficult requirement to fulfil, but it is clearly easier with the modern U-shaped groove.

The fourth requirement is that

(Continued on page 520)

SONOCHORDE

the Supreme Reproducer



STANDARD P.M.
7" Cone



JUNIOR P.M.
5" Cone



**MAINS EN-
ERGISED
MODEL**
7" Cone



**SONOCHORDE
DUAL
MATCHED
UNITS**

... recommended for the
"Wireless Magazine"
"Prosperity" receivers

The success of Sonochorde is evidenced by the fact that several well-known manufacturers are using these supreme reproducers as standard equipment in their receivers.

Sonochorde is the only speaker with a permanently aligned speech coil. There is no spider to warp and throw the speech coil out of centre.

All Sonochorde moving-coil speakers are equipped with universal input speech transformers having terminals for ease in connecting.

The concentric disc suspension ensures a better overall frequency response with added sensitivity.

Note the attractive list prices :

Standard P.M. 7-in. Cone	32/6
Junior P.M. 5-in. Cone	26/6
Mains Energised Models 7-in. Cone				
2,500—4,700 or 6,500 ohms	25/-
Dual Matched P.M. Units—7-in. Cones		pair		65/-
Dual Matched Junior P.M. Units—5-in. Cones		pair		53/-
Dual Matched Mains Energised Models—7-in. Cones	pair	50/-

All prices complete with universal input transformers.

SONOCHORDE REPRODUCERS

1, Willesden Lane, LONDON, N.W.6

'Phone : Maida Vale 6066 (5 lines)

Advertisers like to know whence the business comes—please mention "W.M."

FERRANTI
1882-1932

There is fifty years' experience behind every Ferranti Mains Transformer.

Where else can such experience be found?

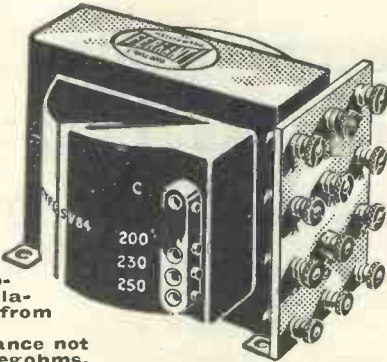

Available for 200/250 volts 40/100 cycle supplies. Voltage regulation 5 per cent. from full to 1/4 load. Insulation Resistance not less than 200 megohms. Pressure Tested at 2,000 volts A.C. Non-Hygroscopic Insulation—does not absorb moisture. Earth shield between windings. Arrangement of windings reduces external magnetic field (which produces hum) to minimum. Liberal rating giving temperature rise far below that dangerous to insulation. Rigorously Tested under actual load conditions.

TYPE EV 4.—For use with the full-wave Rectifying Valve, Marconi-Osram type U 10, Mullard type DW 2, or Cossor type 606 BU, to give a D.C. output when smoothed of 250 volts 60 milliamps.

TYPE EV 5.—For use with the full-wave Rectifying Valve, Marconi-Osram type U 12, Mullard type DW 3, or Cossor 442 BU, to give a D.C. output when smoothed of 200 volts 115 milliamps.

TYPE SV 4.—H.T. and L.T. Transformer. For use with U 10 or DW 2 valve. Output 240 volts 35 milliamps, 4 volts 1 amp. for Rectifier, 4 volts 2 amps. for Indirectly-Heated Valves, and 6 volts 1/2 amp. for Output Valve.

TYPE SV 10.—For use with large Power Amplifiers using U 14 Rectifier. Output: H.T., 400 volts 120 milliamps; L.T., 4 volts 2.5 amps. for Rectifier, 5.25 volts 1.6 amps. for 2 LS 5a's, and 4 volts 3 amps. for Indirectly-Heated Valves.

TYPE SV 13.—For use with the full-wave Rectifying Valve, Marconi or Osram type U 12, to give a D.C. H.T. output of 330 volts 120 milliamps, 4 volts 2 1/2 amps.

for filament of Rectifier, 4 volts 6 amps. for Indirectly-Heated Valves. Two 4 volt 1 amp. windings for two separately biased PX 4 Push-Pull Output Valves. Price 87/6

TYPE SV 14.—For use with two full-wave Rectifying Valves, Marconi or Osram type U 14, to give a D.C. H.T. output of 440 volts 160 milliamps, one winding giving 4 volts 5 amps. for filaments of two Rectifiers, one winding giving 4 volts 6 amps. for Indirectly-Heated Valves. Two 4 volt 2 amp. windings for feeding the filaments of two Push-Pull separately biased PX 25 or PP 5/400 Output Valves. Price 98/6

TYPE SV 84.—H.T. and L.T. Transformer. For use with U 12 valve. Output: 250 volts 70 milliamps, 4 volts 2.5 amps. for Rectifier, 4 volts 5 amps. A.C., and 4 volts 1 amp. A.C. L.T. windings, centre tapped. Price 36/6

TYPE EM 3.—For use with Westinghouse Metal Rectifiers, types HT 5 or HT 7, to give various D.C. outputs up to 200 volts 28 milliamps according to the Rectifier used. Price 22/6

TYPE EM 6.—For use with Westinghouse HT 8 Metal Rectifiers, D.C. output 250 volts 60 milliamps. Price 22/6

TYPE SM 2.—For use with Westinghouse Rectifiers, types HT 5 and HT 7. Gives same H.T. outputs as EM 3 and also provides 4 volts 6 amps. A.C. Price 26/6

TYPE SM 34.—For use with Westinghouse Rectifier, type HT 8. Gives same H.T. outputs as EM 6 and also provides 4 volts 5 amps. and 4 volts 1 amp. A.C. Price 30/6

Types SM 2, SM 34 and SV 84 Mains Transformers are specially suitable for use in connection with Super-Heterodyne Receivers.

Write for leaflet W. 522/1 which gives full details of all models

FERRANTI
MAINS TRANSFORMERS

FERRANTI LTD., Head Office and Works: HOLLINWOOD, LANCASHIRE.
LONDON: Bush House, Aldwych, W.C.2

PUT THE TROUBLE TRACKER ON THE TRAIL!



Whatever fault develops in any radio set, it cannot long elude the vigilance of an "All-in-One" Radiometer. Simply connect each component in turn to the "All-in-One" Radiometer and instantly the sensitive finger of the wonderful instrument points where the trouble lies.

With the aid of this ever reliable trouble-tracker you can keep your set in 100% condition at all times.

Get an "All-in-One" Radiometer to-day and become the master of your radio. Ask to see it at any radio dealer's or electrician's. If in any difficulty, write direct to:—

PIFCO, Ltd.,
High Street,
MANCHESTER.

Standard Model "All-in-One" Radiometer for Battery Sets only, as shown here. Price **12/6**

De Luxe Model for Battery Sets, Electric Receivers, and Mains Units. Price

£2.2.0



PIFCO
ALL IN ONE
RADIOMETER

Please mention "Wireless Magazine" when corresponding with advertisers

IGRANIC MAINS COMPONENTS

The increased popularity of all-electric radio has resulted in a demand for mains components of unquestioned reliability. Igraninc answer the demand with products that are built to the highest standards of quality and efficiency. The Igraninc Mains Transformer is shown on this page. The primary windings are so arranged that it can be connected to any standard 50 cycle A.C. mains supply of from 200 to 250 volts. The input terminals, mounted upon paxolin boards, are clearly marked in 10-volt steps from 200 to 250 volts.

The output terminals are also mounted upon a paxolin board and marked with their respective outputs as follows :—

- Sec. 1. 4 volts 3 amps. centre tapped.
- Sec. 2. 6 volts or 4 volts 1 amp. centre tapped.
- Sec. 3. 4 volts 2 amps. centre tapped.
- Sec. 4. 250-0-250 volts. Price **27/6**

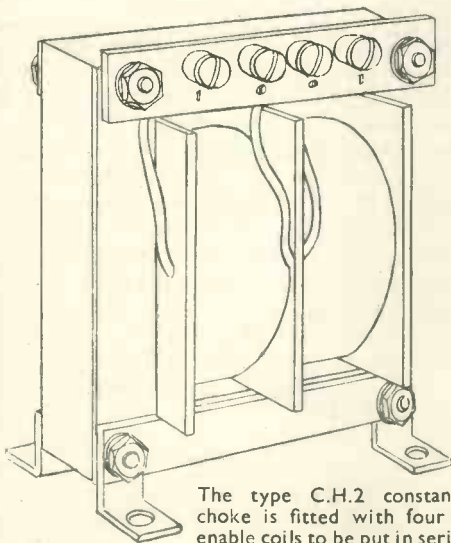
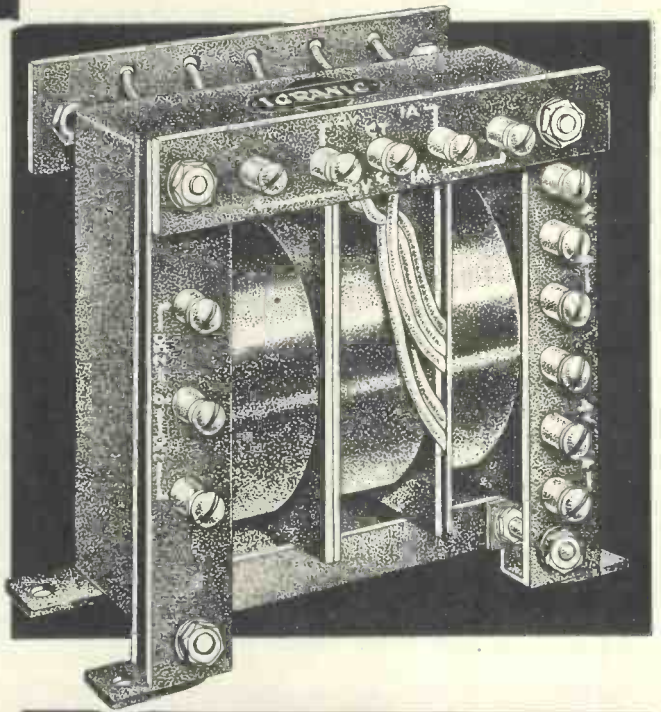

The type C.H.2 constant inductance choke is fitted with four terminals to enable coils to be put in series or parallel. This choke maintains a constant value of inductance up to the maximum current for which it is designed, so that the smoothing remains consistent up to the maximum carrying capacity of the choke.

Price **9/6**

Write to-day for fully illustrated Catalogue No. J. 1202 of complete new range of Igraninc Quality Components.

Igraninc Electric Co., Ltd., 149, Queen Victoria Street, London, E.C.4.

SEND FOR THE 1932 CATALOGUE

**IGRANIC
COMPONENTS WILL
BE THE MAKING
OF YOUR SET.**



THE NEEDLE AND THE RECORD

Cont. from
page 516

the shank of the needle should be sloping in order to avoid needle drag. This condition could be easily satisfied by mounting a small sapphire ball in a surface inclined at the required angle to the axis of the shank.

The fifth requirement is one which has not so far been indicated. It is that the shank should have self-damping properties. This is another of the virtues of a fibre needle over the ordinary steel needle.

A steel needle has a definite note of its own; indeed, this property is made use of in all needle-armature pick-ups to boost up the high-note response of the pick-up.

In my view this is a bad way of

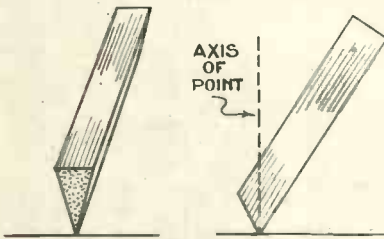

Fig. 3.—Diagram of fibre needle showing vertical point with sloping shank

obtaining adequate high-note response, because mechanical resonances of this kind always introduce a reaction effect between needle and record and this not only interferes with the proper tracking of the needle in the groove, but also gives rise to an excessive amount of surface noise.

A self-damping needle actually reduces surface noise, while still maintaining a good high-note response, that is if the pick-up is designed to suit it.

High-note Response

Using fibre needles in one of my own pick-ups specially designed for them, I obtain all the high-note response that one could wish for and keep surface noise down to a tithe of what one normally has to put up with; and what is left is of a soft, crackling quality and not hard and raucous.

The requirement for a self-damping shank is easily met by making it of bamboo or other fibrous material; even wood would

do, with the grain along the shank.

The material should be stiff, so as to avoid excessive loss of transverse vibration. In order to ensure firm grip in a needle socket it would appear desirable to make the shank triangular in section—like a fibre needle, in fact, but turned through an angle of 180 degrees. The needle would then look more or less as in the sketch, (Fig. 4).

I should emphasise, perhaps, that I have never had an opportunity of trying such a needle. With the old type of groove it was quite out of the question.

I am prepared to wager that it would work well in a modern record groove and give rise to less record wear than any needle at present on the market, other than a fibre or Burmese Colour needle properly used. And it should have none of the defects of those needles.

I mentioned earlier the necessity for ensuring that the needle is firmly gripped in the needle socket. I find that many, perhaps most, of the pick-ups in which a needle screw is used to grip the needle leave something to be desired in this respect, especially when a needle with a long taper is used.

The reason will be apparent from the diagram which I give on this page, (Fig. 5). The needle screw forces the shank end of the needle against the back internal wall of the needle socket. There is line contact only between the two.

When the needle is placed on a record the pressure between the two tries to flex the needle in the opposite direction, with the result that a small gap tends to be formed at the place marked x. Then when the groove moves the point from

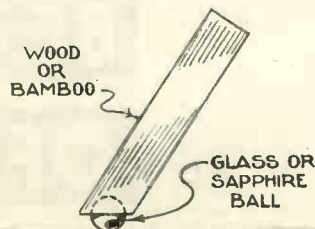

Fig. 4.—Suggested permanent needle with ball point and self-damping shank with which vertical tracking could be obtained without risk of drag. The ball could be sapphire or even glass, and the shank bamboo or wood

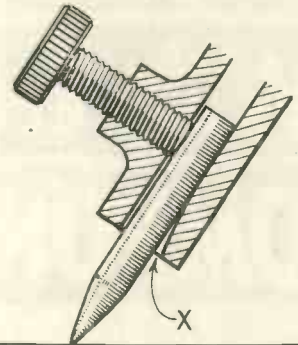

Fig. 5.—Diagram illustrating the necessity for a firm grip of the needle in the needle socket

side to side the needle may tend to twist about the needle screw as pivot and so set up a chatter at the point x.

Here is one of the virtues, probably the greatest virtue, of "featherweighting." And, if I recollect aright, it is one that has not been mentioned before. The disadvantage of featherweighting when a sloping needle point is used is that at difficult parts of the groove it is not easy for close contact between needle and groove to be preserved.

Lighter Contact

This disability, however, would largely disappear if the type of needle I have suggested were used and much lighter contact should be possible without deleterious effects.

Perhaps someone will ask how it is in this case that a rather larger weight on the record is usually recommended for fibre needles, which have a vertical point, than for steel needles. The answer is that in the case of the fibre a certain pressure is necessary to bend the shell under, as I have previously indicated.

Position of Screw

Apart from all this, however, it would well repay pick-up manufacturers to study this question of the grip of the needle in the socket. It is paradoxical that the grip is often better in those pick-ups which rely principally on the weight of the pick-up to wedge the needle into an angular recess than it is with pick-ups which have a needle screw in front.

"I want a good Wireless Set . . .

so that I can have a decent choice of programmes. I want a gramophone too, then I can make up a programme of my own favourites . . . In fact, what I *really* want is the two instruments in one, and its got to sound true to life. There's that transportable radio-gramophone by H.M.V. It's two in one, it's true to life, and no trouble to shift about. 25 guineas is pretty easy going—and, come to that, there's hire purchase . . ."



RECORDS

& RADIO

ASK TO HEAR THESE OUTSTANDING NEW RECORDS

Gracie's Latest & Greatest
He's dead, but he won't lie down—Looking on the bright side of life (From the Film: "Looking on the Bright Side"). Gracie Fields. B4258 2/6

Another Schnabel 'Beethoven' Triumph
Concerto in C Major (C. dur.), Op. 15 (Beethoven). Arthur Schnabel and The London Symphony Orchestra (Conducted by Dr. Malcolm Sargent). DB1690 to DB1694 6/- each (Album Series No. 156).

1,000 Bandsmen Playing!
 Hear the wonderful records actually made at the Aldershot Tattoo, this year. C2437, C2438, 4/- each

Jack Himself from 'Jack's the Boy'
The Flies crawled up the Window—I want to cling to Ivy (Both from the Film: "Jack's the Boy"). Jack Hulbert. B4263 2/6

Two Strauss Records for 8/-
"Der Rosenkavalier": Presentation of the Silver Rose—Ochs' Waltz. C2294 4/-
Breakfast Scene and Trio—Closing Duet C2295 4/-
 Vienna Philharmonic Orchestra
 (Conducted by Karl Alwin).

TRANSPORTABLE RADIOGRAM—THE ONLY 2 IN 1 INSTRUMENT OF ITS KIND. ALL-ELECTRIC, MARCONI VALVES FITTED AS STANDARD, 25 GUINEAS.

Photogravure Catalogue fully describing 22 models gladly sent on request. "His Master's Voice", 367 Oxford Street, London, W.1.

"His Master's Voice"

TRUE TO LIFE — RADIO AND RECORDS

The Gramophone Co., Ltd., London, W.1.

Advertisers take more interest when you mention "Wireless Magazine"

Choosing Your Records

GRAND OPERA AND CLASSICAL ARIAS

(a) *Di-Te (From You)* (Tirindelli), (b) *Torna A Sorriento* (de Curtis), Alfred Piccaver, Ten., 2s. 6d.

DECCA-POLY DE 7001

A good voice and acceptable operatic material on both sides.



ALFRED PICCAVER

I think this record is well worth having. The recording is very good.

CLASSICAL ORCHESTRAL MUSIC

Suite in G (Bach, arr. Goossens), (d.s.), London Symphony Orch., 4s.

H.M.V. C2278

Well worth having. When you think of the popularity of Bach at Queen's Hall you may be curious and ask to hear this although not by the B.B.C. orchestra. When you hear it you will take it home. I can promise you that!

CHAMBER MUSIC

★(a) *Campanella, Op. 7* (Paganini), (b) *"Tzar's Bride"*—*Song of the Bride* (Rimsky - Korsakov, arr. Franko), Master Yehudi Menuhin, 6s.

H.M.V. DB1638

To those who admire this young violinist's playing I suggest they consider this. It is



YEHUDI MENUHIN

what one expects from him. Mainly technique, perhaps, but (in years to come) when more mature records come from his

Here are reviews of the latest releases by **WHITAKER-WILSON**, the "W.M." Music Critic. Outstanding records are indicated by an asterisk (*) against the title

(a) *Caprice Viennols*, (b) *Slavonic Dance No. 2 in E Minor*, Sylva de Gay, rs. 6d. **WIN 5510**

There are many records of the popular "Viennese Caprice" of Kreisler. Also of the "Slavonic Dance" of Dvorak arranged by Kreisler. Here Miss Sylva de Gay gives a good account of both. Her phrasing is good and her tone pleasant. Anyone keen on either work can do worse than hear her version.

LIGHT ORCHESTRAL

Dance of the Cuckoos (d.s.), Laurel and Hardy, 4s. **COL DX370**

I have never seen cuckoos dance, but if this is the sort of music they want when they do dance this record should be broadcast from Radio Whipsnade. The harmonies are so excruciating in parts that one laughs or else feels inclined to cry. You had better hear it; it beats me!

★"*Der Rosenkavaller*" *Suite* (R. Strauss, arr. Nambuati) (d.s.), Vienna Philharmonic Orch., 4s. **H.M.V. C2295**

An outstanding light orchestral record. The recording is particularly good—but H.M.V. very rarely sends out anything that is not perfectly recorded. I think this type of orchestral music which is good in itself but not too "high-brow" is to be welcomed as it trains the listener to higher things. I hope it will sell.

(a) *Nightingale in the Lilac Bush*, (b) *Party of the Cockchafers*, Commodore Grand Orch., rs. 6d. **WIN 5504**

Quite acceptable light orchestral music with some pleasant side-effects. Nothing outstanding, perhaps, but a thoroughly good record.

Schubertiana (Fantasia on Melodies by Schubert) (d.s.), Tom Jones and his Orch., 4s. **H.M.V. C2454**

Very well done because it is by Tom Jones and his Eastbourne friends. Why he did it I don't know. I dislike medleys at any time. Still, you may have another opinion and buy it because it is Tom Jones rather than because it is Franz Schubert.

★*Tales of Hoffman* (Offenbach) (d.s.), Berlin Philharmonic Orch., 2s. 6d. **DECCA-POLY PO 5000**

The "Berlin-Phil." is always worth hearing. This is one of

the best light orchestral records of the month. Get it just for the sake of the admirable recording and performance. I thoroughly recommend it.

LIGHT SONGS

(a) *Boy Saw a Rosebush*, (b) *In a Cool Dell*, Comedy Harmonists, 2s. 6d. **H.M.V. B4252**

Both sides of this are good. The voices are beautifully blended and the words, though German, are clear enough to understand. Male voices are generally effective on a record; these are no exception.

HUMOROUS RECORDS

(a) *Desert Doings*, (b) *King Tut*, Tommy Lorne, Com., rs. 6d. **DECCA F3090**

Quite good. The humour is not heavy but rather delicate. I was very taken also with some of the songs. It is hardly a humorous record, but there is humour in it.

ADDITIONAL RECORDS REVIEWED BY CHOPSTICK

NOVELTY RECORDS

(a) *At the Ready*, (b) *Up into the Mountains*, Theoni and Achermann, 2s. **WIN L5507**

An excellent example of good accordion playing. Both are marches and will certainly amuse the kiddies.

LIGHT SONGS

(a) *Perry Werry Winkle*, (b) *Songs That Are Old Live For Ever*, Jenny Howard with Orch., rs. 6d. **WIN 5503**

These tunes are almost forgotten now but nevertheless Jenny Howard's versions are very entertaining. (a) is in quickstep time and is constant enough for a good dance. The recording is very good.

HUMOROUS RECORDS

★(a) *He's Dead But He Won't Lie Down*, (b) *Looking on the Bright Side of Life*, Gracie Fields, 2s. 6d. **H.M.V. B4258**

I prophesy that this is going to be H.M.V.'s best seller for the next few months. I have never laughed at Gracie so much before. For one thing, she has

★*Heard at Hogsorton*, No. 3 (d.s.), Gillie Potter, 4s. **DECCA K674**

Very good indeed. Gillie Potter has broadcast this scene. It is well produced and is equally funny on second hearing. That is the highest compliment I can pay Mr. Potter!

Hollywood Party (d.s.), Florence Desmond, 2s. 6d. **H.M.V. B4264**

I think this will sell all right! Miss Desmond is thoroughly characteristic and the sketch has



FLORENCE DESMOND

some very amusing lines. You will thoroughly enjoy every inch of this disc. Besides being amusing, Florence Desmond has a fascinating style.

found another new voice. Both songs are from her new film *Looking on the Bright Side*. (a) is the hit which is going to take England by storm.

DANCE MUSIC

★(a) *A Great Big Bunch of You* (f.), (b) *The Clouds Will Soon Roll By* (f.), Jack Hylton and His Orch., rs. 6d. **DECCA K3109**

There is a richness in the tone of this band that puts it in a



JACK HYLTON

class of its own. This month's records show that the "hot" type of record—except for American recordings—is

(Continued on page 524)

A PERTRIX TRADE MARK BATTERY FOR EVERY PURPOSE AND PRICE

High Tension or Low Tension—inexpensive or Super Capacity Batteries—every need for wireless power can be met from the Pertrix range. The extraordinary long life qualities of Pertrix Batteries are the result of over forty years of battery manufacture. Plug into Pertrix and forget all your battery troubles!

PERTRIX TRADE MARK DRY BATTERIES AND ACCUMULATORS

H.T. BATTERIES
from
5/6

L.T. ACCUMULATORS
from
4/6

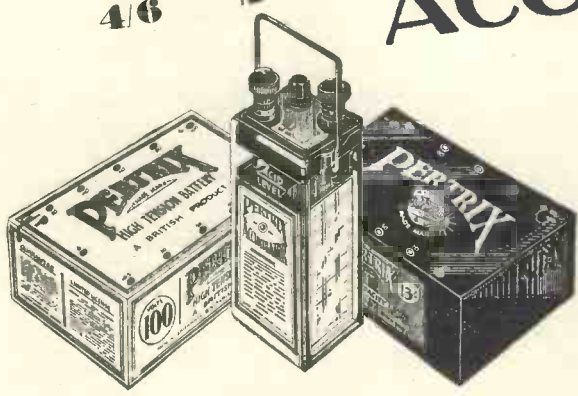

Pertrix Radio Batteries and Accumulators are entirely British made at Britannia Works, Redditch, (Worcs.), where also are made Pertrix Batteries for every purpose — for Motor Cars and Motor Cycles, Lead Stationary Batteries and Alkaline Batteries, etc.

Advt. of Britannia Batteries Ltd., 233 Shaftesbury Avenue, London, W.C.2. Telephone: Temple Bar 7971. (5 lines). Works: Redditch (Worcs.)

It helps us if you mention "Wireless Magazine"

CHOOSING YOUR RECORDS—Cont. from page 522

gradually dying. Both (a) and (b) are well done with melody as the chief recommendation, but Hylton's wonderful showmanship is still there.

(a) *At Eventide* (f.), (b) *After To-night We Say Goodbye* (f.), Ambrose and His Orch., 2s. 6d.

H.M.V. B6229

Ambrose recorded these two tunes when fulfilling a holiday engagement in Monte Carlo



BERT AMBROSE

recently. Both numbers are very pleasant, but this is by no means one of his best records. The orchestration is rather ragged in places, but, as usual, the time is faultless.

★(a) *I Can't Believe That It's You* (f.), (b) *The Roses Are Red, the Violets Are Blue* (f.), Gene Kardos and His Orch., 2s. 6d. H.M.V. B6227

Credit where credit is due; this is well worth having. The recording is crystal clear, and the orchestration is very refreshing. On both sides we have some excellent solo work, especially by the saxophone player and the pianist. I rather liked the American accent in the vocal choruses. I consider this to be the outstanding dance record of the month.

(a) *If I Could Call You Sweetheart* (f.), Ruby Newman and His Orch., (b) *We Were Only Walking in the Moonlight* (f.), Ted Black and His Orch., 2s. 6d. H.M.V. B6234

This is quite a useful dance record well recorded and played in very good time. The mellow

tones of the saxophones are not easy to record, but H.M.V. have certainly done the trick here. A muted-trumpet solo on (b)—a slow foxtrot—is very cleverly played. Both numbers are unusually orchestrated.

★(a) *In Honolulu* (tango), Original Ramblers Orch., (b) *Tatjana* (tango), Otto Lington and His Lingtonians, 2s. WIN L5508

I recommend this record to dancers and to those who enjoy light music. The careful blending of instruments on (a) has produced the most charming tango I have heard for a long while. The time of both is suitable for dancing, although (b) is rather on the fast side.

(a) *Madrecita* (tango), (b) *Oh! Mister Leader* (tango), La Plata Tango Band, 1s. 6d. DECCA F3112

Two delightful tangos played at the correct time. I recommend this record mainly on account of the fine piano solo on (a). There is a vocal chorus on (b) which is sung in German. A very attractive disc.

★(a) *Marta* (slow f.), (b) *One More Affair* (f.), Roy Fox and His Band, 1s. 6d. DECCA F3093

You will thoroughly enjoy both sides. (a) has been in existence for some months, but



ROY FOX

is still going strong. This version is very colourful and will take some beating. Decidedly a record which every dance "fan" should possess.

★(a) *Ooh! That Kiss* (f.), (b) *You're My Everything* (slow f.), Roy Fox and His Band, 1s. 6d. DECCA F3099

A splendid Roy Fox record. This band plays at the Monseigneur Restaurant, Piccadilly. They have a distinctive style of their own and you can always be assured of a versatile orchestration. (a) is a cunningly pleasing tune in perfect quick-step time. (b) is a typical example of the good use a piano can be put to in a dance band. Both numbers have vocal choruses.

(a) *Take Me Away From the River* (f.), Fletcher Henderson and His Orch., (b) *Breakfast Dance* (f.), Duke Ellington and His Cotton Club Orch., 2s. 6d. H.M.V. B6230



DUKE ELLINGTON

Play (b) every morning before breakfast—but not when shaving—and you will have the jumps all day. Duke Ellington is famous for his hot rhythm records, and this is certainly one of the best. Unless you are definitely a student of modern rhythm take my advice and hear it before you buy.

CINEMA-ORGAN MUSIC

(a) *Les Sylphides*, (b) *Softly Unawares*, Harry Davidson, 1s. 6d. WIN 5512

An outstanding organ record. There is some very heavy bass recording which makes this disc invaluable for testing purposes. On the other hand, they are two delightful tunes. I thoroughly recommend it.



HARRY DAVIDSON

ABBREVIATIONS USED IN THESE PAGES

bar ..	baritone	H.M.V. HIS MASTER'S VOICE
COL ..	COLUMBIA	orch. .. orchestra
com. ..	comedian	sop. .. soprano
con. ..	contralto	ten. .. tenor
DECCA-POLY		w. .. waltz
DECCA-POLYDOR		WIN EDISON BELL
d.s. ..	double-sided	ZONO .. ZONOPHONE
f. ..	fox-trot	

(a) and (b) indicate the titles of each side of a record.

Special Christmas Records

MOST gramophone enthusiasts are familiar with Richard Crooks' famous record of Moya's "Song of Songs." Now this famous American tenor has added more laurels to his fame by recording four very old favourites which are to be released in the H.M.V. Christmas lists on December 1. They are "The Holy City," "Nazareth," "The Star of Bethlehem," and "The Rosary."

The songs were recorded in the Kingsway Hall, and Richard Crooks was accompanied by John Barbarolli's String Orchestra with

Herbert Dawson at the organ. During June, July, and August of this year, Richard Crooks has made thirty-four broadcasts in America. Recently he replaced Gigli as leading tenor of the Metropolitan Opera House in New York. This is probably the most coveted position which a singer can obtain. Incidentally it is the highest paid position for any vocalist in the world.

Crooks has sung in opera many times in Germany, where he is considered one of the greatest exponents of the name part in

Wagner's *Lohengrin* and Walther—the leading tenor in the *Meistersingers*.

In America he travels exclusively by aeroplane and flies so much that the insurance companies will not allow him to increase his life assurance. Richard Crooks is only thirty-four years of age.

In addition to the Crooks records, one other important feature of the H.M.V. Christmas lists will be the first records of the B.B.C. Symphony Orchestra. The issue will include a splendid rendering of Beethoven's Eighth Symphony.

FOR EVERY SET — there's a

PILOT AUTHOR KIT

CASH — C.O.D. — or H.P.

FIT THE BLUEPRINT

CALIBRATOR KIT "A"

Described in last month's issue.

Author Kit, but less valves, cabinet, Motor, Pick-up, and speaker.

Cash or C.O.D. Carriage Paid **£6:7:7**

Or 12 monthly payments of 11/8
Valves, £2-2-6. Cabinet, £4-15-0.

EASYTUNE 60 (FRAME AERIAL VERSION)

Described this month.

KIT "A" Author Kit less valves, cabinet, and frame aerial.
Cash or C.O.D. Carriage Paid **£5:6:6**

Or 12 monthly payments of 9/9
5 Valves as specified £2-19-0. Lewcos D.R. Frame Aerial, £1-7-6.

W.M. SHORT-WAVE SUPER

Described this month.

KIT "A" Author Kit, with ready drilled panel, less valves, and cabinet.
Cash or C.O.D. Carriage Paid **£6:11:6**

Or 12 monthly payments of 12/-
5 Valves as Specified, £3-14-0. Cabinet, 16/6.

PROSPERITY 3 (A.C.)

KIT "A" Author Kit including full-covered baseboard assembly, but less valves, cabinet, motor pick-up, and speaker.

Cash or C.O.D. Carriage Paid **£10:15:0**

Or 12 monthly payments of 19/8
Valves, £2-12-6. Cabinet, £6-6-0.

PILOT BAND-PASS UNIT

Whether your set is Mains or Battery operated, the PILOT BAND-PASS UNIT cuts out programme interference effectively and sharpens tuning to needle-point selectivity. It is simple to attach and can be operated by anyone without technical knowledge. No valves or extras required.

Instantly converts any Set to Band-pass Tuning with Needle-sharp Selectivity.



25/- CASH or C.O.D. Or 6 monthly payments of 4/6

IMPORTANT

Part Kits, miscellaneous components or accessories are available, CASH, C.O.D. or H.P., under our own Easy Way System. Send us list of your wants. We will quote by return without any obligation. Orders value over 10/- carriage or C.O.D. charges paid.

TABLE QUAD

Described in this month's issue.

KIT "A" Author Kit, exact to specification, less valves and cabinet.

Cash or C.O.D. Carriage Paid **£6:5:0**

Or 12 monthly payments of 11/5
Carriage Paid

4 specified Valves, £1-19-3. Cabinet (Walnut or Mahogany), £1-15-0.

THESE ARE THE PARTS THE AUTHOR USED

	£	s.	d.
1 PETO SCOTT Baseboard, 15 by 10 in.	2	0	0
1 VARLEY Nichoke II, low frequency choke, type DP.23	10	6	0
1 TELSEN Binocular High Frequency Choke, type W.74	5	0	0
1 READY RAD Standard H.F. Choke	1	6	0
1 set of FORMO coils comprising, 1 pair of band-pass types 62c and 63c, and one anode coil type 61c	1	2	6
2 T.C.C. .0002 mfd. fixed condensers, type 34	3	0	0
1 T.C.C. .0002-mfd. fixed condensers, type 3P	2	4	0
1 T.C.C. .006-mfd. fixed condensers, type 34	2	6	0
1 T.C.C. 1-mfd. fixed condensers, type 50	2	10	0
2 T.C.C. 2-mfd. fixed condensers, type 50	7	8	0
1 POLAR .0005-mfd. three-gang variable condensers, star type	1	5	6
1 TELSEN .0003-mfd. type W.188	2	0	0
4 W.B. four-pin valve holders, miniature type	2	0	0
7 BELLING & LEE marked wander plug	1	2	0
2 BELLING & LEE spade terminals marked LT. + LT. -	4	0	0
4 BELLING & LEE marked terminals	1	0	0
1 GRAHAM FARISH 20,000 ohms Ohmite fixed resistance	1	6	0
1 GRAHAM FARISH 40,000 ohms Ohmite fixed resistance	1	6	0
1 GRAHAM FARISH 50,000 ohms Ohmite fixed resistance	1	6	0
1 GRAHAM FARISH .5 megohm megite	1	6	0
1 TELSEN 2-megohm grid leak	1	0	0
1 VARLEY 50,000 ohm potentiometer, type CP109	6	0	0
Thinned copper wire for connecting, lengths of oiled cotton sleeving, length of rubber covered flex	1	8	0
2 SOVEREIGN terminal blocks	1	0	0
1 BULGIN three point switch, type 8.39	1	0	0
1 SCERTUN low frequency transformer ratio 1-5	8	6	0
1 POLAR Disc Drive	5	0	0

Kit "A" Cash or C.O.D. £6 5 0

1933 ADAPTAGRAM

Constructed of Walnut with contrasting Walnut inlaid Veneers

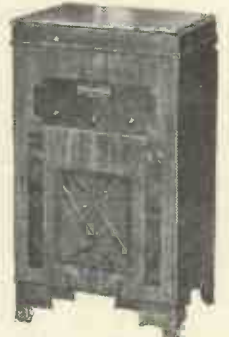

Dimensions: Height, 38 1/2 in.; width, 21 1/2 in.; depth, 15 1/2 in. Panel size: 18 by 8 in.; base-board depth, 14 in. Speaker Compartment, 17 by 19 1/2 in. Clearance between motor board and underside of lid, 4 in. Ready fitted with back Baffle Board, 3/8 extra, if required.

Transform your Set to a thing of beauty with this Modern Walnut Cabinet that is the craftsman's last word in style and appearance. Decorated with carefully matched inlaid walnut veneers of contrasting colour. Hand fresh polished to reveal the hidden beauty of grain only to be found in the finest Walnut, while bringing to perfection the acoustic properties of the correctly proportioned speaker compartment. Gives a new and better tone to your Set; adds beauty to your home at minimum cost.

MODEL A.—Comes to you with vignetted front (as illustrated), and motor-board, ready to take your own Set, Gramophone Motor and Pick-up. Suitable for all popular Sets described in the leading technical journals.

CASH or C.O.D.

63/-

Carriage and packing 2/6 extra. England and Wales.

Or Eastway 12 monthly payments 5/9

MODEL B.—Standard 1933 ADAPTAGRAM. Garrard Double Spring Motor. 12 in. Plush-covered Turntable. Automatic Stop. B.T.H. Tone-arm with Pick-up and Volume Control complete. Automatic Needle Cup that delivers new needles one at a time to your finger tips. (For A. C. Mains 100-130 and 200-260 volts 20-100 cycles.) Details of D.C. Model on application. CASH or C.O.D.

MODEL C.—Collaro Induction Electric Motor with Tone arm, Pick-up and Volume Control in one Unit. 12-in. Plush-covered Turntable. Automatic Stop. Automatic Needle Cup that delivers NEW needles one at a time to your finger tips. (For A. C. Mains 100-130 and 200-260 volts 20-100 cycles.) Details of D.C. Model on application. CASH or C.O.D.

6 Gns. 7 Gns.

or 12 monthly payments of 12/- or 12 monthly payments of 13/9

ANY ITEMS SUPPLIED SEPARATELY. CASH OR C.O.D. ORDERS OVER 10/- CARRIAGE or C.O.D. CHARGES PAID

IMMEDIATE DELIVERY FROM STOCK

PETO-SCOTT CO. LTD. 77, City Rd., LONDON, E.C.1

West End Showrooms: 62 High Holborn, London, W.C.2. Telephone: HOLBORN 3248

Dear Sirs, Please send me CASH/C.O.D./H.P.

for which I enclose £.....d. CASH/H.P. Deposit. Also send your FREE 1933 Radio Catalogue.

NAME

ADDRESS

W.M.11/32

Buy by Post — it's Quicker

Advertisers take more interest when you mention "Wireless Magazine"

In Favour of Frame Aerials

To the Editor; "Wireless Magazine."

SIR,—As a keen radio enthusiast and a landlord of some tenement property, I am asking you to design more sets of the Super 60 type, so helping to do away with all these wires and poles on roofs.

If I allowed outside aerials to be erected on my property, the whole row of buildings would resemble a shipyard—especially as each floor is let separately.

Rotted Window Sills

A major trouble is that when holes are bored in wooden window sills for the aerial wire to pass through, the water which runs down the aerial wire rots the wooden sill in quite a short time. I have seen holes hacked through skylights, pushed through brickwork, and even panes of glass smashed to allow the aerial lead-in.

Most of these ridiculous things are done to get the best results from out-of-date sets. To one and all I recommend the Super 60, which I use myself. I find that people with these out-of-date sets spend a lot of

money on gadgets. It would be better if they were to buy or build a Super 60; then they would be satisfied and, incidentally, would need no gadgets to make it work well.

One point in favour of a set using a frame aerial is that the need of an efficient aerial and earth is obviated. Very few constructors are able to get an efficient earth.

There is one very interesting point about the performance of the Super 60. My friends managed to get Radio Paris with a dial reading of 180 on the oscillator coil, while my version would not bring in this station at all. I have just replaced my oscillator coil, and now Radio Paris comes in around 160 degrees on the dial. The hint may be useful to other constructors.

Alex H. East

Kilburn, N.W.6.

Wright & Weaire, Ltd., of 740 High Road, Tottenham, London, E.17, announce a loud-speaker heterodyne filter priced at 10s. 6d. This should interest many constructors as it can easily be incorporated in an existing set.

Points from Here and There

TEACHERS will be interested in "A First List of Broadcast Receiving Apparatus Suitable for Use in Schools." This deals with all-mains sets and loud-speakers; it is available from the B.B.C.

All listeners will be interested in a new accessory called the Pressland Cop, which is claimed to combine seven uses in one gadget. It acts (1) as a selectivity control, (2) as a lightning arrester, (3) as a static eliminator, (4) as a volume control, (5) as an aerial lead-in, (6) as an aerial cut-out, and (7) gives a £100 free protection policy. It is made in three sizes costing 2s. 6d., 3s., and 3s. 6d., each respectively from any radio dealer.

Further orders have been placed with Burne-Jones & Co., Ltd., for sets for the use of the blind. Over 21,000 sets have been supplied to blind people through the Wireless for the Blind Fund. The present contract is for three-valve sets.

A TRIUMPH OF PRECISION

● Gives extremely fine tuning. Similar in construction to the "NUGANG" Condensers, but the trimmer of front section is operated independently from the receiver panel by means of a second knob concentric with the main tuning knob. Rigid one-piece chassis, very robust construction. Trimmer to each stage. Heavy gauge wide spaced aluminium vanes. Special bearings to rotor ensure permanent accuracy. Capacity .0005. Matched to within $\frac{1}{2}$ mmfd. plus $\frac{1}{2}$ per cent. Complete with disc drive and bakelite escutcheon plate.

2 gang - 18/6 3 gang - 27/-

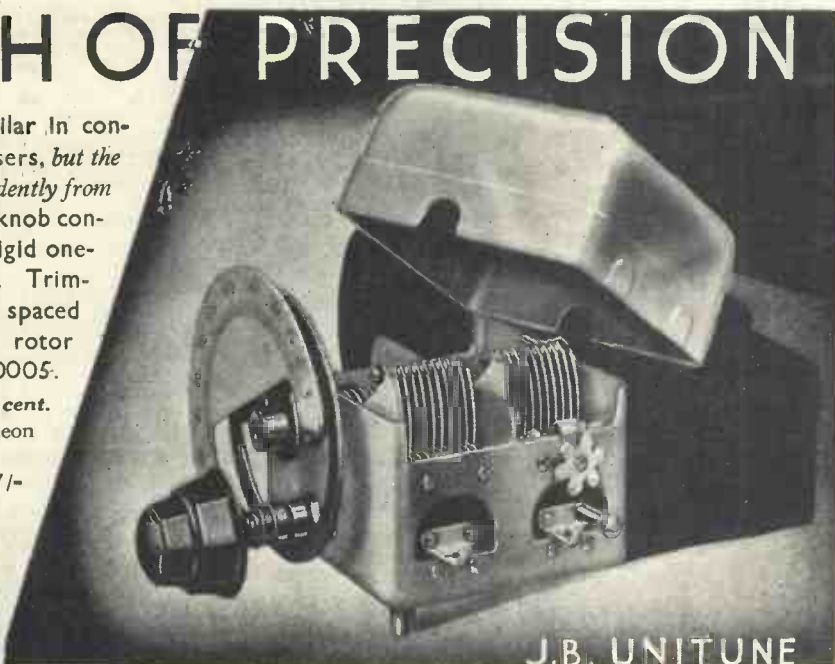

J.B. UNITUNE

PRECISION INSTRUMENTS

Write for New Catalogue.

Advertisement of Jackson Bros., 72, St. Thomas' Street, London, S.E.1.

"RADIO ENTHUSIASTS CAN PURCHASE THEM WITH EVERY CONFIDENCE"



The Ediswan Batteries are giving the first-class service expected of them. Radio enthusiasts can purchase them with every confidence. Their outputs are above the average and they give a clean, steady output . . .

says the Technical Editor of "Popular Wireless"

Settle the H.T. Battery problem once and for all—take no more risks buying batteries "on spec."—It is unnecessary, for Ediswan H.T. Batteries are now **GUARANTEED** against failure to give completely satisfactory service. Every single cell in every Ediswan Battery must successfully pass four tests before it leaves the factory, and special precautions are taken to ensure perfect internal insulation between cells.

60 69
VOLTS

120 134
VOLTS

Standard Capacity. Where the anode current required does not exceed 10 M/a these batteries will give highly satisfactory service. If super-power valves are used, the super-capacity type should be used.

Super Capacity. These batteries have twice the capacity of the standard type, and, owing to their large reserve of power, last nearly three times as long when used as replacements to standard capacity batteries.

Look for the Ediswan Authorised Dealer sign when you buy! Send for your **FREE** copy of "How to get the most out of your H.T. Battery." Full of useful data, hints and tips.

Guarantee

The Edison Swan Electric Co. Ltd. guarantee that Ediswan Batteries are of full voltage and capacity. Should any Ediswan Battery fail to give satisfactory service, we undertake to deal with the customer's complaint within 24 hours of receipt of the defective battery.

EDISWAN

Guaranteed

RADIO H.T. BATTERIES

THE EDISON SWAN ELECTRIC CO. LTD.



PONDERS END, MIDDLESEX

B.174

In Tune with the Trade

FETTER LANE'S Review of Catalogues

SEND TO US FOR THESE CATALOGUES!

Here we review the newest booklets and folders issued by four manufacturers. If you want copies of any or all of them just cut out this coupon and send it to us. We will see that you get all the literature you desire.

Just indicate the numbers (seen at the end of each paragraph) of the catalogues you want below.

My name and address are:—

Send this coupon in an unsealed envelope, bearing 1/2 d. stamp, to "Catalogue Service," WIRELESS MAGAZINE, 58/61 Fetter Lane, E.C.4. Valid till Nov. 30

NOW THEN, SET BUILDERS!

THE advent of the new Igranic catalogue should be the signal for a chorus of welcome on the part of keen set builders. It is full of just those handy and high-grade parts which one expects Igranic to produce. Super-het coils, short-wave coils, condensers, new transformers and chokes, volume controls and new switches—they are all there.

A page of the new catalogue is devoted to the Igranic permanent-magnet moving-coil loud-speaker. Personally I think they should have devoted more than a page to it for it is a fine job. But probably Igranic think that it speaks for itself.

Anyway, all levity apart, I strongly advise you to get the new Igranic catalogue. **287**

PRIMUSTATIC LOUD-SPEAKER

THERE is certainly a furore created by the new Primustatic loud-speaker. The mere fact that it is an electrostatic job is enough to bring it out of the ranks of ordinary reproducers so far as public interest goes, but as it really does work well, is good to look upon, and cheap withal, it is of outstanding interest.

Electrostatic loud-speakers in the past have needed a high energising voltage, but this new Primustatic job needs only 100 to 200 volts, and

this polarising voltage can be taken from the last valve of the set or supplied by a small rectifier or battery as the case may be. As no current is consumed through this polarising the question of supply, is not of great importance.

Several models are available, the Standard model being correctly matched for an output valve having an impedance of 4,000 ohms and the Super model matched to 2,000-ohm valves. **288**

A USEFUL TESTER

W^OE betide the "set doctor" nowadays who hasn't a ready means of fault-finding and of checking up the performance of valves and "juice" supplies. It isn't necessary to go in for anything very expensive in order to do this, and the Pifco de luxe All-in-One Radiometer is a gadget which I am sure you will find helpful in this way.

I'm not going to set out to give you the full list of jobs the Pifco tester can tackle. I will just tell you that in a folder which you can get free through my catalogue service there is a description of simple ways in which the meter can be used for

testing circuit continuity and for checking up such things as valve performance, resistance measurements, insulation tests and so on.

It is a high-grade moving-coil meter and it is claimed that at 125 volts the meter load is 1 milliamperere only. Thus it is possible to get a fairly accurate idea of the voltage on the screening grid of a valve, for the meter will be taking, itself, only just half a milliamperere. **289**

THESE CLASS "A" PARTS

I HAVE just had some interesting information from Partridge, Wilson & Co., the well-known manufacturers of Davenset mains transformers and power smoothing chokes. They are out to start a new idea in the construction of these parts, and the new Davenset Class "A" transformers and chokes look like being among the best on the market.

Mr. Wilson says that his aim is to produce in this class "A" range instruments better than any similar components yet manufactured. A number of important and very definite improvements have been made and covered by provisional patents. **290**

THE ALL-METAL WAY—1933

N^OW comes the 1933 edition of the Westinghouse "All-Metal Way" It is even better than the previous issues for it not only tells you how to build mains units and battery chargers with Westinghouse metal rectifiers, but it gives a lot of interesting facts about mains working.

The rectifiers for each mains job are illustrated and there are simple circuits showing how they can be connected up with mains transformers, and, in some cases, smoothing circuits. One of the difficult jobs, usually, in designing a mains unit is to find the right transformer for the rectifier used. But the Westinghouse

booklet cuts out this difficulty for there are detailed tables in connection with each mains unit showing suitable transformers.

In the technical section of the book there are notes which help you to find the correct resistance and condenser values for smoothing circuits and for obtaining automatic grid bias.

Altogether I feel sure that the 1933 edition of the "All-Metal Way," with its sections on using the new H.T.9, H.T.10, and H.T.11 rectifiers, and the new low-tension units, will be of outstanding interest to mains users.

Applications for copies of "The All-metal Way—1933" must be sent direct to the Westinghouse Brake and Saxby Signal Co., Ltd., of 82 York Road, King's Cross, London, N.1; mention should be made of "Wireless Magazine" and stamps to the value of 3d. must be enclosed.

POLAR



CONDENSERS

Specified for the
"TABLE QUAD"

POLAR "STAR" 3-GANG CONDENSER

The condenser, specified and used for the above receiver, is one of the latest range of Polar "Star" Gang types. It is because of their outstanding features (as detailed below) that set designers, do without hesitation, specify them for modern circuits having gang control.

These condensers are the product of men who have specialised for several years in the design and construction of condensers for every radio purpose.

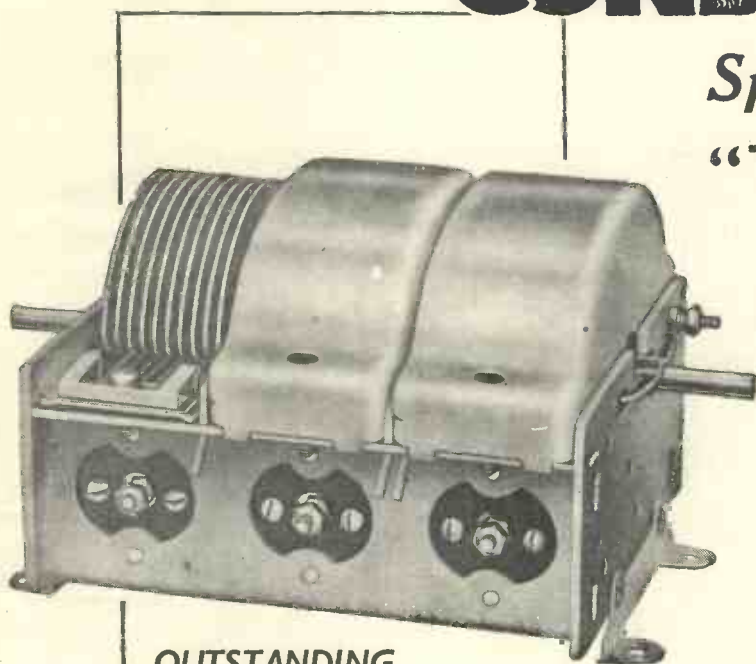

OUTSTANDING FEATURES:

TRIMMERS. Conveniently operated from the top and cannot go out of adjustment.

VANES. Accurate spacing is obtained by precision machine assembly, entirely eliminating the possibility of error.

MATCHING. This is accurate to within half of 1 per cent. plus or minus 1 mmfd.

FRAME. All-steel frame and rigid construction ensures that this accuracy will never vary.

BEARINGS. Strong spring journal bearings give absolute freedom from shake or endplay.

P R I C E

25/6

INCLUDING COVERS

Super-Het Type 27/6
 Two sections .0005,
 with one tracking section.
 4 x .0005 .. 34/-
 All prices include covers
 Disc Drive .. 5/-
 Drum Drive .. 7/6

Complete Polar Catalogue W.2 sent free on request.

WINGROVE & ROGERS, LTD
 188-9 STRAND :: LONDON :: W.C.2
 POLAR WORKS - - - OLD SWAN, LIVERPOOL

Representative for France: W. A. Swift, 6 Rue Duquerry, Paris XI.
 Correspondence in all languages.



Speedy replies result from mentioning "Wireless Magazine"

"Automatic Volume Control"

Owing to a misunderstanding on the part of a draughtsman, the diagrams for P. Wilson's articles on automatic volume control (page 354 of October, and page 462 of this issue) were drawn with battery valves instead of the indirectly-heated mains type. To avoid confusion, the complete set of corrected illustrations is reproduced here

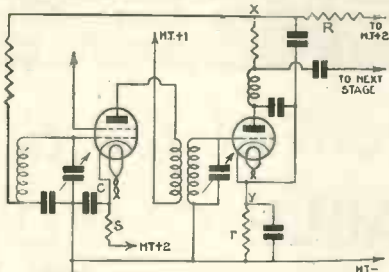

Fig. 3.—Another skeleton circuit of an automatic volume control

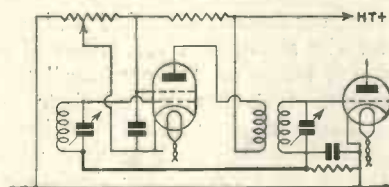

Fig. 6.—Variable-mu screen-grid valve with manual volume control as well as automatic control

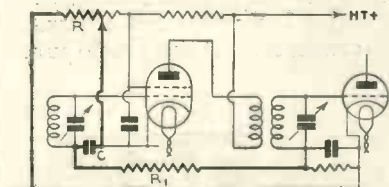
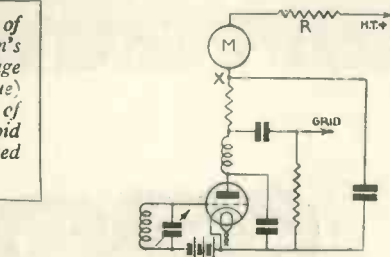

Fig. 7.—Similar to Fig. 6 with the addition of a by-pass condenser C



(Left) Fig. 1.—Circuit of a straight-forward anode-bend detector arrangement

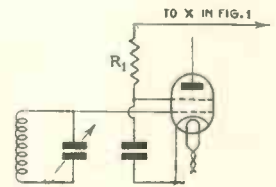

Fig. 2.—Skeleton circuit of a automatic volume control

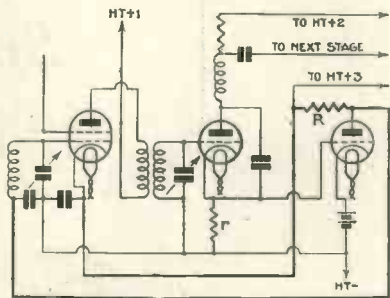

Fig. 4.—A system of automatic volume control that has a wide range

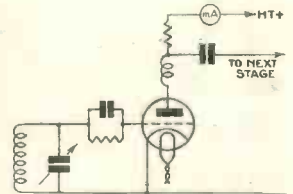

Fig. 5.—Conventional leaky-grid detector circuit with milliammeter

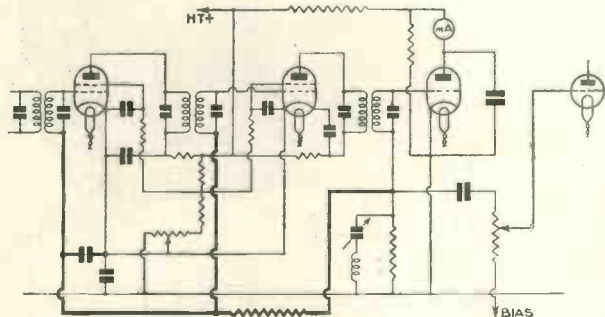

Fig. 8.—Automatic volume control applied to the intermediate-frequency stages of a super-het

Notes and Jottings

BELLING & LEE, LTD., have recently opened a new factory on the Cambridge Arterial Road, Enfield, where 250 girls are employed in turning out a quarter of a million small parts every day and where sixteen million parts are always kept in stock. Eighty-five per cent. of the output from this factory is absorbed by manufacturers for commercial receivers.

During a recent visit we were very much impressed by the appearance of the new factory and the general sense of efficiency that pervades the atmosphere.

Special models of H.M.V. radio gramophones and receivers can be obtained for unusual voltages and frequencies at slightly higher prices.

For use on frequencies between 25 and 40, and 60 and 100 cycles the extra cost varies between £2 2s. for radio gramophones to 17s. 6d. for the Super-het Lowboy Seven. The standard voltage of H.M.V. instruments is 200 to 250 volts, but radio gramophones and receivers can be supplied for operation on 95 to 260 volts at an extra cost of 10s. 6d. for each instrument.

In the list of parts for the Table Quad, on page 493, the disc drive for the Polar condenser has been omitted. The model required is the Polar disc drive and the cost is 5s. In the same list of parts the W.B. valve holders are priced at 8d. each. These are now 6d. for the four-pin type and 8d. for the five-pin type.

An error occurs in the component list for the "W.M." Short-wave Super on page 512. The price of three T.C.C. 1-microfarad condensers should read 8s. 6d., not 2s. 10d., which is the price of one.

THROUGH
PROGRESSIVE
STAGES
OF
AMPLIFICATION

VALVES
GIVE THEIR
BEST —
POWERED WITH

EVER READY

BRITAIN'S BEST BATTERIES

The advertisement features a central graphic of a vacuum tube with four curved electrodes on the left and a central filament on the right. The text is arranged in a dynamic, overlapping layout around this central image. The words 'EVER READY' are prominently displayed in a large, bold, outlined font within a rectangular frame. Below it, 'BRITAIN'S BEST BATTERIES' is written in a smaller, solid font within a similar frame. The overall design is high-contrast and typical of early 20th-century technical advertising.

There is an Ever Ready battery specially made to power each and every set properly. Write for list to

THE EVER READY CO. (GT. BRITAIN) LTD., HERCULES PLACE, HOLLOWAY, LONDON, N.7.

Advertisers take more interest when you mention "Wireless Magazine"

IMPROVEMENTS THAT MATTER

in the New Season's Sets

In these notes ALAN HUNTER reviews the latest developments in commercial receiver design and explains their advantages to the user. Every prospective buyer of a new set should carefully follow his remarks. Reports on the performance of five new sets appear on pages 470-474

WITH all the important radio shows over we can now estimate the value of the developments seen in the new sets. Although the season is devoid of sensational developments and novelty attractions there has been a great deal of solid research work by the leading makers.

Improved Performance

In general, set users with new models will find that the performance for a given number of valves is definitely better than last year, due to the improved characteristics and modifications in the construction of the valves.

Probably the greatest single factor in the improved performance of the new sets is the variable-mu type of screen-grid valve, which has practically ousted the ordinary screen-grid from all but the simplest of sets.

As most readers must know by this time, the variable-mu valve provides us with a distortionless control of the output volume. This is done by varying the amplifying properties of the valve, by varying the grid-bias voltage.

Another advantage of the variable-mu valve, though not so obvious, is that interference known as cross-modulation is eliminated. This

means better selectivity with less costly tuning apparatus. The biggest boon of the variable-mu is seen in the multi-valve sets, such as the super-hets and sets with two stages of high-frequency amplification.

At first it was thought that this year would see the super-het rising supreme over all other systems for multi-valvers, but the coming of the variable-mu screen-grid valve has paved the way not only for worthwhile super-hets but for "straight" sets having enormous high-frequency amplification. Indeed, recent tests show that the well-designed straight four- or five-valver rivals the five-valve super-het in sensitivity and falls short very little in selectivity.

The variable-mu, though mostly used in mains sets, has also been developed for battery sets, and several of the better class battery sets of the new season have a variable-mu preceding a detector coupled to a high-efficiency pentode. Such sets are selective and have a good control of the volume output.

Valves, as might be imagined, largely determine the trend of set design. The coming of the non-microphonic detector has solved one of the problems of the self-contained

set. Previously it was often found that a very sensitive detector valve inside a cabinet housing the chassis and the loud-speaker caused microphonic noises in the reproduction, sometimes entirely drowning speech or music.

Rigid Construction

This trouble has been overcome by the new rigid construction adopted by the leading valve makers in the assembly of the electrode system, particularly with detector valves.

This year there is a remarkable absence of sets for external loud-speakers. It is difficult to find a good set that can be used with an existing loud-speaker. Nearly all the important models have some form of self-contained loud-speaker, usually of the moving-coil type. Provision is made for the external connection of an extra loud-speaker, but often this facility is obviously an afterthought.

Out of Circuit

Some few sets work on the principle that when the loud-speaker plug is inserted the internal loud-speaker can, if desired, be cut out of circuit. This ought to be the standard arrangement, but all too often it is not possible to use an external loud-speaker without the internal one.

The design of this year's cabinets has not received the attention we might have expected. Very small cabinets are obviously not conducive to the good reproduction of bass notes. In fact, mid-get-cabinet construction, as would seem to be standard practice at the present time, tends to produce a "boom" that could be eliminated only by in-

(Continued on p. 534)



A DELIGHTFUL STUDY

Typical of the pleasure that can be derived from radio—listening to music reproduced from a Pye receiver

G.E.C. Radio

**SUPREMACY
IN RADIO**

TWO MODELS OFFERING SUPERLATIVE QUALITY *at a price you want to pay*

**ABSOLUTE
RELIABILITY—
SUPERLATIVE
PERFORMANCE**

REAL ENGINEERING CONSTRUCTION

**GECOPHONE
All-Electric
Radio Receiver
(For A.C. Mains)
"GALA" Model**

Cat. No. BC3335

PRICE 18
including
OSRAM
VALVES
and Royalty
GNS.

HIRE PURCHASE: Deposit
£2 os. od. and 12 monthly
payments of £1 10s. od.

MADE IN ENGLAND

**GECOPHONE
All-Electric
Radio-Gramophone
(For A.C. Mains)
"CARNIVAL" Model**

Cat. No. BC3338

PRICE 30
including
OSRAM
VALVES
and Royalty
GNS.

HIRE PURCHASE: Deposit
£2 12s. 6d. and 12 monthly
payments of £2 12s. 6d.

Sold by all Wireless Dealers

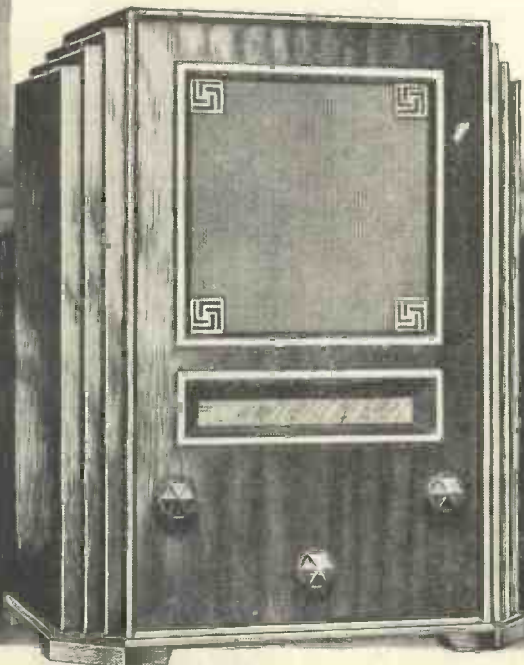
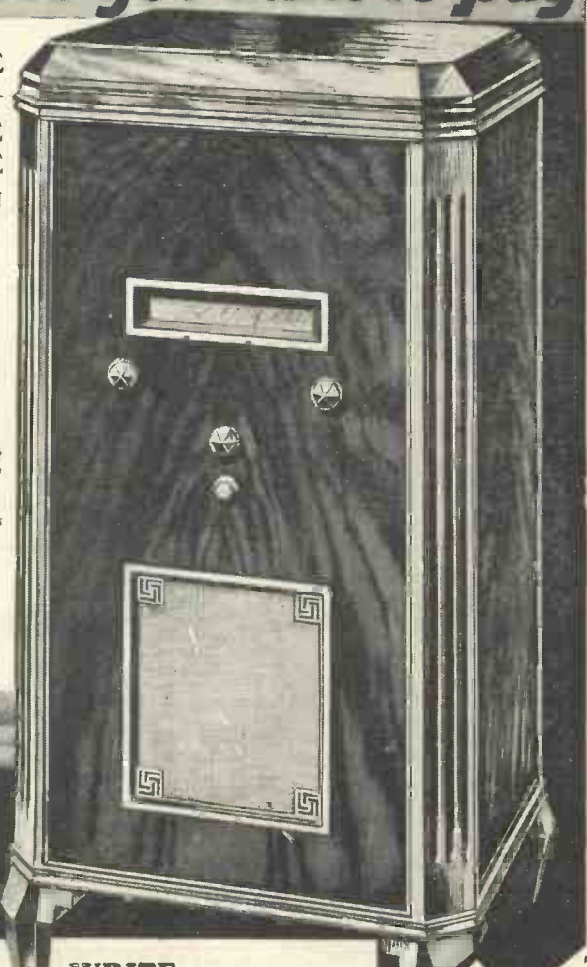

**BETTER RADIO FOR THE
DISCRIMINATING LISTENER**

WRITE for folder BC 6312.
This is a most comprehensive
production giving the fullest in-
formation regarding G.E.C.
Radio products. It merits the con-
sideration of everyone who demands
the finest reception. The coupon
is for your convenience. Make
a leisureed choice, but be
sure it is GECOPHONE

COUPON

Please send me Folder No. BC 6312 giving particulars
of GECOPHONE Radio Receivers and Loud Speakers

Name _____
Address _____

The General Electric Co. Ltd.
Magnet House,
Kingsway,
W.C.2

W.M.
Cut out and paste on a postcard, or
enclose in unsealed envelope, 1d. postage.

Advt. of The General Electric Co. Ltd., Magnet House, Kingsway, London, W.C. 2

Better service results from mentioning "Wireless Magazine" when writing to advertisers

IMPROVEMENTS THAT MATTER—Cont. from page 532

creasing the size of the cabinet or by lining it with some sound-absorbing material, such as slag wool.

Many of the leading chassis are available in either straight radio sets or as radio gramophones. The latter are housed in pedestal cabinets, taking not only the chassis but the loud-speaker and all the gramophone accessories. The larger cabinets certainly give the loud-speakers a better chance to bring out the bass without boom, as anyone can prove by direct comparison.

Loud-speaker Experiments

In radio gramophones there is room to experiment with loud-speakers in a way that would be impossible in the midget-table cabinets. For example, more than one of the latest radio gramophones incorporates two moving-coil loud-speakers, one accentuating the top notes and the other the bass, so producing a much better overall tone than is possible with the compromise in design that has to be adopted with a single loud-speaker.

Listening to these dual loud-speaker models brings out the fact that, quite apart from the improved frequency range of reproduction, there is more realism in reproduced music coming from more than one point. In America, where the dual loud-speaker idea has been widely adopted this year, still further elaboration is shown by the inclusion of three loud-speakers, presumably to improve the sound distribution.

If this idea is to be followed with equal enthusiasm in this country we shall have to enlarge our cabinets. Much larger table cabinets would be rather cumbersome, but there seems to be no logical reason why we should not go in for pedestal cabinets for straight radio sets, just as we do now for radio gramophones.

One of the most outstanding trends of the year is the increased attention paid by the set makers to the needs of those without mains. Battery sets must always be a compromise between practicable running costs and performance in terms of volume output. This year there has been a

determined attempt to meet normal needs by the production of band-pass three-valvers, super-het portables, and sets of generally high performance on the high-frequency side.

On the low-frequency side the makers have seen fit to put economy of operation before volume output. That is to say, they have chosen the most economical form of power valve, the pentode, and limited the output accordingly. The result may not come fully up to every expectation, but it is difficult to see how any greater undistorted volume could be obtained without very considerably increasing the running cost, as by replacing the small standard-capacity battery delivering around 10 milliamperes with a triple-capacity battery giving 20 or 30 milliamperes.

Marvels of Economy

Most of the battery sets are marvels of economical running. With five or six valves the total current is often kept down to 10 milliamperes, without loss of high-
(Continued on page 536)

RADIO POWER PLANT MACHINES FOR EVERY NEED

ROTARY TRANSFORMERS

Models for All Purposes! D.C. to D.C. Models for supplying H.T. Current to Large Public Address Amplifiers, etc. D.C. to A.C. Models for operating A.C. Receivers and Radiogramophones from D.C. Mains.

ANODE CONVERTERS

Give H.T. from L.T. Battery! Special Models for:- McMichael, Phillips, Eddystone and G.E.C. Short-Wave Receivers.



LOOK FOR

THE NEW SYNCHRONOUS GRAMOPHONE MOTOR
THE NEW MAINS TRANSFORMER

Write NOW for Illustrated Literature and Technical Catalogue from
Rotax Radio Dept. (7), Willesden Junct., London, N.W.10.

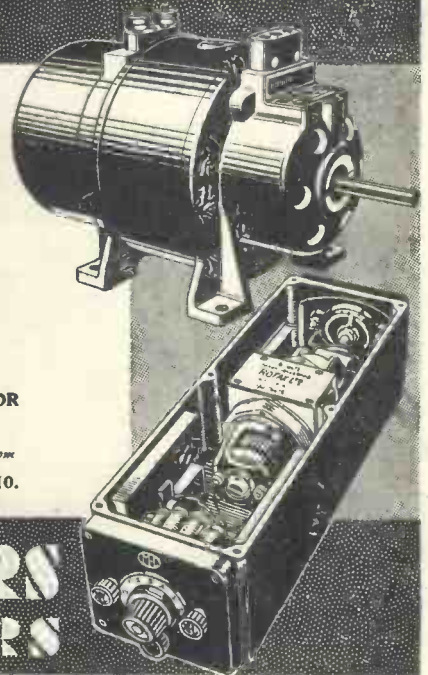

ROTARY TRANSFORMERS & ANODE CONVERTERS

Years ahead of modern radio practice

LOTUS

You must See and Hear these Wonderful Receivers
Let Your Dealer Demonstrate in Your Own Home FREE !

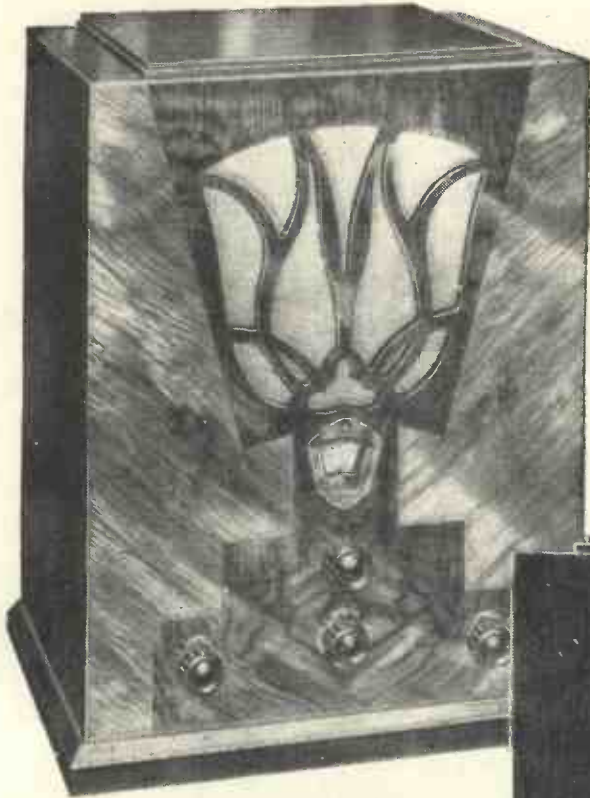

Write now for full details of this
Band Pass Mains Three-valve
Model, A.C or D.C.
16 Gns.

And Five other Great
Models from 19/9 down.

31/6
SECURES

Here's the Coupon
Post it now
**1/2^d STAMP ONLY IF
ENVELOPE IS UNSEALED.**

To Lotus Radio Ltd., Mill Lane, Old Swan,
Liverpool.

Please send details of Lotus Sets and Components to:—

Name

Address

W.M. 10.

N.B.—If you would like a booklet "Choosing a
Wireless Set," enclose 3d. in stamps.

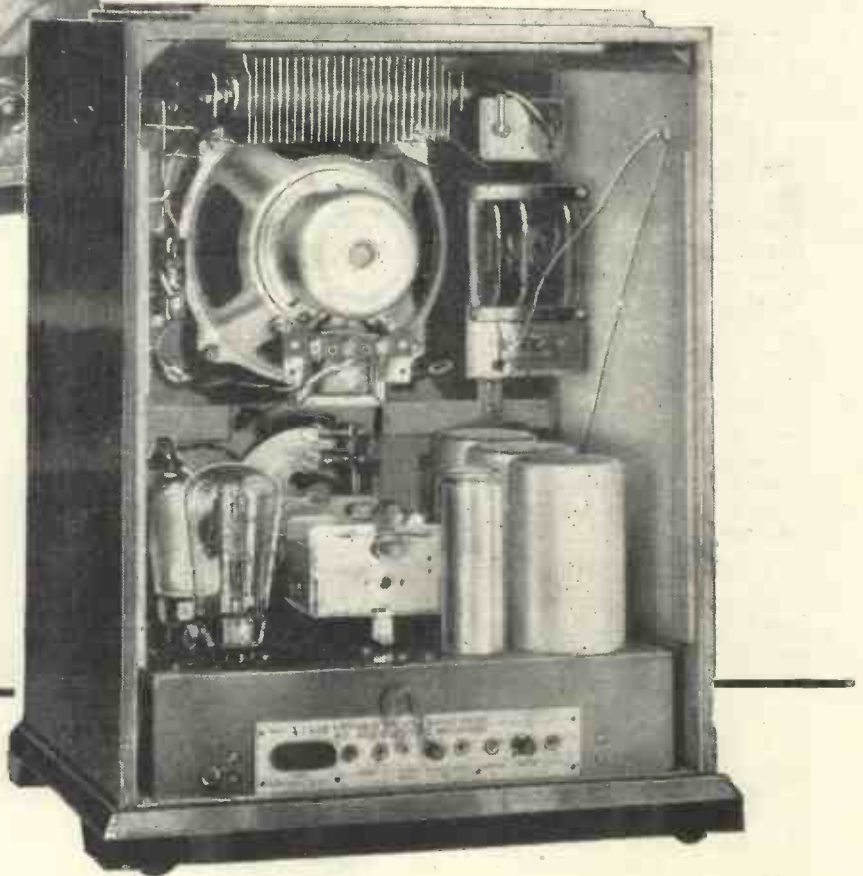

LOTUS RADIO LIMITED - MILL LANE - LIVERPOOL

Better service results from mentioning "Wireless Magazine" when writing to advertisers

IMPROVEMENTS THAT MATTER—Cont. from page 534

frequency performance, only a limitation of volume output. One set has a special valve to keep down the anode current, which shows that the big idea of the set makers is to produce battery sets that can be run for the minimum expense.

Among the technical developments

when the alternative is so obviously less bearable?

This is the first year when a widespread attempt has been made to overcome tuning difficulties. The main method of simplifying the tuning seems to be the provision of an illuminated dial marked in wave-

lengths. Ingenious systems are to be found even in quite moderate-priced sets. One set, for example, has a travelling beam of light behind

Automatic Volume Control

made to improve the sensitivity of this year's sets. First signs that one or two of the snags that were hitherto considered insuperable in distant-station reception are being tackled.

For example, automatic volume control, by means of an additional valve biased to adjust the amplification according to the amplitude of the incoming signal, is to be found in more than one British receiver this year.

This system, which is widely practised in America, overcomes much

The Wireless Zoo:

The Tele-monkey

*The Tele-monkey's full of glee ;
A photographic fiend is he,
Though he is often roundly cursed
He always "snaps" us at our worst,
When we trip up on orange peel
And look as foolish as we feel,
Or when we chase an errant hat,
He, photographing us like that,
Shows the results by Television—
The creature should be sent to prison !*

LESLIE M. OYLER.

of the year must be mentioned tone control, which is not to be confused with tone correction. Some form of tone correction has, of course, been used in most well-designed sets for the past year or more, especially in sets with pentode power valves.

Tone control, effected by an additional knob on the set, is now coming into favour for two reasons. Firstly, it is known that the pitch or timbre suitable for speech may not be equally suitable for music. Some means of altering the frequency response to meet the differing requirements of clarity in speech and balance in music is obviously desirable.

Technical Difficulty

Above this consideration we must bear in mind the increasing congestion of the ether, which makes the reception of foreign stations at anything approaching the quality of the locals a matter of technical difficulty.

Tone control, by cutting down the higher audible frequencies so essential to really perfect reproduction, enables many foreigners to be tuned-in clear of heterodynes and other interference. If the quality is a little impaired who will complain,

the scale, instead of a pointer on a fixed dial, or a fixed pointer and a travelling dial.

That foreign-station reception is no longer regarded as the "freak" part of wireless entertainment is proved by the vast efforts

made to improve the sensitivity of this year's sets. First signs that one or two of the snags that were hitherto considered insuperable in distant-station reception are being tackled.



PRESS-BUTTON TUNING

The Zetavox Model APT console receiver, which has two variable-mu's, screen-grid detector and pentode output valve. The inset shows the press buttons for the reception of nine selected stations

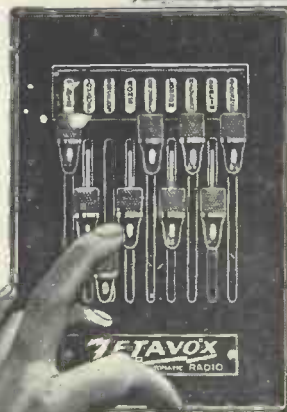

of the fading that is so commonly found in the reception of any station more than 100 miles from the receiving point. At present the idea is limited to the ambitious sets, but in time it may become accepted in some form or another for every set that has foreign-reception pretensions.

BE UP-TO-DATE

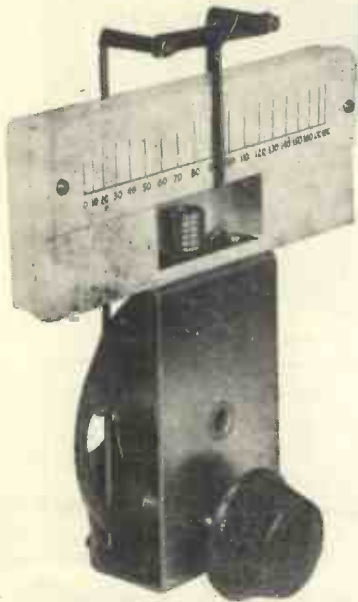

Modernise your set by fitting the new Utility Straight Line Dial, a dial that makes any other form of tuning control obsolete.

The whole of the scale is exposed to view and illuminated. No bending up to a dim and distant future or turning back to a murky past. The whole of your tuning

range always before you—to be read at a glance.

Obviously the common-sense method of tuning is to have a moving pointer traversing a stationary scale. That is the essential feature of this new Utility dial. But ask your dealer to show it to you and judge for yourself.

From your dealer or post free from the makers

PRICE 7/6
complete with Escutcheon.
6d. extra if fitted with panel lamp indicator.

WILKINS & WRIGHT LIMITED

UTILITY WORKS, HOLYHEAD ROAD, BIRMINGHAM

Agents.—London: E. R. Morton, Ltd., 22 Bartlett's Buildings, Holborn Circus, E.C.4.



Belmont

THE BECKER SWITCH FOR THE "PROSPERITY 3"

The Becker type 460 is a most efficient quick make-and-break sunk switch in bakelite, rated at 4 amps.

The design and movement are a definite advance in switches for Radio, and the Becker switch is a first-class electrical job.

Rated at 4 amps., tested at Faraday House to 29 amps!

Type 460, 1s. 10d. Specified for the "Prosperity 3" Battery Model.

Type 462, 2s. 3d. Specified for the A.C. and D.C. Mains Model.



TYPE 460 1/10

If you find any difficulty in buying Becker Switches please write to us.

GEO. BECKER, LTD.
AMPERE WORKS, WEMBLEY, MIDDLESEX
Telephones: WEMBLEY 3737

ROLA

DUAL BALANCED PAIRS

Specified for and Used in the

"DUAL-SPEAKER AMPLIFIER"

described in this Issue

ROLA SPEAKERS
for better Radio Reception

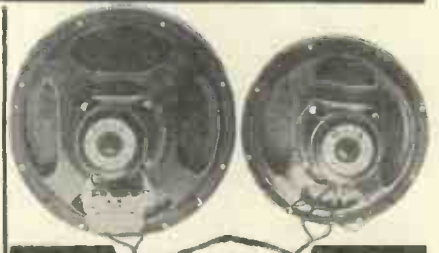

Rola Dual Balanced Speakers have been supplied FOR SEVERAL MONTHS past to various Radio Manufacturers.

These speakers are so constructed as to secure a degree of tonal fidelity which no single speaker can possess. The inherent frequencies and resonant points balance out, resulting in almost perfect reproduction over the whole harmonic scale.

These pairs consist of two F5 (6 in. cone) Speakers at £2 16s. 6d. the pair, or two F5 (6 in. cone) Permanent Magnet Speakers at £3 7s. 6d. the pair, or two F6 (7 1/2 in. Cone) Speakers at £3 10s. the pair, or one F6 (7 1/2 in. Cone) and one F7 (9 in. Cone) Speaker at £4 5s. the pair, or a balanced pair of Permanent Magnet Speakers (7 1/2 in. Cone) at £5 2s. 6d. All pairs are complete with Transformer suitable for triode or pentode valve.

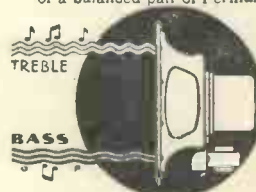

THE BRITISH ROLA CO., LTD.
Bronesbury Works,
179, High Rd., Kilburn, N.W.6
Telephone: Maida Vale 5017-8-9

Advertisers take more interest when you mention "Wireless Magazine"



KENNETH ULLYETT reviews the latest methods of overcoming interference caused by electrical apparatus that have been developed by the Post Office in conjunction with the B.B.C. engineers

DURING the winter the B.B.C. and the Post Office have to fight a very keen battle against man-made static. Immediately official summer-time ended the number of flashing signs, neon lights, and inter-

mittent contact indicators went up by leaps and bounds.

by the Post Office and the B.B.C. to track down the source of interference reported by listeners, and the most sincere steps are taken to mitigate it. No matter whether you write to the Post Office or to the B.B.C. about local interference, you will receive a long form on which you will be asked to fill in certain details likely to assist the interference investigators. The salient points of this form are shown in the panel reproduced on page 540.

It is essential that this actual form be filled in. It will not do to write to the B.B.C. or the Post Office and give details to the best of your knowledge. The form itself must be filled in as it is part of the comprehensive indexing scheme by means of which a check is kept on interference complaints from every part of the country.

If you write to the B.B.C. about interference you will be given a special white form which, on its return after the details have been filled in, is sent either to the

local P.O. engineering staff or, in special cases, to the engineer-in-chief's headquarters staff.

At the present moment, the total number of cases of electrical interference dealt with each year is approximately 10,000, of which 3,000 are received by the B.B.C., and sent on to be dealt with by the Post Office engineers.

Post Office Scheme

The B.B.C. does not do any technical investigation. The Post Office has a complete scheme for tracking down interference and for curing flashing signs, motors, battery chargers and all kinds of electrical apparatus which cause radio interference.

The interference is tracked down by one of the travelling "plain" vans of the Post Office. This may take a week in bad cases. There

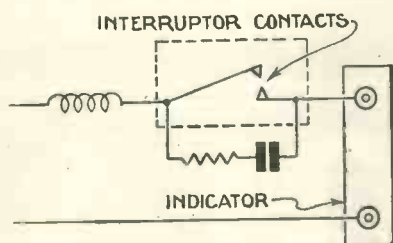

FLASHING SIGN
Interference from a flashing sign can be cured by means of a high-frequency choke and a condenser-resistance combination across the switch contacts

The B.B.C. is being inundated with complaints of interference and requests for help in tracking it down. Even in the summertime there is a high level of correspondence on this difficult problem. For surgical apparatus, lifts and mains interference are always with us; but immediately the long dark evenings started, the consequent increase in interference owing to flashing signs caused the B.B.C. and the Post Office experts to have a busy time.

Nothing is left to chance.

Well Sponsored Scheme

Although there is no law which can compel the Post Office to close down an offending source of radio interference, there is, nevertheless, a complete scheme sponsored both

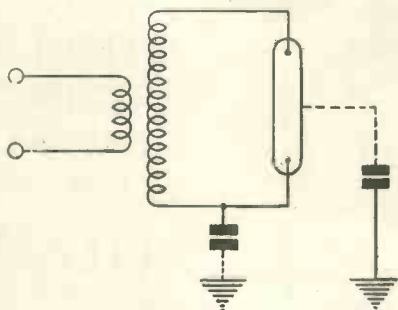

HIGH-FREQUENCY APPARATUS
A filter system for use with high-frequency electrical gear, such as "violet-ray" apparatus used in the home

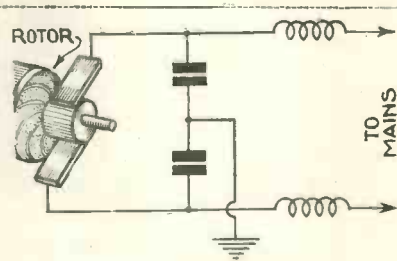

SILENCING THE MOTOR
A different filter system developed for cutting out the interference caused by electric motors—a common cause of trouble

have even been instances of reports by listeners of "serious interference"—and after investigation, and after the Post Office van has

(Continued on page 540)

JUST ATTACH UNIVOLT TO YOUR RADIO SET



Univolt is needed in every home where there is Radio. Connected in an instant, it reproduces electrically all recorded music through your Radio with full clear beautiful volume... giving the performance of an expensive Radio-Gramophone at the least possible cost. Equipped with a controllable speed motor and the super-sensitive Univolt Pick-up. The case itself is made of solid walnut grained bakelite, effectively harmonising in any home. Univolt is only 2" high to top of turn-table.

STANDARD MODEL for A.C. Mains. With super pick-up with swivel head and weight adjustment, square law volume control and automatic start and stop. **5 1/2 G** without pick-up equipment and Start and Stop action **3 1/2 G**

Universal models for A.C. & D.C. mains 15/- extra in each case. Obtainable from most Radio Dealers. In cases of difficulty send direct giving name & address of your local Dealer.

INSTANTLY CONVERT IT TO A RADIOGRAM

without Cabinet or Mounting.

FULLY GUARANTEED TWO YEARS

Absolutely Self-contained. No Radio Interference. Silent and Uniform running. No Over-heating. Simple Voltage adjustment. Minimum Current consumption. Solid Walnut Grained Bakelite Case. Speed Control (70-90 r.p.m.). Invisible Rubber Insulated Feet. On-Off Switch. Flex and Plug-in Adaptor. Univolt Super Pick-up perfect Tracking, Swivel Head, Weight Adjustable Arm. Sensitivity and frequency response hitherto never attained. Square Law Volume Control. Automatic Start and Stop. Terminals to connect to Radio.

UNIVOLT ELECTRIC UNIT

REG'D TRADE MARK

Manufacturers and Patentes **UNIVOLT ELECTRIC LIMITED,** Balfour House, 119 125 Finsbury Pavement, London, E.C.2. National 0620.

LANCHESTER

The lowest priced Permanent Magnet Moving Coil Speaker on the Market Gives Perfect Reproduction

Send for List No. 314 which gives full details

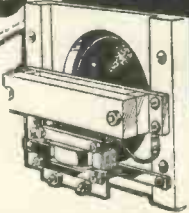

As illustrated, for the ordinary set.

25/6

For sets already fitted with suitable O.P. Transformer

20/-

SOME OTHER CHASSIS PRICES

	£	s.	d.
Super B.	-	-	5 15 0
Special Senior	-	3	3 0
Monitor	-	2	8 0
Junior	-	1	10 0

O.P. Transformers and Postage charged Extra

LANCHESTER'S LABORATORIES, LTD.

RADIO WORKS, SPRING ROAD TYSLEY BIRMINGHAM

'Phone: Acocks Green, 1404

UNIVERSAL!

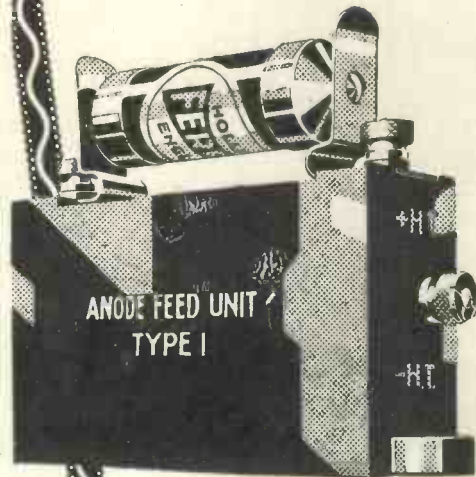

Type I. Resistance and 750v. D.C. Test 2 mfd. condenser.

Price: With Resistance (any size 2.5 watt up to 30,000 ohms.) 7/- Without Resistance .. 4/3

The anode feed system is now universally adopted as the means of avoiding the distortion and reduced volume due to back coupling.

The system was originated and developed by Ferranti, and it is perhaps only natural that the best means of applying the system is by the FERRANTI Anode Feed Units.

Occupying a minimum of space on the baseboard, the use of one neat component simplifies wiring.

Ferranti Anode Feed Units comprise silk insulated wire resistances wound on insulating bobbins, enclosed and finished in a high grade manner, combined with the Ferranti 750v. D.C. Test fixed condensers which have earned world-wide appreciation.

Write for full particulars and leaflet No. W.522/1.

THIRD EDITION N.W. and REVIS. 0



from all dealers or direct

FERRANTI ANODE FEED UNITS

FERRANTI LTD., Hollinwood, Lancashire.

LONDON: Bush House, Aldwych, W.C.2.

Advertisers like to know whence the business comes—please mention "W.M."

CURING MAN-MADE STATIC!—Cont. from page 538



ELECTRIC HAIR-CUTTER

How uncased condensers are built into small motors. This machine is part of a motor hair-cutter made in Germany

scoured the district, these have been found due to motor-boating in the set itself.

There is no law, as I have said, which can compel the owner of any offending apparatus to fit gadgets to prevent high-frequency interference, but generally the Post Office is able to see that there is an amicable settlement between the parties concerned.

Temporary Filter

When, say, a "noisy" motor has been located, the Post Office engineers get the owners permission to fit a filter to cut out the static. When this has been done to the satisfaction of local listeners, the Post Office engineer gives an idea of the cost of permanent apparatus to effect a cure.

If the owner will not go to the whole expense of fitting the filter, then some amicable arrangement between local listeners and the owner of the noisy motor is generally settled. There are only a few black list cases.

Simple Schemes

The Post Office claims to be able to cure practically every kind of interference, and before bothering the experts there is no reason why you should not try cutting out your local interference, using Post Office methods.

There are some simple connection

schemes for filters which cut out interference at the source, and these can be applied to motors, lifts, medical apparatus, flashing signs and neon lights. The two other main sources of interference, which, of course, are out of the scope of the ordinary listener to correct, are tramways and trolley buses.

I have shown some of the filter connection schemes here, and you can see how simple they are. They are the result of experience by the Post Office engineers, and to them the credit is due.

Take the motor-filter circuit, for example. Experience shows that motor interference does not generally extend beyond 200 yards and is heard only at that distance by very sensitive sets. The trouble is usually caused by sparking at the brushes, although there is a certain phenomenon known as "tooth" ripple, which is very difficult to cure without special tuned circuits.

Motor interference in the ordinary way is cut out by putting two fixed condensers in series across the

brushes and earthing the centre point. These condensers should be fairly large. Anything from 2 to 6 or even 8 microfarad; each is generally suitable. Chokes can be put in each of the mains leads still further to cut down the possibility of high-frequency leakage.

Good Earth Necessary

The earth from the mid-point of the condensers must be a good one and, of course, the condensers must be capable of standing up to the peaks of the mains voltage. The Post Office engineers always put fuses in the leads going to a filter of this kind.

A special investigation has been carried out by the Post Office engineers into interference set up by high-frequency apparatus. They find that this interference spreads up to about 300 yards and usually has a wavelength varying between 2,000 and 5,000 metres; broadly tuned, of course.

High-frequency gear of this kind is usually a bad source of interference as there is a huge aerial system formed through the wires on the secondary side of the medical apparatus. The Post Office engineers

(Continued on page 544)

ELECTRICAL INTERFERENCE QUESTIONNAIRE

1. Are you using a valve set or a crystal set? If valve, state number of H.F. and L.F.
2. Does your receiver draw any part of its H.T. or L.T. supply from electric-light mains?
3. Has your set or aerial, etc., been altered in any way prior to the commencement of the interference? (Please give particulars.)
4. (a) Are your neighbours simultaneously suffering the same interference as yourself?
(b) Is the proportion of interference to music the same in neighbours' receivers as in your own?
(c) To which British Broadcasting station do you listen most frequently?
(d) Is this station affected by the interference?
(e) Is the Davenry long-wave station, 5XX, affected?
5. Do you know, and can you give the address of any local listener who hears the interference at a greater strength (in proportion to the broadcast transmission) than yourself?
6. (a) Does the interference cease when you disconnect (1) your aerial (2) your earth, or (3) both? (Please ensure that your set is not oscillating when the aerial or earth is removed.)
(b) Have you examined your aerial and earth wires and connections for frayed strands or bad joints?
7. Are any of the following situated within 400 yards of your residence? If so, please state its approximate distance.
(a) Tram lines or trolley bus systems.
(b) Electric signs of the flashing electric lamp or crimson neon light pattern.
(c) Manufacturing works or garage employing electrical machinery.
(d) Hairdresser or medical establishment using electrical apparatus.
(e) A telephone exchange or overhead wires for the transmission of power.
(f) Refrigerating apparatus or other electrical domestic appliance.
(g) Accumulator charging station for car or wireless batteries.
(h) Laboratory for electrical research.
(i) Talking or silent film picture theatre.
(j) Power station.
(k) Lifts.
8. State periods when interference is most pronounced.
9. If you are not a new listener, has the interference suddenly commenced?
10. Can you give date when interference was first noticed?

WHAT TO DO IF YOU ARE TROUBLED WITH INTERFERENCE

Apply to the B.B.C. for one of their electrical interference questionnaires and answer the questions shown above. Answers MUST be given on the official form

YOU NEED A MOVING-COIL SPEAKER

You will never get the realism and quality that is there to get until you get a modern moving-coil speaker. You need the "Mansfield" permanent-magnet moving-coil speaker—W.B.'s latest and famous P.M.4. It gives true and brilliant reproduction from any 2 or 3 valve set. Price 42/- complete. Write now for the free art booklet "Speaking of Speakers."



PIONEERS & LEADERS

ALWAYS

Whiteley Electrical Radio Co., Ltd., Radio Works, Mansfield, Notts.

London Office 109, Kingsway, W.C.2

Recommended

for the
"Table Quad"

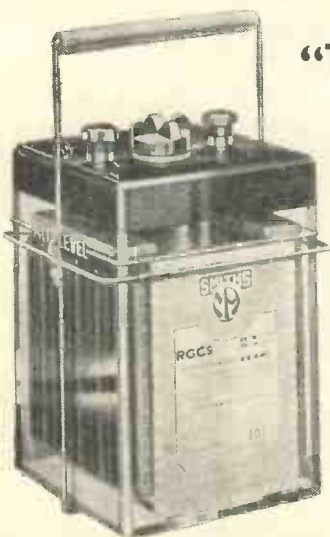

This standard multi-plate type Accumulator has been thoroughly tested and will give satisfactory service, even after constant usage. It has a glass container, non-interchangeable terminals and an extra large porcelain vent to allow for easy "topping up" of electrolyte.

Type. 2-RGC-9, 48 amps. Price 12/6 (complete with metal carrier).

SMITH'S ACCUMULATORS

"ANODEX"

Gives Realism



in Radio

Lack of power, "crackling," distorted reception are now definitely things of the past—thanks to "Anodex." This British Dry Battery brings an entirely new conception of radio technique, made possible only by long experiment and advanced methods of manufacture. Change to "Anodex" now and note the improvements in results.

H.T. PRICES :

120 volt	11/-	99 volt	9/-
108 volt	10/-	60 volt	5/6

"Anodex" Extra Power and Triple Power types are also available.

GRID-BIAS PRICES :

9 volt	1/-	16½ volt	1/9
---------------	-----	-----------------	-----

"Please write for Folders"

S. SMITH & SONS (Motor Accessories) LTD., CRICKLEWOOD, LONDON, N.W.2

NOW The NEW

and

TWO FREE GIFTS

October 29.—A FREE full-sized blackprint of the "New Century Super" will be given with every copy of this issue.

November 5.—A new and original Broadcasting Identification Chart, indispensable to every owner of a wireless receiver, will be presented FREE with this number.



CENTURY SUPER!

You remember the tremendous stir that the "Amateur Wireless" original "Century Super," designed by W. James, created in 1931. For months countless home constructors from all over the country have been asking for a new super-het and, more particularly, a new edition of the now world-famous "Century Super." Realising the difficulty of improving upon the original "super," three leading radio set designers, W. James, Percy W. Harris, and S. Rutherford Wilkins, were instructed to concentrate on producing a new "Century Super," for use with an outdoor aerial, that would be a "world beater."

They have succeeded.

The result of their combined efforts will be published in two special enlarged numbers of "Amateur Wireless," dated October 29 and November 5, (usual price 3d.). Do not miss reading about this "star" receiver. It will be *the* set of the season and will be the most talked of home-constructed receiver designed for many years. Order your copies of "Amateur Wireless" now, as there is sure to be a huge demand for these two numbers. Do not forget the dates—October 29 and November 5.

**OCT. 29 issue will be on sale
on Thursday, Oct. 27**

**NOV. 5 issue will be on sale
the following Thursday, Nov. 3**

CURING MAN-MADE STATIC!—Cont. from page 540



FITTED WITH A TROUBLE COMPENSATOR

German electro-therapeutic apparatus fitted with a double choke and condenser filter to cut out interference

have altered the wiring of these sets to reduce this interference, but it is difficult for the ordinary listener to do this as the owner of a medical outfit will not want his neighbour to probe about in the inside of the box!

Complete Metallic Screen

“There is another method of rendering such apparatus innocuous,” says the Post Office, “which involves the construction of a complete metallic screen large enough to enclose both the apparatus and the patient. The four walls, the floor and the ceiling of the room in which the apparatus is used are covered with wire mesh and two large condensers are connected in series across all electrical circuits entering the room, the middle point of such condensers being joined to the screen. A complete cure results.”

If you can persuade your sick neighbour to build a wire screen like this then you will have no more medical apparatus interference!

Flashing-sign Troubles

Flashing signs and neon lamps are bad sources of man-made static. Flashing signs, operated usually by a thermostat-controlled contact cause a “plop” to be heard in the speaker every time the contact makes and breaks. Where the flashing sign involves a network of wiring, the Post Office engineers have often

found it necessary to run parallel wiring as a screen.

Generally speaking, though, the interference can be cured by putting a high-frequency choke in series with the intermittent contact and a condenser and resistance quencher circuit across the contacts used.

Neon-lamp interference is difficult to check. You must first make sure what type of neon lamp is causing the interference. There are two kinds, high-frequency and low-frequency. For the former type frequencies between 50 and 150 cycles are used. The high-frequency

neon lamps are used in the side shop windows and in similar places where it would be dangerous to have the low-frequency type on account of the risk of shock.

Screened Transformer

Sometimes a metal screen can be built round the transformer to cut down interference and sometimes a very small capacity to earth can be tried at a suitable point along the neon tube. A ring should be put round the tube and connected through a condenser to earth. The ring can be moved along the tube to find the best position.

In some cases where neon lamps are used very close to a listener's set a low-frequency ripple is set up on the mains by these signs. This kind of interference only affects mains-driven sets, of course, and the cure is to increase the smoothing on the high-tension side of the set.

“The Dual-speaker Amplifier”

ARRANGEMENTS have been made for this unit, which is fully described in the supplement on modern loud-speakers that forms part of this issue, to be on view in Selfridge's Somerset Street windows throughout the currency of the number. The amplifier will be complete in the cabinet with the dual-balanced loud-speakers. There is no doubt that many constructors will wish to take advantage of this opportunity of seeing the Dual-speaker Amplifier for themselves.

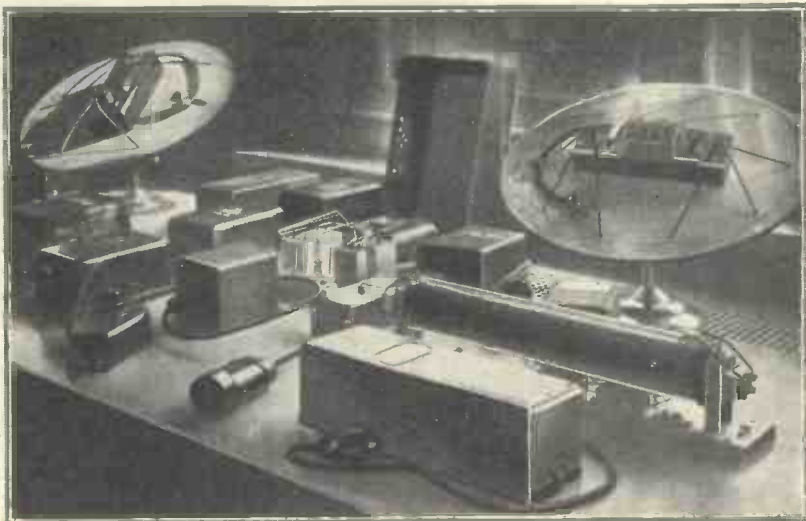

INTERFERENCE ELIMINATORS IN GERMANY

An exhibit of German apparatus for cutting out various types of electrical interference one of the greatest radio troubles in industrial areas

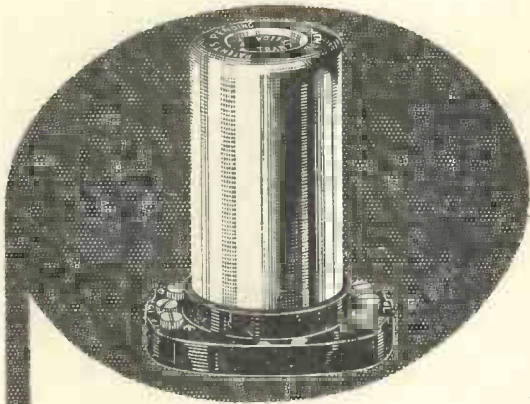

Make a note of it!

The Benjamin Transfeeda—the original resistance-fed L.F. Transformer—is specified in THE CALIBRATOR.

MAKE A NOTE OF IT!

The Benjamin Transfeeda can be connected up in any circuit in which an L.F. Transformer is specified or ordinarily used.

MAKE A NOTE OF IT!

Because of its carefully selected and matched elements, the Benjamin Transfeeda will bring out with startling clearness and volume every note in the musical scale. It will, in fact,

MAKE A NOTE OF IT!

May we send you List 1292, giving full details of the Transfeeda and the reduced prices of the famous Benjamin Sprung Valve Holders

11/6

BENJAMIN TRANSFEEDA

THE BENJAMIN ELECTRIC, LTD.,
TARIFF ROAD, TOTTENHAM, N.17

SAY "T.C.C."— for SAFETY



Here are illustrated the 2 mfd. non-inductive type condensers, price 3/10 each. Note the double mounting bracket—a feature of great importance for sub-chassis wiring. Made in capacities from .005 to 2 mfd. Working voltage 200 D.C.

It is simple enough to be **sure** of absolute reliability in the condensers you buy—just say "T.C.C." and you will get a condenser that is backed by a quarter of a century's specialized research work—a condenser that has won the approval of radio technicians and set designers the world over. . . . Judge for yourself—see the specifications of press receivers—look at the best of commercial sets—you will always find "condensers by T.C.C."

T.C.C.

ALL-BRITISH
CONDENSERS

The Telegraph Condenser Co. Ltd., Wales Farm Road, N. Aston, London, W.1.

♡ 1192

Mention of the "Wireless Magazine" will ensure prompt attention

TESTS OF NEW APPARATUS



Electone Automatic Programme Selector :: Lotus Three-gang Condenser :: Varitone Loud-speaker :: Peak Fixed Condenser

ELECTONE PROGRAMME SELECTOR

APPARATUS: Automatic programme selector.
MAKERS: F. J. Gordon & Co., Ltd.
PRICE: £1 7s. 6d.

THE Electone automatic programme selector is a device



PROGRAMME SELECTOR

By putting a pin in one of the twenty-four holes round the periphery, the set is automatically switched on at the right time

for switching on a set at a given time. It consists essentially of a simple spring-driven clock mechanism, having attached to the hour spindle a wiper which moves over studs arranged behind the clock face.

Around the periphery of the face are twenty-four small holes, corresponding to the studs behind, into which small spring pins may be inserted.

To switch on the set a spring pin is inserted in the hole opposite the required time. When the wiper comes round to the required point it makes contact with the stud and completes the circuit through the spring pin and the metal face of the clock. The contact continues for half an hour, after which it is broken

unless further pins have been inserted in the neighbouring holes.

Six pins are provided with the selector. The whole device is housed in a neat mahogany finished case, approximately 4¼ in. square by 2½ in. deep.

Since the circuit passes through the metal face of the clock, there is danger of shock when used with a mains set. To avoid this a special fibre front is provided which prevents the hand from coming into contact with the metal. We tried the clock on 250-volt A.C. mains and found that it made and broke a 60-watt circuit quite satisfactorily.

LOTUS THREE-GANG CONDENSER

APPARATUS: Three-gang variable condenser.
MAKERS: Lotus Radio, Ltd.
PRICE: £1 9s. 6d. with disc drive.

A VERY neatly made three-gang condenser which we have tested this month is that made by Lotus Radio, Ltd., of Liverpool. The condenser follows popular practice in that the fixed and moving vanes are mounted in a channel section metal framework with metal partitions between the sections and also at the ends. A novel feature is that the three sets of moving vanes are die cast in one unit with the main shaft of the condenser.

A slow-motion friction-drive dial having a reduction ratio of approxi-

mately 6 to 1 is arranged to work on either end of the shaft as may be desired.

The usual type of mica-dielectric compression trimming condensers are provided on the side, these being operated by hexagonal-headed nuts. A neat aluminium dust-cover is also provided.

The condenser was tested for matching between the sections and was found to be well up to standard in this respect, as will be seen from the table. The maximum capacity of each section was .00055 microfarad and the minimum approximately 40-micromicrofarads. The maximum capacity of the trimmers was approximately 90 micromicrofarads each.

Dial reading	Section 1	Section 2	Section 3
	Micromicrofarads		
100	550	552	550
80	326	325	325
50	205	206	206
30	127	127	127
0	40	40	40

(Continued on page 548)

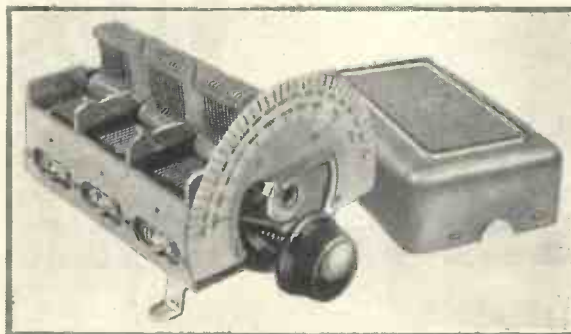

ACCURATELY MADE AND GOOD VALUE FOR MONEY
One of the latest Lotus three-gang condensers, made to a high standard of accuracy. Trimmers are mounted at the side

"PROSPERITY" BUILDERS

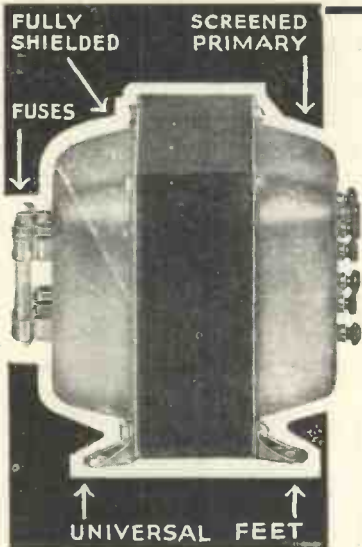

You will require
**THIS SPECIFIED
Sound Sales Super
Shielded Transformer
for your
"PROSPERITY
THREE"**

*Technical Specification:—
H. 8 Shielded Super. West-
inghouse Type. Primary
0-200, 220-240. H.T. Sec.
200-215. L.T. 2-0-2 volts at
3 to 4 amperes. D.C. Output
250 volts at 60 milliamperes.
Using voltage doubler circuit
with H.T.S. Rectifier. Valve
Rectifier Transformers of
similar design to follow.*

Full protection. Silent
operation. No mod-
ulation hum. Dead
accurate layer wind-
ings. Silicon steel core.
Low consumption.

WRITE FOR DESCRIPTIVE LIST "2" OF ALL SOUND SALES
PRODUCTS

SOUND SALES

LTD.

Tremlett Grove, Highgate, London, N.19
Telephone: Archway 1661-2

PRICE
25/-

The New H-8
Model for the
Westinghouse
H-8 Rectifier.
Specified
exclusively

SIMPSON'S ELECTRIC TURNTABLE



Outstanding features:

1. Only 2 1/2 in. deep.
2. Sizes 10 in. and 12 in.
3. Superior finish.
4. 50 Cycles, 100/150 and 200/250 volts A.C.
5. Costs less than 1/4d. per week.
6. Nothing to go wrong.

The famous Simpson Electric Turntable can be fitted in any Gramophone at little cost and no trouble. Starts and stops at the touch of the finger. Price 39/6. See it at your dealers or write for illustrated leaflet.

SIMPSON'S ELECTRICALS LTD.,
Grange Road, Leyton, London E.10

YOUR OLD COMPONENTS

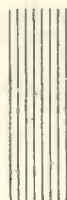

are worth money. Sort out the spare radio parts you no longer require and advertise them in the "Miscellaneous Columns" of **AMATEUR WIRELESS**. You will be surprised how quickly they will be snapped up.

Your announcement will cost you 3d. a word. Send your list of parts, together with your name, address and remittance, to:

"Small Advertisement" Dept.,

AMATEUR WIRELESS 58-61 Fetter Lane, London, E.C.

BRING IN THE WORLD

ON THIS ALL-WAVE
RECEIVER!

(Tunes down to 12 Metres)

The Kilodyne 4 is the voice of the world; it receives stations from every Continent and operates at loud-speaker volume. It opens up a vast new field of interest to the wireless fan.

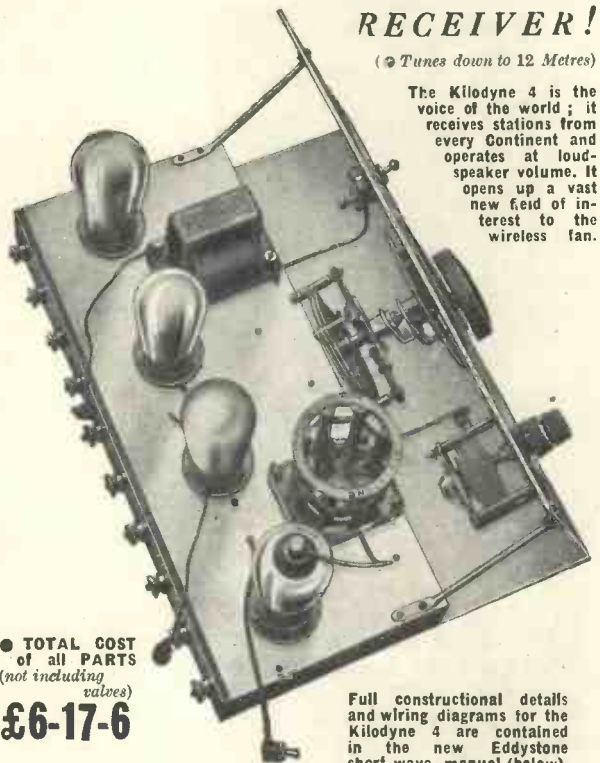

● TOTAL COST
of all PARTS
(not including
valves)

£6-17-6

Full constructional details and wiring diagrams for the Kilodyne 4 are contained in the new Eddystone short-wave manual (below).

The Kilodyne 4 tunes down to 12 metres and is adaptable up to 2,000 metres, incorporates S.G. H.F. amplification, absolutely no hand capacity, perfectly smooth reaction, one-dial tuning, has been designed by short-wave specialists and praised by leading short-wave critics. It is supplied complete ready for any home constructor to assemble easily, or the individual components are obtainable separately.

● FULL CONSTRUCTIONAL DETAILS ARE GIVEN IN THIS MANUAL.
Invaluable to S.W. enthusiasts.

THE
**KILODYNE
4**

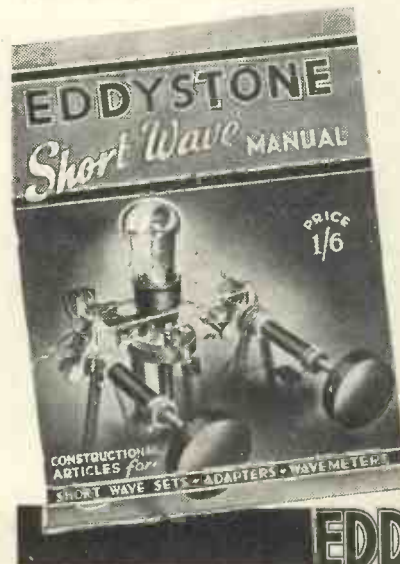

● "The Eddystone Short-wave Manual" includes fully illustrated constructional articles for building 2-, 3-, and 4-valve short-wave receivers, a 1-valve superhet. S.W. converter, a 1-valve S.W. adapter, a dynatron and heterodyne wavemeter, and a 7-metre ultra S.W. converter. List and cost of parts given in detail for each set. Articles on short waves, short wave tuning, S.W. condensers, trouble locating, etc.

PRICE 1/6 (Post Free)

STRATTON & Co. Ltd.
BROMSGROVE STREET,
BIRMINGHAM

EDDYSTONE Service Depot.—
WEBB'S RADIO STORES,
164 Canning Cross Road, W.C.2

EDDYSTONE

Better service results from mentioning "Wireless Magazine" when writing to advertisers

TESTS OF NEW APPARATUS—Cont. from page 546

This condenser is well made and should give excellent service in practice.



BALANCED-ARMATURE MODEL
The Loewe balanced-armature loud-speaker, which is housed in an attractive walnut cabinet

VARITONE LOUD-SPEAKER

APPARATUS: Balanced-armature loud-speaker.

MAKERS: Loewe Radio Co., Ltd.

PRICE: £2 2s.

WE have tested this month one of the new Loewe Varitone loud-speakers. This is housed in a handsome walnut-finished cabinet which would not be out of place in any surroundings. The movement is of the balanced-armature type and is provided with an adjusting

knob at the rear of the cabinet.

An interesting feature is the inclusion at the back of an impedance-matching switch having three positions, which enable the user to match the loud-speaker rapidly with the output valve of his receiver.

The impedance of the loud-speaker with the switch in position one was approximately 9,000 ohms; in position two, 3,000 ohms; and in position three, 2,500 ohms. These values cover all normal requirements, including pentode valves.

On an aural test the speaker appeared to have a good overall response, particularly in the bass. There is a main resonance in the region of 250 cycles, the response falling away on either side, but there is still adequate response at 5,000 cycles.

♦ ♦ ♦

PEAK FIXED CONDENSER

APPARATUS: 4-microfarad fixed condenser.

MAKERS: Wilburn & Co.

PRICE: 12s. 6d.

READERS will recall that we recently reported in these columns on the Peak fixed condensers manufactured by Wilburn & Co. This month we are reporting on a new addition to this range.

This consists of a 4-microfarad

fixed condenser arranged for a maximum working voltage of 800 volts D.C.

The construction of this condenser is similar to the earlier types, in that it is housed in a metal can provided with extensions at the base to facilitate mounting. Terminals and soldering tags are provided for the external connections.

The actual measured capacity of the condenser was 3.96 microfarads, a good agreement with its rated value.

The insulation resistance was too high for any accurate measure to be made, even after a full voltage run.

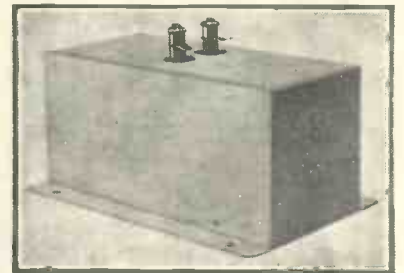

FOR 800-VOLT WORKING

One of the well-made Peak fixed condensers, which has a very high insulation resistance. It is designed for 800-volt working

This condenser is well made and can be recommended for use in any circuit, provided that the peak voltage does not exceed 800 volts.

THE TABLE QUAD—Continued from page 493

selectivity obtained when both coils are tapped at No. 4 is comparable with that obtained from a good super-het receiver.

Of course, the set must be ganged with the cover on the condenser itself and with the cans on the three coils. Any alteration to the aerial system will also mean that the first trimmer will need readjustment.

Simple Controls

The controls of the Table Quad are quite straightforward, as will be clear from the photograph on page 490. In the centre is the main tuning knob, with the volume control on the left. Volume is at its maximum when the knob of this control is turned as far as possible to the right, that is, in a clockwise direction.

On the extreme left is the wave-change switch, which in this case has a rotary motion. The knob is clearly marked "M.W." (medium

wavelengths) and "L.W." (long wavelengths).

On the right of the main tuning control is the reaction condenser, which is, of course, operated in the usual way. With this set it will not be necessary to force reaction to its limit except for the very weakest foreign stations—and then they will not be worth listening to!

It will be evident from the test

report, which was made before Summer Time came to an end, that the Table Quad has great possibilities. The reception of thirty odd stations at really good loud-speaker strength at the end of September means that very much better results will be obtained during the winter months, when radio reception conditions are at their best.

A Good-looker

The set as presented in these pages is efficient and is a "good-looker," as can be seen from a glance at the heading photograph on page 489. We have no doubt that the general lines of the design will appeal to a large number of constructors who want something a little better than the average three-valver and we shall look forward to receiving many reports on its performance from all over the country in the course of a few weeks.

Readers of "Wireless Magazine" are invited to send in reports on the performances of their receivers, whether they are built from details given in these pages or have been bought complete. In the case of "Wireless Magazine" sets, half a guinea is paid for each photograph of a home-constructed model used in these pages

FORMO MATCHED COILS

SPECIFIED for THE "WIRELESS MAGAZINE"

The Heart of a
BETTER Set....

"TABLE
QUAD"

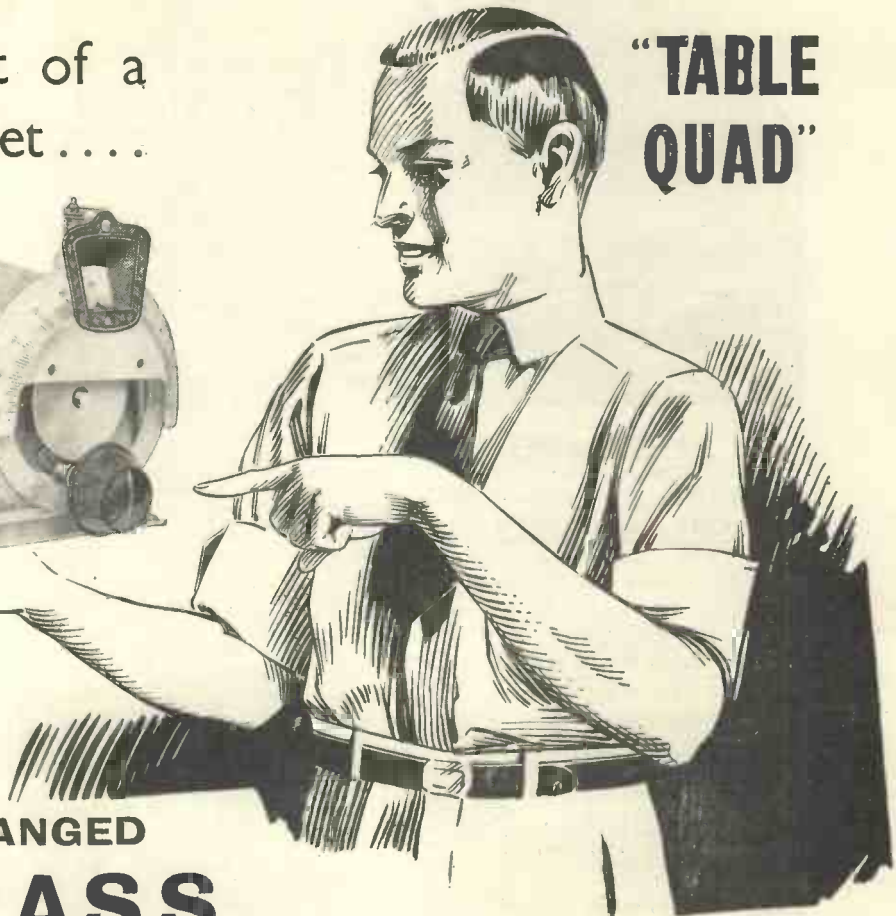
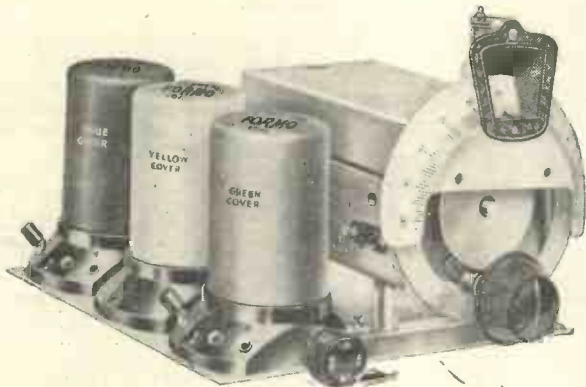

GANGED

BAND-PASS

Tuning Assemblies

The latest development in matched coils and condensers combined as one tuning unit—designed not only for constructors, but so that any set can be brought up to date with the finest in band-pass tuning. The matching of these assemblies is the nearest to perfection yet attained and the resulting selectivity is astonishing. Remarkable range of reception is obtained with a clear space between every station on the dial. Formo has stepped far ahead in accurate and efficient band-pass tuning units at a reasonable cost.

TRIPLE GANG Complete Assembly **46/6** DUAL GANG Complete Assembly **33/6**

If you have any difficulty in obtaining, please send us the address of your nearest dealer.

FORMO Head Office & Works:
Crown Works, Regents Pk., Southampton
London Office; 23 Golden Sq., Piccadilly Circus, W.1

The "MAKING" of
a better set

The FORMO MULTI COUPLER

This advanced L.F. Transformer Unit improves reception, provides an option of three different ratios, and has other advantages, including double screening, which enables it to be placed anywhere in the set without regard to H.F. or L.F. interference.

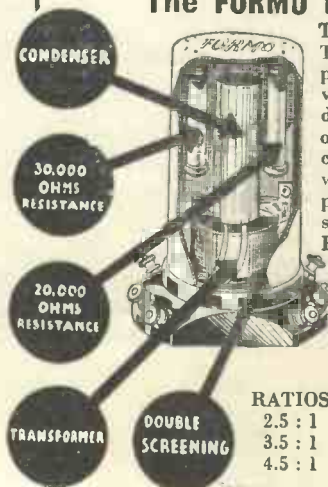

10/6

RATIOS
2.5 : 1
3.5 : 1
4.5 : 1



BUILD

Do you realise that, except for a small number in a range of more than 600, all "W.M." and "A.W." blueprints are full-scale drawings? They are not small-scale drawings which, as you know, are useless as patterns and templates.

Do you appreciate the fact that they save much time and trouble in construction, as they can be used as panel and baseboard templates for marking the centres for drilling holes and laying out components?

CRYSTAL SET

1931 Crystal Set AW308

ONE-VALVE SETS

Short-wave One-valver (6d.) AW327
 Easy-to-Build One AW304
 "B.B.C." One AW344
 Portable Short-wave One AW354

TWO-VALVE SETS

Ever-tuned Regional Two (D, Trans) .. WM241
 Station-finder Two (D, Trans) WM243
 Music-lover's Two (D, Trans) WM269
 New Economy Two (D, Trans) WM265
 Family Two (D, Trans) WM278
 Economy A.C. Two (D, Trans) WM286
 Screen-grid Two (SG, Trans) WM289
 Two for Seven Metres (D, Trans) .. WM295
 New Style Radiogram (D, Trans) .. WM299
 Big-volume Two (D, Pen) AW309
 "Two Star" Two (D, Trans) AW315
 25/- Two (D, Trans) AW330
 Ten Station Two (D, Trans) AW336
 Hiker's Two (D, Trans) AW345
 Inexpensive A.C. Two (D, Trans) .. AW346
 Midget Two (D, Trans) AW348
 Mascot Two (D, Trans) AW353
 Ideal Regional Two (D, Trans) AW357
 Quality 30/- Two (D, Trans) AW361

THREE-VALVE SETS

Meridian Short-waver (D, RC, Trans) WM255
 Five-Advantage Three (D, RC, Trans) WM257
 Everybody's Radiogram (SG, D, Trans) .. WM258
 Double Band-pass Three (SG, D, Trans) WM259
 Everybody's Radiogram (with Automatic Grid Bias) .. WM262
 New Economy Three (SG, D, Trans) .. WM263

Each blueprint shows the position of all components and every wire, and makes construction a simple matter. Copies of "Wireless Magazine" and of "Amateur Wireless" containing descriptions of most of these sets can be obtained at 1s. 3d. and 4d., respectively, post free. Index letters "A.W." refer to "Amateur Wireless" sets and "W.M." to "Wireless Magazine" sets.

New Plug-in-Coil Three (D, 2 Trans) WM270
 Transportable Three (SG, D, Trans) .. WM271
 Multi-Mag Three (D, 2 Trans) .. WM288
 Percy Harris A.C. Radiogram (D, RC, Trans) .. WM294
 Prosperity Three for Batteries (SG, D, Pen) .. WM296
 Prosperity Three for A.C. Mains (SG, D, Pen) .. WM297
 Prosperity Three for D.C. Mains (SG, D, Pen) .. WM298
 Square-peak Three (SG, D, Trans) .. AW293



A NOTABLE THREE
 The Wizard (A.W. 360) has been tested in all parts of the country and gives splendid results

Universal Short-wave Three (SG, D, Trans) AW301
 Olympian Three (SG, D, Trans) AW306
 Tonality Three (D, RC, Trans) AW321
 35/- Three-valver (D, 2RC) AW323
 Baby Three (D, RC, Trans) AW324
 World Wide Short-wave Three (D, RC, Trans) AW332
 New Favourite Three (D, RC, Trans) .. AW334
 Home Lover's All-electric Three (SG, D, Trans) AW335
 P.W.H. Mascot (D, RC, Trans) AW337
 Home Lover's Battery Three (SG, D, Pen) AW341
 New Regional Three (D, RC, Trans) .. AW349
 World-ranger Short-wave Three (D, RC, Trans) AW355
 Wizard (SG, D, Trans) AW360

FOUR-VALVE SETS

Economy Radio Gramophone (SG, D, RC, Trans) WM276
 A.C. Quadradyne (2 SG, D, Pen) WM279
 Ideal A.C. Home Super (Super-het) .. WM290
 Gold Coaster (AC Short-wave) WM292
 Triple-tune Four (2SG, D, Trans) .. WM293
 Calibrator (SG, D, RC, Trans) WM300
 ★Table Quad (SG, D, RC, Trans) .. WM303
 All-Europe Four (2HF, D, Trans) AW173

Stability Four (HF, D, RC, Trans) .. AW182
 3 3s. Four (SG, D, RC, Trans) AW303
 3 3s. Four (Improved Model) AW303A
 Four-star Four (SG, D, RC, Trans) .. AW318
 The 50/- Four (SG, D, RC, Trans) .. AW331
 Up-to-the-Minute Four (SG, D, RC, Trans) .. AW356
 Your Home Radiogram (SG, D, RC, Trans) AW358

FIVE-VALVE SETS

Regional D.C.5 (SG, D, LF, Push-pull) WM252
 Ideal Home Super (Super-het) WM280
 E svtune 60 (Super-het) WM284
 ★Easvtune 60 on a Frame Aerial (super-het) WM301
 ★"W.M." Short-wave Super (super-het) WM302
 Britain's Super (Super-het) AW311
 A.C. Britain's Super (Super-het) AW322
 "Mains section (1/-) AW322A
 James Short-wave Super-het AW328
 Simple Super (Super-het) AW340

SIX-VALVE SETS

Super 60 (Super-het) WM229
 A.C. Super 60 (Super-het Radiogram) .. WM239
 A.C. Super 60 (Super-het Table Model) WM245

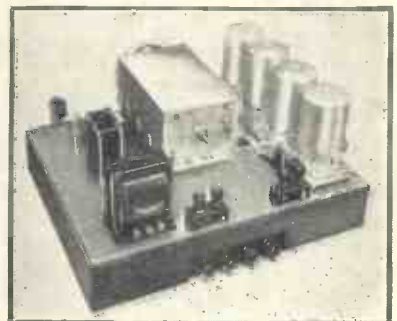

A FINE A.C. SET
 The A.C. Quadradyne (W.M. 279), which was recently described in "W.M.," is the last word in A.C. fours

Send, preferably, a postal order (stamps over sixpence in value unacceptable) to—

from a BLUEPRINT!

Further than this, do you know that all the connecting wires are numbered separately, so that they can be assembled easily and automatically?

Remember also that a blueprint of any set constructionally described in "Wireless Magazine" can be obtained for half price during the currency of the issue by using the coupon to be found on the last page.

"Wireless Magazine" and "Amateur Wireless" are the only papers that can supply full-size blueprints of every set described.



A QUALITY TWO-VALVER
The 30/- Quality Two (No. A.W. 361) is easy and cheap to build. It gives splendid results

- Super 60 (with Wearite Base) .. WM249
- Super 60 (with Lewcos Base) .. WM251
- 1932 Super 60 (Super-het) .. WM269
- 1932 A.C. Super 60 (Super-het) .. WM272

SEVEN-VALVE SET

1s. 6d., post free.

- Super Senior (Super-het) .. WM256

PORTABLE SETS

- Super 60 Portable (Super-het) .. WM238 1/6
- Home and Garden Three (D, RC, Trans) .. WM246 1/-
- Town and Country Four (SG, D, RC, Trans) .. WM282 1/6
- Everybody's Portable (Super-het) .. WM291 1/6
- General-purpose Portable (SGD, RC, Trans) .. AW351 1/6

AMPLIFIERS

All these 1s. each, post free

- Radio-record Amplifier (DC Mains) .. WM183
- Selecto Amplifier (HF Unit) .. WM210
- D.C. Fader .. WM242

- Quality Amplifier (D.C.) 1s. 6d. .. WM264
- A-P-A (Public Address) .. WM275
- A-P-A Radio Unit (SG, D) .. WM281
- Economy Gramophone Amplifier .. WM277
- *Dual-speaker Amplifier (A.C.) .. WM304
- A.C. Push-pull Amplifier .. AW291
- Add-on H.F. Screened-grid Unit .. AW296
- Universal Push-pull Amplifier .. AW309
- "A.W." Record Player (LF, Push-pull) .. AW310



A TWO-VALVE RADIOGRAM
The New Style Radiogram described in the October issue of "W.M." is cheap to build and gives fine results

MISCELLANEOUS

- "W.M." Standard A.C. Unit .. WM214 1/-
- "W.M." Standard D.C. Unit .. WM215 1/-
- Super 60 A.C. Unit (for Battery Super 60) .. WM248 1/-
- Simple Neon Oscillator .. WM251 1/-

- Plug-in Adaptor .. WM267 1/-
- Super-het Adaptor .. WM268 1/-
- A Simple Mains Unit .. WM283 1/-
- Short-wave Director (wavemeter) .. WM285 6d.
- Voltage Regulator .. WM287 1/-
- Simple Gramophone Amplifier .. AW257 1/-
- Novel Linen Diaphragm Speaker .. AW260 1/-
- H.T. Unit for A.C. Mains .. AW262 1/-
- Gramophone Tone Control .. AW264 1/-
- H.T. Unit and Trickle Charger for D.C. Mains .. AW272 1/-
- 2-Watt A.C. Amplifier .. AW283 1/-
- "A.W." Selectivity Unit .. AW290 6d.
- H.B.C. Official Selectivity Unit .. AW294 6d.
- A.C. Trickle Charger .. AW305 1/-
- Amateur's Linen Speaker .. AW307 1/-
- D.C. H.T. Unit .. AW312 1/-
- Output Unit for Pentode Sets .. AW316 1/-
- "A.W." Short-wave Adaptor .. AW317 1/-
- Short-wave Plug-in Adaptor .. AW326 -/6
- Super-het Short-wave Adaptor .. AW327 -/6
- "A.W." Short-wave Adaptor .. AW339 1/-
- Ma cot Mains Unit .. AW350 1/-
- "A.W." Trickle Charger .. AW352 1/-
- Add-on Band-pass Unit .. AW359 1/-

A blueprint of any one set described in the current issue of "Wireless Magazine" can be obtained for half price up to the date indicated on the coupon (which is to be found on the last page) if this is sent when application is made. These blueprints are marked with an asterisk (*) in this list and are printed in bold type. An extension of time is made in the case of overseas readers.

When you use a full-size blueprint to build your next set, the chances of making mistakes are almost negligible. Even if it is the first attempt at making your own set, you will find home-construction a fascinating hobby and as easy as A.B.C. After fixing the parts on the baseboard, start wiring with wire No. 1—each wire is numbered separately—and continue in numerical order until the set is finished.

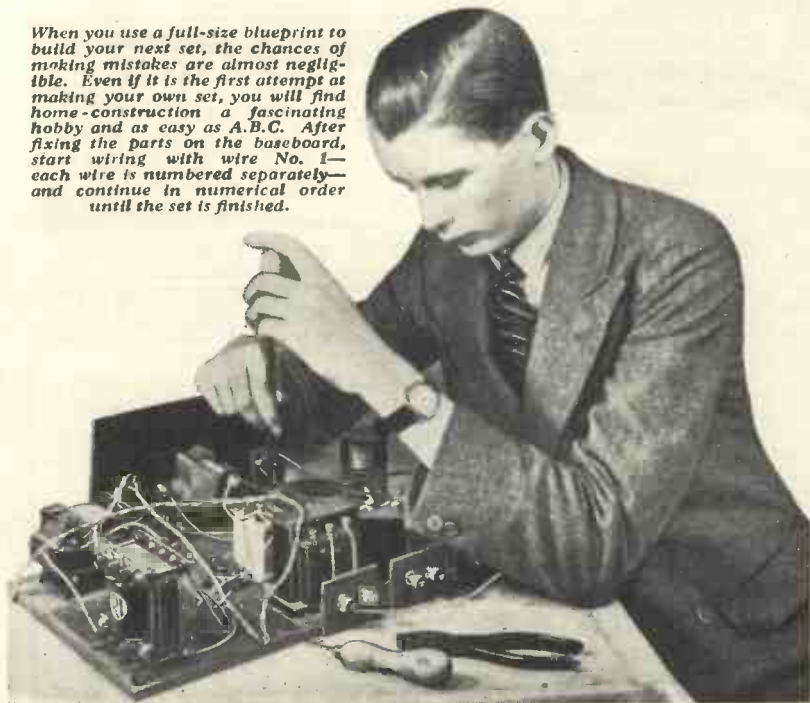

WIRELESS MAGAZINE
Blueprint Dept.,
58/61 Fetter Lane,
LONDON, E.C. 4

BLUEPRINT COUPON

Valid only until November 30, 1932 (or until December 31, 1932 for overseas readers)

FOR ONE BLUEPRINT ONLY

If you want a full-size blueprint of any ONE of the sets constructionally described in this issue for half price, cut out the above coupon and send it, together with a postal order, to Blueprint Department, WIRELESS MAGAZINE, 58-61 Fetter Lane, London, E.C.4.

This coupon is valid for a blueprint of any ONE only of the following sets at the prices indicated:—

EASYTUNE 60 ON A FRAME AERIAL (page 478), No. WM301, price 9d., post free.

"W.M." SHORT-WAVE SUPER (page 508), No. WM302, price 9d., post free.

TABLE QUAD (page 489), No. WM303, price 9d., post free.

DUAL-SPEAKER AMPLIFIER (Page Eight of Supplement), No. WM304, price 6d., post free.

INFORMATION COUPON

Valid only until November 30, 1932 (or until December 31, 1932, for overseas readers)

If you want to ask any questions, cut out the above coupon and send it, together with a postal order for 1s. and stamped-addressed envelope, to the Information Bureau, WIRELESS MAGAZINE, 58-61 Fetter Lane, London, E.C.4.

Note that not more than two questions may be asked at a time and that queries should be written on one side of the paper only.

Under no circumstances can questions be answered personally or by telephone. All inquiries must be made by letter so that every reader gets exactly the same treatment.

Alterations to blueprints or special designs cannot be undertaken; nor can readers' sets or components be tested.

If you want advice on buying a set, a stamped-addressed envelope only (without coupon or fee) should be sent to the Set Selection Bureau, WIRELESS MAGAZINE, 58-61 Fetter Lane, London, E.C.4.

Odd Notes

REPRODUCERS and Amplifiers, Ltd., of Wolverhampton, inform us that the price of their cabinet model 40, specified for the Easytune 60 on a Frame Aerial, is now £2 1s. 6d.

Owing to increased business, F. E. Godfrey (Radio), Ltd., have moved to new premises at 63/5/7 Chenies Mews, Francis Street, London, W.C.1.

From Terrytone Radio Products Co., Ltd., of 33 Crouch Hill, London, N.4, we have received leaflets dealing with the range of Terrytone receivers, which includes a band-pass variable-mu three, a four-valve radio set, and a four-valve table radiogram.

TAYLEX WET H.T. BATTERIES

Give long service, improved volume and tone. Very economical. Replacements for Taylex or Standard batteries at low prices; details post free. Also Bargain List, Radio Kits and parts at lowest prices.

B. TAYLOR, 57 Studley Road, STOCKWELL, LONDON

Famous Makers' Order! **£5 Radio Gram CABINET for 65/-**
7 DAYS' FREE TRIAL

You save 35/-! A few only at makers' prices. Rich Brown Oak "Master Grand" (as made for Radio Press) carriage paid. A fine Bargain. PHOTOGRAPHS and LISTS FREE.



Patent 8123 improved acoustics yields mellow, rich, full volume that your speaker is really capable of. Maker to:— (Radio-Press, B.B.C., 3,000 clients)

PICKETTS Piano Tone Cabinets (M.G.) Albion Rd., Bexleyheath, Kent

CONVERT YOUR D.C. OR BATTERY SET TO A UNIVERSAL ALL-MAINS SET

by aid of the wonderful

OSTAR-GANZ

UNIVERSAL HIGH VOLTAGE MAINS VALVES

The first range of mains valves available in England, incorporating the most recent development in valve design—full mains voltage indirectly heated filament. These valves work direct off either A.C. or D.C. supply. They effect considerable saving in constructional and running costs. No transformers or breakdown resistances required. Considerably lower current consumption than any other mains valve. Remarkably free from mains hum. Descriptive leaflet on request.

G.P. Det and Power	17/6
Super Power	18/-
Rectifying Valves, 50 m.a.	14/6
125 m.a.	15/6

All Mains Receiver and Amplifier Kits available. Write for particulars.

EUGEN FORBAT

Sole Representative for Great Britain

c/o: NIVALIGHT LTD., 1 Rosebery Avenue, LONDON, E.C.1. phone: Clerkenwell 1825

INDEX TO ADVERTISERS

	A	Page
Ampton (1932), Ltd.	426
B		
Baker Selhurst Radio	435
Becker, Geo., Ltd.	537
Belling & Lee, Ltd.	448
Benjamin Electric, Ltd.	543
British Blue Spot Co.	Cover iii
British Rola Co.	537
British Radiophone, Ltd.	445
Burne-Jones & Co., Ltd.	427
C		
Carrington Mfg. Co., Ltd.	439
Clarke, H., & Co. (M/cr.), Ltd.	450
Columbia Graphophone Co., Ltd.	Cover iv
Cosser, A. C., Ltd.	452
D		
Dubilier Condenser Co., Ltd.	430, 438
E		
Edison Swan Electric Co., Ltd.	433, 527, 434	
Ever Ready Co. (G.B.), Ltd.	531
F		
Ferranti, Ltd.	437, 518, 539
Fluxite, Ltd.	426
Formo Co.	549
G		
General Electric Co., Ltd.	449, 533
Gilbert, J. G.	481
Graham Farish, Ltd.	431
Gramophone Co., Ltd.	521
H		
Hayberd, F. C., & Co.	431
I		
International Correspondence Schools, Ltd.	446
Igranic Electric Co., Ltd.	519
J		
Jackson Bros.	526
L		
Leicester Laboratories, Ltd.	539
Lectro Link, Ltd.	451
Limit Radio, Ltd.	451
London Electric Wire Co., and Smiths, Ltd.	Cover ii
Lotus Radio	535
Lyons, Claude, Ltd.	497
M		
McMichael, L. & E.	447
Marconiphone Co., Ltd.	513
Mullard Wireless Service Co., Ltd.	429
O		
Oldham & Sons, Ltd.	435
Osborn, Chas.	426
Ostar-Ganz	552
P		
Partridge & Mee, Ltd.	439
Partridge, Wilson & Co.	424
Parker-Wood & Co.	451
Pertrix, Ltd.	523
Peto-Scott, Ltd.	525
Pickett Bros.	552
Pifco, Ltd.	518
R		
Radio Instruments, Ltd.	441
Regentone, Ltd.	515
Reproducers & Amplifiers, Ltd.	442
Rothermel Corporation, Ltd.	517
Rotax, Ltd.	534
S		
Siemens Bros.	442
Simpson's Electricals, Ltd.	547
Slekun Products, Ltd.	431
Smiths M/A, Ltd.	541
Sound Sales, Ltd.	547
Stambac, Ltd.	434
Stratton & Co. Ltd.	547
T		
Taylor, A.	451, 552
Tekade Radio & Electric, Ltd.	430
Telegraph Condenser Co., Ltd.	545
Tunewell	446
U		
Univolt Electric Ltd.	539
V		
Vandervell, C. A., & Co., Ltd.	451
Varley	450
W		
Westinghouse Brake & Saxby Signal Co., Ltd.	438
Whiteley Electric Radio Co., Ltd.	541
Wilkins & Wright, Ltd.	537
Winrove & Rogers, Ltd.	539
Wright & Wearle, Ltd.	438, 443

Can you afford a "cheap" MOVING COIL SPEAKER?

**100U
32/6**

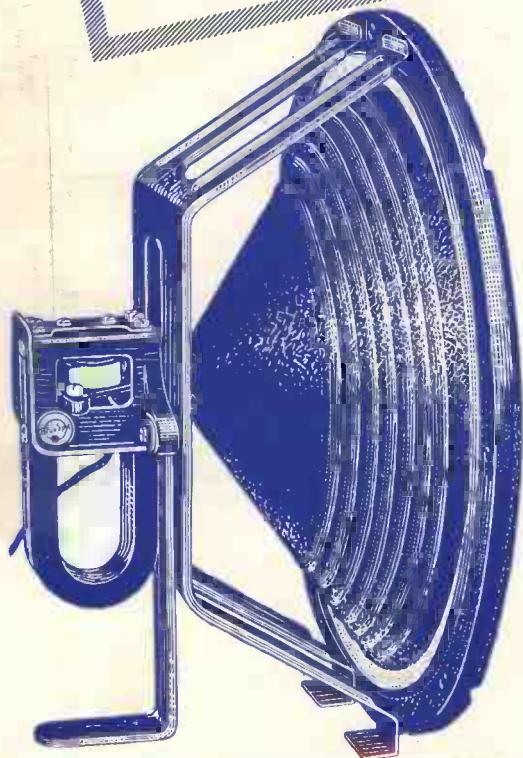

THE trend to-day seems to be to manufacture "down to a price" and let quality take care of itself.

Take Moving-Coil speakers for example—the market is flooded with cheap Moving-Coil speakers.

As one of the largest manufacturers of loudspeakers in the world, we can solemnly assure the public that a really first class, high quality Moving-Coil speaker cannot be produced at a *very* low price. We, ourselves, with a reputation for quality to uphold, would never attempt it.

We have, however, produced Blue Spot 100U which is equal in every degree of performance to an average quality Moving-Coil Speaker. The continuously increasing and very heavy demand for 100U has more than justified our confidence in this speaker. We have duplicated our tools and the greatly increased production has enabled us to effect savings which we are passing on to the public.

Seriously, then, can you *afford* to risk your money on Moving-Coil speakers at a price which makes real *lasting* quality extremely doubtful, if not impossible? Can you afford to risk disappointment and speedy replacement? If you *can* afford to take such risks, you can afford to pay for a first quality Moving-Coil speaker, in which case you cannot do better than consider a Blue Spot Moving-Coil Speaker.

Send for Catalogue W.M. 22.U and learn all about 100U and other Blue Spot Speakers.

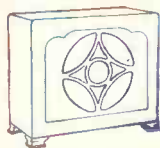

CABINET SPEAKER 100D

in fine quality oak, well made and beautifully finished, complete with 100U unit is now priced at 52/6.

BRITISH MADE



THE BRITISH BLUE SPOT COMPANY LTD

BLUE SPOT HOUSE, 94/96 ROSOMAN ST., ROSEBERY AVENUE, LONDON, E.C.1.

Distributors for Northern Ireland, Scotland and Wales: H. C. RAWSON (Sheffield and London), Ltd., 100, London Road, Sheffield; 22, St. Mary's Parsonage, Manchester; 44-46, High Bridge, Newcastle; 37, 38, 39, Clyde Place, Glasgow.



The Columbia Cradle Chassis

DISTINGUISHES THESE **4** NEW COLUMBIA MODELS



Model 355. "All Electric Four"
Many Modern Improvements.
16 Gns.



Model 620.
Radiograph
Four. New,
Handsome
Model.
32 Gns.

"I wish to congratulate you on your new 1933 programme; I think it is wonderful! I am very impressed with the new Columbia Cradle Chassis, as I think it is very important indeed that the chassis can be removed for inspection in a few minutes—in some cases, seconds. . . . I fully appreciate the thorough way in which you have tackled this important point!"

In these words an important northern retailer describes his reactions to this important new Columbia feature. It is yet another example of that "something extra" which distinguishes Columbia in tone—in performance—in appearance—in reliability.



Model 356. "Superbet Seven" Range.
Tone, Simplicity. 24 Gns.



Model 637.
Auto Radiograph Superbet Seven.
Very Powerful Instrument.
52 Gns.

Columbia TEN POINT RADIO and RADIO-GRAPHOPHONES

- ★ Please send me a catalogue of the new 1933 Columbia models
- OR
- ★ Please arrange a demonstration free and without obligation of Model in my own home.

* Cross out if not required.

NAME

ADDRESS

W. Mag. Nov. 1932

Cut this out and post it in an unsealed envelope bearing 1/2d stamp to Columbia, 98/108 Clerkenwell Road, London, E.C.1.

FREE TRIAL IN YOUR HOME