

WHY AND HOW OF THE RADIO GRAMOPHONE 16-PAGE SUPPLEMENT

132 PAGES

Wireless Magazine

The ^{No 76} Super 60 portable

MAY, 1931
K

JAMES PUTS HIS SIXTY-STATION SET INTO PORTABLE FORM

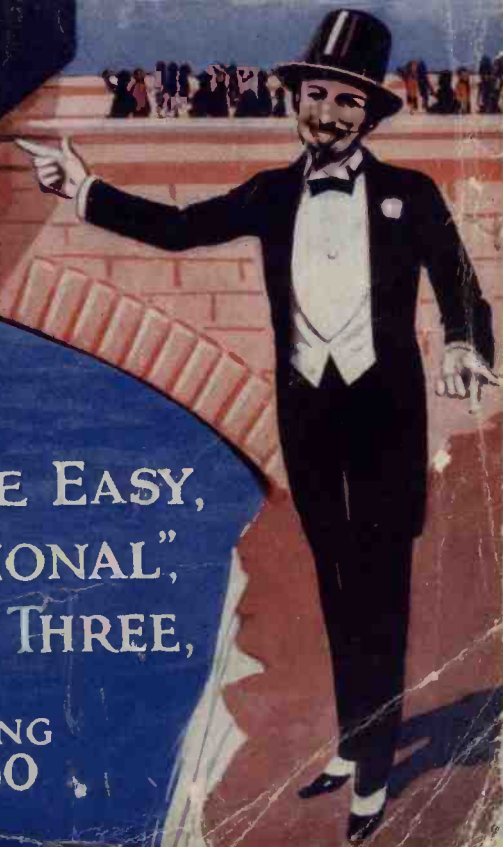

FOREIGN RECEPTION MADE EASY,
ALL ABOUT "NORTH REGIONAL",
A SCREEN-GRID BAND-PASS THREE,
AND
EVERY DETAIL FOR BUILDING
THE ORIGINAL SUPER 60

RANGE THE WORLD

with The

LEWCOS

(Regd)

THIS new LEWCOS achievement—the Super-Het Coil Kit—which has a nine Kilo-Cycle Wave-band separation and consists of one oscillation Coil, two I.F. Coils with "Pigtails" and one I.F. Coil without, marks a new epoch in Radio reception.

Primarily constructed for incorporation in the "Super 60," this Kit can, of course, be fitted with extraordinary ease in any set of similar design and the results will be truly astounding!

This small space is completely inadequate to give even a short description of these wonderful new LEWCOS Coils, but you are invited to write for an illustrated explanatory leaflet.



SUPER-HET COIL KIT

For the
"SUPER 60"
Price 50/-

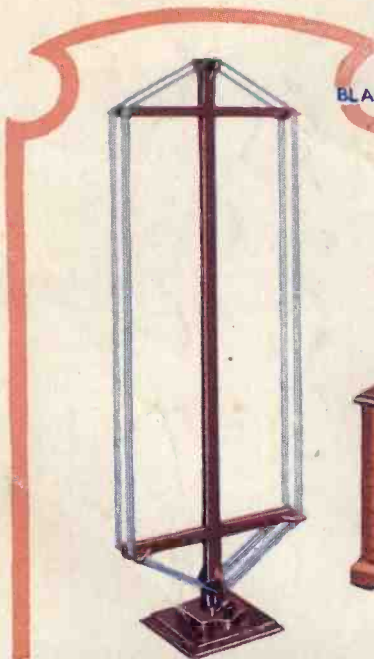

A set of these coils is being tested by the "Wireless Magazine" and the Editor promises that a test report will appear in the June issue.

The illustration on the left shows a LEWCOS Dual-Wave Aerial with the "Super 60" for which it is specified.

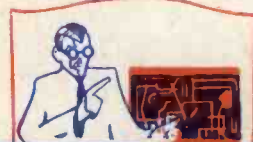

LEWCOS RADIO PRODUCTS—BETTER RECEPTION

THE LONDON ELECTRIC WIRE COMPANY AND SMITHS LIMITED CHURCH ROAD, LEYTON, LONDON E.10

THE AMPLION POPULAR RANGE

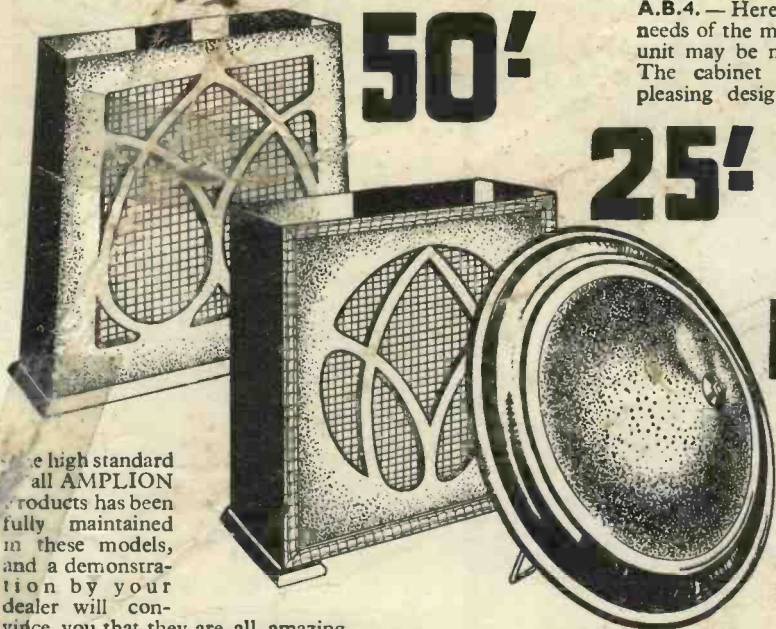

The high standard of all AMPLION products has been fully maintained in these models, and a demonstration by your dealer will convince you that they are all amazing value for money. Ask for a folder illustrating all new AMPLION Speakers. Or write direct to:—
 Graham Amplion Ltd., 26 Savile Row, London, W.1.

A.B.4.—Here is a speaker that in every way meets the needs of the most discriminating. The balanced armature unit may be matched to power valve or Pentode output. The cabinet is built on modern lines of particularly pleasing design. Price, Oak 50/-, Walnut 59/6

A.C.6.—A cabinet model of attractive appearance and really surprising tone. This speaker is fitted with a new and improved unit. The most outstanding speaker value of the year. Standard shaded Oak finish. Price 25/-.

A.C.2A.—Better even in performance and appearance than the famous Guinea-Cone, this 'popular' model is fitted with an entirely new unit mounted in an open cone, Standard finish black and silver, fitted for standing or hanging. Price 15/-.

ASK YOUR DEALER FOR A DEMONSTRATION

AMPLION

Build the "SUPER 60" PORTABLE FOR £9:10

MAGNUM SPAGHETTI RESISTANCES



Specified for the "Regional Three" and "Gramo-Radio A.C. Three."
 500 ohms to 50,000 ohms, 1/6
 60,000 ohms to 100,000 ohms, 2/-
 150,000 ohms, 2/6

MAGNUM TWIN CONTROL UNIT

Specified for "Gramo-Radio A.C. Three," described herein. A new development controlling reaction and L.F. output in one operation. Price 12/6

	£	s.	d.
1 Portable Cabinet as specified	2	5	0
1 Ormond Speaker Chassis and Unit...	1	5	0
1 Set Wearite Super-het. Coils as specified	2	10	0
1 Formo .0002-mfd. Condenser	0	0	6
2 Dubilier .001 type 620 Condensers...	4	0	0
5 Dubilier 1-mfd. type BB Condensers	12	6	
2 J.B. Variable .0005 type No. 2 Tiny Condensers	17	0	
1 Magnum Grid Leak Holder	6		
9 W.B. Rigid Valveholders	9	0	
8 Belling-Lee Wander Plugs as specified	2	0	
1 Magnum 15,000-ohm Flexible Resistance	1	6	
1 Magnum 20,000-ohm Flexible Resistance	1	6	
1 Lissen 1-meg. Grid Leak	1	0	
150,000-ohm Potentiometer	4	6	
1 3-point Switch	1	6	
1 Junior On-off Switch	1	0	
1 Telsen Ace L.F. Transformer	8	6	
Sundries, Connecting Wire, Sleeveing, Frame Aerial Wire, Screws, etc.	5	0	
	£9	10	0

Complete set of valves as specified ... £3 16 0
 Complete set of H.T., G.B., and L.T. Batteries ... £1 11 0

SUPER 60 PORTABLE, ready wired and tested, including valves and batteries and ready for use. Royalties paid £18 10 0

We specialise also in the "Super 60" Table Model, "Gramo-Radio A.C.3," all of which can be supplied as constructional kits or ready wired and tested. Full range of lists, free on request.



MAGNUM SHORT-WAVE CONVERTOR

Readily converts any battery-operated receiver into a highly efficient short-wave receiver. Complete with two coils, 20/40 and 40/80 metres.

Sent on ten days' free trial against cash ... **£3 15**

Full particulars, with list of leading short-wave stations, free on request.

BURNE-JONES & CO., LTD.

"MAGNUM" HOUSE, 296 Boro' High St., LONDON, S.E.1. Phone: Hop 6257 & 6258
 SCOTTISH AGENT: ROSS C. WALLACE, 54 Gordon Street, GLASGOW, C.1

Speedy replies result from mentioning "Wireless Magazine"

THIS DISTINCTIVE CABINET

for Your RADIO, GRAMOPHONE & HOME RECORDER

MODEL A

Cabinet constructed of Oak—
polished.

Price

£3 18 6

MODEL B

Cabinet made of Oak — *not*
polished.

Price

£3 7 6

Packed free and carriage paid.

CHAS. BORST & SONS



Overall dimensions:—
Height 43 ins., Width
21½ ins., depth 21 ins.
Centre opening of
speaker compartment, 7,
9½ or 12½ ins. diameter
(takes 16 x 8 ins. panel
& 16 ins. sq. baseboard)

KIT C

Complete set of parts machined
and ready for assembling.

Price in Oak

£2 7 6

Price in Birch £2 0 0

Post your order to-day to:—
CHARLES BORST & SONS,
306-308 Euston Rd., London, N.W.1

IMPORTANT When ordering please
state size of centre
opening of Speaker compartment.

306 and 308 Euston Road,
N.W.1

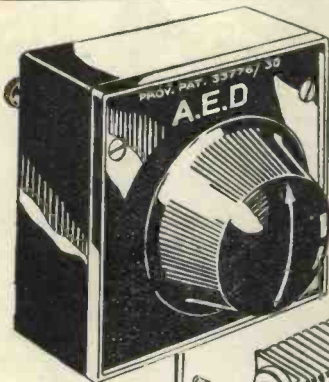

Front view of
A.E.D. Log-Law
Volume Control
Size 2½ in. square,
depth behind panel,
1 in.

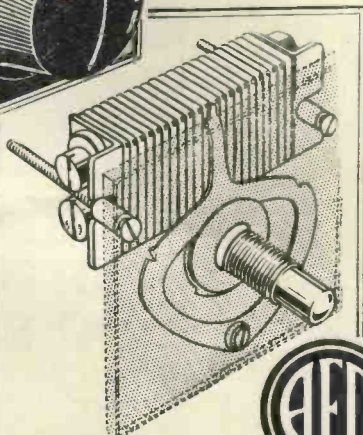

The tapered resistance pack of the A.E.D. Log-Law Volume Control consists of metal plates with special resistance elements clamped between them. Ample metallic contact has been provided between the resistance elements and the wiping arm, which is operated by an ingenious friction device, light and positive in action.
HAVE YOU TRIED THE A.E.D. PICK-UP?
42s. complete.



“A very creditable performance”

says “AMATEUR WIRELESS.”

PRAISE from experts about the A.E.D. Log-Law Volume Control continues to grow in volume. **AMATEUR WIRELESS** recently said:—

“One of the neatest components we have handled for some time is the A.E.D. volume control. The resistance elements are graded to follow a logarithmic law and the variation is a close approximation to a straight line. The device will carry a large current. The sample tested was rated to carry 4 m.a. but we passed it up to 8 milliamps without obtaining undue heating—a very creditable performance.”

The A.E.D. Log-Law Volume Control is the only completely stable non-wire-wound potentiometer. It gives a regularly progressive increase or decrease of audibility “from the merest whisper to full volume.” Ask your radio dealer to show you this excellent component or write for descriptive leaflet.

LOG-LAW VOLUME CONTROL

PRICE 8/6 Complete

Model P.100, 100,000 ohms. Model P.250, 250,000 ohms.
Model P.500, 500,000 ohms. Other values to special order.
One-hole fixing.

AUTO ELECTRIC DEVICES LTD.,
DIAMOND WORKS, BRIGHTON, SUSSEX

Telephone: Brighton 2404. Telegrams: “Selfwind, Brighton.”

It helps us if you mention Wireless Magazine”

MOTOR CHASSIS

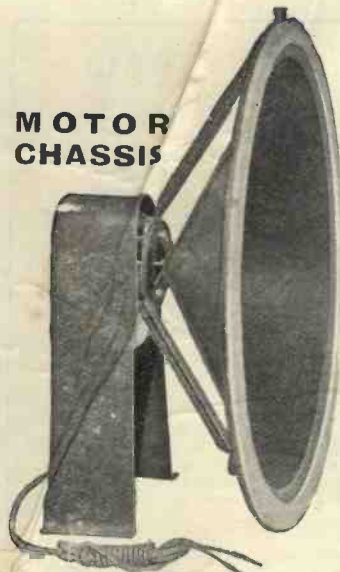

TYPES C44 & C46

A master-built assembly with attractively finished vibrationless stand. Fitted with the famous Type S4 Super-power Isophon-MoToR Unit. Brilliant performance, power and tone.

C44. 12 in. Cone - 42/6

C46. 15 in. Cone - 47/6

TYPE ISODYN C55

A popular chassis outfit (without stand) with strong cast frame and Type S5 Isophon-MoToR Super Unit and 12-Inch Cone.

PRICE 35 -

THRILLING, VIVID REALITY

With all your experience of Loud-speaker performance you have yet to hear the finest, from MoToR Units and Chassis. Their fidelity to tone and wealth of volume give a vividness of reproduction that is almost vision.

• The range of MoToR Cabinet Speakers and Chassis caters for every individual need. If any difficulty in seeing and hearing them locally, send us the name of your nearest dealer.

MOTOR

UNITS • CHASSIS • SPEAKERS

TEKADE Radio & Electric LTD.

29 Farringdon Street, London, E.C.4

Telephone: Central 2482.

Northern Distributors:

L. KREMNER, 49a Shudehill, Manchester.
HARDMAN & Co. Ltd., The Baum, York-shire St., Rochdale; 61 Bridge St., Man-chester; 2a Leach Lane, St. Annes-on-Sea; 25 Trinity Street, Leeds.

Agent for Scotland:—R. G. J. Nisbet, 132, Renfrew Street, Glasgow, C.2.



TYPE S4.
Isophon-MOTOR
Super Power Unit

27/6

A definitely superior 4-pole balanced armature unit, sensitive to the slightest im-

pulse, yet capable of handling an amazing top-load power without rattle or distortion. Quality of reproduction and wealth of volume are exceptional. High notes are brilliantly clear and low notes richly emphasised. Provided with alternative resistances to suit various output valves.

Type S5. Isophon-MOTOR Super Unit

Compact in size, but generously large in power, richness and purity of tone. Handles out-

22/6

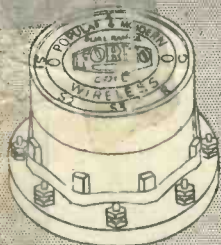

DUAL RANGE COIL 12/6



VERNIER DIAL 3/0



MAINS CONDENSER CAP. 2.0 3/3



FORMO MAINS CONDENSERS

It has been the aim of condenser engineers for years past to produce a condenser having a high test and working voltage, a high insulation value, and long life, at a low cost. The new Formo condensers have a high insulation value which makes leakage infinitesimal and are tested by the sudden application of the test voltage, and not, as is usual, through a non-inductive series resistance. Catalogue of the complete range of Formo quality components sent on request: ARTHUR PREN & CO. LTD., Golden Square, Piccadilly Circus, W.1 FACTORY: Crown Works, Southampton.

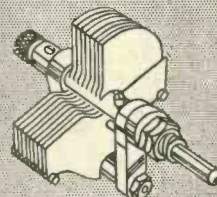

MIDGET CONDENSER 2/9

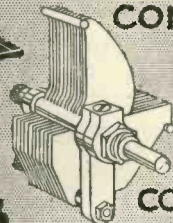

MID LOG LINE VARIABLE CONDENSER 4/6



DIFFERENTIAL CONDENSER 3/9

You will get prompt replies by mentioning "Wireless Magazine"

Broadcast Identification Sheets

For the benefit of readers we are publishing each month a series of panels specially compiled for the WIRELESS MAGAZINE by Jay Cooté.

In these, readers will find a ready means of identifying foreign stations. To prevent any confusion in a.m. and p.m., the times are given on the Continental twenty-four-hour system. Example: 8 a.m.=8.00; 8 p.m.=20.00.

In the event of alterations in wavelength, power or call, a special panel bearing the alteration will be published at the earliest opportunity.

These identification sheets should be cut out and filed either alphabetically or in order of wavelength as they appear.



296m.

(1,013 kc.)

Power: 10 kw.

TALLINN *

(Estonia)

1,112 miles from London.

Standard Time: Eastern European (G.M.T. plus 2 hours).

Announcers: Man and woman.

Opening Signal: Bell.

Call: *Allo! Allo! Tallinn.*

Interval Signal: Gong.

Main Programme: G.M.T. 07.35, sacred service (Sun.); 13.00, lectures in Estonian, Russian, Finnish, and Swedish (Sun.); 15.10, news; 15.10, gramophone records; 16.45, dance music (Sun.); 17.00, weather, news; 18.00, concert (Sun.); 19.00 (week-days); dance music (Sun., Thur., Sat.).

Relays: Tartu (Dorpat), 462.6 m. (648.5 kc.), 0.5 kw.

* Will be found in pre-war maps as Reval (Russia).



335m.

(896 kc.)

Power: 1.9 kw.

POZNAN

(Poland)

728 miles from London.

Standard Time: Central European (G.M.T. plus 1 hour).

Announcer: Woman.

Call: *Rhlo! Rhlo! Radio Poznanskie.*

Opening Signal: Imitation of Carillon.

Interval Signal: Metronome.

Main Programme: G.M.T. 06.00, physical exercises, news; 08.00, concert, news (Sun.); 09.15, sacred service from Cathedral (Sun.); 16.30 (Sun.), gramophone records; 17.45, concert; 19.00, main evening transmission from studio or relayed from Warsaw; 21.00, time signal, news, dance music (daily except Mon. and Thur.). Announcements and news bulletins are frequently given in both the Polish and French languages.

Closes down as Warsaw (q.v.).



342m.

(878 kc.)

Power: 3 kw.*

BRNO

(Czechoslovakia)

752 miles from London.

Standard Time: Central European (G.M.T. plus 1 hour).

Announcer: Man.

Call: *Allo! Radio Journal Brno* (phon.: *Broo-no*).

Good Night: *Dobrou noc*, followed by National Anthem (*Kde Domov Mu*).

Main Programme: G.M.T. 07.00 (Sun.), relay of concert from Carlsbad; mostly relays Prague and Bratislava; broadcasts during daylight hours. 19.00, main evening entertainment; 21.20, relay of dance music from Auto Club (Prague) or from Moravska-Ostrava. Also exchanges programmes with Kotice.

* To be shortly increased to 36 kw. (aerial).

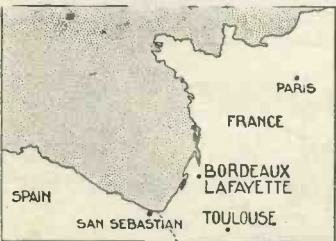

385m.

(779 kc.)

Power: 8 kw.
(temp.)

TOULOUSE

(France)

550 miles from London.

Standard Time: Greenwich Mean Time.*

Announcer: Man.

Opening Signal: Counting of seconds (*vide* Eiffel Tower).

Call: *Allo! Allo! Ici Radio Toulouse, émissions de la Radiophonie du midi.* Between items: *Allo! Radio Toulouse.*

Interval Signal: Gong (about 50 beats per minute).

Main Programme: G.M.T. 12.30 (Sun.), sacred service (R.C.); 13.00 (Sun.), concert; 13.45 (Sun.), sacred service (Protestant); 17.00, dance music, then continuous broadcasts until 20.00, main evening entertainment; 22.45, relay of concert from café; 23.45 (Sun.), picture transmission (Belin method), news (daily).

The greater part of the musical programmes is composed of gramophone records, with publicity items between numbers. Closes down with usual French formula (*vide* Paris stations), followed by *La Marseillaise* or *La Toulousaine*.

* France adopts British Summer Time.



1,445.7m.

(207.5 kc.)

Power: 15 kw.

EIFFEL TOWER

(Paris, France)

214 miles from London.

Standard Time: Greenwich Mean Time.*

Announcer: Man.

Opening Signal: Counting of seconds (from 300 upwards for a period of about 1 minute).

Call: (When own concert) *Ici le poste National de la Tour Eiffel* (phon.: *Two-er Ay-jell*), but when relaying Ecole Supérieure, Paris, *Ici les émissions de T.S.F. du Réseau Français de radio diffusion des postes de l'Ecole Supérieure et de la Tour Eiffel.*

Time Signal (unofficial): G.M.T. 20.00, imitation Big Ben chimes, followed by bugle or trumpet call.

Main Programme: G.M.T. 12.00, official weather report; relay of PTT Paris (Ecole Supérieure). 14.00 and 18.00, talks; 19.10, official weather report; 19.30, concert.

The station usually closes down at 21.00. Frequently relays PTT Paris.

Closes down with usual French formula, followed by *La Marseillaise* (gramophone record).

* France adopts British Summer Time.

THE SPLIT SECOND THAT ADDS MONTHS TO BATTERY LIFE



"Time Factor" is considered by Lissen of such importance to the Secret Process that every operation is controlled with laboratory precision

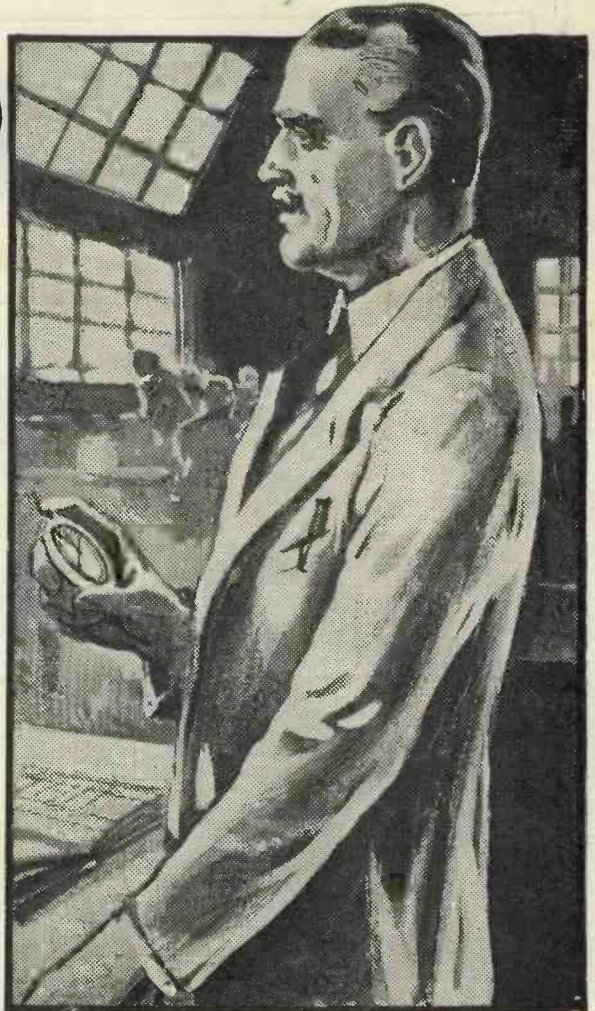

ORINARY mixing of standard battery chemicals will set up a flow of electric current—current good enough, perhaps, to ring a bell or light a bulb. But in radio every flaw is magnified, every fault amplified, the slightest current variation reflected harshly by the delicate receiving valves. That is why the actual factory methods employed in making a battery are so important—that is why such a difference is noticeable immediately a Lissen Battery is introduced into the receiver.

In the Lissen Battery Factory, precise laboratory methods are used. The quantities of the various chemical constituents of the Lissen Secret Formula are controlled with microscopic accuracy. Their purity is ensured by analytical test; their thorough and complete admixture supervised at every stage.

And here enters the time factor. An appreciation of the importance of this time factor makes all the difference between an ordinary battery with an ordinary battery's life, and a Lissen Battery with a Lissen Battery's life! In some parts of the Lissen Secret Process the time factor is considered by Lissen of such vital importance that the operations are controlled on a rigorous time schedule.

The effect of the time-controlled process is shown in the fine response of the battery when the cells are called upon for heavy output over long periods. Then you will find the unique Lissen production methods have put a reserve of chemical activity into the Lissen cells which meet any and every demand for high-tension power. The current always flows steadily and at high pressure—the cells **RESIST VOLT DROP WITH A STUBBORNNESS UNKNOWN IN ANY OTHER BATTERY, AND THE LISSEN BATTERY GAINS MONTHS OF EXTRA LIFE.**



LISSEN BATTERIES ARE WORTH THEIR PRICE!

60 VOLT
7'11
100 VOLT
12'11

LISSEN LIMITED, Worples Road, Isleworth, Middlesex.

WAVELENGTHS OF THE WORLD'S BROADCASTERS

Wave-length	Name of Station	Dial Readings	Country	Wave-length	Name of Station	Dial Readings	Country
172.5	St. Quentin		France	335	Poznan		Poland
200	Leeds		Great Britain	338	Brussels (No. 2)		Belgium
206	Antwerp		Belgium	342	Brunn		Czechoslovakia
	Verviers		Belgium	345.2	Strasbourg		France
216	Radio Conférence Bruxelles		Belgium	349	Barcelona (EAJ1)		Spain
	Chatelneau		Belgium	351.7	Graz		Austria
216.3	Königsberg		Germany	356.3	London Regional		Great Britain
219	Salzburg		Austria	360	Mühlacker		Germany
219	Flensburg		Germany	360.4	Algiers		North Africa
219.3	Beziers		France	364	Bergen		Norway
221	Helsinki		Finland	365.1	Frederiksstad		Poland
223	Fcamp		France	368.1	Wilno		Poland
224.5	Cork (IFS)		Irish Free State	370	Radio LL (Paris)		France
225	Strasbourg		France	372	Hamburg		Germany
	Cologne		Germany	374.5	Seville (EAJ5)		Spain
227	Münster		Germany	376.4	Glasgow		Great Britain
	Aachen		Germany	381	Lviv		Poland
230	Malmö		Sweden	385	Radio Toulouse		France
232	Kiel		Germany	390	Frankfurt		Germany
234	Lodz		Poland	394	Bucharest		Romania
	Kristiansand		Norway	398.9	Midland Regional		Great Britain
235	Nîmes		France	403.5	Sottens		Switzerland
237.2	Bordeaux-Sud-Ouest		France	408	Katowice		Poland
239	Nürnberg		Germany	413	Dublin (2RN)		Irish Free State
240	Oporto		Portugal	416	Radio Maroc		North Africa
241	Stavanger		Norway	418	Berlin		Germany
242	Belfast (2BE)		Ireland	424	Madrid (EAJ7)		Spain
244	Basle		Switzerland	426.3	Kharkov		Kussia
244.7	Ghent		Belgium	430.5	Belgrade		Yugoslavia
245.6	Schaerbeek		Belgium	435	Stockholm		Sweden
	Cassel		Germany	441	Rome		Italy
246	Linz		Austria	447	Paris (Ecole Sup. PTT)		France
249	Juan-les-Pins		France	452	Danzig		Germany
250	Cesky Brod (testing)		Czechoslovakia	453	Bolzano (1BZ)		Italy
251	Barcelona		Spain		Klagenfurt		Austria
253.4	Gleitwitz		Germany		San Sebastian		Spain
256	Toulouse (PTT)		France	453.2	Porsgrund		Norway
257	Hörby		Sweden	459	Beromvenster (testing)		Switzerland
259	Leipzig		Germany	463	Tartu		Estonia
261.3	London National		Great Britain	466	Lyon-la-Doua		France
263.8	Moravska-Ostrava		Czechoslovakia	473	Langenberg		Germany
265	Lille (PTT)		France	479.2	Manchester		Great Britain
268	Valencia (EAJ13)		Spain		North Regional (testing)		Great Britain
269.8	Bremen		Germany	487	Prague		Czechoslovakia
272	Rennes		France	493	Nidaros		Norway
276.5	Heilsberg		Germany	501	Milan		Italy
278.3	Bratislava		Czechoslovakia	509	Brussels (No. 1)		Belgium
281	Copenhagen		Denmark	517	Vienna		Austria
	Magdeburg		Germany	525	Riga		Latvia
283.6	Stettin		Germany	533	Munich		Germany
	Berlin		Germany	542	Sundsvall		Sweden
283.9	Innsbruck		Austria	550	Budapest		Hungary
284.7	Lisbon		Portugal		Kaiserslautern		Germany
285.4	Montpellier		France	559.7	Augsberg		Germany
287.1	Radio Lyons		France	566	Hanover		Germany
	Swansea (SSX)		Great Britain	570	Freiburg		Germany
	Stoke-on-Trent (6ST)		"	574.7	Ljubljana		Yugoslavia
	Sheffield (6LF)		"	589.6	Hamar		Norway
	Plymouth (5PY)		"	689	Lausanne		Switzerland
	Liverpool (6LV)		"	720	Moscow		Russia
288.5	Hull (6KH)		"	760	Geneva		Switzerland
	Edinburgh (2E11)		"	770	Ostersund		Sweden
	Dundee (2DE)		"	800	Kiev		Russia
	Bournemouth (6BM)		"	824	Sverdlovsk		Russia
	Bradford		"	937.5	Kharkov		Russia
	Newcastle (5NO)		"	1,000	Leningrad		Russia
291	Tampere		Finland	1,030	Scheveningen-Haven		Holland
293	Kosice		Czechoslovakia	1,111	Oslo		Norway
294.6	Limoges		France	1,103	Moscow Popoff		Russia
296	Tallinn		Estonia	1,12	Kalundborg		Denmark
296	Turin		Italy	1,200	Reykjavik		Iceland
299	Hilversum		Holland	1,213	Istanbul		Turkey
	Radio Idzerda		Holland	1,243	Boden		Sweden
301	Aberdeen (2BD)		Great Britain	1,250	Tunis Kasbah		North Africa
304.3	Bordeaux (PTT)		Sweden	1,304	Moscow		Russia
306	Zagreb (Agram)		France	1,31	Motala		Sweden
307	Falun		Jugoslavia	1,380	Bakou		Russia
309.9	Cardiff (5WA)		Great Britain	1,411	Warsaw		Poland
312.2	Genoa		Italy	1,445.7	Eiffel Tower, Paris		France
312.8	Cracow		Poland	1,481	Moscow (Koni)		Russia
314	Natan-Vitus		France	1,538	Ankara		Turkey
317.3	Marselles (PTT)		France	1,554.4	Daventry (National)		Great Britain
318.8	Dresden		Germany	1,625	Norddeich		Germany
319	Soňa (Rodno Radio)		Bulgaria	1,735	Zeesen		Germany
322	Göteborg		Sweden	1,785	Radio Paris		France
323	Breslau		Germany	1,796	Lahti		Finland
327.5	Grenoble		France	1,875	Hulzen		Holland
329.5	Poste Parisien		France	1,935	Kaunas		Lithuania
332	Naples		Italy				

There's more
in your records

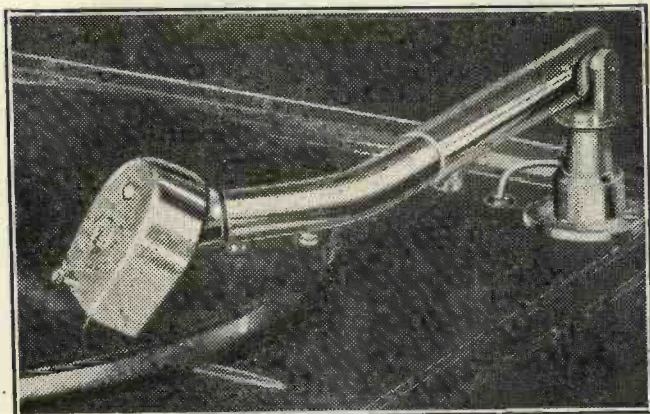

when you play
them with a...



PICK-UP and TONE ARM

Only when you fit a B.T.H. Pick-Up and Tone Arm do you realise how much you have been missing in your records. Passages which are a confused medley when reproduced by ordinary means are now heard with a crisp, sparkling vitality that makes record music live.

**PRICE
COMPLETE
45/-**

Records last longer when played with a B.T.H. Pick-Up. Needle-scratch is eliminated and carefully balanced design gives finest reproduction with an absolute minimum of record wear.

Get a B.T.H. Pick-Up and Tone Arm to-day. It will make your gramophone as good as a factory-built radiogram for a fraction of the cost.



THE EDISON SWAN ELECTRIC CO. LTD.
Radio Division,
155 Charing Cross Road, London, W.C.2
Showrooms in all Principal Towns.

EDISWAN

W 136

**YOU'LL GET
MORE EFFICIENT
DETECTION WITH A**

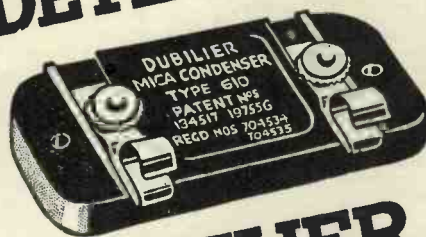

**DUBILIER
GRID LEAK & CONDENSER!**

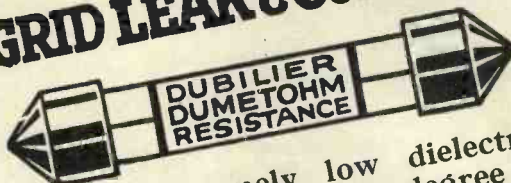

THE extremely low dielectric losses and the high degree of accuracy of Dubilier Mica Condensers are well known. These qualities make them invaluable in any radio-frequency circuit and especially so in the grid circuit of a cumulative grid detector where very minute high-frequency currents are dealt with and where even small losses have an appreciable effect. Specify Dubilier for your next set.

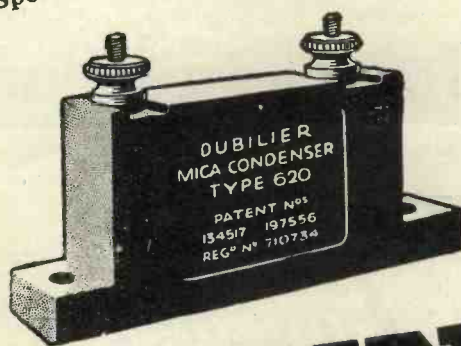

DUBILIER CONDENSERS

Dubilier Condenser Co. (1925) Ltd.,
Ducon Works, Victoria Road, N. Acton, London, W.3.

You will get prompt replies by mentioning "Wireless Magazine"

H & B

GUARANTEED KIT-PORTABLE

	£	s.	d.
1 Set of Super-hot Coils (Lewcos, Wearite) ...	2	10	0
1 Fixed Condenser, .0002 (Formo) ...			6
2 Fixed Condensers, .001 (T.C.C., flat type) ...	3	0	
5 Fixed Condensers, 1 mfd. (Dubbler) ...	12	6	
2 Variable Condensers, .0005 mfd., type 2 (Tiny J.B.) ...	17	0	
1 Grid-leak Holder (H. & B.) ...			6
9 Valve Holders (W.B.) ...	9	0	
1 Spaghetti Resistance, 15,000 ohms (Lewcos) ...	1	6	
1 Spaghetti Resistance, 20,000 ohms (Lewcos) ...	1	6	
1 Grid Leak, 1 megohm (Telsen) ...	1	0	
1 Potentiometer, 50,000 (Electrad, type C) ...	6	0	
1 Three-point Switch ...	1	6	
1 On-off Switch (Junit) ...	1	0	
1 L.F. Transformer (Telsen Ace) ...	8	6	
8 Marked Wander Plugs ...	1	4	
Wire, Sleeving (H. & B.) ...	1	6	
CASH PRICE ...	£5	16	4



COMPLETE KIT, with all Accessories, Valves and Cabinet ... £14 13 0
PORTABLE CONSTRUCTED, with all Accessories and Valves ... £16 13 0
 (Royalty paid.)

SUPER 60 ACCESSORIES

	£	s.	d.
ACCESSORIES			
1 Ormond Speaker Unit and Chassis, portable type ...	1	5	0
1 Pertrix 108-volt High Tension ...	14	0	
1 Siemens 9-volt Grid Bias ...	1	6	
1 C.A.V. Accumulator, 2 N.S. 17 ...	1	6	0
6 Specified Mullard or Marconi Valves ...	3	16	0
1 Portable Cabinet made exactly to specification, fitted with turntable and frame aerial frame ...	2	5	0
1 Portable Cabinet, same as above, with frame aerial ready wound, complete with turntable ...	2	10	0
SUPER 60 Standard Kit, as described in March and April "W.M."			
THE 60 STATIONS SET			
H. & B. Guaranteed Kit contains every part necessary to construct this receiver.			
CASH PRICE, £3 3 0			
Frame Aerial, ready wound ...	£1	7	6
Oak or Mahogany Cabinet ...	£1	0	0
6 Specified Valves ...	£3	16	0

Detailed list appears in our advertisement, page 327, April "W.M."

TRADE SUPPLIED.

TERMS.—Carriage paid on all cash orders.

C.O.D. charges paid on orders over £1.

H & B RADIO CO. Gerrard 2834

34, 36, 38 BEAK STREET, REGENT STREET, LONDON, W.1

Complete in Cabinet

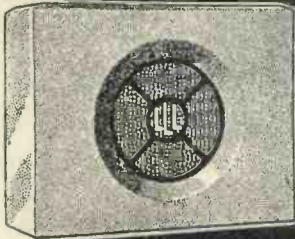

A Permanent Magnet Moving Coil Speaker

of perfect reproduction & full volume

The "Wireless World" test report is an unbiased criticism of the LANCHESTER speaker:
Sensitivity of a high order, and quite equal to the average moving coil with mains energised field. Crispness and brilliance in upper register. speech quite exceptionally good. general effect surprisingly good—18th Feb., 1931.

Try it in your own home and enjoy perfect reproduction

of the Lanchester

PERMANENT MAGNET MOVING-COIL SPEAKERS
 (Patents pending)

SENIOR MODEL JUNIOR MODEL

Complete in Cabinet

£4:4:0

Chassis only £2:18:0

Complete in Cabinet

£2:8:0

Chassis only £1:8:0

We sell direct to the public only

Write to-day for full particulars

LANCHESTER'S LABORATORIES
 TYSELEY LIMITED BIRMINGHAM

TRADE MARK



Amateur Wireless HANDBOOKS

each 2/6 net.

Loud-speaker Crystal Sets.

The Wireless Man's Workshop.

Wireless-Controlled Mechanism for Amateurs.

The Practical Wireless Data Book.

THE BOOK OF THE NEUTRODYNE, by J. H. Reyner, B.Sc. (Hons.), A.M.I.E.E. Price 1/6 net, or post free for 1/9

Of all Newsagents and Booksellers or by post, 3d. extra, from Cassell & Co., La Belle Sauvage, E.C.3.

FOR THE GRAMO-RADIO A.C.3

USE

TRIX MAINS TRANSFORMERS, CHOKES, FLEXIBLE RESISTANCES AND FIXED CONDENSERS

As used in the original set described in this issue. TRIX Components are tested for large voltage and current and have ample margin of safety.

ERIC J. LEVER (TRIX) LTD., Dept. M.5
 8-9 Clerkenwell Green, London, E.C.1

Phone: Clerkenwell 3014/5

Advertisers like to know you "saw it in the 'Wireless Magazine'"

Cheaper Radio!

Everlasting High-Tension for a trifle over the cost of two 120-Volt Batteries



The Neatest & Cheapest A.C. Unit ever made

Model A.C. 244

With alternating current electric lighting in the home it is now possible for you to banish your radio troubles and assure H.T. for your Set for a lifetime at a little more than the cost of a year's supply of Batteries—the secret is the "ATLAS" new Unit A.C.244. A development of the famous "ATLAS" Olympia Winner—Model A.C.188. It is no larger than a 60-volt Battery, and no matter what your Set is from one to four Valves, Standard or Portable, the facilities and output of A.C.244 will be found more than satisfactory. Three Variable Tappings are provided—60-80 volts for Screen Grid Valve, 90-100 volts for Detector Valve, and 120-150 volts for Pentode or Power Valve. Output: 120 volts at 20 m.a. or 150 volts at 15 m.a. It incorporates the Westinghouse Metal Rectifier and is complete with Wander Plugs and Earth Terminal, and fully guaranteed for twelve months.

59/6
CASH PRICE

"CLARKE'S ATLAS"

MAINS H.T. UNIT—A.C. 244.

Ask your Dealer for a demonstration of this amazing Unit and in case of difficulty write direct for Folder No. 56 to the makers:—

H. CLARKE & CO. (M/CR) LTD., Atlas Works, Old Trafford, Manchester.

LONDON OFFICE: 60 CHANDOS ST., STRAND, W.C.2.
GLASGOW OFFICE: 24 OSWALD STREET.



HERE are the valves that are making radio history—ETA. They demonstrate conclusively that highest efficiency can be combined with reasonable economy. Fit ETA Valves and know the satisfaction of wonderfully improved reception. Prices from 7/-

Ask your Radio dealer for particulars of the ETA Valve to suit your set.

ETA VALVES

The Electrical Trading Association Ltd., Aldwych House, Aldwych, W.C.2.
Telegrams: Eltradax, Estrand, London. Telephone: Holborn 8139

Advertisers take more interest when you mention "Wireless Magazine"

IN TUNE WITH THE TRADE

FETTER LANE'S Review of Catalogues and Pamphlets

SEND TO US FOR THESE CATALOGUES!

As a keen wireless enthusiast you naturally want to keep abreast of all the latest developments and this special feature will enable you to do so with the minimum of trouble and the cost of only 1/4d. for postage.

Here we review the newest booklets and folders issued by six well-known firms. If you want copies of any or all of them just cut out this coupon and send it to us. We will see that you get all the literature you desire.

Just indicate the numbers (seen at the end of each paragraph) of the catalogues you want below.

My name and address are:—

Send this coupon in an unsealed envelope, bearing 1/4d. stamp, to "Catalogue Service," WIRELESS MAGAZINE, 58/61 Fetter Lane, E.C.4. Valid till May 30.

"THE WHOLE TRUTH"

LLOUD-SPEAKER people in general are developing an "urge" towards the purity end of loud-speaker reproduction, and Tekade, following suit, have adopted the slogan "The Whole Truth" to describe the new Motor loud-speaker units and chassis.

It is the title also of a fine little folder which has just been produced and on which I have spent an interesting ten minutes or so studying the new Motor types.

If you are in search of a better speaker than your present instrument then write to Tekade Radio Electric, Ltd., through my free catalogue service, for a copy of this latest publication. When you get it you will see details of two Motor chassis and three types of complete cabinet loud-speakers.

All these cabinet instruments are of a futurist design and are certainly most pleasing to look at. One type is capable of handling an output up to 3 watts and another a maximum output of 8 watts. This means in non-technical terms that a type is available for practically any set.

The units without the cone and chassis are available for amateurs who want to make up their own loud-speakers. **188**

IN SPRING

SPRING is here although, at the time of writing, the weather looks a little pessimistic! Somehow I do not think that nowadays in spring time the young man's fancy always turns to thoughts of love. It is my experience (not a very close one, I will admit) that it generally turns to thoughts of tennis, motoring, and out-of-door radio.

If you find your thoughts wandering in this last direction, then I know you

will be keen to see a new folder issued by Graham Amplion, Ltd., giving details of the Amplion Two Screen-grid Portable set. This can be obtained either in a suitcase cabinet or in a house transportable type of cabinet.

As this folder gives full details there is no need for me to elaborate here, but I will just say that this set has a useful range because of its two screen-grid stages and that the pentode valve in a special output circuit ensures adequate amplification and a good power output. **189**

SOME NOVELTIES

FROM Dubilier comes a fine catalogue which I heartily commend to your attention. Naturally, a large section is devoted to the condensers which have made the Dubilier name famous, and if you need condensers then you certainly need this catalogue, which gives very full technical details.

But what I am concerned with at the moment are some novelties—two new wavetraps which have been produced to cut down interference in the Northern Regional area, and an anti-interference unit which, connected up to practically any set, will cut down the noise caused by motors, electric signs, refrigerators, and so on.

As man-made static of this ilk is causing a deal of trouble in some districts, I prophesy a big scope for the Dubilier interference eliminator, and I congratulate Dubilier on a novel idea.

By the way, the last section of this catalogue is devoted to high-tension and grid-bias batteries. This is well worth your perusal. **190**

THE FERRANTI RADIOGRAM

WHEN a firm like Ferranti decides to make a radio gramophone then you have the reassuring knowledge that it is properly designed and will work as a good radiogram should. You can be sure, too, that although no attempt will be made at "cut price" construction, the set will represent good value for money.

All this one knows from previous experience of Ferranti products. In order better to introduce the Ferranti radio gramophone I advise you to get a very well-got-up book, a copy of which I have just received from Ferranti, Ltd., which tells the whole story of this new instrument, representing, as I judge it, the very latest in radio-gramophone technique.

This new model works from the mains and is entirely automatic in its operation. An idea of the volume obtainable can be gauged from the fact that the undistorted output fed to the moving-coil loud-speaker is about 6 watts.

This Ferranti book, from which I get these details, gives all the particulars you will need when selecting a radio gramophone. **191**

A MINE OF FINE PARTS

I HAVE always been intrigued by the sort of apparatus sold by Electradix Radio, and I confess that I have spent over half an hour looking through the new Catalogue No. 75. The most extraordinary apparatus is listed, and there are a number of parts which it would be impossible to manufacture in the ordinary way.

Handy gadgets and accessories are given, and there is a large section devoted to ex-Government apparatus suitable for use in present receivers and made according to a standard of workmanship which, unfortunately, is not always appreciated to-day.

There are seventy-four pages in this catalogue packed with illustrations and full descriptions of every sort of radio part from a complete transmitter to a spade tag. Meters, switches, valves, special condensers, complete sets, high-tension generators, transformers, and literally, hundreds of other parts are reviewed, and for sheer novelty I think you will find this Electradix Radio book hard to beat. **192**

A MARCONIPHONE BATCH

MARCONIPHONE have just sent me a number of very interesting little folders—eight of them. It is rather difficult to say which is most likely to interest you, and so no apology should be needed for referring to them all.

First is the folder describing the Marconiphone speakers—the plaque type, cabinet and moving-coil. Next is one which describes the popular two-valvers, one mains driven and the other battery driven.

The Marconiphone model 55 portable set, undoubtedly one of the best portable sets available for amateur use, is described in another leaflet, while as a contrast in the fourth leaflet is described the Marconiphone console type set, the new model 560.

In other folders we have full descriptions of an all-electric four-valver and a three-valve screen-grid set which is available either for battery or mains working.

A fine five-valve screen-grid set (for battery or mains) is dealt with in a separate leaflet, and the last two leaflets are devoted to Marconiphone service and to a brief résumé of all the sets and speakers. If, out of this selection you cannot find something of interest, then you are no true radio fan! **193**

GET YOUR JUNE "W.M." ON MAY 22



Varley All-Electric Radio-Gramophone.

A. C. or D. C.

Price 85 guineas.

Valves and Royalties included.

Hire Purchase Facilities available.

THE RADIO-GRAMPHONE OF THE YEAR

The most advanced ideas in gramophone and receiver design are embodied in the new Varley All-Electric Radio-Gramophone. Clear treble and powerful bass, startling in its faithfulness. Majestic volume or a whisper at will. Europe's stations on a single dial. Realism from radio or record.

Don't fail to hear this wonderful Varley instrument. It arouses enthusiasm whenever it is heard or seen.

Write for the free illustrated colour folder.

Varley Gramophone Pick-up, 37/6. Light damping and minimum record wear. Valuable bass uplift. Fits any gramophone.

Varley Gramophone Auto-Arm, 35/-. Ensures correct alignment and tracking. Automatic stopping. For 10" to 12" turntables.

Volume Control, 300,000 ohms. 6/6.

Write for Sections B. & C. of the Varley Catalogue.

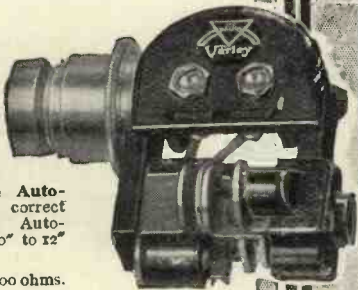

Varley

Advertisement of Oliver Fell Control, Ltd., Kingsway House, 108 Kingsway, London, W. O. 9 Telephone: Holborn 5908

MAKE YOURS A MAINS SET FOR LESS THAN £3

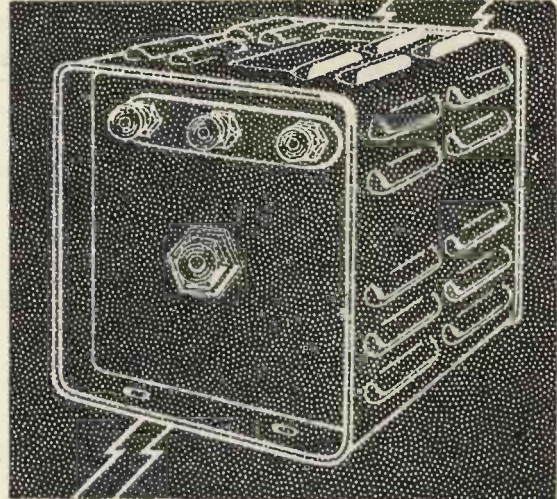

If your house is supplied with alternating current, as little as £2.15.0 will enable you to run your radio set from the mains—less than you would spend on dry batteries alone during the course of a year.

As you know, a rectifier is necessary when employing alternating current to run a wireless set.

Of the many types of rectifier obtainable, none can claim so many virtues as the "Westinghouse." It is all-metal . . . substantial . . . compact . . . never needs attention . . . and its life is so prolonged, we haven't yet been able to determine its limit.

The H.T.5, priced at 15/-, is a particularly popular style.

If you think of converting an existing battery-driven receiver to mains-driven, or building a new one, send for the booklet, "The All-Metal Way, 1931," which tells you all about the Westinghouse Metal Rectifiers, and also contains chapters on high-tension trickle charging, low-tension trickle charging, moving-coil loud-speakers, general principles and methods of rectification, smoothing transformers for eliminators, the voltage doubler circuit, voltage dropping, etc.

(Please enclose 3d. for your copy.)

WESTINGHOUSE

METAL RECTIFIERS

The WESTINGHOUSE BRAKE & SAXBY SIGNAL CO., LTD.

82 York Road, King's Cross, London, N.1.

Telephone: North 2415.

W.M.

Mention of "Wireless Magazine" will ensure prompt attention

Low Price with Certainty of Best Results

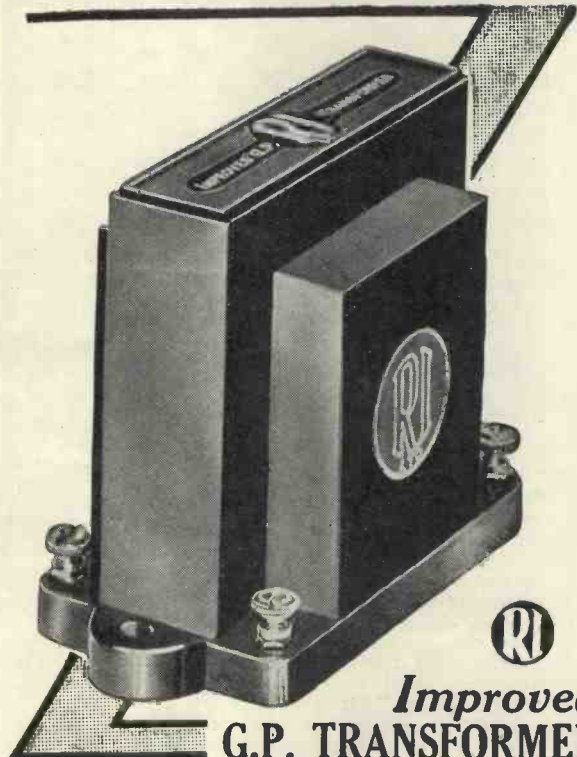

**Improved
G.P. TRANSFORMER**
GIVES DEFINITELY "BEST"
PERFORMANCE of any
Transformer at or below
its Price

A new, larger "general purpose" transformer for use where considerations of space do not arise. Fitted in a beautiful green bakelite case with an improved iron core, its electrical characteristics show a vast advance on the original G.P. model. Ratio 3½ to 1. Primary inductance 35/40 henries. Weight 18 ozs. The lowest priced transformer with such high primary inductance

10'6

The "HYPERMITE" Nikalloy Core Transformer

A marvel for its weight and size, the "Hypermite" is indispensable in compact set assembly. When employed with the G.P. Transformer above, definitely gives higher amplification and purer reproduction than any other combination of transformers at the price. Ratio 3½ to 1. Primary inductance over 50 henries.

12'6

**The HYPERMU
NIKALLOY CORE
TRANSFORMER**

Gives the highest and most uniform amplification of any commercial transformer in existence. 25 to 7,000 cycles. Primary inductance 85 henries. Ratio 4 to 1 **21/-**



**The Dual
ASTATIC H.F.
CHOKE** The only choke ensuring perfect amplification from screened grid valves at all broadcasting wavelengths. Resistance D.C. 650 ohms. Inductance 60,000 microhenries **7/6**

R.I. Ltd., Madrigal Works, Purley Way, Croydon
Phone: Thornton Heath 3211

THE LAST WORD

Highest
Efficiency
Lowest
Cost



Consider the price of the Wufa and read the letter below
Southall, Middlesex.
March 24th, 1931.
Dear Sirs,
At a meeting of our local Radio Society last Wednesday (March 18th), there was held a Loud-speaker Test to determine the best loud-speaker.
The speakers were placed behind a screen out of sight and played off in twos. Members then voted which speaker was the better of the two. This process of elimination was kept up until there was only one speaker left, which was therefore by universal vote, the best.
Although there were about twenty-five speakers there of all makes, and including two moving-coil speakers, my Wufa was found to be the winner.
The members were amazed at the fidelity of its reproduction and afterwards a lecture was given on its merits.
Hoping this may be of interest to you.
Yours truly, E.C.P.

Beware of imitations. The genuine Wufa has R.I.D. Magnets

40/- Complete with chassis **27/6** Unit only

WUFA

From All Dealers
M. LICHTENBERG
4 Great Queen Street, London, W.C.2

Chosen for the "Gramo-Radio A.C. 3"

Powerful and unvarying voltage, with an ideal combination of H.T. and L.T. supplies, were some of the reasons why the Heayberd All-Mains W.25 Transformer was selected for the "Gramo-Radio A.C. 3"

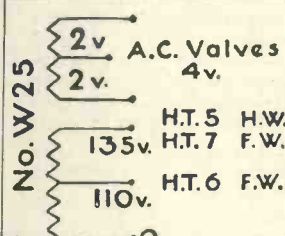

Price - - 21/-

RECTIFIED OUTPUTS.
200 v. at 28 m.a. using tapping
135 v. with Rectifier H.T.7
120 v. at 20 m.a. using tapping
135 v. with Rectifier H.T.5 (H.W.)
175 v. at 25 m.a. using tapping
110 v. with Rectifier H.T.6.
4 v. 4 amps. for A.C. Valves from 4 v. L.T. tapping.
Send 3d. stamps for full Lists giving details of the particular Transformer required by YOU.

Model W.25 is one of a special series designed expressly for use with Westinghouse Rectifiers.

10 Finsbury St. **F. C. HEYBERD & CO.,** London, E.C.2

HOUSE YOUR PORTABLE IN



You must have a good cabinet for your portable. The Camco "Riverside" is strong and well built and yet is handsome and attractive. Covered in good quality blue leatherette. Inner frame, bass-board, etc. As used by leading manufacturers. With polished wood panel, 14 in. x 6 3/4 in., **45/-**.

Send Coupon for free Catalogue to—
CARRINGTON Mfg., Co., Ltd.,
24 Hatton Garden, LONDON, E.C.1
Phone: Holb. 8202. Wks.: S. Croydon

Name _____
Address _____
W.M.2

Advertisers like to know you "saw it in the 'Wireless Magazine'"

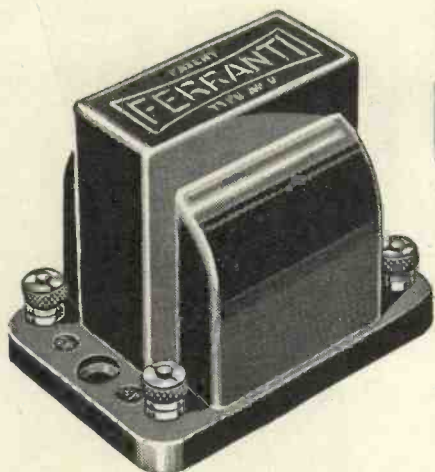

NOW———A
FERRANTI
TRANSFORMER

AT

11'6

TYPE—AF8
RATIO—1 to 3½

With an amplification curve better than any transformer available at the price. Built to the Ferranti Standard of quality and performance. Don't impair the quality of your set by fitting an inferior transformer.

FERRANTI LTD. Head Office and Works: HOLLINWOOD, LANCASHIRE.
London: BUSH HOUSE, ALDWYCH, W.C.2.

LOTUS VALVE HOLDERS

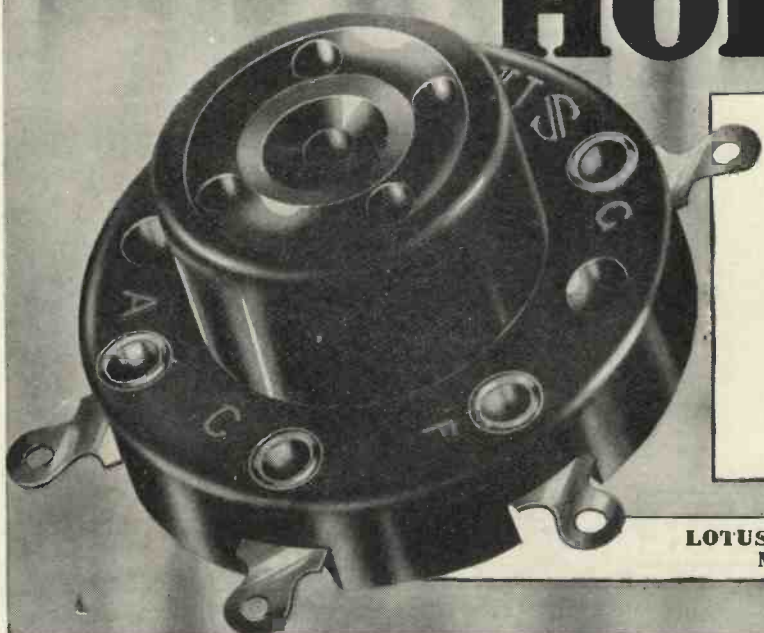

**SPECIFIED IN THE
GRAMO-RADIO A.C. 3**

**Three Lotus Rigid Type 5-pin
Valve Holders (for A.C. valves)**

The experts are loud in their praise of this Valve Holder, which is specially suitable for modern indirectly-heated valves. Careful attention has been given to the current-carrying capacity of the valve sockets, which is considerably in excess of what is required from the ordinary valve holder.

Only 1½" in diameter, and universal for 4- or 5-pin valves, the price is 1/- (with terminals), 9d. (without terminals).

Also Anti-Microphonic Valve Holder (with terminals) 1/9; (without terminals) 1/6, and Miniature Type Anti-Microphonic Valve Holder (with or without terminals) 1/8.

From every Wireless Dealer

**LOTUS RADIO, LTD., LOTUS WORKS,
MILL LANE, LIVERPOOL**

It helps us if you mention "Wireless Magazine"

A STRAIGHT LINE

A PERTRIX Non-sal-ammoniac Dry Battery plus an Improved Pertrix Accumulator equals perfect reception.

Every Pertrix Battery that leaves our factory at Redditch tells us that somebody is going to get better radio. Why shouldn't it be you?

You have only to fit a Pertrix Dry Battery and Accumulator to your set—plug in—and listen, and we *know* that you will say "That's something like radio."

Ask your dealer to-day—he will tell you the most suitable type for *your* set.

The types illustrated are a perfect pair for two- and three-valve sets.

Do you know that you can get Pertrix Batteries for your flash-lamp? They are 6d. each, with an unlimited guarantee.



100 volt Standard Capacity H.T. Battery 13/-

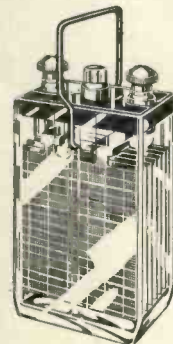

PXG 3, Capacity 30 a.h. at 20 hour rating .. 11/6

TO BETTER RADIO RECEPTION

PERTRIX SUPER LIFE DRY BATTERIES AND ACCUMULATORS

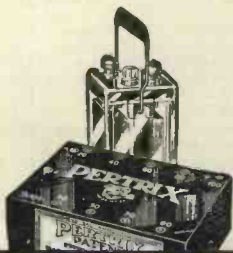

THE PERFECT PAIR FOR PERFECT RADIO

Advt. of PERTRIX, LTD., Britannia House, 233, Shaftesbury Avenue, London, W.C.2. Works: Redditch.
Telephone: Temple Bar 7971 (5 line) Telegrams: Britannia. Westcent, London P104

Advertisers take more interest when you mention "Wireless Magazine"

NO home-constructor set has ever become famous so quickly as did W. James' Super 60, which was first described in the March issue of WIRELESS MAGAZINE. The tremendous success of the Super 60 is a revelation of the keenness with which the construction of sets is tackled by thousands of listeners all over the country.

What It is—and Does

Most readers of WIRELESS MAGAZINE will by now be aware of what the Super 60 is and what it will do. Those to whom the set is new are referred to pages 409-416 of this issue, in which we reprint details of the set from the March and April issues. Everybody will also be interested in the selection of enthusiastic reports from readers that appears on pages 397-399.

As soon as the first details of the Super 60 were published we received many requests from readers for a portable version. They guessed that owing to the compact nature of the original design little or no efficiency would be lost by putting the set into a portable case. In this they were right.

Experimental Work

To make doubly sure, however, W. James has carried out extensive work on the portable edition during the last few weeks. He came across no snags and the model of which

THE SUPER 60 PORTABLE

W. James Puts His Sixty-station Set in Portable Form and Revolutionises Self-contained Battery

Receivers :: The Portable Is As Good As the Original Model in Every Way and Can Be Built Complete with Valves, Batteries, Cabinet and Loud-speaker for £15 :: Construction is Simple and Easily Accomplished

details are presented in the following pages is substantially the same as the original version.

Actually the circuit arrangement is identical, but a slight change has been made in the layout in order to accommodate the components on the different size of panel and baseboard.

Best Portable Yet

There is no question that the Super 60 Portable is the most efficient and satisfactory self-contained battery set of which details have been presented to home-constructors. It can be relied on to give results in every way as good as those obtained with the original Super 60—and that is saying a great deal indeed, as all regular readers will appreciate.

Complete details for the construction of this remarkable portable receiver are contained in the following pages, and no reader will have any difficulty in following the clear instructions, which include many large-sized photographs and drawings.

The cost of building a complete Super 60 Portable is approximately £15, but many constructors will be able to assemble the set at much lower cost because they will already have in their possession a number of the necessary components. Notes on this point will be found at the end of the constructional details in the following pages. Remember that a full-size blueprint is available.

Start Now!

Go ahead now and start building a portable that is so good that you will not be able to resist the temptation of taking it about with you for the edification of your friends. The Super 60 Portable will enable you to tour Europe wherever you may be. It is the Pullman of Portables!



HOW TO BUILD THE SUPER 60 PORTABLE



COMPLETED AND READY FOR USE

Here you see the Super 60 Portable all ready to tune in. It is completely self-contained with aerial, loud-speaker, and batteries. This receiver gives an entirely new conception of portable possibilities.

A SUPER 60 redesigned to fit a portable-type case. That's what this set is! Therefore it is quite different from the usual run of portable receivers.

Extreme Range and Fine Tone

There is no doubt about that. It has the extreme range of the Super 60, the fine tone; the same sharpness of tuning is there, and the operation is just as easy.

This is a real self-contained set, compact and effective. It is cheap to build, too, and the running costs are fairly low.

The total high-tension current is about 12 milliamperes with the volume control in its maximum position. This current will, of course, vary a little with the valves used, and the position of the volume control.

How the Volume Control Works

You will see this if you consider how the control works. It is a potentiometer, which is connected in series with a resistance of 20,000 ohms. The screens of both screened-grid valves are connected to the sliding contact of the potentiometer.

Therefore, when the control is in the position for minimum volume the voltage applied to the screens is small and the current taken by these

The circuit is identical with that of the now famous Super 60. You have first in the lid part of the container a frame aerial. This is wound in two sections, for the long and the medium wavelengths.

A switch is included in the lid and when in its "off" position the long-

two valves is also small.

As the control is moved over towards the maximum the voltage of the screens is increased and this raises the amount of the current passing through the two valves.

wavelength winding alone is in circuit. When the switch is operated the medium-wavelength winding is placed in parallel with the long-wavelength part. The circuit may then be tuned over the medium waves.

Also in the lid is the loud-speaker. This is a well-known unit and it has proved to be a good one, giving acceptable quality of reproduction.

Receiver Arrangement

In the receiver proper you have, in the centre of the panel, which by the way is of wood, a three-point switch connected to the filament circuits. This is the on-off switch for the set and I used a separate switch, instead

(Continued on page 360)

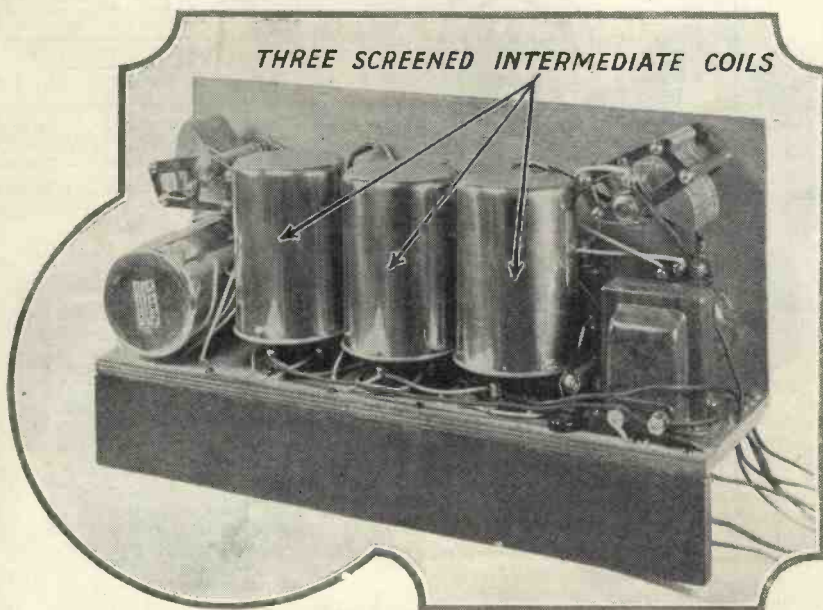

SPECIAL SCREENED INTERMEDIATE COILS

This photograph shows the under side of the wood panel. The oscillator coil is on the extreme left (horizontal), while the three intermediate coils are seen upright.

Layout and Wiring Plan of the Super 60

The length indicated against each number is that of the insulated sleeving needed for each lead. In all cases the wires should be cut about 1/8 in. longer than the sleeving to allow for screwing under terminal heads. Use No. 20-gauge tinned-copper wire. If either of the two flexible resistances is too short a piece of wire should be joined to one end to make up the length

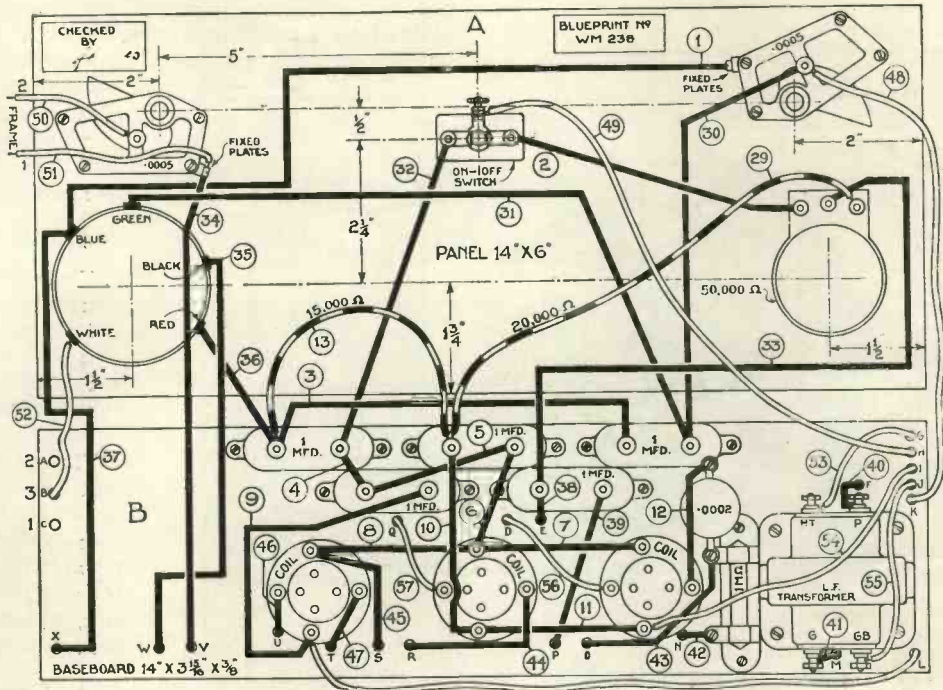

- Connection No. 1 .. 12 in.
- Connection No. 2 .. 5 1/2 in.
- Connection No. 3 .. 6 1/2 in.
- Connection No. 4 .. 1 1/2 in.
- Connection No. 5 .. 3 1/2 in.
- Connection No. 6 .. 3 1/2 in.
- Connection No. 7 .. 3 1/2 in.
- Connection No. 8 .. 3 1/2 in.
- Connection No. 9 .. 5 1/2 in.
- Connection No. 10 .. 5 1/2 in.
- Connection No. 11 .. 3 1/2 in.
- Connection No. 12 .. 2 1/2 in.
- Connection No. 13 .. 15,000 ohm flexible resistance
- Connection No. 14 .. 2 1/2 in.
- Connection No. 15 .. 2 1/2 in.
- Connection No. 16 .. 2 1/2 in.
- Connection No. 17 .. 3 1/2 in.
- Connection No. 18 .. 2 1/2 in.
- Connection No. 19 .. 2 1/2 in.
- Connection No. 20 .. 3 1/2 in.
- Connection No. 21 .. 2 1/2 in.
- Connection No. 22 .. 2 1/2 in.
- Connection No. 23 .. 2 1/2 in.
- Connection No. 24 .. 2 1/2 in.
- Connection No. 25 .. 1 1/2 in.
- Connection No. 26 .. 1 1/2 in.
- Connection No. 27 .. 4 1/2 in.
- Connection No. 28 .. 2 1/2 in.
- Connection No. 29 .. 20,000 ohm flexible resistance

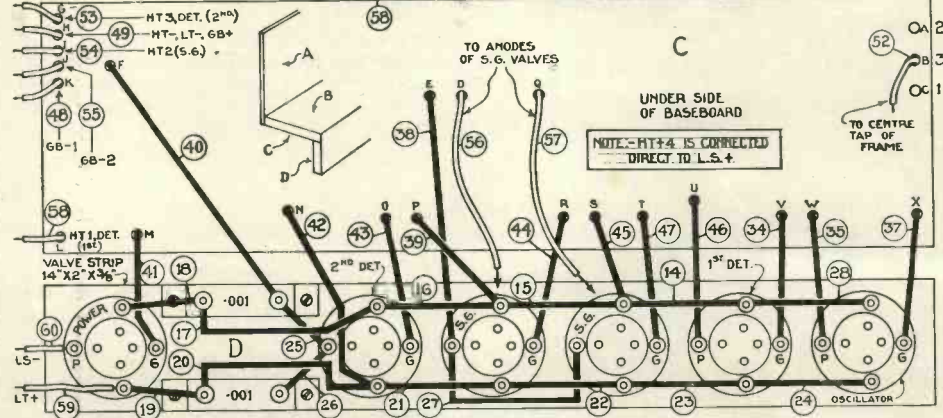

A full-size blueprint can be obtained for half-price (that is, 9d., post free) if the coupon on page 448 is used by May 30. Ask for No. WM238 and address your inquiry to Blueprint Dept., WIRELESS MAGAZINE, 58-61 Fetter Lane, London, E.C.4. This diagram is one-third scale. Use the section marked B as a template to mark positions of holes for sub-baseboard leads. Section C is the underside of the baseboard (see B)

- Connection No. 30 .. 5 in.
- Connection No. 31 .. 9 1/2 in.
- Connection No. 32 .. 2 1/2 in.
- Connection No. 33 .. 5 1/2 in.
- Connection No. 34 .. 5 1/2 in.
- Connection No. 35 .. 5 in.
- Connection No. 36 .. 2 1/2 in.
- Connection No. 37 .. 6 in.
- Connection No. 38 .. 5 1/2 in.
- Connection No. 39 .. 6 1/2 in.
- Connection No. 40 .. 3 1/2 in.
- Connection No. 41 .. 2 1/2 in.
- Connection No. 42 .. 3 1/2 in.
- Connection No. 43 .. 4 1/2 in.
- Connection No. 44 .. 3 1/2 in.
- Connection No. 45 .. 4 1/2 in.
- Connection No. 46 .. 2 1/2 in.
- Connection No. 47 .. 3 1/2 in.
- Connection No. 48 .. 23 in. flex to G.B.-1

- Connection No. 49 .. 24 in. flex to H.T.-plug, then 9 in. to L.T.-spade, then 11 in. to G.B. + plug.
- Connection No. 50 .. 24 in.
- Connection No. 51 .. 24 in.
- Connection No. 52 .. 20 in.
- Connection No. 53 .. 18 in. flex to H.T. + 3 (second det.)
- Connection No. 54 .. 22 in. flex to H.T.+2 (S.C.)
- Connection No. 55 .. 22 in. flex to G.B.-2

- Connection No. 56 .. 7 in.
 - Connection No. 57 .. 7 in.
 - Connection No. 58 .. 25 in. flex to H.T.+1 (first det.)
 - Connection No. 59 .. 16 in. flex to L.T.+
 - Connection No. 60 .. 18 in. flex to L.S.-
- NOTES.—Connections Nos. 50, 51 and 52 are to frame aerial; Nos. 56 and 57 to screen-grid valve anodes. An 18 in. flex is needed between L.S.+ and H.T.+4 plug.

There is a possibility that the tip of the filament on-off switch may touch the middle intermediate coil when the set is pushed in its cabinet.

To avoid a contact being made in this way it is advisable to wrap a turn or two of insulating tape round the top of the copper can.

The coil in question is the centre upright one seen in the lower photograph on page 358.

THE SUPER 60 PORTABLE—Continued

of combining it with the frame-aerial switch, in the interests of simplicity in wiring.

There are six valves, of course. The first is the oscillator. This valve

and these are coupled by screened filter coils to the second detector. The long-wavelength signal is therefore amplified by the two stages, the amount of the magnification being

nification to be obtained is considerable. The coils are shielded and by-pass condensers are used where necessary. They are properly designed transformers having very good characteristics. Both the primary and secondary windings are tuned by condensers included in the coil units and the units are accurately tuned by the makers.

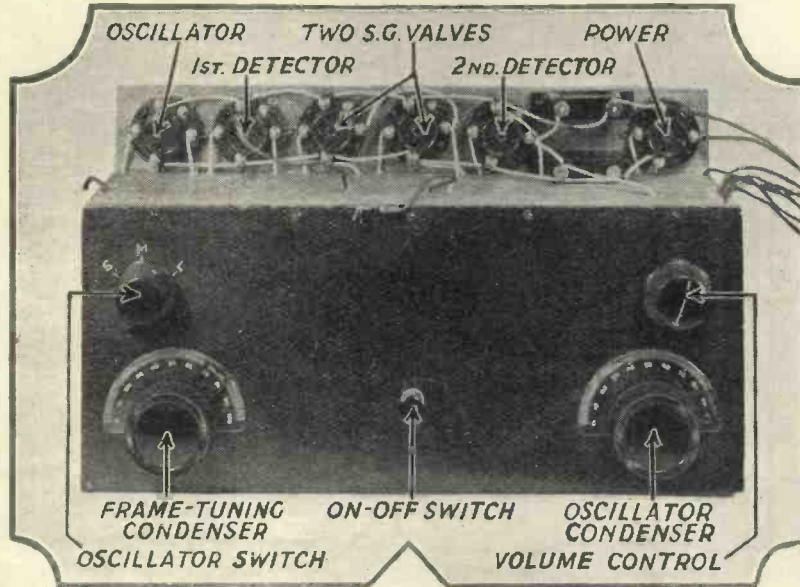

HOW THE CONTROLS ARE ARRANGED

From this plan view it will be clear how the tuning controls are arranged. The positions of the six valves will also be clear. Note the short-, medium- and long-wave positions of the oscillator switch on the left.

has connected to it a tuning condenser and oscillator unit. The oscillator unit is complete with switch and is mounted on the panel with the switch spindle projecting through. This is a three-range oscillator, one of the ranges being for the short waves; we do not use it. The tuning condenser is .0005 microfarad.

First Anode-bend Detector

Next to the oscillator valve is the first detector or modulator as it is often called. This valve works as an anode-bend detector. It is connected to the centre-tapped frame and to the oscillator as well. The result is that the locally-generated oscillations and also the signal being received are applied to the detector.

Intermediate Filter Units

In the output circuit of this detector is the first filter unit. This is so designed that the signal, which we have created by mixing the signal collected and the local oscillations, is passed by the filter, while the unwanted currents are passed to the filament circuit.

There are two screen-grid stages

controlled by the screen-grid potentiometer, which we call the volume control.

Owing to the design of the long-wavelength part of the set the mag-

Accurate Matching

Thus there is no matching to be carried out by the amateur, the coil units being alike electrically. You just plug them into the holders provided, knowing them to be accurately tuned and that they match up satisfactorily.

The second detector is of the leaky-grid type and has normal values, but in the anode circuit are two by-pass condensers; one is connected between the anode of the detector and the negative side of the filament circuit, while the second goes between the anode and the positive side.

Condenser Positions

In the set itself these two condensers are fitted between the detector and power valve holders. You obtain short wires by this means.

The oscillator has a negative bias of the same value as the first detector and this is by-passed with a 1-microfarad fixed condenser. A resistance is included in the anode circuit of the

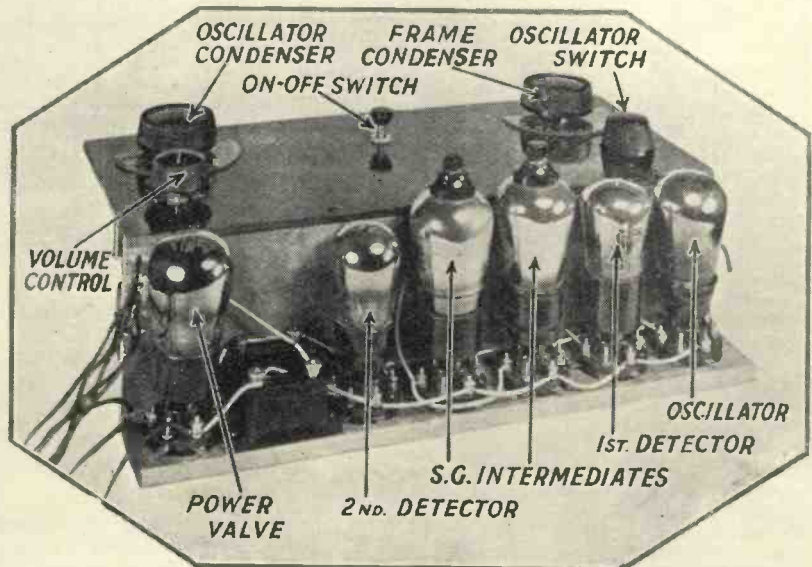

EXTREMELY SIMPLE FORM OF CONSTRUCTION

In spite of the number of valves, there is little cramping in the design and construction can be completed without difficulty.

THE BEST PORTABLE YET PRODUCED !

oscillator and is by-passed with a further 1-microfarad condenser. This resistance acts to limit the amount of the current taken by the oscillator.

As designed, the tendency is for the oscillator to pass a greater anode current over part of its range. With the resistance connected the current is made more uniform in value and does not exceed a certain reasonable value at any part of the tuning range.

By-pass Condensers to give Stability

There is another by-pass condenser for the screens of the screen-grid valves and two more are connected across the different high-tension circuits. The result is that the set is stable.

The long-wavelength part of the set can be made to oscillate by turning up the volume control, but is not used in this condition. Only with the weakest of signals is the volume control turned so far round that the set is approaching the oscillating point.

Three pieces of wood are used for the set. First is the panel proper, upon which are fitted the two tuning condensers, the volume control, the oscillator with its wave-range switch and the filament-circuit switch. This panel has screwed to it at one end a piece of wood which in turn carries the valve platforms.

Upon the valve platforms are fitted the six valve holders and two by-pass condensers. These are first screwed in place.

Follow the Original Layout

If you look at the illustrations and diagrams you will see the parts referred to. There is not a great deal of room for the parts so the drawings must be carefully followed. Notice, in particular, the positions of the 1-microfarad condensers and of the four coil units. The cases must not touch and as arranged there is ample clearance.

Be careful in fitting the grid-leak holder and the transformer. In the transformer used is an earthing terminal; I cut this off as it is not needed and tended to be in the way.

There will be no difficulty in fitting the grid condenser, one end being fixed to a terminal and the other having a small bolt and nut ready for a connecting wire.

Numerous holes must be drilled through the wood for connecting wires. Put these through carefully so that the wires shall pass through conveniently.

ACCESSIBLE BATTERIES

The photograph on the right shows the cover of the battery compartment removed. The high-tension consumption is of the order of 12 milliamperes.



THE DESIGNER

Lissenden's impression of W. James, the designer of the Super 60 and the Super 60 Portable.

Remember that W. James' A.C. version of the Super 60 will be described in the next issue—on sale Friday, May 22

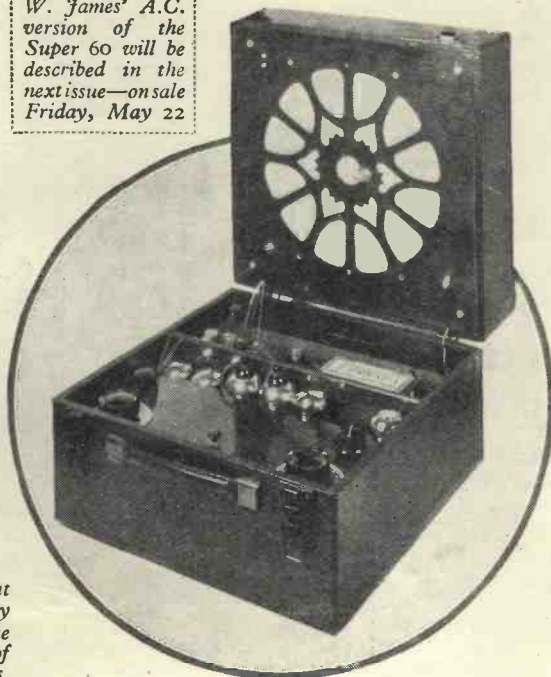

The oscillator unit which I have used is provided with connecting tags that project through pieces of coloured insulating material. There is no need to solder the circuit wires to the tags, as these are so made that the wire is tightly gripped when the tags are pressed with pliers.

Be careful not to make contact with the cover at any of the connecting points, by pushing the Systoflex well down the wires. Put the wires on before the unit is finally fixed in position and you will notice that the unit is arranged with the wires coming from it in certain directions. Attention to

THE SUPER 60 PORTABLE—Continued

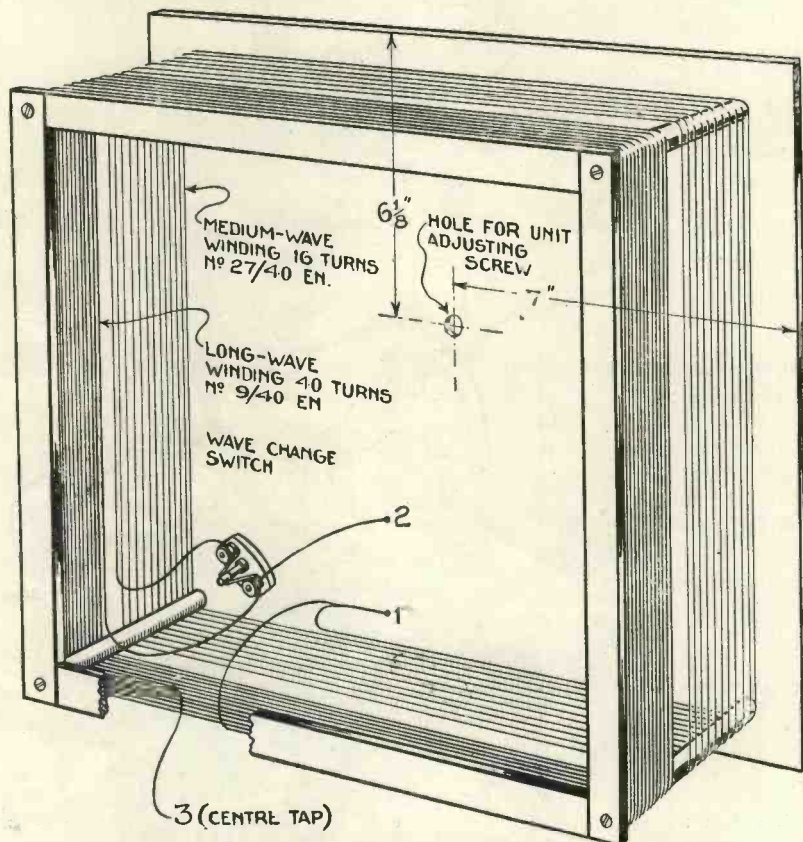

HOW TO WIND THE DUAL-RANGE FRAME AERIAL

This diagram shows clearly the aerial winding. The wooden frame is supplied with the Camco cabinet. If an Ormond loud-speaker unit is used a hole must be drilled for the adjusting knob as indicated (for clearness the fretted design is not shown).

this will simplify the wiring.

It is as well to make sure that everything fits in the case before starting the wiring and to provide the necessary fixing holes for the wood screws.

I started the wiring by connecting the filament circuits, using No. 22 tinned-copper wire and Systoflex. Then the long-wavelength coil unit holders can be wired and so on. The wires which pass from one side of the panel to the terminal strip must be put in carefully in order to clear other parts.

No Difficulty in Wiring

There is actually no difficulty at all in the wiring in spite of a few long wires which cannot be avoided and do not affect the efficiency of the circuit at all. These wires, from the oscillator coil unit to the oscillator tuning condenser, for example, are best laid by the by-pass condensers so as to be a short distance from the panel itself.

Notice which way round the volume control is wired and do not mix the two flexible resistances which are wired into the circuit.

Flexible Battery Leads

There are a number of flexible wires for the battery supplies. These should be marked as they are fitted in position, using tags or engraved connectors. The loud-speaker wires must be run at one end and also the frame-aerial connecting wires. There are three frame-aerial wires, the centre tap and the two ends. The tap is actually made in the long-wavelength part of the winding and this suffices for long and medium waves.

Two wires are needed for the anodes of the screen-grid valves, ordinary flexible wire having a rubber covering is suitable, there being no real advantage in using screened connecting wires.

Winding the Frame Aerial

It is not difficult to wind the frame aerial or to fit the loud-speaker. Details are given in the drawings.

Stranded wire is used for the frame windings. Wind the turns quite tightly, and connect the ends as shown, remembering that the two parts are in parallel when receiving on the medium waves and that the long-wavelength part is used alone when tuning over the long waves. Use stranded wire for the frame as

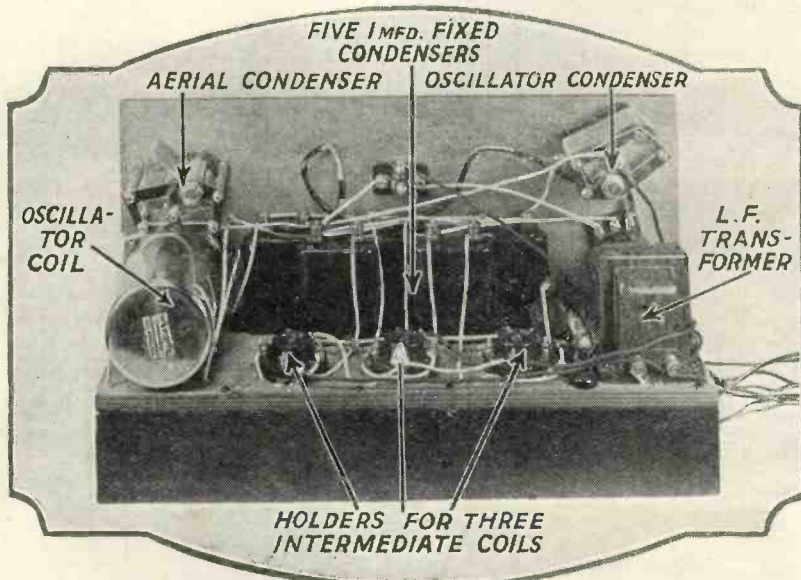

COMPONENTS UNDERNEATH THE WOODEN PANEL

This view shows the components on the under side of the wood panel. Note the three valve holders for the intermediate coils, none of which are provided with flexible screen-grid connectors. All connections are made to the coil holders.

How to Connect the Frame Aerial, Loud-speaker and Batteries in the Super 60 Portable

DISTANCE PIECES
AT TOP AND BOTTOM
9" X 5/8" SQ.

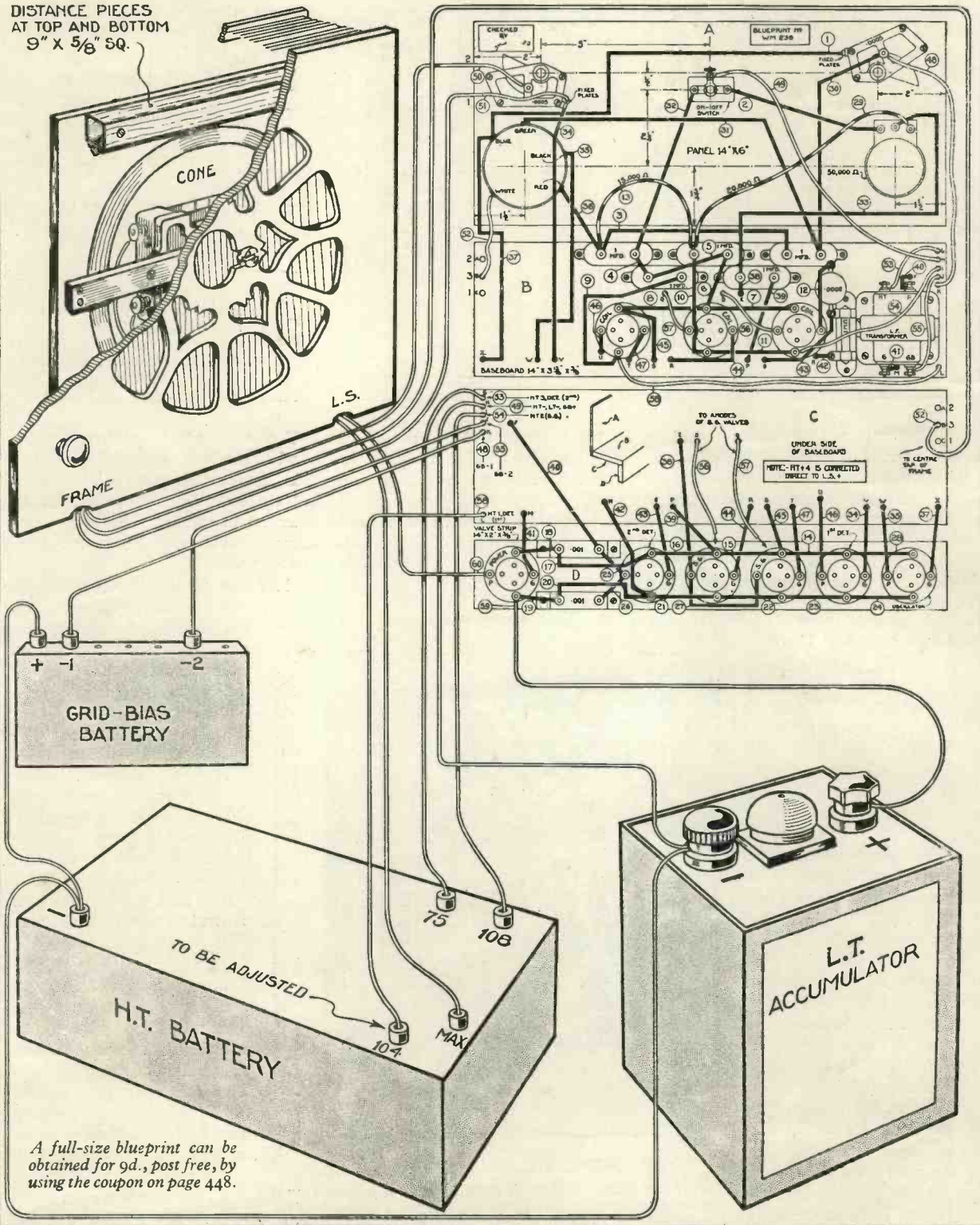

A full-size blueprint can be obtained for 9d., post free, by using the coupon on page 448.

THE SUPER 60 PORTABLE—Continued

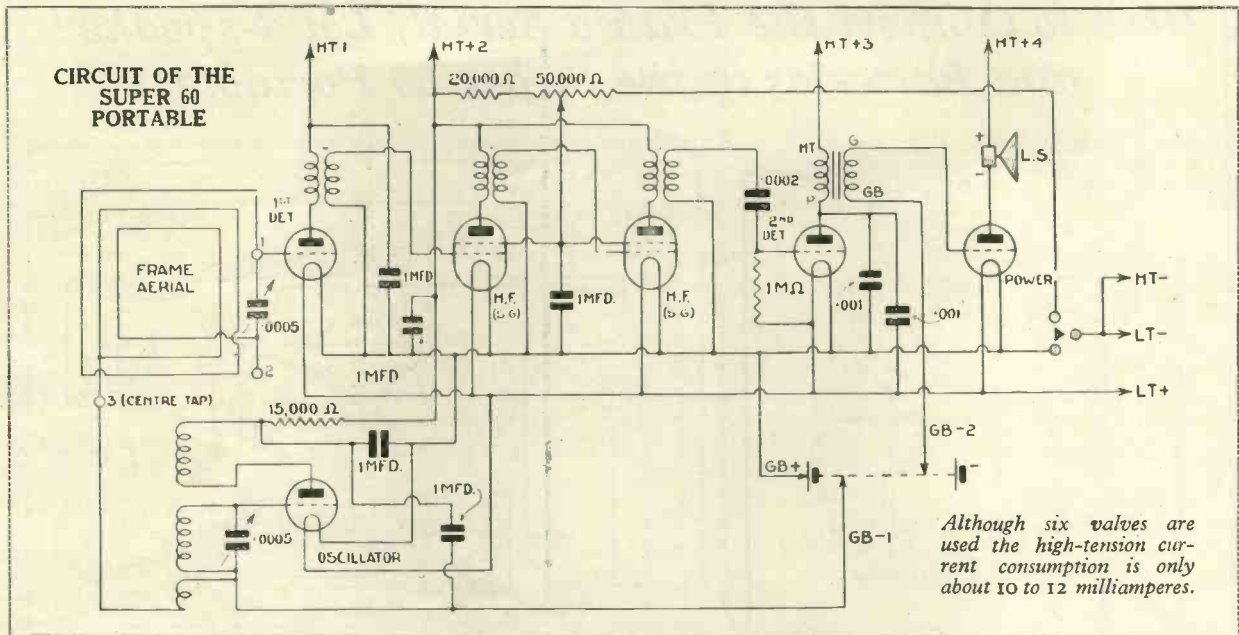

specified and not ordinary solid copper wire.

The frame is, of course, a vital part of the set and should be made as nicely as possible. Be careful of the ends, baring them properly and joining all strands together.

With the turns given the wavelength ranges are just right.

Loud-speaker Unit

Fit the loud-speaker unit carefully, making as sound a job as possible. Make sure it is fitted properly to the front of the lid.

Several wires must be taken between the lid and the set, for the frame and loud-speaker connections. Make these no longer than necessary, particularly the frame-aerial wires which are, of course, part of the tuned circuit.

There is no difficulty over the valves as they are not critical. For the first detector, which is an anode-bend rectifier, a high-impedance valve can be used, with a medium-impedance valve as oscillator. The same grid bias is used for these two valves, negative 1.5 or 3, but the detector has a separate high-tension tapping in order that it may be accurately adjusted.

In the next two stages are fitted screen-grid valves and then comes the detector. You can use here any usual detector valve, but do not use too low an impedance valve as it will probably pass too much current. This stage has a separate high-tension feed and so may be adjusted.

You will find the quality is not so good when the voltage applied to this detector is very low, so the voltage should be adjusted in the interests of quality. For the power stage we can use the usual small power valve.

Here we would like to use the largest valve possible so as to get the greatest power output. But the total high-tension current must be considered and an ordinary valve will give comfortably strong signals.

You will find when tuning that the frame-aerial condenser appears to tune fairly sharply and that the oscillator condenser is sharper still. Set the frame switch and the oscillator to the medium waves and turn the volume control to near its maximum.

Sounds You Know

Then, as you bring the oscillator condenser into its position of tune with respect to the frame circuit the characteristic noise is heard. You can then adjust the volume control and proceed to tune by turning the two tuning condensers very slowly.

The tuning is quickly mastered and having heard a station move the set round so that the signal is made

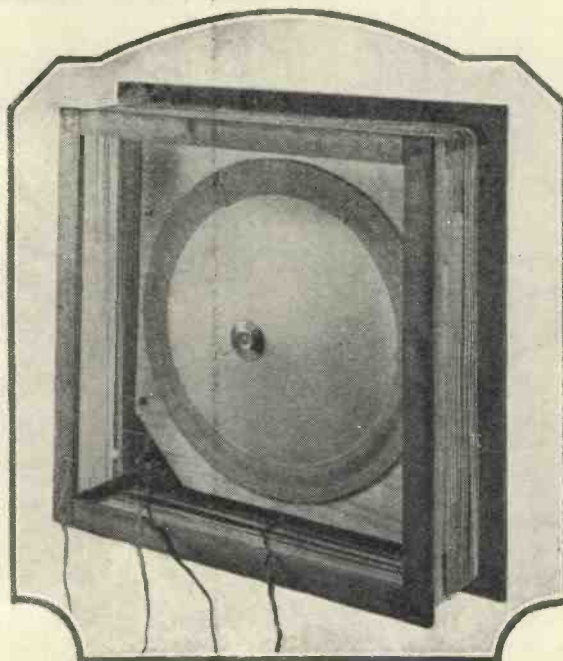

FIXING THE LOUD-SPEAKER

The Ormond loud-speaker is supplied already mounted on a square board which is screwed behind the fretted opening of the Camco cabinet. The board must be spaced from the front by small blocks or strips of wood.

W. JAMES REVOLUTIONISES RADIO DESIGN

weak. Then you can adjust the battery voltages in order to obtain the maximum strength.

See in particular to the first detector, trying first a bias of negative 3 volts and a suitable high tension and afterwards a bias of 1.5 and a lower high tension. It is to be preferred to use the greater grid bias.

Oscillator Tuning

You will probably notice that a station can be tuned in with two positions of the oscillator. This is normal, and if the tuning is carried out systematically will not cause confusion. Shift both tuning condensers together a little at a time, as the tuning is very sharp, probably much sharper than anything you have handled before. You will notice that the frame aerial is a little directional, and so advantage might be taken of it.

Good Quality

The quality of the reproduction is just as good as would be expected from the parts and batteries used, that is quite acceptable. A large number of stations is heard on both wavelength bands; interference is practically non-existent; the tuning is easy; and the set is not too heavy to be fairly portable.

Incidentally, for home use, a mains unit can be fitted in the place of the high-tension battery.

Finally, remember that the Super 60 Portable is the Super 60. Nothing has been changed except the layout and identical results can be expected—no more need be said.

BUILDING THE SET CHEAPLY

ALTHOUGH the cost of building the Super 60 Portable has been mentioned as about £15, this figure only applies if every part has to be bought—down to the last screw.

Almost anybody who has built a set before will be able to save considerably on this cost, as a glance at the list of components will show.

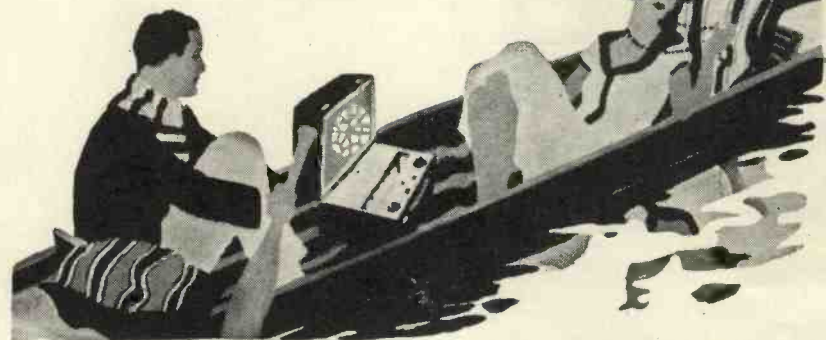

For instance, many constructors will have by them some spare valve holders and one or two 1-microfarad fixed condensers. Others will have some spare fixed resistances, a potentiometer and a small low-frequency transformer.

Again, a large number of prospective builders will have some valves.

The only parts that the majority of WIRELESS MAGAZINE readers will not have in their possession is a portable cabinet, small loud-speaker unit, and

the special coils. If these are the only parts that have to be specially bought the cost of building the set will be only about £6.

Everything in the Case

Even if you do not want a portable as a portable, remember that this version of the Super 60 is every bit as efficient as the original model, with the advantage that everything—set, loud-speaker, frame aerial and batteries—is in one case.

COMPONENTS NEEDED FOR THIS SET

COILS

- 1—Set of Wearite super-hot coils (one O2 and three OT1), £2 10s.

CONDENSERS, FIXED

- 1—Formo .0002-microfarad, 6d. (or Ormond).
2—Dubilier .001-microfarad, type 620, 4s. (or Telsen, T.C.C.).
5—Dubilier 1-microfarad, type BB, 12s. 6d. (or T.C.C., Franklin).

CONDENSERS, VARIABLE

- 2—Jackson .0005-microfarad, type Tiny No. 2, 17s. (or Utility).

HOLDER, GRID-LEAK

- 1—Bulgin, type G6, 9d. (or Dubilier, Lissen).

HOLDERS, VALVE

- 9—W.B., rigid type, 9s. (or Telsen, Lotus)

PLUGS AND SPADES

- 8—Belling Lee wander plugs, marked: H.T.+4, H.T.+3, H.T.+2, H.T.+1, H.T.—, G.B., G.B.—1, G.B.—2, 2s. (or Clix, Eelex).

- 2—Belling-Lee spade terminals, marked: L.T.+ , L.T.—, 9d. (or Clix, Eelex).

RESISTANCES, FIXED

- 1—Lewcos 15,000-ohm, flexible type, 1s. 6d. (or Magnum, Bulgin).

- 1—Lewcos 20,000-ohm, flexible type, 1s. 6d. (or Magnum, Bulgin).

- 1—Lissen 1-megohm grid leak, 1s. (or Dubilier, Watmel).

RESISTANCE, VARIABLE

- 1—Sovereign 50,000-ohm potentiometer with black knob, 4s. 6d. (or Regentstat, Rotorohm).

SUNDRIES

- Tinned-copper wire for connecting. Lengths of insulated sleeving. Frame aerial wire to specification (Petoscott or Lewcos).

SWITCH

- 1—Readi-Rad three-point, 1s. 6d. (or Bulgin, W.B.).
1—Bulgin junior on-off, 1s. (or Readi-Rad, W.B.).

TRANSFORMER, L.F.

- 1—Telsen Ace, 8s. 6d. (or Ferranti AF8, Igranic Midget).

ACCESSORIES

BATTERIES

- 1—Pertrix 108-volt, portable type, 14s.
1—Pertrix 9-volt, grid-bias type, 1s. 6d. (or Drydex, Ever Ready).
1—C.A.V. 2-volt accumulator, type 2NS17, 16s. (or Exide, Gecophone).

CABINET

- 1—Carrington Riverside portable, £2 5s.

LOUD-SPEAKER

- 1—Ormond portable chassis and unit, £1 5s. (or Mullard).

VALVES

OSCILLATOR

- 1—Mullard PM11F, 8s. 6d. (or Marconi L2/6, Osram L2/6).

FIRST DETECTOR

- 1—Mullard PM11F, 8s. 6d. (or Marconi H2, Osram H2).

S.G. INTERMEDIATES

- 2—Mullard PM12, £2 (or Marconi S215, Cossor 215SG).

SECOND DETECTOR

- 1—Mullard PM11F, 8s. 6d. (or Marconi HL2/c, Osram HL2/c).

POWER

- 1—Mullard PM2, 10s. 6d. (or Marconi LP2/c, Cossor 215P).



Billy Mason is the pianist-conductor of the Cafe de Paris dance band

IT appears that there are still many listeners who are of the opinion that an annual expenditure of over £100,000 on the new orchestra is an expensive luxury indulged in by the B.B.C. at the expense of the listener and at the expense of the more popular type of programme.

Capable of Division

This supposition is by no means true. The new orchestra is more than an ordinary symphony orchestra. It can be divided into smaller combinations to give almost all the orchestral programmes that are broadcast at the present time.



The well-known writer whose thriller, "Light and Shade," was recently broadcast—L. du Garde Peach

THE MONTH'S

Cost of B.B.C. Orchestra Explained :: Recent Performances at Queen's Hall :: Future Concerts :: Lunch-hour Concerts on Sundays :: Grand Opera Arrangements

The full orchestra consists of one hundred and fourteen players; every member has been carefully chosen on merit alone.

The result of this careful selection of players is that the B.B.C. has got together an orchestra that compares favourably with many of the firmly established Continental symphony orchestras.

In practice, this orchestra is divided into four or five sections for general work. The Sunday evening concerts relayed from No. 10 studio are given by about seventy-eight players, light orchestral concerts by about thirty-six

players, light symphony concerts by sixty-seven, and for popular concerts forty-seven players are utilised.

Listeners will realise that the large amount of money spent is in no way an extravagant waste, but a systematic method by which all musical programmes are assured of being performed in first-class style.

It is the aim of the B.B.C. that this orchestra should fix a standard for orchestral playing in this country and, by the method adopted, its aims appear to have been realised.

Performances given at the Queen's Hall this season have reached a very high standard and next season should see even better renderings of large orchestral works.

National Chorus

Amongst the more recent of these concerts we have had, at last, a good opportunity of judging the capabilities of the National Chorus.

This opportunity was given by performances of two contrasted choral works. The first was at the concert on March 18, conducted by the eminent German musician, Oscar Fried, when Beethoven's Choral Symphony (the ninth) was performed. Here the chorus showed its capabilities in singing one of the greatest works by this master musician. The

singing was excellent, of good quality, and properly balanced.

On March 25 we heard it sing again in the first London performance of Arthur Bliss' new work, *Morning Heroes*, an entirely different aspect of music. This work, which is essentially modern, constituted the main item in



Isabel Armour, 'cellist, heard from Scottish stations



Mathew Nisbet, bass, sings in Northern programmes

the first of Series D of these concerts, to which reference was made last month.

Described as a symphony in five movements, it is written for a large, mixed chorus, full orchestra, and an orator. The orator was Basil Maine, who took that part in its first performance at the Norwich Musical Festival in October last year.



Henry Hall—the leader of the Glen-eagles Hotel band, one of the best of broadcast dance orchestras

RADIO MUSIC

Northern Regional Programmes :: Commodore Orchestra Broadcasts :: Philip Ridgeway's Hoax :: Vaudeville Favourites :: Successful Dance Bands

The performance was, as a whole, good, but its enjoyment must have been limited to the very few to whom music of this type appeals. It was by no means an easy subject for broadcasting. Choral music is very difficult to "get over" with any fair amount of success. Basil Maine, however,

Rosamunde overture will be the main features in this interesting concert.

The last concert of the series on May 6 will be conducted by Dr. Adrian Boult. Items of a more popular type will be played, including Sir Edward Elgar's famous *Enigma Variations*. The soloists will be Cortot, the French pianist who will play Concerto No. 4 by Saint Saëns, for piano and orchestra, and Maria Olszewska will sing.



A clever young pianist, Myra Cohen has recently broadcast



A favourite singer, John Thorne is well-known to listeners



Sara Sarony, a variety artiste, has been heard from Midland Regional

deserves special mention for his clear rendering of the spoken part.

In this same programme Suggia, the world-famous 'cellist, played the concerto in B minor for 'cello and orchestra by Dvorak well.

It was originally announced that this work was to have been played by Pablo Casals, but on account of a family bereavement all his European engagements were cancelled.

Two Concerts

When this issue is published, there will remain only two concerts to be performed before the season closes. Sir Henry Wood will conduct the concert on April 29, in which the soloists will be Gota Ljunberg, the famous Swedish soprano, and Myra Hess, the popular English pianist.

Mendelssohn's Scherzo in G minor, Symphony No. 2 by Arnold Bax and Schubert's

will be performed at the Queen's Hall, under Stanford Robinson, with Olga Haley, Stuart Wilson, Harold Williams, as soloists, and the National Chorus.

This popular work

Many rumours have been circulating around regarding lunch-hour concerts on Sundays. The authorities state that this extension of Sunday programmes is not contemplated.

Grand Opera Season

During the Grand Opera season at Covent Garden listeners, it is understood, will hear several excerpts broadcast commencing with Strauss'

The Brosa Quartet, heard lately in chamber music, consists of Brosa, Wise, Rubens, and Pini



THE MONTH'S RADIO MUSIC—Cont.



Thelma Nurich, pianist, has been heard with Myra Cohen in duets for two pianos

popular opera, *Der Rosenkavalier*, on the opening night, April 27.

At this performance the part of the rose bearer will be sung by Margit Angerer, a leading soprano at the Berlin State Opera, and that of Baron Ochs by Richard Mayr. Two other famous singers in the cast will be Lotte Lehmann and Elizabeth Schumann.

Microphone Positions

The usual procedure will be adopted to ensure satisfactory reception for listeners. On the stage of the theatre the central control position will be installed and five microphones will be fitted in different positions around the stage. Three of these will be in the footlight trough and one on either side of the proscenium opening. The latter will be visible to the audience and will be mainly used for ensuring an even-balanced tone from the orchestra. From the control room two lines run direct to Savoy Hill.

Fine Singers

These relays will be heard at intervals during the season and should prove interesting mainly on account of the fine international singers that are taking part.

When the new North Regional station is put into full use, we learn that its programmes will be chiefly arranged by the Manchester station authorities. Mr. Liveing is the man

concerned with arranging these programmes and it will be up to him to give Northern listeners what they really want.

The critical tastes of Lancashire and Yorkshire people will not be satisfied with items of a stodgy nature. Band music and plenty of it is what these people like, but it must be played properly.

This district produces some of the finest local colliery bands in the country and many have been broadcast. It is doubtful even whether the Wireless Military Band is so popular as these brass bands.

Its conductor, Captain B. Walton O'Donnell, has had great experience in military band music, nevertheless his band does not seem all that could be desired for broadcasting purposes. Many of us prefer to hear a concert given by one of these colliery bands than one given by that of the B.B.C.

Those to whom music of this type appeals should make a note to listen to the massed military bands which will be relayed from York Minster on May 3.

Relays of the Commodore Cinema Orchestra as lunch-time music on

Saturday have become a popular feature of the weekly programmes. Their idea of giving a piano solo in the programme is novel, nevertheless one word is necessary. Grieg did not intend his concerto for piano and orchestra to be played in cinema houses with a cinema orchestra as accompanist. Capable as it is, this orchestra cannot produce this as it should be performed, and this type of music would be far better left alone

Summer Programmes

With summer approaching, we look to the B.B.C. to give us something interesting in the way of



A violinist heard from Scottish stations, David McCallum



William Michael, baritone, has broadcast in opera relays

vaudeville and light programmes. Philip Ridgeway has certainly bucked things up with his parades, of which Joe Ramsbottom is the outstanding amusing character.

Several vaudeville programmes have included many popular favourites, such as Florence Oldham and Mabel Constanduros. Florence Oldham is one of the earliest broadcast artistes, now but seldom heard.

When she first went to Savoy Hill it was as an accompanist; but one day she asked to be allowed to sing and soon became an outstanding success.

Amusing Buggins Sketches

Mabel Constanduros is a favourite on account of her amusing Buggins sketches. The bulk of appreciations received by the B.B.C. name "Grandma" as being the best liked character in her sketches.

Many new bands have joined the rank of broadcasting lately, including Claridges' Orchestra and Clive Erard and his band from the Amateur Dancers' Club. The most successful broadcast dance bands will be those who remember that there are more listeners than dancers.

T. F. HENN.



The popular organist of the Regal Cinema, Reginald Foort, needs no introduction

UNDER MY AERIAL

*HALYARD'S Chat on
the Month's Topics
Specially Illustrated
by GLOSSOP*

The Census

"HOW many wireless occupations will the new census reveal, George?" I asked my technical adviser during our most important wireless conversation last week.

"At least a few; in fact, I shouldn't be surprised if there were quite a number," replied George in his most thoughtful manner.

"Starting at the broadcasting end, I suppose two of the occupations will be announcer and broadcasting official," I remarked.

"There will also be Governor of the B.B.C. and station director," said George.

"I wonder how the aunts and uncles at the different studios will describe themselves, George."

"As plain announcers, I expect."

"The making of valves must have brought into being a large number of

there can be no revision of the present allocation of European wavelengths until 1932, we had better make up our minds to be content with the present situation. After all, they are not really as bad as they might be.

When we can get five or six jolly good stations on the long wave-band, and twenty, thirty, or even forty stations on the medium band, we ought to be a little more appreciative, perhaps, of things as they are to-day.

One of my friends was showing me the tuning curves of his receiver this morning, and on them—one for the long waves, and one for the medium waves—there were recorded no less than fifty stations, most of which had been identified. The receiver was one of a type perfectly familiar to you, and there are dozens of others which will give equally good results.

If you know of anyone who is dissatisfied with the present state of European ether, tell them to sit up until the small hours of the morning and try the American ether. I have done very little small-hour work myself lately, but the most energetic of my neighbours have told me many times this year how well the American stations came in.

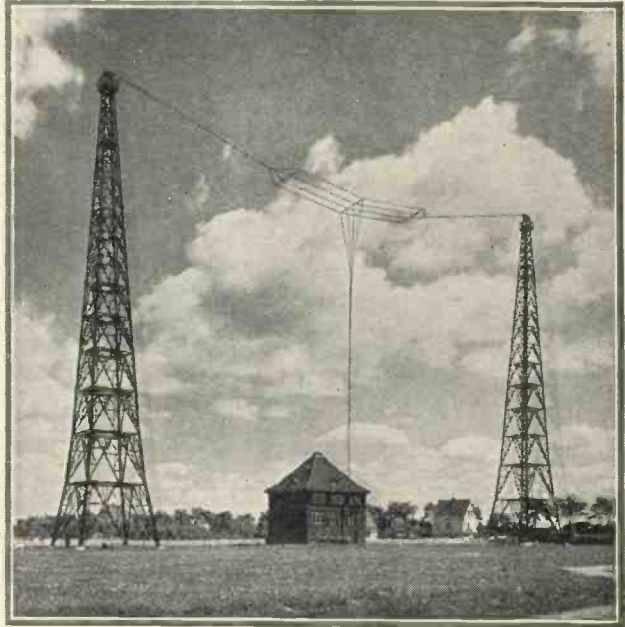

A BROADCASTER'S IMPOSING AERIAL

This fine photograph shows the masts of the Flensburg station in Germany. It works on 219 metres

The Demon Descends

Owing to the cold weather in March, the demon of spring cleaning descended on my house this year a few weeks later than usual. There were times when I thought the demon was going to pass us by, but no, after a delay of several weeks, it descended upon us with more violence than ever.

My junk room has survived rather well the last few years but this year it came under special consideration and I am still bemoaning the loss of many old treasures.

The things which I gave up with most regret this year were several old panels on which were mounted "freak" sets of years ago. These were of the old-fashioned horizontal type, and the respective cabinets had long since been used for other purposes.

Amongst these old panels were an Armstrong super-something-or-other, a Flewelling set, and a strange super set of my own which George called the "Supercilious Three". When I was having my last look at these dust-ridden veterans of bygone years, I was struck with the fact that we never seem to hear of "freak" circuits these days.

Why is it, do you think, that "freak" circuits are things of the



Most important wireless conversation

occupations, George. There will be valve manufacturers, valve makers, valve testers and valve packers."

"And there will be the man who paints the 'A' above the anode pin."

"I expect the term 'wireless engineer' will cover a good many cases."

"Aye—from the chief engineer of the B.B.C. down to our very good friend Mac, who might reasonably describe himself as solver of wireless troubles to the whole village."

"By the way, George, how are you going to describe yourself?"

"'Practical wireless technician' is the best I can do this decade."

Be Content

Now that we know definitely that



Sit up until the small hours

UNDER MY AERIAL—Continued



I thought the demon was going to pass us by

past? My view is that modern receivers, valves and component parts are so wonderfully good that there is no need for the development of "freak" circuits to obtain outstanding results. With ordinary, straightforward circuits we can get all that we can reasonably desire.

Wiring Up A.C. Valves

Have you had any experience of the wiring up of a number of A.C. valves in a mains set? You know the kind of valve I mean, the modern valve which has a filament or cathode indirectly heated by a heater through which passes alternating current from one of the secondaries of the mains transformer.



I didn't find it quite so simple

In order to prevent mains hum from the heaters, it is advisable to run twisted flex from the mains transformer to the heater terminals of the valves. This is quite a simple thing to do when you have only one valve, but if you have two or more valves it isn't quite so simple. At least, I didn't find it quite so simple to do when I made my first three-valve mains set some time ago.

I wonder how you carry out this rather important piece of modern wiring? In my first attempt, I began by cutting off a length of flex to reach from the first valve to the potentiometer and thence to the proper secondary terminals of the mains transformer. Then I cut two other short lengths of flex to run from the second and third valves to the long lead of flex from the first valve to the potentiometer.

The work of removing the insulation and making the necessary

soldered joints was so fiddling and tedious, however, that I eventually gave up the idea. As a final, and perhaps rather poor expedient, I ran three separate lengths of flex one from each valve to the potentiometer.

I have no fault to find with this method, but I should be most interested to know how you have carried out a similar bit of wiring.

S.W.P.

Have you ever heard of a short-wave portable? If not, why not, and how about making such a receiver for the coming summer and holiday season?

A short-wave portable set seems to me to be an attractive possibility, and I do not think it would take away from the general attractiveness of the set if it were necessary to use a small aerial with it out in the open. An aerial for the very short waves need not be a big and cumbersome affair, and since many short-wave sets work as well, if not better, without an earth, there would be no need to carry an earthing rod with the set.

There are so many good short-wave stations these days that I really believe one could capture a fair number out in the open with a portable. I have discussed this suggestion of a short-wave portable set with George, and I am sorry to say that my technical adviser does not seem to be attracted by the suggestion.

For one thing, George says fine tuning is absolutely essential in a short-wave set, and he doesn't see how you could effect fine tuning with the set in a position of unstable equilibrium in a field with cows in it. Another thing, George reminded me, is that short-wave work is largely night work and there is nothing at



An attractive possibility

all attractive in night reception in the open even when the moon is at full.

Still, for once in a while, I do not consider George speaks with authority and I rather like my idea of a portable short-wave set for work in the open air.

The New Resistances

I wonder who the ingenious fellow was who first thought of the spaghetti resistance. Whoever he was, he deserves our grateful thanks, for these neat little resistances are amongst the handiest things in wireless. Previous types served their purpose well, but the new resistance links have two great advantages, namely, they take up much less room, and



The spaghetti resistance

they are much more quickly connected.

The great demand for the new type of resistance has made it rather difficult to obtain supplies. I have had a number on order for over a month now, and I do not know when I shall get them. The last time I was in our local wireless store I picked up a couple of "spaghettis" of the higher values, but I seem to be no nearer getting a small supply of the lower values than I was weeks ago.

In using these new resistances it is necessary to take into account the current-carrying capacity. For example, the 1,000-ohm resistance will take currents up to ten milliamperes or more. The 100,000-ohm resistance will not take a current much above two milliamperes.

Hence, when employing those "spaghetti" resistances, it is desirable to make quite sure that the

"The Constructor Interviews the Manufacturer"

That is the title of a special article which will appear in the next issue. It will interest all set users

HALYARD ON THE MONTH'S TOPICS

current-carrying capacity of the resistance is high enough for the current which has to flow through the resistance.

Sums

The mains set has brought a little more arithmetic into wireless than there was previously. Luckily, this arithmetic is not very difficult, and so far, I, myself, have not been compelled to consult my mathematical friend.



Brought a little more arithmetic

This arithmetic of the mains set, although quite simple, is of considerable importance, and it is necessary to do the little "sums" properly and carefully and get the right answers.

Take the mains transformer for example. The various secondaries on this transformer call for little calculation. If you are going to run three A.C. valves say, of the usual type, in your mains set, you must be certain that the appropriate secondary winding is good for three amperes, one ampere for each valve.

The secondary feeding the filament of the rectifying valve automatically looks after itself, but the secondary for the high-tension supply calls for careful consideration. If that secondary is designed to give thirty milliamperes, say, you must be sure that the valves in use do not take more than a total of thirty milliamperes anode current.

Other calculations regarding mains sets are those dealing with anode resistances and automatic grid bias. I learnt how to do these calculations from the article on the Brookman's A.C. Two in the February number of the WIRELESS MAGAZINE. If you do not know how to do these calculations I would advise you to turn back to that article in the February number.

Wireless Wins

Here is a very true story which I think you will like. The maid of all work who visits this house told the story to—who told it to—, but

The Rubáiyát of Broadcasting

(After Omar Khayyám)

*A written speech, extremely long and dry,
A studio, a microphone—and I
Beside it, shivering in abject funk,
"A studio is purgatory," I sigh!*

*Myself when young did eagerly employ
Trumpets and whistles with a fiendish joy,
I loved to shout about and hear my voice—
I've altered greatly since I was a boy.*

*The bold announcer speaks, and having spoke
That "Mr. Smith will talk on Rural Folk,"
Looks hard at me. I grasp my collar tight
And ease it while I feel that I must choke.*

*O gaping thing they call a microphone,
Why can't it leave us nervous men alone?
Courage! . . . I've made my speech, I've
broadcast now,
But was that faint and feeble voice my
own?*

LESLIE M. OYLER

never mind how the story reached me. Let me just tell it to you as best I can. Here it is:

At the house in question wireless has been installed for years. Some weeks ago a gramophone was purchased and the four working members of the household agreed to purchase a record each week in turn. Father had first turn, mother second, the daughter third, and the son fourth turn. The gramophone and the new records were all the rage for a while, but gradually wireless came back into partial favour.



The chief thing in favour

One evening a discussion took place on the rival merits of the gramophone and wireless. It seemed as if the chief thing in favour of the gramophone was the choosing of the records.

Each member of the family had thoroughly enjoyed the excitement of the weekly purchase. Wondering what someone else would choose was quite as exciting as choosing a record one's self.

Other familiar points in favour of the gramophone were mentioned and it looked as if the gramophone was an easy winner, when father was appealed to for his opinion. Father, a quiet man, said he preferred wireless.

"Why?" asked the others in surprise.

"Because you don't have to get up to wind it up," said father.

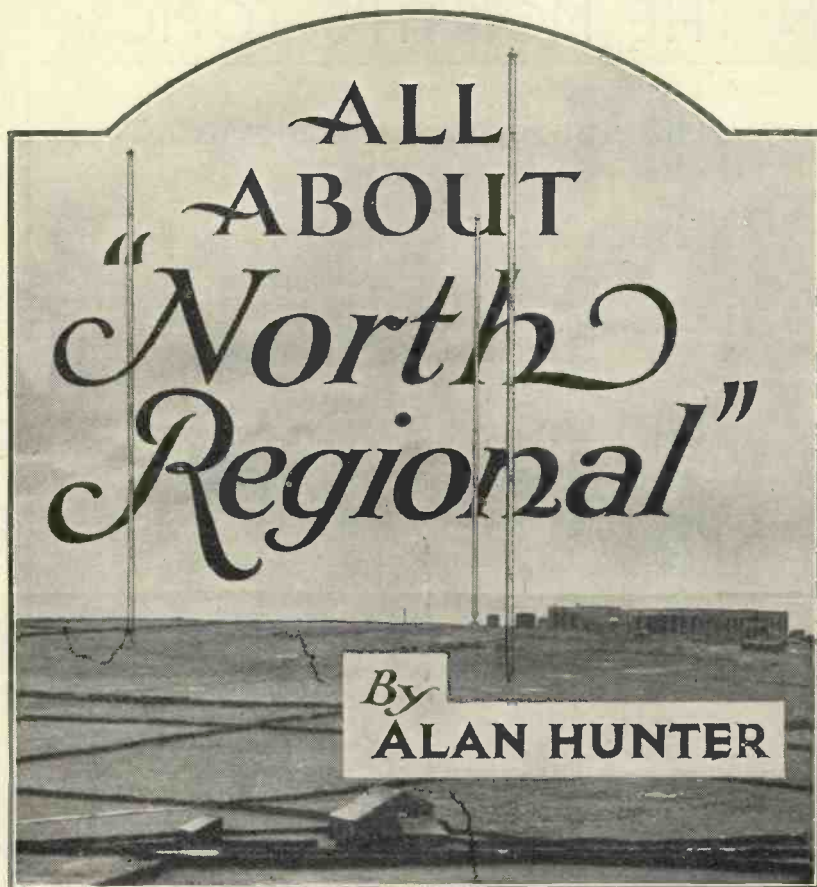

PRONOUNCE IT "SLEW-IT" OR CALL IT "NORTH REGIONAL"!

A fine view of the B.B.C.'s latest transmitter at Moorside Edge in Yorkshire. The masts are about 500 ft. in height and will radiate between 50 and 70 kilowatts

ABOUT five miles west of Huddersfield and a mile and a half north-west of Slaithwaite, one discovers Moorside Edge, at which elevated site, some 1,100 feet above sea level, the B.B.C.'s latest regional centre has been erected. At the time of writing test signals are being radiated from one of the two aerials suspended between three 500-ft. lattice masts.

Alternative Programmes

North Regional will soon be settling down to its regular work of supplying listeners within at least 100 miles of Huddersfield with alternative programmes, such as we in the South and Midlands have been enjoying for some time.

The start of Daventry Experimental, as it was then called, was a great event for Midland listeners; and when Brookman's Park was opened the bulk of London and South of England listeners rejoiced; but I think the opening of North Regional is by far the most important B.B.C. development to date.

It is not often remembered that before the Midland Regional opened listeners in that area had already a powerful station in Daventry 5XX. And before Brookman's Park opened London listeners had quite a strong signal from the 3-kilowatt transmitter radiating from the masts in Oxford Street.

In the Manchester district listeners have long had to reconcile themselves to a comparatively weak signal from 2ZY. So much so that I suppose it would be true to say that the average Northern listener has had to equip himself with a valve set or forgo entirely a satisfying service of British broadcasting.

Although we hear quite ominous forebodings from certain people about the difficulty Northern listeners are likely to encounter in separating the two powerful North Regional transmissions, not merely from one another but from foreign stations, I feel that for the first time the patient Northerner is to be given something like a service.

That some dislocation will ensue

seems inevitable when we look into the proposed wavelength changes that will have to be made to accommodate the two North Regional programmes. There is no harm in analysing these changes, which are, at present, by no means generally understood by the listeners who will be most nearly affected.

Longest Medium Wave

The most important wavelength change to be noted at the present time is the appropriation for the first North Regional station of the 479-metre wavelength at present used by the Midland Regional station. This wavelength is the longest medium wavelength at the disposal of the B.B.C.

It has been given to North Regional because the new station has to serve important towns on both sides of the Pennine Chain, areas where signals from the central point at Huddersfield have some difficulty in penetrating.

It is well known that the longer the wavelength for a given power the less is the attenuation of the ray travelling along the ground and so consequently the greater is the service range of the signal. On account of this technical consideration North Regional has been assured of as great a penetrating power as possible by giving it the wavelength of 479 metres.

Trouble with London

It follows that Midland Regional must be given another wavelength. The obvious wavelength would be that of the present Manchester station, namely 376.4 metres. But this is much too close in frequency to the London Regional wavelength of 356 metres, so a somewhat more roundabout means of allocation has had to be found.

It has been decided that Midland

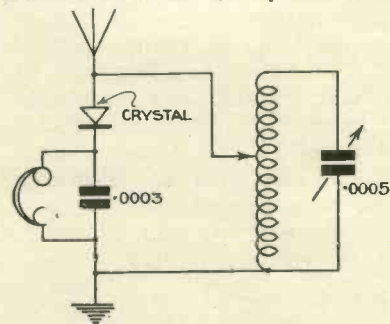

Fig. 1.—Crystal-set circuit recommended by the B.B.C. engineers

Practical Hints for All Listeners

Regional shall take Glasgow's present wavelength of 398.9 metres, because this will mean a frequency separation between London and Midland Regional stations of 90 kilocycles, which, if distinctly less than the present separation of 216 kilocycles, does give the average set a chance to receive the two programmes clear of each other.

Low Power and Great Distance

As the present Glasgow station is on low power and is a considerable distance from London, there is no difficulty in placing the Scottish station near the London Regional station in the frequency plan. So

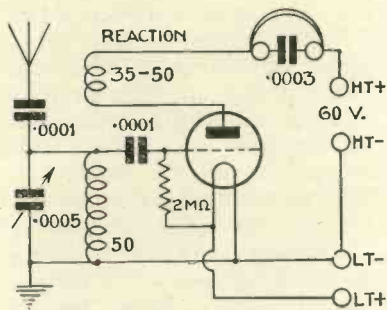

Fig. 2.—B.B.C. engineers' recommended one-valve circuit for sharp tuning

Glasgow is to have Manchester's present wavelength of 376.4 metres.

The inception of North Regional, radiating a programme of Northern interest on 479 metres, thus involves changes in the tuning apparatus of listeners' sets at present adjusted to receive Manchester, Midland Regional and Glasgow transmissions.

Another Alteration

Still another station will be affected when North National starts. This will not be for some time; certainly not until North Regional has quite settled down to its regular service work. As Northern listeners can tap Daventry 5XX on the long waves and the 288-metre relays on the medium waves for the National programme, the need for a wide range medium-wave station for National transmissions is not so urgent in the North as is the need for the alternative programme of regional interest.

This programme consideration reconciles us to the technical limitation of the shorter medium wavelengths at the disposal of the B.B.C., namely

their attenuation. Just as the shorter of the two Brookman's Park wavelengths takes the National programme, owing to the National programme being available from Daventry 5XX, so for the same reason North National programme will be sent out on 301 metres.

Unfortunately, this is the only way in which the B.B.C. can fit in the Northern alternative programme. And this is at the expense of Aberdeen, which at present has the exclusive wavelength of 301 metres.

One must anticipate a certain uproar in the Aberdeen district when listeners up there find their station relegated to the 288-metre National common wave, but no doubt the B.B.C. will pacify them with the promise of Scottish Regional programmes on high power within the next twelve months.

At this stage it is difficult to say what effect North Regional on 479 metres is going to have on the design of sets used within, say, 50 miles of Huddersfield. In its elevated position, with its 500-foot masts and on anything between 50 and 70 kilowatts power in the aerial, North Regional is certainly going to be a big noise. Here in London its daytime strength at the time of writing is as good as, if not better than, Midland Regional.

Whatever happens, we have the benefit of our reception experiences of Brookman's Park. Similar conditions, perhaps more pronounced, will presumably be experienced in the North. No doubt a preliminary

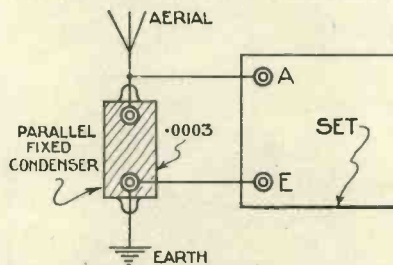

Fig. 3.—A small parallel fixed condenser can be used for extending the tuning range of a coil

phase of expedients, such as the installation of wavetraps and the wholesale shortening of aerial wires, will be followed by more rational attempts to reconcile high-power transmissions with receivers.

My experience is that a minimum of

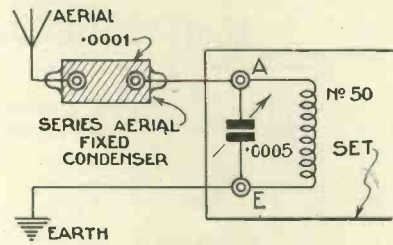

Fig. 4.—Use of a small fixed condenser to improve selectivity

two tuned circuits is essential for sets in regional broadcasting areas. If possible three tuned circuits, arranged on the band-pass principle, should be considered. The advice to shorten the aerial has been given so often that I hesitate to repeat it.

Too Big a Price

But I should like to emphasise the fact that, if a distant station does not come in at good strength on a modern three- or four-valver, with no more than 50 feet of aerial wire, that station is not worth hearing. Certainly its reception by the use of a long aerial is too big a price to pay for the hopeless unselectivity that then ensues.

By the time this article is read, the B.B.C. will have issued its helpful pamphlets to Northern listeners. I have had an opportunity to read these in advance and I must say the B.B.C. has collected information likely to be of service to headphone listeners using crystal or one-valve sets.

Fig. 1 shows the type of crystal set that the B.B.C. has found effective in separating the two Brookman's Park stations and that is therefore likely to be equally useful in the north. It consists of a tapped coil, arranged so that the aerial and crystal damping is reduced, thus increasing the selective properties of the tuner.

B.B.C. Valve Circuit

Where headphone listeners propose to use an indoor aerial at more than 20 miles distance from Moorside Edge, the B.B.C. recommends the one-valve circuit shown by Fig. 2. This consists of a leaky-grid detector with a No. 50 or No. 60 plug-in coil tuned by a .0005-microfarad variable condenser.

The aerial is connected to the grid end of the coil through a .0001-microfarad fixed condenser in order

(Continued on page 376)

Short Waves on the Super 60

W. JAMES Explains How to Get Them in the Simplest Way

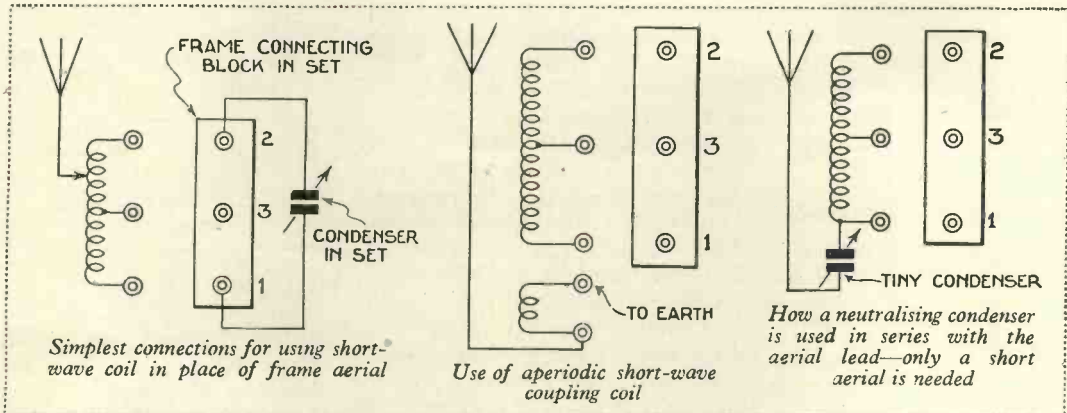

THE Super 60 receives short-wave stations very well.

Included in the set as described is a three-range oscillator unit. One of the ranges covers the longer broadcasting wavelengths, the second range tunes over the medium band, and the third range covers the short waves.

Now the frame aerial used has two windings only, one for the medium and the other for the long waves. Provision for the reception of the short waves was not made in the original design.

Actually the short-wavelength signals are easily received in the following manner. Connect a coil of about nine turns having a centre tap to the three terminals marked 1, 2, and 3 on the diagram of the set.

You could, of course, join the plug used to connect the frame to the terminal block to the short-wave coil. It is better, however, to make the connecting wires as short as possible. You could easily fit a small piece of ebonite to the side of the set having three ter-

minals or sockets for the short-wave coil and wire this to the terminal block already fitted to the baseboard. The diagrams show this point.

Thus the short-wavelength coil is connected in place of the frame aerial, but with shorter leads. Now provision must be made for the aerial.

There are several ways of connecting an aerial. Probably the best is to tap the aerial to the second or third turn from the centre tap.

The earth is, of course, joined to the negative low tension.

Aerials vary so much in size and characteristics, however, that it is possible you will find the best results to be obtained when the aerial is joined to the grid end of the coil through a very small condenser.

You could use a condenser having the maximum value of 50 micro-microfarads, such as a neutralising condenser. This condenser provides the coupling between the aerial and the tuning coil.

As the capacity is reduced so the loading effect of the aerial is lowered and you will be able to find a setting of the condenser which provides the best results over the tuning range.

There are short-wave coil units having a grid and an aerial coil, the position of the aerial coil being adjustable. One of these units may, of course, be used. It will not be difficult to provide the necessary centre tap. You may have to solder a connecting wire or, perhaps, a clip connected to the centre of the coil winding.

The tuning

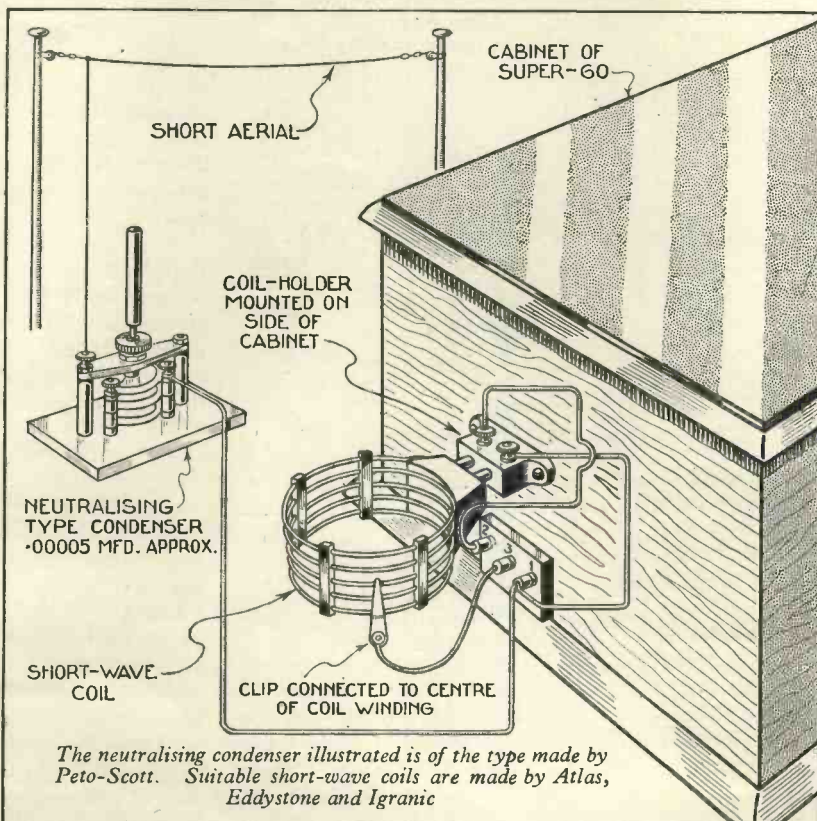

The neutralising condenser illustrated is of the type made by Peto-Scott. Suitable short-wave coils are made by Atlas, Eddystone and Igranic

range is from about 20 metres. As .0005-microfarad condensers are used the tuning is, as you would expect, quite sharp.

It has been suggested that fixed condensers of .0005-microfarad capacity be placed in series with both aerial and oscillator tuning condensers for the purpose of reducing the wavelength range covered. This is hardly necessary, however, as good results are to be obtained from the

Reception of short-wave signals varies considerably, but I have found there is usually something to be heard at good strength. A station will be heard at various settings of the oscillator. It should be remembered that the oscillator is set at a frequency either above or below that of the signal being received.

The actual difference is equal to the frequency of the long-wavelength or beat-frequency amplifier, in this case

judge when the two circuits are in tune. Having found the two tuning points, it is easy enough to go very slowly round the dials.

Fading and Noises

There are, I found, some stations which cannot be received properly owing to fading. Other stations are, of course, accompanied by so much noise that little of value is heard. But there are usually several stations

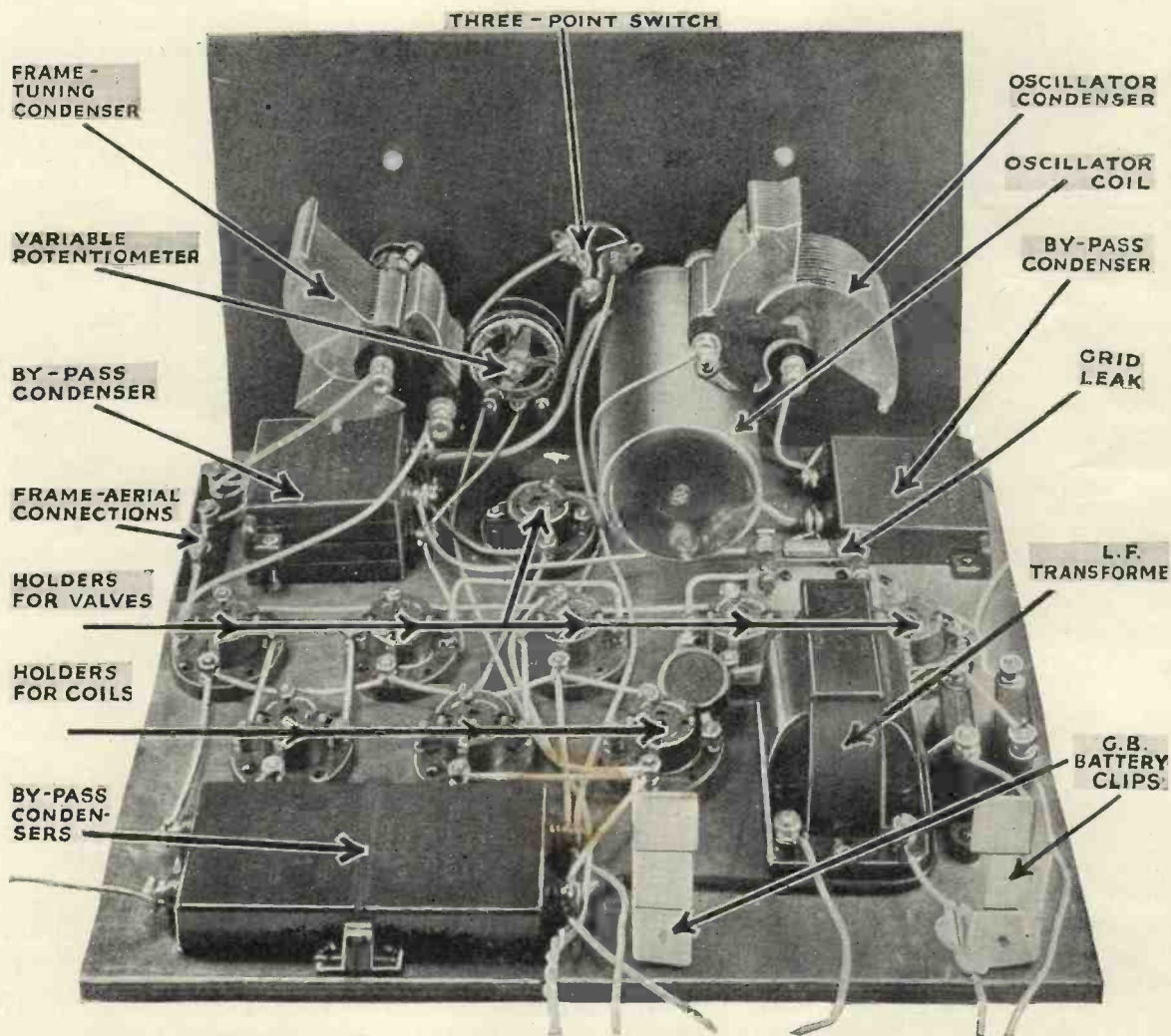

This photograph shows clearly the positions of the components in the Super 60, full constructional details of which were given in the previous two issues of WIRELESS MAGAZINE. Test reports from readers all over the country will be found on pages 397, 398 and 399 of this issue

standard components specified.

Tuning is effected in the ordinary way, excepting that the two tuning condensers must be turned even more slowly than when receiving over the normal broadcast band.

It is surprising what latitude seems permissible in the aerial circuit. A large aerial is not needed—in fact the coil itself collects signals.

Hand effects are absent and the set is stable and easy to work.

about 127 kilocycles.

When the two tuning dials are accurately set and the volume control is turned up the usual noise and mush will be heard owing to the disturbances collected by the aerial being magnified. This is the case also with an ordinary set having two circuits and reaction.

When one of the circuits is out of tune the characteristic noise will no longer be heard. You can, therefore,

which are interesting enough for the trouble taken in providing the short-wavelength coils.

Several readers have already written saying that short-wavelength stations can be received with ease and you may, therefore, try the short waves, expecting to bring in some stations most nights.

I have found the short waves most interesting and well worth the trouble of fitting a special coil.

THAT ENGLISH VOICE

By JAY COOTE



"... for the enlightenment of distant eavesdroppers"

IF you listen to foreign transmissions you will notice that more and more English announcements may be picked up; this is, no doubt, due to the great use made by the studios of gramophone records in compiling syncopated music and dance programmes. As most of these melodies bear English titles, so the foreign announcer is compelled to tackle them.

Special Announcers

But bear in mind also that during the past few months several foreign stations have put on publicity broadcasts mainly destined to listeners in the United Kingdom; these are both sponsored and organised by British firms and, in most instances, English announcers are specially engaged for the evening.

You will find such entertainments at Radio Paris, Radio Toulouse, Brussels (No. 2), and at other studios, and in these broadcasts English is used as an auxiliary language for the enlightenment of distant eavesdroppers.

It is not likely that our native tongue will be adopted generally as a subsidiary at all stations, although there is no doubt that to-day its knowledge by the average foreigner is considered more than a mere social accomplishment.

There is a possibility that the fact that many "talkie" films are being relayed to broadcasting stations on the Continent may act as an extra impetus, as most of these records are of American origin and mainly reproduced in the original.

It is true that at the picture theatres, where a foreign sound film is being shown, it is usual to flash a line or so of translation in order to explain the dialogue but, believe me, even if this is done, it is seldom that it will prove sufficient explanation to hold the interest of the spectator.

For this reason alone, therefore, the number of students of the English language on the Continent is daily increasing. Further, have you noticed also how vastly better English voices come over the ether than do those of the Latin or Teutonic nations; at least, so far as it concerns male announcers?

If you listen to the Continental studios you will obtain ample proof of this statement. Study the twin announcers in these foreign publicity transmissions and sponsored broadcasts; you will find that the Englishman invariably speaks in a more natural manner than his Continental colleague; he appears to feel more at ease in front of the microphone and adopts an ordinary conversational style with his unseen audience; in fact, he does not merely announce.

Possibly because he does not force his voice its tone is both purer and pleasanter to the ear.

At any time when sitting at our receivers we hear a number of

different speakers of widely different nationality; it is an easy matter, therefore, to compare them.

It is not just a question of understanding the actual words in a foreign language; it is simply the fact that the average English announcer, whether at home or abroad, would appear to possess a voice more suited to the "mike."



"He appears to feel more at ease . . ."

No doubt, the English announcers are specially picked for their job and both enunciation and voice have been tested out before engagement, but I think that you will agree that very few of their Continental confrères would pass any reasonable test.

It is just that English voice which makes all the difference.

All About "North Regional"

(Continued from page 373)

to improve selectivity. Reaction is obtained by means of another plug-in coil magnetically coupled to the tuning coil and inserted between the anode and headphones as shown.

At the present time Northern listeners will be interested only in 479 metres, on which wavelength the preliminary tests are being radiated. Some sets, especially those tuned to 376 or 288 metres, may not tune up to 479 metres. For such sets the B.B.C. recommends the temporary expedient of a fixed condenser connected across the aerial and earth terminals of the set, as Fig. 3.

This means that the parallel capacity across the coil is the capacity of the fixed condenser plus whatever

amount of the total .0005 microfarad of the variable condenser is needed to tune to 479 metres.

A better plan is shown by Fig. 4, where a series fixed condenser is used with a larger coil. The size of coil should be so chosen that the 479-metre station comes in towards the top end of the tuning condenser scale. If this is done there will be no difficulty later on in tuning to the 301-metre station, which will come in towards the bottom end of the scale.

The fixed condenser in series with the aerial and the tuning coil will probably give sufficient selectivity to the aerial circuit to enable the 479-metre and 301-metre stations to be received clear of each other.

'THE RIDGEWAY PARADE'

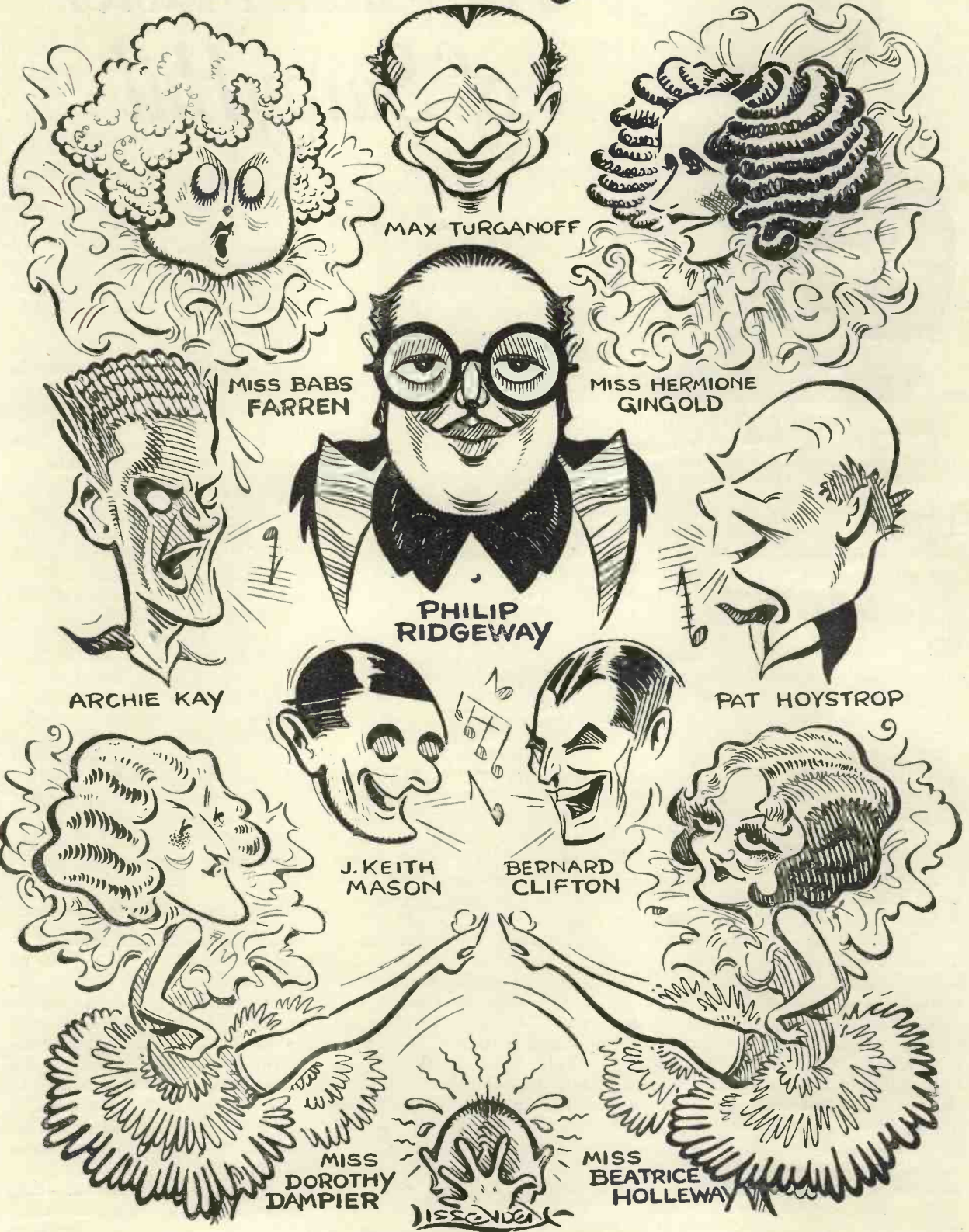



THE B.B.C.'S MUSICAL DIRECTOR

Introducing Adrian Boult, musical director of the B.B.C. Many listeners would like to meet him face to face, but perhaps they will be more tolerant in their criticisms after reading this article!

I HAVE been thinking recently that it may be of interest to the readers of WIRELESS MAGAZINE if I give other people's views on broadcast matters rather than my own. I am rather tired of my own views, as a matter of fact, and consequently I welcomed hearing those of another musician when, a few days ago, I interviewed Adrian Boult in his private room at Savoy Hill.

First of all he tells me that he pronounces his name *Bolt* and not *Boult*, though he has to submit to the latter pronunciation when in Germany.

Music in Particular

I had no preconceived ideas of the likely trend of our conversation on entering his room, but, as I might have expected (had I thought about it at all), we soon began talking of things in general and music in particular.

Naturally our thoughts were centred upon music of the more serious type; the other kind is not Boult's business and, consequently, this article can only deal with the more important broadcasts. When I come to deal with the lighter side of musical transmissions I shall have to visit someone else.

It needed no persuasion on my part to get Boult to speak frankly

The Music Master of Savoy Hill

of the musical policy of the B.B.C.; he is far too much in earnest over the whole business of broadcasting to think of disguising facts.

So far as that goes there is very little to disguise; the B.B.C.

plans out its policy, carries it out to the last letter, and takes all the kicks it gets for its pains.

As far as I

can see, there is no other course open to it.

All the same, I was struck with the absence of "you must not say this officially, of course," or "I think you had better leave that out of your article." Yet Boult spoke very definitely. "Our aim, so far as the musical side goes," he said, "is not so much to try to please everybody as to try to interest listeners in every form of music. We are determined to give everything a chance."

"Even Stravinsky," I said. "Yes," he replied, "as you say, even Stravinsky." This opened the ball, so to speak. "What are your feelings about modern music so far as the listener is concerned?" Boult laughed. "What are your own—what are anybody's? I feel personally that it must be tried. We must learn."

"I often feel inclined to doubt the sincerity of some of these hyper-modernists," I said. "I cannot say which way I feel about Stravinsky, for I only met him for a few moments," replied Boult. "But it is a fact," he continued, "that very few composers have been appreciated until after their deaths, although I have been recently criticised in the Press for saying so in one of my fortnightly talks."

I saw his point. He feels, as all

musicians feel, that music has undergone a change—a very noticeable change—in the last few years. My argument was that hyper-modern composers are speaking a musical language different from what he and I were taught to speak in the days of our training.

He agreed, but inclined to the view that, as modern music was as it was, it must be part of the policy of the B.B.C., whether listeners, as a whole, appreciate it or not.

The Student's Attitude

Adrian Boult's whole attitude was that of a student—an amateur, if you will. I found him exceedingly humble in the matter. I referred to the Stravinsky concert again and remarked upon the fact that Ansermet conducted it.

"I should not undertake a concert wholly devoted to Stravinsky," he said at once. "I am forty-one years of age; Ansermet is older and more experienced. I prefer to stick to the classics for the moment."

Those of you who are musicians will appreciate that. I most certainly did. It is one thing to give a performance of Beethoven's *Eroica*, and quite another to render the work of a contemporary composer, especially when he himself is present.

Honour to the Music Master

All the same, I rather honoured the music master of Savoy Hill for his point of view. Many a man less balanced in spirit might have made a slip; he might have taken the reins into his own hands and have risked what there was to risk. It is not that he *could* not conduct a Stravinsky concert; such a thought is absurd. It was that he preferred to engage the best man for the particular piece of work in hand.

Now, I have given you this frank view of Boult as I found him because I want to give you a message from

him. People are writing to Savoy Hill. They are writing every day; they are writing by every post in the day.

Boult is lucky if he escapes with fifty letters a day. He is luckier still if he escapes with only a dozen asking him why he allows these atrocious quartets to play still more atrocious chamber music; why does he not stop the Bach cantatas; why does he not—well, think of the *poor defenceless listeners* who pay so heavily for the privilege of listening.

Defenceless rubbish! What is the matter with switching on to something else? *That* might be his answer; it would certainly be mine.

All Kinds and Types

No, his answer is patient enough. All the letters are read and reported on. Some are mere abuse and have to be rejected on that account; some are quite sincere and heart-felt grumblings and have to be thought of sympathetically; many are wholly appreciative; few enough are really constructive in their criticism and are, therefore, *welcomed*.

The plea of the music director of the B.B.C. is for tolerance and an intelligent co-operation on the part of the listeners. He believes, as I believe, that a love of great and good music is only a matter of time, provided the listener takes some trouble in the matter of listening.

As for the others—those who

would rather have a tooth drawn than be asked to use their brains—no one can do much for them; they will probably do all that is necessary for themselves.

Last month I pulled the legs of the knob-twisters; the Editor told me he thought I should get into hot water for it.

It will be interesting to see. As a matter of fact, Boult and I fell to discussing knob-twisters, when I was outlining my work for this magazine. As I said to him, the magazine tells people how to build sets; hundreds of sets must be in existence made from our "recipes."

My job, apart from the gramophone records, has always been to try to interest the listener in what is being broadcast rather than in the quality of the reception he happens to experience at the time of listening.

That, in a very much wider sense, of course, is Boult's job at the B.B.C. What he (and everyone else at the B.B.C.) wants is a fair hearing for every composer and every type of composition.

The B.B.C. is out to *make people think*—and what is the matter with that, anyway? So many correspondents imagine, judging from their letters, that the B.B.C. is out to bore everybody.

The sooner that idea is dispelled the sooner will everybody in this country begin to enjoy what is "so enjoyable to those who really do take

some trouble in the matter of listening.

I hope no one will, after reading this article, say, "Oh, Boult! It is obvious that he is just another of the B.B.C. highbrows."

That is the very worst point of view that can be taken. If you mean by highbrows that he is a cultured musician, then he must submit to the term being applied to him; but if you ever have the pleasure of personal contact with him you will find him a deep, earnest student.

Whole-time Job

You may argue that it is his job and that he does nothing else, whereas you occupy yourself in a different calling. Granted, but his reply would be that unless someone gave every moment of his time to thinking out a definite policy, the result would not be very satisfactory.

His whole attitude was that of a student; I repeat it because it was what I expected to find. His attitude should be yours, mine, and everyone else's.

In your more serious moments you must expect a good deal of Adrian Boult; therefore you must also be students of the higher forms of music, for that is what the music director of the B.B.C. expects of you.

I conclude by repeating his first words: "*The policy of the B.B.C. is to give everything a fair chance.*" What is the matter with such a policy?



Adrian Boult putting the B.B.C. Symphony Orchestra through its paces in the riverside studio at Big Tree Wharf. He is seen on the right in his shirt sleeves

Choosing Your Records

Sacred Music

Easter Service, St. Mary-le-Bow, Cheapside (d.s.), 2s.

BRDCST 5220

This contains what you would expect it to contain, and there is nothing to complain of. It may be found very acceptable.

★If With All Your Hearts, Walter Widdop, ten., with orch., 4s. 6d.

H.M.V. E566

Excellent, but he always is. Also in *Then Shall the Righteous Shine Forth*. To lovers of



WALTER WIDDOP

Mendelssohn's *Elijah*, I sincerely commend this record as outstanding.

When I Survey the Wondrous Cross, Choir of St. Margarets, Westminster, with organ, 3s.

H.M.V. B3746

And also *The Church's One Foundation* (A. & M., 108 and 215). Effective sung; there may be a use for it.

Grand Opera and Classical Arias

★Pagliacci, Mostyn Thomas, with orch. (d.s.), 4s. 6d.

COL DX213

His English is so Welsh that it might be Italian, but his voice is excellent, and I consider this as a good version of the ever-popular Prologue. Except for his bad pronunciation there is no fault in this admirable record.

★Song of the Vagabonds, Chorus and Orch., 1s. 6d.

BRDCST 3024

This is very entertaining. The chorus is smart and precise. I like their effects very much. *You Will Remember Vienna* is the companion; very well done.

Chamber Music

★Sonata in G Major, Op. 30, No. 3, 1st, 2nd and 3rd movements (Beethoven), Sergei Rachmaninoff and Fritz Kreisler, piano and violin, 8s. 6d.

H.M.V. DB1463-4

A fine rendering. All amateur (or professional) violinists

Here are reviews of the latest releases by WHITAKER-WILSON, the "W.M." Music Critic. Read them carefully before buying your next batch of records. Outstanding records are indicated by an asterisk (*) against the title.

should invest in these two discs without delay. Even 17s. is cheap for those to whom an authoritative rendering is valuable in the aesthetic sense.

Light Opera & Songs

Across the Breakfast Table Looking at You, Al Jolson, com., with orch., 3s.

BRUNS 1059

He forces his voice a little; a pity, because he takes the trouble to sing, which so many of these dance-singers do not. Quite a good song of its type.

★Bobbie Shaftoe: Chinese March, Templars, male voices, 3s.

H.M.V. B3588

They are excellent and the arrangement, by Whitaker, is admirable. Male voices do not usually record very well—there is always a danger of someone "blasting." This, however, is quite good in that respect. A very entertaining record.

By All the Stars Above You, Stanley Kirkby, with orch., 1s.

RAD 1457

Rather sentimental but not unattractive by any means. It matches *Somewhere in old Wyoming*, on the other side, which should be some sort of guide.

By the Waters of Minnetonka, Betsy de la Porte, with orch., 2s.

BRDCST 5219

Not a bad recording voice, by any means. The song does not get anywhere, it seems to me. I prefer *My Little Irish Cottage*, on the other side. It is at least distinctive in style, which the other is not.

★I'm Alone Because I Love You, Bert and Bob, with piano, 2s.

DEC F2225

Not a very complimentary statement, now I come to think of it. These two are really worth hearing and Decca's surface, in this instance, is better than any I have examined of theirs up to now. They sing *Pasadena Rose* on the other side, very effectively.

★Make Yourself a Happiness Ple (f.), G. H. Elliott, with orch., 1s.

RAD 1453

And *Here Comes the Sun*. I am sick of both, but I enjoyed both, simply because the chocolate-coloured coon sings and does not emit adenoidal explosions. Get it; you will not be disappointed.

Makin' Wicky Wacky Down in Walkiki, Sophie Tucker, with orch., 1s. 6d.

BRDCST 3001

Those who admire Miss Tucker's vocal efforts may appreciate this; I am, however, not amongst her admirers.

Mender of Broken Dreams, George Price, com., with orch., 3s.

BRUNS 1071

You had better ask to hear this; it does not appeal to me, but I think it may to many. Anyhow, the record is worth acquiring because of the *Song of the Fool* on the other side, which is distinctly good.

Miner's Dream of Home, Joe Leigh, with acc., 1s.

BRDCST 687

I cannot see any point in this sort of stuff. Too obvious to notice!

Moanin' Low, Libby Holman, com., with orch., 3s.

BRUNS 1058

The bass instrument in this is extraordinarily good and the record is entertaining. I do not admire the voice but I imagine I am not asked to. Anyhow, the recording is admirable. Brunswick surfaces take some beating, as far as I can judge.

More Memories from the Fireside, Bob and Alf Pearson, with piano (d.s.), 1s.

BRDCST 677

All the old rubbish you hope you will never hear again. Buy it and try it on your grandmother; she will appreciate it.

Mountains Ain't No Place for Bad Men, Ben Malone, with organ and guitar, 2s.

DEC F2222

The title rather attracted me, but I was disappointed. The song is sheer, unadulterated tosh, both words and music. Really, Decca, have mercy upon some of us. There is a limit to the "tripe," surely?

My Dreams, Guy Marshall, ten., with orch., 2s.

BRDCST 5224

Quite effective, though rather sugary. Likewise, *Ah, Moon of My Delight*.

My Heart's a Compass, Olive Groves, sop., and Cliff Connelly, ten., with orch., 2s.

DEC F2212

Not a bad song of the musical comedy type. I do not dislike *You Looked at Me*, which they do on the other side. The music is distinctly attractive; the singing not too good, though not exactly bad.

★Seven Vells, Bob and Alf Pearson, with piano, 1s. 6d.

BRDCST 3002

This is very effective. I have marked it as an outstanding record and suggest you ask to hear it. It is one of the best of their productions, which are usually good.

Silver-toned Chimes of the Angelus, Mason and Dixon, rs. 6d.

WIN 5235

Quite effective as they generally are. Also *Moonlight on the Colorado*. A pleasant light vocal record!

Song of the Dawn, Guy Marshall, ten., with orch., 1s. 6d.

BRDCST 3010

And *Of Man River*. Both are well known and I need only say that this is a fairly good representation. The soloist seems to have been a little too far from the microphone.

Sunshine of Your Smile, Masked Strollers, rs.

RAD 1451

And *Love's Old Sweet Song*. A negligible record; the music is as dead as mutton now. Why attempt to revive it? Do let us have something original!

★Take a Pair of Sparkling Eyes, Guy Marshall, ten., with orch., 1s. 6d.

BRDCST 3022

The right type of voice for the song, which never wants overdoing in the matter of tone. His *O Sole Mio* is also effective. To be recommended.

Waiting by the Silvery Rio Grande, Maurice Elwin, bar., with orch., 2s. 6d.

ZONO 5828

Rather sugary, but there must be a use for these things, otherwise they would not appear in such profusion. The other side matches this: *When It's Sunset on the Nile*.

What Good am I without You (f.), Lem Sylva and his Band, 1s.

BRDCST 690

And *Just a Little Closer*. A very good band. If you have not acquired this for your dance collection, I commend it to your notice.

What's It Matter, as Long as it's Dark, Randolph Sutton, with orch., 1s.

RADIO 1467

Sutton sings well. I am not thrilled by it. *If You Can't Sing, Whistle* is a trifle better. Good recording.

When Your Hair Has Turned to Silver, Bud and Joe Billings, with orch., 2s. 6d.

ZONO 5834

These two artists take the trouble to sing though their pseudo-Yankee accent is a little tiring. As duettists, from the vocal point of view, they are admirable.

You will Remember Vienna, Richard Crooks, ten., with orch., 6s.

H.M.V. DA1174

I have had no chance of forgetting it recently. This is a good version by Crooks, who "brings a love song" with him on the other side.

Classical Orchestral Music

★Symphony No. 5 in C Minor, Op. 67, 1st, 2nd, 3rd and

GRAMO-RADIO SECTION

4th movements (Beethoven) Vienna Philharmonic Orch., 4s. 6d. H.M.V. C2022-5

I am glad H.M.V. has done this again. The playing by Schalk is in many respects really fine. I cannot offer to dissect each movement for the benefit of readers who are seeking a good version of the immortal symphony; it would need an article for that. The recording is greatly superior to that of the firm's previous set of records of this work. Ask to hear the second side of the *Andante* and you will realise that the production is excellent.

Military Bands

Classical Memories, Band of H.M. Life Guards (d.s.), 2s. BRDCST 5223

Very good as a military-band record, though I am not keen on medleys.

Liberators, Band of H.M. Scots Guards, 1s. RAD 1454

A very good military-band effort—plenty of grip about the playing. Acceptable, or should be, to those interested in such things.

New Colonial March, Band of H.M. Life Guards, 1s. 6d. BRDCST 3009

I was asked the other day to give a list of good military band records. I forget who asked the question; anyhow, here is another of outstanding qualities.

Song by the Camp Fireside, Band of H.M. Welsh Guards (d.s.), 1s. 6d. BRDCST 3013

Very well played—if you want *Old Folks at Home* and *Auld Lang Syne*. Personally, I can live without them.

Organ Music

Song Without Words, Op. 30, No. 3, Professor Hans Bachem, organ, 3s. H.M.V. B3579

What is the matter with playing organ music, H.M.V.? Why must it be an arrangement, and a vulgar one at that? The organist of Cologne Cathedral ought to be ashamed of this. Brahms' *Cradle Song*, where it is intelligible at all, is a travesty of the original. I have no opinion of this sort of thing. Sorry, but I must say so! Very bad playing, I call it.

What Good Am I Without You? organ, Reginald Foort, 3s. COL DB407

The title should recommend it to those who like such things. Of its kind, it is good.

Piano Solos

★Aufschwung, Op. 12, Ignace Hilsberg, piano, 3s. BRUNS 1072

By Schumann. The recording here is so fine that the piano is really natural. Pianistically speaking, I am not very keen on the actual interpretation, but that is only a personal opinion. *Cracoviense Fantastique*, by Paderewski, is the companion. An outstanding piano record, in my opinion.

Mazurka in C Minor (Chopin), Arthur Rubinstein, 8s. 6d. H.M.V. DB1462

I don't admire your piano, H.M.V.! Why don't you give your artistes something worth



ARTHUR RUBINSTEIN

playing on? That instrument wants a pole-axe on it! Rubinstein is so good, too. A pity; a good record spoilt.

Spoken Record

Almost a Film Actor, Horace Kenney (d.s.), 4s. 6d. COL DX216

Kenney, as the old dodderer who applies for a job on the films that he cannot possibly fulfil, is really quite interesting. I think this is quite attractive, but I suggest you ask to hear it



HORACE KENNEY

and judge for yourself. It is not too funny but it has an atmosphere about it.

Changing of the Guard, Band of H.M. Welsh Guards (d.s.), 1s. BRDCST 680

I should imagine it is an authentic rendering. If you have seen the changing of the guard, you can now hear it.

Murder in the Air, Broadcast Dramatic Players (s.s.), 1s. BRDCST 679

This purports to be an air-plane tragedy and is labelled a "thriller." Like most thrillers it is a trifle morbid, but the "effects" are well done. It interested me as I listened to it. I think it is worth a shilling; buy it, hear it, give it away, and forget it!

Light Orchestral Music

Auld Scots Songs, Maestros, with orch. (d.s.), 4s. 6d. COL DX214

Here we are again; Columbia, like all the others, occasionally cannot think of anything worth producing and we so get a

medley of *Annie Laurie*, *Loch Lomond*, etc. Personally, I have not the slightest use for such records. "Light Orchestral," I suppose it had better be!

Ballashanon Boys, and Rolliecan Boys, Sweeney Brothers, 2s. 6d. ZONO 5833

This excellent disc devotes itself to Irish reels and jigs, and should appeal to those who are Irish by blood. I recommend the disc to them unreservedly.

Bees' Wedding, Hunting Song, Peter Yenovitch, with Metropolitan Symphony Orch., 2s. BRDCST 5221

Scored effectively, but they are rather noisy bees! I am not keen on orchestral arrangements of piano music, but these are good.

★Blue Danube (w.), Black Diamonds Band 2s. 6d. ZONO 5849

Together with the *Carmen March*, this makes an outstanding light orchestral record with what I imagine will be a long-wearing surface. I sincerely recommend it.

Blue Danube (w.), Schomberg's Viennese Orch., 1s. 6d. PIC 721

A very acceptable version, but it has been a trifle overdone lately.

Chanson Hindoue, Hastings Municipal Orch., 3s. 6d. DEC K568

Very fair on the whole, but I think it should be *sleepier*. I have always liked the theme, but this rendering leaves me cold. *Humoreske*—an orchestra version not at all badly scored—is the companion.

Estudiantina Waltz, violin, Albert Sandler, with piano, 3s. COL DB362

By Waldteufel. I think you will recognise your old, wireless



ALBERT SANDLER

friend; he plays characteristically. I like him better in Waldteufel's *Dolores Waltz* on the other side.

Hungarian Rhapsody, No. 2, H.M. 1st Bn. Border Regiment (d.s.), 1s. 6d. PIC 712

Not at all a bad arrangement. Of course, it does not sound the same as on a symphony orchestra, but it is quite passable.

★La Fille de Mme Angot, Paris Symphony Orch., 1s. RAD 1462

A double-sider. A very pleasant light orchestral record—one of the best I have heard, with an excellent surface.

★Le Chasseur Maudit (third record), Royal Opera Orch., Covent Garden, 4s. 6d. H.M.V. C2017

By César Franck. A very beautiful record, beautifully played. Not too highbrow for any of you. Buy it; there is Chabrier's *March Joyeuse* on the other side to cheer you up! That is to say on the *fourth* side. There are two discs.

Minuet, Peter Yenovitch and Metropolitan Symphony Orch., 2s. BRDCST 5216

This was originally a piano work but in this form it is for piano with an orchestral accompaniment. It is rather effective. The other experiment, on the other side, is a little more dangerous; it is Mendelssohn's *Rondo Capriccioso*. I rather like it, all the same. In this form both works had better be regarded as being "Light Orchestral."

★Nights of Gladness, International Novelty Quartette, 2s. 6d. ZONO 5832

And *Valse Septembre*. These, of course, belong to the days of our youth. They are certainly in advance, musically speaking, of many turned out in these days. The Zonophone surface is admirable. I am putting them amongst the light orchestral records as they are not suitable for modern dancing.

On Wings of Song, Schwiller Octet, 2s. DEC F2236

This popular Mendelssohn melody is always welcome. Here it is very effectively rendered by this octet. Although not making chamber music, exactly, I should be inclined to suggest that it is an excellent light orchestral record.

★Saschinka, Marek Weber and his Orch. (d.s.), 4s. 6d. H.M.V. C2100

This is a pot-pourri of gipsy songs and dances and very pleasant light orchestral music it makes. I sincerely recommend it.

Song of the Volga Boatman, String Orch., with organ, 2s. BRDCST 5217

Quite effective if only the organist had sufficient decency about him to keep those cursed tremulants in! He exhibits the same regrettable tendencies in Rachmaninoff's hackneyed *Prelude in C sharp minor*.

Traviata, Viennese Light Orch. (d.s.), 2s. BRDCST 5222

Very effective light music and worth getting.

Venetian Barcarolle, J. H. Squire Celeste Octet (d.s.), 4s. 6d. COL DX211

This is a medley and as such is quite acceptable, for once in a way; it contains such well-



J. H. SQUIRE

known airs as the *Carnival of Venice*, the Italian National Anthem, etc. There is not much *Barcarolle* about it, but it makes an excellent light orchestral record.

CHOOSING YOUR RECORDS—Continued

Humorous
Records

Barracky Bert, the Soldier, Bobby Comber, com., with acc., is. **BRDCST 676**
Very ordinary. Not amused.

It's a Pleasure, Sophie Tucker, with orch., is. **BRDCST 674**

Supposed to be funny, but in reality is stupidly vulgar. *Make Yourself at Home* is silly without being either funny or vulgar.

Leonard Henry Lets Himself Go, Leonard Henry, com., with orch. (d.s.), is. 6d. **BRDCST 3012**

To some purpose; he is exceedingly amusing. Get it!

Maggie and Me and the Baby, Charlie Higgins, com., with orch., is. **BRDCST 682**

No, I did not even smile—either at this side or the other.

Naw! I don't Wanta be Rich, Carson Robison, 3s. **BRUNS 1065**

Quite amusing, though not very funny. *So I Joined the Navy*, on the other side, comes under the same observation. I am, candidly, not too keen. Surface, of course, irreproachable.

Poor Ned and Other Limericks, Harold Williams and the B.B.C. Male Chorus, with piano, 3s. **COL DB399**

These limericks are quite safe, being under the auspices of the B.B.C., conducted by Stanford Robinson. The tune, which elongates the limerick form, is very taxing. I like also *Bonnie*



HAROLD WILLIAMS

Wee Thing, on the other side. This recording is very well produced.

Sandy Buys a Wireless Set, Sandy Powell, com. (d.s.), is. **BRDCST 683**

Yes, quite good, but the salesman's laugh—indeed, his whole characterisation—is distinctly poor—irritating, in fact. Sandy, however, is good.

Sandy, the Tram Conductor, Sandy Powell, com. (d.s.), is. **BRDCST 675**

He seems to have been everything except an archbishop; that will come, no doubt. He's quite amusing, though he has never been so funny since he left the constabulary. Still, this can very well decorate the humorous column.

Those Four Chaps Go Shopping, Those Four Chaps (d.s.), is. **BRDCST 684**

Very good. Ask to hear it; I think you will be amused.

We All Go Oo, Ha, Ha! Together, Leslie Weston, with Harry Hudson's Melody Men, is. **RAD 1461**

Very good, if you are not sick to death of it. I hope it will soon die either a natural or else a violent death. The patter is amusing. *I Want to Go to Africa*, on the other side, is only moderately good.

Dance Music

Allways in All Ways (f.), Merle Johnston and his Saxophone Orch., 3s. **COL CB216**

A moderate tune; I have heard better. I much prefer *It's a Great Life* on the other side.

Betty Co-ed (one-step), Rhythmic Eight, dance orch., 2s. 6d. **ZONO 5839**

An excellent one-step. The Rhythmic Eight rarely fail to produce something good; this is one of their best. I like the waltz on the other side—*Tears*.

Button up Your Overcoat (f.), Spike Hughes and his Dance Orch., 2s. **DEC F2217**

This came out again? Well, it is very attractive and the words are excellent. The recording here is not quite as it should be. It is better in *Moanin' Low*, on the other side.

Carolina in the Morning (f.), Red Nichols and his Five Pennies, 3s. **BRUNS 1062**

If it is permissible to speak of orchestration in a record of this kind, I am inclined to express admiration for the "scoring" in this excellent record. Also the weird effects in *Who?* on the other side.

Cheerful Little Earful (f.), Tom Gerun and his Orch., 3s. **BRUNS 1064**

A lively fox-trot. This is the first time I have heard this orchestra; very good. The dance value is only nominal of this particular record; it is better in *The Song of the Fool*, a slower fox-trot song on the other side.

Blue Pacific Dance Band, is. 6d. **PIC 716**

And *Choo-Choo*. This is a very good band. I recommend it to your notice.

Elizabeth (f.), Jack Phillips Melodians, is. 6d. **BRDCST 3011**

An outstanding quick fox-trot. Splendid for dancing. *You're Driving Me Crazy* is on the other side.

Girl Friend of a Boy Friend of Mine, Bright and Bruce, with acc., is. **BRDCST 678**

Quite a good dance record if electrically reproduced. *O-Kay Baby* is on the other side, equally well done.

Here Comes the Sun (f.), Hal Swain and his Band, is. **BRDCST 688**

Quite a good version and also of *Cupid on the Cake*, which I like immensely. Some originality in it!

He's Not Worth Your Tears (f.), Jack Harris and his Orch., 2s. **DEC F2209**

A very danceable version of this popular fox-trot. *Blue Without You* is on the other side, very well done. A cheap two-shillingsworth.

Highway to Heaven (f.), Jack Phillips Melodians, is. 6d. **BRDCST 3005**

I do not seem to remember having heard a record by this band before. A conventional dance band, certainly; but their playing is clear and effective.

Hurt (f.), Hal Kemp and his Orch., 3s. **BRUNS 1075**

A good dance record with a very modern ballroom touch about it. I also like *Overnight*, by the Emil Coleman orchestra; I do not remember having heard it before. I recommend this as an outstanding dance record.

I'm Alone Because I Love You (w.), Jack Phillips' Melodians, is. 6d. **BRDCST 3021**

And *Three Little Words*. Excellent tone. These Broad-cast records are improving each month.

Mellow and Rich, with acc., is. **BRDCST 685**

And *Sunny Days*—both very well done.

I Haven't Heard a Single Word from Baby (f.), Jack Payne and his B.B.C. Dance Orch., 3s. **COL CB209**

Splendidly played; also *Make*



JACK PAYNE

Yoursself a Happiness Pie, on the other side. An outstanding dance record.

I'll be Blue Just Thinking of You (f.), Hal Swain and his Band, is. **BRDCST 670**

For an inexpensive eight incher, I think this is admirable. The surface is excellent. *Sweet Jenny Lee* is on the other side, and is equally effective. An outstanding dance record.

I'm Tickled Pink with a Blue-eyed Baby (f.), Red and his Big Ten orch., 3s. **H.M.V. B5977**

A very good tune which I have not heard before. I also like *Yours and Mine* on the other side. An outstanding dance record. *Yours and Mine* is a slower fox-trot than the other.

In the Valley of Dreams (f.), Nat Lewis and his Dance Band, is. **BRDCST 672**

A good surface characterises this record. You will know the melody. If you want it—this is a good version; the singing is above the average, which is not saying much for it, I fear!

Just a Little Dance Mam'selle (f.), Earl Burt-

nett and his Los Angeles Orch., 3s. **BRUNS 1074**

A slow fox-trot of the sleepy type. *Sweet Jennie Lee*, the companion, is a quicker movement. Excellent for dancing; I have therefore marked it with an asterisk.

King's Horses, Bob and Alf Pearson, with piano, is. 6d. **BRDCST 3014**

And *Oh, Donna Clara*. An excellent edition of both.

King's Horses, Marius B. Winter and his Dance Orch., is. 6d. **BRDCST 3018**

A very good version of it, with *Moonlight on the Colorado* on the other side.

Little Lady, (tango), Geraldo's Los Cauchos Tango Orch., 2s. **DEC F2204**

And *Manette*—both tangos. The rhythm strikes one as being fresh after the fox-trot. This record is not particularly good for dancing, unless well toned up on a powerful loud-speaker. Then it would be all right for dance purposes.

Live and Love To-day (f.), Abe Lyman and his California Orch., 3s. **BRUNS 1073**

And *This is Love (w.)*, both from *Madam Satan*. An excellent surface characterises both these dance numbers. Try them on a good electric machine.

My Bluebird was Caught in the Rain (f.), Ferrachini's Hawaiian Band, is. 6d. **BRDCST 3008**

Not very outstanding in the way of melody, though it has an atmosphere about it. *Somewhere in old Wyoming* is the companion.

My Ideal (f.), Dave Frost and his Orch., 2s. **DEC F2232**

A new band to me; rather subdued but very musical. *A Little Love Song* is the companion. The voice is rather adenoidal, but there is music in it.

Nine Little Miles from Ten-Ten-Tennessee (f.), Tom Gerun and his Orch., 3s. **BRUNS 1063**

Very good words and a splendid tune, well sung. Bruns-wick! I congratulate you on something worth hearing. Buy it, everybody!

Nobody Cares if I'm Blue (f.), Waikiki Serenaders, is. **BRDCST 673**

And *Oh, Donna Clara*—both well produced.

Oh, Donna Clara, Marius B. Winter and his Dance Orch., is. 6d. **BRDCST 3017**

And the *Kiss Waltz*. Both are hackneyed now, but this edition is worth having—if you have no other, of course.

Okay, Baby, Marius B. Winter and his Dance Orch., is. 6d. **BRDCST 3004**

Another good dance record, especially if electrically reproduced. *Little Love Song*, on the other side, is also attractive. A good dance record.

On a Little Balcony in Spain (f.), Blue Pacific Dance Band, is. 6d. **PIC 715**

And *Sleepy Head*. Not perfect recording, but the band plays well.

SPECIAL REVIEWS BY WHITAKER-WILSON

On a Little Balcony in Spain (f.), Orpheus Dance Band, 2s. 6d. ZONO 5840

A quick and jolly fox-trot. *Peanut Vendor* is the somewhat original title of a fox-trot (also quick) on the other side. The rhythm in this instance is a trifle disturbing, but such things do not trouble modern dancers!

Pas de Quatre, Ye Band of Rustics, dance orch., 2s.

DEC F2235

Rather a welcome revival; it is really an excellent tune! *La Paloma*, on the other side, is rather a stodgy tango but the disc is worth purchasing for this side alone.

★Peanut Vendor (f.), Marius B. Winter and his Dance Orch., 1s. 6d.

BRDCST 3019

A very good number, with *Choo-Choo* on the other side. An outstanding record of which the surface is excellent.

★San (f.), Jack Harris and his Orch., 2s.

DEC F2174

A splendid quick fox-trot and very useful for dancing. *Three Little Words*, on the other side, is slower in tempo. Both are very well produced. An outstanding dance record with a good surface.

★Say "Oul," Cherie (f.), Jack Phillips' Melodians, 1s. 6d.

BRDCST 3020

Very good. An outstanding rhytmical production.

Savoy Welsh Medley (one-step) International Novelty Quartette, 2s. 6d.

ZONO 5846

A mixture of Welsh airs (*Harlech*, etc.) in one-step time. Other side, American airs similarly arranged. Not impressive. However, it is only fair to say that they make excellent one-steps and that the recording is admirable.

★Sing Holly, Go Whistle Hey Hey (f.), Million-Airs orch., 2s.

DEC F2238

A very jolly fox-trot. The tune is not particularly original, but it is very taking. The surface is good enough to place the record amongst the outstanding productions of the month. The singing, also, is good.

★Sing Song Girl (f.), Colonial Club Orch., 3s.

BRUNS 1061

Quite a good orchestra. The movement is in quick fox-trot time. *Fraternity Blues* is a really quick fox-trot (on the other side). Very useful for dancing and so marked for special choice. Very good words.

OTHER GRAMO-RADIO FEATURES WILL BE FOUND IN THE SPECIAL SUPPLEMENT

The Seventh Special WIRELESS MAGAZINE Supplement, entitled "Why and How of Radio Gramophones," appears after page 400.

★Someday Sweetheart (f.), Ted Lewis and his Band, 3s. COL CB215



TED LEWIS

Another good quick fox-trot. The tone is not so good as that produced by Jack Payne, but I think he must be exceptional. However, as a dance record, this is good enough.

Somewhere in Old Wyoming (w.), Palm Beach Hawaiians 2s.

DEC F2213

Quite an attractive waltz, and the P.B.H.'s have an atmosphere about them. I like this record very much.

★Star Dust (f.), Ambrose and his Orch., 3s.

H.M.V. B5967

This is an exceedingly attractive slow fox-trot, or moderately slow. I am very taken with it. *Blue Again* is on the other side.

This is perhaps the better known of the two. In any case, the record is very having.

Tell Me I'm Forgiven, Eddie Gross-Bart and his Ambassador Club Band, 1s. 6d.

WIN 5230

A soft-toned orchestra but pleasant to listen to. If you want this for dance purposes, use a loud needle. The number, I am told, is very popular. Also *Elizabeth*, on the other side.

There's Always To-morrow (f.), Jack Harris and his Orch., 2s.

DEC F2205

Rather a nice orchestra. The rendering is better as lunch-time music than for use between 8 and 2 a.m. I rather like the tone of some of the instruments.

★Three Little Words, Sid Phillips and his Melodians, 1s.

RAD 1464

And *Cheerful Little Earful*, which is a good dance number. Excellent recording makes this record worth getting.

We All Go Oo, Ha, Ha, Together, Leslie Sarony, com., 1s. 6d.

BRDCST 3013

Yes! Very good and worth having if you are not bored by it. You can learn how to sit on a five-barred gate on the other side. A good piece of recording.

Wedding Bells are Ringing for Sally, Billy Marlow, with acc., 1s. 6d.

BRDCST 3015

And *Roamin' Through the*

Roses. His voice appeals; but I feel he would sing better if he had some good lessons. Which is what most of these dance-singers need!

★Jack Hylton and his Orch., 3s. H.M.V. B5976

Very pleasant to listen to, but not essentially a dance record. Jack Hylton's band is improving in tone.

Hal Swain's Band, 1s. BRDCST 689

And *Happiness Pie*. Both well known, of course. A very good rendering of both, with a good surface.

★Wedding in the Ark (f.), Six Jumping Jacks, 3s.

BRUNS 1070

A little of Mendelssohn—"ragged"—opens it. The words are very good; it is a pity the words of the average fox-trot are not more carefully written. What we want is a few lyrics with a punch in them. Here is one. A very good record. *She Loves Me Just the Same*, on the other side, is equally good.

When the Little Red Roses Get the Blues for You, Al Jolson, com., with orch., 3s.

BRUNS 1060

He sings rather appealingly. That's right, Brunswick! Let us have some singers. Only don't let them whistle, please! A very good record in every other respect.

You Are the Melody (f.), Marius B. Winter and his Dance Orch., 1s. 6d.

BRDCST 3003

Quite a good tune and suitable for dancing. I wish we could get these things better sung. They are very unsatisfactory as they are.

You Will Remember Vienna (w.), Sam Browne, with orch., 1s. 6d.

WIN 5208

Quite a good version, but there are so many from which to choose that I can say very little about it. Other side: *I Bring a Love Song*.

You're Driving Me Crazy (f.), Jerry Hoey and his Band, 1s. 6d.

PIC 722

And *Send Out Sunshine*. Hoey and his band are worth hearing, but the surface is fair to moderate only.

Lew Sylva's Band, 1s. BRDCST 691

And *Memories of You*. This is a good band; I recommend this record.

ABBREVIATIONS USED IN THESE PAGES

bar.	baritone
BRDCST	BROADCAST
BRUNS	BRUNSWICK
COL	COLUMBIA
com.	comedian
con.	contralto
DEC	DECCA
d.s.	double-sided
f.	fox-trot
H.M.V.	HIS MASTER'S VOICE

IMP	IMPERIAL
orch.	orchestra
PHONY	PHONOCORD
PIC	PICCADILLY
RAD	RADIO
sop.	soprano
ten.	tenor
w.	waltz
WIN	WINNER
ZONO	ZONOPHONE

See the blue-paper supplement for other grammo-radio features



A SIMPLE SYNCHRONISING GEAR FOR HOME TALKIES

This apparatus is the Reylix. It couples a home cinema projector with a gramophone turntable

THE possibility of making one's own talking pictures is no longer a wild flight of imagination. There are on the market numerous cinematograph cameras and projectors capable of giving excellent results for home use, and it has been patent for some time that home-talkie apparatus could not be very long delayed.

The hobby of home cinematography, indeed, links up very pleasantly with that of wireless.

A brief description of the types of apparatus available for home cinematograph work is desirable.

There are two forms of equipment, known respectively by the size of the film they use. The first of these, which is in many ways the most satisfactory, although the more expensive of the two, is what is known as the 16-millimetre equipment, which is merely a smaller-size reproduction of the standard cinematograph film.

Perforated Edges

It consists of a long strip of film, the centre portion of which is occupied by the pictures in succession, the outside edges being perforated with holes at regular intervals for feeding the film over the sprockets in the camera and projector.

In this type of film there is one pair of sprocket holes per picture instead

of four as in the standard film, but experience shows that owing to the smaller size this is perfectly satisfactory.

The size of the image on the film itself is 10.5 millimetres by 7.5 millimetres, and this will throw a picture on a screen 6 ft. by 4½ ft. with a suitable projector. This is amply large enough for home work, and in practice a screen 3 ft. by 4 ft. is more usual.

Other Form of Film

The other form of film is known as the 9.5 millimetre, and has the merit of being much cheaper. The size of the actual image on the negative is very little smaller than in the case of the 16-millimetre stock. This film, however, is not provided with perforated edges each side, but the holes are punched in between the successive pictures, in the manner illustrated opposite. Thus the width of the film is considerably reduced and the cost is brought down accordingly.

Both these forms of film are made upon a non-inflammable base, so that there is no danger of fire as is the case with ordinary standard film. If the film gets over-hot all that will happen is that the image will blister, but there is no risk of the serious conflagration which occurs if ordinary celluloid is employed.

Projectors for running through the film range in price from £2 15s. to £100, and cameras run on much the same lines.

When it comes to the question of making home talkies the problem to be decided is which system shall be employed. A little consideration shows that sound-on-film is almost impossible in the present state of development. The film runs through at the standard rate of sixteen (or in the case of the 9.5-millimetre film, fourteen) frames per second, but owing to the much smaller size of picture, this only involves a run of about 6 in. per second.

Standard film runs through at twenty-four frames per second, an increase of fifty per cent. on the old sixteen frames, which was made necessary by the general introduction of talkies, and this is equivalent to about 18 in. per second.

Adequate Top Notes

The difficulty of obtaining adequate top notes with the present sound-on-film system is well known, and consequently, if the speed is only 6 in. per second, nothing above 1,500 to 2,000 cycles per second is capable of being reproduced; apart from this the cost of the recording and reproducing apparatus is high.

The disc system, on the other hand, offers quite reasonable possibilities.

It is practicable to obtain a point on nearly every projector from which a turntable may be driven, and if the gear ratio is correctly chosen, film and record may be synchronised perfectly from start to finish. The gearing requires to be well made so that it runs silently and so that the power required to drive it shall be very small. Otherwise the extra load imposed on the mechanism of the projector may cause damage.

Three Methods

Apart from these points, however, it is possible to obtain excellent reproduction in synchronism with the film, and thus reproduce quite satisfactory talking pictures. There are three methods which may be used for the purpose.

The first method uses existing records of a suitable type, such as two comedians singing a song with piano accompaniment, or something of that nature. The words of the song are learned, together with various idiosyncrasies of the original perpetrators.

The turntable is then linked up with the camera, and the record played at the same time as the picture is being taken. The budding actor sings the song in time with the music, which is already being reproduced from the record, and subsequently when the film is run through the record originally employed is linked up with the projector and supplies the words and the music.

This method produces amusing results, but suffers from two disadvantages. Firstly, the choice of subject is somewhat limited, and secondly the linking of the turntable with the camera introduces certain difficulties, the greatest of which is the necessity for providing an external motor as described later.

Making One's Records

The second and really more satisfactory method is where one makes one's own records for the film. One of the simplest outlets here is that of running commentaries on existing films, describing holiday scenes, etc. The turntable is linked up with the projector as already described.

When the film is run through the turntable is rotated at the correct speed (eighty revolutions per minute) and a tracking device is incorporated together with the use of a diamond or sapphire cutter, which makes the record at the same time.

A microphone is stationed a little

way away from the projector to avoid picking up any stray noises, and spoken comments made upon the various incidents as they appear. Musical interludes may be faded in and out during the commentary and, indeed, there is considerable scope for ingenuity in this direction.

This method may be used quite easily for making talkies. For this purpose the plot is rehearsed and is "shot" silent. That is to say, all the characters speak their parts and behave in a normal manner, but there is no recording taking place. The film is developed and suitably edited. Little bits which have not come out as well as they should do are cut, or perhaps retaken.

Titles are introduced if they are considered necessary, although in general the only title required is that at the beginning, and in general the scenes are arranged in their correct

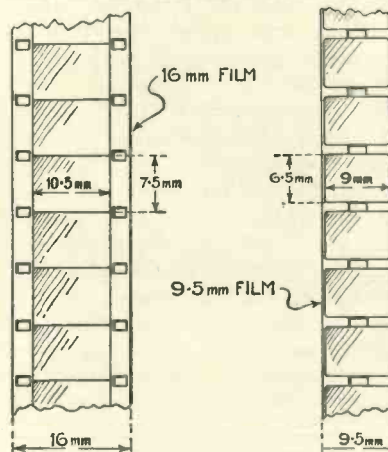

TWO SIZES OF FILM

The two standard sizes of film in use for home-cinema purposes

order, and the continuity is adjusted to the satisfaction of the producer.

At this stage the turntable is linked up with the projector, and the film is run through. The various actors who have already appeared in the film then speak the appropriate words as they see themselves take up their various positions on the screen.

Since the part has already been learned very little practice is necessary to obtain perfect synchronism here, and the method has the advantage that all the characters speak directly into the microphone, thereby obtaining perfect clarity, even in the case of outdoor shots.

It is practicable, of course, to provide a microphone for each

character or group of characters, while at the same time the control engineer must have at his disposal sources of music and other incidentals which he can fade in and out as required.

It is clearly possible to build a small monitoring desk with fade panels so that the actual recorded output is completely under the control of the recording engineer.

Successful Apparatus

Very successful talkies may be made in this way, and the apparatus illustrated with this article, known as the Reylis, has been used by the author for many of these experiments with every success.

It consists of the turntable together with the necessary gearing, a pick-up for reproducing, a tracking device and cutter for recording, and a flexible shaft for connection to the projector or camera. Metal discs, of course, are used for recording.

The third method, which is not to be recommended for general use, is the making of the talkie at the same time as the film is being shot. This involves linking the camera and the turntable, and since the clockwork drive inside the camera is quite inadequate for driving the turntable and the recording mechanism, it is necessary to link up an electric motor externally.

On the particular machine already mentioned provision can be made for this as an extra, but there are numerous difficulties which crop up.

A proper recording studio must be used. The sound effects must be just right as well as the photographic lighting effects for the shooting of the film, while in addition if any mistake is made the whole thing has to be done again.

When the film itself is photographically correct attempts may be made to obtain the recording, and even if a mistake is made here, the only expense involved is the cost of the disc—a few pence.

Adaptability

The standard gear is suitable for an 80-r.p.m. record. By the introduction of extra gearing, however, the turntable may be arranged to run at 33¼ revolutions per minute, in which case a standard 10-in. disc will last for a full 400-ft. film, which takes twenty minutes to run through. The apparatus is capable of being used either with the 16-millimetre or the 9-millimetre projectors.

DOES THE B.B.C. NEED ITS £1,000,000



All listeners are fond of criticising the British Broadcasting Corporation. Here **KENNETH ULLYETT** discusses B.B.C.

finance and shows how the B.B.C.'s income is allocated for different purposes. We shall be glad to have comments from readers.

IT is a popular misconception that there is unlimited money at Savoy Hill.

Those who complain of the programmes express the view that they could provide much better material if only they had the golden opportunity of having about four million ten-shillings coming in every year. Amateur artistes who have been once before the mike speak glibly of their "fees," to impress listening friends. There is still much talk of the £1,000-an-hour performances of Lauder and Chaliapin.

A Rude Knock

It all creates the impression of there being money and to spare in the B.B.C. coffers, which is a notion given a rude knock by an examination of the latest B.B.C. revenue and licence figures.

The real truth is that while there are now at least 4,000,000 licensed

listeners, and goodness knows how many unlicensed ones, the B.B.C. receives nothing like 4,000,000 times 10s. The arithmetic of the revenue account is much more involved.

The whole of the B.B.C. revenue does not come from the licence fees. Quite 10 per cent. of it, according to the latest figures available, is derived from the sale of pamphlets, talks, booklets, and programme papers. Practically the whole 90 per cent. of the rest of the revenue, however, comes from listeners *via* the Post Office, and it is that portion which is most important.

Many people have the impression that the B.B.C. gets 7s. 6d. out of each 10s. licence fee, but this is far from the truth. The Post Office makes a profit out of the licensing, and the Treasury takes its portion of "entertainment tax," or luxury tax, whichever way you like to look at it. The important thing to notice is

that the amount taken by the Treasury varies in proportion to the number of listeners, and the scheme is so arranged that, in effect, the B.B.C. is virtually discouraged from encouraging licensed listeners.

Of all licence fees the Post Office retains 12½ per cent., which is supposed to cover the cost of collection and administration. A question raised in the House recently forced the Assistant Postmaster General to admit that a licence costs 1s. 2d. to issue, taking every detail into account. Simple arithmetic will show whether 1s. 2d. per licence is equivalent to 12½ per cent. of the total of licence fees!

What the Treasury Gets

In respect of the first million licences issued, the Treasury retains 10 per cent.; in respect of the second million, 20 per cent.; of the third, 30 per cent.; of anything over 3,000,000, 40 per cent.

A TRIO OF "STRING" BROADCASTERS



Pierre Fol, a broadcast violinist



Another violinist—
Alfredo Rode



Cedric Sharpe is a well-known cellist

Take an example to see how little of the licence money really does reach the B.B.C. Suppose that there are 2,500,000 listeners bringing in a total sum of £1,250,000. Now, the Post Office takes its 12½ per cent., representing £156,250. The Treasury's 10 per cent. of the first million, 20 per cent. of the second million, and 30 per cent. of the part of the third million amount to £43,750, £87,500 and £65,625 respectively.

If you add this up you will find that the B.B.C. gets only £896,875 out of the total of £1,250,000; which is just under 72 per cent.

That is not the only trouble, for the B.B.C. gets its salary in arrears; that is to say, the payments made during one year are calculated on the number of listeners in the previous year. This makes a big difference to the actual amount of money received.

What It Loses

For example, if the amount actually received by the B.B.C. were £800,000, then the amount that would have been received had the payments *not* been paid in arrears would have been about £880,000, or 10 per cent. more.

So, you see, the B.B.C. does not get half of the support that listeners would be willing to give, and it is frankly owing to lack of funds that the regional scheme is not going ahead so quickly as it could. Brookman's Park is stated to have cost £100,000, and Slaithwaite has cost about the same.

The amount which the B.B.C. has managed to put into the reserve fund to cover the regional scheme is rather inadequate in comparison, and it is quite obvious that, while there is no immediate possibility of a deficit, there is no opportunity for the B.B.C. to waste money in giving contracts at unfavourable rates.

What is worrying listeners is the question whether the B.B.C. is spending too much in proportion on building new stations, and is spending too little on the programmes themselves.

Lack of Alternatives

At present the real trouble with programmes is not the intrinsic degree of poorness, but the lack of alternative. The National programme of one night is the Regional programme of the following night. If this sort of thing happened only once or twice, one might blame the programme arrangers, but its constancy leaves no

doubt about the real cause, namely, insufficient revenue to provide a night-to-night alternative.

It is perhaps not an exaggeration to say that what is worrying listeners now is not the condition of the stations, for reception conditions are very favourable, but the constant "grousing" about the standard of the matter broadcast.

More Programme Money

No programme can ever be entirely good or entirely bad, for taste enters into the question; but good programmes cannot be given on insufficient funds, and there is a general impression in certain sections of the daily Press, representing a large body of listeners, that the funds are insufficient.

More money for programmes can be obtained in one of three ways. Money at present spent on development of plant can be handed over to the programme department; the Treasury can be induced to take a reduced proportion of the revenue; the licence fee can be raised to a guinea, as some people suggest.

Two of these ideas are hopeless. There would be a general outcry, it is quite certain, if any change were made in the cost of a licence; and, furthermore, there would be an evasion to a greater extent than even at present. The possibility of the Charter being altered so that the B.B.C. obtains a greater benefit is so remote as to be unworthy of consideration.

Political Support

True, when the Charter expires on December 31, 1936, it may be altered on renewal (which is fairly certain) in the B.B.C.'s favour, but no political party has yet seen fit to extend a financial helping hand to the B.B.C. And it would need political support to bring about a reduction in the Treasury's "profit."

It remains to be seen whether the B.B.C., largely influenced at present by the enthusiasm of the engineering department in favour of the regional scheme and the giant, expensive stations entailed by it, will check its headlong expenditure of many thousands of pounds in the direction of the station-builders and the manufacturers of radio plant.

It could divert some of this present expenditure into the pockets of the programme people; but whether it should do so is, of course, a personal opinion.

ESCUTCHEON PLATES

MANY modern sets incorporating drum-drive condensers require one or more rectangular holes in the panel for the fitting of the escutcheon plate or plates.

A template is generally supplied with the parts which show the exact size of the hole required, and if this template is of thin paper it may be

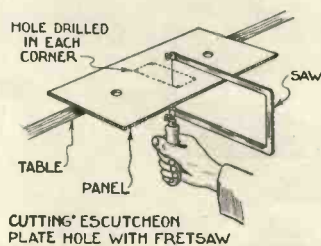

stuck to the panel in the correct position and the making of the hole proceeded with.

If, however, the template is of cardboard, the boundary lines of the hole must be either traced on to thin paper or the actual lines marked on the panel with a scriber.

The work of cutting the hole may be carried out by using a fretsaw, as shown above, or a series of small holes may be drilled around the inside of the boundary lines of the hole and the surplus piece knocked out.

When removing the piece after drilling, care must be taken not to break the panel, and in this connection it will probably be found advisable to file through from hole to hole by means of a ¼-in. round file. The surplus

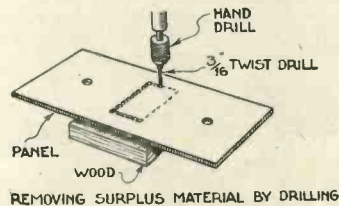

piece will then, of course, drop out, when no more connecting strips are left.

The edges of the hole may finally be smoothed with a flat file and the escutcheon plate fitted into position after the remaining holes required in the panel have been drilled.

In passing it may be mentioned that either of the piercing methods illustrated may satisfactorily be used for the making of a hole in a panel for fitting a meter or flush-mounting switch, etc.

A. P.

THE REGIONAL THREE



IN introducing this receiver to WIRELESS MAGAZINE readers, we cannot do better than refer to the ten special features associated with the Regional Band-pass Four. They apply equally well to the new model:

Special Features

- (1) Band-pass tuning gives the necessary degree of selectivity on the medium waves to give satisfactory reception under modern high-power broadcasting conditions.
- (2) Uniform selectivity on all wavelengths is a feature of great value and one that will be appreciated by all listeners.

(3) Consistently good results are assured by the fact that uniform magnification is obtained.

(4) The tuning is so simple that any member of the family can operate the set and get satisfactory reception from a large number of stations.

(5) A pre-detector volume control is provided in order to avoid overloading of the detector during the reception of local stations.

(6) Both medium and long wavelengths are covered by the special Binowave coils, which are controlled by a single switch on the panel.

(7) A gramophone pick-up can be added to the set without any altera-

tion, a special jack being provided at the back.

(8) Great magnification is provided by the Binowave coils and the special arrangement of the circuit.

(9) Perfect stability is a feature of this receiver, as indeed it is of all sets using Binowave coils.

(10) First-class quality of reproduction is assured, provided that the proper valves and correct voltage are employed.

Band-pass Interest

At the present time there is extraordinary interest in band-pass tuning circuits. Whilst being very selective, they give better quality than an

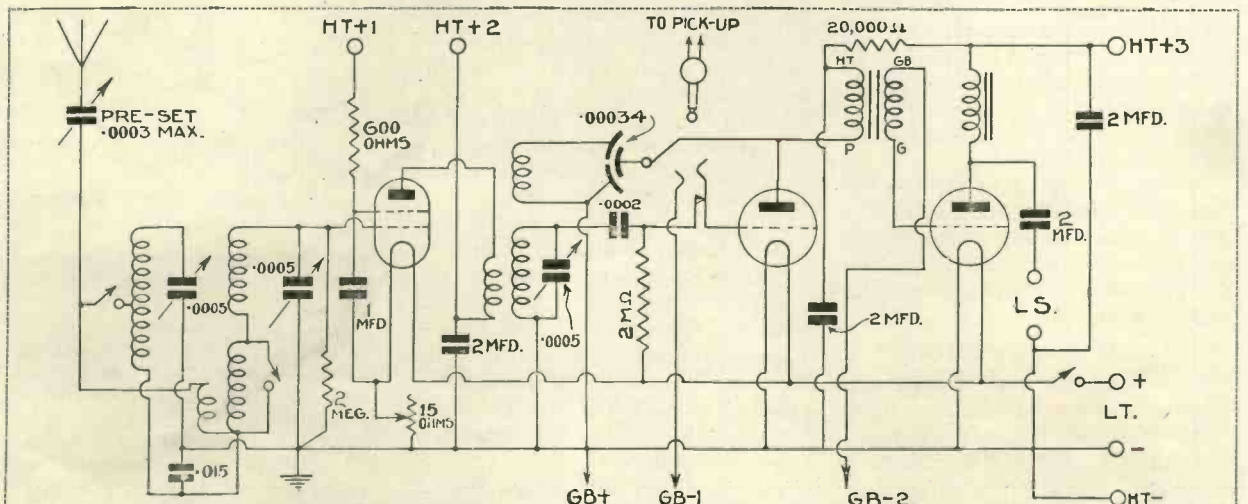

A COMPANION TO W. JAMES' REGIONAL BAND-PASS FOUR

This circuit comprises a screened-grid high-frequency stage, leaky-grid detector, and transformer-coupled power stage. Provision is made for switching a pick-up in circuit when desired

This set is a companion to the Regional Band-pass Four designed for WIRELESS MAGAZINE by W. James and described by him in October last. The three-valve adaptation, of which details are presented here, has been carried out by the WIRELESS MAGAZINE Technical Staff with Mr. James' approval

ordinary sharply-tuned circuit, because there is no loss of high-note strength. There is no question that band-pass filters give the most satisfactory compromise between selectivity and quality that can be obtained.

Loss of Strength

It is fairly well known that a band-pass circuit does not give as great a signal strength as an ordinary single tuned circuit, yet in practice a three-valve set with band-pass aerial tuning appears to give greater volume than a similar set with single-circuit aerial tuning.

For example, one would suppose that the Regional Three compared with the New Brookman's Three would prove to be more selective but to give less volume because of the loss

of strength in the band-pass filter.

Such does not seem to be the case in practice, however, and it is not easy to find a reasonable explanation.

Members of the WIRELESS MAGAZINE Technical Staff have discussed this point and are forced to the conclusion that the seemingly greater volume obtained from a band-pass circuit is due to the better reproduction of the top notes.

For a given amplitude high notes seem to be louder to the ear than are low notes. This point can be proved experimentally by the use of a loud-speaker tone control unit as described in the supplement presented with the April issue.

It will be found when this is in use that over-emphasis of the top notes has the effect of making the volume seem greater than it is when low notes

predominate in the reproduction.

No matter what the explanation may be, there is no question from the tests we have carried out that the Regional Three gives better results than either the original Brookman's Three or the New Brookman's Three. This means a great deal, as all the regular readers of WIRELESS MAGAZINE will appreciate

Number of Stations

We have published in these pages dozens of letters from readers recording the reception on any evening of forty, fifty, and even sixty stations at loud-speaker strength on one or other of these receivers.

The Regional Three costs more to build than the Brookman's Three because of the ganged condenser needed for tuning the two circuits

INDEPENDENT TEST REPORT

Power Consumption.—Using the valves specified below the total anode current of this set was found to be 10 milliamperes. With this consumption standard-capacity dry batteries can be used, but it is better policy to use the double-capacity type for economical working.

The anode-current measurements were taken with H.T.+1 at 60 volts, H.T.+2 at 90 volts, and H.T.+3 at 120 volts.

Filament consumption was .5 ampere. A 30-ampere hour accumulator would give approximately 60 hours' service per charge.

Valves Used.—Cossor valves were used throughout in this test. An SG215 was used in the high-frequency stage, a Detz10 for the detector, and a 220P in the output stage.

Operation.—In spite of the large number of knobs in the panel, I found the operation extremely simple. Any beginner will be able to master controls in a short time without any difficulty.

Reaction was quite smooth on the medium waves, but a certain amount of care was necessary on the long waves to ensure smoothness.

Sensitivity.—Tests made in South-east London on a 60-ft. outdoor aerial between 8.30 p.m. and 10.30 p.m. on

March 23 showed that the sensitivity of this set was above the average of three-valve battery-operated receivers. No less than thirty-five stations were received on the medium waves at good loud-speaker strength.

The great chaos which prevails in the European ether prevented a large number of the stations logged from having an entertainment value that would satisfy a musically-minded person.

Below are mentioned some of the principal stations that could be listened to without interference from heterodyning or morse.

Budapest came in at 85 degrees on the left-hand dial and 95 on the right at pleasing strength and quality; also Vienna at 76 and 86½, Brussels at 74 and 84, and Milan at 74 and 82½. Midland Regional and Langenberg were easily separated at 68 and 78, and 66½ and 76 respectively.

The new North Regional transmitter was received at a greater strength than the present Midland Regional station during its first experimental transmission.

Between Midland and London Regional there were six stations capable of giving satisfactory entertainment value. Langenberg at 66½ and 76, Rome at 60 and 70, and

Stockholm at 59 and 68, Berlin, Katowice and Glasgow were received at fair strength. Toulouse was a very powerful signal with dial readings at 49 and 57.

The new high-power station at Lvov, in Poland, came in at good strength at 47½ and 56 degrees. The local London Regional station was received at tremendous strength, which necessitated the free use of the volume control, at 43 and 50.

Other stations worth listening to included Strasbourg, Bordeaux, Hilversum, and Heilsberg.

On this particular occasion the London National station, received at 24 and 26 degrees, was not entirely free from heterodyne interference.

On the long waves ten stations were received during my test, but of these only six were received clear of all interference. Huizen was received well at 82 and 85, Radio Paris at 72 and 75, and Daventry National at 62 and 62. Motala, Kalundborg, and Oslo were received quite clear.

I have no doubt that builders of this receiver will, with longer time at their disposal, log far more stations than have been listed here.

Quality.—In every case where the station has been received free from inter-

ference the quality has been of the best.

Selectivity.—I found that this receiver is selective enough for all general purposes and is such that it can be used quite close to a regional transmitter without any swamping effects.

As mentioned before, the dial readings for London Regional were at 43 and 50. Keeping the two condensers in step I found that this station could be tuned out at 48 and 54 above and at 39 and 47 below the maximum point giving a spread of 9 and 7 degrees. London National had a maximum spread of 9 degrees over both dials.

It will be clearly seen that quite a small percentage of the dial is taken up by the combined spreads of the National and Regional stations.

Such high-power stations as Rome and Stockholm, Langenberg and Midland Regional were received clear of each other. On the long waves, Königswusterhausen could not be separated entirely from Daventry 5XX.

Summary.—This receiver is undoubtedly an ideal set, in view of its extreme sensitivity and selectivity, for those constructors who want a battery set with a very low current consumption and capable of giving exceptionally good quality.

THE REGIONAL THREE—Continued

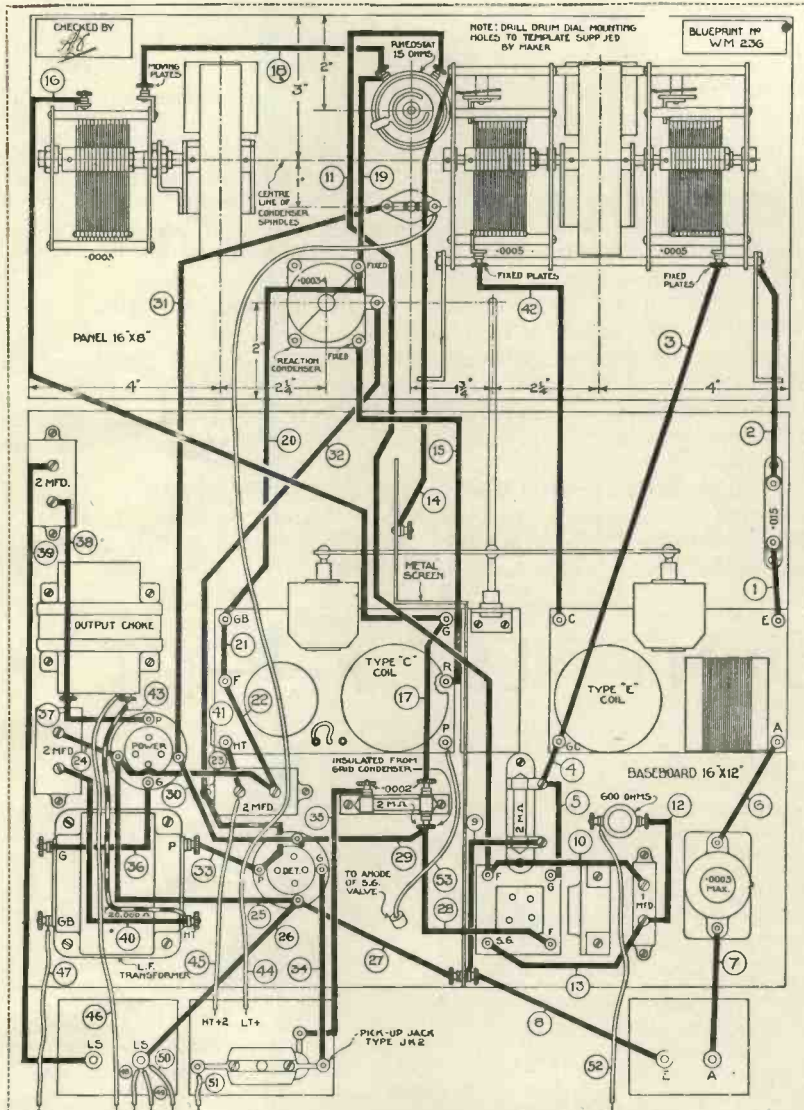

LAYOUT AND WIRING OF THE REGIONAL THREE

This wiring guide can be obtained as a full-size blueprint for half price, that is 6d., post free, if the coupon on the last page is used by May 30. Ask for No. WM236

that comprise the band-pass filter. The fact that the extra expense is justified will be apparent from the remarks that have already been made.

Special Test Report

Readers should also carefully note the remarks made in the independent test report on the Regional Three that appears at the bottom of page 389.

It is not too much to say that the Regional Three is the best "straight" set of its type of which details have been published in these pages. We can recommend it with every confidence and with the assurance that

it will enable the user to pick up a really good number of foreign stations at a quality that can be termed real entertainment value.

Not only can the Regional Three be relied on to give thirty or forty good foreign programmes, but it can also be used for the electrical reproduction of gramophone records without any alteration to the circuit. A pick-up can be put into use by inserting a plug into a jack mounted at the back of the baseboard.

The circuit employed is identical with that of the Regional Band-pass Four, except for the omission of the

resistance-capacity-coupled low-frequency stage. It will be seen that a semi-variable condenser of .0003-microfarad capacity is provided in the aerial lead in the usual way.

Band-Pass Arrangement

The aerial-tuning arrangement consists of two coils, each tuned by one half of a two-gang .0005-microfarad condenser, coupled to give a band-pass action by a .015-microfarad fixed condenser. These coils are contained in a single Binowave coil known as type E.

The band-pass action is obtained only on the medium waves, where it is most needed, and ordinary tuning is utilised for long-wave reception.

A serious problem during the reception of local high-power stations is to avoid overloading the detector valve of a set, for if overloading should occur the quality will be poor.

Simple Volume Control

There is no cure, except to cut down the magnification of the screened-grid stage, and this is done most satisfactorily by means of a rheostat in the filament circuit; this reduces the magnification and at the same time introduces no distortion on its own account, such as is the case with some types of volume control.

We have not thought it necessary to incorporate a low-frequency volume control because the strength of radio reception can be adjusted within close limits by means of the screened-grid rheostat. It is intended that an external potentiometer should be used across the pick-up if it is necessary to reduce the volume during record reproduction.

The coupling between the screened-grid high-frequency valve and the detector is made by means of a type C Binowave coil, as used in the well-known Brookman's series of receivers.

Reaction Circuit

In this case a differential reaction condenser has been employed so that a constant by-passing effect for high-frequency currents is obtained. This helps to stabilise the set and ensures smooth control of reaction.

It is not too much to say that a set of this type is largely made or marred by the type of power valve used. The volume that can be

A Band-pass Set That Is Even Better Than the Famous Brookman's Three—Build It and See!

ADAPTABLE LAY-OUT

It will be seen from the photograph on the right that the low-frequency choke and low-frequency transformer used in the Regional Three are on the large side and therefore there is no difficulty about substituting alternative parts in these positions. The pick-up jack is mounted at the back of the baseboard instead of on the panel in order to keep the detector-valve grid wire as short as possible. The aluminium or copper screen should be so arranged that it forms an extension to the screen-grid inside the high-frequency valve, which is mounted in a horizontal position on the baseboard.

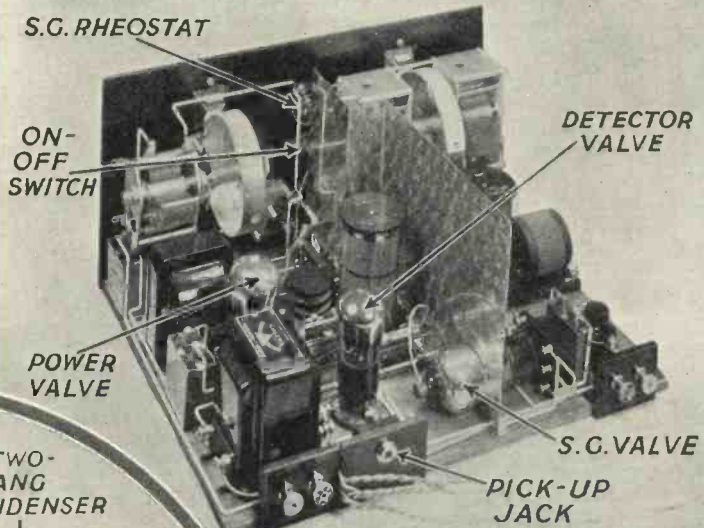

NO CRAMPING OF PARTS

From the plan photographic view on the left it will be seen that there is no cramping of the components or wiring in the Regional Three. If desired, two separate .0005-microfarad variable condensers can be used for tuning the band-pass circuit in place of the two-gang instrument incorporated in the original model. The wave-change switches on both of the Binowave coils are actuated by a single panel control fixed to a special coupling bar. It should be noted that the reaction condenser is of the differential type.

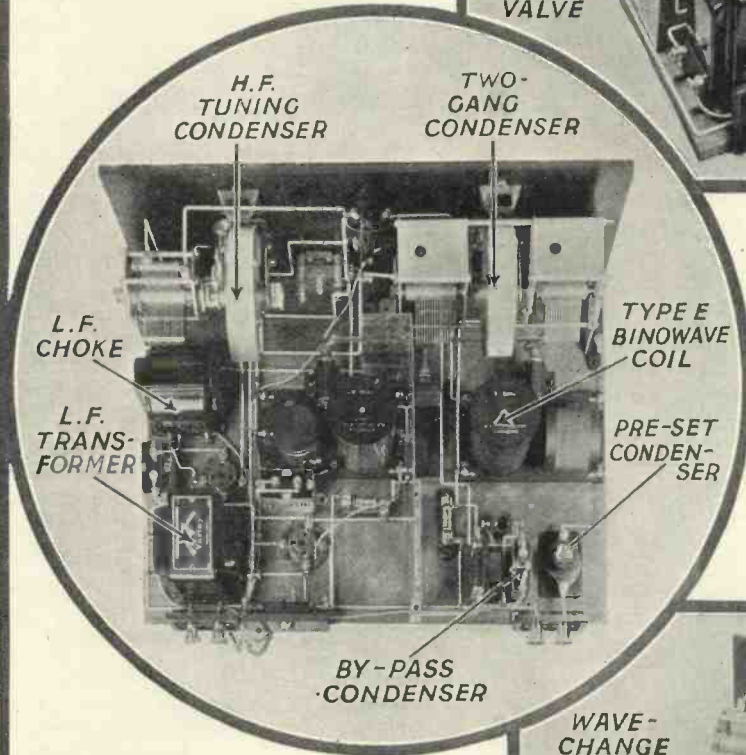

BATTERY CONNECTIONS

It is a good plan to use a shrouded connector at the end of the lead that goes to the anode of the screen-grid valve; then it will be impossible for a short-circuit to occur if this wire should accidentally touch the screen. Four terminals only are provided (for the aerial, and earth and the loud-speaker), all the battery connections being made by means of flexible leads cut to the required lengths by the constructor when the set is first assembled. If desired, of course, a terminal strip could be placed along the whole length of the back edge of the baseboard to accommodate the necessary terminals.

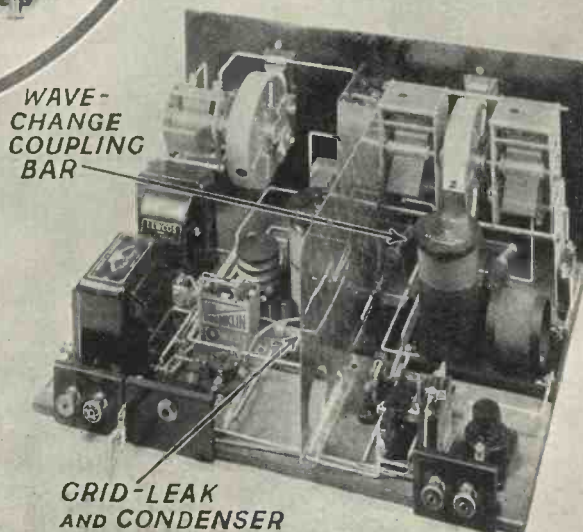

THE REGIONAL THREE—Continued

COMPONENTS FOR THE REGIONAL THREE

CHOKE, LOW-FREQUENCY

- 1—Lewcos, type 34, 17s. 6d. (or Varley, Lissen).

COILS

- 1—Pair of Wearite Binowave coils, types C and E, with ganging device, £1 17s.

CONDENSERS, FIXED

- 1—Telsen .0002-microfarad, 1s. (or Watmel, Lissen).
- 1—T.C.C. .015-microfarad, upright type, 3s. 3d.
- 1—Franklin 1-microfarad, 2s. (or Ferranti, Hydra).
- 2—Franklin 2-microfarad, 5s. 4d. (or Ferranti, Hydra).

CONDENSERS, VARIABLE

- 1—Polar two-gang .0005-microfarad, with drum drive, £1 6s. 6d.
- 1—Polar .0005-microfarad Universal type, with drum drive, 16s.
- 1—Lotus .00034-microfarad differential, 8s. 6d.
- 1—Lewcodenser, .0003-microfarad maximum, type W, 2s. 6d. (or Formo, R.I.).

EBONITE

- 1—Red Triangle 16 in. by 8 in. panel, 8s. (or Becol, Trelleborg).
- 2—Junit terminal blocks, 1s. 4d. (or Belling-Lee).
- 1—Block, 2 in. by 3 in.

HOLDER, GRID-LEAK

- 1—Bulgin, type G6, 9d. (or Dubilier, Magnum).

HOLDERS, VALVE

- 2—Telsen, 2s. (or Benjamin, W.B.).
- 1—Junit Universal, 1s. 9d. (or W.B.).

PLUGS AND TERMINALS

- 4—Ealex terminals, marked: Aerial, Earth, L.S.—, L.S.—, 1s. 6d. (or Belling-Lee, Clix).
- 7—Clix wander plugs, marked: H.T.+3, H.T.+2, H.T.+1, H.T.—, G.B.+ , G.B.—1, G.B.—2, 1s. 2d. (or Belling-Lee, Ealex).
- 2—Clix spade terminals, marked: L.S.—, L.S.—, 4d. (or Belling-Lee, Ealex).

RESISTANCES, FIXED

- 1—Magnum 600-ohm, 1s. 6d. (or Wearite, Bulgin).
- 1—Magnum 25,000-ohm flexible, 1s. 6d. (or Lewcos, Bulgin).
- 2—Telsen 2-megohm grid leak, 2s. (or Dubilier, Watmel).

RESISTANCE, VARIABLE

- 1—Wearite 15-ohm rheostat, 1s. 6d. (or Lissen, Gecophone).

SCREEN

- 1—Parex to specification, 4s. 6d. (or Peto-Scott, Ready Radio).

SUNDRIES

- Glazite insulated wire for connecting.
- 1—Lotus jack, type JK/2, 2s. 3d.
- 1—Lotus plug, type JP/1, 2s.

SWITCH

- 1—W.B. two-point, push-pull type, 1s. (or Bulgin).

TRANSFORMER, LOW-FREQUENCY

- 1—Varley, type DP3, £1 3s. 6d. (or Ferranti, Igranic).

ACCESSORIES

BATTERIES

- 1—Full O'Power 120-volt, type H3, 16s. 6d. (or Ever Ready, Drydex).
- 1—Full O'Power 9-volt grid-bias, type G2, 1s. 6d. (or Ever Ready, Drydex).
- 1—Exide 2-volt accumulator, type C2G4, 13s. 6d. (or C.A.V., Lissen).

CABINET

- 1—Pickett table model in oak, £1.

VALVES

- 1—Cossor 215SG, £1 (or Mazda 215SG, Osram S215).
- 1—Cossor 210 Det., 8s. 6d. (or Mazda HL210, Osram HL2/c).
- 1—Cossor 220P, 10s. 6d. (or Mazda P220, Osram LP2/c).

Ask for No. WM236 and address your inquiry to Blueprint Department, WIRELESS MAGAZINE, 58-61 Fetter Lane, E.C.4.

No doubt a number of constructors will want to know whether the pick-up jack can be moved from the back of the baseboard on to the ebonite panel. This course is not recommended because it would necessitate a very long grid wire between the detector valve holder and the jack terminals; very often, long connections of this type introduce low-frequency oscillation and howling.

Positions of Controls

The arrangement of the controls on the panel is neat and quite straightforward. The two large drum dials are for aerial tuning (left) and anode tuning (right) respectively. The two knobs in line horizontally at the bottom of the panel are the wave-change switch (left) and the reaction control (right). At the top of the panel the two knobs in line vertically are the screen-grid valve rheostat (top) and the filament on-off switch (centre).

Actually the wave-change switch has three positions. When turned as far as possible to the left, the set is adjusted for medium-wave reception. In the mid position, the tuning circuits are completely broken, but the set is not switched off, as is the case when a type A Binowave coil is used for aerial tuning. With the switch in its right-hand position, long-wave reception can be carried out.

Adjusting Condensers

When the set is first put in operation it will be necessary to adjust the tuning condensers that form part of the two-gang instrument. The adjustments for the trimming condensers are two small pieces of ebonite, similar in appearance to screw heads made of ebonite, seen at the top of the aluminium shielding plates.

A station should be tuned in in the ordinary way and these trimming condensers adjusted until the best signal strength is obtained.

It should be noted that each time the pre-set condenser in series with the aerial is altered in capacity, so must a readjustment be made to the trimming condensers on the two-gang instrument to keep the two band-pass circuits in step.

obtained depends ultimately on the power-handling capabilities of the last valve.

If this is of a type with only a small grid swing it will give only very small volume without the introduction of distortion. A large power valve taking a high anode voltage and a comparatively heavy anode current is essential if a large undistorted output of power is to be obtained.

Choke-filter Output

For this reason a choke-filter output circuit has been incorporated in the set, the purpose of this is primarily to protect the loud-speaker from the heavy current that will have to flow through its windings.

These remarks cover the chief features of the circuit of the Regional Three and we can now turn our attention to the practical side of construction.

Essential Details

There is no need to go into a great deal of detail about this, for all the salient points will be clear from the photographs and diagrams reproduced in these pages. All the essential details are reproduced, but those

who desire it (and their number seems to be for ever on the increase!) can obtain a full-size blueprint for half price, that is 6d., post free, if the

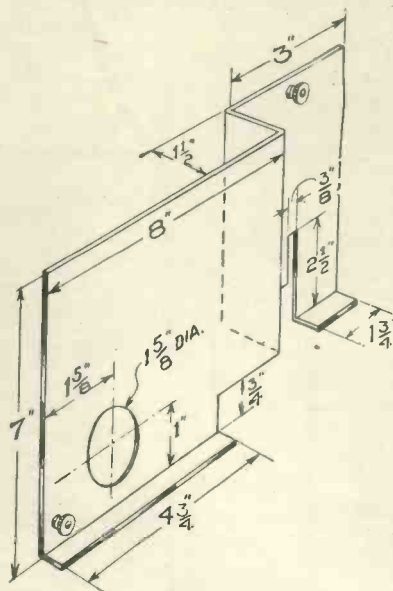

SCREEN FOR STABILITY

Dimensions of the simple aluminium or copper screen needed for the Regional Three

coupon on page 448 is used by May 30.

SANTOS CASANI, the Famous Teacher of Dancing, Discusses

"HOW many people are really keen on dancing?" a beginner asked me the other day. I think I astounded him when I said that I can definitely prove a million people dance every night, in this country alone!

Cinemas are popular; you have only to look at the huge queues which line up outside the new "super" cinemas. But the number of cinemas is limited, and that is why a million people dance nightly. Every little hall and even council public baths are used for dancing, and no elaborate paraphernalia is wanted.

A million people! The most prolific source of modern music is dance music. Dancing has created a new industry of its own and is doing much to help unemployment, because each new industry is a help.

And yet the most convenient method of entertainment and education, the wireless, almost entirely overlooks dancing.

A Great Chance for the B.B.C.

You will tell me that the B.B.C. has Jack Payne's band and that practically every evening's programme concludes with syncopation. Off-hand you will say that the B.B.C. is a fairly enthusiastic supporter of dancing.

My new idea is that the B.B.C. should not concern itself so much with giving dance music, which can very well be obtained from our own orchestras, or even the gramophone: *the B.B.C. should teach people how to dance.*

Mind you, I'm not grouching. I myself have broadcast about twenty times and I have had letters from listeners so far away as Palestine! What is more important, I have been able to teach dance devotees, over the microphone, all the new steps. I have given radio lessons in the Yale Blues, the Charleston, the tango, the new waltz, and many others.

I think the idea so good that the lessons should be given regularly. In many average man-in-the-street circles the present dancing is so poor that what the B.B.C. ought to do is, literally, to teach listeners how to dance to the broadcast dance music.

Here's an instance. The six-eight came along and almost immediately there were broadcast some of the latest six-eight tunes; but the listening public didn't realise and the thing developed into a kind of military march.

Proper Lessons for Enjoyment

The only folk who really could enjoy this pleasing new step were those who had taken the trouble to have proper lessons; but I quite realise that this isn't possible for all dancers and it is a thing which could be done by the B.B.C.

A great thing would be that these radio dance lessons would be in your own home. There is nothing like a little privacy at first to give a dancer confidence, particularly in learning a new dance. With the loud-speaker going in your own home you could enjoy free private lessons of a type which, in the ordinary way,

IMPROVING YOUR DANCING BY RADIO

would command high fees from a reputable tutor.

I wonder that the B.B.C. afternoon broadcasts to schools do not embrace dancing as a subject. This may sound odd to teachers who still believe that the "three R's" embrace all that a child should learn; but the B.B.C. gives broadcast education in the foundations of music, in French, and in other similar modern matters, so why not include dancing?

Don't forget that dancing doesn't only mean shuffling round a crowded ballroom. That is dancing as it is done by those who don't know. Real dancing embraces quite a considerable amount of physical exercise and the acquisition of a sense of balance and natural rhythm.

All these things one likes to see in a child and are an asset in life as great as the ability to speak properly. So, I repeat, why not more radio dance lessons?

I feel sure that if the B.B.C. Programme Board received a few requests from people who want to improve their dancing in this way it would be found possible to squeeze say, quarter-of-an-hour lessons into the daily radio fare. It is difficult to say which would be the best time of day to give broadcast radio dancing lessons for adults.

Most Valuable Broadcast Period

The most valuable period is the evening session just after dinner, say at about half-past eight; but it would be asking too much that this most valuable listening time should regularly be given to dancing. A "star" lesson might be given once a week at this time.

Of course, it isn't easy to find a good tutor who will broadcast, or who can broadcast well, but, joking part, I do think that a dance tutor who can speak well will find the "mike" easier to address than a nervous beginner. Clear, explicit step instructions can be given in a quiet room to the listening microphone, but in personal teaching one has to consider nervousness and many other personal things, all of which take up time.

People like Sir Walford Davies, who has done so much broadcasting, think that broadcasting is a good medium for teaching people about music. His quiet radio talks must be a great help to those who want to learn about music.

There are a million people who, nightly, would want to listen to interesting dance instruction before the late period of broadcast dance music. I feel sure that something will be done before long. This chance is too good to be missed.



FOREIGN RECEPTION MADE EASY

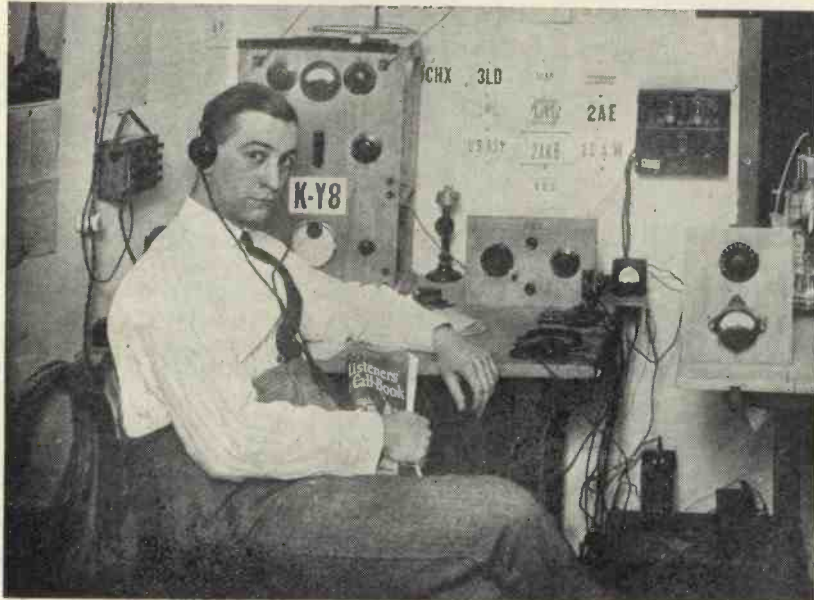

WILL THIS SORT OF GEAR BE OBSOLETE IN THE FUTURE?

Elaborate apparatus would no longer be needed for long-distance reception if Manfred von Ardenne's new scheme were taken up generally

ALTHOUGH listeners in towns easily outnumber those living in the country, they are by far the more heavily handicapped of the two when it comes to receiving Continental or other distant programmes.

In the first place, when the B.B.C. were organising the present broadcast service, they very naturally selected sites for the local transmitter not too far distant from the centres of dense population, so as to supply programmes at maximum strength to the greatest possible number of listeners.

So far so good. This certainly ensures favourable conditions so far as the local programme is concerned.

Getting Variety

But once within the shadow of the local transmitter it is very difficult to get away from it when one desires a little variety. By the time the waves from a distant station come near home, they are so attenuated that it requires a receiver with at least two stages of screened-grid high-frequency amplification to select and separate them from the local B.B.C. transmitter.

Then there is a second and, in some cases, an even more trouble-

some problem to be faced by town-dwellers. Electric trains and tramways are responsible for radiating a mass of "artificial" disturbance which simply refuses to be kept out of the set. The use of tuned high-frequency stages will often solve the problem of separating one programme from another, but they are of little use in cutting out "man-made" static.

Interference under this heading is, in fact, steadily growing with the increasing use of all kinds of electrically-driven apparatus. The motors used in vacuum cleaners and similar labour-saving devices, the elaborate switches used in flashlight advertisements, and installations for sunlight-ray treatment are only part of the sum total of offenders against the peace and quietness of the ether in and around the larger towns.

The country listener, on the other hand, is fortunately subject to little persistent interference of this kind.

On the whole, the position of the urban listener calls for special treatment if he is to enjoy a fair share of the numerous programmes now being fed into the ether from all quarters.

and would cut out electrical interference experienced by many town-dwellers.

This scheme merits attention for it is projected by a well-known German radio worker, Manfred von Ardenne, who developed the multiple valve.

Special schemes to assist the town-dweller have already been put forward from time to time. It is, for instance, obvious that, since the elimination of artificial interference is essentially a job for the skilled radio engineer, a central receiving set, fitted with every modern improvement and maintained by a skilled operator,

A revolutionary system of distant-station reception is described in this article. It would solve the selectivity problem of many listeners

could with advantage be used to relay "interference free" programmes to a circle of local subscribers.

This is the basis of the so-called "community" broadcast which has recently been installed in certain towns.

Another remedy that has been suggested is the use of wired wireless for distributing a number of different programmes simultaneously over supply wires. This has some features in common with the first-mentioned scheme, except that the programmes can be fed into the distributing wires directly from the studio, instead of being picked up from the ether.

Utility in Cities

It is, of course, particularly suitable for use in cities which are already provided with a widespread network of distributing lines.

Existing telephone wires, or electric power or light mains can all be utilised for supplying wired-wireless programmes without interfering in any way with their primary purpose.

Since wired wireless involves the use of a high-frequency carrier wave, it is possible to superpose several programmes simultaneously on the same line, and to insert simple filter circuits at the receiving end in order to separate out any particular programme desired.

It will be noticed that in each of these schemes it is necessary for the listener to be connected by line wire with a central distributing station. This is a distinct drawback, since it means extra expense and inconvenience in laying down the feed wires.

Ingenious Scheme

In order to overcome this difficulty Manfred von Ardenne, a well-known German radio engineer, has recently put forward a highly ingenious scheme whereby a selected number of foreign programmes can be re-radiated locally and so brought within easy reach of city listeners, in spite of the peculiar disadvantages to which such listeners are subject.

His scheme, broadly speaking, is to erect a special receiving or relay station located a few miles away from the actual area to be served, so as to lie outside the reach of any local or "man-made" static. This station is fitted with a number of highly-selective high-frequency amplifiers, say four or five—or even more—according to the number of foreign programmes to be handled.

It will also, of course, be fitted

with anti-fading devices, and with every other modern improvement designed to ensure freedom from interference of any kind. The important point is that the received signals are not rectified here. Each amplifier simply selects and amplifies the high-frequency carrier wave and associated side bands of one particular foreign station.

In other words, the main object is to "boost" or increase the field strength of each distant station until

can select the particular programme he fancies and reject the others. Accordingly, the mixture of high-frequency currents is superposed on a new and ultra-short carrier wave, say of the order of 10 or 15 metres, and then re-radiated from the central aerial.

For reception the only additional equipment required is a short-wave aerial followed by a rectifier. The output from this rectifier contains all the different carrier waves spaced

WHAT HUNDREDS OF LISTENERS ARE WAITING FOR!

As soon as details of the original Super 60 were published in the March issue of WIRELESS MAGAZINE we were inundated with requests for a description and blueprint of an A.C. version using indirectly-heated mains valves. Literally hundreds of readers have asked for such a set. Now W. James has almost completed his work on this design and full details will be available in the June issue, to be published on Friday, May 22.

it is brought to a level where it can compete on an equal footing, so far as reception is concerned, with the radiation from the local transmitter.

From the relay station the various high-frequency currents are fed into a single line, by which they are conveyed simultaneously to a small transmitting aerial T, located in the centre of the town, as shown on the diagram below.

Here it is necessary to re-radiate them in such a form that each listener

out according to their particular frequency, just as they would be if received direct.

It follows that any standard type of broadcast receiver can then be applied, after the short-wave rectifier, to separate one programme from the other, by simple tuning in the ordinary way.

The selected carrier wave must, of course, pass through a second detector—that of the broadcast receiver—in order to separate out the audible signals. In fact, apart from the use of a short-wave aerial and a preliminary detector, the process of reception is perfectly normal.

Inexpensive Receivers

The advantage of the system is that each foreign programme is strengthened locally to such a degree that after it has passed through a short-wave rectifier it can be applied directly to a comparatively inexpensive broadcast receiver. This will then give results superior to that normally obtained from an ultra-selective set having at least two stages of high-frequency amplification.

In addition, each programme is relayed locally under the most favourable conditions, that is, with a high proportion of signal strength to static or other interference.

Finally, no connecting wires are necessary except the single pair of feed lines laid down between the outer relay station and the central short-wave re-radiating aerial in the centre of the town.

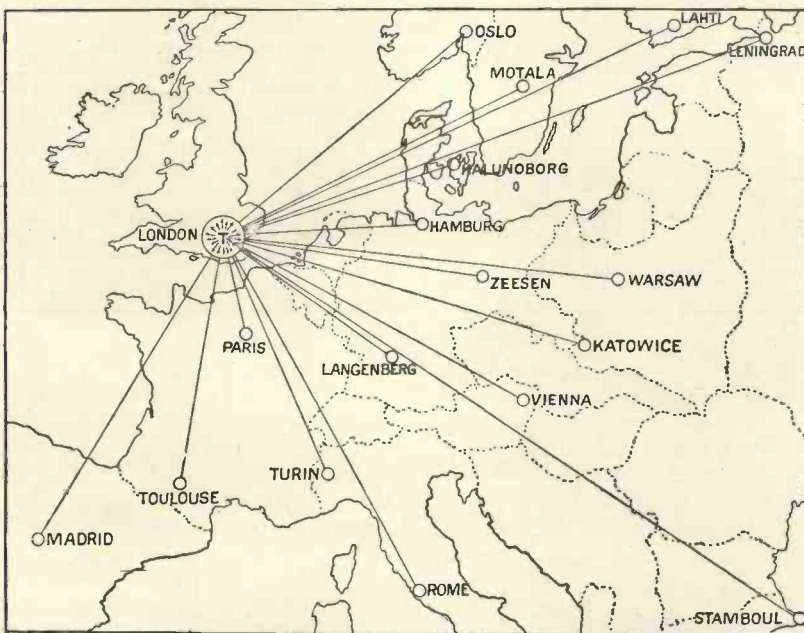

HOW LONDON LISTENERS COULD GET FOREIGN STATIONS

This map shows how long-distance transmissions could be picked up in London and re-radiated on short waves for the benefit of local listeners

WHAT THE *Daily Express* SAID ABOUT THE SUPER 60—

TUESDAY

THE DAILY EXPRESS

MARCH 10, 1931

Wireless Notes

NEW 'SUPER-HET' BUILT FOR £12 65 STATIONS ON FRAME AERIAL

The Continental movement in favour of high-powered stations has made good reception on adjacent wavelengths increasingly difficult so far as a good many sets in popular use to-day are concerned.

Radio engineers have been seeking a remedy, but some of the obstacles in the way have been found extremely difficult to overcome. Muhlacker is a case in point. This new German station transmits on a wavelength of 360 metres, with a power of 75 kilowatts, and plays havoc with London Regional on 356 metres.

This is only one of numerous instances of clashing wavelengths. Moradvska-Ostrava comes through on 263 metres, or two metres above London National. Graz, on 352 metres, is only four metres below London Regional, and causes as much trouble as Muhlacker, though its power is much lower.

These difficulties have had the effect of bringing the super-heterodyne back into favour. The new super-het, however, is not the somewhat bulky, costly, and complicated instrument of earlier wireless days.

Compactness

It is a receiver whose six valves and all the other component parts are contained within a cabinet measuring 12 in. by 8 in., with a baseboard only 10 in. deep. It will bring in sixty-five stations, and, most astonishing feature of all, it can be built for £12.

This really amazing new receiver, the design of Mr. W. James, is described in complete detail in the March number of the "Wireless Magazine." A full list of all the components is given, with layout and wiring plan. It can be put together ready for use in three hours.

The "Super 60," as Mr. James calls this new set, employs six valves—oscillator, first detector (anode-bend), two stages of screened-grid intermediate amplification, second detector (leaky grid) and power valve.

If the set is revolutionary in design, it is no less so in selectivity and power. At four miles from Brookman's Park the London stations have a spread of only one degree on the tuning dial.

Graz, four metres below London Regional, and Muhlacker, four metres above, are brought in at full strength, while London Regional is working, without a shadow of interference, nor is there a trace of background from either of those foreign stations when London Regional is tuned in. No test of selectivity could be more searching.

One of the drawbacks of the old type of super-het, apart from its complicated circuit and its size, was its high running cost. The "Super 60," on the other hand, takes no more current than the average three- or four-valve set.

Many home constructors have fought shy of attempting anything in the nature of a super-het by reason of the many difficulties

involved in putting it together. All these troubles have been eliminated in Mr. James' receiver. Construction is simplicity itself.

Another advantage, apart from its immense range and powerful reception, is that it requires no external aerial or earth. The frame aerial from which it works stands only eighteen inches high and measures twelve inches across. Placed on top of the cabinet, it is neither ugly nor obtrusive.

Effective Circuit

All the components for this set can be purchased from any wireless dealer for £12 inclusive of cabinet and frame aerial.

Under actual test during two evenings the "Super 60" brought in fifty-six stations on the medium waves and nine on the longwaveband, and even this wonderful record does not exhaust its possibilities.

Two special advantages of this circuit are the great magnification to be obtained on the long wavelength with complete stability, and the fact that the long wavelength amplifier has fixed tuning and band-pass characteristics.

It seems almost incredible that a super-het of such uncanny selectivity and sensitivity can be constructed for so small a sum, but the specification of parts shows that it can be done without difficulty.

Mr. James is to be congratulated on an extremely noteworthy achievement.

ABOVE we reproduce an article on the Super 60 that appeared in the *Daily Express* on Tuesday, March 10. It created considerable interest among listeners everywhere and this reprint will serve as an introduction to new WIRELESS MAGAZINE readers who have not yet seen anything about the receiver.

There is no question that the Super 60, which was specially designed by W. James, is the best set of which details have ever been presented to the home-constructor.

Full details of the Super 60 were given in the March WIRELESS MAGAZINE and in the April issue further practical points were discussed. A limited number of copies of these two issues is available, at 1s. 3d. each, post free, from the Publisher, WIRELESS MAGAZINE, 58-61 Fetter Lane, E.C.4.

So great has been the interest in the set, however, that only a few dozen copies of the March issue are available. For this reason full constructional details of the set are

reprinted in this present issue.

Literally dozens of enthusiastic readers have sent us reports on the performances of their Super 60's and we are glad to be able to publish a selection in the following pages. Further reports will be welcomed.

On other pages of this issue will be found details of a portable edition of the Super 60 and details of short-wave reception with the original model. Remember that full details of an A.C. version will be published next month.

—AND WHAT “W.M.” READERS ARE DOING WITH IT

NEARLY seventy stations in three days is the record of a Gosport constructor:—

The Super 60 is easily the best set ever designed. A station comes in at every degree of the dial and it is easy to get a 1-kilowatt station which comes in as clear and distinct as the local.

I find a Triotron super detector makes the best oscillator valve. The best valve for the second detector is the Mullard PM2A and for output, the Mazda P240 (super-power valve).

I have logged approximately seventy stations since last Thursday. I hope you will publish reports and get this set the publicity it deserves. I am persuading all my friends to build one or have one built.

“SHOULD have been called the ‘Super-charged 60’,” says an Edinburgh reader:

I have just constructed the Super 60 and would like to say how delighted I am with the results obtained with it. The sixty stations claimed for it come tumbling in with remarkable volume, clarity, and with a most silent background.

The set should have been called the “Super-charged 60,” so well does it accomplish all that is claimed for it.

I am not by any stretch of imagination a wireless expert and the ease with which the set can be constructed and the results obtained greatly surprised and appealed to me.

I can therefore, with confidence, assure those who may be hesitating regarding the above points not to hesitate any longer, but to “go to it” and be as pleased as I am with the set.

“RESULTS are beyond my expectations,” says a reader living at West Kensington:

Apropos your request for reports on the Super 60, I have made the set up with the components suggested, which include a Peto-Scott frame, and the results are beyond my expectations.

I have obtained practically all the stations summarised on page 140 of the March WIRELESS MAGAZINE. The quality and volume are as near perfect as is mechanically possible.

“SIXTY stations” is the estimate of a reader at Nonington (near Dover), who has built up the Super 60:

Having made up two days ago this Super 60, may I take this opportunity of congratulating Mr. James and Wright and Weaire, Ltd. on a marvellous set? I have had experience before in superhets, having owned two commercial models.

The Super 60 is in, of course, quite a different class. Lately I had the Brookman’s Four, a very good set indeed, but the Super 60 is infinitely superior.

I can get Graz, the Regional and Mühlacker entirely free from inter-

ference; also the National and Leipzig. I should imagine sixty stations is a conservative estimate for the set’s powers from what I have heard of it so far.

I trust Mr. James will soon tell us how to get the ultra-short waves on this set, as it ought to be very interesting on that band.

I have made up this set as you say, except that I use Remler condensers and a Ferranti AF5 transformer; the quality is excellent, I think the best I have heard, and the current consumption extraordinarily low—11 milliamperes on my Compton meter.

I am using standard-capacity H.T. batteries (150 volts on power valve), and the new large Blue Spot loud-speaker.

Wishing you all success and again thanking Mr. James and Wright and Weaire, Ltd., for a very efficient set.

The same reader a few days later sent us the following letter:

Further to my letter of about a week ago about the Super 60, I have now

logged forty-five stations on the medium wavelength and nine on the long.

I have also been experimenting on the ultra-short waves and have made a frame similar to your dual-range one, but only 13 in. high.

I find by using only two turns of No. 9/40 wire I can get quite a lot of stations—W2XHF at 33 on the oscillator and 22 frame (I use Remler condensers); Chelmsford at 15½ and 10; another American at 15 and 9½; and Rome at 13½ and 8½—all very loud.

I have no doubt that my frame is not at all right for these wavelengths and am anxious to hear what one really ought to use.

I find tuning on these waves very critical and hand-capacity rather a nuisance, but expect this will be explained in your next issue.

I am, of course, extremely pleased with the set and have never heard anything to equal it on medium and long waves.

“TAKES the whole biscuit factory,” is the verdict of a Peckham constructor of the Super 60:

I am very pleased to inform you of the really exceptional results I have had with the Super 60. I have logged all the stations on the medium and long waves, as in the test report, but what has impressed me more than anything else with the set is the results obtainable on the ultra-short waves.

I can get at least four American stations with certainty any evening at real loud-speaker strength from 10.30 p.m. onwards, besides numerous European short-wave stations—and this is with volume control well down.

I wound two turns on a frame 22 in. square and centre-tapped it, but found it was not so critical. I am running this set from the A.C. mains (H.T. and L.T.) through a smoothing unit and it is impossible to tell whether it is running from mains or batteries.

I am not easily impressed with a set, being a bit hard boiled, having been a reader since No. 1, but the Super 60 takes the whole biscuit factory.

“A WONDERFUL set,” says an Erith reader regarding the Super 60:

I have just built your James Super 60, and it is all you claim for it, and more. It is a wonderful set and if anyone had told me a week ago that it was possible to get such results without using a Stenode I would have been sceptical.

The stations come in with remarkable ease and strength, all at full loud-speaker volume. The set is remarkably easy to tune. The most powerful regional stations are separated by half a degree on my 100-degree dial.

I dismantled the James Quality Five to build the Super 60 and the results have justified this. Previously the James Quality Five was easily the best set I had handled.

WHEREVER YOU USE IT

the Super 60 can be relied on to give excellent results—better results than you have ever had with any other set.

Equally good results are being recorded all over the country. We are publishing here a selection of reports from enthusiastic readers and these, together with those printed last month, prove conclusively that the Super 60 can be relied upon to give good results anywhere in the country.

Following is a list of the districts from which the published reports come:—

Alexandria (Dumbartonshire)
Aston (Birmingham)
Birmingham
Bletchley
Bushey
Edinburgh
Erith
Glasgow
Gosport
Kilburn
Lowestoft
Manchester
Nonington (near Dover)
Palmer’s Green
Peacehaven
Peckham
Prestatyn
Stourbridge
Welling (Kent)
West Kensington
Whitchurch

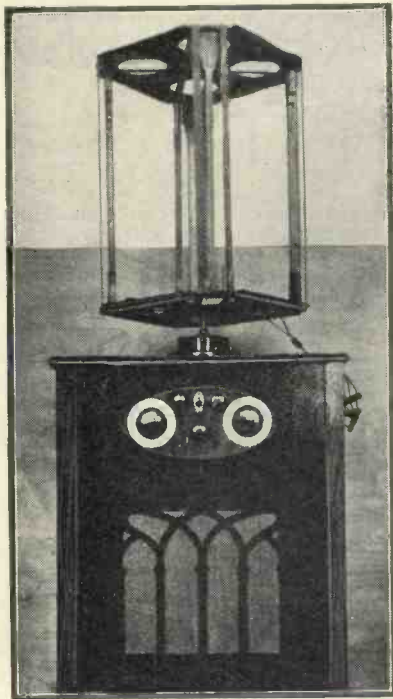

A PEACEHAVEN VERSION

Here is a Peacehaven reader's version of the Super 60. The results are perfect, he says

RESULTS are perfect in every way," says a Peacehaven reader:

I am not quite sure if I really dare send you photographs and my report on the Super 60, although Mr. W. James did say "the set is so straightforward that I do not mind your departing a little from the layout."

Well, I have taken him at his word, and have departed slightly from his layout, although fundamentally the set is the same, excepting that I have incorporated the following additions: push-pull output using two Mazda PX650 valves, with 200 volts on the plates, and a variable resistance in the anode circuit of the oscillator valve.

Almost the whole of the wiring of the set is under the baseboard, and two Ferranti transformers have been used. The whole is placed in a cabinet with a Blue Spot unit (66R) and chassis.

I can only say that from the results I have obtained from this set that all the other sets I have built now appear to have been a gross waste of time and money. The results are perfect in every way—tone, ease of control, and remarkable selectivity being only a few of its wonders.

FROM Edinburgh comes another enthusiastic report on the Super 60:—

You ask readers of WIRELESS MAGAZINE to send in their experiences and opinions of the Super 60 set. May I congratulate you on publishing such a wonderful set for amateur constructors. Mr. James certainly makes one doff one's hat to him.

Stations? Honestly, one has to be able to spend a considerable amount of time at the set to actually count the number of stations. I have given up counting the really loud stations that it

SUPER 60 REPORTS—Cont.

brings in—and with such ease of control.

All components and valves used in my set are exact to specification except the frame aerial (which is home made).

May I add I have been able to get over a dozen (no exaggeration) fellow amateurs to order coils, etc., for themselves. One is really astonished at the set's selectivity and volume with purity. Wishing you always the very best.

STATIONS roll in at Bletchley, according to a report from a keen constructor there:

The accompanying photos will show you that I have constructed the Super 60, and the results are certainly all you claim and more, inasmuch as by connecting a small aerial wire, indoor, to a loop coil, I can get dozens of short-wave stations. There is no sign of instability at all.

You will see that I have converted the Super 60 to all-mains working. On the medium waves, stations roll in; nine on the long waves. Daventry is in and out in one degree.

I have built dozens of sets, but I must congratulate Mr. James for designing the best ever. It is ideal for regional conditions and the quality on a moving-coil loud-speaker is excellent.

AT Manchester the set also gives excellent results, as is proved by the following letter:

I built the Super 60 up in just over three hours, and am pleased to say that I have never handled a set like it. I have logged all the stations mentioned in your lists with the exception of Hilversum, which happens to be my pet station.

Just to see what it was like on short waves, I wound a four- and nine-turn coil with centre tap, and tried it out. I pulled in seven stations, as follows:—W8XK, W3XAL, W2XAF, W2XAD, KDKA; also an Italian station whose call sign I could not make out.

I am going to build this set up using A.C. valves, and if the results are to be compared with the battery set, it will be SOME SET.

FROM Whitchurch (Salop) comes a good report of the Super 60:

Mr. W. James has indeed kept his New Year resolution. The Super 60 does all and more than all you claim. Living in what is known as the Hundred of Maelor, Manchester is our local station, and one had become quite accustomed to a background of Hamburg and Radio Toulouse, London Regional obliterated by Mühlacker, and 5GB infected with Prague and Langenberg.

Reception of a B.B.C. programme was confined to 5XX if any real enjoyment was required. That was my experience with the Empire Five for the past two and a half years.

Now the quality of reproduction from that set needs no reference from me. The Super 60, in my opinion, equals it, and, at about half the cost in components, gives perfect separation of all stations that are not heterodyned, lacks nothing in sensitivity, and is far easier to tune.

I've had it on trial now for five days and have nothing but praise for it.

AT Aston (Birmingham), a constructor has received seventy-two stations on the Super 60:

I have made the Super 60 and I am writing to say how pleased I am with it. Your estimate of sixty stations is well below its capabilities.

I have logged seventy-two on the loud-speaker, only using a frame aerial made on a cardboard box (I have a Peto-Scott on order and am using my home-made one temporarily until its delivery).

I was surprised how easily the stations came in, all clear and at good strength, and no overlapping.

I have always believed in Mr. James' sets, having made the Brookman's Three, the Brookman's Four, and now the Super 60, easily the simplest and best set I have heard or handled.

I thank Mr. James for this wonderful circuit.

THOSE who want to use 6-volt valves in the Super 60 will be interested in the following report from "Septuagenarian" at Stourbridge:

You ask for reports on the Super 60. I have just constructed one from your design, using Ormond variable condensers which I had by me, and old valves, namely: oscillator, Osram DEL610; first detector, Marconi HL610; two S.G. valves, Marconi S610; second detector, PM5X; power, Mazda 625A (using, of course, a 6-volt accumulator). In fact, the only special parts I used were the Wearite coils and Peto-Scott frame aerial.

The set is most satisfactory. I am working the H.T. off a Ferranti unit, also home constructed.

In every set I have made previously the spread of 5XX (45 miles distant) has been so great as to obliterate Königswusterhausen, but last Wednesday afternoon on the Super 60 I got a talk from Berlin, while the Bournemouth concert was on, with no trace of interference.

I had more difficulty in finding the condenser readings for the medium waves, but eventually found the aerial condenser was thirty degrees below the published figures.

I have succeeded in separating the London Regional from Mühlacker, Graz and Barcelona and 5GB from Langenburg, and Rome from Stockholm.

The set certainly comes up to all you say in its favour as to selectivity and the quality is very good.

"SIMPLY amazing" is the verdict of a Welling (Kent) reader who has constructed the Super 60:—

As a reader of WIRELESS MAGAZINE since its start, I have nothing but praise for the Super 60 as designed by Mr. James. I have made up a good many "W.M." sets but never one with the capabilities that this one has. To me it is simply a revelation and far exceeded my expectations; it is simply amazing.

At present I have logged thirty-five medium- and seven long-wave stations.

82 STATIONS IN THE NORTH

EIGHTY-TWO stations is the record of a Manchester reader with the Super 60. He describes the set as a "miracle".

Your Super 60 is a miracle; no other word fits it. It is a revelation to me to find station after station coming in absolutely clear of its neighbours.

I am afraid I would get writers' cramp if I tried to write out all of the eighty-two stations I have picked up on it, apart from half a dozen unidentified short-wavers.

A list of local stations must suffice: Vienna, Brussels 1, Prague, Midland Regional, Langenberg, Lyons Doua (not as good as others), Rome, Stockholm, Berlin, Dublin, Katowice, Frankfurt, Toulouse, Manchester (1½ miles away), Mühlacker, London Regional, Strasbourg, Brussels, Breslau, Göteborg, Bordeaux, Bratislava, Heilsberg, Moravska-Ostrava, London National, Leipzig, Hörby, Gleiwitz, Belfast, Nürnberg and Helsinki.

And on the long waves: Zeesen, Midland National, Eiffel Tower, Warsaw, Motala, Moscow, Kalundborg, and Oslo.

Thirty-nine stations are just as good as Manchester, and can be heard with pleasure any night. Another forty are not quite as good, being about as loud as Rome and Stockholm on my old five-valve set.

My criticism is that it will not tune high enough on either waveband; all stations above Riga on the medium waves, and Zeesen on the long ones, are out of my reach.

I have added a push-pull stage for gramophone reproduction, although it is unnecessary for radio, as for all stations I have to use my secondary volume control, which I added when the potentiometer for the screen voltage packed up.

As I have built it, the set is about twice as big as the original, the push-pull stage taking 12 in. of valuable baseboard. The rest is as arranged in the original.

The quality turned out in a "W.M." linen diaphragm loud-speaker is remarkable; it is much better than anything I have heard yet from any radio set at any price.

I am hoping to prepare some photographs.

In conclusion, I must thank Mr. James for such an outstanding design.

A READER at Kilburn uses his Super 60 with a James' Lodestone moving-coil loud-speaker:—

I enclose a photograph of the Super 60, the very set I have been looking for. It is "the goods." You will notice I have mounted it on a 4-ft. baffle board, which I use for your Lodestone moving-

coil loud-speaker. I am a firm believer in a large baffle. Also I have a 21-in. panel, which is the panel of a seven-valve super-het I have just scrapped for the Super 60.

I was troubled with mains hum in my old set and tried everything without success, but with the Super 60 there is none. The eliminator on the left is an L.T. one, 2 amperes output at 6 volts. The one on the right is H.T. for the field, ½ ampere trickle charger behind board.

I have a push-pull amplifier by the side of set on the same baseboard, also provision for pick-up on the spare part of panel, which makes a nice combination.

The little lamp-post in the centre of frame lights up; also behind the fret of

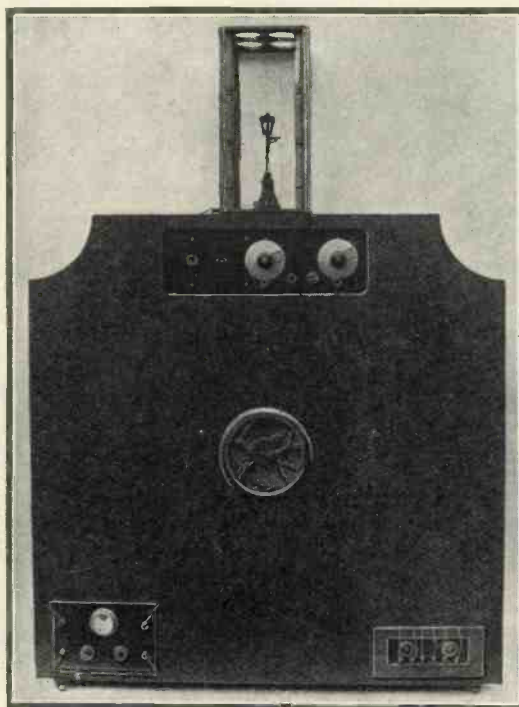

SOMETHING LIKE A BAFFLE!

Everything is complete on this baffle, which can be moved from place to place as desired. It is the work of a Kilburn reader

the loud-speaker when set is working, acting as a guide as to how much current the valves are getting on the filaments.

Very many thanks for a really grand set. One cannot beat a super-het to my mind. I can wheel the baffle board complete with everything into any room or the garden, plug in and there you are. Again thanking you for a set that will get the stations.

A BIRMINGHAM reader has scrapped the Brookman's Push-pull Three in favour of the Super 60 and finds the change worth while:

Enclosed are photographs of this set described in the WIRELESS MAGAZINE for March, which I have built into a radiogram cabinet.

My previous set was the Brookman's Push-pull Three, and I have incorpor-



WITH PUSH-PULL OUTPUT

Above is a photograph of the Super 60, with push-pull output, made by a Birmingham reader

ated the push-pull stage in the Super 60, using many of the parts from the former set, including valves, milliammeter, etc. (two Osram P2 power valves). I take H.T. from the mains, using an eliminator.

The Brookman's Push-pull Three was a fine set, both for radio and gramophone work, but your design of the Super 60 tempted me, and I am delighted with its many good points, which you have not exaggerated; for quality of reception (which I consider very important); programme value; volume; clean-cut selectivity without any loss of quality; number of stations obtained, it is unique, and I have not heard anything to come near it. Gramophone-record reproduction is also A1.

I have built a number of sets, but the Super 60 is far ahead of them all. It is easy to operate, although sensitive, and stations come in and go out cleanly in quite an amazing manner.

The reading on the oscillator dial is very near the diagram you give and your claim of sixty stations is within the mark.

I congratulate you and thank you for producing such a fine set, which certainly gives a new standard in radio.

A NOTHER reader at Birmingham gets excellent results with only a 100-volt battery:

I have built the Super 60 and even with a 100-volt dry battery the results are very good. Until Peto-Scott's send the frame aerial, I am using a hook-up affair for medium waves only. Later on I will attach my H.T. unit and then send you a full report.

The Super 60 separates Midland Regional from Langenberg in Birmingham, and that, in my opinion, is a greater achievement than separating Mühlacker and London Regional.

MYSTERIES OF MAGNETISM

By Morton Barr

MMAGNETISM is so closely allied to electricity that it is practically impossible to say where one ends and the other begins. Actually both are simply different aspects of one and the same thing. When an electric charge moves, magnetic effects always appear.

For instance, every electric current is associated with a magnetic field. A wireless wave passing through the ether has an electrostatic and an electromagnetic component, and it is impossible to isolate one from the other.

Deceptive Appearance

Yet the kind of magnetism with which we are most familiar, that is the ordinary horse-shoe or bar magnet, appears to be a stationary or static event. In fact, however, this is not the case.

The invisible force which spreads out from an iron magnet is produced by the rapid rotation of the electrons in each atom of the iron.

But since all matter is built up from atoms, and since all atoms are associated with whirling electrons, it is somewhat strange that the only natural magnets are iron, nickel and cobalt or their alloys—the so-called ferromagnetic metals. Why doesn't a piece of bismuth, for instance, show magnetic properties, since it is built up from atoms and whirling electrons?

Actually, of course, all substances are either paramagnetic like iron, or diamagnetic like bismuth. If they belong to the first class they are attracted by both poles of a horse-shoe magnet, whilst if they belong to the second class they are repelled by both poles. The clue to this behaviour is to be found in the way in which the atoms of the two metals are arranged relatively to each other in space.

If they are so arranged or aligned that the magnetic fields from each atom assist or strengthen each other, then there will be a resultant field outside the substance, as is the case with iron. But if, as is more often the case, the atoms are arranged so

that they mutually cancel, or coalesce to form closed magnetic circles internally, then we can find no external evidence of magnetism.

There are other peculiar features to be noted. For instance, soft iron is highly magnetic, and so is hard steel, though in a different fashion, because steel will retain its magnetism permanently, whilst soft iron soon loses it.

Yet the only chemical difference between the two metals is that steel contains a very small proportion of carbon and has been subjected to special heat treatment. By contrast, wrought iron, which is chemically the same substance as soft iron, is practically unmagnetisable.

Again, if cobalt and steel are mixed in certain proportions, the resulting alloy has an enormous magnetic capacity, being capable of retaining a flux density of over 8,000 lines per square centimetre. This alloy is now being used for making permanent-magnet moving-coil loud-speakers which require no special current to energise the field.

As another contrast, if steel is mixed with 15 per cent. of manganese, the effect is equally curious, for the resulting alloy is practically non-metallic. The same result is obtained when nickel and steel, both magnetic metals, are mixed in the proportion of one to three. The resulting body is less magnetic than either of its constituents—unless it is cooled to a temperature below zero Centigrade, when it suddenly becomes magnetic.

Subject of Research

These and other mysteries of modern magnetism are at present the subject of intensive research by Professor Kapitza of Cambridge. So important is his work considered that Sir Ernest Rutherford recently announced a grant by the Royal Society of no less than £15,000 for the building of a suitable laboratory at Cambridge at which investigations can be continued on a permanent basis.

Professor Kapitza, by using special accumulators, first succeeded in ob-

taining a magnetic field of 200,000 lines per square centimetre, which is twenty times more powerful than the new cobalt-steel magnet. This was subsequently increased to 400,000, and it is now hoped to reach the million mark.

To create a field of 400,000 Gauss, a 2,000-kilowatt generator of special design was constructed which gives, when short-circuited, the enormous current of 72,000 amperes.

One of the chief difficulties was to devise a coil capable of passing this huge current without burning out, and strong enough to resist the enormous disrupting forces involved. Naturally, the current is only momentary—its duration being limited to the one-hundredth part of a second.

Enormous Power

Even then the power developed amounts to 160,000 kilowatts, so that the coil is surrounded with a protecting ring of tempered steel capable of withstanding a pressure of 100 tons.

The production of magnetic forces of this intensity is unique in science.

One particularly interesting phenomenon is that of magnetostriction, or variations in the bulk or shape of a body caused by magnetic action. The effect is somewhat similar to the mechanical vibrations exhibited by quartz and certain other crystals under the action of electric forces.

In fact, it has been proposed to utilise the magnetostrictive effect as a substitute for the piezo-electric crystal as a means for stabilising the frequency of broadcast transmitters.

We know that the magnetic effect of iron is due to the rotation of electrons about the nucleus of the atom. It has recently been discovered that an electron also spins about its own axis in addition to rotating around a fixed orbit—just as the earth spins whilst revolving around the sun.

This axial spin produces a magnetic effect, which is distinct from that due to the orbital movement, and is more intimately bound up with atom and therefore with the ultimate constitution of all matter.

WHY AND HOW OF THE RADIO GRAMOPHONE



By reading this Supplement carefully anybody can learn all that the average listener needs to know about modern radio gramophones without going into a host of technicalities.

The information is practical rather than theoretical and will prove of real value to all who are thinking of building or buying an electrical reproducer for both radio and records.



WHY YOU SHOULD USE A RADIOGRAM

If we may judge by readers writing to the Set Selection Bureau for advice on the choice of a set, quite a number of listeners do not realise why they should use a radio gramophone. We say this because, in detailing their requirements, readers frequently ask for sets provided with gramophone pick-up terminals.

We often wonder what sort of externals are connected to sets so provided and recom-

some form of record turntable, an electric pick-up and a volume control between the pick-up and the set.

The only part of the mechanical gramophone actually used in such an arrangement would be the turntable. The mechanical soundbox would have to be removed and the electric pick-up put in its place. Leads from the pick-up would then have to be taken to the set.

turntable, a gramophone pick-up and a loud-speaker. One of the most important controls of the radio gramophone is a switch offering the user the two alternative sources of musical entertainment.

The self-contained nature of a radio gramophone not only avoids the untidiness of straggling leads, but definitely provides a very high standard of quality in the reproduction. The maker of a complete radio gramophone is able to match the amplifier with the loud-speaker and to include a pick-up and volume control most suitable for the particular circuit of the radio equipment.

It is not generally realised that the radio gramophone as we know it to-day is a highly developed product, combining improvements in radio technique and electrical reproduction that were unknown two or three years ago. At that time we could certainly obtain elaborate radio sets and there were one or two very elaborate electrical gramophones.

The next phase was the introduction of a small amount of radio amplification into these elaborate electrical machines. It has, in fact, been a justifiable complaint that until recently radio gramophones were more worthy of their gramophone side than of their radio side.

Now the manufacturers have got down to the idea of an instrument just as efficient in the reproduction of gramophone records as in the reception of broadcasting stations. One of the reasons

why we now exhort **WIRELESS MAGAZINE** readers to buy radio gramophones is that there is no sacrifice on the radio side.

The economic aspect of the radio gramophone must also be considered. As an example, we have in mind a well-known four-valve console, comprising two stages of high-frequency amplification, a power grid detector and a super-power pentode. These valves drive an efficient self-contained moving-coil loud speaker of the permanent-magnet type.

Provision for Pick-up

The price of this machine is 38 guineas. Provision is made for the connection of a gramophone pick-up, presumably to pander to those who really want to make use of the excellent low-frequency-amplifying part of the console in conjunction with their existing mechanical gramophone.

Not long after this console was introduced a radio gramophone embodying the same receiver chassis appeared on the market at a price of 48 guineas. It is interesting to see what one gains for the extra 10 guineas. Firstly, a self-contained record turntable driven by a smoothly working electric motor. Secondly, a self-contained electric pick-up that would cost several guineas if bought separately.

Admittedly, that exhausts the additional gear, but in our opinion the very considerable attraction of the combined instrument more than justifies the extra expense. Certainly, if one were thinking of buying a radio and some members of the family wanted gramophone music, one would be indeed foolish to go in for the console instead of the radio gramophone.

Typical Example

The example we have quoted is fairly typical. In other words it is definitely more economical, if one desires both radio and gramophone reproduction, to buy a radio gramophone and not a radio with provision for external paraphernalia.

Many listeners, again judging by our Set Selection Bureau letters, do not appear to be interested in the idea of a radio gramophone. Whether this is because they do

(Cont. in second col. of page five)



RECORDS ON THE ROAD
A "radio" van that tours Germany. It gives record and record demonstrations

mended. Usually, we presume, the set-buyer contemplates the use of his existing mechanical gramophone in conjunction with the new broadcast receiver.

It is true that the radio gramophone of to-day has been developed from sets adapted for electrical reproduction of gramophone records. Let us briefly review the way in which this adaptation process is carried out.

L.F. Amplification

Common to every broadcast receiver is a certain amount of low-frequency amplification. In a three-valver, for example, there is usually one low-frequency amplifying stage after the detector. And the detector itself, by suitable negative biasing, is readily converted into a preceding stage of low-frequency amplification.

Thus a three-valver designed for broadcast reception easily resolves itself into a two-valve gramophone amplifier, by switching out the high-frequency amplifying valve in front of a detector and at the same time altering the bias of the detector.

The externals needed to complete the conversion from radio reception to gramophone reproduction comprise

Altogether, the idea of using the broadcast receiver as an amplifier, by electrical means, of gramophone records is more attractive in theory than in practice. For in practice one finds a certain amount of untidiness and inefficiency inevitable.

For this reason there is every inducement for the set-buyer to consider the self-contained radio gramophone, which consists essentially of a radio set, a record

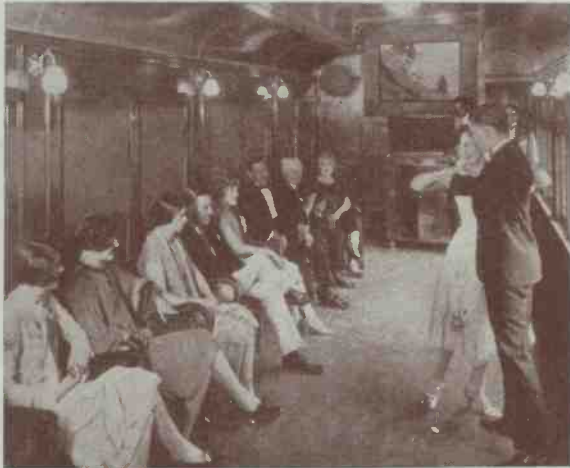

DANCING IN A TRAIN
Dancing in a railway carriage to the music provided by a radio gramophone

SOME POINTS ABOUT PICK-UPS

ONE of the most important links in the gramophone radio chain is the electromagnetic pick-up, or electric "soundbox" as it might be called. Indeed, it is no exaggeration to say that the pick-up is the most important link of all, because if it is a poor one practically nothing

needle movement the stronger will be the currents generated in the pick-up.

There is, of course, a limit to the "waviness" that can be impressed on the grooves because if it is more than a certain amount the walls between the adjacent grooves will break down and

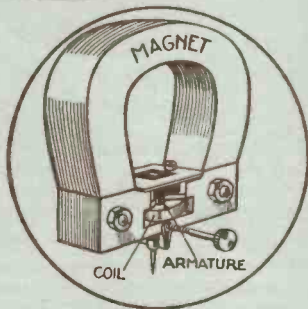
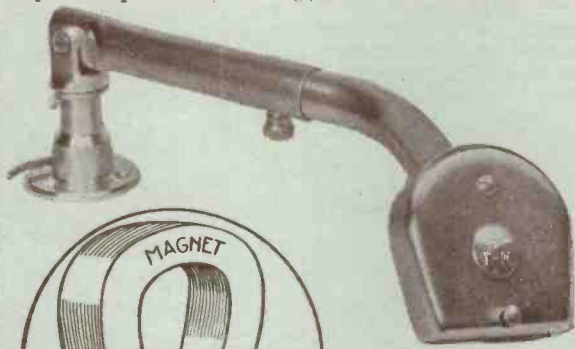

B.T.H.

The well-known B.T.H. pick-up is now fitted with a swivelling head to facilitate needle changing. The price in gilt or nickel finish is £2 5s.

can be done to improve the results.

The function of a pick-up is to change small mechanical movements into electric-current variations that can be amplified sufficiently to give reasonably good loud-speaker volume. A pick-up is something like a loud-speaker unit working backwards.

Record Grooves

Most people know that records produce different sounds by reason of the variations in the shape of the grooves on them. If looked at under a magnifying glass the grooves no longer appear to be perfectly straight, as they do to the naked eye, but assume the appearance of wavy lines.

Minute Currents

As the needle moves along the groove it also wobbles from side to side, as it were, and the armature to which it is attached (see the small diagrams reproduced in these pages) sets up a changing magnetic field which results in the production of minute electric currents which are passed on to the radio amplifier.

According to the degree of "waviness" of the record grooves, so will the sideways movement of the needle be affected. The greater the

there will no longer be a perfect spiral in the record, which will in fact be unplayable.

For this reason it is necessary to design pick-ups with particular care so that minute movements of the needle and armature will result in the production of reasonably strong electric currents. Different pick-ups vary considerably in their sensitivity; some give an output of the order of only .25 volt, while others give as much as 1.5 volts.

One of the chief troubles about a pick-up is that it does not give the same output

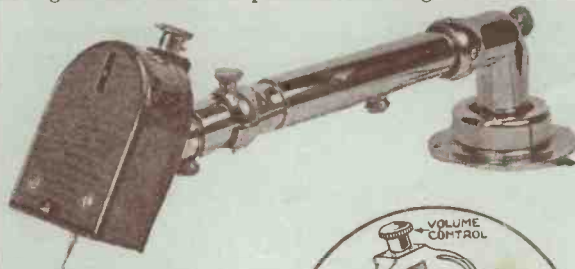

EDISON BELL

This pick-up has a special form of volume control mounted in the unit itself. Gilt or nickel finish is available and the price is £1 15s. (model 448)

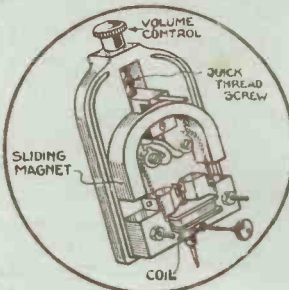

AUTO ELECTRIC DEVICES

The response of this A.E.D. pick-up is above the average and is well maintained at the lower frequencies. The price is £2 2s.

voltage at every frequency. For instance, it often happens that the sensitivity to high notes is very much greater than the sensitivity to low or bass notes. Occasionally it happens that the pick-up is more sensitive in the bass than it is at the top.

It is the aim of every pick-up designer to produce an instrument with an even response; that is to say, he tries to make the pick-up equally sensitive to all notes throughout the musical scale.

There are some people who think that the top-note response should be definitely limited above a certain point in order to reduce surface noises and needle scratch, which usually occur at a frequency of the order of 4,000 or 5,000 cycles.

range of musical frequencies, but so accommodating is the human ear that quite large variations in response are not appreciated without the use of delicate measuring instruments.

Effect of Load

Moreover, another snag about judging pick-up performance solely from response curves is that these vary even for any one particular instrument according to the load to which it is

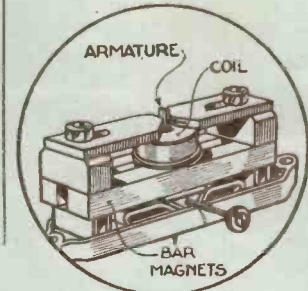

BLUE SPOT

Another pick-up with a swivelling head is the Blue Spot type 88. A volume control is incorporated in the tonearm and the price complete is £3 3s.

In choosing a pick-up it is desirable to select one that has a fairly level response curve throughout the whole

connected. For instance, a pick-up followed by a high-impedance valve would give quite a different response curve from that which could be obtained were a low-impedance valve used with it.

Track Alignment

A most important point about pick-ups is a feature called "track alignment." To get perfect alignment a pick-up must be so mounted that the sideways motion of the needle falls along a line at right angles to the tangent of the groove at the point where the needle is resting. In practice this effect is reached by making the tonearm long or shaping it in some special way.

The beginner need not worry himself unduly about track alignment, for most manufacturers of good-class

SOME POINTS ABOUT PICK-UPS—Cont.

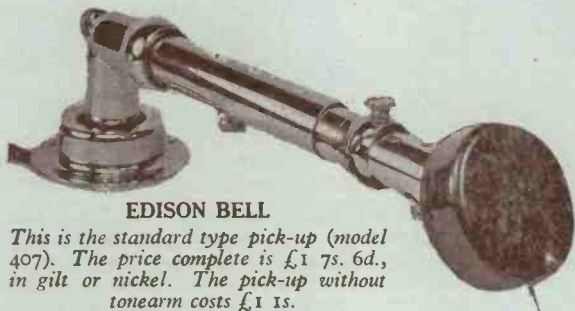

EDISON BELL

This is the standard type pick-up (model 407). The price complete is £1 7s. 6d., in gilt or nickel. The pick-up without tonearm costs £1 1s.

pick-ups nowadays supply with their instruments some kind of template that automatically gives the position for best alignment.

In these pages fifteen representative pick-ups are illustrated; the photographs are accompanied by five sketches showing the internal

In many cases the arm is telescopic, so that the pick-up can be arranged to get the best track alignment. In some cases one end of the arm is provided with a counterbalance weight in order to reduce the pressure of the needle on the record and so increase the life of the discs.

(3) The most elaborate

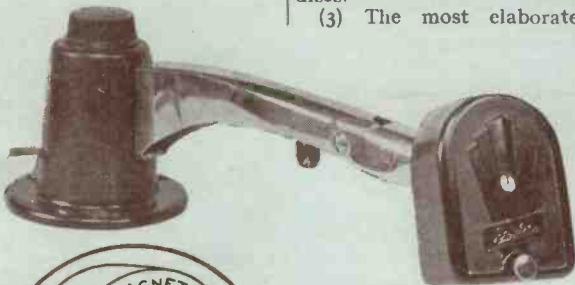

HARLIE

This pick-up, together with a tonearm and volume control, costs £1 17s. The pick-up alone to fit all tonearms is £1 7s. 6d.

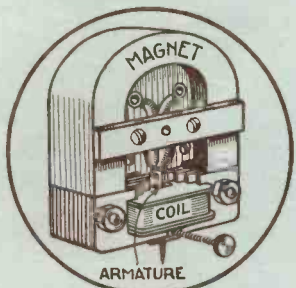

arrangement of a number of instruments.

Pick-ups for gramo-radio are available in various types, and for the sake of convenience we can say that there are three classes:—

Three Types

(1) Pick-ups can be obtained without any tonearm, but with adaptors that enable them to be attached to the tonearm of any gramophone. This form of pick-up is especially useful in cases where it is desired to make use of an existing gramophone which is already provided with a soundbox and tonearm. The soundbox is removed and the pick-up attached in its place.

(2) The commonest form of pick-up is that which is combined with a special arm.

be assembled by the constructor.

Apart from such volume control on the tonearm there is usually no adjustment to be made to the pick-up itself, but in one or two cases special devices are incorporated. Two of the pick-ups illustrated in these pages, for instance, are provided with screw adjustments to alter the damping of the armature, thus controlling the output to some extent.

facturers so arrange their pick-ups that the head can be swivelled right round. When so turned the needle hole appears at the top instead of at the bottom and a new needle is very easily inserted.

Must Be Well Made

Unless these pick-ups are



IGRANIC

Known as the Igranic Special, the price of this pick-up is £4 4s. Needles are easily changed by inverting the head of the pick-up, over the record if desired

Most pick-ups are provided with a set screw to hold the needle in position, but there are available one or two special models in which

very well made they are to be avoided. In some cases the head is not held rigidly enough in its vertical position and the whole head is inclined to wobble sideways. On the whole, it seems wiser to use instruments without any arrangement for swivelling the head.



LIMIT

The tonearm of this instrument is compensated by a combination of weight and spring force. The price complete is £1 11s. 6d. A screw is provided so that the damping can be adjusted

the needle is held by a special grip without any kind of screw fixing.

In order to facilitate needle changing a number of manu-

There is a general impression that pick-ups cause more wear to records than do ordinary mechanical soundboxes. Experience seems to indicate that this is not true with modern pick-ups, at any rate, and provided that the instrument is mounted with some regard to getting fairly good track alignment, there is no fear that records will be damaged any more by an electrical machine than by a mechanical reproducer.

Tone Controls

It has already been pointed out that some pick-ups emphasise a particular part of the musical scale or, alternatively, are weak at some particular frequencies.

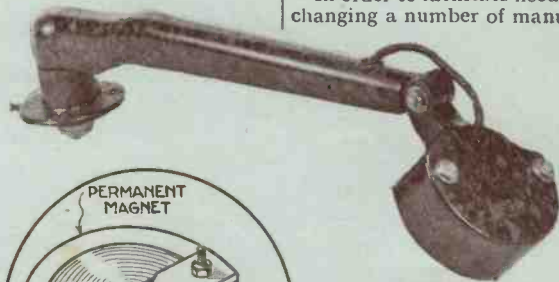

LISSEN

This pick-up is of the needle-armature type and costs £1 17s. 6d., complete with tonearm. Without the tonearm, but with two adaptors for use with any type of gramophone, the price is £1 10s.

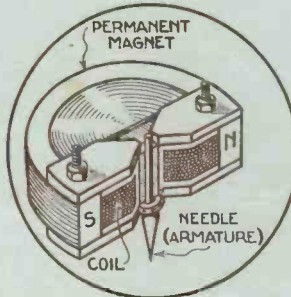

USEFUL HINTS FOR THE BEGINNER

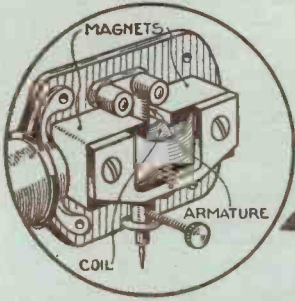

WHY YOU SHOULD USE A RADIO GRAM

(Continued from page Two)

not appreciate the advantages of an instrument capable of supplying a continuous source of musical enter-

LOEWE

This pick-up (type LR92) can be supplied either with spade tags or with a two-pin plug. The price is 15s.



In order to overcome this defect there are available a number of devices for compensating for poor bass response and for the general control of tone. In some cases these devices not only improve the overall reproduction, but can also be adjusted to reduce the amount of needle scratch.

A number of these instruments can be added to existing radio gramophones without any constructional alterations, only a few connecting leads being changed.

For instance, one well-known compensator that increases both the overall volume and the bass response is the Novotone. Two models

tainment is a matter for conjecture.

It may be that they do not realise how very little more

expensive is a modern radio gramophone compared with a console type of set comprising a three- or four-valve broadcast receiver and self-contained loud-speaker.

When broadcasting began there were many who said that the gramophone was doomed. During the last few years we have all seen how the application of broadcasting tech-

VARLEY

An ingenious needle clutch is provided with this pick-up. The needle is merely pressed into position; there is no set screw to tighten. The price is £1 17s. 6d.

are available, one giving greater step-up than the other.

The Edison Bell people make a combined scratch filter and volume control that will prove useful in many cases. It is a compact unit that can easily be used with any existing apparatus

nique to record making and reproducing has revolutionised the whole gramophone industry. Only now, though, have instruments become really practicable for those equally enthusiastic regarding broadcasting and gramophone records.

MAGNUM

This pick-up has been redesigned recently and the price is £1 15s. The type-number is 1104

Those who enjoy the advantages of a modern radio set by which we mean the lifelike realism of the reproduction of broadcast programmes, should certainly ask themselves whether they must put up with the medio-

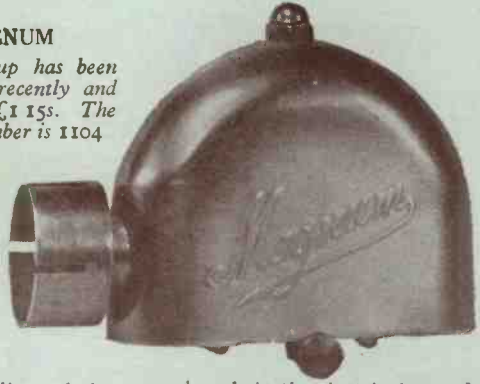

made in the electrical recording of gramophone records that only an electrical reproducer can do them justice. And there is no better way of reproducing records by electrical means than through the medium of a modern radio gramophone.



MARCONIPHONE

This unit has recently been redesigned with a larger and more robust moulded base. The pick-up and tonearm are enclosed in a brown bakelite casing. The cost is £3 3s.

cre gramophone reproduction obtained from a mechanical machine.

While it is true that broad-

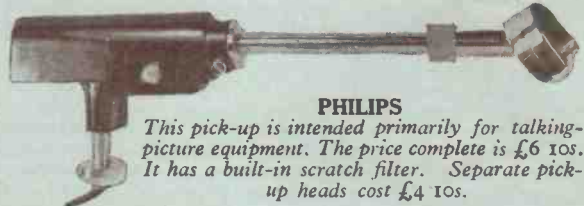

PHILIPS

This pick-up is intended primarily for talking-picture equipment. The price complete is £6 10s. It has a built-in scratch filter. Separate pick-up heads cost £4 10s.

casting has not killed gramophone music it is certainly rapidly killing mechanical forms of reproduction.

Such progress has been

Whitaker-Wilson's review of gramophone records will be found on pages 380 to 383 of this issue.

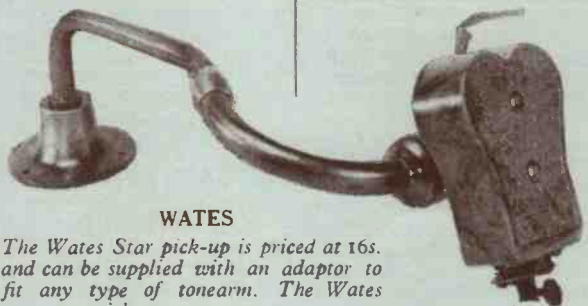

WATES

The Wates Star pick-up is priced at 16s. and can be supplied with an adaptor to fit any type of tonearm. The Wates pick-up arm costs 5s.

HOW TWO GRAMOPHONE MAKERS— NEW CHROMOGRAM RADIO GRAMOPHONE



HANDSOME CABINET
This is the revised Chromogram radio gramophone. It takes all its current from the mains

SOME time ago we tested the radio gramophone designed and produced by Micro-Perophone and Chromogram, Ltd. This instrument was especially interesting because it represented a gramophone firm's idea of how radio should be combined with gramophone reproduction. Another interesting point about the Chromogram machine was its comparatively low price, namely 35 guineas.

Moderate Price

We feel that many more listeners would take advantage of the complementary forms of entertainment offered by the gramophone record and the broadcast programme if they could be reproduced by a machine of fairly moderate price.

Inherently, a radio gramophone does not offer much scope for price cutting unless it is at the expense of quality of reproduction. Thus it is doubtful whether any radio gramophone is worthy of the name when worked from

batteries. And the cost of equipment for mains operation immediately precludes the possibility of a really cheap machine.

It is therefore interesting when one comes across a fairly inexpensive radio gramophone, and one made by a firm noted for its development work in the realm of mechanical gramophones, to see in what direction economy has been effected.

Certainly, in the modified Chromogram instrument under review the moderate cost is not a corollary of mass production. The Chromogram machines are definitely in the custom-built class.

From a thorough examination of the receiver chassis, a three-valver designed on modern lines, it is clear that no skimping has been countenanced in the general layout. But there is evidence of a careful choice of relatively inexpensive parts. That they work so well together is proof of the designer's

painstaking preliminary work.

In outward appearance the new Chromogram is similar to the machine tested and approved a few months ago. That is to say the oak cabinet accommodates the loud-speaker in the bottom section of the cabinet and immediately above the loud-speaker grille is the control panel. Under the lid is the usual turntable with automatic stop and gramophone pick-up.

At the back of the chassis one finds two aerial terminals and an earth terminal. By connecting together the two aerial terminals the chassis is rendered suitable for use with the mains as an aerial. But with this connection a good earth is desirable.

We are glad the makers have included the mains aerial device since many flat-dwellers likely to be interested in a self-contained instrument such as this have no facilities for the erection of an external aerial.

When considering the use of the mains as an aerial one must ascertain whether the amount of high-frequency amplification provided by the chassis is sufficient to justify one in dispensing with the more usual and certainly more efficient external aerial wire.

The Chromogram chassis comprises one high-frequency amplifying valve, a detector valve, and a power pentode. All three valves are indirectly heated at four volts and are supplied with high-tension current through a Philips 506K valve rectifier.

Amplification

The overall amplification of this chassis, as our tests have proved, is quite considerable and is sufficient to enable one to bring in a fair number of stations at loud-speaker strength on the mains aerial connection.

Near the terminals for the aerial and earth are pick-up terminals, loud-speaker terminals, and connections for the mains supply. These are

public with an efficient radio gramophone to be used under adverse conditions, with the minimum amount of interference from powerful local stations

Band-Pass Coils

The three band-pass coils are arranged in line from the front panel to the back of the chassis. A switch on the panel simultaneously changes all three band-pass units from medium to long waves. The two positions of this switch are clearly engraved on the panel.

Not far from the wave-change switch is the knob controlling reaction. As there is only one stage of high-frequency amplification this reaction control is invaluable when receiving foreign stations.

The centre of the panel is occupied by the escutcheon plate of the three-gang tuning condenser associated with the band-pass coil. At the bottom of the escutcheon plate is a knob rotating an illuminated dial.

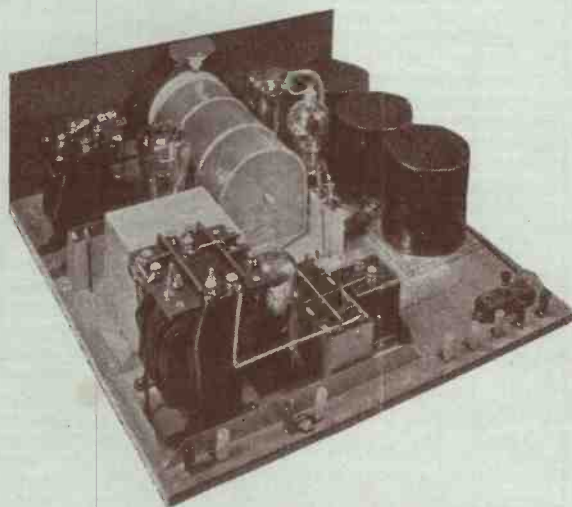

WELL-DESIGNED SCREEN-GRID CHASSIS

Particularly efficient is the screen-grid band-pass circuit incorporated in the Chromogram machine

neatly wired to the appropriate components in the cabinet and if anything should go wrong it would be easy to remove the chassis for inspection.

The chassis is available in two models, the more interesting of which is the band-pass model, which we also tested and approved. The band-pass chassis has been developed to supply the

To the right of the ganged tuner is the mains switch, which in its central position switches off the set. To the left it provides gramophone reproduction and to the right broadcast reception. The remaining control is for volume, which is applied to the low-frequency amplifying valve.

Tested on our standard
(Continued on Page Sixteen)

— HAVE TACKLED RADIO DESIGN

HIS MASTER'S VOICE MODEL 521

IN the H.M.V. model 521 we have a fine example of a gramophone company tackling radio design along the right lines. Undoubtedly this radio gramophone is a worthy successor to the long line of H.M.V. machines dating back to the earliest phonograph.

Specification

The specification is most impressive. Firstly, we have a circuit comprising four valves, two of which are for high-frequency amplification. Then comes the detector valve, which is coupled to a super-power pentode output valve by means of a transformer connected by the resistance-feed method.

This circuit has been interpreted in such a way that control is essentially simple. There is one knob for tuning; another knob for doing the combined work of changing the wavelength range, switching the machine on and off, and bringing into circuit as required the gramophone reproduction; and lastly there is a clever combined volume control, which works for radio and gramophone.

Although the original model 521 was designed for A.C. mains only, of 100 to 110 volts and 200 to 250 volts, with periodicities between

40 and 60 cycles, there is now a model suitable for D.C. mains.

We have recently examined the A.C. model and the following notes give some idea of our impressions during tests. Firstly, one cannot help admiring the handsome walnut cabinet, which is designed to convey a note of simplicity. Then the self-contained nature of the machine has an appeal that will commend itself to the fastidious home-lover.

The controls have been arranged from the gramophone user's point of view. In other words, simplicity is their keynote. One feels that technical knowledge is unnecessary in mastering the machine. In fact, a short experience in handling this radio gramophone clearly shows that it gives its best with the minimum of effort on the part of the operator.

New Products

The four-valve circuit works in conjunction with several new H.M.V. products, including a permanent-magnet moving-coil loud-speaker and a high-impedance electric pick-up. The new loud-speaker comprises a cone built up of laminated cloth, specially treated and metalised to ensure long life and a high standard of performance.

It is claimed that this loud-speaker, which has a permanent cobalt-steel magnet that works without external excitation, reproduces frequencies over nearly the entire musical range with great fidelity.

Our tests certainly enable us to substantiate this claim. The quality of reproduction, both for radio and gramophone, is as good as any we have heard in commercial practice.

The gramophone pick-up is very sensitive as our tests of it with other sets have shown. It is mounted on a well-balanced tonearm, shaped

to give correct tracking. One of its most attractive features from the user's point of view is the reversible head, by means of which needle-chang-

ing is made an easy matter.

This pick-up, which is certainly of very robust construction, incorporates a cobalt-steel permanent magnet, said to be "aged" to give very long life.

Apart from the fact that the head of the pick-up turns upwards to make easy the insertion of a fresh gramophone needle, a slight movement of the pick-up to the right releases the automatic brake of the gramophone turntable and so allows the record to revolve.

The volume control deserves a word of praise, because it does mean real simplification. During radio reception volume is controlled by varying the screen voltage on the high-frequency valve, but the spindle of the variable resistance employed for this function also operates the potential divider shunted across the electric pick-up.

In the normal set requiring an external pick-up one finds no provision made for controlling the voltage developed by the pick-up and handed on to the first valve of the gramophone amplifier. But in a complete radio gramophone, such as the H.M.V. model under review, it is obvious that the volume control must be applicable both to radio and gramophone reproduction.

In the ordinary way this would mean two volume controls, but as already mentioned the H.M.V. people have cleverly combined two functions in one control knob.

The tuning arrangement is straightforward. One rotates a knob controlling a three-gang condenser and an illuminated dial. We are glad to say that both medium and long wavelengths are calibrated and from tests we can say that these calibrations are accurate enough to assist



EASY TO OPERATE

There is nothing complicated about this H.M.V. radio gramophone

the operator in locating foreign stations.

Multi-purpose Switch

Immediately above the escutcheon plate of the illuminated tuning dial is fitted the multi-purpose switch knob, providing long waves, medium waves, gramophone reproduction, and an "off" position.

The back of the walnut cabinet can be removed.

The valves are arranged in separate compartments at the back of the metal chassis. From left to right one finds the detector, super-pentode, two screened-grid high-frequency-amplifying valves and finally the rectifying valve.

Thanks to the enormous amplification imparted to the set by the screened-grid high-frequency valves, only a short aerial wire is needed to provide full loud-speaker reproduction of a dozen or more foreign stations. If the user is a flat-dweller or is in a location where difficulty is experienced in the erection of an aerial wire, the mains aerial device incorporated in the H.M.V. radio gramophone can be utilised.



MUSIC AT ALL HOURS

With a radio gramophone you can get entertainment at all times in the comfort of your own home

A SIMPLE GRAMO-RADIO AMPLIFIER

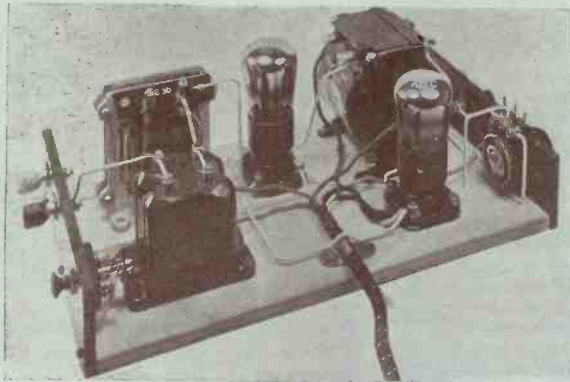

This photograph shows the simple nature of the two-valve gramophone amplifier

THERE must be a considerable number of broadcast listeners to whom gramophone-radio is unknown. It is probably not generally realised how comparatively simple and inexpensive is the apparatus necessary for reproducing gramophone records by electrical means.

For Beginners

Quite definitely, the amplifier and equipment illustrated here is not intended to interest the listener who already possesses a modern set with gramophone pick-up terminals.

Rather this simple gramophone amplifying equipment is described for the benefit of the amateur who, with no experience of pick-up work, desires to start experimenting with the least amount of trouble and expense.

One of the most important constituents of a gramophone amplifier is an electric pick-up; this corresponds to the soundbox of a mechanical gramophone, but instead of converting the mechanical variations of the needle traversing the grooves of the gramophone record into sound waves, the pick-up converts these mechanical variations into minute electric-current variations.

Two Valves Needed

The output from the pick-up is therefore a varying current of exactly the same nature as wireless signals after detection. The pick-up energy is usually so minute, of the order of a volt or less, that at least a two-valve amplifier is needed to produce loud-speaker results from the initial pick-up energy.

It should be pointed out that the carrying arm for the pick-up is designed to ensure

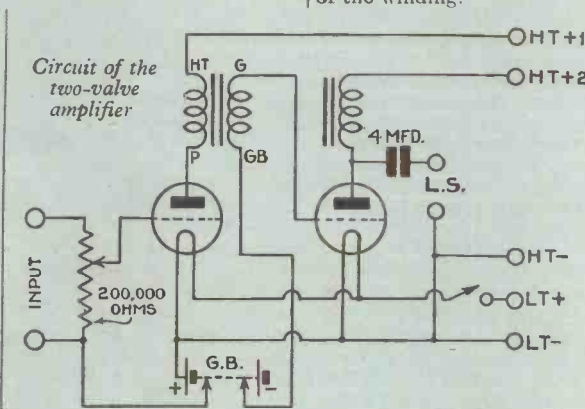

Components Needed for the Gramo-Radio Amplifier

CHOKE, LOW-FREQUENCY

- 1—Igranic, type C90, 15s. 6d. (or Varley, Ferranti).

CONDENSERS, FIXED

- 2—Hydra 2-microfarad, 6s. (or Ferranti, Lissen).

HOLDERS, VALVE

- 2—Benjamin Vibroholders, 3s. (or Lotus, W.B.).

RESISTANCE, VARIABLE

- 1—Electrad 200,000-ohm, type J, 6s. 3d. (or Regentstat, Rotor).

SUNDRIES

- Glazite insulated wire for connecting.
- 2—Ebonite strips, 7 in. by 2 in.

- 1—Wooden baseboard, 12 in. by 7 in.

- 1—British General 9-way battery cord.

SWITCH

- 1—Readi-Rad on-off, 10d. (or W.B., Bulgin).

TERMINALS

- 4—Clix, 2 red and 2 black, 1s. (or Belling-Lee, Igranic).

TRANSFORMER, LOW-FREQUENCY

- 1—Ferranti, type AF6, £1 10s. (or Lewcos, Igranic).

ACCESSORIES

VALVES

- 1—Six-Sixty SS210HF, 8s. 6d.

- 1—Six-Sixty SS220P, 10s. 6d.

“L.F. valve,” but through a 200,000-ohm potentiometer. This potentiometer has three terminals, one for each end of the winding and the third for the slider making contact with the winding.

The pick-up leads are taken to the two ends of the potentiometer winding. One end goes to a tapping on the grid-bias battery, and the slider goes to the grid of the first amplifying valve. In this way the first valve is negatively biased through the part of the potentiometer winding determined by the position of the slider with respect to the grid-bias end of the winding.

As the slider is moved towards the end of the potentiometer winding not connected to grid bias, the amount of pick-up energy handed on to the grid increases until, when the slider is at the very end, the maximum voltage of the pick-up will be applied. In this way a very good control of volume is obtained.

Top-note Cut-off

It is important to note that the winding of the potentiometer shunts the pick-up and for this reason its value should be high compared with that of the pick-up. Otherwise, the pick-up is unduly loaded, and high notes will be cut off.

The amplifier itself is very straightforward, and can probably be assembled from the amateur's existing stock of components. The first low-frequency amplifying valve is coupled to the power valve by means of a low-frequency transformer. Note that the high-tension supply for the first valve is obtained by taking a lead from one of the primary terminals of the transformer to a tapping on the high-tension battery, say, 80 volts.

Power Valve

The secondary of the low-frequency transformer is connected to the grid of the power valve and to the maximum tapping on the grid-bias battery.

Between the power valve and the loud-speaker terminals of the amplifier is connected an output filter, comprising a low-frequency choke, which should have a value of 20 to 30 henries, and 4 microfarads capacity, comprising two 2-microfarad condensers in parallel.

(Cont. on Page Sixteen)

correct tracking of the needle across the revolving record, and has no acoustic properties as in a tonearm of a mechanical gramophone. Usually, the pick-up arm carries the two leads from the pick-up, and these are usually brought out at the base of the pick-up support.

From the diagram, readers will see that the pick-up leads are connected to the two pick-up terminals on the two-valve amplifier. The pick-up output is not applied directly to the grid-filament circuit of the first of the two amplifying valves, marked

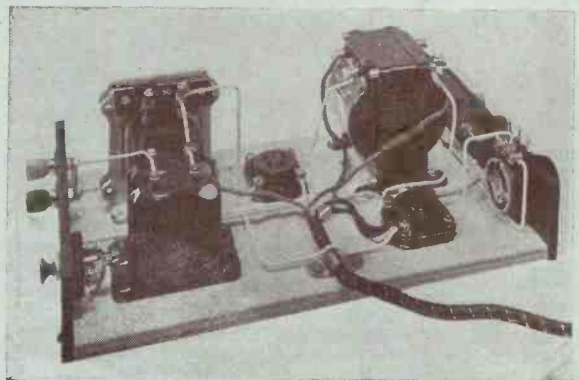

Another photograph of the two-valve gramophone amplifier

How to Wire Up the Gramophone Amplifier to Play Your Records Electrically

See opposite page for full constructional details and list of parts needed.

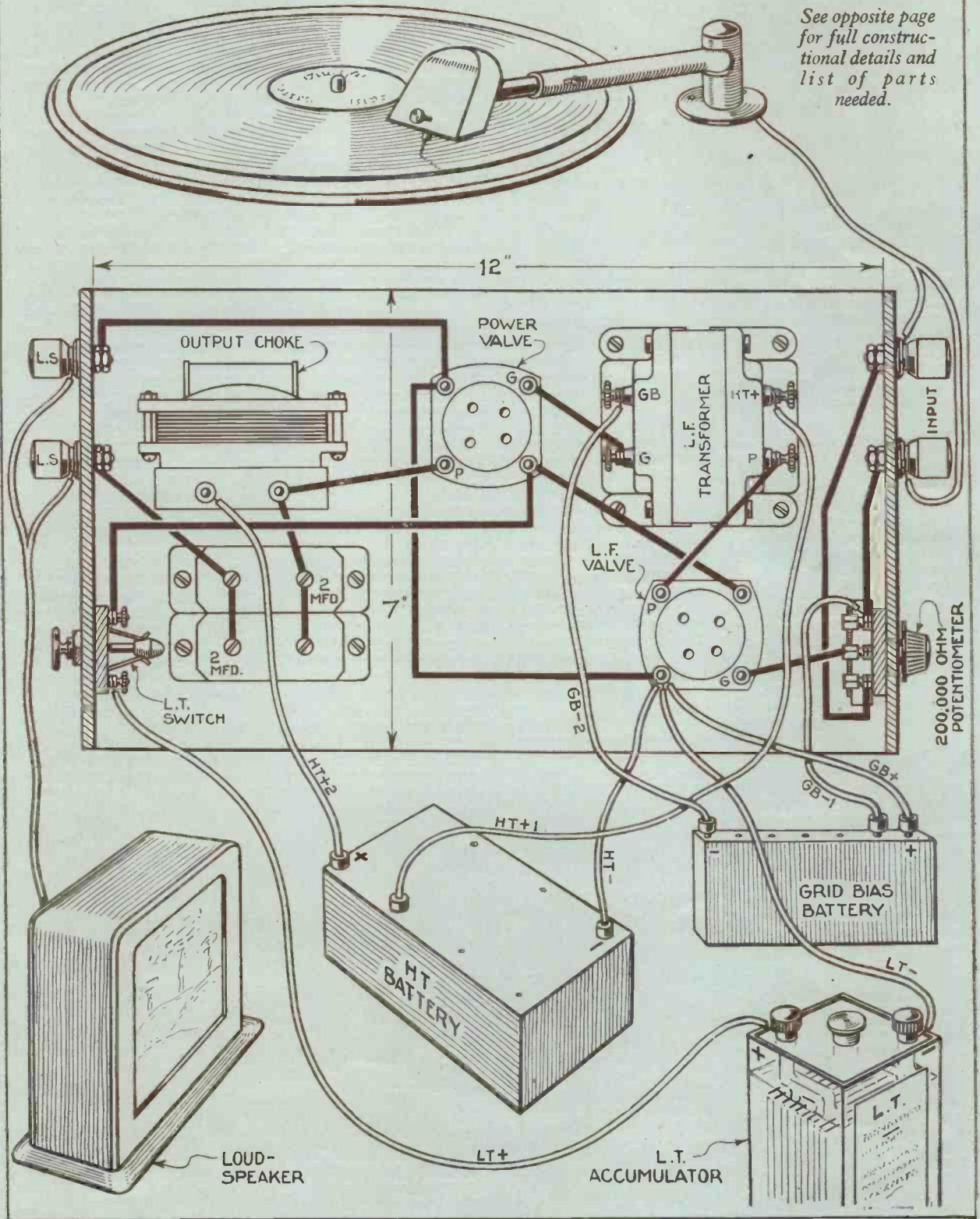



SMALL BUT EFFICIENT INDUCTION MOTOR

The Paillard induction motor costs £4 17s. 6d. It is supplied for 100-120 volt and 200-250 volt A.C. mains only

THIS is a question I am often asked. Obviously the answer must be determined by many considerations, among which are finance, availability of mains current (A.C. or D.C.), any objection to winding a clockwork motor before each record, and the sensitiveness of the ear to changes of pitch during the progress of a long musical work.

Luckiest Class

The luckiest class are those with plenty of money and alternating-current mains laid on in their houses.

In such a case unquestionably an induction motor of the slow-speed type, having the rotor integral with the record spindle, should be bought.

I know and use two such motors, the Garrard (English make) and the Paillard (Continental make): both are no-trouble things in every sense of the word. There is plenty of energy wasted in them and this ensures extraordinary regularity of speed, no matter how much the needle resistance to the recording may vary, yet the consumption of current is a negligible cost.

No Drop in Pitch

The speed varies so little that there is no drop in pitch between the finish of one side of a record and the beginning of the next; therefore the most sensitive musical ear can never be annoyed by pitch differences during the playing of a long work, such as a symphony, for example. The normal flywheel effect

of the rotating record and table, which we sometimes find insufficient to prevent sudden pitch drop on exceptionally heavy chords, is in these machines greatly increased by the considerable weight of the slow-running rotor of the motor, which is mechanically attached (not geared) to the record spindle.

Lubrication is simple and rarely necessary. The motors are approximately similar in price and the only notable difference between them is that the Garrard can be used on any ordinary voltage, while the Paillard is made in two windings, one for a 100-to-120-volt supply and one for 200-to-250-volt mains.

For those with less money and alternating-current supply, there are many induction motors on the market at

WHAT MOTOR SHALL I USE?

By H. T. BARNETT, M.I.E.E.

prices from £2 to £3. In these the rotors drive through gearing to the record spindle.

Certainly they are mechanically inferior to the low-speed rotor type and more likely to show pitch variations under differing resistance to the needle, but I consider either the Collaro (British), at £3, or the Paillard (Continental), at £2 5s., a far better proposition than any clockwork motor.

Now comes the case of the man with plenty of money and continuous (direct) current supply. For him there is no ungeared electric motor available; all such D.C. motors have commutators, and commutators, brushes, and gearing are subject to wear.

When a belt is included in the gearing there is a further cause of trouble. In the Thorens motors the frequent breaking of these belts is extremely annoying. Such motors not having belts, so far as my experience goes, are liable to rattle, vibration, and "hunting." Over-heating is often a further cause of damage.

I know of only one motor that gives no trouble on D.C. and that is the Garrard Universal, which can be used on any voltage; unfortunately, it costs £5 10s.

Let me here say that I would not use this or any commutator motor on alter-

nating current. Before the days of induction motors they were used in that way, but trouble was invariably experienced sooner or later; fortunately, nowadays there is no excuse for subjecting a commutator motor to such a strain, for induction motors are both better and cheaper.

No one who can supply with current and can afford an electric motor should use a clockwork one.

Motor Switches

It is fashionable to provide the motor with a switch, but in a very short time you will come never to use it. Cost of running current is negligible and when you switch on your machine the motor will start running and it will not stop till you switch off again, because it is just as easy to put the records on and off with the turntable rotating as it is with it still.

Automatic Stops

The automatic stop is a thing I never fit, because all records to-day have running grooves at their ends, and even if the needle jumps the groove (it may do that if the label or a royalty stamp is stuck over it!) it should be stopped by the spindle from crossing over to the wrong side of the record.

In the rare case of a very short pick-up arm, where the track alignment is such that

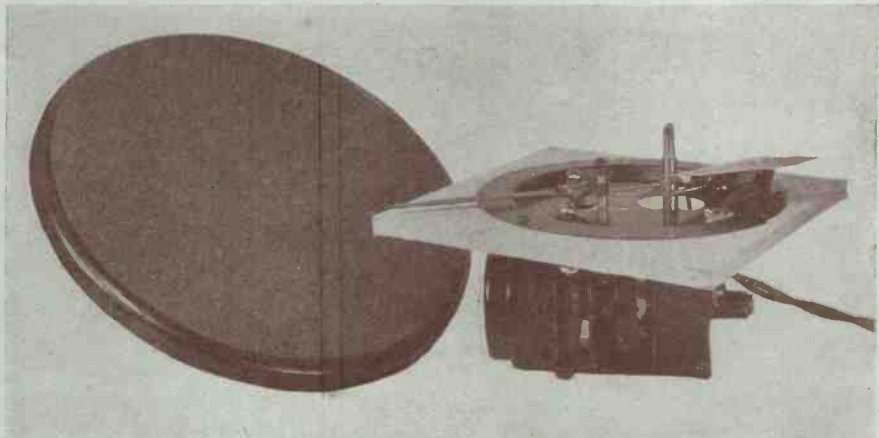

A FINE MOTOR THAT COMES FROM THE UNITED STATES

Another good induction motor is the Diehl Aristocrat. Its price is £4 4s. This also is only for A.C. supplies

the needle and pick-up can get past the spindle, it is much better to fit a stop to limit the swing of the arm than to fit an automatic stop.

I had a case once of a terrible hum in the loud-speaker. I found the frame of the motor earthed to the same connection as the set. On cutting the motor earth wire the trouble disappeared.

Clockwork

Now we come to the case of the man who *must* use a clockwork motor. If he wishes to be able to wind up while a record is playing and to play several records without change of pitch and between windings, there is only one motor that I know which will do for him and that is the Garrard Super, which costs over £5.

For my part I say *wind before every record* because although the spring is running down while the record is being played, the needle all the while is traversing progressively shorter groove turns, so that its decreased resistance tends to compensate for the decreasing driving force of the spring.

The pitch of the music at the end of one side is not likely greatly to differ from the pitch at the beginning when a *strong spring motor* is used in contradistinction to one having a *long spring*.

Those satisfied to follow this advice need not buy an expensive double-spring motor: the type having one extra big spring is far better than the motor comprising two or three small springs.

Such motors are on the Garrard list—No. 12 B.B. £1 9s.—and on the Collaro list—A30, 19s.

Needle Friction

Users of clockwork motors should do all in their power to lessen needle friction, being careful to use steel needles having *fine points* at 50 degrees needle angle and with *minimum weighting*.

If you wish to buy a motor from the cheap ones shown in shop windows, get the dealer to let you try the best you can pick out with a *big single spring*, agreeing to take it back if you find it will not play a long 12-in. record without loss of pitch.

With the exception of the electric motors and the Garrard Super, which should be sent back to the works for any repair other than a belt replacement, your dealer will be able to effect any necessary repairs or renewals.

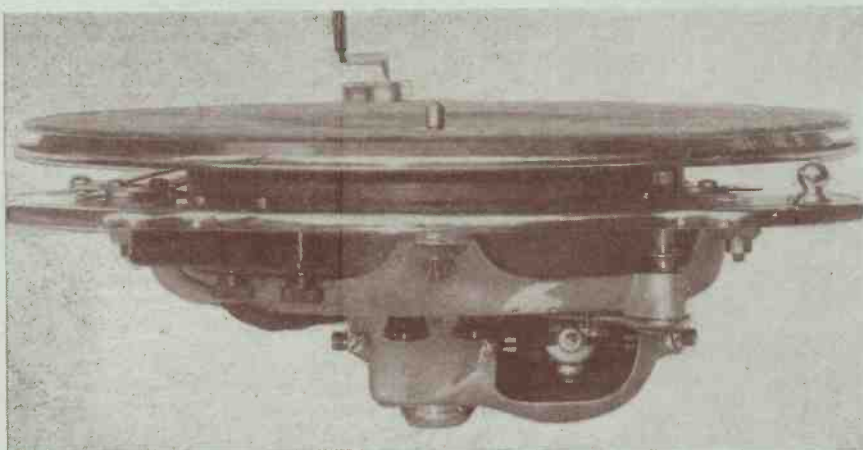

ONE OF THE BEST-KNOWN ENGLISH GRAMOPHONE MOTORS

Here is the Garrard induction motor—one of the best of its type

A MUSICIAN'S VIEWPOINT

By WHITAKER-WILSON, the "W.M." Music Critic

I HAVE been asked for a musical opinion on reproduction of gramophone records by means of a pick-up in comparison with the ordinary mechanical means. I think there are *pros* and *cons*; there must be, or one would have given way to the other long ago.

Good Machines

I am inclined to think that a *good mechanical gramophone* takes a great deal of beating, but I speak from no personal experience of actually possessing a fine instrument of this description. On the other hand, I have friends who do possess such things.

I use a pick-up. It is not used under the best conditions, by which I mean that the pick-up is attached to a portable machine of no great value. This is wrong, gramophonically speaking, because the motor-board is not large enough to admit of the tonearm being placed properly.

In trying to say which of the two methods I prefer, with the limitation I have just suggested in view, I am inclined to suggest that *unless your gramophone is really good and satisfactory in every way*, it is decidedly better to use the pick-up method of reproduction.

It is a question, so far as I can see, of becoming accustomed to one type of tone. You know as well as I that if you chance to hear a

gramophone record being played you can tell in a second which method of reproduction is being used. I know I can.

To describe the actual difference in words is a task I should personally be extremely sorry to undertake; it is quite indefinable, but it is, on the other hand, also quite definite.

I feel, musically speaking, that it is a far, far better thing to abide by one decision than by two. Surely it is better to listen to Christopher Stone broadcasting a record which takes your fancy, to buy it and reproduce it the same way as he did!

The gramophone broadcasts are done by pick-up; they are produced by wireless, sent out by wireless, and I personally think it better to reproduce them by wireless.

As I have said, I use a portable—at least, I use its motor to spin the record. I use yards of "rope" and put the portable in the hall, close the door and, seemingly, listen to wireless!

Radio Type

If I were contemplating the purchase of an expensive gramophone, it certainly would be of the radio type.

No one who has a really selective ear can fail to appreciate that there is still a slight difference of tone between the actual sounds produced by a piano in the studio and those which come through a loud-speaker.

On one occasion, after broadcasting from Savoy Hill, I chanced to hear the same piano on which I myself had just played being broadcast through the loud-speaker in the waiting room. I went back and quietly opened the studio door. There *was* a slight difference.

Broadcast Tone

The point, in my judgment, is that you and I have become thoroughly used to a certain *broadcast tone* on our own sets. If, therefore, we do not possess a first-grade gramophone, with a first-grade soundbox, I think we serve ourselves musically if we use the one method only for reproduction.

Musical sounds and effects have become important factors in the artistic side of our lives; wireless has done much for all of us.

I am, therefore, strongly of opinion that we should concentrate upon improving our wireless receivers with the definite view of trying to produce one particular type of musical sound. In short, *use a pick-up unless you can pick up something better!*

Helpful reviews by Whitaker-Wilson of the latest record releases will be found on pages 380 to 383 of this issue. Read them before buying your next batch of discs.

RADIO MANUFACTURERS WHO HAVE— LISSENOLA BABY GRAND



IN WALNUT—
*This is the Lissenola Baby Grand
in a walnut cabinet*

WE were recently given an opportunity to try out the very moderate-priced Baby Grand radio gramophone made by Lissen, Ltd. Designed for operation from A.C. mains, this instrument can be used on voltages between 100 and 125 volts or 200 and 250 volts. The price of 22 guineas includes the radio gramophone complete with valves and mains equipment.

The Lissenola Baby Grand is notable for the fact that only two valves are used. From the circuit specification we see that the first valve is the detector, working as either a leaky-grid detector or as the first low-frequency amplifying valve for gramophone reproduction.

Circuit Used

The tuning circuit of the detector valve consists of a dual-range coil, tuned by a .0005-microfarad variable condenser, with a switch arranged so that the long-wave coil is short-circuited when medium waves are wanted. In series between the aerial lead and a tap on the tuning coil is a .0001-

microfarad pre-set type of condenser, by means of which volume and selectivity can be varied.

As this radio gramophone is designed primarily for local-station reception, there is no real necessity for a high-frequency amplifying valve, provided that a moderately efficient aerial and earth system can be erected.

To make up for any deficiencies in the aerial system, reaction is applied to the detector valve by means of a differential .0001-microfarad variable condenser connected to a winding common to both long- and medium-wave coils.

A somewhat unusual combination of values has been chosen for the grid leak and condenser. For whereas the condenser is of .0003-microfarad capacity, the grid leak is only .25 megohm. These values appear to provide good quality in the reception of local stations, as our tests have shown.

Coupling together the detector and output valves is the standard transformer, with a 4-to-1 ratio. In series between the anode of the detector and the transformer winding is a high-frequency choke, which serves to divert the high-frequency component of the detector anode current through the differential condenser to earth, thus ensuring stability in the low-frequency side and efficiency of detection.

We note that the makers have not considered complete mains operation essential in such a simple set. For this reason, instead of using resistances to obtain grid bias for the valves from the high-tension supply, a grid-bias battery is incorporated.

The output valve is a pentode, providing considerable amplification and working quite satisfactorily in conjunction with the 1,000-ohm self-contained loud-speaker.

Other circuit details show that the makers have thoroughly grasped the essentials of an inexpensive radio gramophone. Across the gramophone pick-up, which has a resistance of over 6,000 ohms, is shunted the winding of a 50,000-ohm volume control, the slider of which provides the variation in the voltage applied to the grid of the first valve when it is working as a low-frequency amplifier.

The two valves actually supplied with the set we tested were a Mazda AC/HL for the first stage and a Lissen PT425 for the output stage. Both these valves are heated with A.C. current at 4 volts. The Mazda is, of course, an indirectly-heated type, but the Lissen output valve is directly heated.

Pentode Points

We note that the impedance of the pentode is 35,000 ohms and the amplification factor 70. This valve consumes .25 ampere filament current at 4 volts. At 150 volts on the anode the recommended grid-bias volt-

age is minus $10\frac{1}{2}$ volts, indicating a maximum grid swing of 21 volts. The anode current is between 10 and 15 milliamps at the maximum anode voltage.

Valve Rectifier

There is yet another valve supplied with the Lissen radio gramophone, namely, the Lissen U650, a two-electrode type providing single-wave rectification of the A.C. mains supply. This rectifier can supply a maximum current of 40 milliamperes and is thus very suitable for this particular instrument.

From notes made at the time, we see that the installation of the Lissenola Baby Grand proved to be a very simple matter. Following the clear instructions given in the booklet, we encountered no snags in the fitting up of the valves, grid-bias battery, and aerial and earth.

The layout of the cabinet is a little different from usual, since the control panel is mounted under the lid at the top of the cabinet immediately behind the gramophone turntable.

The control panel is quite easy to understand. Fitted in a central position is the dial of the tuning condenser, calibrated in degrees from 0 to 100. To the left is the knob controlling reaction and to the right a switch knob with three positions, for long waves, medium waves, and gramophone reproduction.

There are two other controls that tests have proved to be effective. That on the extreme left is the knob controlling the variable condenser in series with the aerial and the tuning coil. Nearby are the aerial and earth terminal connections. To the extreme right is the gramophone volume control.

The gramophone turntable is driven by an A.C. motor, and from tests we can say that it runs silently and smoothly. It is fitted with a speed regulator on the left and a motor switch on the right. A notable feature of this radio gramophone is the Lissen needle-armature pick-up, which un-



—OR IN OAK
*Here is the same radio gramophone
in an oak cabinet*

(Cont. on Page Sixteen)

—TURNED TO THE GRAMOPHONE

AS the makers of this instrument point out, it is natural that the radio gramophone should become part of every well-equipped home. By means of such an instrument it is possible always to have available some form of musical entertainment.

The Varley radio gramophone is a de-luxe instrument, which can be obtained for either D.C. or A.C. mains operation. Whichever type of supply is required, the price is 85 guineas.

For All Mains

For A.C.-mains supplies the instrument can be adjusted for voltages between 100 and 120 volts or 200 and 250 volts. The periodicities covered by the A.C. model are from 25 to 100 cycles. For the D.C.-mains model supplies between 200 and 250 volts can be utilised. The makers have obviously made provision for practically every type of mains supply in this country.

When we first examined the Varley radio gramophone we were at once impressed with the beautiful and dignified burr-walnut cabinet. Although this cabinet is on the large side, there is no doubt that it would ornament any room in which it might be placed.

The general lines of the cabinet can be seen from the illustration, but we would emphasise the fact that only by actually seeing the instrument can one appreciate its real attraction.

Apart from its size, the cabinet has been specially designed to prevent that objectionable boom sometimes noted in radio gramophones. Far more care than usual has been taken by the designer to avoid the bad effects of box resonance. All the woodwork is exceptionally stout.

Expansion Chamber

At the back of the loud-speaker we were shown a specially-designed expansion chamber that has an appreciable effect on the acoustic properties of the cabinet. It would be true to say that the cabinet of the Varley radio gramophone sets a new standard in the scientific design of cabinets for housing the equipment of electrical reproduction.

Looking at the specification, one sees that the basis of the Varley radio gramophone

VARLEY ALL-ELECTRIC MODEL

is the popular three-valve combination, consisting of a high-frequency amplifier, a leaky-grid detector valve, and transformer-coupled power valve.

As a matter of fact, there are two power valves connected in parallel. Together these two valves are capable of handing on to the moving-coil loud-speaker a maximum undistorted power of 2 watts, representing very considerable undistorted volume; certainly enough to fill a small hall if necessary.

been introduced, in the form of a differential variable condenser connected between the anode and grid circuits of the detector valve. We note that the values of the grid condenser and grid leak of the detector valve are 0.002 microfarad and 1 megohm respectively. These values should certainly ensure distortionless detection of fairly strong signals.

The transformer coupling between the detector and paralleled power valves is quite standard, with the

220 volts to the field winding of the magnet of the moving-coil loud-speaker. Here is yet another example of the maker's desire to produce the very best results, more or less irrespective of cost.

On every count we find ample justification for the price asked for this instrument.

Layout of Controls

We paid particular attention to the layout of the controls. The main control is, of course, for tuning, and this is done by means of a large knob rotating an illuminated dial, as well as a two-gang condenser unit.

To the left of the main tuning control is the radio volume control, which takes the form of a series variable condenser in the aerial lead. Incidentally, there are three aerial connections for obtaining different degrees of selectivity. This form of radio volume control has proved quite effective in general, and certainly works well in this particular instrument.

Immediately below the radio volume control we find the gramophone volume control, which takes the form of a potentiometer across the gramophone pick-up. Below the tuning knob is a convenient switch knob for changing over from medium to long wavelengths.

Pick-up Control

We have not yet exhausted the controls, for at the bottom right-hand corner is the switch for bringing into action the gramophone pick-up, the voltage from which is applied to the detector valve, which then becomes, by suitable biasing, the first stage of low-frequency amplification.

The only remaining control is the knob at the top right-hand corner, for reaction. We have tested the chassis embodied in this radio gramophone and we know that, with a gentle application of reaction, it is possible to tune in a considerable number of home and foreign stations at excellent strength and quality.

Apart from the generous design of the chassis, we must not forget to mention the lavish electrical gramophone equipment, which includes a Garrard motor and the latest Varley pick-up and automatic arm.



A BEAUTIFUL INSTRUMENT

The excellent cabinet of the Varley radio gramophone must be seen to be appreciated. It is particularly well made and finished

There are several points of interest in the circuit arrangement. For example, to couple together the aerial and the high-frequency amplifying valve is a double-wound high-frequency transformer, the long-wave secondary winding being shunted by a resistance of 25,000 ohms, presumably for damping purposes.

The high-frequency-amplifying valve is coupled to the detector valve by a choke-fed transformer, which actual results certainly prove is a good method of obtaining considerable high-frequency amplification from one stage.

As there is a limited amount of high-frequency amplification, reaction has

usual decoupling resistance and condenser connected in the primary circuit of the transformer. The output circuit of the paralleled power valves consists of a choke-filter circuit designed to work the Baker moving-coil loud-speaker, which is of the high-resistance type.

The high-tension current for the valves is obtained by means of a valve rectifier and by the use of separate resistances in the cathode leads of the indirectly-heated valves; grid bias is also obtained from the valve rectifier.

When examining the Varley radio gramophone, we were interested to see that a metal rectifier is included to supply energising current at

A RADIO-GRAMOPHONE CABINET FOR £2



HANDSOME APPEARANCE

This photograph shows the handsome appearance of the cabinet with a receiver in position ready for use

HOME constructors will find it interestingly and unduly to undertake quite intricate work involved in the assembly of multi-valve sets and amplifiers, but it seldom occurs to them that a cabinet for their radio-gramophone components is very easily assembled.

There must be quite a number of readers of WIRELESS MAGAZINE who at present put up with somewhat untidy arrangements for want of a suitable cabinet. Thus we often find the broadcast receiver being used with an external loud-speaker and an external gramophone motor, with attendant pick-up and long leads.

Simple Assembly

There is no longer any need for our readers to put up with such untidy installations, for here we describe the assembly of a very attractive cabinet designed to house not merely the set and loud-speaker, but also the gramophone motor.

The large drawing on the opposite page shows more clearly than words how the constituent parts of the cabinet hang together. The front of the cabinet is cut to take the panel of the set at the top, and there is a loud-

speaker fret immediately underneath. A shelf is fitted behind the opening for the panel in order to accommodate the components for the gramophone set.

Above this is the hinged lid, which covers up the shelf supporting the gramophone motor, fitted at a convenient distance above the shelf for the radio-gramophone set.

When this cabinet has been assembled the constructor can easily stain and wax-polish it, or the more expert woodworker will no doubt prefer to french-polish it.

The successive assembly instructions are best given as a series of sixteen points. A study of these instructions and of the drawing will greatly facilitate the assembly:

(1) The first thing is to fix the stays to the plywood sides. This fixing is readily done with the panel pins provided. Care should be taken to fix these stays so that the rounded end is at the top and the rebated part of the stay must face the rear of the cabinet.

Another point to note is that the stays should be mounted on the rough face of the plywood sides, that is to say, the surface that will come on the inside of the cabinet. As the sides and the stays are of exactly the same height, the constructor should take care to see that the top of the stay comes level with the top of the plywood.

(2) Now that the two plywood sides have been fitted with the stays, these sides can be attached to the front board by means of the panel pins provided. Here the constructor should see that the veneered surface of the front board faces outwards. Again, take care that the top edges of all three pieces of wood are exactly level. When fixing the sides it is as well to knock the pins through the plywood into the edges of the front board.

(3) The centre shelf can be fitted in the position marked on the sides. For this

fixing, panel pins should be put in from the outside of the sides. As the heads of these pins are very small they are not likely to be seen when the outside surface of the sides is stained and polished.

(4) At this stage the constructor can fit the legs to the front corners of the "box," these being screwed in position by means of the 1 1/4-in. wood screws provided. In locating the position of the legs the constructor should take care that the tops of the legs come exactly level with the top edge of the box. The holes for the screws will be seen along the outer side of the triangular corner strips attached to the front board.

The rear legs can now be attached. The holes for the screws will be found in the back stays. As with the

put through from the outside of the sides.

(6) Fix the small pieces of plywood, measuring approximately 16 1/2 in. by 3 1/2 in., at the top of the back by means of panel pins. This piece of plywood fits into the rebate cut into the back stays. Screw the small brass catch in the centre near the lower edge.

(7) Fix the framing pieces, with the exception of the back piece at the bottom, by means of wood screws. The holes for these screws will be found at the upper and lower ends of the sides and front. The upper edges of the top framing and the lower edges of the bottom framing should come flush with the edges of the sides and front.

(8) Hinge the two plywood back covers together by means of the hinges and rivets supplied.

Screw the final framing piece to the lower edge of the outside of the larger cover. This large cover, which encloses the loud-speaker compartment, should finally be screwed in position in the rebate in the back stays.

(9) The 2-in. lengths of corner strip, which will be seen loosely attached to the corner strips on the front board, should now be detached and nailed into the corners at the inside of the back of the cabinet with their tops level with the mark denoting the position of the underside of the motor board. These strips are for the purpose of supporting the back end of the motor board.

(10) Next, the constructor should drill the motor board to take the gramophone motor and any other fittings. The board can then be fitted in position and held by screws

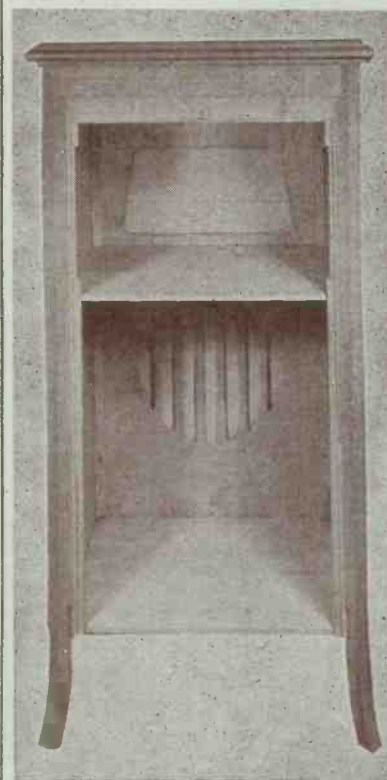

PLENTY OF SPACE

There is plenty of space in the cabinet to accommodate a set, loud-speaker, batteries or mains unit

front legs, care should be taken to see that the back legs are fitted exactly level with the top of the box.

(5) Next, the constructor can fit the bottom shelf in position by means of panel pins. These pins should be

passing into the corner strips.

(11) Pin the capping strips to the top of the cabinet in order to cover the ends of the legs and the edges of the front sides and back.

(12) Assemble the lid. (Continued on Page Sixteen)

The Assembly of the Radio-gramophone Cabinet is Particularly Simple and Straightforward

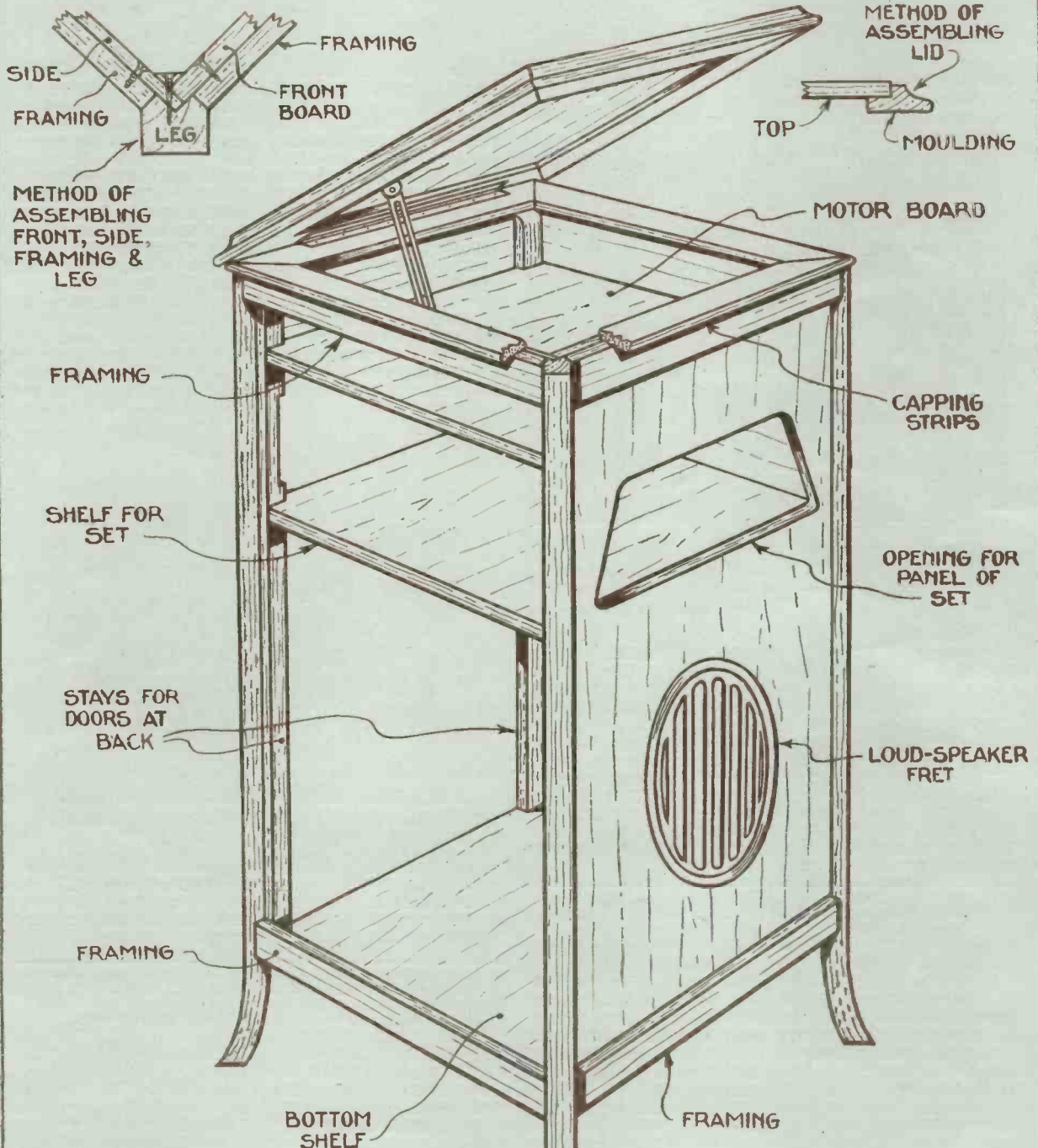

This cabinet has been produced by Charles Borst and Sons in conjunction with the "Wireless Magazine" Technical Staff. A complete set of parts costs £2 in birch and £2 7s. 6d. in oak.

This cabinet takes a 16 in. by 8 in. panel and a baseboard 16 in. deep. The inside dimensions of the lower compartment are 18 in. wide, 20 in. high and 17 in. deep.

NEW CHROMOGRAM RADIO GRAMOPHONE—(Continued from page Six)

aerial, the Chromogram band-pass chassis certainly put up a very good performance. We logged London National at 27 degrees on the dial, and we were impressed with the fact that all trace of this powerful local station was eliminated by the time the dial had reached 31 degrees above the point of tune and 21 degrees below, an overall spread of only 10 degrees.

we were therefore not surprised at being able to log no less than 21 stations at a good loud-speaker strength.

On the long waves the band-pass action still held good and we were able to get Zeesen at 85 degrees almost clear of Daventry at 70 degrees. Radio Paris was a fine signal at 95 degrees, and most of the other foreign



WHY NOT USE A HOME RECORDER?

This photograph shows the reproducing and recording pick-up supplied with the Kingston system, the price complete being £3 16s. 6d.

London Regional came in at 72 degrees and was also restricted in its swamping effect by the band-pass action of the tuning circuits. Thus it had disappeared at 63 and 86 degrees, a total spread of 23 degrees.

The daytime strength of Midland Regional at 137 degrees led us to conclude that we should be able to log a fair number of foreign stations later on. After dark

stations on the long waves were logged at fair strength.

In view of the fact that a pentode power valve is used we made particular note of the quality of reproduction. We found this very satisfactory due to the inclusion of a pentode output transformer. This serves to match up the pentode with the inductor dynamic loud-speaker, which provides very satisfying quality.

A SIMPLE GRAMO-RADIO AMPLIFIER

—(Continued from page Eight.)

The power valve gets its high-tension voltage through the choke winding, for it will be seen that one side of the choke is connected to the anode, and the other, by means of a flex lead, to the maximum tapping of the high-tension battery, say, 120 volts.

This output choke not only diverts the direct current of the battery from the loud-speaker winding, but also serves to send the low-frequency signal current through the 4-microfarad condenser and loud-speaker winding, and so back to low-

tension negative.

The battery lead connections should be easily understood. Note that to one of the filament terminals of the first valve are connected three flexible leads, one for grid-bias positive, another for low-tension negative, and the third for high-tension negative. The remaining low-tension positive lead comes from one side of the filament switch.

Suitable valves for this amplifier will probably be found among the amateur's existing stock. The first valve should have an impe-

dance of about 20,000 ohms, and the second valve can be any good power type of 5,000 ohms or less.

The grid-bias values will depend upon the high-tension battery values. If the maxi-

mum H.T.+2 is 120, then G.B.—2 should be between 4½ and 9 volts, according to the power valve selected.

Usually, G.B.—1 should be taken to a 1½-volt tapping.

LISSENOLA BABY GRAND

—(Continued from page Twelve)

doubtedly contributes to the surprisingly good quality of reproduction.

In the Lissen needle-armature pick-up the only moving element is the needle itself, which the makers claim is responsible for the very uniform reproduction obtained. No needle screw is used, for the needle is held in position simply by pushing it into the hole provided at the base of the pick-up.

A critical test of the quality showed that the self-contained balanced-armature cone loud-speaker is capable of reproducing both high and

says much for the selective properties of the coil that this station had disappeared at 32 and 40 degrees, an overall spread of only 8 degrees; a very good performance for such a simple set.

London Regional was tuned in at 64 degrees and extended to 60 and 68 degrees, a spread of only 8 degrees. Midland Regional came in at quite good strength at 88 degrees, and we definitely logged eight foreign stations at moderate loud-speaker strength by the application of the maximum amount of reaction. On the

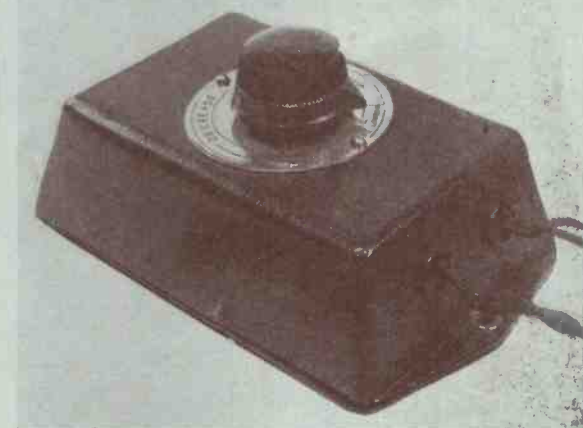

A SCRATCH FILTER AND VOLUME CONTROL

This is the Edison Bell scratch filter and volume control. The price is 15s. 6d.

low notes in a very pleasing way.

The London National station was tuned in at 35 degrees on the dial, and it

long wavelengths we obtained Daventry 5XX at 68 degrees, this station being heard at full loud-speaker strength.

A RADIO-GRAMOPHONE CABINET

FOR £ 2—(Continued from page Fourteen.)

using the four mitred pieces of lid moulding and the veneered top piece. The moulding may be fixed to the top piece by means of panel pins put through the upper side of the top into the rebated portion of the moulding.

(13) Fit the lid carefully into its correct position on the top of the capping with the hinge, supplied ready-fixed, at the back. Wood screws passing into the cap-

ping should be used for this fixing.

(14) Fix the lid stay into position on the left-hand side of the cabinet.

(15) The whole cabinet, which is now completed, should be rubbed over with smooth glass paper.

(16) Stain and polish with one of the many easy french-polishing outfits on the market or alternatively, stain and wax polish.

HOW MUCH MAGNIFICATION SHALL WE USE ?



MODERN engineering progress has to-day placed at our disposal an almost unlimited reserve of power. We are using nowadays in the commonest household receiver, without thinking anything of it, values of gain which yesterday were beyond the brightest dreams of the most optimistic of engineers. So far as efficiency is concerned, there is little left to be desired. As for quality, however, that is another matter.

Room for Improvement

In spite of the tremendous strides that have been made toward distortionless magnification, there yet remains a great deal of room for improvement before the loud-speaker's version of a broadcast programme shall be identical with the original.

In the meantime, the tendency among constructors has been rather to overcome interference and blank out shortcomings by increasing volume, on the supposition that if the set is played loudly enough, deficiencies in reproduction will pass unnoticed.

If the quality is poor, turn up the rheostats, increase the anode voltage, add a larger valve; enough quantity will make up for lack of quality.

There are, however, definite psychological reasons that this policy is wasteful of human energy. The human nervous system is operated by energy discharged through the nerve cells.

When a sound vibrates the sensory apparatus of the ear, a certain amount of "nerve current" is released over the circuit which leads to the brain. The louder the sound, the more energy that is consumed. This energy has to be replenished.

For this reason, life in the city, where the hearing apparatus is con-

stantly shocked by noise and confusion, involves a strain which drains the system of a great deal of nervous energy. A set which is harsh and jangling, which thunders at all times with ten times what would be a pleasant volume, is a source of fatigue no less actual than the fatigue caused by any mental work.

How much volume is desirable? Obviously, the quantity depends upon the size of the room. Ordinarily, however, there is no reason that a loud-speaker should supply more volume than is necessary to make it heard distinctly in all parts of the room.

Does your set screech and shout? A good radio set is not rude. Teach it manners—it should not try to bring a whole symphony orchestra of a hundred musicians into a room hardly large enough for the bird cage and gramophone. How much energy goes into the microphone at the studio, after all? No more than a person standing in the same place would hear.

Distribution of Energy

Put yourself in the place of the microphone. If the volume is just sufficient to produce the same distribution of sound energy in one's home as prevails in the studio, the illusion of "presentness" will be at its best.

Even if a set magnified all fre-

quencies equally, it would be impossible for the distribution of sound energy per unit of area, the sound flux, as it were, to be increased above the last-mentioned level without distortion.

To be sure, the various components of the speech currents would still be in the same proportion and there would be no electrical distortion, but the ear itself is by no means uniformly sensitive over the scale.

Sensation Level

The variation from a flat characteristic depends not only upon the frequency but upon the loudness or "sensation level" of the sound. In the accompanying graph (Fig. 1) the frequency is plotted against a "weight factor," which is a measure of the extent to which the ear favours certain frequencies. Thus it will be seen that at the lower levels of loudness the higher frequencies give much greater proportionate response than the lower.

At the higher volumes the situation is reversed, the lower pitches becoming predominant in their effect upon the ear. The "sensation level" is measured in units which are based upon the "threshold of hearing," which is the minimum value of intensity that will elicit a sensation.

When the receiver is being operated at the same level as prevails in the studio, if the receiver is distortionless, the various components of sound will be reproduced in their true relative proportions. If the volume is increased above this value, the raising of the sensation level will throw the emphasis upon the lower pitches; if it is decreased, the higher notes will be exaggerated.

This phenomenon manifests itself as well in long-distance telephone transmission, where the higher fre-

Selectivity in relation to quality can be a highly technical subject. This article by C. STERLING GLEASON presents a clear view of the whole proposition and will be read by all serious listeners with interest.

HOW MUCH MAG. SHALL WE USE?

quencies tend to be accentuated, because of the reduction of sound level through attenuation on the line. It is one of the reasons that telephone systems are designed with a "cut-off frequency" of about 2,000 cycles.

The fact that there is a threshold value, below which a sound is too

at a distance of one hundred miles. If the intensity of radio waves, as is approximately the case with other forms of wave motion, vary inversely as the square of the distance, the intensity of each component of the wave here is ten thousand times less than before. Thus certain components are reduced to a value which is

below the threshold of audibility, until it merges into a common jumble of inarticulate sounds and becomes mere noise.

Another aspect of the non-linear response characteristic of the ear that has a considerable effect upon radio reception is the variation of sensitivity with the intensity. This law, as expressed by the scientists Weber and Fechner, states that the strength of the sensation produced by a sound varies not directly as the physical intensity of the sound, but logarithmically.

Audibility Variation

The effect of this characteristic is that at low sensation levels a very slight change in loudness is easily detected, while at higher levels of volume a considerable increase is required for perceptibility of change.

Weber found that the same characteristic is operative to some extent in the other human senses, such as feeling, sight, etc.; that the smallest detectable change in a stimulus is proportional to the intensity of that stimulus.

The range of audible sounds extends from a threshold of an almost infinitesimal fraction of a watt to an intensity a million million times as great, at which value is produced the sensation of pain. Yet the ear can recognise but about four hundred distinct degrees of loudness over the whole gamut of intensities.

This limit cannot be looked upon as a defect. The human ear was not intended for an audiometer, any more than the eye was made for a photometer. Primitive man was little concerned with the intensity in sensation units of the sound in the night which sent him scurrying to the shelter of a cave; he was interested wholly in the quality of the sound, which from experience he knew to herald the approach of a hungry dinosaur.

Discrimination

The fourteen thousand fibres comprising the auditory nerve leading from the ear to the brain must have a value more important than the mere measuring of quantity of sound. Discrimination of quality is the outstanding characteristic of both eye and ear.

As few as two complete vibrations are often sufficient for the ear to recognise a sound as a musical tone

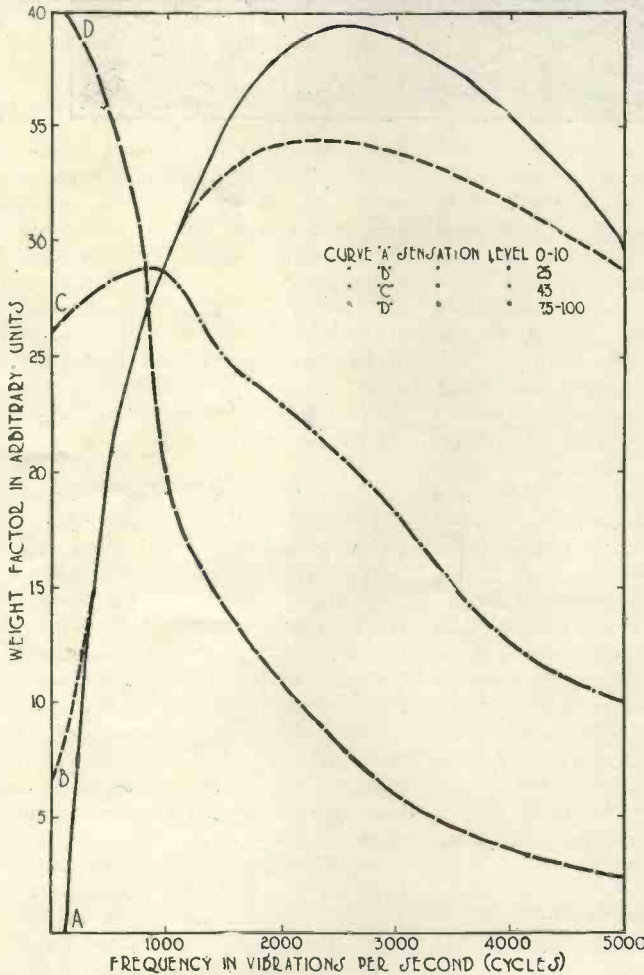

Fig. 1.—How apparent loudness of sound varies with frequencies. At the lower levels of loudness the higher frequencies give greater proportionate response

weak to be detected by the ear, is responsible for an apparent distortion which is, perhaps, often attributed to another source.

Let us suppose that at London the sound broadcast from a certain station has at a particular instant the various components in proportions as represented by Fig. 2. At a short distance, say one mile, where our receiver can bring the volume up to studio level, these will be audible in their true proportions.

But suppose that our set is located

of medium and low frequencies, the consonants, which are the most important factors in clearness of articulation, owe their characteristic sounds to the higher components.

It is said that 50 per cent. of the mistakes in interpretation of speech come from the consonants *th*, *f*, and *v*. On the other hand, the short vowels, *u*, *o*, and *e*, carry determining characteristics of frequencies below 1,000 cycles. As both the higher and lower regions are eliminated, the sound loses more and more of its

identity, until it merges into a common jumble of inarticulate sounds and becomes mere noise.

All frequencies in the upper and lower shaded portions are now missing, so far as the ear is concerned. The quality of the tone has apparently changed. If the intensity is reduced only one thousand times, the frequencies of 128, 256, and 2,048 appear above the threshold, but those remaining in the lower portion of the graph—the highest and lowest components—are still missing.

The quality of the sound still suffers. If it is a piano tone, for example, it will lack resonance and appear flat and dull. If it be voice, it will be unintelligible. Whereas the vowel sounds are composed largely

BEST VOLUME FOR NATURAL RESULTS

possessing a definite pitch, rather than a noise.

In contrast to such acuity it may be noted that three sounds which appear to stand in loudness approximately in the ratio of 1, 5, and 10, represent actual physical values of intensity of 1, 150, and 22,500.

Sensitivity to Small Sounds

Nature has wisely provided man with a much greater sensitivity to small sounds, for in that range lies the greater part of aural experience in the normal life of a human being.

The characteristic of logarithmic response may have an important effect upon the apparent selectivity of a receiver. Let us suppose that while listening to station GGG we are able to get rid of a background of noise from GGH. The former has a signal strength of, let us say, one hundred units; the latter, ten.

We add a stage of magnification which yields a net gain of ten. The signal strengths are now respectively one thousand and one hundred. But to the ear the stations sound in the ratio of the logarithms of their intensities, or three to two. GGH has come up from an audibility of one-tenth, that of GGG to two-thirds. The interference is now more pronounced than ever.

Here is a strong argument for magnification at high frequency. If the stage be of low frequency the situation is merely aggravated, but because of its selective effect a high-frequency stage can over-rule this tendency. For the reason just stated the background of extraneous noises, being also in the region of relatively small intensity, has the advantage when it comes to magnification. Thus the number of low-frequency stages is at once limited to two or three.

Wasted Magnification

Within certain bounds the advantages of greater selectivity obtainable with high-frequency magnification more than offset the ear's discrimination in favour of the weaker static impulses; but the point is eventually reached where this factor has increased so much as to preclude further magnification.

Thus may it be seen that theoretical selectivity, as measured by the ratios of the various receiver currents,

is not the same as selectivity as the ear hears it.

Neither is the much-discussed "noise level" a background of fixed value, but a relative matter; nor is the so-called "getting down below the noise level" much more than an apt figure of speech, for it is not magnification itself which makes this possible, but the properties of a good, sharply-tuned circuit which can select the frequencies it intends to magnify.

In the discussion of the noise level with relation to distant reception, the importance of keeping out extraneous noises simply as a means of obtaining better quality is perhaps lost sight of. The best audio amplifier is helpless against noises which are introduced into circuits before the detector stage.

The problem of noise is more serious than that of interference, so far as quality of reproduction is concerned. How detrimental to satisfactory hearing are extraneous noises is shown by the fact that acoustical experts recommend, for satisfactory results, that the speech energy should be from one thousand to ten thousand times that of any noises.

Again, the peculiar properties of the ear augment the distracting effect of interference. Experiments have demonstrated that a noise has twice the interfering effect of a musical tone. Probably the reason for this is the irregular wave-form of the noise, which may give it a greater psychological "factor of advantage" in commanding the attention of the listener.

And again, the compounding itself, the interfering effect of noise, increases with the intensity, not uniformly,

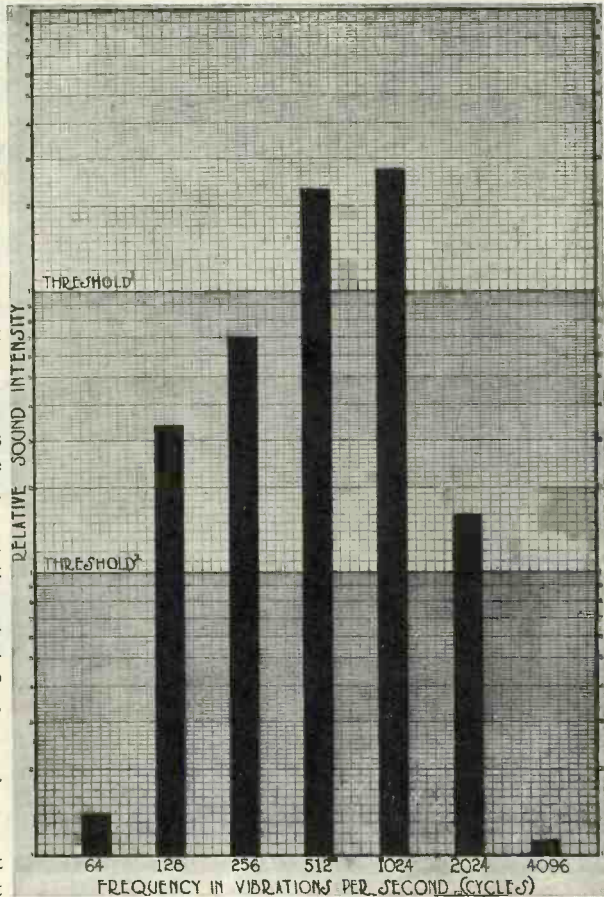

Fig. 2.—Illustrating the effect of volume level upon tonal quality. If the volume is quite low, only those components rising above Threshold 1 are audible. If the volume is increased ten times, those rising above Threshold 2 are audible

but at a steadily increasing rate. Once more it pays doubly to eliminate the noise before magnification.

The moral of this discussion is one that has been preached since time immemorial in the history of radio, yet its truth is ever timely. Until, at least, some genius gives to the world a successful static eliminator, our salvation lies in selectivity—the selectivity that comes from properly designed circuits with few losses.

Band-pass Advantages

True, care must be taken to avoid cutting sidebands; but with circuits of the order of band-pass filters, that is possible. All "static eliminators" that have had any degree of effectiveness have owed their success chiefly to an unusually high degree of selectivity.

Finally, along with these factors of design, we can always help matters by weeding out noises originating in the set itself.

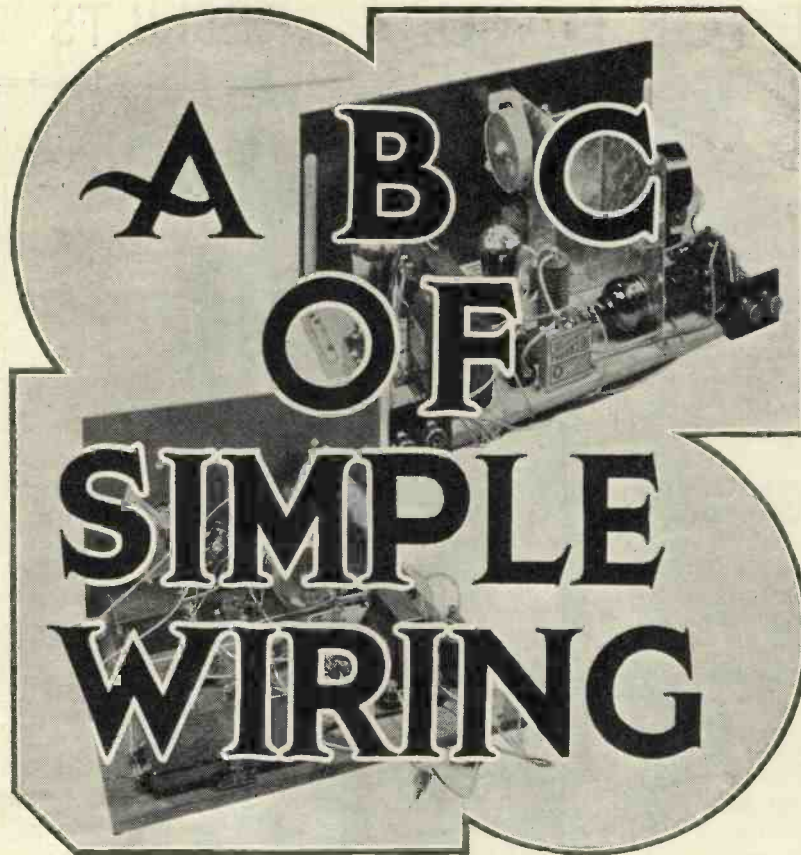

By L. M. WATERHOUSE, A.M. Inst. C.E., M.I.E.E.

THERE is a growing tendency on the part of home constructors to side track the employment of tinned-copper wire and soldered joints in favour of rubber-insulated flexible wires or solid tinned-copper wires, cotton covered and finished with distinctive varnished and enameled coverings.

The question of wiring plays a very important part in the efficient construction of receiving sets and the object of this article is to put before home constructors the result of the writer's experience of flexible wiring after experience with many alternatives.

For Manufacturers

Undoubtedly the solid soldered connection, being an all-metal joint and, as such, electrically and mechanically perfect when carried out by an expert, is invariably employed by manufacturers and, as their sets are intended for permanent use and not for experimental purposes, the conditions are obviously quite distinct from those which influence the home constructor.

Further, the majority of such constructors do not take kindly to sol-

dering and there is really no necessity for them to employ the soldered joint, even when putting up a set for permanent use, as a very efficient and workmanlike circuit can be made by the employment of tough rubber-covered flexible wires.

The tinned-copper conductor consists of 14 wires of .076 in., which corresponds to a No. 22 gauge solid wire. They are then lapped with a single covering of light cotton and either covered with a tough compound rubber covering or a cover of pure and vulcanised rubber. The usual sizes used having an outside diameter of from $\frac{1}{12}$ in. to $\frac{1}{8}$ in., possibly the $\frac{1}{8}$ in. size would be more generally used; the retail price being round about a penny per yard.

The necessary equipment is surprisingly simple and consists of a tapered former about 6 in. long. The writer has found that one of the composition or ebonite tapered penholders makes an ideal tool for this purpose; the only other article required is a pair of scissors.

It will be noticed from the sections reproduced at the different points on the tapered former that an eye can be formed for the requisite sizes

required for the different connections corresponding to the usual sizes of studs and screws used in connection with wireless components.

In every case the diameter of the eye formed should have a reasonable clearance to allow for the flattening and reducing of the diameter owing to the pressure of the terminal when connected up.

Stripping Insulation

Presuming it is desired to connect the grid terminal on a valve to a terminal on a tuning condenser, we can first cut off a length of 2 or 3 feet from our coil of flexible wire and for a 2 B.A. stud should require to strip the insulation for a distance of slightly over one inch.

On no account must this be done by means of a knife or any sharp instrument, as this would invariably result in severing or damaging one or more of the fine strands comprising the wire; this in its turn would prevent the formation of a perfect eye.

It would also probably give rise to a more serious trouble by fouling or jamming the threads on the stud, preventing the formation of the proper contact.

The simplest procedure is to hold the end of the wire in the left hand tightly between the ball of the thumb and the middle joint of the forefinger, as in the sketch, with about $1\frac{1}{2}$ in. of the flexible wire projecting.

Then with the thumb only of the right hand press the wire firmly against the middle joint of the forefinger of the same hand and, turning the right hand slightly towards the left thumb, remove the insulating covering in one piece. With the majority of this wire, it will be found that only reasonable pressure is necessary to effect this.

Unwinding the Cotton

After removal it will be necessary to unwind the thin winding of cotton and cut this off where the insulation ends. It will be next necessary to twist the fine wires together in the direction in which they are stranded until they are uniform and tight.

To form the eye take hold of the former in the left hand and, at the correct position on the taper, press the prepared end firmly between the thumb and the former. With the right hand take one complete turn round the former and, releasing the unsecured eye, hold this between the thumb and forefinger and the right hand. Take

two complete turns round the standing part of the wire and clip off any excess wire that may be left over. The finished eye should appear as shown in the diagrams.

Cutting with Scissors

Having completed the first eye, temporarily slip this on the stud on the valve grid connection and lay the wire along the path which you wish it to occupy and, at the point where it reaches the terminal for its connection on the tuning condenser, allow a further 1/4 in. and clip it at this point with the scissors.

Now remove the temporary contact and proceed to make the eye at this end in the manner already described.

The advantages of connections made in this way are that the flexible wire, being compressible under the pressure of the contact, has a circular section flattened out, resulting in contact over a large area and consequent lowering of resistance.

There is also considerably less tendency for this joint to become

slack than is the case where solid wire is used and, with the growing tendency for the employment of two-volt valves, there is considerable advantage in securing efficient contact throughout the whole of the filament circuit.

The sectioned sketch reproduced below, showing the relative areas in actual contact between a flexible and a circular wire, will clearly demonstrate this.

Connections for wiring by wander plugs and to the various types of terminals employed can be carried out in precisely a similar way, but there will be instances where there will be no need to form the eyes and with wander plugs it will be only necessary to remove the insulation for about 3/8 in.

Where terminals are fitted with grub screws and have unusually large holes it is advisable to double twist the wire back on its standing part to increase its diameter correspondingly.

Wire of this description can be set

to a useful extent where spacing apart is necessary between circuits.

When wires pass through copper or aluminium screens it is necessary to remove all sharp edges and, particularly in cases where the wire has to be deflected after passing through a screen, it is advisable as an additional precaution to enlarge the hole in the screen to about 1/4 in. in diameter and bind the flexible at the point with three or four turns of 1/2 in. black compound tape, so as to make a fairly tight fit.

Use of Washers

In cases where the clamp to terminal is effected by a small brass nut, it is advisable to employ a brass washer between the nut and the wire so as to preserve the strands from injury.

In conclusion it cannot be too strongly urged that the practice of using a knife blade to strip insulation from these flexibles must on no account be resorted to. No damage can occur if the insulation is dealt with in the way described.

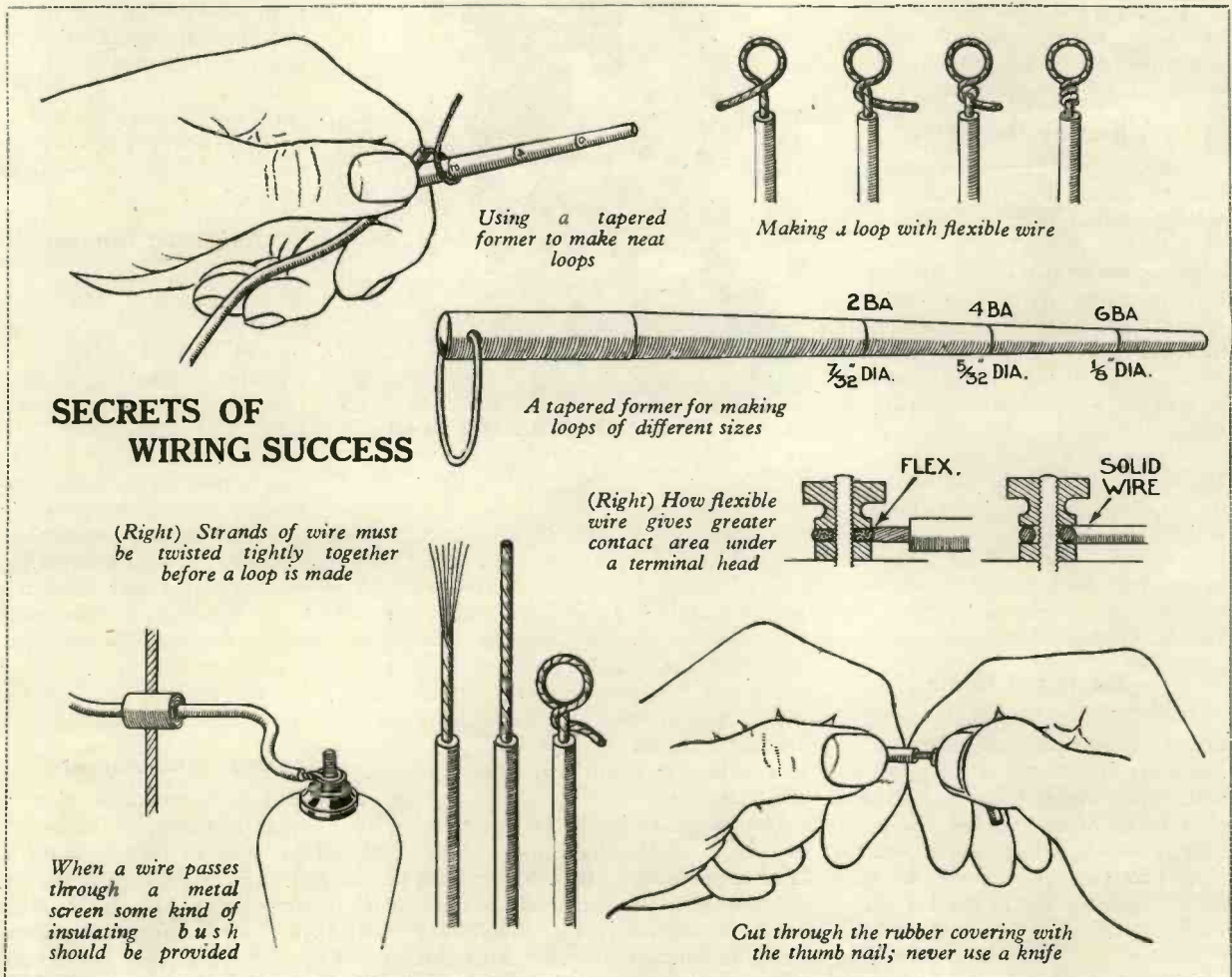

SECRETS OF WIRING SUCCESS

(Right) Strands of wire must be twisted tightly together before a loop is made

When a wire passes through a metal screen some kind of insulating bush should be provided

(Right) How flexible wire gives greater contact area under a terminal head

Cut through the rubber covering with the thumb nail; never use a knife



ALWAYS READY FOR USE

A good portable set is a great convenience. Here you see Vera Lennox and Harold French listening to a McMichael

NOW that the football season has drawn to its close it is a matter of interest to review the unfortunate situation created by the attitude of some clubs to broadcasting.

Affecting the Gates

Some few years ago, when this controversy first arose, the case of the clubs was that their gates would be prejudicially affected by broadcasting, whereupon the B.B.C. set to work to collate such details as were available respecting the attendances at certain matches over a number of years; the view of the B.B.C. being that this excuse was unjustified and capable of being disproved.

In pursuance of its campaign, the B.B.C. challenged the clubs to produce figures relating to matches which had been broadcast in comparison with matches of a similar type which had taken place before broadcasting came to relieve the tedium of thousands of homes.

Staying at Home

The clubs then shifted their ground and declared that if the gate was not affected at the particular match which was being broadcast, it was affected at other matches and probably also at the games of smaller clubs, as people preferred to stay at home and listen to the big clubs' broadcasts.

Evidence is available to show that



A THRILL YOU COULDN'T HEAR

The broadcasting of matches would never stop people from wanting to see thrills of the sort shown above

this argument is equally fallacious. On one day, for example, the B.B.C. relayed the England v. Ireland Rugby match at Twickenham, where the gate was 58,000. On the same day the Chelsea v. Blackburn Rovers game was broadcast and the attendance was 61,000. Simultaneously another big match was taking place in London, at Highbury, where the attendance was 45,000.

Outside London, the matches Southport v. Bradford and Sunderland v. Sheffield United drew record gates, despite the fact that the Chelsea v. Blackburn Rovers match was being broadcast to the Northern

Football Broadcasts

By Our Special Commissioner

Region, a northern club—namely Blackburn—being engaged.

As regards the smaller clubs, the attendances have been found to be fairly constant, whether broadcasting was in progress or not. The attendances at games played by minor clubs which were in difficulty over matters of finance have been followed with especial interest and it was ascertained that on days when the broadcasting of big matches was in progress the gates were about the same as on those Saturdays when no running commentary was in progress.

Increased Interest

In reply to the allegation of financial loss, therefore, the B.B.C. expresses the firm conviction that so far from inflicting a penalty on club funds, broadcasting maintains and strengthens the interest of the public, even to the extent of inducing listeners to go and see games in

which, in normal circumstances, they would only take a casual interest.

The football enthusiast does not enter into the question at all, as probably nothing short of physical incapacity would induce him to stay away from a match that he particularly wanted to see.

Another Vital Aspect

Physical incapacity in the view of Savoy Hill is, however, a vital aspect in another sense of this question of broadcasting running commentaries. Mr. George Allison struck the right note in his introductory remarks at the Cup semi-final match between

Birmingham and Sunderland in March last, when he spoke as follows:—

"The wife of a very good friend of mine came to me this morning and said that her husband had been taken into a nursing home. He asked her to see me and beg the loan of my portable set, as his removal to the nursing home had been quite unexpected and it had deprived him of the chance of seeing the Birmingham and Sunderland match. His only consolation was the prospect of hearing a description of it."

Attendance Impossible

"That," added Mr. Allison, "is a true story which conveys its own moral. It is one very good reason for my being here this afternoon; for my friend's case is unfortunately one of thousands—cases in which it is impossible for those listening to me to be present at this match in person."

This may be said to be the B.B.C.'s case in a nutshell. One of the main appeals of the running commentary is to those who find it impossible to attend matches, through no fault of their own. If the B.B.C. found that it was causing distress and ruin, or affecting the livelihood of any section of workers, it would be the first to review the position with the view of a change in policy. But Savoy Hill knows full well that that is not the case as regards football.

The B.B.C. has evinced a desire to work in co-operation and not competition with football officials; but co-operation must be mutual; and the Corporation would dislike intensely being faced with the necessity of curtailing its services in devoting so much time on Saturday evenings to the announcing of football results because of the absence of co-operation on the part of football officials.

Using the Axe

Savoy Hill has come in for some sharp criticism of late over its use of the axe during broadcasting. But the criticism has been perhaps too comprehensive.

The programme officials have had to deal with the rebukes of listeners who would brook no departure from programme timing; at other times the charge was that the B.B.C. shows itself only spasmodically artistic and that bureaucratic control ends, as one might presuppose, in the ruthless lopping-off of items which ought to be allowed to run their full course, no

matter how long overdue the next item or programme may be in consequence.

It must be admitted that the programmes are to a considerable extent arranged by rule-of-thumb methods; but there is something to be said for this system. Without it, simultaneous broadcasting would become an impossibility; artistes would have to hold themselves at the disposal of the B.B.C. for hours together and regular features would be remarked chiefly for their irregularity.

Listeners may be interested in the B.B.C.'s side of the case so far as one or two recent instances of mistiming are concerned. One incident involved a string quartet which was performing in the studio, with a Hungarian singer. The quartet started precisely on time, but one of its items was the Brahms B flat Quartet.

No previous performance of this work had been given in the studio and so the B.B.C. consulted reference works and found that the piece was timed to take twenty-nine minutes, whereas it actually took thirty-eight minutes in performance.

The singer timed her group as fifteen minutes, but it would have taken about twenty-four had it been allowed to run its full course.

In compiling the programme, the B.B.C. was obliged, in the case of these unknown works, to rely upon timings obtained from reference works and the singer; but it would have been wrong to over-run by eighteen minutes. The only means of handling the situation was, therefore, to omit part of the performances of both singer and quartet; one could not have been penalised without the other.

In another case a violin recital was timed for twenty-five minutes. The artiste, however, had the true artiste's conception of time and arrived at the studio with a pile of items which, it was found, would have run for exactly forty-three minutes. The announcer had no alternative but to suggest drastic "cuts."

In a case like this, where the artiste has a European reputation, the B.B.C. exercises toleration and does not insist on being given advance information by the artiste as to the items of the programme, the length of the engagement only being stated.

The time factor is constantly in the minds of the programme compilers and they are learning by experience that it is better to over-time items rather than allow no margin.

By careful indexing and compilation of records they are gradually making towards a situation where it should be impossible for any serious over-running of musical performances in the studio. In the course of time the necessity of cutting should be definitely eliminated.

Two series of talks mentioned in the arrangements for the summer period will probably provoke criticism in certain quarters by their mere titles. One series entitled "Russia in the Melting Pot" will be an attempt on the part of recent visitors to Russia to describe conditions as they saw them.

Judging India

The other series will deal with existing conditions in India, which will be described in a manner that should enable listeners to form their own judgment on the future of that country.

One cannot describe these talks as strictly controversial; and any suggestion that may be made, as, no doubt, it will be made, that the B.B.C. should give the opponents of Russian activity, or the opponents of the present policy in India, an opportunity of discrediting these broadcasts, may be regarded as based on a fallacy.

To describe by wireless a condition of affairs is not to express a personal opinion upon that condition; nor is it to be accepted as the broadcasting corporation's opinion; nor should it be regarded as an attempt to foist propaganda upon the mass of the listening public.

Broadcasting merely aims to give a comprehensive impression of world conditions to-day and to treat of Russia much in the same manner as it has treated of the United States of America, France, Finland and other countries.

Savoy Hill is Amused

To the officials at Savoy Hill, struggling to cover most of the interests of mankind in as entertaining way as possible, it is amusing, even to the point of being ludicrous, to note that political bias is read into its efforts at programme-building.

This was probably the view taken recently by the House of Lords, when they declined to see eye to eye with the critics who in frenzied passion hurled at the B.B.C. day by day accusations of misfeasance, or something worse.

Compiled by JAY COOTE

A LISTENER'S LOG

IN previous years the advent of the month of May with its longer and brighter days usually spelt a serious shrinking in our daily log, and most of us found that the late spring and the summer months curtailed considerably our choice of foreign broadcasts.

Such, of course, were the conditions when the bulk of transmitters in operation possessed a power of less than 8 to 10 kilowatts. To-day, however, there are so many giants on the air that, even during the brightest of sunny days, long-distance reception has become an easy matter.

Our Range Extended

Germany, France, Norway, Sweden, Belgium, Czechoslovakia, Italy, Poland, Switzerland and Russia are well within the reach of the average three-valver. Moreover, as every month sees new high-power stations launched on the ether, so gradually our range is extended and more European cities are brought to our front door.

At time of writing, in addition to the North Regional transmitter of the B.B.C. system, Switzerland has supplied two further additions to my log. Söttens, a 25-kilowatt situated within easy distance of both Lausanne and Geneva, pours through my loud-speaker musical entertainments from these two studios; hitherto they could only be faintly heard under favourable conditions on headphones.

It is true that Söttens has monopolised the 403-metre channel used by Berne, but this latter station has not been lost, for its transmissions, with those of Basle and Zurich, now pass through Beromuenster, a 60-kilowatt Titan working on 459 metres.

Unfamiliar Calls

Bear in mind, however, that when one super-transmitter acts as the mouthpiece of several cities we must accustom ourselves to somewhat unfamiliar calls.

No longer do we hear exclusively the familiar *Rah-dee-owe Bairn*, but from the same station, in addition, references to *Tzew-risch* and *Bar-zel*, also through Söttens, "Ici radio Suisse Romande" tells us that the programme emanates from Lausanne, "Emissions de Radio Genève" remains unaltered.

By the way, I notice that a lady announcer has been added to the staff of the Lausanne studio and on most evenings it is her voice you will pick up between items in the programme.

The fact that these cities are erecting local relays barely interests us, as the worth-while entertainments are broadcast, without exception, through the two main Swiss national channels.

Later, we may tap the Italian district of Switzerland when the Ente Autonomo di radiodiffusione nella Svizzera Italiana brings the Tessin transmitter into operation.

♦ ♦ ♦

For some unknown reason lately, Juan-les-Pins has loomed up big on my radio horizon and on many evenings I have listened with pleasure to some excellent entertainments relayed from the Palais de la Méditerranée at Nice perhaps, one of the most luxurious Casinos on the French Riviera.

At present Juan-les-Pins is only a small "one-horse" station, but it possesses ambition and already in succession it has added Nice and Cannes to its call.

As authority has now been received from the French Ministry of Posts and Telegraphs to increase the power of the plant I expect that the Radio Côte-d'Azur will assume a service to Antibes, Mentone, Saint Raphael and Monaco (Monte-Carlo), as well as sundry other Mediterranean resorts within (or without!) its reach.

But it will have to shorten its opening and interval announcements or most of the programme time would be wasted in putting out the call!

♦ ♦ ♦

Apparently the innumerable publicity puffs broadcast throughout the Radio Toulouse canned-music entertainments have given local listeners a bad attack of nerves and the French press is up in arms against this excessive use of microphone advertising.

The Frenchman does not say that he is bored; the colloquialism used is "c'est rasant or barbant." This reference to a shave and a beard explains the recent gift of a razor sent to the director of the station. It was

a strong indication of the unknown donor's feelings, but did not, as some reports erroneously stated, intimate that the announcer should cut his throat with it.

It was an unkindly act, but if you do listen to Radio Toulouse you will be quite justified in turning down the volume control of your receiver between items. Reference to fattening or to slimming foods, furniture, H.T. batteries, soaps, perfume and such like permeate the programme.

Until Midnight

The entertainment is now a continuous one and with but a few intervals of the "ding-dong" bell is carried on until midnight. And to think that within a few months perhaps the station will pour out these ads. with a power of some 50 kilowatts in the aerial!

♦ ♦ ♦

Do you ever tune in to Bordeaux-Lafayette? It may not be as well known in Great Britain as Radio Strasbourg, but some of its musical broadcasts are worth hearing. If you do, you may have noticed that the signals from this studio are at their loudest after 7.30 p.m. G.M.T., the reason being that except for the evening transmissions the old 1-kilowatt plant is still being used.

The fact is that many of these French provincial stations are granted ridiculously small subsidies by the French State and their income does not allow them to develop.

£25 A Month!

It is difficult to believe, but it is true, that Radio Montpellier, one of the PTT transmitters, is allowed the princely sum of 3,000 francs (or £25) monthly to spend on its broadcasts. Of this amount the local municipal authorities contribute £8!

♦ ♦ ♦

By the time these notes are in print you may have logged tests by the new Prague (Cesky-Brod) high-power station. It works on 486.2 metres, thus leaving the old Strasnice transmitter to supply an alternative programme on 249.7 metres. As its power, if necessary, can be pushed up to 120 kilowatts, the Czech entertainments will (or should!) figure largely on your daily wireless menus.

We make no apology for reprinting from the March and April issues full constructional details of the Super 60—we are forced to do so because of the amazing interest taken in this receiver by listeners everywhere

THE SUPER 60

Every Detail for Building W. James' Simple Sixty-station Set for £12—the Best Design Ever Presented to the Home Constructor

BY now, everybody must have heard of W. James's Super 60 set. So great has been the public response to this new design that the first two issues describing what the Super 60 is and how it is built have gone right out of print. It is, therefore, necessary to recapitulate the story for the benefit of new readers and for those who desire a ready reference to all the points raised since the Super 60 was first revealed.

First of all, let us make it clear that the Super 60 is a powerful and selective super-heterodyne, providing good quality reproduction from a remarkably extensive number of foreign stations.

Programme Values

With the normal three- or four-valver it is certainly possible to log thirty stations, but only a fraction of this number is usually worth considering as programme alternatives to the local station. Moreover, the reception of a great number of stations is, on many sets, only possible if the operator is an expert knob-twiddler.

The Super 60, a six-valve super-het, is very easy to tune. This ease of tuning is all the more remarkable in view of the fact that stations can be heard on nearly every degree of the dials.

It so happens that each degree on the dial of the oscillator condenser corresponds to roughly 9 kilocycles. In other words, if two stations are separated by only 9 kilocycles they will be logged on adjacent degrees on the dial. For example, one degree below London Regional will be found Graz and one degree above will be found Mühlacker.

No Interference

The extraordinary fact is that, in spite of the great strength of the London Regional, these adjacent foreign stations come in, not merely as loudly and as clearly as the local, but absolutely clear of its interference.

A word or two about the controls of the Super 60: of the five knobs on the front panel two are for tuning, one is for volume control, another changes the waveband range and the smallest one is the on-off switch. The large left-hand dial controls the tuning of an oscillator valve and the right tunes the frame aerial. Although the setting of



the oscillator dial is very sharp the setting of frame-aerial tuning dial is not particularly critical.

In tuning the set it is found that stations are easily "held" because they do not come and go in a fraction of a dial degree, but are heard over an appreciable part of a degree. This is because the tuning is on the band-pass principle, which means that, although a station's signals are confined to the required 9-kilocycle frequency band, they are not cut off sharply on each side of the fundamental frequency of transmission.

In other words, the whole of the modulated frequencies are dealt with and consequently there is no appreciable loss of quality.

How the Set Works

The action of the Super 60 is indeed the action of any straightforward super-het. First of all, the signals picked up by the frame aerial are handed on to an anode-bend detector.

A separate valve is arranged as an oscillator in such a way that energy from it is fed into the frame aerial by means of a coupling coil. The first anode-bend detector, therefore, receives the incoming signal and an oscillation from the separate oscillator valve. In this way the incoming signal is converted into a long-wave signal having a wavelength of 2,400 metres.

Following the anode-bend detector are two stages of screen-grid high-frequency amplification. These stages are tuned by means of special band-pass coils to the pre-determined wavelength

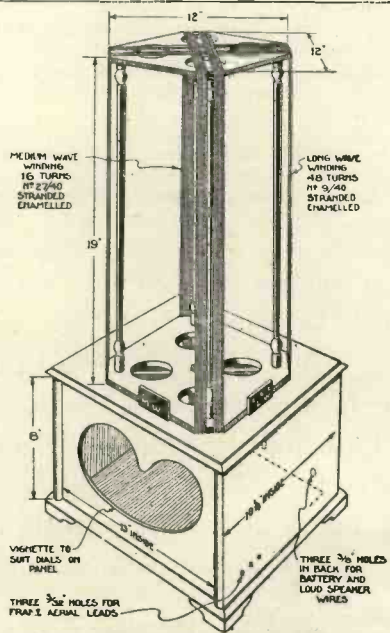

CABINET AND FRAME DETAILS
The compact nature of the Super 60 will be clear from this dimensioned drawing

THE SUPER 60—Continued

MEDIUM-WAVE STATIONS RECEIVED ON THE SUPER 60					LONG-WAVE STATIONS				
All stations received on the evenings of January 26 and 27 at good loud-speaker strength in South London.					Wavelength	Station	Country	Oscillator	Frame
Wavelength	Station	Country	Oscillator	Frame	Wavelength	Station	Country	Oscillator	Frame
217	Königsberg	Germany	58	35	1,060	Oslo	Norway	125	105
221	Helsinki	Finland	59	36	1,155	Kalundborg	Denmark	135	116
224	Cork	I.F.S.	62	39	1,304	Moscow	Russia	150	130
227	Cologne	Germany	64	45	1,348	Motala	Sweden	155	137
230	Malmö	Sweden	65	44	1,411	Warsaw	Poland	160	140
232	Kiel	Germany	63	47	1,446	Eiffel Tower	France	162	144
239	Nürnberg	Germany	71	50	1,554	Davenport, 5XX	Great Britain	173	160
242	Belfast	Ireland	73	51	1,635	Zeesen	Germany	177	163
248	Juan-les-Pins	France	76	55	1,725	Radio Paris	France	180	170
257	Hörby	Sweden	80	59					
259	Leipzig	Germany	81	61					
261	London National	Great Britain	84	65					
263	Moravska Ostrava	Czecho-Slovakia	85	65					
265	Lille	France	86	68					
276	Halsberg	Germany	91	73					
279	Bratislava	Czecho-Slovakia	93	74					
296	Turin	Italy	100	82					
299	Huizen	Holland	102	85					
301	Aberdeen	Great Britain	104	86					
304	Bordeaux	France	105	87					
310	Cardiff	Great Britain	108	90					
322	Göteborg	Sweden	112	95					
325	Breslau	Germany	114	97					
338	Velthem-Louvain	Belgium	118	101					
342	Brunn	Czecho-Slovakia	120	102					
345	Strasbourg	France	121	106					
349	Barcelona	Spain	122	107					
352	Graz	Austria	124	109					
356	London Regional	Great Britain	125	111					
360	Mühlacker	Germany	123	113					
364	Algiers	North Africa	128	114					
372	Hamburg	Germany	130	117					
376	Manchester	Great Britain							
380	L'vov	Poland							
385	Toulouse	France							
390	Frankfurt	Germany							
397	Belgrade	Jugoslavia							
399	Glasgow	Great Britain							
403	Berne	Switzerland							
409	Katowice	Poland							
413	Dublin	I.F.S.							
416	Rabat	North Africa							
418	Berlin	Germany							
424	Madrid	Spain							
431	Belgrade	Jugoslavia							
435	Stockholm	Sweden							
441	Rome	Italy							
466	Lyons	France							
473	Langenberg	Germany							
479	Midland Regional	Great Britain							
487	Prague	Czecho-Slovakia							
501	Milan	Italy							
509	Brussels No. 1	Belgium							
516	Vienna	Austria							
533	Munich	Germany							
542	Sundsvall	Sweden							
550	Budapest	Hungary							

of 2,400 metres. The incoming signal is, therefore, changed to 2,400 metres by the action of the first detector and oscillator valve and is amplified by the two intermediate stages. The greatly magnified signal is then handed on to the second detector valve, which is transformer-coupled to a power valve in the usual way.

Fixed Intermediate Tuning

The great advantage of this system is that the high-frequency amplification is done on a wavelength that permits of stable and very considerable signal amplification. A further advantage is that the long-wave amplifier has fixed tuning without the need for ganged condensers and other complications. Moreover, this intermediate long-wave tuning does not mutilate the quality owing to the band-pass action of the coils.

No matter what the wavelength of

the incoming signal may be, its frequency is changed by the first two valves to the frequency of the intermediate amplifier. To do this one simply adjusts the oscillator until signals are heard at maximum strength, indicating that the local oscillation and the incoming oscillation have combined to produce a wavelength of exactly 2,400 metres, namely the fixed wavelength to which the intermediate amplifier is tuned.

Suppose the station desired is transmitting on a wavelength of 300 metres, corresponding to a frequency of 1,000 kilocycles. The oscillator is adjusted to beat with this frequency and to produce a new frequency of 126 kilocycles, corresponding to a wavelength of 2,400 metres.

Now it happens that the oscillator can be adjusted to two frequencies to produce the desired intermediate frequency. One oscillator frequency can be 1,000 kilocycles plus 126 kilocycles and the

other oscillator frequency can be 1,000 kilocycles minus 126 kilocycles.

This means that, when tuning the set, the oscillator condenser can be adjusted to two alternative points to produce the necessary long-wave signal. One oscillator frequency will be above that of the station required and the other below.

From the diagrams it will be seen that the frame aerial has a centre-tap. This is introduced so that the local oscillations can be injected into the frame winding at sufficient strength to produce the super-heterodyne effect. This centre tapping of the frame winding also has the effect of stabilising the circuit.

Great Reserve of Power

Although the Super 60 has a very great reserve of power, an efficient frame aerial is an advantage from the point of view of signal strength. Such a frame also assists in making the set selective. The better the frame the more strong is

During the past two months a number of articles have been published about the Super 60.

If you can get hold of a March copy you should read pages 134 to 144, containing the original constructional details.

In the April issue read pages 248 to 256, containing additional notes by W. James, "Points That Are Asked About the Super 60" and "Building the Super 60 With Alternative Parts"; also read "Test Reports

on the Super 60" on pages 322 and 324.

In this issue, do not overlook "Short Waves on the Super 60" on page 374, and "What the 'Daily Express' Said About the Super 60 and What 'W.M.' Readers are Doing With It" on pages 396 to 399. Elsewhere will be found details of a special portable edition of the set.

Remember that next month W. James will present details of an A.C. model using indirectly-heated mains valves.

**WHAT THE NINE VALVE
HOLDERS ARE FOR**

On the right is a photograph of the Super 60 without its valves and coils. The holders numbered 1 to 6 are for the valves, as follows: 1, oscillator; 2, first (anode-bend) detector; 3 and 4, screened-grid intermediate amplifier; 5, second (leaky-grid) detector; and 6, power valve. In the holder A insert a plain coil, and in holders B and C two coils with flexible leads for connection to the terminals at the tops of the screened-grid valves. For types of valves and coils see the component specification

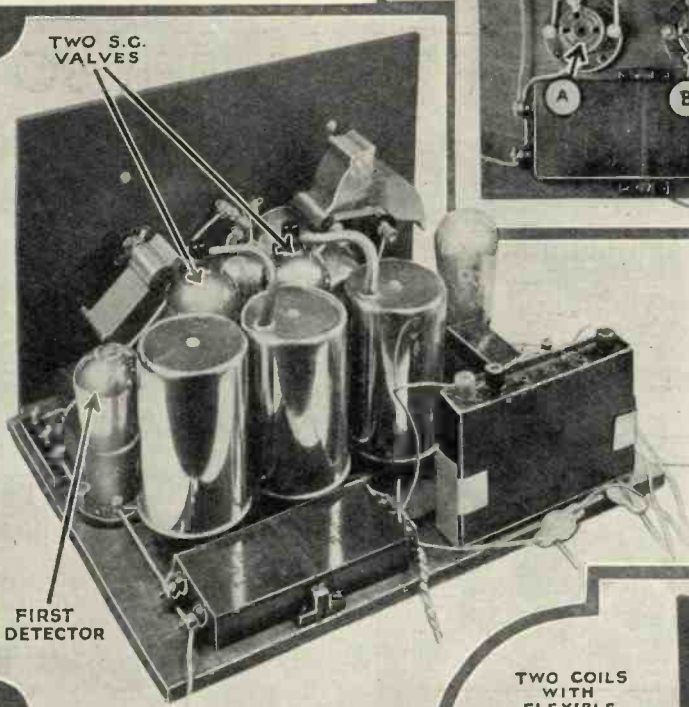
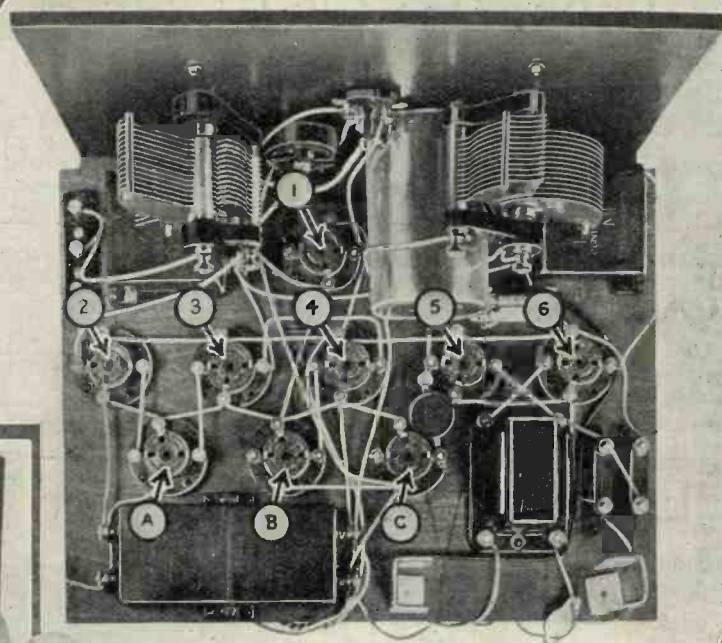

ALL READY FOR USE

Here you see the Super 60 with valves and coils in position all ready for use. The grid-bias battery is mounted at the right-hand end of the baseboard. The other battery connections will be clear from the diagram on page 415. All the coils are matched and the two with flexible leads are interchangeable, so that it does not matter in which holders they are placed. It will be found that the frame aerial is almost entirely non-directional except at its position of minimum strength—a great convenience in operation

**AMAZING PERFORMANCE FOR
ITS SIZE!**

The Super 60 is the best set ever described in WIRELESS MAGAZINE and its performance is all the more remarkable when its small size is taken into consideration. The front panel measures only 12 in. by 8 in. and the baseboard is only 10 in. deep. But, in spite of this, the set is not at all cramped and the wiring can be completed, even by a beginner, without any difficulty. As explained on page 413, a full-size blueprint can be obtained for 1s. 6d. Construction can be completed, even by a beginner, in about three hours. The cost of all the parts is only about £12, including a cabinet, dual-range frame aerial, and valves. A complete list of parts appears on page 412.

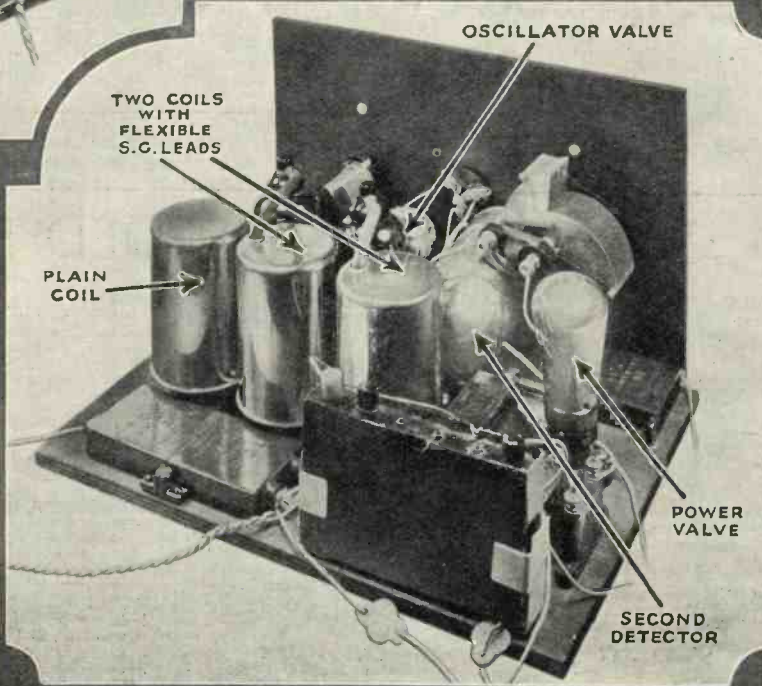

LENGTHS OF CONNECTING WIRES

Connection No. 1	3 1/2 in.
Connection No. 2	2 1/2 in.
Connection No. 3	2 1/2 in.
Connection No. 4	2 1/2 in.
Connection No. 5	3 in.
Connection No. 6	2 1/2 in.
Connection No. 7	2 1/2 in.
Connection No. 8	2 1/2 in.
Connection No. 9	2 1/2 in.
Connection No. 10	1 in.
Connection No. 11	1 in.
Connection No. 12	1 in.
Connection No. 13	2 1/2 in.
Connection No. 14	2 1/2 in.
Connection No. 15	1 in.
Connection No. 16	1 in.
Connection No. 17	1 in.
Connection No. 18	1 in.
Connection No. 19	2 1/2 in.
Connection No. 20	2 1/2 in.
Connection No. 21	1 in.
Connection No. 22	1 1/2 in.
Connection No. 23	1 1/2 in.
Connection No. 24	1 1/2 in.

The length indicated against each number is that of the insulated sleeving needed for each lead. In all cases the wires should be cut about 1 1/4 in. longer than the sleeving to allow for screwing under terminal heads. Use No. 20-gauge tinned-copper wire. If either of the two flexible resistances is too short a piece of wire should be joined to one end to make up the length.

Connection No. 25	1 1/2 in.
Connection No. 26	4 in.
Connection No. 27	2 in.
Connection No. 28	1 1/2 in.
Connection No. 29	1 1/2 in.
Connection No. 30	1 1/2 in.
Connection No. 31	1 1/2 in.
Connection No. 32	2 1/2 in.
Connection No. 33	Flex to H.T.+1
Connection No. 34	Flex to H.T.+2
Connection No. 35	15,000-ohm flexible resistance
Connection No. 36	6 1/2 in.
Connection No. 37	2 1/2 in.
Connection No. 38	2 1/2 in.
Connection No. 39	Flex to G.B.+ about 5 in.
Connection No. 40	Flex to G.B.-1 about 16 in.
Connection No. 41	Flex to L.S.-
Connection No. 42	Flex to H.T.+3
Connection No. 43	Flex to G.B.-2 about 6 in.
Connection No. 44	2 in.

Connection No. 45	Blue lead from oscillator coil
Connection No. 46	4 in.
Connection No. 47	3 1/2 in.
Connection No. 48	Green flex from oscillator coil
Connection No. 49	Black flex from oscillator coil
Connection No. 50	Red flex from oscillator coil
Connection No. 51	White flex from oscillator coil
Connection No. 52	2 1/2 in.
Connection No. 53	20,000-ohm flexible resistance
Connection No. 54	3 1/2 in.
Connection No. 55	5 in.
Connection No. 56	5 in.
Connection No. 57	Flex to L.T.-
Connection No. 58	Flex from L.T.- to H.T.-
Connection No. 59	Flex from L.S.+ to H.T.+4
Connection No. 60	Flex to L.T.+

HERE IS THE CIRCUIT OF THE SUPER 60

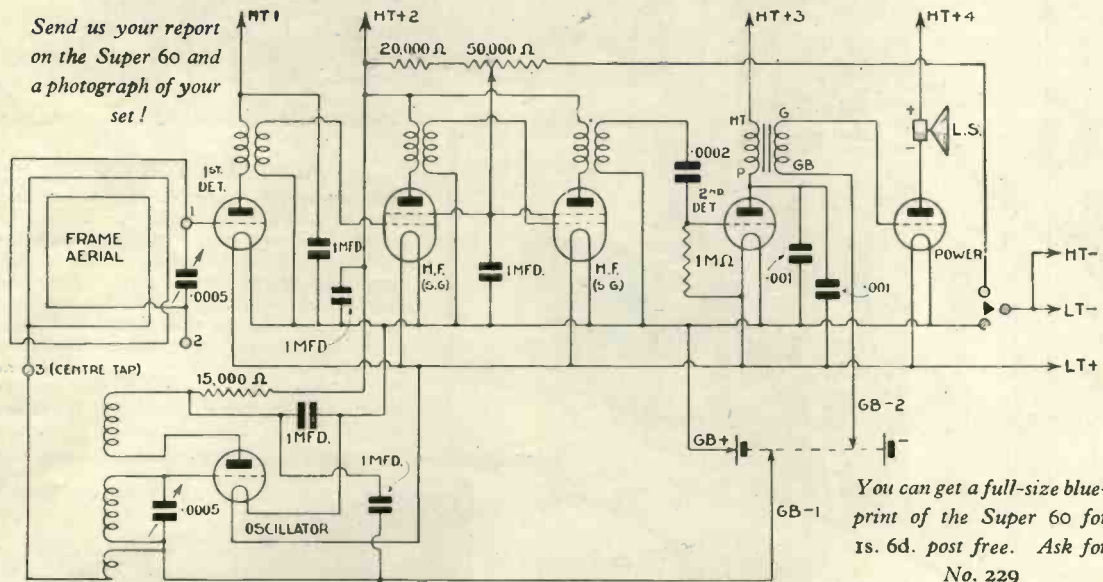

Six valves are used—an oscillator, first (anode-bend) detector, two screened-grid intermediate-frequency amplifiers, second (leaky-grid) detector and power stage. The anode-current consumption is between 10 and 15 milliamperes.

COMPONENTS NEEDED FOR THIS SET

COILS

- 1—Set of 4 Wearite super-hot coils (one O2, two OT2, one OT1). £2 10s.

CONDENSERS, FIXED

- 1—Formo .0002-microfarad, 6d. (or Ormond).
- 2—T.C.C. .001-microfarad, upright type, 3s. 8d. (or Dubilier, Telsen).
- 5—T.C.C. 1-microfarad, type 50, 14s. 2d. (or Dubilier, Franklin).

CONDENSERS, VARIABLE

- 2—Ormond .0005-microfarad slow-motion, type R426, 12s. (or Polar, Jackson).

EBONITE

- 1—Red Triangle panel, 12 in. by 8 in., 6s. (or Becol, Lissen).

HOLDER, GRID-LEAK

- 1—Bulgin, porcelain type, 6d. (or Dubilier, Lissen).

HOLDERS, VALVE

- 9—Telsen, four-pin type, 9s. (or W.B., Lotus).

PLUGS AND SPADES

- 8—Belling-Lee wander plugs, marked: H.T.+4, H.T.+3, H.T.+2, H.T.+1, H.T.-, G.B.+ , G.B.-1, G.B.-2, 2s. (or Clix, Ealex).
- 2—Belling-Lee spade terminals, marked: L.T.+ , L.T.-, 9d. (or Clix, Ealex).

RESISTANCES, FIXED

- 1—Magnum 15,000-ohm, spaghetti type, 1s. 6d. (or Bulgin, Lewcos).
- 1—Magnum 20,000-ohm, spaghetti type, 1s. 6d. (or Bulgin, Lewcos).
- 1—Lissen 1-megohm grid leak, 1s. (or Dubilier, Watmell).

RESISTANCE, VARIABLE

- 1—Rotorohm 50,000-ohm potentiometer, 6s. (or Regentstat).

SUNDRIES

- Tinned-copper wire for connecting. Lengths of Sisto-flex sleeving.
- 1—Set of Cortabs de Luxe.
- 1—Ebonite strip, 2 1/2 in. by 1/2 in.
- 3—Small brass terminals.
- 1—Pair Bulgin grid-bias battery clips, type G37, 9d.

SWITCH

- 1—W.B. three-point 1s. 3d. (or Bulgin, Pioneer).

TRANSFORMER, L.F.

- 1—Ferranti, type AF8, 11s. 6d. (or Telsen, Igranic Midget).

ACCESSORIES

BATTERIES

- 2—Columbia 60-volt triple-capacity type 4780, £1 15s. (or Ever Ready, Pertrix, Drydex).
- 1—Columbia 9-volt, type 4756, 2s. (or Ever Ready, Pertrix, Drydex).

- 1—Exide 2-volt accumulator, type 1CZ3, 11s. 6d. (or C.A.V., Pertrix).

CABINET AND FRAME AERIAL

- 1—Peto-Scott, with dual-range frame aerial, £2 5s. (or Cartico cabinet and Lewcos frame aerial).

VALVES

OSCILLATOR

- 1—Marconi L2/b, 8s. 6d. (or Mullard PM1LF, Osram L2/b).

FIRST DETECTOR

- 1—Marconi H2, 8s. 6d. (or Mullard PM1HF, Osram H2).

S.G. INTERMEDIATES

- 2—Cossor 215SC, £2 (or Mullard PM12, Osram S215).

SECOND DETECTOR

- 1—Marconi HL2/c, 8s. 6d. (or Mullard PM1HF, Osram HL2/c).

POWER

- 1—Mullard PM2, 10s. 6d. (or Cossor 215P).

LAYOUT & WIRING PLAN of the SUPER 60

This diagram is half-scale, but if desired, a full-size blueprint can be obtained for 1s. 6d., post free. Ask for No. WM229 and address your application to Blueprint Dept., WIRELESS MAGAZINE, 58/61 Fetter Lane, London, E.C.4.

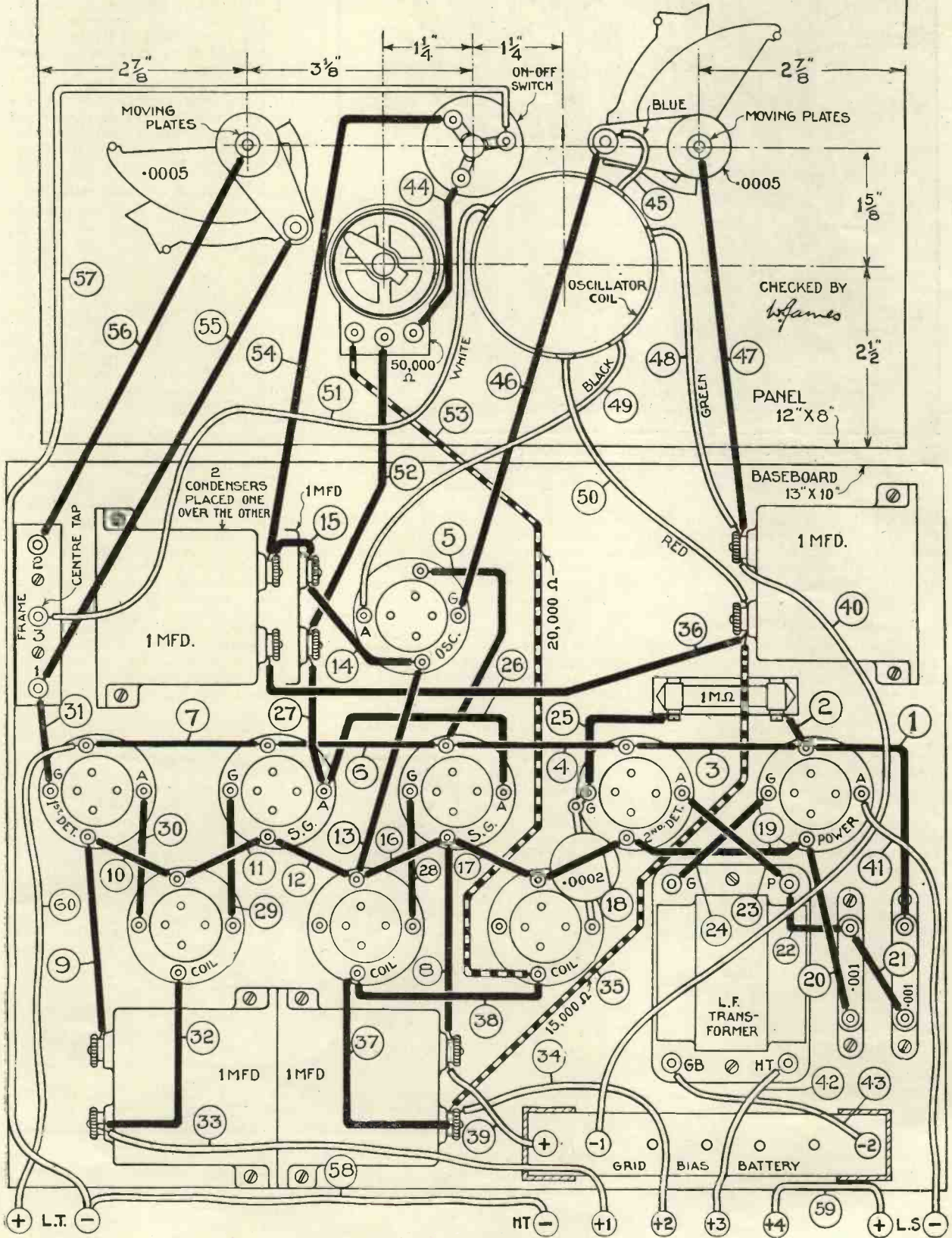

THE SUPER 60—Continued

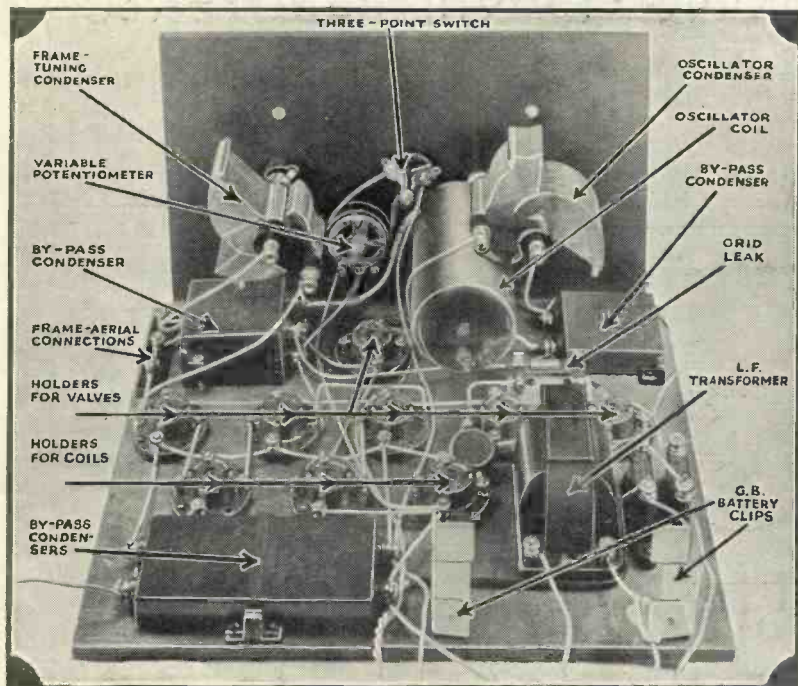

NO DIFFICULTY IN PLACING THE COMPONENTS

This photograph shows clearly the simple type of construction employed in the Super 60. The positions of all the parts will be quite clear

the signal at the beginning. In addition to a strong incoming signal we need a strong local oscillation, such as can be provided only by proper coupling between the oscillator valve and the first detector valve.

Coloured Oscillator Leads

The oscillator unit for this purpose comprises a copper can, inside which are the coils and switch for the three wave ranges, namely ultra-short, medium and long. Coloured flex leads or tags are brought from the coils in the can and taken to the tuning condenser and valve, as shown by the diagrams. In this part of the circuit the 1-microfarad by-pass condenser should be noted.

For the long-wave amplifier three shielded coils are used, two of them with leads coming from the tops for connection to the anodes of the two screened-grid valves. These coil units are fitted with standard valve pins, so valve holders are used to accommodate them on the baseboard. This plan makes for simple construction and is very inexpensive.

Internal "Earths"

As the cans surrounding the coils are internally earthed no external earthing is necessary. In fact, the cans must not be joined to earth externally, neither must they be allowed to touch one another.

Remember that the three long-wave shielded coil units are accurately matched by the makers. All the user has to do is to plug them into valve holders appropriately wired in the set. Ganging and trimming are not needed.

The second, and main, detector valve

of the Super 60 works on the normal leaky-grid condenser system, with a .0002-microfarad condenser and a 1-megohm grid leak. The value of the leak may be still lower, say .5 megohm. Two by-pass condensers are used in the anode circuit of the detector, one going between the anode and filament positive and the other from anode to the negative. To couple the second detector valve to the power valve a normal transformer is used.

The amount of high-frequency amplification provided by the screened-grid valves is so considerable that some form of amplification control is needed. This takes the form of a potentiometer having a value of 50,000 ohms. In series with this potentiometer on the positive side is a 20,000-ohm resistance in order to prevent the possibility of applying too much voltage to the grids of the screened-grid valves.

It will be seen that a three-point switch is fitted; one of the points is connected to the potentiometer and the remaining two go to the filaments and negative low-tension.

This switch, therefore, breaks the potentiometer circuit.

In the Super 60 designed for medium and long-wave reception only, a frame aerial having two separate windings is used, one for the medium wavelengths and the other for the long waves. The outer ends of the winding and the centre tap are taken to separate sets of sockets fitted to the frame. It is easy to connect the frame aerial to the set by means of a three-way plug and three short lengths of flex. It will be seen that the ends of the flex are taken to a small connecting block in the set, fitted quite near the frame tuning condenser.

No Snags in Assembly

As has been emphasised many times, construction of the Super 60 is very simple. Many of these sets have been built up by members of the staff in less than three hours. The simplicity of the layout undoubtedly accounts for the fact that there are no snags in the assembly.

Briefly, we can say how we set about the construction of the original model. Firstly, the parts were arranged on the baseboard in accordance with the numerous diagrams reproduced here. The fixed condensers, be it noted, are laid flat, as this plan enables the wiring to be kept short.

Fixing the Components

In fixing the valve holders one must be careful to space them accurately, because it is essential that the cans of the coils fitting some of the valve holders should not touch. Next, we fitted the panel components. Here one should be careful in fitting the two .0005-microfarad variable condensers.

There is plenty of room for all the parts, in spite of the fact that the layout is so compact. W. James has stated that as the set is so straightforward he has no objection to slight departures from the original layout, such as might be necessary to accommodate alternative components.

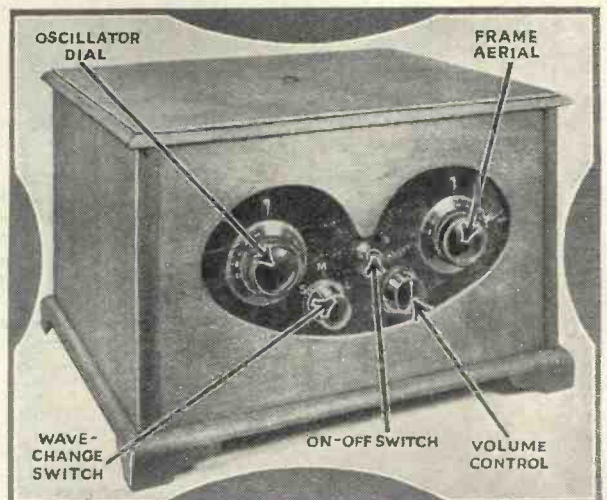

HOW THE CONTROLS ARE ARRANGED

So simple are the controls that the Super 60 is no more difficult to operate than the average three-valve set

HOW TO CONNECT THE FRAME AERIAL, BATTERIES & LOUD-SPEAKER

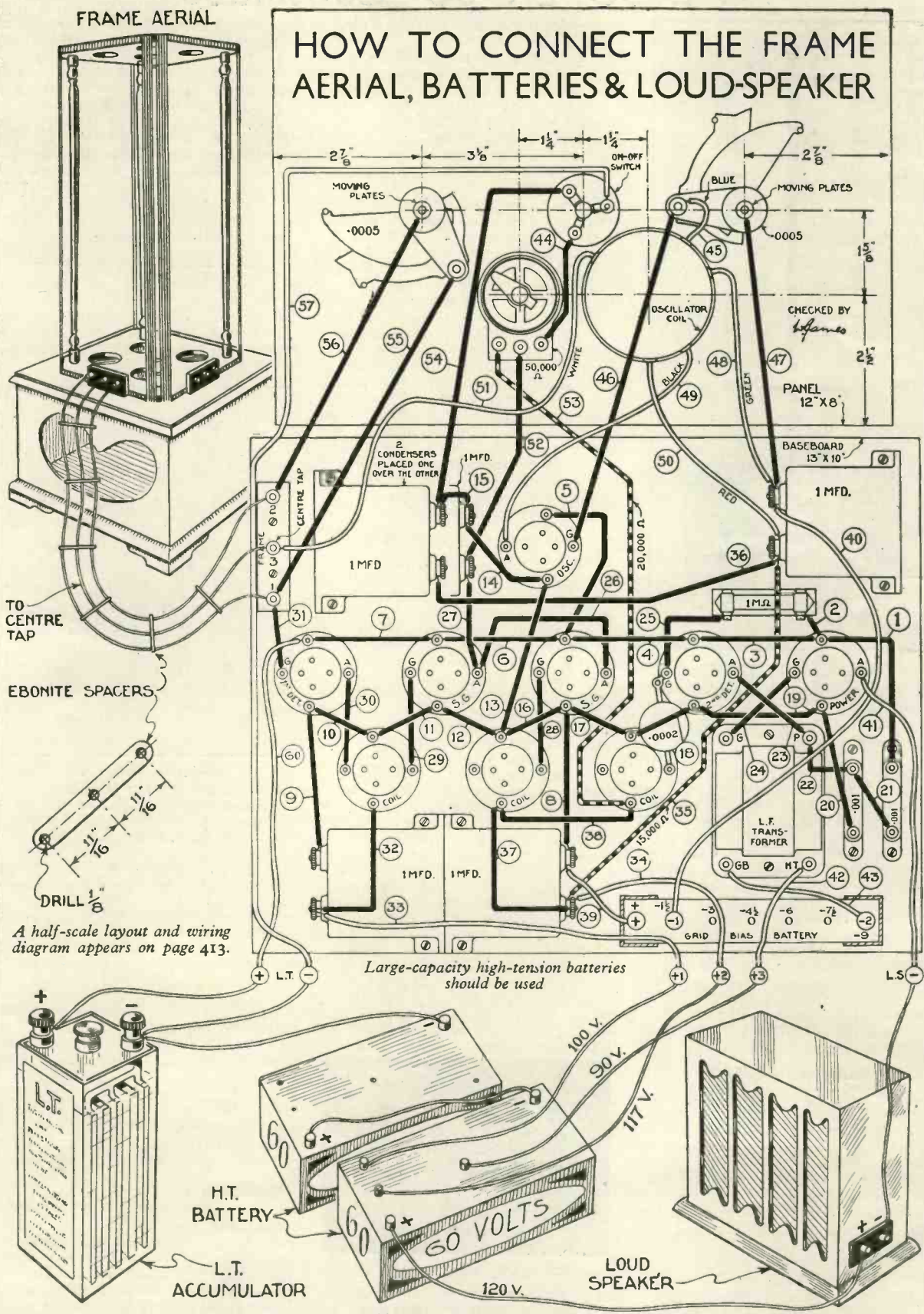

A half-scale layout and wiring diagram appears on page 413.

THE SUPER 60—Continued

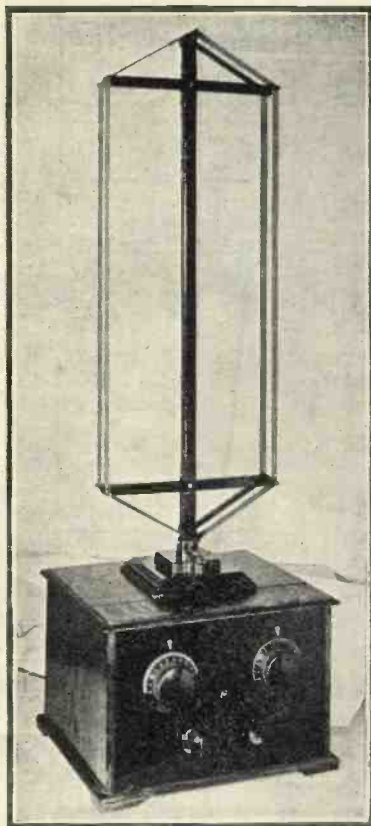

ALTERNATIVE FRAME

Here is the Super 60 built up with alternative parts and used with a Camco cabinet and Lewcos aerial

A point to note is that battery terminals are dispensed with, because the battery leads are taken from the components concerned. Each lead should be fitted with identifying plugs or tags to avoid confusion later on.

In the original model W. James used the following valves: Oscillator, Marconi L2/B (10,000 ohms, amplification factor 15). The first detector, which is at the right-hand end of the set when looking from the front, is a Marconi H2 (35,000 ohms and 35). For the two long wave-length amplifying stages the Cossor 215SG type of valve was used. For the second detector, that is the second valve from the left-hand end, a Marconi HL2/C valve was used and for the power stage a Mullard PM2.

Independent Test

In the independent test of the Super 60 super-capacity batteries were used with the valves specified above. For this test reception the operation was as follows: After pulling out the on-off switch the wave-range switch was set to the centre position for medium-wave reception. Later, it was turned to the right for long waves. If the ultra-short waves are wanted this switch should be turned to the left, as explained in the notes, elsewhere in this issue, on adapting the Super 60 for short-wave reception.

Having set the switch to the medium

waves and having seen that the medium-wave frame aerial, with its centre tap, was connected to the three terminals provided near the first detector valve, the real operation started. The oscillator condenser was adjusted first to 50 degrees and then the frame condenser was rotated until an unmistakable but characteristic "rushing" was heard. This sign of "liveliness" provided the operator with the relative settings of the two tuning controls, that is the frame tuner on the right and oscillator tuner on the left.

As the set was tried with both Lewcos and Peto-Scott frame aerials, it was found that, owing to their slightly different inductance values, the frame condenser readings varied, but the oscillator settings were identical with both frames.

Here it should be pointed out that the log of stations received is merely indicative of the powers of the set and so far as the actual dial settings are concerned should be taken only as a guide.

Since the original article on the Super 60 was published we have received hundreds of letters from enthusiastic constructors, who have raised many points of general interest.

Quality of Reproduction

It has been asked whether the quality of reproduction with the Super 60 suffers in any way from the fact that the super-heterodyne principle is used. The answer is that with the components used in the original design quality is everything that could be desired. The band-pass action of the intermediate coils reduces the usual high-note loss considerably. Any loss of high notes is in any case counteracted by the rising curve of the low-frequency transformer, so that the overall response is satisfactory.

Several constructors have asked whether a gramophone pick-up can be added to the Super 60. It is the opinion of W. James that a pick-up switch would spoil the efficiency of the set for radio reception. If the constructor desires to do so at his own risk, a pick-up switch can be fitted into the grid circuit of the second detector valve in the usual way. It is a much better plan to use a separate gramophone amplifier.

Many people have asked for a Super 60 working with indirectly-heated A.C. valves. There are several snags to be overcome before this alteration can be recommended. W. James is at present working on an A.C. version of the Super

60 and it is hoped that the June issue of WIRELESS MAGAZINE will contain full details.

Arising out of this question of mains working is the need for earthing a mains unit should it be used instead of a high-tension battery. There is no direct earth on the Super 60, as this might affect the directional properties of the frame aerial. As a matter of interest we would remind readers that W. James has tested the Super 60 with a number of mains units to take the place of the high-tension battery.

A.C. High-tension Units

We can recommend the Regentone model W5 (with trickle charger), the Junit type 150/4AC, the Philips 3009 (which gives grid bias), the Atlas type AC188 (with trickle charger) and the Ekco 1V30.



OSCILLATOR COIL

Some of the Wearite oscillator coils are now supplied with coloured tags instead of coloured leads. Wires can easily be attached

If it is desired to use the Super 60 with a moving-coil loud-speaker a super-power valve in the output stage is recommended, such as the Mullard PM252, with the appropriate output transformer to match its impedance with that of the moving-coil loud-speaker.

Best Set Yet

Numerous readers have asked whether the Super 60's performance is likely to be better or worse in outlying districts, such as Cornwall and parts of Wales, than in London. The answer is that the Super 60 has a great reserve of high-frequency amplification and while no extravagant claims are made it is confidently stated that the Super 60 does better than any other home-constructed set.

Lastly, as the Super 60 has created such a very great interest, it is natural that many non-constructional readers have become interested in its possibilities. Such readers will be glad to know that completely assembled sets are now available from firms advertising in WIRELESS MAGAZINE.

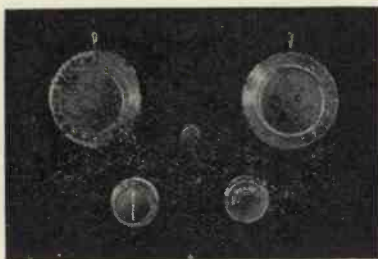

PANEL CONTROLS

How the panel controls can be spaced out if no panel vignette is used



A RADIO FAN'S CAUSERIE CONDUCTED BY BM/PRESS

Praise for the Neut.

MY recent remarks on screen-grid valves versus neutralised triodes for high-frequency amplification have led a number of readers to take up their pens and express their opinions on the subject.

A trader at Prestwich (Manchester) writes to say that he has been testing a six-valve set with three high-frequency stages. When neutralised triodes were used Manchester was cut clean away from Toulouse and Hamburg was also received quite clear of interference. London National was separated from Moravska Ostrava, and Prague and Langenberg from Midland Regional.

When screen-grid valves were substituted for the triodes Manchester swamped Toulouse and Hamburg, and London National spread as far as Horby on one side and Heilsberg on the other.

This reader did find, however, that the amplification with the screen-grid stages was somewhat greater and necessitated the use of an additional volume control.

A Good Bag

Mr. P. J. Stephens of East Finchley believes that a neutralised triode is as good if not better than a screen-grid stage. He says: "I seem to get better stability, selectivity, and sensitivity, being able to pull in over fifty stations (all loud-speaker strength) any night, even though my aerial is screened."

I note from the circuit diagram

Mr. Stephens sends me that he takes his high-tension supply direct from the D.C. mains.

Kidston's Radio

Lt.-Com. Glen Kidston's flight to South Africa interested me more than most such stunts because he carried a radio operator with him.

The operator was Mr. T. A. Vallette, a Marconi engineer, and the set a standard Marconi AD18a aircraft receiver.

I was surprised to learn that it is only a three-valver, with a screen-grid stage, leaky-grid detector, and transformer-coupled low-frequency stage. The wavelength range is 300 to 1,800 metres.

Coincidences

Is radio really so cut and dried nowadays that nobody has any really strange experiences? Such seems to be the case, for only one reader has replied to my invitation for accounts of peculiar radio happenings.

Mr. S. W. Dixon writes to say that one evening he idly tuned to Hilversum and hit on what must have been a kiddie's school lesson. A voice said: "Now say this after me: 'This little girl has been to the barber's and had her hair cut.'"

A chorus of voices repeated the phrase, and Mr. Dixon's little daughter, who was standing by his side, was dumbfounded. How did they know that *she* had just come back from the barber's?

"Ghastly"

On another occasion Mr. Dixon struck Chopin's *Funeral March* on the long waves. Liking its beauty, he listened and noted the reading on account of the clarity.

"Now the strange part," adds my correspondent. "Three times later during the evening, at long intervals, I tuned in at the same spot and heard just the same tune. Coincidence and ghastly."

Can anybody beat these two interesting experiences, which Mr. Dixon states are "gospel"?

Mains in the U.S.

I had thought that battery-operated sets were almost extinct in the United States until I came across some authoritative statistics on the subject the other day.

The report I saw was to the effect that of the 29,000,000 homes in America 20,000,000 have electric power, but of these only 7,700,000 have mains radio sets. There are said to be 2,300,000 farms in the States with battery sets.

It is certainly an eye-opener to learn that the number of all-electric sets in use is less than 50 per cent.

Batteries or Mains?

I am still getting quite a lot of correspondence on the battery versus mains question. One reader writes: "I see a Romsey reader's policy is 'Battery always, no hum.' Well, you can tell him from me that if the

RADIO MEDLEY—Continued

mains unit is adequately smoothed and in some cases where H.F. ripple is experienced, a heavy-duty H.F. choke can be inserted in each of the mains leads, a background as silent as battery operation can be obtained."

Another reader at Hanwell is in trouble with a commercial unit which he describes as "a poor success and a disappointment." Apparently it has a habit of surging up and down and has two variable tapings, the resistances being of the type one can turn without apparently coming to a stop!

From Scotland

Mr. T. Gillespie, of Glasgow, has come to the conclusion that mains operation is the thing. He has just built a three-valve A.C. set with which the results are amazing.

"Previously with a battery set," he says, "to enjoy quality one had sparingly to use a super-power valve, but now the latter on the mains is both able to give and sustain quality."

"Have had three battery sets and am now running my second all-mains, which gives better reproduction, greater power (range) and eliminates all trouble," writes Mr. H. N. Pilley, of Leicester. He considers the extra outlay for an all-mains set money well spent.

Slight Hum

Mr. E. N. Ramsbottom, of Lytham, who puts after his name the letters "M.D., B.Sc., etc." and so can be expected to know what he is talking about, says that he does not like A.C. valves on account of a slight hum.

He has two sets in use, a simple four-valver for family use and a powerful "five" recently built for experimental work. High-tension accumulators are used for the family set and a Marconi mains unit for the large five-valver.

The background with the accumulator is quieter than with the mains unit, but Mr. Ramsbottom prefers mains high tension for efficiency.

Miserable Quality

Mr. T. M. Pearce, of Folkestone, is another who seems to have been unlucky with mains sets. He tried a D.C. set with three screen-grid stages, detector, and power valve, and found that it gave miserable quality.

The same set, however, run from 190-volt high-tension accumulators

gave splendid results, but the batteries must be charged fully every three weeks. Mr. Pearce has a home-charging board for this purpose.

"I perhaps speak with prejudice," says Mr. H. W. Hodges, of Twickenham, "as I am using 210 volts on the final stage with 100 milliamperes on two LS5A's in push-pull."

Mr. Hodges is enthusiastic about high tension from the mains—provided the mains are A.C. With his six-valve set quality is perfect and with the volume for an ordinary room hum is non-existent.

Feeling Against D.C.

There seems to be a general feeling against D.C. mains for Mr. F. G. Styles, of Hanwell, writes: "I unhesitatingly advocate the all-mains type of set, provided A.C. is available."

Mr. Styles uses a modified kit set with A.C. valves. "By a very slight alteration in the wiring and the addition of automatic grid-biasing on the high-frequency valves," he writes, "I have effectively eliminated battery troubles and messy accumulators, with the result that I am getting excellent results from an A.C. moving-coil loud speaker with separate rectifier, and only the most minute trace of hum."

I particularly appreciate his final comment: "Lastly, but not least, one has the certain knowledge that the juice is always on tap, and one has not the mental strain of inventing painful apologies when friends drop in for a trip round Europe."

For Low Tension as Well

"I have used D.C. (230-volt) mains for over four years now, always on home-made sets varying from three to seven valves. I cannot understand why anyone should want to use batteries!"

Thus writes Mr. G. B. G. Chapman, of Grimsby, who adds that he has also always used the mains for low-tension as well as high-tension supply. For the former he arranges to balance the input through a resistance to a small accumulator. This accumulator has been in its cabinet untouched for over four years now, and does "not seem to have suffered much."

He adds: "The above arrangement is now working perfectly on the James' Super 60—a truly remarkable set."

More D.C. Trouble

From Worthing, Mr. Darby writes to give his mains experiences and also those of two of his friends using the identical high-tension "gadget."

It seems that all of them have had trouble with a particular make of commercial D.C. unit. In less than six months all of them have been sent back to the makers, two of them twice and one (his own) three times for overhaul and adjustment.

"I can only conclude that D.C. juice is the cause of the trouble, in this town at least," says Mr. Darby, "as I know of sets of the same make in use in London giving entire satisfaction."

This experience, I think, must be extremely rare, and it seems hardly possible that the trouble is an ordinary one although, as I have remarked before, there does seem to be a feeling that D.C. apparatus is not nearly as satisfactory as A.C. gear.

My Super 60

Since I wrote that I intended to run a Super 60 from D.C. mains (for high tension only) and with push-pull output for gramophone work, I have been getting into hot water.

Mr. James has stated that he does not recommend the use of a pick-up with the original set because of the long grid lead to the detector that would be unavoidable. Now some people want to know how it is that I can use a pick-up if Mr. James cannot.

The point is that a pick-up can be used if the layout of the set is altered a little to keep the wires short, and at present I am experimenting in this direction.

Mr. Frank K. Ball, of Weston-super-Mare, is also going to build a Super 60 with push-pull output. He will use eight valves altogether.

Pick-up Connections

This constructor is at present using a straight three-valver with two transformer-coupled low-frequency stages. Great purity is obtained by using two super-power valves in push pull.

"But," continues Mr. Ball, "I think the secret of the set is due to the method of placing the pick-up, which is across the primary of the first transformer and volume control across the secondary.

(Continued on page 420)

SAVE MONEY AND TROUBLE

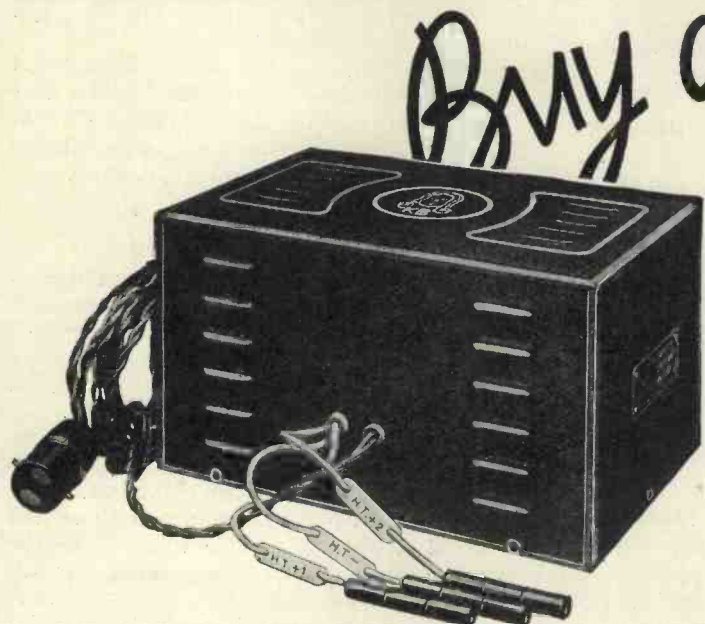

K-B H.T. SUPPLY UNIT

The K.B. PUP RECEIVER has proved an outstanding success. Complete with Speaker, Valves and Batteries (inc. Royalties)
£5.3.9

KOLSTER-BRANDES H.T. Supply Units are the most economical means of obtaining H.T. Supply from either A.C. or D.C. electric supply mains; they overcome the necessity and continual expense of H.T. Batteries. With a K.B. Unit the H.T. Supply remains constant and the performance of the receiver consistently good. Just as the K.B. Pup Receiver has set a new standard in radio value, so are K.B. Units creating new ideas of eliminator value.

There is a model to suit any kind of Battery Receiver.

- K.B. 262 D.C. ELIMINATOR, 120 volt at 10 milliamperes ... **£1.9.6**
Or 3/- down and six monthly payments of 5/4.
- K.B. 263 D.C. ELIMINATOR, 150 volt at 30 m/a ... **£2.10.0**
Or 5/- down and six monthly payments of 8/9.
- K.B. 261 A.C. ELIMINATOR, 120 volt at 10 m/a ... **£3.7.6**
Or 7/- down and nine monthly payments of 7/9.
- K.B. 259 A.C. ELIMINATOR, 120 volt at 20 m/a ... **£4.2.6**
Or 8/- down and nine monthly payments of 9/3.
- K.B. 260 A.C. ELIMINATOR, 150 volt at 25 m/a ... **£4.10.0**
Or 9/- down and nine monthly payments of 10/-.

K.B. 261 (A.C.) and K.B. 262 (D.C.) ELIMINATORS, as illustrated, have been specially designed for the famous K.B. Battery Pup.
Ask your dealer for details or send the coupon below.



Kolster-Brandes

INEXPENSIVE RADIO

COUPON

To Kolster-Brandes Ltd., Cray Works, Sidcup, Kent.

Please send me full details of the new K.B. H.T. Supply Units, together with the name of the nearest K.B. dealer.

NAME.....

ADDRESS.....

W.M.r

Advertisers like to know whence the business comes—please mention "W.M."

RADIO MEDLEY—Continued

Metal-coated Valves

I remember years ago, when valve bulbs were made of glass much thinner and more fragile than used nowadays, it used to be a popular thing to discuss the possibilities of valves with metal containers.

As far as I know, nothing has ever come of the idea, but Mullards are producing mains valves with a coating of metal on the outside of the bulb, earthed to the cathode pin.

This coating, I understand, is to be provided with certain screen-grid and detector valves. The object is to reduce mains hum and, with screen-grid types, to reduce the inter-electrode capacity.

The Prince's Radio

Just now the Prince of Wales must be taking more than usual interest in short-wave radio gear because it was used to keep him in constant touch with England during his voyage to and from South America.

A special Marconi short-wave set was fitted to the R.M.S.P. liner *Arlanza*, on which the Prince made the return voyage. This apparatus

supplemented the standard equipment and kept the ship in direct touch at all times with the Post Office station at Portishead, near Bristol.

Bouquets

"After reading your extremely interesting article," says Mr. H. Walker, of Nottingham, "I am trying to write you a line or two." He succeeds very well.

Mr. Walker thinks that the Brookman's Four is the best "four" out. He considers Mr. James "the ace of wireless," and adds: "My wife says she wishes the WIRELESS MAGAZINE came out every week as it is a treat to her to see me so very interested."

Micro Rays

Undoubtedly the most sensational radio development recently was the announcement and demonstration of telephony on a wavelength of 18 centimetres, which is approximately 7 inches.

It does not look as if the new method of communication will be of

any broadcast value; the most important thing about the "micro" rays seems to be their great directional properties.

Still, a cross-Channel transmission with a radiated power of half a watt is certainly startling, and he would be a rash man who overlooked the possibilities that are opened up.

Help Wanted

Many readers must be in the same boat as Mr. H. Barrow, of Hanwell. He has noticed that the Editor offers half a guinea for each photograph of a WIRELESS MAGAZINE set that is published.

"But not yet have I seen hints on how to get the best from one's camera," adds this enthusiast. "I've tried quite a number of times and have always made a hash of it—the snag is it being indoor work."

Now, then, some of you photograph enthusiasts, what about it? I cannot help, but you can. Just drop a line to "BM/PRESS, London, W.C.1."

BM/PRESS

The
Receiver
of the
Year

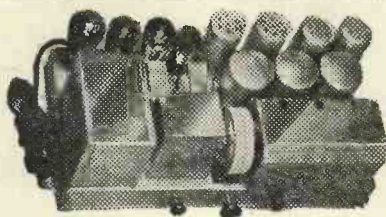

PEERLESS EIGHT

Read the following extracts from the WIRELESS MAGAZINE unbiased test report, contained in the March, 1931, issue:

"Some indication of the tuning range can be seen from the fact that the London National was logged at 10 degrees, London Regional at 35 degrees, and Midland Regional at 73 degrees. Some of the foreign stations were really terrific in strength.

"We obtained the most powerful signals yet experienced from Hilversum at 90 and Oslo at 20. In between we got Paris at 75, Zeesen at 69, and Daventry at 60 degrees. Motala at 45 was unusually strong.

"With the moving-coil loud-speaker supplied, this set gave very good quality reproduction."

The Peerless Eight enables you to enjoy radio reception from your favourite station without fear of cross talk or interference and with perfect tonal results.

Price £36

complete with valves and matched moving-coil speaker.

Write for copy of "W.M." Test Report and full particulars.

THE ROTHERMEL CORPORATION LTD.
24, Maddox Street, LONDON, W.1 'Phone: MAYFAIR 0573/9

Continental Sales Office:

27, QUAI DU COMMERCE, BRUSSELS, BELGIUM.

Preserve your
copies of the
"WIRELESS MAGAZINE"

THE ideal way of keeping your copies of the "Wireless Magazine" is to have them bound into volumes, each with its appropriate index, in the handsome grey-tinted stiff covers which are obtainable, at 2/6 each (inclusive of the index for each volume of six copies), plus postage, 3d. from the publishers.

BERNARD JONES PUBLICATIONS LIMITED,
58-61 Fetter Lane, London, E.C.4

No need to wait! You can get

your **Drydex**

to-day!



The supreme new dry battery by the makers of the world famous **Exide**

RED TRIANGLE GREEN TRIANGLE ORANGE TRIANGLE BLUE TRIANGLE

60 volts 7/ • 66 volts 7/6 60 volts 9/6 • 66 volts 10/6 Triple Capacity • 60 volts 14/- For portable sets? 63 volts 9/-
99 volts 11/6 • 120 volts 14/- 99 volts 15/6 • 120 volts 18/6 105 volts 24/6 • 120 volts 27/- 99 volts - 14/- • 108 volts 15/6

For Grid Bias: *Red Triangle*, 9 volts—1/4, 16.5 volts—2/3, *Green Triangle*, 9 volts—1/9, 16.5 volts—2/9.

Unit Cells for Torches: *Green Triangle*, 1.5 volts—4d, Batteries for Pocket Lamps: *Blue Triangle* 4.5 volts 6d.

Obtainable everywhere from all good dealers.

Exide Batteries, Clifton Junction, near Manchester. Branches at London, Manchester, Birmingham, Bristol and Glasgow.

Dx 16

Advertisers take more interest when you mention "Wireless Magazine"

Convert your plug-in coil set to mains operation

THE GRAMO-RADIO AC3

Advanced design but very simple to construct

DESIGNED BY J.H. REYNER, B.Sc., A.M.I.E.E.



Here are complete constructional details for building a simple three-valve set that takes all its power from A.C. mains. Standard two-pin plug-in coils are used, and therefore many listeners will already have a large proportion of the necessary com-

ponents in their possession. A single switch adjusts the set for long or medium waves or gramophone reproduction; a combined reaction and volume control—something new in the way of components—is also incorporated in this design.

THIS set is a three-valve mains model having one stage of screen-grid high-frequency amplification, followed by a detector and an output valve. As far as is consistent with good practice an attempt has been made to cheapen the design and to simplify it from the point of view of controls so the reader not only has the pleasure of constructing his set, but obtains results comparable with those produced by factory-built equipment.

Layout of Controls

Let us examine the panel for a moment. There are two tuning dials. This has been done deliberately because many readers still prefer individual control as long as there are

only two knobs to operate. In between the control dials, at the bottom of the panel, is a switch. This switch has three positions. In the upper position it connects the apparatus for medium waves. In the middle position long waves are received, and in the bottom position the connections are changed over for gramophone reproduction.

At the top of the panel is one more knob, making four in all. This knob, however, serves three purposes. Its normal position is with the pointer upright. As the knob is rotated to the right, reaction is applied to the detector valve in order to increase the strength on distant stations. As the knob is moved to the left, a volume control is introduced which

cuts down the signal strength on strong stations.

The change over from volume control to reaction is perfectly smooth, since there are no switching operations conducted inside the gadget. By a simple movement one obtains either volume control on the left-hand side of the scale or reaction on the right, with a perfectly smooth graduation from one to the other.

For Gramophone Use

Moreover, there is a third use for this knob. It is so connected that it provides volume control on the gramophone as well as on the radio. What could be simpler?

Let us now turn to the circuit. *(Continued on page 424)*

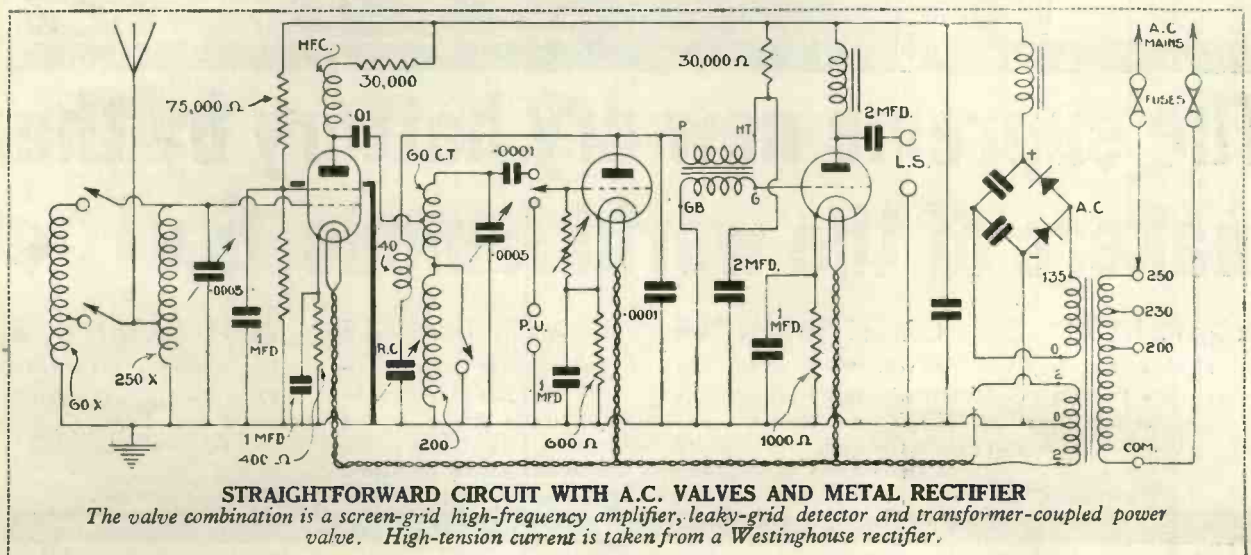

STRAIGHTFORWARD CIRCUIT WITH A.C. VALVES AND METAL RECTIFIER

The valve combination is a screen-grid high-frequency amplifier, leaky-grid detector and transformer-coupled power valve. High-tension current is taken from a Westinghouse rectifier.

WHAT THE MIKE TELLS TO TELSEN-TELSSEN TELLS TO YOU

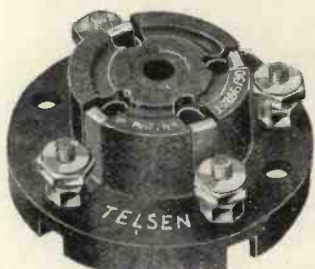

Telsen Four-Pin Valve Holders
Price 1/- each.

TO YOU

Telsen Valve Holders.
Pro. Pat. No. 20286/30.
An entirely new design in Valve Holders, embodying patent metal spring contacts, which are designed to provide the most efficient contact with the valve legs, whether split or non-split. Low capacity, self locating, supplied with patent soldering tags and hexagon terminal nuts.

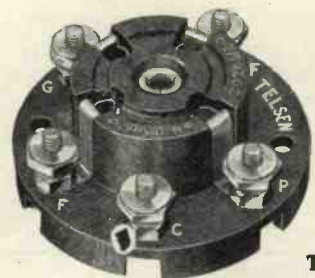

Telsen Five-Pin Valve Holders. Price 1/3 each.

TELSSEN L.F. TRANSFORMERS

- "ACE" - Ratios 3-1 & 5-1 8/6
- "RADIOGRAND" - 3-1 & 5-1 12/6
- "RADIOGRAND" - Super Ratio 7-1 17/6

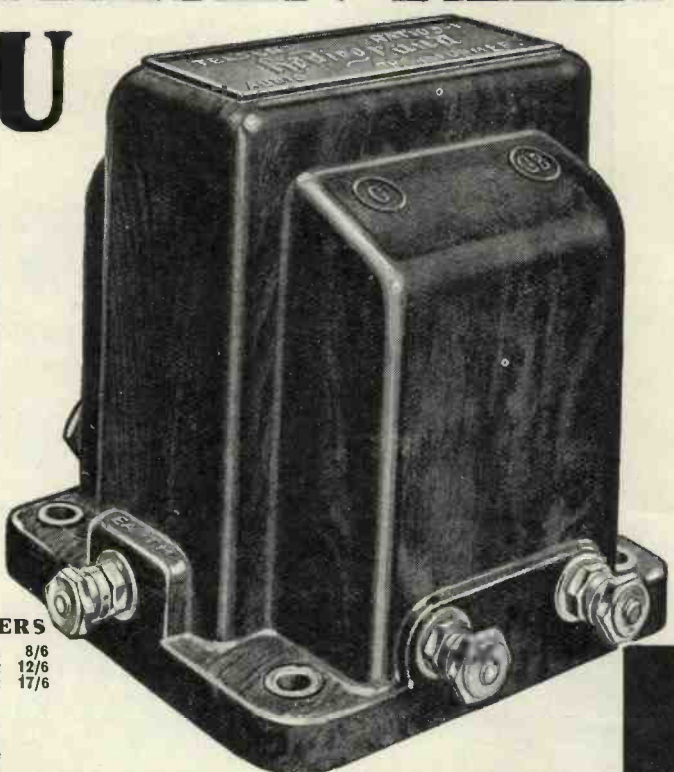

Telsen H.F. Chokes. Designed to cover the whole waveband range from 18 to 4,000 metres, extremely low self capacity, shrouded in genuine bakelite. Inductance, 150,000 microhenries; resistance, 400 ohms. Price 2/6 each.

Telsen Grid Leaks. Absolutely silent and non-microphonic, practically unbreakable, cannot be burnt out, and are unaffected by atmospheric changes. Not being wire wound, there are no capacity effects. Made in capacities: $\frac{1}{4}$, $\frac{1}{2}$, 1, 2, 3, 4, and 5 megohms. Price 1/- each.

TELSSEN Components pass on to you the full perfection of the original—no need to test them—you can rely on the guarantee which is in the name TELSEN . . . As you construct your set you know of at least six points of possible weakness which are safeguarded by TELSEN . . . As you switch on the receiver for the first thrilling test of the completed instrument there is no need to strain forward and 'listen'—you lean back and 'hear' . . . Fit TELSEN Components and safeguard the Key positions of your new set . . .



Telsen Fixed (Mica) Condensers. Shrouded in genuine bakelite, made in capacities up to .002 mfd. Pro. Pat. No. 20287/30. .0003 supplied complete with patent grid-leak clips, to facilitate series or parallel connection. Can be mounted upright or flat. Tested on 500 volts. Price 1/- each.



TELSSEN COMPONENTS

THE GRAMO-RADIO A.C.3—Continued

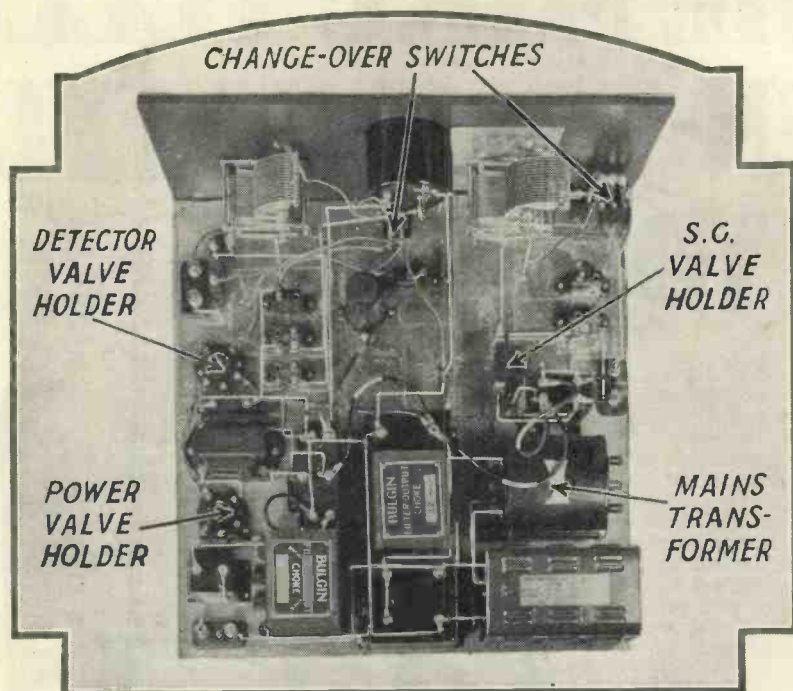

EASY TO LAY OUT AND WIRE UP

This photographic plan view shows clearly how the set is laid out. The wiring will be clear from the diagram on page 426.

Plug-in coils can be used for the tuning, the connections being changed over by means of a switch as already discussed. In the aerial circuit two X-tapped coils are used.

The aerial and the tuning condenser are normally connected to the long-wave coil. For the reception of medium waves, the medium-wave coil is placed in parallel with the long-wave coil and the aerial tapplings on both the coils are also connected in parallel.

Satisfactory Arrangement

This is an arrangement which works very satisfactorily, provided that the tapping points are approximately the same proportion of the full coil in both cases. This is the case with most coils, particularly if two of the same make are employed.

A tuned grid circuit has been employed in the H.F. side, and here a simple shorting-out system has been adopted. The long-wave coil is connected in series with the medium-wave coil and is short-circuited when not required. The anode is tapped

(Continued on page 426)

A NEW W.B. PERMANENT MAGNET MOVING-COIL SPEAKER FOR £4-10-0

So sensitive that any 2- or 3-valve set will drive it—no mains or batteries needed.

Identical with the very successful model introduced earlier this season—only the Darwin Sheffield-made Cobalt steel magnet is not quite so massive.

Hear this new W.B. Moving-Coil Speaker at your dealer's. Ask him for the free colour-folder or write to us direct.

The standard model has a low-resistance winding. A multi-ratio step-down transformer must be used between set and speaker, suitable ratios for the average valve set being between 15 and 25/1.

Made by the Makers of the famous W.B. Cone Speakers, Switches and Valveholders.

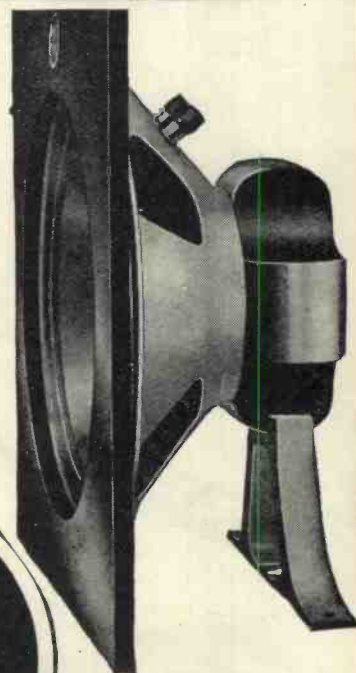

Type P.M.2. Chassis completely assembled with 11½ in. x 11 in. baffle board.

£4 : 10 : 0

A double-ratio step-down transformer can be supplied attached to the Speaker for 15/- extra.

Whiteley Electrical Radio Co., Ltd., Radio Works, Nottingham Road, Mansfield, Notts.
Irish Free State Distributors: Kelly & Shiel, Ltd., 47 Fleet Street, Dublin.

Specified for the "Super 60"

Because of its outstanding efficiency and its high effective amplification the Cossor 215 S.G. is specified for the Intermediate Frequency Stages of the "Super 60." Greater effective amplification is definitely ensured by the New Cossor Screened Grid Valve. This is due to its minute inter-electrode capacity which has been reduced to the order of .001 micro-microfarads—lower than that of any other Screened Grid Valve on the market. Because of this and because grid current has been eliminated the use of this new Cossor Valve will considerably increase the efficiency of your Receiver.

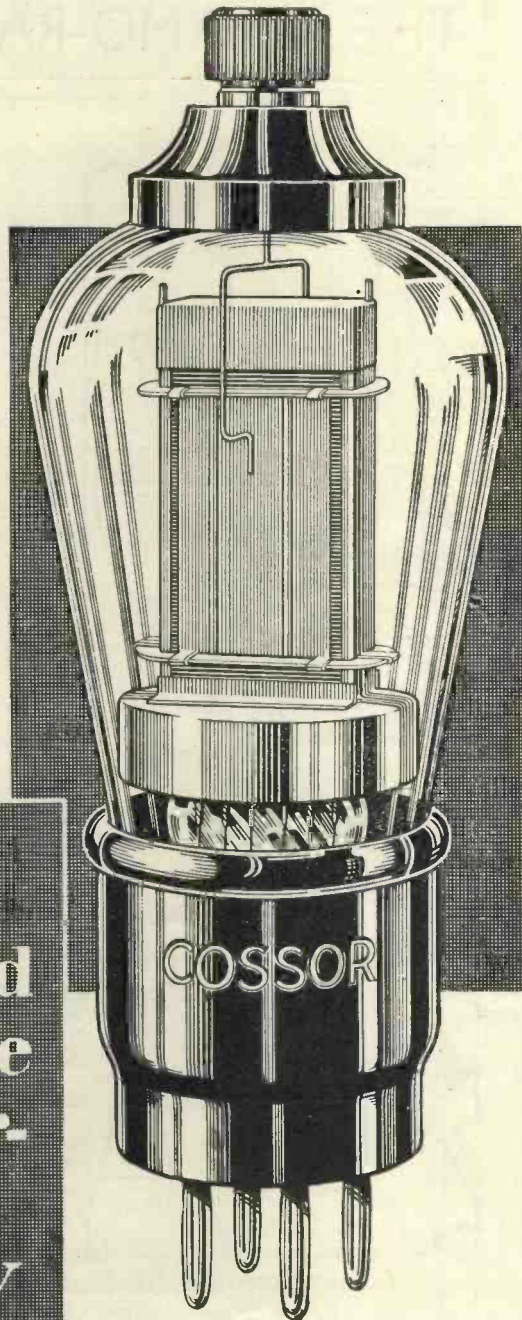

The
Screened Grid
valve with the
lowest inter-
electrode
capacity

Cossor 215 S.G. 2 volts,
15 amp. Impedance
300,000 Amplification
Factor 330. Mutual
Conductance 1.1 m.a./v.
Normal working Anode
Volts 120. Positive
Voltage on
Screen 60-80
Price . . . **20/-**

Use these valves in your "Super 60"
and ensure maximum results:—

Oscillator	Cossor 210 L.F.
First Detector	Cossor 210 H.L.
S.G. Intermediates	Cossor 215 S.G. (2)
Second Detector	Cossor 210 H.L.
Power	Cossor 215 P.

The above Cossor Valves are obtain-
able from any Wireless Shop.

THE NEW
COSSOR
215 S.G.

G R E A T E S T E F F E C T I V E S T A G E G A I N

A. C. Cossor Ltd., Highbury Grove, London, N.5.

8199

It helps us if you mention "Wireless Magazine"

THE GRAMO-RADIO A.C.3—Continued

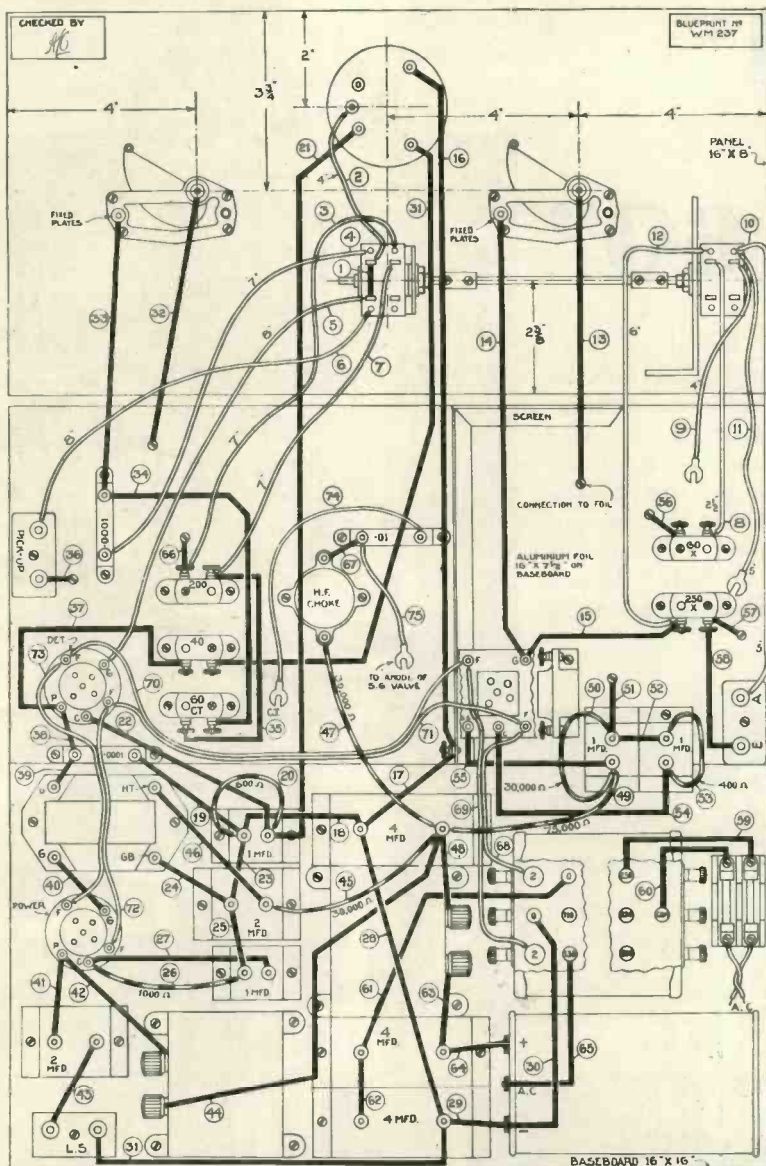

LAYOUT AND WIRING DIAGRAM OF THE SET

If desired, a full-size blueprint can be obtained for half price (that is, 6d., post free) if the coupon on page 448 is used by May 30. Ask for No. WM237 and address your application to Blueprint Department, WIRELESS MAGAZINE, 58-61 Fetter Lane, E.C.4

part way down the medium-wave coil in order to increase the selectivity.

For most purposes a centre tap will be convenient here, but the wiring has been so arranged that if desired an X-tapped coil may be used. The connections are reversed from the normal, giving a tapping near the top of the medium-wave coil. This is only practicable in cases of country dwellers who are not unduly troubled with the problem of selectivity. On the long waves, of course, the tapping is across practically the whole of the coil winding.

The reaction coil is coupled to both long- and medium-wave coils, and one size of reaction coil serves for

both wavebands without any difficulty.

On the detector circuit it will be noticed that a variable grid leak is used. This is found to work as an excellent volume control, and the system also has the advantage that it will operate on a gramophone as well as if the connections are arranged as shown in the circuit.

Automatic Grid Bias

It may be remarked that the grid leak actually goes to the cathode of the detector valve, whereas the pick-up is connected across grid and H.T.—, thereby applying a small negative grid bias to the valve when it is used as an L.F. amplifier. A by-pass condenser of .0001 microfarad is applied around the detector in accordance with the usual practice.

A de-coupling arrangement is also applied to the detector valve, partly for the purpose of reducing the voltage on the detector, and avoiding saturation on the transformer, and partly in order to avoid back-coupling through the mains equipment.

Freedom from Back-coupling

This, in conjunction with the choke-output circuit used in the last stage, renders the arrangement absolutely free from back-coupling, and despite the use of a small and inexpensive transformer the quality is really very pleasant.

There is little more to be said about the circuit. The mains equipment uses a Westinghouse type H.T.7 metal rectifier with a voltage-doubling circuit, and this has enabled an inexpensive mains transformer to be employed, which is in keeping with the policy throughout the set.

Grid Bias on each Valve

Automatic or "free" grid bias is applied on every valve, flexible resistances being used for the detector and output valves, while a 400-ohm potentiometer, used as a rheostat, has been employed in the case of the H.F. valve.

This is in the nature of a refinement which may be omitted if the reader desires. I have found during my experiments that the grid bias on A.C. screened-grid valves is inclined to be critical, some valves requiring more than others.

By using a variable grid-bias resistance up to 400 ohms it is possible to adjust the bias to give the best results. Once this adjustment has been found, it does not require to be altered again, and I therefore felt that it might justifiably be included in the set. If any reader does not wish to go to this trouble, however, he should include a 350-ohm Lewcos spaghetti resistance across the terminals of the 1-microfarad condenser

(Continued on page 428)

Have you tried the

NEW

FULL O'POWER BATTERY?

SIX

technical reasons why FULL O'POWER is the finest H. T. Battery obtainable to-day!



Specially recommended by the designers of "THE WIRELESS MAGAZINE" Sets.

1

Only Seamless Drawn PURE Zinc Cups used.

Avoids corrosion and deterioration, gives larger output and longer life.

2

New design of Unit Cell.

Contains 20% more active regenerative materials.

3

New Regenerative Materials, much more chemically active.

Means higher voltage, extra power and punch, pure tone, undistorted volume.

4

Lower Internal Resistance throughout its life.

Does away with "Howling," distortion and ragged tone caused by high internal resistance.

5

Immense Storing Properties.

Exceptional shelf life due to pure zinc, pure chemicals, uniform manufacture, perfect moisture-retaining seal.

6

Perfect Internal Insulation.

Prevents any possibility of parasitic leakages of current; a Full O'Power Battery cannot cause noises.

It costs no more than an ordinary battery

FULL O'POWER

"THE POWER BEHIND THE TONE"

SIEMENS BROTHERS & CO. LTD., WOOLWICH, S.E.18.

Better service results from mentioning "Wireless Magazine" when writing to advertisers

THE GRAMO-RADIO A.C. THREE—Cont.

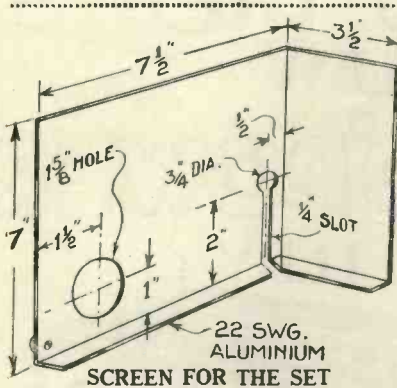

SCREEN FOR THE SET
Details of aluminium or copper screen for shielding the high-frequency and detector circuits

instead of the potentiometer shown.

In the construction a baseboard 16 in. square has been used, since this gives plenty of room and will fit a standard radio-gramophone cabinet. All the mains apparatus has been laid out at the back left-hand corner of the baseboard.

A sheet of foil has been placed across the front of the baseboard as part of the screening necessary. A simple partition screen between the

H.F. and detector circuit is also provided, and the circuit runs from the left-hand front part of the baseboard across to the right and then round to the back right-hand corner of the baseboard, where the output terminals are situated.

In this way a straight run is obtained and all the wires are relatively short.

Switch Connections

Terminals are provided on all the apparatus with the exception of the switches, to which soldered connections must be made. The flex leads connected to the appropriate points of the switches will be clear from the blueprint or wiring diagram. These leads may be soldered up with the switch separate from the set. This is then quite an easy job, since access can be had all around the switch without any other components getting in the way, while in addition the actual lengths of the flex leads are marked on the drawing, thereby simplifying the operation to the greatest possible degree.

When these connections have been

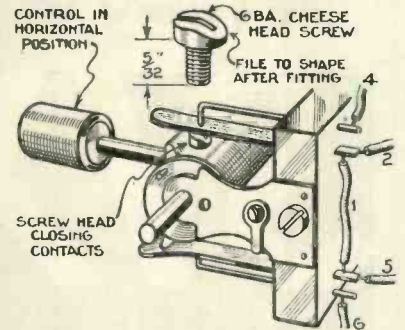

STUD ON SWITCH BARREL

How a small stud is fitted to one of the barrel switches

made the switch may be mounted in its proper position on the panel and the various flex wires taken to the appropriate points on the rest of the circuit. It will be observed from the diagram and photographs that the right-hand switch is actually mounted on the panel, the left-hand switch being supported by a bracket from the baseboard. A 7-in. connecting rod between the switches serves to operate them both together.

(Continued on page 430)

SUCCESSFUL EXPERIMENTERS IN SHORT-WAVE SET BUILDING use specially designed parts

The Manufacturers of the SUPREME EDDYSTONE components SPECIALIZE IN SHORT-WAVE APPARATUS, resulting in high efficiency over vast distances.

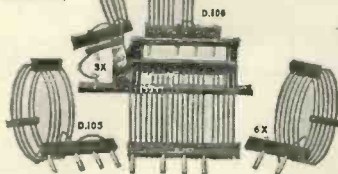

SHORT-WAVE INDUCTANCE UNIT
Forms complete inductance portion for Short-wave Receiver, providing aperiodic aerial coil, grid coil, and reaction winding. Covers whole short waveband from 15-95 metres. Price 22/6. complete with full circuit details. (Extra coils for B.B.C. waveband obtainable.)



6-PIN SHORT-WAVE COILS.
Extremely efficient in screen-grid S.W. circuits. Obtainable for all wavebands from 12.5 to 2,000 metres. Air wound on a skeleton bakelite former. Special banana type pins ensure perfect contact.

Price 4/6 to 6/-. Plain Former 2/6. Ribbed Former 3/-.
BUY SPECIALLY DESIGNED PARTS
Send NOW for Free S.W. List No. 46

EDDYSTONE

STRATTON & CO., Ltd., Bromsgrove Street, Birmingham.

WEBB'S RADIO STORES, 164 Charing Cross Road, W.C.2. (adjoining Tottenham Court Road Tube Station.) Telephone: Temple Bar 2944

NO SLIP OR BACKLASH

Separate each programme easily with the J.B. Drum Dial. Its smooth and powerful friction drive will move your condenser vanes the merest fraction of an inch without slip or backlash. Its attractive finish will set off any panel. See it at your dealer's.

The drum can be earthed to form an anti-capacity shield, since the dial is completely insulated from the condenser. The position of the control knob allows the scale to be brought flush with the panel for easy reading. The ivoryine scale is reversible to read 0-100 or 100-0.

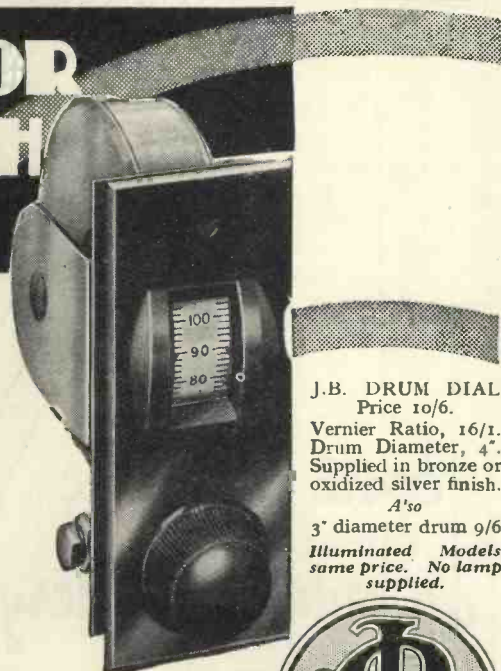

J.B. DRUM DIAL
Price 10/6.
Vernier Ratio, 16/1.
Drum Diameter, 4".
Supplied in bronze or oxidized silver finish.
A'so
3" diameter drum 9/6
Illuminated Models same price. No lamp supplied.

PRECISION INSTRUMENTS



Recipe for a perfect Loud-Speaker

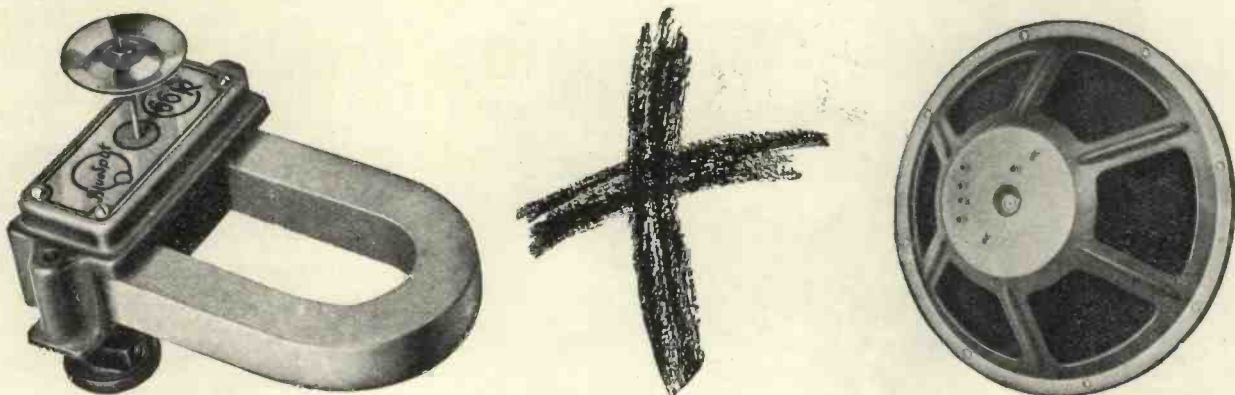

BLUE SPOT UNIT + BLUE SPOT CHASSIS

There are no finer units

A bold statement—but a true one, as the experience of millions of users has proved. Blue Spot Units are made with the scrupulous care and attention to detail that is the hall mark of the highest class product. Blue Spot 66K used with a small or medium powered receiver is a revelation of what a good unit can accomplish. It affords ample volume, but no blare. It gives perfect reproduction of speech and music without a trace of distortion. What a pleasure to realise that your present set is so much better than you thought. And the thanks are due to Blue Spot.

66R has the same perfection but it is designed for powerful multi-valve sets—the big fellows that seldom receive just treatment from the loud-speaker.

66R does them justice, though. It handles enormous outputs with ease. Give it as much power as you like—you will never succeed in making it rattle or distort either speech or music.

A good unit deserves a good chassis

—and that is why the Blue Spot technical staff have taken such pains in producing the Blue Spot Chassis. Its dimensions are scientifically accurate as regards the measurements from apex to base and the diameter of both apex and base, thus ensuring a completely harmonious response to the vibrations of the stylus of the unit. For your satisfaction you should insist on having a Blue Spot Chassis when you buy a Blue Spot Unit. Accept no other—there is nothing “just as good.”

THE BRITISH BLUE SPOT COMPANY LTD

BLUE SPOT HOUSE · 94/96 ROSOMAN STREET · ROSEBERY AVENUE · LONDON · E C 1

'Phone: Clerkenwell 3570.

'Grams: “Bluospot, Isling, London.”

Distributors for Northern England, Scotland and North Wales:
H. C. RAWSON (Sheffield and London) LTD., 100 London Road,
SHEFFIELD; 22 St. Mary's Parsonage, MANCHESTER;
183 George Street, GLASGOW.



Advertisers like to know whence the business comes—please mention “W.M.”

THE GRAMO-RADIO A.C. THREE—Cont.

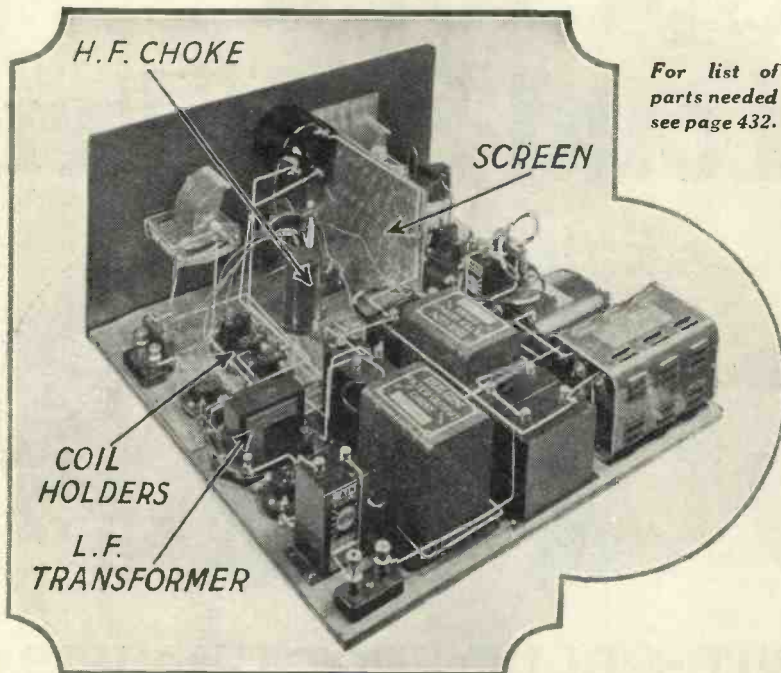

For list of parts needed see page 432.

Your Set As A Barometer

HAS it ever struck you that a wireless receiver can act as an assistant - barometer and affords material help in forecasting the weather for the following day?

At first I was under the impression that atmospheric discharges occurred at all times, but experience tends to prove that a particularly healthy crop invariably precedes a drastic change in the weather.

Distant-Station Reception

You must not conclude from this statement that these miniature explosions heard through your loud-speaker necessarily foretell *rain*; they do not. I find that in most instances during a spell of wet weather—and Heaven knows this spring has given us many opportunities for study in this respect—reception of distant

(Continued on page 432)

MAINS GEAR AT THE REAR OF THE BASEBOARD

As can be seen from this photograph, all the mains apparatus is placed along the rear of the baseboard, the set proper being placed just behind the panel

The switch employed is a standard Wearite type, with the exception of an extra contact on the barrel on the right-hand switch. The standard switch is a change-over switch, and only has two positions. For our purpose we require three positions, for the grid must still be connected to radio in the middle position (long waves).

Special Stud on Barrel

I have inserted a small stud on the barrel, therefore, in the position shown in the diagram, which keeps the two grid contacts closed even when the switch is in the mid position, and only opens them when the switch is in the down position, in which case the grid is connected to pick-up.

Inserting the Screw

This screw is quite easily inserted by drilling a hole in the ebonite. This may then be tapped out and a No. 4B.A. screw inserted, or alternatively a wood screw may be used if desired, since this will bite into the ebonite without any tapping. Do not drill the hole too deep so that it comes into contact with centre spindle.

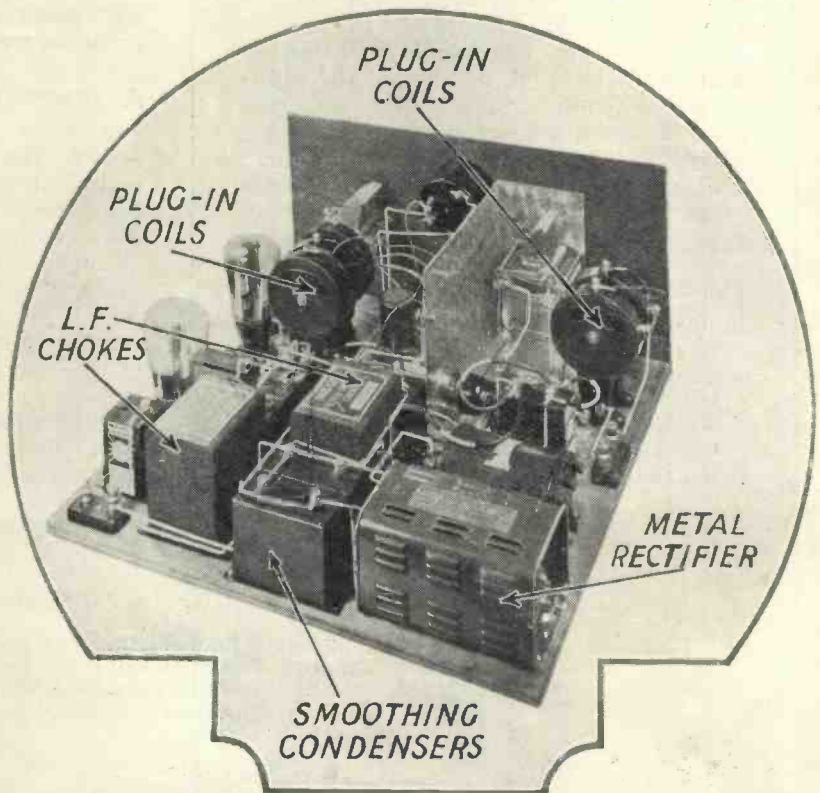

POSITIONS OF THE VALVES AND PLUG-IN COILS

How the set appears when ready for use, with all the coils and valves in position. Any standard two-pin plug-in coils can be used

Improve your portable— give it a **FULLER NON- SPILL**

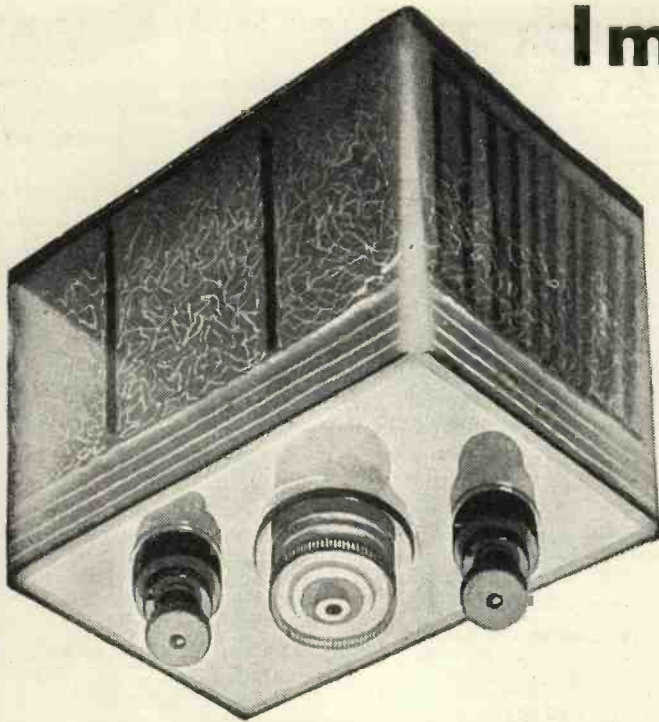

A portable receiver needs special care in the selection of its accessories. L.T. Accumulators are all-important. You won't discover the full range of your portable till you've fitted a Fuller *Non-spill*, which will keep working far longer than is regarded as normal. It combines high capacity with absolute reliability. Another reason for this dependability is that the plates are micro-porous pasted. You get micro-porous paste only in Fuller L.T. Accumulators: it is much finer in composition, and much stronger. No crumbling troubles, no sudden breakdowns. Indestructible separators, jelly electrolyte and large non-spill vents are other features of this fine accumulator, which can be used in any position whatsoever.

Fuller 2-volt "Non-spill" L.T. Accumulator for Portable Receivers. Standard on well-known Portable sets. Type JAP II. Price 13/6. Capacity 22 amp. hours. Overall size $4\frac{5}{16}'' \times 3\frac{9}{16}'' \times 3\frac{1}{2}''$. Also the JUA9. 18 amp. hours, 13/-, and other sizes from 11/6 upwards.

FULLER **SUPER** **BATTERIES**

Obtainable through Fuller Service Agents or any reputable dealer.
Full list of sizes and types post free.

FULLER ACCUMULATOR CO. (1926), LTD., CHADWELL HEATH, ESSEX

Speedy replies result from mentioning "Wireless Magazine"

L.T. ACCUMULATORS

Mammoth plates for modern valves; micro-porous paste; patent double grease-cup terminals; patent non-slip metal carrying handle: L.D.G. 2v. 60 A.H. 9/6 M.S.G. 2v. 22 A.H. 4/6.



FOR MULTI-VALVE SETS.

Accumulators for comparatively heavy discharges. Moulded glass containers. Micro-porous pasted plates. Patent double grease-cup terminals. S.W.G. 7. 30 A.H. capacity. 11/-.



H. T. DRY BATTERIES.

The Fuller W.O.P. 100 gives portables the power they need—guaranteeing up to 20 milliamps, 100 volts (reads 108) $10'' \times 5'' \times 3''$. 15/-. Complete range of standard, super power and grid bias batteries available.



CAR BATTERIES.

Patent double grease cup terminals eliminate risk of acid creep. Strong durable ebonite containers. Micro-porous paste. A type for every car. Ask for lists 104a and 105a.



COMPONENTS NEEDED FOR THE GRAMO-RADIO A.C.3

For full description see page 422.

CHOKES, LOW-FREQUENCY

- 1—Bulgin, 20-henry, 12s. 6d. (or Varley, R.I.).
- 1—Bulgin, 32-henry, 12s. 6d. (or Varley, R.I.).

CHOKE, HIGH-FREQUENCY

- 1—British General, 5s 0d. (or Lewcos, Wearite).

COILS

- 1—Atlas No. 40 plug-in, 2s. 6d. (or Lewcos Tunewell).
- 1—Atlas No. 250 plug-in, 4s. 6d. (or Lewcos, Tunewell).
- 1—Atlas No. 60 centre-tapped plug-in, 4s. 3d. (or Lewcos, Tunewell).
- 1—Atlas No. 60 X-tapped plug-in, 5s. 6d. (or Lewcos, Tunewell).
- 1—Atlas No. 250 X-tapped plug-in, 7s. 6d. (or Lewcos, Tunewell).

CONDENSERS, FIXED

- 1—Trix .0001-microfarad, 1s. (or Lissen, Telsen).
- 1—Trix .0002-microfarad, 1s. (or Lissen, Telsen).
- 1—Trix .01-microfarad, 1s. 9d. (or T.C.C. Dubilier).
- 4—Formo 1-microfarad, 10s. (or T.C.C., Dubilier).
- 2—Formo 2-microfarad, 6s. 6d. (or Ferranti, T.C.C.).
- 3—Formo 4-microfarad, 16s. 6d. (or T.C.C., Franklin).

CONDENSERS, VARIABLE

- 2—Readi-Rad .0005-microfarad, 9s. (or Lotus, Lissen).

DIALS

- 2—Astra Popular, 6s. (or Lissen, Utility).

EBONITE

- 1—Becol 16 in. by 8 in. panel, 7s. (or Red Triangle, Potter).

The prices mentioned are those for the parts used in the original set; the prices of alternatives as indicated in the brackets may be either higher or lower

HOLDERS, COIL

- 5—Lissen two-pin, 5s. (or Lotus, Wearite).

HOLDERS, VALVE

- 2—Lotus five-pin, type UH/31, 2s. (or Benjamin, Telsen).
- 1—Junit S.G. Universal type, 1s. 9d. (or W.B., Parex).

METAL RECTIFIER

- 1—Westinghouse, type HT7, £1 1s.

RESISTANCES, FIXED

- 1—Lewcos 600-ohm, flexible type, 9d. (or Bulgin, Magnum).
- 1—Lewcos 1,000-ohm, flexible type, 9d. (or Bulgin, Magnum).
- 3—Lewcos 30,000-ohm, flexible type, 4s. 6d. (or Bulgin, Magnum).
- 1—Lewcos 75,000-ohm, flexible type, 1s. 6d. (or Bulgin, Magnum).

SCREEN

- 1—H. & B. specification with sheet of aluminium foil, 16 in. by 7½ in., 2s. 9d. (or Peto-Scott, Ready Radio).

SUNDRIES

- Glazite insulated wire for connecting.
- Lengths of rubber-covered flex (Lewcos).
- 3—Lissen terminal blocks with terminals, 3s.
- 1—Magnum twin-control unit, 12s. 6d.

SWITCH

- 2—Wearite ganged switches, type I22, with lever control, 7s. 9d.

TRANSFORMER, LOW-FREQUENCY

- 1—Lissen Tonex, 5s. 6d. (or Igranic, Formo).

TRANSFORMER, MAINS

- 1—Heyberd, type W25, £1 1s.

ACCESSORIES

VALVES

- 1—Mazda AC/SG, £1 5s.
- 1—Mazda AC/HL, 15s.
- 1—Mazda AC/P, 17s. 6d.

Your Set As A Barometer

—Continued

stations is always good and enjoys a silent background. Should, however, on one day, that background become noisy with atmospherics, you may take any bet with less experienced acquaintances that the weather will change.

Time after time in my log I have jotted down in a special column the state of the atmosphere at the moment the entry was made and in almost every case where warning was given by these unpleasant hisses, crashes and grinds, my forecast for the next twelve hours was fairly accurate.

Try it yourselves; it will prove an interesting experiment and possibly, in your own home, may enhance your reputation as a weather prophet!

J.S.A.

Make a note of the following publication dates so that you can buy your WIRELESS MAGAZINE at the earliest possible moment:—

JUNE issue out on Friday, May 22.

JULY issue out on Wednesday, June 24.

AUGUST issue out on Friday, July 24.

Edison Bell



The Pick of Gramophone
Pick-ups bears the World's
Best-known Trade Name



Cat. No. 448.
Revised Price,
£1 15s.

Ask your Dealer for
Demonstration or
write for Lists to:—

Unless you have heard a gramophone record played electrically with an Edison Bell Pick-up you have never really heard a record at its best.

STUPENDOUS Price Reductions

ONE GOOD THING FOLLOWS ANOTHER

On introducing the Edison Bell Pick-up some three to four years ago, though we were perfectly aware we had produced the very thing the Public had long been looking for, we had no idea it would enjoy such inordinate sales. Sales went up by leaps and bounds so that without delay our Supply Facilities had to be enormously increased.

Larger Quantities ordered spelt a great Reduction in Overhead Charges; so that to-day we are pleased to be able to announce that while the superlatively high quality of Edison Bell Pick-ups is still maintained, we are able to revise our Prices and thereby to hand back to the Public the Surplus Profits.

NOTE THESE SENSATIONAL PRICE REDUCTIONS:

- Cat. No. 407—New Price, 27/6 (Old Price, 37/6).
- Cat. No. 407A—New Price, 21/- (Old Price, 30/-).
- Cat. No. 448—New Price, 35/- (Old Price, 45/-).
- Cat. No. 455—Cinema Model, Price 30/-.



Cat. No. 407
Revised Price
£1 7s. 6d.

EDISON BELL, LIMITED, LONDON, S.E.15

Edison Bell Condensers—Best for all purposes

LITTLE STORIES OF GREAT MOMENTS

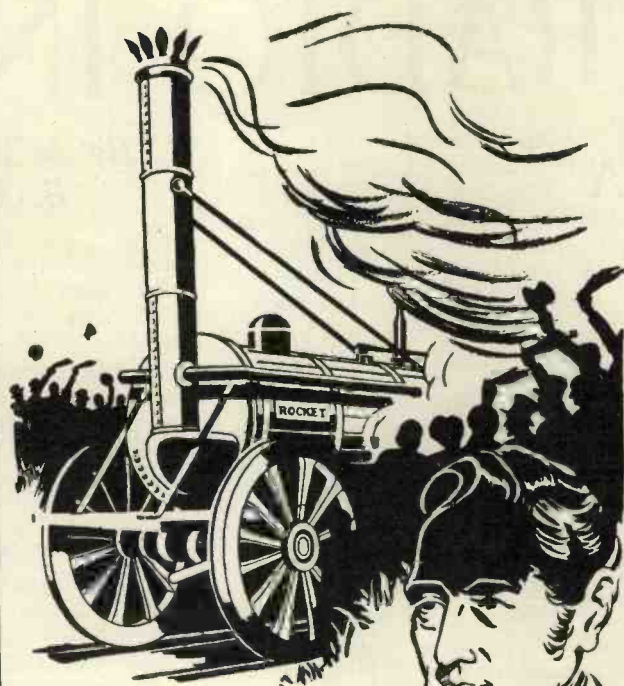

**"Look!
It's going-it's going!"**

There was gladness in some hearts and consternation in many when Stephenson's Rocket started on its first perilous journey. Long embittered critics were confounded and the habits of a nation transformed. It was the complete triumph of a lifetime spent in doing one thing and doing it well.

It is this same spirit of "doing one thing and doing it well" which has, for years, been behind all T.C.C. endeavour. That is why T.C.C. have never made anything but Condensers, and that is why T.C.C. Condensers are unmatched—for accuracy and for dependability.

One of the many types is shown here. It is the T.C.C. .0003 mfd. Upright Mica Condenser. Price 1/6.



TELEGRAPH CONDENSER CO., LTD., N. ACTON, W.3.

♥ 8047

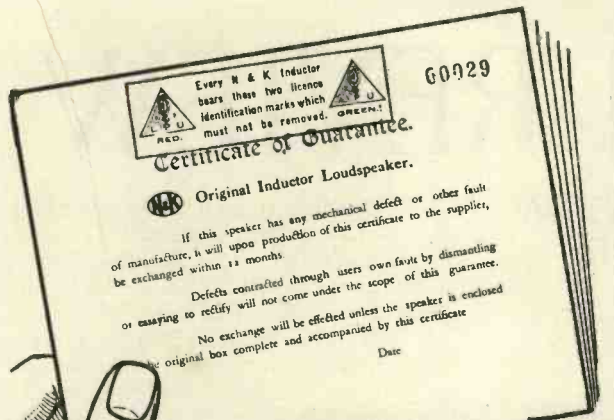

THIS 12 MONTHS GUARANTEE

and the original N & K Inductor Loud-speaker are obtainable from all good dealers. If you have both, you ensure having perfect reproduction, beauty and clarity of tone. So order NOW, the—

Chassis complete
£3 10s.

Full details from all dealers and—

Original Inductor **N&K** LOUD-SPEAKER

and Guarantee, issued by the Sole Distributors—
A. BRODERSEN
11, Northampton Sq., Goswell Road, E.C.1
Clerkenwell 7286.

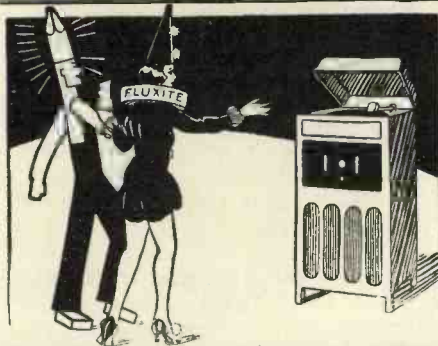

We're Fluxite and Solder, The reliable pair, Famous for soldering—Known everywhere! You've trouble with wireless? Well, don't get put out—We'll SOLDER the connections, That's the trouble, no doubt!

See that Fluxite and Solder are always by you—in the house, garage, workshop—anywhere where simple, speedy, soldering is needed. They cost so little, but will make scores of everyday articles last years longer! For Pots, Pans, Silver, and Brassware; RADIO; odd jobs in the garage—there's always something useful for Fluxite and Solder to do.

ANOTHER USE FOR FLUXITE
Hardening Tools and Case Hardening. Ask for Leaflet on improved method.

All Hardware and Ironmongery Stores sell Fluxite in tins, 8d., 1/4 and 2/8.

FLUXITE SOLDERING SET

Simple to use and lasts for years in constant use. Contains special "small-space" soldering iron with non-heating metal handle; pocket blow-lamp, Fluxite, Solder, etc.; and full instructions.

COMPLETE, 7/6, or LAMP only, 2/6.

FLUXITE, LTD.

(Dept. 332)
ROTHERHITHE, S.E.16

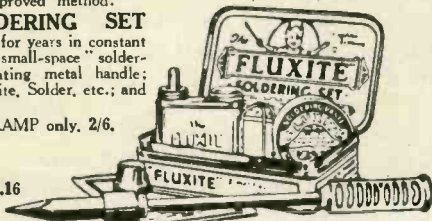

ALL MECHANICS WILL HAVE
FLUXITE
IT SIMPLIFIES ALL SOLDERING

Speedy replies result from mentioning "Wireless Magazine"

RADIO IN REVIEW

All-mains Receivers

AT the recent fair in Leipzig over 90 per cent. of the wireless receivers shown were of the all-mains type, from which it seems that Germany is following the lead set by the United States even faster than we are.

Of course, the fact that all the German electric-supply mains are now standardised at 110 or 220 volts simplifies matters very considerably and helps to explain why their sets can be marketed at roughly half what ours cost.

In the States, where there are roughly ten million homes on the mains, as compared with our three million, the battery-driven receiver is now definitely a back number. It is a significant fact that the home-constructor has almost disappeared, too.

"Man-made" Static

Local interference of the "man-made" kind is usually more troublesome when using the mains than with batteries. To some extent this is no doubt due to the higher amplification factor of A.C. valves, though it may also be traced to the fact that the set is actually connected, or coupled, to the mains.

It has been found that much of the disturbance caused by trams, trains, lifts and switches is distributed through the medium of electric-lighting wires, as well as through gas and water supply pipes.

The whole network of conductors helps to spread such disturbances over a wide area. Some of it is re-radiated locally, and is then picked up by the aerial and fed into the set. But a considerable amount also manages to get into the valve circuits directly when these are fed from the mains.

The only real remedy for this kind of interference is to stop it at the source by making it compulsory to fit all electrical apparatus liable to radiate "static" noises with some form of anti-sparking device.

Set and "Service"

Electric-supply companies are beginning to take a closer interest in the

By **MORTON BARR**

requirements of broadcast listeners. It was recently suggested in these columns that the time was not far distant when some of the more enterprising companies would supply all-mains sets on the hire-purchase plan, as they do kettles, radiators, and other electrical apparatus.

This idea does not appear to be viewed favourably by wireless dealers generally. Some of them have, in fact, recently been complaining that it is an unfair form of competition.

There is, of course, much to be said for the retailer's point of view, but at the same time it is sometimes very difficult to get adequate or satisfactory service when an all-mains set goes wrong. It is often beyond the local dealers' competence to put matters right and, in consequence, the set has to be sent away to the manufacturer, where it may remain for several weeks.

After all, one could reasonably expect an electric-supply company to keep a small staff of radio engineers specially trained for the job of maintaining any receiver supplied by the company in good going order.

In fact, the prospect of getting adequate "service" would undoubtedly prove an inducement to many people who at present are rather shy of the all-mains type of set for this very reason.

Television Developments

One of the difficulties in television is to secure a sufficient degree of light when scanning the object or scene to be transmitted, because it must be borne in mind that the scanning ray is first passed through a comparatively small hole in a rapidly rotating disc.

This difficulty is naturally increased when dealing with three-dimensional objects, as in real life, so that the transmission, say, of a number of actors moving about on a stage becomes practically impossible.

By reducing the object to a two-dimensional scene, as is the case when

transmitting from a cinematograph film, the problem is simplified. Also the scanning ray can be made much more intense than could be borne in comfort by a human actor.

For these reasons there is much to be said in favour of the method of televising scenes directly from a cinema film. The received pictures are quite clear-cut, and cover an altogether wider area of view than anything yet televised direct from life.

Cathode-ray Tube

Another promising development is the Farnsworth cathode-ray tube, which makes it unnecessary to use any mechanical scanning device, and therefore does away with the limitations introduced by the ordinary rotating disc. The object to be televised is first focussed on to a sensitised cathode surface through a window at the opposite end of the tube.

Electron emission then occurs automatically from the cathode, in accordance with the varying light-and-shade values of the focussed image. The ingenious feature of the new tube is that the emitted electrons are kept in separate streams and travel out from the cathode in perfectly straight lines towards the plate or anode, where they reproduce the original image.

In the new tube an "electron image" of the light image first thrown on to the cathode is formed and preserved as such until it reaches the anode, where it is used to modulate a carrier wave for transmission to a distance.

Radio Homes

As showing that broadcasting is now fully recognised as one of the ordinary amenities of life, many new houses are at present being completely equipped with radio equipment by the builders.

An aerial is fixed to the roof, whilst loud-speaker extension wires are laid on to all the downstairs rooms and to some of the bedrooms. A high-tension eliminator and a trickle charger for the accumulator are also thrown in to make the equipment of the radio-enthusiasts' home complete.

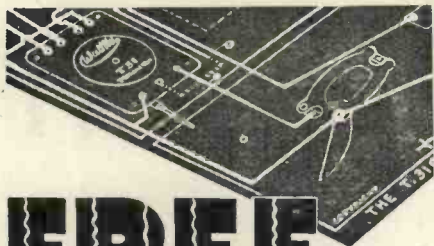

FREE BLUE PRINT!

SIMPLE SCREENED-GRID RECEIVER

This receiver has been designed in response to the many requests received from constructors who have built our "Imperial Three" and would like to build a Screened-grid Receiver incorporating our T.31 tuner. The receiver is extremely simple to construct—without any complications, and has a high degree of selectivity with a long range. There is no coil changing and surprising results will be obtained from this instrument. This blueprint will be sent free, but we should esteem it a favour if two 1d. stamps are enclosed to cover postage. It is approximately full-size and is laid out for easy wiring. Write Now.

UNIVERSAL DUAL - WAVE TUNER (Type 31)

This tuner can be incorporated in all receivers and greatly increases the selectivity of any set, cutting out all interference. It has had exceptionally good press reports and is accepted as the most efficient tuner possible.



PRICE
17/6

THE BINOCULAR H.F. CHOKE was selected by "Radiolog." It is highly efficient and should be used wherever it is necessary to obtain the maximum choking effect, such as in choke grid H.F. Inter-valve coupling or following H.F. Amplification.

TYPE D.X.3

Inductance .. 200,000 mh.
Self Capacity .. 1.6 m.mfd.
D.C. Resistance 1,400 ohms.

PRICE 6/-

TYPE D.X.2

Inductance .. 40,000 mh.
Self Capacity .. 1.2 m.mfd.
D.C. Resistance .. 450 ohms.

PRICE 4/-



Watmel

WRITE TO—**WATMEL WIRELESS CO., LTD.**,
Imperial Works, High Street, Edgware.
Telephone: Edgware 0323.

M.C.22

COLUMBIA 4780

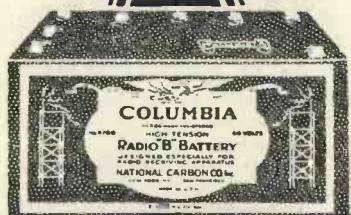

The world's best battery value because

- (1) It is Triple Capacity and outlasts three ordinary batteries.
- (2) Its larger cells give you smoothly-flowing power night after night, month after month.
- (3) Its careful construction minimises wastage when the battery is not in use.
- (4) It is absolutely silent.
- (5) It now costs only 17/6.

Ask your dealer for Columbia 4780. If your dealer has not Columbia in stock, send to us, giving his name.

Columbia RADIO BATTERIES

J. R. MORRIS, Imperial House,
15 Kingsway, London, W.C.2

Scotland: J. T. Cartwright, 3 Cadogan Street, Glasgow

A NEW BELLING-LEE SPADE TERMINAL for

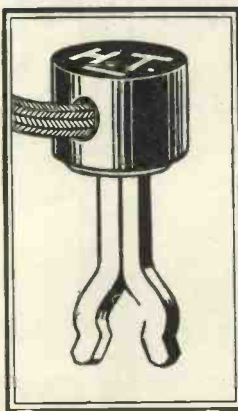

Patent Nos. 329463 & 12423/30

Use it for neat and permanent connections to receiver terminals, tapped coils, L.T. accumulators etc.—for hook-ups, clipped on to any screw or wire!

The new Belling-Lee Spade Terminal clips on to any terminal stem and makes good contact with its powerful spring prongs. Connecting up becomes a one-hand job. See it at your dealer's.

BELLING-LEE FOR EVERY RADIO CONNECTION

Advertisement of Belling & Lee, Limited, Queensway Works, Ponders End, Middlesex.

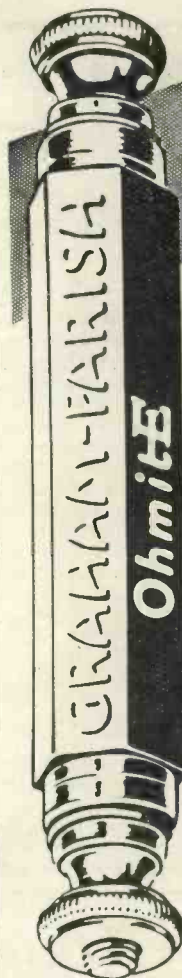

OHMITE

Axial Resistances. All values, 100 ohms to 500,000 ohms.

2/3 each

Ohmite and Megite Resistances are constant in value, of negligible self capacity and non-inductive. Dead silent and always reliable, they provide the most effective resistance on the market, giving the full range of values required. Supplied with vertical or upright holders of superior brown bakelite construction 6d. extra.

Graham Farish components carry a written guarantee of accuracy.

Ask your dealer to obtain, or write to

GRAHAM FARISH LIMITED . . . BROMLEY, KENT

WHEN YOU SEE



SPECIFY

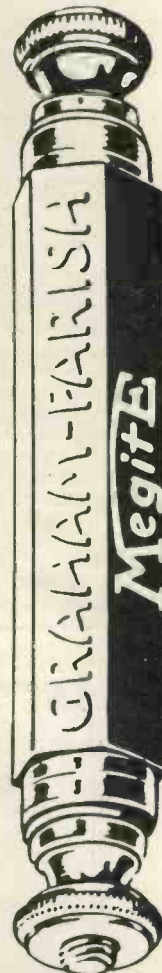

MEGITE

Grid Leak. All values, 1 megohm to 5 megohms.

2/- each

LISTENERS' FORUM

A Selection of Readers' Letters to the Editor

GREETINGS FROM BURMA

SIR,—I have derived so much pleasure from WIRELESS MAGAZINE in the last five years that I feel it is fitting I should express my appreciation for the way in which it has kept on being what you rightly call it, "The Best Shillings-worth in Radio." I used to buy all the radio magazines I could get at one time, and found by comparison that yours is the best as it gives me just what I want.

I especially enjoy reading Whitaker-Wilson's "Choosing Your Records." It saves me a great deal of time when I buy records. Captain Barnett's hints on the gramophone are very welcome. I hope to build his resonance cabinet soon.

I like the way you cater for overseas listeners and readers by describing fairly regularly a receiver suitable for them; such sets as the Outpost and Invitation Fours and the Overseas Five. I am glad you do not limit your sets to three-valvers and five-valvers, as some other magazines do. After all, even though we cannot all of us build a super de luxe all-wave receiver, we like to read about it and even save up for one.

In short, your magazine is the best of its kind. Keep up the good work.

I built your Outpost Four last Decem-

ber, modified a little. Volume and quality were perfect, tuning so easy that my father and mother can work it with the greatest of ease.

Our best stations are: Manila KZRM, Saigon, and Bangkok, all at very good loud-speaker strength.

I also built the Invitation Four for a friend, also modified. It is a fine set and tunes from 15 to 2,000 metres.

I am glad the super-het has come back. I hope you will publish a super-het for short waves and broadcast waves in one unit in the near future.

F. A. BEAVER.

Maymyo, Upper Burma.

BINOWAVE COILS

SIR,—As I am, I believe, the nearest regular reader of your magazine to the London twin transmitters—I can see the aerials from where I write, about half a mile away—perhaps my experiences with some of your sets may prove of interest to you.

First of all I must say that Binowave coils are by far the most suitable for use in this district. The set I am using at the present time is your Regional Band-pass set, with the R.C.C. stage omitted.

The results with this receiver are very satisfactory and compare very favourably with any three-valve commercial receiver.

Of course, foreign reception on the medium waveband is limited, but I can always get good reception from the following: London National, London Regional, Rome, Midland Regional, Oslo, Kalundborg, Motala, Eiffel Tower, 5XX, Radio Paris, and Huizen.

By good reception I mean signals that can be tuned-in and heard in every corner of a fairly large room, and remain constant all the evening.

I have also constructed the Brookman's Two. That also was very successful, being the only two-valver that I have handled in which interference was not present between the two local transmitters, when connected to a 60-ft. aerial.

The Binowave coils have another great advantage, in that even from where I am using them no interference from Brookman's Park is heard, when the long-wave coil is in circuit, or at least not to interfere with any of the stations I have listed.

F. C. HOLMES.

Potters Bar, Middlesex.

"ASTRA" AGAIN SPECIFIED

This time by Mr. Reyner for his
GRAMO-RADIO A.C.3

in this issue

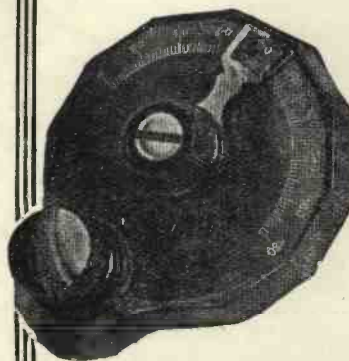

THE "ASTRA" "POPULAR"

embodies the same precise, geared action of the "Astra" which assures a firm, noiseless movement with no trace of backlash.

Direct drive is obtained by switching up the lower knob. Easily mounted and fits any condenser spindle. Diameter 3 inches. Attractive finishes.

Price 3/-

"Astra" No. 1. 3 in. diameter
3/6

"Astra" No. 2. 4 in. diameter
5/-

"Astra" are the only dials
manufactured under Ormond
licence.



"ASTRA" PRODUCTS ARE OBTAINABLE
FROM ALL DEALERS

NO INTERFERENCE



if you fit a

PAILLARD ELECTRIC INDUCTION MOTOR

When building your radiogram, ensure the admiration of your friends and your own satisfaction in the perfect results by fitting a PAILLARD Electric Induction Motor. It has no brushes or commutator to cause interference, and no belt. The motor runs silently and smoothly, without variation in speed despite widely fluctuating mains current. Dimensions 7 1/2" x 5 1/2" x 5 1/2". For 100 to 130v. or 200-250v. 40-60 cycles A.C.

Price complete with 12' velvet covered turntable, automatic brake and cut-out.

£4:17:6

(without Unit Plate, £4 10s. 0d.)

PAILLARD JUNIOR ELECTRIC INDUCTION MOTOR with 12' turntable and switch brake. Automatic brake 2/6 extra.

45/-

APOLLO GRAMOPHONE CO., LTD.
4-5 Bunhill Row : London : E.C.1

BUY YOUR SUPER 60 ON THE 3-WAY PLAN

C.O.D.



CASH

PAY THE POSTMAN—it costs no more
— **WE PAY ALL CHARGES**
(on all orders over 10/-)

Strict Privacy Guaranteed
on all H.P. Orders

with order—Carriage Paid

THE ORIGINAL SUPER 60

(See special supplement in this issue)

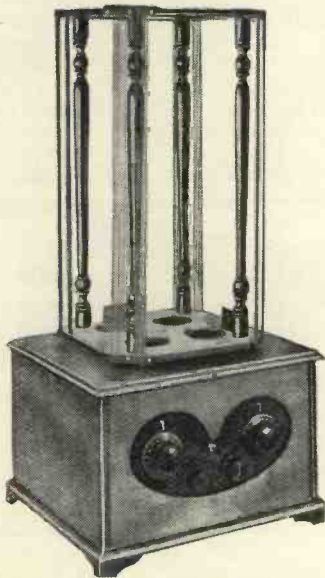

Handsome Polished Mahogany Cabinet as supplied and used by Mr. W. James. Same price in Oak. **17/6**

Mahogany Frame Aerial, ready wound. Oak, 5/- extra. **27/6**

Set of parts for Frame Aerial including polished mahogany spindles, top, and base, special turned spacing pieces, centre bearing and bush, special frame aerial wire, wave change plugs, 6 wire spacings and flex for leads, all packed for **17/6**

Set of parts in polished oak, 5/- extra.

Set of 4 Wearite Super-hot Coils...	£ s. d.
2 Reels of special Frame Aerial Wire	2 10 0
Ultra Short Wave Coil No. 9	5 6
Peto-Scott Special Short Wave Neutralising Condenser, as specified	2 9
	3 0

★ **NOTE.**—Genuine Peto-Scott Aerials are identical to the illustration here. It has come to our notice that a certain firm advertising, to supply a Duo-Frame Aerial made by Peto-Scott have been supplying inferior substitutes. You are warned therefore to make certain your Duo-Frame Aerial is made by Peto-Scott, the inventors, if you want proper results.

SUPER 60

As designed by Mr. W. James and described in "Wireless Magazine"

PILOT KIT "A" — USING SPECIFIED PARTS.
SEE SUPPLEMENT IN THIS ISSUE.

You pay the Postman — **£6-0-0**
We pay all C.O.D. charges

Or Easy Way —
12 monthly payments of 11/-

Less Valves, Cabinet and Frame

ANY PARTS SUPPLIED SEPARATELY

FREE! With this and every other Pilot Kit on this page we give a Konnecterkit, containing all necessary screws and wire.

FINISHED INSTRUMENT

Super 60, including Valves (less Batteries) **£13 10 0**

Royalties extra **£1 10 0**

WE SUPPLY PILOT KITS for this Month's "W.M." sets as below:

Radiogram A.C.3
Simple Gramophone Amplifier
Regional Three

as well as others on this page

WE shall be pleased to give prices, details, etc., on application. Send also for our free illustrated catalogue. Let us have your requirements and we will willingly quote you by return.

SUPER 60 PORTABLE

KIT OF SPECIFIED PARTS

1 Set 4 Wearite Super Hot Coils	£ s. d.
1 Formo Condenser .0002 mfd. or Ormond ..	2 10 0
2 Dubilier Condensers .001 mfd. type 620 ..	6
5 Dubilier Condensers 1 mfd. type BB or Franklin ..	4 0
2 Jackson Variable Condensers .0005 mfd. ..	12 6
1 Grid Leak Holder	17 0
9 W.B. Rigid type Valve Holders	8
8 Belling Lee Wander Plugs marked HT+4, HT+3, HT+2, HT+1, HT-, GB+, GB-1, GB-2	9 0
1 Fixed Resistance Flexible type, 15,000 ohms Keystone	2 0
1 Fixed Resistance, 20,000 ohms Keystone ..	1 6
1 1 megohm Grid Leak, Telsen or Sovereign ..	1 6
1 Sovereign 50,000 ohm Potentiometer	1 0
1 3 point Switch Keystone	4 6
1 On-Off Switch Keystone	1 6
1 Telsen Acc Low Frequency Transformer ..	1 0
2 Reels Frame Aerial Wire—Peto-Scott as specified	8 6
Connecting Wire, Steering	5 6
	Gratis

KIT "A" — Pay the Postman £6 0 0

EXTRAS:—

1 Carrington Portable Cabinet	£ s. d.
1 Ormond Portable Chassis and Unit Speaker ..	2 5 0
6 Mullard Valves—P.M.1LF, 2 P.M.1HF, 2 P.M.12, 1 P.M.2	1 5 0
1 Pertrix 108v. Portable type Battery	3 16 0
1 Pertrix 9-v. Grid Bias	14 0
1 C.A.V. 2-volt Accumulator type 2NS.17 ..	1 6
	16 0

ANY PARTS SUPPLIED SEPARATELY

EXPRESS ORDER FORM

To Peto-Scott Co. Ltd.

Please send me C.O.D. H.P. or CASH:

.....

.....

.....

.....

.....

For which I enclose Cash / H.P. Deposit
£ s. d.

Name

Address

W.M. 5/1931

PETO-SCOTT CO. LTD.

77 CITY ROAD, LONDON, E.C.1: Clerkenwell 9406; **62 HIGH HOLBORN, LONDON, W.C.1:** Chancery 8266; **MANCHESTER:** 33 WHITELOW ROAD, CHORLTON-CUM-HARDY. Phone: Chorlton-cum-Hardy 2028; **NEWCASTLE, STAFFS:** 7 ALBANY ROAD. Phone: 67190

Speedy replies result from mentioning "Wireless Magazine"

OUR TESTS OF NEW APPARATUS

W.B. Moving-coil Loud-speaker :: A.E.D. Variable Resistance
 K.B. Mains Unit :: Eta Valves :: Undy Loud-speaker

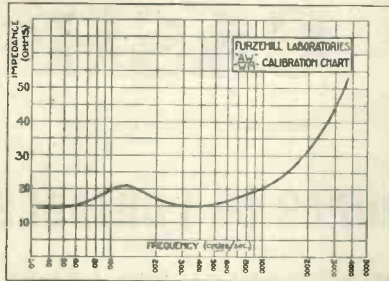

Curve showing impedance of the W.B. model PM2 loud-speaker

NEW W.B. MOVING-COIL MODEL

PERMANENT-MAGNET moving-coil loud-speakers are undoubtedly coming to the fore. We have tested this month a new W.B. model, which is in chassis form. This is quite a compact job. A 7-in. cone is employed, and the whole unit measures just less than 5 in. from the front. Its sensitivity is good, and its impedance curve is uniform over the greater part of the scale.

The diaphragm material is soft to avoid paper resonances. We found on test that this effect had been rather overdone for use with ordinary triodes, since there was a certain lack of brilliance in the reproduction as compared with our standard speaker. We should imagine, however, that this component would be particularly suitable for use with pentodes where the use of a soft material for the diaphragm is highly desirable. The price of the instrument is only £4 10s.

A.E.D. VARIABLE RESISTANCE

THERE have been one or two attempts lately to produce a new form of variable high resistance. One of the neatest of these is the A.E.D. volume control marketed by Auto Electric Devices, Ltd., of Brighton.

In this component the resistance element is built up of alternate washers of brass and resistance material. The whole resistance unit is a little over an inch long, and travelling over the edge of this is a little pointer. This pointer, therefore, makes contact with the brass discs and is never actually in contact with the resistance material; since the current can only get from one brass disc to the next through the intervening resistance element, however the necessary high resistance is obtained.

By having a sufficient number of contacts, it is possible to get a smooth

graduation, and this appears to have been done in the device in question. By the use of an ingenious mechanism, somewhat similar to that of a slow-motion dial, the pointer is geared down about 2 to 1, so that although the actual travel over the resistance unit is little more than an inch the knob makes a full half turn going from maximum to minimum.

The resistance washers in the element are graded so that the variation increases as one goes towards the high-resistance end of the scale. The grading is approximately logarithmic, as we found by making a number of tests at various parts of the scale and plotting the results. Moreover, the resistance range is very wide, since the maximum is in excess of 500,000 ohms, while the minimum is only a few hundred ohms.

Owing to the fact that the area of the resistance washers is nearly half a square inch, the device will carry a larger current than usual. We actually passed 5 milliamperes through the resistance without obtaining any undue heating. This must be regarded as a very good current-carrying capacity for such a large resistance.

This component is altogether very cleverly thought out, and we shall look forward with interest to the production of further instruments from this firm.

KOLSTER-BRANDES MAINS UNIT

A CONVENIENT A.C. mains unit, suitable for small sets, is the Kolster-Brandes 260 unit. This instrument, which incorporates a Westinghouse metal rectifier, is housed in a case,



The A.E.D. high resistance, particularly useful as a volume control

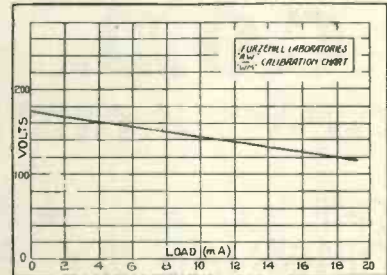

Output curve of the K.B. mains unit reported on below

7½ in. by 5 in. by 4 in., finished in brown and gold. Ventilating slots are provided, and the only control of the instrument is that mounted on the side of the case for controlling the voltage on the second tapping.

The tappings themselves are brought out to flex leads terminated in insulated plugs and sockets. These are so constructed that no metal parts are exposed, so that even if the ends are allowed to



Note the neat appearance of the new K.B. unit for A.C. mains

touch there is no danger either of shock or short-circuit.

The model submitted for test was suitable for 200 or 250 volts input, a small wander plug underneath the chassis being provided for adjustment to the correct input voltage.

Three tappings are provided, one for the screening grid, one variable tap, and one power tap. We found on test that the output voltage was not maintained quite up to the load suggested, as will be seen from the accompanying regulation curve.

This was plotted on the power tapping, the other tappings delivering 1 and 5 milliamperes respectively, under which conditions the voltages were 55 and 80. The regulation curve will be seen to be fairly flat, which is a good property, but the voltage falls somewhat too low after 16 to 18 milliamperes.

This, of course, is a criticism not of the eliminator so much as of the marking on the case, and for the average set this unit is quite suitable.

(Continued on page 440)

ORMOND *of course!*

THE LOUD-SPEAKER ASSEMBLY FOR THE SUPER 60 PORTABLE RECEIVER *combines Quality-Reliability & Economy!*



This loud-speaker assembly has been specially constructed for use with the Super 60 Portable Receiver.

It comprises a cone of specially selected material firmly secured to a five-ply baffle board, and the famous Ormond Four-Pole Adjustable Loud-speaker Unit.

This combination ensures a quality of reproduction which is unsurpassed; both music and speech are reproduced with perfect clarity with an entire absence of "druminess" and without a trace of chatter.

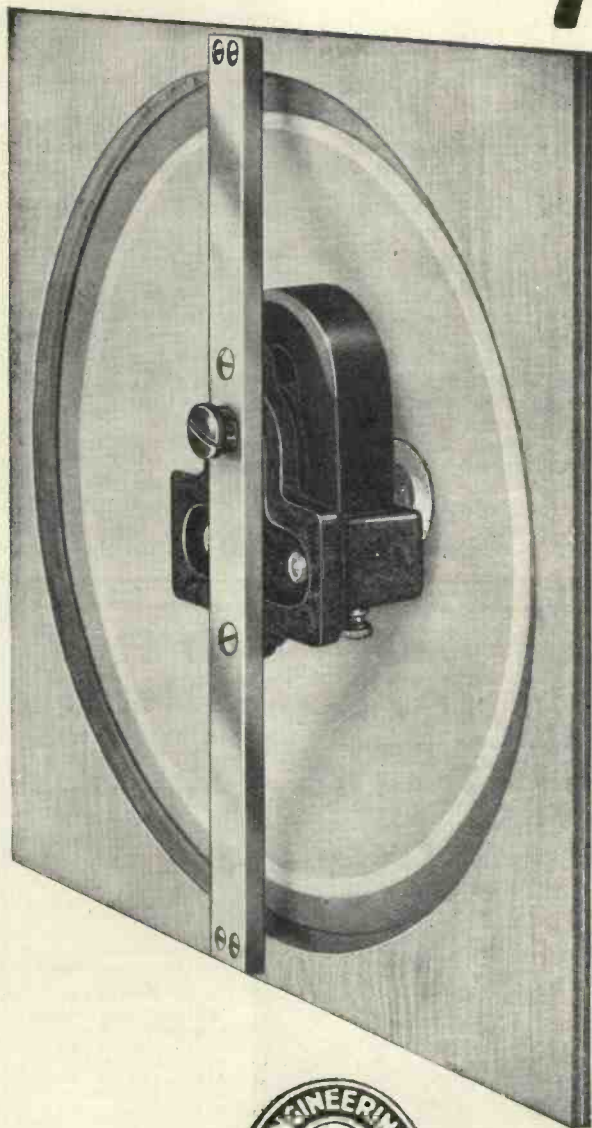

Price Complete 25/-

Board Chassis. Cat. No. R/460

THE ORMOND ENGINEERING CO., LTD.

ORMOND HOUSE, ROSEBERY AVENUE, LONDON, E.C.1

Telephone: Clerkenwell 5334-5-6 and 9344-5-6
Telegrams: "Ormondengi, Isling."



for PUNCH, POWER & PURITY !

OUR TESTS OF NEW APPARATUS—Cont.

ETA VALVES

WE have been very interested to receive recently a number of valves of French manufacture marketed by the Electrical Trading Association, of Aldwych House, London, W.C.2, and known as Eta valves. These valves are non-ring products and are sold at a somewhat cheaper price than the customary British valve. Their performance, however, compares very favourably with the best modern practice.

We received a number of representative samples, two being battery valves and the remainder being A.C. valves.

In the former class were the BY2023, the code number being made up of the amplification factor and the impedance, which are 20 and 23,000 respectively. There was also the DX502, a valve having an amplification factor of 5 and an impedance of 2,100 ohms.

It will be seen that these figures, giving mutual conductances of 0.85 and 2.4 milliamperes per volt respectively, are quite in keeping with modern standard practice.

We think, however, that readers will be particularly interested in the range of A.C. valves, having regard to the fact that they sell at 11s. 6d. only. Reviewing these valves in descending order of impedance, we have the DW4023, a very useful high-amplification H.F. valve. As will be seen from the

table below, our figures on this valve give us rather better results than those claimed, since the amplification factor was 49, and the mutual conductance was 2. The characteristics were plotted, showing that this valve will handle a grid swing of 1½ volts with 150 volts H.T. quite easily.

Next we have the DW1508, a medium-impedance valve with a somewhat lower amplification factor, suitable for a detector having to handle a heavy input or a first-stage L.F. valve. Here, again,

All these three are indirectly heated. The DW302 is a directly-heated output valve, designed for 250 volts on the anode, having an amplification factor of 3.5 and an impedance of 1,800 ohms. Our figures are in substantial agreement with these, and this valve appears to be quite a useful product.

It will handle a grid swing of nearly 50 volts, and is capable of giving an output of 1,600 milliwatts. The calculations taken from our own characteristics actually gave 1,550 milliwatts, with an

Type	Maker's Rating			Test Results		
	Impedance	Amp. Factor	Mutual Conduct.	Impedance	Amp. Factor	Mutual Conduct.
DW4023	23,000	40	1.75	24,500	49	2
DW1508	7,500	15	2	12,000	21.2	1.77
DW704	4,500	7	1.5	5,400	9.7	1.8
DW302	1,800	3.5	1.95	1,850	3.28	1.76

we found that the figures were rather higher than were listed, and in this instance the mutual conductance was not quite as good. This valve will handle 4½ to 6 volts grid swing.

Then there is the DW704, an output valve capable of handling a grid swing of 12 to 14 volts with 150 volts on the anode. This particular valve will give an output of approximately 200 milliwatts at the maximum anode voltage of 150, the optimum load being in the neighbourhood of 7,500 ohms.

optimum load of 4,500 ohms. This is a very satisfactory output from a single valve with only 250 volts on the anode, and we imagine that this valve in particular will be met with approval.

Altogether we feel that the new Eta valves will be welcomed by readers. The valves mentioned here are only a selection. There are two A.C. screened-grid valves selling at 19s. 6d., and we understand that a complete range of battery valves is available.

(Continued on page 442)

A N O S B O R N R A D I O C A B I N E T



MODEL No. 218
Send 3d. in stamps for 56-page illustrated catalogue.

IS THE IDEAL HOME FOR YOUR SET

MODEL No. 218
A Queen Anne Radio or Radio Gramophone Cabinet, 3 ft. 10 ins. high, 2 ft. 2 ins. wide, 1 ft. 6 ins. deep. Size of baffle board behind fret, 24 ins. x 24 ins. Metal fabric for fret front included. Opening at top and back. Cabinet takes panel 2 ft. x 9 ins., or smaller.

PRICES:
Machined ready to Assemble: Oak £3.10.0, Mahogany £3.15.0. Assembled ready to polish: Oak £4.10.0, Mahogany £4.15.0. Assembled and polished: Oak £5.10.0, Mahogany £6.5.0. All Models Carriage Paid.

STAND No. 486
FIRST FLOOR,
EMPIRE HALL,
"DAILY MAIL"
IDEAL HOME EXHIBITION,
OLYMPIA,
April 7th to May 2nd.

CHAS. A. OSBORN

(DEPT. W.M.)

The Regent Works, Arlington St., London, N.1

Telephone: Clerkenwell 5095. And at 21, ESSEX ROAD, ISLINGTON, N.1 (1 min. from the Agricultural Hall). Telephone: Clerkenwell 5634.

THE CHROMOGRAM

IS AGAIN THE SUBJECT OF SPECIAL COMMENT IN THE "WIRELESS MAGAZINE"

PRICE 35 GUINEAS



Complete All Mains Electric equipment. 4 valves comprising 3-valve Radio stage, 1 screen grid, 1 Detector and Pentode with single dial tuning. Perfectly balanced amplification. No distortion. Wonderful range of European Stations on Long and Short Wave bands.

Catalogue on application. Deferred terms arranged when desired.

CHROMOGRAM

76-78, CITY ROAD, LONDON, E.C.1

QUIS ?

If you had to devise an experiment to show quantitatively how a sprung valveholder damped out vibration which a solid holder transmitted to the valve, how would you set about it ?

There are no prizes, but as a test for your ingenuity you might care to sketch out an idea and then write to us for a little booklet "The Elimination of Pong" which describes how a well-known scientist set about the job—and what he found.

THE BENJAMIN ELECTRIC LTD.,
Tariff Rd., Tottenham, N.17

BENJAMIN



Piano craftsmanship—for YOUR SET—OR RADIO-GRAM.

"bound to improve results"
Wireless Magazine
"the nicest I have seen" says—
'Wireless Constructor'
The sort people desire to possess and keep.

Advantages also of—
PIANO TONE Baffle and acoustic chamber—yields an amazing body of tone—with that golden mellowness that music-lovers desire.
(No dull drumming—no thin cabinet noises.)
De Luxe models (Pianocraft) from 75/- to £25 (cash or deferred), sent to EXACT size of YOUR set ON APPROVAL—you may return at OUR expense.
Photographs and lists free from actual makers.

PICKETTS, Radio Furniture Specialists,
M.G. ALBION ROAD, BEXLEYHEATH.
(Over 3,000 delighted clients)

Get the Best from

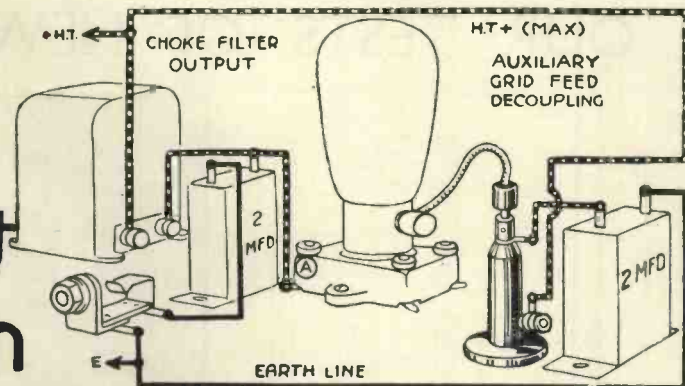

your Pentode

It is a well-known fact that a Pentode gives better results and is more economical when the auxiliary grid is given a slightly lower potential than the anode voltage.

The Bulgín Safety Decoupling Resistance incorporates a wire-wound resistance of 5,000 ohms, the optimum value for this purpose. The wander plug in the top permits easy removal of the valve and automatically disconnects the H.T. By the use of this component a normal power valve can easily be substituted for experimental purposes without any modification to the wiring of the receiver.



Safety Coupling Resistance (R63) 3/-

Write for 60 pp. Catalogue and Manual, Enclose 2d. postage.

A. F. BULGIN & CO., LTD., 9, 10, 11, Cursitor Street, Chancery Lane, London, E.C.4.
Phone: Holborn 1072 Phone: Holborn 2072

(PAREX)

SCREENS VALVE HOLDERS

as used and specified for

THE REGIONAL THREE

Special Aluminium Screen, cut to shape 4/6

S.G. Valve Holder for same 2/-

GRAMO-RADIO A.C. THREE

ALUMINIUM Screen cut to size and drilled, with foil 16" x 7" 3/6

Screens for all Circuits

E. PAROUSSI, 10, Featherstone Buildings, High Holborn, W.C.1

Phone: Chancery 7010



GRIPSO

"SUPER PUSH-PULL INDICATING SWITCH WITH FOOLPROOF CONTACTS"

NICKEL PLATED OR BRONZE ESCUTCHEONS

2PT. 19 3PT. 2/- 3MB. 26

THE GRIPSO COY.

31, VICTORIA STREET, LONDON, E.C.1

Tell Your Friends about the Super 60

What other Condenser withstands this test?

Condenser manufacturers almost invariably stipulate that their condensers must, when under full load, be discharged through a resistance—not by short-circuit. Now read what "Wireless World" says about Franklin:

"... was left in circuit on a steady 1,000 volts supply. It withstood this test without breakdown as well as the severe conditions imposed by repeatedly discharging by short-circuit."

Franklin Condensers have no fear of this short-circuit test, because this is the test applied to each one in the factory.

PRICES: Tested at 500 v. D.C., 1 mfd., 2/2. 2 mfd., 3/-
All capacities. Also available tested 1,500 v. D.C.

FRANKLIN ELECTRIC CO., LTD., 119 Kingsway, London, W.C.2 Phone: Holborn 1080

FRANKLIN

MOULDED CASE CONDENSERS



CONVERT YOUR BATTERY SET TO A.C. MAINS and get the added efficiency and convenience of Mains-Radio without altering a single wire. The Six-Sixty A.C. All-Mains Conversion Equipment includes a set of the wonderful Six-Sixty A.C. Valves to suit your circuit and supplies H.T., L.T. and Grid Bias at a fraction of the cost of batteries—takes no more room.

Price complete from £8 : 5 : 0

Write for FREE BOOKLET giving full particulars.

SAY

SIX-SIXTY

Six-Sixty Radio Co., Ltd., Six-Sixty House, 17-18 Rathbone Place, Oxford Street, London, W.1.

Telephone: Museum 6116-7

There is news in the "Wireless Magazine" advertisements

OUR TESTS OF NEW APPARATUS—Cont.

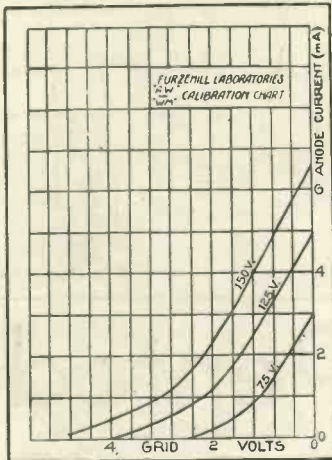

Characteristic curves of the Eta valve, type DW4023 (see report on page 440).

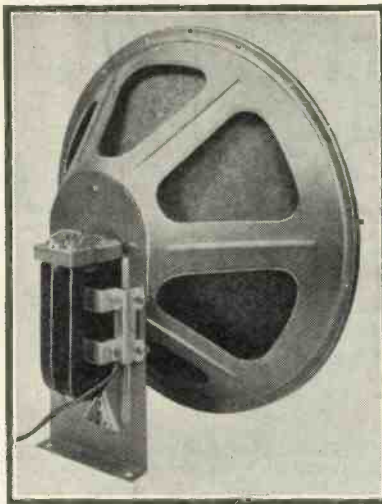

Undy moving-iron cone loud-speaker chassis

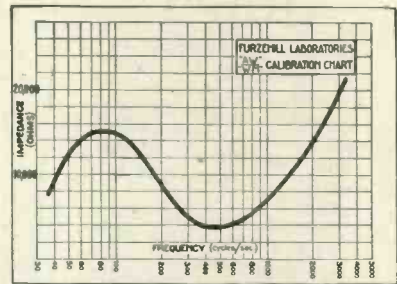

Impedance curve of the Undy eight-pole loud-speaker

iron type of instrument. From the curve on this page it will be seen that this is so, and the test on our standard amplifier confirmed this theory. The bass was particularly well in evidence and the sensitivity was good. The high frequencies, however, were a little disappointing as compared with our standard moving-coil loud-speaker.

The instrument is well constructed and will handle a good volume without rattling.

UNDY LOUD-SPEAKER

THE Undy eight-pole dynamic loud-speaker is a further attempt to improve the performance of the moving-iron type of reproducer. The unit is provided with eight magnet poles, as the name suggests. These are arranged in two sets of four, one on each side of the pivotal point of the armature.

There are two coils, one for each set of poles, the windings being so arranged that the forces on the armature are the same at any given instant. A 6-in. magnet is provided. The motion of the armature is transmitted to a diaphragm 15 in. across, carried in a light, but rigid, pressed-metal housing.

This loud-speaker is unusual in that it incorporates a transformer actually built into the chassis, which is not usually done in the case of moving-iron loud-speakers. This is undoubtedly a step in the right direction, since it enables the characteristics to be matched more suitably to those of the output valve in the receiver.

In this particular instance the transformer is provided with three ratios, so that the optimum load can be chosen.

The benefit of the transformer is demonstrated quite well by the fact that

the impedance remains much more constant than is usual with a moving-

AROUND AND ABOUT

THE original model of the Regional Three described in this issue is now on show in the Somerset Street windows of Selfridge & Co.

In a test report of the Gambrell Novotone (type J) on page 651 of the January issue it was stated that the price is £3 10s. This should be £3 3s.

Philips have recently produced a new photo-electric cell, type 3510, at the low price of £2. It has been produced specially for amateur use.

Those who listen on the long waves will have noticed that the reception of Konigswusterhausen has been marred by interference from a powerful morse station. This has now been traced to the activities of TRA, a Soviet station, with which the German radio authorities are now in touch with a view to abating the interference.

The New Zealand Government are to take over the radio stations at Auckland, Dundee, and Christchurch, at present owned and operated by the Radio Broadcasting Co., from 1932 onwards.

Listeners on the ultra-short waves should note the latest transmitting schedule of PCJ, the well-known Dutch station: Wednesdays, 5 to 8 p.m.; Thursdays, 2 to 4 p.m., 10 p.m. to 2 a.m. (Friday); Fridays, 8 to 10 p.m.; Saturdays, 2 to 6 a.m. The above times are G.M.T. and subject to slight alterations.

Radio stations in the United States are only allowed to deviate slightly from their allotted wavelengths. As soon as the Federal Radio Commission, the chief

control of American broadcasting, notices a station off its wavelength or over-modulating, it is deprived of that wavelength and no other is issued. The wavelength is then allotted to one of the many stations on the Commission's waiting list. American listeners enjoy practically interference-free reception, as once a station loses its wavelength it is almost an impossibility for it to be recovered.

Several new stations are being built in Italy. The transmitters at Trieste and Palermo should be heard testing very soon. Rome's Broadcasting House, which is nearing completion, will contain five studios and be equipped on modern lines.

Bombay has lately changed its wavelength from 49 metres to 31.1 metres.

Another new giant transmitter is being built by the Soviet near Moscow. This station will have a power of 500 kilowatts and will be the largest and most powerful station in Europe.

From France comes the news that Radio Paris will soon be operating on increased power (probably 80 kilowatts) and Poste Parisian on 60 kilowatts. It is evident that France intends to keep up with other countries in the matter of transmitting power.

A new permanent-magnet moving-coil loud-speaker has just been marketed by Partridge & Mee, Ltd., of 74 New Oxford Street, W.1. The price of the chassis is £6 10s. An output transformer, designed to give ratios of 1 to 11 and 1 to 22, can be obtained for £1 10s. extra.

First—
THE SUPER 60
 An instant success with listeners everywhere.

Now—
THE SUPER 60 PORTABLE
 A revelation of what self-contained radio can be.

Next—
THE A.C. SUPER 60
 Full details in the next issue, out on May 22.

FOR SUPER RESULTS

Build with a Ready Radio Guaranteed Kit

SUPER 60 PORTABLE

	£	s.	d.
1 Set Wearite Super-hot Coils	2	10	0
1 Formo Mkadenser, .0002 microfarad	2	0	0
2 Telsen .001-microfarad Fixed Condensers	14	2	0
5 T.C.C. 1-microfarad Fixed Condensers	17	0	0
2 J.B. .0005-microfarad No. 2 Tiny Condensers	17	0	0
1 Read-Rad Grid Leak Holder	9	0	0
9 W.B. Rigid Valve Holders	9	0	0
1 Read-Rad 15,000-ohm Link Resistance	1	3	0
1 Read-Rad 20,000-ohm Link Resistance	1	3	0
1 Read-Rad 1-megohm Grid Leak	10	0	0
1 Sovereign 50,000-ohm Potentiometer	4	6	0
1 Read-Rad Wavechange Switch	1	6	0
1 Read-Rad On-and-off Switch	1	0	0
1 Telsen "Ace" L.F. Transformer	8	6	0
1 Portable Cabinet (to specification)	2	5	0
1 Ormond Portable Chassis and Loud-speaker Unit	1	5	0
100 Yds. Lewcos 9/40 Enamelled Frame Aerial Wire, LZ2140	4	3	0
50 Yds. Lewcos 27/40 Enamelled Frame Aerial Wire, LZ2240	5	6	0
8 Belling-Lee Wander Plugs	1	4	0
1 Packet "Jiffilix" for wiring	2	6	0
6 Mullard Valves to specification	3	10	0
Screws, Flex, Plugs, Cortabs, etc.	1	7	0
TOTAL (including Valves, L/S Unit, and Cabinet)	£13-13-0		

RECOMMENDED ACCESSORIES

	£	s.	d.
1 Fuller W.O.F. 100-volt H.T. Battery	15	0	0
1 Fuller W.O.9 G.B. H.T. Battery	1	8	0
1 C.A.V. 2N.S.17 L.T. Accumulator	16	0	0
Complete Kit, including Valves, L/S Unit & Cabinet	£13.13.0	Or 12 monthly payments of	25/-
Complete Kit, including Valves, Cabinet, with ready-wound Frame Aerial	£13.17.6	Ditto	25/6
Complete Kit, including Valves, Cabinet, L/S Unit, and all Accessories	£15. 5. 6	Ditto	28/-
Complete Kit, including Valves, L/S Unit, Cabinet, ready-wound Frame Aerial, & all recommended Accessories	£15.10.0	Ditto	28/5
SUPER 60 PORTABLE RECEIVER			
Completely assembled and ready for use, with H.T. and L.T. Batteries, etc. Royalties paid	£17.17.0	Or 12 monthly payments of	32/9
Super 60 Portable Frame Aerial, ready wound	£3. 0.0	Ditto	5/6

REGIONAL THREE

- KIT A** (less Valves and Cabinet) **£9.1.6**
Or 12 equal monthly instalments of **16/8**
- KIT B** (with Valves, less Cabinet) **£11.0.6**
Or 12 equal monthly instalments of **£1.0.3**
- KIT C** (with Valves and Cabinet) **£12.10.6**
Or 12 equal monthly instalments of **£1.3.0**

Complete list of Approved Components on request.

GRAMO-RADIO A.C. THREE

- KIT A** (less Valves) **£10.19.0**
Or 12 equal monthly instalments of **£1.0.0**
- KIT B** (with Valves) **£13.16.6**
Or 12 equal monthly instalments of **£1.5.4**

SIMPLE GRAMO AMPLIFIER

- KIT A** (less Valves) **£3.1.0**
Or 12 equal monthly instalments of **5/7**
- KIT B** (with Valves) **£4.0.0**
Or 12 equal monthly instalments of **7/4**

THE SUPER 60

- KIT A** Less valves and cabinet, but including ready wound Frame Aerial **£7.6.0**
Or 12 monthly payments of **13/3**

- KIT B** Including valves less cabinet **£11.2.0**
Or 12 monthly payments of **20/3**

- KIT C** Including valves and cabinet **£11.19.6**
Or 12 monthly payments of **21/9**

Ready Radio

159, BOROUGH HIGH STREET, LONDON BRIDGE, S.E.1.

Telephone: Hop 5555 (Private Exchange) Telegrams: READIRAD, SEDI ST.

ORDER FORM

To: Ready Radio (R.R.Ltd.), 159 Borough High St., London Bridge, S.E.1

CASH ORDER FORM

Please dispatch to me at once the goods specified for which I enclose payment in full of

£

Name

Address

C.O.D. ORDER FORM

Please dispatch to me at once the goods specified for which I will pay in full on delivery the sum of

£

KIT REQUIRED

HIRE PURCHASE ORDER FORM

Please dispatch my Hire Purchase order for the goods specified for which I enclose first deposit of

£

TO INLAND CUSTOMERS

Your goods are dispatched post free or carriage paid.

TO OVERSEAS CUSTOMERS

All your goods are very carefully packed for export and insured, all charges forward.

Performance

In construction, many Low Frequency Transformers are similar in appearance. The only way to judge a Transformer is by its performance—QUALITY OF REPRODUCTION.

THE IGRANIC MIDGET TRANSFORMER

is noted for its distortionless reproduction of both speech and music.



Small in size, handsomely finished, and provided with milled terminals and soldering tags, this MIDGET TRANSFORMER is termed a "Masterpiece in Miniature."

PRICE 10/6

Specified for the

"BROOKMAN'S THREE-PLUS-ONE"

If you are unable to obtain Igranic components locally, write direct to us to Dept. J.H24.



DESIGN DATA SHEETS By J. H. Reyner, B.Sc., A.M.I.E.E.

"W.M." Design Data

No. 1

OUTPUT CIRCUITS

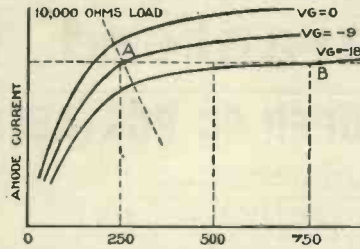

Load characteristic of pentode

WHEN using a pentode output valve the arrangement should be such that the effective impedance in the anode circuit is distinctly smaller than the internal resistance of the valve itself. This condition is exactly the opposite to the practice with an ordinary power valve, although the actual impedance of the anode circuit works out approximately the same.

Thus with a power valve of 2,000 or 3,000 ohms impedance, one would use an external impedance of 5,000 to 6,000 ohms. The same value would be reasonably satisfactory with the average pentode, although the optimum value would probably be nearer 10,000 ohms. A higher value than this is not desirable.

This condition of affairs arises from

the characteristic of the pentode, which is illustrated in the diagram. *A* is the normal working point. Let us assume that we have a very large impedance in the anode circuit, so large that the anode current does not change appreciably if we alter the bias.

Let us suppose our grid voltage alters from the normal value of -9 volts to -18 volts. If we are to maintain the same anode current it will be seen that we must take up a position as at *B* on the -18 volts characteristic, which will correspond to an anode voltage of 800 volts.

This is, of course, a dangerously high value, and would probably result in damage, either to the loud-speaker, output circuit, or to the valve itself.

The remedy is to use a value of external impedance distinctly smaller than the valve resistance where the conditions are represented by the load line shown dotted through the point *A*. Then as we run from one grid-volt curve on to the next, the anode voltage variation is not excessive.

A pentode, therefore, should be used in the majority of cases with 1 to 1 output (or even a step-up), to prevent the anode impedance becoming excessive.

"W.M." Design Data

No. 2

TROPADYNE OSCILLATOR

THE increasing popularity of super-het receivers has revived interest in the various forms of oscillator-rectifier circuits which can be employed.

In the customary super-het receiver it is necessary to have a first detector on which the original signals are received and rectified, and also an oscillator which generates a local oscillation which is mixed with the incoming signal and produces the beats for supersonic operation.

While it is undoubtedly more satisfactory to use two separate valves for the purpose, there are cases when the two operations can conveniently be combined in one valve. Difficulties are experienced in keeping the two operations separate within the same valve, as may be imagined, one of the most common forms of trouble being that reaction effects can be obtained either on one waveband or on the other, but not on both.

Thus if reaction is obtained on the normal receiving circuit, it is not found possible to make the oscillator function. Conversely, if reaction is obtained to a satisfactory extent in the oscillator circuit, then the detector circuit cannot obtain any regeneration.

A form of circuit which has been used successfully is shown in the

diagram herewith and is known as the Tropadyne circuit. It depends for its operation on the selection of an accurate centre tap on the oscillator coil, as otherwise the arrangement does not behave satisfactorily.

The value of the resistance *R* must not be too large or there is a violent squealing howl, which spoils the reception. On the other hand it must not be shunted by a capacity, as this will

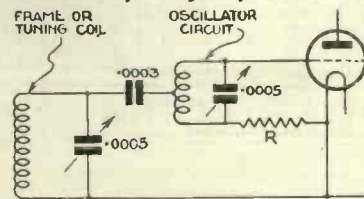

Tropadyne oscillator circuit

stop the oscillation completely and care must be taken to see that by-pass condensers in other parts of the circuit are not effectively connected across this resistance.

With suitable precautions, however, the circuit is capable of giving quite satisfactory results. It gives a tight coupling between the oscillator and the incoming signal, which tends to produce a good super-het action.

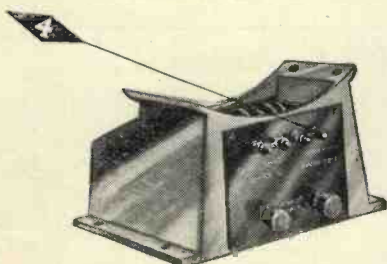
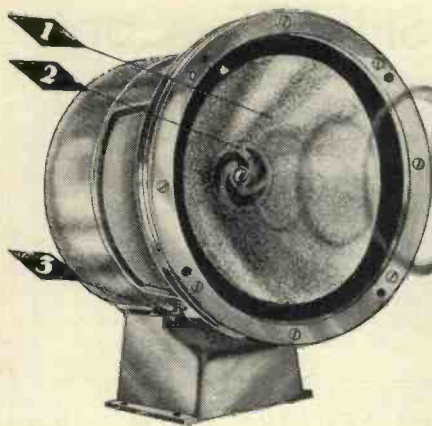

NEW

PARMEKO

MOVING COIL SPEAKER

- 1 **DIAPHRAGM MATERIAL**
A new material produced after exhaustive tests; a distinct advance on anything used before. Rigid centring allows for free parallelling.
- 2 **FIELD STRENGTH**
9,000 lines per sq. cm. in the gap, giving extreme sensitivity coupled with ability to handle almost unlimited power. Permanent magnet requires no energising.
- 3 **CONSTRUCTION**
Robust Diecast Aluminium housing makes this a most workmanlike job, and every detail has the honest finish associated with all PARMEKO apparatus.
- 4 **OUTPUT TRANSFORMER**
In special base; series-parallel change-over (no loss of efficiency) from 11:1 to 22:1 and from 2,000 to 8,000 ohms primary impedance for pentodes, etc.

REAR OF BASE WITH OUTPUT TRANSFORMER

Further details from

PARTRIDGE & MEE LTD.,

Prices: Speaker only **£6:10:0** Output Transformer in base **30/-**

Ask your local dealer to demonstrate

25 Dover Street, Leicester, and 74 New Oxford Street, London
Phone Leicester 22276 Phone Museum 5070

BEAUTIFY YOUR SET

Add Pounds to its appearance by placing it in this Elegant, High-Class Radiogram Cabinet

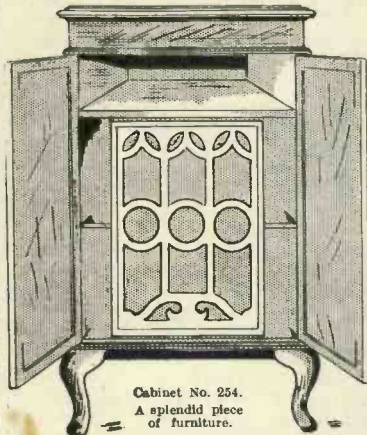

Cabinet No. 254.
A splendid piece of furniture.

Made of best seasoned Oak or Mahogany. Ample room for Batteries and Loudspeaker. Opening at top, and double doors front and back. Takes Panel 21"x9" or smaller.

No. 254. 4 ft. high. 2 ft. wide. 1 ft. 6 ins. deep.

Prices:

Machined ready to Assemble: OAK, £2 15s., MAH. £3.

Assembled ready to Polish: OAK, £3 5s., MAH. £4.

Assembled and Polished: OAK, £4 15s., MAH. £5.

Prompt Deliveries. Phone: Bishopsgate 9094. Send 2d. for Illustrated Catalogue. Dept. W.M.

WOODCRAFTS CO.,

15 Cygnet St., Bethnal Green Road, E.1.
Branches: 1 Winchester Street, E.2; 96 Wood Street, E.17; 289a Hoe Street, E.17.



BUY

AMATEUR

WIRELESS

30.

WEEKLY

THE BEST
COMPANION
TO WIRELESS
MAGAZINE



OVERHAUL YOUR GRAMOPHONE AND FIT THE NEW "DIEHL" ARISTOCRAT ELECTRIC MOTOR

The Price?—Remarkably Low—Only 84/- Complete!

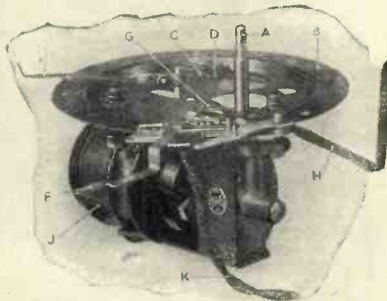

AT LAST!—A NEW, BRILLIANTLY "ORIGINAL" ELECTRIC GRAMOPHONE MOTOR THAT IS DISTINCTLY "BETTER." Produced by the DIEHL MFG. CO., Electrical Division of the World-Famous SINGER SEWING MACHINE CO., and distributed exclusively by "LYONS."

That we are behind this new motor is sufficient warranty that it marks a step

forward in correct design; it is really superfluous to add that Singers' 46 years' experience in the World's largest Small Motor Plant is also backing and positively guaranteeing this proposition.

NEW FEATURES INCLUDE: Bakelite Non-Rusting and Non-Warping Turntable; Spring Suspension; One-Hole Fixing; Induction Motor; Guaranteed Humless; Non-Interfering; No Brushes; Worm-Driven with Single-Plate Cork Clutch; Speed Indicator; Automatic Stop and A.C. Snap Switch.—IN FACT, DEFINITELY THE BEST MOTOR NOW AVAILABLE. AND WHAT A SURPRISINGLY LOW AND ATTRACTIVE PRICE... ONLY 84/- COMPLETE! THE DEMAND IS ENORMOUS.

Special Folder Free on Request by Return. Large Stocks.

EXCLUSIVE DISTRIBUTORS IN GREAT BRITAIN:

CLAUDE LYONS LTD.,

76 Oldhall St., LIVERPOOL. LONDON, 40 Buckingham Gate, S.W.1.
Demonstrations willingly given at either establishment



Please mention "Wireless Magazine" when corresponding with advertisers

PUT
YOUR SET
IN THE
VOXKIT



Reg. Design
SPECIFICATIONS: 3'4" high
x 1'10" wide x 1'5" deep.
Panel size, 18" x 8". Baseboard
depth 14". Loud-speaker com-
partment suitable for Double
Linen Diaphragm or Moving-
Coil Speakers, 17½" x 17" x 14".
In hand French-polished Oak;
removable back; with lift-uplid;
and silk-covered fret.

CASH PRICE

63/-

or 6 monthly payments
of 11/-
PETO-SCOTT CO. LTD.
77, CITY ROAD, LONDON, E.C.1.
62, HIGH HOLBORN W.C.1.

DESIGN DATA SHEETS—Cont.

"W.M." Design Data

No. 3

WINDING DATA

WHEN designing a winding it is usually desired to know the largest gauge of wire which can be used to obtain the required number of turns within the area available. It is not satisfactory to divide the available area by the area of the wire, and see whether this is the correct number of

turns, because there must be some air space between the various turns of the wire and due allowance must be made for this.

The following table gives the approximate number of turns per square inch for different gauges of wire in common use.

URNS OF WIRE PER SQUARE INCH

S.W.G.	Enamelled Wire	D.S.C. Wire
20	685	640
22	1,100	1,000
24	1,775	1,600
26	2,750	2,275
28	3,775	3,175
30	5,390	4,520
32	6,930	5,690
34	9,700	7,400
36	13,750	10,500
38	21,000	15,250
40	34,000	21,500
42	46,000	29,500
44	66,500	39,500

CLIX

By specifying Clix for the "REGIONAL THREE" the designer has assured perfect contact at the most important points.

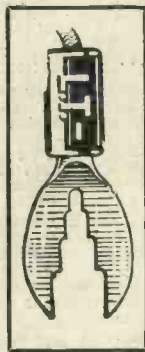

"FIT-ALL" SPADE TERMINAL

Fits all sizes of screw terminals. Lead-coated for L.T. Nickel plated for general use. Insulators red or black. Engraved or plain 2d



"SPRINGSCREW" WANDER PLUG

Helically-formed leaves, self-cleaning surfaces, and solid end. Non-collapsible. Red or black. Engraved or plain 2d.

No. 8. Pat. Pro. Pat. Reg. Des.

If unable to obtain locally please forward us name of dealer.

LECTRO LINX, LTD.
254 Vauxhall Bridge Road, S.W.1

"W.M." Design Data

No. 4

CONDENSER LOSS

IT is necessary in the construction of wireless apparatus to insulate certain parts from the remainder. A simple case is to be found in the ordinary variable condenser employed for tuning purposes. The fixed plates of a condenser must be separated from the moving plates and, in order to build the whole into a rigid mechanical structure, some insulating material must be employed.

This introduces loss into the circuit. In a perfect insulator high-frequency currents can flow without any loss of energy, but in all solid insulators, or dielectrics as they are termed, some energy is absorbed during the passage of current. Consequently, the circuit behaves as if it had an additional high-frequency resistance and will neither tune as sharply nor deliver as strong a signal.

The loss may be very small in a good condenser or it may be appreciable. During some recent tests the voltage developed in a high-frequency stage was increased three times by removing the existing variable condensers and replacing them with high-grade components.

The difference was due to the material used for the insulation and to the general construction. Both con-

densers were of the air-spaced type. The loss becomes much greater if the plates are separated by a thin sheet of insulating material. This is often done to cheapen the cost of production and reduce the size, but such condensers must be used with caution and with due appreciation of their defects.

One of the most common types of condenser uses a bakelised paper interleave. During the same series of tests a small trimming condenser was employed across one of the tuning condensers. The capacity of the trimmer at the particular working position was about 0.001 microfarad, while the main tuning capacity was about 0.002 microfarad.

The voltage across the circuit was measured with the trimmer in position, and again with an air-spaced trimmer in place of the paper-dielectric component originally employed. The voltage was found to have increased over two and a half times due to the removal of the paper dielectric.

The combination of this loss due to the paper dielectric and that due to the inferior construction of the main condensers made the receiver lifeless since the additional loss was too great to be adequately compensated by reaction as is usually done.