

# The Wireless 6<sup>d</sup> Constructor

Vol. XIV.

MAY, 1932.

No. 67.

## THIS MONTH THE "VI-KING" SUPER



## AND MORE ARTICLES

by JOHN SCOTT-  
TAGGART  
F. INST. P. AM. I. E. E.

ALSO: "TUNING MADE READABLE," by HERBERT K. SIMPSON.  
"SHALL I DESIGN A PORTABLE?" by VICTOR KING.  
AN ANALYSIS OF "THE WIRELESS CONSTRUCTOR" SHORT-WAVE TESTS.



Colvern Coils  
exclusively specified  
for the S.T. 300  
Now chosen for  
the A.C.  
model.

The Colvern Coils  
chosen for the A.C.  
Model of the S.T.300—  
1 pair Colvern Coils,  
Type S.T.300,

**12/-** pair.

**COLVERN LIMITED, MAWNEYS ROAD, ROMFORD, ESSEX**

# CONTENTS

	Page		Page
The Editor's Chat .. . . .	5	As We Find Them .. . . .	29
"The Best Three-Valver of Recent Times" .. . . .	6	From My Armchair .. . . .	31
Decoupling Simply Explained .. . . .	9	Making Tuning Readable .. . . .	33
Queer Queries .. . . .	12	The Month on Short Waves .. . . .	36
B.B.C. News .. . . .	13	"On the Grid" .. . . .	36
The "Vi-King" Super .. . . .	15	Pick-up Hints and Tips .. . . .	38
With Pick-up and Speaker .. . . .	21	A Practical Man's Corner .. . . .	39
Round the Dials .. . . .	22	Shall I Design a Portable? .. . . .	42
Points for Purchasers .. . . .	22	In Lighter Vein .. . . .	44
The "Pentode" Two .. . . .	23	Wireless Woodwork .. . . .	47
The "Constructor" Test Analysis .. . . .	28	Where to See the "S.T.300" .. . . .	48
		Our News Bulletin .. . . .	50
		A Famous Patent Expires .. . . .	51

As some of the arrangements and specialties described in this Journal may be the subjects of Letters Patent the amateur and trader would be well advised to obtain permission of the patentee to use the patents before doing so.

## SHORT WAVES

### on A.C. MAINS or BATTERY SETS

An entirely new design of amazing efficiency.

This Short-Wave Adaptor can be used with any type of receiver (excluding D.C.), whether A.C. Mains, Battery Operated or Super-het., irrespective of the circuit or the number of valves. It is supplied complete with one Special Short-Wave Coil, 40, 80 metres, Cord and Plug. No extras whatsoever are required. Can be attached to your set in a

few seconds. Full particulars with free trial offer and a list of Short-Wave Stations right up to date, free on request.

PRICE COMPLETE

**39/6**

Extra Coil if required, 18/40 metres **3/-**

Comprehensive lists, including a booklet on the "Stenode," free on request.

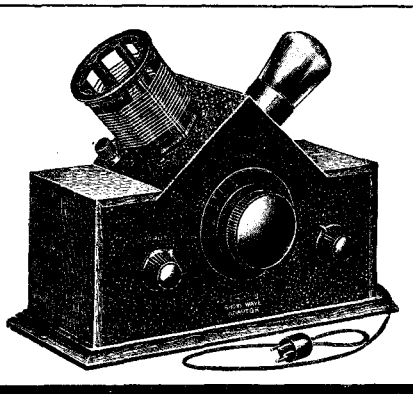

SHORT-WAVE ADAPTOR

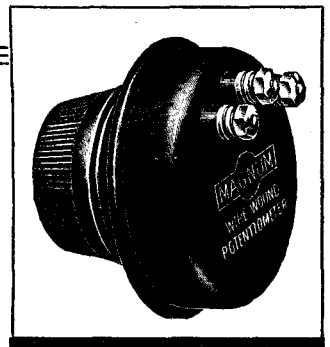

#### MAGNUM WIRE-WOUND POTENTIOMETER

Specified for the "Victor King" Super. 50,000 ohms .. . . . **7/6**

#### MAGNUM SOLID DIELECTRIC VARIABLE CONDENSERS

'0001—'0005 .. . . . **2/6**  
'00075 .. . . . **3/-**  
Including knob.

SAND-BLAST SCREEN, for "S.T.300" .. . . . **2/-**

"VICTOR KING" SUPER, "PENTODE" TWO, "S.T.300"

and all "Wireless Constructor" sets are available ready wired and tested. Every set is hand-made and tested by skilled craftsmen, thus ensuring perfect and guaranteed performance.

**BURNE-JONES & CO. LTD.,**  
"MAGNUM" HOUSE, 296, BOROUGH HIGH STREET, LONDON, S.E.1.

Telephone: Hap 6257 and 6258.

Scottish Agent - Mr. Ross Wallace, 54 Gordon Street, Glasgow. C.1.

# The BEST

## Magazine-value

### in the WORLD!

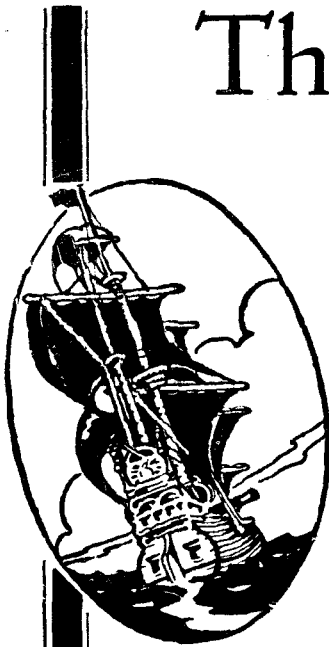

Such is THE ARGOSY MAGAZINE, every issue of which is packed with a wonderful selection of the world's best fiction. The short story—highest form of prose-writing—is well represented. Every issue contains examples from the pens of the masters. The novel?—that, too, has its place in THE ARGOSY, for there is a complete book-length novel in every number. There is no other publication in the world which offers you so much for so little expenditure. Not merely once now and then, but *every month*. If you appreciate cultivated fiction you will appreciate THE ARGOSY. So much so that you will almost certainly become one of the rapidly-growing army of ARGOSY readers. In the MAY issue, which is now on sale, there are—

**12 BRILLIANT SHORT STORIES, AND  
A COMPLETE BOOK-LENGTH NOVEL.**

and here are just a few names from the list of distinguished contributors:—

JAMES OLIVER CURWOOD

LOUIS GOLDING

HUGH WALPOLE—JOHN RUSSELL

PERCEVAL GIBBON

You will never regret it if you tell your Newsagent to deliver this excellent magazine regularly.

# The ARGOSY

MAGAZINE

Get YOUR Copy To-day

1/-

# PILOT AUTHOR KITS

EXACT TO SPECIFICATION

**C.O.D.  
CASH  
OR  
H.P.**

## S.T.300

### BATTERY MODEL

Described in *Wireless Constructor*,  
February issue, 1932.

#### PRICES OF COMPLETE KITS IN SEALED CARTONS

**KIT "A"** Author's Kit, less  
valves and cabinet

CASH or C.O.D. **72/6**

**EASYWAY**  
12 monthly payments of 68  
Valves as specified, £1:12:3. Cabinet, 15/-

**KIT "B"**  
Author's Kit, with  
valves but less cabinet  
CASH or  
C.O.D. **£5:4:9**  
**EASYWAY**  
12 monthly pay-  
ments of 9/7

**KIT "C"**  
Author's Kit, complete  
with valves & cabinet  
CASH or  
C.O.D. **£5:19:9**  
**EASYWAY**  
12 monthly pay-  
ments of 10/11

This is the Kit of Parts  
actually used and specified  
by John Scott-Taggart

1	Panel, 16" x 7" x 3/16" ready drilled black knob	8	4	6
1	Telsen '0001 differential condenser, with valves	2	0	
2	Telsen Lund. Mansbridge condensers	4	6	
1	Telsen binocular H.F. choke	5	0	
2	ReadiRad 3-point switches	3	0	
1	ReadiRad '0015 diff. condenser	2	6	
1	Peto-Scott standard screen, 10" x 6", with notches filed	2	0	
1	Peto-Scott terminal strip, 16" x 1 1/2" x 3/16" ready drilled	1	3	
1	Peto-Scott baseboard, 16" x 10"	1	3	
1	Peto-Scott copper sheet, 10" x 7", about "006" thick	1	0	
2	Ormond '0005-mfd. S.M. condensers	13	0	
1	Pair Colvern "S.T.300" coils, with sup- porting pillars, special "S.T.300" wind- ings and terminal connections	12	0	
1	Dubilier '0001-mfd. type 670 condenser	1	0	
1	Graham Parish "Mighty" long grid leak	1	6	
1	Lewcos H.F. reaction choke "Rot. M.C."	2	6	
1	Lewcos Spaghetti resistance, 20,000 ohms	1	6	
1	Varley "Nixot" L.P. transformer, 3.5:1, type D.P.21	7	6	
2	Lotus valve holders, type T.H.K.	1	0	
1	W.B. valve holder (S.G. horizontal)	1	0	
10	Bulgin terminals, marked	2	6	
1	J.B. midge condenser, '00004-mfd.	4	0	

Use this detailed Price List when ordering  
parts for the "S.T.300".  
Any items sent separately. If value over  
10/-, sent Carriage Paid or C.O.D.—all Post  
charges paid.

### "S.T.300" BATTERY MODEL FINISHED INSTRUMENT

**£7 : 7 : 6** Complete with valves  
and cabinet. Factory  
wired—Aerial tested  
—Royalties Paid.  
CASH or C.O.D.  
or 12 monthly payments of 13/6.

Read this glowing testimonial.

"I received the Pilot Author Kit for the 'S.T.300' on Friday and thank you for your prompt attention. . . . I wired it on Saturday. Between 7 o'clock and 9 I managed to pick up 30 stations at full strength. . . . This is the best investment I have ever made as I now cut out Glasgow in 3 degrees. My aerial is only 15 ft. on high and screened on 3 sides. . . . On Sunday evening I picked up Belfast and Cork. . . . Very few can do this. . . . even on 4-valve sets. . . . Selectivity is all that can be desired. . . . I have been able to pick up no less than 60 stations at full pick-up strength. . . . I consider the loud-speaker strength. . . . I consider the 'S.T.300' worth every penny I have paid for it. It is a remarkable set and I have been astonished at results. . . . Assuring you of my custom at all times."  
8.2.32. A. G. (Renfrew, Scotland).

### KIT-BITS

Selected Components

### CASH or C.O.D.

You pay the postman. We pay post charges on all orders over 10/-.

#### "S.T.300" (Battery Model)

1 pair Colvern "S.T.300" Coils	12	0
2 Ormond Slow-Motion Condensers	13	0

#### "S.T.300" (A.C. Model)

2 Lotus '0005-mfd. slow-motion tuning condensers	13	0
Peto-Scott '00004-mfd. air-dielectric variable condenser	3	6
Pair Telsen "S.T.300" coils	11	6
Wearite output choke, H.T.5	12	6

#### "VICTOR KING" SUPER

J.B. Double-gang '0005-mfd. variable condenser with disc drive	1	1	0
J.B. '0005-mfd. variable condenser with disc drive	12	6	
2 Cordo coils with extension rods	17	0	
Lewcos standard oscillator unit	18	6	
Set of Lewcos intermediate units	1	1	0

#### "PENTODE" TWO

Telsen '0005-mfd. tuning condenser and Formo slow-motion dial	7	0
Varley Pentode Nichoke output choke	12	6
3 Peto-Scott coil quitoes, ready wound	6	0

### IMMEDIATE DELIVERY

### A.C. "S.T.300"

### KIT "A" Author's Kit, less valves and cabinet.

CASH or C.O.D.

**£5-7-0**

or 12 monthly payments of 9/10  
Specified Valves £2:7:6. Specified Cabinet 15/-

**KIT "B"**  
Author's Kit, with  
valves but less cabinet,  
CASH or  
C.O.D. **£7:14:6**  
**EASYWAY**  
12 Monthly payments  
of 14/2

**KIT "C"**  
Author's Kit, complete  
with valves and cabinet  
but less eliminator.  
CASH or  
C.O.D. **£8:9:6**  
**EASYWAY**  
12 Monthly payments  
of 15/6

The Heayberd Eliminator, Type M.W.1 (£6:7:6 Cash Price) is an essential accessory of the A.C. "S.T.300".  
If required add 11/8 to each monthly payment.

### "VICTOR KING" SUPER

As described in this month's issue.

### KIT "A" Author's Kit, less valves and cabinet

CASH  
OR  
C.O.D.

**£7-14-8**

or 12 monthly payments of 14/2  
Specified Valves, £2:19:0. Specified Cabinet, 16/6

**KIT "B"**  
Author's Kit, with  
valves but less cabinet,  
CASH or  
C.O.D. **£10:13:8**  
**EASYWAY**  
12 monthly pay-  
ments of 19/7

**KIT "C"**  
Author's Kit, complete  
with valves and cabinet  
CASH or  
C.O.D. **£11:10:2**  
**EASYWAY**  
12 Monthly payments  
of 21/1

### "PENTODE" TWO

As described in this month's issue.

### KIT "A" Author's Kit, less valves and cabinet

CASH  
OR  
C.O.D.

**£4-0-8**

or 12 monthly payments of 7/5  
Specified Valves, 24/6. Specified Cabinet, 15/-

**KIT "B"**  
Author's Kit, with  
valves but less cabinet,  
CASH or  
C.O.D. **£5:5:2**  
or 12 monthly pay-  
ments of 9/8

**KIT "C"**  
Author's Kit, complete  
with valves and cabinet  
CASH or  
C.O.D. **£6:0:2**  
or 12 monthly pay-  
ments of 11/-

FOUNDERS OF CONSTRUCTOR KITS IN 1919

# PETO-SCOTT

CO. LTD.

77, CITY ROAD, LONDON, E.C.1. Telephone: Clerkenwell 9406-7-8. 62, HIGH HOLBORN, LONDON, W.C.2. Telephone: Chancery 8266.

Messrs. PETO-SCOTT CO. LTD., 77, City Road, London, E.C.1.

Please send me C.O.D./CASH/H.P. (Strike out wording not applicable.)

"S.T.300" BATTERY MODEL KIT A/B/C.

A.C. "S.T.300" KIT A/B/C with without specified Eliminator.

"VICTOR KING" SUPER KIT A/B/C.

"PENTODE" TWO KIT A/B/C.

for which I enclose £ s. d. CASH/H.P. Deposit.

NAME.....

ADDRESS.....

W.C.5 32

# THESE ARE THE MULLARD VALVE TYPES FOR THE S.T.300, A.C. VERSION

Mullard Valves, up-to-date, efficient, non-microphonic, mean improved results at every stage; consistently better receiver performance. These are the correct types for the A.C. version of the S.T.300.

- S.4VB** - Screened grid H.F. Valve - Price 19/-
- 354V** - Detector - - - - - " 13/6
- 104V** - Output Valve - - - - - " 15/-

The Mullard Rectifier valve for use with A.C. all mains receiver is:

- D.W.2** - Full-Wave Rectifier - - - Price 12/6

## S.T.300, BATTERY MODEL

The Mullard Valve types for use in the battery model are:

- P.M.12** - Screened grid H.F. Valve - Price 16/6
- P.M.1 HL** or **P.M.2DX** Detector - - - " 7/-
- P.M.2A** - Power Valve " 8/9  
or for the Output stage
- P.M.22** - Pentode " 17/6

**MULLARD VALVES ARE MADE IN ENGLAND**

# Mullard

***THE MASTER VALVE***

*Advt. The Mullard Wireless Service Co. Ltd.  
Mullard House, Charing Cross Road, London, W.C.2.*

*4783*

# The WIRELESS CONSTRUCTOR

Published by the Amalgamated Press, Ltd., Fleetway House, Farringdon Street, London, E.C.4.



## THE EDITORS' CHAT



This month we make the important announcement that in future it will be possible for readers of "The Wireless Constructor" to hear local demonstrations of the "S.T.300" and other famous receivers by means of the scheme referred to below. Brief details of some fine sets are also given, the full particulars of which appear in other pages of this issue.

WE feel certain our readers will be interested to learn that we have been able to make arrangements for the famous "S.T.300" receiver to be demonstrated at leading radio shops throughout the country. Thanks to the enthusiastic co-operation of retailers—who thus become officially recognised exhibitors of leading WIRELESS CONSTRUCTOR sets, as well as of outstanding sets described by our contemporary, "Popular Wireless"—our readers in the majority of towns in this country will shortly be in a position to examine actual "S.T.300" designs and other outstanding receivers described from time to time in THE WIRELESS CONSTRUCTOR.

By visiting their local radio shops, readers will thus be able to have a demonstration of the "S.T.300" and other sets; and they will be able to get a thoroughly good idea, not only of how these sets operate under local conditions, but how they look "in the flesh," so to speak.

### Our Official Exhibitors

On another page we present the first of a series of lists of the names and addresses of those retailers who have agreed to co-operate in this scheme, and readers of THE WIRELESS CONSTRUCTOR in the areas covered are thus in possession of a reliable guide to officially recognised exhibitors of our outstanding set designs.

We feel that this scheme will not only enhance the popularity of the "S.T.300" and other leading designs published in this paper and in our contemporary, "Popular Wireless," but will greatly assist readers—and the radio trade as well. We should like to mention here that any retailer desiring to exhibit an "S.T.300" receiver and a "P.W." "Cosmic"

receiver—whether these sets be purchased through a wholesaler or built up from parts as specified in the descriptions of the sets published in this journal, and in our contemporary, "Popular Wireless"—may apply to the Editor, THE WIRELESS CONSTRUCTOR, Tallis House, Tallis Street, London, E.C.4, to be placed on the official exhibitors' list.

Look out for the first list of retailers who have become exhibitors of our designs.

### A Remarkable Tribute

There can be no doubt that the "S.T.300" has proved the greatest success of any set design of the year.

### JAPAN'S NATIONAL HERO



Admiral of the Fleet Count Togo, Japan's National Hero, as he appeared before the microphone during a recent broadcast from all the Japanese stations.

We can only publish a fraction of the number of letters we are receiving from enthusiastic constructors; but letters continue to arrive day by day from all parts of the country, and from all kinds of people.

It is a remarkable tribute to Mr. Scott-Taggart's design that, although many of these letters contain queries about the set, they are—without exception—eulogistic to a high degree.

The recent publication of details of the "S.T.300" for A.C. mains has also brought in a surprising batch of letters. Frankly, we did not expect that the A.C. version would make such a great appeal, in view of the recently published statistics showing the comparatively few number of homes in this country fitted with A.C. mains; but there is every indication that quite a large percentage of home constructors who have their houses fitted with A.C. mains have built, with remarkable success, Mr. Scott-Taggart's A.C. version of his famous receiver.

In this issue, Mr. Scott-Taggart continues his "From My Armchair" series—a series which bids fair to be one of the most popular ever published in a wireless journal.

### The "Vi-King" Super

Even if you are not inclined to build a set at the moment, carefully study the description of Mr. Victor King's "Vi-King" Super. We think you will agree that this is a magnificent set, representing the peak of accomplishment of this well-known set designer.

The "Vi-King" Super employs a variable-mu valve, band-passing, and various other up-to-date features. Although this set is immensely powerful, and a very fine programme collector, it definitely is moderately inexpensive to build.



# "The Best 3-Valver"

10, Kingsmead Avenue,  
Edmonton,  
London.

Dear Sir,—Reference and in addition to my published letter in the March issue of THE WIRELESS CONSTRUCTOR, I really must confirm my report on the "S.T.300." When I wrote the set had been in operation less than an hour; since, I have been able to give it a full test, and my previous report is mild in comparison with my present appreciation of its performance.

I have logged over 50 stations on the loud speaker, and though I do not know the names of them all, I have identified thirty-one. I have never before built a simple three-valver like it.

Stations like Prague, Rome, Toulouse, North Regional, Midland Regional, Berlin, Radio-Paris, Eiffel Tower, and National come in so strong as to require volume cutting down and I have had to include a Colverstat in the filament circuit.

I have had many communications from would-be constructors, and to all I have given the same final words—

**I vote plump for the "S.T.300" as the best and most inexpensive three-valver of recent times.**

I have also had the pleasure of demonstrating my set to several London inquirers, and although I live within ten miles of Brookmans Park I have been able to separate Midland Regional and Toulouse entirely from

each other and from London Regional, also Bratislava entirely from London National. Prague, North Regional, and Langenberg, although within a degree or so, are entirely separate, and the volume of the first two controlled.

I have built another "S.T.300" for a friend, and he is just as pleased with it as I am. Thanks for a very excellent set.

Yours faithfully,  
W. J. SCARR.

**Blackburn says: "Too Modest!"**

"Moreton,"

Sydney Avenue,  
Whalley, Near Blackburn.

Dear Sir,—I wish to thank you for your amazing "S.T.300." I have followed nearly all circuits in leading wireless journals, but when I read that you, sir, would be returning to THE WIRELESS CONSTRUCTOR, for the benefit of the amateur, I had a vision of something good; then I got THE WIRELESS CONSTRUCTOR, and after reading from end to end a few times, decided to scrap my latest five-valve super with the full confidence of an old follower of yours that the "S.T.300" would do all that you had reported it to do.

**My honest opinion is that you have been far too modest about its capabilities.**

It is simply wonderful!

**I am open to test this set against practically any four- or five-valve**

**Again this month we have  
ters from all over the  
results obtained  
Read them carefully and  
only that any set can  
but that it should so  
sorts of**

commercial or amateur set, and guarantee to beat it.

I may add that I have for two nights given the "S.T.300" a severe test for five super-wireless fans, and they all asked me the same thing: Get Prague clear of North Regional, which is our local, and I won. The next was: Get Hilversum clear of North National. I got that with a faint trace of North National only, and at four yards they could not hear any trace of North National. Two I know for certain are building the "S.T.300" this afternoon.

Yours faithfully,  
HARRY HARGREAVES.

**Somerset's "Best Ever Heard"**

"Brynteg,"  
Milton Road East,  
Weston-super-Mare,  
Somerset.

Dear Sir,—I feel that I must write to you and congratulate you on designing such a wonderful set as the "S.T.300."

I built the "S.T.300" a few days ago and the results attained are amazing. It has a very high degree of selectivity on both the medium and long wave-bands, while still retaining plenty of volume.

The only difference I made when constructing your set was in place of the Varley Niclet L.F. transformer I fitted a Ferranti A.F.4.

I have been a keen experimenter in wireless since 1921, and I can honestly say that the "S.T.300" is the best S.G.3 that I have ever heard.

Yours faithfully,  
JAMES A. MANN.

**Edinburgh Reader's "Best of Ten"**

1, Merchiston Bank Gardens,  
Edinburgh.

Dear Sir,—The "S.T.300" set is a revelation—plenty of stations and

## THE ORIGINAL "S.T. 300"

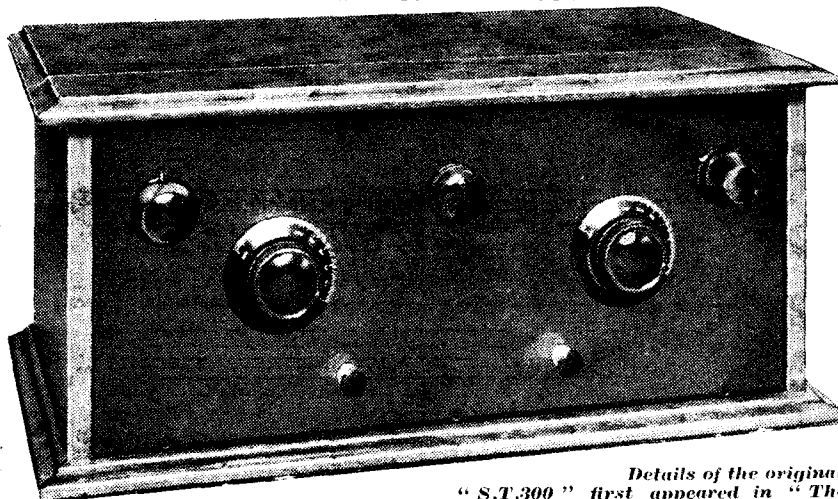

Details of the original "S.T.300" first appeared in "The Wireless Constructor" for February, and since then it has caught on in an absolutely amazing fashion. It is a no-compromise set that enables you to use to full advantage the biggest and best aerial you can put up.



# of Recent Times”

**selected some typical let-country telling of the with the “S.T. 300.” you will be amazed, not arouse such enthusiasm, consistently triumph in all conditions.**

**easy to separate them ; the best three-valver out of the ten I have built.**

The trouble taken over the blueprint, in addition to the directions given in the CONSTRUCTOR, make the set easy to build and ensure good results.

Many thanks for it; am looking forward to future numbers of the CONSTRUCTOR for more of your ideas.

I am willing to demonstrate the set to anyone you might wish to send to me.

Yours faithfully,

L. HAMMOND,

Eng.-Captain, R.N. (Retd.).

## “Does All You Claim”

19, Kett Street,  
Bulwell,  
Nottingham.

Dear Sir,—I must congratulate you for making it possible for the readers of THE WIRELESS CONSTRUCTOR to build the “S.T.300.”

Although I have only had the set working about seven days, I have logged without interference several stations which were not mentioned in your list.

**You have more than solved the present troubles of stations jamming.**

I have tried numerous sets, and the greatest trouble has always been separating stations.

**In trying out the “S.T.300” I find it does all you claim for it.**

I can sit down and enjoy a programme without interference of other stations, a thing which has been almost impossible this winter.

Yours faithfully,

A. PEARCE.

## “Second to None”

14, Lime Avenue,  
Huthwaite,  
Near Mansfield,  
Nottingham.

Dear Sir,—Seeing the “S.T.300” in THE WIRELESS CONSTRUCTOR, I must

needs have a shot at it, but it would not run to buying coils, etc., so I had to utilise my old friends the plug-in coils.

I made no other alterations to my four except the wiring for coils and the addition of a 2s. differential. The aerial condenser I am using is a queer type of differential, with fixed vanes either side centre spindle, but it does the trick.

Now for results : On long waves—being in the Midlands—I could never cut out Daventry without reducing Radio-Paris to nothing. But all this is altered—the more you cut out 5 XX, the more Radio-Paris comes in, and five or six more long-wavers, too ! And on the short waves you can just about get stations every three or four degrees of the dial—and all clear one of the other.

**To sum up : It is the most simple of sets to build and to handle, yet it is absolutely second to none.**

Yours faithfully,

VICTOR STENDALL.

## “Over 40 Stations”

173, Gossett Street,  
London, E.2.

Dear Sir,—In my previous letter I stated that after your demonstration I was scrapping my 4-valve S.G. I have done so and made up the

“S.T.300,” and I am delighted with the results.

**I have logged over forty stations, all fully identified.**

Yours faithfully,

W. IRONS.

## “Over 50 Stations . . . Uncanny!”

“Longfrie,” St. Peters,  
Guernsey, C.I.

Dear Sir,—I am writing to let you know of my experiences with the “S.T.300.”

I have had the set in use for four evenings, and it is most gratifying to know that at last there is a set quite capable of handling present-day conditions.

I have not logged the number of stations by their actual call-signs, but, believe me, there is no difficulty

THE  
DESIGNER



*A portrait of John Scott-Taggart, F.Inst.P., taken at Tallis House.*

## "The Best 3-Valver of Recent Times"—continued

in tuning in well over 50 stations that can be properly heard.

As regards selectivity, your claims are fully justified. The "S.T.300" is uncanny as compared with several good sets I have built. Tuning the set is easy after an hour's practice—no one need grumble about separating stations if they build and use the "S.T.300" properly.

I may say that on the long waves, and on all the Regionals, I have not had to touch the reaction control once. It is left "dead" for these stations.

As the set is not of the expensive class, one would not expect quality to be first-class, but, believe me, it is every bit as good as my own "Sunday suit" set—a band-pass super-het. five-valve, made with everything of the very best, which is "hot stuff." I cannot claim the number of stations with this big set as with the "S.T.300."

As I make nearly all the "Popular Wireless," CONSTRUCTOR, and "Modern Wireless" sets, I think I know what's good and what isn't.

If anybody in this island would like to hear the "S.T.300" I would be pleased to demonstrate a really marvellous set.

In conclusion, please accept my sincere thanks for giving us that set of sets.

Yours sincerely,  
E. A. JAMES.

P.S.—Please may I add that using a Mazda S.G., P.M.2D.X. and Mazda P.220, the total consumption using 100-volt battery with  $4\frac{1}{2}$  volts bias is only 7 m.a. ! Who can grumble at that ?

### Glasgow's 60 Stations and Hamburg Without Glasgow !

6, Baron Street,  
Victory Gardens,  
Renfrew.

Dear Sir,—I can now give you further particulars of the "S.T.300" which I have built. In the first place, my aerial is only 15 ft. high and 50 ft. long, and screened by buildings on three sides. This does not affect the set in any way.

Sunday morning I picked up Radio-Paris, and it came in very loud and clear, and on Sunday evening I managed to pick up Belfast and Cork. I may say that very few people in Renfrew can do this even on four-valve sets.

The selectivity is all that could be desired. Being only five miles from Glasgow, I can cut out this station and bring in Hamburg without any background. Since I have built this set I have been able to pick up no less than 60 stations at full loud-speaker strength.

I have told lots of people about my set and have advised them that if they want a cheap set, and yet equal in performance to any four-valve set,

### NO DISTRICT IS TOO DIFFICULT !

#### BLACKBURN :

A reader scraps his super-het. in favour of the "S.T.300."

#### CHANNEL ISLANDS :

"No one need grumble about separating stations."

#### NOTTINGHAM :

"I can sit down and enjoy a programme without interference . . . a thing which has been almost impossible . . ."

#### RENFREW :

"Screened by buildings on three sides . . . does not affect the set in any way."

to build the "S.T.300," as I consider it worth every penny that I paid for it. It is really a remarkable set, and I have been astonished at the results that I have got since building it.

Of course, you may use all or part of any letter that I have written about my set, and I have no objection if you do use my name and address, as the "S.T.300" is, in my mind, a set which deserves well-spread publicity.

Yours sincerely,  
ALEXANDER GAULD.

### "Certainly Wonderful!"— Manchester's Opinion

54, Walker Road,  
Blackley,  
Manchester.

Dear Sir,—Having built the "S.T.300," I desire to congratulate you upon your achievement in designing such a wonderful set, and to thank you for placing at the disposal of even such novices as myself such clear details for its construction. The photographs were particularly helpful.

**The performance of the set is certainly wonderful, as in three evenings I have been able to log**

practically all the stations mentioned in your article in "The Wireless Constructor."

Belfast is received at full strength.

My set varies in the components used from those specified by the inclusion of a Climax binocular choke and an R.I. Varley choke, and the valves used are Mullard P.M.12, P.M.1L.F., and P.M.252. The tuning is similar to yours on the left-hand dial, and four degrees higher on the right-hand condenser.

Yours faithfully,  
GEO. HALL.

### 40 Stations Half-mile from Belfast Station !

51, Wellesley Avenue,  
Belfast, Ireland.

Dear Sir,—I constructed your "S.T.300" about ten days ago, and decided not to send you a report until I had given same a thorough test. It certainly exceeds all your claims for it. I can receive over 50 stations at good loud-speaker strength. The quality on a M.12 Celestion speaker surpasses many factory-made sets selling at £15 to £20. And just a final word on selectivity. I even went so far as to take the set to a friend's house about half a mile from our local station, and found no difficulty in confining it to about three degrees on the dials, and, with badly screened aerial, succeeded in bringing in about 40 stations at full volume.

I must say I welcome you back to THE WIRELESS CONSTRUCTOR, and in future I will be looking forward to the 15th of each month, when I can read your interesting and helpful notes. It is what I now consider to be the best wireless journal published.

Again saying how delighted I am with "S.T.300."

I remain,  
Yours truly,  
JOHN DONALDSON.

### "A Great Success"

9, Hadley Street,  
Kentish Town, N.W.1.

Dear Sir,—Have just completed your "S.T.300" circuit, and must say that it is a great success, very stable and very sensitive over the whole ranges. I am using the specified S.G. and detector, but a heavier power valve.

Yours faithfully,  
H. GILLKERSON.

# DECOUPLING SIMPLY EXPLAINED



by

John Scott-Taggart

F. Inst. P., A.M.I.E.E.

WHO was it that first thought of tacking one valve on to another to get greater amplification?

Whoever it was, we can be pretty certain that he began by connecting up two identical amplifier circuits with their separate batteries and then feeding the output of one valve into the grid circuit of the next.

### Common Batteries

He must next have decided that having a separate filament battery and separate H.T. battery for every valve was a nuisance. The "common" L.T. and H.T. battery arrangement must then have followed. One inventor during the war thought this was such an important invention that he applied for a patent for the idea!

We are so accustomed to the convenient "common battery" system that it seems ludicrous to us to think that anyone could regard it as anything but the obvious thing to do. Nevertheless, we did not seriously consider all the technical aspects of using a single H.T. source until about five years ago, and only a fraction of the sets in use to-day employ "decoupling," which is a device for reducing the ill-effects which may be caused by the use of a common H.T. or other battery, or by a mains unit.

### Internal Resistance

Decoupling a high-tension battery is carried out in order to avoid the effect of the internal resistance of the battery itself. Although one cannot see this resistance, every cell has its own internal resistance, and as an H.T. battery may have a hundred of such cells in series the total resistance can become appreciable.

Now the current flowing through the "H.T." may be considerable, and

Many readers must have wondered why decoupling is so essential in a multi-valve receiver, how it works, and what makes the set start "motor-boating" if decoupling is omitted. This article tells the whole story in easy-to-understand language.

it is being varied in all sorts of ways; each valve's own anode current may be of a different character. The first valve may be an H.F. amplifier and its current variations will be small, but of high frequency; the last valve, however, will produce large low-

can howl like mad through absence of "decoupling" is the old popular one shown in Fig. 1. You will see that I have shown the internal battery resistance as if it were an external resistance in series with the H.T.

### L.F. Reaction

Note how easily a chain of L.F. reaction can be set up. L.F. currents are applied to the grid of the output valve; large current variations occur in the battery resistance, thus setting up L.F. potential variations across the resistance; these are communicated

### POPULAR IN THE DAYS BEFORE DECOUPLING

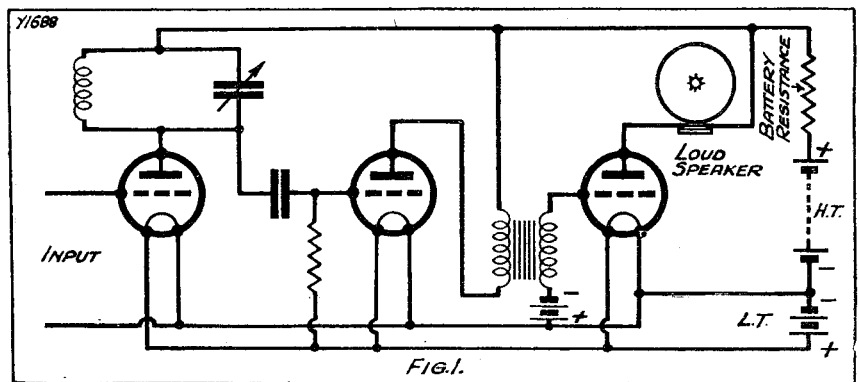

Here is a very old-fashioned circuit that used to be extremely popular. No decoupling was employed, with the result that it was very prone to howling troubles.

frequency currents through the battery.

These current variations passing through the internal resistance of the battery set up corresponding voltages across the battery, so that instead of, say, a steady 120 volts we get variations above and below this value while signals are being received. These fluctuations can cause a great deal of trouble, because they are applied to the anodes and grids of valves which may set up oscillations.

A good example of a circuit which

through the tuned-anode inductance of the first valve to the grid of the second; the second valve amplifies them and passes them to the grid circuit of the last valve. We have thus the fatal chain of amplification which either produces reaction and therefore probably L.F. oscillation, or—if the roundabout feed-back is of a reverse kind—signals are reduced in strength.

In the simple example given, the actual effect, i.e. L.F. howling or reduced amplification, depends on the

## Decoupling Simply Explained—continued

connections of the L.F. transformer. But obviously both effects are bad! And the chance of trouble increases with the resistance of the H.T. battery. This rises with the number of hours it has been used and may easily be from 200 to 800 ohms.

A second factor which makes decoupling necessary is the improvement in modern valves. Obviously, valves which amplify more effectively will increase the bad effect of battery resistance. The widespread use of

the last valve has an L.F. (iron-cored) choke in the anode circuit.

### The Easier Paths

In each case the *alternating* currents tend to shun these obstacles. The amplified H.F. currents hate the H.F. choke and prefer to go through the condenser C and energise the tuned-grid circuit. The "detected" currents (which are now of L.F.) work the intervalve transformer after passing through the second condenser

The prevention of H.F. or L.F. oscillation in a receiver is not the only thing to be avoided; even a little unwanted reaction can produce unpleasant distortion, and reverse reaction can likewise produce distortion and signal reduction. The modern trend is to keep *all* current variations out of the H.T. supply and—what is equally important when sets are worked off the mains—to keep the smoothing equipment (chokes and condensers) from setting up interference with the set by acting as a coupling impedance. Low-frequency oscillation due to the "smoother" circuits will cause the "motor-boating" sound sometimes obtained with a set improperly decoupled

### PROVIDING SEPARATE PATHS FOR THE "SPEECH"

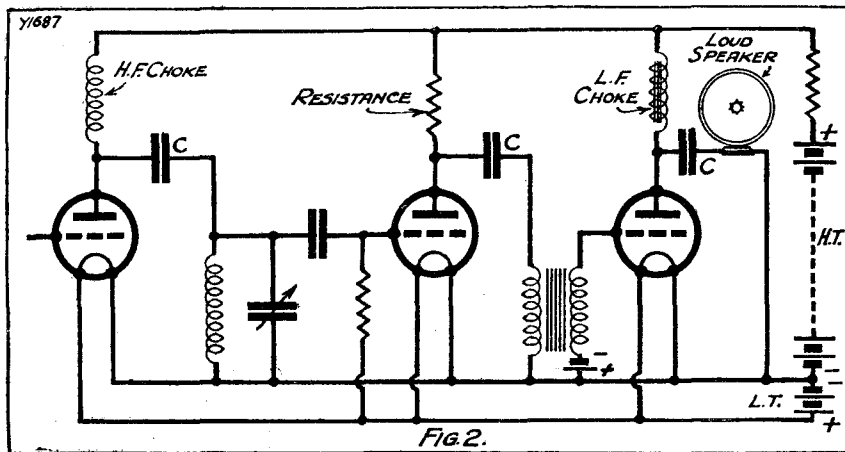

In this circuit the tuned grid coil and the primary of the L.F. transformer are parallel-fed. By using this scheme any tendency to instability is greatly reduced.

battery eliminators also has caused trouble because their impedance produced unwanted coupling between valves.

How, then, can we cut down the resistance coupling in the H.T. supply? We can shunt a large capacity condenser across it, but this is only a palliative. What we do is to make the alternating current (H.F. or L.F.) go along a by-pass route which avoids the dangerous resistance. The steady anode current continues to pass through the resistance.

Fig. 2 shows a circuit which is really Fig. 1 with "parallel feeding." As a matter of fact, it resembles the A.C. "S.T.300" in its system of separating the direct-current path and the "signal" path.

### A.C. "Stoppers"

Fig. 2 possesses several merits of its own, but I should like you simply to note that although the H.T. voltage is applied to each anode, there is in the case of the first valve an H.F. choke in the way; the second valve has an anode resistance; and

C. The final L.F. currents prefer the path through the third C and loud speaker. All these "parallel feed" schemes are becoming increasingly popular, and, although possessing additional merits in some cases, are forms of "decoupling."

### Detector Stage

The original "S.T.300" (for battery valves) has its detector decoupled. The arrangement used is similar to that shown in Fig. 3. A reaction choke, the L.F. transformer primary and a "decoupling resistance" are all in series and in the anode circuit of the detector valve. Note, however, that a "decoupling condenser" is connected as shown.

The decoupling resistance should be large, but in practice we have to remember that it cuts down the steady anode voltage of the valve. In the "S.T.300" I use a 20,000-ohm decoupling resistance and a 1-mfd. decoupling condenser. The latter is intended to pass most of the A.C. component—as it is called—of the anode current. The average steady

### ON THE LINES OF THE "S.T. 300"

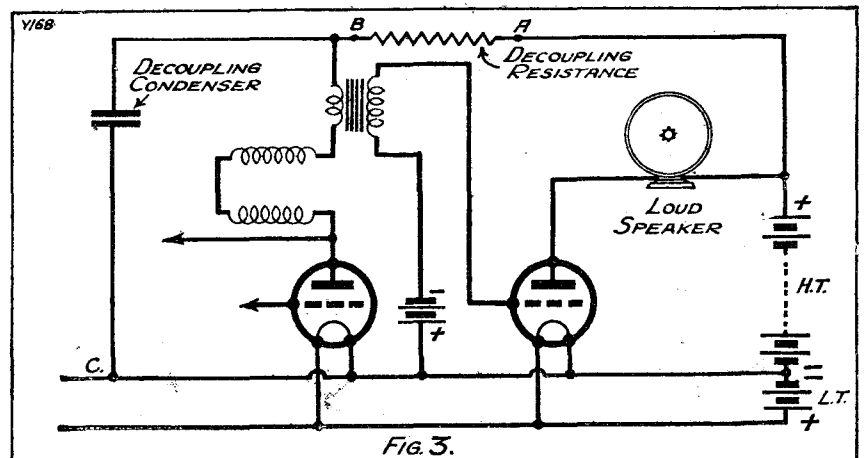

The arrangement of this circuit is similar to that of the "S.T.300." The detector is decoupled, a suitable value resistance being included in the H.T. lead, with a large-capacity fixed condenser by-passing it to earth.



## Decoupling Simply Explained—continued

H.T. current passes through decoupling resistance, L.F. transformer primary and H.F. choke.

You can look upon a decoupling condenser as an easy short-cut for the alternating currents which—whether of high or low frequency—are set up in different parts of a receiver by incoming signals. You can regard the decoupling resistance as an obstacle deliberately put in the main H.T. lead to make the A.C. signal currents all the more willing to go through the condenser.

### A Good Analogy

It is as if a small, quiet town objected to noisy motorists, and not only built a delightful by-pass road, but discouraged motorists from passing down its main street by erecting hurdles or digging pot-holes! We can take it that alternating currents know a good thing when they see it,

and they plump every time for the decoupling condenser.

If in Fig. 3 the loud-speaker current variations produce voltage variations across the H.T. battery owing to the latter's internal resistance, the decoupling circuit prevents these variations from affecting the anode of the valve beneath, and therefore the grid of the last valve.

This is explicable as follows: the voltage variations mentioned are produced across the points A and C. The voltage is split up between the decoupling resistance (which offers a high impedance) and the decoupling condenser (which offers a low impedance). The two act as a sort of A.C. potentiometer, and the variations between B and C (which are the ones which affect the valve anode) are very small. Therefore there is no appreciable back-coupling.

Incidentally, the decoupling circuit will lessen any tendency to "hum" from a battery eliminator or mains unit, for the reason just given.

The type of decoupling circuit just described could be inserted in the H.F. valve anode lead of Fig. 2 and also a similar circuit in the lead to the resistance of the detector. In fact, there is almost no limit to the amount of decoupling that can be done in a receiver. It is applicable to the screening grids of S.G. valves and to grid-bias connections.

### Not Expensive

The cost of decoupling is usually about four shillings per circuit, spaghettis and non-inductive Mansbridge-type condensers being used.

I could say a good deal more about decoupling, but I see that I have used up all my space and that if I go on I shall be decoupled myself.

### HOW PARALLEL FEED IS EMPLOYED IN THE FAMOUS A.C. "S.T.300"

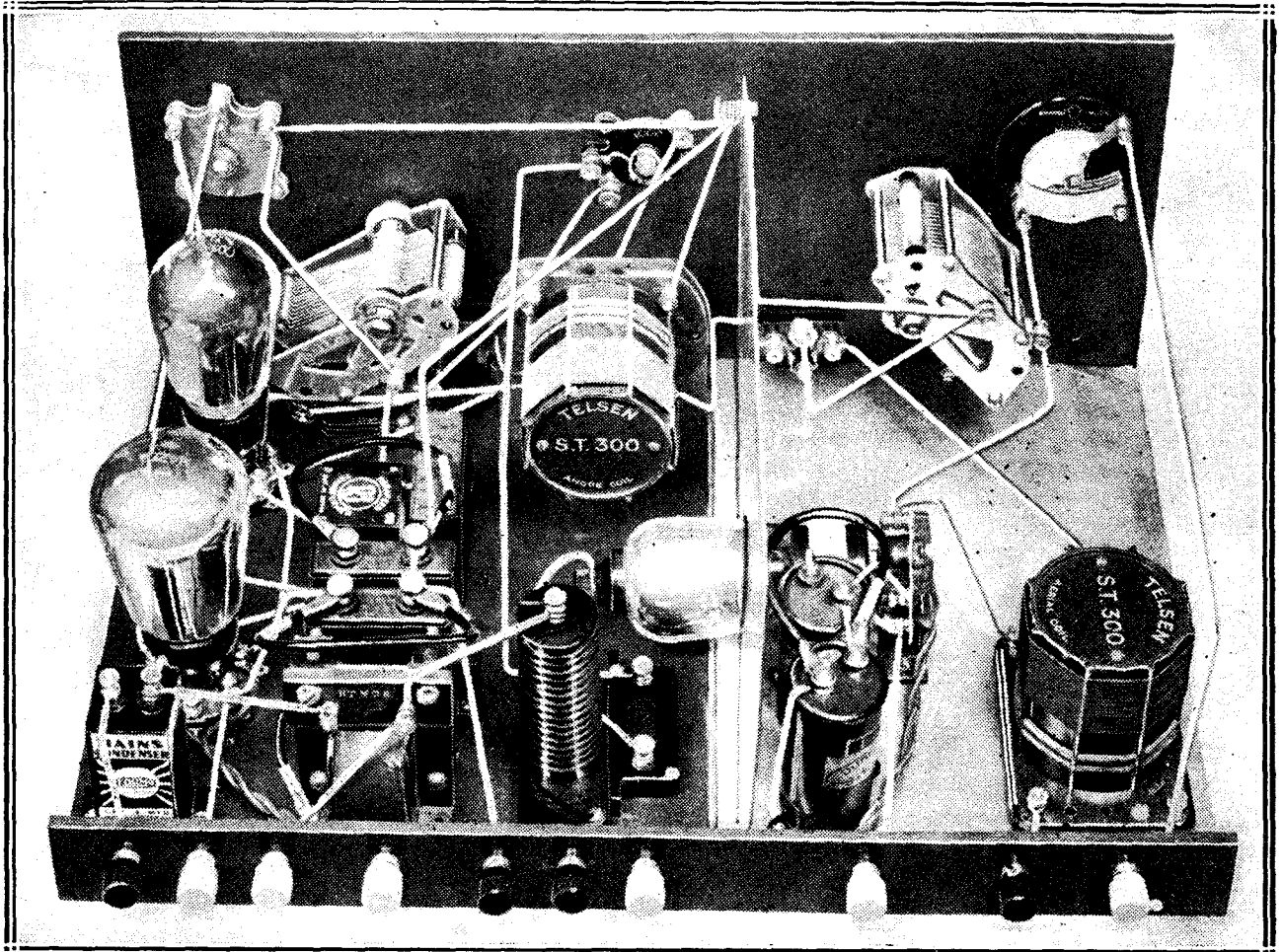

This new photograph of the "S.T.300 for A.C. Mains" provides an excellent illustration of how arrangements like those of Fig. 2 for separating the direct-current path and the "signal" path are carried out in practice.

**"Lights Out"**

WHAT on earth is one to do with a wireless set that packs up every time the house lighting is switched on or off?

A London reader (L.L., of E.1) tells of a temperamental receiver of this kind in the amusing letter below.

"Dear Sir," he says, "I read with interest your 'Queer Queries' page, but wonder if any can beat this.

"My set is a three-valver—S.G., det. and power—employing two-pin plug-in coils, and it is working off D.C. mains via the super D.C. eliminator described in the Booklet '77 Selected Circuits.'

"Now this is the funny part about it.

"Every time somebody switches on

**DIAL SLIP**

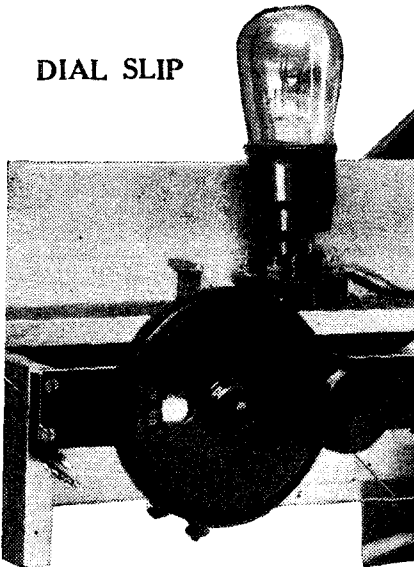

When screwing a knob on to a rounded spindle remember that if the latter is flattened a little with a file there is far less tendency for it to work loose and cause puzzling tuning variations.

or off a light in any part of the house, no matter how far away from the set the switch is, *my set stops working directly!*

"And to get it going again I have to wallop the set or stamp on a certain loose floor-board. To see me stamping to get the set going is the laughing stock of my friends!

"Anyhow, my first conclusion was a loose connection in the eliminator, but no! It took me nearly a week to find the fault. It was a *bad connection in the aerial coil* of the set.

"How an electric light switch can affect a faulty coil beats me, but on changing the coil I could switch on as many lights as I chose and nothing happened. I wonder if there is an explanation?"

The main thing, of course, was to

# QUEER QUERIES

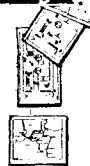

Some details about unusual radio faults and some suggestions that may help you to better radio reception.

By P. R. BIRD.

get it right, and L.L. certainly deserves a pat on the back for curing this obscure fault.

To diagnose the cause of it requires more details than are given above, but possibly the S.G. valve went into oscillation when the switch was clicked, and this caused the programme to vanish. Or the switch clicks caused a rush of electrons to the S.G.'s grid from which they could not escape, owing to a broken grid circuit.

A chancy coil contact might easily be restored by thumps, or by the floor-board stunt, and thus result in clearing the trouble—till next time! Such a fault can be terribly difficult to locate, and I am sure we all congratulate our fellow-reader on the way he "sleuthed" till he got that coil culprit!

**What is "Plate Current"?**

Desiring to use "automatic grid bias" for his S.G. valve instead of a G.B. battery, a Warwickshire reader recently found himself up against a poser. He did not know what is usually understood by the term "plate current."

It looks easy enough. Plate current is obviously the H.T. current supplied to the plate of the valve.

But, he wondered, in the case of an S.G. valve does the H.T. current to the screen also count as plate current?

He asked himself this question not in a spirit of idle curiosity, but because he was going to insert a resistance between the cathode of the valve and the rest of the circuit, and so obtain grid bias. And to calculate the value of the grid bias

so obtained he had been told to multiply the resistance (ohms) by the plate current (amps.).

Thinking it over, he came to the conclusion that plate current really meant "plate current plus screen current," because both plate and screen current had to pass from the cathode through the resistance in question. And, he argued to himself, this total current through it would produce the voltage across the resistance.

He was quite right, and it is a point that is worth bearing in mind when calculating resistance values in such cases.

**Why Did It Rattle?**

A Birmingham reader reports an interesting item which may prove useful to others. He is a quality enthusiast, not much concerned with distant stations, but a stickler for good reproduction.

**HOW IS YOUR SET BEHAVING NOW?**

If you are troubled by a radio problem, remember that the "Wireless Constructor" Technical Queries Department is fully equipped to help you.

Full details of the service, including scale of charges, can be obtained on application to the Technical Queries Department, "Wireless Constructor," Fleetway House, Farringdon Street, London, E.C.4.

SEND A POSTCARD, on receipt of which the necessary application form will be sent by return.

LONDON READERS, PLEASE NOTE. Applications should not be made by telephone, or in person at Fleetway House or Tallis House.

His set, working in conjunction with a permanent-magnet moving-coil speaker, was a three-valve combination of detector and two low-frequency amplifiers, one resistance capacity-coupled and the other transformer-coupled. It was an unqualified joy until—it rattled.

For a long time he thought it was the set, but a prolonged test proved it could not be, for a similar speaker did not rattle on his set and his speaker *did* rattle on another set.

So he concentrated on the speaker itself, and eventually found the trouble. One small nut on the front of the metal chassis was loose.

The re-tightening of this stopped the annoyance completely, and he was so pleased that he wrote a thank-offering letter to remind other readers who are "being rattled by a rattle."

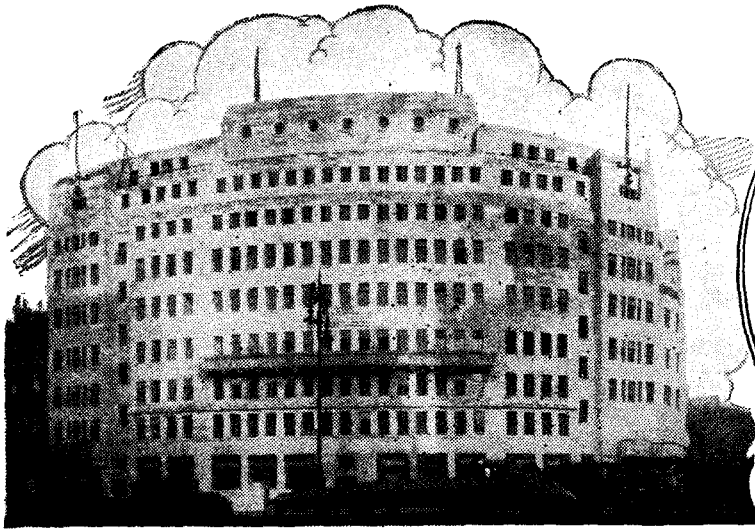

# B.B.C. NEWS

*Topical notes regarding British Broadcasting Stations and Programmes.*

**By Our  
Special Correspondent.**

## Programme Exchange Difficulties

THE business of effecting the exchange of programmes internationally is not turning out as smoothly as was anticipated. Nor is the fault technical. It is political and artistic.

On the one hand there is America, which has apparently an insatiable thirst for European programmes of nearly every kind. On the other hand there is no corresponding desire on this side of the Atlantic to hear anything like an equivalent number of American productions.

The truth, of course, is that in the United States stunt values are still important; whereas in Britain, and in the Continental countries that count, artistic values are pre-eminent. This being so, no periodical automatic system of exchange is feasible or desirable.

## Westerglen

The B.B.C. plans for the opening of the new high-power regional station at Westerglen, near Falkirk, are proceeding apace. It is hoped that at least one of the frequencies will be functioning in June, this period being favoured for various reasons.

## Broadcasting House

There has been a great deal of disappointment because the B.B.C. appears to have taken no special steps to arrange an inaugural function for Broadcasting House. So far as I can discover, the B.B.C. policy has been wisely directed in avoiding all the tumult and public enthusiasm which a formal opening might impose.

As things stand, the studios and their accessories continue to enjoy precedence. For the rest, people take their own chances. There will be no official function, but I have it on excellent authority that His Majesty the King, accompanied by other members of the Royal Family, will inspect Broadcasting House within the next year.

This, after all, is tantamount to an official opening, and will greatly comfort the vast hinterland of listeners who would like to feel that an important development in broadcasting was recognised by Royalty.

## Microphone Critics

Despite "smoothing over" statements and explanations, I have no doubt the B.B.C. is gradually relinquishing microphone criticism of

theatres, books and films. I see theatre criticism is now reduced to half an hour every quarter. The disappearance of criticism will silence the complaints of those who have been concerned at what they regarded as the misuse of monopoly.

On the other hand, listeners will regret the withdrawal of a programme feature of undoubted popularity. Mr. James Agate is always stimulating and refreshing at the microphone. It is a great pity that his series has been so restricted.

## Future of the International Union

The amount of work to be done by the International Union of Broadcasters steadily declines. This is not because of the absence of need for effective international action. There

## WORKING ON THE WEST REGIONAL SITE



*The B.B.C. is making great progress with the new West Regional Station at Washford Cross, near Taunton. This photograph shows workmen excavating for the foundations.*

## B.B.C. News—continued

are still numerous difficult problems. The truth is, however, that on most subjects of genuine importance the Union has exhausted its usefulness.

By this I mean that for the immediate future, at all events, any changes or reforms must come about by Governments acting through their competent departments, usually the Post Office. It is not clear yet whether this change will adversely affect the organisation of the Union.

ear-marking a definite proportion of licence revenue for a specific purpose, perhaps against expert advice. No, I don't see Parliament accepting this suggestion, but I believe that the present limited subsidy will be continued.

### The New Local Studio Policy

The decision to grant the request of Sheffield not to withdraw the existing studio from there, although

purpose of entertainment. They are meant to allow local notabilities and speakers to originate their broadcast addresses in their natural environment.

If or when the ultra-short waves come into practical use, there will be steady extension of the scope and value of these local studios.

### Promotion in the B.B.C.

Some complaints have reached me of the treatment in connection with promotion in the B.B.C. staff. It is alleged that there is no regular system nor sufficient consideration of seniority; people who happen to be in favour at the right moment securing preferment on an arbitrary decision. I do not know if or to what extent this complaint is justified.

It would be a good thing, however, if the B.B.C. would make it clear how it handles this question of promotion and seniority.

### Wales and the West Region

Since it has become known in the West that Bristol is to have a headquarters analogous to that of Cardiff, there has been a good deal of resentment in Welsh Nationalist circles. Wales has always felt that she was entitled to a separate and distinctive broadcasting service on her own wavelength.

The B.B.C. has maintained that there are insufficient channels for this purpose, and that, therefore, Wales must put up with the best that can be done from the new West Regional and Daventry 5XX.

### USED BY THE POPE FOR ADDRESSING THE PEOPLE

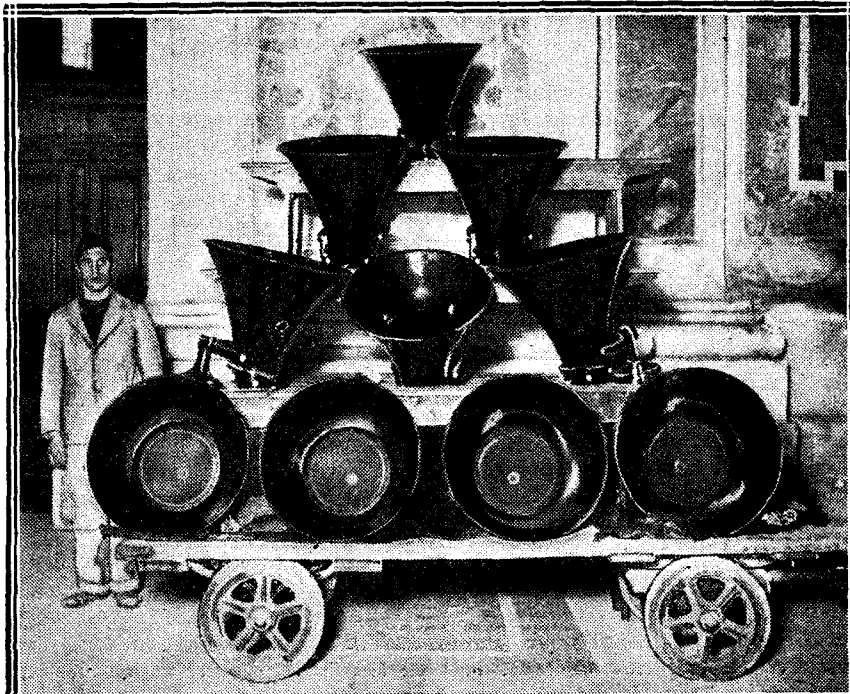

These colossal loud speakers were used to "broadcast" the voice of the Pope on the occasion of the tenth anniversary of his coronation. Thousands of people were able to hear the Papal message by this means.

There is a move to reduce its staff to a skeleton. The issue will be determined by the results of the Madrid Conference in September.

### Broadcast Opera

Lady Snowden's impassioned appeal for sixpence of every 10s. licence to support opera permanently and nationally has not been received everywhere with equal enthusiasm. Many listeners look back with longing to the time when the B.B.C. put on programmes of "potted opera" from the studios.

It was felt that in this form opera was much more palatable to the general public. But the two principles are incompatible. There are also grave doubts about the precedent of

the local transmitting gear is to be taken away, has done a great deal to improve local feeling towards the B.B.C. It is having, however, another result not quite so happy for the B.B.C. Other cities, regarding themselves rightly or wrongly as at least as important as Sheffield, are beginning to agitate for similar facilities. The few I have heard mentioned include Hull, Liverpool, and Londonderry.

I should think that in due course, when some of the urgent capital expenditure of the moment has been met, the B.B.C. will be glad to gratify these requirements within reason. Studios contemplated are not to be elaborate or, indeed, for the

### YOUR NEXT 3-VALVER

#### An Important Announcement

Numerous readers are enquiring whether they are "too late" to build the "S.T.300" and whether it would be wiser to wait for a new design by the same inventor. Mr. John Scott-Taggart informs us that he has not even considered a new 3-valve set. He is adhering to his policy of "fewer and better sets"; his "S.T." sets are not flash-in-the-pan receivers which start becoming obsolete the moment they are published; they are built on his "progressively adjustable" system.

A "snowball" popularity through personal recommendation is being achieved by the amazingly successful "S.T.300," and Mr. Scott-Taggart's advice—and ours—is:—

**"Build the 'S.T.300.'"**



# The "VI-KING" SUPER

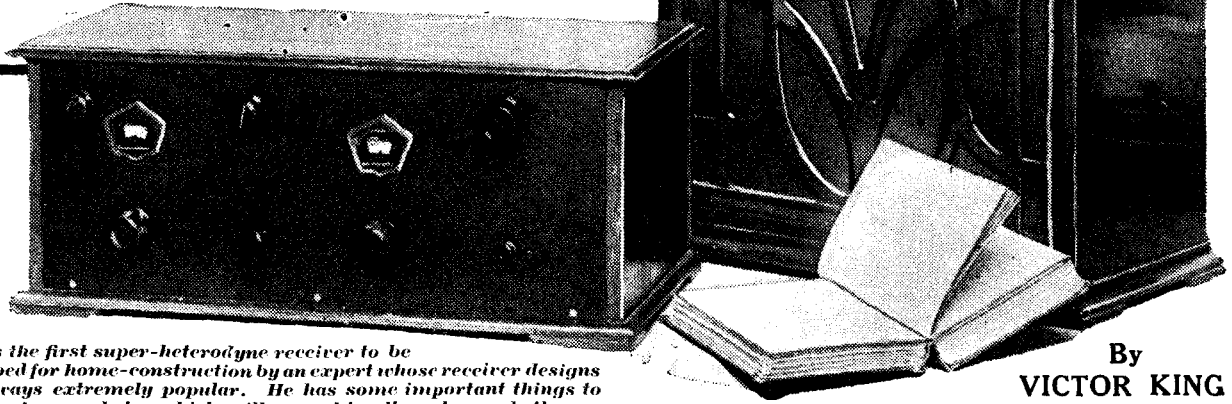

By  
**VICTOR KING**

*This is the first super-heterodyne receiver to be described for home-construction by an expert whose receiver designs are always extremely popular. He has some important things to say about super-hets. which will appeal to all readers, whether or not they are interested in building this particular set.*

ARTICLES dealing with the working of super-heterodyne receivers seem to dwell considerably upon the question of the beat-note and the workings of the various frequencies involved. This, of course, is as it should be; but there is an aspect of this type of set that is often ignored entirely, and which is consequently seldom appreciated.

From the detector (that is, the so-called 2nd detector, for the 1st detector is better termed the "mixer"; more of which point in a moment) to the output of the receiver it is really a completely ordinary det.-L.F. set. Although perhaps there may be more H.F. stopping precautions than ordinarily, the detector is fed with modulated H.F. in the same way as the detector in a simple type receiver.

### Like Locals!

The fact that the H.F. impulses are always of the same wave-length does not affect the matter. It is just as though it were a det.-L.F. set always receiving the local station.

As a matter of fact, this local-station way of looking at the second detector can be carried much farther. For instance, with the super-het. we do not have reaction from the second detector; it is no more necessary than it would be on a det.-L.F. working from a powerful nearby transmission.

Why not, did you ask? Well, it is because of the work carried out by the preceding valves, the real super-het. part of the set.

Their job is, in effect, to bring the

stations nearer. They are fed with modulated carriers from the stations, and they hand on a carrier with the same modulations to the detector.

### The Single-Wave-length Effect

The fact that they convert all stations to the same wave-length is because all the amplification is to be done on one wave-length—the intermediate—no matter what the wave-length of the received station. This is simply because it is possible to get more mag. out of a valve when it has to handle only one frequency than when the circuits have to be arranged to amplify at all sorts of different frequencies.

A so-called peculiarity of the super-het. principle is that most of the stations received sound "just like the local" and come in at similar volume. It is not so very peculiar when looked at in the light of our parallel between the detector of the super and the detector of a simple set working on the local.

The amplification before the

### A CLEAN DESIGN IN EVERY LINE!

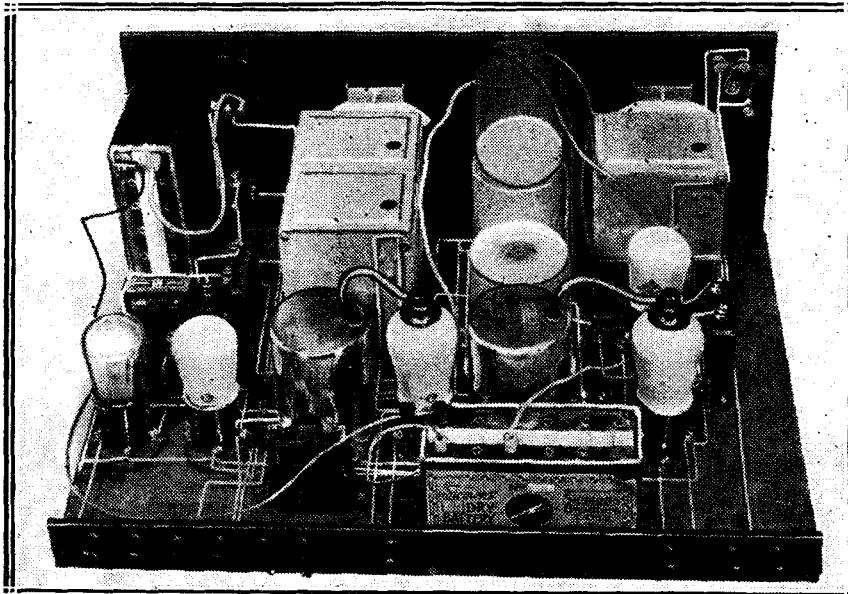

*The receiver has a particularly smart appearance, even behind the panel, as this photograph—taken with the valves, intermediate transformers, and grid-bias batteries in position—clearly shows.*

## The "Vi-King" Super—continued

### VOLUME CONTROLLED BY "VARIABLE-MU"

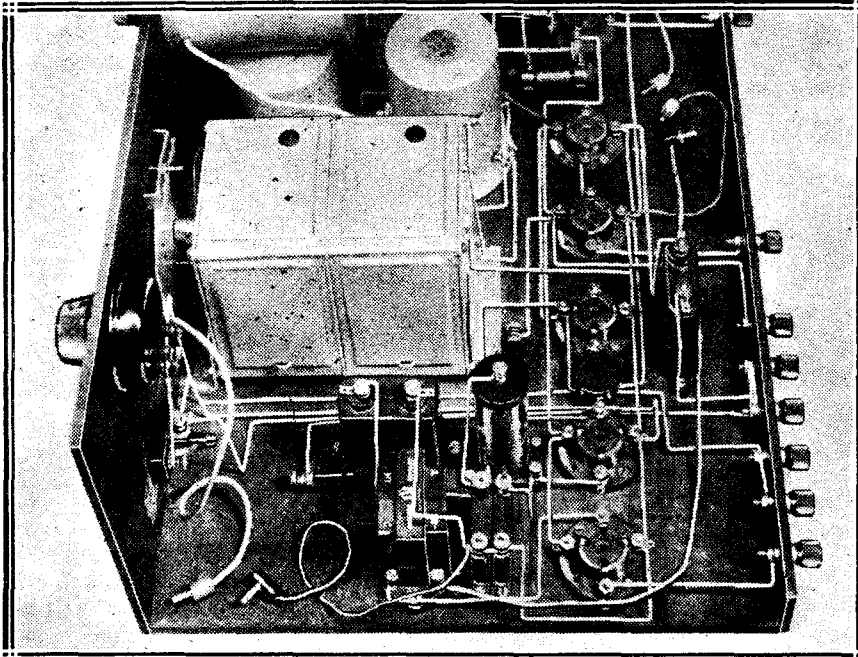

The potentiometer which varies the grid bias on the variable-mu intermediate S.G. valve, and so controls volume, can be seen at the top of the panel to the left of this view. The two holes in the condenser screen provide access to the trimmers.

detector is so large that the limit to volume on most stations is the amount of power which the detector will handle. The limit is, therefore, the same for a foreigner as for a local.

The only time this does not apply is on the very distant and weak foreigners. As a matter of fact, on the super I am going to describe in this article, volume controlling is necessary on the large majority of the stations received.

Before going into more details let

us have a look at the circuit of the "Vi-King" Super. There are five valves, the last two making up the ordinary det.—L.F. part. That leaves us with three others.

#### Valve Vocations

The third one,  $V_3$ , simply does the amplifying at the fixed wave-length already mentioned. That leaves two.

Of these,  $V_2$  is the mixer, usually called 1st detector. This valve receives the incoming modulated

carrier-wave from the aerial circuit, and also oscillations from the oscillator valve. Its job is to mix these two together and pass out a carrier of the frequency required by the amplifier, and modulated exactly the same as the modulations on the original received carrier.

An interesting point about the mixer valve on this set is that it is of the S.G. type. The sole reason of this is one of sensitivity. As well as mixing, this valve is able to amplify, and more amplification can be obtained from the S.G. than from an ordinary three-electrode.

#### The Separate Oscillator

And that is also the reason why a separate oscillator is used. Because with a double-grid valve acting as mixer and oscillator we naturally cannot get the S.G. magnification.

I have explained how the detector provides the real limit to volume (don't think it's a low limit, for it's higher than will be wanted in the majority of cases), and so we must take care that it does not get overloaded and so spoil quality. To do this a pre-detector volume control is the only way, and I have made use of a variable-mu valve in the intermediate position for this purpose.

To control the amplification given by this valve, and therefore the power applied to the detector, we alter the bias on the valve, thus changing the valve's slope. You will see the potentiometer that effects this in the bottom right-hand corner of the circuit diagram.

### HERE ARE DETAILS OF ALL THE COMPONENTS NEEDED

- |  |  |   |
|--|--|---|
| 1 Panel, 18 in. × 7 in. (Permeol, Becol, Peto-Scott, Wearite, Ready Radio).                                      | Ready Radio, Cyldon, J.B., Polar, Wavemaster, Lotus).  | 2 .0003-mfd. fixed condensers (one "button" type) (Formo, Dubilier, T.C.C., Igranic, Ready Radio, Telsen, Lissen, Graham Farish, Goltone, Sovereign, Watmel, Ferranti). |
| 1 Cabinet to fit, with baseboard 12 in. deep (Pickett, Camco, Moreco, Osborn, Gilbert, Ready Radio, Peto-Scott). | 1 50,000-ohm potentiometer, wire-wound (Magnum, Colvern, Varley, Wearite, Clarostat, Igranic, Sovereign).              | 2 2-meg. grid leaks with holders, if required (Graham Farish Ohmite, Dubilier, Telsen, Ferranti, Ready Radio, Loewe, Lissen).   |
| 1 Double-gang .0005-mfd. variable condenser with disc drive (J.B., Cyldon, Polar, Utility).                      | 1 Three-point on-off switch (Ready Radio, Telsen, Bulgin, Wearite, Colvern, Magnum, Lissen, Goltone, Peto-Scott).      | 1 15,000-ohm resistance (Graham Farish Ohmite, etc.).   |
| 1 .0005-mfd. disc-drive variable condenser (J.B., etc.).   | 1 H.F. choke (Ready Radio super-het., R.I. Dual Asiatic, Wearite, Varley, Tunewell, Lewcos, Sovereign).                | 2 .0005-mfd. fixed condensers (T.C.C., Dubilier, Telsen, Ferranti, Graham Farish, Ready Radio, Igranic, Sovereign, Lissen, Goltone, Formo, Watmel).                     |
| 2 Screened coils with extension rod (Cordo, or Colvern KBLC).  | 1 L.F. transformer (R.I. Hypermite, Ferranti, Varley, Climax, Telsen, Graham Farish, Lotus, Formo, Sovereign, Lewcos). | 1 Terminal strip, 18 in. × 2 in.  |
| 1 Standard oscillator unit, 126 ke. (Lewcos, Wearite).   | 1 2-mfd. fixed condenser (Dubilier, T.C.C., Telsen, Igranic, Sovereign, Graham Farish, Helsby, Hydra, Lissen).         | 10 Indicating terminals (Belling & Lee, Bulgin, Igranic, Clix, Eelex).  |
| 2 Intermediate units with pigtailed (Lewcos, Wearite, or Colvern, see special photograph and text).              | 2 1-mfd. fixed condensers (Dubilier, etc.).  | Battery plugs (Clix, etc.).   |
| 7 Four-pin valve holders (Telsen, Graham Farish, Wearite, Igranic, W.B., Clix, Bulgin).                          |  | Glazite, Soldawyre, Quickwyre, Jiffilinx, Laeoline.   |
| 1 .00015 differential condenser (Telsen,   |  | Flex, screws, etc.  |

# The "Vi-King" Super—continued

You will be interested to hear, so great is the mag. of this set, that for local-station work this control of the variable- $\mu$  valve is hardly sufficient in itself to cut the volume down to a suitable level. Partly for this reason, but more because it gives a fine control of the selectivity of the set and enables many stations that jam one another to be separated, I have included another control in the aerial lead.

## Differential Feed

This takes the form of a differential feed condenser to the band-pass coil. The latter covers both the long and medium wave-bands and is controlled by a double-gang condenser. There are thus only two tuning controls, the one for the band-pass coil and the other for the oscillator coil.

There are two other small points worthy of mention before finishing off my exposition of the circuit. The first of these is the three-point on-off switch. The extra point on this is to break the circuit of the potentiometer connected across the volume-control grid-bias battery.

Although this potentiometer only takes about one-third of a milliamp.

## ALL COILS AND TUNING CONDENSERS SCREENED

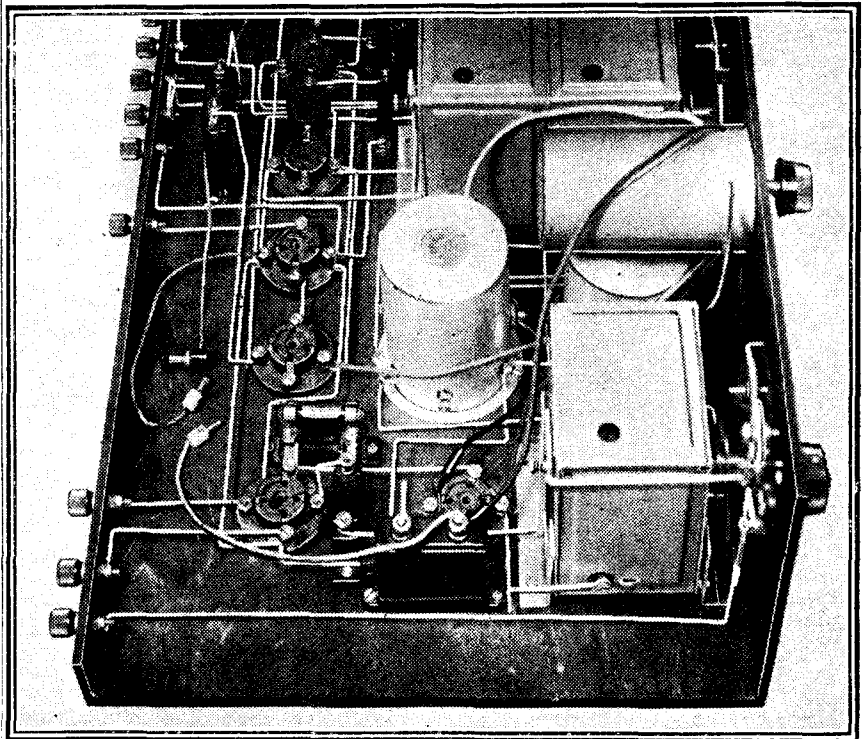

The two vertically mounted round screens house the two sections of the band-passing arrangement, while above them is the wave-change oscillator coupler. The extensive screening of components gives absolute stability and ensures a quiet background.

## THE CIRCUIT BRISTLES WITH BRILLIANT POINTS AND BRIGHT NOTIONS

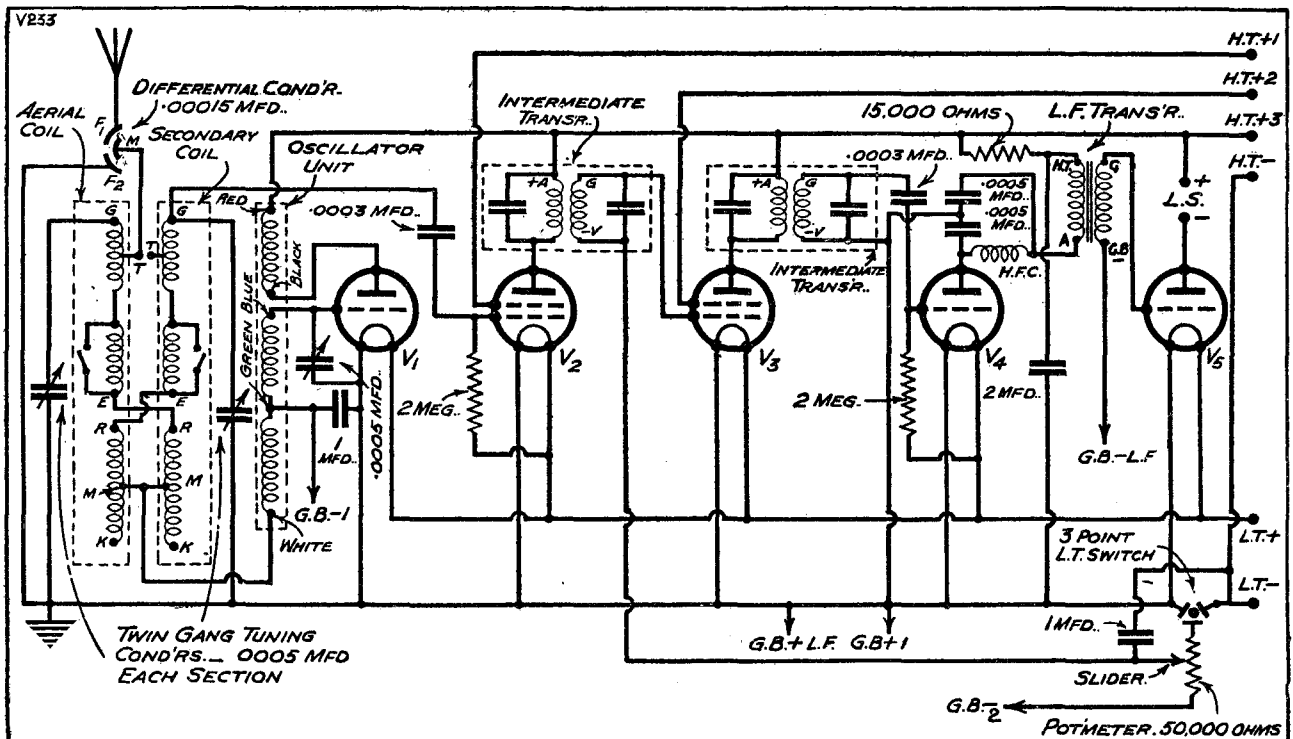

The design of the set, the circuit of which is shown here in full, has several ideas that are quite unusual if not entirely new to super-hets. Among these are a differential aerial input, screened-grid mixer valve, and a variable- $\mu$  intermediate stage. The last mentioned enables a very useful pre-detector volume control to be arranged by means of a potentiometer.

# The "Vi-King" Super—continued

from the battery, it would continue to take this whether the set was working or not if a three-point switch were not used. And the second point: the two .0005 condensers connected across the H.F. choke in the anode circuit of the detector form with that choke an efficient H.F. stopper which keeps

unwanted high-frequency fluctuations out of the L.F. portion of the receiver.

### Concerning Construction

Now a word or two about the practical side of the construction. It will not be more than a word or two because there is so little to say. There

is the usual ebonite panel on which are mounted some of the components, and the wooden baseboard on which are mounted the remainder.

There is the wiring to be done, and there is the usual very clear wiring diagram and photographs to make this quite easy for you. My available

## HOME CONSTRUCTION IS CATERED FOR IN EVERY DETAIL

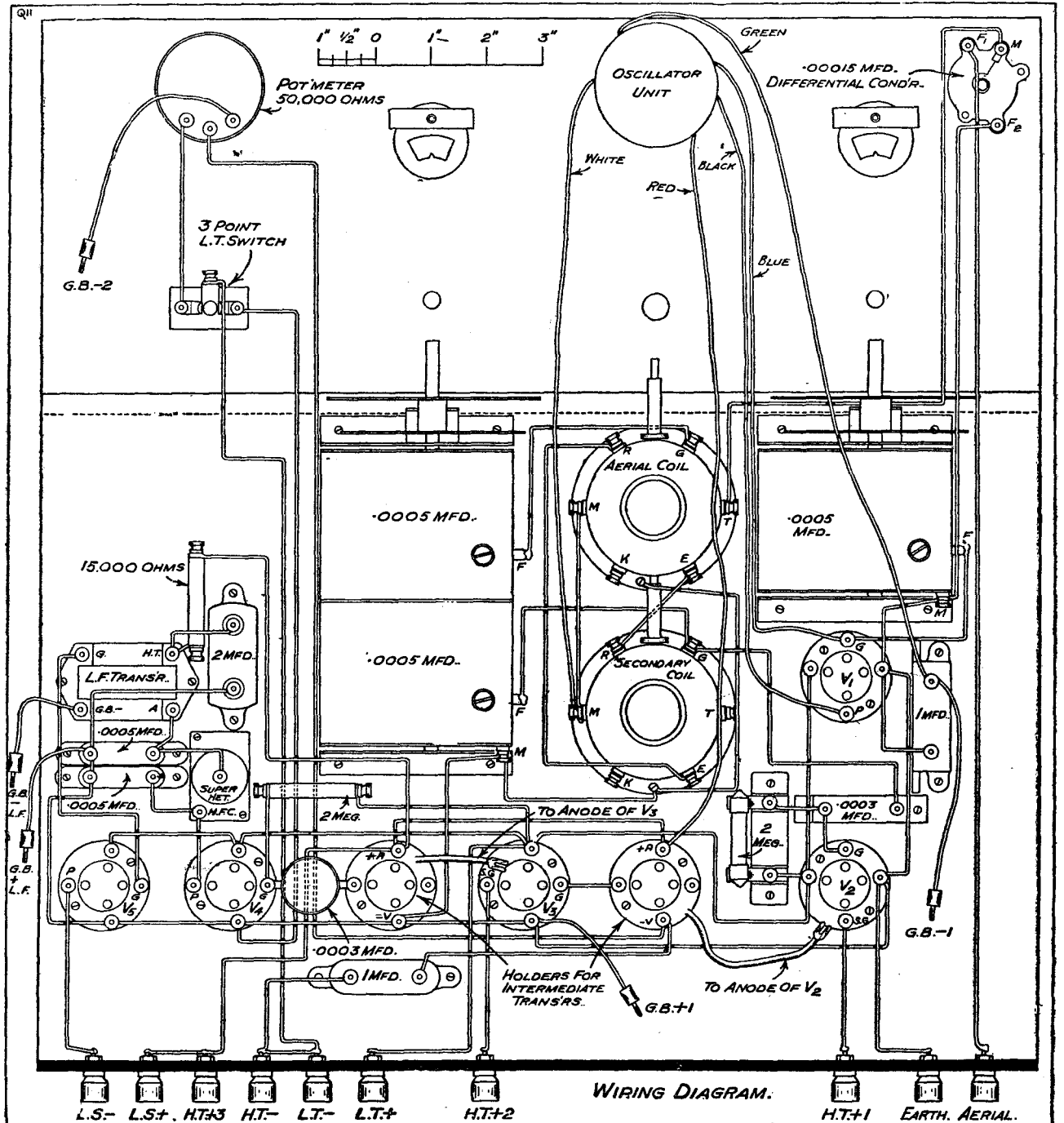

Surprisingly simple, don't you think, for a receiver that is capable of reaching out to every part of Europe? There is nothing difficult even about the wiring, which is probably the least-liked part of making a set. Victor King always bears in mind the view-point of the home-constructor when working out every detail of a receiver.



## The "Vi-King" Super—continued

### ACCESSORY SUGGESTIONS

**Loud Speaker.** (Epoch, Blue Spot, H.M.V., Celestion, Amphon, Marconiphone, Graham Farish, Undy, R. & A., B.T.-H., W.B., Cossor.)

**Valves.** 1 S.G. (Mazda S.G.215, Cossor, Osram, Marconi, Mullard, Six-Sixty, Eta, Tungram, Lissen).  
1 L.2/B. (Marconi).  
1 H.L. (Mazda H.L.2).  
1 Power valve (Mullard P.M.202, etc.).  
1 Var.-mu S.G. (Cossor V.S.G. 215).

**Batteries.** H.T., 120- to 150-volt,

super-capacity (Pertrix, Drydex, Ever Ready, Magnet, Lissen).

G.B. battery to suit output valve.

G.B. battery for H.F. valve and oscillator, 15 volts (Ever Ready, etc.).

**Accumulator.** 2-volt (Exide, Ediswan, Lissen, Oldham, Pertrix, G.E.C.).

**Mains Unit.** To give 150 volts at 20 milliamps. (Heyberd, R.I., Formo, Ekco, Tannoy, Regentone, Atlas, Tunewell, Lotus). State voltage and type of mains when ordering.

space will be better occupied with details concerning connecting-up adjustments and the other goings-on after the pliers-and-screwdriver work is completed.

But before I commence on these I

am going to air a personal opinion that I have kept to myself for some time now. It concerns the use of four valve pins and a valve holder for mounting super-het. intermediate transformers of the latest type.

First of all, let me assure you there is nothing whatever wrong with these from the efficiency and operation points of view. Otherwise, of course, you would not find them incorporated in one of my designs.

### An Interesting Point

No, it is just a matter of unnecessary duplication of parts, and of mechanical weakness. Once the intermediate transformers are in place they do not require moving.

Why, then, have them to plug in? Extra valve holders are needed, and there are extra points of contact. Why ever did the makers not put terminals straight on to the cases, and mount the units straight on to the baseboard?

Naturally, having nearly all followed

### YOU COULD NOT HAVE A FINER SET FOR FINDING FOREIGNERS

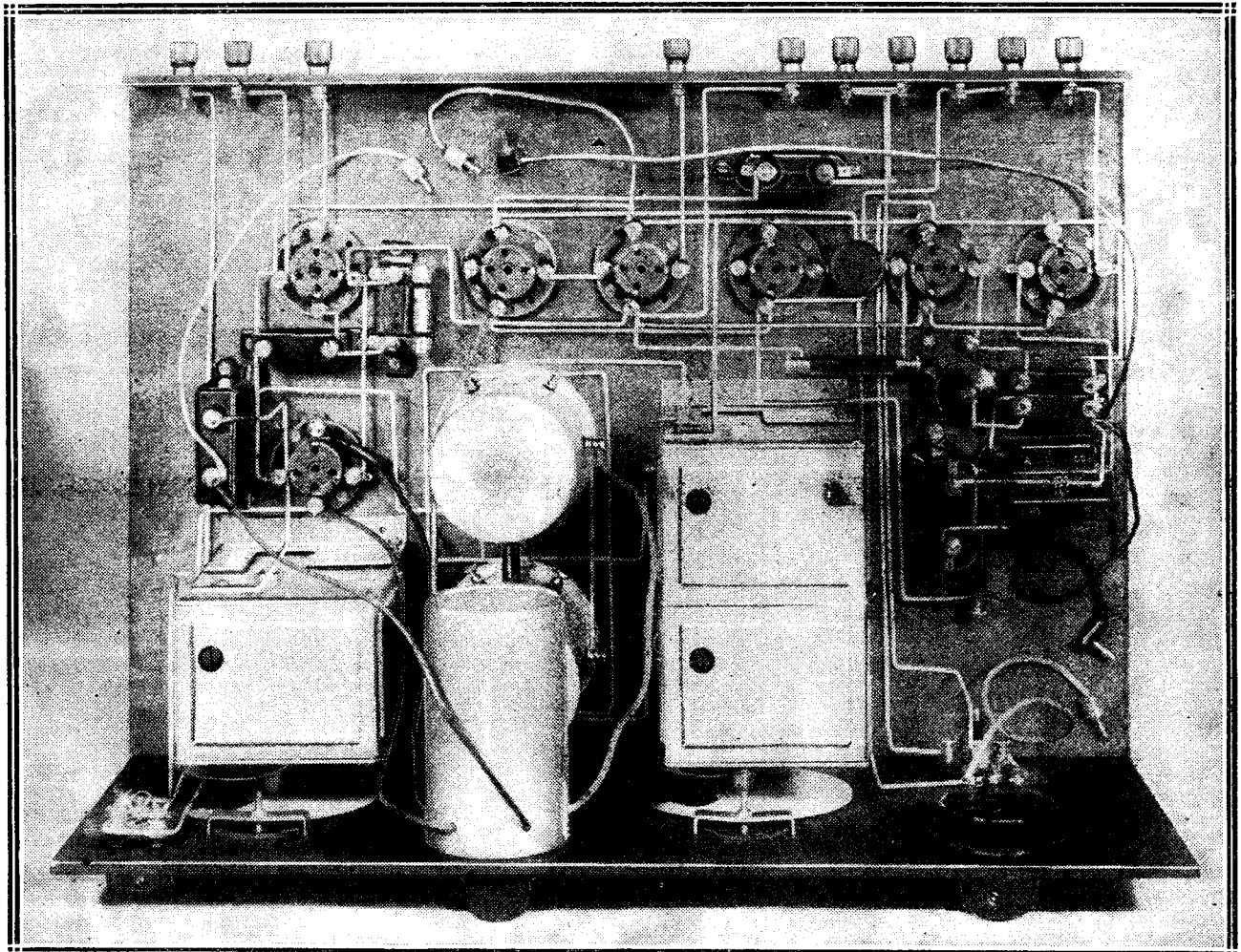

Efficiency is the keynote of the receiver, and the tidiness of the layout is largely brought about by careful component arrangement to avoid losses. Note how the valve holders, both for valves and intermediate transformers, are lined up close together, thus keeping vital wires very short. (For G.B. connections see operating panel on next page.)

# The "Vi-King" Super—continued

## "THE WIRELESS CONSTRUCTOR" "VI-KING" SUPER

Circuit: 5-valve super-het with separate oscillator, S.G. mixer and 1 L.F. stage.

### VALVES.

Oscillator (holder by itself): Marconi L2/B (Note.—Oscillations may not be strong enough if other make of H.L. is used.)  
 Mixer (first holder of row, at aerial end): S.G.  
 Intermediate (third holder in row): Variable-mu S.G.  
 Detector (fifth in row): Special detector, or H.L. type.  
 Output (last holder in row): Power or super-power.  
 Two-volt valves recommended, but four- or six-volt suitable.

### VOLTAGES.

G.B. +1, G.B. -1 and -2 require 18-volt battery. Place -1 in 3 or 4 volts negative and -2 in max. neg. tap.  
 G.B. + L.F. and G.B. - L.F.: Apply voltage to suit power valve. Separate battery.  
 H.T. + 1: Up to 80 volts.  
 H.T. + 2: 60-80 volts.  
 H.T. + 3: 120-150 volts.

### CONTROLS.

LEFT-HAND DIAL and control is for oscillator. RIGHT-HAND DIAL and control is for aerial tuning.  
 CENTRE TOP KNOB is switch for oscillator unit. Turn fully clockwise for long waves, and back ONE notch for medium.  
 LEFT-HAND TOP KNOB controls selectivity and also at the same time volume. Use in conjunction with  
 RIGHT-HAND TOP KNOB, which is main volume control.  
 LEFT-HAND SWITCH is for changing wave-band of aerial tuning. Push in for long waves and pull out for medium waves.  
 RIGHT-HAND SWITCH is for switching set on and off. Push in for off.

### ADJUSTMENTS.

TRIMMER on oscillator condenser has no effect and need not be touched.  
 TRIMMERS on double-gang condenser should be varied until reception is at its loudest, with the set tuned to weak station near the bottom of tuning dial (aerial).

So if you use these you will have to wire them directly into circuit instead of the two valve holders that take intermediate transformers. You will see these, one situated between valves two and three, and the other between the third valve and the fourth.

### Alternative Intermediates

You will see that only three terminals of these holders are connected up, the fourth connection to the transformer being via the pigtail to the screen of the S.G. valve. On the Colvern transformers there are four terminals.

These are marked +, E, G, and P. The plus equals + A, and E

one another in this matter, it is difficult for them to change. I say nearly all because there is one make, the Colvern, which seems to me to be the only firm "in step," as it were (and not using that term in its sarcastic way!).

I used the plug-in ones in the original design because most likely some of you will already have the intermediate transformers on hand, and because there are more makes in this style. But you will see a special photograph showing the Colvern type connected into the set.

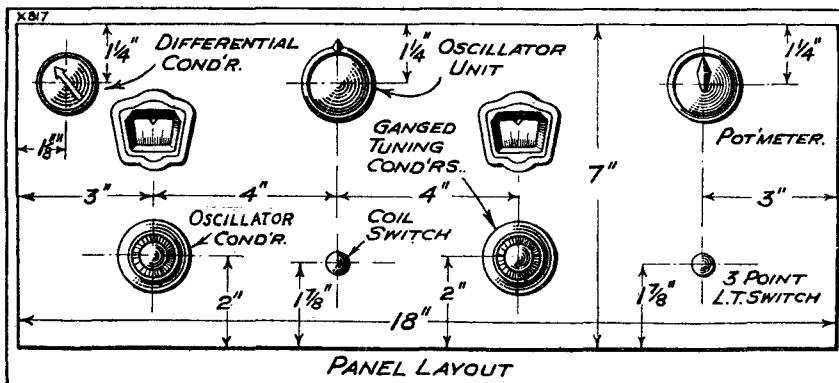

### WITH COLVERN COILS CONNECTED IN CIRCUIT

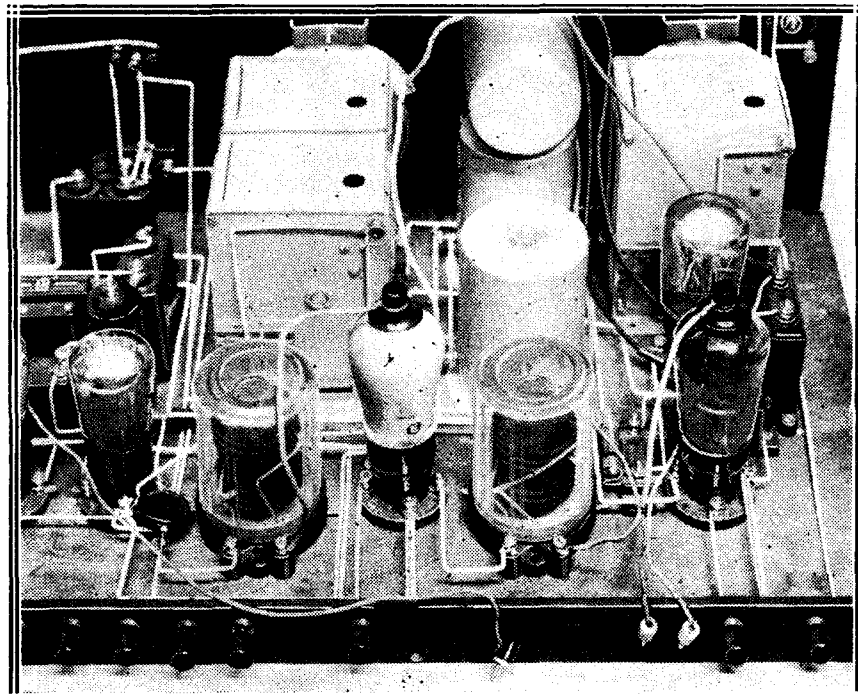

This illustration shows how the set appears when Colvern type intermediate transformers (which can be screwed direct to the baseboard) are employed.

The two large bottom knobs seen in this panel-drilling diagram are the only two that have to be touched when searching for stations, which come in one after the other in a simply amazing manner.

equals -V on the valve holders, and these terminals are connected up instead of the "valve-holder" terminals.

Instead of the pigtails, the P terminals go to the terminals on the valves, and the G terminals are connected up instead of the remaining terminal (the normal plate terminal incidentally) of the "valve holders." Each transformer has two adjusters and these should be moved to give loudest results. Adjust them on a weak station.

There are two separate bias batteries, one for the H.F. side of the receiver and the other for the L.F. Both batteries may be of the "fat" type; you will see exactly what I mean by "fat" if you take a glance at the photograph of the two batteries in place. This picture will also indicate just where the two batteries stand on the baseboard.

(Please turn to page 52.)

# WITH PICK-UP AND SPEAKER

by  
A.  
JOHNSON-  
RANDALL

*Cleaning Records—Concerning Needles—The Coupling Resistance.*

**J**UST before sitting down to write this page I had been playing over a few test records. These records had not been shifted for a day or two and had a layer of dust over their surfaces.

### Cleaning Records

While I was idly cleaning the dust off it occurred to me that a few words on the subject of dirty records might not be out of place.

Dust damages the surface of a record very quickly if the discs are played in this condition. What is dust but fine particles of grit? It is merely an abrasive and if permitted to remain on the record it forms an excellent "grinding compound" between the needle and the record grooves.

If you want your discs to last it will pay you always to see that they are perfectly clean. It is so easy, too. You can buy little velvet cleaning pads for a small sum from your dealer, or alternatively you can use a very soft brush of the camel hair variety.

A light rub over with the pad or a few strokes of the brush and the job is done.

### Concerning Needles

And now another point—this time concerning needles. Some of my friends have been in the habit of rotating their needles into a new position after playing a record, in preference to changing the needle for a new one in accordance with the makers' instructions.

Now this is false economy—you can get a box of 200 steel needles for a shilling. When a record has been played once it will be found that appreciable wear takes place on the

needle point. This is plainly visible under a microscope, and I have seen micro-photographs which illustrate it very clearly.

It is evident, therefore, that by rotating the needle the point becomes badly distorted, so much so that serious wear occurs on the record itself, and the useful life of the disc is shortened considerably.

I have mentioned this matter of needle changing before, and I feel that I must keep hammering it in, because where steel needles are concerned it is of the utmost importance to renew them regularly. If you

### AN EXCELLENT CABINET



*An extremely attractive radio-gram cabinet manufactured by the well-known firm of Pickett Bros. This particular model is known as the "Pianotone," and can be had in a variety of finishes.*

object to the slight trouble involved, then use some of those special needles such as tungstyles.

H.M.V.'s recently sent me one of their 1932 catalogues of records. What a magnificent production! It contains 428 pages of alphabetically indexed records.

One section of the catalogue contains a number of excellent photographs and biographies of celebrities who have recorded for the H.M.V. people. At the end is another section comprising recordings of historic interest, including those by such great names as Caruso, Melba, and Tetrassini.

### The Coupling Resistance

A correspondent asks me whether it is permissible to use fairly high value R.C. coupling anode resistances in an amplifier designed for gramophone work. He suggests that since the "super-top" frequencies do not appear on the records it doesn't much matter if the amplifier cuts off everything above about 5,000 cycles, and in view of this the increased magnification due to the higher value resistances might be worth while.

Well, there is some truth in this, but the "snag" is that very high resistance values may cut off, not at 5,000 cycles, but nearer 2,000 cycles.

There is nothing to approach a good transformer on the score of magnification coupled with economy in valves and simplicity.

A few years ago there were special high-magnification valves which, when employed with suitable R.C. values, gave a step-up per stage in the neighbourhood of 30. But one rarely sees valves of this type used these days.



*Practical notes on what stations to look for and how to get the foreigners that are coming over well.*

LAST month it was mentioned that so good were medium waves for long-distance reception that American stations were being received with quite simple and straightforward sets. Surprising as it may appear to be, this statement can now be amplified considerably.

For while most valve-set owners are quite content with picking up W.P.G., W.T.I.C., or any of the well-known U.S. stations working on the 250-500-metre wave-band, some hardy souls aim higher than this. And there are now many reports of reception from South America.

Most of these reports concern Buenos Aires, which is a matter of some six thousand or so miles from

this country. This is a phenomenal distance-spanning feat on ordinary wave-lengths, and it speaks volumes for the 1931-32 season that such reception has been achieved.

To come back to European stations after such voyaging may seem very tame, but for the majority of us Europe has proved exciting enough. All "the regulars" have been in good form, and the new Post Parisien station on 328.2 metres has already established itself as a favourite.

Another newcomer—Florence, the Italian regional, on 500.8 metres—has so far been disappointing. Using the old Milan wave-length it was expected that the 20 kilowatts behind this programme would place

Florence well and truly in the easy-to-receive class. Actually it has proved rather difficult to pick up.

Reports from Italy show that this is due to the fact that the aerial at present in use is only a temporary one. When the new one is installed Florence will be a safe bet.

Long waves have been very interesting. For some reason the Russian stations have been getting over with great effect, particularly Moscow Trades Union on 1,304 metres. Leningrad, too, has been much easier to pick out from the interference that usually prevails on 1,000 metres, and there have been several Russian "mystery-stations" on other wave-lengths.

An interesting news item is that Kalundborg—always good—is going to put up his power in the near future; and this with the various other improvements contemplated should give us plenty to tune for during the coming months. We are now definitely turning our backs on the 1931-32 season, and whatever the future holds we must all admit that it has been a wonderful winter, and one that will long be remembered by the long-distance listener.

**Getting Ready for Summer?**

Those keen constructors who have leanings towards a nice portable set for summer use will be interested in the Camco "Carrier" cabinet. It is a strong job, suitable for out-of-door handling, and yet well-designed and finished to provide a handsome indoor article of furniture if required.

Battery space is provided, and besides the loud-speaker's fret there is provided a highly-polished wood front that will serve as a panel. In oak it comes out at 35s., and details of other designs will be forwarded on application to the firm for the 24-page free catalogue. Address and showrooms: Carrington Manufacturing Co., 24, Hatton Garden, E.C.1.

**Metallised Resistances**

The latest Dubilier metallised resistances appear to fulfil a real radio need in their classification into power-handling grades—one-watters, 1s.; two-watters, 2s.; and the three-watters, 3s. each. At these prices they should prove extremely popular, as they have a large overload factor and are silent in operation.

**POINTS FOR PURCHASERS**

*Interesting details from manufacturers about recent trade activities.*

**For the Mains**

A.C. mains users who are looking for something sturdy and reliable in the H.T. supply line should drop a line to F. C. Heayberd & Co., enclosing 3d. in stamps for their lists, including No. 962.

These describe the firm's products and also include diagrams of great interest to the mains man. Particular attention is drawn to the D.200 model unit which hands out an unruffled 30 milliamps. at 200 volts.

**Space Saving with Safety**

Talking about mains, have you noticed the new Bulgin space-saver—a combined mains connector and twin fuseholder? It's sold complete with two fuses (1 amp.) for 4s., and is an excellent example of just-what-you-want design.

The idea is that everybody needs a fully-protected safety-connector to the mains, and also adequate fuse arrangements, so these two desiderata are incorporated into the one compact unit. The live parts are fully protected, but readily accessible at will, and the fuse-change can be carried out in a moment.

**The Best of H.T.**

"Trouble-free high-tension for 1s. a year" is the attractive slogan of the Westinghouse people when talking of their metal-rectifier units. Full details of various types, with circuits and other particulars, will be found in "The All-Metal Way," which will be sent to all readers of THE WIRELESS CONSTRUCTOR" who enclose 3d. for postage to the Publicity Manager, Westinghouse Brake and Saxby Signal Co., Ltd., 82, York Road, King's Cross, London, N.1.

**Wearite Coils for "S.T.300"**

The price of Wearite coils for the "S.T.300" was given as 12s. 6d. in the advertisement in our last number, but this was a mistake. The correct price of these coils is 12s

SIMPLE—EFFICIENT—INEXPENSIVE

# THE "PENTODE" TWO

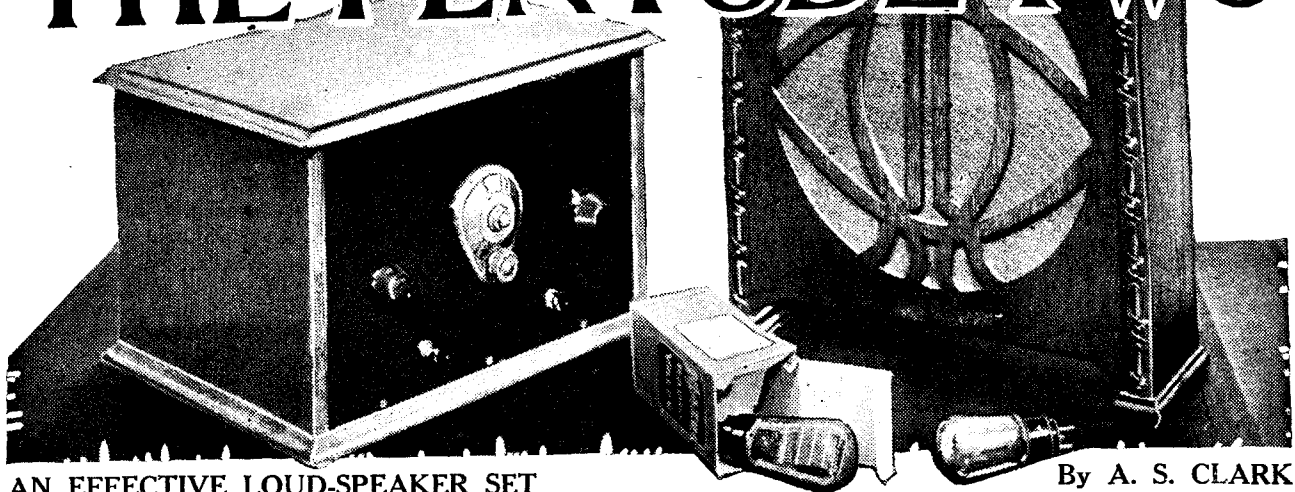

AN EFFECTIVE LOUD-SPEAKER SET

By A. S. CLARK

**E**VEN the cleverest designer cannot design a set that will suit everybody's tastes and requirements—to say nothing about everybody's pocket. That is why there are so many different receivers from which to choose when you are going to make up a new set.

### Built for Service

And yet I can well imagine the constructor whose requirements are very modest feeling that most of the designs cater only for technical enthusiasts, experts or millionaires. As various designs pass through his

*With its fine tone, ample volume, simple operation and low cost, this two-valve constitutes an ideal receiver for anyone who does not want or cannot afford an elaborate outfit. It has two-band tuning, and by no means confines reception to the local or home stations.*

mind, one after the other, like some mannequin parade, I can hear him say of a detector and two L.F.: "Too powerful!" Or of a 2 S.G., det. and L.F.: "Too many knobs!"

So he would go on, with a "Too many valves!" against a super-het.,

and "Too expensive!" when it came to a magnificent radio-gram. Quite likely most of you would soon be out of patience with him, feeling that he did not know *what* he wanted, to condemn so many good receivers; receivers that are popular with large numbers of constructors!

### Single-Knob Tuning

Yet how often does one hear something like the following! "I only want a simple set; not too expensive. One that will just do the job nicely, and not be too difficult to tune."

## QUITE A MODEST SHOPPING LIST

- |  |  |  |
|--|--|--|
| <ul style="list-style-type: none"> <li>1 Panel, 12 in. × 8 in. (Permoal, Wearite, Peto-Scott, Lissen, Becol, Ready Radio).</li> <li>1 Cabinet, with baseboard 10 in. deep to fit (Gilbert, Camco, Pickett, Osborn, Compton, Ready Radio, Peto-Scott, Moreo).</li> <li>1 .0005-mfd. tuning condenser (Telsen, J.B., Cyldon, Polar, Lotus, Lissen, Ormond, Igranic, Ready Radio, Dubilier, Formo, Wavemaster, Graham Farish).</li> <li>1 Slow-motion dial, if condenser is not of slow-motion type (Formo, Telsen, Igranic).</li> <li>1 .00025-.0005-mfd. variable series aerial condenser with shorting position (Ferranti, Ready Radio).</li> <li>1 .00015-mfd. differential reaction condenser (Ready Radio, Lotus, Igranic, Polar, J.B., Dubilier, Lissen, Magnum, Formo, Wavemaster, Telsen, Cyldon, Graham Farish).</li> <li>1 3-contact push-pull wave-change switch (Bulgin, Ready Radio, Peto-Scott, Wearite, Magnum, Telsen, Goltone).</li> <li>1 Push-pull filament switch (Bulgin, etc.).</li> </ul> | <ul style="list-style-type: none"> <li>1 4-pin valve holder (W.B., Telsen, Igranic, Lotus, Lissen, Clix, Graham Farish, Bulgin, Formo, Wearite, Dario, Magnum).</li> <li>1 5-pin valve holder (W.B., etc.).</li> <li>1 400-ohm potentiometer for baseboard mounting (Sovereign, Ready Radio, Igranic, Wearite, Lissen, Magnum, Varley).</li> <li>1 .0003-mfd. fixed condenser (Dubilier type 670, Telsen, T.C.C., Ediswan, Lissen, Ferranti, Igranic, Watmel, Formo, Graham Farish, Goltone, Sovereign).</li> <li>1 .0003-mfd. fixed condenser (Sovereign, etc.).</li> <li>1 .01-mfd. fixed condenser (Dubilier non-inductive, etc.).</li> <li>2 2-mfd. fixed condensers (T.C.C. and Dubilier, Formo, Igranic, Helsby, Hydra, Ferranti).</li> <li>1 L.F. transformer (R.I. Dux, Telsen, Igranic, Lissen, Varley, Ferranti, Lotus, Lewcos, Goltone, Graham Farish, etc.).</li> <li>1 H.F. choke (Ready Radio, Lewcos, Peto-Scott, Telsen, R.I., Tunewell, Varley, Dubilier, Lissen, Lotus,</li> </ul> | <ul style="list-style-type: none"> <li>Wearite, Magnum, Watmel, Sovereign, Atlas, Graham Farish).</li> <li>1 2-meg. grid leak with terminals or holder (Graham Farish Ohmite, Lissen, Ferranti, Ready Radio, Telsen, Igranic).</li> <li>1 Pentode output choke (Varley Pentode Nichoke, R.I., Atlas).</li> <li>1 15,000-ohm spaghetti resistance (Bulgin, Ready Radio, Lewcos, Magnum, Keystone, Sovereign, Graham Farish, Lissen, Varley, Telsen, Goltone, Igranic).</li> <li>1 5,000-ohm spaghetti resistance (Ready Radio, etc.).</li> <li>1 P.J.3 coil (Ready Radio, R.I., Wearite, Goltone, Peto-Scott, Ferranti, Formo).</li> <li>2 Coil quoits (Peto-Scott, Ready Radio, Wearite, Sovereign).</li> <li>4 ozs. of No. 30 D.S.C. wire.</li> <li>1 Terminal strip 12 in. × 1½ in.</li> <li>9 Indicating terminals (Belling &amp; Lee (type R), Eelex, Igranic, Clix, Bulgin, Goltone).</li> <li>Battery plugs (Clix, etc.).</li> <li>Screws, wire, flex.</li> <li>Jiffilinx, Lacoline, Quickwyre, Soldawyre, Glazite.</li> </ul> |
|--|--|--|



# The "Pentode" Two—continued

## EACH VALVE WORKS AT ITS BEST

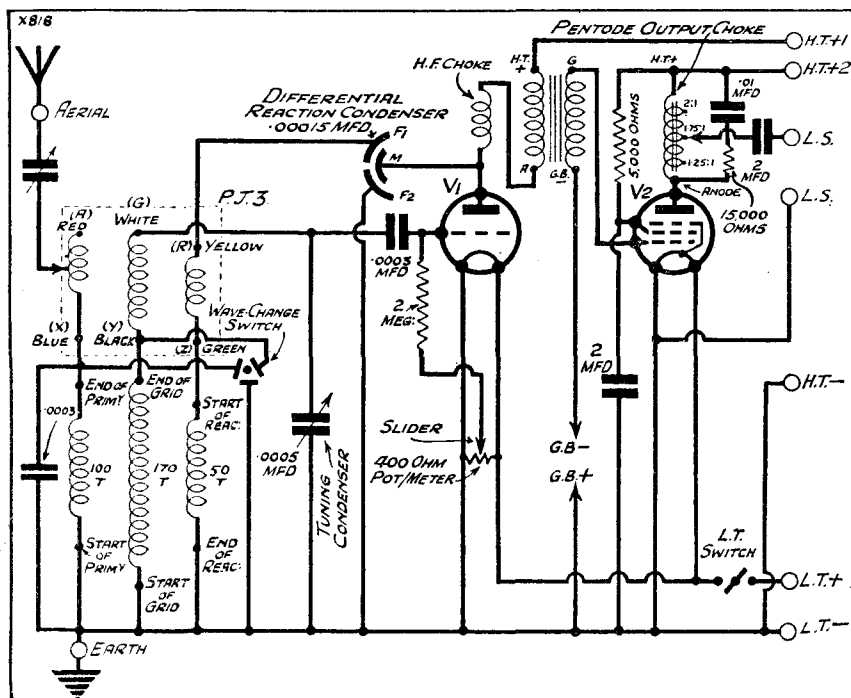

Among the several refinements which enable the circuit to get the most out of each valve are the potentiometer and output equaliser. The first ensures that the reaction control shall be smooth, and the latter brings the tone of reproduction to a suitable pitch.

Not super-selective or tremendously powerful or capable of bringing in everything on earth, but just to give the locals with medium power, to separate them properly and to bring in some of the "better" foreigners at "small speaker" strength. There will always be a big demand for such a design.

But don't run away with the idea that the details of such a set can be worked out in a slap-dash manner. Oh, no! Efficiency has got to play a very big part.

### No "Surplus" Stages

There are no "surplus" stages where one can make up for losses in obtaining selectivity and so forth. And no elaborate schemes are available for use, or up goes the cost of the outfit and it defeats its own end.

Let's take a look at the claims of the "Pentode" Two, and see how well it fills the bill. The circuit diagram will help us if considered in conjunction with the photographs.

There are only two stages, a detector and low frequency, so that it is easy to make and easy to tune. Also, the component list is not large, so that there is not a big budget to meet.

But volume will not be lacking either on the locals or on the distant stations, because the low-frequency

stage employs a pentode valve which ensures that the most will be got out of it.

Then the coils that provide for quick changing from one broadcast band to the other are not elaborate, and can all be made at home, so that here the cost is kept well down. At the same time, even if the main coil is purchased ready-made, which it can be, it is not an expensive proposition.

### Easy to Handle

Taken as a whole the set is ideal for home use. Inexpensive, easy to handle, and at the same time, and most important of all, inexpensive.

Before I go on to the details of the coil construction and assembly there are one or two small points in connection with the circuit to which I would like to call your attention.

First of all, there is the variable condenser in series with the aerial lead. This is for the purpose of adjusting the selectivity on the medium waves, but it has an automatic shorting position at its maximum capacity so that it is cut out for the long waves when set at this value.

Then there is the fixed condenser across the long-wave part of the

## DOWN AT THE PENTODE END

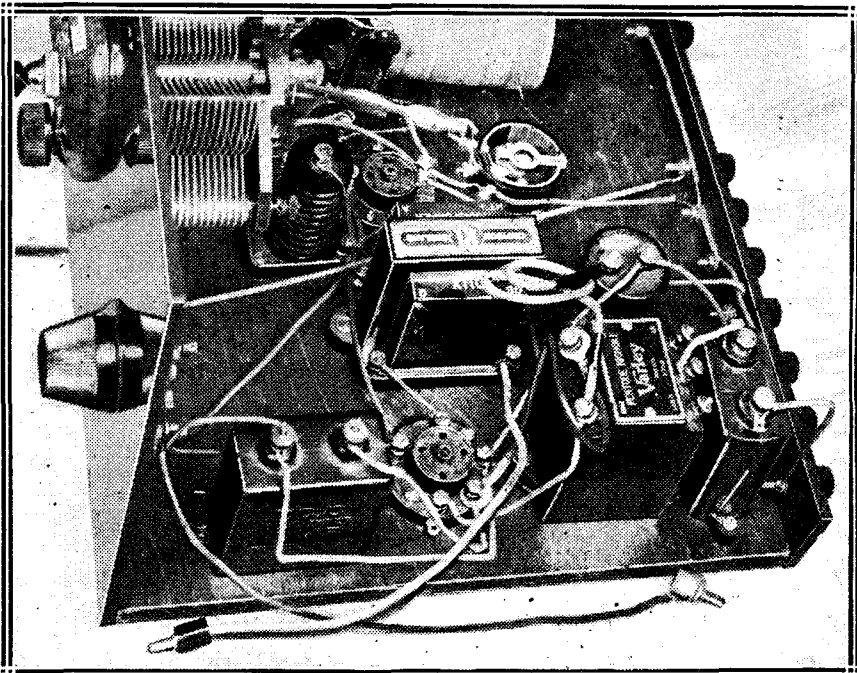

The valve-holder in the foreground of this photograph is of the five-pin variety and accommodates the pentode. The priming-grid connection is to the centre-pin, and there is a by-passed decoupling resistance in series with it.

## The "Pentode" Two—continued

primary. This is for the purpose of avoiding medium-wave break-through when the set is working on the long waves.

Lastly, there is the fixed condenser and resistance that is connected across the output choke. This is called a frequency equaliser. It prevents the tendency for reproduction to take on a high-pitched tone, which is otherwise often characteristic of the pentode valve.

### The Medium-Wave Coil

And now I think we can get down to more practical details. So far as the components are concerned you have a very wide choice of alternatives, as none of them are at all critical.

The medium-wave coil may be purchased ready-made if desired, but details of how to construct it are given. The long-wave windings must be wound by yourself, but they are particularly easy.

Perhaps it will be as well if we deal with the winding of the coils before going on to the other constructional details. First of all, there is the medium-wave one.

This is known as a P.J.3 coil, and has three separate windings all in single-layer form. The wire used for

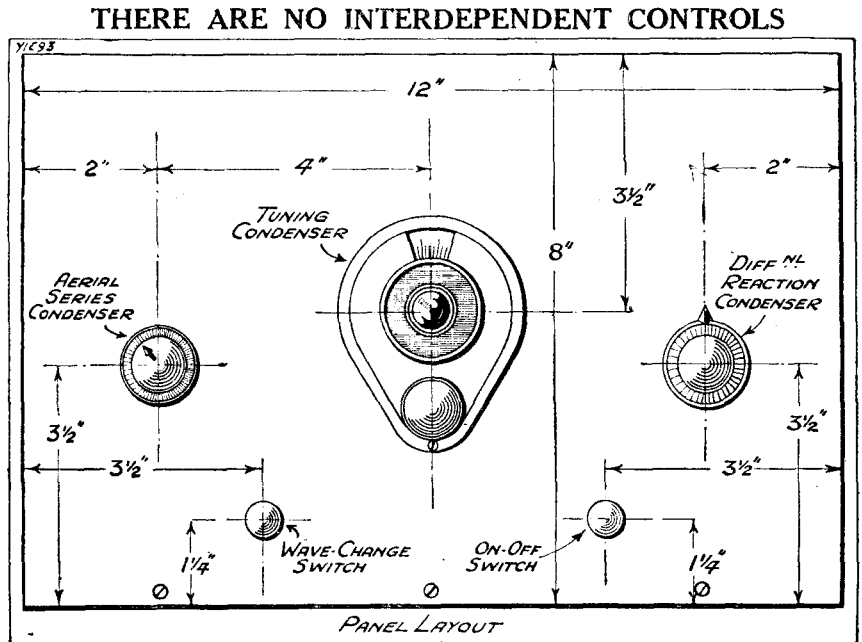

Control of the set and station-searching is particularly easy, as each knob has its definite purpose. It is very easy to set the tuning for a given station which has previously been tuned in and had its setting noted.

all three is 30 gauge D.S.C., the same as that required for the long-wave windings, and the insulating former is 3 in. long and 2 in. in diameter.

In the diagrams you will see that the ends of the various windings are marked with colours as well as

letters. This is because on the commercial versions of these coils the different leads are distinguished by means of coloured flex wires. In describing the coil we will refer to letters for convenience.

Kick off with the primary winding by fastening one end of the wire a short distance from one end of the former. The best way to do this is by means of two small holes about 1/4 in. apart.

### Winding Details

The primary has 30 turns in all, and two taps; one at 10 turns and another at 20 turns. These taps are best made by threading a loop of the wire through holes in the former, afterwards baring them and twisting up tightly.

The beginning of the primary is A and the end X. Three-eighths of an inch away from where you end the primary, with the help of two small holes start the secondary or grid winding.

This has 64 turns and is wound in just the same way as the primary, and finished off in the same way with two small holes. Now leave a 1/4-in. space and commence the reaction. This is also wound in the same direction as the other two windings and has 34 turns.

The beginning of the secondary winding is G and the end Y. The

### ALL COILS ARE VERY EASILY WOUND

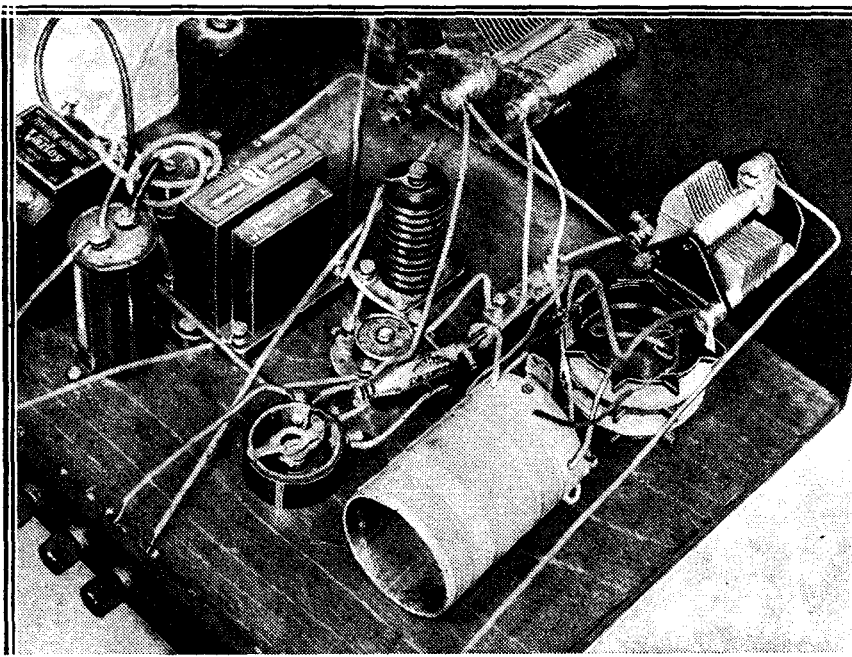

The medium-wave windings, carried on two coil-formers, are quite separate from the long-wave inductances. Full details are given in the text how these simple coils can be wound at home.

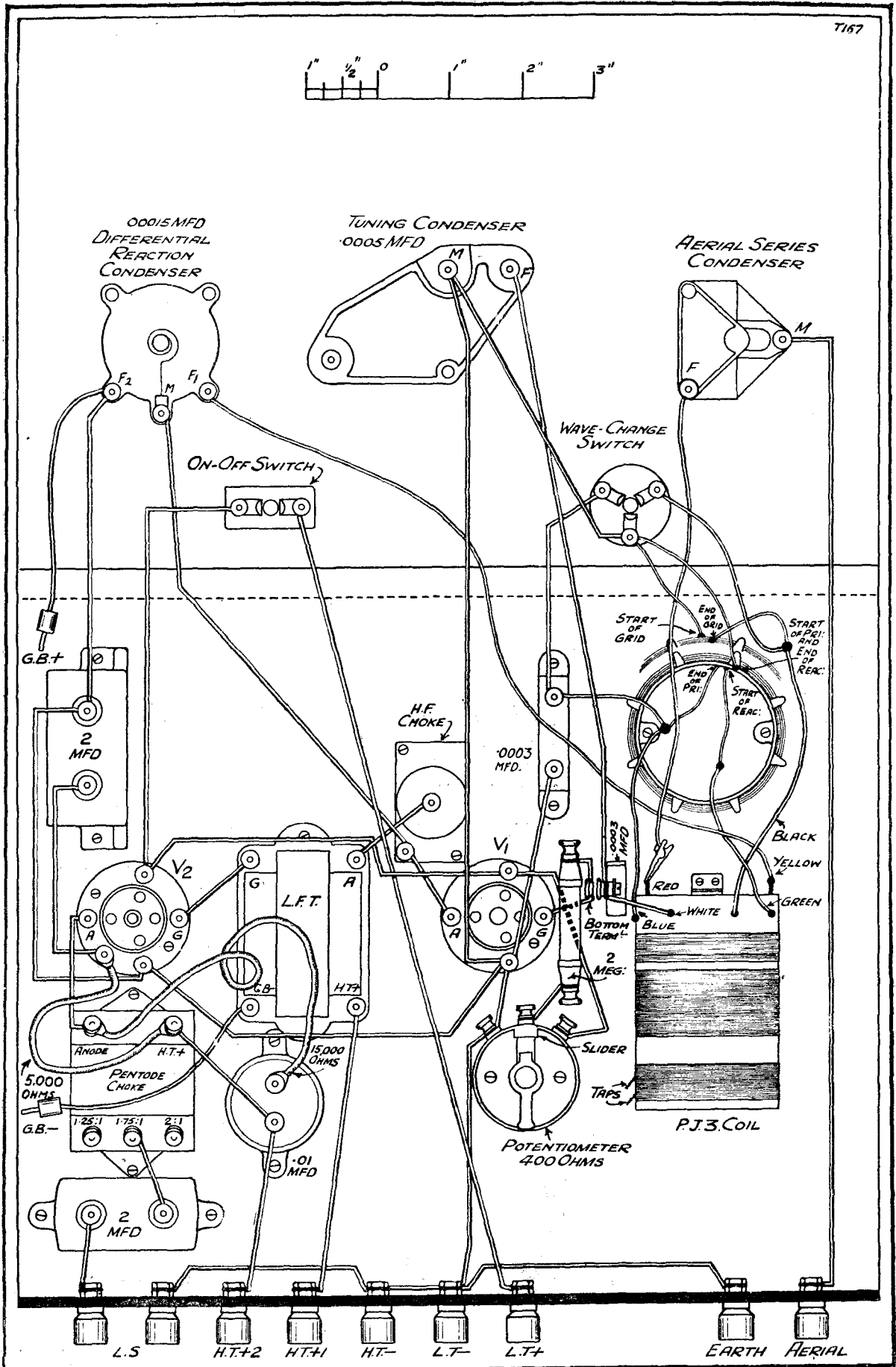

## The "Pentode" Two—continued

beginning of the reaction winding is Z and the end R. Take care to mark the ends carefully so that you will not get them muddled up, and leave them long enough for connecting-up purposes.

are in place. Just fasten off a large loop with the aid of the holes in the former.

The primary winding comes next, in the same direction as the reaction winding, but before you put it on fix a

The grid winding on the second quoit has to be wound in a certain direction in relation to the reaction on the one we have just considered. So as to ensure getting this right, fit the two quoits together before winding the second one, and then make sure that you wind it in the same direction as the first one. There are 170 turns.

### "THE WIRELESS CONSTRUCTOR" "PENTODE" TWO

Circuit: Dual-wave-band detector and pentode L.F.

#### VALVES.

1st (near coils): H.F., H.L., or special detector type.  
2nd: Small pentode (or large pentode for great volume).  
Valves may be 2, 4, or 6 volts.

#### VOLTAGES.

L.T.: 2, 4, or 6 volts, to suit rating of valves.  
H.T. + 1 (feeds detector): 40 to 60, according to which gives best reaction control.  
H.T. + 2: 120 volts or maximum available up to maximum rating of pentode.  
G.B. —: Voltage to suit pentode and H.T. in use. (Consult valve-maker's details.)

#### PANEL CONTROLS.

**CENTRE KNOB** tunes receiver.  
**LEFT-HAND TOP KNOB** adjusts selectivity on medium waves. Turn anti-clockwise to increase.  
**LEFT-HAND BOTTOM KNOB** controls wave-band. Push in for long. Pull out for medium.  
**RIGHT-HAND TOP KNOB** controls reaction. Turn clockwise to increase.  
**RIGHT-HAND BOTTOM KNOB** switches set on and off. Pull out to switch on.

#### BEHIND-PANEL ADJUSTMENTS.

Spring clip goes either to one of taps on solenoid coil or to red flex. Selectivity on medium waves alters with position.  
Slider of potentiometer varies smoothness of reaction control according to its position.

Next for the long-wave windings. These are carried on two of the well-known coil-quoit formers, which are fitted together one on top of the other.

You cannot go wrong with these windings so long as you take care to follow the instructions exactly. One quoit carries the primary and reaction windings, while the other accommodates the grid winding. This latter is the one mounted next to the baseboard.

couple of turns of Empire cloth or stiffish paper round the other winding. There are 100 turns on this winding.

### Mark the Leads

Carefully mark the leads from the quoits so that you know which is beginning and which end of the various windings. The easiest way to fix the P.J.3 coil to the baseboard is by means of a piece of wire running through it, which is screwed to the baseboard with two small screws.

That completes the coil details, the only part of the construction that requires detailed instructions. In fact, I don't think there is anything else so far as the construction is concerned for me to write about. Still, I'll just have a look.

(Please turn to page 54.)

### ALL READY TO "DRIVE AWAY"

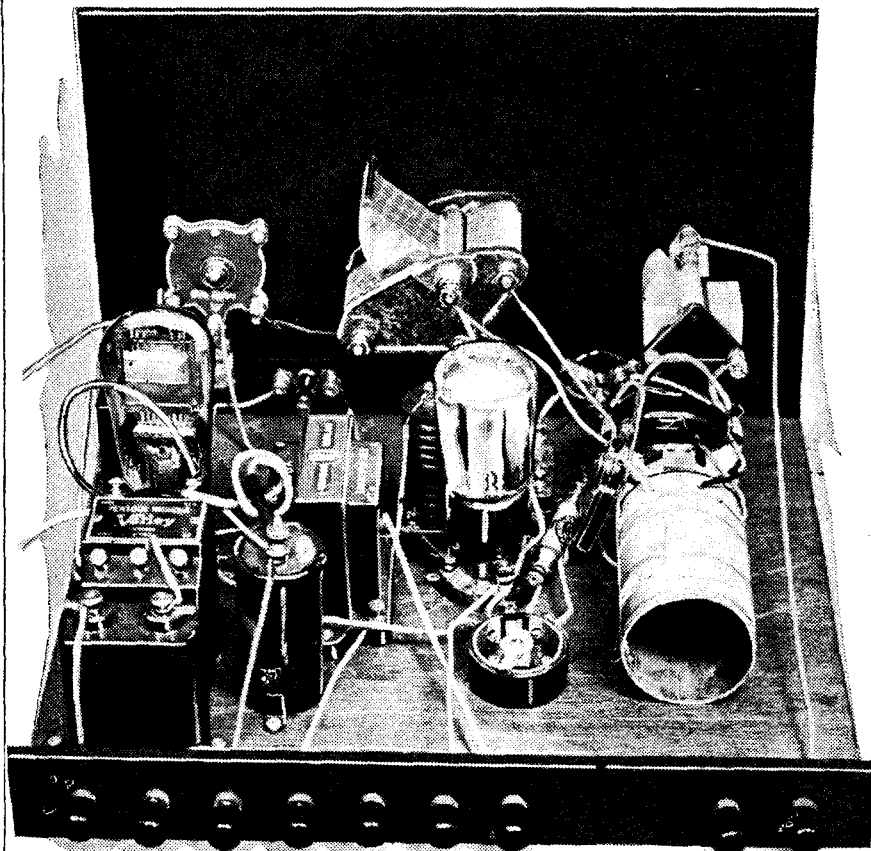

A behind-panel view of the completed "Pentode" Two, with valves in place, and just waiting for battery and other external connections before it will turn out loud, pure programmes on the loud speaker from local or foreign stations.

#### THESE WILL BE SUITABLE

**Loud Speaker.**—Amplion, Celestion, H.M.V., Blue Spot, R. and A., Undy, W.B., Marconiphone, Cossor, Graham Farish, B.T.-H., Epoch.

**Valves.**—1 Det. (Cossor H.L.210, Mazda, Marconi, Mullard, Six-Sixty, Lissen, Osram, Tungram, Eta).

1 Pentode (Mazda Pen.220, Marconi or Osram P.T.2).

**Batteries.**—H. T., 100-150 volts (Pertrix, Ever Ready, Magnet, Lissen, Ediswan, Drydex).

G. B., 9 volts (Every Ready, etc.).

**Accumulator.**—2-volt (Exide, Lissen, Pertrix, Ediswan, G.E.C.).

**Mains Unit.**—To give 100 volts at 12-15 m.a. (Heayberd, Lotus, Atlas, Regentone, Formo, Tune-well, R.L., Ekco, Tannoy).

First of all, put on the reaction winding. The wire is fixed by being threaded through two of the tiny holes that you will find in the former, a length of about 6 inches being allowed for connecting up.

There are 50 turns on the reaction, but don't break the wire when these

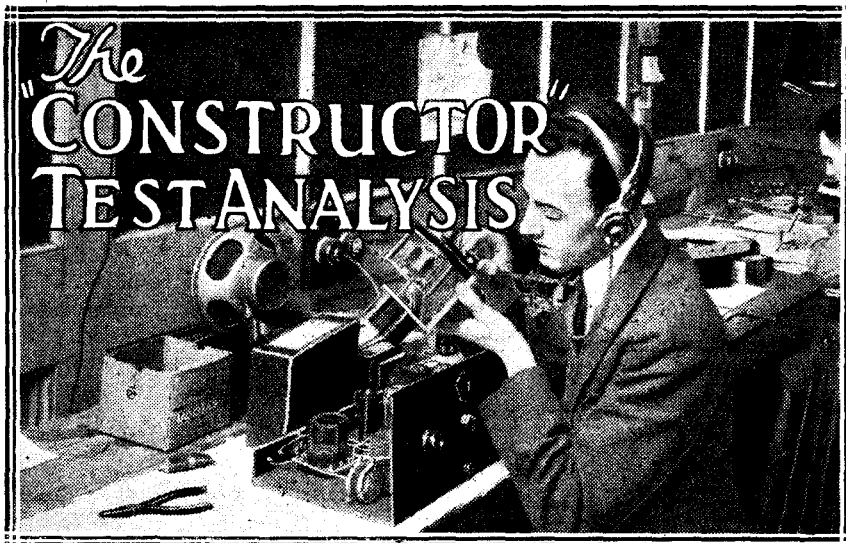

Some readers' experiences with two famous American stations.

As a result of the recent CONSTRUCTOR readers' test on the American short-wave stations W 2 X A F and W 2 X A D, some most illuminating facts have been brought to light—facts which prove beyond all doubt that it isn't an exaggeration to refer, as I did in my recent short-wave notes, to these two stations as being—in the short-wave sense—"punch-merchants."

**How It Started**

This friendly controversy, as most of you will remember, was brought about in the first case by a letter from W. H. H., of Willesden, who asserted that my notes were more or less incorrect, inasmuch as it was not possible to receive these two stations at anything like decent strength between the months of September and March.

I'll be quite frank about it and admit that I am now extremely grateful to W. H. H. for his contradiction, for as a result of the little

competition which we instituted to get a country-wide opinion on the matter, it has been possible to arrive

**ON SCHENECTADY'S SHORTER WAVE-LENGTH**

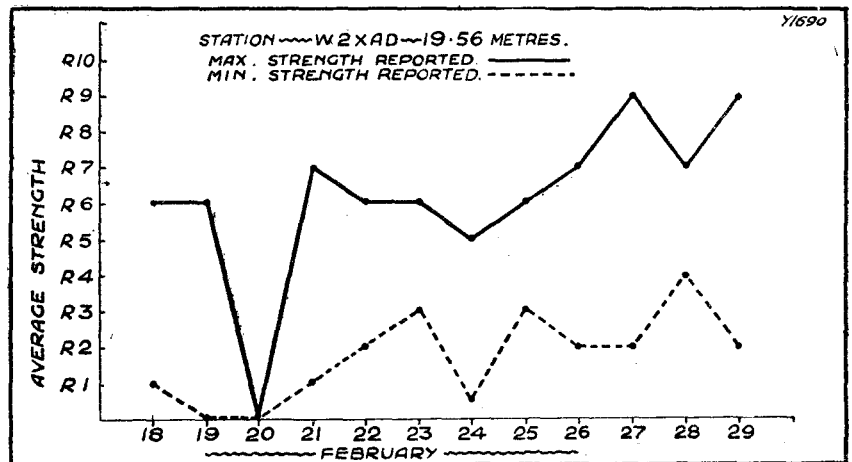

How strength varied over a 12-day period.

at some facts which otherwise might never have been brought to light. The only thing that I did not quite

bargain for was to be deluged with so many letters!

There were piles of them, some running to as many as fifteen and sixteen pages, and it might not have been so bad had I not offered to give the original "Kelsey" Adaptor to the writer of the best report!

**A Difficult Problem!**

As it is, I have been carefully weighing up the merits of every letter received—all of which are of a very high standard indeed—and I must confess that I have had the very greatest difficulty in deciding which, of all the reports received, was the best one.

After hours and hours of careful sorting, I managed to eliminate all but ten. And then came the task of making the final selection!

Well, I am not going to keep you in suspense any longer by telling you how the final choice was made, just

suffice to say, then, that each one of the ten was very carefully reviewed, and the adaptor goes to Mr. W. H. Rowley, of 7, Clarence Place, Stonehouse, Plymouth, for what was in every way an excellent report.

**The Winner**

Mr. Rowley's report contained detailed and accurate observations on the two stations on every day from February 15th to the 27th inclusive, and although he did not log both the stations on every day during the period in question, on those days when he was successful he certainly made a good job of the observations.

To the other nine who ran Mr. Rowley so close I am afraid that, much as I should like, I cannot give the original adaptor, but as a mark

(Please turn to page 55)

**LOWER POWER, BUT A HIGH AVERAGE**

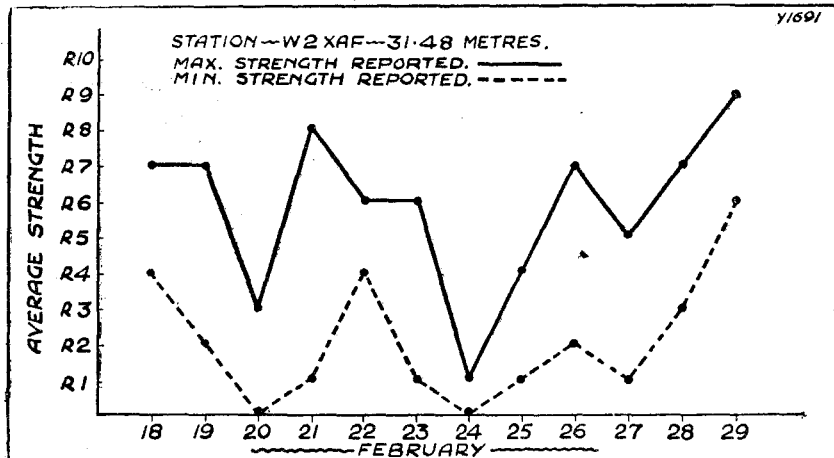

On 31.48 metres, using half the power, results were extremely interesting.



# AS WE FIND THEM NEW APPARATUS TESTED



Under this heading we publish reviews of apparatus submitted by radio manufacturers and traders for examination and test in "The Wireless Constructor" laboratories.

## H.M.V. S.7 Loud Speaker

**T**HIS is a permanent-magnet moving-coil loud speaker manufactured by The Gramophone Company at their works at Hayes, Middlesex.

It is supplied complete in a walnut cabinet for 5 guineas.

The magnet itself is of cobalt steel, and is non-rustable. The Swedish iron pole-pieces are copper-plated,

### GOOD RESPONSE

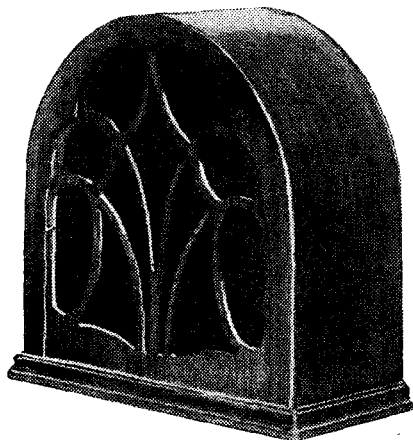

A very fine moving-coil loud speaker manufactured by the H.M.V. people.

and the flux-density is 6,000 lines per square centimetre.

The cone is of a laminated linen material, which is hot-pressed from sheet into the shape required, and afterwards sprayed with a cellulose compound. The latter operation renders the cone waterproof and assists in the reproduction of the higher musical frequencies.

Special attention has been given to accuracy in centring the moving coil in the air gap.

Since the coil itself has a low resistance (approx. 8 ohms) it is necessary to employ an output transformer, and the makers have incorporated a suitable instrument in the chassis assembly.

This transformer can be readily adjusted so as to match up the output load to suit varying conditions, and the input can thus be arranged to suit three-electrode output valves, pentodes, and push-pull outputs. Alternatively, the transformer can be cut out of circuit for direct attachment to receivers already incorporating a suitable transformer.

The power-handling capacity of the S.7 is 2-3 watts, and the response to musical frequencies between 100 and 4,000 cycles is exceedingly good.

### Highly Sensitive

Our tests revealed a degree of sensitivity well up to the average for moving-coil speakers of this type.

The general balance of tone was extremely good, the various instruments being well-defined. Objectionable resonances and "slurring" were completely absent, while speech was characterised by a crispness and clarity due to the presence of the higher musical frequencies.

The mechanical workmanship of this loud speaker—in common with other H.M.V. products—is above reproach.

### Bulgin Mains Connector

The Bulgin F15 combined mains connector and fuse holder is a practical and soundly designed component.

There is an insulated plug to which the mains flexible lead is joined, and a baseboard-mounting terminal block to which the set side of the mains is connected.

The terminal block incorporates two 1-ampere cartridge-type fuses, through which the mains current must pass on its way to the receiver.

### Accessible Fuses

The fuses are readily accessible, but in order to remove them the insulated mains plug must first of all be withdrawn. Then the two milled nuts securing the plate upon which the connector pins are mounted can be removed, thus exposing the fuses.

### SAFETY FIRST

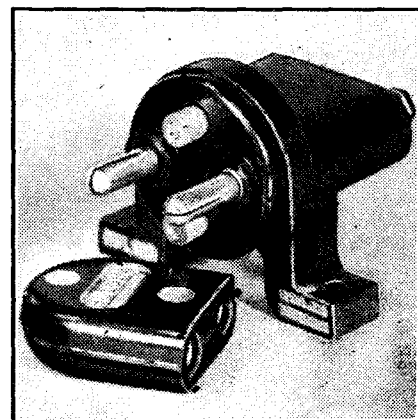

Ample protection is provided in this really excellent mains plug, which is made by Messrs. Bulgin.

We were very favourably impressed by the sturdy construction and high-grade finish of the sample submitted. It is essentially a quality component.

The price is 4s., and the makers are A. F. Bulgin & Co., Ltd., Abbey Road, Barking.

## As We Find Them—continued

### The "Atlstat"

Messrs. H. Clarke & Co. (M/cr.), Ltd., have produced a potentiometer which they call the "Atlstat." The resistance rating is 100,000 ohms, and the power-handling capacity up to 2 watts.

The resistance element in appearance somewhat resembles a miniature

### FOR HEAVY DUTY

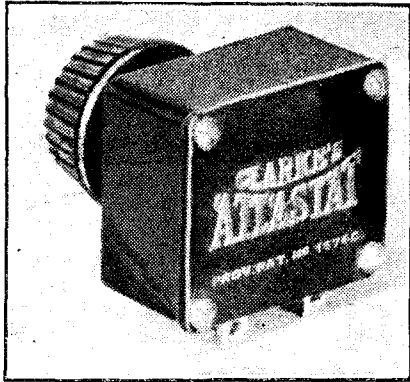

Here is a very useful high-resistance potentiometer, which can handle as much as 2 watts, and is made by Messrs. H. Clarke & Co., of mains-unit fame.

dry metal rectifier and gives one the impression that it is intended for long service.

The makers have designed the component to give a logarithmic increase of resistance value for equal angular movements of the knob—a distinct advantage when used as a volume control.

The method of attaching the knob is one which is worthy of mention.

With the majority of components of this type the knob is secured by a small grub-screw, and the constructor sometimes discovers that the blade of his screwdriver is too wide to engage with the screw slot.

In the case of the "Atlstat," however, you just push the knob on to the spindle, and it is held securely in position.

On test the component acquitted itself well, and we found the movement to be positive, yet pleasantly smooth.

The measured resistance value was within satisfactory limits of the manufacturers' nominal rating.

The price of the "Atlstat" is 8s. 6d.

### Igranic Potential Divider

In the article describing the A.C. H.T. unit in the March issue of the WIRELESS CONSTRUCTOR (pages

270-271), we specified an Igranic potential divider having a value of 20,000 ohms.

Actually the resistance of this component should have been given as 15,000 ohms, and it is, of course, the standard potential divider listed by the above firm.

### A Useful Screwdriver

Most of us have at some time or other been faced with the task of inserting a screw in an inaccessible place. You all know the kind of thing—a spot where it is impossible to guide the screw with the fingers until it "bites" sufficiently to hold itself in position unaided.

The Clarke's "Gripscrew" overcomes the difficulty. It is a slender screwdriver provided with a collar at the handle, and two wedge-shaped blades. The screw slot is placed in the centre of the blades and the collar is then pressed towards the blade ends of the screwdriver. That causes the blades to wedge into the screw-head slot and thus hold the screw firmly.

The screwdriver is available in sizes up to  $\frac{1}{4}$  in. and will be found very useful by the set constructor.

The sample we tried functioned admirably with the small screws used in wireless work. The makers are The Rawlplug Co., Ltd.

### Epoch Loud Speaker

Epoch moving-coil speakers need no introduction. The model 99K, for instance, has long been recognised as being among the leaders of its class. Recently we have had the opportunity of trying the model J.1, a permanent-magnet moving-coil instrument selling at a popular price.

This speaker has been re-designed, and the magnet, which is of 9 per cent cobalt steel, now weighs one pound more than the earlier model.

The diaphragm is approximately 8 inches in diameter, and is of a "doped" linen material moulded in one piece, thus dispensing with usual leather or stockinette surround.

An output transformer is supplied as "part and parcel" of the unit, and three ratios are available to facilitate matching. The output valve can thus be a power, super-power or pentode.

We found the model J.1 to be sensitive (i.e. it doesn't require a big set to work it), and while the bass response was well maintained the

upper register was remarkably good. "Brilliancy" is one of the features of Epoch speakers, and plays an important part towards obtaining faithful reproduction of music and intelligibility in speech.

This loud speaker is a good one, and at 45s., including the three-ratio transformer, it is excellent value for money.

### "Akros" Flexible

A new flexible cord without cotton padding. Such is Messrs. Ward & Goldstone's "Akros" flexible conductor. The makers point out that circular flexible cords have hitherto been padded with cotton or some other material in order to provide the shape required prior to braiding.

But cotton absorbs moisture, which is a disadvantage. The Goltone "Akros" cord achieves its circular shape by reason of the fact that each of the conductors is placed within a semi-circular rubber sheathing, this

### TRANSFORMER AS WELL

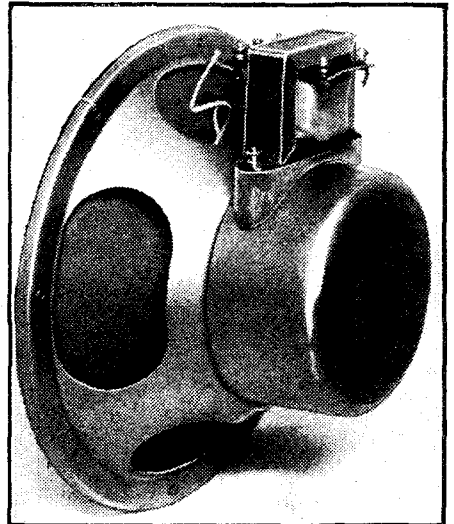

An inexpensive moving-coil loud-speaker unit which, at the modest price of 45s., takes some beating. It is a product of the well-known firm of Epoch.

procedure resulting in a very efficient twin conductor having high insulation properties and long life.

The price is reasonable, the 23/36 gauge conductor retailing at 22s. 6d. (glace cotton braiding) per 100 yards. The available sizes range from 14/36 to 110/36, and the prices are proportionate.

Incidentally, the first figure in the above sizes stands for the number of strands of No. 36 gauge copper-wire employed in each stranded conductor.



WHAT will the "S.T.300" do in my district?—is a natural query of those who are still hesitating before putting their hands into their pockets and buying the extra components for this set. This question is being answered by readers themselves.

I want to thank the senders of letters not merely for their appreciation, but for the valuable information given in them. The publication of readers' letters is not merely to show how successful a set has been, but to show what it is doing in different areas. It is also helpful to know the valves, speakers, etc., used. Letters have now been published from all over Great Britain—including the Channel Islands and the Isles of Bute.

**A Personal Interest**

When I get these letters I feel a real personal interest in that man's set at Longsight, Manchester, or in that "S.T.300" described by a Leeds correspondent; when I hear of previous difficulties due to interference, there is an added satisfaction. Your letters, when published, are a valuable guide to others in your district, so please let me know how your "S.T.300" is going on.

I wonder how many "S.T.300"-ites have improved their aerials on my advice? You may remem-

*Queries raised by readers about reception, hints on aerials, and notes on choosing a mains unit are among the diverse topics discussed in this informal chat.*

ber how, in my original article, I very strongly advised a better aerial. Lots of readers must have raised their eyebrows over that. For years we have been advised to "shorten your aerial" to get better selectivity. The no-compromise flexibility of the "S.T.300," however, enables one to

get all the benefits of better pick-up given by a higher and longer aerial. If you have room for a better aerial I again strongly urge you to improve your reception by this means. But if your set is not an "S.T.300" you may quite likely make "jamming" intolerable.

This *causerie* of mine is not intended to be only for "S.T.300" users, so I shall not harp too much on this set. Before leaving the subject, however, I should like to draw attention to a reader's admirable suggestion that if a *small* indoor aerial is used, an increase in signal strength may be obtained by shorting the aerial coupler. He suggests—and it is very easy to do—that the end of one moving vane be bent so that when the aerial coupler is "full in" the condenser is shorted.

**Small Aerials**

This dodge is of no appreciable value except on *very* small aerials, and even then its advantage is obtained chiefly on the long waves. My own opinion is that a four-valve set is necessary for a small indoor aerial if really respectable results are to be obtained. But readers with "S.T.300's" may try the shorting idea. I shall be interested in results. Of course, when selectivity requires it, you turn the

**AIR-TAXI'S RADIO 'PHONE**



*This is Capt. Hope speaking into the microphone of his air taxi, which enables it to connect with aerodromes when in flight. Incidentally, our readers will remember that Mr. John Scott-Taggart, who writes on this page, is himself very keen on aeronautics, and has owned and flown a number of 'planes.*

## From My Armchair—continued

coupler anti-clockwise (reducing its capacity). The shorting should only occur when full in, and is, of course, done by the bent moving vane scraping against the fixed one.

By the way, see that the wave-change switch on the "S.T.300"—or any other set for that matter—does its job properly. An uncertain contact can produce very blurry effects. It is a good plan to turn the knob clockwise several times now and again to keep the contacts clean; this is done while the switch is in the medium-wave position.

### About Mains Units

Advice on the choice of a mains unit is being asked. It is rather difficult to give. I am referring especially to the kind of unit off which to work A.C. valves, i.e. one which will give, say, 200 volts maximum, and 4 volts raw A.C. to heat the cathodes. The question is what milliamperage output should it give?

The anode current taken by the valves in the set appears the right answer. The A.C. indirectly-heated valves on the market, however, vary widely in the current they take. For example, you may have noted that in the A.C. "S.T.300" the total current consumption varies from about 19 milliamps. for one make to 27 milliamps. for another.

Speaking generally, I should advise the reader to purchase a unit capable of delivering somewhat more current than is desired for the set he is building. A point of importance arises here which seems to receive little attention, and that is that the "load characteristics" of mains units are not flat. I am using on my own A.C. "S.T.300" a Heayberd M.W.1 unit rated to give 50 milliamps. at 200 volts.

### Varying Output

I measured the voltage delivered by this unit when withdrawing different amounts of current from it. At zero current the voltage was 400, while at 50 milliamps. it was 200 volts. Between 0 and 50 milliamps. the

maximum voltage given by the unit varied by 200 volts.

Working the "S.T.300" with valves taking about 20 milliamps., the maximum anode voltage (on the S.G. and power valves) was over 300. The makers of A.C. valves usually restrict the permissible anode volts to 200. My own solution is to connect

### THE APPEAL OF "MRS. LINDY"!



*Taken just before her baby was cruelly kidnapped, this portrait shows Mrs. Charles A. Lindbergh delivering a nationwide radio appeal on behalf of the sufferers from the Chinese floods.*

a 6,500-ohm resistance outside the mains unit, but across its maximum output voltage terminals. This resistance must be capable of carrying 30 milliamps. without overheating. The external resistance drops the voltage on the S.G. and

power valve anodes to the desired 200 by increasing the load on the unit.

This is rather wasteful, and a smaller unit would do, but advising on units is like advising a newly-married couple on the size of house they ought to buy. Should the house be large enough to provide for future contingencies? And, if so, how many contingencies should be provided for?

### Prices Still Too High

I should like to design some mains units for WIRELESS CONSTRUCTOR readers. The trouble is that I should want to specify transformers and condensers and rectifiers sold at reasonable prices. It is not, of course, my job to try and reduce prices, but neither am I going to help to keep them up.

My belief is that mains unit components at the present time are not sufficiently cheap to attract me or any readers. I will make a bargain with the manufacturers. If they will produce for us cheap components, I will design the units, and I am certain large numbers of readers will make them up.

I believe the great circulation and influence of THE WIRELESS CONSTRUCTOR would ensure sufficient demand for the parts to justify the lower prices.

I am getting a number of letters from some of you asking whether the "S.T.300" is still worth building. They admit delay in deciding about the matter, and are wondering now whether it would not be wiser to wait and see what happens next.

### Good Advice

My advice is, go ahead now. The "S.T.300" is still being built in thousands weekly, and as far as I am concerned I have nothing better in three-valve sets even at the back of my mind. I advise the "S.T.300" in the knowledge that it will remain "fresh" for a long time to come. This policy of aiming at fewer and better sets may need getting used to, but I am sure all readers will back me up in it.

## EVERY MONTH IN "THE WIRELESS CONSTRUCTOR"

Readers of this journal will find an "Armchair" article from the pen of John Scott-Taggart, F.Inst.P., in which the designer of the "S.T.300" will discuss all sorts of radio topics of mutual interest.

To keep in touch with the trend of design and development make a point of regularly reading

**"From My Armchair"**



# Making Tuning Readable

BY HERBERT K. SIMPSON

JUGGLERS and others often pride themselves on their prowess at doing more than one thing at a time; but even though a radio set is something of a box of tricks, we are most pleased when it entertains us with just the one station's programme that we have chosen from the many at our command.

### Different Frequencies

In this third chat I am going to talk about the way in which our sets are able to make use of the "signals" from one station and yet ignore those from others. When we speak of "signals" we mean the currents in our aerials, and these currents are tiny reproductions of the aerial currents of the various broadcasting stations that are sufficiently powerful to produce them there.

These currents must all be different in some way or we should never be able to pick out the ones that we wanted. At first thought we might imagine that there was about as much chance of doing this as of recognising a single sheep in a flock (leaving out the black one!).

The currents are certainly all minute alternating currents, but where they do differ is in their *frequency*. That really tells the whole story, so we must examine the fact in greater detail.

### The Ether Waves

We discussed *frequency* last month, but it would be just as well to run over the main points again before going any farther. Alternating currents, you will remember, are those which flow first in one direction along a wire and then in the other, the

This month we present the third article of our contributor's series, in which he makes radio readable for beginners.

sequence being repeated like the swinging of a clock's pendulum. The number of times that the current carries out complete back-and-forth movements per second is known as its *frequency*, and is said to be the number of cycles per second.

There is another way of looking at frequency in broadcasting, and this point of view is not concerned with aerial currents, but with the wireless waves which act as the link between the broadcasting aerial and our own.

waves, viz., 186,000 miles per second. That is enough to make even Sir Malcolm Campbell seem a little on the slow side! This speed can also be written as 300,000,000 metres per second. (A metre is a little longer than a yard.)

### Those Wave-lengths

Since the number of waves sent out per second is equal to the frequency of the aerial current, it follows that a current of very high frequency will send out waves so rapidly that they will follow very closely on each other's heels, and will therefore be short.

The distance between the crest of one wave and the next is known as the *wave-length*, and if the frequency is high this *wave-length* will be short, and if the frequency is low the *wave-length* will be long. Thus there is a definite connection between *wave-length* and *frequency*, and you will often find that both are given after a station's name in the broadcast programmes.

### Their Relation

Knowing one, the other can easily be found in the following way. If you divide 300,000,000 by the wave-length it will give you the frequency. If you divide 300,000,000 by the frequency in cycles per second it will give you the wave-length in metres.

Let me take, for instance, the Leningrad transmitter, not from any Bolshevistic leanings, but because this station has taken to itself the convenient wave-length of 1,000 metres. To find its frequency, we divide 300,000,000 by 1,000 metres, which gives us the frequency as 300,000

### A SIMPLE CIRCUIT

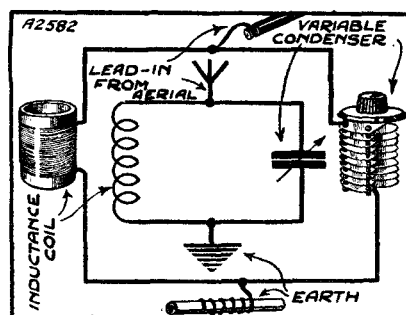

Here we have a simple tuning circuit in both diagrammatic and pictorial form.

Wireless waves are set up when alternating currents of high frequency are made to flow in the sending or transmitting aerial; there being a complete wave for each complete to-and-fro motion of the current.

Now, these waves travel out in all directions, and they do so at a speed which is the same for all wireless



## Making Tuning Readable—*continued*

cycles per second, or, as it is more usually written, 300 kilocycles per second (kilo meaning thousand).

### The Simplest Tuner

It is possible to connect between aerial and earth an arrangement which sorts out the currents of desired frequency, and makes use of these, letting the rest run to waste.

figure. This circuit is made up of two components, one being an inductance coil, the other a condenser. The inductance coil, which is a coil of wire, can take many forms, only one of which is shown in the figure next to the symbol which we use to represent any inductance coil in a circuit diagram.

The property of the coil is to have

leave when a knob is turned, the condenser being made so that one set of plates does not touch the other.

### Picking Out Stations

The property of the condenser is to have what is known as *capacity*, and the larger the area of one set of plates that is facing the other set—i.e. the more the two sets are interleaved—the greater is the *capacity*. (There are other things, such as the distance between the plates, whether they are separated by air or some other insulating material, which affect the capacity of a condenser, but we need not trouble about them here.)

Now for the actual process of tuning. The frequency to which a circuit is tuned depends upon the values of the inductance and capacity in the circuit. By varying either, or both, we can adjust the circuit so that it will respond to the frequency of the station that we wish to receive. It is usually more convenient to vary the capacity, as is done in the case we are dealing with.

This will give a range of frequencies (and the corresponding wave-lengths) over which we can tune; but if we want to have another frequency range at our disposal we change the number of turns that are used in the inductance coil.

### Wave-Band Changing

This change is usually effected by a switch which is connected across some of the turns in the coil, the switch being closed while we are using the higher frequency range (corresponding to the shorter wave-lengths). When the switch is open all the turns of the coil are being used, with a consequent increase in the inductance in the circuit. In this condition the circuit will work over a lower frequency range (corresponding to the longer wave-lengths).

Next month we will get a stage farther and say something about the way in which the currents we have selected are used to give us our entertainment.

## STARTING UP THE NEW PITTSBURGH STATION

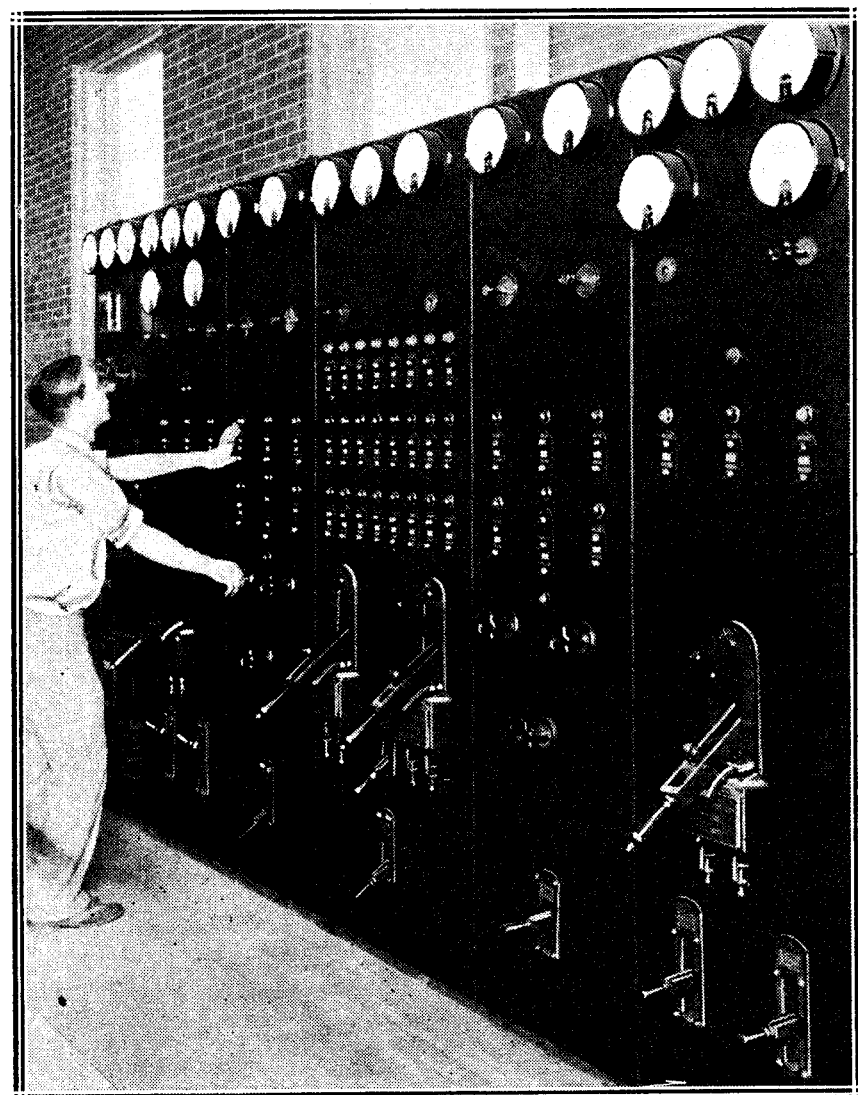

**K D K A, Pittsburgh, U.S.A., pioneer broadcaster of the world, has recently installed a new transmitter. Here is a view of the main control panel, showing an engineer pressing one of the starting buttons in preparation for the day's programmes.**

The arrangement is known as a tuning circuit, and when adjusted to pick out the desired currents it is said to be tuned to their frequency (or the corresponding wave-length).

One of the simplest forms of tuning circuit is shown in the accompanying

*inductance*, and the more turns of wire it has the greater will be its *inductance*. The condenser, too, can take many forms different from the one which is shown next to its symbol. Most tuning condensers consist of two sets of metal plates which inter-

### GET TO KNOW YOUR SET.

If you follow this special series of articles carefully, month by month, you will soon acquire a practical "working knowledge" of the theory of radio reception. You will find each article written in a manner which is both interesting and very easy to understand.

# ST 300 *will breaking records!*

*More stations than you have ever heard before  
More popular than any previous set . . . . .*

**OFFICIAL BLUEPRINT FREE WITH EVERY KIT**

**Kit "A"** (less valves and cabinet) **£3:18:6**  
OR BY EASY PAYMENTS  
**7/3** down and 11 monthly payments of 7.3.

**Kit "B"** (with valves less cabinet) **£5:10:9**  
OR BY EASY PAYMENTS  
**10/3** down and 11 monthly payments of 10.3.

**Kit "C"** (with valves and cabinet) **£6:9:3**  
OR BY EASY PAYMENTS  
**12/-** down and 11 monthly payments of 12/-

## A.C. S.T.300

**Kit "A"** (less valves and cabinet) **£5:11:6**  
OR BY EASY PAYMENTS  
**10/6** down and 11 monthly payments of 10.6.

**Kit "B"** (with valves less cabinet) **£7:19:0**  
OR BY EASY PAYMENTS  
**14/9** down and 11 monthly payments of 14.9

**HEAYBERD MAINS UNIT, TYPE M.1.**  
As specified - - - - **£6:7:6**  
OR BY EASY PAYMENTS  
**11/9** down and 11 monthly payments of 11.9.

*If purchased by Easy Payments with either of the above Kits, add 11/9 to the monthly Kit price.*

**Send to Ready Radio for details of Kits for the "VI-KING" SUPER**

**TO INLAND CUSTOMERS**  
—Your goods are dispatched post free or carriage paid.  
**TO OVERSEAS CUSTOMERS**  
—Everything Radio can be supplied against cash. In case of

doubt regarding the value of your order, a deposit of one-third of the approximate value will be accepted and the balance collected by our agent upon delivery of the goods. All goods are very carefully packed for export and insured, all charges forward.

## S.T.300 (Battery Model)

	£	s.	d.
1 Polished oak cabinet, 16 in. × 7 in. × 10 in., with baseboard	18	6	
1 Ebonite panel, 16 in. × 7 in., drilled to specifications	5	0	
2 Ormond .0005 slow-motion condensers, No. 6	13	0	
1 J.B. Midget .00004 condenser	4	0	
1 ReadRad .00015 differential condenser	2	6	
1 Telsen binocular choke	5	0	
1 Differential condenser, .0001	2	0	
2 Colvern S.T.300 coils	12	0	
1 W.B. horizontal valve holder	1	0	
2 Valve holders	1	0	
1 Lewcos H.F. choke, type M.C.	2	6	
2 ReadRad 3-point switches	3	0	
1 Varley Niclet L.F. transformer, 3.5-1	7	6	
1 T.C.C. .0001 fixed condenser, type S	1	3	
1 Graham Farish 1-meg. Ohmite	1	6	
2 T.C.C. 1-mfd. fixed condensers, type 50	5	8	
1 Lewcos 20,000-ohm spaghetti	1	6	
1 Terminal strip, 16 in. × 1½ in., drilled to specification	1	3	
1 Screen, 10 in. × 6 in. (with notches)	2	0	
1 Sheet copper foil, 10 in. × 7 in.	1	0	
1 Packet Jifilink	2	6	
3 Valves as specified	1	12	3
2 Belling-Lee wander plugs	2	4	
10 Belling-Lee terminals, type R	2	6	
Flex, screws, etc.			6
	<b>£6</b>	<b>9</b>	<b>3</b>

**"WIRELESS CONSTRUCTOR"**  
**OFFICIAL EXHIBITORS SELL READY RADIO KITS.**  
**LOOK FOR THE SIGN IN THE WINDOW.**

**HEAD OFFICE & WORKS:**

**EASTNOR HOUSE, BLACKHEATH, S.E.3.**

'Phone: Lee Green 5678.

'Grams: Readrad, Blackwil.

**Showrooms:**

**159, Borough High Street,**

**London Bridge, S.E.1.**

'Phone: Hop 3000.

# READY RADIO

**CASH or C.O.D. ORDER FORM**

To **READY RADIO, LTD.,**  
Eastnor House,  
Blackheath, S.E.3.

To **READY RADIO, LTD.,**  
Eastnor House,  
Blackheath, S.E.3.

**EASY PAYMENT ORDER FORM**

Please dispatch to me at once the following goods.....

for which (a) I enclose (Cross out line) £ .....  
(b) I will pay on delivery (not applicable)

Name .....

Address .....

W.C.53

Please dispatch to me the following goods.....

for which I enclose first deposit of £ .....

Name .....

Address .....

W.C.5/32

# THE MONTH ON SHORT-WAVES

All the latest news about this interesting band.

I THINK the most interesting item of my last month on short waves has been delving into, not short waves, but the correspondence concerning our recent "H.M." test on stations W 2 X A F and W 2 X A D!

Reports simply "poured" in, and I am extremely grateful to you all for your interest, and for the very detailed way in which reports were submitted. My only regret is that there isn't more than one original "Kelsey" Adaptor!

### The "Kelsey" Adaptor

A complete analysis of the results obtained, together with an announcement concerning the reader to whom the adaptor is to be given, is contained elsewhere in this issue, and I am afraid that I haven't the space to say any more about it here beyond once again thanking you for your reports.

And now for some "meat"!

My own experience of the past month on short waves is that conditions were inclined to be "jumpy." On the whole, conditions were good, but there were one or two really dead days, when I had the greatest difficulty in logging anything worthy of the name of distant station.

### American Reception

With very few exceptions, the "W's" have been consistently good, and my log includes W 8 X A L, W 9 X F, our old friends W 2 X A D and W 2 X A F, and W 3 X A L. W 3 X A L has been putting up such a good show that I am going to raise him to the rank of "punch-merchant" and make him the subject of our next "H.M." test. So now is the chance of a lifetime to qualify for "honours."

I am indebted to W. H. R., of Plymouth, for information concerning

a slight change in the wave-length of V K 2 M E.

Our Australian friend, who is coming over extremely well at present, considering the distance (a fact which we are apt to overlook!), is now working on 31.44 metres. That removes the possibility of interference from his next-door neighbour, Zeesen.

### The CT 1 A A Broadcast

By the way, did any of you hear the recent broadcast from CT 1 A A on behalf of our companion paper, "Popular Wireless"? I thought it was a jolly good show, and reception was about as good as it could possibly have been.

I listened to the programme for over two hours, and the transmission was at loud-speaker strength for the whole period.

G. T. K.

### THIS MONTH'S "H.M." STATION

**Note for Newcomers.**—Every month in these columns details are given of a short-wave transmission which readers are invited to receive and, if successful, to report in detail to THE WIRELESS CONSTRUCTOR. Those sending in the best reports receive "honourable mention" in these columns, and are thereafter styled WIRELESS CONSTRUCTOR "H.M.'s."

**Location:** Bound Brook, New Jersey.  
**Call-sign:** W 3 X A L.  
**Wave-length:** 49.18 metres.  
**Time of Transmission:** From 10 p.m. G.M.T. almost daily.

### "ON THE GRID"

Mysterious noises—Effects of damp wood—Switching units.

WHAT is the most mysterious radio noise that you have heard? I do not include the various weird and wonderful sounds that a set can give out, for they are legion, but on the lines of the following.

I expect many readers can beat it, but nevertheless I was quite puzzled for a minute or two at the time. It was like this.

### Queer Squeaks

I was hurrying down a road lined on either side by smallish houses, when I heard quite a loud and regular squeaking noise.

It was so like a squeaky wheel that I looked for a boy's home-made "trolley," in spite of the hour. But there was no one in sight.

The next thing that occurred to me was a faulty revolving chimney cowl. But there was no wind!

Well, to cut the story short, what do you think it was? Why, someone lowering their aerial, presumably to remove the snow from it to improve the dance music. The squeak came from a pulley at the top of a metal mast mounted on the roof of a house!

\* \* \*

Writing of winter weather reminds me of another little item. It concerns dampness; not the kind we are so used to, but dampness in wood.

Much of the plywood that is purchased from local shops is not properly seasoned, and contains quite a large percentage of moisture. If it is used to make a cabinet for a portable set in which a frame-aerial is employed, results may be quite poor.

The moisture in the wood surrounding the frame windings may act like a screen and prevent the proper pick-up of energy. But if you dry the wood out well first, this trouble will not assail you.

A similar effect may be produced by using a water stain for colouring the wood. This once happened to me, when a portable refused to behave at all properly.

After being laid aside for a bit, however, it was dug out to be further investigated. Imagine my surprise when, on connecting up, it worked!

### Mains Units

Some do, but some don't! That applies to mains-unit makers, and the fitting of on-off switches to the units.

It is correct to switch off H.T. before L.T. with A.C. mains, so a journey must be made to the wall switch, and then one must come back to the set, and then, most likely, pass the wall switch again on the way out of the room. A switch on the unit would obviate this.

And then what about cases where the wall plug is not fitted with a switch. I'll guarantee after a while the plug will not fit properly or the flex will come off, due to the constant fitting and removing of the plug.

A. S. C.

# When your friends ask you, as a radio expert, which is the best Wireless Receiver remember what the Press has said about **HIS MASTER'S VOICE** MODEL 435 — PRICE 20 GUINEAS

"This is one of the best sets we have tried this season. Its many technical points will interest the enthusiast and its wonderful performance will thrill the ordinary listener . . . Model 435 incorporates many requirements not found in the usual straight set. . . . One could not wish for better selectivity." *Wireless Magazine*

"It would be difficult to overdo praise for this excellent table-console set, which has a great many points that distinguish it from the ordinary run of sets. . . The quality of reproduction from the self-contained moving coil loudspeaker is simply great. The deep rich bass and the clear-cut treble combine to give a balance of tone not often found in table-sets."

*Amateur Wireless*

"Practically every modern feature likely to enhance the performance of the set and simplify its operation has been incorporated. Sensitivity is well above the average for a receiver of this type. Separate tuning scales are provided for both wavebands . . . We found the calibration quite accurate and very helpful. All scales are illuminated by concealed lamps."

*Wireless World*

## His Master's Voice



*Above price does not apply in Irish Free State.*

The Gramophone Co. Ltd., London, W. 1

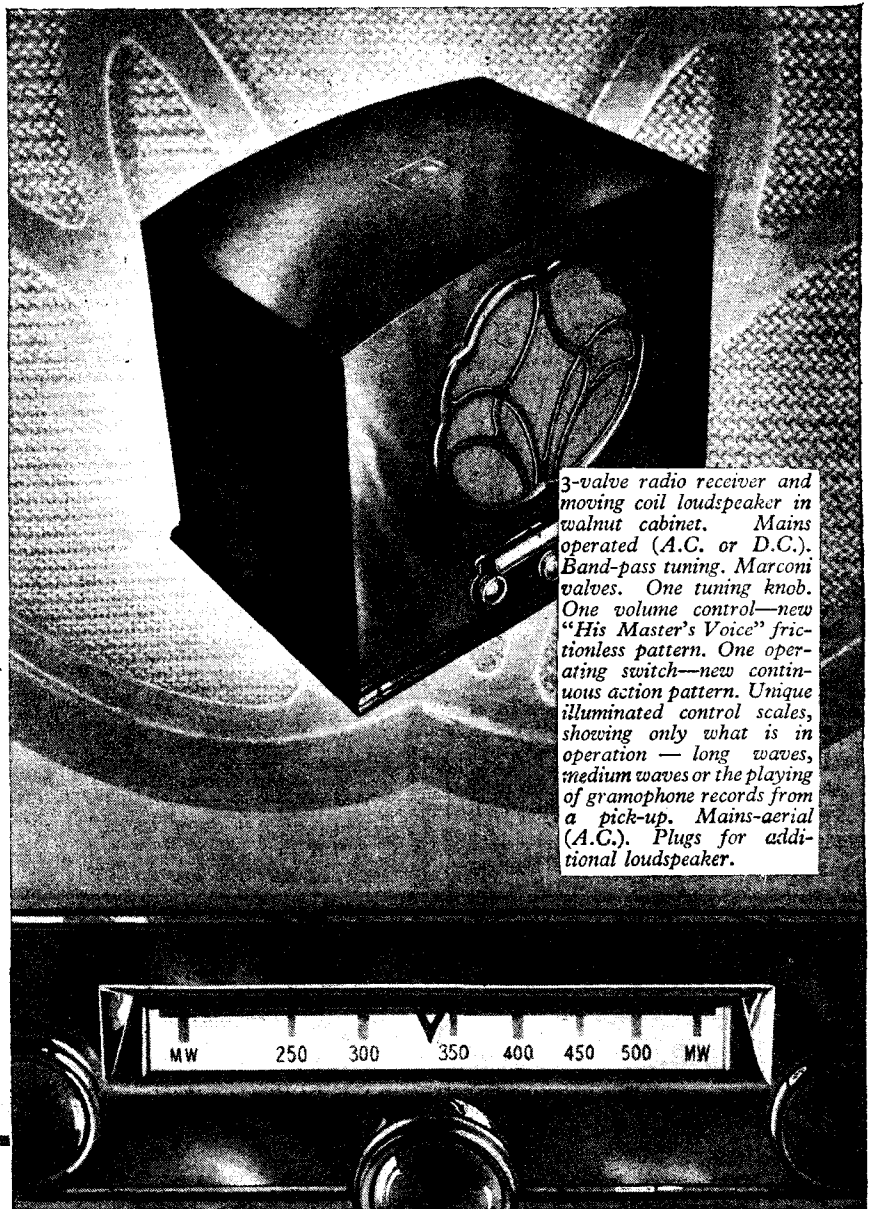

3-valve radio receiver and moving coil loudspeaker in walnut cabinet. Mains operated (A.C. or D.C.). Band-pass tuning. Marconi valves. One tuning knob. One volume control—new "His Master's Voice" frictionless pattern. One operating switch—new continuous action pattern. Unique illuminated control scales, showing only what is in operation — long waves, medium waves or the playing of gramophone records from a pick-up. Mains-aerial (A.C.). Plugs for additional loudspeaker.

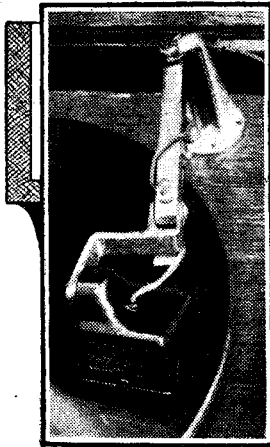

# PICK-UP HINTS AND TIPS

*Some interesting notes on various practical aspects of radio-gram reproduction.*

By A. BOSWELL

*Using a Jack for Switching In—Modulating a Heterodyne Wavemeter with a Pick Up—Good Tracking.*

There are two ways of introducing a pick-up into the grid circuit of the detector valve. One is to have a change-over switch that joins up the grid leak and condenser to the grid, or alternatively connects up the leads from the pick-up.

The other is to employ a jack instead of a switch. The same effect is obtained, but instead of changing over the switch, a plug connected to the pick-up is inserted in the jack when it is desired to listen to records.

## When Radio Breaks Through

A trouble that sometimes crops up with the latter method is that radio breaks through and interferes with the record reproduction. This is due to the capacity of the jack acting as a small by-pass condenser for the high-frequency currents, and the usual remedy suggested is to connect a switch in one of the filament leads of the H.F. valve.

As a matter of fact, I suggested this to a friend the other day, and was immediately informed that it could not possibly work with his set because it has not got an H.F. stage. Well, there is still a simple way out.

As the by-passing effect of the jack is very small, due to its very small capacity, it will only be powerful transmissions from a local station that will break through. So the remedy is just simply to detune the set from the local programme or programmes when you go over to records.

## An Interesting Method

I think this solution should be just as effective in cases where a high-frequency stage is used as well. It is certainly simpler than the addition of another switch, although the switch has the advantage that it saves filament and H.T. current when the set is run from batteries.

My next tip this month concerns a very interesting way of playing records

on a radio receiver. These are the circumstances that gave rise to it.

We particularly wanted to hear some new records, and the only set already available that would give good volume and impeccable quality had no provision for joining up a pick-up. But a heterodyne wavemeter was handy and this solved the problem.

A DOZEN GOOD RECORDS FOR YOUR RADIO-GRAM.		
Comedy.		
Archie Glen Makes a Blaise of Himself in the Recording Studio.	Broadcast	
He Played his Ukulele as the Ship Went Down.	Down.	
The Masqueraders	Columbia	
Orchestral.		
Berlin State Orchestra	Broadcast	Anitra's Dance.
Vocal.		
Binnie Hale	Columbia	You're Blasé
Peter Dawson	H.M.V.	Ginchy Road.
Elsie Carlisle	Zonophone	You Try Somebody Else.
Instrumental.		
Rudy Starita	Columbia	When the Circus Comes to Town.
Eddie Peabody	Columbia	St. Louis Blues.
Dance.		
Savoy Hotel Orpheans	Columbia	Just Friends.
Paul Whiteman	H.M.V.	Gettin' Sentimental.
Trees.		
Ambrose and his Orchestra	H.M.V.	He Played his Ukulele as the Ship Went Down.
Ambrose and his Orchestra	H.M.V.	Down.

This particular meter was one that could be modulated, and employed an S.G. valve. So it was the work of only a few moments to join up the pick-up leads to it so that the records modulated the oscillations in accordance with the recording on the channels.

## The Little "Local"

There then simply remained to tune the set to a point where no powerful station came in, set reaction

at zero, and place the wave-meter alongside it before the records came through O.K. The quality was surprisingly good, too, as, of course, it should be.

We don't hear so much about correct tracking of pick-ups nowadays as we did. Not because it does not now matter so much—it is just as important as ever—but most likely because so many of the pick-ups on the market are now supplied with their own tone-arms.

## Correct Tracking

A special template is also given with them, and its use ensures that the needle shall be as near in track as possible the whole time. To aid in obtaining this ideal the arm is usually arranged so that the pick-up is off-set in relation to it.

But in spite of the generality of this ideal scheme, there are many pick-ups about that are quite independent from the tone-arm. Most of them are intended for fitting in place of the sound-box of a mechanical gramophone.

## The Separate Tone-Arm

This is a very undesirable thing to do, because the position of the sound-arm cannot be altered and the chances are many against the tracking being anywhere near right. It is much better to have a separate "tone-arm" for the pick-up, even if it is only a simple home-made affair.

The simplest way of getting fairly good tracking when no template is available is first of all to place the tone-arm so that the needle swings across somewhere near the centre of the record, and then to move it about a little until the needle is out of track by just about the same amount at the inner and outer channels. But at the outer groove it should be out in the opposite direction from what it is at the centre.

The corner of a piece of paper laid on the record is the best indicator for tracking.

## A Good Scheme

For trying out separate pick-ups I have a simple tone-arm mounted on the motor-board, of which the straight part is a length of flat aluminium about 1/2 in. wide and 1/8 in. thick. It is soft so that it is easily bent.

It is, therefore, a most simple matter to bend the arm to any degree of off-setting which enables any pick-up to be adjusted so that it is out of track the same amount at the outer groove as at the inner.





# A PRACTICAL MAN'S CORNER

By R. W. HALLOWS, M.A.

*In these pages, month by month, our contributor packs a wealth of practical information and advice on constructional work. The regular reader of this "Corner" cannot help picking up a more or less complete training in radio workshop practice, while every month there are wrinkles to read, gadgets to make, or hints to help you.*

## Self-Tapping Screws

THOUGH, so far as I know, they are not yet available for the constructor, self-tapping screws are now being used by a good many manufacturers of wireless sets. The idea is, of course, an excellent one, partly from the labour-saving point of view and partly because such screws eliminate the need for any

### GOOD GRIPPERS

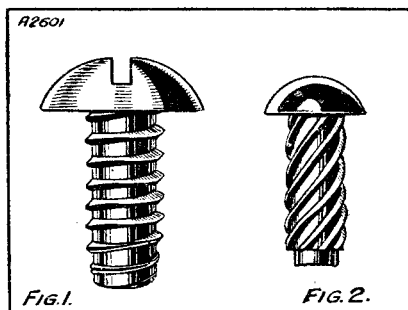

Fig. 2 shows a useful type of self-tapping screw designed for hammering home, while Fig. 1 depicts one for use with a screwdriver.

skill on the part of the user in the art of tapping.

You simply make a hole and drive the screw straight in. It cuts its own thread as it goes. The screws are of two kinds. In Fig. 1 you see the type designed for use with a screwdriver. A hole of the correct size having been drilled, the screw is turned straight into ebonite or metal. It goes in quite easily and once home it is as firm as a rock.

In Fig. 2 is seen another type largely used in chassis construction. This is even easier to work with, for all that is necessary is to drill a hole and to drive in the screw with either

a hand hammer or a mechanical hammer. Screws of this second class are not removable once they have been inserted—they are meant to "stay put," and they do so.

### A Great Boon

It is to be hoped that self-tapping screws will before long become available for the man-in-the-street, for they will be exceedingly useful in the making of wireless sets. The other figure shows a few of the many types now made, and a glance at it will show that these screws are the very thing for all kinds of jobs.

Meantime readers may be interested to know that self-tapping can be done quite satisfactorily with ordinary B.A. screws in soft materials such as ebonite. I have used the method for years, either when I had not by me a tap of the right size or when I wanted to save time on a small job.

Suppose that you want to fix a 4 B.A. screw without tapping into ebonite. Here is the way to do it. Look up the size of drill for making a clearance hole, if you have not this already in your head.

### Size of Hole

This size is actually No. 26. Make the hole with a drill three sizes smaller; that is, with a No. 29. You will now find that you can turn in the screw with a driver, and that it will cut a thread as it goes.

It won't be anything like a full thread, but it will be sufficient to hold the screw securely. For finer screws, such as 6 B.A. or 8 B.A., the drilling size for self-tapping purposes is two sizes smaller than that required for clearance.

## Loud-Speaker Mounting

Many people mount their moving-coil loud speakers in cabinets, but personally I much prefer to use a plain baffle board, for in this way one can avoid any tendency to "boxiness" in the reproduction. Unless a cabinet is designed with both good luck and good judgment there is always the danger of there being a resonance.

The only objections to the plain baffle are first that it takes up rather a lot of room, for it should not be less than about 2 ft. 6 in. square, and, secondly, that the loud-speaker unit behind it is not protected.

There is, though, a way out of this last difficulty; enclose the whole of

### LABOUR SAVING

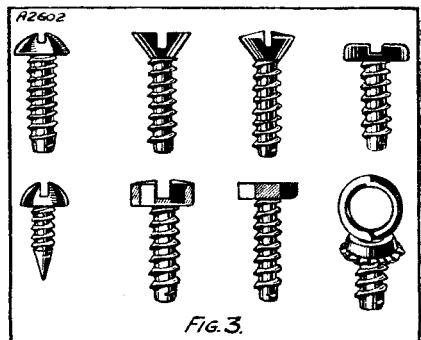

Here is a very handy assortment of self-tapping screws. This form of screw is extremely useful and saves a great deal of labour.

the driving unit in a bag made of some thin but closely woven material. If we decide upon using a plain baffle, the next point to consider is whether the driving unit, if sufficiently light and compact, shall be attached directly to it or placed on a small support of its own.

## A Practical Man's Corner—continued

I am rather strongly against attaching any kind of loud-speaker unit, whether balanced-armature or moving-coil, directly to a baffle board, for I have known many cases in which reproduction was spoilt in this way. Unless the baffle board is of very thick, hard wood, the actual vibrations of a driving unit screwed to it may suffice to set the whole baffle in strong vibration, and to give rise to resonance effects.

I described some months ago the making of a little wooden stool in-

### A USEFUL SCHEME

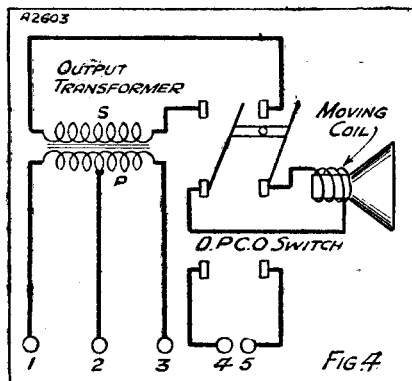

This switching scheme is intended for cases when an output transformer is included inside a receiver, and it is desired occasionally to use the loud speaker (moving-coil type) with another set.

tended to stand upon a horizontal base attached to the baffle and supporting the driving unit. This will be found a very satisfactory method.

### Baffle-Board Hints

Thin wood is quite unsuitable for baffles owing to its proneness to vibrate. Do not, therefore, try to use three-ply, for this will not be found satisfactory; it is almost certain to cause a drummy effect. One of the best materials that I know is good, stout 7-ply with a veneer of oak, mahogany, walnut, teak or some other ornamental wood.

Attach your baffle board by means of brackets to a base made of 1-in. thick deal. The hole in the baffle should on no account be smaller than the diameter of the mouth of the cone; too small a hole in the baffle leads to a loss of bass. Between the legs of the stool and the baseboard place a shock-absorbing mat of several folds of thick material or of rubber.

Don't bring your driving unit so close up to the back of the baseboard

that the supporting ring of the chassis touches the wood. Either glue a ring of felt to the back of the baffle to act as a buffer or place the unit so that the ring is about  $\frac{1}{8}$  in. from the wood.

### Universal Mounting

One problem that confronts the experimenter or the man who wants to try out different kinds of sets and different kinds of valves with the same loud speaker is what to do about the input transformer. To mount this transformer on the base of the driving unit is satisfactory enough so long as you are always going to use a set with no built-in output transformer of its own, and so long as the last valve in the set is always one that suits the transformer attached to the loud speaker.

But what is to happen if you want to try out a set which contains an output transformer of its own, or if you want to use a pentode valve when the transformer attached to the loud speaker is one adapted for power valves only? To overcome these difficulties, I recently made up a universal mounting for one of my moving-coil loud speakers, which has proved so handy that details may be of interest to readers.

### A Simple Arrangement

Fig. 4 shows a simple arrangement which will be found useful by those who use only one kind of transformer with the loud speaker. In any convenient place is arranged a small panel containing a double-pole change-over switch and either four or five terminals—three for the transformer primary connections, if it is tapped, or two if it is not, and two for connection to one pair of the switch contacts.

The connections from the moving coil of the loud speaker are taken to the arms of the switch, one pair of the fixed switch contacts being connected to the transformer secondary, and the other pair, as I have already said, to terminals. Now suppose that the set that you want to use has a suitable transformer of its own; simply turn down the arms of the D.P.C.O. switch, if arranged as shown in the drawing, and connect the loud-speaker leads to terminals 4 and 5.

With a set that has no transformer of its own, turn the arms of the switch up and connect the loud-speaker leads to terminals 1 and 2, 2 and 3, or 1 and

3, according to the impedance of the output valve.

### For S.P. or Pentode Valves

Details of a more ambitious arrangement are given in Fig. 5. Here two transformers are used, one suitable for super-power valves and the other for pentodes. The little connection panel has again a double-pole change-over switch, and this time the number of terminals required varies from six to eight, according to whether the transformer primaries are tapped or not.

The moving-coil connections go both to the arms of the switch and to the "direct" terminals, Nos. 4 and 5. One pair of fixed contacts is connected to the secondary of the super-power transformer and the other pair to that of the pentode transformer.

With this arrangement, one and the same loud speaker can be used with practically any kind of set, and the necessary connections can be made in a moment. If, for example, you want

### POWER OR PENTODE

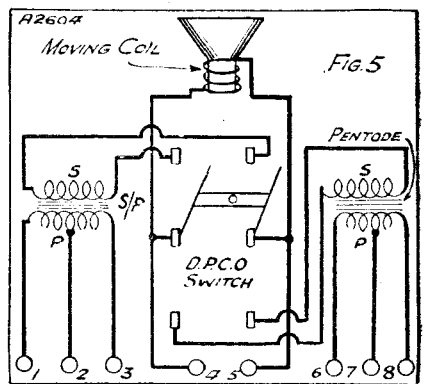

Here is another switching arrangement similar to that shown in Fig. 4, but in this case two output transformers are provided, so that the speaker may be employed on sets employing either a power or pentode output valve.

to work the speaker from a set containing a pentode valve, but without an output transformer of its own, simply turn the switch down (assuming that it is placed as shown in the drawing) and connect the loud-speaker leads to terminals Nos. 6 and 7, or 7 and 8, or 6 and 8, according to the impedance of the pentode.

Either this arrangement or the simpler one described in the previous paragraph is very easy to make up. Which ever is adopted, it will be found to save a great deal of time.

# for the S.T.300

# USE Specified COMPONENTS!

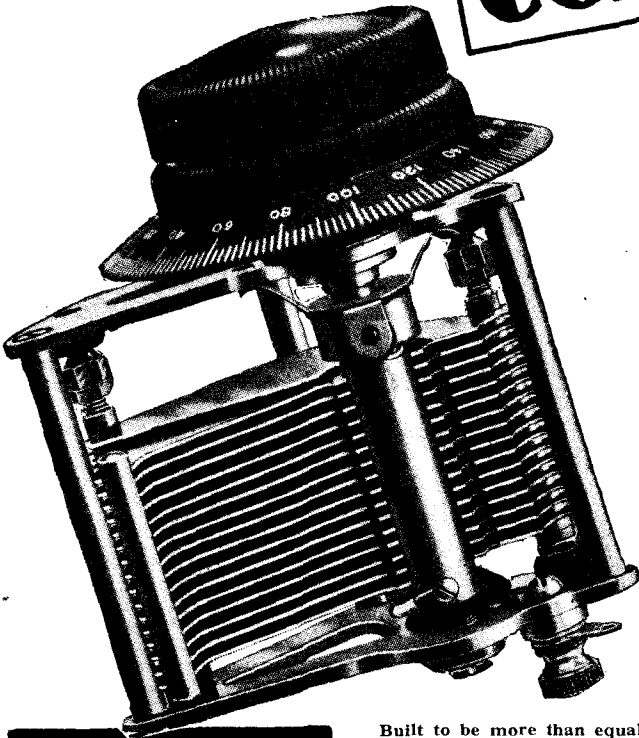

**ORMOND**  
**No 6**  
*Slow motion*  
**CONDENSERS**

Built to be more than equal to the most exacting job, this component has won the approval of experts and amateurs alike. Only under the name of Ormond is such quality allied with such low price, as to offer incomparable value. This Ormond condenser is constructed of brass and is very robust. The vanes are perfectly rigid, being firmly secured to slotted spindles. Dielectric losses are reduced to a minimum by the special mounting of the moving vanes' support. The moving vanes are connected to the frame, thus eliminating stray capacity effects.

A slow-motion device, ratio approximately 9 to 1, is incorporated in the condenser and is controlled by the upper small knob, direct drive being obtained on the dial, which is engraved 0 to 180 degrees.

Easy to mount, "one-hole" fixing. Terminals and soldering tags for connections. Complete with 2½-in. dial and slow-motion control knob.

Catalogue No.	Capacity	Price
R/484	·00025	6/6
R/485	·00035	6/6
R/486	·0005	6/6

The  
**ORMOND ENGINEERING**  
**COMPANY LIMITED,**  
 Ormond House,  
 Rosebery Avenue,  
 London, E.C.1.

Telephone: Clerkenwell  
 5334 5-6 and 9344 5-6.  
 Telegrams: Ormondengi  
 Isling.



## Get the best for perfect reproduction

*The* **ORMOND**  
**No 3**  
**LOUDSPEAKER**  
**UNIT**

With such a receiver as the S.T.300 you will want a speaker that will do it justice. Incorporate this famous Ormond unit, and enjoy perfect reproduction at a price amazingly low.

A Cobalt magnet is incorporated and the working parts are enclosed in a beautifully finished bakelite cover of Walnut colour. It is easily mounted in a cabinet or chassis, only two screws being required. An adjustment is fitted in a readily accessible position. Cat. No. R.463.

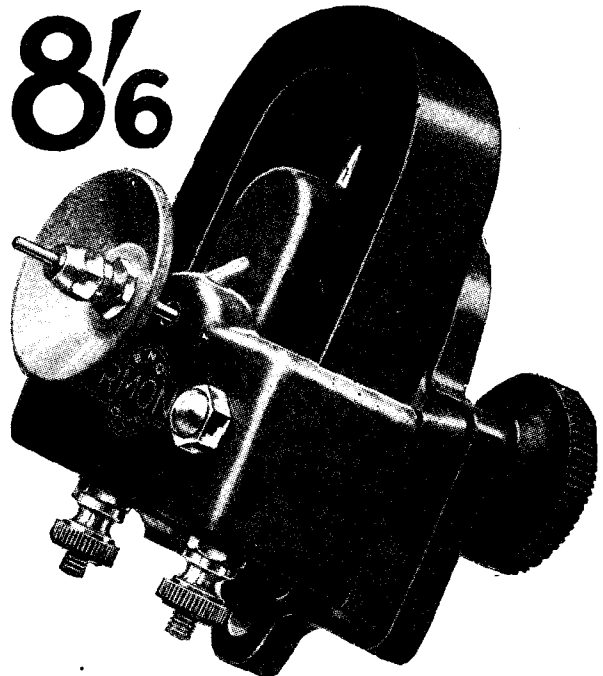

**FOR PUNCH, POWER & PURITY**

# SHALL I DESIGN A PORTABLE?



THE portable has been immensely popular. I say "has been" because I do not think this type of receiver is as greatly in demand these days as it was a year ago.

Now why was it so popular? Not, I venture to suggest, because of its portability in the widest sense of the word.

## Not Seen Out-of-Doors

Surely if it had been we should have seen portables on every seaside beach, in every park, on every common, and in every picnickers' forest glade, for it is an indisputable fact that tens of thousands of portables were sold during 1930 and in the early months of 1931.

And yet I cannot remember seeing more than two or three in the whole of my holidayings at the seaside or in the country.

Yet I came across quite a few portable gramophones. And I find that the majority of my friends have had similar experiences. I believe that only a very small percentage of portables were bought to carry into the "wide, open spaces."

But they provided escape from the inartistic "fixed" types with their external batteries and speakers and untidy wires and aerial and earths.

And when the console type of arrangement was developed, this at once began to displace the portable as the public's first favourite.

## "Self-Contained" Sets

The call was still for "self-contained" sets, but not necessarily sets disguised as attaché cases.

A certain measure of proof of this is afforded by the continued prosperity of those portable set manufacturers who made their portables more in the form of very compact console receivers.

You know the sort of design I mean. A handsome polished wooden cabinet with a discreetly concealed handle is provided. It looks quite a handsome affair when standing on a dining-room table.

Nevertheless, it is perfectly transportable and often has a stout fabric envelope which can be slipped over it in order that the pristine polish of its woodwork can be preserved during its travels.

To call it a portable is a polite fiction, for its owners never take it with them on their daily outings or annual holidays and hardly ever shift it from room to room in the house.

## ARE YOU LOOKING OUT FOR ONE TO BUILD?—

Our famous contributor raises an interesting and important question in this very readable article, and asks your co-operation in the shape of a postcard vote. So if you want a good portable design in an early number of "The Wireless Constructor," now's your chance!

But it is tidily "all in," and there are no external fittings or wires to offend housewifely eyes!

## Attaché-Case Style

On the other side of the picture are those firms who pinned their faith in portability pure and simple and encased their products in leather attaché cases. A few may still be doing good business, but others have faded away in the direction of Carey Street.

Of course, it is always possible that portables sold mainly on their "novelty" value. After all, the public was not properly introduced to radio until a few years ago, and a case that could be picked up and carried about with grand opera and the voices of eminent men issuing from it was bound to strike great wonderment and awe into the breast of the layman.

Does all this apply to the constructor? I ask that question, for I fancy there has been just as much decline in interest in this particular type of set among constructors.

My own postbag used to contain a goodly proportion of letters dealing with portable sets, but nowadays I do not get one a month.

And yet . . . And yet I may be misreading the whole situation. The decline in interest, especially among constructors, may be due to the fact that they have not encountered any portable set designs during the past year which have attracted them.

## What Do You Think?

I would most heartily welcome correspondence on this subject, and I can assure those readers who may be so good as to oblige me in this matter that I will pass their letters on to my colleagues after I have read them.

If there is a wide appeal for more portables I will at once get to work on the development of some new ideas I have in this direction. But I do not feel inclined to spend the long time which will be needed for this unless there is some evidence forthcoming that the work will not be wasted.

Not that I would mind the work, but, you see, there is so much else to

do in other directions. Hundreds of readers have asked for certain types of sets, and the production of these will give me plenty to do quite apart from certain lines of original research which must be pursued.

Nevertheless, if you want a 1932 "Vi-King" portable I'll give you one, and I'll have the temerity to say that it will be a good one, not a standard circuit squashed into a box! Let me have your vote on a postcard, c/o the Editor, and you will earn the honest gratitude of all my colleagues as well as myself.

THE JUNE ISSUE OF  
"THE WIRELESS CONSTRUCTOR"

will be on sale on

WHIT-SATURDAY

May 14th.

Price 6d.

# THE world's most ECONOMICAL BATTERY

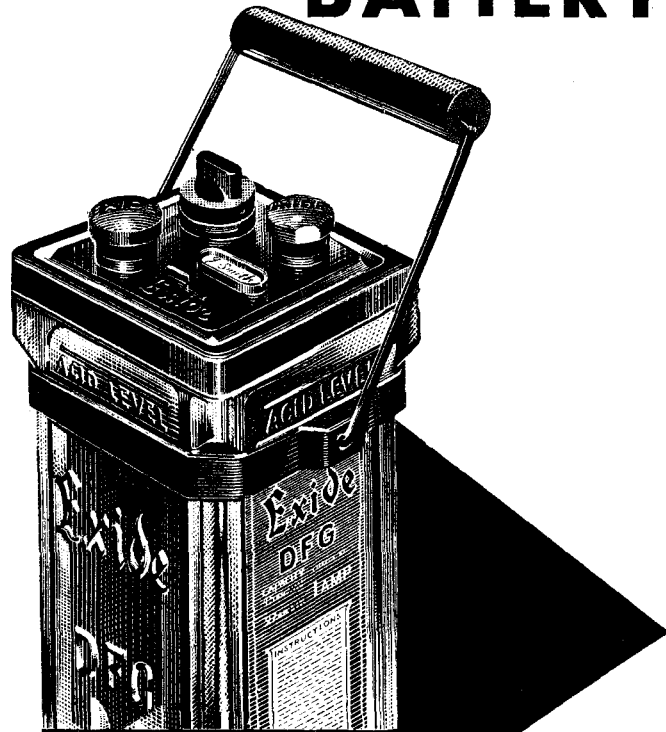

# Exide

"D" TYPE FOR WIRELESS L.T.

The Exide "D" Type Low Tension Battery for slow discharge will save you in first cost and save you in recharging. Size for size it costs less to buy than any battery made.

**PRICES PER 2-VOLT CELL** • DTG - 20 amp. hours - 4/6  
DFG - 45 amp. hours - 8/6 • DMG - 70 amp. hours 11/-  
DHG - 100 amp. hours - 14/6. *These prices do not apply in the Irish Free State.*

From Exide Service Stations or any reputable dealer.  
Exide Service Stations give service on every make of battery.

Exide Batteries, Exide Works, Clifton Junction, near Manchester.  
Branches: London, Manchester, Birmingham, Bristol, Glasgow, Dublin, Belfast

N 80

# DUBILIER IS THE NAME OF THE CONDENSER YOU CAN TRUST

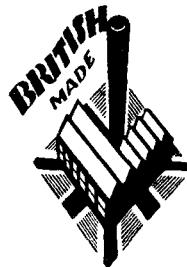
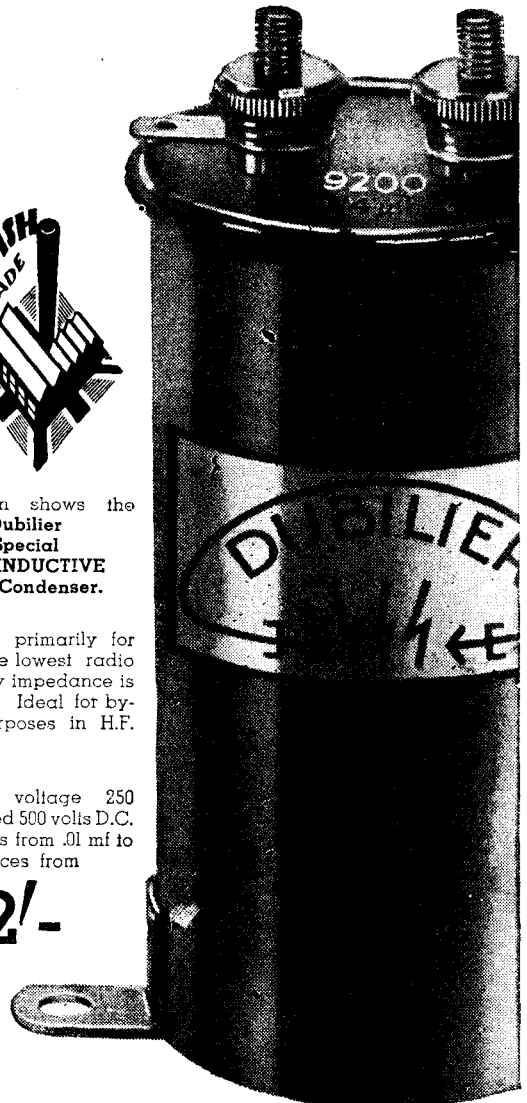

Illustration shows the  
Dubilier  
Special  
NON-INDUCTIVE  
Type Condenser.

Designed primarily for use where lowest radio frequency impedance is required. Ideal for by-pass purposes in H.F. circuits.

Working voltage 250 D.C., tested 500 volts D.C.  
Capacities from .01 mf to 2 mf. Prices from

**2/-**



B3

**DUBILIER CONDENSER CO. (1925) LTD.**  
Ducon Works, Victoria Road, North Acton, W.3



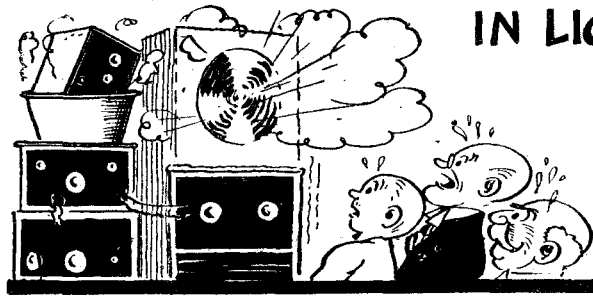

IN LIGHTER VEIN

# The GOOP-WAYFARER EXTERMINATOR

By "WAYFARER"

"\*\*\*!!!\$\$%@@???" bellowed the Professor.

"What's wrong?" I inquired.

"It won't work!"

"Why not?"

"You pop-eyed, lop-eared, fat-headed, blithering idiot, if I knew *why* it wouldn't work I could *make* it work! Stop asking silly questions."

### The Latest Thing in Radio!

And the Professor got down to it again. Need I say that he had just finished building the very latest thing in wireless sets, and that, as is so often the case when great minds evolve things, there appeared to be just a tiny hitch somewhere? Nothing seriously wrong, of course. The only trouble was that not a sound would come from the loud speaker.

"Try changing the valves," I suggested.

"I have changed 'em, every blessed one!"

"The coils?"

"Changed those, too."

"Variable condensers?"

"Yes, done that."

"Resistances?"

### QUICK SHOOTING



"You have hardly had time to see him reach down for it before the thing has whizzed past your ear!"

"Yes, they have been changed, and the valve holders and the fixed condensers and the L.F. transformers and the chokes—in fact, every single part. I've even re-wired the whole blessed thing!"

"Ah, ha!" I said. "I have got it. There is one thing you haven't changed."

"What's that?"

"The terminals."

You have often read in cowboy books about fellows who are quick on the draw. When they flash their guns,

if you remember, their hands move so quickly that the eye can't follow them. Well, I don't think that the most skilled of wild and woolly Westerners can hold a candle to the Professor when it comes to quick shooting. His weapon is not a gun.

It is generally a high-tension battery, a power transformer or the works of a moving-coil loud speaker. You have hardly time to see him reach down for it before the thing has whizzed past your ear. This time it was a 60-ampere-hour accumulator cell, well and truly flung.

### Full in the Face

Had my dodge been less rapid than the Professor's heave I should not be here now to tell the tale. As it was, I removed my face just in time from its path and it met that of a grandfather clock in the corner instead.

This seemed to relieve the Professor's feelings quite a bit. You know, if you *are* rather worked up there is nothing like smashing something. In the old days there used to be at fairs and so on a marvellous institution known as the Krazy Kitchen.

It was a stand fairly covered with huge china vases and jugs and things, and for sixpence you could have three shies with good, solid wooden balls. Many a man has been saved from committing a murder by having a couple of bobs' worth in the Krazy Kitchen, and I am sure that the world would be a much brighter and happier place if every wireless enthusiast had in his home a Krazy Kitchen room.

### An Expensive Business

Grandfather clocks, after all, are just a leetle expensive, though I must admit that they serve the purpose admirably, and that the impact of a 60-ampere-hour accumulator upon the smug face of one of them produces a crash likely to relieve the most wrought-up feelings.

"There is only one thing to do with this set," I remarked, "and that is to apply the coke-hammer."

The Professor agreed heartily. Like me, he feels that wireless apparatus is

sometimes absolutely bewitched. Every component can be right, every connection correct, the circuit as good as good can be, and yet the thing won't even howl. You can make any alterations that you like and it still won't work. Sometimes, though, the very threat of the coke-hammer has a salutary effect. I have known a silent set leap into life at the very suggestion.

### A Brain Wave!

The Professor rose slowly with the idea of proceeding forthwith to the coal cellar in search of a weapon, but when half-way across the room he paused.

"Inspiration," he yelled. "Wayfarer, my dear fellow, our fortunes are made!"

"What, again?" I sighed sadly. "They have been practically made hundreds of times, but somehow things always seem to come unstuck at the last minute. I had, you know, to part with my family plate during the recent gold rush."

"And I suppose that you've got a vulcanite one now?" smiled the Professor.

### THE GOLD RUSH

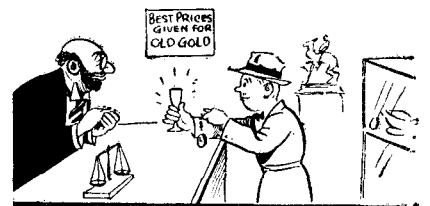

"I had to part with the family plate during the recent gold rush."

fessor. "But cheer up, my boy, all your financial worries are over. In a few weeks from now you'll think nothing of using sovereigns for the plates of your home-made fixed condensers and interleaving them with five-pound notes for dielectric!"

"Could I borrow ninepence on account?" I inquired in a shaky voice.

For answer the Professor slowly turned his trouser pockets inside out.

"Not for the moment," he replied. "You must go on taking in your belt

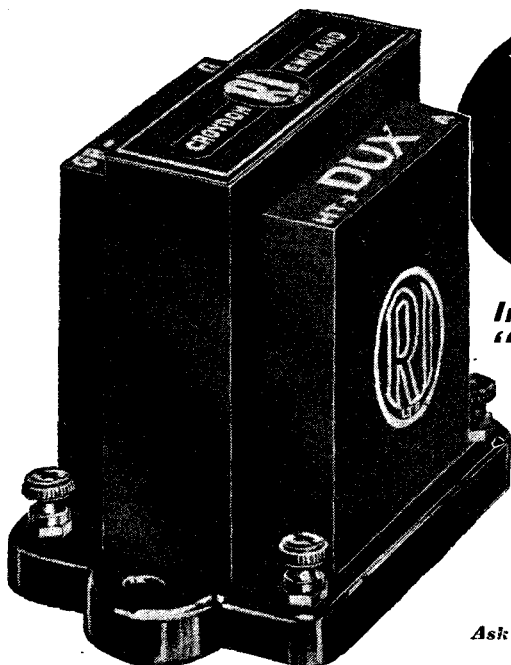

# COMPONENTS are featured in All Principal Circuits

Including "Vi-King Super,"  
"Pentode 2" and "S.T.300"

Efficiency at lowest cost is the dominating influence in circuit design to-day, hence one finds, in all principal circuits for 1932, the specification of R.I. productions, because they are designed and built first and foremost for absolute efficiency and reliability irrespective of price, yet they cost no more than ordinary components.

Ask your dealer or us for your copy of the new R.I. Catalogue.

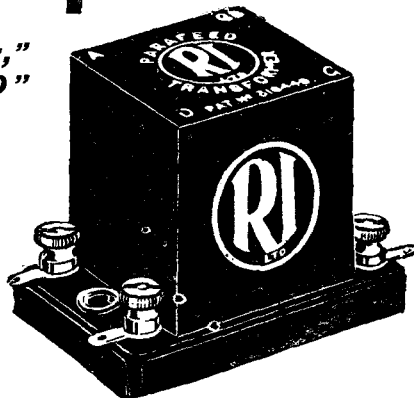

## The "DUX" TRANSFORMER Specified for the "Pentode 2"

This remarkable transformer has attained enormous popularity by virtue of its unequalled performance in hundreds of thousands of sets. It is the designer's first specification for the "Pentode 2" because it is the lowest-priced transformer that is really efficient, and gives remarkably good L.F. amplification. Inductance, 30 henries. Ratio, 1:3½ (standard), 1:4½ (auto-connection). List No. DY29.

6/9

## "PARAFEED" TRANSFORMER Specified for the A.C. "S.T.300"

For parallel-feed amplification "Parafeed" possesses advantages not equalled by any similar transformer. The amazing N.P.L. curves published are proof positive before you buy, that "Parafeed" will give the best results. Get a copy of the "Parafeed" book—it is an education in amplification. Primary inductance, 80-100 henries. Primary D.C. Resistance, 1,100 ohms. Secondary D.C. Resistance, 2,800 ohms. Ratio, 1 to 6.

8/6

Advt. of Radio Instruments, Ltd., Croydon, Surrey. 'Phone: Thornton Heath 3211.



### NEW SCREENED COIL

CORDO COILS (Provisionally Patented) are the only Coils which enable the user to have the advantage of the new balanced Band Pass Circuit chosen by Victor King to obtain 9 kilocycle separation at all wavelengths.

## SELECTED FOR USE IN THE "VI-KING" SUPER

- (1) One piece screen ensuring no loose contacts and perfect screening.
- (2) Best gauge wire is used to obtain maximum dynamic resistance.
- (3) NEW BAND PASS method giving a perfectly balanced tuned Band Pass circuit.
- (4) 9 kilocycle separation is obtained at every wavelength on both bands.

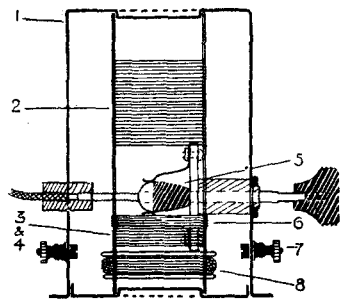

- (5) Trouble free positive action push pull switch.
- (6) Special reaction coil allowing one to obtain different degrees of reaction to suit different circuits.
- (7) Very easily accessible terminals.
- (8) Highly efficient, air spaced, Long Wave Coil.

8/6

each  
Post Free.  
17/- per pair  
including  
ganging link.

The CORDO COILS embodying the new balanced Band Pass tuned coupling can be introduced into any set with a corresponding increase of efficiency.

FOR YOUR **S.T.300** You should use the specially tested Cordo Coils. **9/6** pair

Telephone: Victoria 6873.

**CORDO ELECTRICAL PRODUCTS LTD.,**  
68, Victoria Street, London, S.W.1.

## Run your "S.T.300" from the A.C. Mains

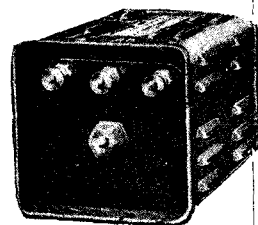

H.T.5 Metal Rectifier

If you have A.C. mains in your house, you have the perfect power for running your "S.T.300." An eliminator incorporating

### THE **WESTINGHOUSE** METAL RECTIFIER

will ensure a permanent and adequate anode supply. Most manufacturers incorporate them in their units. If, however, you prefer to build your own eliminator, and are using A.C. valves, there is a Westinghouse Metal Rectifier to meet your needs. If ordinary battery valves are being used, the H.T.5 will be suitable. It costs only 12/6, and has an output of 120 volts at 20 milliamps.

Send for our booklet, "The All-Metal Way," containing circuits and full particulars.  
**THE WESTINGHOUSE BRAKE & SAXBY SIGNAL CO., LTD.,**  
82, YORK ROAD, KING'S CROSS, LONDON, N.1.

## In Lighter Vein—continued

for a week or two yet, but at the end of that time you will be ordering ortolans at the Ritz."

"I shouldn't mind tripe at Lockharts, just to go on with," I suggested. "And two or three weeks is a long time to wait until one's next meal."

The Professor told me not to be so materially minded. What after all was mere food? One must look forward to the future and not bother about the present. The future, he assured me, was pure golden, and one hundred and twenty-six shillings an ounce at that.

### A Great Invention

"Tell me the great idea," I begged.

"This," said the Professor, "is my latest and, I need hardly say, my greatest invention."

"Every invention of yours," I murmured, "is always the latest and the greatest."

"But this one is still later and still greater than any of the others."

"And what is it?"

"The Goop Exterminator."

"Goop-Wayfarer. Are we not going to work it out together as we have always done in the past?"

"The Goop-Wayfarer Exterminator," corrected the Professor.

### BEATING BINGO!

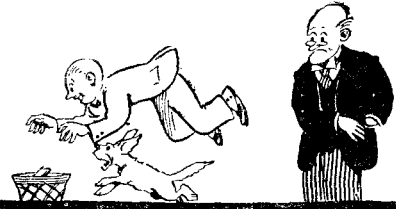

"I beat the small hound by a short head."

"Good," I said. "And now tell me something of the splendid invention that we have made? Being the co-inventor, I feel that I have a right to know something of the gadget that I have thought out with you."

"The scheme," said the Professor, "is to provide every constructor of wireless apparatus with a cheap and reliable method of annihilating any piece of apparatus of his own make which steadfastly refuses to work."

"Sounds pretty useful," I commented. "Y-e-e-s, I think I agree with you, there are distinct signs of a

and pulled out what he thought was an old envelope. He began to sketch rapidly, but as the "envelope" happened to be a distinctly second-hand sandwich he didn't get on very fast. Seeing his mistake, he flung it into the wastepaper basket. Little Bingo and I appeared to be about equally hungry, but I beat the small hound by a short head.

### An A.C. Model

A real envelope being at length forthcoming, the Professor removed from it the bill which it contained, shied this disdainfully into the fire and proceeded with his drawing.

"This," he said, "is the A.C. mains model. The apparatus to be exterminated is fed in here. By means of a step-up transformer a current at a million volts is applied to its terminals. What is left is next delivered by the conveyor belt to six high-frequency electrical hammers. The conveyor then comes into action again, taking the remains to the super-mincer, which you see here. The output is moulded into small, neat cakes which serve excellently as fuel."

"Not bad," I said, "but remember that we must appeal to the ear in order to satisfy the outraged feelings fully."

"I was coming to that," murmured the Professor, resuming his sketching. "You'll see that the apparatus incorporates a microphone and a cascade of valves, the output being through four pentodes in parallel push-pull. These feed into a special moving-coil loud speaker capable of handling half a kilowatt without distortion."

"What about the battery model?" I asked.

"That is going to be good, too," said the Professor, "but I think that we'll complete the mains model first. Come round to-morrow morning and we'll get busy."

### Strenuous Work

At the end of three strenuous days' work, during which the Professor laboured like a nigger whilst I directed operations from an armchair, the thing was complete, and very beautiful it looked. As we had used up a good many of the parts of the Professor's

making it, we had ss nature available nents in exterminator, who was at the ed with his better-utting Mrs. Goop

through the machine, but I was able to dissuade him in time.

"Let's go and give Sir K. N. Pepper a surprise," I suggested.

The Professor thought that this was a really bright idea, so off we went, pushing the Exterminator in the Microgoop's perambulator. We arrived absolutely at the psychological moment, for we found Sir K. N. just tightening down the last connection of a gigantic 10-valve super-het. Not saying a word about the Extermina-

### EXTERMINATING THE EXTERMINATOR

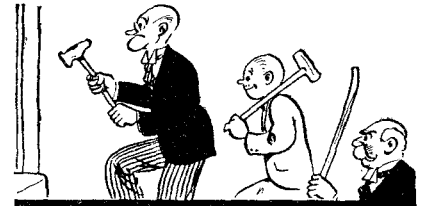

"We found two coke hammers and a crowbar . . . and I don't think I ever enjoyed anything so much!"

tor, we begged to see it tried out. The old fellow was only too pleased. Having made all the connections, he switched on. Immediately one valve spouted blue flames and died.

"Tut, tut!" (or words to that effect) said Sir K. N. "A small defect somewhere." He altered one lead and switched on again. Every light in the house went out as the main fuse blew. We replaced this, and tried again.

### The First Test

By the time that he had done in all his valves, burnt out two transformers and had had several nasty shocks, Sir K. N. was, we judged, exactly in the right frame of mind to be an enthusiastic collaborator in our first test. We brought in and installed the Exterminator, after explaining its purpose to him. It swallowed that ten-valve super-het as a python swallows a rabbit. An appalling din proceeded from the loud speaker. Over Sir K. N. Pepper's congested countenance there gradually dawned a beatific smile.

"Oh, beautiful!" he chortled. "Oh, perfect. Hullo, what's happened?"

The Exterminator had suddenly ceased to work.

In Sir K. N.'s coal cellar we found two coke hammers and a crowbar. I don't think I have ever enjoyed anything so much as the extermination of the Exterminator.

# WIRELESS WOODWORK

By REGINALD TEECE

*Some useful tips, which include the making of a handy tool and hints on keeping chisels in good trim.*

THE scraper is a most handy little tool. It saves a good deal of time and will almost halve your expenditure on glass-paper, except for the fine grades, for finishing. Although simple to make, and materially only a small piece of steel, it will remove large shavings in a most satisfactory and delightful manner.

## AN IMPORTANT OPERATION

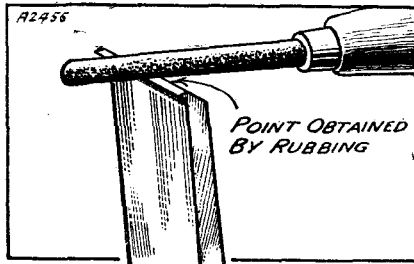

Two or three rubs with a round piece of steel will be sufficient to put on a good cutting edge.

Obtain a piece of steel (not too hard) about 4 in. by 2 in. A piece of an old saw will serve the purpose. Decide on which edge you intend to sharpen, and see to it that this edge is dead true. With a file carefully cut a good bevel on one side, making it about 45 degrees inclination to the edge.

## Turning the Edge

After you have done this you will find that the opposite side to the bevel is ragged. Lay the scraper with this ragged edge downwards on an oilstone and carefully true it up—the scraper must be kept flat on the stone during the removal of the wire edge.

With another piece of steel, round if possible, rub the extreme point of the scraper in such a manner as to

## HOW IT WORKS

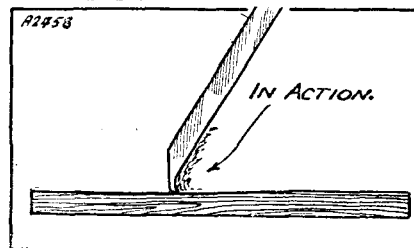

This diagram shows how the tool cuts when in action.

cause a "flat top" to the edge. Two or three careful strokes are quite sufficient. If you now scrape your thumb nail against the edge opposite to the bevel you will find that you have turned the edge over—this is the real cutting edge of the tool.

Do not imagine that the scraper can be sharpened by the use of the file, this is used for cutting the bevel only, and you *must* remove the wire edge most carefully afterwards as this edge has no cutting properties whatever. It is the final rubbing of the edge with the piece of round steel that makes the tool cut.

## Renewing the Edge

After a while you will find that the edge gets dull, but all you need do to resharpen is remove the "burr" on the oilstone, and simply repeat the rubbing process. In use the scraper is held firmly in both hands and drawn along the wood, towards the operator—a little pressure is needed to make it cut.

When you get used to sharpening and using the tool you will find it an easy matter to remove large shavings, and, strange to say, the harder the wood on which you are working, the better the tool cuts. The tool is used

## GRINDING CHISELS

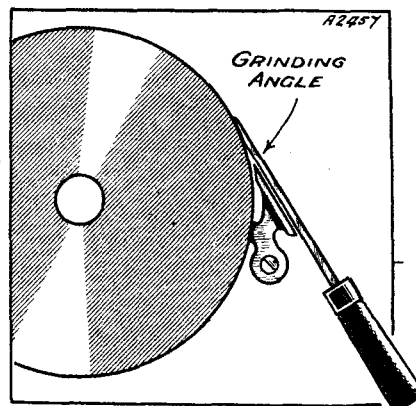

When grinding chisels keep the angle of the bevel at about 30 degrees.

for removing plane marks from the wood and truing up the surface, etc.

If you find it necessary to drive panel pins into delicate moulding or other small pieces of wood, before you start turn the nail, head down, on to

a piece of metal and tap the extreme point with the hammer. It is only necessary to strike it once, and lightly, so as to make the point slightly flat. You can now drive it into the wood as near to the end as you like, and it will *not* split.

## Handy for Sawing

The bench-hook illustrated on this page is a handy little device for the woodworker. It is best made out of stuff about 12 in. by 8 in. by 1 in. and two cleats screwed on to each end as

## FINISHING OFF

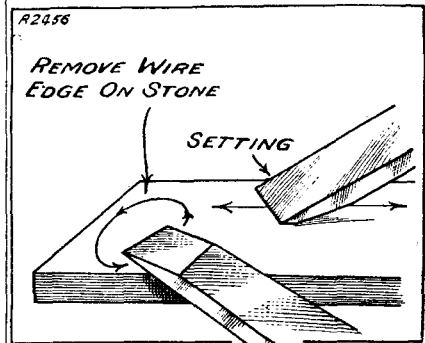

Here you see how to hold a chisel on the oilstone when setting, and also when removing the wire edge.

shown. These cleats want to be about 1½ in. thick. A useful addition to this hook would be to fix a spike in one of the cleats as shown, so as to help in preventing it from moving out of place on the bench.

Always keep the bevel on your chisels to an angle of 30 degrees. This

## A BENCH-HOOK

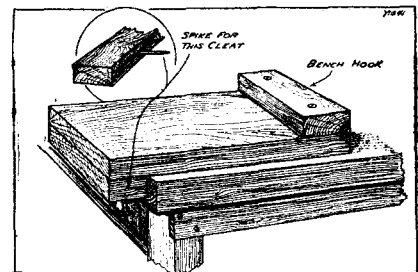

This useful bench-hook is very easily made, and one should be in the possession of every woodworker.

must be carried out on a grindstone or similar device, which can be had for a few shillings nowadays.

After you have cut the bevel to the required angle you will have to set the tool on an oilstone. The setting angle only needs to be quite short, and the back of the chisel is then rubbed on the stone in order to remove the wire edge.

This last process *must* be carried out with a circular motion, with the blade perfectly flat on the stone.

## WHERE TO SEE THE "S.T. 300"

Here is the first list of "The Wireless Constructor" official exhibitors. Visit your local radio retailer and ask for a demonstration

- LONDON.  
John Braham,  
194-200, Bishopsgate, E.C.  
Real Radio Service,  
61, Cannon Street, E.C.4.  
E. O. Ellis,  
15, The Village, OLD CHARLTON, S.E.7.  
M. Kams & Co.,  
9, High Street, PUTNEY, S.W.15.  
J. Collier & Sons, Ltd.,  
53-57, High Street, PECKHAM, S.E.15.  
G. Goodwin,  
6A, The Broadway, WOOD GREEN, N.  
T. M. Barbour,  
24, Knights Hill, S.E.27.  
F. Galt,  
56, Norbury Road, THORNTON HEATH, S.W.  
Bush Radio Stores,  
184, Railway Approach, W.2,  
and  
7, Fulham Palace Road, W.  
Morgan & Gamut,  
25A, Montpelier Vale, S.E.3.  
The Woolwich Radio Supplies,  
22, New Road, WOOLWICH, S.E.  
F. Mace & Sons,  
15A, Delacourt Road, BLACKHEATH, S.E.3.  
W. A. Andrews,  
13, Burnt Ash Hill, LEE, S.E.12.  
H. C. Fieldhouse,  
95, Valentine Road, WOOD STREET, E.17.  
Alexander & Sons, Ltd.,  
130, Clapham Road, S.W.9.  
Saville Radio Company,  
19, Saville Place, S.E.11.  
H. A. Wireless,  
139, Bethnal Green Road, E.2.  
Empress Radio,  
680, High Road, TOTTENHAM, N.  
Hackney Wireless Supplies,  
614, High Road, TOTTENHAM, N.  
G. Stern,  
115, Fleet Street, E.C.4.  
H. A. Wireless,  
13, Hackney Road, SHOREDITCH, E.2.  
Wal's Radio Stores,  
65, Cadogan Terrace, VICTORIA PARK, E.9.  
James & Williams,  
31, Queen's Road, BATTERSEA, S.W.8.  
J. J. Vertue,  
25A, Brighton Road, SOUTH CROYDON.  
R. Silverstone, Ltd.,  
186, High Street, CAMDEN TOWN, N.W.  
Angel Radio Supplies,  
428, St. John's Street, ISLINGTON, N.  
V. Zeitlin & Sons, Ltd.,  
144, Theobalds Road, W.C.  
Maxims Stores, Ltd.,  
7A, Tothill Street, S.W.1.  
H. Mozer,  
111, High Street, STOKE NEWINGTON, N.16.  
E. Spelle,  
14, Lancaster Street, HYDE PARK, W.2.
- ACCRINGTON.  
G. V. Stephenson & Sons,  
31, Blackburn Road, ACCRINGTON.
- BACUP.  
J. J. Holden,  
25, St. James' Street, BACUP.
- BELFAST.  
W. Houston (Everay Service Co.),  
10, Newtownards Road, BELFAST.  
The Wireless & Electric Co.,  
32, Dublin Road, BELFAST.
- BERWICK-ON-TWEED.  
Knox Bros.,  
25, Bridge Street, BERWICK-ON-TWEED.
- BEXLEYHEATH.  
Bexleyheath Electric Co.,  
191, Broadway, BEXLEYHEATH.
- BICKLEY.  
Richardson & Whittaker,  
Bickley Station, BICKLEY.
- BIRMINGHAM.  
F. W. Beeby,  
25, Winson Green Road, BIRMINGHAM.  
Bayricks Radio Stores,  
2, Hamstead Road, Handsworth, BIRMINGHAM.

BRIDGWATER.  
Whitty's Music & Radio Stores,  
1, Cornhill, BRIDGWATER.

BRISTOL.  
Hamblyn, H. E.,  
39-40, Bridge Street, BRISTOL.

BROWNHILLS.  
Everson's Radio Depot,  
93-95, High Street, BROWNHILLS, STAFFS.

CAMBRIDGE.  
W. P. Webb,  
188, Mill Road, CAMBRIDGE.  
W. K. Islip,  
42, Chesterton Road, CAMBRIDGE.  
Baily, Grundy & Barrett, Ltd.,  
2, St. Mary's Passage, CAMBRIDGE.

CASTLE HEDINGHAM.  
G. H. Sylvester,  
Wireless Dealer, CASTLE HEDINGHAM,  
ESSEX.

CHELMSFORD.  
Flexman Bros.,  
44, New Street, CHELMSFORD.

CHESTERFIELD.  
H. E. Drabble,  
High Street, Staveley, nr. CHESTERFIELD.

COLCHESTER.  
F. W. Straw,  
9, St. John's Street, COLCHESTER.

COVENTRY.  
H. J. Cleaver,  
112, Spon Street, COVENTRY.

COWES.  
J. A. Attrill,  
Birmingham Road, COWES, I. of W.

DARTFORD.  
S. N. Hammond & Son,  
62, Lowfield Street, DARTFORD.

DARWEN.  
J. E. Loynds & Co.,  
204, Duckworth Street, DARWEN.

DONCASTER.  
Brook Harcastle, Ltd.,  
21, Cleveland Street, DONCASTER.

DOWNHAM.  
R. S. Ewell,  
Nordolph, DOWNHAM, NORFOLK.

DUNDEE.  
Clydesdale Supply Co.,  
13, Crichton Street, DUNDEE.

DUNFERMLINE.  
Clydesdale Supply Co., Ltd.,  
137, High Street, DUNFERMLINE.

DURHAM.  
G. R. Thomas,  
6A, Grant Street, JARROW, DURHAM.

EDINBURGH.  
Clydesdale Supply Co.,  
5, Lindsay Place, EDINBURGH.  
and  
66, South Bridge, EDINBURGH.

GLOSSOP.  
L. P. Penny,  
65, High Street West, GLOSSOP.

GLASGOW.  
Clydesdale Supply Co., Ltd.,  
2, Bridge Street, GLASGOW,  
and  
63, Renfield Street, GLASGOW,  
and  
160, Sauchiehall Street, GLASGOW.

GAINSBOROUGH.  
H. E. Cobb,  
10-14, Hickman Street, GAINSBOROUGH.

GRAYS.  
T. H. Grylls,  
Electra House, Clarence Road, GRAYS.

GRIMSBY.  
The Electrical Service Co.,  
323, Cleethorpes Road, GRIMSBY.

HAYES.  
Spratley Bros.,  
Station Road, HAYES, MIDDLESEX.

HILLINGDON.  
A. H. Lawton,  
Field Heath Road, HILLINGDON.

HITCHIN.  
H. Shadbolt,  
6, Tilehouse Street, HITCHIN.

HOYLAND.  
A. Bircher,  
King's Street, HOYLAND.

IPSWICH.  
Boddey Page & Co.,  
16, St. Margaret's Green, IPSWICH.

LEWES.  
E. Goldsmith,  
19, The Cliffe, LEWES, SUSSEX.

LONGSIGHT.  
S. Abbott,  
519, Stockport Road, LONGSIGHT.

MANSFIELD.  
J. Jennings & Sons,  
High Street, MANSFIELD WOODHOUSE.

NELSON.  
F. Delun & Co.,  
3-5, Prospect Buildings, NELSON, LANCAS.

NEWCASTLE.  
W. Emerson,  
255, Westgate Road, NEWCASTLE.  
John Mills & Sons,  
63, Grainger Street, NEWCASTLE

NEWPORT.  
Newport Electrical Co.,  
3, Dock Street, NEWPORT.

OLDHAM.  
F. Fryer,  
141, King's Street, OLDHAM.

Another list of exhibitors of the "S.T. 300" receiver will appear in our next issue.

## THE "HAPPY" TRADE

STRIKING testimony to the vitality of Britain's newest industry is provided by the review of the radio business in 1931, just published by the wireless trade journal, "The Wireless and Gramophone Trader." The statistics supplied show that the gross turnover advanced by 50 per cent during the year, the figure for 1930 of £20,000,000 yielding to one of £29,750,000 last year.

The figures are compiled with the co-operation of the General Post Office, which records the issue of listeners' licences, and of manufacturers, who provided details of their own production.

### A Bright Future

The Post Office figures show that 900,000 new licences were issued during the year, while the statistical survey in question discloses that of a total of 1,250,000 receivers sold during the period, 600,000 were bought by new listeners, while 650,000 were sold as replacements to existing owners; the balance being made up of "reformed pirates," home constructors, and users of coupon gift sets.

A market for not less than 1,800,000 new sets is forecast for the present year, and it is clearly demonstrated that radio, with only half of the potential market yet filled, can look forward to still greater progress in 1932.



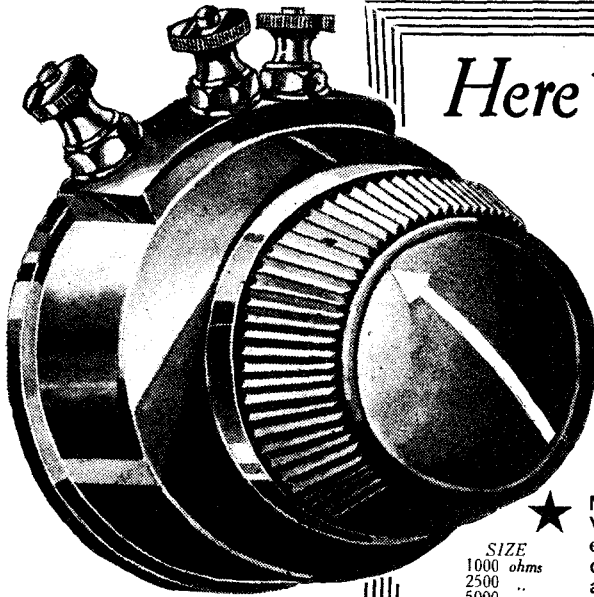

Here's a  
**WIRE-WOUND  
VOLUME  
CONTROL**  
for every type of modern set

**5/6**  
all sizes.

★ Write for descriptive leaflet No. J.1175

SIZE	
1000 ohms	..
2500 ..	..
5000 ..	..
10000 ..	..
25000 ..	..
50000 ..	..
CURRENT CARRYING CAPACITY	
55 Milliamps	..
35 ..	..
25 ..	..
18 ..	..
11 ..	..
8 ..	..

★ Make sure you specify IGRANIC when you buy a Wire-Wound Volume Control. Note these exceptional points: Smooth contact ensuring silent operation. Resistance wire wound on high-quality insulating former. Moulded Bakelite case, neat and attractive, to protect winding from mechanical damage. Definite travel stops. Single-hole fixing and two insulating washers supplied for mounting resistance on metal panel. Pointer control knob. Igranitic workmanship. Igranitic perfection. What more!



IGRANIC ELECTRIC CO., LTD., 149, QUEEN VICTORIA STREET, LONDON

**YOU'LL NEED THESE  
WEARITE COMPONENTS**  
for your "VICTOR KING SUPER"

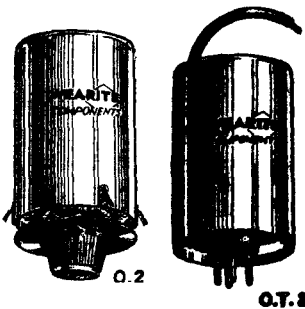

- Wearite "Super-Het" Coils
- One Type O2 Oscillator Price 18/6
- Two Type OT2 Band filter Price 10/6 each
- One 50,000-ohm. Potentiometer Type Q35 (wire wound) Price 4/-
- One H.F. Choke Type H.F.S. - - - Price 6/6
- One Three-Point on-off switch Type G23 - - - Price 1/6
- Seven Four-Pin Valve holders Type S1 - - - Price 1/3 each

and for your "PENTODE TWO"

- One P.J.3 Coil (Guaranteed to specification) Price - - - - - 7/6
- Three "Quoit Coil" Formers - Price 6d. each
- One H.F. Choke Type H.F.S. - - Price 6/6
- One 3-point wave-change Switch, Type G.23 Price 1/6

- One 4 and One 5-Pin Valve holders Type S1 - - - - 1/3 each
- One 400-ohm Potentiometer complete with baseboard Bracket (Q 13) - - - - - Price 2/9

Write for applicable leaflet which gives full particulars.

**WEARITE**  
COMPONENTS

WRIGHT & WEAIRE LTD.,  
740, HIGH ROAD,  
TOTTENHAM, N.17.  
Telephone: Tottenham 3847/8/9.

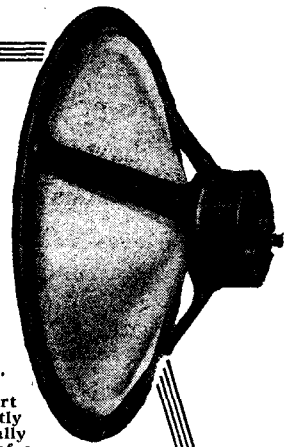

R & A Reproducers, as the name implies, are something more than "loud speakers." They are designed to reproduce speech and music with a fidelity as closely resembling the original performance as is possible in the present stage of development.

As the "Wireless World" Test Report on the "R & A Type 40" so aptly states, "Speech is exceptionally good . . . Bears all the marks of a thoroughbred. . . It stands in a class by itself."

You will appreciate the reproduction of speech and music with an "R & A"—the purity and truth, the volume, the clarity—qualities for which the R. & A. are so well known. Your dealer can supply you. The R & A Type 40, illustrated, is more than moderately priced at sixteen shillings and sixpence.

Write for Descriptive Literature.  
REPRODUCERS & AMPLIFIERS Ltd.,  
FREDERICK ST., WOLVERHAMPTON.

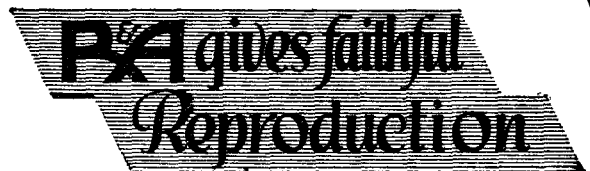

# TUNEWELL

Coils & Components  
for the

## S.T. 300 For Batteries or AC Mains



Note the new super-efficient low-loss formers, which ensure minimum dielectric loss and consequent gain in range and signal strength.

Anode Coil with neat mounting bracket, one screw fitting.

TUNEWELL  
COILS

**9'6 per pair**

- Tunewell H.F. Choke - 6/6
- Tunewell Spaghetti Resistances:  
All sizes 9d. to 2/- each.
- Tunewell 3-point Switch - 1/3

# TUNEWELL

Components for the

## VI-KING SUPER

described in this issue

- \*Tunewell H.F. Choke - 6/6
- Tunewell Eliminator:  
For D.C. Mains, D.C.150/20

**£2-5-0**

- For A.C. Mains, F.V.150/30 - **£5**

\*This H.F. Choke is also suitable for the "PENTODE" TWO, described in this issue.

**FREE!** Tunewell illustrated Guide to New Super Radio. Not merely a catalogue—it shows how everyone can have better radio at less cost. Eight Blue Prints of new circuits including Kit Eliminator. Write to-day for a free copy, giving name and address of your nearest radio dealer.

**TURNER & CO.**

54, Station Road, London, N.11.

# TUNEWELL



a time inevitably when the public will not stand for it, and licence figures will drop.

### Money Owing

Although it has been pointed out that, after making allowance for the sacrifice of £150,000, the B.B.C. will receive £149,000 more than last year, those critics who maintain that the steady increase of licence revenue should enable the B.B.C. to make a bigger contribution seem to forget that whatever other faults the B.B.C. may have they do believe in progress and expansion. Furthermore, there is still a lot of money owing in connection with the various technical improvements made by the B.B.C.—Regional Schemes, etc., certainly cost money.

### Rachmaninoff's Radio Views

THAT famous composer, Rachmaninoff, was in London a few weeks ago, and in an interview with a reporter again expressed the idea that broadcasting is bad for art. Rachmaninoff hates broadcasting because "nothing can convince me that the result is pure art." The famous composer of the Prelude in C Sharp Minor also fears that the world is losing interest in music and art.

### Strange Views

Well, everybody is entitled to their opinion, but it seems strange that such a famous man as Rachmaninoff—who, by the way, has no objection to making gramophone records—should hold such strange views about broadcasting to-day.

### Has He a Good Set?

There are very few famous pianists in the world to-day who have not at one time or another made their debut before the microphone. Even Paderewski, the doyen of them all, once broadcast a recital from the old 2 L.O. Perhaps Rachmaninoff has not kept abreast of the times by buying himself a really good set and a good loud speaker. If he had, we feel sure he would not be so down on broadcasting.

### The B.B.C.'s Bit

What with offering £50,000 to the Exchequer as an additional contribution for the year just ending, and £150,000 for the twelve months about to begin, the B.B.C. has certainly done a reasonable share in helping towards the alleviation of the National emergency.

Readers will remember that the May Economy Committee decided that £475,000 a year more could be provided by the B.B.C. without any deterioration in the quality of the broadcast programmes.

We are glad the B.B.C. disagreed on this point, for if the programmes deteriorate any more there will come

### JUST A REMINDER

Have you ever thought how difficult it is for a newsagent to order just the right number of copies of any particular paper each month?

You can make his task much easier if you place a regular order with him. You will not only help him to order correctly and avoid waste, but you will make sure of getting your copy regularly each month.

### The "Hazard" Series

It was a good idea of the B.B.C. to follow up the "Escape" talks by a new series entitled "Hazard." These talks will be given by men whose lives bring them, or have brought them, into great danger. One of the chief speakers in this new series will be Rear-Admiral E. R. G. R. Evans, the famous Evans of the "Broke," who fought the great destroyer action in the Channel, and who was a member of Captain Scott's South Pole expedition. We understand this new series will commence early in the summer.

### Opera from Abroad

The B.B.C. is contemplating in auguring a regular broadcast of operas from the main theatres on the Continent when technical conditions permit. It is chiefly a question of suitable telephone landline facilities,

(Continued on page 52.)

# A FAMOUS PATENT EXPIRES

*After an exciting life of sixteen years, the well-known "eliminator" patent has expired. In this striking account our special correspondent recounts how the owners applied, though unsuccessfully, for an extension of time in which to exploit this clever invention.*

THE well-known eliminator patent No. 148,129, owned by the British Thomson-Houston Co., Ltd., and covering the "smoothing" circuit used when energising a wireless receiver or gramophone amplifier from the mains, is no longer in force. This is the result of a decision given by Mr. Justice Luxmoore in the High Court on December 8th.

The patent dates back to December 22nd, 1915, and was due to expire, in the ordinary course of events, on the sixteenth anniversary of that date.

Application was, however, made by the patentees for an extension of the normal period, the application being opposed by the Hazeltine Corporation and by Messrs. Brown, Boverie & Co. At a later stage in the proceedings the Marconi Wireless Telegraph Co., Ltd., were joined in support of the patentees.

## Disallowed Argument

The ground on which the British Thomson-Houston Co. based their request for a further term of protection was that part of the normal period of protection coincided with

the war, and that during this time the patentees were prevented from exploiting the invention because they were engaged in other work of national importance.

However, this argument did not succeed, and the patent is now dead.

## Now Free to All

Once a patent has expired the benefit of the invention passes to the general public, who are then entitled to use it freely. It is, therefore, interesting to see exactly what the eliminator patent covered.

It claimed a method of obtaining a smooth or unvarying direct current from an alternating-current source, by first rectifying the A.C. and then delivering it to a circuit containing a series choke coil shunted by condensers.

The object of the choke is to allow the passage of direct current, whilst obstructing as much as possible the passage of any fluctuations or "ripple." The purpose of the shunt condensers is to by-pass the "ripples" rejected by the choke.

For instance, the A.C. supply from the mains is first fed to a rectifier D,

which may be of the single- or double-wave type.

In either case the output from the rectifier consists of a series of uni-directional "pulses" which merge together to form a direct current having a surface "roughness" or ripple.

## Removing Roughness

The "roughness" is removed from this current by the combined action of the choke coil L and the shunt condensers C and C<sub>1</sub>. The coil L offers very little resistance to the passage of a steady current, but chokes back any fluctuating components.

On the other hand, the condenser C presents an absolute bar to the passage of direct current, but serves to by-pass the ripples from the positive to the negative lead of the smoothing circuit. The potentiometer P is in consequence supplied with a steady current from which steady potentials can be tapped off to the receiving set.

## THE CAUSE OF THE TROUBLE!

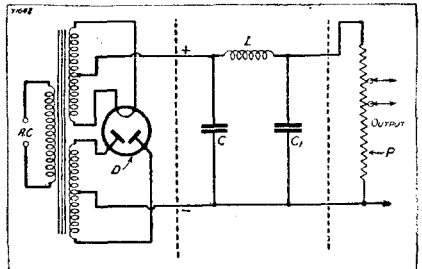

The patent was founded on the smoothing part of the circuit, the part shown within the dotted lines in the above diagram.

The smoothing effect of the circuit L, C, C<sub>1</sub> is equally applicable in the case of D.C. mains where "ripple" voltages may arise in the mains owing to commutator action at the power generating station.

## Wiped Out Fluctuations

By choosing suitable values for the choke and condensers such voltage fluctuations can be wiped out, and a steady or unvarying current supplied through the potentiometer P to the valves of the set.

The effect of the High Court decision is to remove any liability to pay patent royalty in the future for the use of the simple smoothing circuit shown between the dotted lines on the diagram.

It is not unlikely that the expiration of this patent will produce a slight reduction in the cost of mains units.

## RADIO PARIS AS IT IS TO-DAY

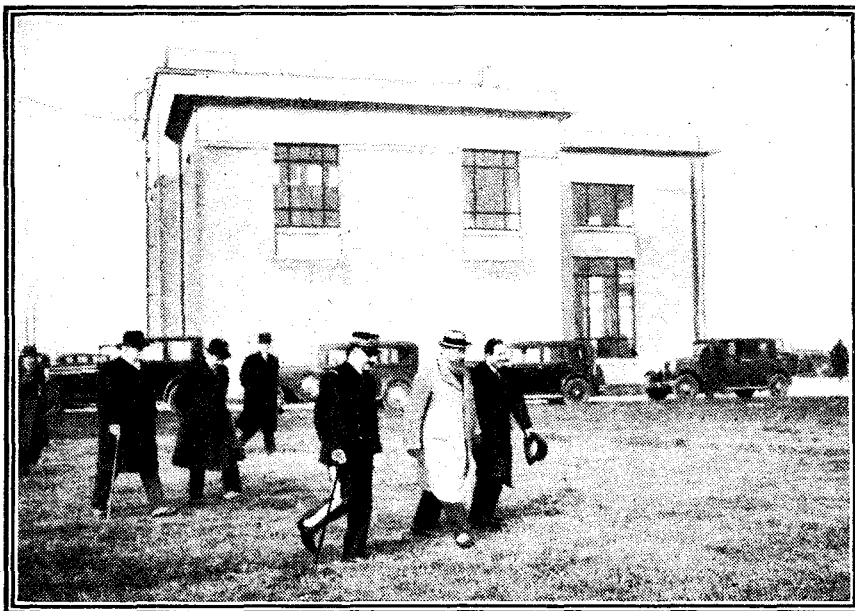

A view of the transmitter building at the recently opened high-power Radio-Paris station. The original station started life under the name of "Radiola" in the very early days of broadcasting.

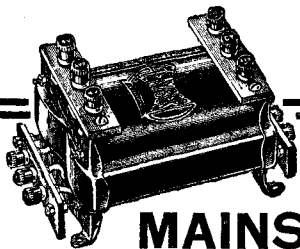

## MAINS TRANSFORMERS

Designed for use with Valve Rectifiers, the Heayberd 715 Transformer produces a powerful and accurate voltage delivery with good voltage regulation.

SECONDARY OUTPUTS		
230+230 v.	2+2 v.	2+2 v.
30 m.a.	1 amp.	4 amps.
MODEL 715	PRICE 28/6	

**POST NOW**  
I enclose 3d. stamps for lists, with diagrams of Heayberd Transformers, Mains Kits, etc.

Name.....  
Address.....



10, FINSBURY STREET, LONDON, E.C.2.  
(One minute from Moorgate Und. Station.)

### COILS! COILS! COILS!

'S. T. 300,' 7/9 Per Pair, Post Paid.  
'P. W.' Dual-Range, each 6/9, Post Paid.  
C. GRAY (Rundie), Hindhead, Surrey.

**MIRROR LIKE**

Specified for the 'S. T. 300,' THE 'VICTOR KING' SUPER

Use PERMCO the modern Ebonite guaranteed never to spoil your set by discolouring. Black, Mahogany or Walnut finishes, perfect mirror polish, highest insulation, easy to cut and drill and costing only 4/6 for 1' x 18" panel. Ask your dealer or write to us for list. Any panel size cut. Cash or C.O.D. by return.

**BRITISH HARD RUBBER CO., Ltd.,**  
PONDERS END MIDDLESEX

**DERMCO**

Famous Makers Offer! **£5 Radio-Gram CABINET for 65/-**  
(or 10/- monthly.)

**7 DAYS' FREE TRIAL**  
Polished Oak and Piano built! the acoustic Tone brings a fine thrill. Makers to (Radio Press, B.B.C., 5,000 cicutele). Other Models 35/- to £15. Photographs and List FREE.

**PICKETTS** Piano-Tone Cabinets,  
(C.W.) Albion Rd., Bexleyheath.

NSR FREE.

Please be sure to mention "The Wireless Constructor" when communicating with Advertisers. **THANKS!**

## OUR NEWS BULLETIN

—continued from page 50

but in due course listeners in this country may hear opera relays from such famous places as the Scala at Milan, the Teatro Reale at Rome, and the San Carlo at Naples. Although no definite arrangements have yet been made, the B.B.C. hopes that very shortly a weekly broadcast from one or more of these opera houses will be possible.

### The New "Uncle"

No doubt many readers of THE WIRELESS CONSTRUCTOR remember a broadcast a few weeks ago by Mr. John Kettelwell, who sang some traditional songs. Mr. Kettelwell has now been appointed Chief of the Children's Hour staff in succession to Mr. Alan Howland. Mr. Kettelwell has undeniably a first-rate broadcasting voice.

He was educated at St. John's College, Oxford.

### A Programme Exchange

The Chief of the Brighton and Hove Relay Station—a station which supplies some thousands of listeners with broadcast programmes from one central station—hopes in the near future to be able to offer subscribers the choice of a London or a Continental programme.

In fact, this go-ahead concern has a scheme in mind whereby subscribers to the system will be able to select any of the dozen programmes merely by dialling London, Paris, Berlin and so on, just as one dials an exchange on an automatic telephone.

### Broadcast Buttons

Speaking at the Regent Advertising Club in London recently, Captain Eckersley remarked that the end of wireless "will be five buttons in the wall of every home which will bring in any desired programme. It may interest you to know that I am working at the present time on experiments that will bring this nearer."

### A Chance Missed!

Referring to the B.B.C., Captain Eckersley said the Corporation have missed a wonderful chance. To the listeners they had not said: "We are going to give you something a little better than you think you like," but "You are going to have what we give you, and you are going to like it."

## THE "VI-KING" SUPER

—continued from page 20

The H.F. one is the one along by the terminal strip of the set, and feeds the variable-mu valve and also the oscillator valve, which requires 3 or 4½ volts negative bias. The positive for this battery is marked G.B. + 1.

### H.F. and L.F. G.B.

G.B.—1 serves the oscillator from this battery, and is therefore put in 3 or 4½ volts, as indicated already. The actual value is not critical, and if you cannot tell any difference in the working in either position, leave it in the higher one, as this will economise in H.T. a little.

G.B.—2, which also goes to this battery, is connected up to the potentiometer that supplies the interme-

### NEXT MONTH

## The JUNE Number of THE WIRELESS CONSTRUCTOR

will be another splendid issue, and among other attractions will contain several

### Special Contributions by JOHN SCOTT-TAGGART.

ON SALE USUAL PRICE,  
MAY 14th. ORDER NOW.

diator valve with its grid bias. This is best plugged into the maximum voltage position of the battery.

The battery for the L.F. valve has its leads marked G.B. + L.F. and G.B.—L.F., and the value to apply here will depend upon the output valve that you use and also upon the H.T. voltage that you apply to it. The correct value can be found from the maker's literature.

### Preliminary Adjustments

Apply 120 to 150 volts to H.T. plus 3. H.T. plus 1 and plus 2 serve the two screening grids of the S.G. valves. Although suitable voltages for both of these will be up to 80 volts, since one of them is acting as a detector, it is most likely that for best results the two voltages will be different. That is why separate terminals are provided.

The preliminary adjustments for  
(Continued on page 53.)

**THE "VI-KING" SUPER**

—continued from page 52

the set are particularly simple, since they consist merely of bringing the two sections of the double-gang condenser into step. This is best done on a station somewhere about the middle of the medium wave-band.

Choose a weak one so that the adjustments are fairly definite, although you will not find the adjustment of the one nearer the panel at all critical. Use a wooden-handled screwdriver, or similarly-shaped piece of wood, to fit into the slots on top of the trimmer condensers.

**The Final Trim**

Simply tune the station in as well as you can on the dial on the front of the panel, and then alter the trimmers until it is at its loudest. There is a similar trimmer on the oscillator condenser, but this does not have to be touched.

The operation of the receiver is extremely easy. There is nothing to be said about the use of the two tuning dials except to keep them in step; not so far as degree numbers are concerned, but so that the two circuits themselves are in step.

You will have no difficulty in doing this, as the "in-step-ness" is clearly indicated by a distinct liveliness, which is entirely absent if they are out of step.

For reception on the long-wave band the coil switch is pushed in and the oscillator unit switch is turned as far as it will go in a clockwise direction. For medium waves turn this knob back one notch, not right back, or you will go on to a short-wave position that is included in the unit, but not made use of in the "Vi-King" Super. The coil switch is pulled out.

**Magnificent Results**

I have already explained how the two volume controls work. It is best to use only the bias one, so long as it controls far enough, unless you want to clear up reception a bit, when judicious use of both will give you very fine results.

When I first set this receiver going it was adjusted for medium waves, and I got the impression that it could pick up nearly every station in Europe. There were scores and scores—far too many to count! So if you are out for long distance, and want to pick and choose from the whole of Europe, this set will give you all you want easily—loudly—and SEPARATELY.

**SPECIFIED  
FOR THE  
"VICTOR  
KING" SUPER**

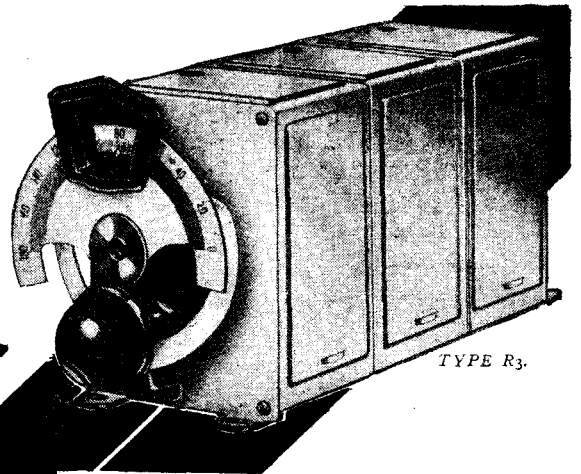

**J.B. "R" TYPE GANGS**

thoroughly shielded. Pressed aluminium clip-on dust-proof covers. .0001 Trimmers (for adjustment once only) in each stage. Very easily fitted—only round panel holes to cut. Complete with Vernier Disc Drive and Bakelite Panel Plate.

For the "VICTOR KING" SUPER you need:  
Type R1 (single) capacity .0005 12/6  
Type R2 (2-gang) capacity .0005 21/-

Write for complete catalogue.

**PRECISION INSTRUMENTS**

Advertisement of Jackson Bros., 72, St. Thomas' St., London, S.E.1. Tel.: Hop 1837

**WHEN IS A FUSE?  
NOT A FUSE?**

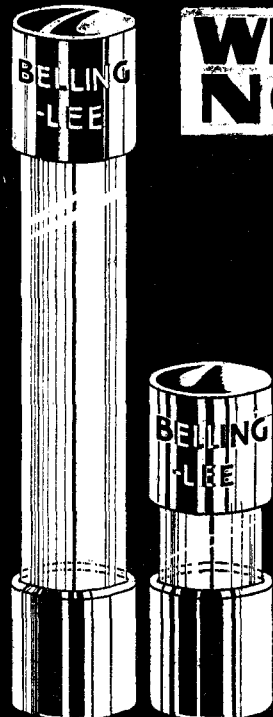

**MAINS FUSE H.T. FUSE**

—WHEN IT IS SO LONG that its resistance couples together the circuits which it protects, making the set unstable.

—WHEN IT IS TOO SHORT to check a powerful surge of current, allowing it to 'arc' across the end-caps instead of ceasing when the fuse wire melts.

Belling-Lee fuses are made in two lengths, for safety and efficiency;  $\frac{3}{8}$ " long for H.T. and G.B. circuits (60 m/a, 150 m/a and  $\frac{1}{2}$ -amp.);  $1\frac{1}{2}$ " long for mains leads (1, 2 and 3-amp.), shorter fuses being unreliable with mains voltages. SPARE FUSES, all ratings 6d. each.

**FUSE HOLDERS**



**BELLING-LEE  
FOR EVERY RADIO CONNECTION**

Advert. of Belling & Lee, Ltd., Queensway, Ponders End, Middlesex



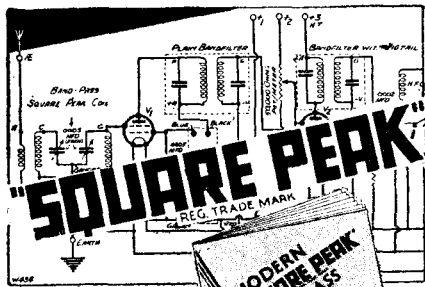

**FREE!**  
Post  
This  
Coupon  
to

**Varley**

DATE .....

Advert. of Oliver Pell Control, Ltd.

To Messrs. VARLEY, Kingsway House,  
103, Kingsway, London, W.C.2.

Please send me, free and post free, the "Square Peak" circuit booklet entitled MODERN "SQUARE PEAK" BAND-PASS CIRCUITS FOR EVERY REQUIREMENT.

NAME .....

ADDRESS .....

W.C.

The Picture Paper with  
the MOST News—

**SUNDAY GRAPHIC**  
and SUNDAY NEWS.

The ACME of  
CRAFTSMANSHIP  
High-Grade  
RADIO-GRAMPHONE  
CABINET

of exclusive modern design, hand made and polished, on Queen Anne legs.  
Figured Oak £4 12 6  
Figured Walnut or Mahogany ... £5 10 0  
Carriage paid.  
Illus. Catalogue Free.  
Cabinets made to order a speciality.

**GILBERT**  
Cabinet Maker,  
**SWINDON**  
Estimates Free. Estd. 1866.

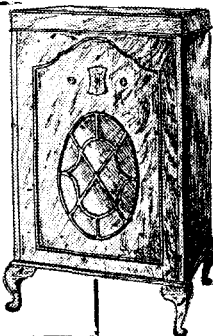

**ADVERTISEMENTS**

As far as possible all advertisements appearing in "Wireless Constructor" are subject to careful scrutiny before publication, but should any reader experience delay or difficulty in getting orders fulfilled, or should the goods supplied not be as advertised, advertisement should be sent to the Advertisement Manager, "Wireless Constructor," 4, Ludgate Circus, London, E.C.4.

**THE "PENTODE" TWO**

—continued from page 27

No, I can't see anything that is not obvious from the diagrams except perhaps the grid leak and condenser. So far as the components used in the original are concerned, these have terminals and are supported up in the air by the wires that connect them to the other components.

The set is wired with Jiffilinx, which undoubtedly provides the easiest and quickest method of connecting up. The ascetic drawback of a lack of accurate right-angle bends and ruler-straight wires from one point to another does not worry me at all, particularly as the efficiency of the set is in no way affected. Personally, and I expect like most of you, I prefer the easiest way out so long as it is good.

**Mounting the G.B. Battery**

If you make the grid-bias leads long enough you can stand the grid-bias battery—providing it is a small one—on the baseboard behind the medium-wave coil. But on the other hand, should you prefer it, it can be attached to the inside of the cabinet.

The wire from the 2-mfd. output condenser that goes to the pentode output choke has a choice of three terminals on this choke. You will find that each gives a somewhat different tone, and it is up to you, naturally, to decide which you like best with your particular loud speaker.

When you come to work the set, all the panel controls except the series aerial condenser will explain themselves. You tune the stations in with the centre dial, increase reaction by turning the right-hand one to the right or, to be more accurate, in a clockwise direction, switch on by pulling out the right-hand switch and go from medium to long waves by pushing in the left-hand switch.

**The Controls**

The left-hand knob is a selectivity control, the more it is turned to the left (or anti-clockwise) the greater the selectivity. But don't make the set unnecessarily selective unless you want to use this condenser as a volume control.

On the long waves this condenser is cut out of circuit by turning to maximum, in which position it shorts.

Further adjustments of selectivity on the medium waves can be obtained by means of the spring clip behind the panel. Try this attached to the red flex (or A) and also on one of the two taps on the P.J.3 coil, leaving it on the one that seems to answer best.

The potentiometer is for the purpose of enabling you to get really smooth reaction control. Start with it right round to the positive end, namely, with slider round to the end nearer coil, and move it just far enough from this position to make reaction O.K.

For all ordinary purposes I should advise you to use one of the small type pentodes that take about five or so milliamps. They give ample room volume.

Still, should you want super-power, there is no reason why a larger pentode should not be used, but it will be desirable in such a case to use H.T. batteries of larger capacity than normal for economical running.

\*\*\*\*\*  
\* **IN PRAISE OF** \*  
\* **THE "I.E." THREE** \*  
\* *A letter from an enthusiastic* \*  
\* *reader.* \*  
\*\*\*\*\*

Sir,—I feel that I must write a few words of praise for the "I.E." Three, which was described in the November issue of THE WIRELESS CONSTRUCTOR.

As the design of the set struck me as being good, and as I was rather keen to have a go at the short waves, I decided to make it up, hoping for the results that I had read about.

Well, I got my results. Just listen to this:

I completed the set just before Christmas and was very pleased with the ease of control and the tone of the set. Since then I have been constantly adding stations to my log, which when tuned properly came over from the Continent at wonderful loud-speaker strength.

**Dozens of Stations**

Up to the time of writing I have bagged 9 stations on the long wave-band and 48 on the mediums, all of which came over on the loud speaker. Now the best part of all this is the "Shorts." On this band I have bagged about a dozen stations, four of which are Americans, namely: W 2 X V, W 2 X A F, W 8 X K, and W 2 X A D. Two of these were on the speaker and the remaining three on the 'phones.

Well, I think I have said enough to convince anybody of the capabilities of the "I.E." Three. Please believe me when I say that I have never handled or heard a set to better it for wonderful range, selectivity and volume.

Thank you and wishing your paper every success,

I remain,  
Yours truly,  
Tunbridge Wells. F. BRAYNE.

**THE "CONSTRUCTOR"  
TEST ANALYSIS**

—continued from page 28

of appreciation for their excellent reports, I am going to enter them in my list of CONSTRUCTOR H.M.'s.

They were: Mr. J. A. Jagger, of Chapel-en-le-Frith (whose report, incidentally, contained most detailed observations on the weather conditions on each of the occasions when he listened); Mr. E. W. Levett, of Felixstowe, Suffolk; Mr. J. F. Mountain, of Ripon, Yorks.; Mr. G. Goodwin, of Birkenhead; Mr. A. W. Brookson, of King's Lynn, Norfolk; Mr. G. A. Plummer, of Wolverhampton; Mr. J. Forster Cooper, of Cambridge; Mr. J. Budge, of Wick, Caithness; and, finally, Mr. B. M. Jenson, of Liverpool, who is the first CONSTRUCTOR reader to become a double H.M. Congrats., Mr. Jenson!

Before passing on to the analysis of all these reports, I want to thank every reader who sent in a report of this test.

Much as I should have liked to, I am afraid that there were far too many letters to reply to each one individually, and so the only alternative is to thank you collectively. After all, we are all one large family of short-wave ginks, aren't we?

**Striking an Average**

Now, as to the results of all these reports; well, there seemed to me to be only one way of getting down to it, and that was to analyse every single report, to make notes of the average maximum and minimum strengths reported for each station on any one day, and then to plot a curve of the period over which the tests were conducted.

May I stress that point about average figures?

By a careful system of grading, these average figures were obtained, and although they do not necessarily indicate the maximum or minimum strength obtained by any one particular reader on a given day, they do enable us to arrive at a general idea of how the two stations came over, which, after all, is what is wanted.

(Continued on page 56.)

**THE "S.T.300."**

**Important Notice to our Readers.**

The enormous interest shown in the battery and A.C. versions of the "S.T.300" has resulted in such a large post-bag that we regret it is impossible for all letters to be dealt with by return. Every effort is being made to handle this correspondence as expeditiously as possible, but at present a little delay is inevitable.

A perusal of the correspondence has revealed that a number of readers have not realised the importance of the correct positioning of the components on the H.F. side, while others have purchased the wrong type of wave-change switch.

It is important to remember that if results comparable with Mr. Scott-Taggart's own results are to be achieved the specification as regards components and his original layout should be duplicated as nearly as possible.

**LOW PRICES-BUT  
BULGIN QUALITY**

**JUNIOR  
'ON-OFF'  
SWITCH  
10 1/2d.  
LIST No. S38**

Efficiency with low cost is the keynote of the "Pentode Two." Therefore, the designer has specified BULGIN as representing the finest value in low-priced switches. The following BULGIN Components are also recommended:—

One 10,000 ohm Electrically Spot Welded Spaghetti, price 1/—, and Quickwyre —the new connecting wire with the slide-back covering—it costs only 6d. per 10 ft. coil. Red or black.

**JUNIOR  
3-SPRING  
WAVE-  
CHANGE  
1/3  
LIST No. 939**

**A. F. BULGIN & CO. LTD.  
ABBEY ROAD, BARKING, ESSEX.**

Telephones: Grange Wood 3266 & 3267.

London Showrooms:

9, 10, 11, Cursitor Street, Chancery Lane, E.C.4.

Telephone: Holborn 2072.

Send 2d.  
Postage  
for 75 pp.  
Illustrated  
Catalogue  
& Manual.



**A "SOUND"**

**INVESTMENT!**

"Sound"—in looks and performance. Cameco Cabinets are in step with Set and Speaker and represent astonishing value. Write for the Cameco Radio Cabinet Catalogue—FREE.

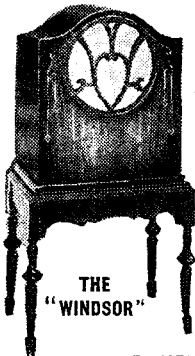

THE "WINDSOR"



**CABINET**

CARRINGTON MFG. CO., LTD.  
Showrooms:  
24, Hatton Garden, London, E.C.1. Phone: HOLborn 8202.  
Works: S. Croydon.

**SOLVE ALL  
H.T. TROUBLES**

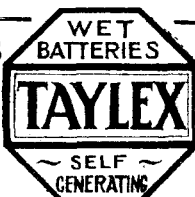

Per doz.	No.1.	No.2.
Jars (waxed)	1 3	1 6
Bags	1 2	1 9
Zincs	10	11
Rubber Bands (24)	4	4
Terminals	8	10

Trade supplied.



**LONG LIFE : SILENT : ECONOMICAL**

Sample doz. (18 volts), complete with bands and electrolyte. No.1, 4/1; No. 2, 5/-; post 8d.; terminals extra. No. 3, with terminals, 7/6 (10,000 milli-amps); sample unit 6d. Orders 10/- carr. paid. New illustrated catalogue post free. **FREE** Bargain List of Receivers, Amplifiers and Components. **G. TAYLOR, 57, Studley Road, Stockwell, London.**

**There's no substitute for cyldon**

**CYLDON EXTENSER**  
Type EX5. Fitted with a perfectly timed, adjustable wave-change switch and noiseless brush wipe contacts. 4" Bakelite, 360° Dial 1/6 extra.

12/6

**CYLDON SLOW MOTION EXTENSER**  
Type EX5V. Fitted with wedge drive, disc type, Slow-motion Control. Hair-line sight. 5 to 1 reduction. Perfectly timed Extenser wavechange switch.

16/6

**CYLDON SLOW MOTION DIAL**  
New wedge friction drive, 8:1 ratio, non-slip, rotation in same direction as condenser, illuminated scale, hair-line sight. Sector vision.

7/6

**SYDNEY S. BIRD & SONS LTD.**  
CYLDON WORKS,  
SARNESFIELD ROAD, ENFIELD  
S.F.B.

**THE "CONSTRUCTOR" TEST ANALYSIS**

—continued from page 55

I have spent hours looking at the resulting curves, which are reproduced on a previous page, for I think they are particularly fascinating.

What, I think, is particularly intriguing is the fact that the troughs and the peaks in the case of both stations seem to occur on the very same days, indicating that, irrespective of wave-length, the Heaviside layer *always* has the last say in the matter!

Have a look at both the curves on February 20th! (Can it be on such days as this that W. H. H. listens?) And then cast your optics on the eruption of the very next day!

**A Curious Effect**

It is obvious that conditions were undoubtedly best towards the end of the period under review. But the curious part of it is that whereas in the case of W 2 X A F the average minimum line rises on the 29th in accordance with the sudden jump up in the average maximum line, which, after all, is exactly what one would expect, exactly the opposite happens with W 2 X A D!

Dare we assume from that that the longer-wave station is the more consistent? Personally, I do not think that it is safe to assume anything on short waves. The thing to do, of course, is to conduct another one of

these curve tests with the valued co-operation of all you fellows at some time in the future.

I venture to suggest that the comparison of curves would be most illuminating, and we shall have to see what can be done.

Meanwhile, and by way of conclusion, I want once more to thank all

**What Does "S.T." Say About It?**

**NEXT MONTH**

In the JUNE issue of

**THE WIRELESS CONSTRUCTOR**

(On Sale May 14th)

we are arranging for more

**Exclusive Contributions**

from

**JOHN SCOTT-TAGGART.**

Not merely the thousands of "S.T.300" builders, but every set-owner will find these articles of absorbing interest. And, remember, the famous set-designer and radio engineer writes only for

**THE WIRELESS CONSTRUCTOR**

June Number  
On Sale May 14th.

Order Now  
Price 6d.

who have taken the trouble to write in. Even though you may not have qualified for the original adaptor or for an "H.M.," you have the satisfaction of knowing that your efforts were far from wasted, and were, in fact, partly responsible for the curves. Thanks very much, and "CU agn." —at least, I hope so!

G. T. K.

**A PENTODE PECULIARITY**

WHEN you ever noticed a bluish glow near the glass? It does not appear to be very common in British valves, but according to reports it is fairly prevalent in "tubes" of American manufacture. Or it may be that the construction of our own valves does not enable us to observe it quite so easily.

The first time I observed this phenomenon I at once jumped to the conclusion that it denoted a "soft" valve, or in other words one with an imperfect vacuum. The correct explanation, however, is quite different.

**"Cathode" Ray Discharge**

What really happens is this: some of the electrons which are "shot off" from the filament, instead of passing through the grids and landing safely on the anode are merely accelerated by the latter and simply fly off into space through the openings at each end of the electrodes.

In doing this they form a concentrated "cathode ray" discharge, which bombards the glass. This continuous bombardment causes the "getter" deposits (that shiny black substance on the inside of the bulb) to glow with a bluish colour.

If there is the slightest trace of gas left in the bulb, however, this phenomenon will not occur, as the stream of electrons will be very quickly dispersed by the gas atoms.

**OHMITE RESISTANCE**

ALL values from 300 ohms to 5 megohms 1/6 Holder 6d.

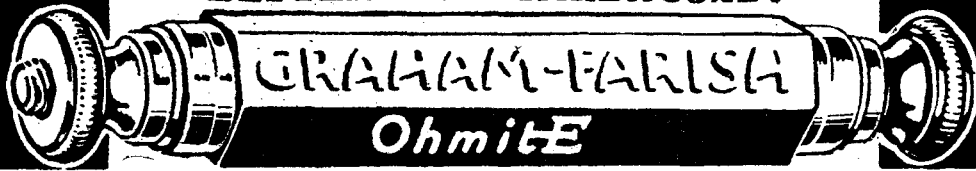

**"BETTER THAN WIREWOUND!"**

Made by **GRAHAM FARISH** Bromley Kent.

**INDEX TO ADVERTISERS**

	Page.		Page.
Argosy Magazine	2	Pickett's Cabinets	52
Belling & Lee, Ltd.	53	Ready Radio, Ltd.	35
British Blue Spot Co., Ltd.	Cover iii	Reproducers and Amplifiers, Ltd.	49
British Hard Rubber Co., Ltd.	52	Radio Instruments, Ltd.	45
Bulgin, A. F., & Co., Ltd.	55	Taylor, C.	55
Burne-Jones & Co., Ltd.	1	Turner & Co.	50
Bird, Sydney S., & Sons, Ltd.	55	Varley Products	54
Carrington Manufacturing Co., Ltd.	55	Westinghouse Brake & Saxby Signal Co., Ltd.	45
Colvern, Ltd.	Cover iii	Wright & Weaire, Ltd.	49
Cordo Electrical Products, Ltd.	45		
Dubilier Condenser Co. (1925), Ltd.	43		
Edison Swan Electric Co., Ltd.	Cover iv		
Exide Batteries	43		
"Film Pictorial"	Cover iii		
Gilbert, J. C. (Cabinets)	54		
Graham Farish, Ltd.	56		
Gramophone Co., Ltd.	37		
Gray, G.	52		
Hayberd, F. C., & Co.	52		
Igranic Electric Co., Ltd.	49		
Jackson Bros.	53		
Mullard Wireless Service Co., Ltd.	4		
Ormond Engineering Co., Ltd.	41		
Peto-Scott Co., Ltd.	3		

All communications concerning advertising in "Wireless Constructor" must be made to John H. Lile, Ltd., 4, Ludgate Circus, London, E.C.4. Telephone: City 7261.





# Magic Shadow SHOW \*\*\*

Entrancing witchcraft of the movie . . . mystic allure of beautiful women . . . enthralling fascination of superb dramatic art . . . magic shadow show, indeed.

FILM PICTORIAL gives you lots of news of the latest of the "Magic shadow shows." Tells you how they're made, glimpses the lives of the players. Describes the pictures you *must* see, mentions those you ought to see, and even includes those about which you can please yourself.

And FILM PICTORIAL is *all photogravure* with pages in *coloured photogravure*. You can't ignore the movies now—they're a part of modern life. And FILM PICTORIAL is a part of the movies.

# Film PICTORIAL

Every Thursday - - - - 2d.



## MOVING-COIL PERFORMANCE for 39/6

A really *good* Moving-Coil Speaker is expensive. If, therefore, the price you want to pay for *your* speaker is round about 40/- you should buy BLUE SPOT 100U—which is the equal of the most expensive Moving-Coil Speakers you can buy.

The tone of 100U for both speech and music is vivid and natural. Every detail stands out like a ship in a searchlight. Like Moving-Coil Speakers, 100U excels on the bass notes, but unlike many of them it sacrifices nothing of the treble. 100U reproduces at good volume even from remarkably small inputs and is entirely free from rattle or distortion.

Hear it at your dealers and you will be glad you read this advertisement. Write for catalogue No. W.C. 15U

**100D**, an attractively designed Cabinet Speaker in fine quality oak, 63/-

### THE BRITISH BLUE SPOT COMPANY LTD

BLUE SPOT HOUSE - 94/96 ROSOMAN STREET - ROSEBERY AVENUE - LONDON - E.C.1  
Telephone: Clerkenwell 3570 Grams: "Bluespot, Isling, London."  
Distributors for Northern England, Scotland and North Wales:—H. C. RAWSON (Sheffield and London), LTD., 100 London Road, Sheffield; 22, St. Mary's Parsonage, Manchester; 183 George Street, Glasgow.





# 2 VOLT MAZDA MASTERPIECES

## REDUCED PRICES

H.210	-	-	7'6
HL.210	-	-	7'6
★HL.2	-	-	7'6
★L.2	-	-	7'6
L.210	-	-	7'6
P.220	-	-	8'9
P.220A	-	-	12'6
P.240	-	-	12'6
PEN.230	-	-	17'6
PEN.220	-	-	17'6
PEN.220A	-	-	17'6
S.G.215	-	-	16'6
★S.215A	-	-	16'6
★S.215B	-	-	16'6

★ METALLISED



LOOK FOR  
"EDDY" IN  
YOUR DEALER'S  
WINDOW

THE AMAZING

## MAZDA PEN. 220

### Characteristics:

Filament Voltage - - 2.0 volts Anode Current (Max) - 12 mA  
 Filament Current - - 0.2 amps. Screen Voltage (Max) - 150 volts  
 Anode Voltage (Max) - 150 volts Mutual Conductance - 2.5 mA/V  
 At  $E_a$  - 100;  $E_s$  - 100;  $E_g$  - 0.

PRICE 17'6



Never, in the history of 2-volt valves, has there been such an amazing range as this—so much evidence of brilliant engineering—so many valves with outstanding characteristics. Instance the Pen.220; a pentode valve which at once presents the solution to the output stage problem in portable sets, giving an extraordinary large output for a combined screen and anode current of under 5mA. It is a valve for which dry battery users have long waited.

Being typical of all Mazda valves, it is outstanding in its efficiency. Mazda 2-volt valves, both metallised and clear bulb types, are sold by all good radio dealers.

# MAZDA

THE  
BRITISH  
VALVES

The Edison Swan Electric Co. Ltd.



155 Charing Cross Road, London, W.C.2