

The Wireless 6^d Constructor

RADIO CONSULTANT-IN-CHIEF CAPT. P. PECKERSLEY M.I.E.E.

Vol. XI.

MARCH, 1931.

No. 53.



DESIGNED
BY
VICTOR
KING

THE
"PARATUNE"
FOUR

ALSO
IN THIS
ISSUE

THE "PLUS-
STAGE" ONE

TRANSATLANTIC
IMPRESSION

By
PERCY W. HARRIS,
M.I.R.E.



Why MAZDA VALVES *give the best results!*

Mazda engineers have the longest experience of any in the design and manufacture of A.C. Mains Valves. Sound manufacturing methods ensure robust construction, long life and consistent quality. Their amazingly high efficiency has won for them a reputation as the "World's finest valves." They are standardised in all the leading commercial receivers.

With the amazing Mazda valves in your set its efficient and trouble-free performance is assured.

From all good radio dealers.

The amazing

MAZDA

RADIO VALVES



THE EDISON SWAN ELECTRIC CO. LTD.
*Incorporating the Wiring Supplies, Lighting Engineering and
Radio Business of the British Thomson-Houston Co. Ltd.*

Radio Division Showrooms:
155 Charing Cross Road, London, W.C.2
Showrooms in all the Principal Towns

EDISWAN

V.98

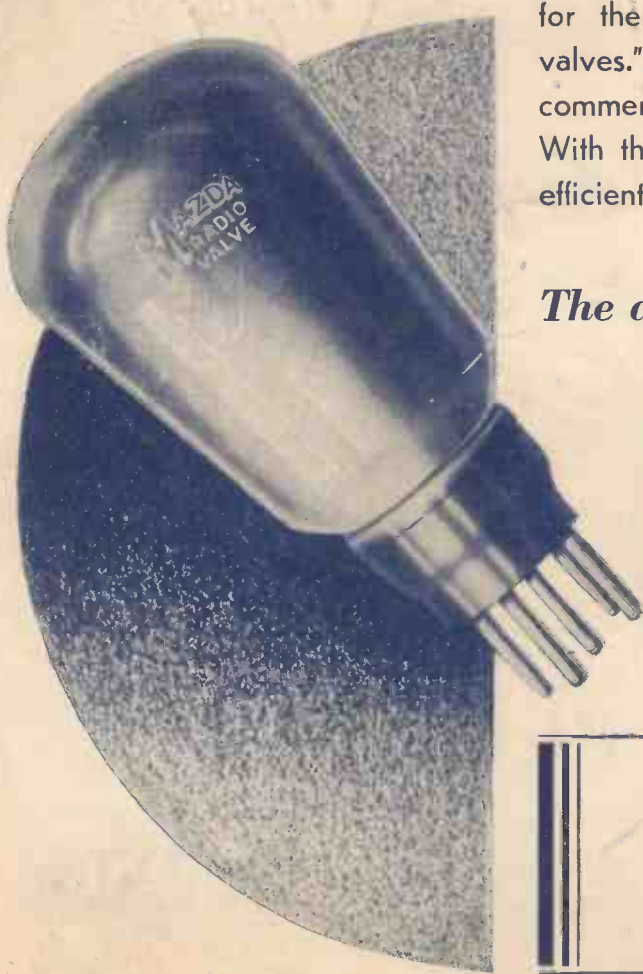

CONTENTS

	Page		Page
The Editor's Chat	271	A Practical Man's Corner .. .	299
Another Sort of Traffic Problem ..	272	Queer Queries	302
Transatlantic Impressions	273	With Pick-Up and Speaker .. .	303
The "Paratune" Four	277	In Lighter Vein	307
Adaptor Adaptations	284	As We Find Them	310
Valve Vagaries	285	Points for Purchasers	312
Savoy Hill News	287	The "Four-Five" Converter .. .	314
The "Bryta-Tone" Amplifier .. .	289	The "Distaswitch"	315
Are Radio-Grams Worth While? ..	293	Our News Bulletin	320
The "Plus-Stage" One	295	How the B.B.C. Receives .. .	326

As some of the arrangements and specialities described in this Journal may be the subject of Letters Patent the amateur and trader will be well advised to obtain the permission of the patentees to use the patents before doing so.

Chief Radio Consultant:
Capt. P. P. ECKERSLEY, M.I.E.E.

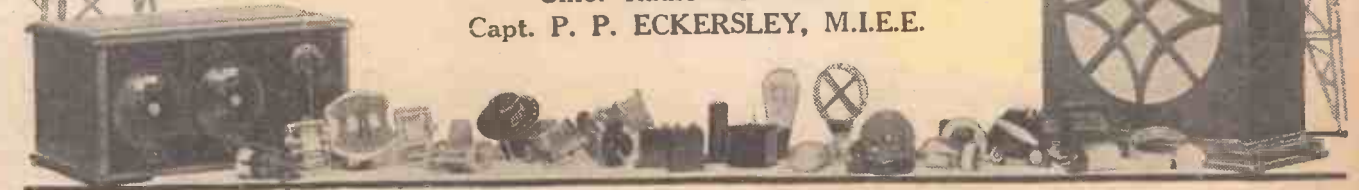

Hear Radio at its best

by incorporating an IGRANIC L.F. TRANSFORMER in your set. You will then realise to the full the pleasure of distortionless reproduction of speech or music.

Have you had a copy of our new Catalogue, J.1115.

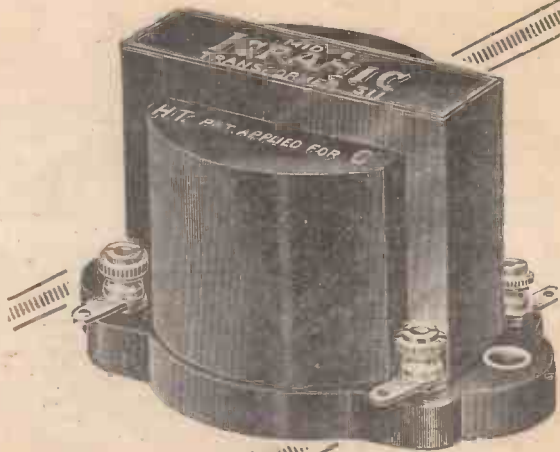

Ratio 3 to 1

**IGRANIC
 "MIDGET"
 TRANSFORMER
 PRICE 10/6**

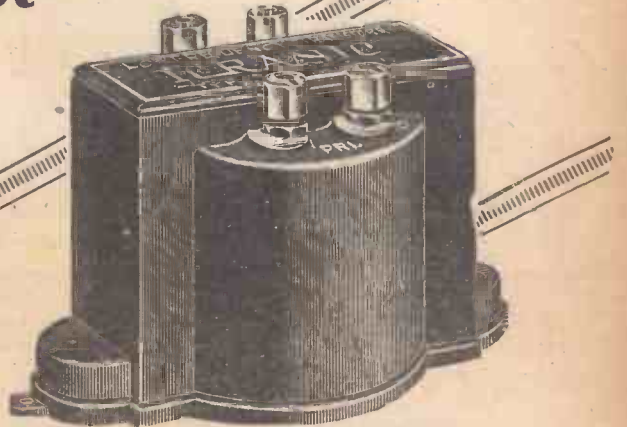

**IGRANIC
 "J" TYPE TRANSFORMER
 Ratio 3 to 1 and 6 to 1
 PRICE 17/6**



210

Specially designed for H. F. Amplification



H L

Incorporating all the most advanced constructional features the new Cossor 210 H.L. is of exceptional interest to all users of non-screened grid Receivers. To ensure complete freedom from microphonic noises the famous Cossor system of Seven Point Suspension is employed. To permit of greatly increased accuracy in the inter-electrode spacing and, therefore, of an unusually high standard of uniformity, the new Mica Bridge Mounting method of assembly is used. In addition to special grid current characteristics and other important improvements, the base is of an entirely new material on which the "Wireless World" reported, "we find the high frequency losses in the bases of both the two Cossor Valves here tested to be negligible." The use of the new Cossor 210 H.L. in any non-screened grid Receiver will considerably increase its efficiency.

The new Cossor 210 H.L. 2 volts,
1 amp. Impedance 22,000.
Amplification Factor 24, Mutual
Conductance, 1.1 m.a./v.
Anode voltage 75-150. **8/6**
Price

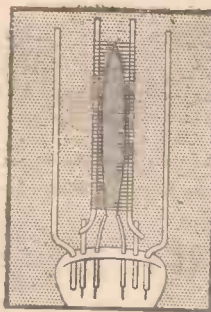

SEVEN POINT SUSPENSION

Practical experience has shown that the Cossor 7 point suspension system definitely eliminates microphonic noises. This system is employed in the support of the exceptionally long filament of the Cossor 210 H.L.



MICA BRIDGE MOUNTING

Permanent alignment of the electrode system is ensured by a stout mica bridge which forms an integral part of the anode assembly. When finally secured in position the whole structure becomes one interlocked unit.

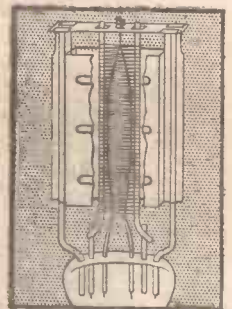

UNIFORM PERFORMANCE

The Cossor mica bridge construction permits no variation of characteristics due to differences in inter-electrode spacing. Complete uniformity of performance is therefore ensured between all valves of the same type.

THE NEW COSSOR 210 H.L.

Be sure to get one of our novel, circular Station Charts, which give identification details of nearly 50 stations with space for entering your own dial readings. Ask your dealer for a copy, price 2d. or send 2d. stamp to us and head your letter "Station Chart" "W.C."

The WIRELESS CONSTRUCTOR

Published by the Amalgamated Press, Ltd., Fleetway House, Farringdon Street, London, E.C.4.

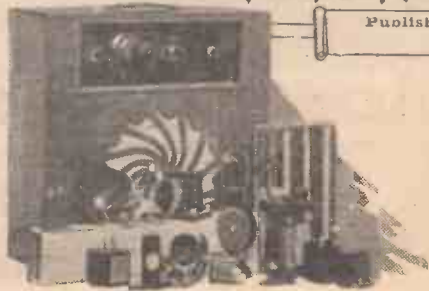

THE EDITOR'S CHAT



Reception conditions are now extraordinarily good, and again this month we are offering you a wonderful selection of constructional work, to enable you to take full advantage of the fare provided.

SOME people are always shaking their heads about radio—just as some people are always wagging their tongues about other people's affairs. The head-shakers are those who simply cannot understand the popularity of radio from the home-constructor's point of view. They draw parallels with other hobbies, and then proceed to draw conclusions. "Look at so and so," they will say. "That hobby was a rage with thousands of people, but it petered out in a year or so, and now nobody takes any interest in it."

Radio's Lasting Hold

Then they will come right up-to-date, and point to midget golf. "Just a passing craze," they will say; but when you mention radio they are stumped. They shake their heads; but they have to admit that of all modern hobbies the fascination of radio, in all its aspects, is supreme, and the hobby itself—again in all its aspects—has a hold on thousands and thousands of people which time seems to strengthen rather than weaken.

They don't understand why this is so—but the answer is not difficult to find: It is because radio is progressive.

Other hobbies lack variation, but the supreme charm about wireless is that it keeps on the move. Each year yields some new development, some improvement in technique, some new angle of approach, some new fashion which revives interest and keeps the amateur perpetually interested.

The Constructor Scores

This is particularly so about home-construction. Of course, new circuits don't "happen" every day—but they happen often enough; and changes in the design of components—improvements in coils, and other items

—all react on the hobby in general, and serve to maintain a steady progress—not only in technique, but in vivid, human interest. In these hard times the factor of expense must play a very big part in the popularity of a hobby; but radio can be a most expensive hobby, and also a most inexpensive hobby. The man with two or three pounds to spend can get just as much fun and interest out of

BERLIN'S BARGAIN BASEMENT



Large Berlin stores have now been equipped with radio for concerts, etc., in the refreshment rooms, and the apparatus shown above can be used in conjunction with the loud speakers to make emergency announcements in the event of fire.

radio as the man with fifty pounds to spend.

For instance, take the "Paratune" Four, which we describe in detail elsewhere in this issue.

This, you will admit, is a magnificent all-wave set. We can assure you that on test we proved it to have remarkable power as well as a remarkable appearance. It is not exactly a

"dirt-cheap" receiver, but if you work out its total cost and then consider what you get for your outlay we think you will agree it can hardly be termed expensive.

Don't miss reading about the "Bryta-Tone" Amplifier. This is the sort of thing which has a pretty well universal appeal; its merits are obvious—its utility needs no explaining.

Another feature in this issue which we should like our readers to examine closely deals with the "Plus-Stage" One. This is definitely economical and efficient. It also has this advantage, you can develop it as your leisure or funds permit.

A Word of Advice

And now—a word of advice. We have given it before, but we offer it again because it really is important: *When you build a set adhere to the designer's specifications.* We particularly want to impress this on the newcomer to radio. If you are going to adopt your own layout for one of our sets—let us say, for example, the "Paratune" Four, as described in this issue—you must not be surprised, or annoyed, if the set fails to give satisfaction when built and put on test.

WIRELESS CONSTRUCTOR sets are not slung together anyhow. They are the outcome of a considerable amount of practical test-bench experiment, and the designer cannot be blamed if you build one of his sets according to your own ideas of layout, etc., etc., and then fail to get identical results. The same warning applies to values of components.

So do please remember—if you build a set, follow the designer's instructions if you want the best results.

ANOTHER SORT OF TRAFFIC PROBLEM

A survey of the present conditions and future prospects of Europe's ether.

THE man-in-the-street needs no convincing that traffic congestion is one of the great problems of city life to-day. On his way home from work, in the bus or in the tram, he has ample evidence of certain facts—the narrowness of streets, the delay caused by horse traffic, crawling taxis, lumbering steam wagons; in short, all the factors which contribute to congested streets and bad traffic conditions generally.

If he reads his newspaper carefully he will realise that a good deal of the present financial depression is also due to congestion—gold congestion in America and France.

Evil of Congestion

And he will appreciate the fact that if one country stores up an excessive amount of gold, other countries are going to feel the shortage and will consequently have less to spend, with the result that the country that stores up the gold inevitably finds that some of its best customers drop away because they have not the cash with which to do business.

Congestion, in fact, is an evil which plays a big part in many varied places of life to-day; but perhaps nowhere is the evil more evident than in the all-pervading ether.

And what is more, the evil is growing; and it seems pretty clear that it will ultimately produce chaos unless some effective remedy is quickly put into operation.

Station after station continues to spring up on the Continent—each elbowing its way into the ether via a wave-band which is already far too overcrowded.

And that is not all: for these new stations not only want elbow-room, they want to attract far too much attention. Not content with butting in where there is no room for them, they assert themselves with so many kw.'s behind them that one wonders where the limit will eventually be set—just as one wonders what will be the limit for a New York skyscraper.

High-Power Russian

Russia has a station under way which, it is said, will have a power of 500 kilowatts, and two new transmitters in Switzerland, a new Polish station in Warsaw of 158 kilowatts,

and a 120-kilowatt transmitter for Prague (Czecho-Slovakia) are reported to be due in the air shortly. The new "Radio Paris" operating on about five times its present power, the addition of the new German regional stations of which there are seven more to come, and a couple of 20-kilowatt Belgian stations—all will contribute shortly to a state of affairs which is already impossible.

"The present overcrowding of the ether is a very serious matter, and it is tending to become still more so," said Colonel Adrian Simpson, managing director of the British Radiostat Corporation, in an interview. "When the several projected high-power Russian broadcasting stations come into full operation it might seem as if there would be very little chance of clear reception from any single European station."

governments concerned gave it real official backing.

But the International Radiotelegraphic Convention is not due to meet (in Madrid) until 1932 to decide upon the allocation of appropriate wave-lengths to public and commercial wireless services. By that time it is estimated that three-quarters of the present European broadcasting stations will be "on the air" with high power by that time.

Twice the Number!

At the International Washington Conference in 1927, in addition to mercantile marine, aircraft, and commercial communications, the broadcasting services obtained a band of wave-lengths between 200 to 545 metres and 1,340 to 1,875 metres.

Only 106 stations can be fitted into the first band and seven stations into the second—a total of 113 stations. There are approximately twice as many broadcasting stations in Europe already!

What will the position be in 1932, unless the Convention—or some other authority—gets busy before then?

RADIO SWEEPS OVER ARABIA



Arabian students at the Wireless School at Chelmsford. Within the next year or so every important centre in the kingdom of Hedjaz will be linked by radio for the first time. King Ibn Saud has ordered fifteen complete stations.

And that is gospel truth, as any radio engineer will admit. Not even the Stenode system will solve the problem—at least, not without other help.

Where that "help" will come from it is impossible to say at the moment, although it is easy to suggest *where and how* it might be obtained.

The International Radio Convention could deal with the matter if the

The situation to-day is bad enough, but if another year goes by without the ether being properly regulated and controlled, broadcasting conditions are going to be absurd.

We shall experience the muddle and confusion which resulted in America when anyone could set up a station and broadcast at will.

(The rest of this straight-to-the-point article will be found on page 330.)

TRANSATLANTIC IMPRESSIONS



By Percy W. Harris, M.I.R.E.

Even if you can't go to America yourself, you can certainly get a good idea of how that exciting country strikes the travelled Englishman by reading this intensely interesting and informative article. Mr. Percy W. Harris has crossed the Atlantic several times on business, and below he tells of his latest visit to the U.S.A.; and of radio conditions there to-day.

IT is five years since last I visited America in the flesh. I say "in the flesh" deliberately, for in these days of simply constructed and highly efficient short-wave receivers one can visit America "by ear" almost any night, and often during daylight. Plenty of WIRELESS CONSTRUCTOR sets will enable you to do it.

But to visit the United States and listen "on the spot" is quite a different matter; and so, within an hour or two of landing from the White Star liner "Homer," in October last, I sat down with pleasant anticipation to listen-in:

An American Set

The set I used followed the present trend of fashion in the States. A handsome and not too ornate cabinet,

about breast-high, with doors which opened and revealed a single tuning control, a kind of keystone-shaped illuminated window showing dial degrees, a volume control, a tone control and a radio-or-gramophone switch.

Plenty of Stations

The set easily "plopped" from one station to another as the tuning knob was turned with the volume kept down (I should say about a dozen stations came in in this way), and the quality was good; distinctly good if the "tone control" were kept on "high."

To get any more stations it was necessary to turn the volume control well up, with the result that as you moved past any local or semi-local

stations you nearly blew your head off, and, furthermore, the full volume necessary brought in a tremendous lot of mush and background noise.

Still, with all that, it was a very good set in range, sensitivity and quality. The speaker (built-in, of course) was a "dynamic," or, as we prefer to call it, a "moving coil."

A Common Characteristic

I then gave closer attention to tone with the set tuned-in to a station giving good quality (unlike our stations, which are all of high technical quality, American stations vary a good deal), and this revealed what later I found to be a common characteristic of modern American sets—a rather pronounced boom in the bass and a peak at about three thousand

"BROADCASTING FROM THE PIONEER STATION OF THE WORLD"



This is the orchestra at the famous East Pittsburg station, K D K A, which proudly announces itself as "The Pioneer Broadcasting Station of the World." The main programme goes out on 306 metres, but in this country K D K A is generally picked up on short waves, and it often comes over very well indeed.

Transatlantic Impressions—continued

to give the impression of good "top." These two peaks—top and bottom—had to be looked for in the particular set in question, but in many others I tried later these characteristics were most pronounced.

About "Power Detectors"

Of mains hum there is very little in modern American sets. Careful design of the mains units themselves has something to do with it, but more is due to the increasing use of what are called "power detectors," with only one stage of audio-frequency amplification.

menal, judged by standards on this side of the Atlantic, but this is easily understandable when we remember that seven, eight, nine and even ten valves are often used. The principle adopted is not to force the utmost out of each valve, but to arrange a moderate gain in each of several stages, a practice which personally I think by far the best in commercially-built receivers.

By having a comparatively small gain per stage two big advantages accrue. Firstly, stability is easily obtained, there being practically no unwanted reaction between circuits,

The second important commercial point about a relatively small gain per stage is that accuracy in matching valves is not required, and the customer can replace his valves by any other good ones of the same type without altering the performance of the receiver.

Few Types of Valves

Instead of the seemingly needless multiplication of valve types, and considerable differences in characteristics between different makes, which characterise valve manufacture in this country, the United States has only a comparatively few types, fairly uniform in standard.

I admit cheerfully that the efficiency of these valves is much below that of ours, but I do know that the American valve manufacturers could easily increase the efficiency if they wanted to, but it is not generally thought advisable.

In selectivity the sets are on the whole very good, but not good enough for the existing conditions. To judge by their advertisements, American radio manufacturers achieved 10-kilocycle selectivity long ago, but this is an exaggeration.

Regarding Selectivity

With comparatively weak stations most sets will separate stations on adjacent 10-kilocycle channels, but if one of the stations is at all strong it is quite a different story. I tried a number of different receivers, and found they varied very considerably.

Sometimes different examples of one maker's model vary between them—and this certainly applies to some of the newer super-heterodynes. On most sets a strong "local" would blanket two or three channels on each side—sometimes more; and as most of the programmes one wants to listen to come from more or less local stations, a high degree of selectivity is certainly needed.

An Interesting Demonstration

For this reason tremendous interest was shown in the demonstration models of the Stenode Radiostat brought over by Dr. Robinson and his party. One demonstration which created quite a sensation was given in a private house within sight of station WOR in Newark.

This station was first tuned in, and then as the knob was turned tuned

"WIRED UP" TO PREVENT INJURY



This picture was taken at an outside broadcast of a baseball match, and it will be noted that the commentator is protected by sturdy wire from being knocked out by Babe Ruth, or by one of the other hard hitters. At the moment he is "interviewing" one of the players.

There is a lot of loose talk about power detectors, as if they were something essentially different, but on analysis a power detector differs from the older kind only in being able to handle a loud signal without appreciable distortion.

By producing as much as possible of the amplification prior to the detector, trouble from mains hum can be practically eliminated, and, furthermore, the cost of the mains unit can be reduced (a highly important point in view of cut-throat competition), as less filtering is required.

In range the sets are quite pheno-

and consequently the individual circuits are not unduly sharpened. This is very important from the manufacturer's point of view, as a fairly wide tolerance can be allowed in the manufacture of parts.

Important Commercial Considerations

For example, the units in a gang condenser need not to be matched with laboratory accuracy; although, of course, they have to be matched with a good degree of fineness. The coils, too, can be machine wound to a standard which gives easy matching.

Transatlantic Impressions—continued

out, and the next station, W L W (at Mason, near Cincinnati, and only 10 kilocycles away), tuned in quite clear of the slightest interference. Not only was there no interference, but

part of New York and a considerable area of Chicago are thus supplied. I found that 110-volt D.C. sets were quite good considering the difficulty of designing a good output stage at

“tone-control” as a fitment on receivers. Many sets have such a control this year. At first it sounds a very useful attachment, suggesting that either high or low notes can be emphasised at will, giving the set user a means of adjusting the set to his own standard of quality.

HERE ARE THE ROD AERIALS OF KDKA

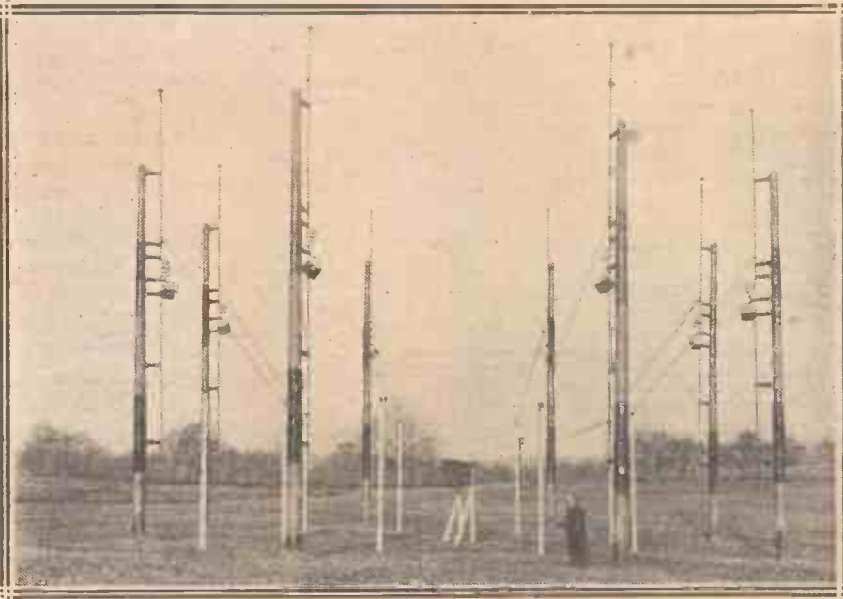

Stiff upright rods, supported by poles and carefully spaced, are used instead of aerial wires at East Pittsburg. The idea is to generate a powerful sky-wave with a minimum of direct ground-wave to interfere with local listeners.

there was actually a blank space between the two programmes. No other set could approach this degree of selectivity.

When I last visited the States there appeared to be no heterodyning of stations, but this time I heard a good deal after dark. According to regulations this should not be, but there it was all the same!

Battery Sets Still Selling

Naturally, with the widespread use of electricity practically all sets are mains-driven, but it will surprise most English listeners to hear that there is still a brisk demand for battery sets, and quite recently a new line of 2-volt valves, specially designed for battery operation, with a comparatively low filament current, has been brought out.

Farming communities buy most of the battery sets, for although they have electricity on the farms the voltage is often low, and D.C.—of no use for H.T. purposes.

Speaking of direct current reminds me that large areas are still supplied with D.C. at 110 volts. A very large

this voltage. Push-pull, of course, is a great help here.

Earlier in this article I referred to a

A Very Nasty Business

However, use of the control soon disillusion the discriminating listener! No set I heard had adequate top-note reproduction with the tone control turned up to the fullest “high,” and as one turns the control what top there is is gradually extinguished, giving by the very absence of proper high-note reproduction an illusion of more bass. A very nasty business to the musically minded!

If, and I say *if* with emphasis, a set has too much top, then means can be adopted for reducing the top rendition. I described such a device for the benefit of WIRELESS CONSTRUCTOR readers at least two years ago, and it is interesting to note that many of the tone-control devices are made in exactly the same way.

To refresh readers’ memories, I will recall that the tone control described in these pages consisted of a condenser of about .004 or .006 mfd. in series with a continuously variable resistance of about 250,000 or 500,000 ohms.

THE STENODE’S SUPER-SELECTIVITY



The author of this absorbing article, Mr. Percy W. Harris is here shown operating the Stenode Radiostat, invented by Dr. J. Robinson (right). The set gives phenomenal selectivity, and is arousing great interest in America, where the interference problem is very acute.

Transatlantic Impressions—continued

this combination being placed across the output of the set.

If you think for a moment you will see that a resistance of, say, 200,000 ohms in series with .004 mfd. practically cuts it out of circuit, but if the resistance is lowered to a few hundred ohms then we have a state of affairs practically equivalent to shunting

well as needle scratch in radio-gramophones. The first is useful in long-distance listening with the volume control turned full on.

Interesting Construction Details

About the second, opinions differ, many people thinking that the advantage of reducing needle scratch

or flexible type with insulating coverings.

To distinguish them in assembly and fault tracing the wires are differently coloured according to their particular circuits, and connections are generally made with eyelets of the stamped variety, screwed under nuts which are held secure with shake-proof washers.

A MEETING OF THE MIKES



Interviews with sporting celebrities and running commentaries on games are greatly in demand by American listeners, and this photograph shows a typical grouping of microphones ready for a big broadcast of this kind.

the speaker with .004 mfd., a value of capacity which will very effectively by-pass a large proportion of the higher frequencies.

They Call It "Mellow"!

Between these two limits a wide range of by-passing is possible. Just such a device is the much advertised tone-control of modern American receivers. And a whole lot of people like it! They call the result "mellow!"

On the other hand, cutting off the higher frequencies also cuts off a lot of high-pitched background noise, as

is too highly paid for by the loss of brilliance in reproduction.

The constructional details of modern American receivers are very interesting to the home constructor. Stiff wiring has entirely disappeared, due in the main to the risk of broken joints due to vibration during transit from factory to dealer and from dealer to user.

All those wires which can run together without harm—and a surprising number can!—are bunched and "cabled" in flexible leads, and even the separated wires are of the stranded

Component Design

Chassis construction is universal, either aluminium or steel being used. Soldered connections are cut down to the minimum by careful design, and when you realise how much of the cost of a set goes in labour, the saving of a few joints and the reduction of assembly processes are very important manufacturing considerations.

Components are designed with ease of assembly in mind, and astonishing simplifications have been brought about in dozens of ways. Valve holders, for example, consist generally of five holes stamped out of a thin strip of bakelised fibre, or similar material, with thin brass stampings riveted on to the underside to form contact with the valve pins. You may think this shoddy manufacture, but such sets work well and give far less trouble in servicing than the older forms of construction.

Mains units are fairly well standardised in these days, and valve rectification is practically universal in factory-built sets.

America's "Midget" Sets

Of late, due to the financial stringency, and consequent reduction in spending power of the public, the so-called midget sets are becoming very popular. The American midget set is about the size of our larger cabinet loud speakers, and contains a five- or six-valve mains receiver with two or three stages of radio frequency, and a moving-coil loud speaker.

Single-control tuning is, of course, standard here, as in all other receivers, and the sets are made to work on small exterior aerials. Their range is limited in comparison with the larger sets, but they put up an astonishingly good performance for their price, which averages about £14 in English money.

The "PARATUNE" FOUR

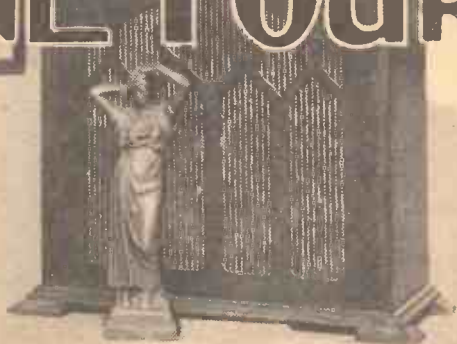

THERE are two intimate details which can be learnt about any wireless wave, and when you know one you know the other, or at least you can find the other in an extremely easy way. The two things, as many of you will know, are its wave-length and its frequency.

Importance of Frequency

The speed at which all radio waves travel is near enough for all normal calculations 300,000,000 metres per second. If, therefore, you know the frequency of a wave, namely, the number of times a complete wave-form is produced each second, you have only to divide this number into 300,000,000 to find the wave-length.

VICTOR KING

has "let himself go" in this magnificent all-wave design.

Employing an S.G. H.F. amplifier, detector, and two low-frequency stages, the set is capable of tremendous long-distance reception, combined with an enormous reserve of power for the loud speaker.

Outstanding features are "Paratune" selectivity, super-simple switching, differential reaction, smooth volume control, and wonderful ease in operation.

the longer the wave-length the lower the frequency, and vice versa.

It is really the frequency that is important, because the permissible closeness of two stations is determined by their frequency and not wave-length difference. This is the reason why there is the present tendency to replace wave-length calibrations by frequencies, and always to give both in lists of broadcasting stations.

On Twenty Metres

All this, you may say, is rather obvious, and without doubt you will be quite correct. But it leads up to a particular point which I want to bring out rather strongly.

Of course, if you know the wave-length you can find the frequency in a similar manner, because one is dependent on the other. Consequently,

A "PARATUNE" CIRCUIT FOR PARAMOUNT PERFORMANCE

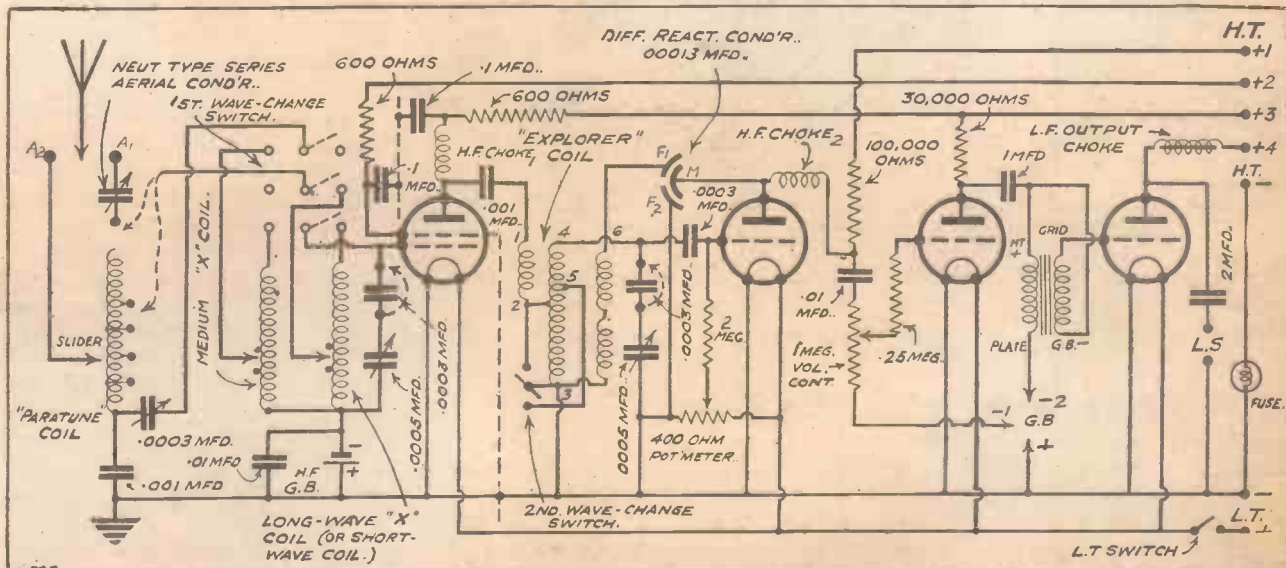

The "Paratune" coil (left), in conjunction with the "X" coils, tops after the S.G.'s input, while an "Explorer" coil links the H.F. stage to the detector. Very simple switching cuts out all bother of wave-changing and swings over to either wave-band with wonderful swiftness and ease. Moreover, the two quality L.F. stages develop phenomenal punch and purity. It's a set to swank about!

The "Paratune" Four—continued

It is this. While most constructors realise that the shorter the wave-length the higher the frequency, many do not know (or if they know they do not appreciate the significance of the fact) that the shorter the wave-length the larger the difference a change of one metre makes on the frequency.

15,000,000 from that on 300 metres. On the other hand, even when we have gone up as far as 1,800 metres, the difference in frequency from 300 metres is still less than one million.

Waves of the order of 15,000,000 frequency are highly-strung fellows, and liable to be completely upset by small things. For instance, as most

possible to obtain H.F. amplification on short waves with ordinary three-electrode valves.

With screened-grid valves, however, it is a different matter. With these valves and a properly designed set it is possible to obtain a noticeable degree of amplification as well as several other advantages.

Simplified Tuning

Chief among these other advantages is a considerable simplification of tuning, in that the controls become less critical and reaction does not seem to have to be pushed so far. The production of flat spots by the aerial is also less noticeable, and a general cleaning up of extraneous noises results.

I have gone rather fully into this matter of H.F. on short waves, so that you will fully appreciate my meaning when I say that the "Paratune" Four is a general-purpose receiver *par excellence*. It is a four-valver which is remarkably sensitive on all three wave-bands, and super-selective with wave-change switching on the broadcast ranges.

There are three big features combined in this receiver: S.G. H.F. on short waves, "Paratune" selectivity, and a coil using the "Explorer" system of wave-changing. Let us just inspect the theoretical circuit diagram together.

Ingenious Switching

By means of a three-pole change-over switch a very ingenious arrangement of wave-change switching is possible in the first tuned circuit. Two "X" type coils are employed, and the "Paratune" coil is automatically connected up in the right way on both bands.

On medium waves the "Paratune" coil is coupled to the "X" coil via the .0003 variable condenser, and, as you are probably aware, the "Paratune" system is used to give great selectivity on this band. When the switch is put over to the long-wave position the "Paratune" coil is coupled up to the long-wave "X" coil via one of the taps on it, and it seems to cut out any medium-wave interference that may be experienced.

On short waves the switch is set as for long waves, and the long-wave "X" coil is changed for an ordinary short-wave grid coil. The clip which

NOT A DIFFICULT SET TO BUILD

The sloping panel does not add any complications to the construction. Moreover, no special cabinet is needed, but the whole operation of the set is strikingly simplified.

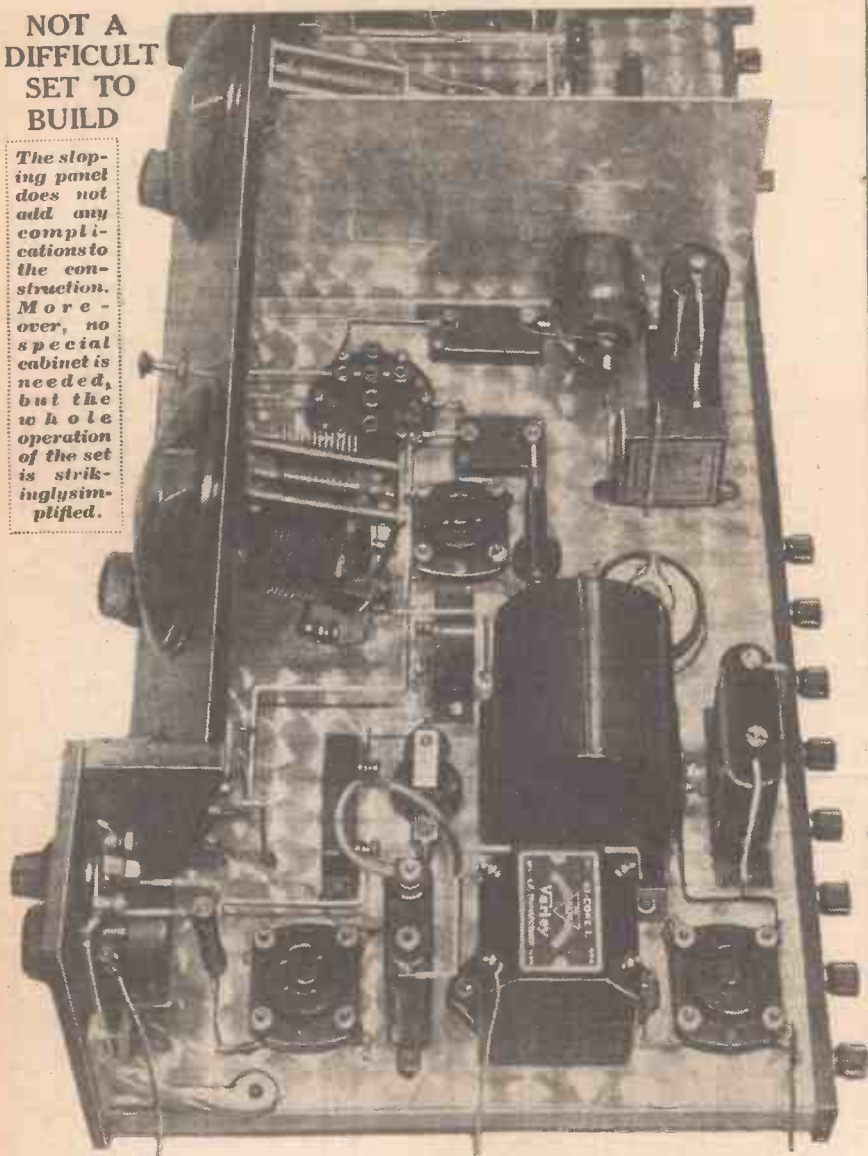

This view of the L.F. end shows clearly how the on-off switch and volume control are mounted on the side panel.

The result is that as we go down in wave-length from, say, 300 metres, the frequency changes at a much greater rate per metre than as we go up in wave-length from 300 metres. And when we have gone down to 20 metres we are dealing with a frequency with a difference of

of you know, only a very small change in capacity is necessary to tune in and out a short-wave station.

But this is not the only way in which a very small capacity will affect short waves, for very small capacities will often completely bypass them. That is why it was im-

The "Paratune" Four—continued

normally goes to one of the taps on the long-wave "X" coil is now clipped on to a suitable turn on the spaced short-wave grid coil, and the clip which is normally taken to one of the taps on the "Paratune" coil is clipped on to the unconnected terminal on the neut-

simple switch of the three-contact on-off type serves for changing from medium to long waves, and all that is necessary to change to short waves is to remove the 6-pin broadcast "Explorer" coil and insert a short-wave "Explorer" coil.

small copper strips connected across their terminals. One end of these has an ordinary hole in it, and the other is simply provided with a slot so that it can conveniently be removed from under the terminal without completely removing the terminal screw.

THESE ARE THE PARTS YOU WILL NEED TO MAKE—

- Ebonite panel, 24 in. × 7 in. (Goltone, or Red Seal, Lissen, Permeol, etc.).
- Cabinet for above panel size, with baseboard 10 in. deep (Pickett, or Camco, Lock, Kay, Osborn, etc.).
- 2 Panel brackets (Magnum, or Camco, Keystone, Ready Radio, etc.).
- 2 ·0005-mfd. variable condensers (Lissen, or Lotus, Ormond, Ready Radio, Igranic, Dubilier, J.B., Polar, Formo, Burton, etc.).
- 2 Geared dials, if above condensers are not of slow-motion type (Lissen, or Ready Radio, Igranic, J.B., Ormond, Formo, Brownie, Lotus, etc.).
- 1 Solid-dielectric type ·0003 variable condenser (Ready Radio, or Burton, etc.).
- 1 Three-pole change-over switch for panel mounting (Wearite, or Utility, etc.).
- 1 Three-point "on-off" wave-change switch (Bulgin, or Ready Radio, Wearite, Lissen, Ormond, Magnum, Red Diamond, Pioneer, etc.).
- 1 ·00013-mfd., or larger (up to ·0002-mfd.), differential reaction condenser (Lotus, or Igranic, Ready Radio, J.B., Dubilier, Parex, Ormond, etc.).
- 1 1-megohm three-terminal type volume control (Gambrell, or Igranic, Lissen, Varley, Rotorohm, etc.).
- 1 L.T. switch (Benjamin, or Goltone, Ready Radio, Igranic, Ormond, Bulgin, Lotus, Magnum, Wearite, Red Diamond, Lissen, Junit, etc.).
- 1 "Paratune" coil unit (Home-made, or Ready Radio, Wearite, etc.).
- 2 Single-coil holders (Lotus, or Bulgin,

- Igranic, Magnum, Wearite, Lissen, etc.).
- 1 6-pin coil holder (Wearite, or Leweos, Magnum, Keystone, Colvern, etc.).
- 1 Neutralising type condenser (Bulgin, or J.B., Magnum, Igranic, Lissen, etc.).
- 1 600- or 500-ohm resistance and holder (Ready Radio, or Magnum, Parex, Wearite, Keystone, etc.).

- 3 ·0003-mfd. fixed condensers (Formo and T.C.C., or Ferranti, Telsen, Ediswan, Dubilier, Lissen, Igranic, Ready Radio, Mullard, Watmel, etc.).
- 2 ·001-mfd. fixed condensers (Lissen and Dubilier, or Telsen, etc.).
- 2 ·01-mfd. fixed condensers (Lissen, or Dubilier, T.C.C., etc.).
- 2 ·1-mfd. fixed condensers (Igranic, or T.C.C., Lissen, Hydra, Dubilier, etc.).

—A MAGNIFICENT SET



An unusually high degree of stateliness is given to the receiver by the sloping centre panel.

- 1 1-mfd. fixed condenser (Dubilier, etc.).
- 1 2-mfd. fixed condenser (Ferranti, etc.).
- 1 400-ohm baseboard-mounting potentiometer (Igranic, or Ready Radio, Lissen, Wearite, etc.).
- 1 L.F. transformer of medium ratio (Varley, or Telsen, Ferranti, Lissen, R.I., Lotus, Igranic, Mullard, Leweos, etc.).

- 1 600-ohm Spaghetti resistance (Magnum, or Ready Radio, Bulgin, etc.).
- 1 30,000-ohm Spaghetti resistance (Bulgin, or Ready Radio, Magnum, etc.).
- 1 100,000-ohm anode resistance and holder (Igranic, or Varley, Dubilier, Lissen, Mullard, etc.).
- 1 2-megohm grid leak and holder (Graham Farish, or Lissen, Dubilier, Igranic, Ediswan, Ferranti, Mullard, etc.).
- 1 25-megohm grid leak with terminals at ends (Lissen, etc.).
- 1 Valve holder to take valve horizontally (W.B., or Junit, Bulgin, etc.).
- 3 Ordinary sprung-type valve holders (Benjamin, or Igranic, Lotus, Lissen, W.B., Bulgin, Junit, Formo, etc.).

- 1 Output choke (Atlas, or R.I., Igranic, Varley, Wearite, Ferranti, Lissen, Bulgin, etc.).
- 2 H.F. chokes (Leweos and Telsen, or R.I., Dubilier, Lotus, Varley, Igranic, Ready Radio, Wearite, Keystone, Parex, Watmel, Magnum, etc.).
- 1 10 in. × 6 in. standard metal screen with hole for valve (see photos) (Parex, or Ready Radio, Wearite, Magnum, Keystone, etc.).
- 1 Ebonite strip, 24 in. × 1½ in.
- 12 Insulated terminals (Belling-Lee, or Igranic, Eelex, Clix, etc.).
- Piece of copper sheet, 25 in. × 11 in. (Parex, or Ready Radio, etc.).
- Pieces of aluminium sheet, wood, flex, battery plugs, wire, screws, spring clips, etc.

ralising condenser. This terminal is marked "X" on the wiring diagram.

An ordinary "Explorer" coil is used for coupling purposes between the H.F. and detector valve. Here a

The two fixed ·0003 condensers in series with the tuning condensers for reducing the effective tuning capacity on short waves are short-circuited for both broadcast bands by means of

You will note that a ·00013-mfd. differential reaction condenser is employed, and it is not advisable to use one of smaller capacity than this. The reason is that on short waves a

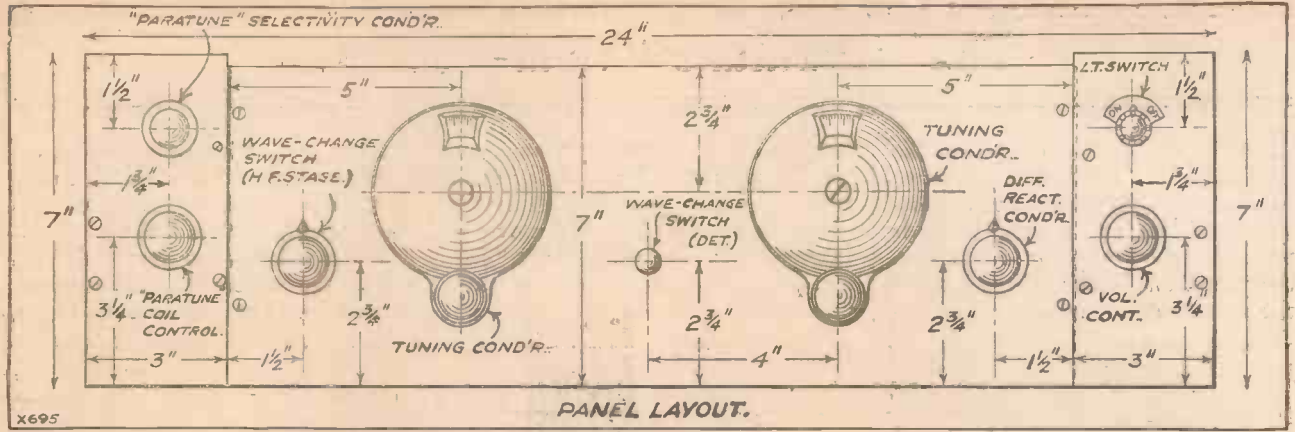

X695

The controls (above) are self-explanatory, while the photograph shows how the valve protrudes through the screen. The under-baseboard wiring is depicted below.

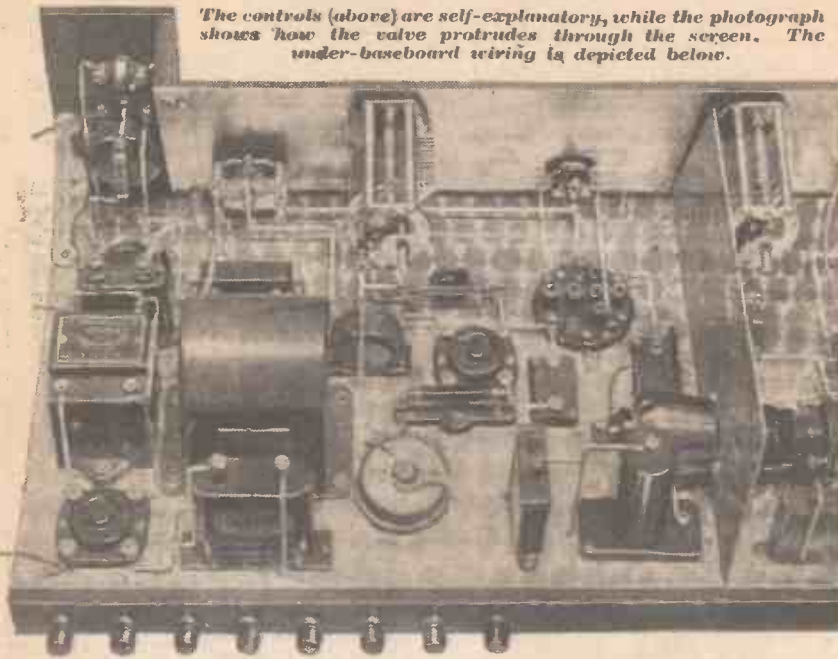

The lines denoting the under-baseboard wiring in the diagram are shown dotted because the baseboard is to be regarded as transparent, and the sketch shows how these leads would then appear as you looked down on the set.

reaction capacity a little above the average for broadcast sets is often necessary to get sufficient feed-back over the whole short-wave band.

The L.F. end of the set consists of one R.C. stage followed by a transformer-coupled stage, with very special anti-instability precautions. These you will see consist of parallel feed to the transformer, which incidentally enables the latter to be arranged as an auto-choke, a grip stopper for the first L.F. stage and an output filter circuit.

Particularly Good

Filter circuits of the resistance-capacity type are also provided in the screened-grid valve's H.T. supplies. The result of all these precautions is that quality is particularly good, and the set should work on almost any mains unit without giving trouble of the instability type.

A potentiometer is provided for adjusting the bias on the detector valve so that really smooth reaction

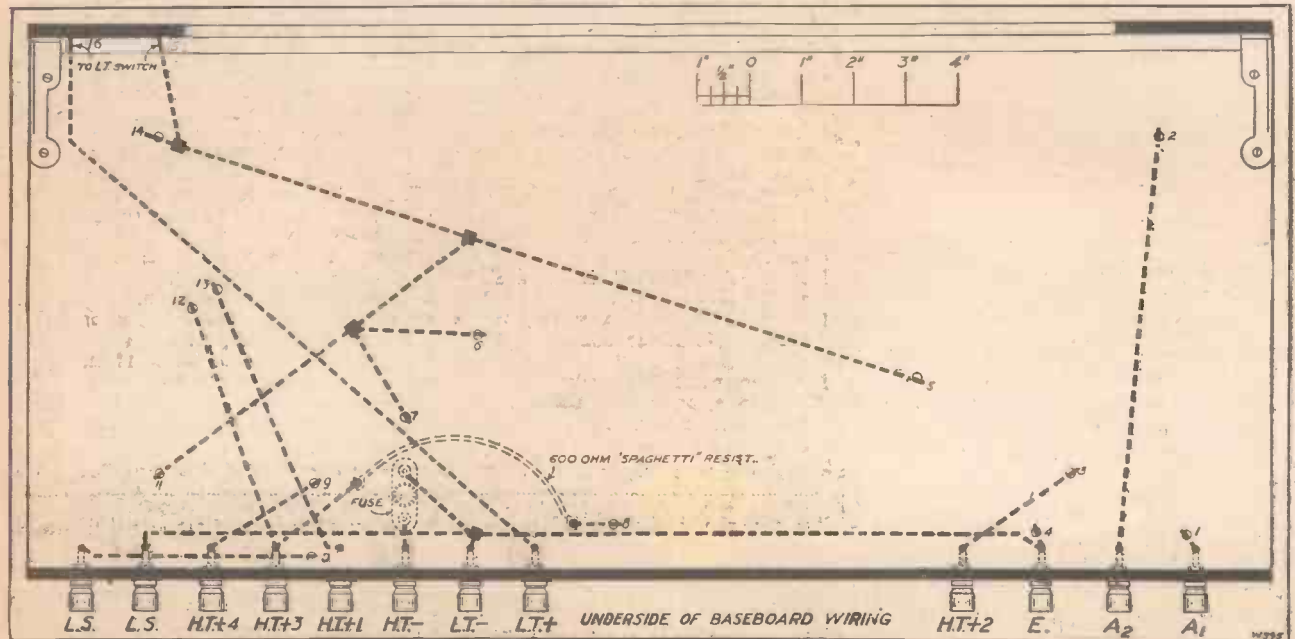

The "Paratune" Four—continued

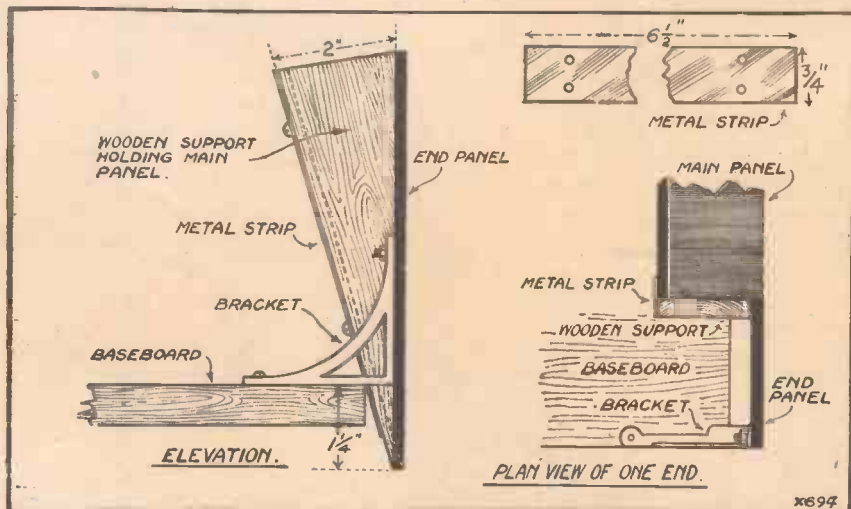

Above are shown the details for "setting back" the sloped panel, which is not half so difficult a task as might at first be imagined. Note that the baseboard is raised a little to allow for under-baseboard wiring.

may be obtained on all wave-bands. The .0003 variable "Paratune" condenser provides an easy means of adjusting the degree of selectivity on medium waves.

So much for the circuit arrangement, and now a few words about the general design of the set.

You will have spotted that the exterior of the set presents a particularly imposing appearance, due to the fact that the main part of the panel slopes backwards from bottom to top.

This effect is obtained simply by cutting two strips off the ends of the panel, each strip being 3 in. wide. The centre part of the panel is held to the end pieces by means of two wedge-shaped pieces of wood and two strips of metal.

Sub-Baseboard Wiring

The end pieces are in turn held to the baseboard by panel brackets and screws. A special diagram is provided of the details of this assembly, which should make them quite clear.

The baseboard is arranged so that its top surface is 1 1/4 in. above the bottom edge of the panel, which enables much of the wiring to be carried out underneath it. The whole top surface of the baseboard is covered with copper sheet, which is earthed, and to which all points to be connected to L.T.—are joined direct.

This sub-baseboard wiring and direct earthing both help to make the back-of-panel appearance neat and straightforward, in spite of the elaborate nature of the set.

If you glance at the wiring diagram you will see that all the wires which pass through the baseboard are numbered at the points where they disappear. These numbers correspond with those on the sketch of the baseboard which shows the sub-baseboard wiring.

This diagram is drawn as though the baseboard were transparent and you were looking through it. You will therefore have no difficulty in following out the complete wiring of the receiver.

Of course, you must be particularly careful that the wires are well insulated where they pass through the

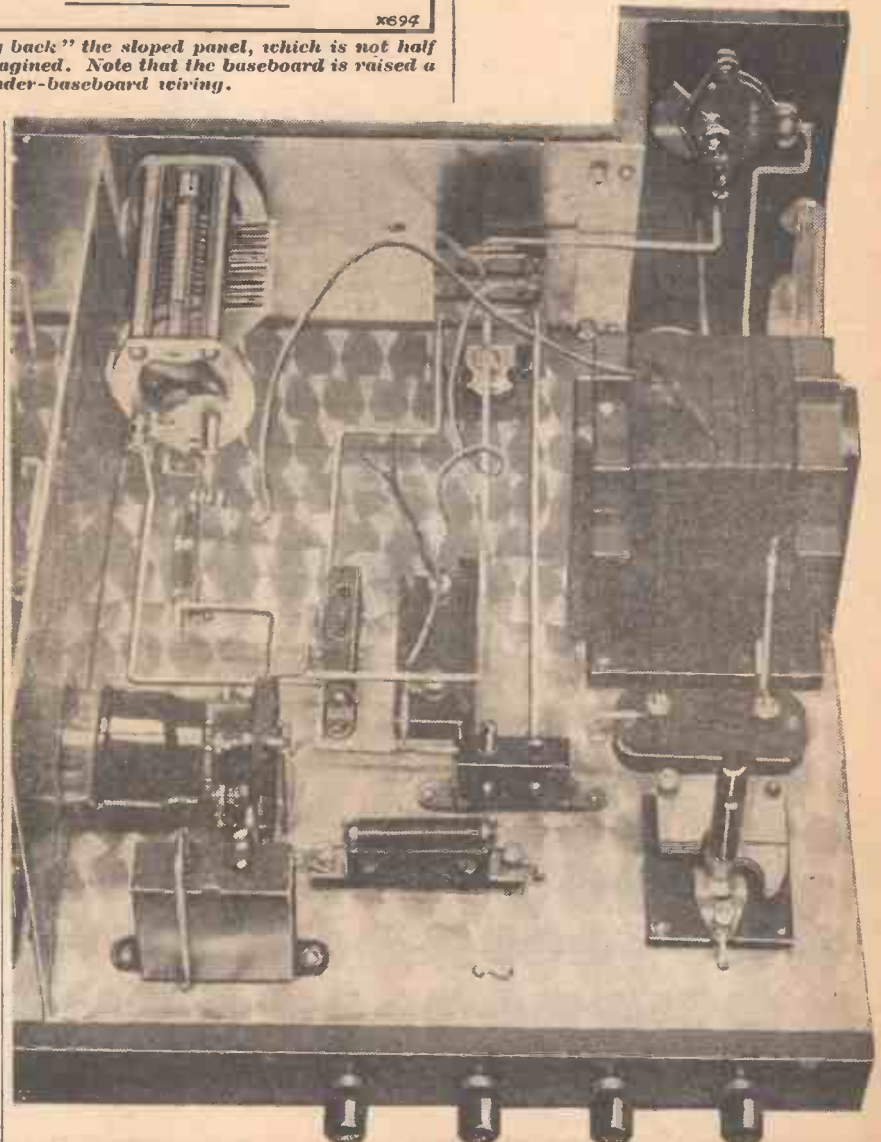

Spacing at this—the high-frequency—end of the set is supremely important, and it will be seen that there is plenty of room for every component and ample space for the wires. The two leads from the fixed condenser in the centre of the picture are for H.F. grid bias. (See wiring diagram.)

The "Paratune" Four—continued

copper sheet on top of the baseboard, otherwise you will have all sorts of shorts occurring, which may cause a lot of trouble and possibly injure some of the components. It is as well to interspace a piece of cardboard between those components which have bare metal parts on their underneath, and the copper sheet. This is also to avoid shorting troubles.

The diagrams are sufficiently comprehensive to show the constructional details of the receiver without much amplification. There are a few points worthy of mention, however, and these are dealt with fully in the following paragraphs.

experienced constructor, who no doubt will be able to solder.

Still, there is no reason why the inexperienced should not tackle it, and if you are unable to solder you can make the connections to the copper sheet by means of brass screws and washers to clamp the wires in place. Don't forget that the copper sheet may quite likely be lacquered, and it is necessary to remove this lacquer at the point where the wires are to make contact with the copper.

All the joints which are soldered are shown by small black squares on the wiring diagram. Incidentally,

sheet, which, of course, can be very thin.

Actually, the latter need not have extended beyond the "Explorer" coil holder, but since it makes a convenient earthing point for many connections and improves the set's appearance it has been carried over the whole baseboard.

Home-Made "Paratune"

The "Paratune" coil employed is a "home-made" one, but, of course, commercial types can be used. On the latter a terminal instead of the flex pigtail would be provided for making connection to the slider.

INDICATING A FEW OF THE SALIENT FEATURES OF THE SET

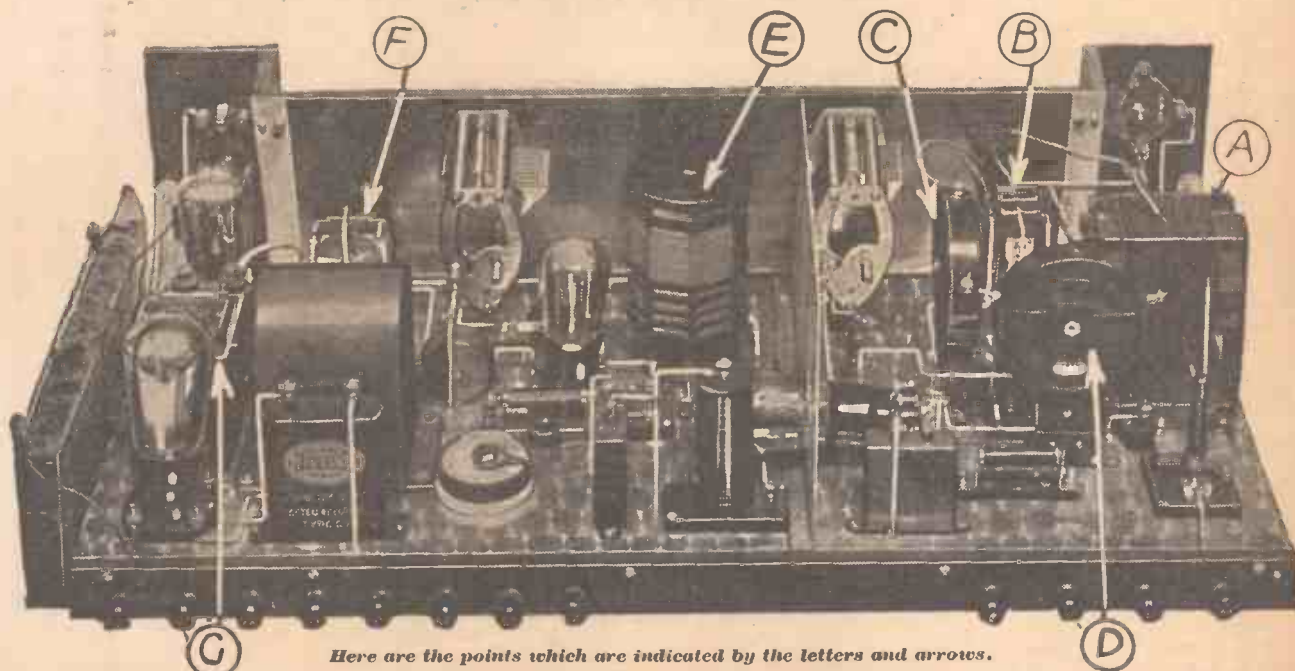

Here are the points which are indicated by the letters and arrows.

(A) is the "Paratune" coil, which gives selectivity and cuts out medium-wave interference on the long waves. (B) is the special wave-change switch that automatically changes over from the medium-wave coil (C) to the long-wave coil (D), and changes round the "Paratune" coil. (E) is the dual-range "Explorer" coil; (F) the differential reaction condenser, and (G) the L.F. transformer arranged on the shunt-fed principle.

The two Spaghetti resistances, one of which is underneath the baseboard, have had wires soldered direct on to their terminal tags. These tags are connected up to the actual resistance element simply by being pinched tightly on to it. Consequently no harm can be done by heat being applied to the tags for soldering purposes.

Need Not Solder

Nevertheless, if you desire, you can make the connections with nuts and bolts instead of soldering. But we would like to point out that the set has been designed mainly for the

the removal of any lacquer on the copper sheet which covers the baseboard is very necessary along the part where the vertical screen is screwed to it, if a special earthing connection is not made as shown in the wiring diagram.

This vertical screen, which must be cut to the right shape and height of 5½ in. after purchase, provides the main screening between inductances and other components in the grid and anode circuits of the H.F. valve. But by itself it would not be sufficient, and this is the reason why the baseboard is covered with copper

This flex is soldered to a piece of stiff wire which emerges from the baseboard at the point labelled 2.

In the original set the holes in the ebonite for the bolts which hold the panel brackets to it, and the screws and bolts which are used to fix the pieces of ebonite together, were all heavily countersunk, so that when the screws and bolts were in place there was room to cover their heads up with heel-ball. This is not, of course, essential, but if done very carefully improves the appearance.

(Final details of construction and operation will be found on pages 331 and 332.)

ADAPTOR ADAPTATIONS

Some further uses of the "Kelsey" Adaptor for short waves which was described in our last issue.

By G. T. KELSEY.

FOLLOWING upon the publication of the "Kelsey" Adaptor in the last issue of WIRELESS CONSTRUCTOR, some interesting queries have been received from readers, one of which was: "Can the adaptor be used alone as a single-valve short-waver?"

Now at first sight there would not appear to be very much point in using the adaptor alone, because one of the outstanding features of this little short-wave unit is the fact that it is designed for use in conjunction with your present set.

Used as a One-Valver

Yet when you consider the matter, if without alteration the adaptor can readily be converted into a self-contained single-valve short-waver it would seem to be quite a useful feature. Because there are bound to be times (probably quite often, if the family have any say in the matter!) when the ordinary set is not available to "loan out" its L.F. stages for ether searching on short waves.

Naturally, there is the drawback that when the adaptor is used on its own as a single-valve unit, the range of reception will be somewhat limited. Yet even when using it alone I was surprised to find that with only a short length of wire slung across a ground-floor room as an aerial, I could still hear signals quite well from some of the more powerful Continental short-wave broadcasters.

Easily Connected

It is for this reason that I propose to tell you how it can be used alone, so that you, as well as my correspondents, can if you choose operate the adaptor quite independently. Naturally, you mustn't expect under these circumstances to hear the more distant short-wave transmissions which, when used in the orthodox manner, the adaptor is capable of receiving.

The most convenient form of an "Adaptor for the Adaptor" is an arrangement similar to that shown in the diagram on this page.

It consists of a baseboard on which are mounted vertically two small ebonite supports for the actual adaptor. An ordinary valve holder

placed between the ebonite supports provides a ready means of connecting the adaptor—via its plug—to the necessary batteries.

So that apart from having to join up the batteries it is no more trouble to use the adaptor as a single-valve short-waver than it is to use it in the normal manner as a converter for your ordinary broadcast receiver.

One of the other points raised by a correspondent which is likely to be of interest to all those readers who have

The arrangement as it is at present covers the most interesting of all short-wave bands, and incidentally the one on which almost all of the really distant broadcasters are to be found.

But providing some simple plug-in arrangement is used to make the coils interchangeable (ordinary valve pins and sockets well spaced on ebonite mounts constitute one of the most efficient ways) there is no reason why the range of the adaptor should not be extended to cover all stations up to 90 or 100 metres.

Up to 100 Metres

The existing coil will go up to approximately 47 metres, and for the band between 47 and 100 metres a coil wound on a similar former consisting of 10 turns (spaced) for the grid coil, with 8 turns for reaction

HOW THE CONNECTIONS ARE MADE

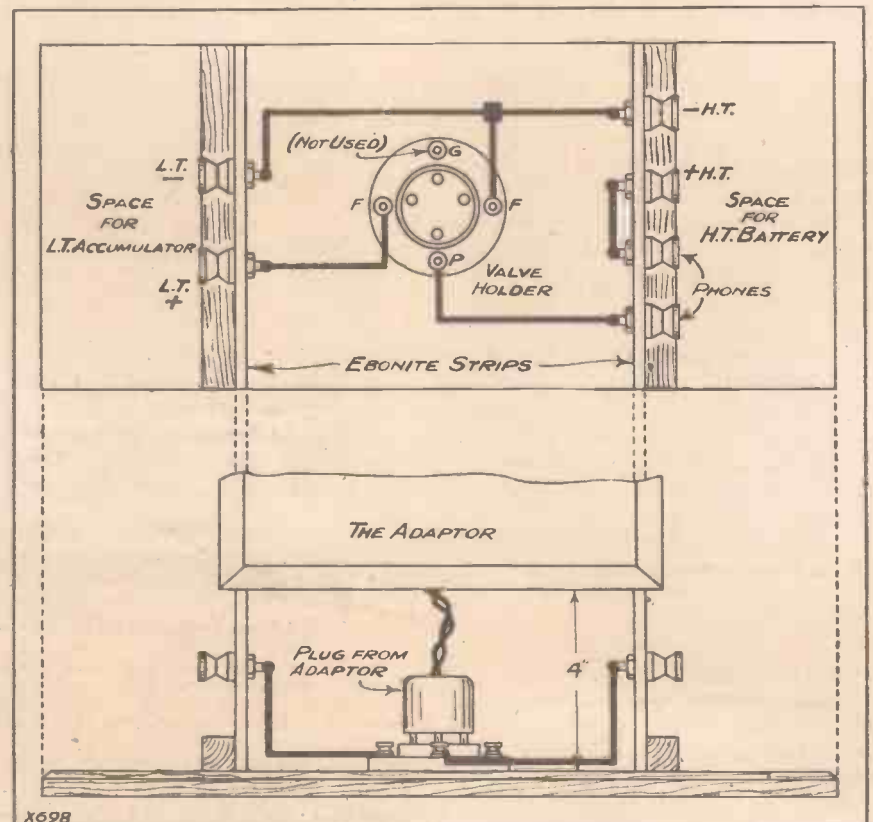

The two side supports enable the adaptor to stand above the valve holder in which its plug is placed. As will be seen, the constructional work involved is of the very simplest type, four or five wires being sufficient to connect up the six terminals.

built, or who are building, the "Kelsey" Adaptor is that of receiving on waves other than those covered by the coil described in the original article.

It is rightly pointed out that there are many short-wave stations transmitting on waves above 50 metres, which, of course, are outside the range of the present coil.

(both coils of No. 20 tinned copper wire), will not be very far out.

In joining the ends of the coils to the pins be careful to see that the connections are carried out in such a way that the windings are in the same direction as the coil in the original version, otherwise you may have trouble in getting the adaptor to oscillate.



VALVE VAGARIES

Do your valves ever "play you up"? Here are some interesting experiences with freak specimens of valves. Such occurrences as are mentioned are rare, of course, but their recounting makes interesting reading.

By G. W. EVANS.

VALVES are funny things. I don't mean they sit up and laugh at you when you open the lid of your set and have a peep inside, but they have their own peculiar whims and fancies almost as if they had personalities of their own.

The Whistler!

For instance, would you ever think it possible that a valve should whistle at you? Seems silly, I know, but I really mean *whistle*. I have. I came across one only the other day.

It was in a four-valve set, and a peculiar sort of heterodyne whistle seemed to be emanating from the outfit. A most annoying whistle it was, and whatever one did to the tuning it remained perfectly steady and fairly loud.

Of course, the speaker was suspected; and then, as that proved not to be the culprit, the transformers; for they do occasionally make noises, though not usually whistles. Finally it was proved to be the S.G. valve. There it was, whistling away on its own and nothing would stop it.

Naturally, it was a faulty specimen and was not working in a radio sense at all—merely whistling. I have never come across one before (though I have encountered S.G.'s that buzzed), and I don't suppose I ever shall again!

A Buzzer, Too!

Why it behaved in that peculiar manner I have not the slightest idea, but if you are ever troubled by a set that whistles at you, just listen at each valve—it *might* be one of them, though they are not usually addicted to faults of this nature.

Another S.G. I had behaved perfectly for many months, and then one day I noticed a peculiar buzzing sound on certain notes, a noise almost like that caused by grid choking, though not quite the same. The

loud speaker was behind the set and fairly near it.

I opened the lid, and as I did so was greeted by another buzz from the speaker, and apparently also from inside the set.

As is my wont when visited by a phenomenon of this sort, I began banging about round the set. Hammering on the lid with my fists sometimes produced the buzz and sometimes it didn't. Then I began tapping the valves, getting a nice musical ring from the valves themselves (not the speaker) on all except the first S.G. This caused a colossal buzz in the speaker.

Caused by Vibration

I took it out and replaced it with another and the trouble was cured. On tapping the valve out of the set it gave a slight buzz from its interior anatomy, and that was that. The valve worked quite well as long as

it was free from all vibration, but otherwise would cause intermittent buzzing, and so it had to be discarded.

Some Queer A.C.'s

You will be beginning to think that even the much-praised modern valve is rather an unreliable affair, and that purchasers are apt to be the victims of a hit or miss selling policy. That is emphatically not the case. Some of the valves I get hold of are first factory samples, freaks sent to me from firms as a matter of interest, and all kinds of unreliable makes. The good British makes are very rarely at fault, and if you should be so unlucky as to get a dud the firm will always be ready to put the matter right.

Such was the case of a friend of mine who thought he had a couple of "wonky" A.C. mains valves. They worked well for a time and then there was a peculiar *fizzing* noise and

A FAMOUS SHORT-WAVE STATION

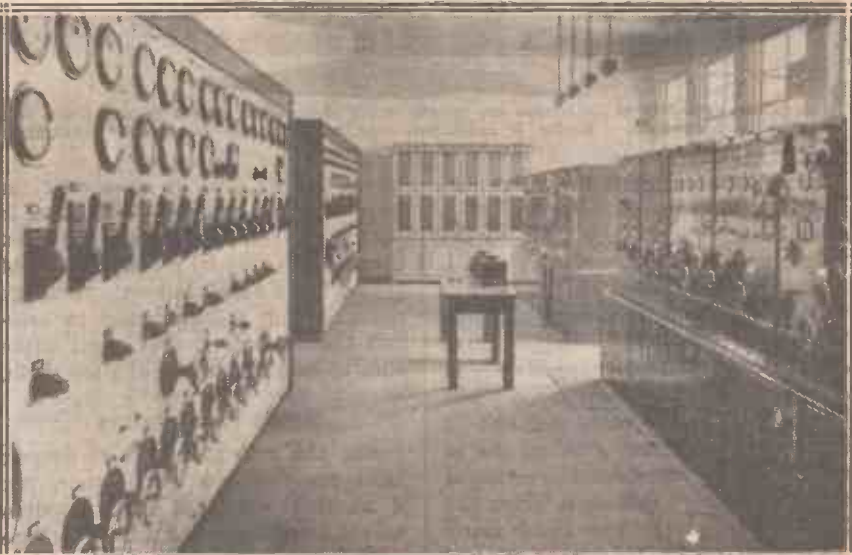

Two of the Telefunken short-wave transmitters in the giant commercial station of Nauen, one of Germany's first radio centres.

Valve Vagaries—continued

reception was interrupted. Then everything would be normal again, perhaps for days or weeks.

As the trouble kept coming on, sometimes several times in an evening, he sent the valves to me. I tried them with milliammeters and voltmeters in a set and for days they behaved perfectly. I was going to give them back to my friend and tell him not to be silly, but he swore they would "do the dirty" on me sooner or later, and I kept them.

So Blue!

He was right. One evening, without warning, one of the valves (an L.F. type) "went wild," the fizzing started, and the milliammeter leapt from 4 to 10 milliamps, and stayed there till the bout of hysterics was over.

The second valve followed suit some days later, and finally I sent them to the makers, with the request that they would test them carefully as I thought they were suffering from faulty cathode-heater insulation.

After prolonged tests they agreed that such was the case, and that the shorting, or partial shorting, only

If the results are good I should not worry about it, especially if the valve is consuming its normal anode current, but if the blue glow is accompanied by a rushing or breathing sound things are not so healthy.

Rough Treatment

"Blue glow" can be brought on in quite "hard" valves by means of too much H.T. I have had two perfectly good P.X.4's which gave excellent results on 200 volts—their proper anode voltage—and stood up to 300 volts with plenty of bias without a murmur for a long time. At any increase, however, they "blue glowed" beautifully, and, after all, who can blame them?

Power pentodes will also "blue" if badly treated, and in fact it is a dangerous thing to pile up the volts on a pentode. I have, in valve test work, put on the volts to such an extent that flash-overs have occurred between the electrodes. Here again one cannot blame the valves or the makers.

Everything has a limit, and the modern radio valve will usually stand

because of their peculiarity, and so I have recorded a few of the unusual valve happenings I have come across.

And now let me introduce to you three of the latest additions to the

THE APRIL "WIRELESS CONSTRUCTOR"

WILL BE ON SALE

MARCH 14th

Sixpence. Obtainable Everywhere.

vast family of British valves. I refer to the P.M.2A. (Mullard), and the L.P.2 and P.2 (Marconi and Osram).

These are valves of fine mettle, full of punch, and threatening to take the laurels from the A.C. indirectly-heated valve in the matter of mutual conductance. The P.M.2A. has a slope of 3.5, an impedance of 3,600 ohms, and takes 150 volts H.T., at which figure and about 6 volts grid bias it is remarkably economical. The slope shows what a wonderful punch can be obtained from it—and it is a two-volter that consumes only .2 amp. l

The L.P.2 and P.2

The L.P.2 is the new 3,900-ohm impedance two-volter, which has a magnification factor of 15, and takes only 11.5 milliamps at 150 volts H.T. and 4½ volts grid bias. For portable sets where low H.T. consumption is essential the makers advise 6 volts grid bias when the anode current falls to 6.8 milliamps.

The P.2 is a bigger brother, having an impedance of 2,150 ohms and a magnification factor of 7.5. It takes 17 milliamps at 150 volts H.T. and 10½ volts grid bias, a low or "economy" figure for portables being given as 10½ volts at 125 volts H.T., at which figures only 9 milliamps are "consumed."

Really Reliable

Some valves, are they not? And they are good illustrations of what the valve manufacturers are doing to advance radio. And, what is more, they are not a bit moody, and the title of this article, applicable as it is to the earlier portion, is not at all suitable when considering these three valves. Vigorous they are, perhaps, but not vagarious

RADIO ON A SPEED-BOAT



A peculiar speed-boat in which an enthusiastic American hopes to sail from Los Angeles to Honolulu. Radio is installed, and, here we see the owner making a preliminary telephony test.

became apparent after the valve had been in use for some hours at a stretch. Of course, they replaced the valves and all is well again.

Some readers have written to ask why their A.C. valves "go blue," or "give off a blue light." They refer, of course, to the well-known phenomenon of "blue glow." If this is very bad it means that the valve is "soft"; it contains too much residual gas in the "vacuum" and should be returned to the makers. But more often the blue glow is quite in order and in many cases disappears after a week or so of use.

about 25 per cent or more over the proper anode voltage (with bias to match, of course) without the least murmur. Often 50 per cent does not "hurt" the valve, but set owners are naturally not recommended to over-run their valves if they want to be sure of long and useful life for them.

Some Newcomers

But the present-day valve doesn't have many whims; or, rather, put it another way, not many modern valves have whims at all. It is rare to find cases such as I have depicted. But rareties are interesting if only



The Talks War—Radio Circles—Economy in the B.B.C.—Cecil Lewis Back—Philip Ridgeway Again—Adult Education—Broadcasting House Construction—B.B.C. Publications—A Publications' Syndicate.

By OUR SPECIAL COMMISSIONERS.

The Talks War

THE eternal problem of resolving the organisation of the Talks Department at Savoy Hill has advanced another stage. There are now three Talks Directors, namely, Miss Matheson, Mr. Charles Siepman, and Miss Mary Somerville, the two latter being promoted to status equivalent to that of Miss Matheson, formerly head of the department.

"General" Talks are being handled by Miss Matheson, Adult Education by Mr. Siepman, and School Talks by Miss Somerville. A new element of competition has been introduced, because there are certain periods for which all three can scramble, and it will rest with Mr. Roger Eckersley to determine the victor.

It remains to be seen whether the programmes will benefit. My view is that about half the talks are very good indeed; that about a quarter are just tolerable, and that the remaining quarter are defective.

The right policy, therefore, would be to reduce talks time by about a third and insist that the two-thirds should be as good as the present half. Any time saved should go to music; always infinitely preferable to mediocre or inferior "yap."

Radio Circles

At the end of 1930, memberships of Radio Circles were as follow:

London and Daventry ..	44,268
Midland	8,622
North Region	11,204
West Region	3,453
Scottish Region	4,020
Belfast Station	711
Plymouth Station	3,002
TOTAL ..	75,280

These Radio Circles of children with small subscriptions and badges keep up extraordinarily well. It was believed that they would not survive the passing of the old multiple station regime, but they are going as strong as ever in the regions.

But Savoy Hill appears to have divided opinions about their value. There is a tendency to blow hot and cold. The right line would be to give these organisations every possible help and encouragement. They are a vast nursery of permanent goodwill.

Economy in the B.B.C.

Sir John Reith's reputation for careful administration and exacting supervision of detail is such that one

"queries" and investigations of claims of all kinds.

It would be a bad day for Government departments if the B.B.C. were to come under the review of the Parliamentary Committee on Public Accounts; bad because of the much more stringent economy and supervision of the B.B.C. system, which would then be applied generally.

Cecil Lewis Back

Cecil Lewis, whose activities at Savoy Hill have been conspicuously absent for some months, is producing one of George Bernard Shaw's plays, "You Never Can Tell," for broadcasting in March. Later on he will be responsible for the production of "The Italia," a translation of the

O.B.'s ABROAD

Broadcasting a description of the Wilno (Poland) Fair. This fair is an annual event that creates vast enthusiasm among the population of all the surrounding towns and villages.



would not expect to find much wrong with this side of the work of the B.B.C. Nor is there. Every now and then there is a general "stir up."

Such apparently trivial things as paper-clips are issued more sparingly. Expenses are scrutinised jealously, and there is a good deal of heart-burning as a result of the frequent

German play on the crash of the Italian airship during its ill-fated trip to the North Pole.

Philip Ridgeway Again

Thousands of listeners will be pleased to learn that Philip Ridgeway has been commissioned to produce another series of his inimitable light

Savoy Hill News—continued

feature entertainments during the spring. Details to be announced later. One wonders whether André Charlot will be induced soon to give another microphone series. The last one was certainly a great success.

Adult Education

That portentous body, the Central Council for Broadcast Adult Education, which is the professional aid to the B.B.C. in part of its educational work, is becoming restive. The Council claims that its work should be governed by definite pledges and guarantees given by the B.B.C. as the result of the Hadow Report.

demands sufficiently to make it worth their while to continue in existence.

Broadcasting House Construction

There has been a good deal of ill-informed speculation about who are actually handling the job of the erection of Broadcasting House in Portland Place. The finance is in the hands of a big syndicate, the moving spirit of which is Captain Robert B. Solomon, M.C., whose residence at No. 14, Holland Park Road is one of the most magnificent mansions of London.

The syndicate's architect is Lieut.-

B.B.C. Publications

There are again rumours that the B.B.C. may solve its financial difficulties by capitalising its publications in some way which will leave a capital sum of the order of a million sterling, and a subsequent annual revenue of about £100,000.

It appears that the publications of broadcasting are now making about £200,000 a year. This is very useful for programmes while the Treasury is helping itself to about £350,000 of licence money, apart from the Post Office's 120,000 odd for collection and "administration."

But the need of ready cash for capital outlay is extremely pressing. The B.B.C. is naturally anxious to get the Regional stations completed as soon as possible. So far, financial stringency has imposed a slow pace: one station at a time, with a year or eighteen months elapsing between the openings.

This is far too slow considering the demands of listeners and the more rapid developments abroad. Therefore, the B.B.C. would like to put the Scottish and West Regional and Belfast stations in hand simultaneously. But this would require a great deal more money than is available from current revenue.

A Publications' Syndicate

There are State policy reasons against a public loan. So the publications have come under review as a possible means of securing capital. The idea is either to farm out the publications to an established publisher or grant a concession to a subsidiary company formed for the purpose, probably in co-operation with an established publisher and a financial syndicate of the kind represented by Captain Robert B. Solomon, M.C., for the construction of Broadcasting House.

Apparently, there has been so far only preliminary discussion of this proposal, but much more may be heard of it before the year is out. At least one B.B.C. Governor is known to be strongly in favour.

TESTING A NEW TRANSMITTER TRAILER

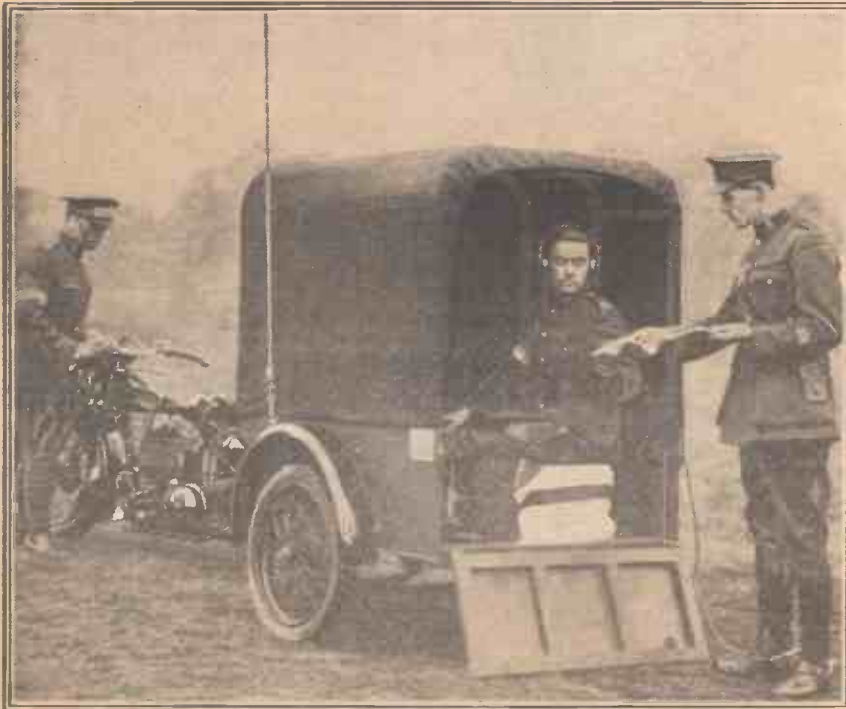

Army signallers testing one of the new radio outfits that are carried in trailers drawn by motor-bikes. Note the folding aerial mast in position at the side.

The B.B.C., on the other hand, is equally restive on this matter. To implement the policy of the Council means a good deal of rigidity in programme arrangements. Courses have to be settled a long way ahead; times allotted without elasticity; and a steady increase of educational grimness in the programmes results.

All these things are regarded at Savoy Hill as bad for programme building. The conflict of view is clear, and it is not apparent yet whether the council will modify their

Col. G. Val Myer, A.R.I.B.A., who is regarded as the most brilliant and successful of the school of architects who concern themselves particularly with modern office buildings. Apart, of course, from contractors, the other most important factor in the business is the civil engineer to the B.B.C., Mr. W. T. Tudsbery, who is making a name for himself on this job. Mr. Tudsbery is one of the select few who are members of the Athenæum by "prescriptive hereditary right."

NEXT MONTH

An important announcement of vital interest to all radio enthusiasts will be made in the

"WIRELESS CONSTRUCTOR"

On Sale March 14th.

Price 6d.

THE "BRYTA-TONE" AMPLIFIER



PROBABLY one of the first things that will occur to you regarding this new amplifier of ours will be to query the need for it nowadays when pretty well everyone seems already to be in possession of a receiver that will give adequate loud-speaker results.

As a matter of fact, there are several very sound reasons. And when we have told you some of the various uses to which the "Bryta-Tone" amplifier can be put we feel sure that you will agree with us when we say that it is one of the most universally applicable amplifiers that has ever been designed.

First of all, do you remember that rather remarkable loud-speaker design which was fully described in the January issue of this journal? We refer to the "Brytacone," which, as was explained at the time, was a design likely to satisfy even the most critical ear in matters of fidelity of reproduction.

Realistic Results

But, as most of you know, it is not a bit of good to make a loud speaker and expect realistic results unless you can first be certain that each link in the chain constituting your receiving outfit is doing its job properly.

If for any reason distortion is occurring in your amplifying arrangements, then contrary to effecting an improvement, the use of a "Brytacone" (or, for that matter, any other really good loud speaker) will in all probability make matters worse, because for one thing it will result in the distortion being reproduced more faithfully!

A first-class amplifier for quality loud-speaker results that has several distinctive and attractive uses. But although it is capable of really high-grade results, it is an exceptionally inexpensive instrument. Read about it—you may then find that here is just the thing you have been looking for.

Designed and Described by the "Wireless Constructor" Technical Staff.

True, these remarks can hardly be said to apply to readers who are using receivers designed during the last twelve months or so. In the case of every single one of the WIRELESS CONSTRUCTOR designs during that period very special attention has been

given to the arrangement of the amplifying stages.

But the use of a "Bryta-Tone" to replace the amplifiers in a more or less obsolete design will bring about an improvement with which you will be more than pleasantly surprised.

"Outer-Circle" Listeners

That is just one of the reasons which prompted us this month to get busy with a design for a really good amplifier. Another—and perhaps more important—application of this somewhat novel amplifier arises, strange though it may sound, in consequence of the introduction of regional transmissions.

Ever since the regional stations have been operating on high power, many

MAKES YOUR SET A RADIO-GRAM

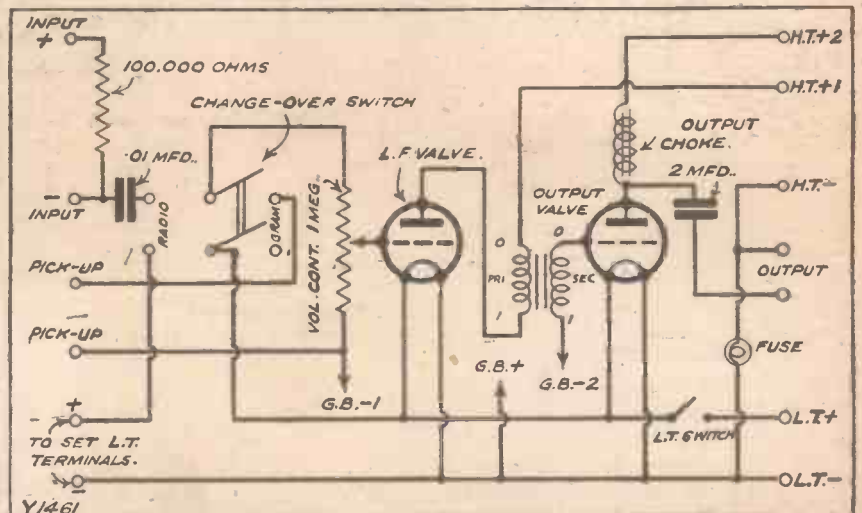

This powerful amplifier can be fitted to practically any set, and there is a change-over switch with which you can switch over from radio to records, or vice versa, in a moment.

The "Bryta-Tone" Amplifier—continued

thousands of listeners—previously out of range—have found it possible to tune in the programmes at 'phone strength. So that by adding a "Bryta-Tone" Amplifier all these—shall we call them "outer circle" listeners—will now be able to enjoy loud-speaker results not only from the high-powered stations, but possibly from others as well.

The third use for this amplifier is very closely allied to the subject that has been discussed this month by the

WIRELESS CONSTRUCTOR Ideas Committee, a full report of which is given on another page.

An Ideal Amplifier

It concerns the electrical reproduction of gramophone records. The "Bryta-Tone" is, in every sense of the word, an ideal amplifier for gramophone pick-up work.

Used with a moderately sensitive pick-up, it is capable of supplying adequate volume for all normal

domestic purposes. The fidelity of reproduction obtainable—providing, of course, you use the outfit in conjunction with a good and reasonably sensitive loud speaker—will amaze you.

There are many more uses to which this amplifier might well be put, but for reasons of space the only other one that we think it necessary to mention here is its possible use as a unit to be added to the "Eaglet" receiver.

A NOVEL BUT SIMPLE LAYOUT OF PARTS

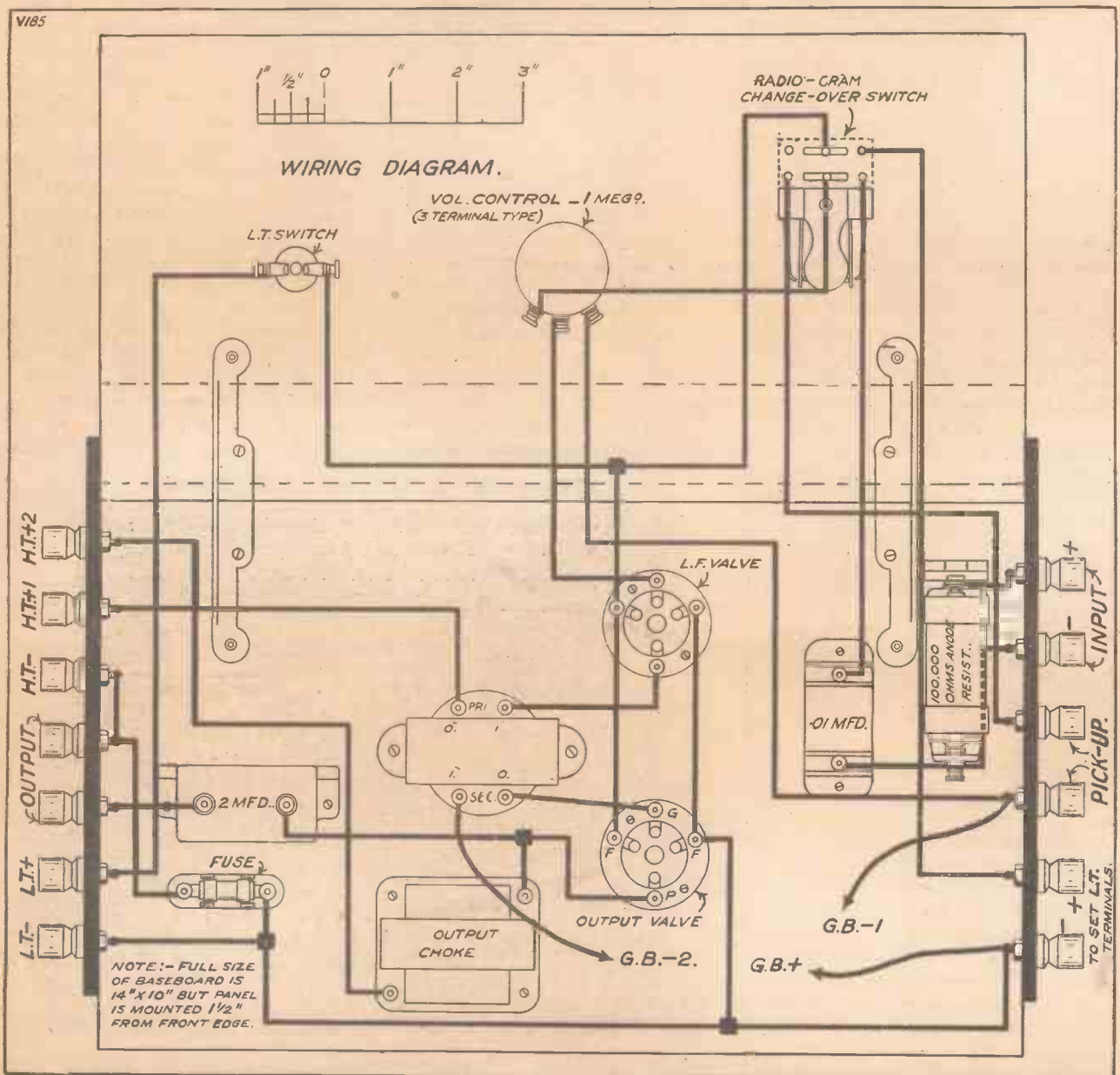

The terminals are arranged in a particularly convenient manner. The "inputs" are to the right in the diagram and the L.T. battery and loud-speaker leads are shifted from the set to the row of terminals on the left.

The "Bryta-Tone" Amplifier—continued

This popular little H.F. and Det. design, which was evolved to meet the requirements of all those who are keen on 'phone searching, can, by the addition of the "Bryta-Tone" Amplifier, be turned into a handsome loud-speaker receiver. (The "Eaglet" was

are not many parts required. In consequence the amplifier need not involve an expenditure of much more than £3 10s. to build.

True, this figure does not allow for the cost of a cabinet, for the simple reason that the one into which the

for the sloping sides, which when stained and properly varnished look every bit as good as the wood from which the rest of the cabinet is made.

All the required dimensions and details for the construction of the cabinet are given in the diagram, but, even so, there are just one or two special points to which perhaps we ought to refer.

CONTROLS YOUR SET AS WELL

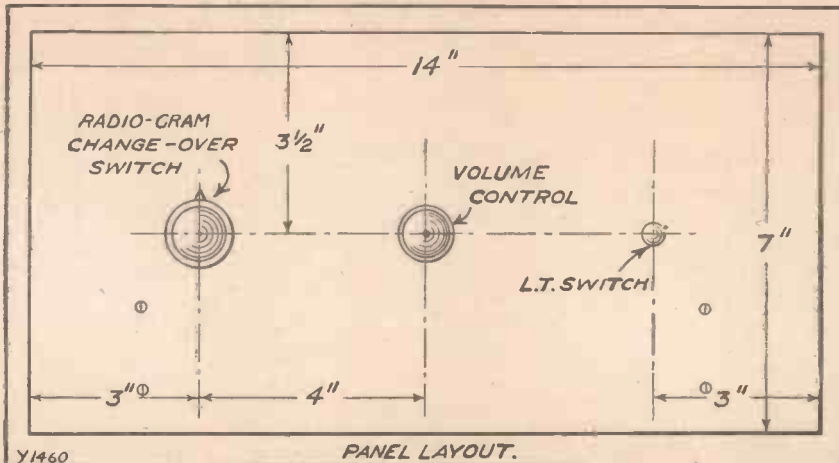

When you have the "Bryta-Tone" coupled to your set, you can switch the whole outfit on and off by the above L.T. switch.

described in the December, 1930, issue of the WIRELESS CONSTRUCTOR.)

For whatever purpose you may choose to build the "Bryta-Tone" Amplifier, of one thing you can be certain. It will amplify from the lowest to the highest notes as faithfully as any present-day circumstances are likely to require.

Easily Attached

It is but the work of a few moments to add it to an existing design. (In general, we do not recommend it for use after sets with existing L.F. stages, unless the L.F. stages are first cut out of circuit.) By a carefully designed arrangement of battery terminals and switching, the filaments of the valves in your existing set are automatically turned off when the amplifier change-over switch is placed in the "pick-up" position.

A further advantage is that the pick-up can be left permanently connected to the amplifier. Thus the only operation necessary when it is desired to change over from radio to the gramophone is that of moving the switch. The volume control, by the way, is joined up so that it is always in circuit.

To turn for a moment to the question of cost, when you refer to the component list you will see there

original amplifier was built was home-constructed. In this connection we would ask you not to be unduly alarmed at the complicated-looking shape of the lid.

The "gramophony" appearance is obtained simply by using cardboard

Making the Cabinet

First of all, the cabinet should be assembled using the amplifier base-board as a foundation. When the whole thing is completed the base-board can then be removed, for the purpose of building the actual amplifier, by taking out two screws at one end of the base, and two corresponding ones at the other end of the cabinet.

The framework, both for the main cabinet and the lift-up lid, is made from $\frac{3}{8}$ in. by $\frac{3}{4}$ in. material, and since this is more or less a standard size you should not have much difficulty in obtaining it ready planed to size.

With regard to the lid, the top is one solid piece of wood $6\frac{1}{2}$ in. by $11\frac{1}{2}$ in., and the cardboard pieces are cut out with a flap on each of the long edges so that they can be nailed or glued on one side to the inside of the

THE POWER BEHIND THE PANEL

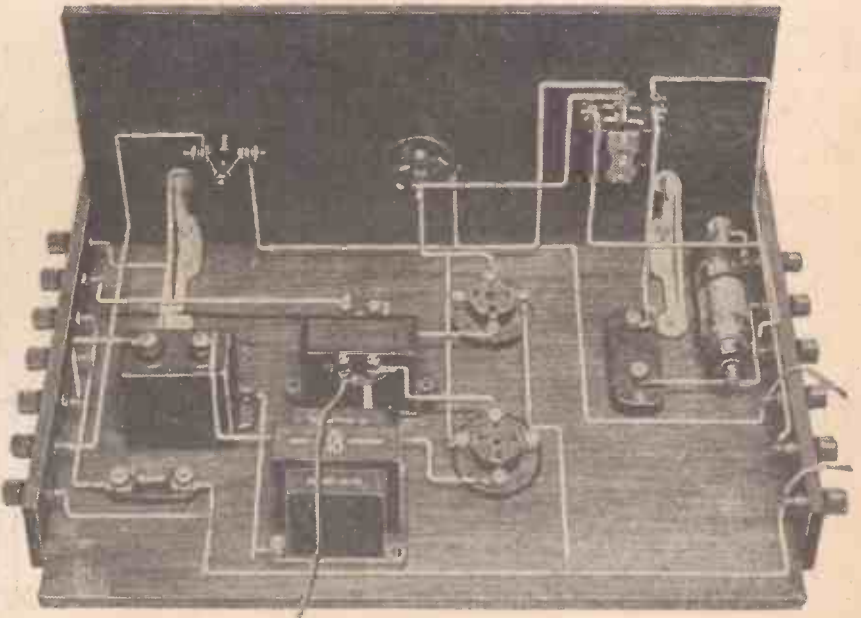

Only a few standard components are used, but you will develop sufficient power for working anything from a small cone to a big moving-coil speaker.

The "Bryta-Tone" Amplifier—continued

lid framework, and on the other to the underside of this top piece of wood.

By the way, in case you experience any difficulty in arriving at the correct angles for the cardboard strips, the one at the ends are $8\frac{1}{2}$ in. and $6\frac{1}{2}$ in. along the bottom and top edges respectively, while those for the front and back are $14\frac{3}{8}$ in. along the lower edge, and slope away to $11\frac{1}{2}$ in. The overall depth of the four strips is $2\frac{1}{2}$ in.

Trying It Out

When the cabinet is completed, remove the baseboard and proceed, after having drilled the panel, to mount it on the baseboard by means of angle brackets at a distance of $1\frac{1}{2}$ in. from the front edge.

If you decide to build your amplifier into a standard ready-made cabinet, then there will not, of course, be any need to set the panel back from the front edge of the baseboard.

Most readers are so familiar with the general principles of set construction that with such a simple arrangement as this it seems hardly necessary to dwell upon component fixing and wiring. Follow the wiring diagram as closely as possible, and you cannot then go very far wrong.

IT MATCHES THE GRAMOPHONE

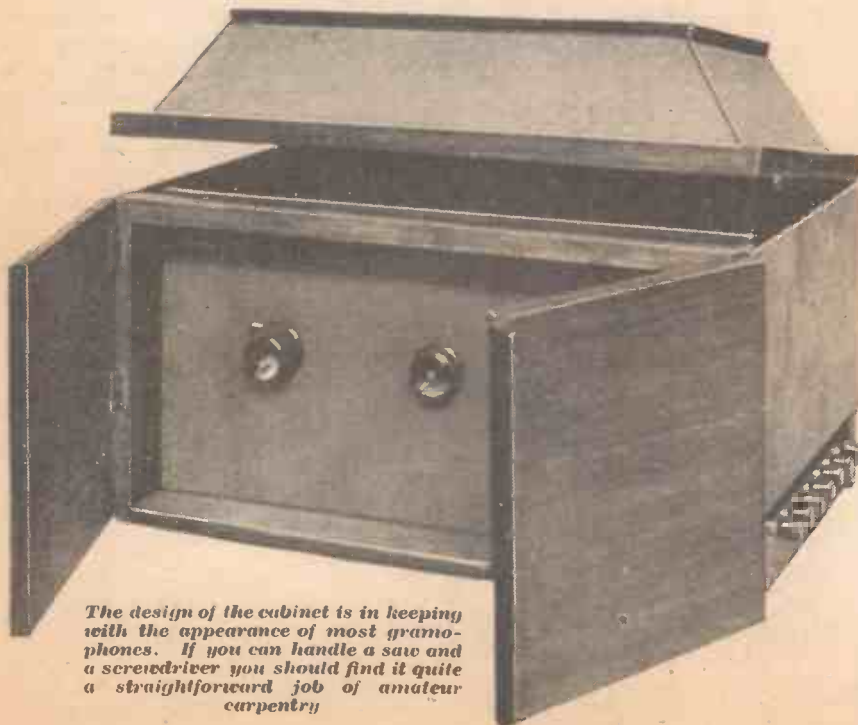

The design of the cabinet is in keeping with the appearance of most gramophones. If you can handle a saw and a screwdriver you should find it quite a straightforward job of amateur carpentry.

THE DOMED LID IS OPTIONAL

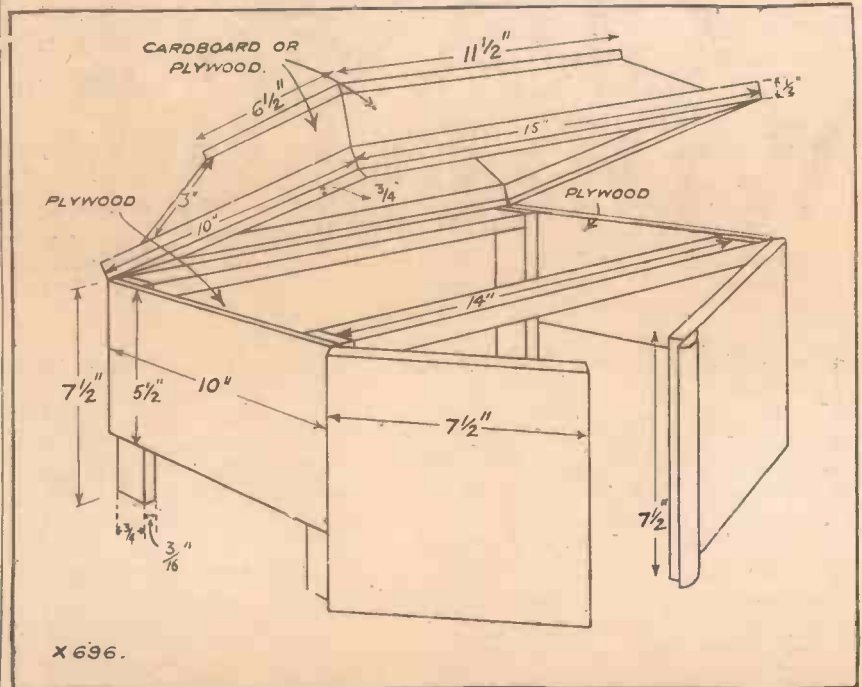

If you do not wish to construct the domed lid, which is really quite easy to make, the case will still look quite nice with a flat, hinged lid.

The way in which to connect up your completed amplifier will depend upon the use to which it is to be put. But, in any case, you will first require some suitable valves.

For the first position (the valve holder nearest the panel) you will require a valve of the L.F. type, while for the output stage a power or super-power type is the valve to use.

The Battery Connections

If you have built the amplifier to use after an existing receiver, join its output plus and minus terminals (those marked "phones" or "L.S.") to the appropriate plus and minus input terminals of the amplifier, disconnect your L.T. accumulator and join it instead to the L.T. terminals on the terminal strip at the output end of the amplifier.

Next join your set L.T. terminals to those correspondingly marked on the input side of the "Bryta-Tone." The amplifier terminals marked H.T. + 1 and H.T. + 2 should be joined to 120 volts positive and the maximum positive respectively on your present H.T. supply.

An Important Point

But do not make any connection to the amplifier terminal marked H.T. negative. This terminal only comes into use when the amplifier is being used as a separate unit for pick-up work.

(For conclusion of article and the list of parts needed to build the "Bryta-Tone" Amplifier please turn to page 332).

ARE RADIO-GRAMS WORTH WHILE?



The "Wireless Constructor" Ideas Committee dealt with this intriguing subject at a recent meeting, and the following represents a résumé of the higher lights of the discussion.

THE following questions are, in principle, those outlined by Mr. Kelsey in a suggested topic for the WIRELESS CONSTRUCTOR Ideas Committee to discuss:—

- (1) Are radio-gram sets popular?
- (2) Does the average set give you an electrical reproduction of records superior, to any real extent, to the mechanical?
- (3) What additional advantages over improved quality (if given) has the pick-up?
- (4) Should all radio sets incorporate radio-gram switches as a matter of course, or should it be left to the individual constructor to add the refinement if he so desires?

Of Vital Interest

At the last meeting Mr. Victor King agreed that these were indeed questions of vital interest, inasmuch as it was apparent from correspondence from readers that there was by no means a clear conception in their minds regarding all that was meant and implied by radio-gram working—and that despite Mr. Johnson Randall's excellent articles on the subject. He suggested that Mr. Randall should open the discussion.

Mr. Johnson Randall then said:

"My answer to Mr. Victor King's question is that radio-gram receivers are most definitely worth while; and, as my friend knows, I am a confirmed pick-up enthusiast.

Alternative Programmes

"I like to think that whenever I am dissatisfied with the wireless programmes I can switch straight over and play a selection of gramophone records, choosing my own items at will, and obtaining absolutely first-class reproduction—certainly better than anything one can get from a gramophone of moderate price.

"I am asked: 'Are radio-gram

sets popular?' Well, I feel that they are not so popular as they deserve to be, but I think that the average listener is beginning to realise more and more every day how very simple it is for him to convert his existing set into a radio-gram, and to enjoy

The Ideas Committee comprises selected members of the Editorial, Contributing, Research and Queries Depts. Meeting once a month, these people informally discuss such interesting matters as may arise, more particularly in connection with the home-construction of radio sets. Readers' comments and suggestions regarding past and future meetings will be welcomed.

the advantages of being able to play his gramophone records via a pick-up and first-class L.F. side, and, provided

A RADIO-GRAM AMPLIFIER

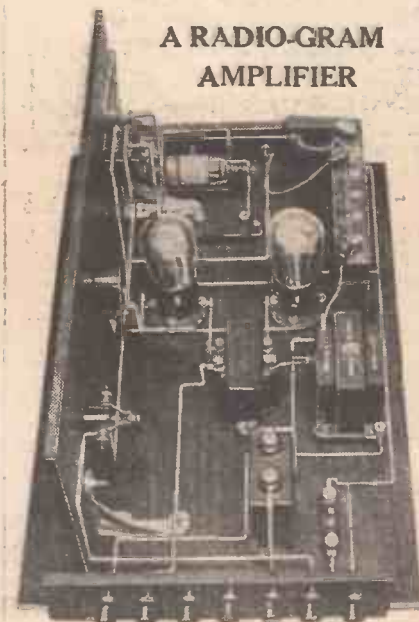

A view of the Eight-Ton Amplifier—an interesting and useful radio-gram device that is fully described in the pages of this issue.

the loud speaker is a good one, to hear a bass rendering and 'smoothness' vastly superior to the average sound-box and small portable or 'table-grand' type of gramophone.

"Then, again, the modern pick-up does not wear the record grooves to the same extent as a sound-box.

Valuable Bass Lift

"I am, of course, assuming a well-designed pick-up in this case.

"Moreover, it is possible with a good pick-up to get a valuable lift up at the bass end, and the resulting reproduction, in conjunction with an L.F. side containing modern transformers or R.C. coupling, together with a decent cone loud speaker, really does justice to the records.

"I am of the opinion that the conversion of a well-designed wireless receiver into a radio-gram is the most economical method of getting the finest quality from records. It is infinitely cheaper than a first-rate gramophone.

"I think that all radio sets should incorporate radio-gram switches as a matter of course, provided the L.F. sides will give adequate amplification when used with the average pick-up. After all, it is only a question of inserting a three-point switch and of putting a couple of terminals on the terminal strip.

Quite Inexpensive

"Practically every enthusiast wants to try his hand at pick-up work sooner or later, and since the cost of inserting the necessary switch in the set is only about 2s., I do not think that there are many constructors who will begrudge this, even though they may not want to use a pick-up at the moment."

And here is a précis of Mr. G. T. Kelsey's views as expressed at the meeting:

Are Radio-Grams Worth While?—continued

"Mr. Randall very ably sums up my own personal opinions in his reply to the first question, except that he has rather left me with an impression that he only finds pick-up reproduction definitely advantageous over mechanical methods in the case of small portable gramophones or table-grand instruments.

More Realistic

"Is it not true that a suitably designed all-from-the-mains amplifier (or, if you like, well-designed I.F. stages of an existing set), used in conjunction with, as near as possible, a "straight-line" pick-up and a good moving-coil loud speaker, results in the reproduction of records in a manner more faithful and realistic than is possible with any known mechanical means?

A "ONE-HORSE"-POWER TRANSMITTER!



Operating an Army field radio station. The whole outfit, including the mast, can be packed up and carried by one horse, as you see on the left of this photo.

"Perhaps he has considered the matter purely from the point of view of expense? In that case, there is no doubt a great deal of truth in what he says; but, even so, I feel that the only rightful way in which to draw a comparison between electrical and mechanical means is on the basis of an assumed equal expenditure. If we regard it thus, I think we should be justified in saying that from the smallest portable to the finest console the pick-up has it every time.

Most Convincing

"To give an illustration of what I am getting at, would it be possible to obtain for a matter of, say, £5 a gramophone that would be in any way comparable to the realistic results

obtainable with the 'Bryta-Tone' Amplifier described in this issue?

"I can assure you from actual results that it would not, because I have heard the 'Bryta-Tone' under working conditions; but more than that, I have also heard a gramophone costing roughly the same as the amplifier, and that, after all, is surely the most convincing way of settling the argument.

"Now to come to the second point, the question relates to the advantages of a pick-up over mechanical means in so far as the average set is concerned.

"In other words, I interpret that to mean that if we went to Tom, Dick or Harry's set and inserted a pick-up, would he be more pleased with the resulting reproduction than he is with his present gramophone?

should find that his gramophone is also of a reasonably cheap variety, in which case I do not think there would be any doubt as to the advantages of a pick-up.

"To turn for a moment to the third question, I don't personally think there is any need to search for advantages resulting from the use of a pick-up other than the outstanding one of improved reproduction.

Quality First

"True, there is probably less record wear, and it is also possible with a pick-up to regulate volume, but the main idea, I think, is quality.

"My answer to the final question is very definitely that we should show the connections for a pick-up in every suitable design. It may be argued that there will be some readers who will not require provision for a pick-up. Well, my answer to that is that at the time of publishing the design we should give, in addition to the normal wiring diagram, another small sketch showing the alterations necessary to the main diagram for those who desire to use a pick-up. That, I think, would solve the problem from everybody's point of view."

Mr. A. S. Clark then continued the discussion.

What Is a Radio-Gram?

"I must say I feel quite happy in having to answer the questions which we have before us for consideration, as I have some pretty definite ideas on the subject of the electrical reproduction of records. I will not trouble to pass any comment on what has already been said, for you will quite easily be able to see to what extent it differs from my own views.

"Before dealing with the questions specifically, let me inform you that I do not think a set provided merely with pick-up terminals and switch (or their equivalent) worthy of the name of "Radio-Gram." A radio-gramophone should, in my opinion, include the motor, pick-up and receiver all in the same cabinet.

"That, however, is by the way; both schemes have their individual advantages, with which we are not concerned at present, and both should receive their due amount of attention.

So far, throughout this discussion, (Follow Mr. Clark's arguments on page 329.)

"Naturally, even if we agree that a pick-up is definitely advantageous, we must also take into account the question of whether the improvement is sufficiently marked to justify the amplifier upkeep costs.

Balance of Expenditure

"With few possible exceptions, I am bound to say that I think the electrical means would hold the day every time, because it is my opinion that the average man preserves a sort of balance of expenditure between his set and his gramophone according to his means.

"If his set is home-constructed, and of the reasonably inexpensive (though certainly not necessarily inefficient) type, then I think we

THE "PLUS-STAGE" ONE

Here is an idea in set building that we think will appeal to a great many of our readers. Instead of building a three-valve straight off, with panel, baseboard, and heaps of components and gadgets, we are suggesting that you build the detector portion first, without a panel, then add the 1st L.F. stage, and then the 2nd L.F. Finally, if you so desire, a panel can be added and the set can be housed in a cabinet in the usual way. But at each stage the set is complete in itself. A good scheme, isn't it? And it's economical and efficient, too!



Designed and Described by
the Research Dept.

IMAGINATION, so long as it is not allowed to run riot, can be extremely useful. So we are going to ask you to imagine for a moment or two a three-valve set of the detector and 2 L.F. type which has an obscure fault.

The symptoms do not give much in the way of clues to the trouble, for the set is just giving poor results, such as lack of volume and range. What is the best way to track down the trouble?

(The case to be considered we will suppose is connected with a constructor with little experience, and

does not concern an expert of the type who, after one minute's listening, will remark, "Ah, yes!" and proceed to put matters right with a few moments work on the receiver.)

Step-by Step

The best thing to do in the case we are imagining is to connect 'phones in the plate circuit of the detector valve and to make sure this is working O.K., and then to put the loud speaker in the plate circuit of the first L.F. valve and get the two valves working properly before going on to the third valve. Obviously that is the best way for anyone with not too much technical knowledge to proceed.

Now let us reverse the argument. Why not produce a set stage by stage

so that anyone can be absolutely confident of obtaining maximum results from the completed receiver? It was thus that the idea of the "Plus-Stage" One was born.

It is an absolutely complete, efficient single-valve set, but designed on such lines that L.F. stages can be added at a later date, either when you feel sure you are getting the utmost from it or when funds permit. Which brings us to another great point about the design.

There are many who would like to build a three-valve set, but have not the means whereby to obtain all the necessary parts right away. If they start by building a single-valve set of ordinary type, when they are ready to make a two-valver they will have

WHAT YOU NEED FOR THE FIRST VERSION OF THIS INGENIOUS SET

- 1 Baseboard, 18 in. x 9 in.
- 1 Variable condenser, .0005-mfd. (Lotus, or Lissen, J.B., Polar, Ormond, Ready Radio, Igranic, Burton, Formo, etc.).
- 1 Slow-motion dial for above, unless geared type of condenser is used (Igranic, or Ready Radio, Ormond, Lissen, J.B., Formo, Lotus, Brownie, etc.).
- 1 .0001-mfd., or greater, up to .0002-mfd., differential reaction condenser (J.B., or Lotus, Ready Radio, Lissen, Ormond, Igranic, Magnum, Dubilier, Parex, Wearite, Burton, etc.).
- 1 .0003-mfd. compression type condenser (Formo, or Lewcos, Lissen, etc.).
- 1 .001-mfd. fixed condenser (Lissen, or Telsen, Ediswan, Dubilier, T.C.C., Ready Radio, Ferranti, Mullard, Igranic, Watmel, Formo, etc.).
- 1 .0003-mfd. fixed condenser (Dubilier, etc.).

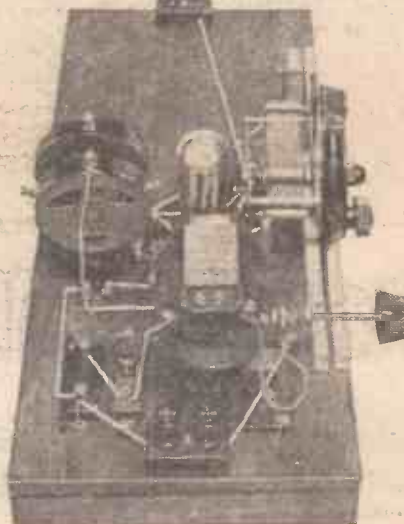

The detector section is the first to be built, and, as will be seen, plenty of room is left for the L.F. stages.

- 1 "Paratune" coll unit (Wearite, or Ready Radio, etc.).
- 1 Valve holder (W.B., or Telsen, Clix, Lotus, Igranic, Benjamin, Bulgin, Junit, etc.).
- 1 2-meg. grid leak and holder (Dubilier, or Igranic, Ferranti, Lissen, Mullard, Ediswan, Telsen, etc.).
- 2 Single-coil holders (Magnum, or Lissen, Lotus, Bulgin, Igranic, Red Diamond, Wearite, Keystone, etc.).
- 1 H.F. choke (Magnum, or Ready Radio, Telsen, Lissen, Varley, Lewcos, Wearite, Lotus, R.I., Dubilier, Watmel, Igranic, Parex, Keystone, etc.).
- 2 Two-terminal blocks with terminals (Belling-Lee, or plain strips with any standard make of terminal, e.g. Igranic, Eellex, Clix, etc.).

Wood, ebonite, wire, screws, battery, plugs, etc.

The "Plus-Stage" One—continued

to scrap their panel, cabinet and possibly several of the components.

Consequently they are faced with waiting till they can afford the three-valver (which probably never arrives!), or being content with a one-valve set. The problem is solved for them by the "Plus-Stage" receivers.

They are so designed that a single-valve set is made first, and then one L.F. stage is added and later another; and not a single fixed condenser has to be scrapped in the process.

Nor indeed do any components have to be moved once they are screwed into position; in fact, hardly any wiring has to be touched when adding the extra stages.

This month we are giving full details of the first stage, namely, the

detector. Next month we shall tell you how to add an L.F. stage, making a complete and efficient two-valver, and, the month after, details of the third stage will be given.

That gives you a good idea of the advantages of the set, and now we will go into the details of the construction. The general arrangement of a vertical panel attached to a baseboard has not been followed.

Instead of a Panel

Instead you will note that each component which would normally go on the panel is attached to a small piece of ebonite, which is held in a vertical position by being placed between two wooden fillets arranged along the front of the baseboard.

These fillets are $\frac{1}{4}$ in. apart, and $\frac{1}{4}$ -in. ebonite is employed.

By arranging the controls in this way the expense of a panel is avoided, and other components can be inserted when necessary. Incidentally, quite apart from its use in connection with "Plus-Stage" sets, this arrangement has much to commend it to experimenters who are continually changing from one circuit to another.

Strips of wood are arranged at the ends of the baseboard so that the battery leads may be brought out underneath it. No terminals are employed for the batteries, a saving on expense being made by connecting them up with flex leads taken direct to the various points.

As already mentioned, efficiency

THE CIRCUIT IN THEORETICAL AND PICTORIAL FORMS

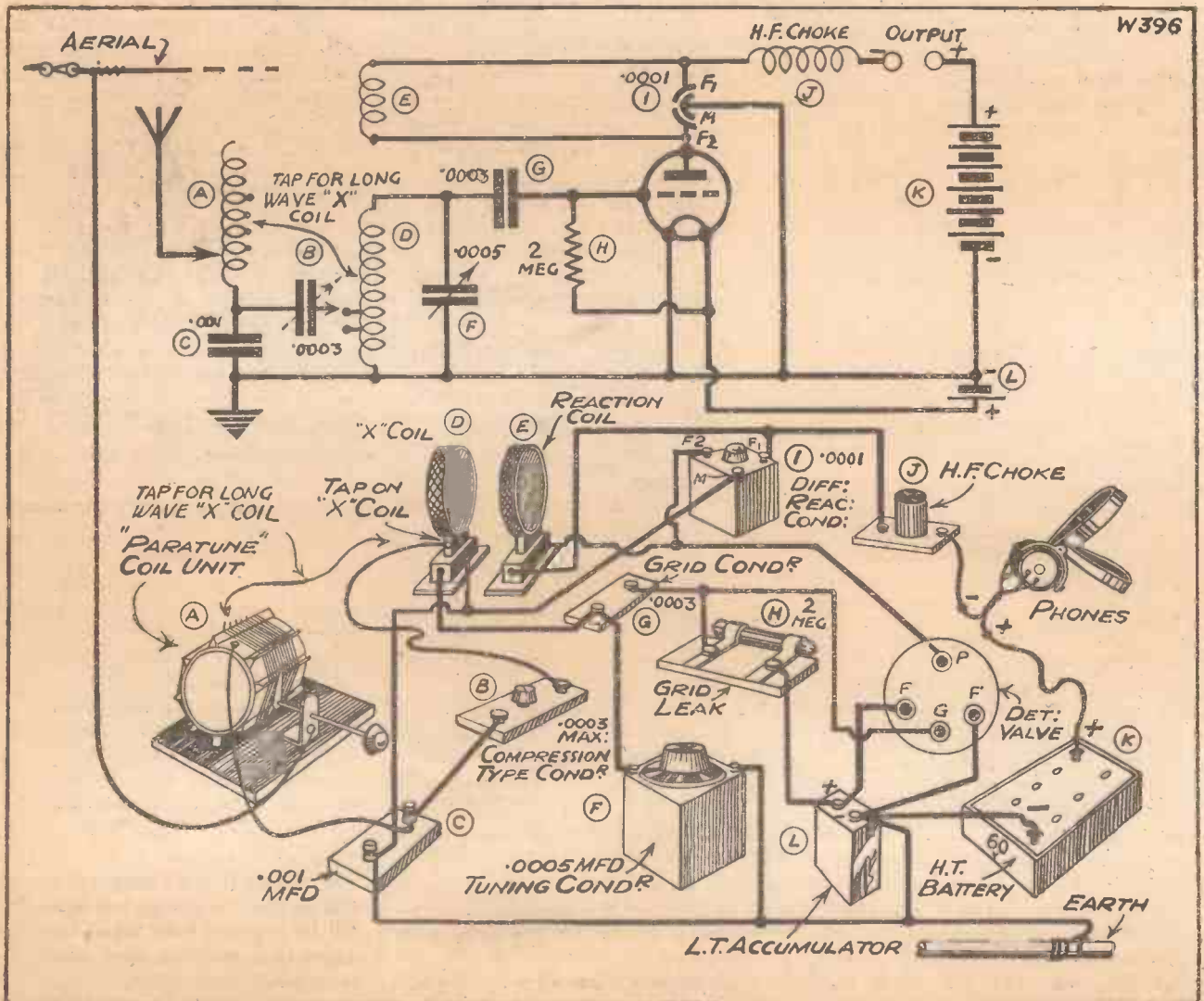

Under the usual theoretical circuit we give a pictorial representation of it so that you can see exactly how the parts are used.

The "Plus-Stage" One—continued

has not been sacrificed in any way to help keep the expense down. You will therefore expect a set that is sufficiently selective to deal with modern regional conditions and sensitive enough to bring in many continental stations.

Very Straightforward

You will not be expecting too much, for the "Plus-Stage" One is super-selective and capable of bringing in a very large number of continental stations without any interference from powerful local transmissions.

Its efficiency is largely due to the use of the "Paratune" system of tuning, which has been a prominent feature of WIRELESS CONSTRUCTOR sets during last few months.

You will see by a glance at the theoretical circuit diagram that it is very straightforward. Every detail, apart from the "Paratune" system, being such that you will probably be perfectly familiar with it.

No L.T. switch has been incorporated, because it is an easy matter to remove one spade tag from the accumulator; and as the first stage is the most expensive, every permissible step to keep the cost down has been taken. Instructions for adding a switch will, however, be given with one of the later stages.

For the benefit of those who are not very conversant with theoretical circuit diagrams, a pictorial circuit diagram is given as well. The letters against the components, both in the theoretical and pictorial diagrams, will help you to cross refer, and so follow even the theoretical circuit.

Keeping Down Cost

If you wish to keep the cost down to a bare minimum you will want to make the "Paratune" coil yourself, and in this case you will find the necessary details in the October, 1930, issue of WIRELESS CONSTRUCTOR. Or you can purchase the coil ready-made from the firms mentioned in the list of components.

The strips of wood which form the slot into which the pieces of ebonite that carry the condensers are placed should be about $\frac{3}{8}$ in. square. They may run for the whole length of the baseboard, or be cut shorter as shown.

The pieces of ebonite for the components should be 1 in. or $1\frac{1}{2}$ in. wide, one 3 in. and the other $5\frac{1}{2}$ in. high,

the latter being for the tuning condenser. A convenient height at which to drill the necessary holes for the components would be $3\frac{1}{2}$ in. in the case of the tuning condenser, and $2\frac{1}{2}$ in. for the reaction condenser.

With some makes of variable condensers you may find that in order for it to be quite solid when in place it is desirable to mount it on a much wider piece of ebonite. In such a case, a piece 2 in. or 3 in. wide should suffice.

When screwing the components in place, follow the layout shown in the wiring diagram as closely as possible. Three holes are required in the baseboard for the three battery leads.

An ordinary twist drill is best for drilling the wood, which should be $\frac{3}{8}$ in. thick if plywood, and $\frac{1}{2}$ in. if

possibly upsetting the working of the "Paratune" system.

Use some form of insulated wire when connecting up, and run the leads as far as possible in exactly the same way as indicated on the wiring diagram. The lead to one of the output terminals is rather long, but this is because the extra stages come between these terminals and the other components.

This lead will be considerably shortened when the other stages have been added.

Easy to Make

There is no need to enlarge further on the constructional details, for the set is very easy to make, and the diagrams are really self-explanatory. Don't rush the construction, as at most

THE FIRST STAGE COMPLETED

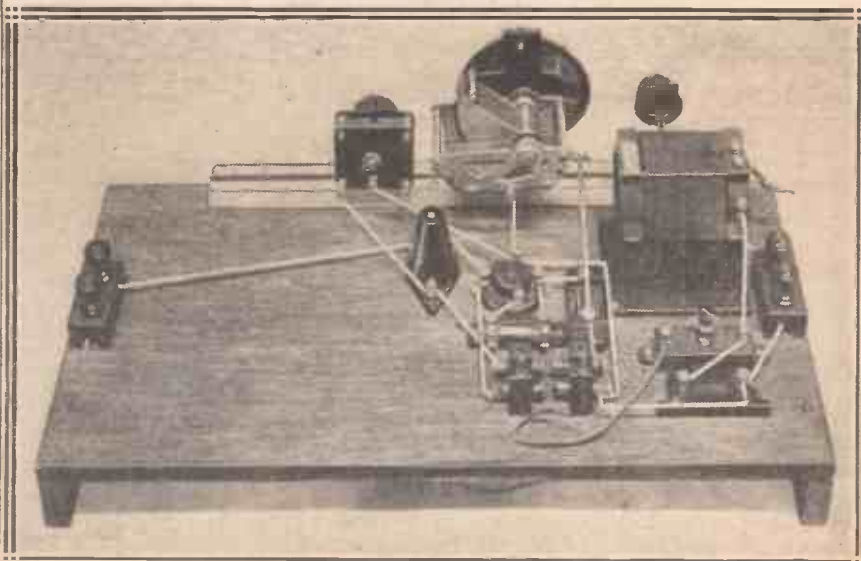

Here is the detector portion wired up and ready for work. Every stage in the construction of the set provides you with a complete receiver of maximum efficiency.

plain wood is employed. You will see that there are only three battery leads, L.T.— and H.T.— being connected to the same lead.

For this purpose a battery plug is inserted in the L.T. negative lead at a suitable distance from the spade tag which is joined to the accumulator.

The "X" Coil Holder

When you are wiring up the single-coil holders, take care to connect them up exactly as shown, and to have the pin of the "X" coil holder in the same position. Failure to get these connections correct can result in reversed reaction and inselectivity, apart from

you will save only very little time, and a rushed job may lead to all sorts of peculiar troubles.

Practically any valve will work in the set, and it may be a 2-, 4-, or 6-volt one. Of course, for best results you must use one of the most suitable types, namely, either a special detector valve or an H.F. type. The voltage of the accumulator will naturally be the same as that of the valve.

A 60-volt H.T. battery will be suitable for the one-valver; but more H.T. will be required later when the other stages that enable a loud speaker to be employed are added.

The "Plus-Stage" One—continued

Four plug-in coils will be necessary, two for the medium waves and two for the long-wave band. Their numbers are as follow: 60X and 35 or 50 for medium waves, and 250X and 100 or 150 for long waves.

Adjusting Selectivity

When working on medium waves the flex lead attached to the .0003 compression-type condenser is joined to the tap on the "X" coil which gives best results. Tuning is carried out on the .0005 variable condenser, and the slider on the "Paratune" coil has to be adjusted to keep in step with the tuning condenser. Reaction is controlled with the reaction condenser in the ordinary way.

The .0003 adjustable condenser is for the purpose of adjusting selectivity

out of circuit on long waves, and once you have found the best setting for it there is no need to readjust it.

On long waves the "Paratune" coil can be used to cut out medium-wave interference if it is experienced. If it is, connect the flex lead from the "Paratune" coil to one of the "X" taps (try both to see which is better).

This flex lead is shown joined to one particular tap on the "Paratune" coil, but it should be tried on the other three to ascertain which is most effective. The slider should be adjusted each time until the interference is at a minimum or completely removed.

On Long Waves

On long waves, once the "Paratune" slider is adjusted it does not

operation, and here are a few hints about long-distance reception. Naturally you must have a smooth control of reaction. This should be easily obtained by a careful adjustment of the H.T. voltage, so try the H.T. plug in different taps on your battery.

Some Final Hints

Often a different size coil for reaction—sometimes larger and sometimes smaller—will help to get the reaction control perfect.

The adjustment of the "Paratune" coil, reverting now to the medium waves, will not be critical in operation. To a large extent you will be able to search on the tuning condenser alone, simply adjusting the "Paratune" coil for best volume when the wanted station has been found.

VERY FEW CONNECTIONS—BUT VERY FINE RESULTS

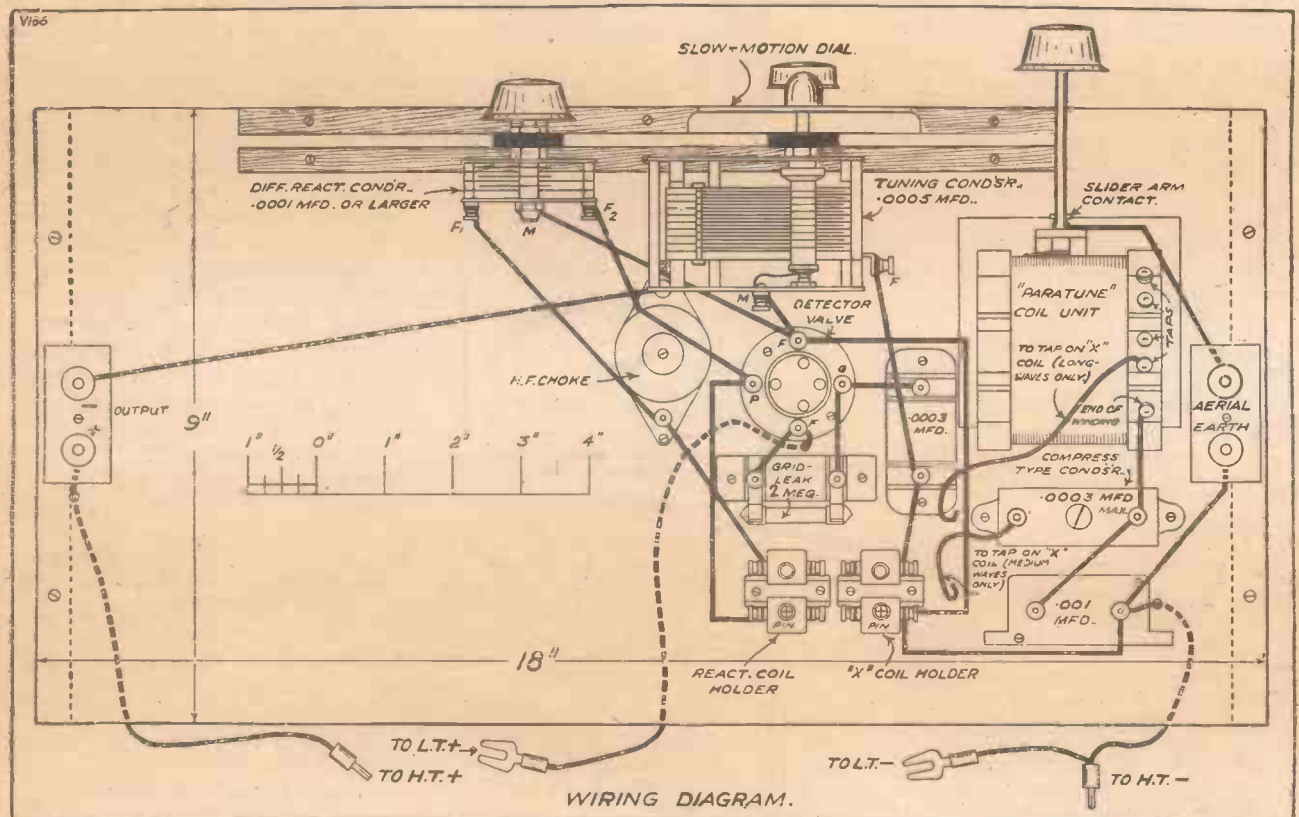

The wiring of the detector stage is very easy, as you will see by this diagram (drawn to scale) which shows the completed one-valver.

on this band. Start off with it at maximum and reduce its capacity until selectivity is sufficient. Do not reduce the capacity more than necessary.

If you change from one tap on the "X" coil to the other you will have to start at maximum again with this .0003 condenser. It is completely

have to be touched, and tuning is carried out entirely on the .0005 variable condenser. If you do not experience any medium-wave interference the aerial lead can be taken direct to the "X" coil, thus cutting the "Paratune" coil out of circuit.

That covers the general details of

Remember to keep the set just off oscillation while searching.

I think we can now leave you to get on with the set, which you will be able to get going long before details of the 1st L.F. stage appear next month. Don't forget to look out for these details.

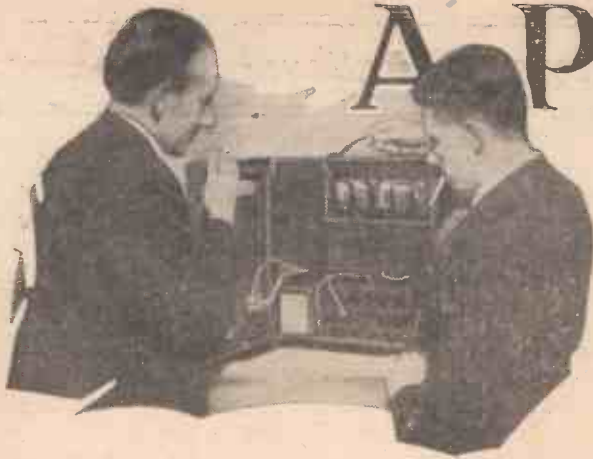

A PRACTICAL MAN'S CORNER

Some valuable hints for the home-constructor.

By R. W. HALLOWS.

By no means everyone is a master of the art of making neat loops in the ends of wires. There is a good deal more in neat loops than their mere appearance.

Ill-fitting sloppy loops have a tendency to spread when the milled nuts of terminals are tightened down hard upon them, but well-made loops, which are a good fit for the terminals to which they are attached, retain their shape and ensure good contacts.

We will deal first of all with plain insulated wire of the kind generally used in wireless set construction.

The initial process is, of course, to bare the end. The amount that must be bared depends upon the size of the loop, which must depend upon the terminal to which connection is to be made. For 2 B.A. an inch is needed, for 4 B.A. three-quarters of an inch, and for 6 B.A. just over half an inch.

Baring Wire

Here are some of the best ways of baring various kinds of wire. With double-cotton-covered wire wind off the outer covering as far as is required, then make fast with a single knot and cut off. Deal with the inner covering, whose "lay" is in the opposite direction, in the same way.

When working with single rubber-covered wire, make a very gentle pinch with the wire cutters at the right distance from the end. This will nick the rubber, but will not touch the

metal. The rubber can now be pulled straight off either with the pliers or with the fingers.

For Glazite and similar wires, simply unwind the outer covering and cut off short. Enamelled wire demands special treatment. The best method is to scrape the end bare with an old and rather blunt table-knife.

Pliers and Their Use

The pliers needed for the job are those of the bottle-nosed variety seen in Figs. 1, 2 and 3. Recently a special kind of pliers has been put on the

LOOPING THE LOOP

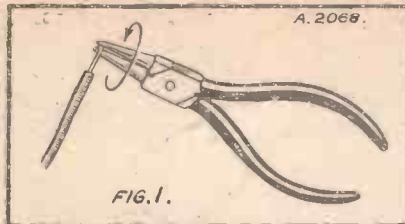

FIG. 1. The first step in making a good loop is to hold the wire and prepare to turn as shown.

market with the noses arranged in "steps" of different diameters.

These are, I believe, excellent for radio work, though I myself always use the ordinary type, and one very soon learns to know instinctively just how far down the tapered nose to grip the end of the wire in order to make a 2, 4 or 6 B.A. loop. The first step in loop-making is shown in Fig. 1.

Hold the wire firmly in the pliers, preparing to turn them away from you. In Fig. 2 is seen the second step. A half-turn away from you has been made, and the loop is then shaped as seen in the drawing.

The finishing touch is added as shown in Fig. 3, by releasing the grip on the pliers, swinging them right round towards you and then gripping again just at the neck of the loop, after which a fraction of a turn is given.

This centres up the loop and makes all shipshape, as you will see from the drawing. Try it once or twice and you will find that it is just as easy to make good loops as bad ones.

Flexible Wire

The only other material that we need consider is flexible wire, over which not only beginners but also old hands not infrequently go wrong. Bare the end of your wire (for making loops in flex you will require about one and a half times as much bared end as for stiff wire), and then twist the strands as tightly together as you can.

I have underlined those words because so many people omit to do this, with the result that they make poor loops, which lead to bad connections and broken wires. Next take your wire round one nose of the pliers, as shown in Fig. 4, hold it firmly close to the insulation, bring the bared end over the standing part and twist it round once or twice.

Now hold the twisted part of the wire firmly with the left hand, and with the right hand turn the pliers over and over until you have twisted up a tight neck for the loop. The more tightly you twist together the strands of the wire before starting to make the loop, and the more tightly you subsequently twist up the neck of the loop, the better and the more durable will be the job.

FINISHING IT OFF

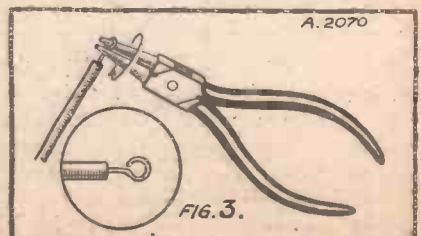

FIG. 3. To finish off nicely a reversal of the turning is necessary, leaving the neat "ring" shown inset.

THE FIRST TWIST

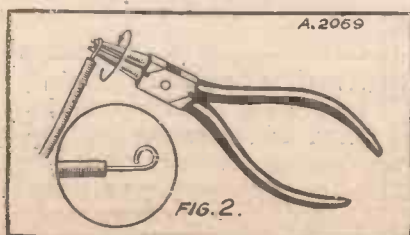

FIG. 2. Here a half-turn has been made, leaving the wire shaped as in the circle.

A Practical Man's Corner—continued

Not a few constructors positively ask for breakdowns in their connections by placing wire leads incorrectly over the screwed portions of terminals. Are you never guilty of attaching a loop as shown in Fig. 5A?

Fixing the Loops

I don't mind wagering two to one in 4 B.A. nuts that you occasionally err. You have only to examine the drawing to see what happens. As the milled nut is tightened down with a clockwise action it tends to make the loop open by breaking the end away from the shoulder. If, on the other hand, you place your loop over the terminal as shown at B, screwing down the milled nut tightens up the loop. The nut moves in a clockwise direction and the loop lies in the same way. If several loops are placed on the same terminal it is a good plan to place washers between them, for when they are jammed together one may cause another to spread.

Washers should always be used above flex loops; for, if they are not, strands are sure to be broken as the nut is tightened or loosened. One last point about loops in stiff wire. These should always be as tight a fit as possible for the shank of the terminal—the looser the fit the more liable is the loop to spread during tightening down.

If you find that a loop is not a close fit, pinch it round the shank of the

IT'S SO SIMPLE

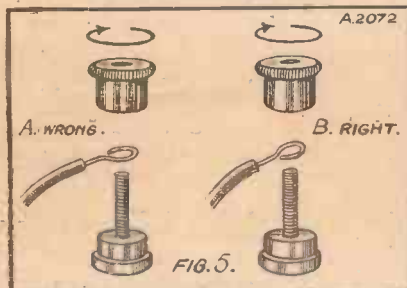

There are only two ways of fitting a loop like this to a terminal and yet many constructors go wrong. Note the arrows showing wrong and right methods

terminal with a pair of flat-nosed pliers before putting on the milled nut.

Condensers and Dials

It is rather annoying to find after finishing the wiring of the set that slow-motion dials cannot be made to lie flush with the panel. Many

constructors mount these components last of all, and if the discovery is made at this stage it may mean that a considerable amount of the wiring will have to be undone, or even screen and baseboard-mounting components removed, in order to get the condensers out of the set.

The trouble is usually caused by the fact that the one-hole-fixing bush protrudes rather too far from the front of the panel, thus preventing the dial from going properly home. The remedy, of course, is a washer between the condenser and the back of the panel, and it is easy enough to put this in position if you test the fit of the dial at the very outset.

In certain cases the spindle of the condenser is too long for the central boss of the dial. When this happens the best course is to shorten it by means of a hacksaw—but be careful that you do not cut off too much. (No one has yet discovered a satisfactory method of lengthening a spindle that has been made too short.)

Small Diameter Spindles

Another little problem concerning condensers and slow-motion dials is that which sometimes arises when it is desired to provide a small condenser used for reaction control with an S.M.D. These little condensers have often spindles of very small diameter and one is apt to find that a dial which is in other respects ideal is a very loose fit.

Do not try fitting the dial with a longer grub screw, for if you do it will be eccentric with the spindle. You will then find either that it jams altogether or that the motion is jumpy instead of being perfectly smooth. The soundest plan is to make a split bush for the spindle. The best material that I have found for this purpose is thin sheet aluminium.

You can always be sure of a supply of this if you make it a household rule that discarded aluminium utensils from the kitchen are offered to you before being consigned to the dustbin. However bad may be the condition of a saucepan, you will generally find that a respectably-sized piece of good metal can be cut from it with tin shears and afterwards beaten flat. In this way one can accumulate a useful supply of sheet aluminium of different gauges.

Split Bush Making

And now for the split bush. Cut with tin snips or large scissors (aluminium is a very soft metal) a strip whose width is a little less than the length of that part of the spindle which protrudes beyond the fixing bush of the condenser. Wrap this round the spindle, moulding it with the fingers. Cut off so that the ends of the bush do not quite meet.

Now see whether the dial is a good fit. If it is too tight make another

FOR FLEXIBLE WIRES

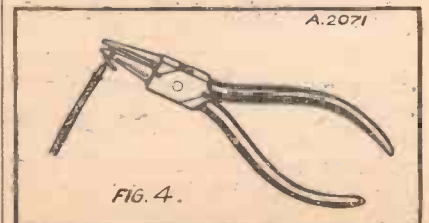

The loop at the end of a flex wire should be just as strong and satisfactory as one made with "solid" wire, and if you make your loops as explained on this page you will soon prove how easily it can be done.

bush of thinner metal, or, should this not be available, scrape the bush that you have made with an old table-knife until it is reduced to the right size. If the dial is still too loose, make another bush of thicker metal.

Where only a very thin bush is required, you may find copper foil a better material than aluminium. Copper foil is obtainable very cheaply from any largish shop which deals in electrical supplies, and it is very useful stuff to have in the workshop equipment.

HAVE YOU SEEN THE SPECIALLY ENLARGED FEBRUARY "MODERN WIRELESS"?

It contains
**Three Illustrated Special
Sections and a
FREE GIFT BOOK**

As well as a wealth of technical, constructional and general interest articles covering all phases of radio.

**GET A COPY TO-DAY
NOW ON SALE PRICE 1/6
AT YOUR BOOKSTALL.**

LISSEN

FIXED CONDENSERS

Deliver all their
stored up energy

Because you are using bigger H.T. voltage—because you are seeking always more power and more purity from your set—because you are going out for ever more distant stations—your need for condensers that will stand up to all demands without leakage and without breakdown is more urgent now than ever.

Lissen fixed condensers have become the standard fixed condensers in almost every published circuit. Accurate to within 5 per cent of stated capacity.

·0001 to ·001 mfd., 1/- each
·002 to ·006 mfd., 1/6 each

INSIST UPON LISSEN PARTS ALWAYS

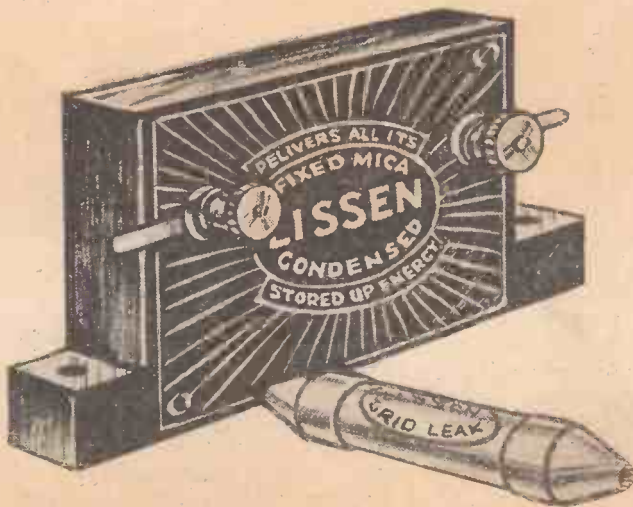

TYPES AND PRICES.
D.C. MODEL "A"
(100-150 volts and 200-250 volts).

Employs 3 H.T. + tap-
pings: H.T. + 1 giving
80 volts for S.G. valves;
H.T. + 2 giving 60 volts
at approx. 2 mA. for
detector valves; H.T.
+ 3 giving *120/150 volts
at 20 mA. Price 27/6

D.C. MODEL "B"
(100-150 volts and 200-
250 volts).

Employs 3 H.T. + tap-
pings: H.T. + 1 and
H.T. + 2 are continu-
ously variable (by
means of two control
knobs) and capable of
giving any desired vol-
tage up to *120/150

The current you get from Lissen Batteries is the purest form of current you can get for radio. But if you want to use an eliminator, use a Lissen Eliminator. You'll then get H.T. current from your mains smoother steadier better than before. There are four types of Lissen Eliminators; one of them will almost certainly be just right for your set. Tell your dealer what voltage your mains supply is, and whether it is A.C. or D.C.; tell him what output you require, or what valves you are using, and he will demonstrate for you the Lissen Eliminator to suit your needs

volts at approx. 2 mA.; H.T. + 3 giving
*120/150 volts at 20 mA. for power
valves. Price 39/6

*(The output voltages given from D.C. models
operating from 100/150 volt mains are approxi-
mately 75 per cent. of those quoted).

A.C. MODEL "A"
Tappings as in D.C. Model "A"
(100-125 volts and 200-250 volts).
Price £3-0-0

A.C. MODEL "B"
Tappings as in D.C. Model "B"
(100-125 volts and 200-250 volts).
Price £3-15-0

LISSEN

ELIMINATORS

LISSEN LIMITED, WORPLE ROAD, ISLEWORTH, MIDDLESEX



Some interesting radio faults reviewed and questions answered.

By P. R. BIRD.

A "Paratune" Puzzle

WRITING in praise of the "Paratune" Three, a Leicestershire reader of the WIRELESS CONSTRUCTOR gives some interesting particulars of what he calls some "really intermittent" faults.

"Intermittent faults are often referred to in wireless," he says, "but what would you make of a crackle which drops in on you every other week? Regular as clockwork.

"My wife (who does not miss much) was the first to notice that one week we had the programmes absolutely free of crackle, and the next week it was threatening in the background all the time.

"Once this seven-days-on-and-seven-days-off crackle habit had been noticed the rest was easy. It was quite obvious that as the accumulator was changed weekly (one accumulator being on the set and one on charge), the cause of the crackle one week in every two was the accumulator then in use."

To put the matter beyond doubt this reader got the service station to lend him another one, instead of his own, for one week, and sure enough the crackle disappeared immediately, thus proving it was the accumulator; one 2-volt section of which (it was a 6-volt battery) had deteriorated.

A Loud-Speaker Lament

The mounting of an ordinary cone unit in a cabinet is not reckoned a difficult task even by those with little experience of radio construction. But even a simple task like this may sometimes hold a surprising snag.

The recent experience of a Scotch friend of mine bears this out very

well. He is a dour and determined fellow, with a won't-be-done-by-anybody-or-anything temperament.

When a friend of his who knew nothing whatever about radio asked him if he would mind putting a new unit and chassis into a new cabinet, he promised readily to look round one evening. Moreover, assured his friend that it would take only a few minutes.

IS YOUR SET "PLAYING UP"?

Present-day radio is remarkably reliable. But every set "goes off" sometimes, and therefore it should not be assumed that it is wearing out. All it wants is proper maintenance—like a car or a bicycle, or any other similar contrivance.

If you have any knotty little problem requiring solution, remember that the WIRELESS CONSTRUCTOR Technical Queries Department is in a position to give you an unrivalled service.

Full details, including the scale of charges,

can be obtained direct from the Technical Queries Department, WIRELESS CONSTRUCTOR, Fleetway House, Farringdon Street, London, E.C.4.

A postcard will do. On receipt of this all the necessary literature will be sent to you, free and post free, immediately. This application will place you under no obligation whatever.

London Readers. Please Note: Application should not be made by telephone or in person at Tallis House or Fleetway House.

As a matter of fact it was after about two hours of really hard work that he got that loud-speaker unit going properly. It appears that he himself had unpacked it from the box in which it had been bought, and had mounted it straight on to the chassis (which was intended specially for it).

Before actually mounting it to the chassis, and as a matter of form, he had turned the adjusting screw and been rewarded with the usual click, showing that the unit was sensitive. But when everything was screwed in place and connected up the results were very weak indeed, and also distorted.

Some little time was spent in making sure that the output filter circuit was O.K., and then it was proved that the fault must lie in the new loud speaker itself.

There was nothing for it but to disconnect it from the cabinet, have the unit out again, and examine it properly. This was done and the most careful examination failed to reveal anything wrong!

It was one of the balanced-armature type in which there is not very much to see, because the gap itself is obscured by the pole-pieces, etc. But for all its impeccable appearance it was evident that something was seriously wrong inside this unit.

By this time the shop had closed and it was impossible to get another unit for trial; and, in any case, my friend was now on his mettle, and determined to see why the speaker failed to work. It almost beat him, but being blessed with a Bruce-and-Spider-temperament he finally shaped a piece of thin wire so that he could "feel" inside that part of the gap which he could not see. And then the truth came out.

The Trouble Located

At first the gap appeared to be quite clear and open. But when carefully investigated with this improvised scraper the cause of the trouble was revealed.

It was one of those "posh-looking" units coated with metallised paint, and somehow the makers had allowed

flakes of paint that had picked up metal filings to come too near the unit, and these flakes were held in the gap by the pull of the magnet.

An Interesting Fault

All the shaking and tapping failed to shift them as they were strongly magnetised. It was only when the properly-shaped scraper pushed them bodily from the pole-pieces that they could be moved, thus allowing the armature to move freely and properly in the gap.

It was an interesting fault if only for the blood-curdling threats on the lives of the loud-speaker makers that it evoked. And it certainly provided a good example of the way in which even an apparently simple operation can prove extremely puzzling.



WITH PICK-UP AND SPEAKER

How to make sure you are getting the best out of your radio-gram receiver.—Reducing scratch.—What needles do you use?

Conducted by A. JOHNSON-RANDALL.

FOLLOWING on my remarks last month concerning the provision of adequate volume, I have had a number of queries on the subject. Many of my readers use pentodes, but seem to be rather worried about their reproduction.

Lack of bass seems to be a large fault, and though many querists realise that this can be cured by means of careful impedance-matching in the output circuit, they seem to be doubtful exactly what kind of musical balance they should expect. How much bass and how much high stuff should be present in the reproduction?

Pick-Up Peaks

This is a difficult type of question to answer, but I will do my best by discussing the matter at some length. In the first place, before you can get a radio-gram receiver to deliver really satisfactory reproduction it is essential that the set and loud speaker give good results on radio. If the outfit is not satisfactory on broadcasting, it is hopeless to expect it to be good on record reproduction. This is easy to understand if you remember that the broadcast frequency curve is a better one than that employed by most records. The latter fall off badly below about 200, whereas radio does not fall off nearly so steeply or so early.

The upper end, however, may appear more pronounced on the record than on radio because of the fact that the lower end is not so strong in comparison, and because many pick-ups tend to peak round about 4,000 cycles.

The Real Thing

But you must start with the knowledge that the set is O.K., and to do this it is best to get things absolutely right on broadcasting. Then you can tackle the record side by means of corrective devices placed between the pick-up and the set.

Listen, if possible, either to the broadcast version of a well-known orchestra or dance band, or, better

still, to the original band, and then put a record of that orchestra on, preferably playing the same number. Compare the result and, if possible, decide where your set is giving the wrong impression.

The broadcasts of Jack Payne and Marius B. Winter are quite useful in this respect. (The former records for Columbia, and the latter for Vocalion, their numbers being published on the Broadcast Super Dance "Twelves.")

There are plenty of good records by which you can test your radio-gram. For instance, if you want to test the bass reproduction you could use "The Midnight Review," which gives a good representation of vocal part and drums. It is a baritone song by Peter Dawson, on H.M.V. C1988.

for piano reproduction, for the piano stop of the organ is remarkably lifelike.

Any of Chaliapine's recordings will prove of value for deep vocal tests; while if you can get your record dealer to play you over the "Victory" march on the H.M.V. demonstration record and to play it on the latest H.M.V. radio-gramophone (No. 521), you will get a good standard on which to base further tests.

Loss of Harmonics

But deep notes are not the only things to worry about. With certain speakers (especially the poorer of the moving coils) and certain pick-ups it is only too easy to get "plenty of bass." This, unfortunately, is accompanied in ninety-nine cases out of a hundred by lack of treble.

HEAR YOURSELF AS OTHERS HEAR YOU



Pupils in a West End school for broadcasters listening to a record taken of their voices as heard by the microphone. By this means they are enabled to know how they will sound to listeners when they eventually "go on the air" at Savoy Hill.

The Columbia record of the Hungarian Rhapsody No. 2, by Liszt, played on the Regal Cinema organ by Quentin McClean, is an excellent record for low-pedal notes and also

This usually means a very serious falling off of notes above about 2,000 and an almost complete lack of some of the main harmonics that give timbre to the violin, cymbals,

With Pick-Up and Speaker—continued

trumpet, clarinet, and many other instruments. Also, it usually means, as well, a bad suppression of transients—those inharmonic notes that do such a great deal to provide crispness and brilliance to orchestral music and definition to speech.

Listen to "Old Sam" (Columbia DX168) and to "The Murder on the Portsmouth Road" (H.M.V. C2044) and see how the *consonants* come out. Don't worry about the vowels, they will be there all right; but so many sets leave the listener to pick out the words almost by vowel sounds alone instead of supplying the very necessary consonants.

Some Good Tests

Listen for such words as "this," "that," "fizz," "tissue," "distance," on records and radio. The difference between "th" and "f" and between

The various devices, such as the "Novatone," "Tiltatone," and other tone correctors, will help, and so will the choice of a really good pick-up with, perhaps, a bit of "lift" at the bass. Unless the reproduction is frightfully hard and piercing on high notes (such records as "Follow a Star" Selection, H.M.V. C2057, will be a good test), don't use a scratch filter. It will only mean a loss of high notes and transients.

Fitting a Filter

If, however, the reproduction is very harsh and high-pitched, then you might try a "mild" filter. A 200,000-ohm resistance in parallel with a .0003-mfd. condenser across the pick-up will help. The .0003 condenser could conveniently be of the compression type and could be reduced in capacity if less filtering is required.

which drops off very considerably above 4,000, but becomes flat roughly below about 3,000. A rough calculation can be made as follows:

Take the 200,000-ohm resistance. At 100 cycles the impedance of this is 200,000 ohms. At 4,000 it is still 200,000.

Condenser Impedance

Now parallel it with a .001-mfd. condenser. This at 100 cycles has an impedance of about 1.6 meg., and at 4,000 of only about 40,000 ohms.

The formula by which these figures can be worked out is simple. Impedance = $\frac{1}{2\pi fc}$, where f = frequency and c = the capacity in farads.

Thus in the first case we have $Z = \frac{1}{2\pi fc} = \frac{7 \times 1,000,000}{44 \times 100 \times 0.001}$ ohms (working in mfd. instead of farads).

$Z = 1.6$ meg. (approx.).

Quite easy to design a filter of this sort as you want it, isn't it?

And now let me remind you that the needle you use plays quite a large part in the success or otherwise of your outfit.

I have found that the tungstyle needle is ideal in certain highly-damped pick-ups, but I have one very low-damped needle armature type which this needle definitely does not suit.

It "improves" the bass somewhat, but it "splits" the high notes in a most disconcerting way. In increasing the bass it also reduces scratch, but the result is not right.

Those Needles

I like the "spearpoint" or the Columbia talkie needle better. The latter is rather prone to reproduce the scratch, but this can be dealt with afterwards if desired, and the needle does seem to suit quite a lot of pick-ups.

Loud- or medium-tone needles are good in some pick-ups, but I have had little success with fibres or Burmese colour needles and the like.

These experiences are only given as guides, however; and I am well aware that your own choice may be quite different, for it rests with the individual to decide which needle best suits his particular pick-up and radio-gram outfit.

HOW DOES THIS SOUND ON YOUR SET?



This is Mr. Edward O'Henry, the organist at Madame Tussaud's Cinema. Records of cinema organ music are very valuable for testing the reproduction of a large band of frequencies, as most cinema organs cover a very large range of instruments.

"t" and "d" should be clearly defined, and the "s" sound should be clear and sharp. If the word "that" might be mistaken for "fad," something is seriously wrong, and if "tissue" sounds like "tizzyou," and "distance" like "disdanze," then the transients again want attention.

The best speech records give clear indication between the various similar consonant sounds; and it is no excuse if they cannot be heard on your radio-gram receiver.

Should you need more cut-off, try a larger condenser. Remember, we want to make the impedance of the condenser at about 3,500 or 4,000 cycles to be much less than that of the resistance.

A Falling Curve

Below 4,000 cycles (roughly the scratch frequency) the impedance of the condenser must rise, so that the medium and low notes are less affected. Then we get a falling curve

IMMEDIATE DISPATCH

-For Cash or Easy Payments-

Ready Radio holds colossal stocks of radio sets, equipment and components. Your order can be supplied from stock. There is no need for you to suffer the inconvenience of delay; you need not accept substitutes—if you send your order to Ready Radio you know that you will get what you order—immediately—and that everything you order will be new and in perfect condition.

"PLUS-STAGE" ONE

	£ s. d.
1 Special 18 in. X 9 in. baseboard to specification	1 6
1 ReadiRad 0005-mfd. variable condenser	4 6
1 ReadiRad duograph S.M. dial	6 6
1 ReadiRad 00015-mfd. differential condenser	5 0
1 Formo 0003-mfd. compression type condenser	1 6
1 ReadiRad "Paratune" coil unit	8 6
1 ReadiRad 0003-mfd. fixed condenser	10
1 Telsen 4-pin valve holder	1 0
1 Telsen 001 fixed	1 0
1 ReadiRad 2-meg. grid leak and holder	1 4
2 ReadiRad single-coil holders	1 8
1 ReadiRad "Hilo" H.F. choke	4 6
2 Belling Lee terminal blocks	1 4
4 Belling Lee "B" terminals	2 0
2 Ebonite strips, 5 in. X 2 in. X 1/4 in. and 4 in. X 1 in. X 1/4 in.	8
4 Lewcos plug-in coils (60X, 250X, 50 and 150)	19 3
1 Packet Jifilinx for wiring	2 6
1 Valve to specification, detector	8 6
Flex, wander plugs, tapping clip, etc.	1 5
	£3 13 6

or 12 equal monthly instalments of 6/9

INLAND ORDERS.

Goods despatched post free or carriage paid.

OVERSEAS ORDERS.

Goods very carefully packed for export and insured, all charges forward.

"PARATUNE" FOUR

	£ s. d.
1 Panel, 24 in. X 7 in. X 7/8 in., specially constructed and drilled to specification	12 6
1 Hand polished Oak cabinet, with 10-in. deep baseboard	1 17 6
1 Pair ReadiRad panel brackets	10
2 ReadiRad 0005-mfd. variable condensers	9 0
2 ReadiRad duograph S.M. dials	13 0
1 ReadiRad 0003 "Brookmans" condenser	3 6
1 Wearite 3-pole change-over switch, P.M.	4 0
1 ReadiRad 3-point wave-change switch	1 8
1 ReadiRad 00015-mfd. differential reaction condenser	5 0
1 Igranite 1-meg. megostat volume control	6 0
1 ReadiRad on-off filament switch	10
1 ReadiRad "Paratune" coil unit	8 6
2 ReadiRad single-coil holders	1 8
1 Lewcos 6-pin coil base	2 0
1 Bulgin N.7 neutralising condenser	4 9
1 ReadiRad 600-ohm resistance and holder	2 8
1 Link resistance, 600 ohms	9
1 Link resistance, 30,000 ohms	1 6
1 Varley 100,000-ohm resistance and holder	7 0
1 ReadiRad 2-megohm grid leak and holder	1 4
1 Lissen 25-megohm grid leak with terminals	1 3
1 W.B. horizontal valve holder	1 3
3 Telsen 4-pin valve holders	3 0
3 ReadiRad 0003-mfd. fixed condensers	2 6
2 Telsen 001-mfd. fixed condensers	2 0
2 Dubilier 01-mfd. fixed condensers	6 0
2 Dubilier 1-mfd. fixed condensers	5 0
1 Dubilier 1-mfd. fixed condenser	1 10
1 Dubilier 2-mfd. fixed condenser	3 6
1 ReadiRad 400-ohm potentiometer	2 9
1 Telsen "Radiogrand" L.F. transformer, 5-1 ratio	12 6
1 Atlas output L.F. choke	1 10
1 ReadiRad "Hilo" H.F. choke	4 6
1 Telsen H.F. choke	2 6
1 Screen, 10 in. X 6 in., with S.G. hole to specification	2 6
1 Ebonite strip, 24 in. X 1 1/4 in. X 7/8 in. drilled for terminals	1 9
12 Belling Lee "R" terminals	3 0
1 Sheet copper foil, 24 in. X 10 in.	3 6
2 Lewcos coils, 60X and 250X	11 3
1 Atlas short-wave coil, No. 6	2 8
1 Explorer dual-range coil	10 6
1 Explorer short-wave coil	7 0
1 Siemens S.G. cell	1 0
4 Valves to specification (S.G., Det., L.F. and Power)	2 7 6
1 Packet Jifilinx for wiring	2 6
Flex, screws, wander plugs, 3 spring clips, etc.	1 7
	£14 8 0

- KIT "A"**, less valves and cabinet, £10 3 0.
or 12 monthly payments of 18 7 6.
- KIT "B"**, with valves less cabinet, £12 10 6.
or 12 monthly payments of 23 7 6.
- KIT "C"**, with valves and cabinet, £14 8 0.
or 12 monthly payments of 26 5 6.

"BRYTA-TONE" AMPLIFIER

	£ s. d.
1 Panel, 14 in. X 7 in. X 7/8 in., drilled to specification	4 6
1 Baseboard, 14 in. X 10 in.	2 0
1 Igranite 1-meg. volume control	6 0
1 Wearite 2-way change-over switch	3 6
1 ReadiRad on-off switch	19
1 Varley 100,000-ohm resistance and holder	7 0
1 Dubilier 01-mfd. fixed condenser	3 0
2 Telsen 4-pin valve holders	2 0
1 Telsen "Radiogrand" L.F. transformer, 3-1	12 6
1 Atlas L.F. choke	1 10
1 Dubilier 2-mfd. fixed condenser	3 6
1 ReadiRad fuse holder, complete	1 3
13 Belling Lee terminals, type "R." Input +; -; 2 Pick-ups; 2 each L.T.-; and +; L.S.+; -; H.T.-; H.T.+; + 2	3 3
1 Pair ReadiRad panel brackets	10
2 Drilled ebonite strip, 10 in. X 2 in. X 7/8 in.	2 6
1 Packet Jifilinx for wiring	2 6
2 Valves, L.F. and Power (P.M. I.D.F. and P.M.2A.)	19 0
Screws, flex, plugs, etc.	10
	£4 16 0

or 12 equal monthly instalments of 8/9

Send for the Ready Radio Catalogue: A complete encyclopedia of all modern Sets, Speakers, Equipment, Components and Accessories, including everything needed by the set-builder.

Price 1/-, post free.

Cash or Easy Payments

Ready Radio

159, BOROUGH HIGH STREET, LONDON BRIDGE, S.E.1.

Telephone: Hop 5555 (Private Exchange) Telegrams: READIRAD, SEDIST.

Ready Radio (R.R. Ltd.), 159, Borough High Street, London, S.E.1.

Immediate Dispatch



USES

RADIO manufacturers all over the world are using Dubilier Condensers because it is known that their robust construction and high electrical efficiency can make all the difference to the performance of their sets.

You can do no better than follow their lead and make use of Dubilier Condensers for efficiency, accuracy and reliable Service.

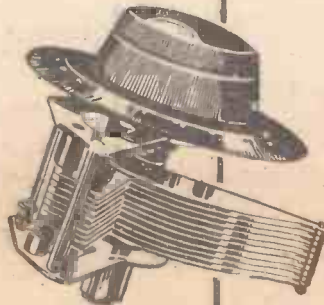

K.C. Variable Condenser

With knob, dial, and slow-motion device **11/-**

Without knob, dial, or slow-motion device **7/6**

**DUBILIER
CONDENSERS**

DUBILIER CONDENSER CO. (1925) LTD.

Ducon Works, Victoria Road, N. Acton, London, W.3

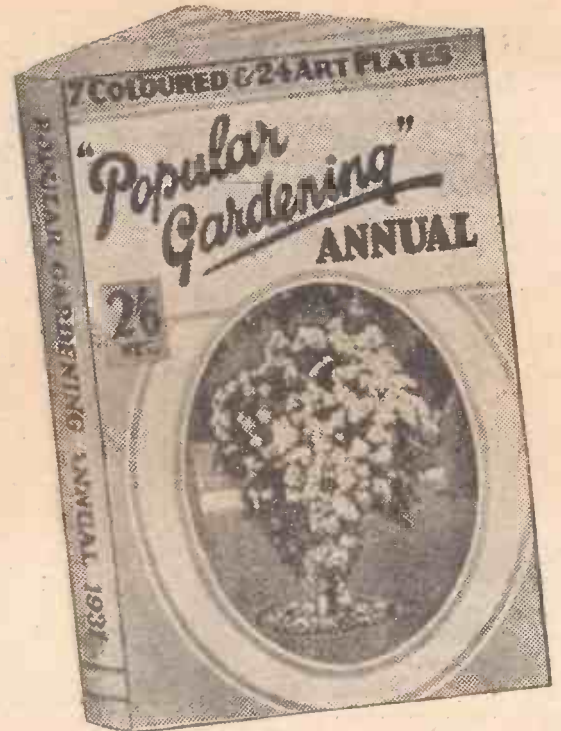

**An Ideal Gift
for your gardening
friends!**

There is no happier gift for gardening friends than a copy of **POPULAR GARDENING ANNUAL**. This very useful book is an illustrated budget of information for amateur gardeners. It contains an immense amount of information, seven coloured plates and twenty-four art plates, from photographs and diagrams. The contents include :

- Many Things you Ought to Know.
- Why not Plant a Tree or Two?
- Picture Dictionary of Flowers.
- Answers to Questions you Often Ask.
- The Flower Garden and Rockery.
- Designs for Flower Beds.
- What Flower Names Mean.
- Rose Growing for Amateurs.
- Some Shrubs we Recommend to You.
- How to Manage Greenhouse Flowers.
- Cures for Common Pests.

**POPULAR GARDENING
ANNUAL** *Now on Sale* **2/6**

IN LIGHTER VEIN

PROFESSOR GOOP

LOOKS AHEAD!

By Wireless Wayfarer



"WHAT spring message have you for my readers?" I asked Professor Goop.

"Readers?"
"Why, yes."

"I knew," smiled the professor, "that there was one who writes to you from Wigan, but who is the other?"

Between ordinary folk a nasty remark of that kind might easily lead to violence. The professor and I are always able, thank goodness, to settle our little differences in a calm and gentlemanlike manner.

When Mrs. Goop had dressed my black eye with a raw steak and had stuck on again the professor's right ear, which had somehow become semi-detached, I returned to my request.

Getting Him Started

To begin with the professor was not disposed to be expansive, and I will not pass on the rude messages which at first he bade me send. I am sure, for example, that none of you wishes to go and boil himself or anything of that kind.

WHY QUARREL?



"We can always settle our differences in a calm and gentlemanlike manner."

It seems to me that the best way to get the professor started would be to ask him a few definite questions, and I led off by requesting his opinion upon portable sets.

"Will they retain their popularity?" I asked.

"Why, certainly," answered the professor; "in fact, I think that this year's models, which are provided with brackets for screwing down to the table, will be more popular than ever."

"But I said portable sets."

"I know you did, but nobody ever carries a portable about and you cannot use it for outdoor listening, for

there is nothing to listen to in the afternoons. As I said before, the fixed portable will carry all before it."

"What have you to say about aeri-als?"

"These also will be retained. It is a curious fact that the purchaser of a portable set falls in love with it because it has no wires, but almost invariably uses it in conjunction with a battery eliminator placed on the table beside it, a moving-coil loud

In an interview, the Great Goop reviews the present position of radio and is pleased to expound a little in regard to the future. We are sure our readers will appreciate the immense service this scientist is rendering by bringing his mighty intellect to bear on the practical problems of radio in the home.

speaker, and an outside aerial. He does not feel really happy until there are plenty of wires knocking about."

"Is it necessary, do you think, to support the aerial mast with stays?"

"Of corset is," snapped the professor, dodging the high-tension battery which I flung at his head.

"Shall we see legislation introduced to make it a punishable offence to cause interference with wireless reception by flashing signs, sausage machines, automatic cradle-rockers and the like?"

"That is, I think, hardly likely," murmured the professor, "for some little time to come. You must not forget the lines upon which this country of ours is run and the procedure of thousands of years which has made us (here he proudly smacked his chest) what we are.

The Brush Problem

"If you think for a moment, you will see that our plan is invariably to let a nuisance that could have been nipped in the bud go on increasing until it has reached such stupendous proportions that something terrific in the way of legislation is required.

"And then, so that nobody shall suffer by being forced to spend about sixpence in putting matters right, it is enacted that the new law shall not come into force for five years."

"But could we not compel users of electric motors to see that their brushes were in good order?"

"The suggestion bristles with difficulties," replied the professor.

"And what about the B.B.C.? I mean, do you think that they will give us brighter programmes and all that kind of thing?"

The professor smiled rather sadly.

Real Alternatives

"They will give us," he said, "large numbers of genuine alternative programmes by sending out the same two on different wave-lengths from each of their high-power stations.

"Each of those transmissions, by the way, will be found as it comes into operation to jam some station on the Continent, or to be jammed by it, and a great deal of thoroughly

THOSE SYMPHONIES!



"The work of modern composers, who write for six police-whistles, a steam-hammer and a factory hooter."

genteel correspondence on the subject will be issued from Saveloy Hill.

"It will probably be found that we are receiving too much entertainment on Sundays, and as for weekdays, I expect to see all stations closing down at 9.30 p.m., in order to send us to bed early so that we may rise fresh and fit for our work on the next day. That is, of course, an urgently needed reform."

"What will happen about the London Regional and Stuttgart, or the next pair of stations that start mousing each other up?"

"The solution of this problem is, of course, perfectly obvious. The suffering British station should

In Lighter Vein—continued

immediately increase its power to a hundred kilowatts. The foreigner would then retaliate and go to two hundred. Then the British leap to five hundred and, since all sets within the service area are promptly burnt out, the interference problem is automatically solved."

"Now tell me your views about receiving sets of 1931. Do you foresee great advances?"

"Most certainly I do," came the reply. "The tendency will be all towards simplification."

No-Knob Tuning

"But surely we cannot simplify much further. We have already brought tuning down to one knob, and one cannot go beyond that."

"Oh, yes, we can! In fact, I think that when the power of all our stations is properly pushed up under the Regional scheme, the majority of receiving sets will automatically incorporate no-knob tuning."

"How do you mean, exactly?"

"Well, no movement of any knob will bring in anything but one or both of the local transmissions, so one might just as well rid the panel of all excrescences."

"Don't you think," I asked, "that more efficient screening may save us from the swamping that you have sketched so vividly?"

WITH GOOD REASON!



As regards dials—the professor is pessimistic.

"There's a good deal in that," returned the professor. "Many users of antiquated sets are feeling the draught, and screening may well help to temper the wind to the shorn lamb, if I may so put it."

"I wish," I said, "that somebody would invent an overscreen."

"What on earth do you mean?"

"To keep out the overdrafts."

When order had been restored, I led the professor on to deal with components such as we use when we get our friends to construct wireless receiving sets for us. The

professor is very shortly bringing out one of his own invention, which will, I am sure, meet with a very cordial reception.

This is the Goop Topical Talk Eliminator. It is a small and very neat gadget whose cost should be only a matter of pence. A small knob placed upon the panel actuates a moving contact. Pulling out the knob brings a metal arm into electrical connection with a small spring clip.

If the knob is pushed in, contact is broken, since the arm is caused to sever its connection with the clip. The Topical Talk Eliminator is placed in the low-tension positive lead immediately between the filament battery and the filament positive busbar.

Jacks and Plugs Again

If with the knob in the "out" position a topical talk is found to be coming in, it can instantly be eliminated by a slight pressure on the knob with the thumb of the right hand.

The device is equally useful for chamber music and for those symphonies which our most modern composers write for six police-whistles, a steam-hammer, a bird-scarer's rattle, a battery of field artillery, and a factory hooter.

In the professor's view, we shall see certain returns to once popular components which have of late rather lapsed from favour. He expects to see the plug and jack very widely used in the sets of 1931.

For the Short Waves

For the short waves, the professor is very much impressed by the latest invention of a Frenchman, M. Marcel, which appears to be most promising. One of the troubles hitherto has been the flightiness of short-wave transmissions. I mean, you never know whether you are going to be able to receive W2XAD or not. M. Marcel's method solves the problem by making these somewhat chancy waves permanent.

As regards dials, the professor is a little pessimistic.

"That possessed by the average listener," he said, "is not inspiring, and I am often moved to tears when, at meal-times, I see it in slow motion.

"Many of these that I meet with appear to have suffered from side-

slip, and not a few, though they may themselves be smooth enough, give me the jumps. The male dial is not infrequently disfigured by cat-whiskers, while the female dial is often so nearly obliterated by colouring matter during the marking-out process that it is exceedingly difficult

WELL EQUIPPED!



A handy fitment for the home workshop.

to obtain an accurate reading, though the clearly defined hair-line is occasionally a help. The female dial has, in the professor's view, become less and less satisfactory since washing went out of fashion in favour of cold cream.

Lastly, the professor asks me to bid you see that your workshops are thoroughly well equipped, for he foresees a strenuous year of constructional work. One of the handiest little fitments imaginable is illustrated in the last drawing.

 * "RE-WINDING" *
 * MADE EASY *
 * A reader's tip for fine wire. *

Sir,—May I make a remark on the article, "Rewinding Made Easy," by J. Bond, in your January number; and that is, that for a really reliable job the fingers should not be allowed to touch the wire on any account. The acid will sooner or later cause a fault when dealing with fine wire. Remedy: Use a small piece of flannel or linen between the fingers.

My "authority" for this suggestion is some (not very much) experience in winding, including secondaries, of H.T. mags., and a good many loud speakers. Incidentally, old Ford coils are excellent if other fine gauge wire is missing.

Good luck to your most interesting paper.

Yours faithfully,

E. HALLEWELL.

Cornwall.

The
Ear of
Many
Successful
Receivers—



**THE
LEWCOS**
(Regd.)

"X" COIL

PRICES (X 50-75 4/9)
(X 200-300 6/6)

As many wireless experimenters are aware, the Lewcos X Coil, with its sister component, the Lewcos Centre Tapped Coil, has figured prominently in the specification lists of many of the most successful sets, constructed, tested and described by the experts of this Journal. Thousands of discriminating amateur constructors who have taken the advice of the experts know that the Lewcos X Coil is as vital a necessity to their receivers as are the ears to the human being.

Write for fully descriptive leaflet Ref. R. 34.

**Spells
Superiority**



The Lewcos H.F. Choke (Price 7/9d.) and the X Coil, illustrated above, are specified for the "Paratune" Four Receiver described in this issue.



A Twin Two-Pin Base, which eliminates coil changing, is now available for use in connection with Lewcos X and Centre Tapped Coils.

Write for leaflet Ref. R.69.

LEWCOS RADIO PRODUCTS FOR BETTER RECEPTION

THE LONDON ELECTRIC WIRE COMPANY AND SMITHS LIMITED, CHURCH ROAD, LEYTON, LONDON, E.10

AS WE FIND THEM



The "Torex" Transformer

Messrs. LISSEN, LTD., Worpole Road, Isleworth, Middlesex, have sent us one of their new "Torex" transformers. This instrument is remarkable for its low cost—it retails at 5s. 6d. An examination reveals a compact little transformer



The new Lissen "Torex" transformer. It sells at the remarkably low price of 5s. 6d.

having a nicely finished bakelite casing, which the makers claim to be hermetically sealed. Neat terminals and soldering tags are provided. The core is of silicon steel, and the makers' curve taken with the component used as a parallel, resistance-fed transformer shows even amplification over a wide band of frequencies.

The ratio is 3 to 1, and on test we found the device gave surprisingly good results. It is excellent value for money.

A Cone Extension Rod

Messrs. J. H. Weedon & Co., 80, Lonsdale Avenue, East Ham, E.6, have sent us a self-centring driving

and extension rod for use with cone loud speakers.

The device consists of a length of threaded brass rod, with a ball and socket joint at one end and a couple of aluminium washers at the other. This extension rod can be fitted to the driving rod of the loud-speaker unit, and should be useful in cases where there is some difficulty in correctly aligning the unit and cone diaphragm. The price is 1s. 6d.

A Short-Wave Kit

We have received from The Rothermel Corporation, Ltd., 24-26, Maddox Street, Regent Street, London, W.1, a Hammarlund two-valve short-wave kit which is being marketed in this country.

The Hammarlund short-wave coils are already known to constructors in this country, and, as readers are aware, the Americans have carried out a

The Weedon cone unit extension rod has a ball and socket joint and is intended for use in cases where there is some difficulty in obtaining correct alignment.

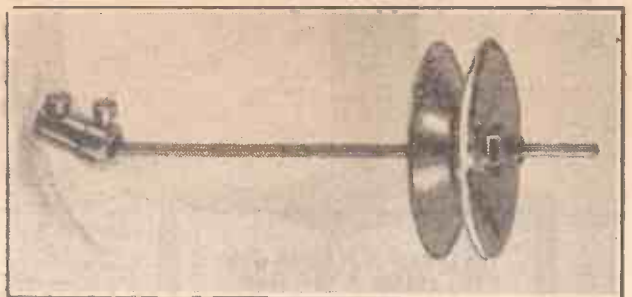

great deal of pioneer work in short-wave reception.

We are making up the kit with the intention of subjecting it to exhaustive tests, and we hope to publish the results obtained in an early issue of the WIRELESS CONSTRUCTOR.

Competa Fuses

Messrs. A. F. Bulgin & Co., Cursitor Street, Chancery Lane, London, E.C.4, recently sent us some samples of their "Competa" fuse bulbs.

These fuses are of the flash-lamp type, with screw bases for use with the standard pattern fuse holders.

The current-carrying capacities of the various types are as follow: Type A, 60 m.a.; type B, 100 m.a.; type C, 150 m.a.; type D, 200 m.a.; type M, 250 m.a.; type N, 300 m.a. They are rated to fuse at 50 per cent overload.

Messrs. Bulgin inform us that the fuses are specially manufactured for them, and that during the last year they have supplied large numbers to leading set manufacturers.

The "Kelsey" Adaptor

Messrs. Peto Scott, of 77, City Road, London, E.C., have sent us their version

of the "Kelsey" Adaptor unit, which was described in last month's issue.

Readers will remember that the adaptor is a compact little unit, designed for use with practically any receiver which it is desired to

(Continued on page 332.)

Perfect Ensemble



TELSEN H.F. CHOKES. Designed to cover the whole wave-band range from 18 to 4,000 metres. Extremely low self-capacity, shrouded in genuine Bakelite. Inductance 150,000 microhenries. Resistance 400 ohms. Price 2/6 each.

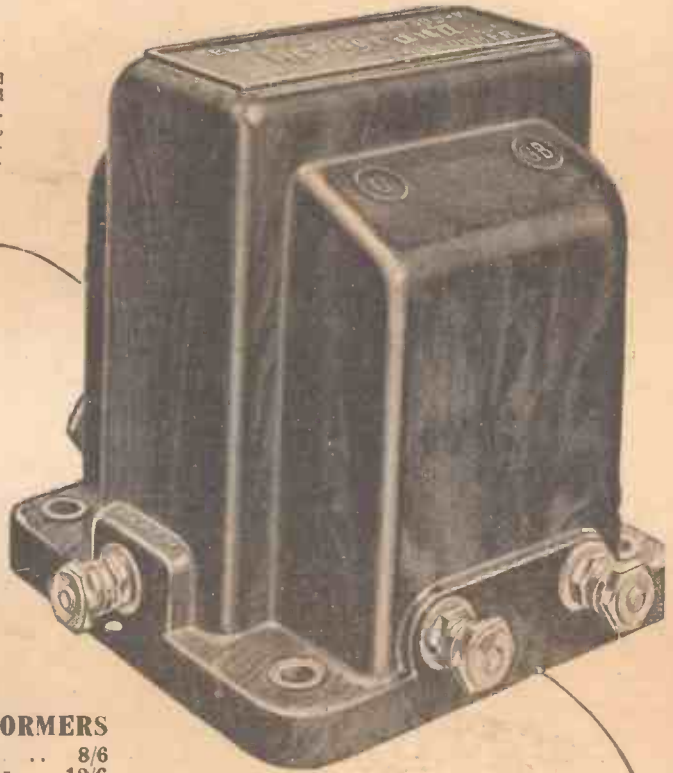

TELSEN FOUR PIN VALVE HOLDERS. Price 1/- each.



TELSEN VALVE HOLDERS. Pro. Pat. No. 20286/30. An entirely new design in Valve Holders, embodying patent metal spring contacts which are designed to provide the most efficient contact with the valve legs, whether Split or Non-split. Low capacity, self locating, supplied with patent soldering tags and hexagon terminal nuts.

TELSEN L.F. TRANSFORMERS

- "ACE" Ratios 3-1 and 5-1 . . . 8/6
- "RADIOGRAND" 3-1 and 5-1 . . 12/6
- "RADIOGRAND" Super. Ratio 7-1 17/6

Collective efficiency—simply another way of saying that efficient parts make an efficient whole. Especially is this the case where TELSEN components are concerned . . . each one a masterpiece of design and workmanship embodying many patented features . . . each one perfect in performance.



TELSEN FIVE PIN VALVE HOLDERS. Price 1/3 each.



TELSEN GRID LEAKS. Absolutely silent and non-microphonic, practically unbreakable, cannot be burnt out and are unaffected by atmospheric changes. Not being wire wound there are no capacity effects. Made in capacities: 1, 3, 4, 2, 3, 4, and 5 megohms. Price 1/- each.

Experienced radio designers consistently choose TELSEN . . . there are reasons . . . here are three of them . . . amazing tonal quality . . . extraordinary volume . . . exceptionally long life.

Choose your circuit . . . then choose TELSEN . . . and you will get the most out of your circuit. Your present set will take on a new lease of life if fitted with

TELSEN FIXED (MICA) CONDENSERS. Shrouded in genuine Bakelite, made in capacities up to .002 mfd. Pro. Pat. No. 20287/30. .0003 supplied complete with Patent Grid Leak Clips to facilitate series or parallel connection. Can be mounted upright or flat. Tested on 500 volts. Price 1/- each.



TELSEN

COMPONENTS

POINTS FOR PURCHASERS

Some interesting items mainly from radio manufacturers and distributors about their latest lines.

"Everybody's Battery Book"

RADIO manufacturers have an enviable reputation for issuing informative literature about their products, and this will certainly be enhanced by the latest edition of Ripaults' "Light on the H.T. Battery."

This book has been specially prepared for radio enthusiasts who would like to know more about this important accessory and how it affects their reception. Admirably arranged, well illustrated, and most convincingly marshalled, are an array of facts about H.T. batteries and the folly of buying very cheap types if economy is the first consideration.

One graph gives a telling comparison between various batteries, tested by discharging them through a fixed resistance at 6 milliamps; the batteries being worked for three hours each day and rested for the remaining twenty-one hours, as under working conditions. This, of course, is the ideal way to test a battery's radio capabilities.

Any WIRELESS CONSTRUCTOR reader who writes to Ripaults, Ltd., King's Road, London, N.1, will receive a copy of this instructive booklet.

The Ferranti Screened-Grid Four

Ferranti, Ltd., the famous firm of Hollinwood, must find that their constructional charts are highly appreciated, for another addition has been made to the already comprehensive range.

This describes in detail the Ferranti Screened-Grid Four, 1931 model, a battery-operated receiver for both long- and medium-wave stations, which can also be used in conjunction with a gramophone pick-up. Set out with admirable clearness and with full instructions for the actual making and operating, this addition to the Ferranti constructional literature will find a hearty welcome.

Applications from WIRELESS CONSTRUCTOR readers for the chart should be addressed to the firm at their head office and works, Hollinwood, Lancashire.

Two-Volt Valves

From the Marconiphone Company, Ltd., we have received particulars—in the form of a supplement to their

recently issued valve catalogue—of a new two-volt series of Marconi valves.

The makers claim that a comparison will reveal genuine supremacy on every essential point, giving vastly improved performance and greater range with amazing volume. Readers who are interested in the new two-volters should write to the Marconiphone Company, Ltd., at 210, Tottenham Court Road, London, W.C.1, for a copy of the folder.

It is well arranged and shows characteristic curves of each of the

"SANG FOR HIS SUPPER"



Visitors to "Little Tommy Tucker," at Daly's Theatre, London, will remember this Mullard "Orgola" playing records in the foyer of the theatre.

new valves, together with details of recommended grid-bias and anode voltages, and much useful operating information.

New Varley Folder

We have received from Varley (Oliver Pell Control, Ltd.), Kingsway House, 103, Kingsway, London, W.C.2, a new folder which has been prepared to familiarise the public with the Varley all-electric receiver and radio-gramophone.

Obtainable in A.C. and in D.C. models, this instrument uses the most modern A.C. valves—H.F. screened grid, detector and output.

A wide variety of continental programmes is obtainable under average conditions, and provision is made for a gramophone pick-up.

The volume obtainable is ample to work a moving-coil loud speaker, and anyone who contemplates buying an all-electric outfit will receive a copy of this new folder on application to the makers.

Radio Text-Book

The fourth edition of "The Handbook of Technical Instruction for Wireless Telegraphists,"* just received from Illiffe & Sons, Ltd., is a complete text-book for the use of wireless telegraphists, and others interested in the subject. Written by H. M. Dowsett, M.I.E.E., F.Inst.P., M.I.R.E., who was responsible for the second and the third editions of the original work by Hawkhead, the subject matter has been entirely recast and the scope of the book widened to meet the exacting requirements of the operator of to-day. This book of more than 480 pages is certainly good value at twenty-five shillings for the specialised class for which it is intended.

"A Million Aerials"

Everyone interested in radio and an eye for advertising will be familiar with the slogan, "A Million Aerials Lead Down to Mullard Valves." The firm has prepared a new edition of the folder of this name and it is available to the trade in quantities.

Full details regarding all Mullard battery- and mains-operated receiving and rectifying valves, including the latest editions to the range, are incorporated, the inside pages having been revised and brought right up to date. Application should be made to Mullard House, Charing Cross Road, London, W.C.2.

Exchanging Variable Condensers

Messrs. Wingrove & Rogers have hit upon an attractive scheme for popularising "Polar" condensers. Until the end of February they are allowing 2s. off the price of any "Polar" variable condenser sold, in return for the old variable condenser (of any make) it replaces. Full details can be obtained from your local dealer.

*By H. M. Dowsett, price 25s., or by post 25s. 9d. Illiffe & Sons, Ltd.

Order your April
"WIRELESS CONSTRUCTOR"
On Sale March 14th. Price 6d.

Listening at less cost per hour

Here are low tension batteries specially made for economical sets. You know that with ordinary batteries you do not get the full saving from modern low consumption valves, because the battery has to be recharged every two or

three weeks even if it has not completely run down. This is to prevent it sulphating. Here are batteries that **will not sulphate**. They are made with special "mass" type plates for slow discharges that will stand for months without taking harm. These robust batteries are called the Exide "D" Series.

They mean that you can now use with advantage a battery of a much larger

capacity than before, and so **reduce recharging**. This, together with their low price, makes them the world's most economical batteries.

Note, too, their **convenience**. Terminals differently coloured and shaped that can be distinguished even in dark corners. Trough to catch acid. Strong metal carrier. All owners of small sets should avail themselves of an Exide "D" Battery.



"D" Series L.T. Batteries. Prices per 2-volt cell: DTG, 20 amp. hrs. 4/6 DFG, 45 amp. hrs. 8/6 DMG, 70 amp. hrs. 11/- DHG, 100 amp. hrs. 14/6 From Exide Service Stations or any reputable dealer. Exide Service Stations give service on every make of battery

Exide Batteries, Clifton Junction, near Manchester. Branches at London, Manchester, Birmingham, Bristol and Glasgow M 20

THE "FOUR-FIVE" CONVERTER

An easily-made gadget that enables you to try an A.C. valve in any set designed for battery varieties.

By A. S. CLARK.



WHEN experimenting with A.C. valves it often happens that it is desired to try one of them in a set which is intended for ordinary valves.

This can be done without altering the set in any way by means of the "Four-Five" Converter, which is plugged into the ordinary valve holder, the 5-pin valve then being inserted into the converter.

The grid and plate pins of the 5-pin A.C. valve are in the usual positions and are connected up in the usual way. Therefore, the sockets in the converter which take these pins are connected direct to the plate and grid pins on the converter, and these in

THE SAME WIRING

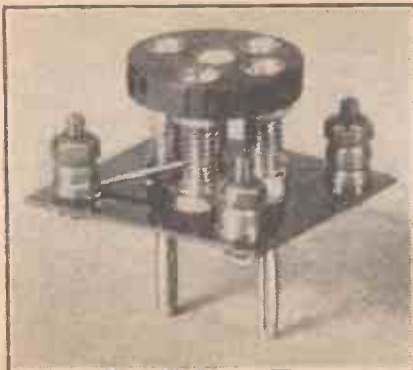

You don't have to alter the set's wiring.

turn go direct into the plate and grid sockets of the ordinary holder.

They are the only two pins on the converter, for the other three valve pins (those joined to the filament heater and cathode) have to be joined up to special points. For this purpose three terminals are provided. No connections are made to the filament sockets of the ordinary valve holder.

Simple Construction

The photograph and diagram should give you a good idea of the construction. The top part of the converter consists of a small, round piece

of ebonite into which five valve sockets are inserted.

The two filament heater sockets are longer than the other three, and pass right through a small, square piece of thin fibre or other insulating material. Nuts put on the ends of the shanks of these two clamp the square piece in place.

Exactly below the grid and filament sockets two valve pins are fixed to the square piece by means of nuts on top of it. These two nuts just touch the bottoms of the grid and plate sockets to which they have to be soldered.

Terminals are fixed at three of the corners of the square piece, and are connected by wire to the centre or cathode socket and the two heater sockets. The wires for the latter are arranged under the square piece, while that for the cathode is on top.

The Parts Required

For your convenience I will just enumerate the materials and parts required. A round piece of ebonite 1 in. in diameter and a $\frac{1}{4}$ in. thick (this can be cut out with a fret-saw). A square piece of thin fibre or other hard insulating material $1\frac{1}{2}$ in. square. Three small terminals, two valve pins, and two long and three short valve-pin sockets.

The pins and sockets are Clix, and if you keep to this make you will find that the various "bits" fit together just right.

The dimensions for drilling the ebonite and square piece are given in the diagram, which also shows other details of construction. If you prefer, instead of marking out the positions of the pins and sockets by measurement you can make a template by pressing the pins of a valve on a piece of soft paper, and this can be used by pricking through the centres of the indentations.

The holes for the valve sockets have to be countersunk so that the sockets fit right home in them.

How to Use It

When using the converter, connect the two terminals joined to the sockets which take the heater pins to the terminals of the mains transformer which supply the necessary 4 volts A.C. The point to which to attach the cathode terminal depends upon the valve being used and the circuit.

In cases of automatic biasing it will go to the bias resistance and, possibly, bypass condenser, whilst in other cases it should be joined to H.T.—. Sometimes it will be found desirable to join one heater terminal to L.T. negative.

DETAILED DIMENSIONS

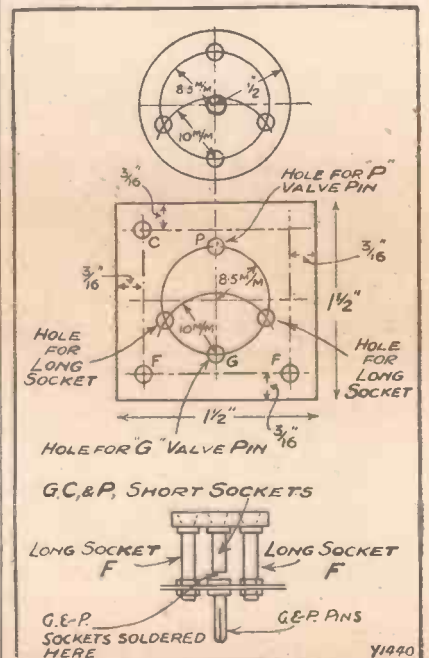

If you work closely to the above few details you will find that an A.C. valve fits like a glove.

The "DISTASWITCH"

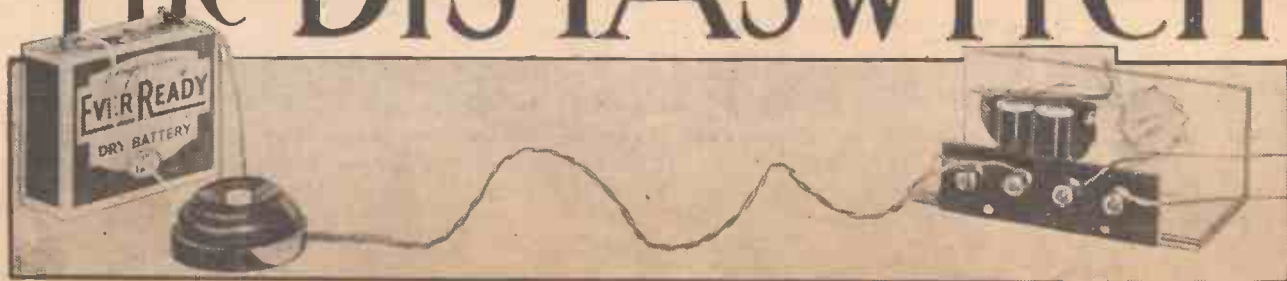

Has it ever occurred to you to look upon a remote control switch as an excellent current economiser?

But perhaps you are not familiar with the function of a remote control device, so it would be as well if we dealt with this first.

Nowadays it is almost universal practice to use the radio in more rooms than one, which means to say that when the loud speaker is in use in a room away from the set the programme cannot be switched off without a journey to the room in which the receiver is located.

Switching the L.T.

As most of you know, there are certain technical objections to running the L.T. leads of the set along to a switch at the loud-speaker end of the extension leads, and the only

EASY TO MAKE

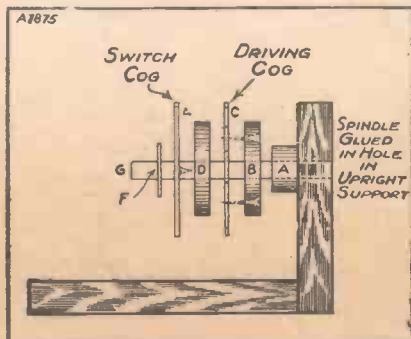

The parts are assembled on the spindle in the order shown.

alternative is to use a switch at the loud-speaker end to actuate a relay at the set end.

This, in effect, is what a remote control circuit does. It switches the set off for you, and the loud speaker will remain silent until the actuation of the remote control switch once again brings the receiver into operation.

Where does the current economising part of the business come into it?

Well, is it not a fact that you leave on many of the "five-minute fill-up"

The lazy man will like this gadget, which enables him to sit at ease in one room and switch the set in another on and off! It costs very little, but it is worth a lot, because you need never listen to an unwanted item or miss a wanted one if you fit a "Distaswitch."

Designed and Described

By G. T. KELSEY

most useful addition to the receiving outfit.

Only One Extra Wire

This article is all about a reliable remote control unit which, for a matter of a couple of shillings or so, you can make at home, and which to put into use requires only one wire in addition to those normally em-

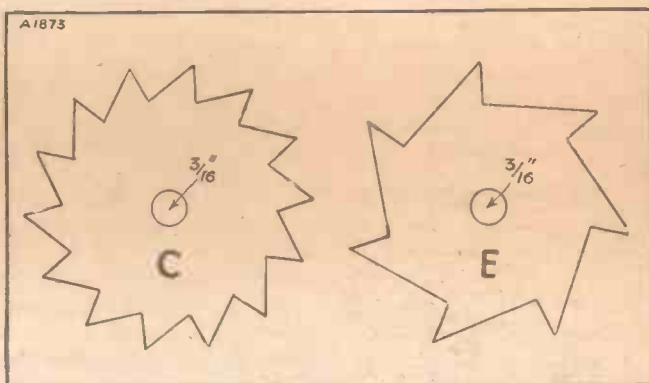

You cut the cog-wheels out of copper sheet or aluminium—it can be done with ordinary scissors.

items, and, if you are very redoubtable, perhaps even some of the talks, in preference to making a double journey to the set just for the purpose of switching it off and then on again?

The use of a remote control switch will save you both the journey and the current, and you will find it a

ployed for the loud-speaker extension.

The actuating mechanism consists of the bobbins and armature taken from an ordinary common or garden electric bell and, providing you go to the right place, you should not have very much trouble in obtaining one for about two shillings.

HOME-MADE BUT EFFICIENT

An old electric bell or buzzer movement supplies the kick that cuts the set in or out as desired.

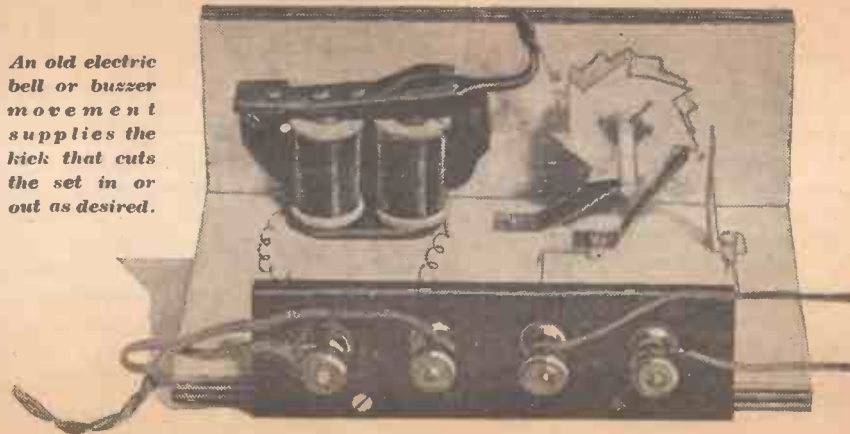

The "Distaswitch"—continued

The—perhaps at first sight—complicated-looking cog-wheel affairs are cut out of aluminium or copper sheet with ordinary domestic scissors (no allowance was made in the estimate for sending the lady of the house to the pictures while this operation is done!) and the drawings are full size, so that they can be stuck on the metal and used as templates.

been given to the diagrams accompanying this article.

Full-Size Templates

After all, the accurate cutting of the cogs is really the most important part of the business, and since you are provided with full-size templates for this purpose it is unlikely that you will go very far wrong.

For this reason I intend to describe the construction of the latter before telling you much about the general assembly. In addition to the two metal cogs (the construction of which will be easy if you cut accurately round the templates provided) you will require two wooden discs of $\frac{3}{8}$ -in. plywood 1 in. in diameter, a metal washer, and a further wooden or ebonite washer to go between the back support and the cog assembly.

Referring to the diagram in which the parts of the cog-wheel are shown separated, the method of procedure should be as follows. First screw wooden disc B to disc D with the cog-wheel C (the one with the most teeth) between the two. Then fasten the remaining cog-wheel by means of small countersunk wood screws to the other side of disc D in such a way that the teeth are accurately opposite to every alternate tooth on the cog already secured.

Fitting on Spindle

The complete assembly should now be free to revolve on the spindle G, but try, if possible, to avoid "wobble" through having the spindle hole too large. Incidentally, you will find the job of assembly considerably simplified if you drill the spindle hole in each component part before the cogs and discs are screwed together.

In order to make an accurate copy of the original it will be necessary for you to obtain an electric bell in which the bobbins are approximately the same size as those I used. But this will not always be possible, because there are so many different kinds available. Naturally, upon the length of the armature and the size of the bobbins depends the "layout" of the parts on the back support.

It would, therefore, probably be best for you to proceed by fixing the spindle to the back piece in roughly the position shown in the diagrams. You can then determine the position for the bobbins by the well-known "trial-and-error" method. But first you must prepare the armature in the manner shown in the elevation drawing.

Armature Preparation

After the striking knob has been removed it should be bent to the angle shown, and then a thin piece of springy copper foil (not too thin) should be prepared as shown and

A TRIUMPH OF SIMPLICITY

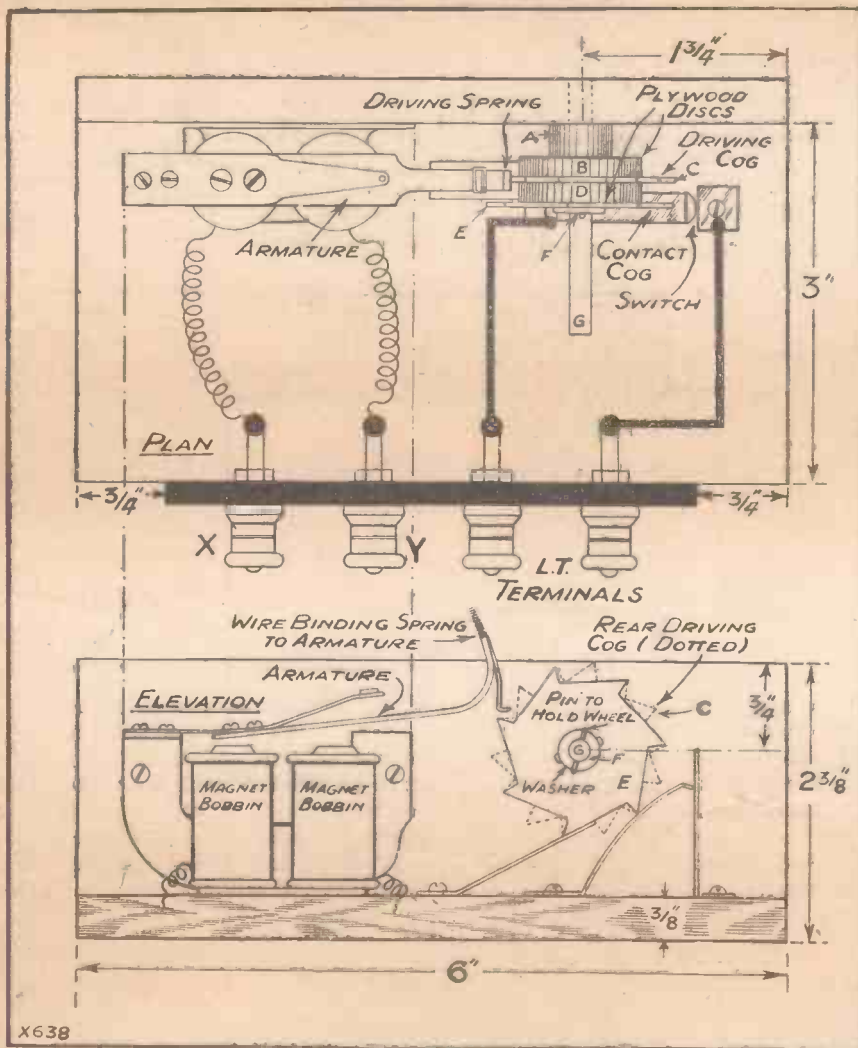

Here you have a "looking-down" view (top) and also an elevation, with all the necessary dimensions to enable you to make your own "Distaswitch" without difficulty.

Naturally, a remote control of any sort is something of a delicate piece of apparatus, and, in consequence, a certain amount of care will be necessary in the construction of this little unit. But actually there is no reason why you should not be able to make almost an exact duplicate of the original, and to help you as much as possible particular care has

First of all, obtain two pieces of $\frac{3}{8}$ -in. plywood to form the back and base of the unit. You can obtain all the necessary dimensions from the plan and elevation drawings, but do not at this stage screw the two together. It is much better first to mount up the bobbins and armature, and the cog-wheels which actuate the switch.

Five Fine Sets

Charts now available



These Sets are the finest ever put out in charted form for the home constructor.

The full scale drawings are clear and easy to follow, so that anyone who can drill a hole and drive a screw can build receivers and secure results not equalled by any other home-constructor's Sets.

They have been designed to combine the three essentials of good radio: 1st—True reproduction; 2nd—Great range and power; 3rd—Adequate selectivity. Each component employed is the best of its class and has been chosen with one object in view—the ultimate performance of the set. Provision for Gramophone Pick-up. **NO SOLDERING.**

1931 Editions

- TWO-VALVE**
Battery Operated
- TWO-VALVE**
A.C. Mains Operated
- SCREENED GRID 3**
Battery Operated
- SCREENED GRID 3**
A.C. Mains Operated
- SCREENED GRID 4**
Battery Operated

Write for the Chart which best meets your requirements

Free on request

FERRANTI

Ask your Dealer for a Chart or write to

FERRANTI LTD, Charts Section, HOLLINWOOD, LANCASHIRE

The "Distaswitch"—continued

bound to the end of the armature by means of wire.

If you now place the cog-wheel assembly on the spindle you will be able, by experimenting with the position, to find the place in which to fix the bobbins. They should be secured in such a position that when the armature is pressed down to the cores of the bobbins the springy copper end-piece drops just sufficiently to move the wheel round one tooth.

ON YOUR SET

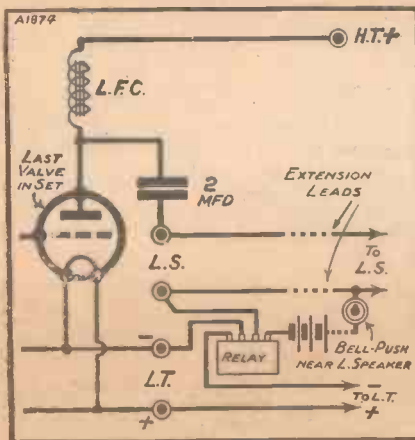

This circuit shows the simplicity of the connections to the set.

Don't worry if the upward movement of the springy copper, when the armature springs away from the bobbins, is sufficient to move the wheel back again, because provision is made to guard against this in the finished unit.

Locking the Movement

As a matter of fact, the wheel is prevented from turning backwards by means of the springy piece of copper shown in the diagrams, which acts on the underside of the cog with the greater number of teeth. It should be so cut and shaped that it falls into the hollow immediately after each tooth when the wheel is rotated. And, by the way, this spring contact must also be of quite thin copper, otherwise the unit will not work.

The switch contacts are actuated by the cog E (the one with the fewer teeth), and the correct placing of the spring contacts will call for a little care. You will find it best if you fix the one operating against the cog first. It should be a perfectly straight piece of springy copper (except for the "leg" at the bottom and the bent-

over piece at the top) of such a length and placed at such an angle that it will just rest in the inverted L shape following each tooth when the switch is in the off position.

The L.T. Contacts

The vertical contact should now be screwed into position with a space of approximately $\frac{1}{8}$ in. between it and the contact you have just mounted.

I'm afraid that on paper this all sounds a very complicated business, but it is not so very difficult, and if you carefully follow the diagrams you should not have much trouble. The remainder of the constructional work, once the mechanical part is adjusted correctly, is quite simple, and can best be followed out from the diagrams.

To put the unit into use, disconnect the wire to the L.T. negative terminal of your accumulator, and join it instead to one of the terminals marked L.T. on the unit terminal strip. The remaining L.T. terminal on the unit should be joined direct to the negative accumulator terminal.

Bell-Push Connections

Next join terminal X on the unit to one side of a $4\frac{1}{2}$ -volt dry battery, and take the other side of the battery by means of an extension wire to one contact of an ordinary bell-push

placed in the room from which it is desired to control the set.

You still have terminal Y on the unit unconnected, and this should be joined to the loud-speaker terminal of your set which goes to L.T. negative.

The remaining contact of the bell-push in the room remote from the set should be joined to the loud-speaker extension lead which goes to the L.S. terminal of your set to which we have already referred, i.e. the one joined to L.T. negative.

Use Without Filter

The above circuit of connections applies, of course, to sets employing a filter output circuit. Incidentally, it is very bad practice to use loud-speaker extension leads *without* a filter.

In cases where a filter circuit is not in use either loud-speaker lead may be employed, and this should be joined direct between terminal Y and the remaining contact on the bell-push (the one which is not connected to the $4\frac{1}{2}$ -volt battery), but special care must be taken that the two cogs are not connected electrically by the screws which hold them to the wooden discs. The L.T. switch in your set should be left permanently in the "on" position, and all that it is necessary to do to switch the set on or off is to press the bell-push.

HAVE YOU HEARD HIM?



This photograph shows the broadcasting station at Linz, Austria, which works on a wave-length of 246 metres.

YOU CAN SIMPLY SWITCH ON!



Wherever electric current is available, batteries are out-of-date. Running your set from the mains means less trouble, less uncertainty, with better reception and greater economy. Where mains provide alternating current, it must be converted to direct current by means of a rectifier. Our Rectifier is different from all others. It is all-metal and contains nothing to burn or wear out. It converts—in conjunction with other components—existing battery-run sets to mains sets; it is ideal for use in constructors' kits, and it is incorporated in most good makes of mains receivers. If you are purchasing, make sure that it is in yours. Prices, according to type, are from 15/-. We cannot give details here, but full information is given in our forty-page booklet, "The All Metal Way, 1931," which will be sent to you on receipt of the coupon (please enclose 3d. for your copy).

WESTINGHOUSE METAL RECTIFIERS

The Westinghouse Brake & Saxby Signal Co., Ltd., 82, York Road, King's Cross, N.1

COUPON

Please send your forty-page booklet, "The All-Metal Way, 1931," for which I enclose 3d. in stamps. Please write in block letters.

NAME.....

ADDRESS.....

Centralab

VOLUME CONTROLS
POWER RHEOSTATS
POTENTIOMETERS

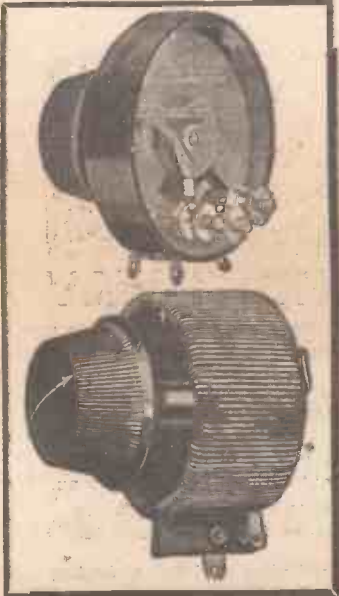

Whether you require a volume control, power rheostat or heavy duty potentiometer, there is a Centralab to take care of your needs.

These famous controls are used as standard equipment by the world's most prominent manufacturers of radio receivers and they are available for you in numerous resistance ranges.

IF YOU HAVE NOT RECEIVED A COPY OF THE CENTRALAB CATALOGUE WRITE FOR ONE TO-DAY. IT'S FREE.

TO MANUFACTURERS
Centralab Volume Controls are available in various styles and forms, both single and dual for manufacturing purposes. It will pay you to write for a copy of "Data on Volume Controls."

THE ROTHERMEL CORPORATION Ltd.,

24, Maddox Street, London, W.1.

Phone: MAYFAIR 0578/9.

Continental Sales Office: 27, QUAI DU COMMERCE, BRUSSELS, BELGIUM.



HAIRBREADTH ADJUSTMENT

that links two Continents

Wonderful selectivity and fractional movement -



The wonderfully smooth action and fractional accuracy of the Formo Vernier Dial used in conjunction with Formo variable condensers makes tuning of close stations a simple operation with the certainty of clear-cut reception.

The scientific thoroughness of Formo condenser construction is your assurance of the best possible results from any set. High performance is further assisted by the enclosed and protected eddy current losses.

MID LOG VARIABLE CONDENSER.

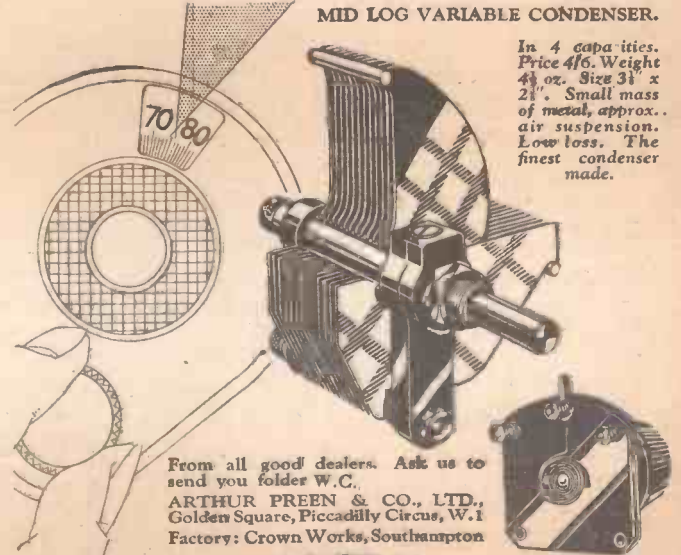

In 4 capacities. Price 4/6. Weight 4 1/2 oz. Size 3 1/2 x 2 1/2". Small mass of metal, approx. air suspension. Low loss. The finest condenser made.

From all good dealers. Ask us to send you folder W.C.
ARTHUR PREEN & CO., LTD.,
Golden Square, Piccadilly Circus, W.1
Factory: Crown Works, Southampton



DIFFERENTIAL CONDENSER.
.00015 Cap. Price 3/9. Compact, perfect, integral pointer.

CONDENSERS

BUY YOUR RADIO WHERE YOU

SEE THESE FORMO Displays



The Sign of the Best Dealers Everywhere



"Pagan Gospel"

It's funny how the critics of the B.B.C. so often contradict each other. The other day a Cardinal, in an address to Birmingham Roman Catholics, slated the B.B.C. for what he described as "the broadcasting of Pagan gospel."

The Cardinal's Criticism

He went on to say that last autumn the B.B.C. permitted, he thought indeed invited, a number of the modern prophets to broadcast their views. This was a more serious matter than any contributions to the press, for the audience in the case of the B.B.C. was immense and composed considerably of the young.

He could not help believing that it was a very serious thing for any country maintaining a State religion

which was avowedly Christian to permit what was almost a national institution to be the vehicle of anti-Christian propaganda.

Hear Both Sides

Following the Cardinal's denunciation of the B.B.C.'s so-called antif-Christian propaganda, the Bishop of Birmingham declared that "it would be fatal to the best interests of religion in this country if it were thought that those who accepted the Christian standpoint were given a perfectly free hand, whereas those unable to accept that standpoint were either suppressed or heavily censored."

Canterbury Approves

And, as a matter of fact, the Upper and Lower Houses of Convocation of Canterbury both carried a resolution expressing appreciation of the services rendered to the religion by the B.B.C.

Cancelled Out

This is a very fine instance of divergence of opinion about the B.B.C.'s religious activities. On the one hand we have a Protestant Bishop congratulating the B.B.C. on its attitude to religion, and, in fact, strongly recommending the B.B.C.'s style, while on the other hand we have a Catholic Cardinal wholeheartedly condemning the B.B.C.'s religious activities.

Well may Sir John Reith hold the view that all critics of the B.B.C. eventually cancel each other out!

An Entertaining Idea

It is announced that the B.B.C. intends to apply to the Theatre and Music Hall Committee of the London County Council for a music and dancing licence in connection with their new giant studio, which will be one of the wonders of broadcasting headquarters in Portland Place.

If this licence is granted it means that the B.B.C. will be able to admit the public on payment of an admission fee to the big studio, just the same as payment can be charged in the case of a concert hall or other place of entertainment.

(Continued on page 322.)

... most perfect receiver yet designed.



MAGNUM UNIVERSAL THREE

(15 to 2,000 Metres).

Free from all amateurish frills, the Universal Three has proved itself so perfect and so efficient in performance that not a single improvement can be made on its original design. This receiver still stands alone, unique, and supreme in every detail.

The most perfect receiver yet designed for Ultra Short Wave, Broadcast, and Long Wave reception. Complete with valves and coils. Royalty paid.

New Reduced Price **£15** from Jan. 15th.

BUILD THE "PARATUNE" FOUR

1 Oak Cabinet, with 10" Baseboard	£ 1 16 0
1 Ebonite Panel, 24" X 7", ready drilled	10 0 0
2 Magnum Panel Brackets	2 0 0
2 Lissen .0005 Condensers with S/M Dials	1 0 0
1 Solid-Dielectric Condenser, .0003 Variable	3 0 0
1 Wearite 3-Pole C.O. Switch	4 0 0
1 Bulgin 3-Point Wave-change Switch	1 9 0
1 Magnum Differential Condenser, .0002	6 0 0
1 Magnum 1-meg. 3-Terminal Volume Control	7 6 0
1 Magnum L.T. Switch	1 6 0
1 Magnum "Paratune" Coil Unit	8 6 0
2 Lotus Single-Coil Holders	1 4 0
1 Magnum 6-Pin Coil Holder	2 0 0
1 Magnum Neutralising Condenser	5 0 0
1 Magnum 600-ohm Resistance	1 6 0
1 Magnum 600-ohm Spaghetti Resistance	1 6 0
1 Magnum 30,000-ohm Spaghetti Resistance	1 6 0
1 Lissen 100,000-ohm Anode Resistance and Holder	5 6 0
1 Lissen 2-meg. Leak and Holder	1 6 0
1 W.B. Horizontal-type Valve Holder	1 3 0
3 Magnum "Vibro" Valve Holders	3 9 0
3 Magnum .0003 Fixed Condensers	4 6 0
2 Magnum .001 Fixed Condensers	3 0 0
2 Magnum .01 Fixed Condensers	5 0 0
3 Lissen 1-mfd. Fixed Condensers	7 6 0
1 Lissen 2-mfd. Fixed Condensers	3 6 0
1 Lissen 400-ohm B/B Potentiometer	1 6 0
1 Varley Nicore II L.F. Transformer	15 0 0
1 Magnum Output Choke	7 6 0
1 Telsen H.F. Choke	2 6 0
1 Magnum Standard Screen, 10" X 6"	2 6 0
1 Ebonite Strip, 24" X 1 1/2"	6 0 0
12 Belling-Lee Insulated Terminals	6 0 0
1 Piece Copper Sheet, 24" X 10"	3 0 0
1 "Explorer" Coil	12 6 0
2 Lowcos "X" Coils, as specified	11 3 0
Pieces Aluminium Sheet, Wood, Flex, Plugs, Wire, Screws, Clips, etc.	3 5 0
	£11 12 6

Any of above parts supplied separately if required.
 1 Set of Valves, as specified £2 9 6
 The "Paratune" Four, as above, ready wired and tested, including valves, coils, and Royalty £17 0 0

BURNE-JONES & CO., LTD.,
 "MAGNUM" HOUSE,
 296, BOROUGH HIGH ST., LONDON, S.E.1
 Telephone: HOP 6257 & 6258.
 Scottish Agent:
 Mr ROSS WALLACE, 54, Gordon St., Glasgow, C.1.

... adapt your set for the Short Waves.



SHORT-WAVE CONVERTOR

Enables you to enjoy the hosts of short-wave stations on your present set, if battery operated, without any alterations or extras.

Try it out without obligation to purchase. Sent on 10 days' free trial against cash **£3-15**

Full particulars and list of leading short-wave stations—Free on request.

The Birthday of the MAGNAVOX LITTLE GIANT Moving Coil Speaker



Here is the new Magnavox Little Giant Moving Coil Speaker, a new unit of outstanding design and an addition to the famous family of Magnavox Dynamic Speakers. The Little Giant equipped with 6½-in. cone—like all genuine Magnavox Speakers—gives clear, true, undistorted and unfettered reproduction, so faithful in sound and spirit that Broadcasting reaches new heights in entertainment value. At this wonderfully low price everyone can now afford to buy a genuine Magnavox Speaker.

Study the Magnavox family:—

THE LITTLE GIANT 6½" CONE

No.	Volts	Power	£	s.	d.
130.	6-12	D.C.	2	17	6
131.	110-190	"	2	17	6
230.	180-300	"	2	17	6
420.	105-120	50 cy. A.C.	5	10	0
424.	220-240	"	5	10	0

THE JUNIOR 7½" CONE

No.	Volts	Power	£	s.	d.
210.	6-12	D.C.	5	7	6
116.	110-190	"	5	7	6
118.	180-300	"	5	7	6
410.	105-120	50 cy. A.C.	8	5	0
414.	220-240	"	8	5	0

THE SENIOR 10½" CONE

No.	Volts	Power	£	s.	d.
211.	6-12	D.C.	6	10	0
117.	110-190	"	6	10	0
119.	180-300	"	6	10	0
411.	105-120	50 cy. A.C.	9	15	0
415.	220-240	"	9	15	0

There is also a Magnavox Auditorium Speaker with 12½-in cone for Public Address work. Prices on application.

WRITE FOR THE NEW MAGNAVOX FOLDER AND DYNAMIC BOOKLET.

DYNAMIC

TRADE MARK REGISTERED

THE ROTHERMEL CORPORATION, LTD.,
24, Maddox Street, London, W.1.

Phone: MAYFAIR 0578/9

Continental Sales Office:
27, QUAI DU COMMERCE, BRUSSELS, BELGIUM.

CONSTRUCTORS!

TEST THIS FREE

and wire your set without SOLDER, TOOLS or TROUBLE

Test—at our expense—SIMPLE STRIP, the amazing new method of wiring up home-built sets without solder, tools, or trouble.

You just bend SIMPLE STRIP with fingers to any angle required and snip off with scissors. Make any number of connections you want under one 4 B.A. nut. Price 2/- per packet



BUT FIRST TEST IT FREE!

SIMPLE STRIP

Cut Coupon For Free Strip Now
The New London Electron Works Ltd.
Please send me Free Sample of SIMPLE STRIP with interesting pamphlet.
NAME _____
ADDRESS _____

The NEW LONDON ELECTRON WORKS Ltd.
76 EAST HAM, LONDON. E. 6.

HIGH-GRADE RADIO - GRAMOPHONE CABINET

of exclusive design, hand-made and polished, standing on carved base.

Figured Oak £17:17:0
Figured Walnut or Mahogany £21:0:0

Carriage Paid.

THE ACME OF CRAFTSMANSHIP.

Sliding doors to set and speaker compartment. Accommodation for records, etc. Photographs and 30-page illustrated catalogue free. Cabinets made to order a speciality. Furniture at makers' prices.

GILBERT, Cabinet Maker, OLD SWINDON.
Established 1866.



CHEAPER ELECTRIC RADIO

by



Write for FREE Art Booklet, with Colour Supplement, "Cheaper Electric Radio by Regentone."
REGENTONE LIMITED, Regentone House, 21, Bartlett's Bldgs., London, E.C.4
Telephone: Central 8745 (5 lines), Irish Free State Distributors: Kelly and Shiel, Ltd., 47, Fleet Street, Dublin.

OUR NEWS BULLETIN

—continued from page 320

A Radical Departure

If this permission is obtained it is certainly a radical departure in Savoy Hill politics. To-day, at the Savoy Hill studios, audiences are admitted only to vaudeville programmes, and sometimes to special concerts where it is necessary to give the artistes the feeling—or atmosphere—of a visible audience.

The Studio Audience

To-day one has to wait sometimes months before one can get permission to be present in one of the studios, because the waiting list is very large owing to the extraordinary interest the public takes in these studio performances; but when the new studio in Portland Place is ready it is reckoned that it will accommodate at least a thousand people. This studio will have two large galleries, which will make it almost like a miniature theatre.

Prohibition Rumours

There have been rumours lately that the B.B.C. is going to ally itself with

Prohibition forces in this country. These rumours seem to be based on the fact that it is well known that Sir John Reith and Mrs. Philip Snowden hold very strong temperance views, and the rumours have gained a certain amount of strength from the fact that B.B.C. publications do not accept advertisements of an alcoholic nature.

Furthermore, it is reported that artistes at Savoy Hill have often complained of the fact that they cannot obtain any stimulating refreshment; in fact, soft drinks are the order of the day at Savoy Hill.

B.B.C.'s Attitude

However, there is probably no truth in these rumours, for the B.B.C. could not possibly, as a public institution, take such a rigid standpoint on the question of Prohibition—anyway, from the broadcasting propaganda point of view. There certainly would be wide resentment if the B.B.C.'s influence were exerted one way or the other.

"I Don't Believe It"

The "News Chronicle" pointed out a curious little happening the other day when Mr. Ramsay MacDonald's broadcast talk on "India" was in

progress. Mühlacker again butted in very markedly, and more than once the Prime Minister's remarks were difficult to follow. There was one occasion, in fact, which was not without a certain amount of humour. The Prime Minister was making an emphatic statement on the subject of self-government, when Mühlacker broke in and, although quite accidentally, the Prime Minister's observation was followed by: "Ich glaube es nicht!" (I don't believe it.)

Still Going Up

According to figures recently published by the B.B.C., at the end of December there were 3,411,910 wireless licences issued, this total including 19,460 licences issued free of charge to the blind.

During last year there was an increase of 455,174, compared with an increase in the previous twelve months of 326,448, and during 1928 of 230,598. In December the total actually rose by 85,012.

Germany's Regionals

Despite the protests from British listeners about the interference from Mühlacker and other German stations, we understand that the German Post

(Continued on page 324.)

LOTUS CONDENSERS

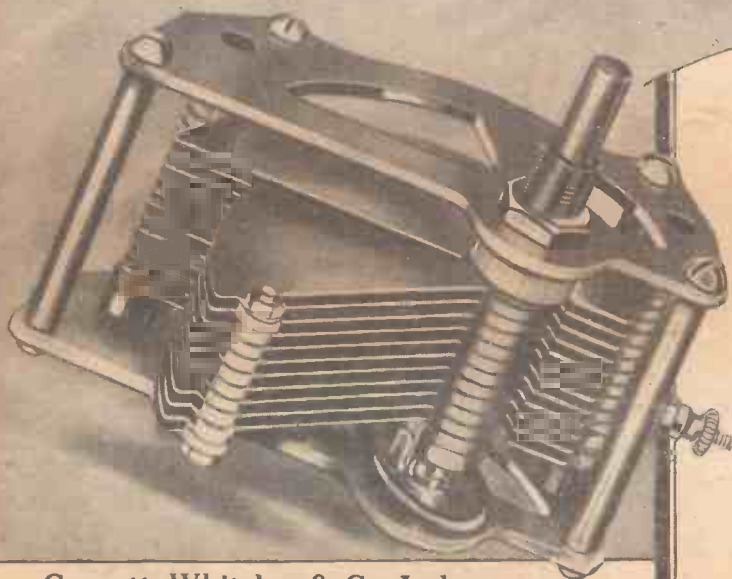

For years, the choice of experts, the worth of Lotus Condensers is again emphasised by their specification in the "Plus-Stage" One, and the "Paratune" Four. In the former circuit, a Lotus '0005 Logarithmic Variable Condenser is employed, and in the latter, a Lotus '0002 Differential Reaction Condenser.

Absolutely reliable, strongly constructed and well finished, Lotus Condensers can be obtained from any Wireless Dealer.

PRICES:

- '0005 Variable Logarithmic Condenser (as illustrated) .. 5/9
(In other capacities from 5/-)
- '0002 Differential Reaction Condenser .. 5/9
(In other capacities from 5/3)
- Also, Reaction Condensers .. from 4/9
- and Drum Dial for Ganged Condensers
- With one '0005 Condenser .. 15/3
- " two " " .. 22/-
- " three " " .. 28/9

**Garnett, Whiteley & Co. Ltd.,
Lotus Works, Mill Lane, Liverpool.**

Specified by all the leading set designers

THE "PARATUNE" COIL

As approved and used in "Wireless Constructor" Sets **Price 10/6**

MAINS SWITCHES

Quick make-and-break type rated to pass 3 amps. Can be mounted on metal panel.

Types:—Single Pole on-off; Single Pole Double Throw; Double Pole on-off; Double Pole Double Throw.

Obtainable in Lever and Rotary Types **Prices from 1/9**

SERIES AERIAL CONDENSER

G.25. Combined fixed '0001 fixed condenser and shorting switch **Price 2/3**

G.26. Similar to above but condenser is variable (Capacity '00005-'00035 m.f.) **Price 3/6**

WEARITE

COMPONENTS

WRIGHT & WEARE LTD., 740, High Road, Tottenham, N.17.
Phone:—Tottenham 3847/8

2/- ALLOWED ON YOUR OLD VARIABLE CONDENSERS

Take your old variable condenser (any make or type) to your Dealer and he will supply you with one of the POLAR "Ideal" condensers listed below, and allow you 2/- from the list prices quoted.

POLAR "IDEAL" POLAR "IDEAL" Drum Control
(with knob dial) (right or left hand)
'0005, 12/6; '0003, 12/- '0005, 15/-; '0003, 14/6

Take advantage of this unique opportunity for you to save 2/- and to modernise your set by substituting your old type condenser with Polar "Ideal" or "Polar" Drum Control. These condensers have the finest Fast and Slow Motion Drive on the market to-day and are regarded as the standard of high-class design.

24-PAGE CATALOGUE—FREE.

WINGROVE & ROGERS, LTD., 188-9, STRAND, LONDON, W.C.2

NEW W.B. 3-POINT SWITCH

Protect your valves with this new W.B. Switch. The extra contact can be used to disconnect the H.T. battery entirely from your filament circuit as you switch out the filaments—a big safeguard where adjustments are being made.

Three powerful spring contacts, firmly gripped between double cones when in the "on" position. Self-cleaning nickel-silver contacts. One-hole fixing. Completely insulated from panel. Price 1/6. 2-point model, price 1/3.



PRICE 1/6



Made by the Makers of the famous W.B. Permanent Magnet Moving Coil Loud-Speakers, Cone-Speakers, and Valveholders.



Prov. Pat.

Whitely Electrical Radio Co., Ltd., Radio Works, Nottingham Road, Mansfield, Notts.



Break Those Bonds

Don't be a slave to circumstances all your life. Break loose. All around you are people with no more intelligence than yourself who have climbed out of the routine class and

are occupying good positions because they availed themselves of specialized training.

Waiting for you at this moment is a bigger and better position. You can have it as soon as you have secured the training that will qualify you for it. And you can get that training in the spare time that you now let go to waste.

No matter where you live, the International Correspondence Schools will come to you. No matter what your handicaps, or how small your means, we have a plan to meet your circumstances.

To thousands of men like you—hands tied, but eager to break free—I.C.S. training has brought success.

We have nearly 400 Standard Courses, including many in the following subjects:

- | | | |
|------------------------------|-------------------------------|-----------------------|
| Accountancy and Book-keeping | Engineering, all branches | Salesmanship |
| Advertising | French and Spanish | Scientific Management |
| Architecture and Building | General Education | Shorthand- |
| Chemistry | Insurance | Typewriting |
| Commercial Art | Plumbing | Showcard Writing |
| Commercial Training | Railway Equipment and Running | Textiles |
| Draughtsmanship | | Window Dressing |
| | | Wireless Engineering |
| | | Woodworking |

ALL EXAMINATIONS—Commercial, Technical, Matriculation and Civil Services
Write to-day for free Booklet containing full information regarding the Courses in which you are most interested.

International Correspondence Schools, Ltd.

172, International Buildings, Kingsway, London, W.C.2.

ALL MAINS TRANSFORMER

Here is the HEYBERD All-Mains W.25 Transformer combining H.T. and L.T. supplies in the one Model. Powerful and accurate voltage delivery.

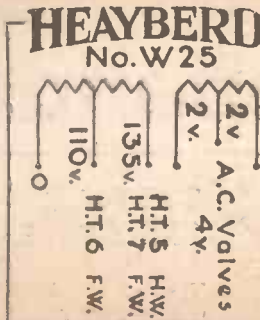

Rectified Outputs.
200 v at 28 m.a. using tapping 135 v. with Rectifier H.T.7.
120 v at 20 m.a. using tapping 135 v. with Rectifier H.T.5. (H.W.)
175 v. at 25 m.a. using tapping 110v. with Rectifier H.T.6.
4 v. 4 amps. for A.C. Valves from 4. L.T. tapping.

For use with Westinghouse Rectifiers.

Watch for further new HEYBERD Models.

Price - - 21/-

Send 3d. stamps for complete Lists giving full details with numerous diagrams. 10, Finsbury St., E.C.2. F. G. HEYBERD & Co. Tel. Met. 7516.



The Cabinet that makes a Good Speaker Better!

This is the Camco "Melodee" Cabinet—suitable for Blue Spot, Dynamic and Moving Coil units. Built on practical lines—gives realistic tone without muffled effect. Price, in Oak and Mahogany, from 22/-.



Send Coupon for Catalogue:
CARRINGTON MFG. CO., LTD.,
24, HATTON GARDEN, LONDON, E.C.1.
Phone: Holborn 8202. Factory: S. Croydon.

NAME.....
ADDRESS.....
..... W. Con.

OUR NEWS BULLETIN

—continued from page 322

Office intends to continue with the construction of its Regional high-power scheme. This scheme allows for nine high-power broadcasting stations. Three of these stations, either in operation or soon about to be finished, are : Mühlacker, Heilsberg (in East Prussia), and Langenberg (in the Rhineland)

A Frankfurt Increase

Other powerful stations are to take the place of stations now broadcasting at Breslau, Leipzig, Berlin, Hamburg and Munich. Also the station at Frankfurt-on-Main is to have an increase in power.

Spending £1,000,000

Some time ago one of the daily newspapers invited suggestions as to how the B.B.C. could spend one million pounds, and we have just come across one of the suggestions made by Mr. Edgar Wallace, the well-known novelist and playwright.

Mr. Wallace hoped that the sum of one million pounds would be spent with the object of teaching everyone

the best English accent. He believes anyone attending an English Elementary School to-day has as good an education as possible in most respects, but he is never taught how to talk.

English for England

Mr. Wallace winds up by hoping that broadcasting will be used to standardise the English of England.

A VERY SPECIAL
ANNOUNCEMENT WILL BE
MADE IN THE APRIL
"WIRELESS CONSTRUCTOR"
ON SALE MARCH 14th
Price 6d.

And exactly what is "the English of England"? Some people will maintain that the London accent is the only accent; but people in Yorkshire won't agree with this, nor will they in Sussex. And the Cockney—that is, the real Cockney—will certainly violently disagree with them all.

The Western Regional

The rumour that when the new B.B.C. Regional station for the West of England is ready the Plymouth

relay station will be closed down is stated to be incorrect. Anyway, the Assistant Postmaster-General has so informed Mr. S. P. Viant, and Mr. J. J. Moses, M.P. for the Drake Division.

The B.B.C. states that it is its present intention to maintain the local Plymouth station even when the new Regional broadcaster is ready.

* THE "PARATUNE" THREE *
* A Reader's Experiences *

Sir,—In the November issue of the WIRELESS CONSTRUCTOR was given a wireless circuit by Victor King.

I am writing to you to express my appreciation of this circuit—the results obtained are extraordinary.

Selectivity is all that the designer claimed, volume and quality are excellent.

I was so pleased with the quality of the reception that I exchanged my loud speaker for a Marconi moving coil. With this combination I do not think that it is possible to obtain better wireless reception.

Yours faithfully,

WILFRED R. BROOK.

Presterque.

ELECTRAD

Dependable Resistances

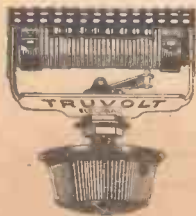

**TRUVOLT
VARIABLES**

The original heavy duty variable potentiometer incorporating the famous Electrad air-cooled Michrome wire resistance.

Available in 12 resistance ranges, 500 to 50,000 ohms. Price 8/- each.



**TRUVOLT
FIXED
RESISTANCES**

Constructed of Michrome Wire on asbestos cord on Isolantite tube. Air-cooled, positive and accurate. Sliding clip enables resistance to be adjusted to required range. Three sizes: 25, 50, or 75 watt, with resistance ranges from 100 to 100,000 ohms.

resistance to be adjusted to required range. Three sizes: 25, 50, or 75 watt, with resistance ranges from 100 to 100,000 ohms.

Electrad offers the finest, sturdiest, most reliable and dependable range of resistances available. No matter what your needs are in resistances, whether variable or fixed, there is an Electrad to give you thorough satisfaction.

Ask for Electrad—Be sure you get Electrad—and do not accept imitations.

Write for the complete Electrad Catalogue—IT'S FREE.

**THE ROTHERMEL
CORPORATION LTD.
24, MADDOX STREET,
LONDON, W.1.**

Telephone: MAYFAIR 0578/9
Continental Sales Office: 27, Quai
du Commerce, Brussels, Belgium:

**ROYALTY
POTENTIO-
METERS**

Used as standard by prominent manufacturers throughout the world and endorsed by technical editors of this and other radio journals.

Available in all resistance ranges up to 7 megs. Price 6/3 each.



**LOFTIN WHITE
AMPLIFIER**

The famous direct complete S.G. amplifier which has proved its merits wherever sold. Undistorted output, 1'6 watts. Ideal for pick-up reproduction. Two models, 110 or 220/240-volt 50-cy. A.C., complete with valves. Price £12 5s.

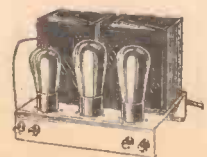



PRECISION INSTRUMENTS

for Constant Calibration

J.B. have concentrated for years on the manufacture of their Precision Condensers and Dials. The excellence of these products to-day justifies this specialisation.

No one could glance at a J.B. Instrument without being struck by its beauty of finish and its workman-like appearance. Closer inspection shows all the accuracy, careful thought and attention to detail that have gone to make it what it is.



PRECISION INSTRUMENTS



J.B. UNIVERSAL LOG CONDENSER

0005	..	9/6	0003	..	9/-
00025	..	8/9	00015	..	8/9

J.B. DRUM DIAL

Drum diameter 4 in.	
Vernier ratio 16	
to 1	10/6
Drum diameter 3 in.	.. 9/6

Advertisement of Jackson Bros., 72, St. Thomas' Street, London, S.E.1.

Telephone: Hop. 1837

A Book You Should Not Miss

50

More Guaranteed Circuits

is the title of a magnificent

FREE BOOK

Given away with every copy of the February

MODERN WIRELESS

Get a copy of this specially enlarged gift number to-day

Price 1/6

NOW ON SALE

Price 1/6



"Look at that!" said one of the Savoy Hill engineers to me in disgust.

"There's a shoal of letters from listeners who complain that certain stations are jammed by Morse or heterodyning, and they seem to think that we ourselves never keep any check on our transmissions."

"Well," I ventured, "how do you keep a check?"

I Visit Tatsfield

"Do you mean to say you haven't been to Tatsfield?" he asked. "That's where the checking is done. If you haven't seen the listening post, then you must try to get permission from the Powers-that-Be to see it."

Permission obtained, I found myself one day recently at Tatsfield, on the county division line between Kent and Surrey. The G.P.O. says that Tatsfield is in Surrey, but the nearest town is in Kent.

With a little trouble I found the field where the small brick buildings of the B.B.C. station are situated. Later my guide told me that the field is very close to that which was considered, but subsequently turned down for various reasons, when Keston (the first B.B.C. receiving station) was being planned early in 1924.

Changes Being Made

I found that changes are now being made in the apparatus at Tatsfield, and the engineer in charge there told me that the reason for this is the increasing amount of listening and testing done, and the need for modernising.

"Come and see how we are progressing," said this official. "The work is confined to this larger building,

We are apt to associate the B.B.C. entirely with transmission, and yet it has some of the finest receiving equipment in the country. Here is an account of a special visit to their receiving station at Tatsfield.

By Our Special Correspondent.

the smaller one next door being used as a store now. Later on we may need it for housing apparatus."

He showed me how the larger building is kept at an even temperature by means of double brick walls—"cavity" walls is the proper term, I think—and this is of great importance, because of some of the highly-sensitive gadgets installed at Tatsfield.

This main building includes an instrument room and a wave-meter

room. The instrument room contains the short-wavers used by the B.B.C. for transatlantic reception, the broadcast-band interference-checking receivers and various testing instruments. The wave-meter room is an indication of another side of the B.B.C.'s activities—the rôle of an "ether policeman."

How It Began

The official accompanying me explained this side of the business in a description of how Tatsfield and Keston came about.

Keston was opened towards the end of 1924, when there was a temporary "boom" in relays from America. It consisted of a couple of huts in a 30-acre field at Fairchild's, Kent, overlooking the valley of Biggin Hill aerodrome.

THE ORIGINAL RECEIVING STATION AT KESTON

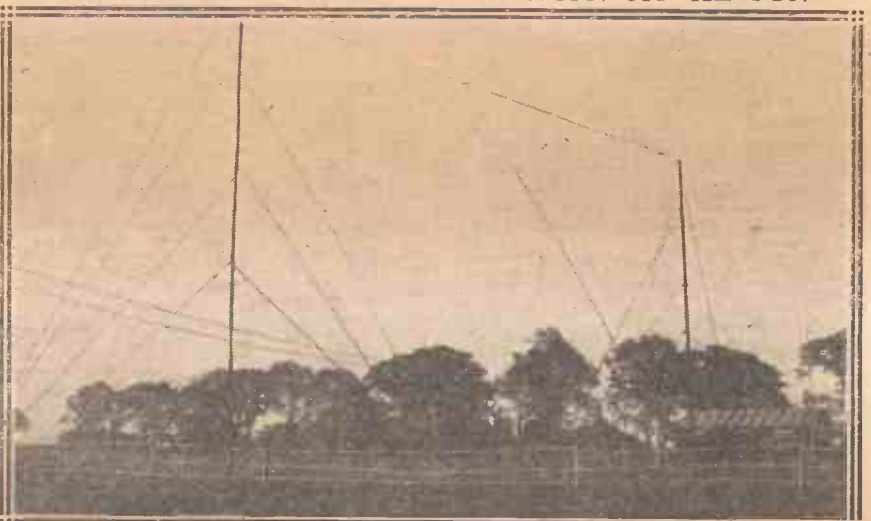

Before Tatsfield was opened much important work was carried out at the Keston station, including the calibration of international wave-meters. Many of the original American relays were also conducted from this earlier receiving station.

A Money-Saving Book for Every Home!

How to make, mend & do everything in the Home

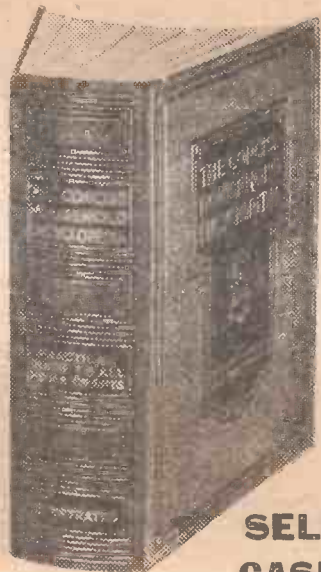

You
Bind
As
You
Buy!

A Novel
**SELF-BINDING
CASE** offered

AT HALF PRICE

THIS new and ingenious method of self-binding is available to subscribers to the CONCISE HOUSEHOLD ENCYCLOPEDIA. The complete work can, by this means, be built up week by week, each part being bound in it as it is published. The finished volume looks, opens, and can be read as an ordinary book, but will be stronger and more durable. Full particulars of this HALF PRICE offer will be found in Part I. For those who prefer it, an excellent binding case of the ordinary type will be available.

**A ONE-Volume Edition
in 6d. Weekly Parts**

**THE CONCISE
HOUSEHOLD
ENCYCLOPEDIA**

FOR HANDYMAN & HOUSEWIFE

Part 1 on Sale Tuesday, Feb. 17th

THE NEW Concise Household Encyclopedia will give you the answer to every household problem. Everything which affects the home, the handyman, the housewife—the cream of the matter embodied in the famous original Household Encyclopedia—has been revised and in many cases rewritten for this invaluable ONE VOLUME edition.

There is no other book like it. It is the most practical, useful and economical guide to household management and the care of the family ever issued, lavishly illustrated with diagrams, plans and photographs. Every one of the 10,000 separate articles is of real help.

The CONCISE HOUSEHOLD ENCYCLOPEDIA will enable you to do a hundred and one jobs in and about the home and will furnish many a useful hint for the leisure hour. Whatever your hobby or whatever your household need you will find it dealt with in these pages.

**10,000 SEPARATE
ARTICLES and 6,000 PICTURES**

Making and Mending, Amateur Mechanics, Woodwork, Needlework, Diet, Antiques, Furnishing, Health, Motherhood, Decorating, Hobbies, Cookery, Gardening, Pets, etc.

THE ANSWER TO EVERY HOUSEHOLD PROBLEM

**6^{D.}
WEEKLY
PARTS**

When you see



specify

OHMITE

Anode Resistances. All values, 100 ohms to 500,000 ohms.

2/3 each

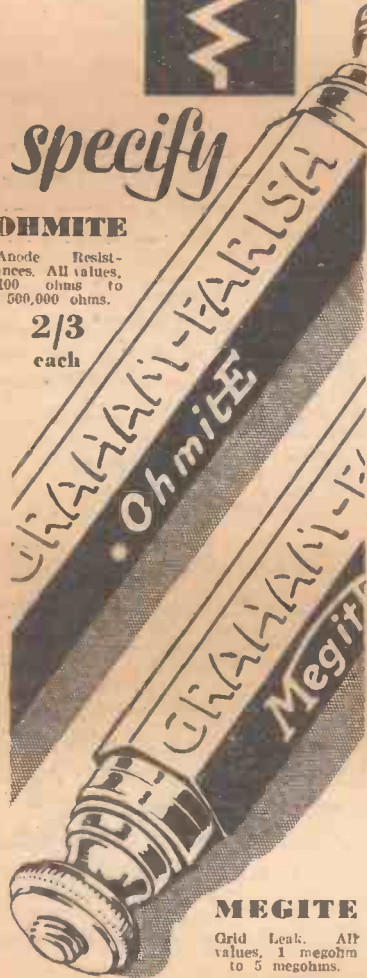

MEGITE

Grid Leak. All values, 1 megohm to 5 megohms.

2/- each

Ohmite and Megite Resistances are constant in value, of negligible self-capacity and non-inductive. Dead silent and always reliable, they provide the most effective resistance on the market, giving the full range of values required. Supplied with vertical or upright holders of superior brown bakelite construction 6d. extra. *Graham Farish components carry a written guarantee of accuracy.*

GRAHAM FARISH LIMITED. . . . BROMLEY, KENT

HOW THE B.B.C. RECEIVES

—continued from page 328

The main idea, at first, was to make Keston the experimental test laboratory of the B.B.C.; for formerly relaying and work of this kind had been done with apparatus installed in engineers' private houses—a makeshift which could not last.

The B.B.C.'s New Job

As time went on the work at Keston became more and more important. Inter-house forms at Savoy Hill, relating to some or other activity, experiment, or discovery at Keston, became increasingly common, and the Bigwigs had to sit up and take notice of the work which the engineers were doing out at Keston.

Gradually a new job evolved and settled itself on Keston's shoulders: that was the checking up of European stations, wave-length, and, later, the calibrations of international wave-meters. This necessitated the installation of very complicated gadgets, such as valve-controlled tuning-forks, and roughly-constructed wooden huts are not ideal houses for expensive apparatus.

Don't Forget to Order
Next Month's
"WIRELESS CONSTRUCTOR"
 Usual Price. Out March 14th.

So when a move became necessary the engineers pressed for a comfortable home for their valuable sets and wave-meters, and now at Tatsfield they have it.

The frequency-testing work carried out at Tatsfield is most interesting, even to those who haven't the vaguest idea of what is being done.

The *pièce de résistance* of the wave-meter room is the Brussels wave-meter used for checking up B.B.C. and European transmitters. It is a wonderful piece of work incorporating four valve oscillators tuning from 175 metres to 600 metres.

Checking Constancy

Daily this is checked up with tuning-fork multi-vibrators, this equipment being rigidly mounted on an iron framework at one side of the room. In this frame (which has a concrete foundation and is immune from vibration) are two Sullivan wave-meters (old friends of war-time radio operators!), one of which can tune down to 10 metres.

So you see, even the short-wave

transmitters are covered by the "beat" of the B.B.C.'s ether policeman, and any illicit transmitter, or any station varying its wave-length, is promptly reported.

On another iron rack are two sets used for checking the constancy of stations' wave-lengths. Any station can be tuned in on one of these sets and then heterodyned with the wave-meter. The calibrated wave-meter dials then show the station's wave-length; or, more accurately, its frequency. B.B.C. engineers never speak of such plebeian things as wave-lengths.

We left the wave-meters and went into the receiver-room, where the new apparatus is being fitted up. Large racks carry the receivers, and neat bus-bars on the wall supply high- and low-tension "juice" from batteries in another section.

The big receiver is a "dual" super-heterodyne; "dual" because it is used on what the engineers term the spaced-aerial system. In another part of the rack is a big low-frequency amplifier, together with 'phone-line arrangements for switching through to Savoy Hill.

Every type of receiver and wave-length checking system seems covered at Tatsfield. It really seems superfluous for any listener to tell the B.B.C. that Newcastle is off its wave-length (hardly probable!), or that GNF was putting dots and dashes on the National.

Tatsfield would know it already!

PAREX

SCREENS COILS, ETC.

Products PAR-EXcellence
 as used and recommended for the
"PARATUNE" FOUR
 and the
"PLUS-STAGE" ONE

Differential Condenser	4/
600-ohm wire-wound Resistance	2/6
with Holder	2/9
Standard Screen (with hole)	2/9
Copper Foil, 24 X 12	4/-
H.F. Chokes, each	3/6
1 Ready-made "PARATUNE" Coil	10/6

PAROUSSI,
 10, FEATHERSTONE BUILDINGS,
 HIGH HOLBORN, LONDON. W.C.1
 Phone: Chancery 7010

— SOLVE ALL —
H.T. TROUBLES

WET BATTERIES

TAYLEX

— SELF GENERATING —

Per doz.	No. 1.	No. 2.
	4, 4, 2, 0.	2, 0, 2, 0.
Jars (waxed)	1 3 1 6	1 3 1 6
Sacs	1 2 1 9	1 2 1 9
Zincs	10	11
Rubber Bands (24)	4	4
Terminals	8	11

Trade Suppliers

LONG LIFE · SILENT · ECONOMICAL

Sample doz. (18 volts), complete with bands and electrolyte. No. 1, 4/1; No. 2, 5/-; post 9d. terminals extra. No. 3, with term. nals. 7/6 (10,000 milli-amps), sample unit 6d. Orders 10/- carr. paid. New illustrated catalogue post free.

FREE Bargain List of Receivers, Amplifiers and Components.

C. TAYLOR, 57, Studley Road, Stockwell, London.

ARE RADIO-GRAMS WORTH WHILE?

—continued from page 294

'radio-gram' has been taken to mean an ordinary set provided with the means for connecting up a pick-up, and therefore I will also stick to this use of the term.

"Question No. 1. Yes, most decidedly radio-gram sets are popular. The reason why, and I think this aspect is covered by the question, is not so definitely answered.

Two Main Reasons

"However, I think there are two general reasons. First, because many people consider the reproduction thus obtained to be far better (this is very much a matter of personal taste, because many don't!). Secondly, from the technical (not necessarily theoretical) point of view the electrical reproduction of records is a fascinating subject, just as also is the reception of radio stations from a technical standpoint.

"Question No. 2. My answer is: sometimes yes, sometimes no. As I have already indicated, this is largely a matter of opinion. And it depends upon the cost.

Depends on Cost

"A £3 gramophone would surely beat a £3 radio-gram which had to include motor, batteries, valves, speaker, etc. In fact, I doubt if it could be done for £3. On the other hand, a £20 radio-gram should be well ahead of a similarly priced gramophone.

"With regard to Question No. 3, low first-cost and convenient volume-controlling are the two chief advantages of a radio-gram over the ordinary gramophone. If you have a good wireless set you have only to buy a motor and pick-up and you can obtain reproduction equal to a very expensive gramophone.

(Continued on page 330.)

MAKE DOUBLY SURE

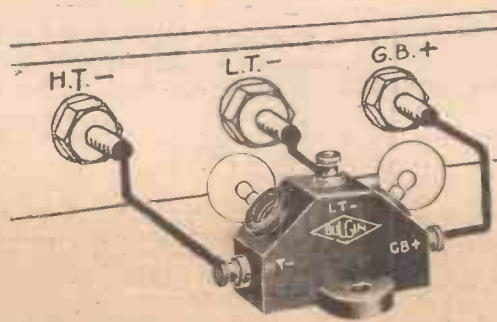

FUSES FOR ABOVE.
60, 100, or 150 m.amps. Cost only 6d. each.

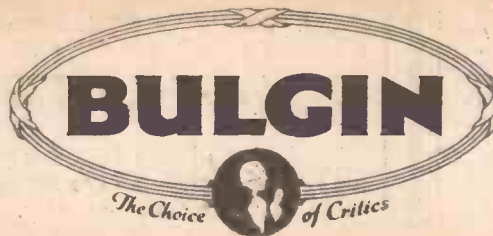

Write for our 60-pp. catalogue (enclose 2d. Postage).

A. F. BULGIN & CO., LTD., 9, 10, 11, Cursitor Street, Chancery Lane, London, E.C.4. Phone Holborn 1072 & 2072.

In these days of "Safety First" a fuse between LT— and HT— is considered essential to a modern receiver. But it is not fully appreciated that the Grid Bias—lead also provides a source of danger to the delicate valve filaments (especially when high voltages are used) should it touch LT+. Therefore, when fitting a fuse, make doubly sure by specifying a Bulgin Universal Fuseholder, and isolate your valves from damage. It is just as easy to fit as a single fuse holder, and connections are clearly shown above.

1/9 each

A Cabinet De-Luxe for YOUR SET OR RADIO-GRAM

The nicest I have seen," says "Wireless Constructor"

The sort people desire to possess and keep TASTEFUL beauty—Piano finish—advantages also of PIANO TONE baffle chamber

The IMPROVED REPRODUCTION that your Set is really capable of gives you a joyous sense of achievement

Sent ON APPROVAL direct from the makers Prices £4 to £15 (Cash or Easy Payments) You may return at our expense if you wish to part with it. Photographs and List FREE!

PICKETTS, Radio Furniture (W. Con.), Aibion Road, Bexleyheath, Kent.

TEST YOUR SET WITH SAFETY

EELEX Testing Prods and save your valves. (List Y84)

3/6 per pair

J. J. EASTICK & SONS, 118, Bunhill Row, London, E.C.1.

TONAX PULSATION! EFFICIENCY!

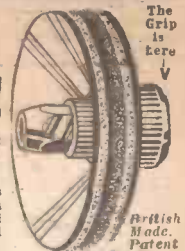

The very Pulse of Loudspeakers has been neglected, and those harsh noises known as "Chatter" and "Rattle" have been tolerated with wonderful patience.

THE CAUSE OF "Chatter" and "Rattle" in Loudspeakers is badly constructed cone fittings. They make it impossible to get perfect tone and reproduction.

THE CURE IS "TONAX"

The new Chuck with Patented Split End Inset, and the screwing device which gives the relentless GRIP AT THE BACK of the cone. This results in all the cone vibrations being passed along and equally distributed to the diaphragm THAT is why "TONAX" vastly improves the tonal quality of all cone loudspeakers "TONAX" fits the cone of any unit.

It is easily fitted and only costs From most dealers or Post and Packing Free, for 1s 2d. Write Dept. C.

GARRATT STORES, WANDSWORTH S.W.18

ALL APPLICATIONS for Advertising space in "WIRELESS CONSTRUCTOR" must be made to the Sole Advertising Agents, JOHN H. LILE, LTD., 4, LUDGATE CIRCUS, LONDON, E.C.4.

SIX-SIXTY

WHEN BUYING VALVES, whether for batteries or for A.C., say Six-Sixty and be sure of best results. Six-Sixty Valves are standard replacements for any set and ideal for every receiver, old or new. WRITE FOR FREE BOOKLET giving particulars of the whole Six-Sixty range.

Six-Sixty Radio Co., Ltd., Six-Sixty House, 17/18, Rathbone Place, Oxford Street, London, W.1. Tel.: Museum 6116/7

for every circuit

Varley

COMPONENTS

WRITE for the section of the Varley Catalogue that interests you.

Section A: All-Electric Receivers and Radio-Gramophones, Pedestal Loudspeakers, Gramophone Pick-Ups, Auto-Arm and Volume Control.
 Sections B & C: H.F. Chokes, Coils, Resistances, Potentiometers, Rheostats, E.C. Couplers, and Mobos.
 Section D: L.F. Chokes and L.F. Transformers (Intervalve, Push-Pull, Output, etc.).
 Section E: Mains Transformers, Mains Chokes, Power Resistances and Power Potentiometers.

Oliver Pell Control, Ltd., Kingsway House, 103, Kingsway, London, W.C.2
 'Phone: Holborn 5303. E.W.G.

NOW—A BELLING-LEE WANDER PLUG



for 2d.

THE BELLING-LEE "MIDGET" WANDER PLUG. See it at your dealers.

Exceptionally compact—fits anywhere, and any size battery socket. Ideal for Portables. Powerful new 3-spring contact. Side entry; the whole flex gripped—wire, fray and rubber. Head clearly engraved in 12 letterings.

Write for Free Belling-Lee Handbook ("Radio Connections," 2nd Edition).

BELLING-LEE
FOR EVERY RADIO CONNECTION

Advert. of Belling & Lee, Ltd., Queensway Works, Ponders End, Middlesex. E.W.G.

ARE RADIO-GRAMS WORTH WHILE?

—continued from page 329

"With regard to volume, it is much better to control volume as in a radio-gram than to shut doors over the mouth of a gramophone horn. Also, armchair control of volume is possible, not to mention the fact that a radio-gram is capable of giving much more volume than most gramophones.

"Now Question No. 4. In view of the very low cost of fitting a radio-gram switch, I think one should always be provided on a set of normal type and which has two low-frequency stages. Even if the constructor does not want to use a pick-up at the time of building, he will later on, without a doubt.

"A couple of shillings on the original cost is better than half pulling the set to pieces in the future to make the alterations necessary. So all power to the so-called radio-gram and the real 'Radio-Gram,' say I!"

Victor King Sums Up

Mr. Victor King said he felt he was going to have a hard job summing up.

"I must say," he added, "Mr. Kelsey's idea of providing separate pick-up instructions with the descriptions of all suitable sets, does very much appeal to me. I feel that if every possible multi-valver automatically starts off as a radio-gram a number of our readers, possibly a minority—but minorities must be catered for—may feel they never will want to use a pick-up, and then the sets would stand in as slightly more complicated and costly to them than they need be.

"I like Mr. Clark's point regarding nomenclature—certainly radio-gram is an ambitious name for the bare set, but after all it is designed to take both 'radio' and 'gram,' isn't it? If you, Mr. Clark, insist that the 'gram' is only justified if there is a turntable, etc., do you consider a 'Radio Set' deserves such a name when it stands shorn of batteries, loud speaker, etc.? However, that is a minor point, I think. By the way, I can't remember any of you saying anything about the radio-gram advantage of being able to push record music through long extension leads—share it out between two or three rooms in the house. Anyway, there seems no doubt that we are unanimous in agreeing that radio-grams are worth while!"

ANOTHER SORT OF TRAFFIC PROBLEM

—continued from page 272

If that state of affairs is experienced in this country—let alone the continent—the radio industry will be the first to suffer; and that includes the B.B.C.

People will not want wireless sets which when operated simply produce a continental version of a radio bedlam or a cats' chorus.

A Crying Need

The obvious and crying need is for the appointment of some Radio Convention or Central Board with authority to limit the number of broadcasting stations and the power employed. This would mean, of course, a sort of Treaty of the Ether and the setting up of a Radio Hague Court of Arbitration.

The International Radio Bureau has no power; to be of real value it *must* have authority—and that authority can only be achieved by the various European governments subscribing to the idea of a Centralised Ether Authority.

If one country refuses to "come in" and abide by that authority's decision, then the plan is a wash-out.

Will it be possible to set up such an authority? It will certainly be difficult. Like international disarmament, the idea is good—but who will disarm first?

And who will first cut down power—and number of stations, if necessary, unless there are satisfactory guarantees that *all* European countries will do likewise—where and when necessary?

Gloomy Outlook

Frankly, we think the outlook very gloomy. The prospect of chaos in the ether is not pleasant, and those who have had personal experience of what *real* ether chaos can be like—as it was not so long ago in America—will agree that immediate and decisive action is necessary if we on this side of the Atlantic are to avoid a similar muddle.

Cannot the Madrid meeting of the International Convention be cancelled, and one be convoked *immediately* in Paris, Berlin, or London? It might be a means to achieving a round-table agreement before it is too late, and before these numerous new high-power stations are *all* "on the air." Certain it is that once they get going

(Continued on page 331.)

C
L
I
X

BUILT FOR EFFICIENCY

Not for Appearance

THE CLIX VALVEHOLDER

SPECIFIED FOR THE "30/- TWO" AND THE "£4 FOUR"

An International Radio Gold Medalist says:—"The losses in your Valveholder, owing to its air spacing, are even smaller than the average Valve Base; also the capacity is greatly reduced."

Modern valves do not require sprung valveholders. Because of the Resilient Sockets used in the Clix Valveholder it is the only one giving perfect contact with SOLID as well as all other types of valve pins.



No. 27. Pro. Pat. Reg'd Des.

Type B for Baseboard Mounting.

- 4 Pin Model with screw terminals... 10d.
- 4 Pin Model without screw terminals 8d.
- 5 Pin Model with screw terminals... 1/-
- 5 Pin Model without screw terminals 9d.

Fully descriptive leaflet on request.

LECTRO LINX LTD.
254, VAUXHALL BRIDGE ROAD, S.W.1

ANOTHER SORT OF TRAFFIC PROBLEM

—continued from page 330

it will be the deuce of a job to suppress them.

Meanwhile every day is of importance, for every day that passes sees the situation getting worse and leading up to a climax which can only mean ether chaos:

So let's hope the various governments concerned will quickly wake up to the gravity of the situation and "get busy."

THE "PARATUNE" FOUR

—continued from page 283

The two leads which go to the underside of the baseboard at the points 19 and 20 do not require holes, because there is room for them between the small end piece of ebonite and the baseboard.

The piece of flex wire from the first wave-change switch, which has a spring clip on the end for connection to either the taps on the "Paratune" coil or the point "X" on the neutralising type condenser, must be fairly long, so that it will carry out its dual job.

By the way, while talking about length it will be as well to point out that the two pieces of triangular wood for the panel assembly are isosceles in shape. That is to say, two sides are the same length, both being 7 in. long. The third, as indicated in the special diagram, is 2 in. long.

The By-Pass Condensers

Perhaps you may wonder why .1-mfd. fixed condensers are used to by-pass the 600-ohm filter resistance instead of the more usual .5- or 1-mfd. condensers. The reason is that these filters are for H.F. impulses and .1 mfd. is large enough, because where H.F. is concerned their impedance is near enough zero when compared with the resistances.

In some receivers the larger capacities are used so that they will provide a fairly low impedance path for any L.F. pulses that may get fed back, as well as serving for H.F. by-passes. The very special precautions taken on the L.F. side of this receiver to prevent L.F. instability troubles, as already mentioned, make the larger capacities unnecessary in the case of this set.

(Continued on page 332.)



CHOOSE THAT NEW ACCESSORY YOU WANT

- Send **8/6** EXIDE 120-VOLT W.H. TYPE H.T. ACCUMULATOR, in grades. Cash Price £4 13 0
- Only Balance in 11 monthly payments of 8/6
- Send **6/5** LAMPLUGH or FARRAND INDUCTOR SPEAKER, for perfect reproduction. Unit and chassis complete, ready mounted. Cash Price: £3 10 0
- Only Balance in 11 monthly payments of 6/5
- Send **7/9** EPOCH PERMANENT MAGNET SPEAKER with type B4 unit only. Cash Price, £4 4 0
- Only Balance in 11 monthly payments of 7/9
- Send **9/2** CELESTION D.12 LOUD-SPEAKER. An entirely new model in oak. Cash Price £5 0 0
- Only Balance in 11 monthly payments of 9/2

SPECIAL ITEMS

C.O.D. Pay the Postman.

WE PAY ALL CHARGES.

"P.W." DOUBLE TRAPPER.

Assembled, Wired, and Tested, ready for use. 11/6. -

"KELSEY" SHORT-WAVE ADAPTOR.

Complete Kit "A" (excluding Pilot Test Meter) 31/- Post Free; or Finished Unit, Tested and ready for use (less cabinet), 37/6 Post Free. Either of these offers sent C.O.D., or against cash we pay all charges. "P.W." and "M.W." Dual Range Coil, as specified and fully approved, 12/6.

Buy by Post - it's quicker

SPECIAL KITS

FOR THIS MONTH'S

"WIRELESS CONSTRUCTOR" SETS.

THE "BRYTA-TONE" AMPLIFIER.

PILOT KIT "A." Kit of Components, but less Valves. Cash Price £3 13 4.

Or 12 monthly payments of 6/9.

PILOT KIT "B." Complete Kit of Components with Valves, but less Cabinet. Cash Price £4 12 4. Or 12 monthly payments of 8/6.

THE "PARATUNE" FOUR.

PILOT KIT "A." less Valves and Cabinet. Cash Price £9 8 0.

Or 12 monthly payments of 17/3.

PILOT KIT "B." with Valves, but less Cabinet. Cash Price £11 15 6.

Or 12 monthly payments of 21/7.

PILOT KIT "C." Complete with Valves and Cabinet. Cash Price £14 5 6.

Or 12 monthly payments of 26/2.

PETO SCOTT CO., LTD.

77, City Road, London, E.C.1.

Phone: Clerkenwell 9406-7-8.

62, High Holborn, London, W.C.1.

Phone: Chancery 8266.

33, Whitelaw Road, Chorlton-cum-Hardy, Manchester.

Phone: Chorlton-cum-Hardy 2058.

Newcastle, Staffs., 7, Albany Road. Phone: 61790.

SEND COUPON NOW

Please send me free your (a) Easy Way Catalogue; (b) Pilot Radio Chart.

NAME.....
ADDRESS.....
..... W.C. 3 1931



OF COURSE!

Benjamin Rotary Switches now appear in the specification of important sets almost as a matter of course. Their positive self-cleaning contacts and sturdy engineering construction have won them a most enviable reputation.

Write for Catalogue No. 1142.

THE BENJAMIN ELECTRIC LTD.

Tariff Road, Tottenham, N.17
Tottenham 1500.



BENJAMIN

Make
The DAILY SKETCH
YOUR Picture Paper

THE "PARATUNE" FOUR

—continued from page 331.

On medium waves the "Paratune" coil has to be adjusted by means of its slider, to keep in step with the tuning condensers. It is advisable to try both "X" taps on the plug-in coil to see which gives best results. For medium waves the H.F. stage wave-change switch is moved to the left, and the detector wave-change switch is pulled out.

For long waves these two switches are reversed. The "Paratune" coil adjustment is now only used to remove any medium-wave interference that may be present. The clip to the taps on the "Paratune" coil should be tried on all taps to find the best one.

The Slider Adjustment

If you have no medium-wave interference, the slider should be set to make contact with approximately the same turn on the coil that the tap—to which the clip is attached—is made. Once again both "X" taps on the grid coil should be tried.

The "Paratune" coil adjustment is not used at all on short waves. The neutralising type condenser should be set at maximum and only altered if reaction is not quite right.

For short waves the aerial should be joined to the A₁ terminal. The A terminal is used for both broadcast bands. It is immaterial in which position the detector wave-change switch is when working on short waves.

In conclusion, details of sizes for plug-in coils must be given. The "X" coil for medium waves should be a No 60, and for long waves a No. 250. The short-wave grid coil should be a four- or six-turn coil.

The operating panel for the "Paratune" Four will appear in our next issue.

THE "BRYTA-TONE" AMPLIFIER

—continued from page 292.

When you have joined up the loud speaker to the appropriate amplifier terminals (those marked output), and the G.B. plugs to the G.B. battery

The Parts Required

- 1 Panel, 14 in. × 7 in. × $\frac{1}{16}$ in. (Lissen, or Goltone, Red Triangle-Permeol, etc.).
- 1 Baseboard, 14 in. × 10 in. × $\frac{3}{8}$ in.
- 1 1-megohm volume control, three-terminal type (Lissen, or Igranic, Gambrell, Varley, Centralab, Magnum, Wearite, etc.).
- 1 Two-pole change-over switch, panel-mounting type (Wearite, or similar type).
- 1 L.T. switch (Red Diamond, or Keystone, Lotus, Igranic, W.B., Ready Radio, Goltone, Bulgin, Magnum, Junit, Ormond, Wearite, etc.).
- 1 100,000-ohm anode resistance with holder (Varley, or Igranic, Dubilier, Mullard, etc.).
- 1 .01-mfd. fixed condenser (mica dielectric) (Dubilier, or T.C.C., Lissen, Mullard, Igranic, etc.).
- 2 Sprung-type valve holders (Telsen, or Igranic, W.B., Benjamin, Lotus, Clix, Bulgin, Formo, Junit, Wearite, Magnum, etc.).
- 1 L.F. transformer of fairly low ratio (Igranic type J, or Telsen, Lissen, R.I., Ferranti, Varley, Lotus, Lewcos, Mullard, etc.).
- 1 L.F. output choke (R.I. Hypercore, or Atlas, Lissen, Ferranti, Varley, Igranic, Wearite, Bulgin, Magnum, etc.).
- 1 2-mfd. condenser T.C.C., or Igranic, Dubilier, Ferranti, Mullard, Hydra, Filta, etc.).
- 1 Fuse, with baseboard holder (Belling & Lee, or Magnum, Ready Radio, Igranic, Keystone, Parex, Wearite, etc.).
- 2 8-in. terminal strips.
- 13 Engraved terminals (Belling & Lee cheap type, or Igranic, Clix, Eelex, etc.).
- 2 Panel brackets (Magnum, or Keystone, Cameo, Ready Radio, etc.).
- Wire, flex, screws, wander plugs, etc.

(use from 1½ to 4½ volts for G.B. — 1 and from 6 to 12 or 15 volts—depending upon the output valve—for G.B. — 2), the amplifier should be all ready for use.

If you are building the amplifier solely for use with a gramophone pick-up, then all the terminals on the input side other than those marked "pick-up" should be ignored. The only alteration on the output side is that for this purpose you will require the normal connection to H.T. negative.

AS WE FIND THEM

—continued from page 310

employ for short-wave work. The unit consists of a special short-wave coil, tuning condenser and reaction condenser, together with the usual components associated with the detector circuit.

There is a plug which is inserted into the existing detector valve holder in the set, and the L.F. stages then become the amplifier for the adaptor.

Messrs. Peto Scott's version is made exactly to our published specification and retails at the remarkably moderate price of 27s. 6d. C.O.D.

We were impressed by the excellent finish and careful workmanship of the sample submitted. On test we found that the coil covered a range of wave-lengths of approximately 19-55 metres. It oscillated beautifully over the whole wave-band, and there was a complete absence of any noticeable hand-capacity effects.

The unit came fully up to the standard of the original "Kelsey" Adaptor, and we can thoroughly recommend it. It is exceedingly good value for money.

INDEX TO ADVERTISERS

	PAGE
Belling & Lee, Ltd.	330
Benjamin Electric, Ltd.	331
British Blue Spot Co., Ltd.	Cover iii
Bulgin, A. F., & Co., Ltd.	329
Burne-Jones & Co., Ltd. (Magnum)	320
Carrington Manfg. Co., Ltd.	323
Cossor, A. C., Ltd.	270
Dubilier Condenser Co. (1925), Ltd.	306
Edison Swan Electric Co., Ltd.	Cover ii
Eastick, J. J., & Sons	329
Exide Batteries	313
Ferranti, Ltd.	317
Formo Coy.	319
Graham Farish, Ltd.	328
Garratt Storcs	329

	PAGE
Gilbert, J. C. (Cabinets)	321
Garnett, Whiteley & Co., Ltd.	322
Hayberd, F. C., & Co.	323
Household Encyclopedia	327
Igranic Electric Co., Ltd.	269
International Correspondence Schools, Ltd.	323
Jackson Bros.	325
Lectro Linx, Ltd.	331
Lissen, Ltd.	301
London Electric Wire Co. & Smiths, Ltd.	309
"Modern Wireless"	325
New London Electron Works, Ltd.	321
Paroussi, E.	328
Peto Scott Co., Ltd.	331
Pickett's Cabinet Works	329
Popular Gardening Annual	306
Radio Instruments, Ltd.	Cover iv

	PAGE
Ready Radio	305
Regent Radio Supply Co.	321
Rothermel Corporation, Ltd.	—
Magnavox	321
Electrad	324
Centralab	319
Six-Sixty Radio Co., Ltd.	329
Taylor, C.	328
Telsen Electric Co., Ltd.	311
Varley Products	330
Westinghouse Brake & Saxby Signal Co., Ltd.	319
Whiteley Electrical Radio Co., Ltd.	323
Wingrove & Rogers, Ltd.	323
Wright & Weaire, Ltd.	323

All communications concerning advertising in "Wireless Constructor" must be made to John H. Lile, Ltd., A, Ludgate Circus, London, E.C.4. Telephone: 7261.

**A
WONDERFUL
COMBINATION**

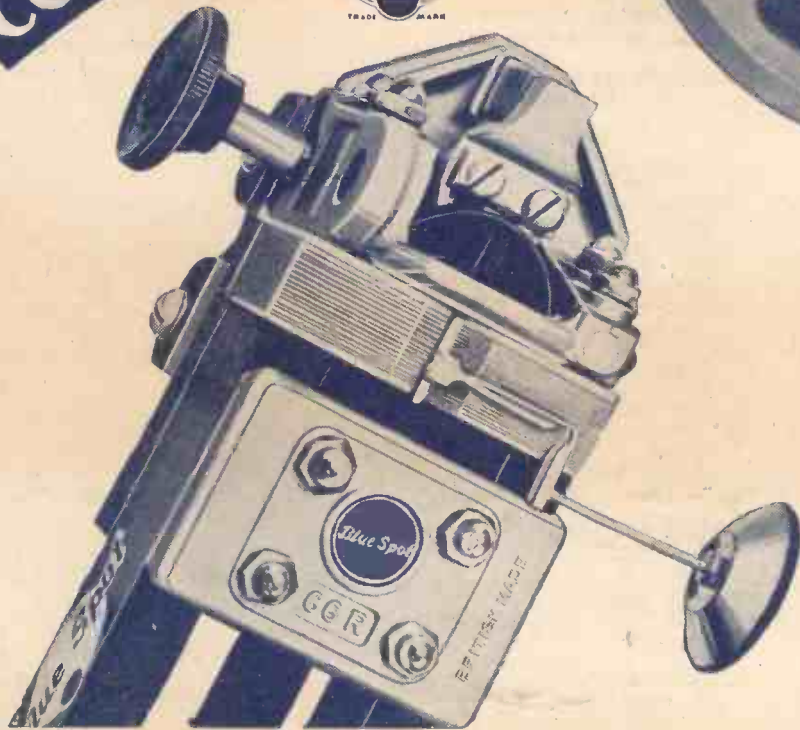

The union of the famous 66R Unit with the Special Chassis results in the finest possible radio reproduction. Whether you are building a radio gramophone or your first loud speaker the only sure way to achieve perfection is to incorporate Blue Spot productions with your set.

- Blue Spot Power Unit
Type 66P - - - 27/6
- Blue Spot Power Unit
Type 66K - - - 25/-
- Blue Spot Major
Chassis - . . - 15/-

BLUE SPOT

66R UNIT
35/-

66R

THE SPECIAL CHASSIS
10/6



THE BRITISH BLUE SPOT COMPANY LTD.

BLUE SPOT HOUSE, 94/96, ROSOMAN STREET, ROSEBERY AVENUE, LONDON, E.C.1

'Phone : CLERKENWELL 3570.

'Grams : "BLUOSPO.T, SMITH LONDON."

Distributors for Northern England, Scotland and North Wales : H. C. RAWSON (Sheffield and London), LTD.
100, London Road, Sheffield ; 22, St. Mary's Parsonage, Manchester ; 183, George Street Glasgow

The Hub of Radio Progress!

R.I. components cover the whole field of modern radio developments. They satisfy in service, efficiency and price the exacting demands of critical experimenters, and those for whom economy is a big consideration. Their standard of guaranteed excellence is alone possible by virtue of the long years' knowledge, experience and reputation of the manufacturers—one of the oldest in the radio industry.



The **HYPERMU**

Incontestably proved by amateur and expert alike the world's best transformer. N.P.L. curves show the most amazing, uniform amplification, and prove the necessity of Ni-Cu alloy as a factor in perfect radio. Primary inductance 85 henries. Ratio 1:1. Weight 13 ozs. **21/-**



The **HYPERMITE**

The lowest priced transformer ensuring absolutely reliable results with modern valves and circuits, and the most efficient in existence for its size and weight. Primary inductance over 50 henries. Ratio 3:1 to 1. Weight 7 ozs. **12/6**



The **HYPERCORE L.F. CHOKE**

The first nickel iron choke for use as an output filter or smoothing choke. Low self-capacity with high inductance ensures brilliance in reproduction. Inductance 30 henries. Maximum D.C. 80 milliamperes. Weight 18 ozs. **17/6**

The New General Purpose SMOOTHING & OUTPUT CHOKE For output filter smoothing or L.F. coupling (maximum D.C. 60 m.a.). A small general purpose choke encased in beautiful green bakelite for portables and other receivers where space is limited. D.C. Resistance 400 ohm Inductance 25 henries. Maximum D.C. 30/60 milliamps. Size 2 1/2 x 2 1/2 inches high. **12/6**



P.W. & M.W. **DUAL-RANGE COIL**
No More Wavelength Troubles

The Right Job. Manufactured and laboratory tested on the wavemeter and inductance bridge. Gives best results and saves the trouble of winding, and assembly. Remember the R.I. mark on this coil is a guarantee of highest efficiency. **12/6**



NEW G.P. TRANSFORMER
Latest Improved Model.

A new, larger "general purpose" transformer for use where considerations of space do not arise. Fitted in a beautiful green bakelite case with an improved iron core its electrical characteristics show a vast advance on the original G.P. model. Ratio 3:1 to 1. Primary inductance 35/40 henries. Weight 18 ozs. The lowest priced transformer with such high primary inductance **10/6**

Ask your radio man to show you the new R.I. components and for the new complete R.I. catalogue. If difficult to obtain write direct to the makers.

R.I. LTD., MADRIGAL WORKS,

PURLEY WAY, CROYDON.