

The Wireless Constructor

6^D
MONTHLY

EDITED BY
PERCY W. HARRIS, M. I. R. E.
Vol. VII. APRIL, 1929 No. 30

A NEW TWO H.F. CIRCUIT THE "AIR COMMANDER"

by
PERCY W. HARRIS
M. I. R. E.





MULLARD (CLEARS) THE WAY

Mullard Pentone and Screened Grid Valves clear the way for the biggest advance in radio history.

Once again Mullard research has smashed through every obstacle, overcome every difficulty; perfected Screened Grid and Pentone Valves are here—perfected by Mullard. It means a revolution in radio, two valves that do the work of four.

You have been hearing about these wonderful new valves for months; it was left to Mullard to make them a practical basis for a new era in radio ideas. All existing standards of comparison are shattered, the new Mullard P.M. Pentone and Screened Grid Valves are the radio valves of the future that you can buy NOW. Every radio dealer stocks them.



Mullard

THE MASTER VALVE

Agents: The Mullard Wireless Service Co., Ltd., Mullard House, Denmark Street, London, W.C. 1.

CONTENTS

	Page		Page
Editor's Chat	399	Happenings at Savoy Hill	423
Comments From Constructors	400	Loud Speakers in the Law Courts	425
The "Air Commander"	401	In Lighter Vein	427
Queer Queries	410	Chats at the Work-Table	431
A High-Selectivity Unit	411	Experimenting with the 31 New Circuits	435
More About the "D.C." Four	414	The H.F. Valve	436
The Whys and Wherefores of H.F. Cir- cuits	415	An Auxiliary Smoothing Unit	439
Radiogramophonics	420	What's New	444
Making Moving Coils	421	Our News Bulletin	452

As some of the arrangements and specialities described in this Journal may be the subject of Letters Patent, the amateur and trader would be well advised to obtain permission of the patentee to use the patents before doing so.

EDITED BY

PERCY W. HARRIS, M.I.R.E.

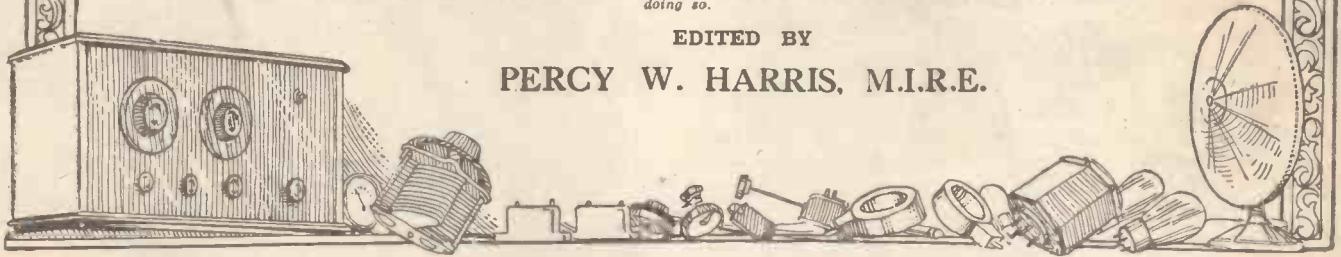

MARCONIPHONE

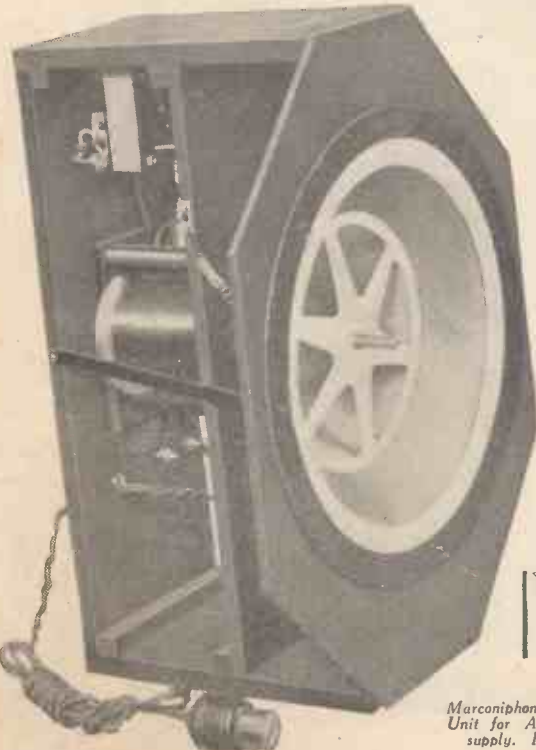

UNLESS your speaker speaks with a true voice it will never give you a fair criticism of your circuit. That's why you need a Marconiphone Moving Coil Unit. No note is too high or too low for it—it gives to every one its own true value. The secret lies in the unique method of double cone suspension that gives the Marconiphone an enormous advantage over other types. Exceptional freedom of motion axially is obtained with complete freedom from side play, resulting in perfect parallel movement of the coil at all times. Resonances due to suspension materials are entirely eliminated.

You buy the Marconiphone Units assembled and tested, and they include coil-driven cone and field magnet mounted in a framework suitable for building into a cabinet or supporting a baffle.

Write, mentioning "Wireless Constructor," for full particulars of all Marconiphone apparatus.

THE MARCONIPHONE COMPANY, LIMITED
 (Dept. P.), 210-212, Tottenham Court Road, London, W.1.
 Showrooms: 210-211, Tottenham Court Road, London, W.1, and
 Marconi House, Strand, W.C.2.

MOVING COIL UNITS

Marconiphone Moving Coil Units are available for 6-10 volt accumulator, D.C. Mains and A.C. Mains (rectifying unit needed).
 Price £6. 6. 0. each.

Marconiphone Moving Coil Unit for A.C. Mains field supply. Price £6 6. 0.

Make the Melody LOUDER and CLEARER



Get better Radio—louder—clearer full-toned melody that delights the ear—change now to Cossor Valves. Cossor Valves made possible the wonderful Cossor Melody Maker. They improve any Receiver. Use them in yours. Every Wireless Dealer sells them.

with

COSSOR VALVES

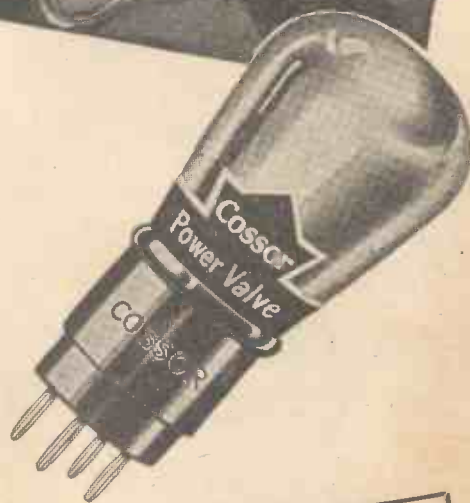

Have you got your copy of the **COSSOR Broadcasting Map**? It shows positions and gives wavelengths and dial readings of 200 European stations. It will double your Radio enjoyment. Write for it now, enclose 2d. stamp to cover postage. **Send at once!**

The WIRELESS CONSTRUCTOR



Published by the Amalgamated Press, Fleetway House, Farringdon Street, London, E.C.4.

THE EDITOR'S CHAT

Percy W. Harris, M.I.R.E., the Editor of the "Wireless Constructor," discusses this special High-Frequency Number and gives some practical hints for improving your reception.

THE present issue of the WIRELESS CONSTRUCTOR can truly be called a special high-frequency number, for not only do we print a full description of one of the most sensitive high-frequency receivers ever designed for home construction, but also an important article dealing in detail with the various forms of high-frequency circuits. The true experimenter who is not merely an assembler of parts should make a point of understanding the why and wherefore of everything he does, and it is the policy of the WIRELESS CONSTRUCTOR to help him not only to build sound and reliable receivers, but also to understand just how they work. The present circuit article is one of the series now being prepared for this purpose, and others will follow from time to time.

Cure for Interference

The high-selectivity unit described by Mr. G. P. Kendall, B.Sc., in this issue is strongly recommended to all who suffer from interference. Exhaustive tests have shown that the scheme described is more effective than any other form of trap when very close tuning is desired, and it works equally well with any set or aerial. Requiring no special parts, it can be fixed up very quickly and should form a part of the equipment of every serious experimenter.

This is the time of the year when every keen experimenter should overhaul both his aerial and his earth connections. The abnormally heavy frosts which we all experienced in the middle of February played many strange pranks with wireless equip-

ment, often bringing down the strength of signals to a fraction of the normal, particularly where the earth connection was made to a small metal plate buried only a few inches. In such cases the frozen ground sometimes expanded and sheared the connecting wires, leaving the unfortunate listener with virtually no earth connection at all!

The Annual Clean-Up

In any case, a thorough overhaul is now advisable, and if you are uncertain of your earth connection,

make a new one. Many water-pipe connections are badly made and of high resistance, and here we would recommend the use of a proper clamp sold for the purpose.

Similarly, aerial insulators should be overhauled and cleaned and the wire itself examined to see that it is not corroded.

The wire itself is nowadays quite cheap, and a new aerial in place of one that has been untouched for a couple of years may give you results almost as much improved as if you had added another valve.



So that the airman need not wind in his aerial when nearing the ground, on each new Imperial Airways' machine a 3-wire permanent aerial is stretched between the wings and tail, as shown in this illustration.

COMMENTS FROM CONSTRUCTORS

A selection from the many letters received by the Editor during the course of the month.

The "P.C." Three

SIR,—About three months ago I constructed the "P.C." Three, and I find that the results are exceedingly good. Up till now I have had 50 stations on the loud speaker, most of them at good strength.

I have also had 7 American stations at good 'phone strength, 4 of which I have succeeded in identifying; they are: W G Y (Schenectady), W J Z (Bound Brook), W E A F (New York), and K D K A (Pittsburg) (306 m.).

Some of the stations received are: Budapest, Vienna, Munich, Brussels, Milan, Oslo, Zurich, Daventry (5 G B), Langenberg, Rome, Stockholm, Brunn, Madrid, Frankfurt, Katowitz, Dublin, Glasgow, San Sebastian, Hamburg, Toulouse, Manchester, Stuttgart, Bergen, Leipzig, London, Graz, Goteborg, Prague, Huizen, Gleiwitz, Cardiff, Breslau, Aberdeen, Belfast, Bournemouth, Konigsberg, Limoges, Turin, Cologne.

Also on the high waves: Huizen, Radio Paris, Daventry, Konigs-wusterhausen, Eiffel Tower, Warsaw, Motala, Kalundborg, Hilversum, Leningrad.

Being keen on short waves, I was wondering if the "P.C." Three would work on short waves with a new H.F. transformer and S.W. coils.*

Wishing you and your paper every success.

Yours sincerely,
F. W.

Newcastle.

[* Ed. Note.—We hope to publish a note on this subject in a very early issue.]

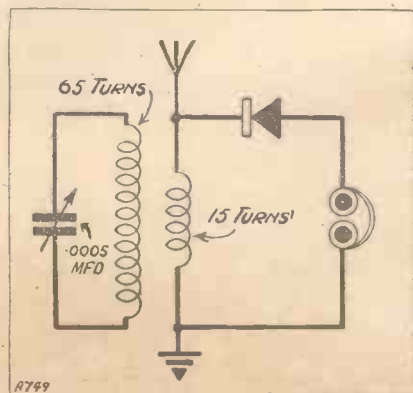

The "Roadside" Four

SIR,—Please accept my heartiest congratulations on a real good portable set which "works." By this I mean *The "Roadside" Four*.

I built this receiver about two months ago, my only alteration being to cut out the H.F. choke, which I

the WIRELESS CONSTRUCTOR, I see one of your readers has sent in a selective crystal set. I am also enclosing one which may be of interest to some of your readers.

The 15-turn coil is wound over the 65-turn coil.

Despite the remarks of an Australian in your September issue, our programmes are far from excellent. Too much advertising is done, and, unlike the B.B.C., few classical selections are broadcast.

I would certainly like the circuit of your correspondent's crystal set which will pick up 2 F C (Sydney) in Adelaide. He would make his fortune if he patented it.

MIKE GOES EAST

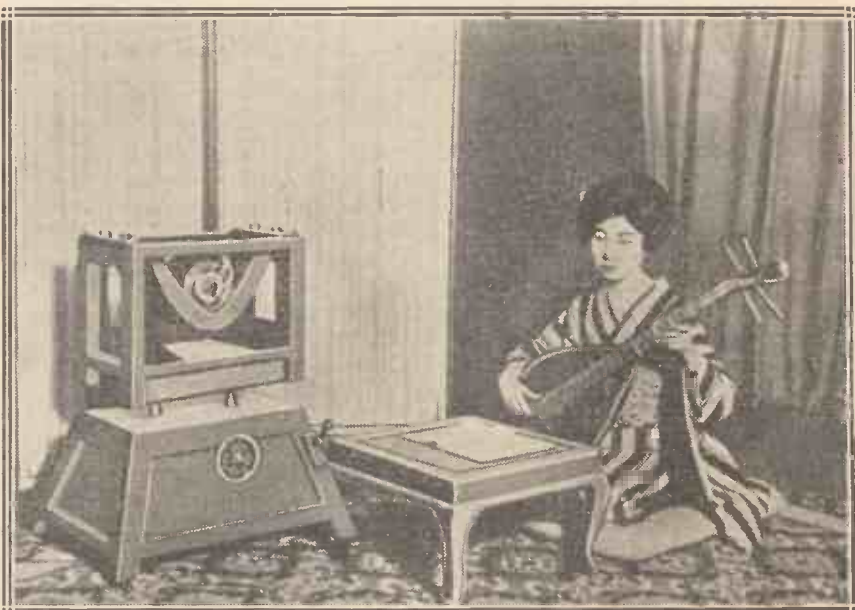

An artiste broadcasting folk songs from a Japanese station. Note the stumpy microphone and table in front of which the artiste either sits or kneels on a cushion.

found unnecessary, and to substitute a transformer instead of an R.C. unit.

Here, in Melbourne, which possesses four stations, viz., 3 L O, 3 A R (A class), 3 U Z, and 3 D B (B class), I have found the set highly selective. Tested one mile from 3 L O and one and a half miles from 3 A R, I have logged all the Sydney stations, 2 F C, 2 B L and 2 G B, also 4 Q G (Brisbane), 5 C L and 5 D N (Adelaide), 7 Z L (Hobart). All on the speaker, which in my case consists of a Mullard P.M. unit, model E.

About three weeks ago I coupled the set on to a moderate outdoor aerial and was surprised to pick up J O A K (Tokio) and 1 Y A (Wellington, New Zealand).

Referring to the October issue of

Wishing the WIRELESS CONSTRUCTOR continued success, and again thanking you for such a fine portable as the "Roadside" Four.

Yours faithfully,
ALAN WILSON.

Moonee Ponds,
Melbourne, Australia.

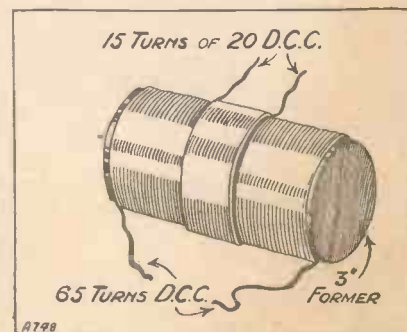

THE "AIR COMMANDER"

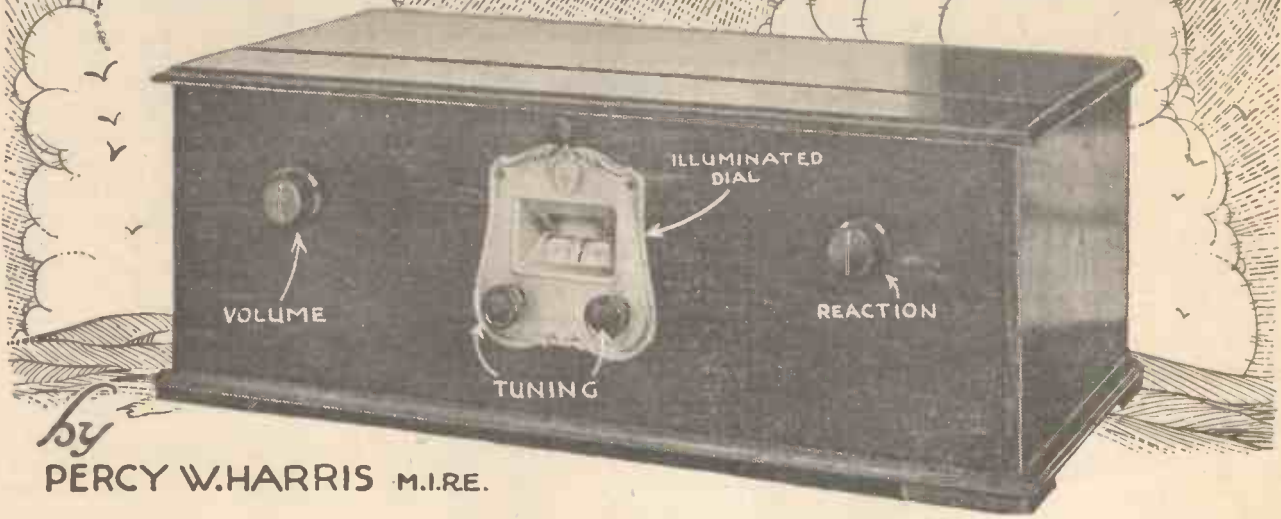

It would be quite easy to begin each constructional article in this journal with a quotation from a reader's letter, for every set published is the result of a group of letters expressing desire for one particular feature, or series of features. The "Air Commander" is certainly no exception to the rule, and results from a series of experiments begun over a year ago.

The Main Features

The three main requirements to be filled in the new design were: (1) long-distance reception of a quality strictly comparable with that obtainable from the nearest station; (2)

Long - distance reception with quality, ease in tuning and simple construction—all are to be found in this latest and up-to-the-minute design. A four-valver par excellence.

great simplicity of operation, and (3) ease of construction.

Analysing our first requirement, we find it means that we must have very considerable high-frequency amplification preceding the detector, together with irreproachable low-frequency magnification. It also meant that we should have the minimum use of reaction and a high selectivity, as our requirements would not be met in a receiver which gave loud signals from

a distant station if these signals were accompanied by interference.

Ease of Tuning

Our second requirement, simplicity, means that the number of tuning controls must be kept small. If, for example, we have the ordinary arrangement of two stages of high-frequency and a detector preceding whatever low-frequency amplification we choose, then we have three tuning controls and probably a reaction control.

One alternative to the three tuning controls is "ganging"—a scheme which brings with it a whole chain of special difficulties. I do not deny that satisfactorily ganged tuning circuits can be produced, for in a factory

COMPONENTS REQUIRED

(Parts actually illustrated are marked in brackets, suitable alternatives are also given).

- | | | |
|--|---|---|
| 1 Cabinet 21 in. × 7 in., with 10 in. baseboard (Camco), Artcraft, Caxton, Pickett, etc. | 1 Wire-wound resistance with holder, 100,000 ohms (Lissen). | 4½ to 1), Lissen, Philips, R.I.-Varley, Igranic, Brown, etc. |
| 2 Pairs brackets (Magnum), Peto-Scott, Camco, etc. | 1 Wire-wound resistance without holder, 2,500 ohms (Lissen). | 1 Output choke (Thordarson), Rothermel, Pye, R.I.-Varley, etc. |
| 1 Panel 21 in. × 7 in. × ¼ in. (Ebonart mahogany), Radion, Becol, Ripault, Trolite, etc. | 1 Wire-wound resistance without holder, 20,000 ohms (Lissen). | 2 Terminal strips, 2 in. × 1½ in. |
| 1 Knob control, double type "Pilot" drum dial with lamp (Rothermel). | 1 Wire-wound resistance without holder, 10,000 ohms (Lissen). | 1 Terminal strip, 6 in. × 1½ in. |
| 2 K.K. arrow knobs, No. 18 (Rothermel.) | 1 Fixed condenser, .002 (Magnum), Dubilier, T.C.C., Mullard, etc. | 10 Indicating terminals as marked (Belling-Lee), Eelex, etc. |
| 1 On-off switch (Bulgin), Lotus, Benjamin, etc. | 2 Fixed condensers, .01 (see above). | 1 Binocular aerial coil (Lewcos B.A.C.5), or Colvern. |
| 2 Standard screens 10 in. × 6 in. (Magnum), Peto-Scott, Paroussi, etc. | 1 Fixed condenser, .001 (see above). | 1 Binocular transformer (Lewcos B.S.P.5), or Colvern. |
| 2 .0005 variable condensers (Lissen). | 2 S/P fixed condensers, .0003 (T.C.C.), Dubilier, Mullard, etc. | 1 Binocular aerial coil (Lewcos B.A.C.20), or Colvern. |
| 1 .0001 reaction condenser (Utility), Cyldon, etc. | 2 Grid leaks, 2 meg. (Dubilier), Lissen, Ediswan, Loewe, etc. | 1 Binocular transformer (Lewcos B.S.P.20), or Colvern. |
| 2 6-pin bases (Lewcos), Colvern. | 2 R.F. chokes (R.I.-Varley), Lewcos, Magnum, Polar. | 1 Screen-grid valve (Cossor, Ediswan, Marconi, Osram, Mullard, Six-Sixty). |
| 4 Valve holders (Lotus), Benjamin, Wearite, Formo, W. & B., Godwinex, etc. | 1 Neutralising condenser (Magnum), Peto-Scott, Igranic, etc. | 2 H.F. valves (Cossor, Ediswan, Mazda, Marconi, Osram, Mullard, Six-Sixty). |
| 2 Ebonite panels, 4 in. × 4 in. × ¼ in. | 1 Micro-fuse (100 milliamperes)(Micro-fuses, Ltd.). | 1 Super-power valve (Cossor, Ediswan, Marconi, Mazda, Cosmos, Osram, Mullard, Six-Sixty). |
| 1 Panel-mounting 30-ohm rheostat (Lissen), Igranic, etc. | 2 2-mfd. fixed condensers (Ferranti), T.C.C., Dubilier, Hydra, etc. | |
| | 1 L.F. transformer (Marconiphone, | |

The "Air Commander"—continued

built set where a high degree of precision is possible, ganged tuning circuits are quite practicable, but in home-constructed sets there is always the danger of a lack of matching of circuits, particularly when it is desired to give the reader a wide choice of components to choose from. In any case, however, the designer of a set in which ganged tuning circuits are included, nearly always sacrifices a little efficiency in each stage in order that the lack of perfect matching may not upset operations too much.

Extremely Successful Circuit

The very successful results given by the circuit I evolved for the "New Business Man's" Four (this circuit, by the way, has been used with great success in the "Titan" Three, published in our contemporary "Popular Wireless") led me to think that the addition of a further stage of high-frequency to this circuit might give us just what we require.

Now the design of any set using a screened-grid H.F. valve is no easy matter if real efficiency is to be

obtained. The experienced experimenter is well aware of the fact that we cannot obtain much sharpness of tuning with a screened-grid H.F. stage unless we are prepared to sacrifice some magnification, while it has

capacitive feed-back, there is still some left, and this, with the other sources of feed-back, is sufficient in a really low-loss receiver to give instability. Our troubles are unfortunately not confined to the valve itself,

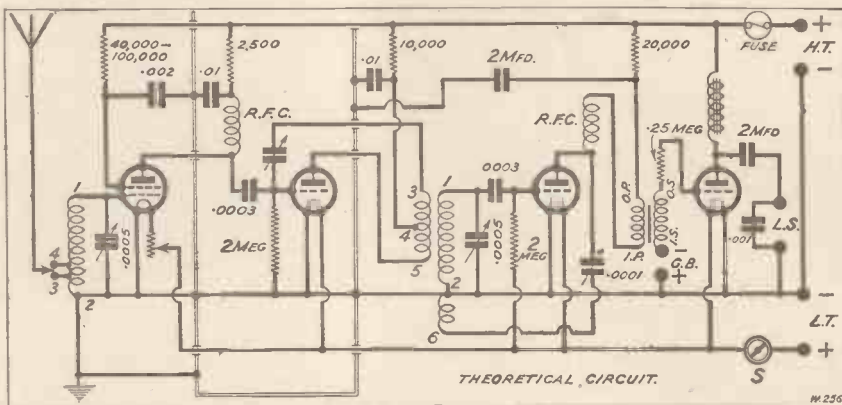

already been found that with two stages of screened-grid H.F. instability is inevitable if the maximum available magnification is used. For though the screening grid inside the valve removes a great proportion of the

and it is extremely difficult—in fact impossible—to use the magnification of the screened-grid valve at anywhere near its limit when using two stages. Additionally, unless we sacrifice a good deal of magnification tuning becomes horribly flat.

How Selectivity is Obtained

In the "New Business Man's" Four the necessary degree of selectivity was obtained in two ways—by the use of reaction in the first grid circuit, thus reducing the damping of this circuit to a minimum, and by the use of a series wave-trap to eliminate the effect of a nearby powerful transmitter. The combination of the two made the arrangement quite practical, and it occurred to me that a combination of one screened-grid H.F. valve and an ordinary neutralised high-frequency stage would give an overall high-frequency magnification, together with good selectivity, strictly comparable with that which we could get with two screened-grid valves, *after we had taken all the necessary precautions to obtain stability and selectivity.*

The use of an additional tuned circuit should also remove the necessity for a series wave-trap, and it should be possible to transfer the reaction effect from the first H.F. circuit to the detector circuit so as to reduce the fairly heavy damping effect there.

Further, by adopting the method of H.F. coupling used so successfully in the "New Business Man's" Four, it would be possible to have one

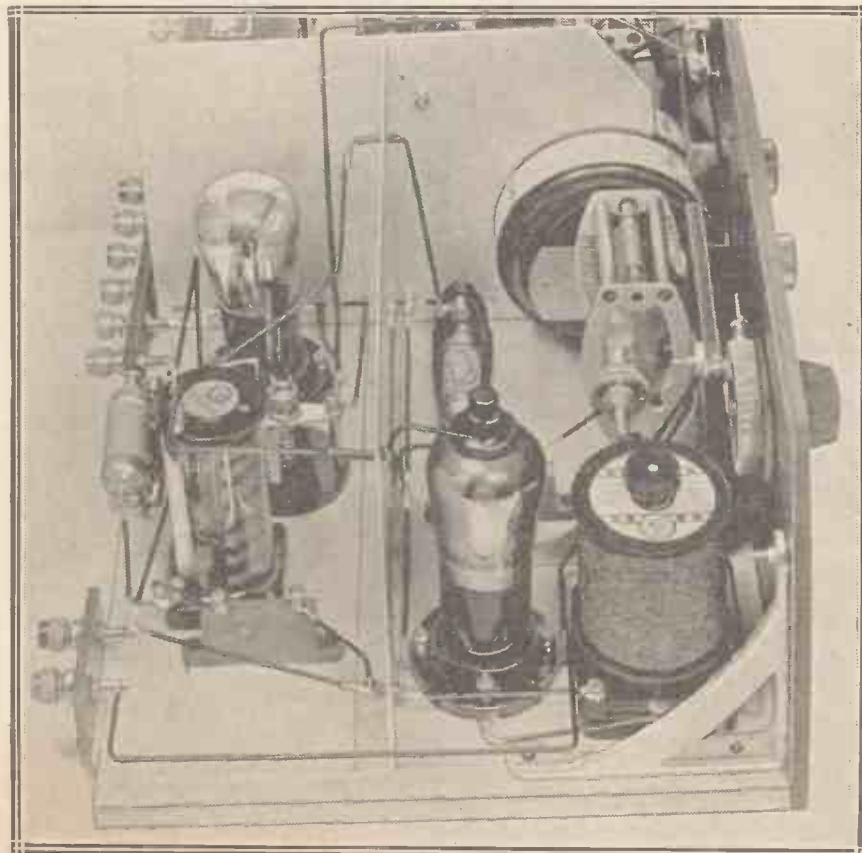

A remarkably clear picture of the two high-frequency stages. In this photograph a single coil is shown, but the binocular type is recommended.

The "Air Commander"—continued

tuned and one untuned high-frequency stage with a tuned detector stage, thus the total number of tuning controls would be but two, while both dials should read approximately the same for a given station. Two other controls were decided upon in the experimental model, one a volume control and the other a variable reaction control.

The H.T. Problem

It was also considered that if the H.F. and detector portions of the circuit worked up to expectations, full loud-speaker strength should be obtainable with only one low-frequency stage, and, as readers will know who have studied our articles on low-frequency magnification and quality in general, the difficulties which face us in designing one low-frequency stage of good quality are negligible compared with those we have to tackle when two stages are used.

Our requirements in the direction of simplicity were thus showing signs of being met. In view of the fact that very little reaction would be used, most of the searching could be carried out with just the two dials, while the volume control would serve to tone any excessively loud signals.

There was still another very desirable feature which we aimed to incorporate if possible, i.e. the use of but one H.T. positive terminal so that the user of the set would be entirely relieved of any bother in finding the correct H.T. tapings, would be certain that his high-tension battery or accumulator would be discharged evenly as a whole and not more in one portion of the battery than in another, and with the increasing use of mains units and the difficulty of ascertaining the exact voltage given at a tapping, the scheme would make good results with mains units obtainable from the very start. Commercial high-tension mains units vary considerably in quality, and thus it was also desired to include a scheme by which howling, "motor-boating," and other troubles arising from poor mains units would be prevented.

Highly Selective

It took a long time to meet all these requirements, but I am glad to say that in the end every difficulty was overcome. The "Air Commander," briefly, is a receiver with two stages of high-frequency, one using a

screened-grid and the other a neutralised high-frequency valve, a detector valve and one stage of low-frequency magnification, transformer-coupled. This one stage is fully able to provide all the note magnification we need, both on near and distant stations, and the quality when using any of the high-grade L.F. transformers and a good modern output valve can be only classed as superb.

There is only one high-tension positive terminal, resistances within the set automatically bringing the voltage down for the required figure for the screening grid, the high-frequency circuit, and the detector circuit; while shunted capacities used in conjunction with these resistances prevent unwanted current flowing in the high-tension supply and causing various troubles.

Simplicity of control is obtained by using only two condensers which are attached to a very ingenious vernier drum assembly, this same drum assembly containing a small

receiver enables us to present what can be claimed without any fear of contradiction as the most handsome wireless receiver yet published in this journal.

Selectivity is such that even under the shadow of a powerful main station a large number of others are receivable, while the sensitivity is such that it must be experienced to be believed.

Stations Received

On a normal outdoor aerial the following stations are receivable in the London area in broad daylight:

Langenberg, one or two German stations below the London wavelength (when these work in daylight, which is often the case), Copenhagen on its wave-length of 338 metres, Brussels, and, on the long-wave band, Hilversum, Kalundborg, Motala, Eiffel Tower, Daventry 5 X X, Konigswusterhausen, Radio-Paris, Huizen. Owing to the fact that it is separated only by about ten

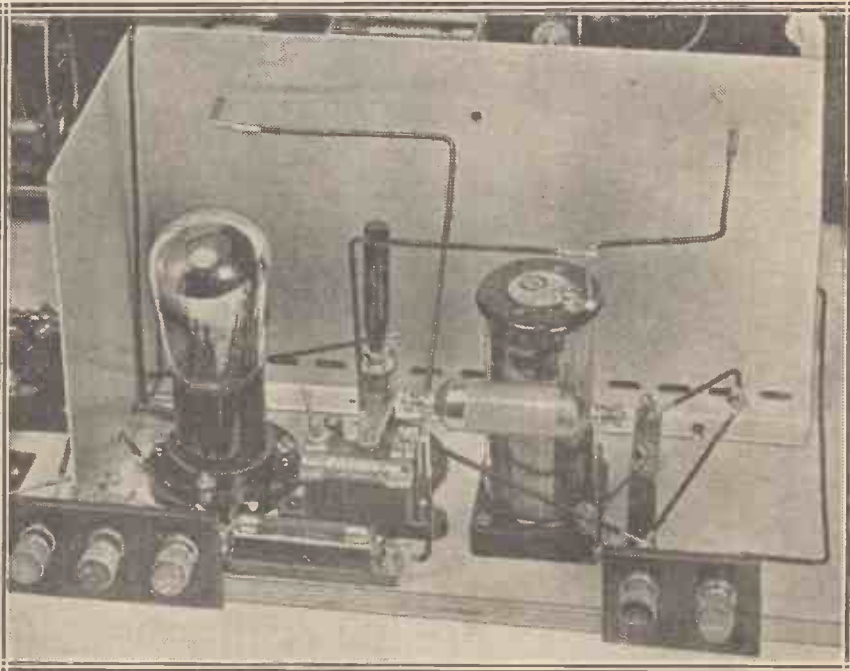

The second H.F. stage is well screened from the first, and is very simple to wire up.

lamp which illuminates the readings, thus making operation particularly simple even in the darkest corner of the room.

Great care has been taken with the layout of the apparatus internally so as to make the wiring extremely simple, while an equal care devoted to the external appearance of the

kilocycles from 5 X X (the closest you can place two stations without an audible whistle), it is not possible to receive Konigswusterhausen without interference from Daventry (nor for that matter do I know of any set, other than a super-heterodyne, which will effect this operation without some additional unit); but with

The "Air Commander"—continued

Mr. Kendall's high-selectivity unit, described in the present issue, even this separation is effected.

Picture Reception

After dark the number of stations received on the ordinary band seems numberless. Owing to the large amount of heterodyning, which varies from night to night, and which also seems much worse since the Brussels plan has started, it is often impossible to get certain well-known stations. I sat down the other night with a copy of a paper opened at the foreign programmes for the day with the idea of giving readers the actual readings for every station in the day's list, but so many were heterodyned or off their nominal wave that I gave up in despair. Whenever a station listed, however, was not heterodyned it was possible to pick it up easily, and there were at least a dozen stations on the short

band from which one could enjoy a programme just as well as if it were from the local, and, indeed, one or two visitors, who dropped in were surprised to know that the stations

and the musical programme so pleasing, that I listened to it for over an hour and a half without a break. During this period there was some fading, but when at the maximum

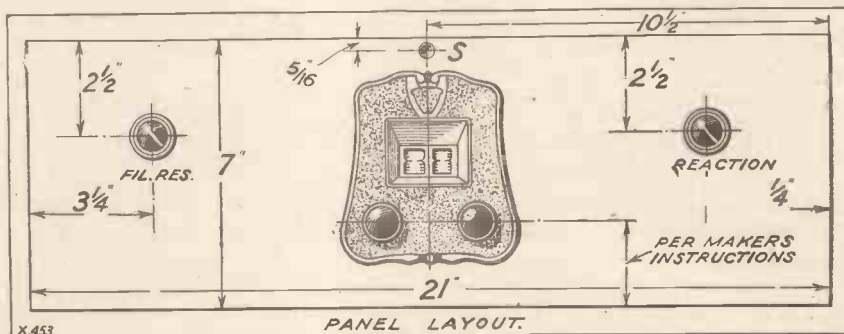

they heard on the speaker were not London.

A typical case was Vienna on 520 metres. When first picked up early in the evening the quality from this station was so extraordinarily good,

strength no reaction was used, and it was necessary to tone down a little by means of the volume control.

At the worst period the volume control was full on and just a little reaction was needed. Thus there was not the slightest interruption of the enjoyment of the programme. Later in the evening signals were amply good enough to enable me to obtain a perfectly clear picture by the Fultograph method from this station. Since my first tests with it I have taken many pictures from Vienna on the "Air Commander"—in fact, although some of the pictures have been spoiled by Morse and interference, on only one occasion have the signals been too weak to operate the picture receiver satisfactorily, and then only for a few minutes.

A "Remarkable Receiver"

It is unfortunate that we now have on the long wave-band three stations (Konigswusterhausen, 5 X X and Eiffel Tower) which are only separated from one another by about ten kilocycles. This means, of course, that when 5 X X is working it wipes out both of the others unless we use a special selectivity unit, but Hilversum, Kalundborg, Motala and Radio-Paris all send good programmes which are quite clear of 5 X X.

I think I have told you enough to indicate that the "Air Commander" is a really remarkable receiver, and that it is more sensitive and selective than any other receiver yet described in the columns of this journal, not even excepting the famous "Straight-Line" Four. It is not intended that it should replace the "New Business Man's" Four, as this latter still

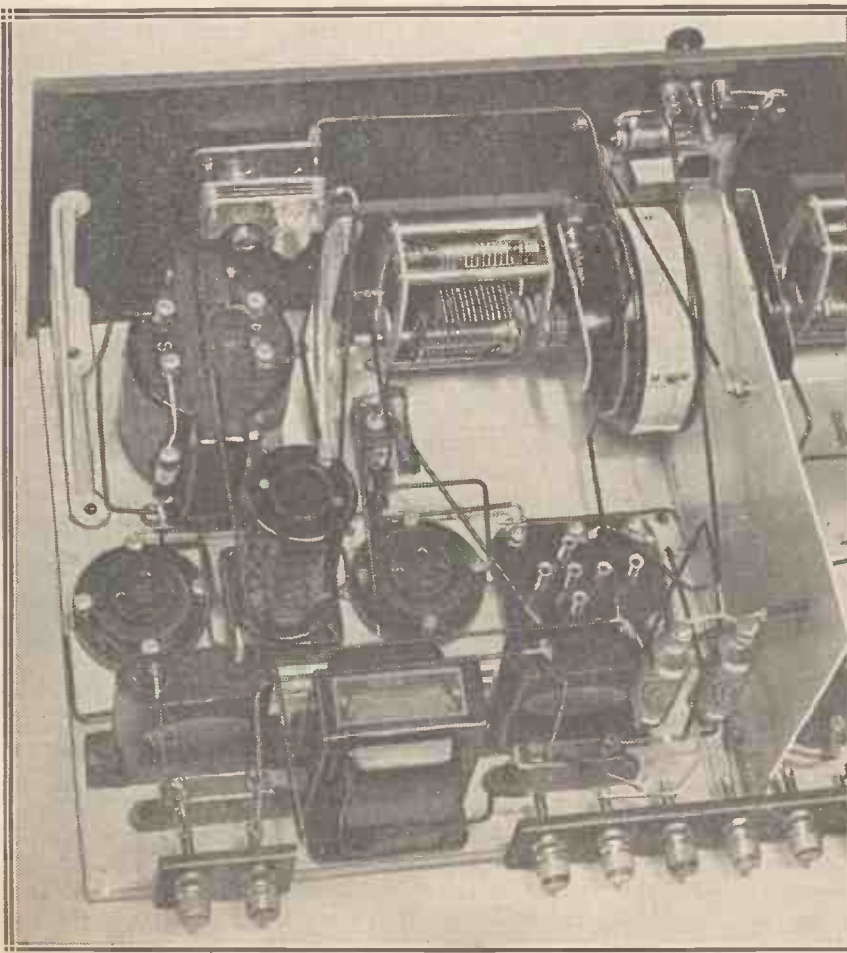

A clear view of the detector and L.F. end. Notice the on-off switch above the dial-lighting lamp. It will also be seen that the vertical screen passes between the two drums.

The "Air Commander"—continued

remains the ideal set for the man who wants the utmost simplicity of control. The "Air Commander" is a "de luxe" receiver in every sense of the word, except in cost, for although its performance and appearance are of the very highest grade, the total cost will be found quite reasonable.

The Final Design

And now to come to the actual design itself and how to build it. Look at the circuit diagram and you will see that the aerial is tapped on to the grid coil of a screened-grid valve, in the anode circuit of which is a radio-frequency choke providing the necessary high impedance. The voltages so obtained are impressed on the neutralised high-frequency valves through the coupling condenser shown.

To avoid interaction the high-frequency stages are screened with vertical screens, battery coupling (so annoying a source of feed-back) is prevented by the insertion of resistances in the H.T. circuits of the screening grid, the plate of the screened-grid valve, the plate of the neutralised H.F. valve, and the plate of the detector valve. These resistances also serve to bring down the voltage of the high-tension supply to the requisite figure for each purpose. Even so, and with these precautions taken, the magnification is so great that coil field interaction will take place without special precautions. To avoid this the coil in the detector circuit is of the binocular form, and I would also recommend that the aerial coil be of the same type, although the ordinary single-

the output valve we have a high-grade output choke which, together with a 2-mfd. condenser, gives the necessary output filter.

A volume control is provided by the variable filament resistance used to control the filament current of the screened-grid valve. By reducing the filament current here we can reduce the magnification down to a negligible figure and thus reduce the signals as desired. This method is preferable to a volume control after the detector, as we can reduce the voltage applied to the detector grid if there is any sign of overloading here.

One H.T. Positive

As previously indicated there is only one high-tension positive terminal, and as an additional safeguard

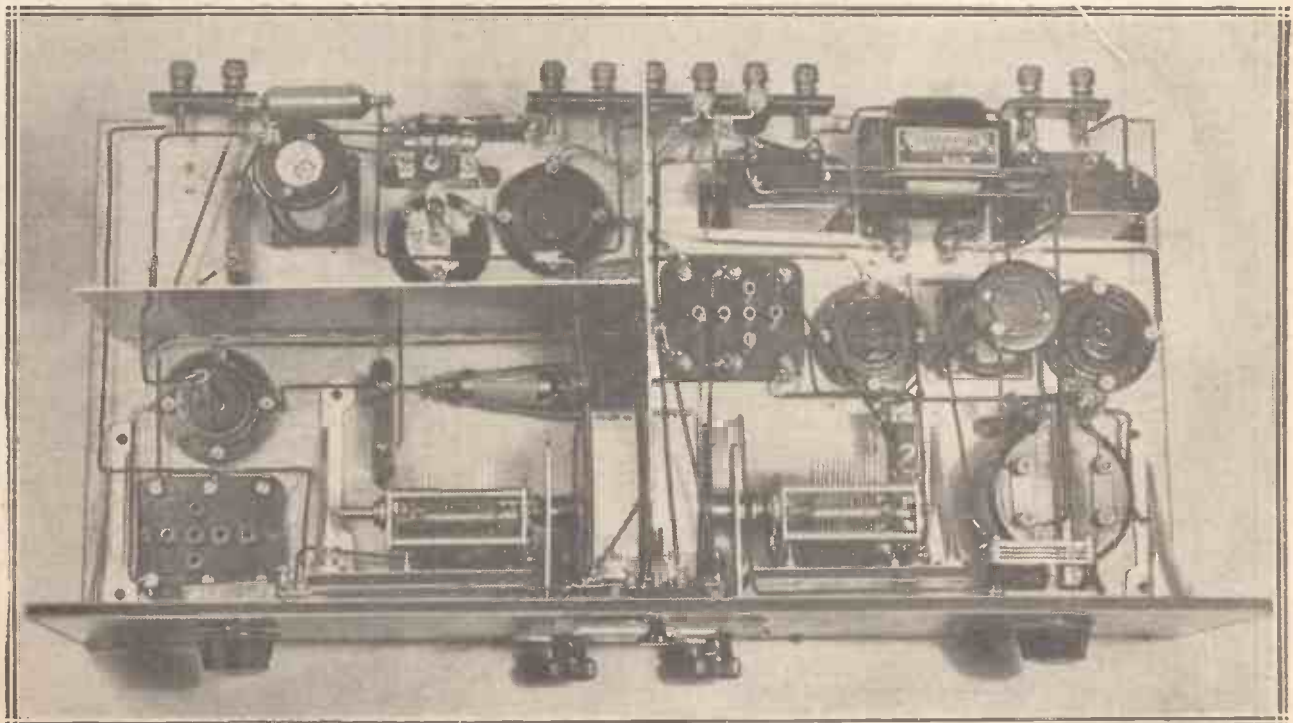

A general view of the "Air Commander" in which the layout of components can be clearly seen. This photograph should be used in conjunction with the wiring diagram when building the set.

This high-frequency valve is neutralised by the split-primary method, a split-primary transformer being used for the purpose. The detector is of the grid leak and condenser type, comparative experiments having shown that the quality given is practically indistinguishable from that of the anode-bend type on loud signals, while on weak signals it is distinctly superior.

layer six-pin type can be used as aerial coil, if desired. The special advantage of the binocular coil here is that it very considerably reduces local signal pick-up, thus enabling us to get improved selectivity.

Transformer-Coupled L.F. Stage

Following the detector we have one low-frequency stage, transformer coupled, and in the plate circuit of

a 100-m.a. Micro-fuse is inserted in the common high-tension lead, so that even if the high-tension wires inside the set should come into contact with the filament wiring the filaments will not be damaged, the only effect being to blow the fuse, which is cheaply replaceable.

This type of fuse, which blows at a figure no higher than that taken by a valve filament itself at a normal

The "Air Commander"—continued

voltage, has passed a number of very drastic tests in the WIRELESS CONSTRUCTOR laboratory before its adoption.

Turn now to the photographs and drawings illustrating the actual lay-

out. You will see that a single vertical screen passes between the two drums of the variable condenser drive, and that a second screen is placed at right angles to this. This enables us to arrange the layout

very neatly and efficiently, the untuned stage being at the back of the baseboard away from the panel.

The adoption of single vertical screens and binocular coils, together with careful wiring and the use of

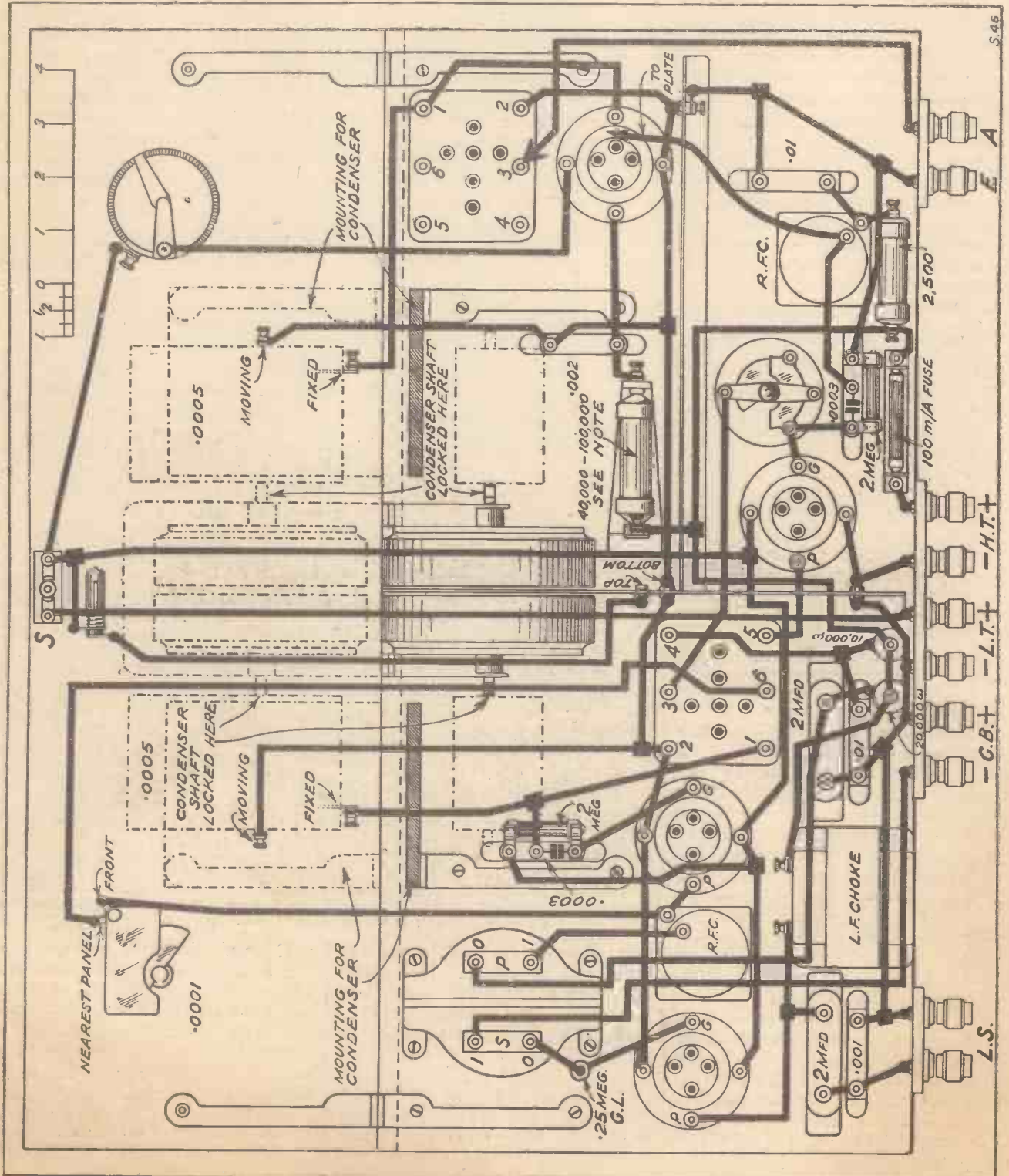

The "Air Commander"—continued

resistances in high-tension leads, shunted by fixed condensers, enables us to eliminate all unwanted feedback, while still enabling the wiring to be carried out far more easily than if we used ordinary coils and complete screening boxes. The use of an untuned stage between two tuned stages also enables us to separate the actual coils used by considerable distance, without spoiling the layout.

The H.T. Resistances

Three of the four wire-wound resistances used for voltage dropping purposes are themselves supported by the stiff wire and their own terminals, this making for greater simplicity of wiring and layout. The fourth is held in the holder designed for these resistances, as in this particular case the experimentally-inclined reader may want to change it for another value to see its effect on

signals, but this, too, can be supported on the wires if desired.

In the list of components given the names of the actual parts used in the model illustrated are given in brackets, but in most cases any good make can be substituted without loss of efficiency.

In this, as in every set using high-frequency, the layout should be followed carefully and should only be varied when the reader is perfectly sure he knows what he is doing.

The constructional work is remarkably easy, the only part which will require a little more attention than usual is the mounting of the drum control and the variable condensers. When you unpack the drum control from its box you will find a cardboard template, and the instructions and markings on this should be carefully followed. Mount the drum control exactly as explained, but ignore the two metal strips with their screws

which are intended for the attachment of the American variable condensers.

Mounting the Condensers

When you have mounted the assembly you will have a panel with two drums protruding at the back, each drum having a central hole and grub screw for holding and securing the shaft of a variable condenser. You will notice on examining this drum that the ordinary type of variable condenser cannot be used.

There are comparatively few condensers adaptable for this purpose, as any condenser used must have a shaft projecting at *each end*. The new pattern Lissen condenser lends itself admirably to this assembly if the instructions about to be given are followed.

It should be pointed out that the earlier Lissen variable condensers were of somewhat different pattern,

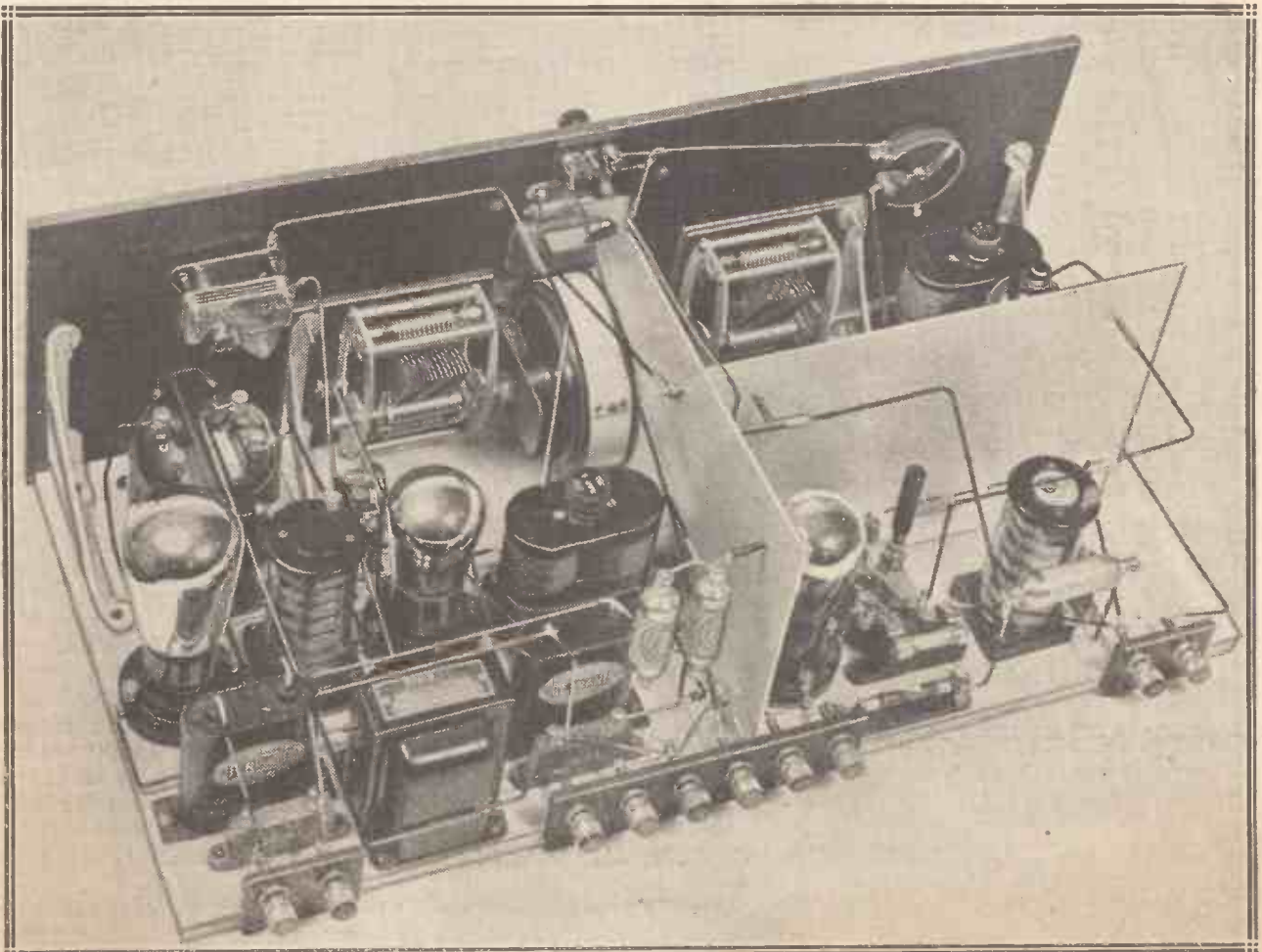

A very businesslike appearance is obtained, which will stand careful comparison with the most expensive commercial receivers.

The "Air Commander"—*continued*

but the present models have lugs which enable them to be used as shown in the photographs. First of all take two pieces of wood or ebonite of the dimensions shown in the wiring diagram (4 in. square) and fix to one end of each, as shown, a strong panel bracket. Next loosen the grub screw on the right-hand drum—looking at the back of the panel—and slip into it the projecting end of the condenser shaft which in an ordinary assembly would be *away* from the panel (not the shaft which normally projects *through* the panel).

Setting the Drums

In doing this you will place the condenser so that the two securing lugs come next to the panel. Lock the shaft by tightening the grub screw, and then slide up behind the wood or ebonite panel to which you have fixed the bracket. Carefully hold the condenser in position, mark through the securing lugs to show where you are to drill the holes for the securing screws.

Now slide away your small panel, and drill the two holes marked. Next replacing the panel in position, pass metal screws through from the back, and lock the condenser in position with lock-nuts and, if necessary, washers. When you are sure that the small panel is in the correct position (you can check this by turning the front knob of the particular drum to find whether the condenser turns smoothly) screw the bracket to the baseboard in its proper position. You will, of course, have previously fixed the brackets of the main panel, and fastened this to the baseboard.

Repeat the procedure with the left-hand drum and condenser, but in this case using the end of the condenser shaft which normally passed through the panel. When you have done this you will find that it will be necessary to slacken the grub screws so that you can make the readings on the drums correspond with the positions of the condensers.

The simplest way to do this is to set the drums at 100 and set the vanes of the condenser at the "full-in" position. If it is awkward to get at the grub screw at this position, just tighten the grub screw lightly at any convenient position on the condenser, and then turn the drum round towards maximum. The condenser will probably reach maximum before the drum, but if you go on turning there will be enough slip to come round to the right place. When you have found the accurate position, tighten the grub screw on each condenser firmly.

The Main Screen

There are, of course, other ways which will suggest themselves to the ingenious reader for mounting variable condensers on these drums, but obviously the ordinary one-hole-fixing method cannot be employed, and it will probably be better to use the particular make of condenser specified and the method indicated. Assuming that you have mounted the volume-control resistance and the reaction condenser together with the on-off switch on the main panel, the next step is to take a standard vertical screen and cut off one corner of it so that when it is slipped in between the two drums (which are separated from one another and have no common shaft) it will not foul the front plate of the drum assembly, the illuminating lamp, and the on-and-off switch. A metal saw will enable you to cut off this corner easily.

The Condenser Connections

The makers of the Magnum screens can supply you with the screen for this purpose already cut. Then lay out the components in the positions shown, placing the screen which is parallel with the panel in position temporarily, so as to see that the components come in their right positions. It can then be removed until the final wiring is carried out.

As it is a little difficult to get at the terminals on the variable condensers when they are in place, readers may care to take two flexible leads from these before they are fastened to the drums. The connections to the moving plates on each condenser can be taken either to the terminal provided for this or to the lock-nut which normally holds the condenser to the panel, whichever is the more convenient. In my own case, I have

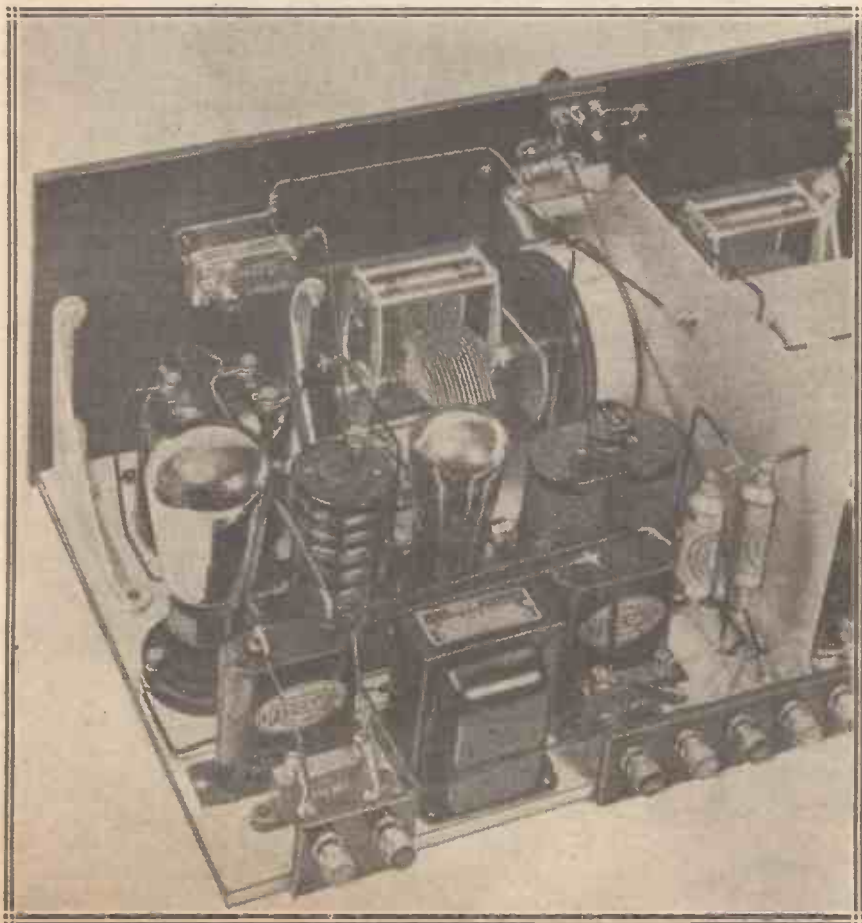

No space is wasted in the L.F. end of the set, but efficiency is not in any way sacrificed because of the compactness of the layout.

The "Air Commander"—continued

passed a wire round the bush of the condenser and locked it tight with the normal lock-nut, on the condenser which is nearer the aerial end of the set.

As it is not possible to solder to an aluminium screen, metal screws and lock-nuts are provided by the makers of the screens, and these should be placed in the slots in the desired positions and locked tightly. Soldering can then be easily effected on the brass screws, or one can make connection without soldering by means of nuts. The points of connection to the screens are clearly marked.

Wiring Up

This set is wired up with No. 16 Glazite wire. It is necessary to point this out, as this wire is sold in two thicknesses, No. 16 in packets of already straightened wire, and No. 18 in coils. All WIRELESS CONSTRUCTOR sets are wired up with the No. 16, or similar stiff type, and in the present receiver, as the wire-wound resistors are held up by connecting wire in several places, it is necessary to use the stiff kind.

Wherever the Glazite passes through a slot or hole in the panel, slip over it, as a precautionary measure, a short length of insulating tubing such as Systoflex, or the rubber tubing used for bicycle valves. This will prevent any possible trouble through vibration chafing through the insulation of the Glazite wire and causing it to short-circuit to the screen. A single length of thick Systoflex of a size to pass over the Glazite wire will be more than sufficient for all the holes and slots.

If a different make of low-frequency output choke from that actually used in the receiver is chosen it may be necessary slightly to rearrange the parts at this end of the receiver, but there is plenty of room and no difficulty should be experienced.

The H.F. Chokes

The reader is advised to use either an R.I.-Varley, Lewcos or Magnum high-frequency choke in the H.F. stage, as the requirements here are rather unusual, and many chokes which prove perfectly satisfactory for normal circuits will not function properly in this particular circuit. It is not desired to make any invidious comparisons, and doubtless there are a number of other high-frequency chokes which would function as well. The

three chokes mentioned, however, work perfectly satisfactorily in this set and the use of one or other of them will assure the reader that no trouble can arise in this regard. The second H.F. choke in the detector circuit can be of any good make.

When wiring up the T.C.C. series-parallel fixed condenser be sure that you have these the right way round. In the case of the high-frequency stage, this means that the outer

on or off. If, however, the reader so desires he can use an extra on-and-off switch for switching on and off the dial illuminator, but this will rather spoil the simplicity of layout of the front panel.

The lamp normally supplied with these dials is for use with 6-volt batteries. If you are using, as many people will do, 2-volt valves, owing to the difficulty at the present time of getting 6-volt screened-grid valves,

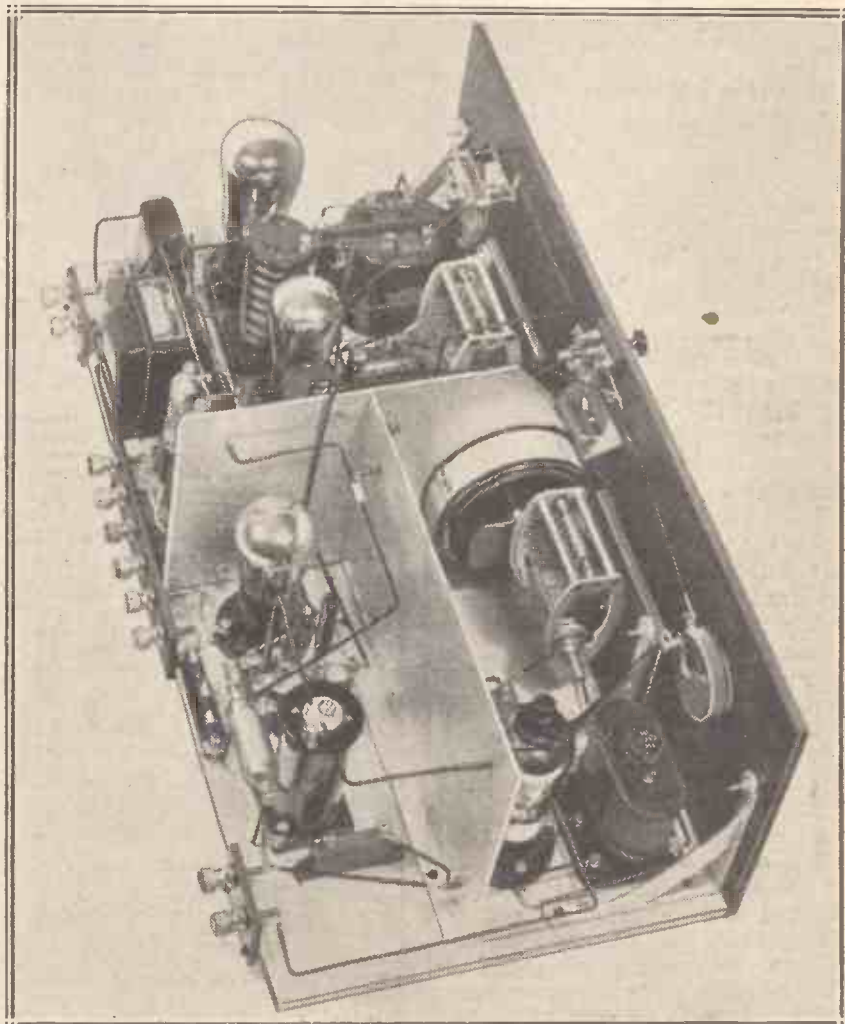

The untuned H.F. circuit is kept well away from the front of panel, and is carefully screened, as will be seen from the above photograph.

terminal, which is marked on the top as connected to the fixed condenser, should be nearest the grid of the high-frequency valve, and in the detector stage this terminal is also nearest the valve.

The receiver has been so wired up that when the on-and-off switch is on the dial is always illuminated, thus one can tell at a glance whether the set is

then an ordinary flash-lamp bulb will do for illuminating the dials.

If you use 4-volt valves (which is not a bad plan at the present time with this set, as excellent 4-volt screened-grid valves seem to be readily obtainable), then the 6-volt lamp will give plenty of light on four volts. For the highest efficiency

(Continued on page 458.)



Some typical faults and remedies reviewed.

By P. R. BIRD.

Condenser Capacity

"H.F. CURRENTS fascinate me," says a Retford reader, "especially their habit of 'going through' condensers. But why is it that when the two '0005 mfd. condensers are connected in series with one another the total capacity is only '00025 mfd.?"

"Electrically I cannot argue," he continues, "but I know that each condenser has a certain number of plates and a dielectric between them, and it seems very strange that with double the number of plates there is only half the capacity. Can it be explained apart from formulae and highbrow hieroglyphics?"

As a matter of fact, it is not at all difficult to see why when two condensers are connected together in series in this way the total capacity is very much smaller than the capacity of either of the original condensers separately.

A little reflection will show that, as half the plates in any condenser are joined together, they can be reckoned as one large plate, and as the remaining half are all joined together they also can be considered as a second single plate. Between these two is the dielectric which insulates them from one another.

Dielectric Thickness

The capacity of the condenser will depend upon the size of the plates and the thickness of the dielectric. If the area of the plate is made smaller the capacity is lessened. Also, if the thickness of the dielectric is increased the capacity is lessened.

Now consider two condensers in series one with the other. The charge

enters the circuit and spreads over one of the plates which is connected to the external circuit. It then has to act across the thickness of the dielectric and influence the opposite plate of the condenser (to which is connected one of the plates of the second condenser).

THE TECHNICAL QUERIES DEPARTMENT

Are you in trouble with your set?

Have you any knotty little Radio problems requiring solution?

The WIRELESS CONSTRUCTOR Technical Queries Department is now in a position to give an unrivalled service. The aim of the department is to furnish really helpful advice in connection with any radio problem, theoretical or practical.

Full details, including the scale of charges, can be obtained direct from the Technical Queries Department, WIRELESS CONSTRUCTOR, Fleetway House, Farringdon Street, London, E.C.4.

A postcard will do. On receipt of this all the necessary literature will be sent to you free and post free, immediately. This application will place you under no obligation whatever.

Every reader of the WIRELESS CONSTRUCTOR should have these details by him. An application form is included which will enable you to ask your questions so that we can deal with them expeditiously and with the minimum of delay. Having this form you will know exactly what information we require to have before us in order to solve your problems.

From this point it again has to act across the second dielectric before it emerges at the other exterior lead. When entering and when leaving the circuit the area of the plate is the same as for the '0005 mfd. condenser, and, other things being equal, we should expect the capacity to remain the same.

But other things are *not* equal. Instead of having to pass through

only *one* dielectric in order to reach the "output," there are now *two* dielectrics, and it is this fact which halves the effective capacity of this condenser.

The thicker the dielectric the less the capacity will be, and as by joining the two condensers in series we have in effect the same plate area, but a double thickness of the dielectric, we have in effect halved the capacity of the condenser.

A Puzzling Point

Again I must appeal to old readers to have patience while a question is being dealt with that is a puzzle to many newcomers to radio. One reader, who apparently had his set only a few weeks ago, lives about twelve miles from his local station and is greatly puzzled because not only is reception quite clear when that station is transmitting, but also he gets it just as strong and clearly when taking the Glasgow programme, or the London programme, or any other B.B.C. station.

"Why is it," he says, "that the distance does not make any difference?"

For the benefit of those newcomers who have not quite tumbled to this point, it should be explained that although the programme may be coming from Glasgow, Aberdeen, or some other distant station, *it is being sent out by your local station.* All that is happening is that instead of your local Auntie or Uncle talking into the microphone at the local station, the telephone line from Glasgow, London, or wherever the station may be, is connected to the local broadcasting station. Then, by means of a low-frequency amplifier, rather similar to those on your receiving set, the voice over the telephones is strengthened up until it is equal to a voice speaking before the microphone.

The Telephoned Input

Such great care is taken, and so good is the amplification at all stages, that hardly anything of the naturalness or of the quality of the voice is lost in its long telephone journey from the distant station to your local station. And as the input to your local station is just as powerful as usual, and it is sending out on its ordinary power from the transmitting aerial, the strength of reception at your set will be just the same as usual, whether the programme is coming from the local station or from one of the more distant links in the B.B.C. chain.



A HIGH SELECTIVITY UNIT

ONE of the most difficult of all the problems we meet with in radio is the old and ever-recurring one of selectivity. Every day it grows more acute, with the increase in the number of stations, increases in the power of existing ones, and the gradual approach of the regional scheme.

When the latter development does really materialise it will suddenly become far more serious still, but even now most of us feel that a little

COMPONENTS

- 1 Panel, 6 in. × 7 in. × $\frac{3}{8}$ or $\frac{1}{2}$ in. (Becol, Resiston, Trolite, "Kay Ray," Ripault, Trelleborg, etc.).
 - 1 Cabinet to fit, with baseboard 10 in. deep. (NOTE.—This is a size often used for mains H.T. units.) (Cameco, Gilbert, Raymond, Lock, Caxton, Pickett, Artercraft, etc.)
 - 1 .0005-mfd. variable condenser, slow motion or with vernier dial (Formo, Utility, J.B., Dubilier, Lissen, Igranic, Ormond, etc.).
 - 1 Wave-change on-off switch (see text). (Burne-Jones, Lissen, Lotus, Wearite, Bulgin, etc.)
 - 3 Coil sockets (Lotus, Raymond, etc.).
 - 1 Neutrodyne condenser, rotating vane type (Peto-Scott, Burne-Jones, etc.).
 - 1 Strip, 6 in. × 2 in., and 4 terminals (Igranic, Burton, Eelex, Belling-Lee, etc.).
- Flex, wire, screws, etc.

extra selectivity is the one thing above all others which we want in our sets, unless we are lucky enough to possess a very exceptional outfit indeed.

Wave-Trap Limitations

Up to a point, we can achieve our desires by using a good modern type of wave-trap. This will enable us to shut out the local station pretty definitely and leave the dials clear

This is not a wave-trap, but a remarkable instrument which can be connected to any set in order to increase its programme-picking powers over the whole of its wave-band.

Designed and described by
G. P. KENDALL, B.Sc.

for searching for distant stations, but it does not go all the way. For example, it will not help you to separate two distant stations working on very nearby waves, nor will it enable you to cut out 5 GB and receive, say, Langenberg, if you are already compelled to set it to eliminate the local station. To put the difficulty in a nutshell, it will only eliminate one station at a time.

Again, there is the question of long waves, and this is even more difficult, for most wave-trap circuits work very poorly on 5 X X, and all seem to be rather unreliable. Some of the best work tolerably with one set and badly with another, vary with aerial and earth conditions, and so on, so that the use of a trap to get rid of 5 X X is at best a matter of luck.

With very many sets this question of selectivity on long waves is one which annoys the user considerably, for he finds that 5 X X spoils two good French stations pretty completely. Something like separation can generally be obtained by weakening the coupling of the aerial circuit (series condenser, small aerial coil, and so on), but with sets of moderate sensitivity this usually weakens signals more than one can afford.

I have recently had occasion to survey this whole question in the light of present conditions and those which are likely to obtain when the

regional scheme begins to take shape, and it seems to me that it is time to attack the problem from a different angle. In the days when a single local station constituted the whole selectivity problem the wave-trap was a fairly adequate solution. It conferred "special selectivity" on any set, i.e. gave it the power to exclude one special station, and this was usually enough.

Modern Requirements

Now, however, it seems that we want something which will provide a higher degree of "general selectivity," i.e. the ability to exclude all stations except the particular one being

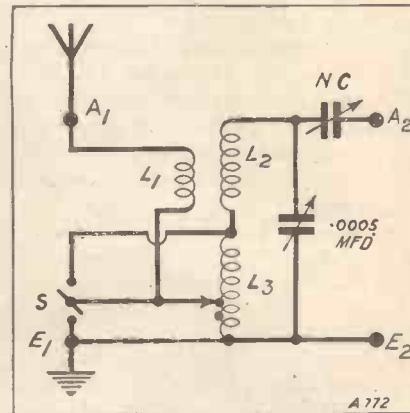

received. I have done a good deal of experimental work on this question, and I have found that it is quite possible to produce a relatively simple little piece of apparatus which can be connected up in front of any set and will have just this effect, and it is such a unit that I am about to describe.

A word of warning here, lest the reader be led to expect too much. A

A High Selectivity Unit—continued

unit of this type, i.e. of the kind which raises the "general" selectivity, is one which will require tuning to each desired station in turn. You cannot just set it once and for all and then do all tuning on your set as you would with a wave-trap. Actually, it practically means another dial to tune, and so it means that your set is going to be a little more complicated to tune until you have got readings for the stations you want.

Handling Still Simple

This is not such a drawback as you might at first sight think, for several reasons. First of all, units of this type are generally used with sets of the "detector and L.F." type, which have only one tuning dial. Hence, when the unit is added there are only two dials in all, which is quite an easy number to handle, as users of a set with an H.F. stage already know. It is merely a matter of getting the dials in step on one



It is a neat, compact unit, and can be switched over in a moment to either wave-band when required.

station, and then learning the knack of tuning them simultaneously, so that they keep in register as you search.

This is really quite easy, since there is a sound of liveliness when the two circuits are in step with each other, and the tuning of the dial on the

"extra selectivity" unit is not very critical.

Again, you do not need to use the extra unit for every station you want, but only for a few, and it is often very easy to pick up the station you want first before you connect up the unit, getting it then with interference.

Next, connect up the unit and tune thereon until the station comes in again WITHOUT interference. The setting of the dial on the set proper you will find in most cases remains very nearly the same with and without the unit, so that finding the station again after connecting up the unit is very easy. (You could, of course, easily arrange a double-pole change-over switch to connect and disconnect the unit to your set as required.)

Another point: All units of this type must be expected to produce a



This unit is a comparatively inexpensive instrument and it is decidedly easy to build and to operate. You can connect it to any set.

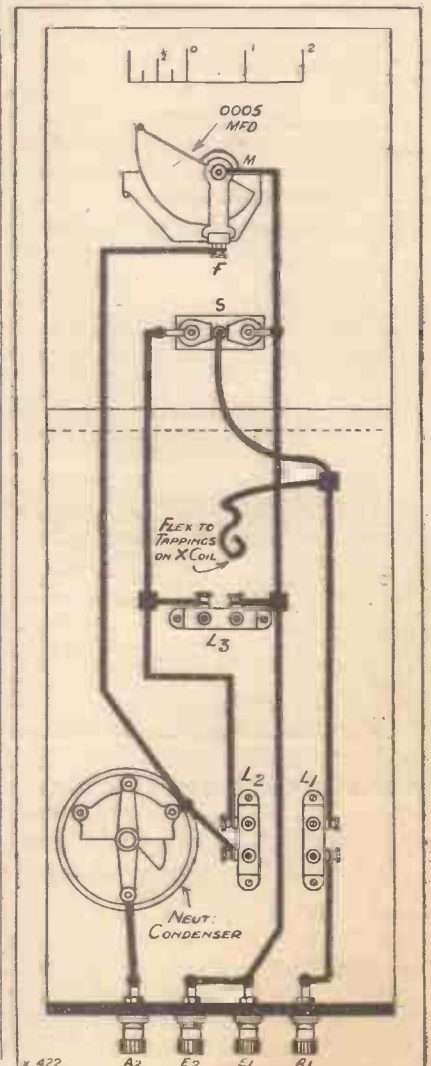

A High Selectivity Unit—continued

slight drop in volume. With a good unit it is very slight indeed, but it is just perceptible. However, it is surely better to hear a station clearly, but at very slightly less volume, than at normal strength with a loud accompaniment from another transmission.

The unit which you see in the photographs is a particularly simple, but highly effective, form of the new type, and after lengthy and thorough tests I can confidently recommend

denser, with a four-terminal strip for the connections at the back.

The coils L_1 and L_2 are the primary and secondary for the ordinary broadcast waves, while L_3 is the "X" coil, which gives you the long waves on switching over. Sizes for these are as follow: L_1 , No. 25 or 35, according to the size of your aerial (large aerial; small coil, and vice versa) and degree of selectivity needed; L_2 , No. 60; L_3 , No. 200X.

Easy to Build

Constructional work is so simple that there seems to be little which I can tell you which is not perfectly clear in the photos and diagrams. You will note that the connection to the moving part of the wave-change switch is of flex, and the end of this is soldered to a stiff lead running to one side of the L_1 socket.

The kind of wave-change switch you want is an L.T. on-off type of the form with a central plunger and two separate side springs. A lead goes to each of the side contacts, and a third (flex) one to the centre plunger. This last can be attached by soldering direct to the metal knob (as with the Lotus switch), by fixing under a special screw (Burne-Jones), or by unscrewing the metal tip a trifle and gripping the bared end thereunder. Again, you could use one of the special switches made expressly for this purpose (Wearite, Bulgin, etc.), which are provided with three side springs. With these, one lead goes to each of the contacts, and wiring is very easy.

Finally, it just remains to give the connections. Aerial and earth go to A_1 and E_1 on the terminal strip, A_2 is wired to the aerial terminal on your set, and E_2 to the earth on the set.

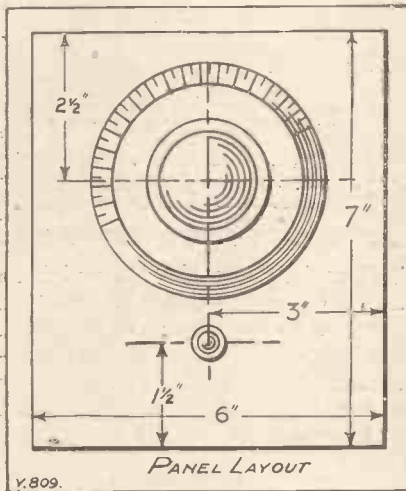

it for all general purposes. It can be relied upon to raise the selectivity of any set up to a very high standard.

Both Bands Covered

With elaborate details of the theory of the circuit I will not weary you. Suffice it to say that the unit contains a complete tuning circuit, with an "aperiodic" aerial arrangement and a fully tuned secondary, with wave-change switching. This last is a great convenience, you will find, for by pushing in the switch knob you can work on the long waves, and by pulling it outwards you are ready to tune-in stations on the lower wave-band, all without changing any coils.

The "coupling" between this extra tuned circuit and the set proper is by means of a very small condenser, which actually takes the form of one of the neutrodyne type. This is normally kept set to its maximum.

You will see that the general make-up of the unit is very simple indeed. A small front panel carries the tuning condenser and wave-change switch, while on the narrow and deep base-board there are merely three coil sockets and a neutrodyne con-

Three plug-in coils are used in the High Selectivity Unit, and there is an efficient wave-change scheme. The unit operates exceedingly well on the long waves and it is here that wave-traps most frequently fail.

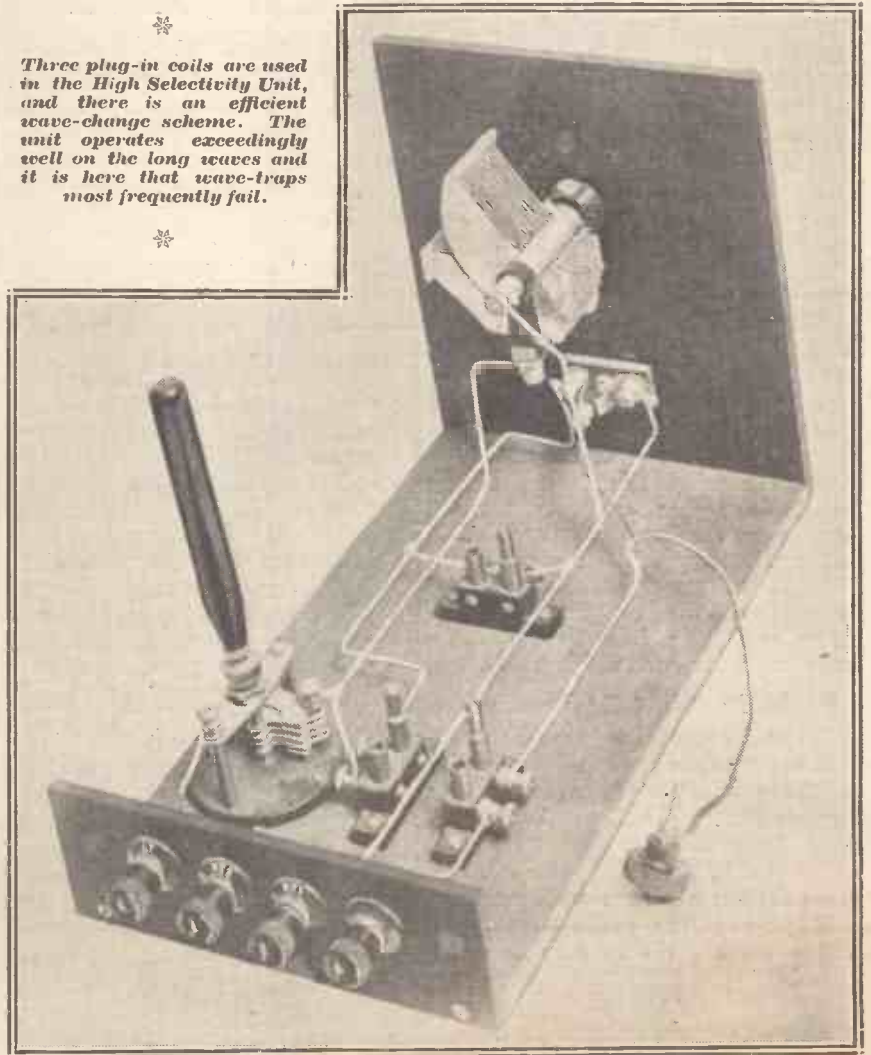

MORE ABOUT THE "D.C." FOUR

Some further details of the powerful all-from-the-mains set described in the February issue of the WIRELESS CONSTRUCTOR.

By G. V. COLLE

IN the original "D.C." Four article which appeared two months ago, it was mentioned that the results compared very favourably with those obtainable from a good four-valver, consisting of a neutralised H.F. stage, detector on the grid rectification principle, and 2 L.F. (resistance- and transformer-coupled respectively).

What it Should Do

The set which the writer had in mind should be capable, under reasonably fair conditions, of cutting out the local station completely in about ten degrees rotation of the drum dials, without the aid of a wave-trap. Further, it should be sufficiently powerful, with a loud speaker of medium sensitivity, of bringing in at least fifteen stations on the local speaker, using an average-sized aerial, not too badly screened, and about 25 to 30 ft. in height. Stations such as 2 L O (or the local), 5 G B, 5 X X and two or three German will be sufficiently powerful to require volume controlling and perhaps detuning.

Actually, these results are but a conservative estimate of the possibilities of the receiver, because since it was described the set has been installed in Clapton, London, E.8, and has far exceeded these limits. Clapton is approximately $4\frac{1}{2}$ miles from 2 L O, but, even so, the receiver can reject this station when tuned to higher or lower wavelengths on the broadcast band. It has also been possible to receive at least 15 stations any night since its installation, the complete "log" being something like 40 stations, including a few on the high waves.

Perfectly Silent Background

No mains hum has been discernible, using a loud speaker fitted with a "Blue Spot" unit, so that with average D.C. mains it can be taken that the smoothing equipment incorporated in the set is sufficient, as those readers who have used sensitive balanced-armature loud speakers will appreciate the severity of this combination. Admittedly the negative main was "earthed," giving the set the benefit of a quiet background, as compared to positive earthing;

but the auxiliary smoothing unit described in this issue will be found to meet all outstanding cases, after other means have failed.

A further number of readers inquired about the possibilities of a screened-grid valve in place of the neutralised H.F. stage, and here the writer would like to add a few words of advice. Theoretically, and to a certain extent practically, it is quite possible to use this valve, after making minor alterations to the circuit wiring. However, the limitations of the last L.F. valve must be taken into account, and the snag is that in making full use of the screened-grid valve, the small power valve would be hopelessly overloaded.

The Output Valve

Unfortunately, one cannot make use of a larger power valve, since the filament current is restricted to 15 ampere, which automatically confines the choice to only a few types, dealing with grid swings of up to about 9 volts.

Happily, it is not quite "Hobson's" choice, because the neutralised H.F. stage does definitely give greater

selectivity than one of the screened-grid variety, and as this is quite an important point when looking at the question from the city dweller's point of view, that of volume hardly enters into it. Looking at it from another point of view, a small power valve of the 15-ampere class also possesses a higher magnification factor than its larger brethren, so that the overall amplification compares favourably to an ordinary set using a high mag. first stage (screened grid) and a large power (but low magnification) final stage.

The moral is, of course, to employ a loud speaker of rather good sensitivity, and keep the input to the small power valve within the limits of its grid swing.

* FOR THE *
* RADIO CLUBS *

NOT long ago the Marconiphone Company prepared a lecture on the screened-grid valve, which was greatly appreciated by hard-working secretaries of radio clubs. Honorary secretaries and organisers will be glad to know that a second lecture has now been completed, and is ready for loan in suitable quarters. (Application should be made to the Marconiphone Company, Ltd., at their head office, 210-212, Tottenham Court Road, London, W.1.) The title of this second lecture is "A.C. Mains Valves."

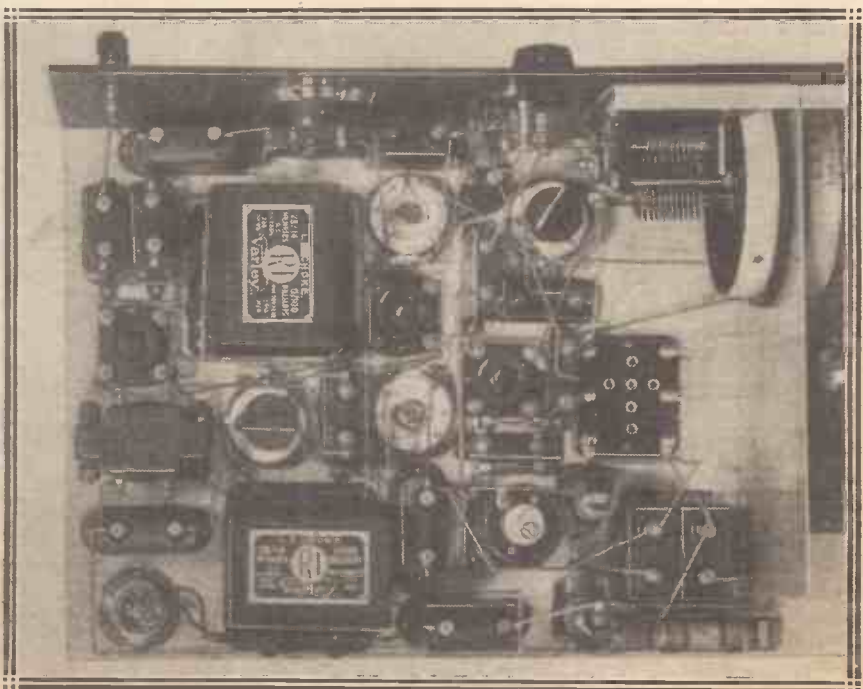

A plan view of the "D.C." Four's detector and L.F. end.

The WHYS and WHEREFORES of H.F. Circuits



An informative article for all constructors interested in the important question of high-frequency amplification.

By THE EDITOR.

IT may sound strange to the ears of a modern listener accustomed to the performance of an up-to-date set to hear that in the first days of broadcasting many quite serious experimenters held the view that no real gain was to be had by adding a high-frequency stage to a detector, and that equally good long-distance results could be obtained with a detector and reaction, always provided that the reaction control was smooth enough.

They had much evidence to support their case, for it must be remembered that valves were poor and inefficient, neutralising methods unknown, and reaction controls, in the main, crude and "floppy." The real truth of the matter was that we

at the beginning of broadcasting, L_1 was a simple tuning coil, often of the plug-in variety, but sometimes a single-layer affair, while L_2 was the reaction coil, either a plug-in coil in a moving coil holder or some form of coil the angle of which could be altered in relation to L_1 . C_1 is, of course, the tuning condenser, C_2 the grid condenser, while R_1 is the grid leak. R_2 was the variable filament resistance always used in early sets, for the simple reason that we had not yet reached the happy state when valves were made for precisely two, four or six volts on the filament.

The Good Old Days

The valves most generally used worked best at about three and a half to four volts, and I am afraid the general rule was to use a 6-volt accumulator with a variable filament resistance to drop the voltage suitably, and gradually to cut out the resistance as the accumulator ran down! You could see to read by the light from the filaments on any two- or three-valve set, and, as each valve took the best part of an ampere, accumulators had to be on the large side!

Now, the troubles with this set were many, viewed with our present knowledge. First of all, the aerial was almost invariably connected across the whole coil, thus introducing heavy damping. The real damping effect of the aerial damping will be better understood by considering Fig. 1b, where the effect of the aerial is translated into an equivalent resistance R .

It will be seen that before such a set would oscillate reaction had to make up the heavy losses due to this

damping, and the net result was that a good deal of reaction could be used before the set oscillated. When it *did* oscillate it generally started to do so very suddenly. With small, efficient aerials the damping was less and the reaction control smoother.

Spurious Reaction

Now consider Fig. 2, one of the first high-frequency circuits used. Here we have the same aerial arrangement as before, but the first grid is connected to the negative valve leg through the coil L_1 , the grid being thus at zero potential.

In the plate circuit of this we have the tuned anode L_2 and C_2 , and farther on a detector valve, the grid leak of which is taken down to

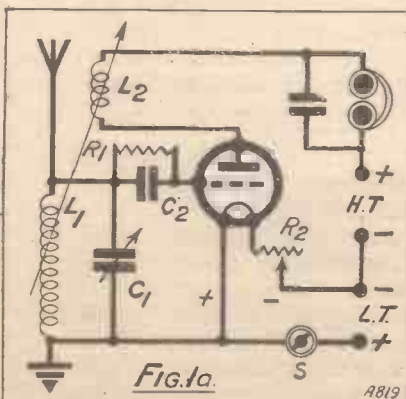

This type of receiver was "all the go" in 1923.

did obtain a small genuine high-frequency gain, while reaction effects were much easier to obtain, or rather to control, and thus the H.F. gain seemed greater than it really was. Take, for example, Figs. 1 and 2.

Fig. 1a shows a type of single-valve receiver which was very popular

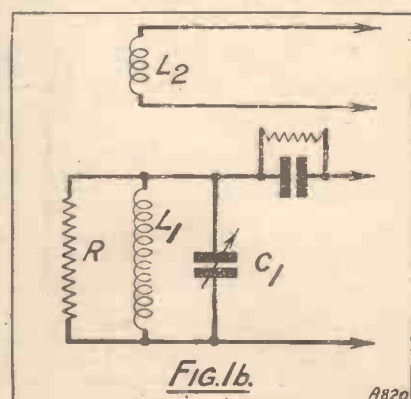

The effect of aerial damping is shown by the resistance R .

positive filament instead of across the grid condenser. (If the latter method were used the high-tension voltage would reach the detector grid instead of being isolated from it by the condenser C_3 .)

Many experimenters said this was a far better arrangement than Fig. 1,

The Whys and Wherefores of H.F. Circuits—continued

and gave much better results. Examination shows that while there is no reaction coil, reaction effects are, nevertheless, obtained.

When the circuit C_2-L_2 is brought into tune with the circuit L_1-C_1 there is a feed-back of energy from the plate to the grid circuit, and whether or not this feed-back is sufficient to produce reaction will depend upon the damping in the two circuits, the magnification given by the valve, and the inter-electrode capacity.

The Grid Return

Even if there were no direct interaction between the coils L_2 and L_1 (which was often the case) such a circuit almost invariably oscillated violently if the aerial were removed from its terminal, thus showing that stability was obtained by the aerial damping. As the circuits would not oscillate unless they were in tune with one another, a very smooth reaction adjustment was possible by turning the condenser C_2 , and so we had a circuit in which the main effect of the alleged high-frequency valve was to give a smooth reaction control, which it certainly did.

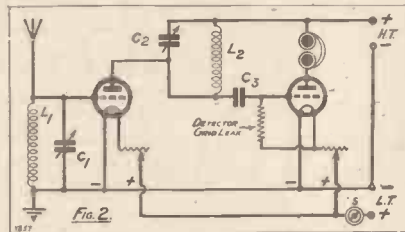

Here the grid of the H.F. valve is connected to L.T. neg. through the coil L_1 .

return to negative, was, however, generally rather unstable and tricky, and while with certain aeriels it worked well, it was by no means a "universal" circuit. A circuit arrangement which worked far better in practice is that shown in Fig. 3, which had several interesting points not immediately apparent. For example, the grid return of the high-frequency valve is taken to the positive and not to the negative leg.

Plate-Grid Feed-Back

As the grid thereupon becomes positive, grid current flows and there is considerable damping, so that the scheme might be considered decidedly inferior to that of Fig. 2. Actually, however, it works better.

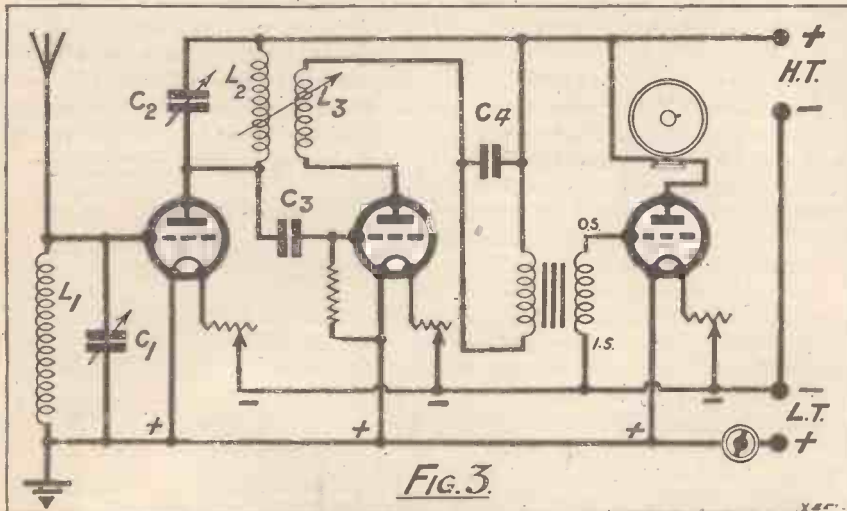

The circuit diagram of the original "All-Concert" receiver.

In the circuit of Fig. 1, by picking a good valve, suitable values of grid leak and condenser, and a properly proportioned reaction coil, very smooth reaction was obtained on a good aerial, and often comparative tests showed very little difference between the results obtained, in expert hands, with Fig. 1a and Fig. 2.

Circuit Fig. 2, with the grid

In the plate circuit we have tuned anode C_2-L_2 , and in the plate of the detector valve a reaction coil L_3 acting on L_2 . The great virtue of this circuit was that it was possible to bring it very smoothly in and out of oscillation by varying the relation of L_3 to L_2 . To understand the circuit, consider C_2-L_2 to be in tune with C_1-L_1 .

Due to the inter-electrode capacity of the valve, there is a reaction effect feeding back energy from the plate to the grid. Owing to the damping in this circuit (both from the aerial and that due to the grid current) there is not enough inter-electrode feed-back to produce oscillation.

Grid Current Damping

If now we bring L_3 towards L_2 we feed back energy from the plate circuit of the detector into this circuit, and reduce the damping in this until C_2-L_2 will oscillate. There will then be still greater feed-back of energy from C_2-L_2 into C_1-L_1 , overcoming almost entirely the additional damping effect of the grid current. In some cases both the circuits C_2-L_2 and C_1-L_1 would oscillate, but frequently only C_2-L_2 would oscillate, and there was no floppiness of reaction.

The idea of connecting the high-frequency grid return to positive in this way originated, I believe, with Mr. Frank Phillips, who was then Chief Engineer of Messrs. Burnham and Company, of Deptford (subsequently Burndep Wireless, Ltd.).

The actual circuit given is that of the original "All-Concert" receiver, of which thousands were made and large numbers are still operating successfully. The difference in practice between the circuits Fig. 2 and Fig. 3 was remarkable, signals being sometimes three times as loud with the latter as with the former (assuming, of course, that a stage of low-frequency was included with each).

The H.F. Transformer

About this time, too, the high-frequency transformer became popular, but the actual transformer used was very different from that of to-day. The circuit was as shown in Fig. 4b or Fig. 4a, according to whether the primary or the secondary winding was tuned. The transformers themselves were small pieces of thick ebonite rod in which deep grooves were cut, primary and secondary windings alternating in the grooves so as to give an extremely tight coupling. The coupling was so tight that it did not make a great deal of difference which winding one tuned.

Personally, I generally favoured tuning the primary. It was not possible to obtain reaction in these transformers themselves and, when

The Whys and Wherefores of H.F. Circuits—continued

wanted, reaction was obtained by breaking the detector plate circuit at the point marked A in Fig. 4a, and connecting a coil so as to react on the aerial. When this was done the grid return of the first valve was often taken to positive for the reasons given in the previously described tuned-anode circuits.

Another high-frequency arrangement which was very satisfactory in pre-neutralising days was that of my original "Transatlantic" Three, in which two stages of high-frequency were used as shown in Fig. 5. Here we have two stages of high-frequency, and actually condensers C_2 and C_3 were ganged, this being the first home-constructor's design ever published with ganged condensers.

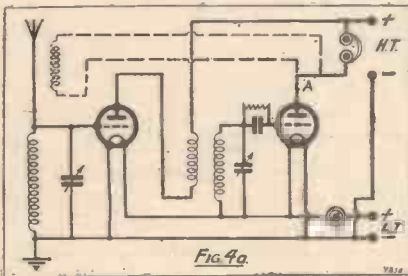

The dotted lines show how reaction can be introduced.

If both high-frequency grids were made negative the set would have oscillated violently. Actually the grid returns of the first and second valves were joined together and taken to a slider on a potentiometer. This was so arranged that when the slider was at one end of its travel the grids were fully positive and at the other fully negative.

Special very low-capacity valves of the tubular type were used in this receiver, thus cutting down the feedback to a very considerable extent, and the results obtained with this set were considered very remarkable in their day, numerous cases being recorded of the reception of transatlantic signals on the 300- to 500-metre band.

Famous "M.W." Sets

There was no attempt at screening, but the fact that the high-frequency transformers were quite small limited field interaction effects quite considerably.

Both the "All-Concert" and the "Transatlantic" Three were published in the first year of our con-

temporary, "Modern Wireless," and both owed much of their vogue to the provision of high-frequency amplification at a time when most receivers built began at the detector.

Soon after this, Professor Hazeltine's inventions, having for their object the balancing out of the capacity feed-back effect in valves, were becoming known, and at the same time valves were improving rapidly in their performance.

The mere fact that valves were improving and giving greater magnification tended to accentuate feedback effects, so that circuits which were quite stable on the older bright-emitter valves with their comparative low efficiency proved hopelessly unstable when the new valves were used. Fig. 6 shows the most popular of the several schemes put forward by Professor Hazeltine, and I might say before we proceed farther that for the remainder of the article I shall illustrate only intervalve coupling, ignoring the aerial circuit, which has no bearing on the subject we are discussing.

Hazeltine's Neutrodyne

Actually the results of Professor Hazeltine's researches and experiments were first published in the spring of 1923, but it was not until the following spring that they really received much attention over here. Prof. Hazeltine worked on the principle that electrostatic coupling behaves like electromagnetic coupling in that it may be reversed in effect, and, in particular, may be reduced to zero.

This is accomplished by balancing one capacity against another. In Fig. 6 the coupling between L_1 (the primary) and L_2 (the secondary) of the high-frequency transformer is

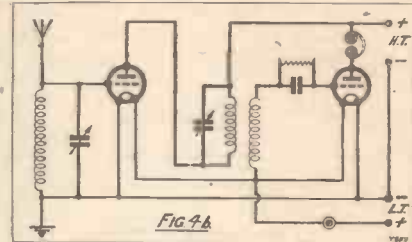

In this instance the H.F.T. primary is tuned.

made quite tight, so that the whole transformer acts very much as if it were a tuned anode. If we consider an anode in the circuit of the first valve tuned to the same frequency as that of the grid, normally the capacity between the plate and grid of the first valve will be sufficient to feedback energy and maintain continuous oscillation.

By taking a tapping on a selected part of the secondary of the transformer, as shown, and joining it to a very tiny condenser (C_2), which is shown connected to the grid, the feedback voltages through the capacity between the plate and the grid of the first valve (shown dotted and marked C_3) can be neutralised or balanced out by applying equal and opposite voltages through the condenser C_2 . For an analogy we can consider the case of swing doors in a bank or office. The doors may be opened easily by pushing from either one

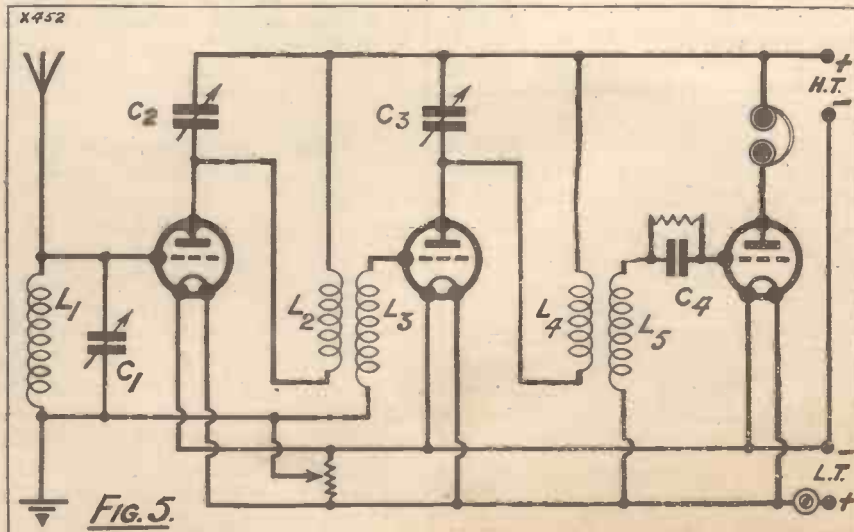

The circuit of another famous set—the "Transatlantic" Three.

The Whys and Wherefores of H.F. Circuits—continued

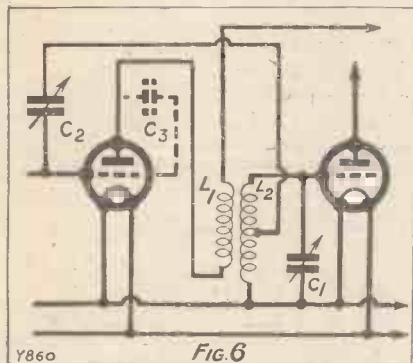

The dotted condenser C_3 indicates the grid-plate capacity.

side or the other, but if simultaneously two men press with equal force, one on each side of the door, the door will remain stationary.

This scheme of Prof. Hazeltine's, of course, would not balance out feed-back effects other than that in the valve itself, and in order that efficient receivers might be built it was necessary to prevent external interaction.

Questions of Screening

This Prof. Hazeltine did by screening (and here it should be said he was the first to outline a proper system of screening in radio-frequency stages), and also by developing a method of placing coils at such an angle to one another that the fields did not apparently interact. Fig. 7a shows how the three coils (aerial transformer, first high-frequency transformer and second high-frequency transformer) in a receiver with two stages of high-frequency were arranged.

By arranging the coils in this manner interaction between fields was reduced to a remarkable extent.

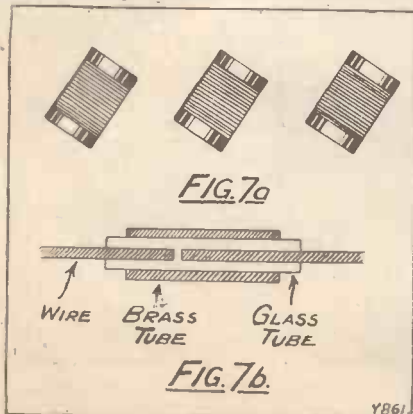

The method of arranging non-coupled coils, and a sectional view of Hazeltine's neutrodyne condenser.

In Fig. 7b a section is shown of a neutralising condenser of the type used by Prof. Hazeltine. In this we have two wires separated by a small gap, a glass tube over them, and, sliding on this glass tube, a brass tube.

"The Curse of Set Design"

When the brass tube slid over one wire and not over the other there was a minimum capacity between the two wires, and when the brass tube was slid equally over both wires, then the capacity was at a maximum, for in effect we had two capacities in series, one from one wire to one-half of the brass tube, and the other from the other half of the brass tube to the second wire. Small as these capacities were they were quite sufficient to neutralise the set, and remarkable improvements in reception were obtained in receivers made up in this fashion.

This particular scheme of neutralising, although highly efficient, never attained any great popularity in this country, mainly because the ordinary forms of plug-in coil could not be adapted to it very readily and the transformers had to be very carefully made to get efficient results.

It was here that we first seriously came up against the curse of set design in this country, i.e. the use of two wave-bands.

Probably nothing has done more to hinder the development in the design of wireless receivers than the use of two distinct wave-bands for broadcast reception in England. Set design would be far easier and the sets themselves far more efficient if we were in the same position as America, with one band only for ordinary broadcast work.

Neutrodyne Tuned-Anode

A scheme which proved to be quite efficient and which lent itself to the use of standard plug-in coils quite effectively was that shown in Fig. 8, and christened the "neutrodyne tuned-anode." Bearing in mind the explanation just given of the Hazeltine circuit using a high-frequency transformer, it will be seen that in this circuit a similar effect (of neutralising the voltage feed-back in the plate-to-grid capacity of the first valve by applying equal and opposite voltages through the neutralising condenser C_1) is obtained.

In each case a phase reversal is needed, being obtained in Fig. 6 by taking the voltage off the secondary of the transformer and in Fig. 8 by using a separate winding. In order that neutralising shall be complete over the whole wave-band, it is necessary, in Fig. 6, that the coupling between primary and secondary shall be very tight (but with a minimum of capacitative coupling), and in Fig. 8 that coupling between L_1 and L_2 be very tight.

On some makes of plug-in coil it was not easy to obtain the necessary tight coupling, and it occurred to me to use the interwoven primary and secondary windings of the then well-known plug-in H.F. transformer

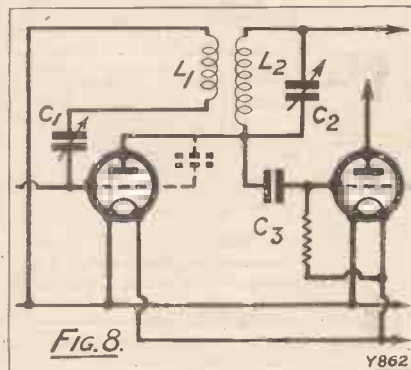

A separate winding (L_1) can be used for phase reversal.

(barrel type) to obtain the effect desired. This proved very successful after the windings had been correctly proportioned, and many thousands of what were then called "neutrodyne transformers" were sold for circuits of this kind.

Binocular Beginnings

Both windings being on the same former, and an ordinary valve socket being used for the four-pin connections, interchangeability of wave range was facilitated in this system.

During an investigation into the wireless conditions in the United States which I undertook in 1925, I was very impressed by the neutralising scheme used in the Grebe Synchronphase receiver. In this the primary winding of a high-frequency transformer was wound with very fine wire, and tightly coupled to a Litzendraht secondary, the primary being tapped in its centre as shown in Fig. 9.

Actually, the coil L_2 was a binocular (it is interesting to note that this name was coined by the

The Whys and Wherefores of H.F. Circuits—continued

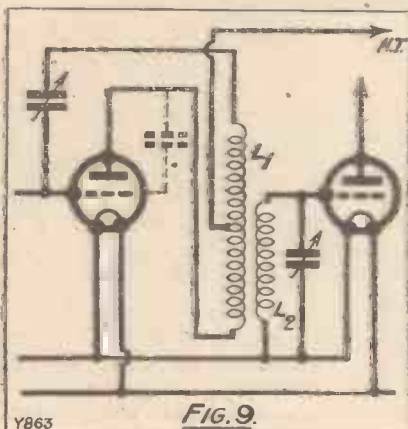

Y863
FIG. 9.
This circuit illustrates the Grebe Synchronphase scheme.

Grebe Company), neutralisation being effected in the usual manner by balancing valve feed-back voltage by equal and opposite voltages through a tiny condenser. This balancing effect is quite easy to understand when we examine the diagram in Fig. 9, for when one end of the coil L_1 is positive, the other end will be negative, and vice versa. This method, too, is covered by one of Hazeltine's patents, although a similar scheme had been invented by Rice.

The Split Secondary

In a subsequent patent action between the Hazeltine Corporation and the Grebe Company, Rice's invention of what we can now term the "split-primary" method of neutralising was quoted, but it was held in the American courts that as described by Rice there was not sufficient data to get efficient results, but that Hazeltine's patents had clearly explained the

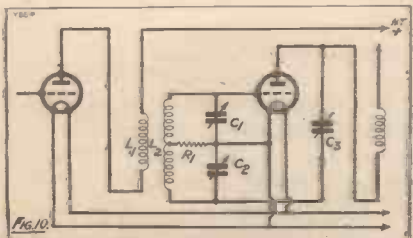

Fig. 10
The split-secondary method which achieved great popularity in the "Elstree" Six.

importance of tight coupling between the two halves of L_1 , and accordingly Hazeltine won the day.

On my return I explained this system, and I think the first set with split-primary neutralising to be described in this country was my

"Special" Five, which appeared in "Modern Wireless" at the end of 1925.

Fig. 10 shows the split-secondary method, which achieved great popularity in the "Elstree" Six, a receiver with three neutralised stages of high-frequency which had a great vogue in the summer of 1926. Here the secondary of the high-frequency transformer was centre-tapped, the necessary tuned circuits being formed by the whole of the coil L_2 and the two condensers, C_1 and C_2 in series.

Parasitic Oscillations

C_3 is the neutralising condenser and any feed-back from the next stage has two equal and opposite paths, through the valve capacity and through the neutralising capacity C_3 . The object of using two variable condensers in series on a common spindle was to enable the moving plates to be at earth potential, and so reduce hand-capacity effects. The resistance R_1 proved to be necessary, as without it parasitic oscillations at a very high-frequency occurred and completely spoiled results.

Fig. 11 shows a simpler method of applying the same principle of split-secondary neutralisation with only one variable condenser. This method is cheaper and gives a greater wavelength range with a given coil and condenser.

About this time separately screened coils were introduced, screens being of circular pattern and earthed. While this cut down coil interaction very considerably—in fact, eliminated it to all intents and purposes—the effect of the metal screen so close to the coil was to introduce quite considerable losses due to eddy currents.

Screening Stages

The scheme is not too bad when the screen is considerably larger than the coil it encloses, but when, as was frequently the case, the coil occupied the major portion of the space inside the box, losses were often quite high. American commercial receivers have used screened coils a good deal, but the coils have been made quite small so as to give wide separation between the coil itself and screening box.

Later American commercial receivers are using large screens enclosing whole stages rather than the coils only, and this is certainly much better than the screen enclosing the

coil alone. Readers will remember that the "Straight Line" Four described in the WIRELESS CONSTRUCTOR, had each stage properly screened in a copper box, and the "Radiano" Four also had the complete stage screened.

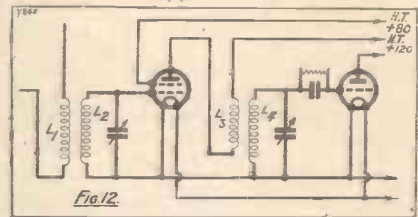

Fig. 12
A screened-grid valve using H.F. transformer coupling.

Recently the standardised vertical metal screen has been popularised, giving very efficient screening with a suitable layout with the additional advantage of greatly simplifying the construction of the set. When very high magnification is obtained with screened-grid valves or with more than one stage of high-frequency, it is often useful to use binocular coils in conjunction with these single screens. (The "Air Commander" adopts this principle very successfully.)

Lastly, of course, we have the popular screened-grid valve, which has been described so recently in these pages that there is no need to go into details here. Fig. 12 shows its use in an ordinary transformer-coupled arrange-

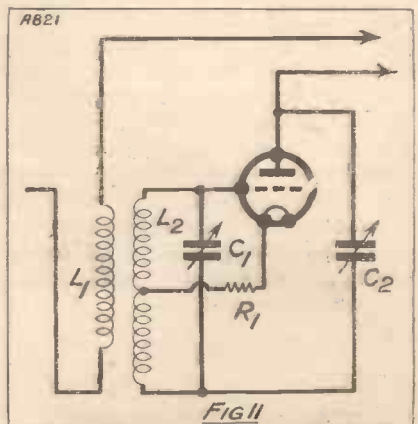

Fig. 11
A simplified split-secondary system.

ment, although greater magnification is obtained (with a sacrifice of selectivity) when using a tuned-anode circuit.

H.F. amplification with screened-grid valves is discussed quite fully in the "Air Commander" article.

RADIOGRAMOPHONICS

A monthly article for the gramophone enthusiast.
 This month the adaptation of the "Radio-Gram" for entertainment purposes is discussed.
 By A. JOHNSON-RANDALL.



ONE of the most general uses of gramophone pick-ups is to provide dance music at private gatherings. It is surprising how many people spoil the effectiveness of the music, however, and simply for the lack of appreciation of some of the more important points of pick-up technique. The information contained in this article will be found useful in connection with ordinary gramoelectrical work as well as for the above.

Obtaining Big Volume

Although the broadcast dance music cannot be depended upon to turn up at the right time, it is as well to provide the means of receiving it. It makes a pleasant change to be able to switch over to some outside broadcast, particularly when some of the more famous dance bands are "on the air."

The chief point that most people overlook is that really large volume must be obtained. It is surprising how loud the average gramophone is, and often the results obtained from the amplifier are not so strong. Actually, if the output from the loud speaker or speakers is not decidedly louder than the gramophone there is not much point in using a pick-up for dancing. In order to avoid accidents and an untidy appearance it is desirable that all the apparatus, including the gramophone, should be put in a separate room. Extension leads are, of course, run to the loud speaker.

Eliminating Hum

An output filter or transformer is necessary for obvious technical reasons, which we need not enter into here. If there are electric mains in the house, as will probably be the case, it is possible that the loud-speaker extension leads will pick up a certain amount of hum. Experiments with these leads in different positions, however, will no doubt enable the hum to be entirely eliminated.

Whether one or two loud speakers are used, a little care in select-

ing their positions is well repaid. This applies more particularly in the case of two speakers. They should be arranged at a height about midway between the floor and the ceiling, and preferably facing out of a corner. In the case of a cone loud speaker, where a large amount of the sound comes out of the back of the speaker, do not put it right into the corner.

The question of whether both the speakers should be at the same end of the room or at opposite ones must be decided in each individual case. A little experimenting will soon enable you to choose the positions that give the most pleasing effect.

If you are going to use two loud speakers, these should be of identical type if possible. If this cannot be arranged, try and have the same resistance. In either case it is best to try them connected in series and also in parallel, to ascertain which scheme gives the louder results.

Now, to turn to the set itself. It is

advisable to have two proper L.F. stages, that is to say, two L.F. valves apart from the one which immediately follows the pick-up. A good super-power valve is, of course, an absolute necessity, as is also ample H.T. to run it. Without these last two requisites it is absolutely impossible to get satisfactory results, and unless they can be provided there is no point in considering a radio-gramophone dance. It is a point that is very often overlooked, that a room full of people (particularly when some are dancing) takes a lot more volume to fill than an empty one.

Switching Over

Some scheme by which it is possible quickly to change from the pick-up to the broadcasting is desirable. Either a change-over switch or a plug and jack will answer the purpose admirably. Do not leave anything to chance. Have everything

(Continued on page 462.)



This is the Webster Electrical Pick-up, an American production sold in this country at £4 4s. The device incorporates a volume control.

MAKING MOVING COILS

An article that tells the constructor how to decide upon the number of turns and gauge of wire to ensure the maximum volume and best quality.

By L. E. T. BRANCH, B.Sc.

IT is often not realised that to obtain a fairly even response over the whole range of the pianoforte it is absolutely necessary to wind the moving coil to suit the output stage of the receiver. If, for example, the coil has too many turns, there will be a greater output in the middle frequencies and a suppressed output at the high and also at the low frequencies, although the effect is not usually so great at the low frequencies as at the high. If the coil has, on the other hand, too few turns, its response will be at least as even, but the output will be considerably reduced over the whole range.

We see, therefore, that too few turns mean a feeble output, while too many turns mean poor quality. Now the coil is, of course, being driven by the current that is passing through it from the valve or valves in the last stage, and the coil, like any other coil, resists the passage of the current due to its impedance and also its D.C. resistance. The output valve also has its impedance, which likewise resists the current.

Obtaining Uniform Volume

Now it is clear that if we wish the volume put out by the coil to be approximately the same at all frequencies (assuming equal inputs to the grid of the last valve), then the currents at all frequencies must be very nearly the same. This state of affairs cannot be attained if the coil and valve together resist the current appreciably more at one frequency than at another.

Therefore it is desirable to see that the electrical sum of the valve impedance and coil impedance does not vary too much for different frequencies. The condenser in a choke filter output is usually so large comparatively (2 mfd. or more) that its resistance is negligible at all frequencies, and need therefore not be taken into account.

Now the ear is relatively so insensitive to differences of volume that it is found that by making our coil

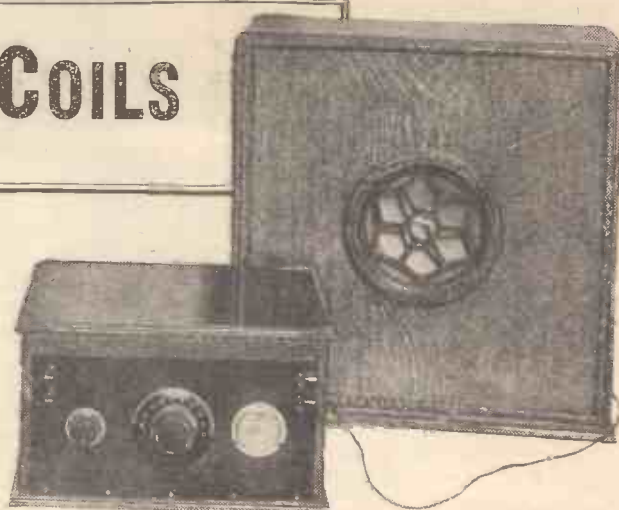

so that the current does not vary more than about 25 per cent at different frequencies for the same input to the grid of the last valve, the effect is indistinguishable aurally from the ideal case where the current is the same at all frequencies. We have to take advantage of this fact for the following reason. On the high notes the coil resists the current because of the inductance of the coil, and this inductance is increased if the number of turns is increased. On the low notes the coil resists the current chiefly because of what is called its motional capacity.

Current Generated By Coil

This is due to the movement of the coil being relatively great (about one-twentieth of an inch for realistic volume) on the lowest notes as compared with a movement of less than a thousandth of an inch on the highest notes. The greater movement on the

low notes causes the coil to generate a current, just as the armature of a dynamo generates a current when it moves.

This current generated by the coil is in the reverse direction to the current flowing through the coil from the valve, so that it opposes this latter. For example, a coil of 1,000 turns in a strong magnetic field moves sufficiently at a frequency of 50 cycles that the opposing current generated has a similar resisting power on the real current produced by the valve that it is equivalent to a resistance of 4,000 ohms in series with the coil.

At the middle frequencies, i.e. round about an octave above middle C, electrical resonance occurs and then the resistance of the coil is purely its D.C. resistance; in the case of a 1,000-turn coil of diameter 2 in., wound with No. 46 S.W.G., the D.C. resistance is 1,000 ohms. At the higher frequencies the resistance of the coil increases, due to its impedance, which at about 4,000 cycles (one of the top notes on the piano) becomes 4,000 ohms.

A Very Good Combination

Such a coil of 1,000 turns is usually used with an output valve of about 3,500 ohms impedance (e.g. P.M.254 or P.M.256). The total resistance of the valve and coil is then the electrical sum of the valve impedance, the D.C. resistance of the coil (1,000 ohms), and the equivalent resistance of the coil (4,000 ohms) due to its motional capacity as explained above.

This electrical sum is considerably less than their actual sum obtained by simple addition and comes to 6,000 ohms. With rise of frequency this resistance falls until at about an octave above middle C it is simply the ordinary total obtained by adding



A typical moving-coil loud speaker. The unit, shown in the foreground, fits behind the large baffle board.

Making Moving Coils—continued

together the valve impedance and the D.C. resistance of the coil, i.e. $3,500 + 1,000 = 4,500$ ohms.

With further rise of frequency the resistance is increased until at 4,000 cycles the electrical sum is again 6,000 ohms. For those who like to see results expressed in curves this is illustrated in Fig. 1.

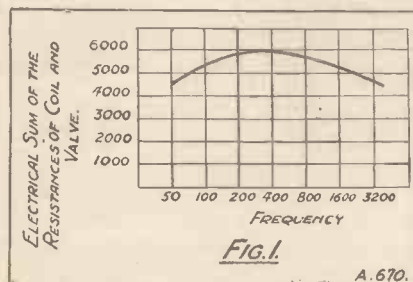

Hence it is clear that over the range of the pianoforte the total resistance does not vary more than 1,500 ohms, i.e. 25 per cent of 6,000, which shows that the combination of the 1,000-turn coil with a P.M.254 or P.M.256, or valve of the same impedance, is a very good combination.

Suppose we were now to place two such valves in parallel in the last stage, then their combined impedance is halved and becomes 1,750 ohms. This will cause the total resistance to be lowered at all frequencies, and therefore more current will pass through the coil, which will then give a greater volume output.

Unfortunately, the increase in the current will be relatively greater at the middle frequencies, which is, of course, undesirable. To get over this the coil should now be wound with 720 turns of No. 45 S.W.G. wire, when the resulting increase in power output will be the same for all frequencies instead of being greatest on the middle frequencies.

Step-Down Transformers

Similarly for three valves in parallel the coil should consist of a still less number of turns. The same thing will also apply if a single valve of very low impedance, such as a Marconi P.625A (impedance 1,600 ohms), is used. If a step-down transformer is employed, then the effective valve impedance is again lowered, so that here also a coil of less turns should be used. It should be noted that to gain the full benefit when decreasing the number of turns the thickness of the wire should be increased proportionally.

With a step-down transformer the effect on the number of turns is very considerable indeed. For instance, the effective valve impedance of a P.M.256 used with a 15:1 step-down transformer is obtained by dividing the impedance of the P.M.256 by 15^2 , i.e. we obtain $\frac{3,500}{15^2} = 15.5$ ohms.

The coil then should consist of 66 turns of No. 34 S.W.G.

If the step-down ratio is 25:1 the effective impedance is lowered still further and becomes

$$\frac{3,500}{25^2} = 5.6 \text{ ohms.}$$

The coil should then consist of 38 turns of No. 30 S.W.G. All these figures refer only to a coil of 2 in. diameter. Since the characteristics

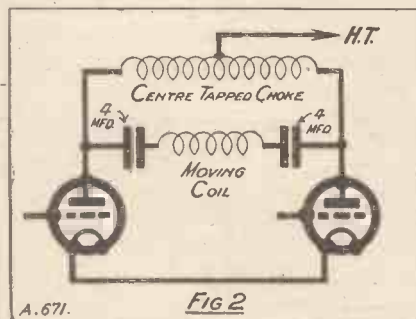

of the coil depend on the total length of wire in the coil, it will be clear that for a coil of 1 in. diameter the number of turns should be double that for a 2-in. coil of like characteristics.

Using the Table

To enable the constructor to find quickly and easily the correct number of turns and gauge of wire for any coil to suit his particular requirements we have compiled the accompanying table, which is used in the following way:

First it is necessary to find the impedance of the output stage. If only one valve is being used, then the impedance is simply that given by the makers. If two valves are used in parallel the effect is to halve the value of the impedance, and if three valves are used in parallel the combination has one-third the impedance of one of the valves.

For example, three Marconi P.625A valves will have a combined impedance of

$$\frac{1,600}{3} = 533 \text{ ohms.}$$

If two similar valves are used in push-pull employing a centre-tapped choke output as illustrated in Fig. 2, then the two valve impedances are in series and the combination will have an impedance of double the value of the impedance of one valve.

If a push-pull output transformer is being used instead of a centre-

(Continued on page 460.)

WINDING DETAILS OF MOVING COILS

A	No. of turns for coil of 1 in. diameter	Gauge of wire S.W.G.	A	No. of turns for coil of 1 in. diameter	Gauge of wire S.W.G.
7500	3100	47	25	168	35
5500	2500		22	156	
3500	2000	46	18	140	34
2700	1760		16	132	
2000	1520	45	13	120	33
1550	1340		11	110	
1100	1120	44	9.3	100	32
900	1020		8.2	94	
680	880	43	7.2	88	31
570	820		6.3	82	
450	720	42	5.5	76	30
380	670		4.8	73	
300	600	41	4.2	70	29
250	545		3.7	65	
200	490	40	3.3	60	28
170	450		2.8	54	
140	400	39	2.4	48	27
115	370		2.0	43	
90	320	38	1.6	38	26
72	285		1.3	34	
55	260	37	1.0	30	25
45	230				
35	200	36			
30	184				



HAPPENINGS AT SAVOY HILL

By OUR SPECIAL COMMISSIONER



More Proms. to be Broadcast
LISTENERS will be glad to hear that the B.B.C. has decided to put on the air a much more liberal dose of the Prom. programmes than either last year or the year before. I understand that London will have as many as three a week.

There are various reasons for this change. For one thing there was considerable complaint last year because of the alleged paucity of relays from the Queen's Hall. For another thing, the B.B.C. is much more confident than it was of filling the Hall without starving the microphone. A third reason is, that by taking nearly 50 per cent of its main programmes from the Queen's Hall, during the height of the summer, the B.B.C. will be able to deal more expeditiously and easily with the problem of holidays for the staff. By the way, Sir Henry Wood is extremely pleased with the generous way in which the B.B.C. has encouraged and supported him in his endeavour to make his 35th consecutive season a "record" one.

Information Wanted

It was only natural during the controversy about "The Listener" for the newspapers to attempt to find all the weak points in the armour of the B.B.C. One of these, perhaps the most popular in the more active press, was the secrecy maintained by the B.B.C. concerning the details of its expenditure, particularly those dealing with salaries.

All that was known was that five Governors between them absorbed about £6,000. But no amount of agitation could induce the B.B.C. to give the details which the newspapers sought. I happen to know a good deal about these details from contact with individual members of the staff at Savoy Hill. I can quite understand the secrecy. No institution will publish any more details about itself than it has to, for the obvious reason that all detail can be misrepresented, and, in the case of the B.B.C., would certainly be misrepresented.

Nevertheless, I have satisfied myself on this point that the real fault, so far as there is one, is in the lowness of the salaries of all ranks. B.B.C. officials are remunerated at about two-thirds what they would get for similar services under commercial conditions. To make an intelligent guess, I would say that Departmental Chiefs get a good deal less than £2,000, and that other ranks are paid correspondingly.

Lord Clarendon's Activities

A pleasing feature of B.B.C. work in the early part of 1929 has been the public activity of the Earl of Clarendon, the Chairman. For the first two years of his tenure of office he made no public appearance and there was no sign that he or his colleagues did anything at all.

Since the New Year, however, Lord Clarendon has been speaking in public both in the House of Lords and outside. His utterances on broadcasting have been so weighty and opportune that no one can now say that he knows nothing about his

job. It only remains for Lord Gainford and Mrs. Philip Snowden to follow their Chairman on to the platform. Activity of this kind not only reassures listeners, but should be of real help to the over-burdened staff at Savoy Hill.

The Profession of Announcing

I am not sure that the B.B.C. has as yet recognised as it should do the status and importance of that devoted group of workers—the Announcers. They are the nucleus of a profession in the making. They are the practical interpreters and go-betweens of the broadcasting service.

In London the Chief Announcers are four in number. The Senior is Mr. Hibberd, who takes infinite pains with his voice and whose expression of simple sincerity has given him a unique and merited ascendancy in this new profession. Rex. Palmer, the famous baritone, vies with Hibberd for the popularity palm. An old-timer of broadcasting, he has a host of friends all over the country. Several approaches have been made

GIANT GERMAN GENERATORS

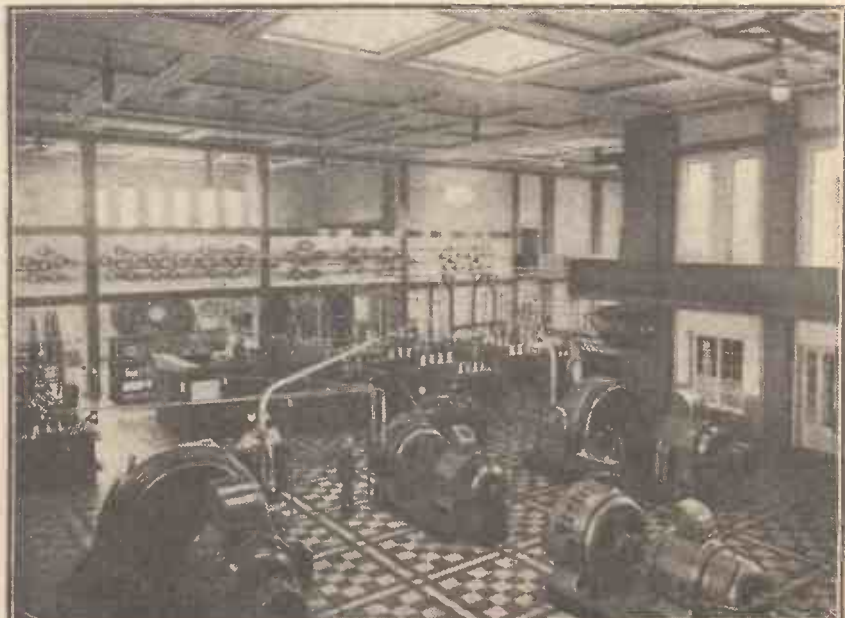

Some of the generators at the huge Nauen station, which dissipates 100 kw. in the aerial.

Happenings at Savoy Hill—continued

to him to take up announcing in America.

Eric Dunstan, fresh back from his adventures in India, earns his title "of the golden voice." He is superb in his own way. Then there is David Tennant, exponent of the Oxford manner, tempered and softened by much study and surpassing natural qualities. Hermione Baddeley's husband absorbs Greek philosophy in the mornings, announces all afternoon and evening, and then manages the Gargoyle all night. Moreover, he does every job well.

Having been driven from the roads by the insistence of those who disbelieve in mixing racing with motoring, he now takes the air with great success. Altogether as varied and capable a group of Announcers as one would find anywhere in the world at any time. They don't complain, but I have a shrewd suspicion that Savoy Hill might do a

to lecture in Montreal, Winnipeg, Edmonton, Calgary, Victoria and Vancouver. The accounts of these addresses appearing in the newspapers are exceedingly flattering both to Mr. Stobart and to the B.B.C.

Apparently, this Missionary of British methods has helped a lot in convincing Canadians that they should look across the Atlantic for the model of the new system of national broadcasting which they are to evolve next year.

B.B.C. and the Trade

The terrific strain of the relations between the trade and the B.B.C. early in the year has been somewhat relieved. For one thing, the B.B.C. has cased up on its plans for the immediate active encouragement of organised re-diffusion. Apparently all that is being done officially is a tentative experiment at Norwich.

Re-diffusion, of course, is the ex-

More Power for B.B.C. Stations

The obvious success of increased power on the Continent has made the B.B.C. engineers "furiously to think." Even after the introduction of the Brussels plan, hardly a British station is entirely free from heterodyne. The new plan, therefore, is to try to get authority from the Post Office to double the power of all main stations as well as of Daventry. It is believed that if this comes about conditions of reception throughout the country will be vastly improved.

Television

I believe that experimental transmissions of television will be given shortly outside programme hours. Politically, television has had a hard struggle to get on anything like even terms with Fultograph, but they are now running neck and neck. Hence the abnormal peace that prevails between the B.B.C. and the Baird Company.

A NOTED SWISS STATION



The main control panel of the Marconi transmitter employed at the Lausanne broadcasting station. It operates on 680 metres from 8 p.m. onwards.

good deal more than it does for these fellows.

B.B.C. Missionary in Canada

Mr. J. C. Stobart, the urbane Director of Education of the B.B.C., is now in Canada attending an Imperial Education Conference. He has taken advantage of the opportunity

pression which the B.B.C. and the Post Office use when they refer to local wireless exchanges by land-line carrying signals to householders from a master-set centrally located. One aspect of this problem which now claims the attention of the Government is the possibility of political misuse in times of emergency.

* **SHORT-WAVERS IN** *
* **INDIA** *

THE EDITOR,

SIR,—I beg to give you this information regarding the report of some of the short-wave telephony stations.

The 5 SW (Chelmsford, England) was received here in good loud-speaker strength, like a local station, their speech and announcement were as clear as possible. The ANE (Java), ANH (Java), 3 LO (Melbourne, Australia), 2 ME (Sydney, Australia), 6 AG (Perth, West Australia), PCLL (Kootwyk, Holland), 7 LO (Kenya Colony), FOA 7 L (Johannesburg), all these stations were received here in good loud-speaker strength.

The American stations 2 X A D, 2 X A F and 2 X G are good headphone strength; PCJJ (Holland), good headphone strength.

The French station LL, and YR (Rome) were received here in good headphone strength. I am now using the Circuit No. 6 which was stated in your 31 Tested Circuits' book. This is the report of your short-wave circuit. Remain for your earliest reply.

Yours faithfully,
M. M.

Calcutta.

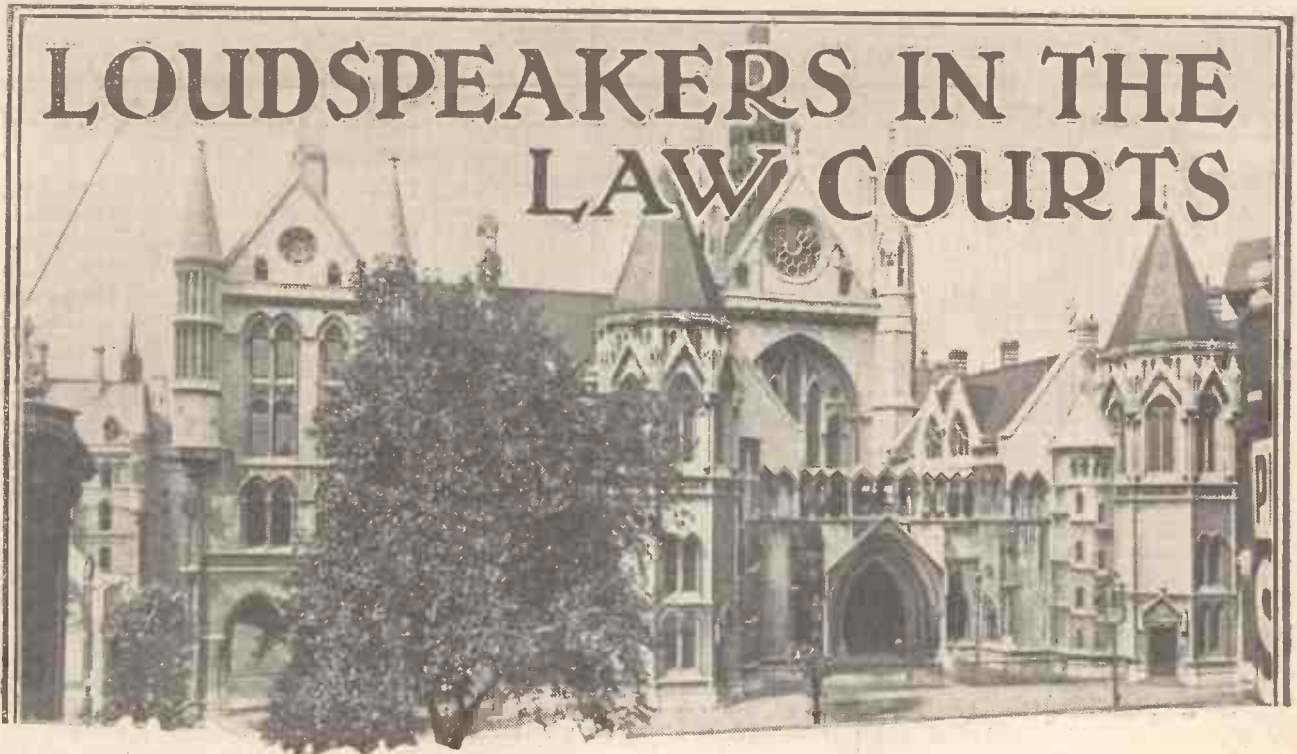

By a Special Correspondent.

WIDESPREAD interest has been aroused in wireless circles generally as the result of recent litigation between the Lektophone Corporation of Jersey City, U.S.A., and Messrs. S. G. Brown, Ltd., to decide the question of patent royalties payable on the use of cone loud speakers.

The Lektophone Corporation, as legal owners of patent No. 16,602, of 1914 (issued to Marcus Clarence Hopkins), sued Messrs. S. G. Brown, Ltd., the well-known wireless manufacturers, for infringement in respect of the sale of the Mascot loud speaker during the Radio Exhibition held in Olympia last September.

Dr. Eccles' Evidence

Plaintiffs claimed that their Hopkins patent covered any sound-reproducing machine using a large conical diaphragm freely exposed to the air and having an annular portion rigidly supported around its outer edges.

The Defendants (Messrs. Brown) denied infringement, and counter-claimed for revocation of the patent on the ground that it was invalid for lack of novelty, subject-matter and sufficiency of description.

Dr. W. H. Eccles, F.R.S., President of the Physical Society, and past President of the Institution of Electrical Engineers, was the principal witness for the Plaintiffs. The import-

ance attached to the action may be estimated from the fact that Dr. Eccles was in the box for five days.

He said that small discs had previously been used in combination

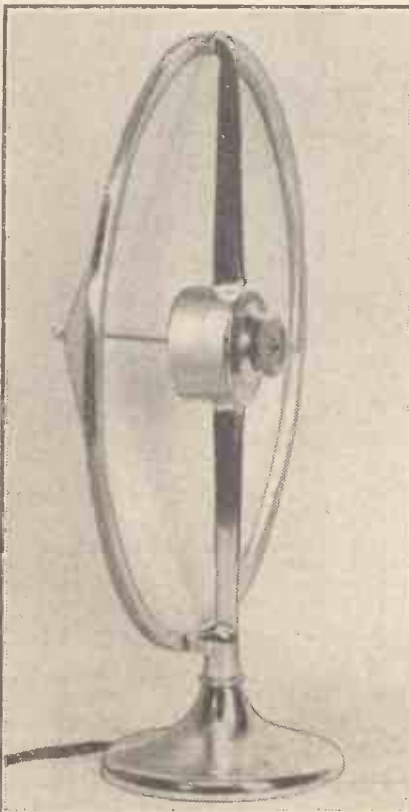

No horn need be employed where the loud-speaker's diaphragm is really large.

with a horn for reproducing sounds. A small disc without a horn would not respond efficiently to low notes. In such circumstances, as it vibrated to and fro, the air could move easily from back to front and from front to back.

This led to the formation of air currents or eddies and represented so much waste of useful energy. By adding a horn the energy was concentrated and spread gradually outwards along the sides of the horn until it reached the open end, where it entered the air and was radiated without perceptible loss.

Common Knowledge

There had been a good deal of investigation as to which was the best form in which to make the horn. Exponential or "compound interest" horns were a favoured type at the present time.

The principal object of the Hopkins patent was to make a sound reproducer that would operate without a horn and yet give a large volume of sound as faithfully as possible throughout the entire musical range.

Asked how long it had been common knowledge that if no horn were used it was necessary to employ a larger diaphragm, Dr. Eccles said: "I don't know that it has been common knowledge at any stage."

"Is it common knowledge now?"—"Yes, since the development of the cone loud speaker."

Loudspeakers in the Law Courts—*continued*

"When do you place the coming in of the cone loud speaker?"—"With the introduction of Hopkins' invention."

"Was it not perfectly well known that in order to avoid local vibrations and to get movement as a whole the diaphragm must be made stiff?"—

"It would be well known that to make the diaphragm move as a whole it must be made stiff."

"The device of getting stiffness by 'coning' has been suggested by a great many other people?"—"It has been used by many people."

Licenses and Sales

The Assistant Secretary of Standard Telephones and Cables, Ltd., giving evidence, stated that his Company had made an arrangement with the Plaintiff Corporation for mutual dealing with patents. The Standard Telephones & Cables, Ltd., granted licences under certain patents jointly with the Lektophone Corporation.

Case for the Defence

In presenting the case for the Defendants, Counsel said that it had been suggested that Hopkins' patent had had a great commercial vogue. In fact, the patent was first dug up in this country about 1927 and had never been heard of before here.

A large diaphragm was practically useless unless employed in combination with thermionic valve amplifiers capable of feeding it with considerable power. The demand for a large disc or cone loud speaker only arose after the introduction of broadcasting.

He submitted that the Hopkins' patent merely applied to sound-reproducing machines of the gramophone type, where the operating impulses were derived from a stylus or needle following the grooves of a record. There were many material differences between such a machine and the modern loud speaker as used for broadcast reception.

9-in. diaphragm was not a critical size for loud-speaker coils, nor was there any suggestion that Hopkins selected a particularly fine form of cone which gave out a particularly fine sound.

In short, the Hopkins' specification did not disclose any profound acoustical knowledge. On the contrary, it merely set out a very precise form of construction which, he submitted, was shown by the evidence to be old.

Professor Swinburne on Broadcasting

Prof. J. Swinburne, F.R.S., giving evidence for the Defendant Company, said that the term "loud speaker" only came into use since the introduction of the thermionic valve, which provided for the application of considerable energy from a local battery.

He thought that neither in gramophone nor in wireless reproduction were the high notes obtained properly even now. The whole of the transmission was distorted. The trouble began when the sound first entered the microphone, so that the blame was not always with the loud speaker.

For instance, the people at the broadcasting studios played all sorts of tricks. If a note was in the double bass and they thought it would not come out well enough, they made it an octave higher, and all that sort of thing.

In his view there was no novelty in what Hopkins claimed, viz., design, the use of a large diaphragm, and the elimination of the horn.

Judgment

In giving his considered judgment, Mr. Justice Tomlin held that the Hopkins' invention had been intended for use with a gramophone or similar stylus machine in which the sound vibrations were derived from a grooved record, and was not designed to be operated by the comparatively large power input derived from a valve amplifier as in modern broadcast reception.

He found that the Mascot loud speaker as sold by Messrs. Brown did not in fact infringe the Hopkins' patent. Judgment would accordingly be given for the Defendants on the main issue of infringement.

At the same time, he did not consider that the counter-claim for a revocation of the patent had been justified.

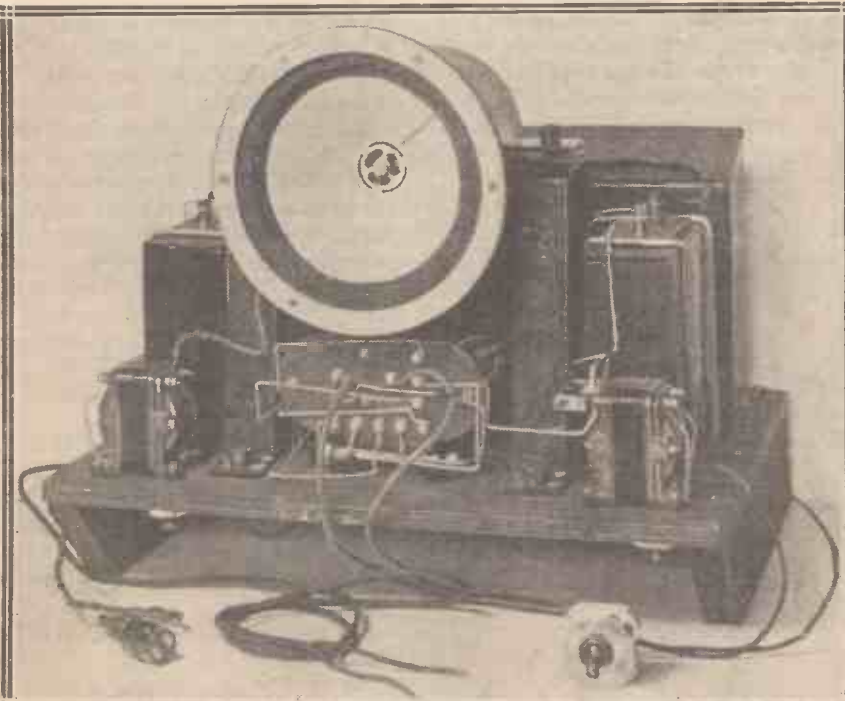

The Rice-Kellogg moving-coil loud speaker, showing the complete mains-driven amplifier with which it is fitted. The cone diaphragm is of what is referred to as the semi-free-edged diaphragm. However, legally, no doubt, it is "clamped."

He gave the following figures as to sales by licensees: Graham Amplion Co., for 1927, 43,108; for nine months in 1928, 26,342. General Electric Co., for 1927, 5,450; for nine months in 1928, 7,866. Celestion Company, from July, 1927, to July, 1928, 9,432.

In his view the Hopkins' diaphragm had absolutely no basis to support the patent grant.

The use of diaphragms with a clamped edge was common knowledge. Practically all telephone instruments were constructed in this way—apart from the Brown reed type. Again, a



In Lighter By Wireless Wayfarer. Vein



"AND what," cooed Miss Worple, "are your feelings as spring approaches, Mr. Wayfarer?"

I am very strongly of opinion that no sudden questions should be allowed at tea-fights held before March, coming in like a lion, has gone out like a lamb. What I mean is that you really can enjoy muffins in March, if you follow me.

On this occasion both Goshburton Crump and I had observed that there was only half a one left, and each of us observed the other observing it. Naturally the piece in hand had to become at once the piece in mouth. Just at that moment Miss Worple turned to me and uttered her question.

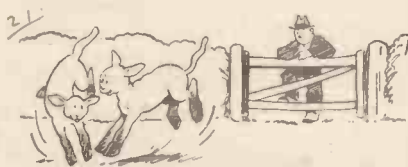

... Lambs made me think of mint sauce ...

"Mmmwoomph," I said.
"Bang him on the back," cried Miss Worple.

Captain Bucket sprang to the rescue, as did Primpleson, Tootle, and Sir K. N. Pepper. That stinker Goshburton Crump waited until he had secured the last bit of muffin before doing so. Now being patted on the back is all very well; I don't mind being smacked on the back; I can endure being thumbed on the back; but when it comes to being positively steam-hammered the thing gets rather beyond a joke.

Rough Treatment

Next time I go to a tea-party in the muffin season I shall wear a chain-mail waistcoat which, as a rule, I reserve for my visits to Chicago. If I hadn't had the presence of mind to duck my head suddenly into Goshburton Crump's waistcoat I should probably have been pounded into a jelly. As it was I was able in the neatest way to transfer the final piece of muffin from his plate to mine

whilst the others were engaged in rendering first-aid to him.

"I think," I said, when all was calm once more, "that you were asking me a question, Miss Worple, when that little attack of croup, a disease to which I am a perfect martyr, came upon me."

"I was inquiring," trilled our hostess, "what precisely were your reactions to the coming of the glad spring."

Coupling Too Tight

"My reaction coupling," I returned, "has to be tightened so much to overcome the damping introduced both literally and metaphorically by this dreary season that I invariably howl. It has perhaps never occurred to you that all the poems upon spring are written months before the advent of this grossly overrated time of year.

"About September, though still feeling quite gay, poets begin to think, 'Well, if I don't bustle round pretty soon I shall be too late for the spring numbers.' They get thoroughly into their stride in November when the fogs are on, and on the principle that nothing could be much worse than the present conditions, they write all sorts of sloppy stuff about lambkins and birdikins and things."

"Consolations"

"But," inquired Miss Worple, "the very thought of lambs inspires you."
I agreed that they did. It made me think of mint sauce.

"Similarly," I went on, "birds to an ardent Belmanist, of course, suggested song; and song suggested quacking, and quacking suggested ducks, and ducks suggested green peas. Those, in fact, were the only consolations that one had in spring time."

"Consolations?"
"Consolations??"
"Consolations???"
"CONSOLATIONS EGAD?????"
(Sir K. N. Pepper was getting a little worked up.)

"Well," I said, "if you really come

down to brass tacks you know well enough what the beastly season means. Everybody has a cold, nobody has any money, and all decent wireless men are thinking of the horrors of the summer that is drawing on."

"Rot!" roared Sir K. N. Pepper.
"What's here?" I murmured, "A portrait of a blinking idiot."

Sir K. N. positively boiled over. What the blinkity blue blank blazes did I mean by using such an expression.

I explained that I was merely quoting Shakespeare, one of the most indefatigable of the spring poets. They refused to believe me.

Shakespeare's Radio

Striding across to the bookcase, I seized the *Merchant of Venice* and turned to Act II, Scene VIII, where you, dear reader, may find it for yourself if (a) you possess a Shakespeare and (b) you are not too jolly lazy to turn it up. Ah, me, if ever a man lived before his time 'twas Shakespeare.

He knew all about wireless, as you may see if you will look (though you probably won't) through *The Tempest*. There you may see how Prospero produced music in distant places by means of his Ariel. Can 2 L O do more to-day?

When the tumult had died down a



... "Eureka!" he cried.

little I looked them over and inquired: "What heinpen homespuns have we swaggering here?" I proved to them that this was merely a quotation from *A Midsummer Night's Dream*, and after that I could say practically anything because no one liked to display ignorance by even venturing to doubt that it came from Shakespeare. I had just called them

In Lighter Vein—continued

all—that is, all the male members of the party—wall-eyed, bandy-legged, lop-eared sons of sea cooks, telling them that this was a quotation from *Love's Labour Lost*, when the door entered and Professor Goop opened.

"Eureka!" he cried.

"You're another," hissed Tootle, who is not very good at repartee.

The rest of us, understanding French, realised that the professor had something on his mind. We were the more convinced of it when we saw that he had dressed so hastily that he had thrust his legs through the arms of his coat and his arms into the tubular portions of a pair of trousers.

"Why these infernal tailors never can fit me," he grated, "but always get my sleeves too long and my trouser-legs too short, I never can think! And I simply refuse to wear coats that button up the back."

Seeing that he was full of great news, we panted out a request to hear his message.

Cycles and Hertz

"The B.B.C.," snarled the professor, "has long been renowned for making straight the path of the broadcast listener."

"Yes, yes," we breathed in chorus.

"As soon as he had got decently accustomed to the intricacies of wave-lengths they made things easier for him by telling him that he was all wrong, and started him upon frequencies."

"Quite."

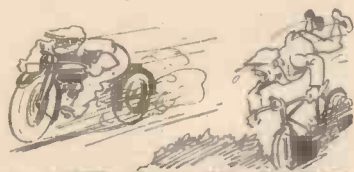

... the motor-cycle was brought out to oust the push-bike ...

"Perfectly."

"Exactly."

"Just so."

"Precisely."

"Mmph!" (This was from Gosh-burton Crump, who had just discovered the chocolate cake.)

"They got the poor B.C.L. just nicely settled down to kilocycles when what did they do?"

Everyone raised his eyebrows or spread out his hands, or wagged his ears, or made other appropriate

gestures to show that he gave it up.

"They flung at him the kilohertz. You see, they said, it is all so beautifully easy. You have been accustomed to wave-lengths that work upwards from two hundred at the bottom of the band to round about six hundred at the top. Kilocycles are just as simple if only you have the nous to remember that they are inside-out.

Upside Down

"We mean that it is a straightforward matter, by standing on our head or writing from right to left, and from the bottom of the graph chart to the top, to realise that there is not an increase but a decrease as you go upwards. In fact, the higher you go, the fewer. You will see, after a moment's thought, that it is precisely the same thing, only just the opposite."

We agreed.

"Well, this being so, the time was obviously ripe for the introduction of the kilohertz in order to kill the kilocycle, just as the motor-cycle was brought in to oust the push-cycle. Progress, my friends; always progress."

"And what," we asked, "may a kilohertz be?"

The professor told us that it was a thousand hertz.

We couldn't help thinking that it was really a thousand pities.

Anyhow, he told us that Hertz was the first practical oscillator, after which he saw at once that it was only right that he should be commemorated.

"But what," I asked, "is the discovery with which you are obviously bursting, professor?"

"The original Plan de Genève was succeeded by the still more original Plan de Bruxelles. You will observe that I do not say Geneva or Brussels, for we have it on the highest authority that it is incorrect to pronounce any foreign place-name in such a way that the average Englishman may recognise it.

The "Kilogoop"

"Now the whole basis of the second of these plans was that every station should be able to heterodyne its next-door neighbours, and be heterodyned by them. The plan, however, is not completely successful, for, despite all efforts, there still remain one or two obscure stations here and there

that are unprovided with heterodynes."

I asked what remedy he proposed.

"I am about," said the professor, "to introduce the Plan de Mudbury Wallow, which will solve all difficulties. Kilocycles and kilohertz disappear. Their place is taken by the kilogoop. Every station is, of course, provided with a specially calibrated kilogometer.



... I have devised a special receiver for them ...

"Under my scheme, the broadcast band will be entirely clear for C.W. and spark signals which have hitherto been most unfairly elbowed out by broadcasting. Further, the need for selective and sensitive sets will entirely disappear, and the man with the simplest apparatus will be on an equal footing with the purse-proud aristocrat."

We asked him for further details of this wonderful scheme.

The unit of separation between stations, he told us, would be exactly one kilogoop, which might be described simply as the square root of the cube of the frequency divided by the reciprocal of the licence fee receipts. In this way, he explained, the separation between stations is so minute that all are working on practically the same wave-length.

The Topical Talks

This will, of course, eliminate all heterodyning, whilst the jamming problem will be solved by getting stations to send by parcels post each day to their subscribers gramophone records containing their programmes.

"And will the topical talks come on records, too?" I inquired.

"Certainly," answered the professor. "And I have already devised a special receiver for them. It consists simply of a coke-hammer and a neat portable anvil."

SPECIAL DOUBLE NUMBER
MARCH
MODERN WIRELESS
Now on Sale. Price 1/6

A CONDENSER THAT will give you STRONGER SIGNALS

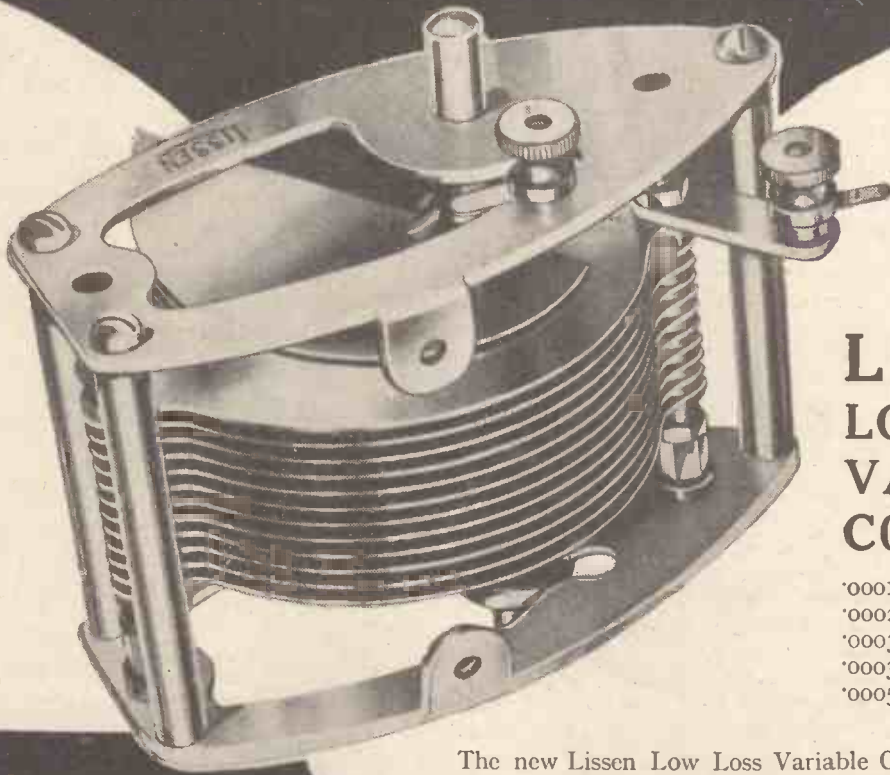

LISSEN LOW-LOSS VARIABLE CONDENSER

'0001 mfd. capacity	5/9
'0002 " " "	6/-
'0003 " " "	6/-
'00035 " " "	6/3
'0005 " " "	6/6

LISSEN REACTION CONDENSER

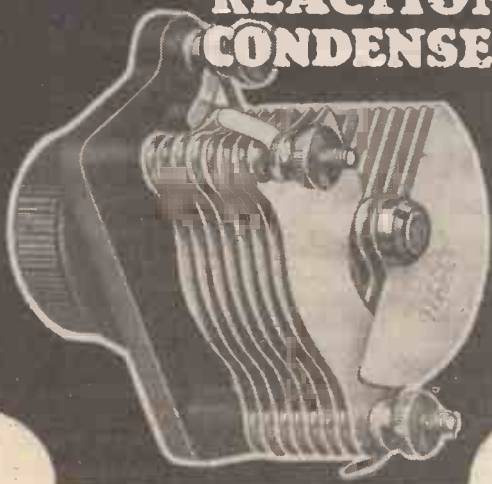

The new Lissen Low Loss Variable Condenser gives you stronger signals because there are no condenser losses. It gives you free and facile tuning, easy and definite separation of stations, even when they are close together.

Notice the unshakeable rigidity of its construction, the long bearing, the absence of end pressure or distortion of the vanes. The spindle is extended for ganging purposes, feet are provided for baseboard mounting, or you can mount it on the panel with standard one-hole fixing. Notice, too, the new and convenient position of the fixed vane terminal, well away from any danger of accidental contact with the moving vanes.

Compare it with any other condenser at any price at all—you will say it justifies everything that Lissen claims for it.

LISSEN REACTION CONDENSER

Embodies many of the exclusive features of the big Lissen Condenser, including no end pressure on any end plate to distort frames or vanes. "A" Type **4/-**
"B" TYPE, with insulated bushes for mounting on panel. Price 4/6

LISSEN LIMITED, 26 - 30, Friars Lane, Richmond, Surrey

(Managing Director: Thos. N. Cole).



Make certain
of your set's success
—build it with
Lotus Components

Every Lotus Component you use is to be depended upon as a sound, well-constructed unit, for it has been made from the best available materials and by careful British workmen, and has been examined and tested thoroughly before it comes to you. Your usual dealer sells Lotus Components.

Lotus Buoyancy Valve Holders, Anti-Microphonic, 1/3; Lotus Variable Condensers from 5/-; Lotus Vernier Dial, 4/9; Lotus Drum Dials, Remote Controls, Jacks, Switches, Plugs, &c.



LOTUS
COMPONENTS

*Lotus Dual Wave Coils
15/-, 16/6, 21/-.*

Garnett, Whiteley & Co., Ltd., Broadgreen Road, Liverpool.

Accept
this FREE Book
from the Makers of
T.C.C. Condensers

**—It will
save you
Pounds!**

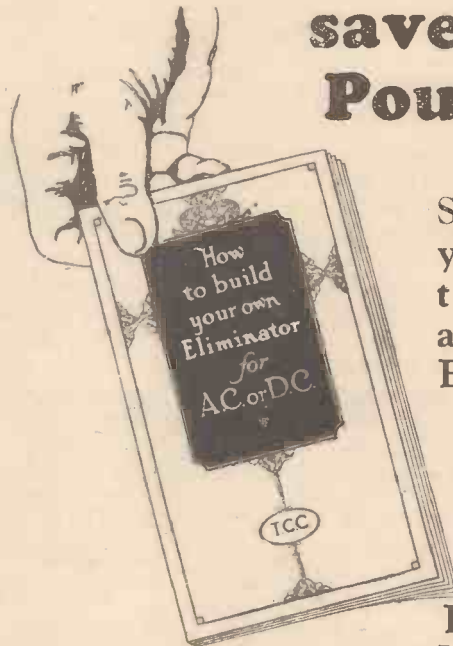

Shows
you how
to build
an L.T.
Elimin-
ator
& get
current
from
your
Electric
Light Mains

If you have electric light, this book will save you money. In simple language and by clear diagrams it shows you how to build an L.T. Eliminator that will give you constant current from your mains. It's amazingly easy. There are only 6 components and 12 wires. First cost is last cost. You can build it in an evening and start saving money right away. Take the step now—sign the coupon below.

FILL IN COUPON NOW

1 minute's
Work and
1d. Stamp
**NOTHING
MORE
TO PAY!**

To TELEGRAPH CONDENSER
Co., Ltd., Wales Farm Rd., North
Acton, London, W.3.
I enclose 1d. stamp for your free Eliminator book.

Name.....
Address.....
W. Con., April.....

CHATS AT THE WORK-TABLE

Many points of practical interest to all radio constructors are dealt with under this heading.

By R. W. HALLOWS, M.A.



An Ingenious Gadget

ONE of the neatest and handiest little tools for straightening out the sometimes difficult path of the wireless constructor is the combined screw and nut gripper, illustrated in Figs. 1 and 2. The tool consists of a frame, which forms the handle, carrying a pair of spring steel blades mounted on a pivot pin. The business end presented depends upon which way the blades are turned

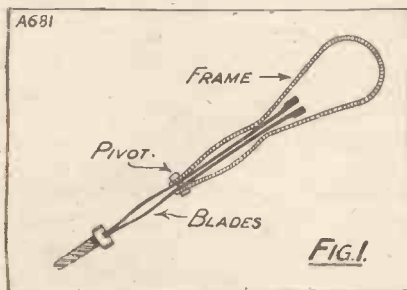

on their pivot. Fig. 1 shows the screw-holder end in action, the nut-gripping end being turned away inside the handle.

In this position the two blades spring apart, forming what may be described as a split screwdriver. One pinches the ends of the blade together between the forefinger and thumb of the right hand, inserting them into the nick of the screw. Owing to their springiness, the blades "stay put" in the nick, holding the screw so firmly that it can easily be started in an otherwise inaccessible spot.

As soon as the screw has obtained a grip on the female threads prepared for it the tool is withdrawn and an ordinary screwdriver is used to drive it home. I have seen and tried a good many other split-bladed screwdrivers,

but in most of them either the points of the blades were wrongly shaped or their springiness was insufficient to keep them in position in the nick of the screw.

With the tool under discussion screws are firmly held, and one has no difficulty at all in putting them into places where they should be.

As a Nut Holder

In order to grip a nut the blades are reversed on their pivot. In each of the pair of ends presented now there is a small recess which fits nicely over the angular parts of such nuts as one uses ordinarily in wireless constructional work. In this position the springiness of the blades holds their tips together. When a nut is to be gripped between them one forces them gently apart and inserts it between the jaws.

It is now so held by them that one can manoeuvre it on to the point of a screw situated in some awkward corner and give it the important first turn which enables it to bite upon the male threads. Once a nut has been started the process of turning it right down is easily carried out with a box spanner.

It needs no words of mine to point out to the constructor the extreme usefulness of this little tool, for everyone knows how difficult it often is to start small screws and nuts in cramped places. Problems of this kind frequently arise, especially if one is making alterations in an existing receiving set.

Wiring Connectors

I have also recently purchased a useful range of small connecting pieces and terminals which very

greatly simplify the process of making neat junctions and connections in the wiring of a receiving set.

The junctions are made in two-way, three-way and four-way form, and there are also neat little "straight through" connectors which are exceedingly handy when one wants to lengthen an existing lead, since they enable another piece of wire to be soldered easily and securely to its end. This junction piece is a little tube about $\frac{3}{8}$ in. in length with a hole cut in it. The two ends of the wire are placed in the tube, a little flux is applied through the hole and solder is run in.

The result is that a lead joined up in this way is practically as sound a job as if it were all in one piece, and the joint is so neat that there is nothing to offend the eye.

The two-, three- and four-way junction pieces are provided with a corresponding number of tubes into which the ends of the leads to be

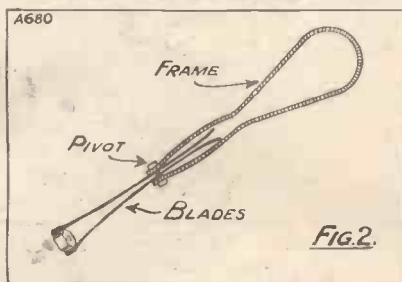

connected are inserted prior to soldering. The arms of these junction pieces are adjustable to any desired angle, which enables all kinds of wiring to be carried out with their help.

The accompanying photograph gives an idea of the ways in which these junction pieces and the connectors

Chats at the Work-Table—continued

can be used, as well as the neat little tags which are made for soldering to the ends of leads. Taken all round, these are excellent little gadgets, which the constructor will find of great value for all kinds of wiring jobs.

Sub-Base Components

The method of constructing receiving sets in which the baseboard is not level with the bottom of the panel, but is raised from one to two inches, has achieved no small amount of popularity and for very good reasons.

It enables quite a number of components of the kind, which in the ordinary way require neither attention nor adjustment, to be tucked neatly away out of sight, and it vastly simplifies wiring, since various leads can be taken from point to point under the baseboard, and there is no need to produce any kind of cat's-cradle effect above it.

Personally, I like to do all my filament and high-tension wiring beneath the baseboard and to mount below it all such components as shunting and by-passing condensers, jacks (these, of course, are actually mounted on the panel, but their contacts protrude

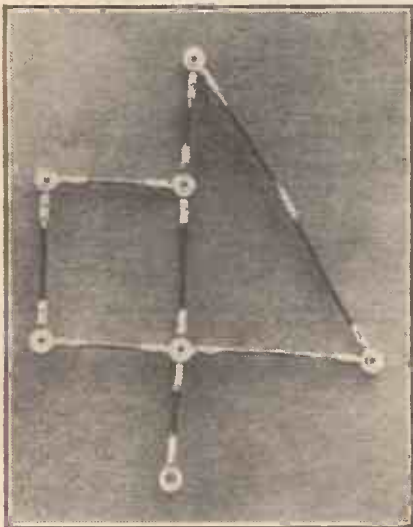

The connector links described on the previous page.

under the baseboard) and sometimes anode resistances and fixed resistors.

One then has plenty of room above board for the components that it is important not to crowd, and the inside of the set has a much better appearance than is generally obtainable if all the components are mounted

upon the same side of the baseboard and all the wiring is done above it.

In the raised baseboard method certain little problems arise for the constructor to deal with. One of these is how to mount in this position the large condensers with capacities of from 1 to 4 microfarads which are used for shunting the various portions of the high-tension battery. Such condensers are often designed with a view to being fixed vertically, and there is not usually room for this kind of thing under the baseboard. A simple but very useful tip is this.

Fix each condenser first of all to a small batten of wood $\frac{1}{2}$ in. square by means of a couple of screws.

The batten can then be fixed to the underside of the baseboard so that the condenser is horizontal. Fixed resistors and various other components may be treated in the same way.

Real Earthing

Another good tip when this method of construction is used is to fix by means of screws a strip of sheet copper from half an inch to an inch in width on the underside of the baseboard, and to connect it directly, both to the earth terminal and to filament negative.

All connections to earth or to L.T.—can then be made to this strip by bringing the necessary leads through the baseboard. They can either be soldered to the strips, or loops can be made in their ends, and they can be fixed in position with wood screws driven through the copper into the underside of the baseboard. In this way one can be sure that points that should be earthed really are earthed.

A Screen-Grid Tip

The rather complicated internal economy of the screen-grid valve makes it particularly liable to damage if it is subjected to rough handling. In fact, in more than one case recently I have had valves in which a small displacement of the electrodes has produced a short-circuit between the screening grid and the anode.

Now suppose that a short-circuit of this kind is brought about whilst the valve is in use in the receiving set—two have actually occurred in mine—a certain amount of damage is likely to occur unless precautions are taken to prevent it.

A moment's thought will show just

why things may be expected to happen. In the commonly used parallel-fed circuit the anode is connected by way of a high-frequency choke to, say, the 130-volt tapping of the high-tension battery. The screen-grid goes straight to, say, the 75-volt tapping.

Should a short occur between screen-grid and plate, 55 volts are available to drive current straight through the choke. Since even a standard capacity dry high-tension

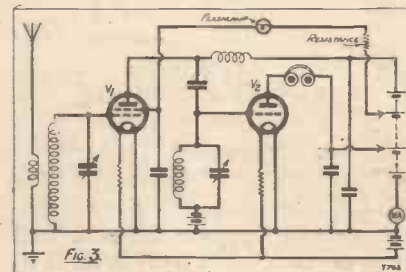

battery can deliver when in good condition 5 amperes of current or more for a short time, the choke is almost certain to suffer, and the battery will probably be done for before it is realised that anything untoward is taking place.

Fuse Necessary

If the plain tuned-anode circuit is used matters are just as bad, for there is then a direct path for current through the anode tuning inductance. There are two ways of safeguarding the receiving set, either or both of which are easily carried out by the home constructor. (Fig. 3.)

One method is to insert into the lead between the screening grid and high-tension positive a fixed resistance of a fairly high value. Its presence prevents current due to a short-circuit from reaching proportions sufficient to do serious damage. There will, of course, be a certain voltage drop across the resistance, which means that the lead from the screen-grid will have to be connected to a higher tapping of the battery in order to compensate.

To my mind, though, a better tip is the second one indicated in the drawing, the insertion of a small flashlamp in the lead between high-tension positive and the screen-grid. The best lamp bulb to use for the purpose is one with a low consumption filament—say, .1 to .15 ampere—for this can be relied upon to "blow" instantly in case of a short.

CONGRATULATIONS RECEIVED from CELEBRATED RADIO ENGINEER

Mr. Percy W. Harris, Editor of "The Wireless Constructor," finds fascination in the Jultograph

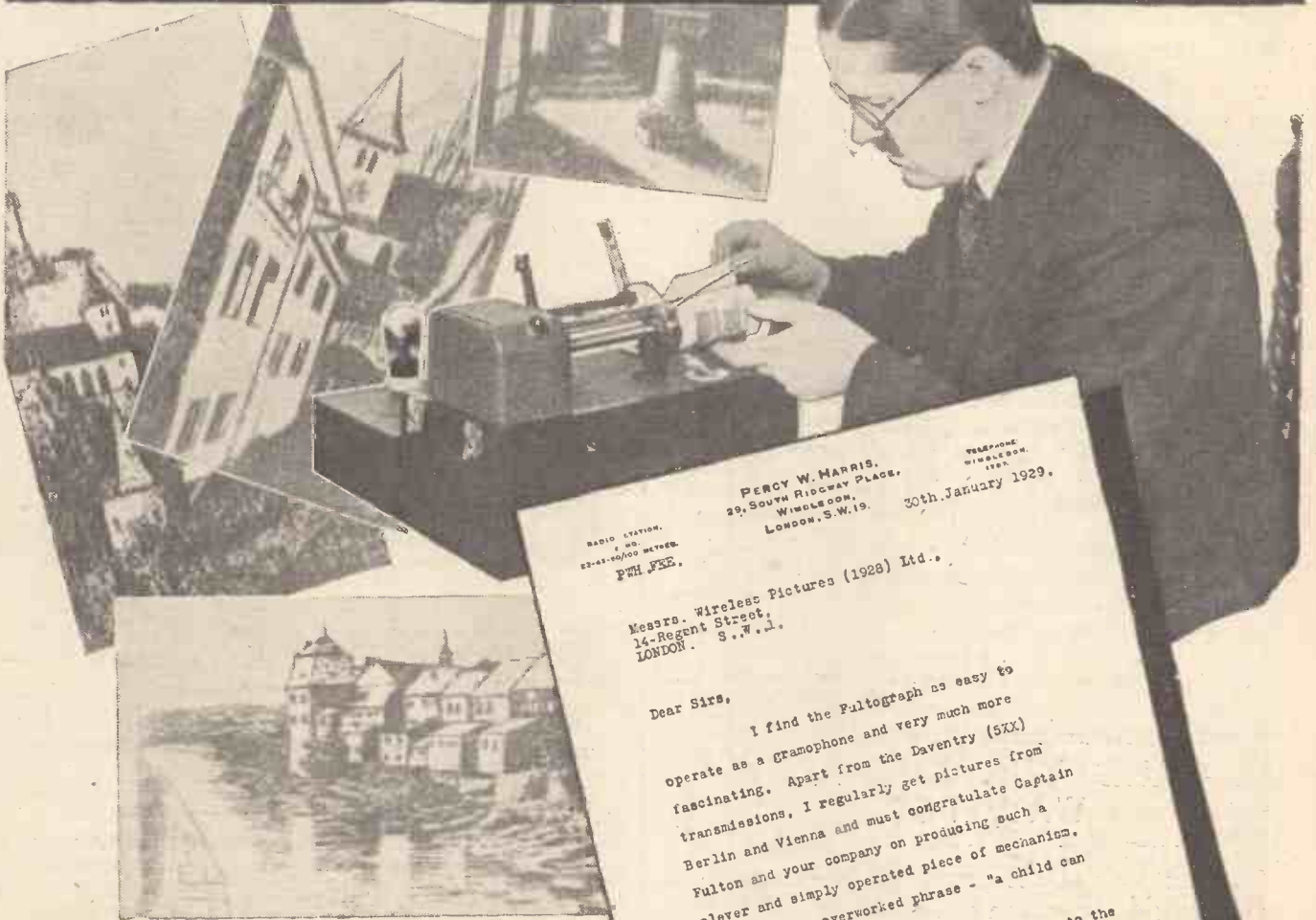

Above are reproductions of pictures broadcast from Berlin and received by Mr. Harris on his Jultograph.

Any set capable of moderate loud speaker reproduction will work a Jultograph and receive the pictures broadcast daily both from this Country and the Continent.

COMPLETE KITS OF PARTS £16

Send for illustrated leaflet for details of complete kits and picture receiver components.

WIRELESS PICTURES (1928) LTD.,
DORLAND HOUSE,
14/16, REGENT STREET, LONDON, S.W.1

Jultograph

PICTURE BROADCASTING IS INTERNATIONAL

RADIO STATION.
100 METRES.
22-23-24/100 METRES.
PTM. FEE.

PERCY W. HARRIS,
29, SOUTH RIDGWAY PLACE,
WIMBLEDON,
LONDON, S.W.19. 20th January 1929.

Messrs. Wireless Pictures (1928) Ltd.,
14-Regent Street,
LONDON, S.W.1.

Dear Sirs,

I find the Jultograph as easy to operate as a Gramophone and very much more fascinating. Apart from the Daventry (5XX) transmissions, I regularly get pictures from Berlin and Vienna and must congratulate Captain Fulton and your company on producing such a clever and simply operated piece of mechanism. To use a much overworked phrase - "a child can use it!"

"Picture hunting" is now added to the older hobby of "station hunting" on a wireless set, with the added advantage that you can prove your claims to have received a particular transmission!

Yours sincerely,
Percy W. Harris
EDITOR... THE WIRELESS CONSTRUCTOR.



—AND THE CHEAPEST WAY, TOO,

guaranteeing utmost satisfaction. Just look at the prices below—made possible by reason of the biggest valve output in the world. Radio without Dario can never be radio at its best. SUPERLATIVE FINISH - LOWEST CONSUMPTION

TWO VOLTS.		FOUR VOLTS.	
General Purpose, .05 amp.	5/6	General Purpose, .05 amp.	5/6
R.C.C., .06 amp.	5/6	R.C.C., .07 amp.	5/6
Super-Power, .18 amp.	7/6	Super-Power, .1 amp.	7/6
Super H.F. & R.C.C., .18 amp.	7/6	Super H.F. & R.C.C., .1 amp.	7/6
Pentodion, .03 amp.	21/-	Pentodion, .15 amp.	21/-

From your dealer or direct:

IMPEX ELECTRICAL, LTD.

(Dept. L),
538, High Road, Leytonstone, E.11.

5'6 7'6

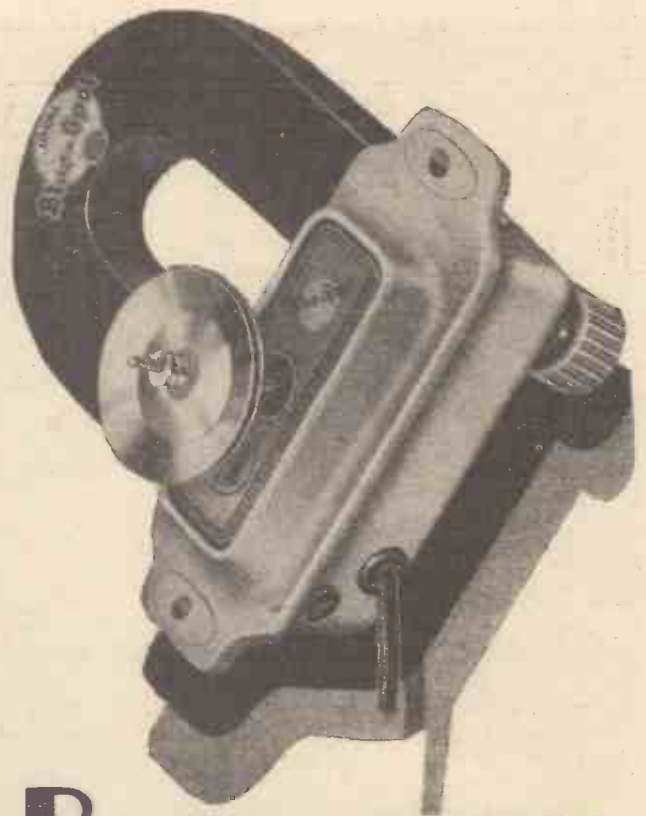

BLUE SPOT

66K UNIT 25/-

Here is the wonderful unit that gives such amazing results. It is completely discharged 4-pole magnet with adjustable reed and is capable of handling any output without any trace of distortion.

Why not make up a speaker of your own using this famous Blue Spot Unit. Full instructions are given with each unit. Obtainable at all leading wireless retailers. There are 25/- three types. The 66K, as illustrated,

Also the 66Z adjustable tongue type - 17/6
And the 66A non-adjustable - 21/6

F. A. HUGHES & CO., LIMITED
204-6, GT. PORTLAND STREET, LONDON, W.1

Distributors for Northern England, Scotland and North Wales:
H. C. RAWSON (SHEFFIELD & LONDON) LTD., 100, LONDON ROAD, SHEFFIELD; 185, PRINCESS STREET, MANCHESTER.

"Ideal Blue Spot Cone Speakers are sold under full protection of the patents owned by Standard Telephones and Cables and the Hopkins and Lektophone Corporations."

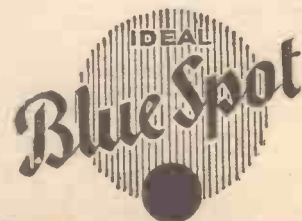

EXPERIMENTING WITH THE THIRTY-ONE NEW CIRCUITS

BY THE EDITOR.

LAST month we dealt with Circuits Nos. 8, 9, 10, 11 and 12. Circuit No. 13, a crystal arrangement of an unusual variety, opens up a wide field for experiment if you do not mind winding your own coils. The special feature about it is the very tight but inductive coupling of the winding carrying the detector itself, with the aerial winding. Particulars are given for certain windings, but the reader will find it very interesting to vary the circuit somewhat by disconnecting the aerial from the point shown and connecting it at various points on the coil to which C_1 is joined.

Strength and Selectivity

Wind this coil with 50 turns, and make tappings at 5, 10, 15, 20 and 25 turns from the bottom. Then tap the aerial on to various points (re-tuning each time) and see which gives you the best results, both as regards strength and selectivity, with your particular aerial, and in your own locality. Try also varying the number of turns of the fine wire, using more, and not less, than those given in the notes below the circuit.

You can also compare the results obtained when connecting the 'phones and crystal to the fine wire winding, with those you get when connecting them to the two ends of the heavier wire coil.

Circuit No. 14, which is due to Mr. G. P. Kendall, B.Sc., is one of the most ingenious wave-change schemes yet evolved, as a single wave-change switch with only three connections to it enables aerial, grid circuit, and reaction windings to be completely changed from one wave-length range to another.

An Efficient Wave-Change

A little examination of the circuit will show how this is done. For example, on the shorter wave the switch at the bottom has its blade vertical so that the coil L_4 is short-circuited. Coil L_1 is then in the aerial, inductively coupled to the coil L_2 , across which the condenser C_1 is then joined. The coil L_3 , which is correctly

proportioned to give reaction on the lower wave-band, is inductively coupled to the coil L_2 , reaction being controlled by the condenser C_2 .

When the switch at the bottom is moved so that the blade is in the position shown, and the flexible lead terminating in an arrow is on one of the tappings (say, for example, that opposite which it is seen in the drawing), the aerial winding is both L_1 and the portion of L_4 between the bottom of that coil and the point to which the flexible lead is joined. The aerial circuit thus goes from aerial through L_1 , the bottom of L_4 up to the tapping, and then to earth. On this band it is thus both directly and inductively coupled.

The grid circuit now consists of the coil L_2 in series with that portion of

Here is a further chat on the practical applications of the circuits shown in the book given away with the December, 1928, issue of the "Wireless Constructor."

L_4 above the tapping point used, the grid tuning circuit thus comprising C_1 , L_2 , and a part of L_4 . The reaction effect provided by the coil L_3 is insufficient on the longer band, and thus, as you will perceive, the reaction circuit goes to the plate through the condenser C_2 , through L_3 , down to the bottom of L_4 and up the tapping and thus round to filament, the reaction winding being a combination of L_3 and the lower part of L_4 .

An ingenious point about this circuit is that the lower portion of L_4 serves both as a partial aerial coupling and a partial reaction winding. Which tap you use on L_4 will depend on circumstances, and is best found by trial, bearing in mind both selectivity and reaction with a given valve.

The rest of the circuit is quite conventional. Readers who wish to try out this circuit with a ready-made

coil should purchase the new "Titan" coil which Mr. G. P. Kendall has designed. In the "Titan" coil, L_1 has several tapping points on it which adds to the usefulness of the circuit, and the whole coil is made up in convenient form for screwing to the baseboard. The reader who makes up his own coils will find sufficient data in the notes accompanying the circuit.

A Puzzling Title!

The title to Circuit No. 15 must have puzzled thousands of readers! Actually an explanation and an apology is due here. The proper title is "An Economical Frame-Aerial Three-Valver." The words "cum-heater" got into print by one of those strange chances which sometimes occur in the best regulated families, for these words did not belong to the title in any way, and should be deleted. I am sorry if any reader has failed to get heat from the circuit.

I am very fond of this circuit, which is far more sensitive than many people would imagine. It will not only suit a small "portable," but is most useful when it is desired to build a set which is completely self-contained, with aerial, H.T. and grid-bias batteries and accumulator in one compact cabinet.

The "Invalid's Set"

The frame aerial can be wound on the back of the cabinet out of sight, and the whole receiver can be carried complete from one room to another, say, from a dining-room to a bedroom in the case of illness, without the usual bother of aerial and earth wires and trailing battery connections. It gives really good small-room loud-speaker results from the nearest station if this is not more than 50 miles away, and might well be called the "Invalid's Set," in view of its great convenience.

The two high-frequency units, one for a screened-grid valve and the other for an ordinary H.F. valve, do not require detailed descriptions, as practical forms of these have already been described in our pages.

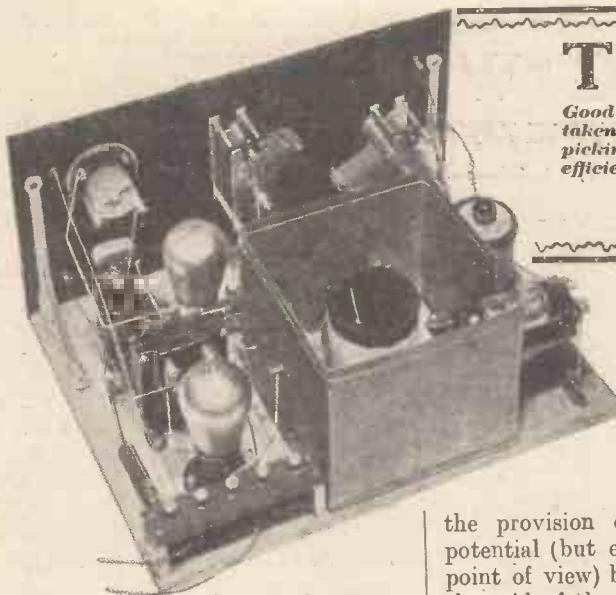

THE H.F. VALVE

Good H.F. amplification is not difficult to obtain provided care is taken in the choice and arrangement of the components, and in the picking out of suitable valves. The modern H.F. valve is far more efficient than that of a couple of years ago, as this short article will show.

By K. D. ROGERS.

A modern three-valve receiver using a screened-grid valve of the horizontal variety.

BROADCASTING has been going on now for well over six years in this country, but it is only comparatively recently that we have been able to say that the solution of the problem of obtaining really satisfactory high-frequency amplification has been found.

Some years ago we used special valves, such as the V.24, coupled them up with ordinary semi-aperiodic and aperiodic transformer-coupling, which was really far from efficient, and then controlled them by a potentiometer—a deadly procedure. No wonder that the efficiency was of an extremely low order.

Following this came more efficient circuits, but for a long time we were faced with the bugbear of self-oscillation, the valve itself having a fairly high self-capacity, and this, together with the stray losses and coupling which we had in our circuits, gave rise to no end of trouble.

Then neutralising was invented and we began to see that, with careful design, H.F. amplification was, contrary to previous ideas, really worth while.

The S.G. Valve

Following upon neutralising, valves were improved, and they began to have better magnification factors, while with the improved valves came improved circuits, and with the improved circuits came improved neutralising methods and improved screening.

Then, finally, valves specially designed for H.F. circuits arrived, not of the old V.24 type, but the screened-grid valve where the inter-electrode capacity is practically nullified by

the provision of a screen at high potential (but earthed from an H.F. point of view) between the plate and the grid of the valve.

These valves have high impedances and therefore need high-impedance plate circuits, but they also have wonderfully high magnification factors, and with well-designed and adequate screening they need no neutralising, providing a magnification which a few years ago we would have thought was impossible with one valve.

The H.F. valve of to-day is a really wonderful piece of work, and constructors need have no hesitation about

One of the latest screened-grid H.F. valves, made by the Osram Valve Co. It is capable of providing extremely high magnification, and does not need to be neutralised.



launching forth into the ether with high-frequency amplifiers. Stability and ease of tuning, with selectivity, are now commonplace in the modern amplifier, and have taken the place of instability and self-oscillation, and the flat and uncertain tuning and insensitivity that was the order of the day a few years back.

It will be said that the screened-grid-valve circuit is not so selective

as the ordinary neutralised H.F. type. That is so. The screened-grid-valve circuit is unfortunately not so selective, but what it loses in non-selectivity it makes up in sensitivity and ease of control.

Simplified Tuning

In modern circuits, such as those recently published in the WIRELESS CONSTRUCTOR, you will have seen that the screened-grid H.F. valve means that we need have only one tuning control, that of the input grid circuit, the screened valve being choke-coupled to the detector stage with no tuned circuit in it.

This greatly simplifies the handling and construction of the set, and with careful aerial circuit design detracts in no way from the selectivity of the receiver, while the magnification powers of the screened-grid valve give really remarkable results.

And now recently we have been presented with a screened-grid valve for A.C. mains, to go with those receivers which employ the indirectly-heated cathode valves popularised by the KL and the Cosmos A.C. types.

It is the Cosmos people who have brought out the new screened-grid valve—the A.C./S.—which is of the Shortpath construction and which has an amplification factor of about 1,200, although the impedance is as high as 800,000 ohms.

A Remarkable Valve

This is a remarkable valve, and although it needs really efficient circuits if anything like a reasonable proportion of the magnification is to be employed, the valve is certainly an advance and will be welcomed by those who favour indirectly-heated valves and work their sets from A.C.

All the big valve manufacturers now market special H.F. valves, both of the screened-grid and of the ordinary types, and such is the consistency of valve efficiency that nowadays there is no need to go through a whole list of valves to pick out a

(Continued on page 453.)

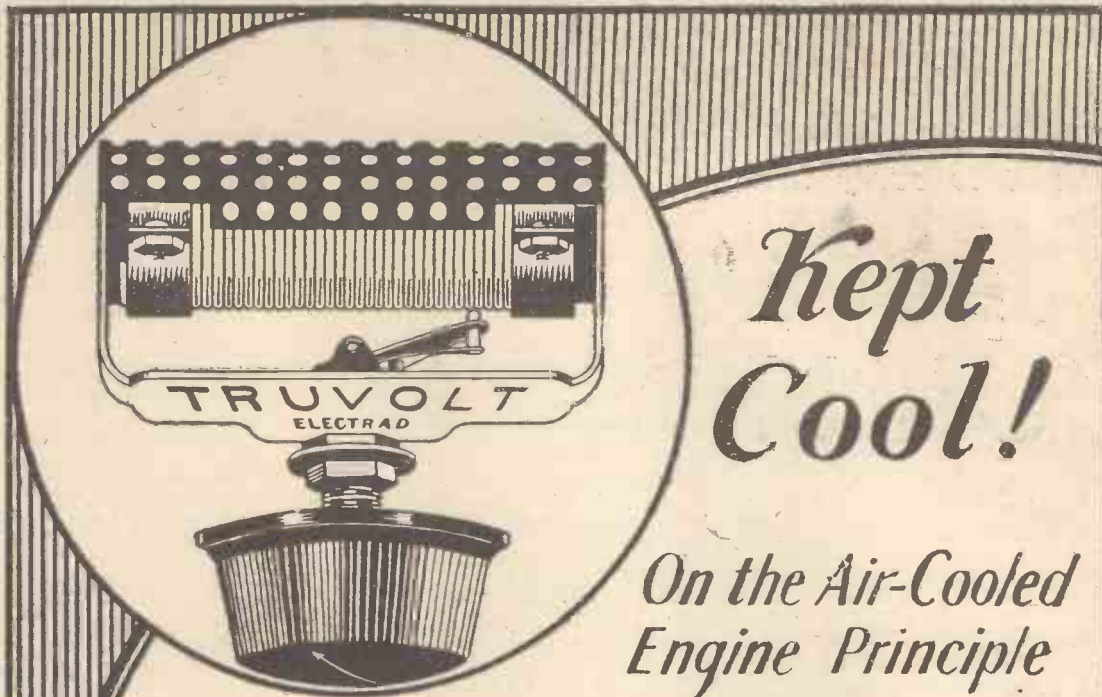

*Kept
Cool!*

*On the Air-Cooled
Engine Principle*

TRUVOLT

A CORRECT WIRE VARIABLE VOLTAGE CONTROL

This new type wire variable resistance is especially recommended for H.T. Eliminators and power work. Air-cooled like the great aviation motors. Develops, because of great radiation area, but half the temperature of other resistances of equal size.

Made entirely of wire; permanently accurate, lasts indefinitely. Positive metallic contact at all times. Nichrome wire resistance with very low temperature coefficient.

That's why Electrad Truvolts are specified for use in the "Wireless Constructor" and all leading Radio magazines.

Type	Resistance Ohms	Current Capacity Milliamperes
T-5	0 to 500	224
T-10	0 to 1,000	158
T-20	0 to 2,000	112
T-50	0 to 5,000	71
T-100	0 to 10,000	50
T-200	0 to 20,000	35
T-250	0 to 25,000	32
T-500	0 to 50,000	22.5

All rated at 25 Watts. Price 15/6 each.

Also a full line of Fixed Wire Resistances

Type B—2' long 25 Watts—Values 500 to 50,000 ohms

Type C—4' long 50 Watts—Values 1000 to 25,000 ohms

Type D—6' long 75 Watts—Values 1000 to 25,000 ohms

Write for complete lists.

THE ROTHERMEL CORPORATION, LTD.,
24-26, Maddox Street, London, W.1.

'Phone: Mayfair 0578-9, 4286.

Telegrams: "Rothermel," Wesdo, London.

This is an Eliminator Year

ELECTRAD

An original work which sheds new light on problems of the utmost interest to every intelligent man

THE SCIENCE OF LIFE

by H. G. WELLS

JULIAN HUXLEY and G. P. WELLS

*Fortnightly Parts
1/3 each.*

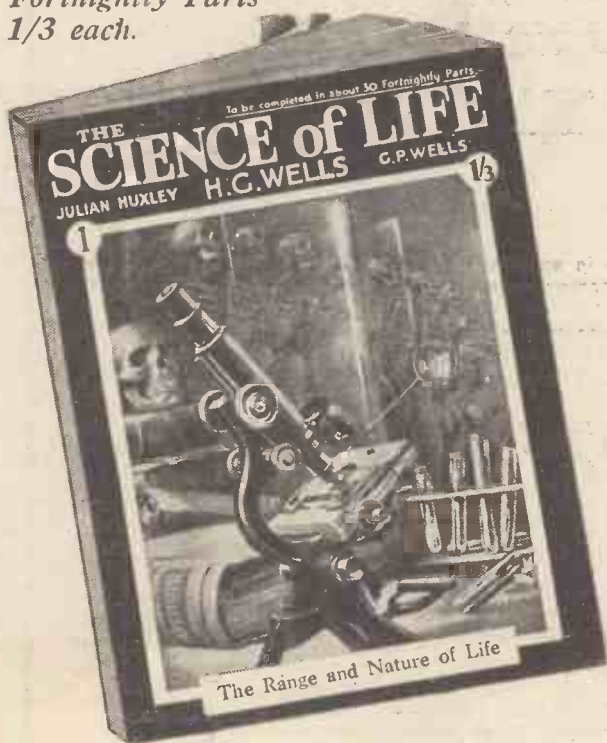

PART 1 Now On Sale

To make sure of the succeeding parts, place a regular order for the SCIENCE OF LIFE with your newsagent or Bookstall clerk.

If you have any difficulty in obtaining a copy of Part 1, send 1/6 to the Publishers, The Amalgamated Press, Ltd., The Fleetway House, Farringdon Street, London, E.C.4.

Owing to Copyright restrictions copies must not be sent to Canada or the United States of America.

THIS original new work appeals first and foremost to readers of sound general education who wish to bring their minds up to date with current biological thought and knowledge.

It is lucid, persuasive, complete and exact, and fully and abundantly illustrated; every section is alive with fresh and stimulating ideas.

It is the joint work of three able and original men, of whom two are biological scholars and investigators, and the third one of our most brilliant thinkers and writers.

It tells all the main facts and all the newest concepts and discoveries about our bodies and our minds in health and disease.

It gives a fascinating survey of the whole realm of natural history.

It relates the history and adventure of life in time.

It sets before its readers with perfect fairness and clearness the essentials of the great controversies about Evolution, and the present state of that discussion.

It enters into the issues of what are called "supernormal" phenomena.

It is, in fact, an encyclopedia of biology and biological fact.

No one who begins now to take the parts and reads them as a magazine fortnight by fortnight, will regret doing so, or cease to read until the end. It is, indeed, the best of all possible illustrated magazines, with one continuing interest linking its progress of brilliant articles into one inspiring whole.

Buy PART 1
TO-DAY

AN AUXILIARY SMOOTHING UNIT

by
G.V. COLLE.

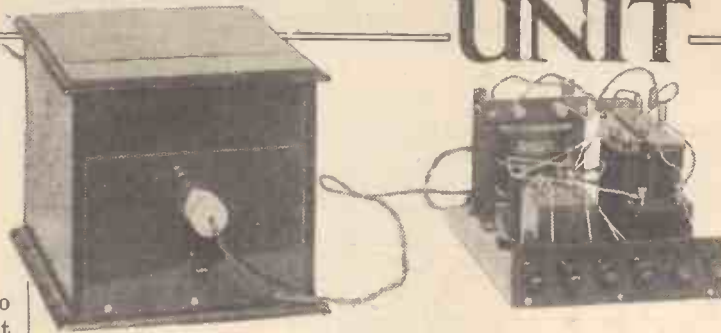

It would be no exaggeration to state that the smoothing unit described hereunder can be put to uses which run into dozens, and, with slight alterations to the wiring, to many more. Actually, the unit was primarily designed to offer additional smoothing for the various D.C. all-mains receivers described by

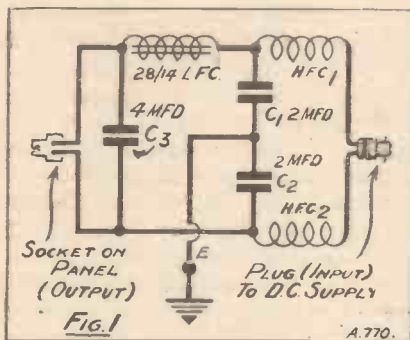

A special but simple smoothing unit for mains H.T. supplies. It is applicable to either D.C. or A.C. eliminators.

connects the D.C. all-mains receiver to the D.C. mains, and insert it in the socket fitted to the panel on the unit.

The connections are, then, D.C. mains (lamp-holder) to plug on unit. Socket on panel of unit to plug which connects to receiver. Simple, isn't

COMPONENTS REQUIRED.

- 1 Panel, 5 in. x 7 in. x $\frac{1}{8}$ in., or 7 in. x 7 in. x $\frac{1}{8}$ in. (Paxolin).
- 1 Cabinet (optional, according to the method of using the unit), 5 in. x 7 in. x 8 in. deep, or 7 in. x 7 in. x 8 in. deep, complete with baseboards.
- 1 L.F. choke, 28/14 henries inductance (R.I.-Varley).
- 1 4-mfd. condenser, tested 750 v. D.C., or any condenser having a working voltage of approx. 300 volts (Hydra).
- 2 2-mfd. condensers, test voltages as per above.
- 2 Special H.F. chokes for mains use (Wright & Weaire).
- 1 "Earth" terminal (Belling & Lee).
- 1 Standard lamp holder.
- 2 Standard plugs, one to fit above holder and one to fit the house fitting from which it is intended to derive the H.T. current.

ing on the side of mains which is "earthed" and the position of any further L.F. chokes in the set (or, if the set is a "straight" one and a D.C. eliminator is used, in the latter).

Generally, where the negative main is earthed, the L.F. smoothing chokes can be inserted in the positive lead, because negative is then "dead" to the set, and all voltage fluctuations can be removed on the lead at opposite potential. Where, however, positive is earthed, a different state of affairs exists, as the negative on the set then becomes "alive" to earth to the full extent of the mains voltage, and any irregularities in the supply are partially impressed on the grids of the valves, a bad hum resulting.

Readily Adaptable

In this case a far greater amount of smoothing is required than in the former case, and as it is usual to include the L.F. chokes in the set

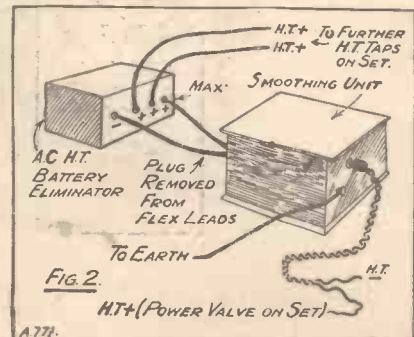

the writer in the last few issues of the WIRELESS CONSTRUCTOR, as it was realised not everyone interested in these receivers could be fortunate enough to have the use of ripple-free D.C. supplies.

However, without any deliberate intention on the writer's part, it is apparent that the unit will adapt itself perfectly to practically every phase of mains use for radio reception, and this, of course, embraces A.C. as well as D.C.

Has Many Uses

Further, by slight alterations to the wiring, one can employ the unit as a choke filter for the output stage on the set, to include the H.F. chokes when using a frame-aerial receiver, so that, should the loud-speaker leads be brought near the frame, it does not cause a feedback from output to input, thus preventing instability and L.F. oscillation.

The main object of the unit is to offer further smoothing for the D.C. all-mains receivers with very bad mains, and the method of attaching it to the set is simplicity itself. Just remove the plug which normally

it? If polarity is not correct on the receiver, it is only necessary to reverse the plug on the panel of unit.

Turn to the theoretical circuit and we find the unit includes an H.F. choke in each mains lead, bypassed by two condensers having a neutral earthing point, and then a further smoothing circuit consisting of an L.F. choke and a by-passing condenser. Since the L.F. choke can only be in one mains lead, we must make the best use of it, depend-

or eliminator in the positive lead, a further L.F. choke in the negative lead often reduces the interference to a negligible quantity.

With the unit under discussion we can do either in a very simple manner. First, we will assume the unit is already connected to the set and the mains, and that it is assisting in eradicating the hum, the polarity through the unit to the set being correct.

An Auxiliary Smoothing Unit—continued

By reversing the plugs in their holders at each end—that is, turning the plug in the lampholder round and treating the one from the set to the unit similarly—we can bring the L.F. choke in the unit in either the positive or negative lead.

It is important to note that elaborate steps need not be taken to verify which is positive and which is negative, as the difference in the residual hum will be apparent aurally by listening carefully at the loud speaker or by 'phones in a quiet room.

This test will apply in the following cases, viz.: (1) Where the unit is employed in conjunction with any D.C. all-mains receiver; (2) where the unit is used with an ordinary D.C. H.T. battery eliminator and ordinary set; (3) where the unit interposes between an A.C. rectifier giving H.T. output and the usual smoothing circuit.

How to Connect Up

In the case of No. 2, "ordinary D.C. H.T. battery eliminators" may be taken to include commercial D.C. eliminators, without reflecting on their efficiency in any way, because it is extremely difficult for any manufacturer to predict the amount of smoothing required, and the best that can be done in this direction is to include smoothing and filter circuits which will meet the majority of cases without making the eliminators too costly to the users.

No. 3 requires a word of explanation, in that the majority of commercial A.C. H.T. battery eliminators cannot be altered to include the auxiliary smoothing unit between the rectifying system and the associated filter circuit. The unit can, however, be used externally to the complete eliminator, and would be available for, say, the power valves, if further smoothing were necessary.

A sketch showing how the unit should be fitted to comply with the latter condition is given elsewhere (Fig. 2). Polarity can be determined by means of a voltmeter placed across the two leads from the socket on the panel of the unit.

Another method of attaching the unit to an A.C. H.T. eliminator, and one which the writer had in mind when mentioning No. 3, was a system yet to become more general.

As a Filter Unit

It was evolved on the assumption that as future receivers would more and more incorporate their own H.T. battery eliminators, stricter attention would have to be paid to the screening of those parts which give out intense magnetic fields. Thus greater attention has to be given to screening when A.C. transformers and rectifying valves are housed in the same cabinets as the sets, otherwise there is a grave chance of a hum resulting which even a battery of large-capacity condensers and chokes would not cure.

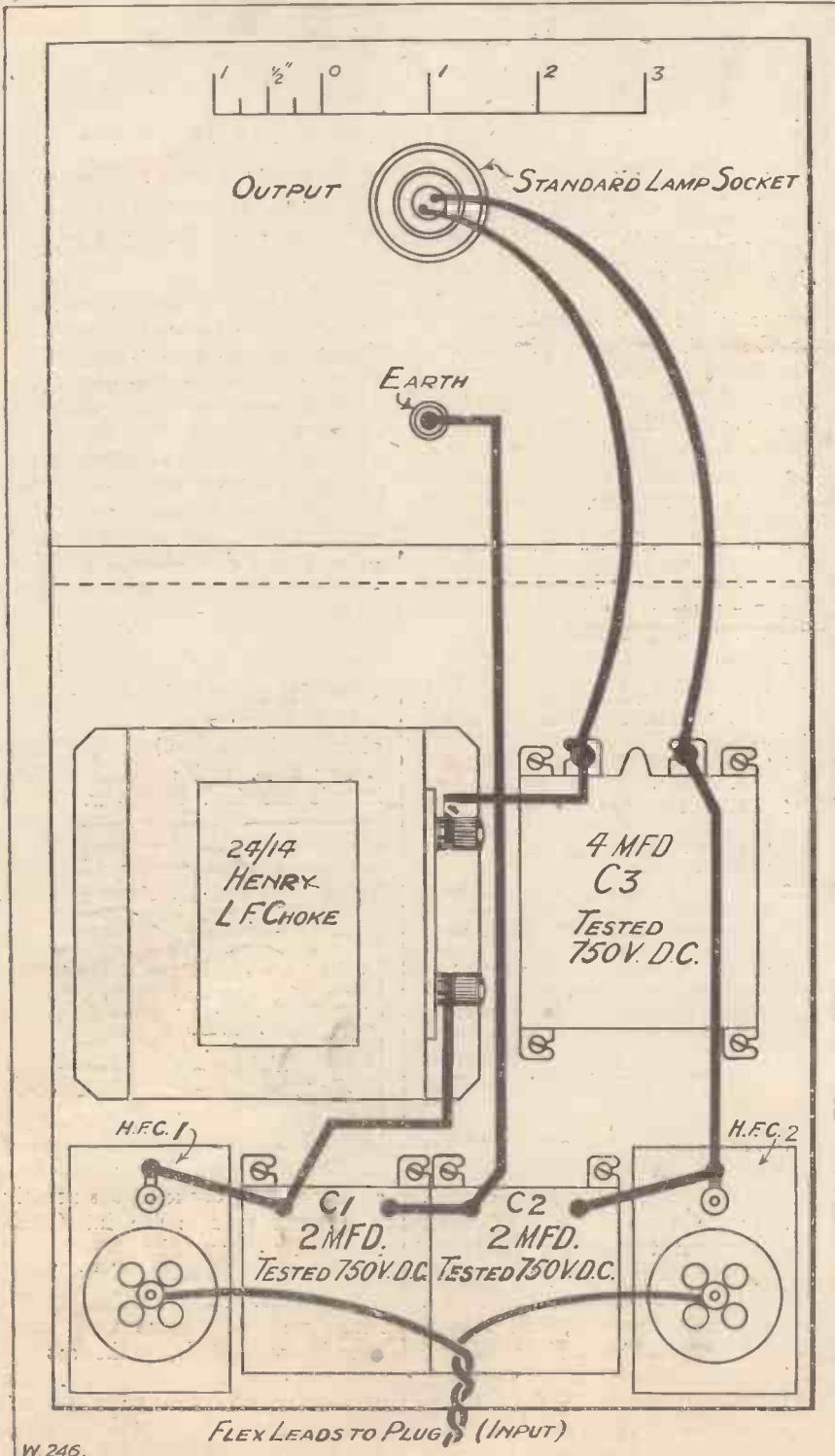

NOW! YOU CAN HEAR THE ROLLING OF THE D-r-r-r-u-m-m-s

**A wonderful new
Transformer with
a marvellous perfor-
mance on the lower
tones**

The Cossor L.F. Transformer gives new realism to the reproduction of any Receiver. It gives even amplification of all tones—from the roll of the drums to the piping of the piccolo. The wonderful reproduction of the famous Cossor Melody Maker is largely due to its Cossor L.F. Transformer. The Cossor L.F. Transformer will give better results in your Receiver—see it at your Dealer's.

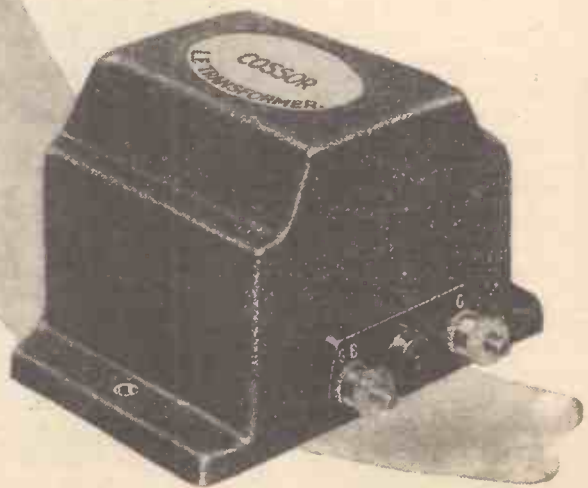

Price 21/-

**The wonderful
NEW**

*Made and guaranteed
by the makers of the
famous Cossor Valves*

Cossor L.F. TRANSFORMER

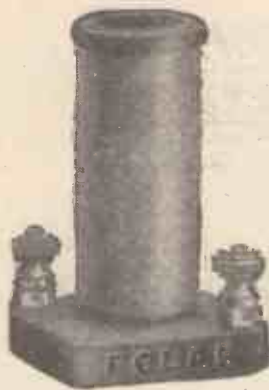

Short Wave

Polar Chokes

STANDARD—50-5,000 metres effective choking.
Size, only $1\frac{1}{4}'' \times 1\frac{1}{4}''$. Price **4/6**

SHORT WAVE—20-200 metres effective choking.
Size, only $1'' \times 1\frac{5}{8}''$. Price **4/-**



Standard

Polar Potentiometers

FOR SMOOTH REACTION

For connection across L.T. and connection of detector leak, thus correctly biasing detector grid, and ensuring perfect tone and even reaction.

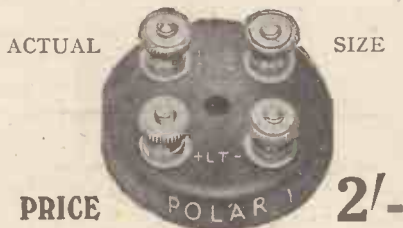

Five different tappings available at $\frac{1}{2}$, $\frac{1}{3}$, $\frac{1}{4}$, $\frac{2}{3}$ and $\frac{3}{4}$, by suitable use of the two terminals provided. Full details and diagrams enclosed with each instrument.

WINGROVE & ROGERS, LTD., 188/9, STRAND, W.C.2.

THE SUPER VALUE TRANSFORMER

Thousands of satisfied listeners who use Weilo will tell you that now it is no longer necessary to pay high prices to secure that perfect design and quality essential to good transformer performance. Specify Weilo and obtain one of the finest all-round jobs on the market. Weilo is built by Transformer Specialists and guaranteed two years, and gives a remarkable purity of maximum amplification. Tested and approved by the greatest expert of all—the listening public! Send for yours now and really transform your reception. Hundreds of testimonials.



"WEILO" TRANSFORMERS

Model No. 10 Model No. 3

11/6 **8/6**

Supplied in Ratios 1-1, 3-1, 4-1, 5-1, 25-1. Supplied in Ratios 3-1, 4-1, 5-1.

Send now for vitally interesting and informative catalogue of N.S.F. and Weilo quality components, post free. Stocked by Harrods' Stores and most Radio dealers. Obtainable by post direct. Get yours now!

S. W. LEWIS & CO., LTD.
(Dept. W.C.), 39, Victoria St., London, S.W.1.

New Controls



CONSTANT INPUT RESISTANCE

An entirely new and revolutionary resistance designed for use in controlling the volume of one loud speaker without affecting the other.

The constant Input Resistance will maintain a constant resistance in the line equal to the impedance of the speaker used. List Price 17/6.

PICK-UP "FADER"

Is another revolutionary unit designed for volume control of two pick-ups with dual turntable. List Price 17/6.

Write for full details and the new Centralab Circuit booklet.



ROTHERMEL CORPORATION, LTD.

24-26, MADDOX STREET, W.1.
Telephone: MAYFAIR 0578.

An Auxiliary Smoothing Unit—continued

A further circuit (Fig. 3) is shown on this page and illustrates how the lamp-holder on the panel. Regarding the latter, it is advisable to attach

from the two terminals on the holder. The holder can then be clamped to the panel between the two screwed rings provided, and the flex leads cut off to the required length for attaching to the 4-mfd. condenser C_3 .

Although the L.F. choke is rated to carry 140 milliamperes, yet the writer has successfully passed 150 through it, the choke becoming only slightly

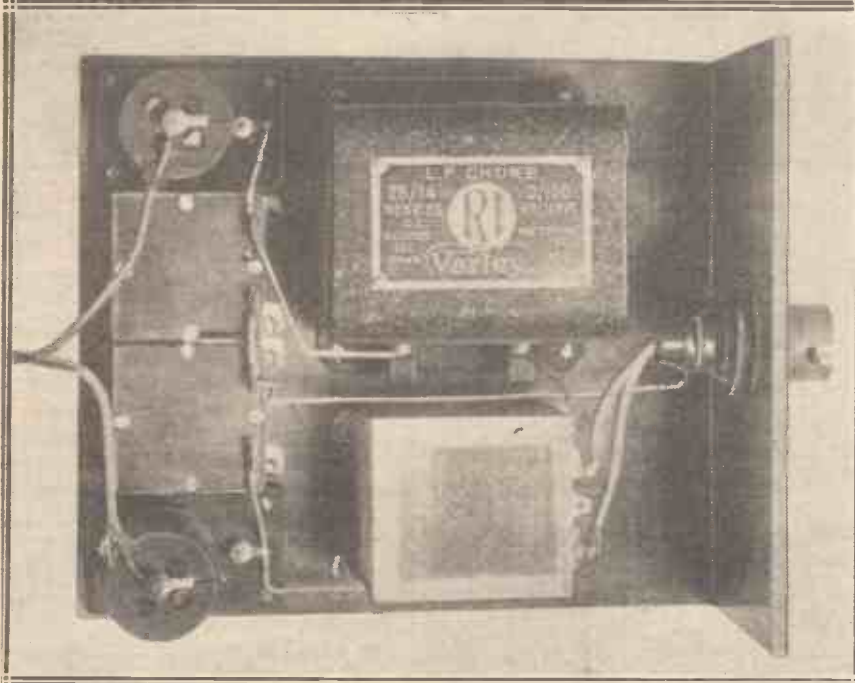

A general view of the unit. Note how the three condensers and the H.F. chokes are arranged.

wiring of the unit can be altered to that of a choke filter output.

Constructional details are conspicuous in their simplicity, the actual amount of drilling being confined to five holes, one being for a standard lamp holder, one for a fully insulated terminal, and three for $\frac{1}{2}$ -in. counter-sunk brass wood-screws.

The Panel and Cabinet

The original panel consisted of a piece of Paxolin sheet 7 in. by 7 in., although any suitable size up to 7 in. by 7 in. of this substance or ebonite may be employed. In the photograph at the head of this article a standard Carrington cabinet 7 in. by 7 in. by 8 in. deep is shown, the 2 in. difference in the height of the panel and cabinet being taken up by a strip of polished wood measuring 7 in. by 2 in. by $\frac{3}{16}$ in. It will be found that a height of 5 in. for the inside of the cabinet will be sufficient, as no component (as shown) projects above the top of the panel.

Wiring is but a matter of less than 15 minutes, and can be carried out with No. 18 or 20 S.W.G. tinned copper wire, covered with thin Systoflex. Alternatively, Glazite can be employed, with flex to the standard

the leads to the holder first, making certain no stray strands are in contact

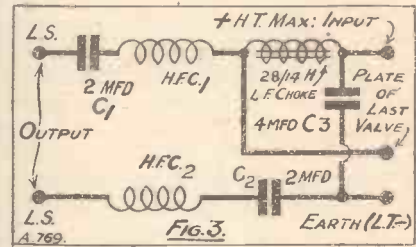

warm; 150 milliamperes represents the current taken by the "D.C." Four described last month, and even at this figure (.15 ampere) there is sufficient inductance in the L.F. choke to effect a noticeable aural difference in reducing the "background" noises.

At lower currents the efficiency increases. The H.F. chokes used in this unit were specially designed to deal with comparatively heavy currents.

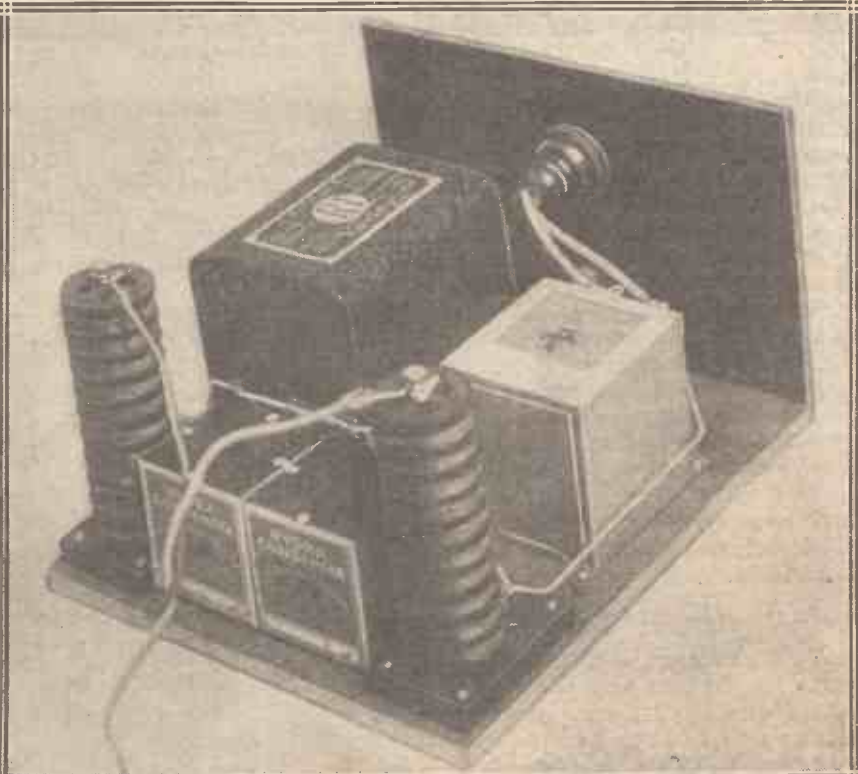

Another view of the smoothing unit, which can be completely boxed in, as is shown in the heading photograph.

WHAT'S NEW

Electric Soldering Iron

THE K.N. soldering iron submitted to us for test heats up readily, and performs the work for which it is designed quite efficiently. It is provided with two small copper bits which screw into the end of the heater, and are easily interchanged. The straight bit (that shown in the photograph) is probably the more useful, but for difficult

A MONTHLY REVIEW OF TESTED APPARATUS

(Note: All apparatus reviewed in this section each month has been tested in the Editor's private laboratory, under his personal supervision).

only manner in which originality can be shown in making up this receiver. Messrs. Ward & Goldstone, who are

standard Cossor "Melody Maker," gave excellent results.

A New L.F. Transformer

Speaking of the new "Melody Maker" reminds us that we have received and tested the Cossor "Melody Maker" L.F. transformer which, although originally designed for the "Melody Maker" kit, is also sold for general use by home constructors. The transformer, as will be seen from the photograph, is neat and rather smaller than most L.F. transformers, and is stated to have been designed with a new type of core. On practical tests it certainly gives a fine quality reproduction with excellent magnification.

We are glad to see that, according to the policy we have so long advocated, the terminals are marked A (for anode), positive H.T., G., and G.B. respectively. On practical tests the transformer compares very favourably with any of the first-grade low-frequency transformers, being only slightly inferior to the most expensive and efficient. A small point, but one which, nevertheless, is helpful to the home constructor, is that it is particularly easy to screw into the baseboard.

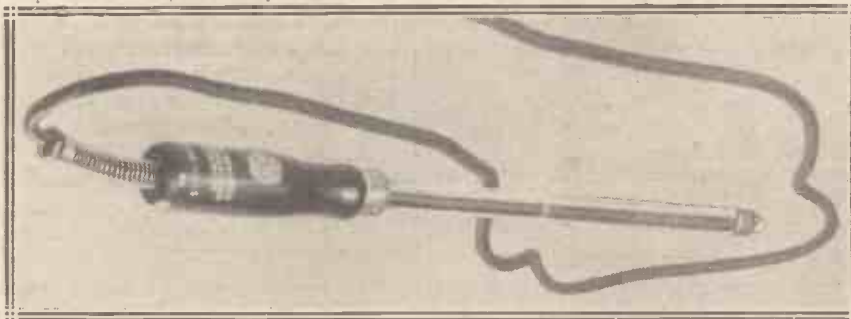

Useful for the mains' man—the K.N. soldering iron.

positions a curved bit also is provided. In all the work of making up a fairly elaborate wireless set, we found the straight bit could do all that was required.

A useful feature about this iron is that it is long and thin, thus making it easy to get the heated point into places where a clumsier shape of iron would make access impossible. An electric soldering iron is such a great boon to the set builder that all who have electric light available should try and manage to get one. Neat, clean soldered joints are assured after very little practice, and the whole job can be completed much quicker than with a gas or fire-heated iron.

Goltone Coils

Although Messrs. Cossor supply all parts for the new Cossor "Melody Maker" complete in a box, many users like to experiment and try different components. Others, too, like to use the circuit but make up the set in their own way. After all, this is the

well-known for their wireless components, have sent us for review a pair of their special coils wound for the new "Melody Maker" with a special Goltone wire. This is of a stranded variety, and the coils submitted to us, when tried in a

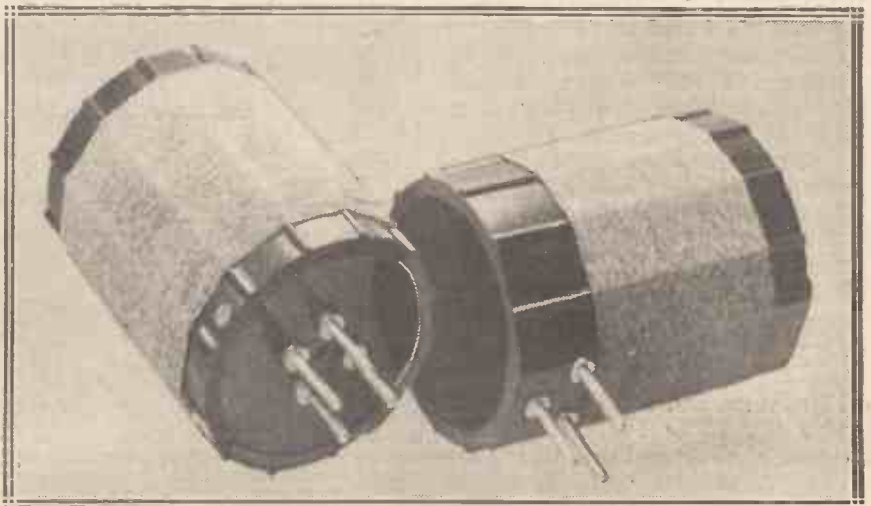

The "Goltone" coils for the Cossor "Melody Maker."



The
SPHINX
In Mahogany,
Oak or Walnut.
Height 16 ins.
£12. 10s.



The
DUCKLING
In Mahogany
or Oak.
Height 9½ ins.
42/-

EVERY note, every word, rings true. The rich notes of the bass soloist, the sweet melody of the violin, the stirring strains of a military band, or the merry rhythm of a Spanish tango . . . each varied item in the programme is reproduced with a fidelity that is almost uncanny. But you are not really surprised; nothing but beauty and truth *could* come from instruments of such handsome distinction as these **BROWN** Loud Speakers. You can hear them at your Dealers. Made by S. G. Brown, Ltd., Western Avenue, N. Acton, London, W.3.



The
MASCOT
In Mahogany
or Oak.
Height 13 ins.
£4. 10s.

ALL
Brown
LOUD SPEAKERS
TELL
THE
TRUTH!

What's New—continued

The holes for the securing screws of some transformers are in rather inaccessible places, but in the case of the Cossor transformer they are so placed that it can easily be screwed down even in an awkward corner of



A new and compact transformer.

a receiver. This is a thoroughly good transformer, representing excellent value for money.

Polar Components

Messrs. Wingrove & Rogers, Ltd., have sent us for test and report a number of components of good quality and performance, some of which are shown in the accompanying photographs. The small variable condenser, with a maximum of .0001 mfd., is supplied with insulated bushings, so that it can be used on a metal panel (these bushings were removed before the photograph was taken), and is very well made, mechanically and electrically.

The movement is smooth. Good contact is made by insulated pigtail, and there is no undesirable concentra-

tion of field through solid dielectric. The moulded knob, attached by means of a grub screw, enables the adjustment to be made with precision, and the measured value of its maximum is .00011 mfd. The minimum is .00001 mfd., which is about the average for such small condensers.

A small point of criticism we would make is that when the condenser is used for mounting on an ebonite panel the threaded bush is not quite long enough for $\frac{1}{4}$ -in. panels, although it serves quite well on those of the $\frac{3}{16}$ th variety. We would suggest that this is made a little longer in future models, so as to add still further to the adaptability of what is really an excellent component. Other good components are radio-frequency chokes for the ordinary band and for the very short band (the taller in the photograph), and a fixed potentiometer, very useful for obtaining a good position for the grid return in the detector circuit.

The short-wave radio-frequency choke is rated for 10 to 200 metres, while the rating of the standard type is from 200 to 5,000 metres. Our tests show that the short-wave choke should be perfectly satisfactory in any of the short-wave receivers, while the standard choke can be recommended for the 200- to 600-metre and the 1,000 to 2,000 band, on both of which it functions excellently.

The fixed potentiometer is a neat little component with four terminals, two of which are joined to positive and negative filament leads, the other two being tappings at a quarter and half-way. In ordinary detector circuits the grid leak is taken either across the grid condenser and thus through the tuning coil round to

filament, or else from the grid direct to positive filament.

A comparison between the results obtained by connecting the grid leak to the positive and to the negative leg respectively shows that positive is the better, although further experiments will show that best of all is an intermediate point between positive and negative. This can be obtained with the ordinary type of potentiometer using a sliding arm, but as these devices are rather large and not always convenient for mounting, a fixed potentiometer of the Polar type can be used quite satisfactorily.

The component is very small (the diameter being exactly that of a penny), and one can choose one or other of the tapping points according to which gives the best results with the particular valve. According to the manufacturers it has a total resistance



The "Polar" reaction condenser.

of about 3,000 ohms, and measurement shows it to be 2,550 ohms. It is a very neat and useful little component which can be recommended.

Centralab Products

From The Rothermel Corporation, Ltd. (English agents for the Centralab Radio Laboratories, Milwaukee, U.S.A.), we have received a number of Centralab products, a few of which are illustrated herewith. The "Moduplug" is a smooth-action volume control which can be connected in parallel with the loud speaker, and being fixed to a long cord can be operated with comfort from an easy chair.

Although some experimenters decry any form of volume control which

(Continued on page 448.)

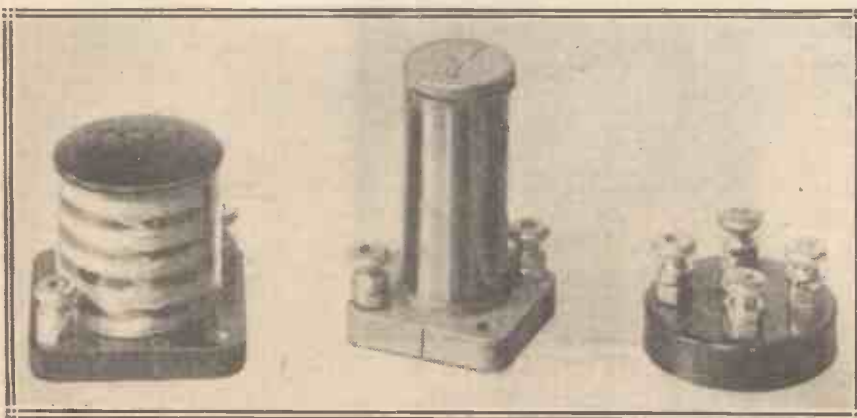

Some of the useful components referred to above.

A triumph in design —
The POPULAR WIRELESS "TITAN THREE"
Now available in complete kits of parts

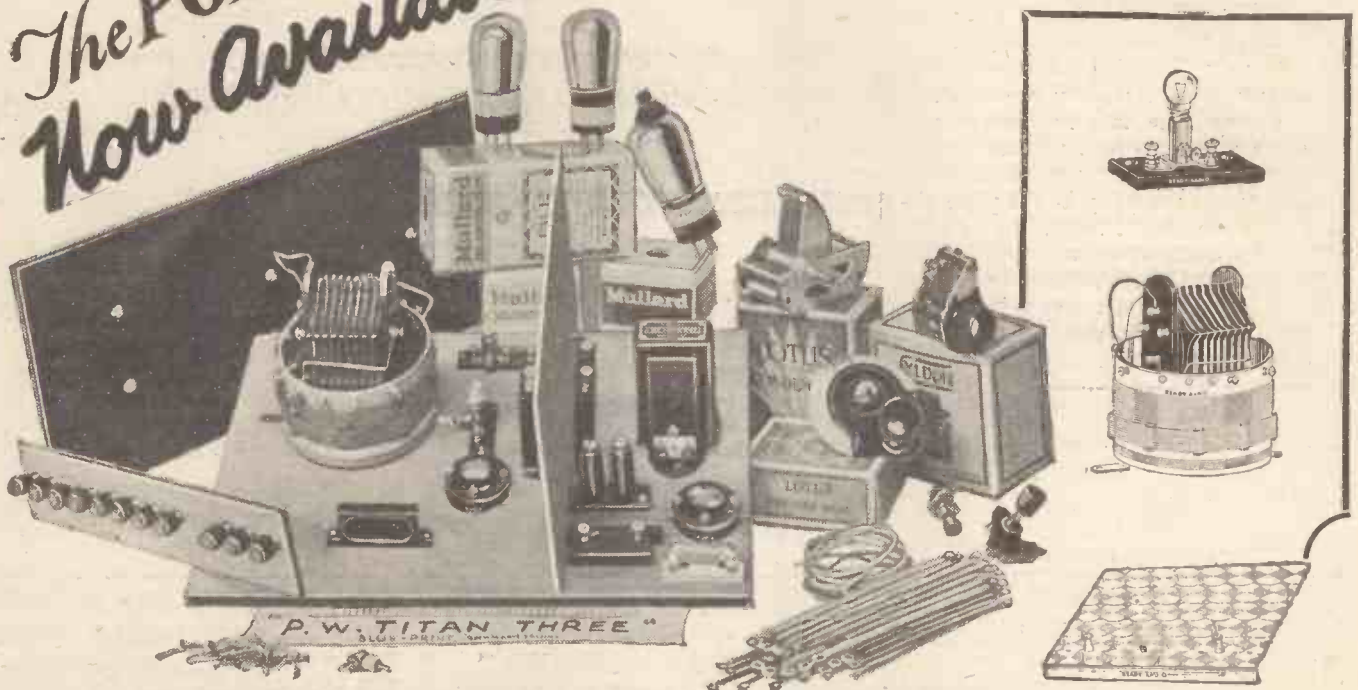

READY RADIO "TITAN THREE" KITS
 APPROVED BY "POPULAR WIRELESS"

No set has met with such stupendous success as the "Popular Wireless" "Titan Three." Its great popularity is due to the remarkable efficiency of the designer's method of employing the screen-grid valve, the small number of parts required, the genuine simplicity in construction, and the resultant low cost.

Write, wire, or 'phone your orders. Inland post free. Overseas orders carefully packed and insured, charges forward.

See page 460 for further announcement with price list of components for "The Air Commander."

- Kit A** Complete, valves excepted **£4.7.0**
- Kit B** Complete with Detector, Screen Grid and Power Valves **£6.12.6**
- Kit C** Complete, with Detector, Screen Grid and Pentode Valves **£7.5.0**

All kits include special connecting links which **OBVIATE SOLDERING**. Official blue print and full instructions are also included.

LIST OF APPROVED PARTS

	s.	d.		s.	d.
1 Baseboard	2	0	2 Dubilier Mansbridge condensers, 1 mfd.	5	0
1 G.E.C. transformer	17	6	1 Lissen 2-meg. grid leak	1	0
1 McMichael H.F. choke	4	0	1 Grid leak holder	0	6
3 Lotus valve holders	3	9	1 Ready Radio mounted terminal strip with 11 Belling-Lee terminals	4	0
1 Drilled panel	6	0	Wire, flex, screws, and wand plugs	2	3
1 Lotus '0005 variable condenser	5	9	1 Screened grid valve, 12	22	6
1 Lotus slow motion dial	4	9	1 Detector valve	10	6
1 Cydon micro condenser and knob	7	0	1 Power valve	12	6
2 Ready Radio fuses	2	0	1 Pentode valve Mullard	25	0
1 L.T. switch	1	0	All components supplied from stock.		
1 Wave-change switch	1	6	Cabinets supplied for this set:		
1 Ready Radio screen	2	6	Polished solid oak	22	6
1 Ready Radio Titan coil unit	15	0	Polished solid mahogany	27	6
1 Lissen fixed condenser, '0002 mfd.	1	0			
2 Lissen fixed condensers, '0003 mid.	2	0			

Any of above parts can be supplied separately if require.

IMMEDIATE DESPATCH!

READY RADIO SUPPLY CO.

Tel. No. Hop 5555

Dept. C, 159, BOROUGH HIGH STREET, LONDON BRIDGE, S.E.1.
 (Three minutes from London Bridge Station.)

'Grams Ready Hop 5555 London

Our complete, cartoned kits with all baseboard components mounted for the "Titan Three" are approved by the Editor of "Popular Wireless," and are available as shown on left. Blue print supplied.

READY RADIO Components specified in "TITAN THREE."

"TITAN" COIL UNIT 15/-

"P.W." SCREEN H.T. FUSE 2/6

Every Radio need supplied. Write for our 144 pp. illustrated catalogue, price 1/- post free.

See page 460 for further announcement with price list of components for "The Air Commander."

WHAT'S NEW

—continued from page 446

operates on the loud speaker itself, our experience is that intelligently used they can prove particularly useful. Adverse criticism of volume controls operating on the loud speaker is generally just only when the output valves are overloaded and we tone down the signals by reducing the current to the loud speaker, for obviously distortion must be present at any strength when this is done.

Furthermore, it is not desirable to use a resistance as a volume control across a loud speaker when the latter is connected directly in the plate circuit of the output valve, but when an output transformer or output choke is used and the output valve is not overloaded this form of volume control is very useful, particularly if during conversation it is desired to reduce the strength of the programme for a short period without cutting it off entirely. With the "Moduplug" on a table nearby or hanging on the arm of a chair one can reduce the strength to any desired level in a moment.

In the Centralab line of products there are a number of very useful wire-wound potentiometers and filament resistances for heavy duties, as in mains units, and controlling a large number of valves. The form of construction in, for example, the 150-ohm power rheostat illustrated is to wind the wire on a 1-in.

steel strip insulated with asbestos. This construction assures not only a wide factor of safety, but also adequate cooling, and it is claimed that the resistances in this series (they range from 30 ohms maximum to 8,000 ohms maximum) will dissipate 70 watts in the resistor itself.

(Continued on page 450.) 8

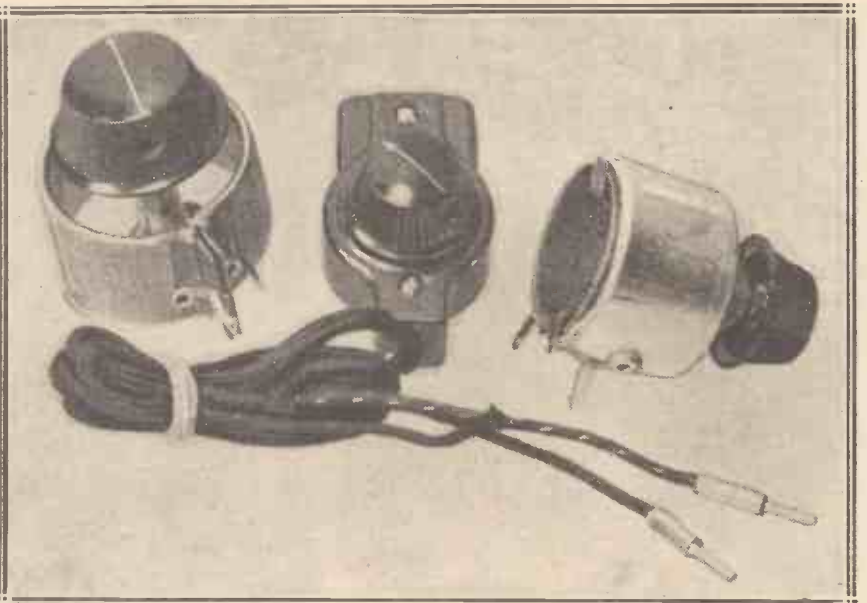

Some interesting "Centralab" components.

HARRIS "STEDIPOWER" UNITS



L.T. from A.C. Mains.

Now available in two sizes:—1-ampere output and 2-ampere output. Assembled and tested, either type .. **£9 10. 0.**
Also supplied as constructional kits.

MAGNUM L.F. CHOKE



With centre-tap 20/40 henries.
15/-

BUILD THE

"AIR COMMANDER"

As described in this issue by Mr. Percy W. Harris.

1 Cabinet, 21" x 7", as described	£ 8 0
1 Mahogany Panel, 21" x 7", ready drilled	11 6
4 Magnum Panel Brackets	5 0
2 Magnum Mahogany Knobs	1 0 0
2 Magnum Standard Screens, 10" x 6"	5 0
2 Magnum Fixed Condensers, .01 mfd.	5 0
1 Magnum Fixed Condenser, .002 mfd.	2 0
1 Magnum Fixed Condenser, .001 mfd.	1 6
1 Magnum Neutralising Condenser	5 0
1 Magnum Push-Pull Switch	2 6
2 C.C. S/P Condensers, .0003, with 2 meg. Leaks	6 8
1 Pilot Double Illuminated Dial and Lamp	1 3 0
1 Lissen 30-ohm Rheostat, Panel type	2 6
2 Lissen .0005 Variable Condensers	13 0
2 Ebonite Mountings for above	1 0
4 Lissen Resistances, as specified, and 1 Holder	15 0
2 R.I. Varley R.F. Chokes	19 0
1 Microf and Base, 100 m/a	2 0
1 Thorndson Choke	12 0
1 Marconi-Phone Ideal Transformer, 4/1	1 5 0
1 Reaction Condenser, .0001 mfd.	5 6
2 Colvern 6-pin Bases	4 0
4 Lotus Valve Holders (terminal type)	7 0
2 Ferranti 2 mfd. Condensers	7 0
3 Terminal Strips and 10 Terminals	5 6
1 Fye Leak, .25 meg.	1 0
1 Length Heavy Systofax	3
2 Sets Lewcos Binocular Coils, as described	2 17 0
Glazite	1 1
	£13 13 0

Set of Valves, 1 Screened Grid, 2 H.F. and 1 Super Power, .. **£2 18 6**
We can supply the amazingly efficient "Air Commander," ready wired and tested, including Valves and Royalty .. Price **£19 0 0**

BURNE-JONES & CO. LTD.,
MAGNUM HOUSE
TELEPHONE: HOP 6257

296, BOROUGHS HIGH ST. LONDON. S.E.1

MAGNUM "UNIVERSAL" THREE



ASTOUNDING results on the ultra-short waves from 15 metres up to 2,000 metres. Price, including coils, valves and royalty,

£18

Free demonstrations within 50 miles of London.
The most perfect set yet designed for the overseas listener.

MAGNUM "TITAN" COIL



as specified for "Popular Wireless" "Titan" Three and "Titan" Two.

15/-

Catalogue and lists on application.

66 "EKCO" First Again!

—AN H.T. UNIT FOR USE WITH ALL TYPES OF SETS INCLUDING ALL SCREEN-GRID VALVE SETS.

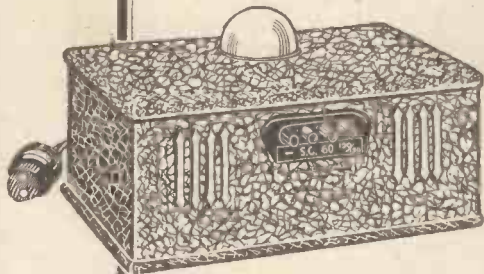

THE NEW "EKCO" H.T. UNIT MODEL 3.F.12

The only satisfactory solution of the demand for an H.T. Unit for use with Screen Grid Valve Sets. This new Model 3.F.12 includes a specially designed TAPPING FOR H.T. SUPPLY TO SCREEN GRID VALVES. Suitable for ALL 3 Valve sets or those requiring not more than 12 m/a.

SPECIALLY DESIGNED AND RECOMMENDED FOR:

1929 COSSOR MELODY MAKER; BURNDIPT SCREENED ETHO 3; LISSON S.G.3; OSRAM MUSIC MAGNET MARCONI TYPE 35; McMICHAEL SCREENED DIMIC 3; FORMO SCREENED GRID3 Etc., Etc.

VOLTAGE TAPPINGS.

- (1) S.G. For the H.T. Supply to a Screen Grid Valve.
- (2) 60 volts. At 2 m/a approx.
- (3) 120/150 volts. Giving 120 volts at 10 m/a approx. or 150 volts at 8 m/a approx.

A.C. Model 3.F.12 £3:18:6 Complete (including valve and Royalty).
D.C. Model 3.F.12 £1:17:6 Complete.

OBTAINABLE ON EASY PAYMENTS FROM ALL RADIO DEALERS. Send a Postcard to-day for the free "Ekco-Lectric" Booklet! Other units complete from 17/6 D.C. and £2 12/6 A.C. There is also the new 1929 "EKCO-LECTRIC STRAIGHT THREE" Receiver. A triumph in electro radio. Just "Switch On—That's All!" D.C. 19 Gns.; A.C., 21 Gns. Complete with Valves and Royalty.

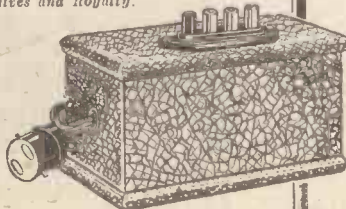

Switch on!—That's all!

E.K. COLE LTD (Dept. D), "Ekco" Works, Leigh-on-Sea.

Weston sets the world's standard



Model 506 Pin Jack Voltmeter with High Range Stand, Measures High and Low Tension Voltages. The Weston free booklet "Radio Control" explains the uses of this and other Weston Radio Instruments. Write for your copy.

Price £2 10 0



Model 506 Mil-Ammeter should be placed in the H.T. circuit of the valve to ensure correct operation and check distortion. Panel mounting type.

Prices
£1.15.0—£2.15.0

Model 506 Panel Voltmeters ensure permanent accuracy. With a high internal resistance of 125 ohms. per volt, they make practically no load on the batteries. Neat and compact.

Prices
£1.15.0—£2.15.0



Model 489 Double Range D.C. Voltmeter is a necessary portable testing instrument for every radio enthusiast. It is of great use

in tracing circuit troubles. Made in various ranges with different sensitivities. Similar instrument for A.C. Model 528.

Prices £3.15.0—£7.5.0

WESTON ELECTRICAL INSTRUMENT CO. LTD.

15 GT. SAFFRON HILL, LONDON, E.C.1

WHAT'S NEW

—continued from page 448

The smaller metal-cased instrument also illustrated in our photograph is a heavy-duty potentiometer with 8,000 ohms resistance. This is of a type which will dissipate 20 watts without overheating. In all the models we have tested the motion has been very smooth and the performance excellent. One-hole fixing is provided.

We can particularly recommend the heavy-duty potentiometer for use in mains units, where, for example, two of the 10,000-ohm pattern in series enable continuously variable tappings to be taken from the maximum of the unit to half the maximum voltage, and from half maximum voltage to zero respectively (see the design for "Stedipower" H.T. Unit).

Good Variable Condensers

A number of excellent and cleverly designed variable condensers are made by Messrs. Wilkins & Wright, Ltd., under the trade name "Utility." The two we illustrate this month have been found very satisfactory on test. They are the Utility low-loss

condenser with a nominal capacity of .0003 mfd., and a Utility "Mite" .0005 mfd. Both have an excellent feature in that the moving plates have one wide bearing only, and the small solid dielectric used is well away from any concentrated field.

Good contact between moving plates and the end plate is assured by a soldered pigtail, while the very wide bearing assuring rigidity has a very smooth action. Both soldering lugs and terminals are provided, and on the larger model the very unusual feature of a dust cover which effec-

tively prevents dust getting between moving and fixed vanes. The maximum capacity of this model proved to be .00031 mfd. and minimum .000013 mfd.—a very useful range, and the condenser is to be commended not only for excellent workmanship and good mechanical and electrical characteristics, but also for considerable ingenuity in design.

The "Mite" condenser illustrated has a maximum capacity of .0005 mfd. nominal, and is a very small condenser particularly suitable for portable sets.

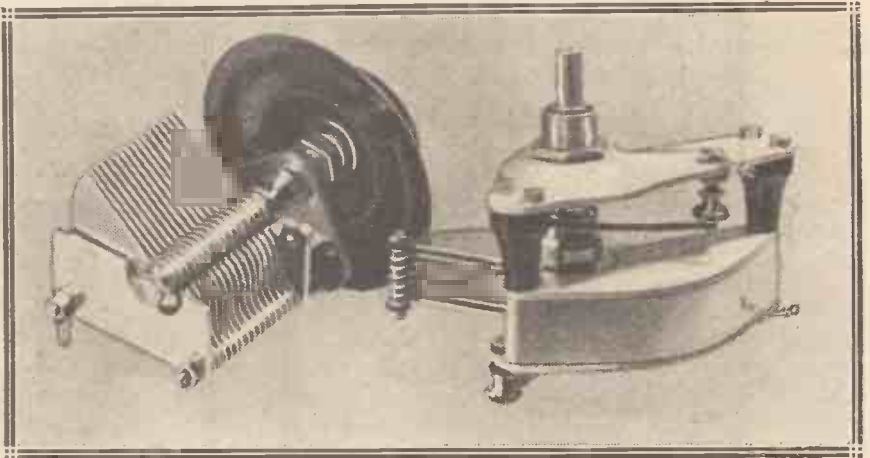

Useful condensers made by Wilkins & Wright, Ltd.

TECHNICAL ADVANCES

By



INPUT TRANSFORMER
For Metal Rectifiers

The most efficient transformer for reducing A.C. mains voltage to value suitable for input to metal rectifier.

No. 92A:—
100-110 or 200-220 volts A.C.
No. 92B:—
115-125 or 230-250 volts A.C.

22/6

With a pentode the output circuit impedance must match that of the valve. This new pentode output transformer has two tappings to give the best step-down ratio for the loud speaker used.

30/-



PENTOFORMER
Output Transformer



Works BEDFORD
Dept. J823

THERE IS A REASON

Why The Lewcos H.F. Choke Stands Alone For Efficiency—
and the reason is not far to seek.

The finest quality materials and the high-class workmanship used in the manufacture of the LEWCOS H.F. CHOKE make it supreme.

The terminals are arranged one at the top and the other at the base of the coil to eliminate the risk of additional self-capacity in the wiring of the receiver.

Equip your set with a LEWCOS H.F. CHOKE and be confident of perfect reception.

The LEWCOS H.F. CHOKE is obtainable at all Radio Dealers.

A Chart showing its performance and full particulars will be sent on application.

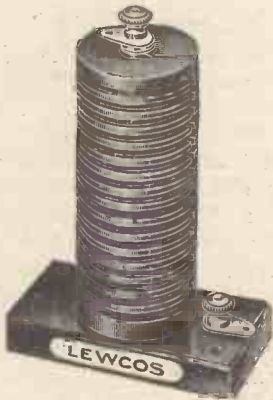

H.F. CHOKE
Price .. 9/-

LEWCOS

(REGD.)
HIGH FREQUENCY CHOKE

OBTAINABLE FROM STOCK
OF ALL RADIO DEALERS



THE LONDON ELECTRIC WIRE COMPANY AND SMITHS LIMITED, CHURCH ROAD, LEYTON, LONDON, E.10. Trade Counter and Cable Sales: 7, Playhouse Yard, Golden Lane, E.C.1.

AN APOLOGY

TELEGRAPH CONDENSER COMPANY LIMITED
DOUBLE MOUNTING CONDENSERS

ADVERTISEMENTS have recently been issued featuring the Telegraph Condenser Company's Condensers with the special feature of the double mounting bracket as an innovation first evolved by us, but we find to our regret that this is incorrect.

This feature, for which originality was claimed by us, had already been previously registered by Mr. T. Graham Farish, of Graham Farish Ltd., on the 16th day of

August, 1926, No. 723271, Class 3, and incorporated in their condensers since that date.

We wish to take this the first opportunity of publicly acknowledging the error, but are happy to announce that arrangements have been made which will enable this special double mounting feature to be continued in T.C.C. Condensers under licence from Mr. T. Graham Farish, the registered proprietor of the design:

TELEGRAPH CONDENSER COMPANY LTD.

OUR NEWS BULLETIN

Some of the More Interesting Happenings in the Radio World this Month.

Brussels Sprouts!

MANCHESTER amateurs have come to the conclusion that, until lately, the Brussels broadcasting station has been working on a wrong wave-length. Interference from that station has now, happily, ceased, and the station seems to have shifted several metres higher up. This places it just above Milan, which formerly it was below.

The Last Place

It is rather curious if Brussels was offending, because that was the last place where the European broadcasting authorities met and drew up the Brussels wave-length plan. Incidentally, it is also the place where an official listening-in post is situated for checking the various wave-lengths of broadcasting stations.

Television Finance

The first report of the Baird Television Development Co., Ltd., which, in the opinion of some shareholders, was unduly delayed, has now been made public. The accounts do not include a profit and loss account, as no trading has so far been carried on, but the balance sheet shows that a total capital of £124,999—nearly half—was at June 30th last still held in cash. Of the remainder, some £22,800 was spent on patent rights, and £13,800 was spent on experiments. The preliminary expenditure amounted to £15,000 odd.

A New System

The Wireless Correspondent of the Leeds Mercury recently made mention of a new principle of television being developed in the United States. It appears that this new invention

does away with the revolving disc with perforations, and scanning discs are eliminated entirely; five or any other uneven number of super-sensitive photo-electric cells are mounted round the circumference of a heavy cast-aluminium disc. A peculiar motion is given to this scanning wheel as it revolves both on its axis and longitudinally with it, giving an effect when the apparatus is in motion of a revolving globe.

"Sphere of Vision"

The cells revolve with the wheel, and a commutator is so arranged that it connects only that vacuum tube which is passing through "the sphere of vision" at the transmitting or receiving circuit. The "sphere of vision" is a portion of the surface of a revolving globe upon which the image to be transmitted is focussed by means of a photographic lens. In the case of the receiver, it is that source which reproduces the image by the variations in light intensity of the glow lamps as they pass through the sphere.

The Cell Next

It is understood that this apparatus is purely experimental, but laboratory (Continued on page 454.)

PORTABLE CABINETS 30/-



Fultograph, the Wireless Picture Receiver demonstrated every day 2-2.30 p.m. in our window. Details on request.

Beautifully covered in leatherette. Choice of six colours, antique, dark claret, black, blue, brown, green. Complete with inside chassis for aerial and set, carriage extra. Outside size, 17 in. high, 9 in. wide, 14 1/2 in. length.

SUITABLE FOR MULLARD MASTER FIVE

Linen diaphragm loud speaker parts. Including woodwork, linen, dope, fixing screws, screwed rod, brackets, 66k Blue Spot unit, reed adaptor and nut £2-12-9

ALL COMPONENTS ABOVE £5 SUPPLIED ON GRADUAL PAYMENT SYSTEM. £1 DEPOSIT, 9/- PER MONTH FOR TEN MONTHS.

Write for further particulars.

WILL DAY, Ltd.,

(THE BEST IN THE WEST),

19, Lisle Street, Leicester Square, London, W.C.2

Telephones (2 lines): Regent 0921 and 0922.

Telegrams: Tilles, Westrand, London.

EELEX WIRELESS ACCESSORIES

are specially designed to minimise the possibility of a wrong or accidental connection; and each individual part is of a standardised size.



EELEX T14E. An Eye Connector specially suitable for connections to accumulators to safeguard a short circuit, etc. Red or black sleeve. Each 2d.



EELEX T14P. This Pin is specially suitable for making connection to terminals, etc. Red or black sleeve. Each 2d.



EELEX T14S. Spade End for immediate multiple connections. Nickel-plated. Red or black sleeves. Each 2d.



EELEX Spring Connector showing method of using a 'phone tag in conjunction with a socket. Spring only costs 1d.

Write for the new EELEX Booklet Y67, which gives full details.

J. J. EASTICK & SONS

EELEX House, 118, Bunhill Row, London, E.C.1

Phone: Clerkenwell 9282-3-4



LISENIN

MADE THEM—

Lisenin, pioneers of the plug and socket terminals, once and for all banished the old eyesore of untidy terminals. Lisenin introduced—and patented—the fool-proof positive Cone grip terminals—the only terminals that ensure a neat and absolutely secure connection.

That is why Mullard and the Six-Sixty circuits specify *Lisenin*; that is why YOU should adopt *Lisenin* terminals. Obtainable at all dealers.

Lisenin Wander Plugs and Spade Ends are also specified by the "Wireless World" for their latest set, the Picture Receiver.

Worth writing for—the New *Lisenin* Booklet.

MULLARD ADOPTED THEM



Look for the Lisenin Show-case on your dealer's counter.

LISENIN

Sole Manufacturers and Patentees: 1C, Edgware Road, London, W.2.



CLAROSTAT

VARIABLE RESISTANCES FOR VOLUME, TONE, DISTANT CONTROL, ELIMINATORS ETC.,

As frequently specified by "The Experts":
• HIGH QUALITY • LOW PRICE •
New 20 Page Brochure free on request.
Many unique circuits.

CLAUDE LYONS LTD.
76, OLDHALL ST., LIVERPOOL

PLEASE be sure to mention "Wireless Constructor" when communicating with Advertisers. THANKS!

THE H.F. VALVE

—continued from page 436

good one which will give you something like amplification.

All H.F. valves give good H.F. amplification when used in modern circuits, provided the constructor of the set keeps to the specification laid down by the designer in the description.

It is useless to build a set with an H.F. amplifier unless the coils and the layout are kept in exact accordance with the instructions. The design of coils plays a tremendous part in the efficiency of such circuits, and because certain types and makes and sizes of coils are advised, and because you have other types and makes and sizes which cover the same wavelengths, it does not mean to say that you can use those others as substitutes.

They may be as efficient or they may not, but ten to one they will not be as efficient and as suitable for the set as those specified by the designer of the set.

The same applies to valves. If you have some valves on hand which you think might do for H.F. valves just as well as those recommended, and say to yourself, "Oh, well, they are only just a little bit below the magnification, I have one with about 13,000 ohms and a magnification of somewhere about 13, surely that will do as well as one with 20,000 ohms and a magnification of 20."

That valve will give results, but it will not work as satisfactorily as a good H.F. valve. It will probably be difficult to neutralise, and you will get nothing like the magnification that the set can provide when used with a really suitable valve.

So let me close this short article with three words which will give you the key to success in all your set building, which will prevent you having to write and say, "I did so-and-so and so-and-so, but the set won't work, can you suggest what is wrong?"

To avoid disappointment and prevent a tremendous loss of time and trouble be sure that you "Keep To Specification," or, put in another way, "Do Not Use Substitutes."

REPAIRS

Any make of L.F. Transformer, Loudspeaker or Headphones repaired and despatched within 48 HOURS—TWELVE MONTHS' GUARANTEE with each repair: 4/- Post free.

Terms to Trade.

TRANSFORMER REPAIR CO., Dept: "C,"

214, High Street, Colliers Wood, London, S.W.19

FOR BETTER RESULTS GOLTONE COILS for the

NEW COSSOR MELODY MAKER CIRCUIT

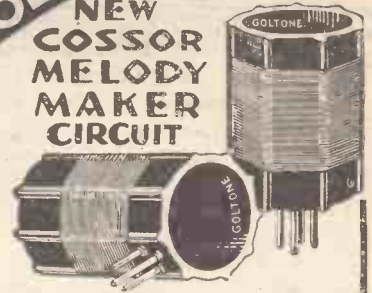

WOUND WITH "GOLTONE" ASTRA MULTI-STRAND SILK-COVERED WIRE.

Infinitely Better Reception—Greater Selectivity—Increased Volume—and enables more stations to be logged.

SHORT WAVE (250-600 metres) Price .. per pair 10/-
LONG WAVE (1,000-2,000 metres) Price .. per pair 12/-

ULTRA SHORT WAVE COILS FOR ABOVE CIRCUIT.

Special "GOLTONE" COILS for short wave stations.

ULTRA SHORT WAVE (From 20 to 100 metres). Price, per pair 10/6

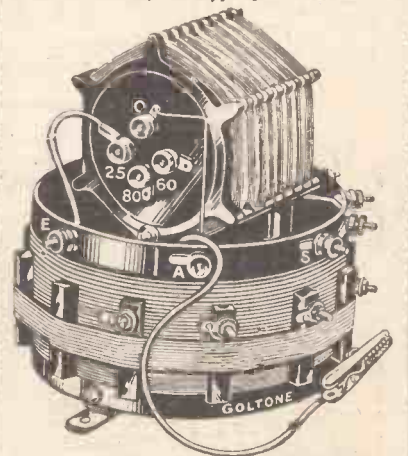

"GOLTONE" SUPER EFFICIENT TITAN COIL UNIT For Best Results

TC/15 .. Price 15/-

"GOLTONE" H.F. CHOKE, TC/17 .. Price 3/9

"GOLTONE" LOADING COIL can be obtained separately if desired. TC/16 .. Price 6/6

PROMPT DELIVERY. Obtainable from all first-class Radio Dealers—Refuse Substitutes. If any difficulty, write direct

Large illustrated Radio Catalogue FREE on request.



London Depot: 5 & 6, Eden Street, Hampstead Road, N.W.1. Phone: Museum 4032/3.

OUR NEWS BULLETIN

—continued from page 452

tests are reported to be encouraging. Of course, before this system can be put into practical use it is absolutely essential that a photo-electric cell be developed which will be capable of handling the fine details which the new system promises.

P.M.G. Holds Tight

It is quite obvious that the Postmaster-General has no intention of parting with the surplus licence money. Last year the fees collected in wireless licences amounted to one and a quarter million pounds, leaving at least a quarter of a million surplus for the Postmaster-General.

In view of this it has been suggested that listening-in licences should be reduced to 7s. 6d. a year, and a question was recently put in the House of Commons to this effect. Obviously, the cost of issuing wireless licences does not come near anything like a quarter of a million a year, and it is about time this very unsatisfactory situation was definitely cleared up.

Fine Figures

Just to remind our readers of the growth of wireless, we are again quoting the figures in connection with wireless licences. The number in force on December 31st, 1926, was 2,178,430; on December 31st, 1927, 2,395,106; and on December 31st, 1928, approximately 2,628,000.

Don't fail to get your copy of

**MODERN WIRELESS
DOUBLE NUMBER**

This March issue—which is now on sale everywhere—is a

Special Constructor's Number and is packed with good things for set-builders and listeners.

Price 1/6 :: :: **GET IT NOW!**

The Flying Squad

The usefulness of wireless equipment in connection with the Flying Squad was demonstrated the other night, for a detective passing Dalston Junction about 7 o'clock saw two men acting suspiciously. He followed them, saw them grab at some leather cases outside a shop, and then dash on to a tramcar travelling towards the Angel.

At the Angel

The detective 'phoned Scotland Yard and a wireless message was sent out to the Flying Squad cars. One of these picked up the tram and followed it to the Angel, where the two men alighted. Here the detective followed them into a café and sat at a table near to them, and, of course, the story ends with one of the men being arrested, while the other one got away.

League Broadcasts

The Secretariat of the League of Nations informed the Federal Radio Commission of America that they will conduct short-wave broadcasting trials during March to the United States, South America, Japan, and Australia. These trials will be a resumption of attempts made by the League last summer to broadcast features which are considered of general interest to the world.

Japanese, Too!

The speeches will be made in English, French, Spanish, and Japanese; and on the 19th and 26th speeches will be broadcast to the American continent in English, French, and Spanish for one hour; on March

(Continued on page 456.)



Write for one of these beautiful Radio Bureaus

and experience the joy and pride of having your set tastefully housed in an exquisitely designed cabinet such as will excite the admiration of your friends. Think of the pleasure it will give your wife, the hiding of unsightly wires and batteries, the freedom from dust and damage, the refinement. You just slide your set in, a matter of a few seconds.

"RADIOLA" WIRELESS BUREAUS

are made in many beautiful models in highest grade oak or mahogany, highly polished. Prices: De Luxe, £5 5 0 to £11 11 0. Popular Model, £3 15 0. Write for price-lists and photos of all models to the *Makers* and have a RADIOLA sent you ON APPROVAL

"The Grand Piano of Wireless"

PICKETT'S
Wireless  Cabinets
CON WORKS BEXLEY HEATH NEAR LONDON

Used by Percy Harris, W. James, etc.



PRECISION RADIO
H.F. SUPER-CHOKE
LABORATORY TESTED
and proved right

PRICE **6/9**

If your dealer cannot supply send us his name and address

We knew from the first one made that the "Precision Radio" H.F. Super-Choke was right, but we sent it for laboratory test for proof positive. The result astonished even us, for the figures showed conditions which were considered beyond reach. An inductance value of 85,000 microhenries, a self-capacity of 2.5 micro-micro-farads are bound to give astonishing results. And here is the perfect choke at last at the price you would pay for an inferior article.

Other "Precision Radio" Components are equally good. Dual-range Coils are a new line and follow the latest practice. Wire-wound Resistances, Anti-microphonic Valve Holders (improved and reduced to 1/3) and Wire-wound Rheostats have long enjoyed widespread favour amongst experts. The "Precision Radio" Wire-wound Rheostat is illustrated at 2/6.



PRECISION RADIO & MANUFACTURING CO. LTD.,
8, Board School Road, WOKING, SURREY

"IT'S A FERRANTI"

The wireless constructor about to build a receiver in which economy must play a part, can make no more satisfactory choice than the Ferranti AF4 Transformer:

In quality of performance it is better than any transformer at its price, and better than many costing more. The AF4 is frequently and freely recommended in the Radio Press.



TYPE A F 4
17'6

FERRANTI

FERRANTI LTD.

HOLLINWOOD

LANCASHIRE



High-grade QUEEN ANNE STYLE FIGURED OAK CABINET

Designed to take Set, Loud Speaker, Accumulators, Batteries, etc. Height 3 ft. 6 ins., width 2 ft. 4 ins. For panels up to 24 ins. x 8 ins. Baseboards up to 12 ins.

£6 : 12 : 6

Carriage Paid.

Prices of other sizes in proportion. Manufacturer of all types of wireless cabinets and furniture of every description. Illustrated lists free.

**GILBERT,
CABINET MAKER,
SWINDON.**

Estimates Free.

Estd. 1866.

NOW ON SALE

Full constructional details of
The "Radiano" Three

and

The "Concert" Four

are obtainable in Envelope form in

THE WIRELESS CONSTRUCTOR

ENVELOPE SERIES Price 1/6

ON SALE EVERYWHERE

By post, 1/9, from Wireless Constructor Envelopes, The Amalgamated Press, Ltd., Bear Alley, Farringdon St., London, E.C.4



The Latest and Best MOVING COIL LOUD SPEAKER

Made exactly to Mr. W. James' specification.

SOLD AS A KIT OF PARTS FOR £4-4-0, AND CAN BE ASSEMBLED WITH PERFECT EASE BY ANYONE.

Demonstrations given daily at 21, Bartlett's Buildings, Holborn Circus, E.O.I. Literature from here or Nottingham Road, Mansfield, Notts.

The "Lodestone"

Send for Full Particulars.

WHITELEY BONEHAM & CO., LTD.
Nottingham Rd., Mansfield, Notts.



For 3, 4, or 5
Volts, Panel
14" x 6"
Complete
45/-



**FOR
PORTABLE
AND
TRANSPORTABLE
CASES**

In all Finishes

SEND FOR LATEST LIST TO
CARRINGTON MFG. CO., Ltd.

Camco Works, Sanderstead Rd., South Croydon.
Telephone: Croydon 0623 (2 lines).

**THERE MUST
BE A REASON-**

Why Celestion is the most popular Loud-Speaker among the many thousands of Listeners.

**IT IS
RECOGNISED**
as the one Loud-Speaker which shows you just how good Broadcast transmission really is.

CELESTION

THE VERY SOUL OF MUSIC

Models from £5:10:0. Made under Licence. Insist on your dealer demonstrating or call at our showrooms, one minute from Victoria Station, where you can also hear the finest sets. Write for illustrated Booklet to:—

CELESTION LTD. (DEPT. L),
KINGSTON-ON-THAMES

Showrooms :
106, VICTORIA STREET,
LONDON - - - S.W.1



Model C.12.

WHEN A BETTER LOUD-SPEAKER IS
MADE—CELESTION WILL MAKE IT.

* THE FARADAY *
* CENTENARY *

A CELEBRATION will be held in 1931 in connection with Faraday's great discoveries, and, at a recent meeting at the Royal Institution, Sir William Bragg, the Director, explained the proposal for this celebration. He pointed out that 1931 was the centenary of one of Faraday's greatest discoveries, and on that discovery rested a vast body of scientific development, and also the industrial development of the last part of the last century.

Faraday's work had touched so many developments in science and industry that a great number of parties were interested. There were, also, the great developments in electricity, electro-chemistry and many other instances that would help people all over the world to realise the work which Faraday did in the building of the Royal Institution.

The Faraday centenary would mark the work of a very great Englishman. Sir Ernest Rutherford, President of the Royal Society, also spoke approvingly of the arrangements for the centenary. He pointed out that possibly no scientific discovery had had so much practical effect on the world as Faraday's discovery of electro-magnetic induction.

Plans were also being made for the celebration, in 1931, of the centenary of the birth of James Clerk-Maxwell, one of the greatest figures in Natural Philosophy.

Sir Ernest pointed out that in a sense Maxwell was the interpreter of Faraday, and put in mathematical form the latter's ideas. The great strides in radio-telegraphy had practically depended on the utilisation of Maxwell's electro-magnetic theory. Sir John Reith, who also spoke, pledged the B.B.C. to co-operate as far as possible.

A TESTING TIP.

When checking over a valve set to find a fault, it is necessary to test the legs of the valve when inserted in its holder. It is useless to check at the valve-holder's terminals, because there may be no contact between the pin and its socket.

PAREX SCREENS FOR THE

"AIR COMMANDER"

Copper Screen (as specified), 4/6

THE "THREE CHOICE" 4

Copper Screens (as specified) 12 - 6"; 12" x 2 3/4" 4/6

From your dealer or direct from—

E. PAROUSSI, 10, Featherstone Bldgs., HIGH HOLBORN, W.C.1.

Phone: Chancery 7010

OUR NEWS BULLETIN

—continued from page 454

20th, and 27th, in Japanese for half an hour; on March 14th, 21st, and 28th, in English to Australia for half-hour periods.

The call-sign of the station will be P C L L, and wave-length 18.4 metres.

"Communing" With Mike

Some time ago three Communists in Berlin abducted a Socialist journalist who was to give a talk from a broadcasting station. One of the abductors took the journalist's place before the microphone, and astonished listeners with a long tirade of a Communist character.

As a result of this broadcasting hoax, which some of our readers may have heard, the ringleader of the three, a young Austrian, Carl Franck,

HE WHO RUNS . . .

A wireless set without much technical knowledge

MAY READ . . .

all about beginners' problems in the Radiotorial Columns of

POPULAR WIRELESS

Every Thursday :: Threepence

with a university degree, was sentenced to four months' imprisonment; his two companions got off with three months apiece.

The Hague Conference

A conference is to be held at Prague, in April, on the subject of wave-lengths. The Brussels plan, as most of our readers know, has not been working too well, and the allocation and readjustment of European waves for broadcasting and commercial telephony will occupy the larger part of the agenda.

A Watching Brief

Most of the leading continental states will be represented, and the United States of America will be sending a representative to hold a watching brief. It is to be hoped that this Conference will result in some definite arrangement for clearing up the chaos which still exists in the ether, despite the re-arrangement of wave-lengths according to the Brussels plan.



ARE YOU GOING TO BUILD A SET?



If so, you must not miss the new

"BESTWAY" WIRELESS BOOKS

Four Fine Sets in Each!

"Bestway" No. 328 tells you how to build

- | | | |
|---------------------------------|--|-----------------------|
| A Wave-Change One-Valver | | A Two-Valve Amplifier |
| The "Bestway" Wave-Change Three | | The Home-Circle Four |

"Bestway" No. 329 contains full details of

- | | | |
|--------------------------|--|---------------------------|
| A "Regional" Crystal Set | | A One-Valve Amplifier and |
| An All-Wave Two-Valver | | The S.G. & Pentode Three |

PRICE
6d.
NOW
ON
SALE



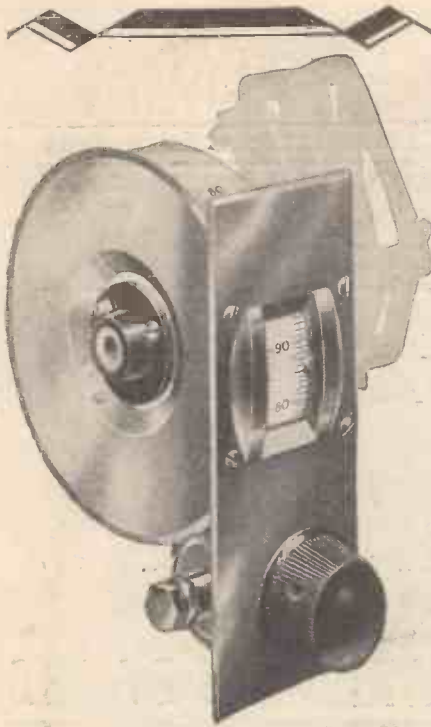

A Real DRUM DIAL

It has been left to J.B. to improve on models of recent years and to produce a perfect rum Dial—the only *real* Drum Dial.

The design is most ingenious, the control knob being placed just under the scale which is thus flush with the panel plate and easily readable. Positive Friction Drive eliminates backlash. This new product reaches that high standard of finish and precision found in all J.B. instruments.

The Condenser may be mounted on left or right of Dial. The Drive will handle a heavy gang condenser with ease. Panel Plate in either bronze or oxydised silver.

PRICE **10/6** COMPLETE

The Drum Dial is designed so that it can conveniently be used as a Dual Gang Unit by adding one left-hand Condenser and bracket. Price, complete, '0005, £1-10-6; '0003, £1-8-6.



**PRECISION
INSTRUMENTS**

Advt. of JACKSON BROS., 72, St. Thomas' Street
London, S.E.1 Telephone: Hop 1837.

THE "AIR COMMANDER"

—continued from page 409

6-volt valves should be used throughout, but admirable results are obtainable on 2-volt valves. The tests to which I have referred were carried out with 2-volt valves so that they should be possible on an average aerial by any reader.

It is possible to use a 2-volt screened-grid valve while the rest can be 6-volters by using a fixed resistor of 25 to 30 ohms connected *in series* with the volume control. This value is correct for a screened-grid valve working at 2 volts and 15-ampere filament current. If, however, the screened-grid valve should be one with a filament current of only 1 amp., then the fixed resistance should have a value of 40 ohms. Similarly, to use a 4-volt screened-grid valve with 6-volt valves in the rest of the set a fixed resistor of 20 ohms will suit (assuming the screened-grid valve to be working at 4 volts and 1 ampere). In all of these cases the volume control can be used in the normal way.

The H.T. Voltages

After the set is wired up very little adjustment is necessary, and it is only needed to attach a high-tension supply of 120 to 150 volts to the H.T. terminals, and a low-tension supply at whatever voltage the valves need to the L.T. terminals. Grid bias will be set according to the super-power output valve used and the makers' leaflet will give the necessary value for the voltage here. The maximum H.T. voltage should not be higher than 150 here, and 120 will suit excellently.

The values of the wire-wound resistances given are for the H.F. type of valve in the neutralised H.F. stage and in the detector stage. The resistance used for bringing down the voltage to the screening grid can be anything from 40,000 to 100,000 ohms and, generally speaking, 100,000 ohms will be found to suit all the screened-grid valves on the market.

On some of the 2-volt makes, however, slightly better results are obtainable with resistances of a lower value than 100,000. The experimentally inclined reader can try various values here, but 100,000 ohms can be taken as a standard.

Neutralising is very simply effected if you are living about 15 to 20 miles from a main station. First of all, tune in your station the loudest with the volume control full on and no reaction. Next disconnect one wire from the

filament of the neutralised H.F. valve, and put the plates of the neutralising condenser "full in." Now slightly retune if necessary and you will hear the local station very loudly in your loud speaker. Slowly turn the neutralising condenser and signals will become weaker and weaker until a point is reached when you will hear nothing from the local station.

Completing Neutralisation

Make sure you have this point sharply, using a little reaction so as to bring the strength back again, and after a few trials you will find a clearly-defined position on the neutralising condenser where nothing can be heard from the local station.

When this point has been found reconnect the filament and your set is then neutralised and will remain so without any further adjustment until you change the valve for another.

If you are not very near to a station and cannot adopt this method, set the moving plates to a position approximately a quarter interleaved

"Wireless Constructor" Envelopes

covering the following sets can now be obtained:

The "RADIO" THREE
The "CONCERT" FOUR

Price 1/6 per envelope at any bookseller, or by post direct from "Wireless Constructor" Envelopes, The Amalgamated Press, Ltd., Bear Alley, Farringdon Street, London, E.C.4

with the fixed. Set both variable condensers at the bottom of their range and turn them backwards and forwards to see if at any position of the two oscillation occurs when no reaction is used. If it does not, well and good, but if the set seems a little unstable and tends to oscillate, then readjust the neutralising condenser until stability is reached.

Set Very Stable

The receiver is very stable and the set will not oscillate over quite a wide range of settings on the neutralising condenser. When you are very near a station it is best to have it accurately neutralised in the manner above described as this will probably improve your selectivity so far as getting rid of the local station is concerned.

(More about this remarkable receiver next month!)



**DUBILIER
DUMETOHM**

A high resistance of special construction which has many uses and is supplied in nine resistance values—'25, '5, 1, 1'5, 2, 3, 4, 5 megohms. Other higher values specially to order. Holders are supplied either horizontal or vertical.

If unobtainable from your dealer write to us giving his name and address.

**DUBILIER
CONDENSERS**

DUBILIER FOR DURABILITY

PRICES
Dumetohms, all resistances
2/6 each
Holders, Horizontal or Vertical
1/- each

Advertisement of the Dubilier Condenser Co. (1925), Ltd., Ducon Works, Victoria Road, N. Acton, London, W.3.

©181

TELSEN

TRANSFORMERS



MADE BY
TELSEN
ELECTRIC
Co. Ltd.

give purity of tone and a full degree of amplification unrivalled by instruments costing considerably more, **TELSEN** popularity was built up by efficiency in the first place, backed by remarkable value.

Guaranteed 12 months. ENTIRELY BRITISH. Ratios 5-1 or 3-1 and **SOLD EVERYWHERE**

Illustration shows the "RADIOGRAND." **12/6**
TELSEN ELECTRIC Co., Ltd.,
207, Aston Road, Birmingham

THE ONLY BRITISH VALVE WITH A WRITTEN GUARANTEE AS TO PERFORMANCE AND LIFE.

All orders executed by return of post.

Matched valves 1/- extra.



WHY USE FOREIGN VALVES ?

There is a lot of talk about unemployment, yet no less than TWO MILLION Foreign Valves are sold annually in this country!!! We want this trade. We don't want protection. We only want you to know that you can buy a better valve fully guaranteed for 3/6. British made to the hilt. "P.R." Valves are British standard—second to none made anywhere. We still stick to our guns. Try one—no risk; if not fully satisfied that it equals your favourite at any price your money will be refunded by return. You are the sole judge.

3/6	Type	Fil. Volts	Amp.	Imp. Ohms.	Amp. Fac.	
Post 4d.	PR 2	2	-095	28,000	13	H.F. Det.
	PR 3	2	-095	15,000	8	L.F.
	PR 4	2	-095	120,000	32	R.C.
	PR 9	3-5-4	-063	18,000	14	H.F. Det.
2 VALVES OR MORE POST FREE.	PR10	3-5-4	-063	10,000	8-7	L.F.
	PR11	3-5-4	-063	88,000	40	R.C.
	PR17	5-6	-1	18,000	17	H.F. Det.
	PR18	5-6	-1	9,500	9	L.F.
	PR19	5-6	-1	80,000	40	R.C.
POWER 7/6 Each Post 4d.	PR20	2	-15	7,000	6	Power
	PR40	4	-15	7,000	6	"
	PR60	6	-1	5,000	6	"
SUPER POWER 12/6 Each Post 4d.	PR120	2	-3	2,750	4	Super Power
	PR140	4	-2	2,500	4	"

WHAT OTHERS SAY OF P.R. VALVES.

POPULAR WIRELESS, Sept. 8, 1928: "Has quite remarkably good characteristics, and should appeal to those to whom the price of the usual British valve is still too high."
AMATEUR WIRELESS, 14/3/28, says: "The characteristics of this Valve compare favourably with many well known makes."
GUARANTEE. All valves despatched under guarantee of Money Back in Full if not satisfied within 7 days. All valves are carefully packed and breakages replaced.

P.R. VALVES (Opposite Post Office Tube), 17-53, Paternoster Square, London, E.C.4.

THE 100% Broadcast Receiver
BUILD and OPERATE in ONE EVENING
FORMO Screened Grid

FAMOUS FORMO COMPONENTS as used in this Set and in ALL NOTABLE PUBLISHED CIRCUITS

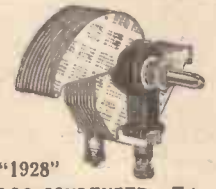
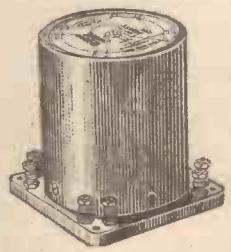

FORMO-DENSOR 2/-
In four variable capacities

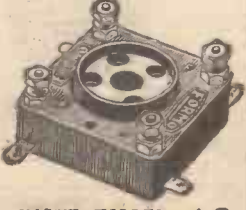

VALVE HOLDER 1/3

TRANSFORMER-OUTPUT FILTER CHOKE 25/-

"1928" **LOG CONDENSER** 5/-
'0005 '00035 '00025

"De Luxe" Model **6/-**
'0005 '00035 '00015

COILS SG 1 & 2 10/6 each

BRITISH Components Throughout
Send for Catalogue.

THE FORMO CO., CROWN WORKS, CRICKLEWOOD LANE, LONDON, N.W.2.

MAKING MOVING COILS

—continued from page 422

tapped choke, then the impedances of the two valves are virtually in parallel, so that the impedance of the combination will be half the impedance of one of them.

So long as a step-down transformer of any kind is not being used the next step is simply to read off in column A of the table the combined impedance obtained in the way just described, and in the corresponding columns we see the number of turns and gauge of wire suitable for a coil of 1 in. diameter.

LISTENERS FLY



THREE READINGS ON ONE DIAL.

Readings :
 0-6 VOLTS Crystallised
 0-150 VOLTS black finish,
 0-30 MILLI- fully guaran-
 AMPS teed.
 RES. 5,000 Can be used as
 OHMS. a Pole finder.

Price **8/6**

If you want to get the best from your set—use a Wates Meter and surprise yourself with the wonderfully improved reception that this super-meter ensures. It gives both volt and amp. readings that any expert will tell you are the essentials to perfect set control. It costs but 8/6 and gives three dead beat readings from one clearly engraved dial. Fully guaranteed. From your dealer or direct complete with explanatory leaflet. Stocked by Halford's Stores, Curry's Stores, and all radio dealers.

"CERTAINLY WORTHY OF A PLACE ON YOUR WIRELESS TABLE."—Vide "THE DAILY MIRROR."

Tested against very much more expensive instruments the "volt amp" shows accurate readings. Possession of this "Three-in-one" meter will greatly help towards the better running and care of a Receiver and Batteries, for it is perfectly simple to use, convenient in size, very reasonable in price, certainly worthy of a place on your wireless table. Extract from "The Daily Mirror," Feb. 14th, 1929

TO THE WONDERFUL

WATES
three in one
VOLT AMP
 RADIO TEST METER

8/6

M.S.

The Standard Wet-Battery Co.
 Dept. W.C., 184-188, Shaftesbury Avenue, London, W.C.2.

Of course, if the calculated combined impedance does not coincide exactly with any of the values given in the table, either the nearest value should be chosen or a compromise made according to the amount of the difference. In any case, the number of turns so obtained is solely meant for a 1-in. coil, hence for a coil of any other diameter we simply have to divide the number of turns for the 1-in. coil by the diameter of the coil required, the gauge of the wire remaining the same.

A Practical Example

Now, if a step-down transformer is being used, whether it be a straight transformer or a push-pull transformer, we have to take into account the step-down ratio and thus find what we will call the "effective impedance" of the output valve or valves. This is done by taking the combined valve impedance obtained as described above and dividing this by the square of the transformer ratio.

This is, then, the figure which we read in column A, and so obtain the number of turns and gauge of wire for a coil of 1 in. diameter. For other sizes of coils the method of modification applies as before.

Let us finally consider two typical examples :

(1) Two P.625A valves are used in push-pull, employing a centre-tapped choke output and a coil of 1½ in. diameter is required.

Now, the impedance of a P.625A valve is 1,600 ohms, and since our two valves are in series their combined impedance is 2 × 1,600=3,200 ohms. From the table we see that the nearest figure in column A is 3,500, and for this a 1-in. coil should consist of 2,000 turns of No. 46 S.W.G.

(Continued on page 461.)

The BEST WAY

to achieve
IDEAL RADIO RECEPTION
 is to scrap your OLD and OUT-OF-DATE Components and build a set with the latest products of TECHNICAL SKILL.

OUR **EASY TERMS**

Enable you to reach this Ideal.
ALL COMPONENTS SUPPLIED FOR MULLARD MASTER 3 : COSSOR MELODY MAKER ; LISSON 5-G-3 ; MASTER 5 PORTABLE, Etc.

EVERYTHING WIRELESS

PORTABLE SETS from 16 gns.—Pye, Lotus, Halcyon, Lissen, etc.
 H.T. UNITS from 17/6—EKCO, ATLAS, MARGONI, etc.
 LOUDSPEAKERS from 29/6—Celestion, Amp-lion, M.P.A., etc.

BEST MONTHLY TERMS QUOTED BY RETURN

CASH ORDERS PROMPTLY EXECUTED
 Call or send list of requirements. Hundreds of Satisfied Customers recommend us.

The P.D.P. Co., Ltd.
 (Dept. C.), 121, CHEAPSIDE, E.C.2.
 Telephone: City 9846

READY RADIO

159, Borough High St., London Bridge, S.E.1
 3 Minutes from London Bridge Southern Jly. and Tube Stations Phone: HOF 5555.

IMMEDIATE DESPATCH
 of ALL the CORRECT Parts for
THE "AIR COMMANDER"

	£	s.	d.
1 Ready Radio Cabinet	1	12	6
2 Pairs of Ready Radio Brackets	5	0	0
1 Panel, 21 in. x 7 in.	12	3	0
1 Rothermel Knob Control, double type "Pilot" drum dial with lamp	4	0	0
2 Rothermel K.K. Arrow Knobs, No. 18	1	4	0
1 On-off Switch	1	1	6
2 Ready Radio Standard Screens	5	0	0
2 Lissen .0005 Variable Condensers	13	0	0
1 Cydon .0001 Reaction Condenser	7	6	0
2 Lewcos 6-pin Bases	5	3	0
4 Lotus Valve Holders	5	0	0
2 Ebonite Panels, 4 in. x 4 in. x 1 in.	2	2	6
1 Lissen 50 ohm Rheostat	2	0	0
1 Lissen Resistance, with Holder, 100,000 ohms	5	6	0
1 Lissen Resistance, 2,500 ohms	3	6	0
1 Lissen Resistance, 20,000 ohms	3	6	0
1 Lissen Resistance, 10,000 ohms	3	6	0
1 Dubilier .002 Fixed Condenser	3	0	0
2 Dubilier .01 Fixed Condensers	5	0	0
1 Dubilier .001 Fixed Condenser	3	0	0
2 C.C. .0005 S/P Fixed Condensers	7	0	0
2 Dubilier 2 meg. Grid Leaks	5	0	0
2 R.I.-Varley R.F. Chokes	19	0	0
1 Magnum Neutralising Condenser	5	0	0
1 Ready Radio Fuse and Bulb	1	3	0
2 Dubilier 2 mfd. Fixed Condensers	7	0	0
1 Marconiphone Ideal Transformer, 4-1	1	5	0
1 R.I.-Varley Output Choke, 28/14	1	1	0
2 Terminal Strips	1	9	0
10 Belling-Lee Indicating Terminals (insulated)	5	0	0
1 Lewcos B.A.C.5	10	0	0
1 Lewcos B.S.P.5	15	0	0
1 Lewcos B.A.C.20	12	0	0
1 Lewcos B.S.P.20	1	0	0
4 Valves (as specified)	2	18	6
PRICE (including Valves)	£17	13	0

Any of the above parts can be supplied separately.

WRITE or WIRE 144-page Illustrated General Catalogue, 1/- post free.
 All orders post free. Overseas orders carefully packed and insured, charges forward.

National Physical Laboratory Test Report shows Breakdown-8000volts



But Belling-Lee terminals proved equal to the terrific test and refused to "short circuit." Belling-Lee bakelite insulation was responsible for this remarkable achievement. It will pay you to buy these terminals.

Type 'B', 6d. Smaller insulated model, type 'R', 3d. For instruments where insulation is not important our type 'M' terminal at 4d. is ideal. All types made in 40 different engravings.

BELLING-LEE TERMINALS

Belling & Lee, Ltd., Queensway Works, Ponders End, Middx.

**ELIMINATE
ELIMINATOR
TROUBLES
WITH A
SIFAM
"ELIMETER"**

Do you know the current delivered by your Mains H.T. Eliminator? Volume and quality depend entirely on the plate voltage recommended by the valve manufacturers. Without an "Elimeter" you are completely in the dark. The Sifam "Elimeter" is designed specially for this work and gives accurate dead-beat readings up to 220 volts. Res. 100,000 ohms. Hand-some metal Dial. Price 30/- Ask your dealer and write for interesting leaflet. "What simple meters can show you," to Dept. W.G.

SIFAM ELECTRICAL INSTRUMENT CO., LTD., Bush House, Aldwych, W.C.2.

300 volts Combined res. 35/-



500 volts Combined res. 37/6

M.B.

MAKING MOVING COILS

—continued from page 460

Hence, for 3,200 ohms the number of turns will be slightly lower, in fact, about 1,900 turns. Hence, for a 1½-in. coil the number of turns should be $\frac{1,900}{1\frac{1}{2}} = 1,270$ (very nearly).

That is to say, the coil required is 1,270 turns of No. 46 S.W.G.

(2) Three Cosmos A.C./R. valves are used in parallel with a 25:1 step-down transformer, and a coil of 2 in. diameter is required.

Now, the impedance of one A.C./R. valve is 2,500 ohms. Hence, the combined impedance of three of these valves in parallel will be

$$\frac{2,500}{3} = 833 \text{ ohms.}$$

Since a step-down transformer of ratio 25:1 is used, the effective impedance will become

$$\frac{833}{25^2} = \frac{833}{625} = 1.3 \text{ ohm.}$$

From the table we see that for 1.3 ohm in column A a 1-in. coil would require 34 turns of No. 26 S.W.G. wire, or No. 25 S.W.G. Therefore, the number of turns for a 2-in.

coil is $\frac{34}{2} = 17$. The coil required will then consist of 17 turns of No. 26 or 25 S.W.G.

For the Pentode.

It will be noticed that the high values of impedances associated with pentodes are not included in the table. If we were to include these we should find that in some cases No. 48 wire is the best, while for the highest impedances No. 49 would be required.

This latter is practically unobtainable, and even if it were the corresponding number of turns would be so great that for choke output, for example, it is doubtful whether the very high inductance choke which the coil would demand in the anode lead would be a practical proposition.

For use with the present-day pentode it is advised that the coil consist of no more than 4,000 turns of No. 48 S.W.G. for a coil of 1 in. diameter.

When a pentode is used with an output transformer the coil winding should be calculated as in the way for any other valve, and then the number of turns so obtained should be decreased by approximately 25 per cent, otherwise the reproduction of the low notes will suffer.

A HIGH MAST IS EQUAL TO TWO EXTRA VALVES

Everybody knows that to have a high aerial is to get extra powerful signals. The difficulty of fixing up a high aerial is banished if you fit a

P.R. PATENT STEEL MAST

**DAMP PROOF!
ROT PROOF!!
GALE PROOF!!!**

26 Feet high. In 3 sections of 1½ in. Steel tube tapering to 1 in. Carriage, London, 1/6; Midlands, 2/6; elsewhere, 3/6. Weight 24 lbs. Two masts for 28/0.

34 Feet high. In 4 sections of 1½ in. Steel tube tapering to 1 in. Carriage, London, 2/-; Midlands, 3/-; elsewhere, 4/- Weight 34 lbs. Two masts for 40/-.

THE JOY OF SURPLUS POWER

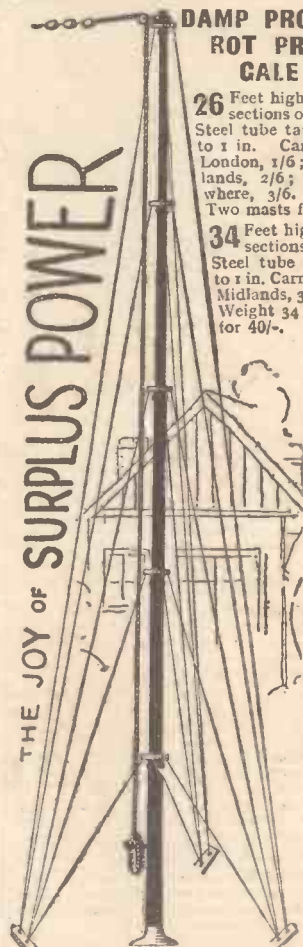

The "Super" Mast.

42 Feet high. In 5 sections of heavy 1½ in. Steel tube tapering to 1 in. A real bargain. Carriage, London, 2/6; Midlands, 3/6; elsewhere, 4/6; Weight 46 lbs. Two masts for 55/-.

P.R. MASTS

are made of British Steel in 9 ft. lengths, from 1½ in., tapering to 1 in., and are supplied with cast-iron bed plate, steel ground pegs, stay rings, galvanised steel flexible wire stays cut to lengths, pulleys, bolts, and fullest erecting instructions. No further outlay necessary.

NO HOLES TO DIG. ONE MAN'S JOB.

Any intelligent man can assemble and erect a P.R. Mast in a couple of hours. Our patent Mast being tapered, it is easy for anyone to raise it from the ground into position. Ordinary tubular Masts require several hands and difficult rigging to do this. To help you the wire rope is sent out to size—a saving of endless worry. Imagine sorting out 500 ft. of rope in your back garden!

Minimum Radius 3 ft. 6 in. The easiest Mast to erect.

GUARANTEE. Money refunded without question if not satisfied and the Mast is returned within 7 days without attempts to erect. The simple instructions are so clear mistakes cannot be made.

PAINTING. Any protective coating applied before dispatch gets so damaged by the Carriers that it is essential to paint the Mast before erection. All P.R. Masts are sent out oxide-finished ready for painting. One coat of P.R. Colloid covering applied—a 10 minutes' job—to all parts of the Mast when ready to erect sets dead hard in an hour and protects it against all weathers.

PRICE OF ACCESSORIES. P.R. Colloid Covering sufficient for a Mast—with brush, 2/6. Halyard Log Line—Hyland's patent rot-proof: For 26-ft. Mast, 1/6; 34 ft., 2/-; 42 ft., 2/6. Per 100 ft., 3/-. Note.—Double length supplied to make lowering of Aerial easy.

A HIGHLY EFFICIENT AERIAL. P.R. Aerial is made of 14-28 High Conductivity Pure Copper Enamelled Wire—each strand insulated from its neighbour to give the highest signal strength obtainable. 100 ft., 4/3; 50 ft., 2/3.

G.O.D. Telephone: City 3788. 17-51, PATERNOSTER SQUARE, LONDON, E.C.4

P.R. MASTS Opposite G.P.O. Tube. IF YOU USE VALVES it will pay you to write to us for particulars of the famous 3/6 range of P.R. valves. Each valve has a written guarantee of life and performance.

SOLVE ALL H.T. TROUBLES

WET BATTERIES

TAYLEX

~ SELF GENERATING ~

LONG LIFE SILENT ECONOMICAL



JARS (waxed) 2½" X 1½" sq. 1/3 doz. ZINCS, new type, 10d. doz. SACS, 1/2 doz. Sample doz. (18 volts), complete with bands and electrolyte, 4/1, post 9d. Sample unit, 6d. illus. booklet free. Bargain list free.

AMPLIFIERS 30.- 3-VALVE SET £5

C. TAYLOR, 57, Studley Road, STOCKWELL, LONDON.

The Picture Paper with the MOST News
:: SUNDAY GRAPHIC ::

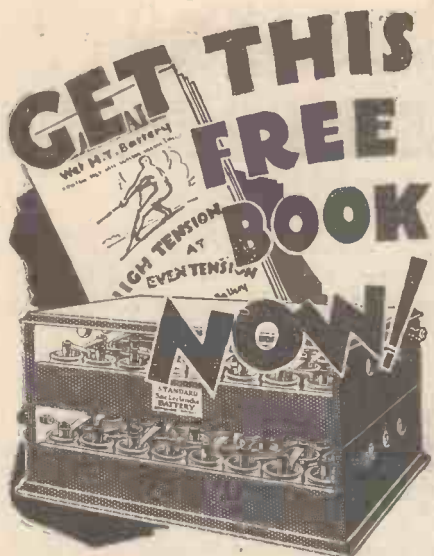

ALL ABOUT THIS AMAZING PERMANENT HIGH-TENSION BATTERY THAT LASTS FOR YEARS

Why spend another penny on costly battery replacements—when you can instal the super and money saving STANDARD Battery and secure permanent H.T. that lasts for years. Positively self-regenerative. Recharges itself overnight. Constant, non-varying flow of H.T. all the year round. Eliminates background, improves tone. All that is necessary to maintain the voltage is replenishment of the elements at long intervals, beyond which little or no attention is needed. The only form of permanent H.T. that really solves the problem. Over 100,000 in use. Fill in the Coupon NOW!

Mr. H. Barton Chapple, W.H.Sch., B.Sc. (Hons. Lond.), etc., etc., the well-known radio expert, says: "I was installed fourteen months ago unhesitatingly recommend this particular battery as being of the highest grade and amply fulfilling the claims of its makers."

STANDARD
SAC REBRANCHE

Popular Model 96-volt Unibloc Battery, completely assembled as illustrated. Cash £2 3 1/6 or 7/6 down and five monthly payments of 7/6. No res., no deposit. Any voltage battery supplied from 1 1/2 volts upwards. Our latest No. 4 cell battery from 60-300 volts gives 60 milliamps capacity.

TO The Standard Wet Battery Co. (Dept. W.C.), 184-188, Shaftesbury Avenue, London, W.C.2.

NAME.....
ADDRESS.....

PREVENT THAT ACID CREEPING!

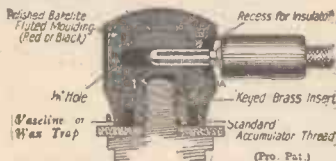

CLIX KNOBS on your accumulator means an end to corroded terminals, bad contact, noisy reception, and all the troubles and damage caused by the creeping of acid. THE VASELINE TRAP in the Clix Knob makes corrosion impossible and ensures clean contact. Connection is made by inserting Clix-Lox or Clix Parallel Plug in socket provided.

Red or Black, 5d. each.
LECTRO LINX, LTD., 254, Vauxhall Bridge Road, London, S.W.1.

Make
The DAILY SKETCH
YOUR Picture Paper

RADIOGRAMOPHONICS

—continued from page 420

ready a day or two beforehand so that it may be thoroughly tested out.

If any accumulators are used these should be charged just before the important day. Do not run the risk of a failure by using doubtful batteries that are running low. Purchase new ones beforehand.

A useful idea to avoid delay and make things go with a much better swing is to have two gramophones. Two pick-ups will then be required. Obtain a double-throw switch of some sort which has two sets of contacts, and connect up as follows. The two centre contacts go to the pick-up terminals of the amplifier, and the two pick-ups are joined to the remaining two sets of contacts. This switch will then make it possible to change from one record to another without a break. As one record finishes the other is started and the switch thrown over.

If it is desired to make announcements via the loud speaker, all that has to be done is to connect a loud speaker across the pick-up terminals of the receiver. It will then become a very sensitive microphone. [Even a pair of sensitive telephone receivers may be employed for the transmitter.

A New Pick-up

We have recently received for test one of the Webster pick-ups, marketed in this country by Messrs. Rothermel.

The model submitted consists of a combined pick-up, pick-up arm, and volume control, and is suitable for use in home-constructed "Radio-Gram" outfits.

The instrument is stoutly constructed and well finished, but this is only what one would expect in view of the price, which is £4 4s.

The pick-up itself is designed on the permanent magnet principle—that is, it does not require a separate exciting battery. It is sensitive and could be used in conjunction with a high-magnification two-stage amplifier of modern design. We are of the opinion that the pick-up is rather on the heavy side, but whether or not this would have any appreciable effect on the life of the record it is impossible to state. In any case, prolonged use would be the deciding factor, and a comparison would have to be made with a sound-box of normal type. The idea of using the base of the pick-up arm as a housing for the volume control is quite sound, and the control is very effective in practice.

TO HOME CONSTRUCTORS

Build the Peerless "Resonic 2"

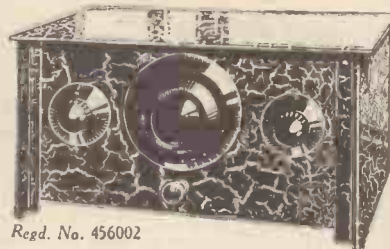

Regd. No. 456002

Anyone can build this set in 60 minutes. No drilling. No soldering. All wires cut and bent. JUST ASSEMBLE and then immediately enjoy the radio entertainment which is of splendid tone and comes in at good loud-speaker volume. Circuit allows use of standard valves (1 H.F. and 1 Power).

COST ONLY
£3.15.0

Blue Print and easily followed Diagram of Connections included with every set. Cabinet and full Kit supplied in Carton.
Obtainable from all dealers or
THE BEDFORD ELECTRICAL & RADIO CO., LTD.,
22, CAMPBELL ROAD, BEDFORD.
Scottish Office: 113, St. Vincent St., Glasgow, C.2.

Go to Goldsman!
RADIO REPAIRS

Go to Goldsman for Radio repairs. Every type of set—BRITISH, AMERICAN, CONTINENTAL. Every type of Moving-Coil Loud-Speaker, Power Amplifier, All-Electric Sets and Components.

Just send a postcard and Goldsman will put your troubles right at really reasonable prices.

Our experience is based on nearly 20 years in wireless.

J.L. Goldsman
I.R.E. A.I.F.E.

4, GREAT QUEEN STREET, W.C.2.
(One minute from Holborn Restaurant.)
TELEPHONE: HOLBORN 8338.

EQUAL TO THREE ORDINARY BATTERIES

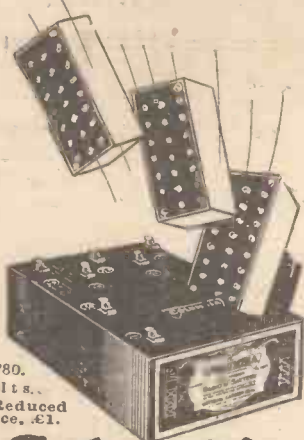

No. 4780.
60 volts.
New Reduced
Price. £1.

Columbia RADIO BATTERIES

The Columbia No. 4780 Triple Capacity H.T. Battery possesses the emission, the lasting power, and the quality of three ordinary batteries.

For the man with the good Receiver, this Columbia battery is indispensable. It's as essential as the good valves he uses.

J. R. MORRIS,
Imperial House, 15, Kingsway, LONDON, W.C.2.
SCOTLAND—**J. T. Cartwright,** 3, Cadogan Street, Glasgow.

ARTCRAFT RADIO CABINETS
BRITAIN'S BEST VALUE
New Catalogue Free
THE ARTCRAFT COMPANY
156, CHERRY ORCHARD R' CROYDON

VOLUME CONTROL



The VOLUVERNIA

THE GAMBRELL VOLUVERNIA
Is a small, neat, compact and efficient Volume Control with a continuous and evenly variable control from full strength right down to nothing. Excellent for use with gramophone pick-up as well as radio.

GAMBRELL RADIO Ltd.
6, Buckingham Street, Strand, London, W.C.2

PLEASE be sure to mention "Wireless Constructor" when communicating with Advertisers. THANKS!

FACTS ABOUT ENERGY

EVERY amateur knows that only a fraction of energy sent out by a wireless transmitting station is picked up by his receiving aerial, and that despite directional wireless and other improvements in the conservance and direction of energy, a wireless transmitting station really relies a considerable amount on its power and is, in fact, quite a wasteful piece of mechanism.

The other day, Mr. Alexander Wood gave a lecture at the Institute of Electrical Engineers on Sound Waves and their Uses, and he pointed out a fact which probably will interest many amateurs: that, for example, a cornet blower only gets a thousandth part of his energy turned into sound. Mr. Wood also pointed out that in the case of signalling by air, much less audibility and much greater variations in audibility were got than might be expected, and, as an example, he mentioned a siren used at sea which, from a theoretical point of view, should be audible over a quarter of the transference of the globe, yet actually in practice it could only be heard from ten to fifteen miles away.

Peculiar Effects

Referring to the case of the human voice, Mr. Wood pointed out that only 1 per cent of the energy reached the ears of an audience, and yet practically the human voice and the apparatus for transmitting it was one of the most efficient known to science.

The most efficient of all, however, was an instrument called The Bombardino, which yielded 1.2 per cent. Mr. Wood went on to explain that variations in atmospheric conditions were the main cause of inaudibility. For example, when the air near the ground was warmest, in the middle of a warm day, with a clear sky, the sound waves were bent away from the earth, with the consequence that audibility was poor, but when the air near the ground was coolest—let us say, in the evening of a hot day, with a clear sky—the sound waves were bent towards the earth, and the audibility became good.

Referring to what is known as the silent zone, Mr. Wood pointed out as an example the great Silvertown explosion of January, 1917. He stated

(Continued on page 464)

K. RAYMOND
27 & 28a, LISLE ST., LONDON, W.C.2
Come to LEICESTER SQUARE TUBE.
This address is at the back of Daly's Theatre. 'Phones: Gerrard 4637 and 2821

WE ARE OPEN
ALL DAY EVERY DAY Hours 9 a.m. to 8 p.m.
ALL DAY SATURDAY Sat. 9 a.m. to 9 p.m.
ALL DAY THURSDAY Sunday morning 11-1

MULLARD MASTER 3*
3 Valve Holders, Lotus, at 1/3; Combined Wave Coil, 17/6; Permacore Transformer, 25/-; Climax "LFA" Transformer, 25/-; Climax H.P. Choke, 7/6; Benjamin Battery Switch, 1/3; J.B. 0005 Log, 11/6; 00035, 10/6; Mullard 0005 and 2 in. 5/6; Magnum Panel Brackets, 2/6; Mullard 0001 Fixed, 2/6.

Total £5 : 12 : 6 Carr. free U.K.
FOR 3/6 2 Handsome S.M. Dials, Set of Connecting Links, 9 Plugs, 2 Spades, 4 Engraved Terminals, 2 Ebonite Strips, Twin Plex, Splendid Aluminium Panel, 4 x 7, drilled ready for use, 9 volt Grid Bias Baseboard.

LEADING HOUSE FOR KITS OF PARTS

See Weekly Advt's.
Any list of components over 25/- quoted for at a special price, where possible.

HANDSOME OAK POLISHED SPEAKER CABINETS 13 x 13 x 6

12/11 POST. 1/0
Cannot guarantee exact pattern of front panel, but all good designs.

Blue Spot 25/-
66K (101)
4-POLE BAL. ARM
OR THE LOT WITH BUCKRAM CONE 12"

Carriage 35/- Paid.
G.O.D. EXTRA.

C.O.D. Customers can have goods sent C.O.D. (U.K.), and pay post-man. It, however, takes longer and costs more.

SQUIRE LATEST 97
with Duplex Floating Cone assembled ready to use
15 6

Make out list of parts over 25/- in value for special quotation.

DARIO RADIO-MICRO
2-v. and 4-v. G.P., 5/6; Power 7/6; H.P. Super, 7/6. Post 6d. (3 free.)

16GIN MULTI-COIL 15/6
ALL LISSÉN Parts Stocked

140p. CATALOGUE ILLUSTRATED ALL LATEST COMPONENTS FREE FOR CARD

CLEARTRON SCREENED GRID 2 Volts 12/6

MULLARD MASTER 5 Portable
Send for quotation and booklet

ALL MAKES of valves stocked

OSRAM MUSIC MAGNET
Kit of Parts & Valves, £8 : 12 : 6.
BOOKLET FREE.

STANDARD LOADING COILS: 7/6
DUAL 4-PIN COIL (Tunewell) 7/9

ORMOND
S.M. Drum Dial, 5/-; Rheostat, 6, 15, 30 ohm, 2/-; Midget, 0001 max., 4/-; Log, 0005 and 4" Dial, 6/-; Log, 0003 and 4" Dial, 5/9. S.L.F. No. 3 same price. We always stock all ORMOND PARTS.

COUPON W. CON. APRIL
ONLY ONE COUPON ON ANYONE ORDER
If you spend 25/- or more you can buy for 3d. extra any one (only) of the following:
S.M. Dial 100 ft. 7/22 Copper Aerial, 12 yards Lead-in, Fuse and Holder. 12 Nickel Terminals, 60X Coil, H.P. Choke, Permanent Detector, Battery Switch, 0003 and 2 meg. Leak, 9-volt Grid Bias, Panel Brackets, 6-pin Coil Base, 100 ft. Insulated Aerial, Loud-speaker Silk Cord, 30 ft. Covered Connecting Wire, Ebonite Panel, 9 x 6, 12 yds. Twin Flex, 100 ft. Indoor Aerial, Cycle Rear Reflector.

SPECIAL COUPON.
(Only available at K. Raymond's).
POST or CALL with this coupon, and if your order is £3 or over FOR 8d. EXTRA you can buy one of the following (state which required):
4 mfd. Mansbridge Condenser, 0005 S.L.F. Variable Condenser, 4 in. Slow Motion Dial, 100 ft. Silk Frame Aerial Wire, 0001 Reflector Condenser, 16-volt Grid Bias, tapped 11; 12 yds. Extra Heavy Double Rubber Lead-in; 5-way Battery Cord for H.T. and L.T.; 10 Engraved Terminals (take plug or spade), state names required.
DON'T FORGET THE COUPON. (W Con.)

TRADE JOTTINGS
 A brief review of recent issues of
 trade catalogues and literature.

Loewe Multiple Valves

A LEAFLET from the makers tells me that, in their ambition to supply radio sets the price of which will be within the reach of everybody, the Loewe Radio Company, Ltd., have just reduced the price of their "local" receiver to three guineas. By speeding up production in their Tottenham factory and reducing prices it has been possible to give the public the benefit of this reduction and an enormous demand is expected.

The new price brings what is virtually a three-valve receiver within the reach of all those who have previously only been able to afford a crystal set. The cautious purchaser will naturally wonder what will happen if one of these three-in-one valves burnt out. How would he be placed as regard replacements?

The Company announce that ample provision is made for this, and provided the glass bulb is intact and the internal structure not mechanically destroyed, any multiple valve can be repaired after the filament has been burnt out.

The cost of this repair has been fixed at 16s. 6d. (including royalty), which is less than the replacement price of a super-power valve. Thus the cost of the valve included in the price of the set is only an initial expense, no further new valves being necessary in ordinary circumstances.

"Volume Controls and Voltage Controls"

The Rothermel Corporation, Ltd.

(of 24-26, Maddox Street, London, W.1), who are the distributors for the well-known Centralab components, are issuing a very useful booklet under the above heading. Designed primarily to show the purchaser how to get maximum results from his variable resistance, volume control, potentiometer, etc., this book deals with the whole subject in a very comprehensive manner, giving a great deal of information about circuits, valves, resistance values, and so forth, of interest to every experimenter.

The book is divided into separate chapters, so that altogether there is a mass of information that is easily

BE UP TO DATE

Read

POPULAR WIRELESS

and get

**All the Latest
Broadcasting News**

Every Thursday. Price 3d.

accessible. An idea of the contents can be gained from the fact that the headings include: "Volume control of electrical phonograph pick-ups," "Volume control in low-frequency circuits," "Rheostats in A.C. filaments," "Auxiliary controls for sets with A.C. mains units," "Resistances for eliminator circuits."

Apart from the illustrations of the actual components there are no less than thirty diagrams of the various circuit arrangements. The book appears to be excellently got up and is extraordinarily comprehensive when it is considered that all the circuits involved are arrangements in which these particular resistances are recommended.

FACTS ABOUT ENERGY

—continued from page 463

that on that disastrous day the whole county of Cambridge was a silent area, yet nevertheless, in the more distant counties of Norfolk and Lincoln, the report of the explosion was clearly heard.

Telling of how sound travelled in water, the lecturer pointed out that one advantage of water was that sound in water could be picked up from long distances by means of special instruments. In practice, said Mr. Wood, there was not a depth of the ocean which could not be sounded, and this was done by making a noise on the surface of the water and then listening for the echo from the bottom of the ocean. The time taken for the sound to travel from the bottom of the ocean could thus be determined.

Using a Beam

He referred, then, to an interesting development in the transmission of sound through water, demonstrated by the use of a French invention which was exhibited for the first time to a British audience. The ordinary depth-sounding instrument was accurate enough for its purpose, the lecturer explained, but it only gave a response from the part of the sea directly beneath the ship. The new invention, due to Professor Langevin, adopted a principle now made use of in wireless work—the Beam.

This beam could be turned about and, as the energy did not spread, the reflection from a comparatively little object, for example, a submarine, could thus be detected.

N. F. E.

INDEX TO ADVERTISERS

Arcraft Company, The	463
Bedford Electrical & Radio Co., Ltd.	462
Belling & Lee, Ltd.	460
Brown, S. G., Ltd.	445
Burne-Jones & Co., Ltd.	448
"Bestway" Wireless Books	457
Carrington Mfg. Co., Ltd.	455
Celestion Radio Company	456
Centralab (Rothermel Corpn., Ltd.)	442
Cossor, A. C., Ltd.	398; 441
Cole, E. K., Ltd.	449
Day, Will, Ltd.	452
Dubilier Condenser Co. (1925), Ltd.	459
Eastick, J. J., & Sons	452
Eerranti, Ltd.	455
Forno Company, The	459

Goldsman, J. L.	PAGE 462
Gambrell Radio, Ltd.	463
Gilbert, J. C. (Cabinets)	455
Graham Farish, Ltd.	451
Garnett, Whiteley & Co., Ltd.	430
Hughes, F. A., & Co., Ltd.	434
Igranic Electric Co., Ltd.	450
Impex Electrical, Ltd. (Dario Valves)	434
Jackson Bros.	458
Lectro Linx, Ltd.	462
Lewis, S. W., & Co., Ltd.	442
Lissen, Ltd.	420
Lisenin Wireless Co.	453
London Elec. Wire Co. & Smiths, Ltd.	451
Lyons, Claude, Ltd.	453
Marconiphone Co., Ltd.	397
Metro-Vick Supplies	Cover iii
Morris, J. L.	463
Parullah Wireless Service Co., Ltd.	Cover ii
Paroussi, E.	456
P. D. P. Company	460
Pickett's Cabinet Works	454
P.R. Masts	461

P.R. Valves	PAGE 459
Precision Radio & Mfg. Co., Ltd.	454
Raymond, K.	463
Ready Radio Supply Co.	417, 460
R.I. & Varley, Ltd.	Cover iv
Rothermel Corporation, Ltd.	437
Sifam Electrical Inst. Co., Ltd.	461
Standard Wet Battery Co.	460, 462
"Science of Life, The"	438
Transformer, Repair Co.	453
Taylor, C.	461
Telegraph Condenser Co., Ltd.	430
Telsen Electric Co., Ltd.	450
Ward & Goldstone, Ltd.	453
Weston Elec. Inst. Co., Ltd.	449
Whiteley Boncham & Co., Ltd.	455
Wingrove & Rogers, Ltd.	442
Wireless Pictures (1928), Ltd.	433
WIRELESS CONSTRUCTOR Envelopes	455

All communications concerning advertising in "Wireless Constructor" must be made to John H. Lile, Ltd., 4, Ludgate Circus, London, E.C.4. Telephone: City 7261.



**'Mr.' Loud Speaker's
Colleagues in the Mains
Operating and Rectifying Classes**

**Don't debate with 'Mr.'
Loud Speaker—give 'him'
no cause for complaint**

Just listen to 'his' opinion of the valves you are using. 'He' knows a good valve when 'he' is in touch with it.

When Met-Vick (Cosmos) Short-path Valves either for 2-volt or 6-volt Accumulator Sets, or the A.C. type for operation from the electric light mains, are used—'Mr.' Loud Speaker never complains. 'His' voice never falters, nor becomes incoherent. 'He' just keeps on reproducing faithfully the happenings at the Broadcast Studio.

'Mr.' Loud Speaker is the greatest authority on valves

MAINS OPERATED VALVES				RECTIFYING VALVES			
AC/G High Amplif'n.	ACR Power Amplif'n.	AC/P2 Public Address	AC/S Screen Grid	SP41/U Half Wave	SP43/U Half Wave	SP45/U Half Wave	SP42/U Full Wave
A. F. : 35	A. F. : 10	A. F. : 5	A. F. : 1,200	Output 30 mA	Output 75 mA	Output 30 mA	Output 60 mA
Price 15/-	Price 17/6	Price 25/-	Price 25/-	Price 15/-	Price 15/-	Price 15/-	Price 20/-

"A.F." = Amplification Factor.

MET-VICK VALVES

METRO-VICK SUPPLIES (Prop.: Associated Electrical Industries Ltd.), 155, Charing Cross Rd., London, W.C. 2

REAL ENGINEERING JOBS!

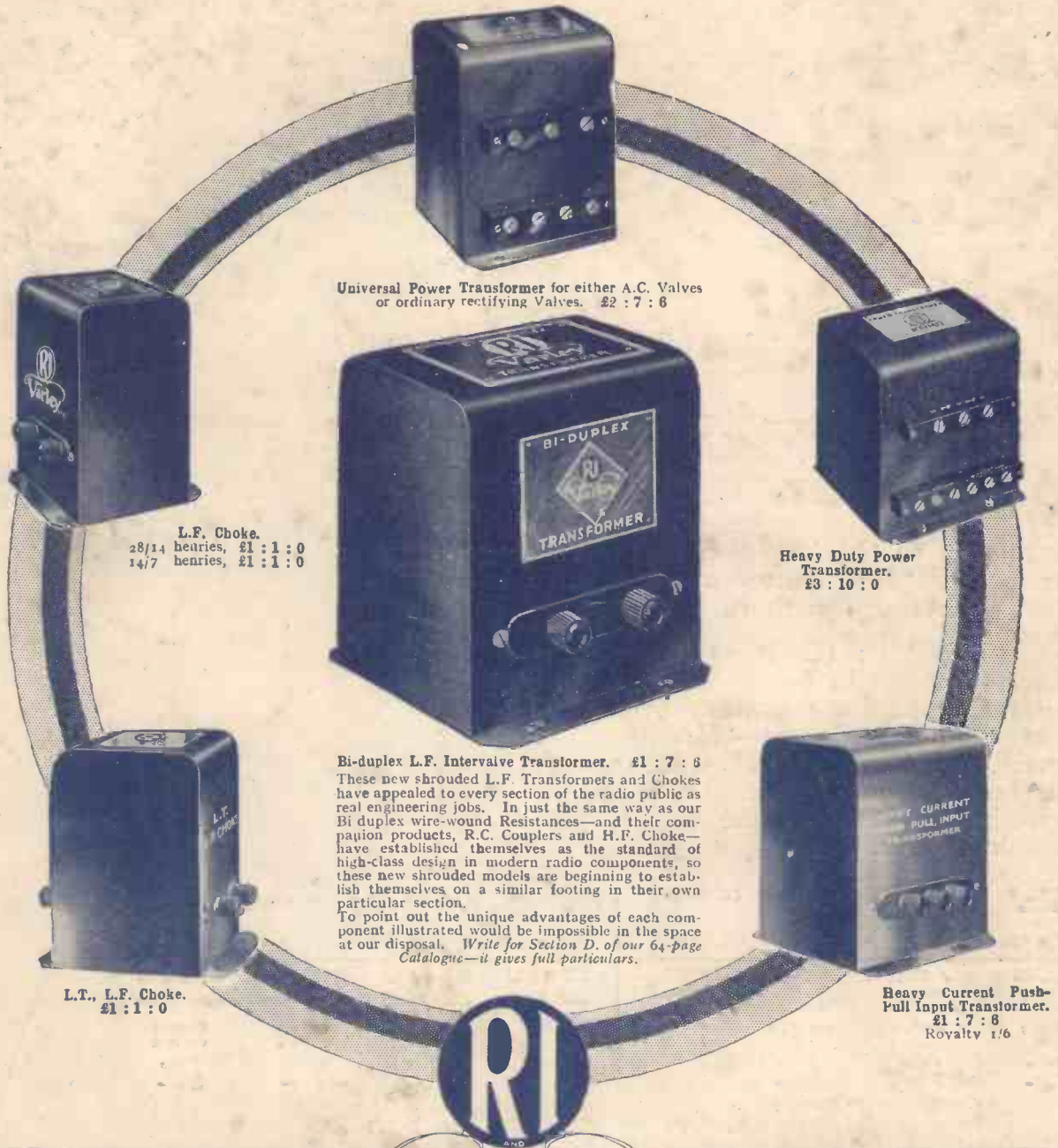

Universal Power Transformer for either A.C. Valves or ordinary rectifying Valves. £2 : 7 : 6

L.F. Choke.
28/14 henries, £1 : 1 : 0
14/7 henries, £1 : 1 : 0

Heavy Duty Power Transformer.
£3 : 10 : 0

Bi-duplex L.F. Intervalve Transformer. £1 : 7 : 6
These new shrouded L.F. Transformers and Chokes have appealed to every section of the radio public as real engineering jobs. In just the same way as our Bi duplex wire-wound Resistances—and their companion products, R.C. Couplers and H.F. Choke—have established themselves as the standard of high-class design in modern radio components, so these new shrouded models are beginning to establish themselves on a similar footing in their own particular section.
To point out the unique advantages of each component illustrated would be impossible in the space at our disposal. Write for Section D. of our 64-page Catalogue—it gives full particulars.

L.T., L.F. Choke.
£1 : 1 : 0

Heavy Current Push-Pull Input Transformer.
£1 : 7 : 6
Royalty 1/6



THE MARK OF **Varley** BETTER RADIO

Kingsway House, 103, Kingsway, London, W.C.2.

Telephone : Holborn 5303