

The **Wireless Constructor**

6^D
MONTHLY

EDITED BY
PERCY W. HARRIS, M.I.R.E.
VOL. V. APRIL, 1928. No. 18.

F5

**A NEW ALTERNATIVE
PROGRAMME SET**

by

**PERCY W.
HARRIS**
M.I.R.E.



Distance to the very edge Volume to fill the house Purity . . . to give radio the breath of life

The Free Blueprint simplifies building to a degree that everyone may duplicate the original set wire for wire without the least difficulty.

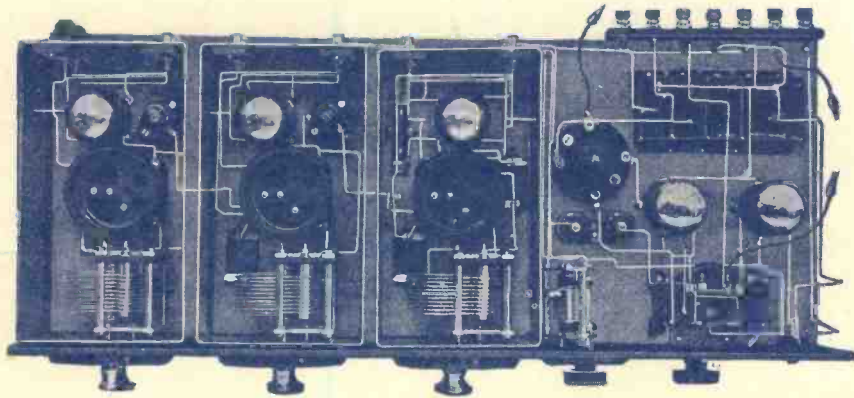

The instructions for building this master receiver have been divided to cover six enjoyable evenings, making success certain.

THE great set for you is the Raleigh P.M. You will be amazed at the remarkable power which its five valves have at their command.

Imagine how much greater one's radio enjoyment would become if possessed of the Raleigh P.M. Once and for all radio from the Continent would find a welcome with all the members of your family. Their prejudice against "foreign stations" which you have almost despaired of ever breaking down, would vanish during your first half-an-hour's test. Think of the untold pleasures to which you will be able to treat them and your friends.

It is hardly creditable that two high-frequency stages are able to reach out to any part of Europe as one feels inclined to direct them.

Yet it is definitely the case, as hearing

is believing. On the long waves one journey round the dials brought in eight stations; most other sets satisfy themselves with four.

If your radio set is to provide your family with a variety of distant programmes at a volume as intensive as the local, it should embody not less than two high-frequency valves.

It must not be assumed that a large set is difficult to handle because it employs a large number of valves. The true state of affairs is rather to the contrary. A group of stations may be tuned-in on the Raleigh P.M. which by comparison almost place a slightly lower powered valve receiver into the category of the crystal set.

It is scarcely believable that the simple addition of two or three valves may completely transform a radio receiver so that it will always provide its owner with more programmes than will ever be called upon to deliver their entertainment. Such an overwhelming supply of music from opera to jazz, from musical comedy to the concert-hall is at the call of any reader who owns a Raleigh P.M.

Fill in the coupon to-day.

STATION.	Aerial	1st H.F.	2nd H.F.
Unidentified	70.5	75	76
Radio Paris	71	68.5	65.5
Daventry	64	59	58
Berlin	44	44.5	44
Unidentified	34.5	35	36.5
Unidentified	31	32	33
Unidentified	26.5	29	29
Hilversum	25	24.75	25
Budapest	94.5	92	93
Munich	88	89	89
Vienna	85	86.25	86
Brussels	83.5	85	85
Daventry (5GB)	81	82	83
Langenaerg	77	78.5	78.5
Oslo	75.5	77	77
Rome	73.25	75	75
Breslau	71.5	73.5	73.5
Frankfurt-on-Main	69	71.25	71
Cracow	68	70	70
Berne	65	68	67.5
Glasgow	63	67.5	67
Plymouth	62.5	66	66
Hamburg	62	65	65
Toulouse	60.75	64	64
Manchester	58.5	62.5	62.5
Stuttgart	58	62	62
London	56	59	57
Koenigsburg	45.5	50	50
Bournemouth	44.5	49	49
Paris	44	48	47
Dublin	43.5	47.5	46.5
Breslau	42	47	45.5
Newcastle	41	45	45
Belfast	38	44	42
Nuremberg	37	43.5	40.5
Liverpool and Hanover	36	41	41
Innsbruck	34.5	40	39
Edinburgh	34	37.5	38
Sheffield and Cassel	31.5	33.5	32
Lille	29	31	29.5
Toulouse	27.5	28.5	27.5
Bremen	26	27.5	25
Gleiwitz	25	26	25
Muenster	23	23	20
Orebro	22.5	20.5	19
Halmstad	10	8	8

THE MULLARD RALEIGH P.M.

The PUBLISHERS, 63 Lincoln's Inn Fields, London, W.C.2. Please forward free, complete instructions, blue print and No. 4 RADIO FOR THE MILLION, to build this master receiver.

NAME.....

ADDRESS.....

W. Con

Mullard MASTER · RADIO

CONTENTS

	Page		Page
The Editor's Chat	415	Within the Vacuum	440
F 5	417	The Television Problem	441
Radiogramophonics	421	What Is a Mains Unit ?	443
The "Concert Four"	423	Chats At The Work-Table	447
Queer Queries	424	Using the 31 Tested Circuits	450
Below Ten Metres	425	In Lighter Vein	456
The "Range-Finder"	429	What's New	461
Comments From Constructors	433	Savoy Hill Happenings	465
Cartoon	434	Unsuspected Causes of Distortion	468
The Cone Amplifier	435	Our News Bulletin	474

EDITED BY
PERCY W. HARRIS, M.I.R.E.

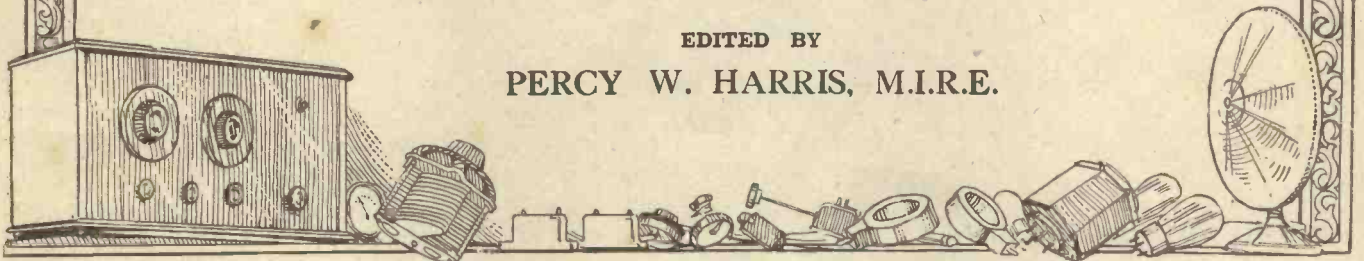

MARCONI Type H.L.210

Dull Emitter
General Purpose
Valve

Filament Volts .. 2.0 max.
Filament Current .. 0.1 amp.
Anode Volts .. 150 max.
Amplification Factor .. 15
Impedance .. 25,000 ohms

Price **10/6** each

Fill in the coupon below for full particulars of this new Marconi Valve.

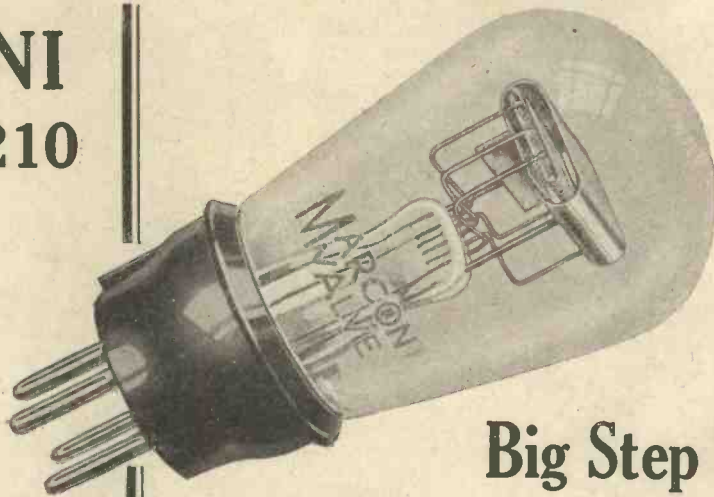

Another Big Step Forward

Here's a new Marconi Valve which embodies the results of our most recent research—the Marconi Type H.L.210. It is a 2-volt dull-emitter suitable for use for H.F. Amplifying, as a Detector (Grid-leak or Anode-bend) or for L.F. Amplification.

It is remarkably economical on L.T.—only 1/4th of a watt being required to heat the filament. The H.L.210 is essentially a high-efficiency valve—as results will prove to you when you try it out. Its amplification factor of 15, combined with an impedance as low as 25,000 ohms, make it particularly useful in all stages, except the last, in receivers calling for maximum sensitivity.

MARCONI VALVES

-do everything that a valve should do

Dept. P, The Marconiphone Company, Ltd.,
210-212, Tottenham Court Road,
London, W.1.
Please send Marconi Publications 443 and other Marconi Valve Literature.

Name

Address

W.C. 13.

TIME was when to claim "seven countries on the loud speaker" from a home-built Set was a remarkable statement. The Cossor "Melody Maker" has proved it to be a modest claim. Hundreds are spontaneously writing to us every week to tell us of results far exceeding anything we have ever said of the Cossor "Melody Maker." Now comes a letter from a user who has actually heard American broadcasting on three successive nights. Read his letter . . . "For selectivity, ease in handling, simplicity of assembly and low cost," he considers the Cossor "Melody Maker" to be THE Set of the Season. How simple it really is you can only know when you have built it yourself. Ask your Dealer (or send a post-card to A. C. Cossor, Ltd.) for the free Chart, "How to build the Cossor 'Melody Maker,'" and begin to-day.

NO! We don't claim U.S.A. Broadcasting

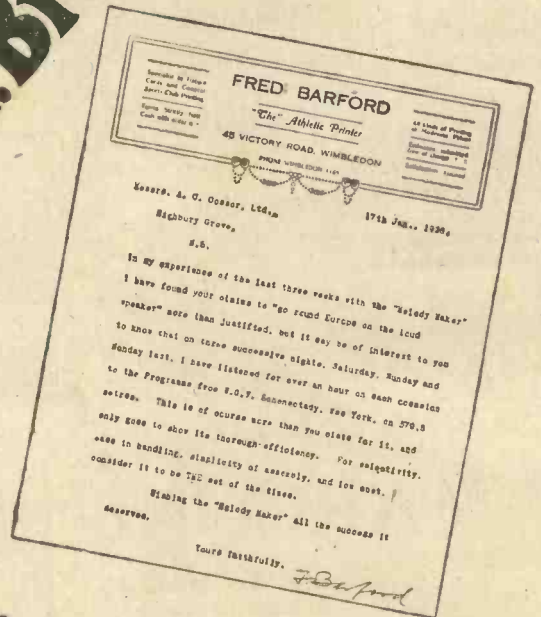

But Mr. Barford gets it all the same

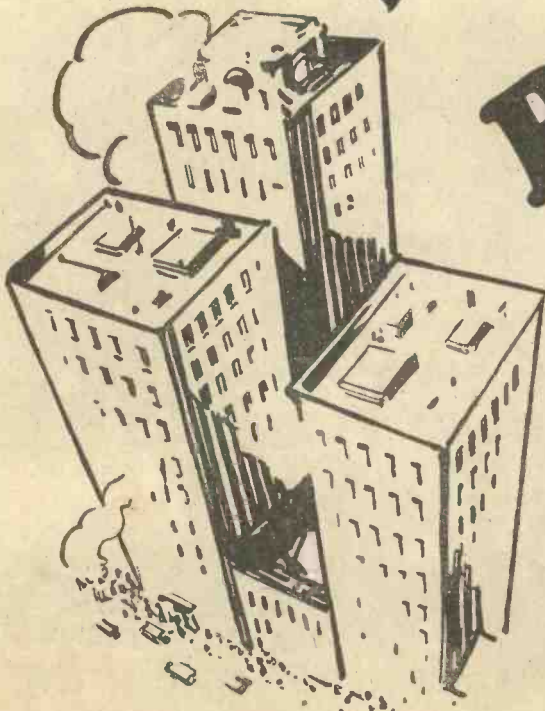

on his home-built
COSSOR
Melody Maker

The WIRELESS CONSTRUCTOR

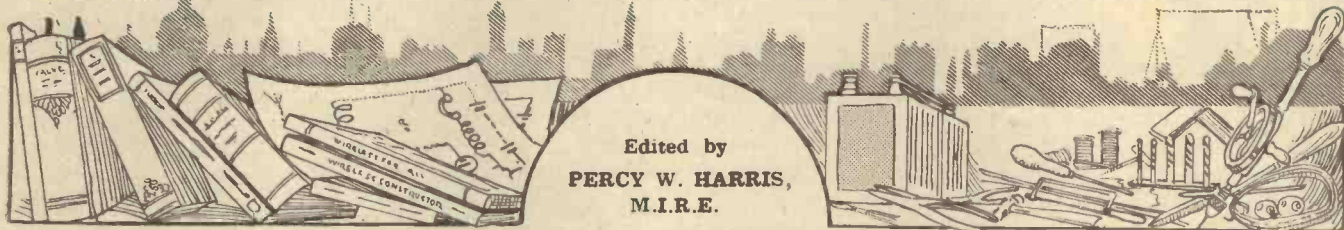

Edited by
PERCY W. HARRIS,
 M.I.R.E.

Published by the Amalgamated Press, Fleetway House, Farringdon Street, E.C.4.

THE EDITOR'S CHAT

Percy W. Harris, M.I.R.E., the Editor of the "Wireless Constructor," discusses the question of inter-valve coupling in L.F. circuits.

"**W**OULD you please tell us," asks a reader from Wiltshire. "just what is the true state of affairs in regard to transformer versus resistance-capacity coupling? My friends seem divided into two camps and heated arguments take place every week at our society. Probably, as in most other matters, there is much to be said for both sides, and in any case we should value your opinion."

Many Tests

It is, as our correspondent suggests, a matter which has two sides, and the question cannot be answered simply. After tests extending over considerable periods, I have come to the conclusion that excellent quality can be obtained with either arrangement, always provided that, on the one hand, high-grade transformers are used, and on the other, that the values of the resistances are correctly chosen. It is a fallacious idea to imagine that *any* resistance-capacity coupling or *any* transformer will give first-grade quality. The matter of good-quality reproduction is so important that I hope I shall be pardoned for dealing with my correspondent's question in a little more detail.

Where Distortion Occurs

When considering quality of reproduction there has been far too great a tendency to consider each link in the chain as a separate item, disregarding the fact that it cannot work alone and that the influence of the other links is vitally important. From the studio to the ear of the

listener there are many possibilities of distortion, and we must consider them both separately and together. We are particularly fortunate in this country in the quality of the broadcast transmissions themselves, and here it can be taken that a negligible amount of distortion occurs before the radiation reaches the receiving aerial. A poor aerial, while reducing signal

frequency stage is used, and the listener is situated quite close to a broadcasting station, the high-frequency circuit may occasion quite considerable distortion on local signals, and it is very easy to overload the detector valve in such a way as to give thoroughly bad reproduction. Every listener who has used a reaction set intelligently knows that the

Europe's Super Broadcaster.

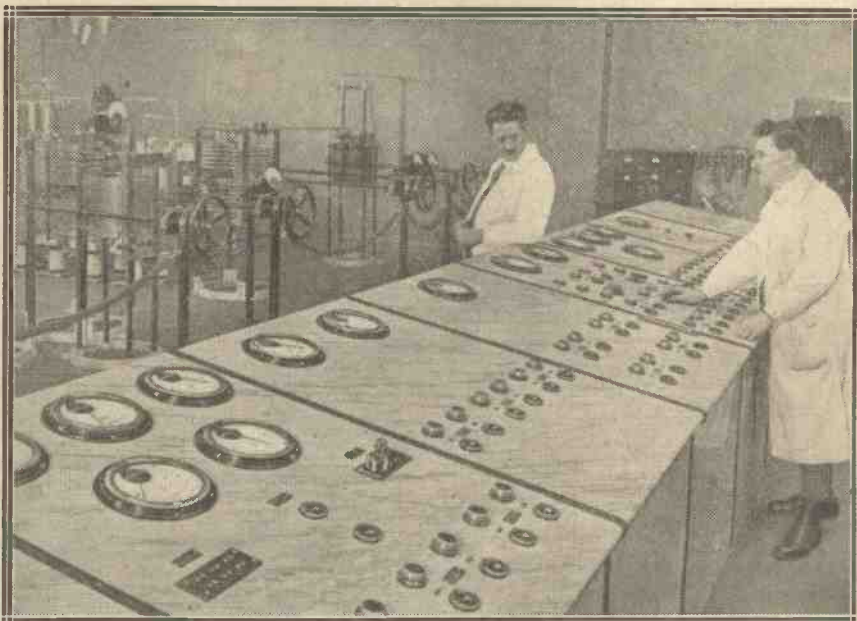

Zeesen is stated to be the most powerful broadcasting station in the world, and operates on 1,250 metres. Here we see the main control room with the H.F. switch panels in front and part of the transmitting gear in the background.

strength, will not distort reproduction, but in ninety-nine cases out of a hundred a greater or lesser degree of distortion occurs immediately the signal is picked up. If a high-

quality becomes very poor when too much reaction is used, while the audio-frequency part of the receiver may occasion all kinds of trouble if we are not careful. If we are lucky

The Editor's Chat—continued

enough to get good signals through the receiver itself, we have still loud-speaker distortion. There is not a single loud speaker made or sold which even remotely approaches the ideal. The best we have been able to get so far is the moving-coil type, but there are extremely few moving-coil speakers (and none that are sold) which will give any adequate reproduction on frequencies of fifty and below.

"Straight-line" Amplification

The sensitivity to low notes of the average loud speaker falls off very rapidly below about frequencies of 200, and there is not a single loud speaker the curves of which are anywhere near so good as that of a modern first-class transformer or resistance-capacity coupler.

As the average loud speaker is so deficient in its ability to reproduce the low notes, we must have, if we want good reproduction, an amplifier which is capable of reproducing them quite fully. Resistance-capacity-coupled amplifiers and transformer-coupled amplifiers can now be obtained which give "straight-line" reproduction from the lowest notes the speaker can adequately reproduce up to the highest. The distortion which so often characterises transformer-coupled amplifiers is due in nine cases out of ten not to the fact that the transformers themselves are poor instruments, but to low-frequency interaction, and a battery coupling between stages, entirely falsifying the rendering.

Effects of Interaction

When this interaction is very strong the effect becomes immediately noticeable as an audio-frequency "howl," which can generally be cured by one of several methods, the most usual

being to reverse the connections of the primary of one of the transformers. If, however, this interaction is not carried far enough to maintain oscillation, one can still get distortion of quality without a howl. This interaction is generally much less likely to happen with resistance-coupling units than with transformers.

NOW ON SALE

THE WIRELESS CONSTRUCTOR ENVELOPE No. 2.

Containing full constructional details of
"THE CONCERT FOUR."
By PERCY W. HARRIS, M.I.R.E.

Obtainable Everywhere. Price 1/6

The combination of one resistance-coupled stage and one transformer-coupled stage gives an arrangement which is particularly free from the tendency to howling and distortion between stages.

New Difficulties

For this reason it is very frequently recommended and used in home-construction designs, but provided the amplifier is free from low-frequency interaction the results obtainable with either form of coupling are practically indistinguishable.

An experimental set I am at present using for reception of London, driving a moving-coil speaker, has an anode-bend detector valve, an iron-core choke coupling to the first note-magnifying valve. This is transformer-coupled to a pair of super-power valves arranged in push-pull fashion, the output of which is taken to another iron-core output transformer and then to the speaker.

Occasionally, and as an alternative arrangement, this receiver is used to drive a cone loud speaker in another room, in which case a still further

iron-core transformer is used to step-up the output once more to a suitable value for the cone speaker! There are thus four iron-core chokes or transformers in use at a time, yet the reproduction is of a remarkably high standard and has frequently been commented upon as "marvellous."

A resistance stage following a detector valve generally makes a very efficient arrangement, but when the amplifier is designed to follow either a crystal receiver or a gramophone pick-up, a transformer input is generally preferable. For this reason the cone amplifier described in the current issue uses two transformers, because this is the most practical form of input following a gramophone pick-up or a crystal set.

Special Cone Amplifier

There will be a steadily increasing tendency in future to consider receivers as a whole, and to design them from this viewpoint. In some cases transformer-coupling will be used, in others resistance, and in still others combinations of the two. With the growing use of mains units for the problem of the high-tension supply, new difficulties are arising, and it is found that many otherwise excellent receivers will not work on existing mains units without giving the phenomenon known as "motor-boating." In general, at the present moment, sets with transformer-coupling give fewer difficulties with mains units than those with resistance-coupling, while sets including one transformer and one resistance give the most difficulty. In such cases it is unfair to blame either the mains unit or the set alone. Careful co-operation between the designers of sets and the designers of mains unit will be necessary before a proper solution of our difficulties is obtained.

"... dance music until 12 o'clock ..."



F5

A NEW ALTERNATIVE PROGRAMME SET

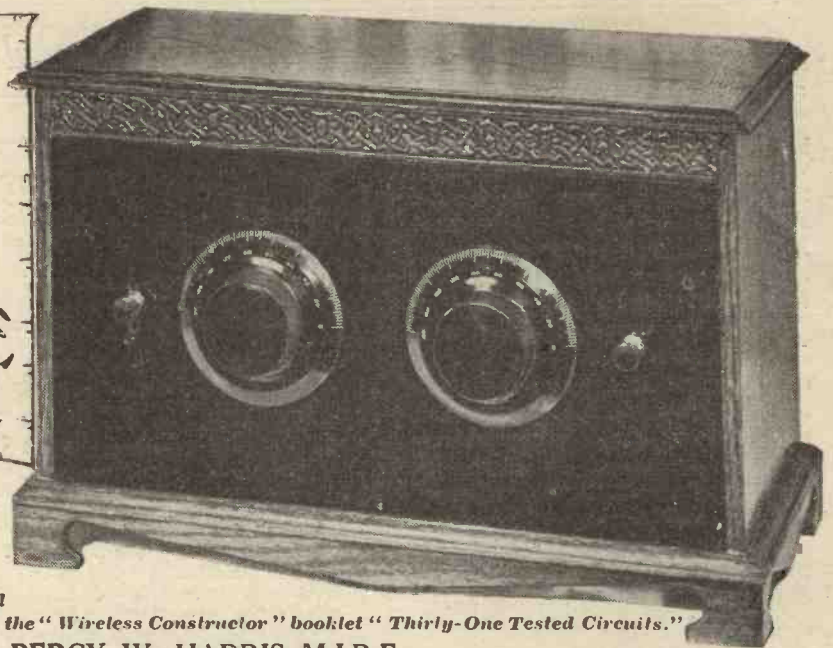

This article gives full details of a practical design for the popular F3 circuit, published in the "Wireless Constructor" booklet "Thirty-One Tested Circuits."

By PERCY W. HARRIS, M.I.R.E.

THE great popularity of three-valve receivers, consisting of a detector followed by two stages of note-magnification, has been one of

none too strong on a small aerial, and require a good deal of magnification to give adequate loud-speaker strength.

There are, of course, a number of other combinations of three valves, all interesting and instructive, and four typical and practical arrangements were given in the free gift booklet, "Thirty-One Tested Circuits," presented with the February issue of this journal. A very large number of readers have written asking that we should give constructional details of a set on the lines of "F3" in that booklet—a circuit with a detector valve followed by one resistance and one transformer stage.

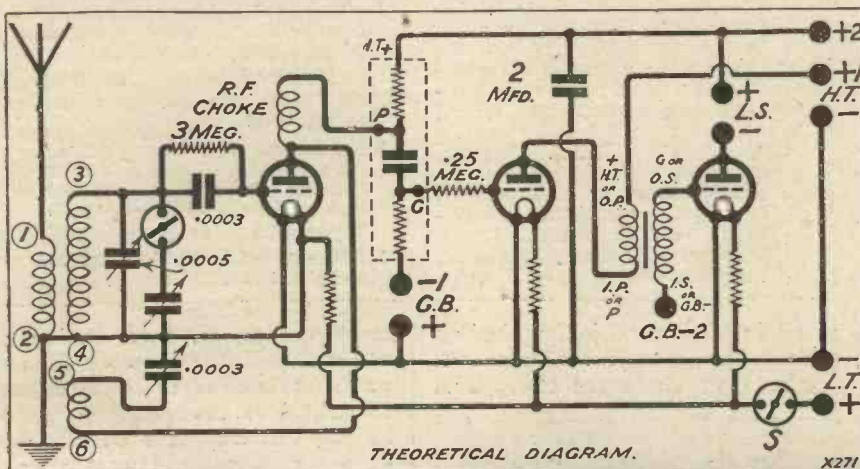

Interesting Modification

It was therefore decided to describe a practical design for this circuit, but during the experimental work an interesting modification was made, enabling a change to be effected from one station to another by simply

the outstanding features of the last year. Typical of these is the "Radiano Three," first published in the WIRELESS CONSTRUCTOR over a year ago, and now available as a constructional envelope. This set has perhaps more adherents than any other receiver described in this journal, and is the ideal "three" for the man who knows nothing about wireless and wishes to try his hand at home construction.

A Popular Set

"Radiano Three" has, as most readers will remember, a detector valve followed by two transformer-coupled stages. Such an arrangement gives the greatest volume obtainable from the three valves, and for this reason makes the set especially popular in those districts where the signals from the nearest station are

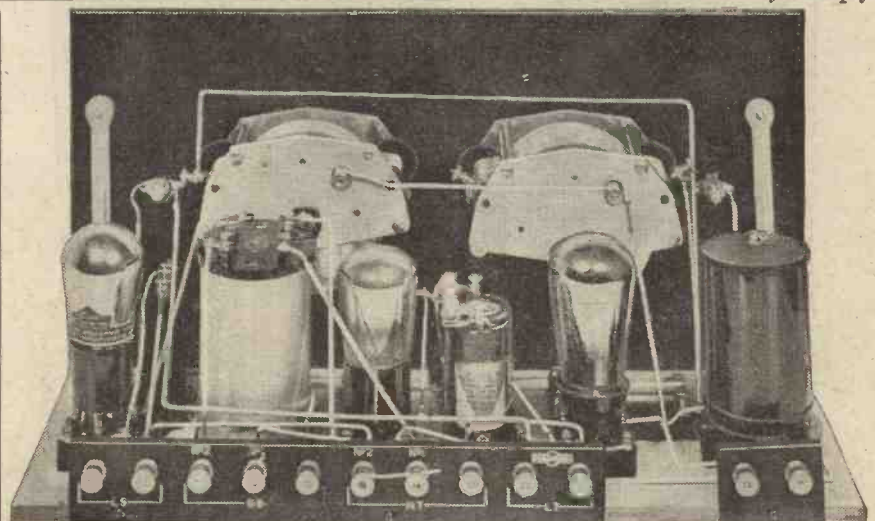

Easy to build, and easy to operate, this receiver should prove exceedingly popular, as it is capable of giving full loud-speaker strength of excellent quality from a number of stations.

F5—continued

pushing a switch. For this reason it was decided to call this set "F5" to distinguish it from the circuits F1, F2, F3, and F4 in the booklet. F5 is, then, the F3 circuit plus an important improvement which I think will appeal to a large circle of readers.

Unlike a number of three-valve designs including a detector with one resistance and one transformer stage, F5 is exceedingly compact, a standard 16 in. by 8 in. panel being used so as to fit into what is perhaps the most popular of all the sizes of cabinets and panels. The circuit itself is given previously, in which it will be seen that the aerial circuit is coupled to the detector-valve grid circuit by a standard Reinartz aerial coil of the six-pin variety, the grid circuit of this being tuned by a .0005-mfd. variable condenser.

Simple Tuning Adjustment

A simple push-pull switch is arranged to throw a small adjustable condenser in parallel with the .0005-mfd. tuning condenser when desired. The method of using this switch is as follows: We will assume that the alternative station it is desired to receive is of a longer wave-length than the local, and for the purposes of an example we will take London and 5 G B as the two programmes to which the receiver is to be set.

First of all, the receiver is tuned to a convenient strength on 2 L O, the adjustable condenser being cut out of circuit by pushing the left-hand

LIST OF COMPONENTS

- 1 Panel, 16 in. × 8 in. × $\frac{1}{4}$ in. (Ebonart). (Becol, Radfon, Trolite, Trelleborg, etc.)
- 1 Cabinet with 7-in. baseboard (Artcraft). (V. C. Bond, Cameo, Caxton, Makerimport, Pickett, Raymond, etc.)
- 1 Variable condenser, .0005 mfd. (Keystone). (Bowyer-Lowe, Cyldon, Igranic, Jackson, Ormond, Raymond, Ripault.)
- 1 Variable condenser, .0003 mfd. (Keystone). (Bowyer-Lowe, Cyldon, Igranic, Jackson, Ormond, Raymond, Ripault, etc.)
- 2 Dials for same (vernier if desired).
- 2 Terminal strips, one 2 in. × $1\frac{1}{2}$ in. and the other 10 in. × $1\frac{1}{2}$ in., with twelve terminals as indicated (Magnum). These strips can be cut from ebonite and drilled by the constructor himself if desired, using one of the many types of indicating terminals, such as Belling-Lee, Eelex, Igranic, etc.
- 1 Six-pin base for plug-in coil (Colvern). (Bowyer-Lowe, Lewcos, Magnum, Peto-Scott, etc.)
- 3 Anti-phonic valve sockets (Bowyer-Lowe White Line). (Benjamin, Igranic, Lotus, Magnum, Pye, etc.)
- 1 Adjustable condenser for baseboard-mounting, about .0005 mfd. maximum (Formodensor). (Igranic, Pilot, XCel, etc.)
- 2 Panel brackets (Camco). (Magnum, Peto-Scott, etc.)
- 3 Fixed resistors with bases (C.E. Precision). (Amperite, Bowyer-Lowe, Dubilier, Igranic, Lissen, Magnum, Peto-Scott, Raymond, Tempryte, etc.)
- 2 Push-pull on-and-off switches (Benjamin). (Bowyer-Lowe, Igranic, L. & P., Lissen, Lotus, Peto-Scott, etc.)
- 1 Fixed condenser, .0003 mfd., with clips and 2-megohm grid leak (Dubilier). (Atlas, Lissen, Mullard, T.C.C., etc.)
- *1 Resistance-capacity-coupling unit (R.I.-Varley, type A).

*In addition to this, clips and a $\frac{1}{2}$ -megohm grid leak are needed. There is a very large number of excellent resistance-capacity units, but not all are suitable for this circuit, as some of them use a very high value of anode resistance which makes smooth reaction control rather difficult in a circuit of this nature. A number of the makes have clips so that the values of the anode resistance and grid leak can be interchanged. These will prove quite satisfactory provided a higher value of anode resistance than 250,000 ohms is not used. The Mullard is an excellent resistance-capacity coupler for this set, and as it includes in the unit itself a high-frequency stopper the use of the additional grid leak will not be required with that make. Lissen, Dubilier, Atlas, etc., are patterns which have an interchangeable anode resistance and can be used quite satisfactorily here.
- 1 Good low-frequency transformer (Bowyer-Lowe Popular). (Any good L.F. transformer can be used.)
- 1 2-mfd. Mansbridge condenser (Dubilier). (Ferranti, Lissen, Mullard, Hydra, T.C.C., etc.)
- 1 Radlo-frequency choke (Ormond). (Bowyer-Lowe, Climax, Colvern, Igranic, Magnum, Metro-Vick, Marconiphone, Peto-Scott, R.I.-Varley, etc.)
- 1 Reinartz aerial coil (Any standard make for 250 to 550 range).

switch in. It is possible that the best position on the main condenser will not be that of maximum strength of

reception from the local station, as this will probably be too loud, and we will assume that it is set 10 degrees lower than the loudest setting. Now, leaving this condenser so adjusted, the left-hand switch is pulled out and 5 G B tuned in by rotating the small adjustable condenser by means of a screwdriver blade inserted in the slot on the knob.

"Fool-proof" Change

This small condenser will be seen between the panel and the base for the six-pin coil. Tuning will be found quite sharp, and there will be very little difficulty in picking up 5 G B's transmission. A little reaction may be necessary.

When this is done the receiver is properly adjusted for practical use. When the left-hand switch is pushed in we shall get London on the loud speaker, and when it is pulled out we shall get 5 G B without touching the tuning dial. Thus, when we tire of one programme, it is but the work

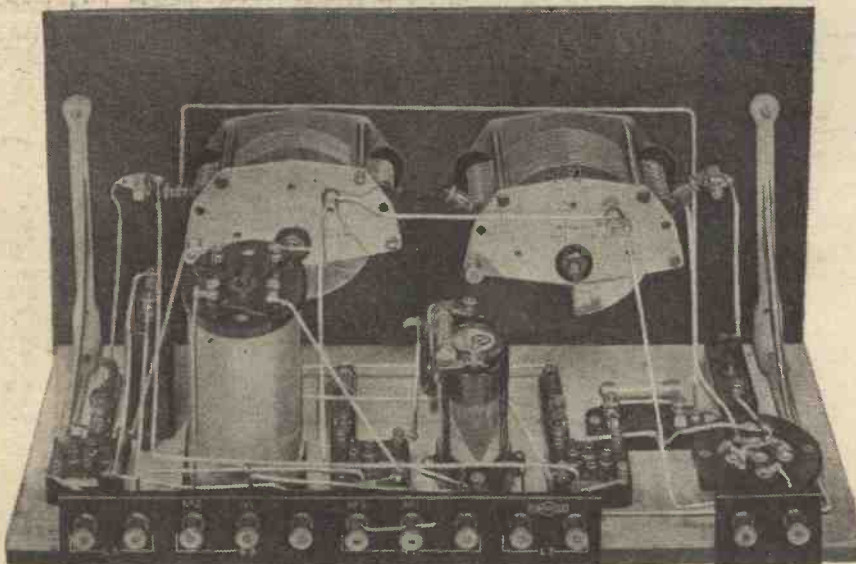

With valves and the coil removed. Note the simple nature of the wiring and the grouping of the terminals, rendering the set as fool-proof as possible.

F5—continued

of a moment for any member of the family to change to the other. A suitable adjustment of the reaction

low-frequency transformer and the loud speaker is in the output circuit of the second note-magnifying valve.

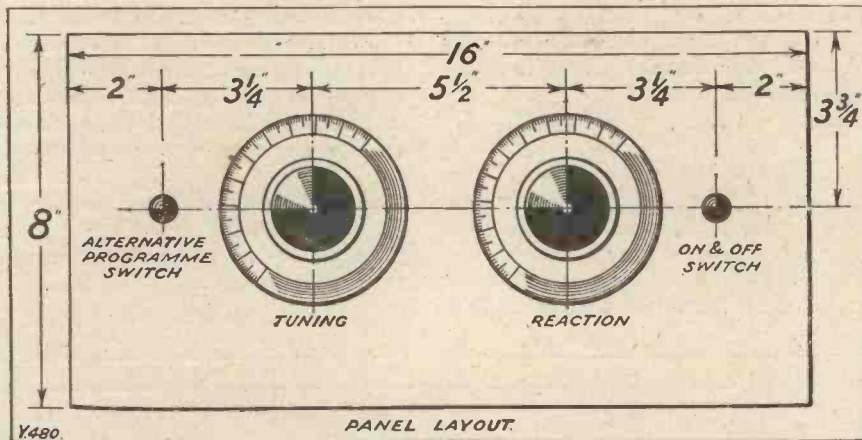

condenser must, of course, be found in this preliminary adjustment.

In practice it will be found to be quite easy to adjust the reaction condenser to give all the sensitivity we require without the set going into oscillation on either adjustment.

Any other pair of stations can be similarly tuned in by the method described, and if the alternative station is of a lower wave-length than the local, then the alternative programme is first tuned with the adjustable condenser out of circuit (the switch in).

The H.F. "Stopper"

Continuing our examination of the circuit diagram, it will be found that in the plate of the detector-valve circuit is a radio-frequency choke and a lead going to the reaction winding through the reaction condenser. On the other side of the radio-frequency choke we shall find a resistance-capacity unit of standard pattern, with a grid leak connected between the G terminal of the unit and the grid of the first note-magnifying valve.

This must not be confused with the grid leak included in the unit itself. The additional leak is there, not to act as a grid leak, but as a series resistance in the grid circuit, serving to prevent radio-frequency current from getting into the note-magnifying stages and thus causing distortion. A note regarding this resistance will be found in the booklet, "Thirty-One Tested Circuits."

The first note-magnifying valve is connected to the second through a

Fixed resistors are used in the filament circuits of the valves. These are not essential and most modern valves will work with the full accumulator voltage, but by inserting a fixed

resistor of the correct value in the L.T. circuit of each valve the valve will probably last a little longer, and it is slightly more economical to use them so far as filament current is concerned. With 2-volt valves, however, they can be dispensed with without effecting any appreciable reduction in the life of the valve.

Constructional Details

The symmetrical arrangement of controls on the front panel is one of the pleasing features of F5; the switch for giving the alternative programme balancing the on-and-off switch on the right-hand side, while, of course, the two dials for tuning and reaction are similar in size and pattern. Every cabinet maker has a variety of styles in the 16 in. by 8 in. size of cabinet used.

A list of components is given. The name given in brackets after each item is that of the make actually

By means of the wave-length switch one can receive either the "local" or 5 GB without touching the tuning condenser.

Including as it does an "alternative programme" switch, the F5 makes a very easy set to handle, there being only one tuning control and one volume or reaction control.

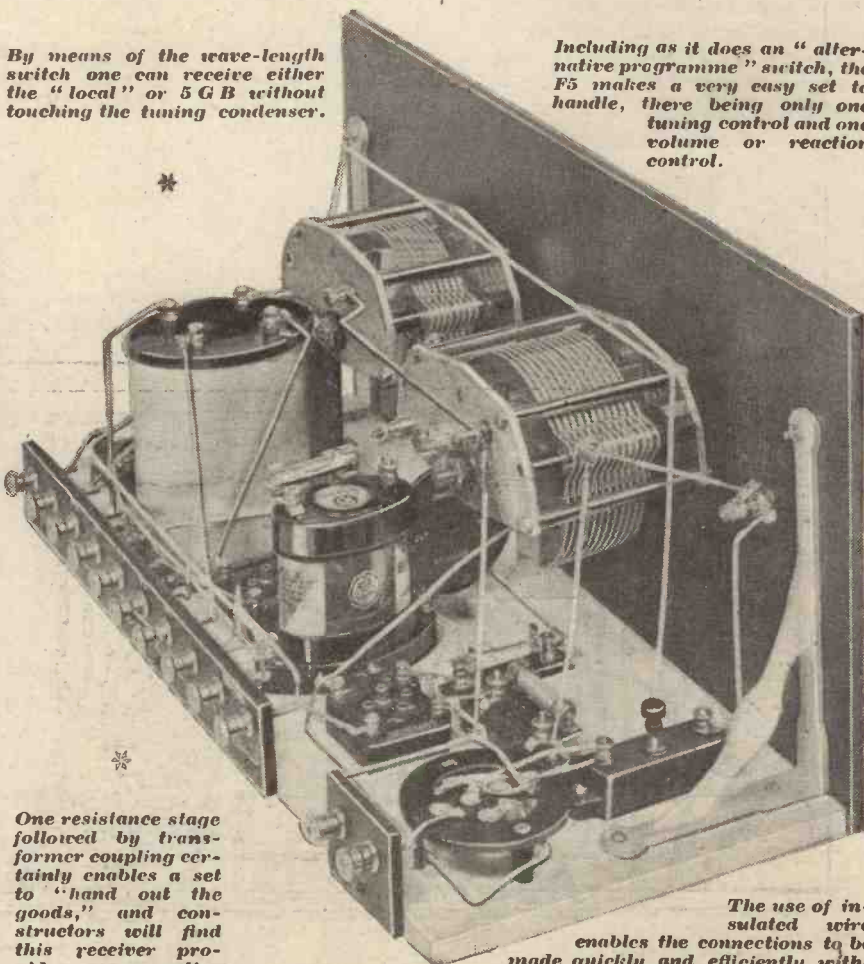

One resistance stage followed by transformer coupling certainly enables a set to "hand out the goods," and constructors will find this receiver provides no exception to that statement.

The use of insulated wire enables the connections to be made quickly and efficiently without fear of short-circuits occurring.

F5—continued

illustrated, while the other names following are suitable alternatives. The choice of the components used in the set itself has been made among representative makes and must not be taken as an indication that they are necessarily better than those given in the alternative lists.

Take panel and place face downwards on pad of paper, mark off positions for two switches, two variable condensers, three holes for securing panel to the baseboard and holes for brackets.

Drill panel, mount switches, condensers, and brackets to panel only

and place on one side. Mount the baseboard components, as shown, and wire the baseboard-mounted components as far as possible without attaching panel. Note particularly which are the grid and plate terminals of the valve holders, so as to avoid mistakes in wiring.

Wiring Up

Notice that terminals 4 and 2 are joined together on the six-pin coil base, that aerial goes to 1, and that the earth terminal goes to terminal 4 on the six-pin base, the moving plates of .0005-mfd. variable condenser and the

positive leg of the first valve holder.

Complete wiring by attaching panel and wiring-up panel, as shown, on to the baseboard. Notice particularly that the two sets of moving plates on the variable condensers are joined and that a lead goes from terminal 3 on the six-pin base to the grid condenser and leak, the fixed plates of the .0005-mfd. variable condenser and to one side of the alternative-programme switch. The other side of this switch is joined to one side of the Form-denser, the other side of which goes to terminal 4 on the six-pin base.

(Continued on page 481.)

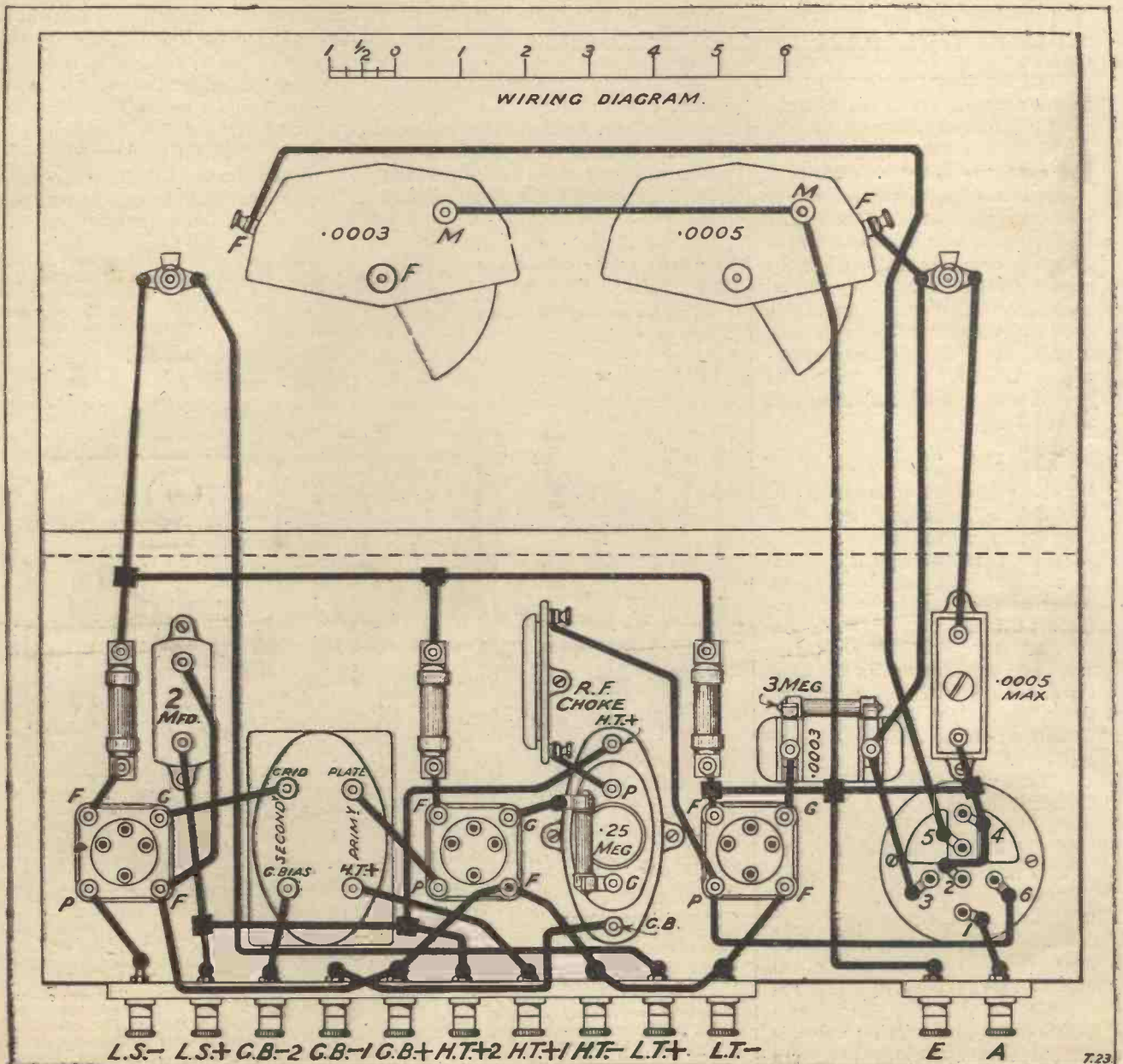

RADIOGRAMPHONICS

The first of a series of articles, specially written for the constructor who wishes to use his radio receiver and loud speaker for the reproduction of gramophone records.

By A. JOHNSON-RANDALL.

HAVE you ever realised what vastly improved results you can obtain by playing your gramophone electrically? The modern gramophone record is produced in a studio of much the same type as that used by the B.B.C. for broadcasting their ordinary programmes. A microphone amplifier is employed, and in consequence the records sold to-day are remarkable for their depth of tone provided the apparatus used for reproducing them can do justice to this improved means of recording.

Improved Reproduction

Those who have a good cone loud speaker capable of responding to the lower musical frequencies, and a well-designed amplifier, can take advantage of this new improved method of electrical recording by using their gramophone and wireless amplifier in conjunction with a device known as a "gramophone pick-up."

A pick-up is simply an arrangement which is used in place of the existing reproducer. It fits into the tone arm of the gramophone in exactly the same way as the ordinary sound box, and one uses it just as if one intends to play the gramophone in the usual manner. The same needles are used, and, in fact, the pick-up is simply a device which automatically transfers the vibrations from the sound channels on the record to the wireless amplifier in the form of small voltages across the grid and filament of the low-frequency valve. Two wires have to be taken from the terminals on the pick-up to the grid and filament of one of the L.F. valves in the existing set.

Easily Adapted

It is quite easy to adapt any set for use with a pick-up. In Fig. 1 I have shown a very common type of circuit, namely, a detector and two low-frequency valves, the first being resistance and the second transformer-coupled. This combination, as readers know, is capable of giving very good reproduction, and there is no reason

at all why it should not be used in conjunction with a gramophone. As will be seen, the detector functions on what is usually termed the anode-bend method. Let us suppose that three plug-in coils are used, that is, L_1 the aerial coil, L_2 the secondary, and L_3 the Reinartz reaction coil. One side of L_2 is normally connected to a point on a small grid-bias battery or direct to L.T. negative, and the other side of this coil is joined straight to the grid of the detector valve. All that we have to do then is to remove this coil from L_2 and to connect our two pick-up leads direct to the plug and socket of the coil holder. This can be done by means of an ordinary coil socket such as one obtains for the purpose of mounting one's home-

necessary to connect the pick-up to the two sockets which connect up with the pins to which the ends of the secondary coil are joined. No other modification is necessary.

Inserting a Switch

Fig. 2 shows another very popular type of circuit. In this case a grid-leak-and-condenser detector valve is employed in conjunction with two resistance-coupled low-frequency valves. The simplest method of altering this circuit to take a gramophone pick-up is to connect up a single-pole double-throw switch so that in one position of the switch the set is arranged to receive broadcast-

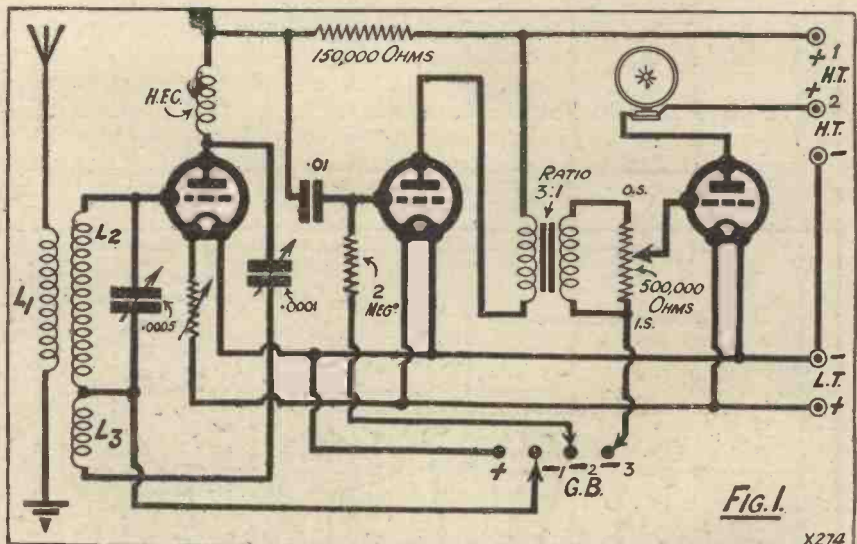

Fig. 1.

X274

made coils. The first valve will then function as a low-frequency amplifier, and the only slight alteration which may be necessary is a reduction in the grid-bias value to the first valve. In most cases $1\frac{1}{2}$ volt will be correct. If a six-pin coil is used, then it is only

ing, whilst in the other position the first valve is connected so as to operate as an L.F. amplifier. The connections are very simple, as will be seen from the figure. The grid of the first valve is joined to the centre point on the switch. The lead from the grid

Radiogramphonics—continued

leak and condenser goes to the other side of the switch, while one terminal of the pick-up is joined to the remaining contact. The other terminal on the pick-up can be taken direct to L.T. negative. The leads from the switch to the pick-up could be taken to an ordinary telephone jack mounted on the panel of the set and the pick-up plugged in when it is desired to use the gramophone. Both of these circuits will give excellent reproduction and extraordinarily good volume when used in conjunction with a moderately sensitive gramophone pick-up.

Special Adaptor Plugs

Of course, in the case of such gramophone attachments as the Amplion Vivavox, and others which are designed to plug direct into the detector socket in the existing set, no alterations such as those just described will be necessary. It will therefore be seen that to use a gramophone pick-up is the easiest thing in the world, and those who have never tried to combine radio and the gramophone may do so with the knowledge that they will not be disappointed in the results.

 * PICK-UPS WE HAVE *
 * TESTED *

WE have recently had the opportunity of giving an extended trial to two gramophone pick-ups marketed by the

makers of well-known loud speakers. One of these is the Woodruffe and the other is the Amplion. The Woodruffe pick-up, a photograph of which appears on this page, is handled by the makers of the well-known Celestion loud speaker. The price is somewhat high—it retails at four guineas, but the results are so good that one feels that one is obtaining ample value for money. The pick-up is supplied in two fittings—one to suit the Columbia and the majority of tone arms, and the other to suit the H.M.V. gramophone. The electrical portion of this component is of fairly conventional design—that is to say, a high-resistance permanent-magnet winding is employed, the movement of a damped armature in sympathy with the sound channel on the records giving the necessary voltages across grid and filament to operate the amplifier. The armature is heavily damped with rubber, and on test no marked resonance peak could be detected.

The Woodruffe Pick-Up

The pick-up is not what one might call highly sensitive, and in order to get maximum results from a cone or moving-coil loud speaker it is advisable to employ three stages of resistance-coupled L.F. or two of resistance and one of transformer. The volume, however, can be increased very greatly if one cares to invest in a Marconi Ideal 8-1 ratio transformer, and to insert this transformer between the pick-up and grid and filament of the first L.F. valve. The transformer is, of course, by no means

essential, and, as stated above, excellent results can be obtained with three ordinary resistance-coupled stages, or, in fact, with any good amplifier of a type designed to give

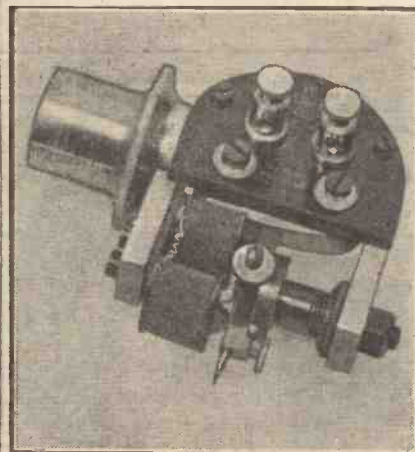

The Woodruffe Pick-Up discussed in this page.

even amplification over a wide range of musical frequencies.

The Woodruffe pick-up is stated to be one ounce lighter than the sound-box used by a well-known gramophone manufacturer, and on the score of weight alone readers need not be afraid that undue wear of the record will occur. The results are so good that it is difficult to find any point to criticise. Possibly the method of adjusting the armature in order to obtain the required degree of sensitivity is a little coarse. In addition no attempt has been made to protect the fine-wire magnet windings, and in consequence one is rather liable to damage the windings when handling the pick-up. These, of course, are quite small points, and the component can be thoroughly recommended.

The Amplion Pick-Up

The question of radio and the gramophone has evidently been tackled very seriously by Messrs. Amplion. This firm have designed their pick-up to be plugged direct into the detector socket of any existing receiver. The device consists of three parts—the pick-up itself, a volume control, and a special plug to be inserted into the detector valve holder on the set. The pick-up is a most impressive-looking job, and is attached to the tone-arm by means of a rubber collar, or in the case of

(Continued on page 480.)

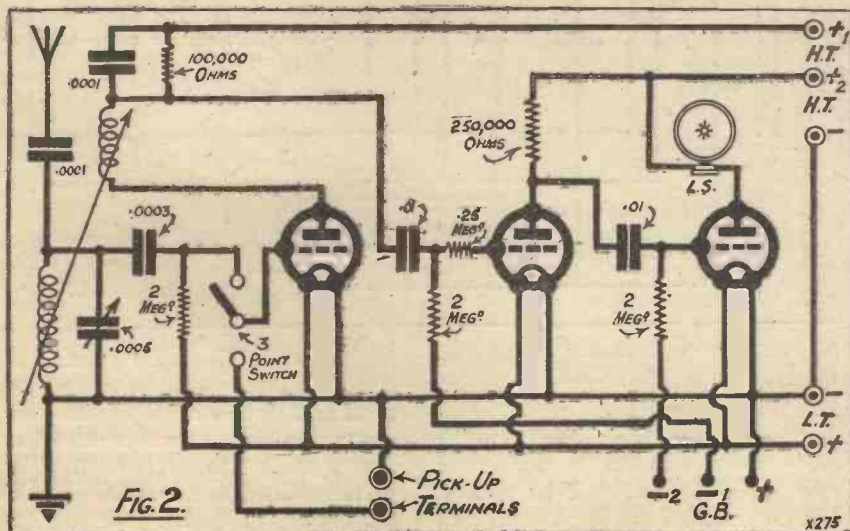

THE "CONCERT FOUR"

A NEW 1/6d. ENVELOPE



The latest addition to the long line of famous radio receivers designed by Mr. Percy W. Harris is the "Concert Four"—a low-cost high-efficiency receiver, details of which are now available in envelope form. The special features detailed below should be considered carefully by every set-builder.

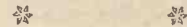

THE publishers of the WIRELESS CONSTRUCTOR have pleasure in announcing that the WIRELESS CONSTRUCTOR Envelope No. 2 is now on sale, giving full particulars of a remarkable new four-valve receiver, known as the "Concert Four," designed, constructed, and described by Mr. Percy W. Harris, M.I.R.E. The circuit is novel, the set is extremely efficient, and the cost of construction, using the best quality parts throughout, is remarkably low; for the complete receiver, as illustrated, in handsome oak cabinet, can be built for less than nine pounds. Valves and coils are, of course, extra.

Extremely Efficient

Mr. Harris has designed this receiver having in mind the latest development in the art and the special requirements of to-day. Although only two plug-in coils are used (one an "X" coil and the other a centre-tapped) the set is fully and accurately neutralised on the high-frequency side, and smoothly controllable reaction is obtained on the detector valve. By the correct placing of the coil and the use of a single aluminium or copper screen, which can be made up by the constructor himself or bought ready cut and drilled for half a crown, complete elimination of interaction between the stages is accomplished.

To give an example of the perfection of the neutralising, it can be stated that the sharp neutralising setting found on the 200 to 600-metre band is also precisely accurate for the longer wave-band.

By the use of a special form of tuned-anode circuit, it is possible to

utilise in the high-frequency stage a very high-magnification valve, while with the particular circuit used it is possible to get sharper tuning than is usually found practicable with the tuned-anode scheme. For example, during the tests at seven miles from 2 L O, it was found that Toulouse on 391 metres and Bournemouth on

only, the power-valve in the last stage being used in both arrangements.

Construction of the set is simplicity itself, for the envelope contains a full-size blue print of the whole receiver and back of panel, with every wire clearly marked, and every component drawn to full scale.

Every reader of the WIRELESS CON-

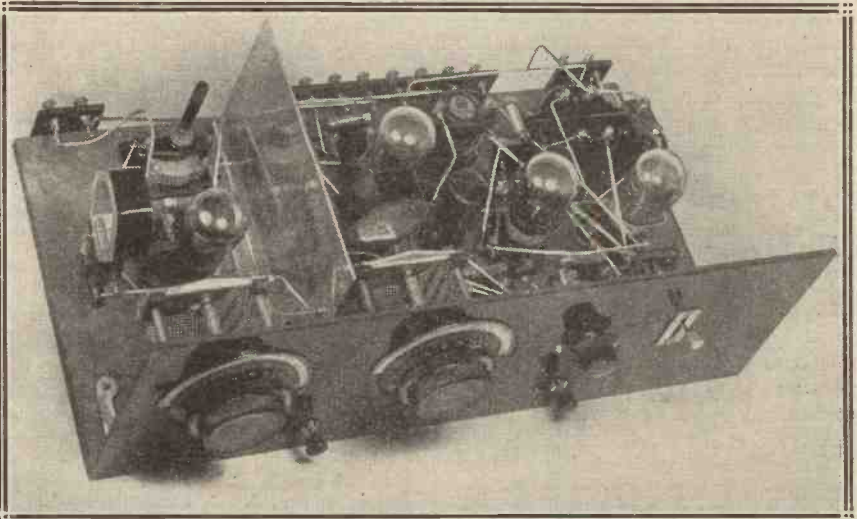

This view of the "Concert Four," and the one at the head of the page, give a good idea of the appearance of the completed set. Note the simplicity of screwing by means of a metal plate.

326 metres could be tuned quite free from the local station.

Pure Reproduction

By the use of one stage of resistance and the use of one stage of transformer note-magnification remarkably pure quality is obtained. So sensitive is this receiver that frequently the use of all four valves will be unnecessary, for which reason a simple lever switch has been provided which cuts out the third valve and automatically changes over the receiver to work on the three valves

STRUCTOR should obtain this envelope, even if he does not intend building the set.

As announced in the last issue of the WIRELESS CONSTRUCTOR, the "Radiano Three" Envelope is now on sale, and is having a remarkable vogue.

Both of these WIRELESS CONSTRUCTOR envelopes can be obtained from any bookseller or newsagent. Be sure to ask for the WIRELESS CONSTRUCTOR Envelope No. 1 for "Radiano Three," or No. 2 for the "Concert Four."



Typical faults and remedies reviewed.

By P. R. BIRD.

Programmes Without 'Phones or "Speaker"

ALL sets are alike in one respect—they all require 'phones or a loud speaker before you can hear the programme. So most of us believe. One friend of mine believed that, too, until recently, and then one evening he had a surprise. This is what happened.

His set was a powerful four-valver, screened-valve H.F., Det., and 2 L.F. It had lived a blameless life (in Ilford) for three months or so, and it could always be depended upon to pull in plenty of programmes. The quality was good, whilst there was plenty of punch on the programmes. In fact, neither 2 L O nor 5 G B could be tuned in fully because they not only made the welkin ring, but they fairly shook the glass on the sideboard!

Late one evening it happened that the loud-speaker leads were disconnected for a time whilst the set itself was left switched on. Dance music from 2 L O could still be heard faintly, and naturally it was assumed that this was coming from next door, until it was noticed that "Ain't that a grand and glorious feelin'?" sounded much louder near to the set. In fact, it seemed to be coming from inside the set!

The Musical Choke

"Impossible" thinks the owner to himself, and just to prove it he pushed in the filament switch to cut off the L.T. Immediately the music stopped! But every time those filaments were switched on again there was a persistent and clear little 2 L O pro-

gramme piping away, apparently inside the cabinet!

So the loud speaker was picked up, lead and all, and banished into another room, and then the puzzled proprietor came back to wrestle with the problem of a set that produced programmes without 'phones or loud speaker connected to or anywhere near it!

THE TECHNICAL QUERIES DEPARTMENT

Are you in trouble with your set?

Have you any knotty little radio Problems requiring solution?

The WIRELESS CONSTRUCTOR Technical Queries Department has been thoroughly reorganised and is now in a position to give an unrivalled service. The aim of the department is to furnish really helpful advice in connection with any radio problem, theoretical or practical.

Full details, including the revised and, in cases, considerably reduced scale of charges, can be obtained direct from the Technical Queries Department, WIRELESS CONSTRUCTOR, Fleetway House, Farringdon Street, London, E.C.4.

A postcard will do: on receipt of this all the necessary literature will be sent to you free and post free, immediately. This application will place you under no obligation whatever. Every reader of the WIRELESS CONSTRUCTOR should have these details by him. An application form is included which will enable you to ask your questions, so that we can deal with them expeditiously and with the minimum of delay. Having this form you will know exactly what information we require to have before us in order completely to solve your problems.

Now it happens that he is a doctor. So quite naturally he reached for his stethoscope, and methodically went over the components one by one with it, just as though the set had a puzzling cough! And he soon found that his wireless "patient" was perfectly normal in every

"organ" except in its L.F. choke, used for the output filter.

All the sound was coming from this, as the stethoscope proved beyond a doubt! It is not at all easy to see how a choke can possibly produce sound, unless one remembers that when in use it has a powerful magnetic field caused by the current flowing through it.

The Diaphragm

If in time one or two of the bolts or screws loosen a little, these magnetic strains "pull" and "push" at the thin laminated core. Eventually this core may loosen, too, moving ever so slightly backwards and forwards as the magnetism attracts and repels. This movement is communicated to the surrounding air, so we have, in effect, a "diaphragm" responding to the plate current and setting up sound waves in the same way that a loud speaker does.

It all seems quite feasible when you know—but I wonder how many could have diagnosed a case of "loose joint" when the only symptom was syncopation, and the only thing that the "patient" had to say was "Ain't that a grand and glorious feelin'?"

An Aerial That Wasn't

One of the oddest queries I remember was the case of a home-constructed two-valve set. According to the letter I received about it, it was nicely built, well-designed, and properly fitted up with 40-ft. aerial, L.T., H.T., valves, etc. But it had one very nasty fault—it would not work!

Hours and hours did its owner spend in tuning, and nothing that could be called a programme could he get. It certainly was a puzzling case, for the valves lit—it was in bright-emitter days, when a valve set looked like the front of a cinema, "now showing"—and a voltmeter showed up all the battery voltages as being quite O.K.

In correspondence with the worried owner of the set I learned that removal of the H.T. + or H.T. — plug resulted in a nice loud click in the 'phones, but there was no "plop" when the reaction and aerial coils were brought close together. So the first suggestion was to reverse the reaction-coil connections. (In those days a two-valve set that would not oscillate was not much good to a country listener.)

Reversal did not improve matters much, so the next suggestion was a larger reaction coil. With this

(Continued on page 480.)

BELOW TEN METRES!

by
A. V. D. Hort
C. B. A.



This article is an interesting record of practical experiences. It is not a mass of theoretical speculation. The author tells you how he himself has actually carried out a series of amazing experiments using ordinary three-electrode valves.

By A. V. D. HORT, B.A.

THE report recently published that WGY, the broadcasting station at Schenectady, New York, is to make experiments with a 5-metre transmission suggests the possibility that the wave-lengths below 10 metres, which have hitherto been almost entirely "laboratory wave-lengths," may come to have a practical value before long.

Many readers must by now have made receivers which will function down to about 20 metres or so, while a certain number have probably worked down to 14 metres to get

read the article in question, and then attempted to follow his instructions, you will most likely have been disappointed. The trouble lies in the fact that the circuits and instructions given by Reinartz apply to the valves in common use in America, and modifications are necessary when our British valves are employed.

Small Coils

In the anode circuit of the valve in Fig. 1, is a two-turn coil of heavy gauge wire, 1½ in. diameter, coupled to a similar coil in the grid circuit. A neutralising condenser connects the ends of the coils, and serves as a control over oscillation. To prevent

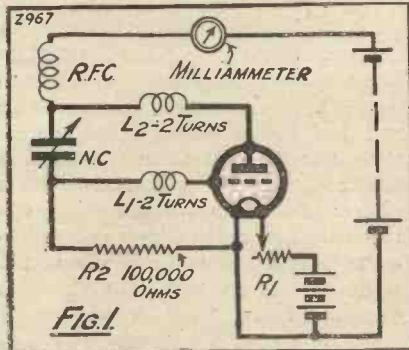
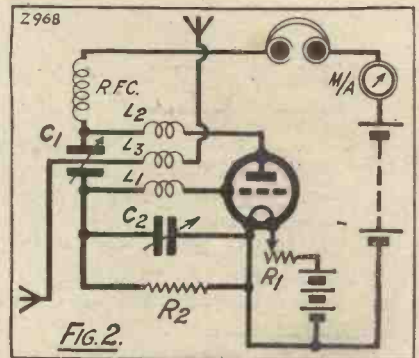

KDKA's broadcast on that wave-length. They will no doubt have encountered difficulties in persuading the detector valve to oscillate consistently. It may therefore come as something of a surprise to learn that between about 5 and 10 metres it is quite easy to get a three-electrode valve to oscillate. A valve of the ordinary four-pin type can be used, and the components needed are few.

Special Modifications

A short while ago the well-known short-wave expert, J. L. Reinartz, published (in "Radio News") an account of his experiments at these high frequencies. If you happened to

the grid from "blocking," a 100,000-ohm leak is connected to the filament. This can be taken either to positive or negative; it makes little difference.

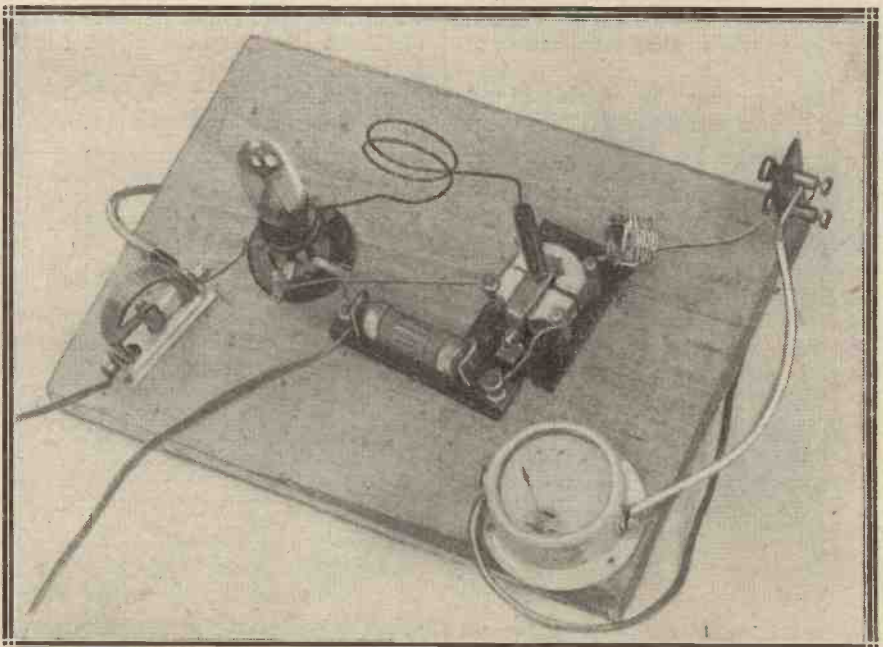

This is Fig. 1 hooked-up in a practical form with a straight wire grid connection and a two-turn anode coil. The H.F. choke is that tiny self-supporting coil which can be seen attached to that terminal of the "neutralising" variable condenser nearest the terminal strip.

Below Ten Metres —continued

For reception, the leak value may be increased to .5 or 1 megohm, with some improvement in the smoothness of the reaction control.

Milliammeter Indicator

The inclusion of the H.F. choke is essential, and this component should possess low self-capacity. A 30-turn coil 1 in. diameter, of No. 28 S.W.G., of the "Lorenz" type, is suitable, though an ordinary solenoid of similar diameter wound with 30 or 40 turns of No. 30 S.W.G., or less, will serve quite well. You are strongly recommended to put a milliammeter in

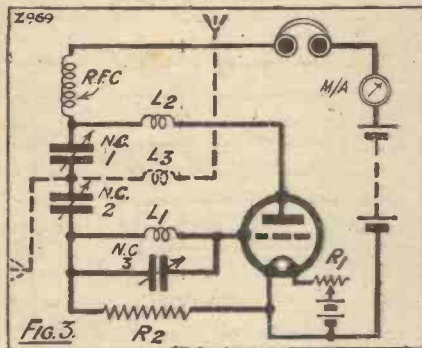

series with the H.T. battery; 0-15 m.a. being a useful range for H.T. voltages up to 120. The meter gives an invaluable indication of oscillation, and greatly assists adjustment of the circuit. With the circuits given in this article the anode current will decrease when the set starts to oscillate.

Now, if you make up this Fig. 1 circuit, you will find that the valve

will oscillate over about half the scale of the coupling condenser when the coils are 1 in. or 2 in. apart. Separate the coils as far as possible, also setting them at right-angles, and the valve will still oscillate. The minimum setting of NC for oscillation will, however, be slightly higher up the scale. By bringing the coils very close together the minimum setting will go down slightly, but not much. This indicates that the coupling between anode and grid is almost entirely capacitive, and that the presence of the coils, as such, makes very little difference to the coupling.

Inclusion of Aerial

This can be still further demonstrated in the following way. Remove the grid coil and put in its place a straight connecting wire. The valve should still oscillate, though, of course, at a higher frequency. With the anode circuit matters are slightly different. You can take out the coil and put in a plain loop or a connection as straight as you can make it, but you will find that the valve will not oscillate if this wire is too short. With the apparatus used in the experiments described, the minimum length of wire for a D.E.5 valve was about 10 in. This wire could be of any gauge and could be bent into any shape without stopping the valve from oscillating. The grid connection could be reduced to the shortest possible, about 1 in., without effect on oscillation.

We shall return to the Fig. 1 circuit again, but there are developments of

this circuit which are of interest. In Fig. 2 a balancing condenser is substituted for the condenser of Fig. 1. If you do not possess a balancing condenser, you can use two neutralising condensers, connected as in Fig. 3, with a plain wire connection joining their moving plates.

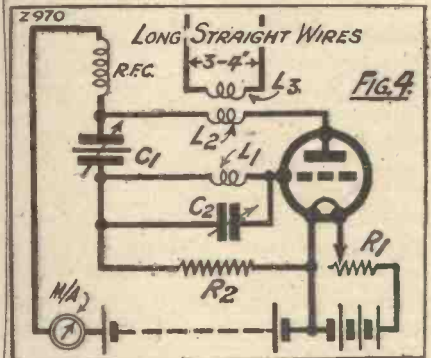

This arrangement allows of the connection of an aerial and earth (preferably a counterpoise earth) as shown. Note that the aerial two-turn coil is wound in the same direction as the grid coil, i.e. in the opposite direction to the anode coil. The length of the aerial should be 10 ft. or 15 ft., though if you are only going to listen for the beat note of another receiver a short distance away, 2 ft. or 3 ft. will suffice. Put the telephones between the milliammeter and the H.F. choke. If the valve refuses to oscillate when the aerial is attached, try cutting a few inches off its free end, as you will probably have made it of a length which is equal to some multiple or sub-multiple of the frequency at which the valve is oscillating.

Question of Layout

You should not find hand-capacity excessively troublesome in handling the circuits. Try touching various points when the valve is oscillating. Touching the anode or grid will naturally stop oscillation. But you will find that you can touch the remote ends of the anode and grid coils without effect, and also any part of the filament circuit. No choke coils are needed in the filament leads, nor in the H.T. negative lead. Experiments with battery leads several yards long, with and without chokes, revealed no difference between the various arrangements. Extra-short leads gave no improvement.

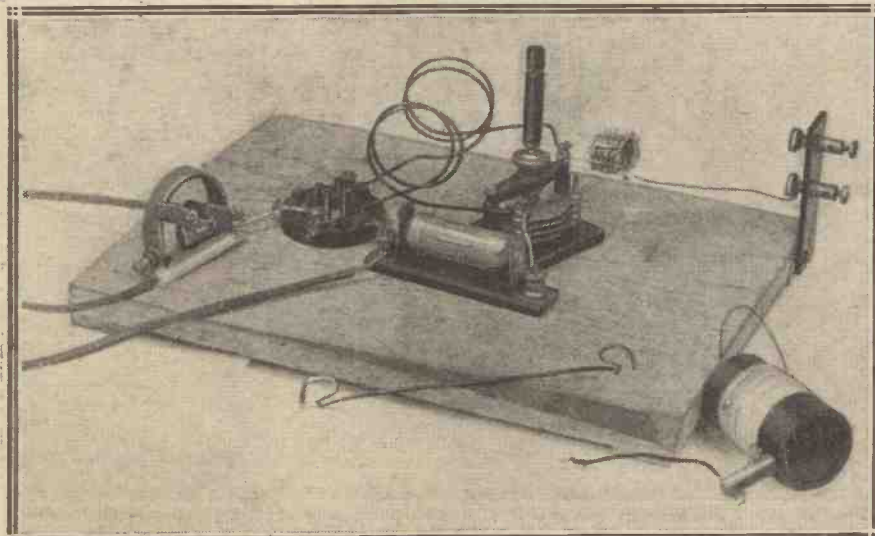

This is another version of Fig. 1. This time with two coils. In the foreground is the alternative type of H.F. choke and the "bridge" wire used for wave-length measurement.

Below Ten Metres!—continued

It may seem from this as though care in the layout of these high-frequency circuits is not necessary. Actually, if you want to get "down to the bottom" with any particular valve you must be very careful with the disposition of the H.F. parts of the circuit, though the rest is less important. Use a valve holder with no solid material between its sockets. You can even try soldering the connections direct to the pins of the valve. The Bowyer-Lowe "Antipong" holder is shown in some of the photographs, and any similar component will be equally satisfactory.

You can try a wide range of valves, but start with a low-impedance valve, such as the D.E.5. Valves with such widely differing characteristics as the D.E.3, D.E.5b, and R.5V. (bright emitter) have been found to work well.

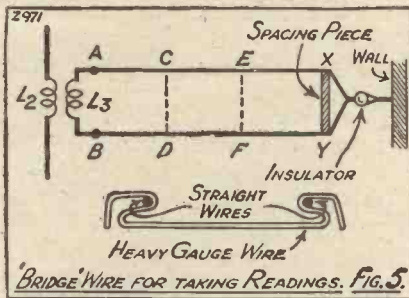

One other accessory is most important, and this is a wave-meter. The absorption wave-meter is the simplest. Across the terminals of a .0001 variable condenser connect a loop 3 in. diameter of stiff copper wire. Tighten up the terminals so that the wire cannot move. When you bring this coil near the anode coil of the oscillating valve, and rotate the dial of the condenser you will find a point where the milliammeter needle rises, and falls again sharply.

Measuring Wave-length

Move the meter away until you can only just get a movement of the milliammeter, and note the wave-meter dial reading. Make a point of taking readings in this way whenever you make the smallest alteration in the circuit.

With 'phones instead of the milliammeter, you will hear two clicks when you rotate the wave-meter condenser close to the anode coil. Move it away till you get one click only, and note the scale reading.

By taking wave-meter readings you will be able to establish a relationship

between various circuit arrangements and sizes of coils. Then, after finding the actual wave-lengths, you will be able to draw a calibration curve for the meter and subsequently ascertain your wave-length more easily.

At first you will have no idea at what frequency the valve is oscillating. You can find out quite easily. In Fig. 4 we have Fig. 2 redrawn, without the aerial connection. Close to the anode coil is placed a two-turn pick-up coil L_3 , and to the ends of this are connected two long, straight, bare wires, not less than 18 S.W.G. Stranded aerial wire is even better. Take these wires across the room, 3 in. or 4 in. apart, for 10 ft. or more, connect them together at the far end, and fix them apart with a strip of wood or ebonite (see Fig. 5).

The "Bridge" Method

You will need also a wire "bridge," as shown in Fig 5, long enough to fit between the straight wires and just to strain them apart, so as to make good contact with them.

Switch on the valve, and see that it is oscillating. Place the bridge at the coil end of the wires, and move it slowly away from the set, watching the milliammeter as you do so. Prop up the milliammeter so that you can see it when you are at any point along the wires. When the bridge comes to a certain point on the wires, the

valve will stop oscillating. On moving the bridge an inch either way, it will start again. Note the exact centre point. Let us assume that the bridge is represented by CD in Fig. 5. With a tape-measure find the length

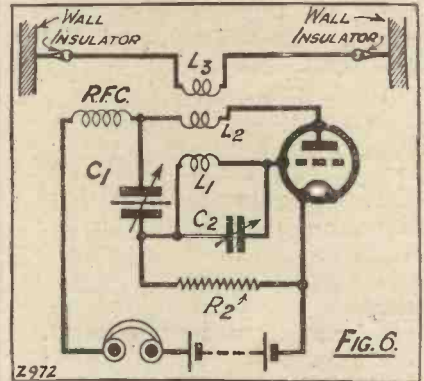

AC, add half the length of the bridge wire and half the length of the wire forming the coil. Multiply by four and you have your wave-length.

An example may help. Using a D.E.5 valve and the Fig. 4 circuit, with C_2 "all out," the distance AC was 76 in. The wire bridge was 4 in. long, and the coil wire 16 in., so that the required length was $76 + 2 + 8 = 86$ in.; $86 \times 4 = 344$ in. Divide by 39 to reduce to metres, and the result is 8.98 metres. With C_2 one-third "in," AC was increased to 86 in., giving 9.84 metres by a similar calculation.

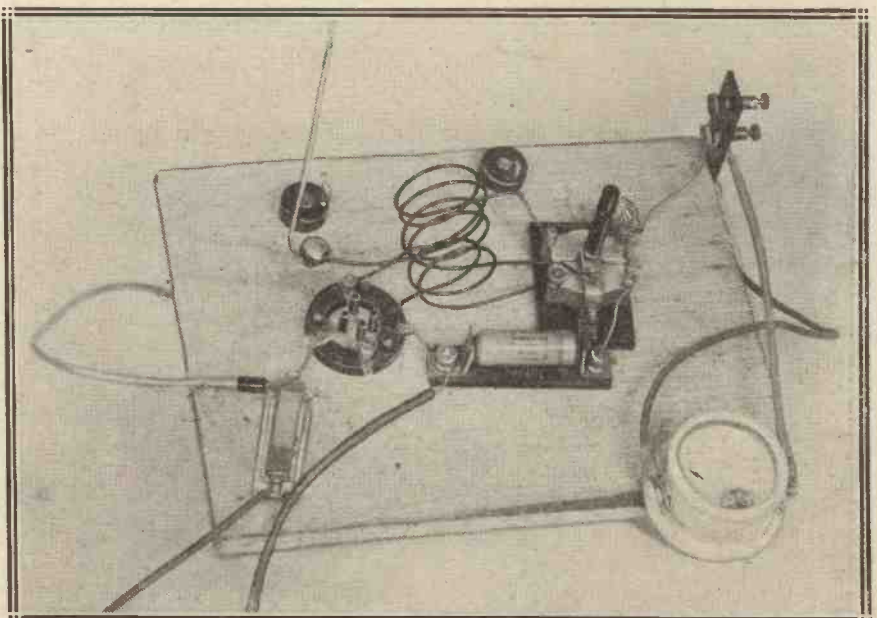

The practical application of Fig. 2. The aerial coil can be seen between the anode and grid coils, with the aerial wire attached. No earth lead is shown. Note the ebonite-mounted hooks at the back, for attaching the coupling cut for wavelength measurements.

Below Ten Metres!—continued

Note that the lengths AC and BD must be equal. When you have fixed wave-lengths in this way which are well distributed over the scale of the wave-meter, make a calibration chart. Then you will not need to use the more complicated method of measurement, unless you run off the scale of the meter.

You may sometimes find difficulty in getting accurate readings with the bridge when the valve is oscillating feebly. If you cannot increase the H.T. voltage to improve this, put a second bridge on the wires, as shown at EF in Fig. 5. This must make a good connection with both wires, and should be located 2 ft. or 3 ft. from the roughly ascertained resonance point, on the side farthest from the set. If this does not improve matters, you must depend on the wave-meter to obtain a reading for that adjustment.

Aerial In Use

When you have finished using the straight wires for measurements, you can convert them into an aerial for reception. The method of doing this is given in Fig. 6. Leave the coil L₃ fixed where it is, and spread out the wires in opposite directions, attaching them to insulators at the ends. Be careful that their length does not equal any multiple or sub-multiple of the wave-length you are using.

Slight variations of electrode spacing, and more particularly of the

disposition of the leads in the "pinch" of the valve, will materially affect the wave-length. By reducing the length of the wire in the coils half an inch or so at a time, it is possible to get down to the lowest wave-length at which any particular valve will function with these simple circuits.

* "THE TRAPPER" *
* A Reader's Results *

SIR,—I have constructed the set "The Trapper," as described in the October issue of the WIRELESS CONSTRUCTOR, and it may be of interest to you to know the results obtained with the same.

During two weeks' work with this set, on a fairly poor aerial, situated about three miles from the 2 L O transmitter, I tuned in and identified 42 stations, without any interference from 2 L O. These 42 stations included: Riga, Moscow, Leningrad, and Warsaw. Many can be received regularly every evening on good head-phone strength. The best received are: Radio Paris, 5 X X, Koenigs-wusterhausen, Kalundborg, Hilversum, 5 G B, Langenberg, Frankfurt-o-M., Berne, Hamburg, Toulouse, Stuttgart, Madrid, Barcelona, Han-over, Muenster.

2 L O, 5 G B, and 5 X X have been

received with excellent loud-speaker strength. On favourable nights Madrid and Langenberg give fairly good loud-speaker results.

It may interest you to know that this set works very efficiently also below 100 metres, provided special coils are used. As a matter of fact, the set oscillates easily tuned down to about 12 metres.

The coils are made as follows: Using standard six-pin coil formers, and No. 22 S.W.G. D.C.C. copper wire, for the range 40-90 metres the aerial coil (between pins 1 and 2) has five turns, with the spacing of about $\frac{1}{8}$ in. between them. The grid coil (between pins 3 and 4) has nine turns spaced $\frac{1}{8}$ in., and the reaction coil (between pins 5 and 6) has ten turns, wound unspaced. For the range of about 20-60 metres the aerial coil consists of three turns, the grid coil of five turns, both spaced $\frac{1}{8}$ in., and the reaction coil of six turns, wound unspaced.

Down Low

For wave-lengths below 24 metres the aerial coil has two, the grid coil three turns, both spaced $\frac{1}{8}$ in., and the reaction coil five turns unspaced.

As H.F. choke I am using plug-in coils, as I have found that on different wave-lengths different coils give best results.

For wave-lengths up to 24 metres I use coil No. 25, for 20-60 metres coil No. 30, and for 40-90 metres the 50-turn coil. On the short waves I receive K D K A on 62.50 and 26 metres, 2 X A F and 2 X A D, also the 2 F C short-wave transmissions, and several English and French amateurs on telephony. 2 X A F, 2 X A D, and K D K A being received with ease regularly every night, giving excellent 'phone strength. Body effects are not very noticeable.

Adding to this set a second L.F. stage, the 2 X A F and 2 X A D transmissions have been received, giving fair loud-speaker strength. If the set does not oscillate easily on the short waves, it is a great help to use in the detector stage a valve of the power type, and insert in the aerial lead a small fixed condenser, but I had no difficulties in obtaining excellent results with an ordinary detector valve, and without the fixed condenser.

Yours faithfully,
L. F., High Holborn, London.

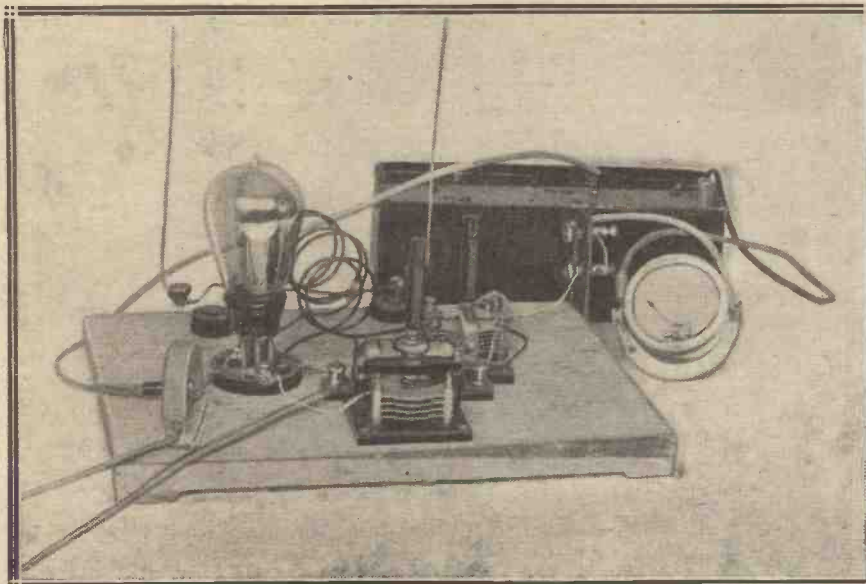

Here we have the practical arrangement of the circuit shown in Fig. 4. The coupling coil is on the far side of the anode coil, with straight wires connected to its terminals. C1 is nearer the back of the baseboard, while C2 is the "neutralising" condenser well to the front.

The "RANGE-FINDER"

This three-valve set, employing the popular arrangement of detector and two L.F. amplifiers, is capable of receiving on all wave-lengths from about 30 to 2,000 metres.

Either grid-leak or anode-bend rectification can be used, and when required two valves only may be employed.

By A Regular Reader

THE "Range-Finder" is a receiver which has been designed to cover a wide range of wave-lengths embracing the broadcast band, and at the same time providing facilities for the reception of both shorter and much longer wave-lengths. Being, as it is, the result of gradual evolution, its wiring is not in the neat form that total re-wiring would make possible, but so far as results are concerned these have been very satisfactory, covering a range of 30 to 2,000 metres.

Melbourne, Australia (3 L O), and Radiola Paris have both been received, the former on 30 metres and the latter on 1,750 metres. Results are excellent on the extreme short wave-lengths, and long-wave reception is also good. The method of reaction employed lends itself very well to short-wave working, and is equally satisfactory on longer waves. Either "anode-bend" or the "leaky-grid" method of rectification may be employed, both forms of rectification having been incorporated so that individual tastes may be satisfied.

An Important Feature

An important feature of the set is the manner in which two valves only may be used, the third valve being cut out of circuit. Frequently, when a set is designed to give alternative service on two or three valves, the last valve (that is the valve in the final amplification stage) is the one discarded when two valves only are required. This procedure has not been adopted in the case of the set being discussed, as it is the intermediate valve which is removed from circuit.

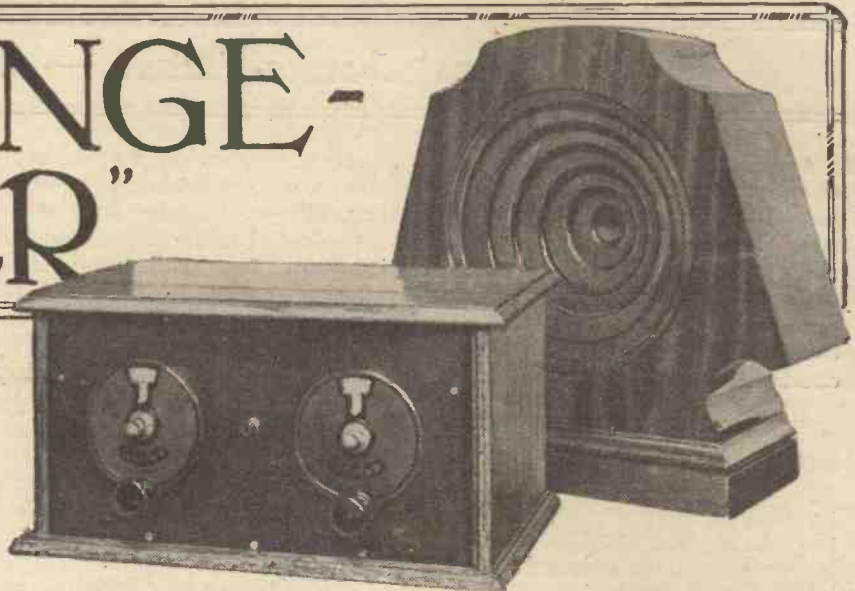

Reference to Fig. 1 will show that by transferring the plug from J_2 and plugging into J_1 , the second or intermediate valve V_2 is automatically cut out, the filament battery supply to the valve being also disconnected.

When the set is working on the longer wave-lengths, that is, on waves longer than 100 metres, the condenser C_4 is short-circuited, as this capacity is not required. The condenser is introduced for short-wave reception by removing the clip K, which places C_4 in series with C_1 , giving a maximum capacity of .00015 approximate. The condenser C_5 is introduced as a precautionary measure for preventing damage to the set, should C_2 for any reason be short-circuited.

The operation of the plug and jack referred to above requires, perhaps, a little additional explanation.

The Jack Switches

When the plug is inserted into the first jack (J_1) the set is operating as a two-valve receiver, with detector and one stage of transformer-coupled low-frequency amplification. The insertion of the jack into J_2 introduces the intermediate valve by switching on the filament of that valve, and the set becomes a three-valve receiver—detector valve, followed by a stage of choke-coupled amplification, completed by a stage of L.F. transformer-coupled amplification.

Either two or three valves can be used at will.

This back-of-panel view shows most of the components and the method of mounting the jacks for switching.

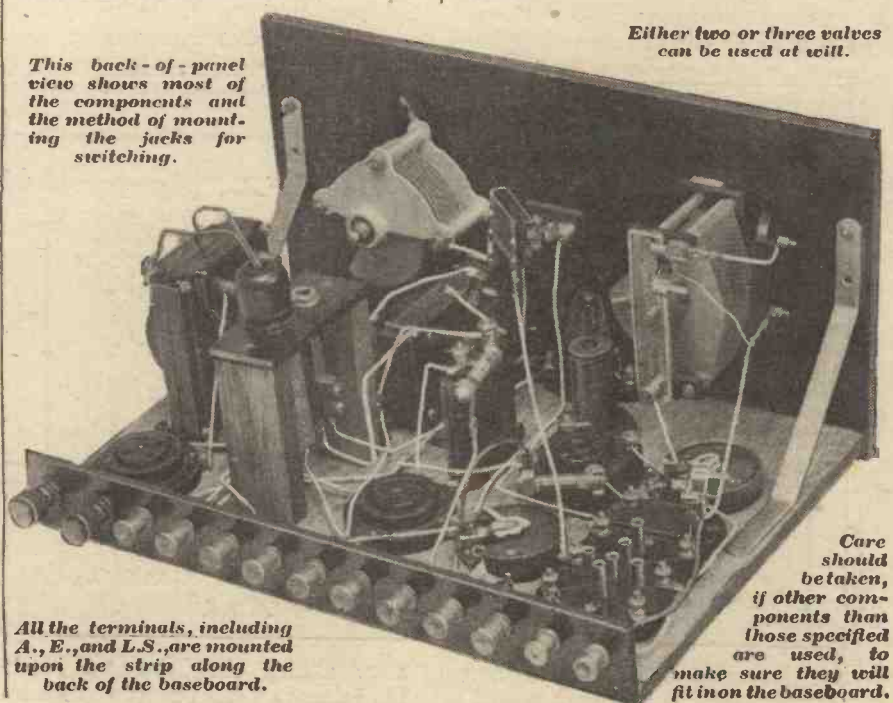

All the terminals, including A., E., and L.S., are mounted upon the strip along the back of the baseboard.

Care should be taken, if other components than those specified are used, to make sure they will fit in on the baseboard.

The "Range-Finder"—continued

A further modification is the use of one valve only. This is accomplished by using a pair of telephones attached to a suitable plug and connecting to J₁. It is, of course, obvious that by plugging the telephone leads into J₂, a stage of choke-coupled low-frequency amplification can be added to the detector valve,

quality, and if for any reason components other than those specified are used, care must be taken to see that no radical change is made in the layout of the receiver. This is necessary owing to the compact manner in which the receiver has been designed, and a study of Fig. 3 will show that it is absolutely

terminal strip is then secured in position, and the baseboard, panel and terminal strip removed from the cabinet. This method will ensure a proper fit when the completed set is finally returned to the cabinet.

Now secure the panel brackets to the baseboard, carefully indicating the position that they will occupy on

LIST OF COMPONENTS REQUIRED.

- 1 Panel, 14 in. × 7 in., black (Ebonart). (Radion, Resiston, Red Seal, etc.)
- 1 .0005 variable condenser (Bowyer-Lowe. Any good make).
- 1 .0003 variable condenser (Utility. Any good make).
- 2 Slow-motion dials (Igranic Indigraph, or other good type).
- 1 "Single open" filament jack (Igranic Pacent in set. Any good make).
- 1 Double-circuit jack (Igranic Pacent in set. Any good make).
- 1 Plug (Edison Bell, or other standard type).
- 1 On-and-off switch (Lissen in set). (Benjamin, Igranic, L. & P., Lotus, etc.)
- 1 Cabinet, 14 in. × 7 in., with 9 in. baseboard (Artercraft, Bond, Caxton, Cameo, Makerimport, Pickett, Raymond, etc.).

- 2 Panel brackets.
- 3 Anti-phonic valve holders (Benjamin, Bowyer-Lowe, B.T.H., Burndept, Burne-Jones, Lotus, Marconiphone, Metro-Vick, Pye, W.B., etc.).
- 3 Baseboard-mounting filament resistances (Lissen, or similar type).
- 1 Fixed mica condenser, .05 (Clarke, Dubilier, Igranic, Lissen, Mullard, T.C.C., etc.).
- 1 Fixed mica condenser, .001 (Clarke, Dubilier, Igranic, Lissen, Mullard, T.C.C., etc.).
- 1 Fixed mica condenser, .0003 (Clarke, Dubilier, Igranic, Lissen, Mullard, T.C.C., etc.).
- 1 Fixed mica condenser, .0002 (Clarke, Dubilier, Igranic, Lissen, Mullard, T.C.C., etc.).
- 1 Fixed mica condenser, .0001 (Clarke, Dubilier, Igranic, Lissen, Mullard, T.C.C., etc.).

- 1 Six-pin-base coil holder (Bowyer-Lowe, Burne-Jones, Lewcos, etc.).
- 1 3-megohm grid leak with clips (Dubilier, Igranic, Lissen, Mullard, Pye, etc.).
- 1 1-megohm grid leak with clips (Dubilier, Igranic, Lissen, Mullard, Pye, etc.).
- 1 L.F. transformer (Ferranti A.F.3 in set. Any good make).
- 1 L.F. choke, 110-henry (Pye, or other good make).
- 1 H.F. choke (Magnum in set. Any standard make).
- 13 Terminals, a strip of ebonite 14 in. × 1½ in.
- 3 Spring clips (Peto-Scott, Ward & Goldstone, etc.).
- Colvern six-pin coil formers. Glazite or Junit, etc., for wiring.

but in either operation it is essential to turn off the filament of the last valve by means of the resistance before plugging the telephones into the set.

The components used in the set are given in detail in the accompany-

necessary to place the components in the exact positions illustrated.

Drilling the Panel

Fig. 2 shows the panel with the drilling points clearly dimensioned.

Drill the panel as indicated, and

the back of the panel, and then remove the panel from the baseboard.

The components can now be fixed to the baseboard in the positions indicated in Fig. 3, and all the wiring possible completed before re-attaching the panel to the baseboard. As previously intimated, it is essential owing to the very small space between the various components to place each component carefully in the position it is intended to occupy. Failure to comply with this instruction will probably result in some difficulty when experienced in soldering when certain connections are being made.

As it is difficult to show clearly the wiring of the jacks on the general layout of the receiver, these connections have been shown separately in Fig. 4, and can easily be followed.

The Coils

The details of the short-wave coil are shown in Fig. 5, and the "broadcast" coil in Fig. 6. For Daventry 5XX and the longer wave-lengths an additional coil is required. Obtain four ounces of No. 4 S.W.G. D.S.C. and a standard former of the type used for the broadcast coil.

The coil is wound in the same manner as that employed in

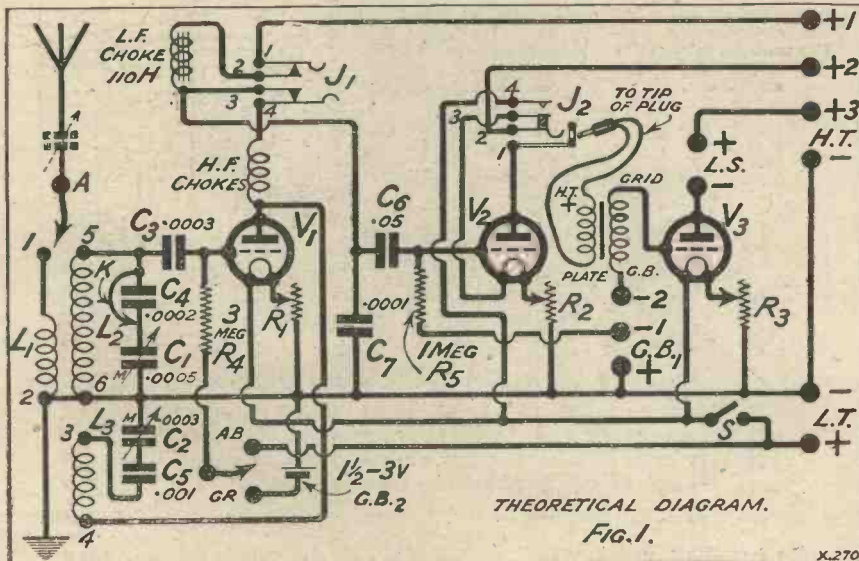

ing list. While there are many possible and good alternatives, it is important to use components of good

after placing the baseboard inside the cabinet attach the panel to it by means of three wood-screws. The

The "Range-Finder"—continued

constructing the coil for the broadcast wave-lengths, and consists of a primary winding of 100 turns (wound in two layers of 50 turns each), a reaction coil of 100 turns (wound in two layers of 50 turns each), and a secondary coil of 210 turns (also wound in two layers).

A Tedious Task

Remember in every case, after completing the first layer, to continue winding the second layer by commencing over the first turn.

It will be found that the secondary winding occupies about $1\frac{1}{4}$ in. of space on the former. The winding of this coil really requires a lathe or some form of coil winder, or else a

As will be seen from the wiring diagram, a small high-frequency choke is connected in series between the anode of V_1 and the "A" terminal of the Magnum choke.

This little choke consists of 100 turns of No. 34 S.W.G. D.S.C. wound on a former of 1 in. diameter. Only by adopting this precaution can the highest efficiency on the short waves be obtained.

The valves actually used by the writer are a Marconi D.E.2 L.F. in the detector stage and the first low-frequency stage, and a Mullard P.M.2 in the final amplification stage.

Experiment has shown, however, that when anode-bend rectification is employed, and the three valves

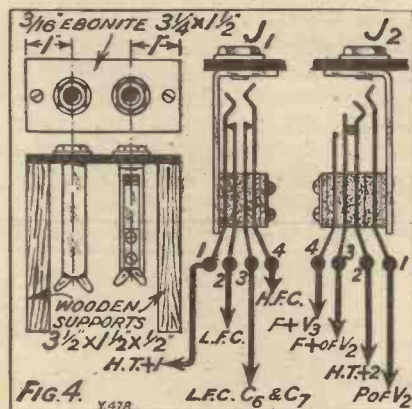

are in circuit, results are improved by using a D.E.2 H.F. valve as a detector. These, of course, are 2-volt valves, but similar valves of the 6-volt class can be utilised, and any valves already at hand could be tried in the set.

Simple to Handle

On the broadcast and longer wave-lengths tuning is extremely simple, and if the set is working properly no difficulty will be experienced in tuning-in on these waves. The tuning chart shown will no doubt be of considerable assistance in this respect. To the uninitiated the reception of extremely short wave-lengths is always difficult, but information is frequently given on the subject in the columns

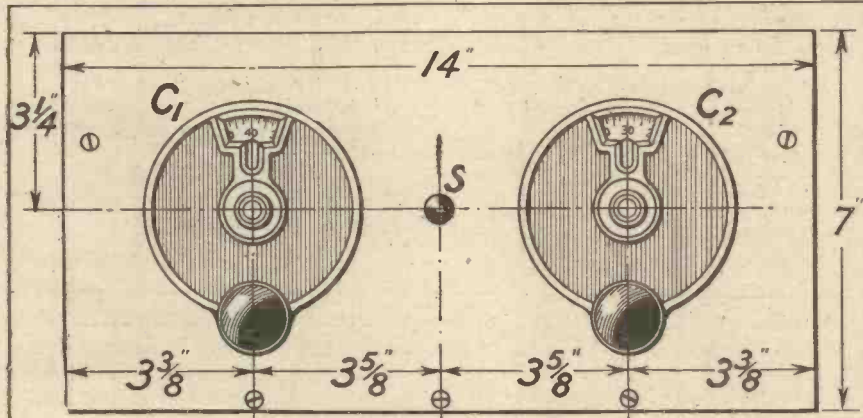

large stock of patience, and it is probable that many readers will prefer to purchase a standard coil covering the longer wave-lengths, such as those sold by Messrs. Colvern, etc.

In this case a small alteration will have to be made to the pin connections by changing over the leads on pins numbered 3 and 5, and also on 4 and 6 respectively.

For Short Waves

The particulars given in Fig. 5 relative to the short-wave coil need not be strictly adhered to, a little experimenting with the number of turns employed being necessary for stations below 30 or above 60 metres.

The aerial coil of five turns covers quite a good range, and generally will include all stations on the short wave-band.

The grid and reaction coils, which are shown as having $6\frac{1}{2}$ and 5 turns respectively, bring in WGY on 32.77 metres at 14 degrees on C_1 .

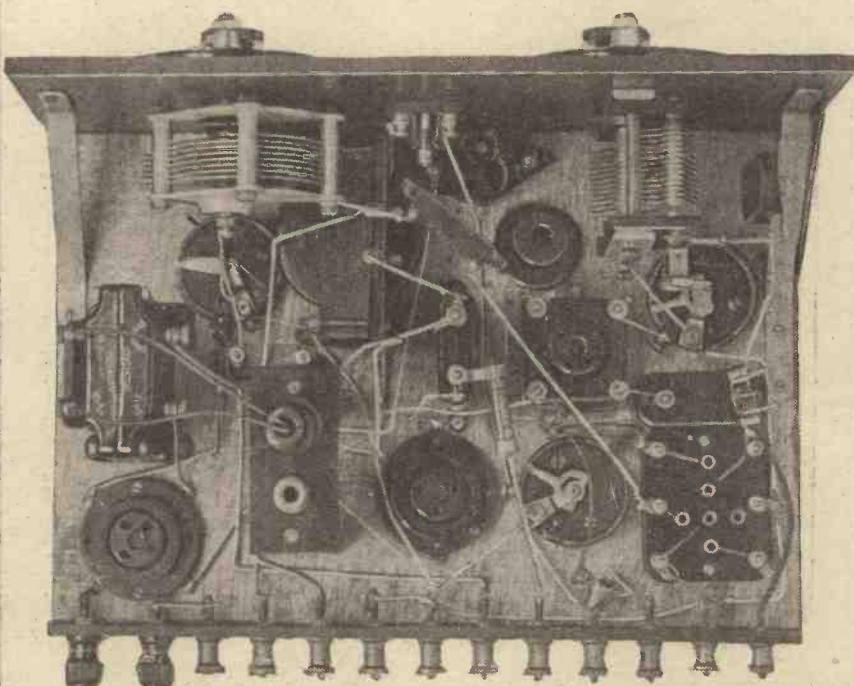

This plan view should be compared with the wiring diagram on the next page.

The "Range-Finder"—continued

of the WIRELESS CONSTRUCTOR, and a little study and experiment on the set will soon bring success,

Always bear in mind that the reaction control must operate smoothly. If the set is suddenly thrown into violent oscillation when

the control is moved, dim the detector valve and reduce the high-tension. If these modifications are not sufficient, substitute a 5-megohm grid leak.

If oscillation is intermittent—that is, if "dead spots" are found where the set will not oscillate—place a small

condenser in series with the aerial. A Formo-densor, .00025 mfd., was found very suitable for the purpose.

This can be brought into circuit when required by the method adopted in the case of C_4 .

(Continued on page 433.)

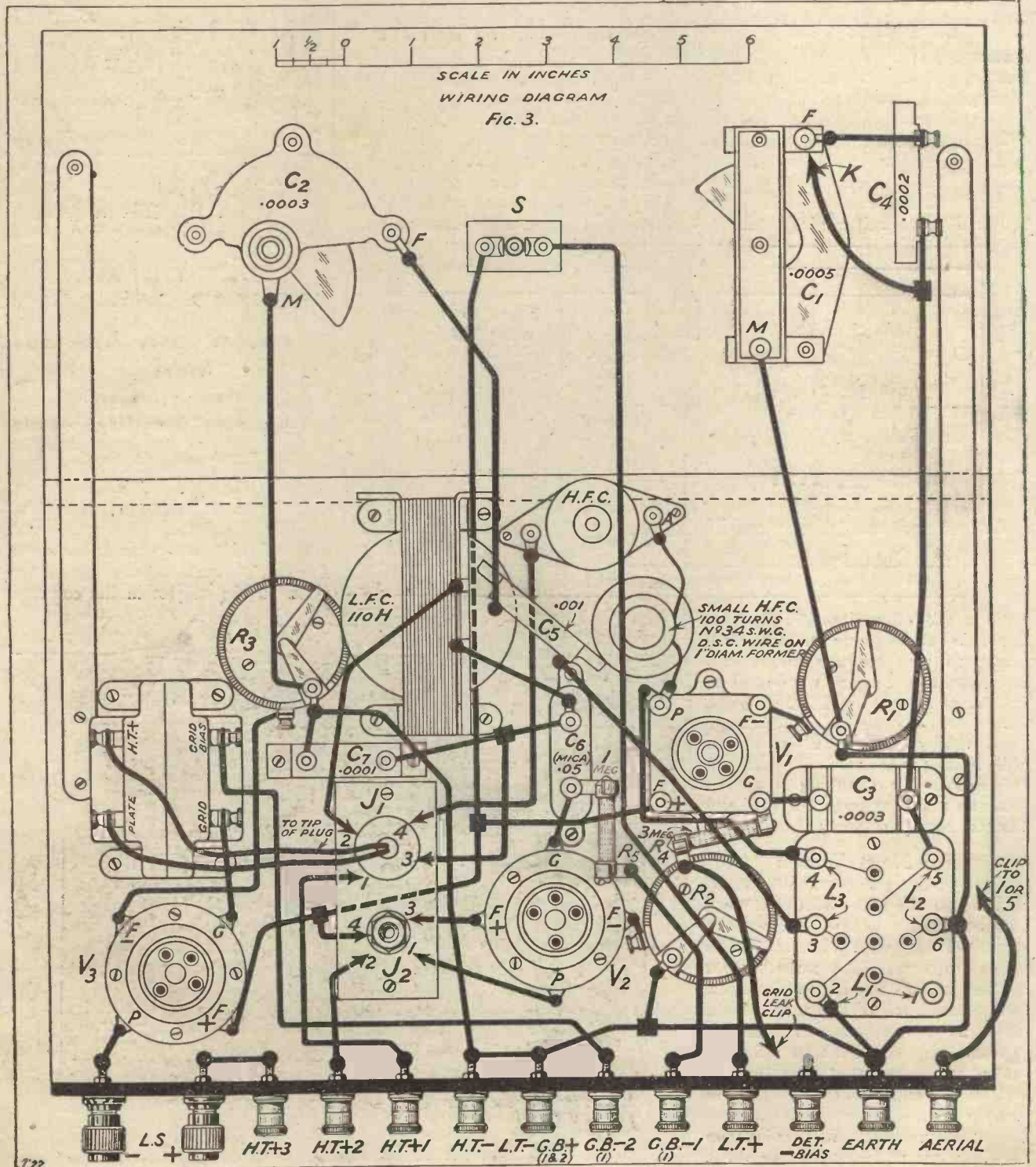

Comments from Constructors

America First Time—Melbourne on the Radiano!

America First Time

SIR,—I find myself obliged to praise your efficient "Radiano Short-Wave Two," which I constructed yesterday.

It was afternoon when I received the necessary components from England, with the exception of variable condensers, which I used good French makes of .00035 mfd. each, and an Igranic L.F. transformer. By the time I finished its construction it was about midnight!

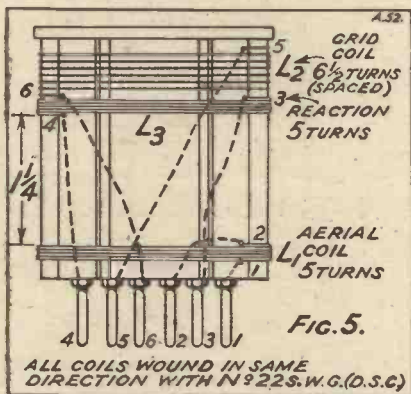

Constructional details for the "Range-Finder's" short-wave coils.

Inserting a 210 H.F. in detector, and D.E.P.215 in L.F., and 60 volts H.T., I put the set on preliminary test, which I found would not oscillate. But on changing the H.F. choke for a smaller value, the set oscillated as smoothly as that of an efficient set of the broadcast band. Hand-capacity was negligible, or perhaps I can say fully absent, which is a very outstanding feature of the set.

Being my first attempt on short waves, I had almost no hopes of getting distant stations, especially with my inefficient indoor aerial of about 20 ft. length and height.

To my surprise, in two minutes' time I was able to receive K D K A on 62.5 metres, whose reception was comfortably loud and sometimes distortionless (very occasional fading). At times even the announcer's nasal accent was plainly audible. I was also able to receive several amateurs' Morse transmissions from different parts of the world. I have not had yet the opportunity to try for Australia.

In conclusion, I offer my heartiest congratulations and thanks for having

made short-wave reception so easy and amusing on your Radiano.

Yours very truly,

Paris.

M. BADIE.

Melbourne on the Radiano!

SIR,—I have made the Radiano two-valve short-wave set as per the WIRELESS CONSTRUCTOR of June, 1927, same as drawings except the following. I cut out the switch and fixed resistor and used two rheostats, and for reaction .0005 variable condenser instead of .0003, as I did not get enough reaction; also I soldered all wires instead of flex and tags, as I am handy with the soldering iron.

I am writing this as I should like to tell you I got 3 L O (Melbourne) on January 1st from 6.45 till 8 p.m., very clear most of the time, especially the announcer's talk. I got it again on January 8th, but there was so many buzzing round oscillating that it was not possible to hear anything plain. (I saw in the Daily Press that 3 L O was discontinuing the tests.) But I am sure I held 3 L O for one and a half hours last night, January 15th, from 6.30 to 8 p.m. I then wanted to

hear Rev. Dimsdale Young, so shut it off. I am very pleased with the Radiano set. I have tuned in 2 X A D, 2 X A P, K D K A, the Dutch, and Paris, and Germany, and many British amateurs.

A friend of mine has built the "Sydney Two," and is getting good results also.

Yours sincerely,

ERNEST E. R. BRYANT.

Sussex.

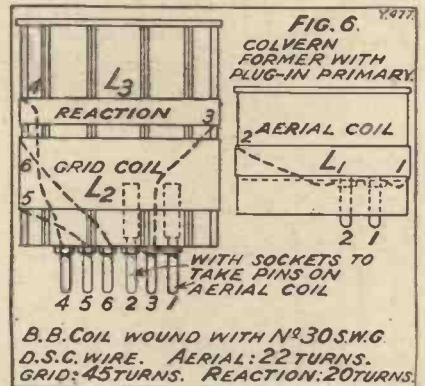

THE "RANGE-FINDER"
—continued from page 432

The condenser is not shown on the wiring diagram owing to the fact that it is attached to the back of the cabinet, but it is indicated in the theoretical circuit, in dotted lines.

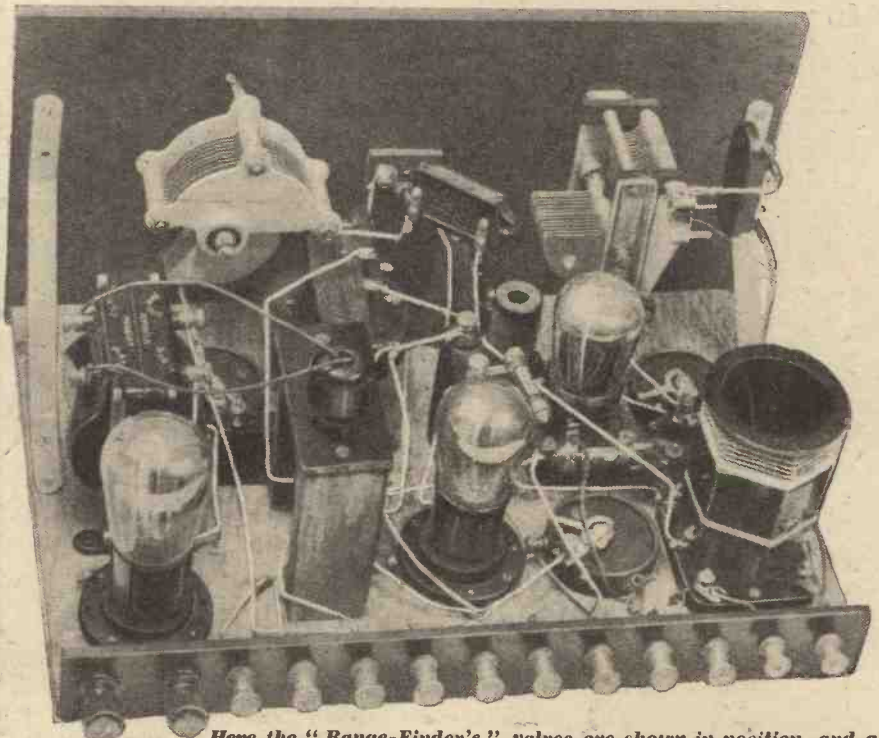

Here the "Range-Finder's" valves are shown in position, and a short-wave coil has been placed in the standard six-pin coil holder.

TO ERR IS HUMAN—

Edn Shaw

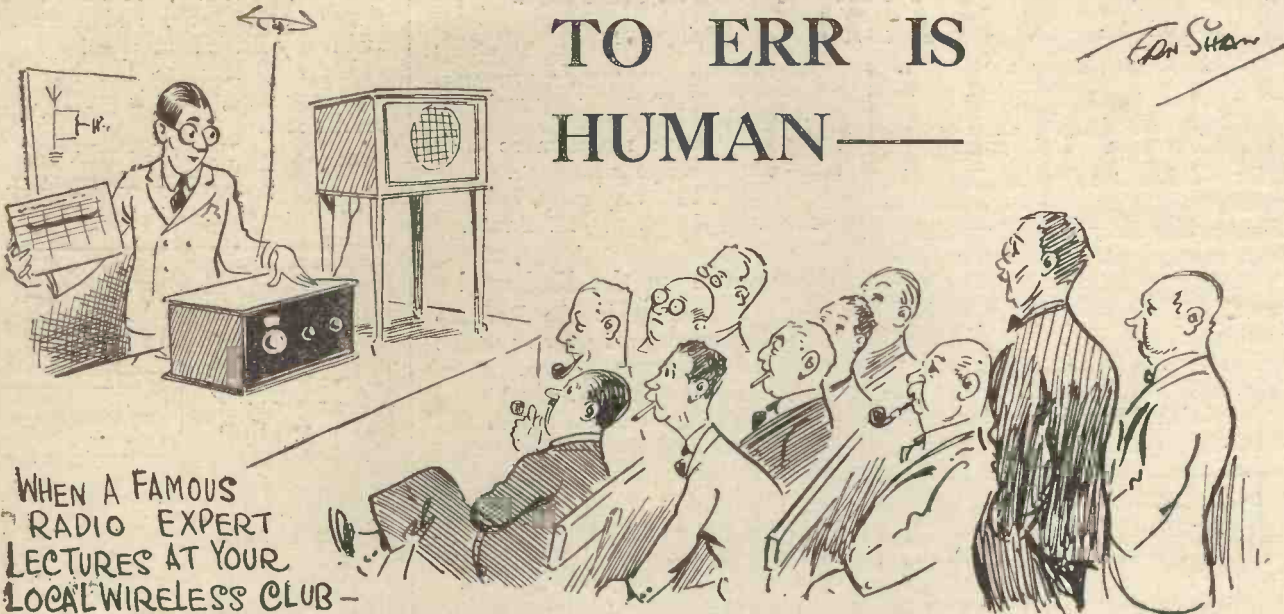

WHEN A FAMOUS RADIO EXPERT LECTURES AT YOUR LOCAL WIRELESS CLUB— AND AFTER HOLDING YOU SPELLBOUND FOR AN HOUR WITH THEORETICAL DETAILS HE ANNOUNCES THAT HE WILL NOW GIVE A DEMONSTRATION OF HIS PET CIRCUIT—

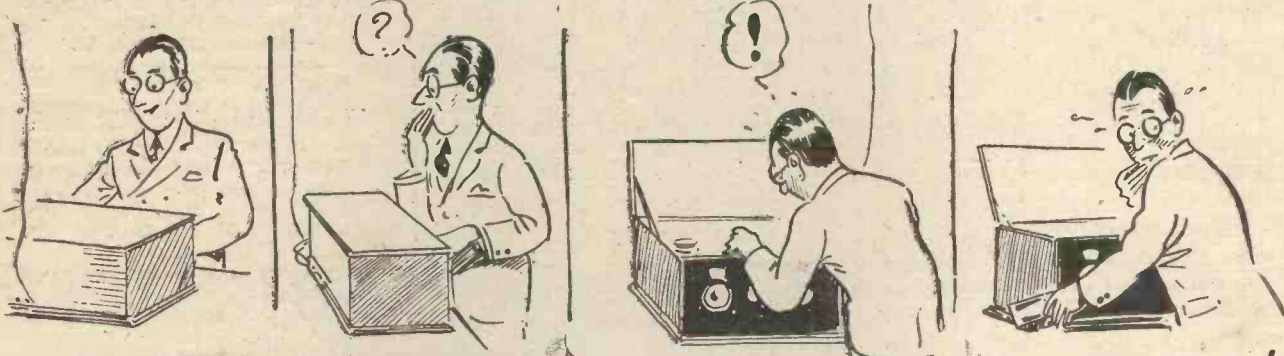

—AND AFTER 10 MINUTES OF FUTILE EFFORT TO PULL SOMETHING IN HE FINDS THAT HE HAS FORGOTTEN TO INSERT THE VALVES!



SORRY GENTLEMEN MY MISTAKE

WHY HE'S HUMAN LIKE WE ARE!

WOULD YOU BELIEVE IT?

THAT'S LIKE ONE OF MY TRICKS

NOW WE SHAN'T BE LONG

NO WONDER YOU EXPERIENCE — THAT GRAND AND GLORIOUS FEELING!

The Cone Amplifier

Here is something entirely novel—an amplifier unit which can be fitted into the back of a cabinet type of loud speaker. The combined instrument can be used either for radio or gramophone pick-up work.

By PERCY W. HARRIS, M.I.R.E.



THIS article describes a new loud speaker and amplifier unit which has a number of important uses. First of all, it enables any possessor of a crystal or single-valve receiver to convert it into a loud-speaker set with a minimum of trouble. Secondly, the amplifier described can be attached to any of the electrical "pick-ups" so as to give electrical reproduction of your gramophone records, while, thirdly, it provides a complete amplifier design for those who are desirous of replacing their present inefficient audio-frequency arrangement by something decidedly better.

This design has been worked out in collaboration with the makers of the Amplion loud speaker, who are prepared to supply their cabinet

loud speakers with a specially hinged back to take the unit described. Readers who already possess this make of cone loud speaker can themselves very easily make the alteration to the back, as it is easily removable.

Compact Device

The outfit, when finished, is of very pleasing appearance, and as the loud speaker can be obtained in either oak or mahogany, as desired, it will fit in unobtrusively into any furnishing scheme, thus overcoming a frequent objection to unsightly instruments in a living room. Furthermore, a small crystal set can be very easily screwed to the back of the loud speaker, so as to give a complete receiver having the appearance of the loud speaker only.

It will be noticed from the theoretical diagram that two trans-

COMPONENTS.

The following are the components actually used:

- 1 Baseboard of dimensions shown. (Notice it is cut away at the back).
- 1 Low-frequency transformer for first stage (Marconiphone, 4 to 1).
- 1 Low-frequency transformer for second stage (Sterling L.F.3).
- 2 Anti-phonie valve sockets (Benjamin).
- 1 2-mfd. condenser (Dubilier).
- 1 On-and-off switch (Bowyer-Lowe).
- 9 Terminals, marked respectively for Input, L.T. positive, L.T. negative, H.T. negative, H.T. positive, G.B. positive, G.B. negative 1, G.B. negative 2 (Eastick).
- 1 $\frac{1}{2}$ -megohm grid leak with clips (Dubilier).
- 2 Spade terminals, one red and one black (Clix).
- 1 Pin terminal, black (Clix).
- 4 Pieces of spongy rubber (Sorbo).
- 1 Terminal strip to dimensions given in drawings.
- 1 Amplion cone loud speaker, oak (A.C.7), or mahogany (A.C.9), with hinged back.

formers are used as the means of coupling.

The Circuit Chosen

While one resistance and one transformer makes an excellent combination in a two-valve amplifier, the coupling of a gramophone pick-up or a crystal set to such an amplifier is more efficiently made by a transformer in the first stage, and owing to the large volume such an amplifier is capable of handling, a transformer in the second stage is very advisable. For this, then, and for other reasons, two transformers have been chosen.

The design has been approved by the makers of the Amplion cone loud speaker as giving first-class reproduc-

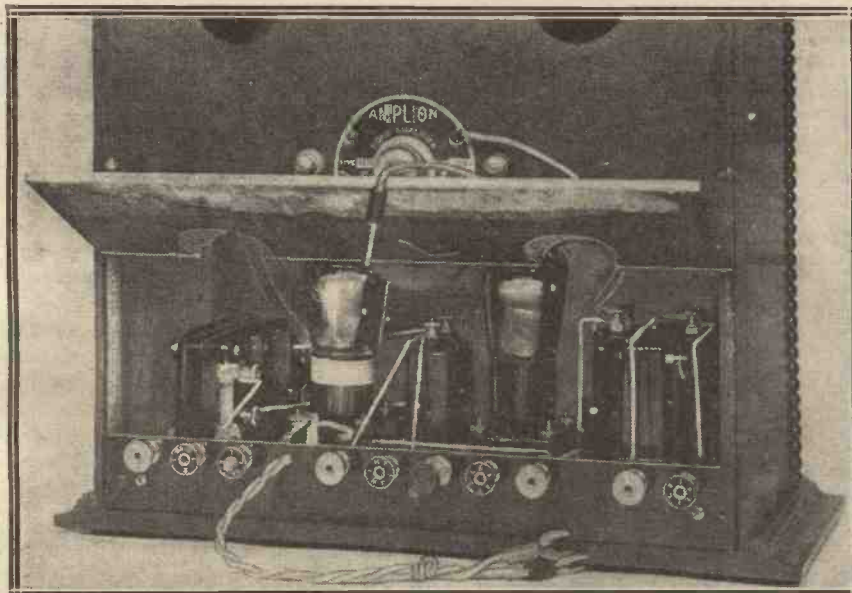

The "Cone Amplifier" unit is tucked away in the back of the loud speaker itself, where it has ample room to operate successfully. Could anything be neater or more compact?

The Cone Amplifier—continued

tion with their cones, and as it is obviously in their interest to see that only the best reproduction is given, the reader may rest assured that if he builds this unit he will get a first-class instrument throughout.

The actual design is very simple from an electrical point of view, but sundry practical points had to be worked out and taken into consideration before producing the final instrument. It is advisable, for example, that the baseboard of the amplifier should be supported on spongy rubber, so as to prevent any vibration being transmitted to the valves from the loud speaker itself, and as an additional precaution the valves are mounted in anti-phonic sockets.

A Simple Device

The device consists primarily of a baseboard on which two transformers, two valve holders, and a Mansbridge shunting condenser are mounted, while at the back is fitted a terminal strip with indicating terminals, an on-and-off switch, and means of attaching exterior leads to the loud-speaker terminals themselves. A grid leak of a value of half a megohm is shunted across the secondary terminals of the second transformer, and a lead is taken from the frame of the loud speaker to negative low-tension. These two arrangements are precautionary and reduce any possible tendency to howling.

The terminal strip, which can be seen very clearly in the photographs, carries nine terminals—for input, low-tension, high-tension, and grid bias; 120 volts high-tension is used throughout, and the terminal strip also carries an on-and-off switch.

So far as the anti-phonic valve sockets, Mansbridge condenser, grid leak, terminals, on-and-off switch are concerned, the reader can choose among the numerous good makes now available. When we come to low-frequency transformers, however, particular care in selection is needed.

It is impossible to give a complete

above the centre-line of the strip, so that they may clear the baseboard, which is mounted somewhat differently from usual. There is comparatively little clearance between the terminals and the baseboard, and for this reason it will be necessary to saw off a small strip of ebonite from the Bowyer-Lowe switch. The terminal

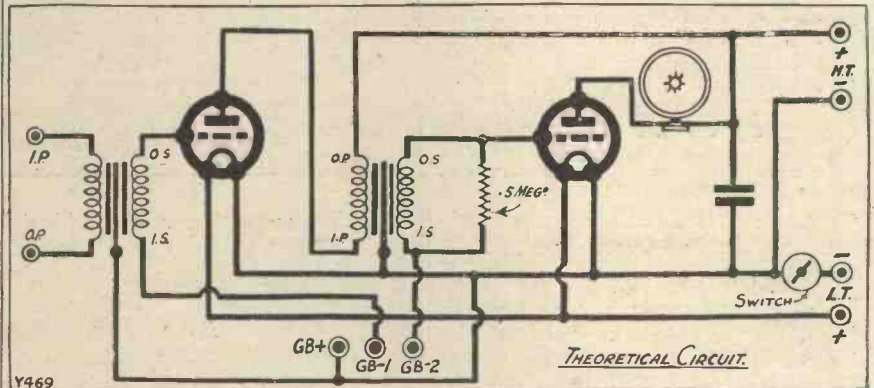

list of alternatives, and it may happen that a pair of otherwise good transformers will not necessarily work well in this particular arrangement. The following, however, have been approved by the makers of the loud speaker as alternatives doing full justice to their loud speaker.

Suitable Transformers

This, however, must not be taken as an indication that those not named are necessarily unsuitable, but it will be obvious that it is not possible to quote all of them in this list. Ferranti, R.I.-Varley, Bowyer-Lowe, Pye, Igranic, Gecophone.

The first step is to drill the terminal strip exactly as shown. Notice that the terminals themselves are mounted

strip itself is so mounted that when the four pieces of Sorbo rubber are glued to the bottom of the baseboard, it just does not touch a table. This causes the whole amplifier to "float" on the spongy rubber blocks.

Do not mount either the rubber blocks or the terminal strip at present, and once you have cut the terminal strip (not forgetting to drill a hole for the flexible leads) lay this aside and mount the two transformers, valve holders, and Mansbridge condenser in place on the baseboard. When this is done, glue the four blocks of rubber to the underside of the baseboard, and carefully attach the terminal strip so that, as indicated above, it is just clear of the table. The position of the terminal strip will be seen quite clearly in the "end-view" photograph.

Easy to Wire

Wiring-up is extremely simple. It is wise to scrape away the paint or enamel from one of the feet of each of the transformers, and to place a soldering lug underneath the screw which secures this leg to the baseboard. You will then be able to connect each of the cores of the low-frequency transformers to a common low potential point, which in this case is low-tension negative (through the switch).

Notice that high-tension negative is connected to low-tension negative in this design, and if it should be used

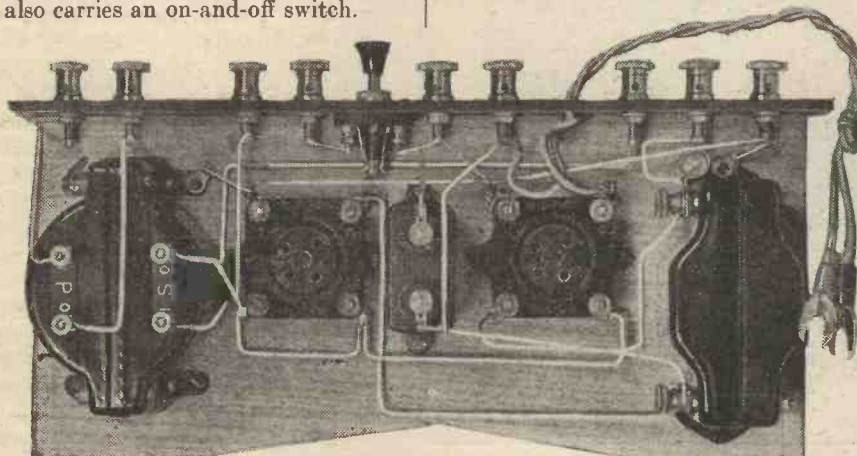

Compare this photo with the wiring diagram. It will help you both in the mounting of components and in the wiring.

The Cone Amplifier—continued

with another valve set be *quite sure* that high-tension negative is connected to low-tension negative in the other set. A very safe precaution, however, is to omit any high-tension negative connection to this amplifier when you are using it with another valve set.

Such a connection is unnecessary when you are working off the same batteries, as the high-tension negative connection is already made in the other set. When you are running this amplifier from a crystal set or a gramophone pick-up, connections should be made as marked on the terminals.

Connecting Up

Wiring-up is carried out with Glazite wire, which will obviate risks of short-circuit between the leads. If you are using bare wire it is wise to use insulating sleeving, such as "Systoflex." Be sure, when you are mounting your parts, that the on-and-off switch clears the valve holder both at the "on" and the "off" positions, as there is comparatively little space at this point.

When you receive your loud speaker with hinged back, you will see that the metal disc bearing the name of the makers is secured to the back board by three screws. These screws also hold the loud-speaker mechanism to the back. Carefully undo the

upper right-hand round-headed screw (do not touch the others), and place underneath it a soldering lug and screw into position again. To this soldering lug solder a short lead, and finish it off with the Clix pin terminal.

You will have already fixed positive and negative Clix spade ter-

We now come to the question of valves. The first valve should be of the type which is generally called "high-frequency." Not because it acts as a high-frequency valve in this position, but because that type of valve seems to work best with good modern low-frequency transformers. Typical valves of this type are

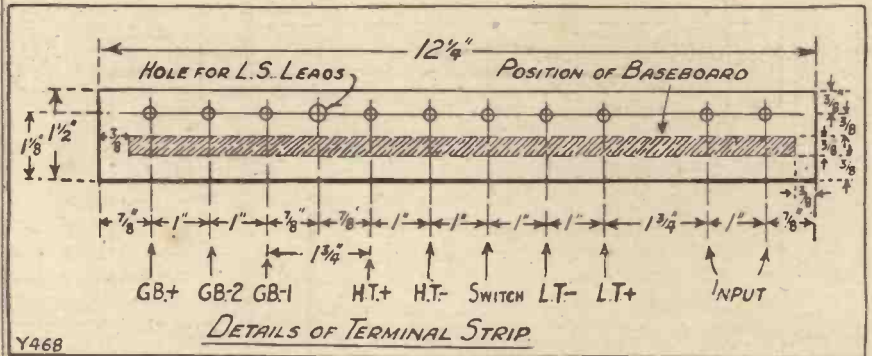

minals to the flexible leads which come through the terminal strip. The positive spade terminal is joined to the positive H.T. terminal, while the negative spade goes to the plate terminal of the second valve-holder. Now lift up your hinged board, slide the amplifier unit into the back, being careful that the baseboard does not foul the cone itself. It will be found that the Ealex terminals have holes which will take pins. The lead from the frame is inserted in the hole of the negative L.T. terminal.

Marconi or Osram D.E.5A., D.E.L. 610 (not D.E.H., which in this make is an R.C. valve), P.M.5X of Mullard, S.S.610 H.F., Ediswan E.S.5 H.F., Cossor 610 H.F., B.T.H. B.4H, etc., or the equivalent in the two-volt series, if so desired.

The output valve should be a small power valve of any of the good makes, or, better still, if adequate high-tension supply is available a super-power valve. To get the best out of the cone loud speaker a super-power valve is really essential, but this requires the large size of high-tension battery, a high-tension accumulator or a mains unit to run it adequately.

Use Crystal Set

The amplifier should be inserted in the cabinet before the valves are put into position, and the valves can then be placed in their sockets. One-hundred and twenty volts high-tension are used throughout, and the grid bias for G.B.1 is that recommended by the makers of the valves for 120 volts on the first valve, while grid bias negative 2 should be that recommended by the makers of the output valve for 120 volts.

Be sure that the loud speaker is properly connected to the flexible leads, the black (negative) spade terminal being connected to the black terminal on the speaker and the red (positive) to the red on the speaker.

To use this amplifier with a crystal set, merely connect the telephone terminals of your crystal receiver to

THE COMPLETE
"CONE AMPLIFIER"
UNIT

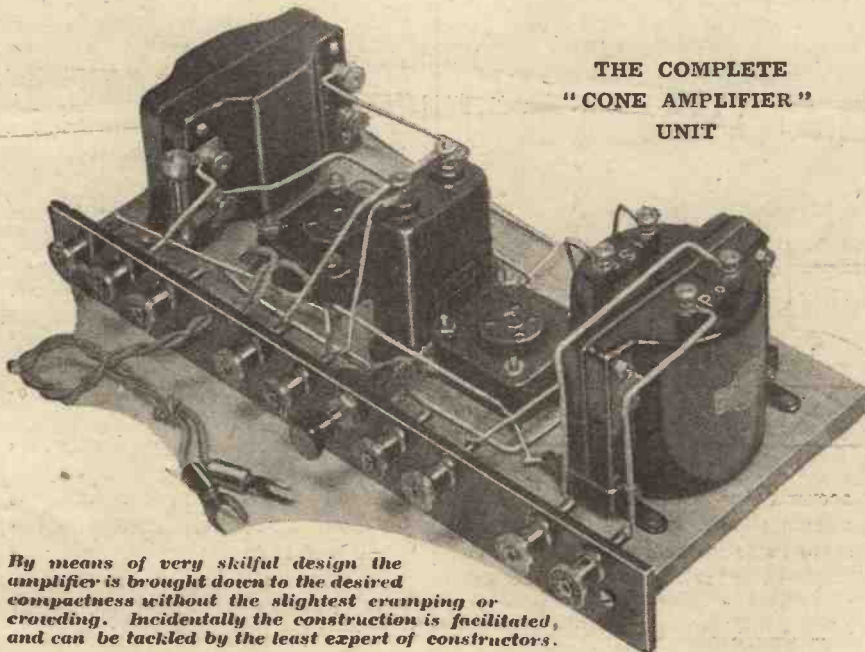

By means of very skilful design the amplifier is brought down to the desired compactness without the slightest cramping or crowding. Incidentally the construction is facilitated, and can be tackled by the least expert of constructors.

The Cone Amplifier—continued

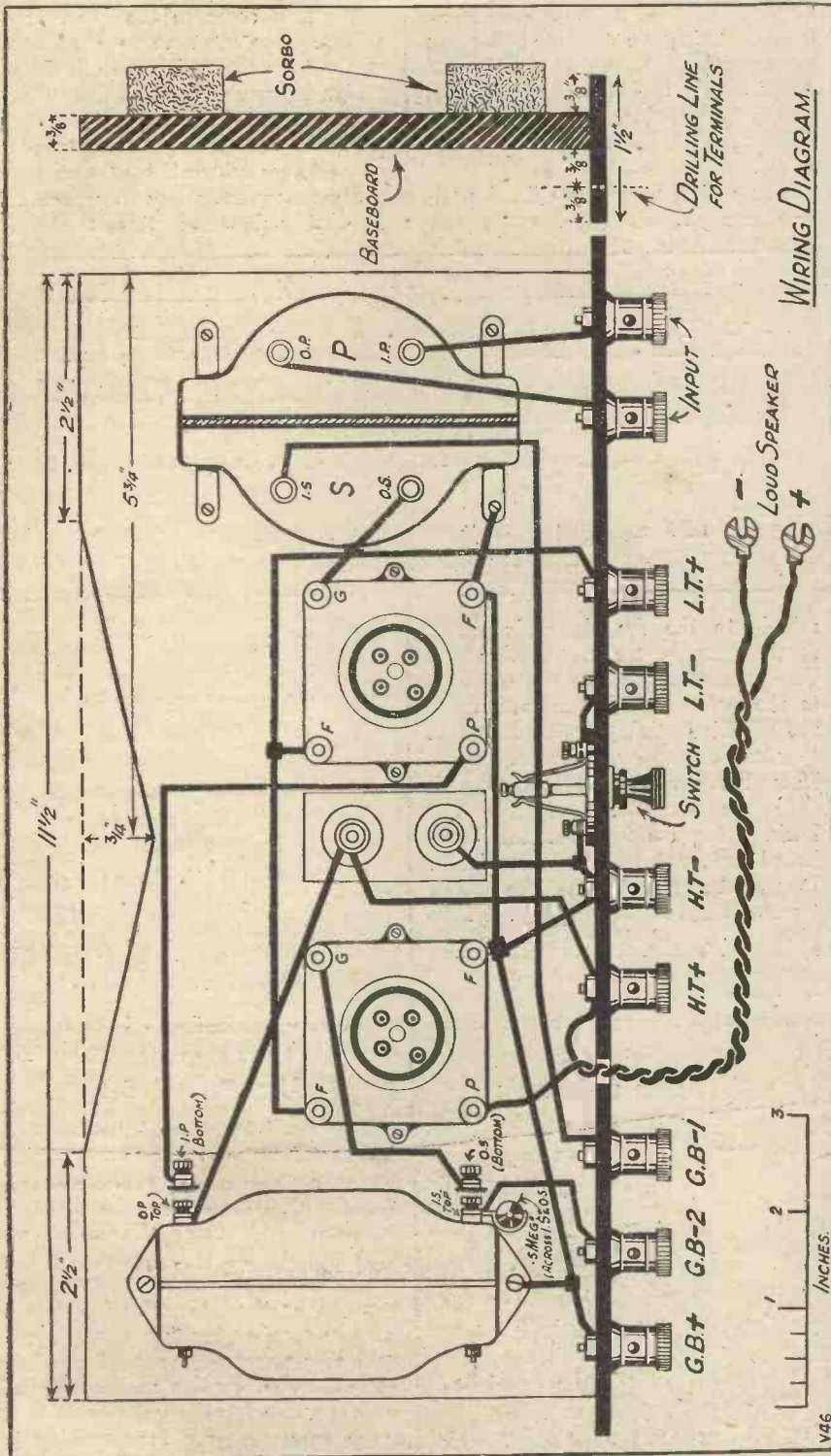

the two input terminals. To connect it to a valve receiver, join the input terminals to the telephone terminals as before, but try reversing the leads to the input terminals—one way will work better than the other. The

accumulator and high-tension terminals should be connected to the same batteries as those used for the single-valve set. No earth connection of the amplifier is necessary when using it with a valve set, but

when it is used with a crystal set it will be found necessary to join negative L.T. to earth, otherwise you will get a howl.

It will sometimes be found convenient to place this loud-speaker amplifier unit in some position in the room, such as on top of a bookcase, where it is not convenient to reach up to turn the amplifier on and off. In such circumstances the on-an-off switch can be left permanently on (pulled out), and an on-and-off switch connected in the leads running from the low-tension accumulator to the L.T. terminal. This switch can quite conveniently be of the "pear" type used for turning on and off electric light. Remember that when this amplifier is used with a valve set, turning off the valve set will not turn off the amplifier. If you do not remember this, you may run your accumulator down by leaving the amplifier switched on all night.

For Best Results

Wonderfully good reproduction is obtainable with any of the good modern gramophone pick-ups by simply connecting to the input terminals of this cone amplifier. Notes on pick-ups will be found in the section, "Radiogramphonics," in the current issue.

SPECIAL NOTE.—To get the best results with this amplifier, be sure to use plenty of high-tension and correct grid bias as specified by the makers. Check the voltage of your high-tension batteries from time to time to make sure that they are keeping well up, and discard any high-tension battery that has dropped to a figure below two-thirds of its new voltage. Remember, too, that as the voltage of a high-tension battery drops, so you should, strictly speaking, reduce the grid bias, for grid bias, which is correct for 120 volts will obviously be too great for, say, 100 volts, or under.

To convert an existing Amplion loud speaker to the new amplifier, follow the instructions below carefully:

Lay the speaker face downwards on the table, using a pad of soft material as a protection against scratches, and carefully remove the small wood screws which hold the back of the speaker to the cabinet. Then remove *any other* screws, or you may damage the movement.

The Cone Amplifier

—continued

When the edge screws have been taken out, insert the fingers in the large holes in the back and lift the whole back out. This will reveal the fact that the speaker movement and cone complete are attached to the back, and that the front edge of the cone merely rests against the front of the cabinet.

Elementary Carpentry

Temporarily replace the back in the cabinet and mark a straight line with a pencil across the back itself, the line coming just below the lower edge of the metal disc marked with the type and number.

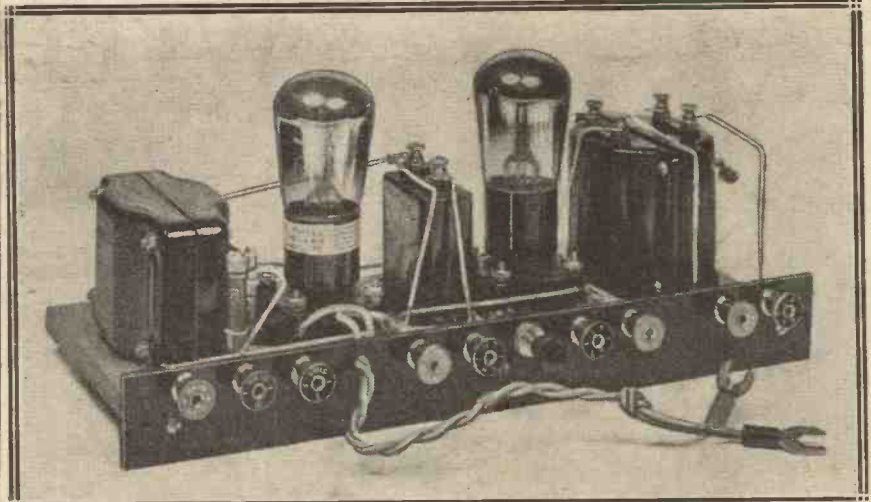

The amplifier has an almost perfectly symmetrical layout and makes a very neat unit. A power valve in the first stage and a super-power valve in the second make an ideal combination.

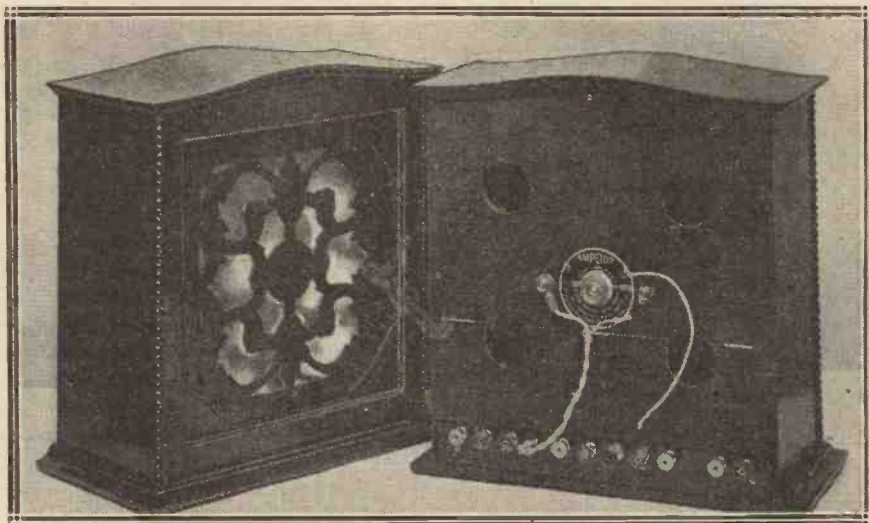

Here you see both the front and back of the completed instrument.

change is easily made. All that is necessary is to disconnect the two leads which at present go from the plate of the detector valve to the primary of the existing transformer or resistance, and from the transformer or resistance to the H.T. positive. (If a radio-frequency choke is interposed between the valve and the transformer or resistance, disconnect the lead on the transformer or resistance side).

The Final Connections

One input terminal of the amplifier is now taken to the disconnected plate lead, and the other to the H.T. positive lead which previously went to the old amplifier. Try reversing these leads to see which is the better input terminal for the plate.

With a sharp knife and a ruler cut along this line until the wood separates. This is not a very long job, as the back is made of plywood and is not very thick.

I do not recommend the use of a saw, as the less vibration to which this movement is subjected the better, and we do not want to risk getting sawdust into the "works." Neither are readers recommended to remove the movement itself from the back-board.

Coupled To a Set

Now cut off a strip from the bottom to allow for the terminal strip.

After the strip is cut off it is an easy matter to fit a couple of hinges and to replace the back ready for the amplifier assembly.

If it is desired to use this amplifier and speaker to replace the existing audio-frequency side of a set, the

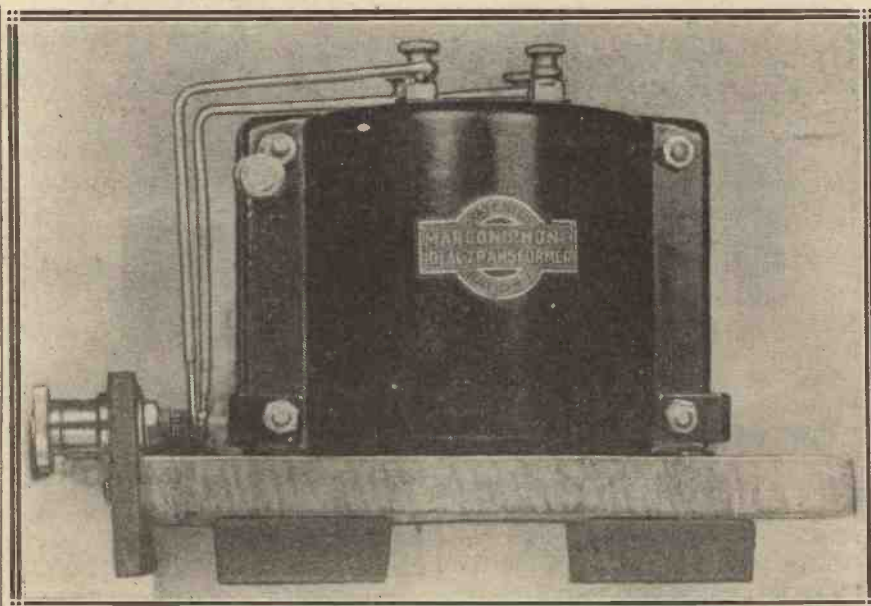

An "end-on" view of the amplifier showing the pads of "Sorbo" rubber used to prevent vibration reaching the valves.

WITHIN THE VACUUM

Is your set costing you too much? Unless you are careful you may find running expenses much higher than they need be as is shown in this article.

By KEITH D. ROGERS.



I WONDER how many constructors use super-power valves in the last stages of their sets? Not a few, I expect, but of these I wonder how many really get the full benefit of this type of valve, and how many find it more of a drain on their pockets than they expected.

A super-power valve is all very well, an excellent proposition, in fact, in its right place, but wrongly used it can be a holy terror in its ravages on the H.T. battery. Let us see why.

This class of valve, it must be understood, was designed to enable strong signals, that is, large grid-voltage changes, to be carried without distortion. It was not designed to give *louder* signals than the ordinary power valve for a given input. In fact, the super-power valve will not amplify so much as the ordinary power valve, and on a weak signal will give less results than the latter valve. Therefore it should only be used when loud-speaker operation without distortion or loud passages is required.

High Plate Current

The super-power valve has a low filament-plate resistance, and thus it allows electron flow between these two points to pass with fairly small opposition. Thus for any given H.T. voltage an appreciable amount of anode current will flow—more so than in the case of the ordinary power valve with its higher internal resistance.

Thus with the grid neglected, or taken to zero grid volts, and about 120-130 volts H.T., we may have as much as 40 milliamps passing in the

super-power valve as against 18-20 or so in the case of the power valve. Clearly, then, the former constitutes a heavier drain on the H.T. battery—if you let it.

The only reasonable way to cut down this current is by means of grid bias; cutting down the H.T. voltage will only result in hopeless reproduction, and anyway for good operation it is essential that a certain amount of grid bias be applied. The question is "How much grid bias can be applied?"

Effect of Grid Bias

This can be judged by a glance at the characteristic curve of your valve, when it will be seen, for instance, that whereas 40 milliamps flow at zero grid bias for 120-130 volts H.T., only 27 flow when the grid bias is adjusted about half-way down the straight portion of the curve.

Increasing the negative bias still further, we can bring the H.T. current

down to about 18 milliamps without being so very far below the centre of the straight portion of the curve—the ideal operating point. As a matter of fact, it is advisable to be a little below this centre point, especially when resistance coupling is being employed in the L.F. stages of the set, and, personally, I find that to bring the current down to about 18 milliamps in such a case does not harm the purity of reproduction in any way.

Practice—Not Theory

The bias should, of course, be adjusted by a trial and error process, and for economy it should be kept as high as possible, consistent, of course, with satisfactory results from the loud speaker. If you can carry on without blasting with 18 or 20 volts grid bias it does not matter twopence if the operating point of the curve is far below the centre point. If "signals" are O.K. then that is all we have to worry about.

Why use 12 volts grid bias because "the makers say so," if 18 or 21 will give us the same quality? For 18 or 21 will give an enormous saving in H.T. current and the consequent increase in the life of the H.T. battery and saving of cost. We must not be too stereotyped about valve operation.

(Continued on page 483.)



A group of H.T. batteries of different capacities. On the left we see large-size dry batteries (standing up), then wet H.T. batteries of super size in the foreground, and wet batteries of medium capacity behind them. On the right are grid-bias batteries and behind these a super-capacity dry H.T. battery.

THE TELEVISION PROBLEM

*True television can only be accomplished by a certain method—
and that method is as yet unknown.*

From a Special Correspondent

WIRELESS television, in the true sense of the term, means the simultaneous transmission and reception of a picture as a whole. The word "simultaneous" is one snag. Leave that out and the true sense of the term "Wireless television" is destroyed; instead we should say wireless photography. And the latter—the transmission of a photo by wireless—can be accomplished to-day with considerable success and with considerable detail if a reasonable time factor is allowed.

Physical Limitations

But in wireless television simultaneity is essential; and that essential factor is, in the opinion of the leading scientists of the day, so bound up with certain difficulties that the known systems of television are definitely debarred, by physical limitations, from the possibility of being sufficiently developed in such a way as to lead to a true solution of the television problem.

There has been much in the newspapers of late about television, and about Mr. J. L. Baird in particular. We have met Mr. Baird several times, and we in common with other people have admired his dogged persistence in the face of many difficulties in connection with his television experiments—his early struggles in the face of poverty, his devotion to his experiments; and we, with others, admired again when he and his disciples floated the Baird Development Company and continued to conduct his experiments on a somewhat more elaborate scale.

Baird's Side Line

There followed in due course the interesting discovery of Noctovision—which Mr. Baird admits is a side line, of no real application value to television—and other highly interesting developments culminating but recently in "Seeing across the Atlantic."

Well, up to a point, the latter is true; if seeing a turnip-shaped object on a screen 3 in. by 2 in., and with black blobs for eyes and mouth can be

called a moving picture by wireless, well and good. But, as a matter of fact, this is not true television, and it represents, in essentials, no advance of importance on the results obtained by Jenkins, Belin, Alexanderson, Mihaly, and others.

Enormous Technical Difficulties

Three or four years ago Jenkins wirelessed a head—and competent witnesses saw it at the receiving end on a screen—and noted the opening and shutting of a black blob—which was the mouth.

The great novelty about the Baird system is the fact that there is not much novelty about it at all. And we would point out to our readers that distance is not so important in television as detail.

If Mr. Baird can televise a crude image 1,000 yards there is no reason why he shouldn't do it a thousand miles also; that part of wireless transmission—power, transmission facilities, etc.—is easily applicable. But if

Mr. Baird can televise a moving picture with reasonable detail only five yards—then he is a very great man, and that success alone would be worth more than a dozen "Seeing across the Atlantic" experiments.

But he can't; and we venture to say that, as far as his present system goes, he never will.

We have said that the factor of simultaneity is one which is tied up with enormous technical difficulties. It is. One of the most difficult is that of synchronisation—or keeping the transmitter and receiver in time with each other.

In all the well-known television systems the transmitting and receiving apparatus has to be run at very high speeds and kept in perfect synchronisation in order to prevent the picture from being blurred. It may be pointed out here, however, that perfect synchronisation is difficult and that a certain amount of blurring is inevitable.

The Vital Process

Now the process of wireless television transmission necessitates the projecting of reflected light from successive elemental areas of the picture or scene on to a Selenium cell, or some other substitute, but which is in fact a light-sensitive cell. This latter converts its impression of each successive light and shade effect into

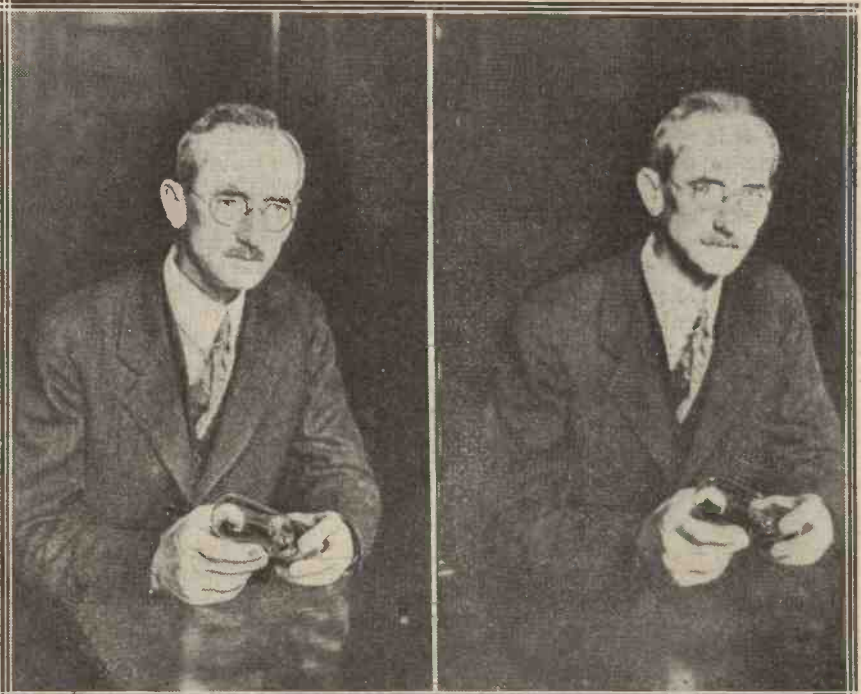

Not a televised image, but a photograph sent by means of radio, an altogether different problem. This process takes about twenty minutes, as a rule, not one-sixteenth of a second as would be required for a televised object. On the left is the original photo, the one on the right being the transmitted image.

The Television Problem—continued

a corresponding electric current which is then used to modulate the carrier-wave transmitted. It might be said that the light cell acts in the capacity of the microphone as in wireless telephony.

Then comes the question of splitting up the wireless picture into a large number of small elements. This is done by exploring or analysing the picture.

At the receiving end this process has to be reversed and the various current impulses corresponding to each separate picture element are converted in order to create momentary light effects which when seen by the human eye give the illusion, or, shall we say, the impression, of the original picture.

The Stumbling Block

But in order to give a picture with any detail, that is to say, a moving picture which can be definitely identified, the picture elements aforementioned have to be closely grouped together.

For instance, any photograph in this issue of the WIRELESS CONSTRUCTOR consists of a large number of dots grouped closely together, and to televise, say, any picture in the WIRELESS CONSTRUCTOR in its present detail, but even then, with a lot of flicker—much more flicker than is shown on a very bad cinema film—would necessitate a minimum of nearly one million synchronised impulses per second. Anyway, unless there are at least sixty of these dots in each square inch in a picture, it is certain that the "screen" of the picture is insufficient to make it recognisable. In other words, the picture is too "coarsely screened." Now supposing we are going to televise a picture on a square screen of, say, 10 in. per side—anything much less is not of real interest to the public:

and here bear in mind that Mr. Baird used a screen for his "Across the Atlantic" experiment 3 in. by 2 in. But with a screen of 10-in. sides we have to deal with an area of 100 square inches; or a minimum of one hundred multiplied by sixty elements; consequently the process of transmission necessitates a moving device capable of separately exploring six thousand elements and converting each element into a corresponding electrical current.

Enormous Difficulties

This survey of the picture must be repeated at least ten times per second, and so consequently the minimum number of signal impulses grows to sixty thousand per second, for anything less than ten repetitions per second will not give anything like a reasonably smooth reproduction of the picture.

And now, at the receiving end, the same number of elements must be reconstituted by the received signals via the medium of a suitable source of variable light, and the latter has to be so varied as to be projected either on the eye or a viewing screen under the control of mechanism which *has to move in perfect synchronisation with the exploring device at the receiving end.*

Baird System's Limitations

If it were possible to explore the minimum of sixty thousand elements in one second at the transmitting end, then again there is the difficulty of running the building-up mechanism at the receiving end *at identically the same speed.* If these two mechanisms are not accurately in synchronisation, and in phase with each other, overlapping takes place, and the reproduction at the receiving end becomes blurred out of all reasonable recognition.

That, briefly, is the problem—a

problem of detail and a problem of mechanism capable of handling detail in such a way that a picture can be built-up with a "screen" sufficiently great to constitute a recognisable picture.

Mr. Baird, at the moment, can only show a crude image, something like a turnip for a head with black blobs for the eyes and mouth. That can be done by Jenkins, Alexanderson and others, and it can be done over five yards or five thousand miles.

Distance is not an insuperable obstacle; although, of course, matters are complicated over great distances by atmospheric interference and the necessity for high power, etc., etc.

An Unknown Factor!

But the problem is the same, and when it comes down to a matter of detail for transmitting and producing a moving picture which would be recognisable, the obstacle may justifiably be termed insurmountable because, apart from all other questions, there is the difficulty of mechanical imperfection. It might be said that mechanical imperfection can be overcome. But there is a limit, just as there is a limit, in practice, to the speed of a projectile, or to the speed of an aeroplane. It might be said that the speed of an aeroplane will one day achieve a thousand miles an hour. It is not impossible. But it is impossible according to present-day knowledge and according to present-day engineering systems.

That is the obstacle to the Baird wireless television system and to other known wireless systems. It is not, of course, an obstacle to *unknown* systems.

We can say that true television is possible only by assuming that it is accomplished by System X. And System X is an unknown factor!



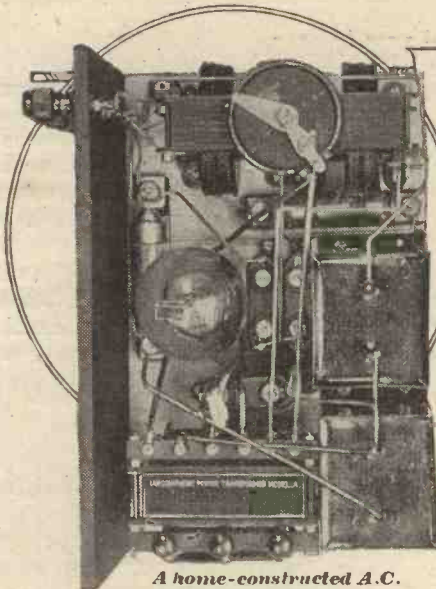

A home-constructed A.C. mains unit with a series of H.T. tappings.

WHAT IS A MAINS UNIT?

The second part of a really comprehensive survey of modern battery eliminators, and such devices, made in a way that the ordinary amateur can understand. In this article the Editor is at his best, and, even if you have only a crystal set, we know you will thoroughly enjoy reading it.

By PERCY W. HARRIS,
M.I.R.E.

WE are now in a position to see what our requirements are in the actual practical construction of an A.C. rectifier. We must provide, first of all, a suitable transformer which will step-up our mains voltage to a voltage suitable for application to the plate or plates of the particular valve or valves in use. This secondary or high-voltage winding

which is very popular, as it will safely pass at least 50 milliamperes, and the U5 of the Marconi and Osram companies, a full-wave rectifying valve with two plates. Both makers, I may mention, make half-wave rectifiers with a single plate and full-wave rectifiers with two plates, and I merely picked these two as representative.

The DU10 takes 1.1-ampere filament current and has a resistance of approximately 300 ohms. The filament voltage is four in this case. The U5 has a filament voltage of five, a filament current of 1.6 ampere and a resistance of 300 ohms. The Marconi and Osram people state that

the maximum rectified current that should be passed through the U5 is 60 milliamperes, and although Mullards do not state in their leaflet the maximum current that should be passed they give various conditions which should be observed, and which actually indicate that about 60 milliamperes is the maximum which should be passed by this valve.

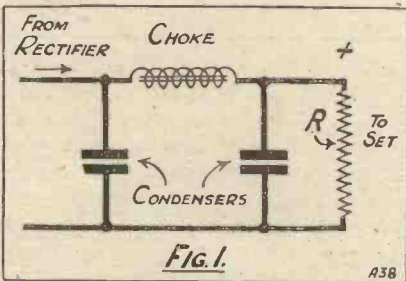

FIG. 1.

A38

must, of course, be centre-tapped if we are using a double-wave rectifier, which in all cases is recommended. The same transformer can conveniently have a third winding, centre-tapped, for supplying the rectifying valve filament or filaments.

Of course, we can, if we desire, run the valve filaments from an ordinary accumulator, but all rectifying valves are quite greedy in their filament current compared with the ordinary type of receiving valve, and the A.C. supply method is best. A few moments' thought will show that the filament current must necessarily be high, for all the rectified current has to go through the filament before it passes across the vacuous space. Two typical amplifying valves of well-known makers are the DU10 Mullard, a half-valve rectifier,

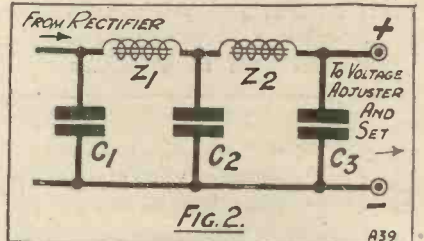
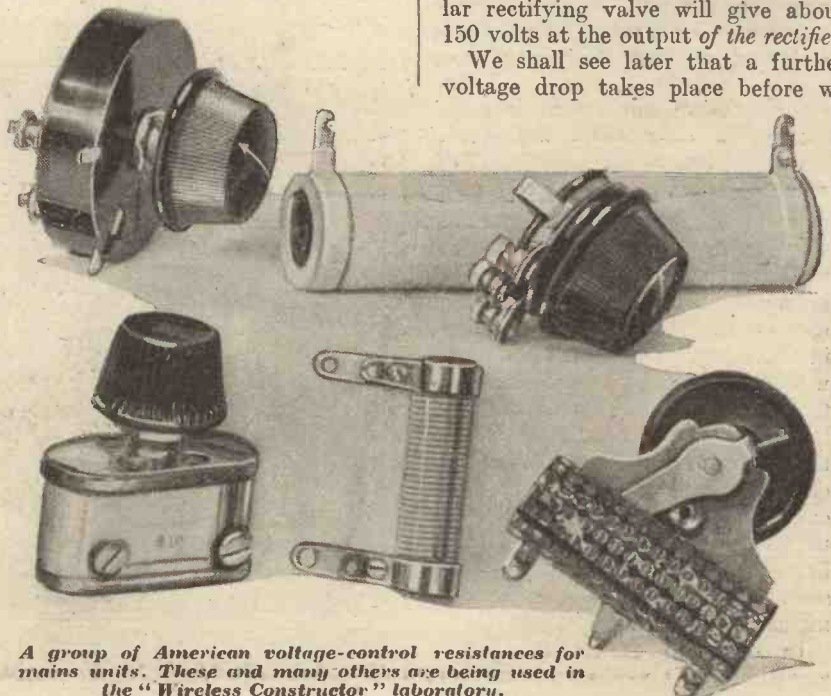

FIG. 2.

A39

The actual voltage lost in the valves themselves, of course, depends on the current passed and the resistance of the valve. It is very easily worked out by Ohm's law. Take the case of the DU10, for example. Here we have a working resistance of 300 ohms, and if 30 milliamperes is passing through the valve then the voltage drop is .03 (amp.) \times 300 = 9 volts. Thus 160 volts applied to this particular rectifying valve will give about 150 volts at the output of the rectifier.

We shall see later that a further voltage drop takes place before we



A group of American voltage-control resistances for mains units. These and many others are being used in the "Wireless Constructor" laboratory.

What is a Mains Unit?—continued

get to the set. Several responsible makers, notably "Climax," are selling excellent transformers giving both the high-voltage winding and the filament winding for particular types of rectifying valves. The Climax Auto-bat transformer, double-wave pattern, for example, provides 250 volts at each side of the centre tap, and a centre-tap filament winding which can be connected directly to two DU10's in series without any filament resistance. This transformer has now undergone a very thorough test, extending over some months in the WIRELESS CONSTRUCTOR laboratory, and proves to function quite satisfactorily in every way.

If this transformer is used with the Raytheon type of gaseous rectifier

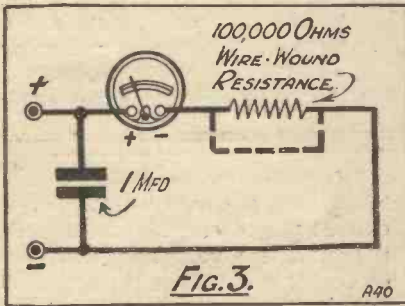

without a filament, one simply uses the two ends of the high-voltage winding for connection to the two small electrodes of the valve, the centre tap of this winding being the negative, the positive connection of the rectifier being taken from the plate or large electrode of the gaseous valve.

Question of Smoothing

With a transformer capable of delivering the correct voltage to the plate or plates of the rectifier (for, of course, we may use one single-wave rectifier, two single-wave rectifiers with combined output, or a single valve with two plates so as to give double-wave rectification in the one valve) we have a device which will give us a pulsating high-tension current. This current will have a voltage the same as that of the transformer *minus* the voltage drop in the valve. This pulsating current, however, is useless for our purpose, so we must smooth it. This brings us to a consideration of the smoothing portion of our complete mains supply unit.

In order to understand how a smoothing unit works we must con-

sider its parts and their functions separately. Imagine for a moment that we have two wires supplying pure direct current at a voltage of, say, 200, and that we have a Mansbridge type condenser of a value of, say, 1 mfd., not yet connected to these wires. If we apply a suitable voltmeter across the wires we shall get a reading of 200 volts, and if we apply the same voltmeter to the condenser the reading will be zero.

How the Condenser Acts

Let us now connect the condenser to the two wires (which we will call the D.C. mains). The current will rush into this condenser, starting with a very large value and diminishing as the condenser takes its charge, until after a very short fraction of time the condenser is fully charged and no more current will flow into it. The condenser can now be removed, and if we apply to its terminal a suitable voltmeter (such as the electrostatic type, which takes no appreciable current), we shall find that we can obtain a reading of 200 volts from the condenser alone.

How long the condenser will remain charged will depend upon several factors, and, provided we do not connect its terminals to a circuit which will allow current to flow, the charge will remain in the condenser for a considerable time, especially if the insulating parts of the device



Interior of the Majestic Unit showing the voltage control, resistances and rectifying valve.

are really free from dust and the air of the room is quite dry. The insulation of this condenser must, of course, be as perfect as possible if it is to hold its charge.

A large condenser of, say, 2 or 4 mfd. can thus be connected across

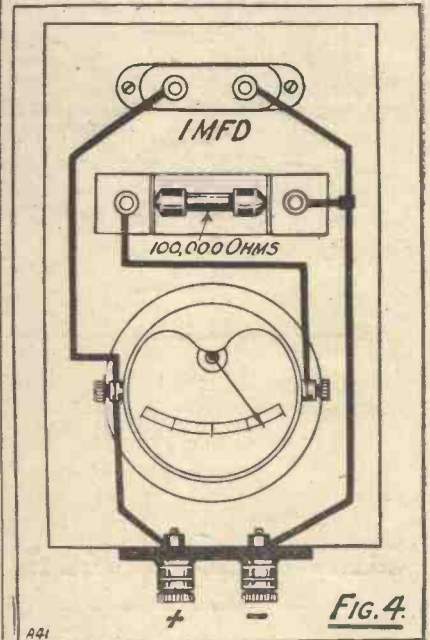

the output terminals of our rectifier, and becomes charged by the high voltage pulsations. If now we connect a high-resistance circuit to the two terminals of our rectifier across which the condenser is placed, we shall get, not a number of sharp pulsations of current, but a slightly more uniform flow, as the condenser will act as a kind of storage tank and will help to smooth out the inequalities.

Choke Systems

The insulation of this condenser, as previously mentioned, must be good, and must be able to withstand the full voltage given by the rectifier without breakdown, plus a wide margin for safety. The reason for this wide margin will be explained a little later. Unless, however, the condenser is far larger in capacity than is practicable to put into wireless sets, this alone will not afford sufficient smoothing, and we must look to other devices.

The second component to be considered is the inductance system. If we suddenly apply to the ends

What is a Mains Unit?—continued

of a coil of wire a direct current voltage, the full current will not flow instantaneously through this coil, but will build up from zero to maximum; the time taken to rise from

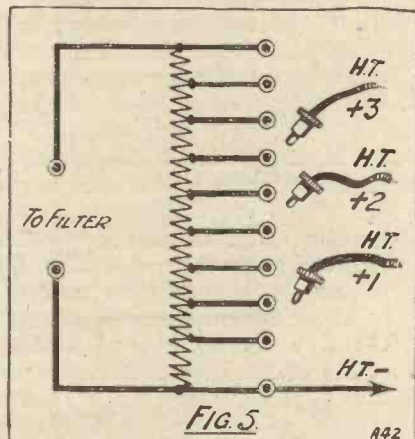

zero to maximum depending upon the length of the wire, the degree in which it is coiled, and the material immediately surrounding the wire.

In an inductive circuit the full current cannot flow until an invisible electro-magnetic field is built up around the wire, and when the wire is coiled the field surrounding one turn interacts with the field surrounding the next turn, opposing its growth and prolonging the time taken to build up to maximum. For a given diameter of coil the more turns of wire the longer it will take the current to build up to its full value. Also, with a given number of turns of wire, the time taken to build up to a maximum is much greater when an iron core is used.

Necessity for Iron Cores

The unit of inductance is the "henry," and in our smoothing unit we may require coils having inductances of 20 or 30 henries. If we were to try to build a coil of an inductance of, say, 20 henries, using an air-core coil, the amount of wire required would be very large, and the coil would be most bulky and expensive. Furthermore, its ordinary direct current resistance to the flow of current would be high, and a loss in resistance is a total loss in such circumstances. If, however, we insert an iron core into our inductance, we find that we can obtain a coil of 20 henries, not only with far less wire but with a much lower direct current resistance.

One very important matter relating to iron cores in chokes or mains units requires explanation, and has been rather overlooked by many experimenters, and even by many designers of mains units. A given coil of wire with an air-core having a certain current flowing in it will set up, as we say, a certain number of lines of force around it.

Leaving the current at the same value, and inserting a small iron core, more lines of force will be set up, as they are created easier in the iron than in the air. From this it follows that the more we displace air by iron, the more easily we shall set up lines of force.

The Meaning of "Saturation"

Now leaving the core constant and increasing the current, we shall increase the lines of force. Unfortunately the number of lines of force

will not increase indefinitely as we increase the current, as happens in the case of air, but a point will be reached when the iron becomes what is called "saturated," that is to say, a further increase of current will not be accompanied by any more lines of force. This is not the only trouble. Not only the number of the lines of force but the facility with which they set up varies with the current.

Simple "Smoothing" System

At the risk of being a little tedious, let us now go back to our direct current mains, across which, you will remember, we placed a condenser. Let us take away the condenser and put an inductance or choke with an iron core in series with the leads. We will take one wire of the mains to one end of the choke, the other end of the choke to an ammeter and the

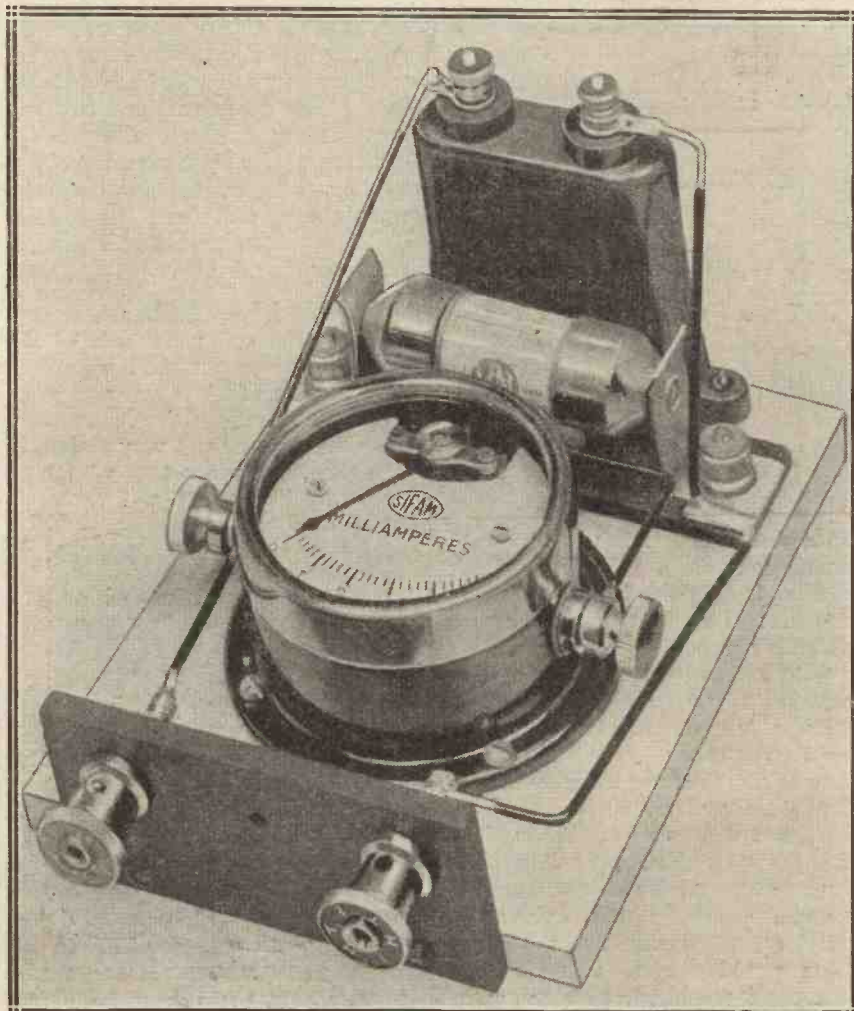

A simple voltage-measuring device for mains units.

What is a Mains Unit?—continued

other side of the ammeter back to the other mains wire. We will set up the arrangement in such a way that by means of a switch we can suddenly join the inductance to the mains.

We are assuming for this experiment that we have rather a large choke, such as is used in a powerful mains unit. What happens? When we switch on the ammeter needle does not kick over at once, but rises quite sluggishly. It may take two or three seconds before it reaches its maximum reading. This is due to the fact that, as explained above, before the full current can flow it has to build up its magnetic field.

What the Condensers Do

So far we are dealing with direct current. Let us see what happens with an intermittent current such as we get from a rectifier. With 50-cycle mains this current will rise to maximum and fall to zero one hundred times per second, and the inductance of the choke will tend to resist the rise of the current and to retard its fall, for once the field has been built

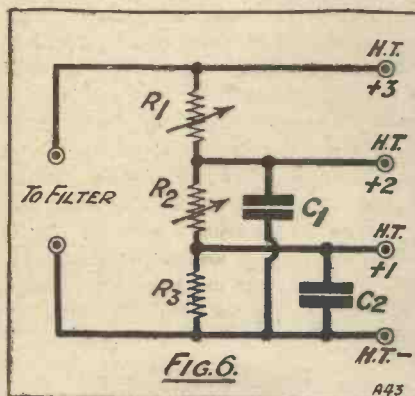

up around the coil it will resist the diminution of the current. Look at Fig. 1. On the left you will see two leads from the rectifier, across which is connected a condenser.

This, as has been explained earlier, becomes charged by the pulsations. On the extreme right we have the leads going to the set, and the resistance R placed across these represents the load taken by the set.

Current will flow from the rectifier in jerky pulses, charging the condenser. It will also flow through the choke and the load back to the rectifier. The presence of the choke alone would not do a great deal, although it would effect some smoothing. Used with the first condenser,

however, it becomes a remarkably useful arrangement.

The first condenser is charged by the pulses and simultaneously a

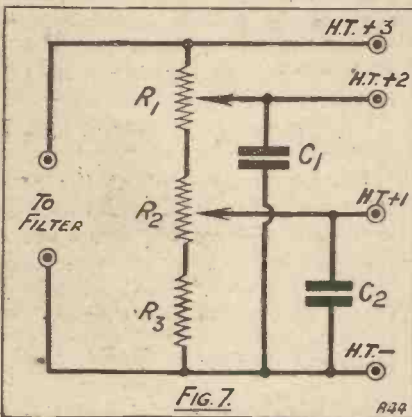

current flows through the choke. Bear in mind that the current from a rectifier keeps on rising to maximum and falling to zero. Assuming that current is flowing through the choke, and that the pulse of current from the rectifier is falling towards zero, what will now happen? There is a charge in the first condenser, and this will continuously discharge through the choke supplying the necessary voltage to keep the current flowing even when the current from the rectifier itself has reached zero. In a word, it keeps things moving!

The Chokes

If now on the other side of the choke we place a second large condenser, this will act as a second store, and will fill up with the rectified current, already very largely smoothed, and will act as a "tank" from which the set will draw its

current, so that even when there is a ripping current coming from the choke, this second condenser will help greatly in smoothing it away.

Obviously we want the choke to have, firstly, a low ohmic resistance so as not to waste the energy, and, secondly, a high choking effect so as to give the maximum opposition to any change in current flow. We have previously seen that there is a limit to the amount of magnetism which can be set up in a given quantity of iron, and if our filter passes a good deal of current it can easily happen that the iron becomes saturated sometime before the maximum current is reached.

The choking effect of the inductance falls very rapidly in such circumstances, and so we may have a mains unit which smoothes small current excellently, but fails to smooth a larger current such as is taken by a power

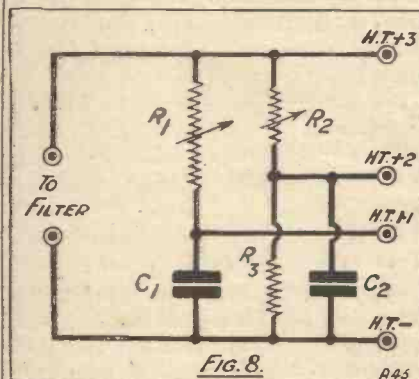

valve. It is absolutely essential for satisfaction that the choke should have plenty of iron, sufficient turns of wire, and a low ohmic resistance. Chokes alleged to be suitable for mains units have passed through my hands which on test have shown themselves to have a D.C. resistance of a couple of thousand ohms or more.

Voltage Drops

Ohm's law tells us that to pass a given current through a given resistance a certain voltage is required, and if we pass 10 milliamperes through a 1,000-ohm choke, 10 volts are required. This means that if our rectifier is supplying the terminals of the first condenser with 100 volts, only 90 will be available at the terminals of the second condenser. To pass 20 milliamperes through the same resistance, 20 volts are required, and thus our output voltage would drop to 80. Resistance in a choke

(Continued on page 452)



The "Majestic" H.T. Unit sold by the Benjamin Electric Co. This is a full-wave rectifying unit using a gaseous, non-fluorescent rectifier of the Raytheon type.

CHATS AT THE WORK-TABLE

Many points of practical interest to all radio constructors are dealt with this month, including *The Bench Drill—Improving Slow-motion Dials—Using Litz Wire, etc., etc.*

By R. W. HALLOWS, M.A.

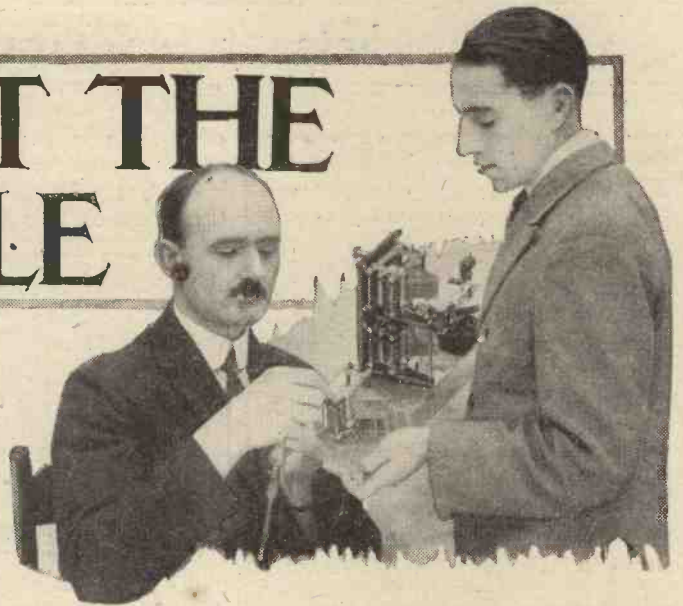

A Felt Want

Two or three years ago I remember seeing somewhere or other the advertisement of a $\frac{3}{8}$ -in. short drill with a $\frac{1}{4}$ -in. shank. Somehow, the advertisement got mislaid and I have never since seen it anywhere. It always struck me that a tool of this description would be very popular amongst wireless constructors, provided, of course, that they knew of its existence!

Time and again I expressed wonder that some enterprising toolmaker did not put one on the market and let us know that he had done so. As a result of this I have just had a letter from a wholesale firm of manufacturers who tell me that they have been making such a drill for quite a long time. They also sent me a sample, which is shown in one of the photographs. The fluted portion of this drill is 2 in. in length and the shank, which has a length of $\frac{3}{4}$ in., is cut down to a diameter of $\frac{1}{4}$ in. It is, therefore, an exceedingly handy tool for wireless purposes since it will fit into the chuck of any hand or bench drill.

A Question of Size

I hear, also, that the firm makes $\frac{5}{16}$ -in. drills on the same lines. Now, there is more in these drills than one might realise at first sight. Their existence means that the constructor can purchase at very small cost a bench drill that will enable him to do every bit of the drilling needed for wireless work. Drills with chucks extending to $\frac{1}{4}$ in. are comparatively cheap, but as soon as you look for a pattern with a chuck to take drills of greater diameter, up goes the cost by

leaps and bounds. Further, the apparatus becomes larger all round, and less and less suited for fine work, as the maximum drill size that it will take increases.

The designer of the bench drilling machine has to take into account the fact that as the size of the drill increases the length also becomes greater. This means that there must be more clearance between the chuck and the table, and since these machines must be made strong enough for working metal it is obvious that



Most large drills of the type necessary for one-hole-filing condensers will not fit into a small hand drill. But the one shown above has a shank enabling it to be used as easily as the smaller drills.

the apparatus that will take normal $\frac{3}{8}$ -in. drills must be heavier all round than that whose maximum size is $\frac{1}{4}$ in.

The wireless man is very seldom called upon to drill metal, and if he is, the kind of job that he is most likely to undertake is making 4 B.A. clearance holes or something of that kind. He will never have to drill such a thing as a $\frac{3}{8}$ -in. hole through an inch of mild steel!

Clearly, then, it is a waste of money for him, unless he does work other than wireless construction, to have to purchase a large and heavy bench drill when only light work will be undertaken with it. Any machine

that is strong enough to take a $\frac{1}{4}$ -in. drill is quite sufficiently robust for drilling $\frac{3}{8}$ -in. holes through $\frac{1}{4}$ -in. ebonite, and now that we have drills of the kind under discussion it can be used for the purpose.

What the wireless man really wants is a bench drilling machine of quite a light type, for he may often be called upon to use very small drills. If, for example, he has to make in an ebonite former holes to pass the ends of the windings of a coil he will probably use a drill between No. 50 and No. 60. The big machine is really too clumsy for these fine drills and a smaller one is far better. Since short drills are now available the problem of clearance between chuck and table is no longer pressing, and a small drilling machine will handle any work that is likely to come its way.

The Bench Drill

In view of these considerations I would very strongly urge any new constructor who is thinking of purchasing his first drilling appliance, or any old hand who wants to add a fresh tool to the equipment, to consider carefully whether it is worth his while to acquire a bench drill. The hand drill is a useful tool, but it has its limitations. It is exceedingly difficult to drill straight with it and there are many wireless drilling jobs that it simply cannot perform.

A small bench drill does not cost a great deal more and it adds enormously to the number and variety of jobs that can be carried out in the home workshop. When you buy a bench drill always choose one whose table will take a vice, and either at the

Chats at the Work-Table—continued

time of purchase, or at some later time when finances will permit, add a drill vice to your equipment. Once you have it there is no need to call upon friends or members of the family to hold work for you whilst drilling is in progress. You can make holes of considerable depth perfectly straight, and these holes will be circular since the bench drill does not wobble as the hand drill so often does, despite all precautions.

There is not the slightest need to acquire an elaborate machine. You do not need two gears, for it is perfectly easy to regulate the speed at which the crank is turned according to the drill in use and the material that is being worked. For the automatic feed I personally have very little use, so far as wireless constructional work is concerned; one can regulate the feed far better by means either of a lever or of a

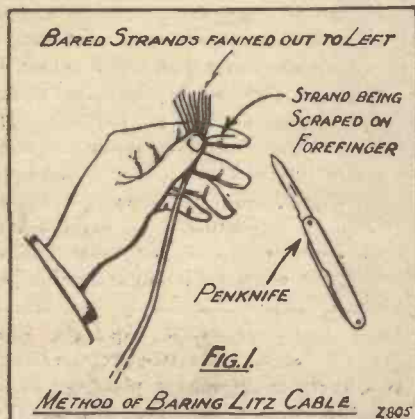

hand wheel. All that is required, then, is a perfectly plain drill without any "frills" and the cost is consequently comparatively low.

Slow-Motion Dials

We are very fortunate to-day in having such excellent slow-motion dials as are now available at reasonable prices. For short-wave work in particular, however, most of them have two rather serious disadvantages. Owing to the fact that the actuating knob is mounted upon a spindle electrically connected via the pulley to a metal driving disc, and thus to the moving vanes, hand-capacity effects are apt to be rather pronounced, even with modern improved Reinartz circuits, on wave-lengths below about 20 metres.

Secondly, the fact that the knob is small does not make it easy to

effect the very fine adjustments that are sometimes necessary. The average knob has a diameter of 1 in. or thereabouts. This means that to

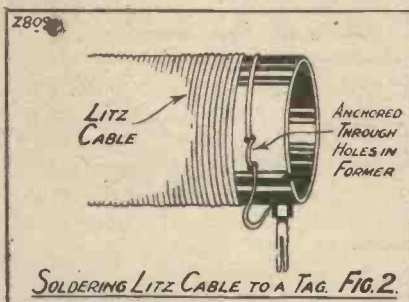

make one complete revolution any point on the circumference of the knob travels through about 3 in. If the reduction is 10 to 1—a common ratio—five complete turns of the actuating knob will cause the dial to pass from zero to the maximum position.

An All-round Improvement

With a 1-in. knob this means that any point on the circumference will travel through a little more than 15 in. during the process, or in other words that 15 in. of knob circumference must be passed through the fingers. A very great all-round improvement both as regards the reduction of hand-capacity effects and an increase in the delicacy of movement can be effected in the following very simple way.

Everyone who uses slow-motion dials must have by him an equal number of 3-in. plain dials which have been discarded in their favour. The suggestion is that the actuating knob of the slow-motion dial should be removed and that it should be replaced by the erstwhile despised plain dial. Since these plain dials are drilled as a rule $\frac{3}{16}$, $\frac{1}{4}$, or $\frac{1}{2}$ in., it will frequently be necessary to enlarge a little the holes in them.

A Simple Job

This, however, is very easily done with the aid of either the hand or bench drill. The setscrew of the dial must, of course, be removed temporarily before any such drilling is undertaken. Put on the plain dial in place of the original knob, and it will be found that an enormous improvement has been effected.

First of all, in operating the condenser the fingers are placed upon the

edge of the plain dial, which means that they are $1\frac{1}{2}$ in. distant from the spindle which carries it. This reduces capacity effects even on the short wave-lengths to a degree that has to be experienced to be believed.

Secondly, since the diameter of the plain dial used as an actuating knob is 3 in., any point upon its circumference, if the reduction is 10 to 1, must pass through $5 \times 2\frac{1}{2} \times 3$ in., or nearly 4 ft. to move the slow-motion dial from 0 to 100. The result is that the tiniest adjustments become quite easy, and that "difficult" stations can be tuned in very easily.

Using Litz Wire

After suffering an eclipse for some little time, Litz wire is returning once more to favour for winding inductances. There can be no doubt that if coils are properly designed, its use adds very considerably to the sensitiveness and selectivity of circuits. Many constructors unfortunately are rather appalled by the task of dealing with this wire. Genuine Litz is always made up with a number of strands that is a multiple of three.

The finest in general use for coil winding is 9/42, which is frequently used for inductances suitable for wave-lengths from 1,000 metres upwards. For the broadcast band, 27/42 is the most convenient size, though there are some who soar yet higher and use such patience-trying stuff as that containing eighty-one strands. Every strand in a Litz cable is separately insulated, which means, of course, that each one must be bared individually before soldering can be done.

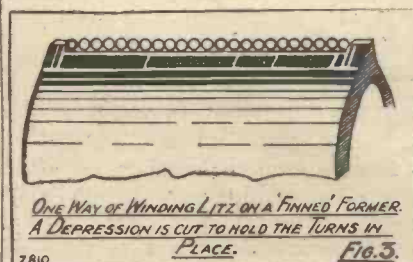

Now, it is of the utmost importance that every individual strand in the cable should be in sound electrical contact at any soldered joint that has to be made. Break one strand and solder only twenty-six out of the twenty-seven to the tag, or omit in a

Chats at the Work-Table—continued

careless moment to remove the insulation from one of them and you may lose some of the advantages of Litz wire. The chief gain in using this kind of cable is that high-frequency resistance is enormously reduced. If any strand is not properly taken in at a joint you are losing conductivity.

Actually Litz looks far worse than it really is to work with. In my time I have made scores and scores of soldered joints with this wire and,

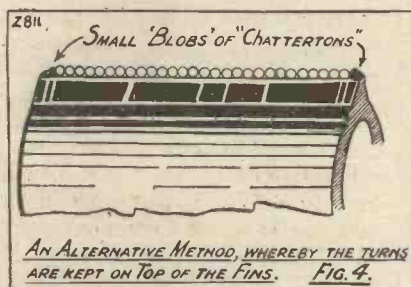

though I touch wood in writing it, I do not remember ever having broken a strand in the process of removing the insulation. I am not blowing my own trumpet; I am merely trying to encourage the faint-hearted!

Here is the best way to set about it. The first thing to do is to remove for about $\frac{3}{4}$ in. the outside insulating winding which bonds the strands together. This is best done by teasing out the end with the fingernails, and then unwinding the silk wrappings. Next, very carefully separate the strands until they stand out fanwise.

Don't Apply Heat

Some people tell you that the insulation of individual strands can be removed easily by charring it with the flame of a match. This is dangerous counsel, for No. 42 wire is fine stuff and if you are not careful you can easily destroy it with a match flame. Further, it must not be forgotten that copper hardens if heated and allowed to cool slowly. When the insulation is burnt off or charred the fine wire is found to become red hot, or very nearly so, and in the subsequent cooling process it grows hard and somewhat brittle.

There is always, therefore, the likelihood that a break may take place at some future time if burning off the insulation is resorted to. My own method is to use a small, sharp

knife-blade in the way seen in Fig. 1. The fanned-out strands are placed between the finger and thumb of the left hand, and all are turned over to the left. The point of the thumb rests against the second joint of the forefinger.

One strand is pulled gently to the right until it rests on the pad formed by the end joint of the finger. The insulation is then very carefully scraped with the point of the penknife until the metal shows through. This having been done, it is a simple matter to slide off the silk covering with the nails of the thumb and first finger of the right hand. The bared strand is now turned right down towards the right, and a second is pulled in the same way on to the pad formed by the end joint of the left forefinger. Strand after strand is dealt with, and when all have been bared, assurance is made doubly sure by passing them one by one back again to the left, counting them and inspecting them as they go.

When all are free of insulation, they are twisted tightly together. The next process is to bond them by running in solder. There is only one flux that can be used for the purpose, and that is resin, which I have recommended previously for general wireless work. Heat up a small iron,

If you are dealing with more robust stuff you may solder the end to a tag and then wind on straight away, keeping it under suitable tension as you go. If this kind of thing is done with Litz wire a break is probable sooner or later. By far the best method is shown in Fig. 2.

Anchor the end first of all by passing it in the ordinary way through holes in the former, and leave a little slack between the anchored portion and the soldered joint. You can then apply suitable tension without putting any strain upon the strands in the neighbourhood of the joint, and a break is unlikely either then or at a subsequent time. It is seldom necessary to wind Litz with air spacing.

Making Neat Coils

For this reason formers do not require to be notched, but there is always the problem of keeping the turns in place. Some recommend, when a finned former is used, that a depression about $\frac{1}{8}$ in. deep should be filed in each fin in the way shown diagrammatically in Fig. 3. The writer does not particularly recommend this method. It is a distinctly laborious business to deal in this way with a six-finned or eight-finned former, but that is not the only reason. If you reduce the height of the fins

*

If the actuating knob of your slow-motion dial is a small one, why not use the old 3-in. plain dial in its stead? As explained in a previous page, there is often a marked improvement in tuning when this has been done.

*

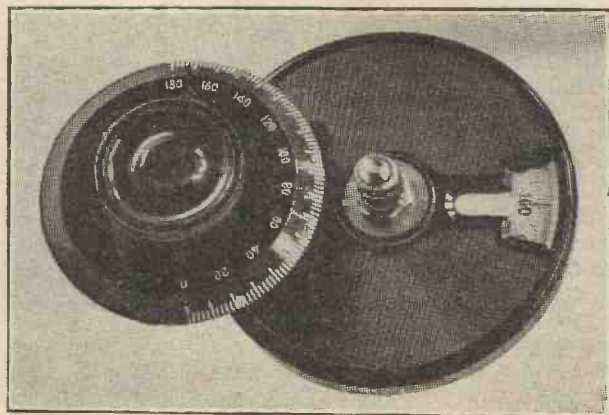

dip the twisted ends of the Litz into powdered resin and apply solder. It will run in easily provided, of course, that the iron is clean and hot. You will now have no difficulty at all in affixing the ends thus bonded to a soldering tag.

Winding Litz

It is most important that there should never be any strain upon a soldered joint made with Litz wire.

by $\frac{1}{8}$ in. you obviously bring the wires $\frac{1}{8}$ in. closer to the central tubular part of the former, and thus increase the proximity of the windings to a largish mass of dielectric material.

A better tip is illustrated in Fig. 4. Here the windings are put on as tightly as possible without cutting the fins in any way. When all are on a tiny "blob" of Chatterton's compound is placed against the outside winding on each fin and moulded into place.

Using the Thirty-One Tested Circuits.

In this article, the second of a new series, the Editor discusses practical points relating to the "Thirty-One Tested Circuits" Gift Book, presented free with the "Wireless Constructor" for February, 1928.

The Single-Valvers

THERE are eight single-valve arrangements in "Thirty-One Tested Circuits," five of the "plain" variety, and three of the "valve-crystal" or "reflex" arrangement. For those who would like to try one of the valve-crystal schemes I would strongly recommend the circuit on page 9. Provided you get a good specimen of crystal this is a remarkably good set. There is, by the way, a slight misprint on this page. The letter C1 has crept in before "The most popular Hale arrangement" and should not be there. The next line should read: "B2-L1-L2 and C1 as in diagram B1" (not C1).

Transformers for "Hales"

The three coils L_1 , L_2 , and L_3 can either be plug-in coils as described, or you can use the standard six-pin Reinartz aerial coil, which indeed makes a very excellent arrangement for this receiver. Most L.F. transformers work well with this arrangement, but not all, for one or two, such as the Ferranti, have condensers built in them which hinder their proper use in this particular circuit.

This must not be taken as any reflection upon such transformers, for this is in the nature of a "freak" circuit. The very large number of letters I have received from readers of the WIRELESS CONSTRUCTOR and of "Popular Wireless," in which I first described the Hale arrangement, has taught me that practically all the makes of low-frequency transformers can be made to work satisfactorily in this circuit.

How "Hales" Operate

The method of functioning is roughly as follows: Signals are picked up on the coil L_1 and transferred to the tuned circuit L_2-C_1 . The high-frequency signal reaches the grid of the valve by the lead from the top of C_1 and across the self-capacity of the secondary winding IS-OS. These signals are then magnified by the

valve and fed back by reaction, giving reaction amplification.

The crystal in series with the primary of the low-frequency transformer rectifies these magnified signals and steps them up through the transformer on to the grid of the valve which now acts as a low-frequency valve. Roughly speaking, the valve acts first of all as a means of giving reaction amplification to the incoming signals, and then, or, rather, simultaneously, as a low-frequency amplifier.

Although this circuit can be used with either the cat's-whisker crystal arrangement or the "permanent" crystal, I prefer the latter; but a

arrangements in circuits C1 to C5 on pages 10, 11, and 12.

Circuit B1, on page 8, is the Hale circuit using swinging-coil reaction. This is slightly simpler than the previous one, and less expensive to make up, but is not quite so easy to handle. Many readers, however, have reported remarkably good results on this arrangement, and although I prefer the Reinartz scheme, many will like the B1 circuit which, when properly adjusted, will give just as good results as the circuit on page 9.

The Unstable Reflex

Circuit B3, on page 10, is still very largely used, but tends to "growl"

Aircraft Apprentices and Radio



In this photograph, taken in the R.A.F. Electrical and Wireless School at Flowerdown, Hants, Air Vice-Marshal Sir John Higgins is shown inspecting successful candidates for promotion.

careful setting of the crystal is necessary in either arrangement to get the best results. If you do not mind taking a little pains in preliminary adjustments, this Hale circuit will give you wonderful results, but if you wish for something rather simpler to handle I would recommend you to use one of the straight valve

and is rather unstable, requiring two tuning adjustments as well as reaction. This is also a circuit which can easily cause annoyance to one's neighbours by oscillation if it is not carefully handled. Personally, I do not consider it is as good as the Hale circuit.

The lower circuit on page 10,

(Continued on page 480.)

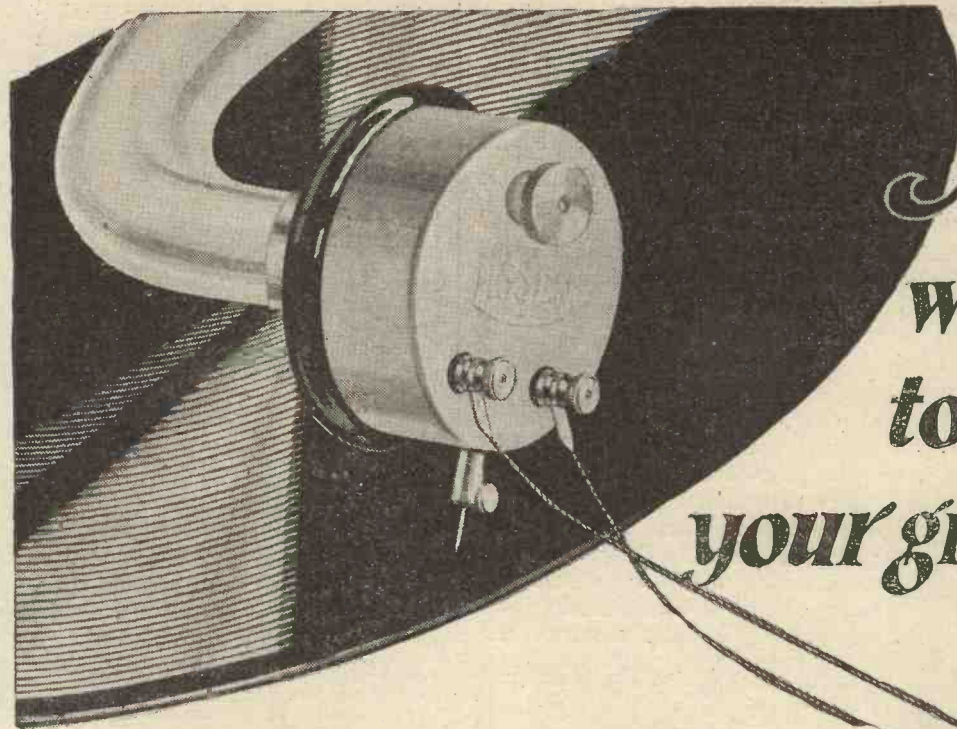

How to use your wireless set to amplify your gramophone

AN ordinary gramophone with an ordinary horn and an ordinary sound box will not reproduce notes below middle C of the musical scale. Now with the new LISSEN Electrical Pick-up your gramophone will not only reproduce the low notes on your records as you never heard them on your gramophone before, but will amplify your gramophone music to any degree of loudness to fill a large room or a large hall for dancing—you can make one gramophone supply every room in the house with music—you can use your old records, long discarded, because needle-scratch is now largely eliminated. Your new records, too, will play better because needle noise is largely subdued.

TO ELECTRIFY YOUR GRAMPHONE

the Lissen Pick-up not only largely eliminates needle scratch, but brings out the low notes on a record which no ordinary sound box is capable of reproducing.

INSTRUCTIONS.

Slip on the new Lissen Electrical Pick-up in place of the sound box on the tone-arm of your gramophone—take one connection from the Pick-up to the grid terminal of the Lissen Pick-up Adaptor (sold separately and having plugs and sockets corresponding to those of an ordinary valve-holder) and take another connection from the Pick-up to the negative filament terminal on the Adaptor (a trial on each of the filament terminals in turn will clearly show which is negative). When the Adaptor is used in the way just explained, care should be taken that NO connection is made to the plate terminal on the Adaptor, otherwise the H.T. battery will be short-circuited.

Alternatively, a connection from the Lissen Pick-up instead of going direct to the negative filament terminal, on the Adaptor, can be made to the negative terminal of a grid-bias battery. A connection should then be made from the positive terminal of the grid-bias battery to the negative filament terminal on the Adaptor.

The connected Adaptor, with a valve fitted into it, should be plugged into the detector valve socket of a two or three-valve set. Volume can be controlled by the round milled nut on the Lissen Pick-up.

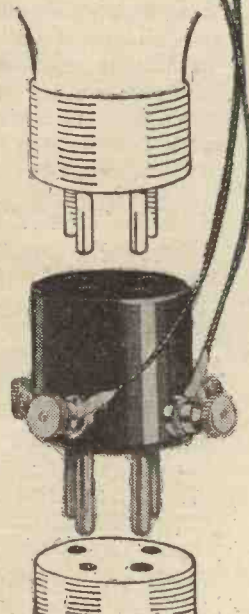

Lissen Electrical Pick-up 15/- Adaptor for same 1/6

Obtainable at most dealers, but if any difficulty send direct to factory, no postage charge. Or can be sent C.O.D.

LISSEN LIMITED, 26-30, FRIARS LANE, RICHMOND, SURREY.

(Managing Director : THOS. N. COLE.)

WHAT IS A MAINS UNIT?

—continued from page 446

means loss of voltage at the output and most mains can ill afford to waste the voltage available.

Fig. 2 shows a smoothing circuit which has now become virtually standard. Here we have on the left the leads from the rectifier, a large condenser C_1 , a choke Z_1 , a second condenser C_2 , a choke Z_2 , and a third condenser C_3 . The values here are usually 2 mfd. for the C_1 and C_2 , and 6 or 8 mfd. for C_3 .

Where Chokes Vary

The chokes Z_1 and Z_2 can have a nominal value of twenty or thirty henries, although the inductance of the choke varies with the current flowing through it, and a choke which is called a "30-henry" choke may fall as low as two henries at its working current. There must be plenty of iron in these chokes, particularly when large currents are to be taken.

It should be borne in mind that the voltage to which such condensers are subjected is not merely the steady output voltage of the rectifier, but that of any surges which may occur when apparatus is switched on and off.

The filter shown in Fig. 2 is eminently suitable for use with direct current mains, as well as with a rectifier, and it will smooth out the inequalities in the direct current from the mains perfectly. *It must not be used straight on to a set as it stands.* With direct current mains one side is practically always earthed, and a direct connection of the mains to this filter and the filter to a wireless set may be the means of short-circuiting the mains to earth, and thus blowing the house fuses and occasioning serious risk generally.

The "Earth" Condenser

When D.C. mains are used for operating a set a high-voltage condenser of 1 mfd. or more should *always* be placed in the earth lead, between the earth terminal of the set and the earth itself. This will not make any difference to the wireless signals or tuning, but will prevent the mains being shorted.

We have now seen how current can be taken from the alternating current mains and passed through a rectifying valve, smoothed out, and delivered as high voltage D.C. to our set. We have also seen that there

is a voltage drop through both the valve and the filter. The more current the set takes the more the voltage will drop, and in comparing eliminators it will be found that the fall in voltage is much more rapid in some than in others. It is for this reason that the markings given on eliminators are quite unreliable. The tapplings, for example, may be marked 120 volts, whereas a test will show that if the current taken is very small the voltage may be 150, but only perhaps 70 or 80 if the unit is used to supply a super-power valve.

"Why worry about that?" you may ask. "It is a simple matter to test the voltage with a voltmeter!"

Would that it were! Owing to the very fact that the voltage obtained from a mains unit is dependent upon the actual current taken, we are up against a big difficulty in measuring voltage. Every voltmeter takes *some* current, and all but the most ex-

It is essential that all condensers used in a mains unit should be of a special and thoroughly reliable high-voltage type. The ordinary Mansbridge type of condenser such as is used for shunting high-tension batteries is not designed to stand the high voltages encountered in mains units, and must on no account be used.

pensive types take even more current than the set itself! An ordinary voltmeter, such as may prove quite satisfactory in testing the voltages of high-tension batteries, may take 10 milliamperes while your set itself may be taking 10 milliamperes.

Measuring Voltages

The actual voltage given by the mains unit with 10 milliamperes may be a hundred, and only 70 with 20 milliamperes. If now you place the voltmeter across the tapping of your mains unit when it is supplying the set, the voltage actually given at that moment will be that delivered by the unit for the current of the set *plus* the current of the voltmeter, and may be thirty or forty volts out!

The leading instrument makers now supply special very high-resistance voltmeters for testing voltages of mains units, but these are very expensive instruments, and beyond the pockets of most experimenters. Fortunately, however, there is a simple device which any reader can make up for a fraction of the cost of these instruments, and which will be thoroughly reliable in use. It

merely consists of taking a low-reading milliammeter—say 0 to 3 or 5 milliamperes—and joining it in series with a 100,000-ohm wire-wound resistance of good quality.

Simple Connections

This, when applied across a high voltage, will pass exactly 1 milliamperes for each hundred volts, and the instrument illustrated will measure 500 volts with only 5 milliamperes passing. The divisions are so marked that it is easy to read to 10 volts, which is accurate enough for most of our tests. Connections are simple, and are shown in Fig. 3. The 1-mfd. condenser is not necessary in voltage tests, but is placed there to shunt the meter when using it purely as a milliammeter, which can be done by short-circuiting the 100,000-ohm resistance, as shown by the dotted line.

Any reader who has a mains unit, whether home-made or factory-built, or plans to build one, should make up one of these little instruments. The meter can be obtained from several makers at reasonable prices. It should not have a bigger scale than 0 to 5 milliamperes, otherwise the readings will be too close for accuracy. The wire-wound resistance must be of good quality and accurate. Messrs. R.I.-Varley, Ltd., will supply one guaranteed accurate for this purpose at a very small additional cost over that of their ordinary wire-wound anode resistances. Do not be tempted to use the ordinary carbon type of anode resistance, as these will not carry the current required and still maintain their accuracy.

If you have a mains unit that is giving an annoying hum, this hum is possibly due to the fact that the smoothing is not sufficient. It is a simple matter to take an extra 2-mfd. condenser and an extra choke and join them up between the mains unit and your set, just as the second choke and condenser are joined up in the diagram in my Fig. 2. You may be able to cure quite an annoying hum in this way.

Adjusting Voltages

There is only one other part of the mains unit to be considered now, and that is the method of adjusting the voltage. Obviously you want "tapplings" and it may not seem simple to obtain this after what has been previously explained. There are several methods of regulating the voltage from a mains unit. Some of these are of purely theoretical interest and others have been abandoned as being unsuitable for practical working,

(Continued on page 455.)

WHEREVER RADIO PARTS ARE WANTED—USE LISSEN—

No matter what may be mentioned or used in any circuit of any booklet or periodical you may be building from . . . remember that you can replace the parts mentioned and use the corresponding LISSEN parts instead, with a gain in clarity and volume of reproduction.

USE ANY CIRCUIT BUT ONLY LISSEN PARTS, NO MATTER WHAT MAY BE NAMED

Facts of importance about LISSEN parts—

LISSEN FIXED CONDENSERS



Fixed condensers should be leak-proof, and if they are LISSEN, which **DELIVER ALL THEIR STORED-UP ENERGY ALL THE TIME**, nothing is lost. Note the case in the LISSEN condenser, how it can be clipped into the LISSEN COMBINATOR in resistance circuits, how it can easily be used upright or flat. Then the price of LISSEN FIXED CONDENSERS is half what it was a year ago. The plates are properly laid in a LISSEN—they are homogeneous with each other, and cannot move or come apart.
Capacities '0001 to '0001, 1/- each (much reduced).
Capacities '0002 to '0006, 1/6 each (much reduced).
DEMAND LISSEN FIXED CONDENSERS.

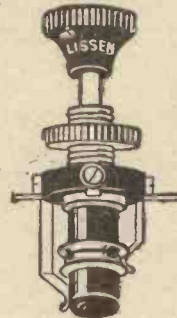

LISSEN SWITCHES

There is one for every switching need in radio. Designed for radio work where currents are small—they will not waste current. They fit easily—take up little room. LISSEN ONE-HOLE FIXING, OF COURSE.

	Pre-viously.	NOW
LISSEN 2-way	2/9	1/8
LISSEN Series-parallel..	3/9	2/6
LISSEN Double Pole Double Throw	4/-	2/8
LISSEN Key Switch ..	2/6	1/6

HOW TO MAKE H.T. BATTERIES LAST LONGER



Every ordinary H.T. battery can be made to yield more energy if a LISSEN 2 mfd. (or 1 mfd. but the larger capacity is the better) is put across it. It will absorb all the noises when the battery gets old. Your dealer will be pleased to show you how to connect it easily.

LISSEN (Mansbridge type) Condenser

2 mfd. 3/6	1 mfd., 2/6
'01 1/8	'1 1/9
'025 1/9	'25 2/-
'05 1/9	'5 2/3

Specially moulded case makes it impossible for the condenser to short-circuit on to case—a feature exclusive to LISSEN.

LISSEN H.F. AND L.F. CHOKES

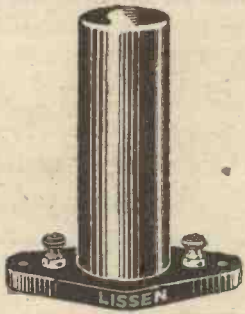

Previously

10/-

NOW

5/6

LISSEN FIXED GRID LEAKS



They do not alter—they are perfectly silent. You can put a LISSEN half-megohm leak in circuit direct on to a 220-volt supply and leave it on indefinitely—it will not alter. It can then be put straight into a critical radio circuit—it will be absolutely silent. LISSEN grid leaks have been further tested by exposure to rain and sun on the roof of the LISSEN factory; they never altered, never varied. Patented.

All resistances—Previously 1/8, NOW 1/- each.

LISSEN VALVE HOLDER



Has both low losses and also low capacity, twin virtues found in few valve holders. Sent out ready for baseboard mounting, but can also be used for panel mounting by bending springs straight. Patented, previously 1/8. NOW 1/- each.

BASEBOARD RHEOSTATS

Reduced from 2/6 to 1/6

To popularise baseboard-mounting resistors, LISSEN has now just reduced the price. Baseboard type are without knob, dial, and pointer, which are not needed for baseboard.

	Previously.	
Prices 7 ohms	2/6	1/6
35 ohms	2/6	1/6
400 Potentiometer	2/6	1/6

Quality Rheostats for Panel Mounting

previously 4/-
NOW 2/6

LISSEN quality—look how they are made, and note the irresistible appeal of price.

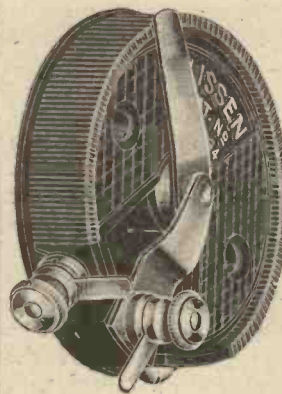

	Pre-viously.	NOW
LISSEN 7 ohms, patented ..	4/-	2/6
LISSEN 35 ohms, patented ..	4/-	2/6
LISSEN DUAL, patented ..	6/-	4/6
LISSEN Potentiometer, patented	4/6	2/6

LISSEN ONE-HOLE FIXING, OF COURSE.

USE ANY CIRCUIT BUT ONLY LISSEN PARTS, NO MATTER WHAT ELSE MAY BE NAMED, and you will gain in volume and eliminate distortion. LISSEN PARTS—WELL THOUGHT OUT, THEN WELL MADE.

LISSEN LIMITED, 26-30, FRIARS LANE, RICHMOND, SURREY.

Managing Director: THOMAS N. COLE.

THE WORLD'S FIRST TELEVISION JOURNAL

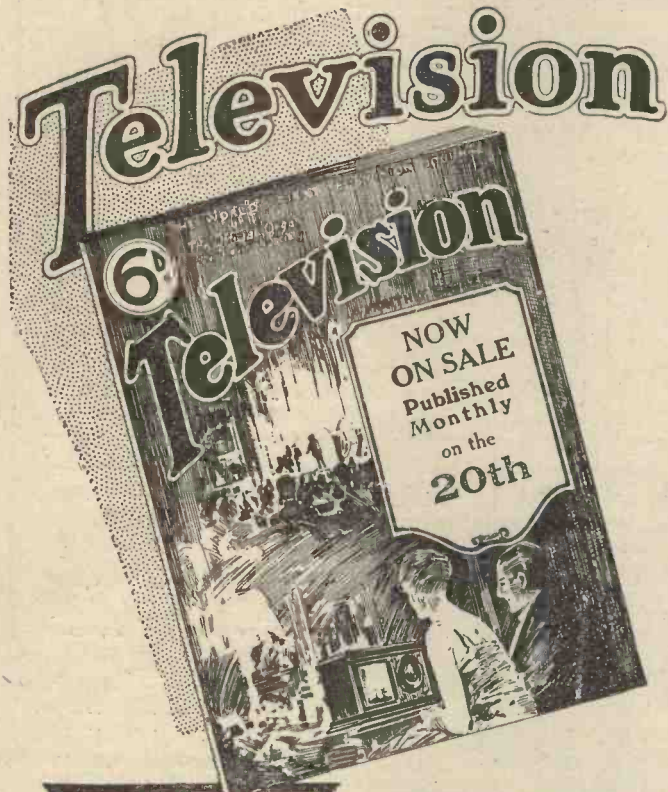

CONTENTS

- Seeing Across the Atlantic.
- How to Make a Simple Televisor.
- Television 1873-1927.
- Commercial Television: By the Editor.
- Optical Projection. By Professor Cheshire, C.B.E., A.R.C.S., F.I.P.
- Glimpses into the Future No. 1, "Television in Warfare." By R. Heath Bradley.
- How to Make a Selenium Cell.
- Light Sensitive Cells. Noctovision.

NEW — absorbing — captivating. The World's first Television Journal comes to you bringing the first official information of the most wonderful discovery of the twentieth century—a complete history of Television from 1873-1927, and telling you how to make a Simple Televisor.

Read what Television means to the world in peace or war. Follow the romantic story of the Light-sensitive Cell.

"Television" will stir your imagination from cover to cover.

You will look for the second number with impatience. Be one of the first to enter this new world. Get your copy of No. 1 now.

No. 2
ON SALE
MARCH 20

6^D
MONTHLY

YOUR FRIENDS WILL CONGRATULATE YOU!

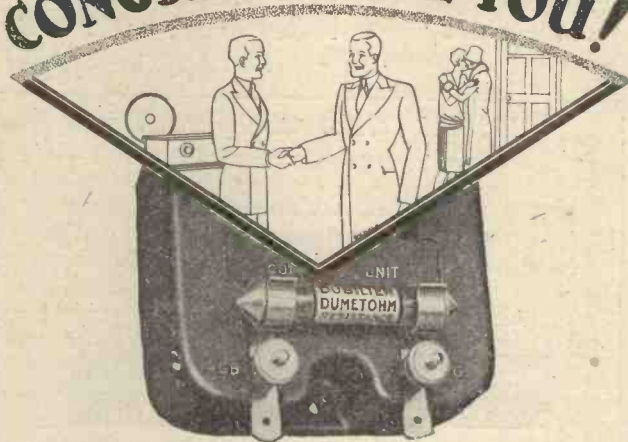

—on the improved performance of your set; on its remarkably increased clarity of reception with yet sufficient volume: meanwhile they might wonder at the cause. They would be astonished if you told them—that it was due to your having fitted a Dubilier R.C. Coupling Unit to your set.

Some may tell you they have tried Resistance Capacity Coupling as the recommended means of obtaining purer amplification, but with disappointing results. Yet the fault lies not in the method—mostly it emanates from the various components in the set having been carelessly selected.

Thousands are now being delighted by the purer reproduction, combined with adequate volume, which their sets have given since they installed the Dubilier R.C. Coupling Unit—proof enough of the supremacy of the Dumetohm for R.C. Coupling.

The Dubilier R.C. Unit will take Dumetohms of various values to suit your particular requirements, an advantage second only to that of price; for this efficient component costs no more than 7/-.



© 119

WHAT IS A MAINS UNIT?

—continued from page 452

and in this as in many other matters connected with the design of mains units designers have settled down to one or two forms which suit practically all purposes.

Three H.T. Tappings

There is no difficulty with regard to the full voltage, for most eliminators are designed to give such a voltage that this suits the last stage or output valve without any reduction. In practically every set, however, we also want a high-tension supply at lower voltages. Generally three different voltages from the eliminator will suit all our requirements—the highest voltage of all for the output valve; a medium voltage, say, about 90, for the first note-magnifying valve and the high-frequency valves; and anything from 30 to 60 for the detector valve (unless this is resistance-capacity-coupled, in which case, of course, we should need a higher voltage). We have seen, in considering the filter choke and the rectifying valves themselves, that we can drop voltage through a resistance and we could place a resistance in series with each tapping, so as to cut down current to that which we require. There are, nevertheless, disadvantages in such a simple scheme, one of the most important being that when we switch off our set the full voltage of the eliminator is suddenly impressed upon the filter condensers, and owing to the large amount of energy stored up in the magnetic fields around the chokes we may get a tremendous surge of voltage rising far above that normally given by the eliminator, thus subjecting these condensers to a tremendous strain and risk of breakdown.

Sudden Surges Serious

An eliminator which is giving, say, 150 volts on load to an ordinary wireless set can, if suddenly deprived of its load by shutting off the wireless set, give a sudden surge of voltage which may rise to 500 or 600 volts. This is one of the reasons why it is essential to use high-voltage condensers in mains units. The ordinary small Mansbridge type of condenser may stand up during normal working, but it is far too weak to stand a sudden surge. It cannot be too often or too strongly impressed upon readers that it is a positive danger to use any but first-grade high-voltage

fixed condensers in a mains unit or "eliminator," as it is sometimes called.

A safe and practical way of obtaining various voltages is to apply the potentiometer principle. Fig. 5 shows the two leads from the filter across which is shunted a fixed resistance having a number of "taps." Now, assuming the voltage across the filter leads to be 120, then at the upper end we shall have 120 volts, and at the bottom end zero volts. If we tap half-way down we shall have 60 volts, quarter-way down 90 volts, and so forth.

If now we have wander plugs connected to the various high-tension tappings on our set and sockets connected to the tapped points on this resistance we can plug in at various points and obtain various voltages. This scheme is quite a good and practical one where simplicity is desired, and where very accurate adjustments of voltage are not needed.

In all cases, whatever adjustment is made to a mains unit (other than varying the voltage by turning a knob or altering the tappings), the unit should be completely disconnected from the mains.

It must still be borne in mind that the actual voltage obtained on a given tap will depend not only on its position upon the resistance but on the current which is being taken, and an increase or decrease of current taken from any one tap will decrease or increase the current taken from any other tapping being used simultaneously.

Separate Shunting Condensers

It is essential with this, as with every other scheme of tapping, that a separate shunting condenser should be used across every tap, 1 mfd. being the smallest value recommended. These can be of the ordinary type.

In Fig. 6 we see another scheme similar in principle but with the changes obtained, not by tapping, but by variations of resistances, which are made continuously variable for the purpose. In both this and the previous scheme there is *always* a resistance across the *whole* of the mains. Thus, if the set is switched off before the mains unit is switched off one does not get that sudden dangerous surge (although, of course, there is always a slight surge).

The principle of working this arrangement is quite simple. Take, for example, tapping H.T. positive 2. The resistance of R_1 is equal to R_2

plus R_3 . Then the voltage on H.T. positive 2 will be approximately half of that of the whole arrangement. Increasing the value of R_1 will decrease the voltage on H.T. positive 2, while increasing R_2 will have the opposite effect. R_3 is generally fixed. It will be observed that any variation of *either* R_1 or R_2 will affect the voltages of both H.T. positive 2 and 1. It will be also observed that there is apparently no condenser shunted across H.T. positive 3 in this diagram. This may be looked upon as an omission, for a moment's consideration will show that the last large filter condenser is across H.T. positive 3 to negative, and therefore an additional shunting condenser is not needed here. C_1 and C_2 can be the ordinary type of Mansbridge condenser, as these are not called upon to stand very high voltages or surges.

A Modification

Fig. 7 shows a modification of the Fig. 6 arrangement, and it is of some interest. Here the resistances R_1 , R_2 and R_3 are all fixed, but R_1 and R_2 have sliders running on them. From this it will be seen that whereas the total resistance of R_1 , R_2 and R_3 in Fig. 6 varies from time to time, as we make the adjustments, in Fig. 7 this value is constant throughout, although variable voltages are obtainable on the taps. In this way Fig. 7 resembles Fig. 5, except that the resistance is continuously variable and not in steps.

Fig. 8 shows a scheme in which R_1 and its associated anode circuit joined to H.T. positive 1 is in parallel with the R_2 - R_3 combination. As resistances in parallel take more total current than resistances in series, the load on the filter is slightly larger with this arrangement; but, on the other hand, the adjustment of one of the variables does not make so much difference to the resultant voltage obtained by variations of the others.

Word of Warning

There are a number of very important matters to consider when designing and making a mains unit, and this work should not be lightly undertaken by the home constructor without most careful and painstaking experiments, or guidance from those who are more experienced in the matter. The voltages used to apply to the rectifying valve are very high, and very severe shocks can be obtained if parts are not adequately shielded and properly handled.

IN LIGHTER VEIN

By WIRELESS WAYFARER.



PROFESSOR GOOP and I have been so absolutely overwhelmed with letters of thanks for our lucid explanation of the working of the high-tension battery that we feel impelled to continue the good work in other directions. As other writers quote the flattering letters of those who have made up their sets, I do not see why the Professor and I should

From the same address comes a letter from Auntie Clara, who asks whether Professor Goop and myself would care to take part in the Second Childhood Hour.

A Noble Offer

General Blood Thunderby wires from Little Puddleton: "**** †††††††† \$\$\$% %! !? ??"

That, of course, is merely a selection. Modesty has caused us to refrain from printing the most flattering of the letters received. And some, I can assure you, were flattering. One came from a chappie called Plantagenet de Vere Marjoribanks, with an address in Jernyn. Street. He appears to be a married man, because his maiden name, printed in very small letters, is Solomon Moses.

He says: "The clearest, the finest, the very best thing I ever read in my life. Allow me to offer you my humble congratulations. It has occurred to me that people who write things like that must often be a little short of cash. If this is so in your case, please remember that I am willing to make advances from 5d. to £5,000,000 on simple note of hand alone." That just shows what true friends we writing fellows make at times amongst our readers.

When I tried to touch Tootle for half a Fisher the other day, he mumbled something about having already had some; yet here goes a fellow like Plantagenet de Vere Marjoribanks offering £5,000,000 on simple note of hand alone. Both the Professor and I, on receiving his letter, immediately dashed round to Madam Oudemia, the Mudbury Wallow palmist, and sent the good fellow simple notes of our hands, together with a request for, at any rate, samples of his wares.

The Golden Future!

When the consignment arrives we are going to make things hum in Mudbury Wallow, I can tell you. The Professor thinks of having his bath in ginger ale, and I have already decided not to have my suits turned more than four times before presenting them to the gardener. It is only those who, like Professor Goop and

myself, have been educated at Eton, Harrow, Oxford and Cambridge that understand how to spend money when they hope to get it.

Just to show our real mettle, the Professor and I have decided on this occasion to explain to all and sundry how the valve rectifies. Lots of other fellows have done that, you say. Yes, but have they? "Professor This, Professor That, Professor Tother have been to the bottom of the entire business." Yes, yes; but did they come back again to the surface? I mean to say, the whole thing is just a little bit difficult, if you follow me. I mean these dear fellows all tell you that unless you rectified, the 'phones simply could not work, because there would be a push followed by an equal pull. They always say "push" and "pull," but one gathers that they mean push and pull.

"Push," Not Push!

In the next breath, when dealing with low-frequency valves, they say, just like that, that if the push is not equal to the pull—I beg your pardon, if the "push" is not equal to the "pull," horrible distortion will result. In fact, they draw diagrams showing the push—that is to say, the "push" mutilated or flattened out, and other diagrams showing the pull—forgive me, the "pull," also rather lop-sided, and



... dashed round to Madam Oudemia ...

prove from these that the less they are together the more distorted they'll be. You see at once how straightforward the whole thing is.

Before we can go any farther, we must examine a valve. Take it in your hand and gaze upon it. What! you've dropped it, terrified by the horrid thing that you saw reflected



... I wish they had not done it with Indian clubs and hockey sticks ...

not give a few from our vict—that is to say, delighted readers.

N. B. G. (Balham) writes: "In order to be able to follow the explanations of other writers, I have always had to tie a wet towel round my head. This has frequently produced a distressing growth of mushrooms in the ears after long periods of study. Having read only three lines of your masterly explanation, I flung my wet towel into the gas stove, which promptly blew up. Will you please explain the working of gas stoves?"

Professor S. O. High writes: "I have never read anything like it."

A Real Compliment!

The Rev. Innocent Slopover, writing from Little Mudhole-in-the-Bilge, says: "How too perfectly charming. I read your exposition to a meeting of our young men's wireless society two nights ago, and when I had finished they all got up and patted me on the back. A real compliment to you and to me, was it not? But I wish that they had not done it with Indian clubs and hockey sticks."

Captain Chuckersley, writing from 2, Saveloy Hill, says: "Thanks, my dear fellows; thanks. Will you please tell me how a short-wave station works when transmitting imperially? I have good reasons for wishing to know."

*Something
Entirely new!*

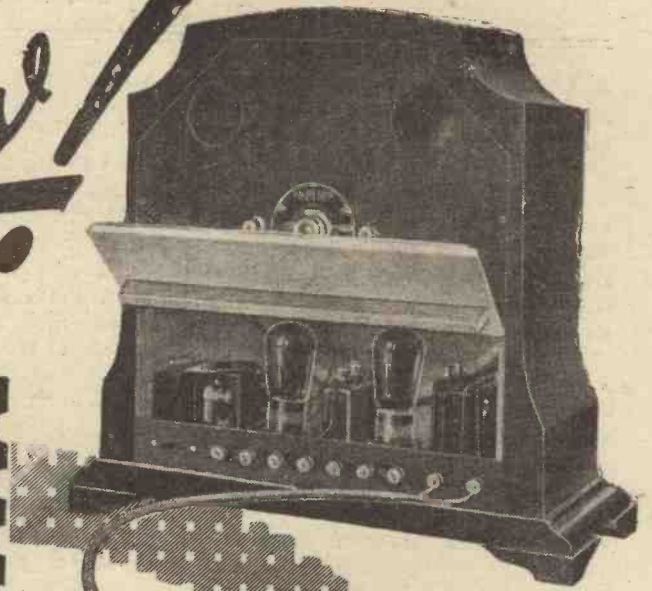

Model A.C.9a

**Buy or Build
The AMPLION
CONE AMPLIFIER**

HERE is an unprecedented opportunity to construct a superb loud-speaker-amplifier that will give reproduction at its very best. A master-combination of the world-famous Amplion Loud Speaker with a really efficient two-valve amplifier;

FULLY DESCRIBED BY MR. PERCY W. HARRIS

with full constructional details on page 435. Prices are as follow: Amplion Cone Speakers with hinged backs ready for home-built amplifier, Model A.C.7H.C. (Jacobean Oak), £6:10:0. Model A.C.9H.C. (Chippendale Mahogany), £7:0:0; or complete with two-valve amplifiers, Model A.C.7a, £10:0:0. Model A.C.9a, £10:10:0. Amplion Vivavox (Gramophone Pick-up), Type G.U.I., complete with volume control, £2:7:6 extra.

Fully illustrated leaflet W.L.26, describing both the complete Cone Amplifier and the method of home construction, mailed free on request.

GRAHAM AMPLION LIMITED
 Head Office and Showrooms:
 25, Savile Row, London, W.1
 Demonstration & Service Depots:
 101, St. Vincent St., Glasgow
 10, Whitworth St. West,
 Manchester.

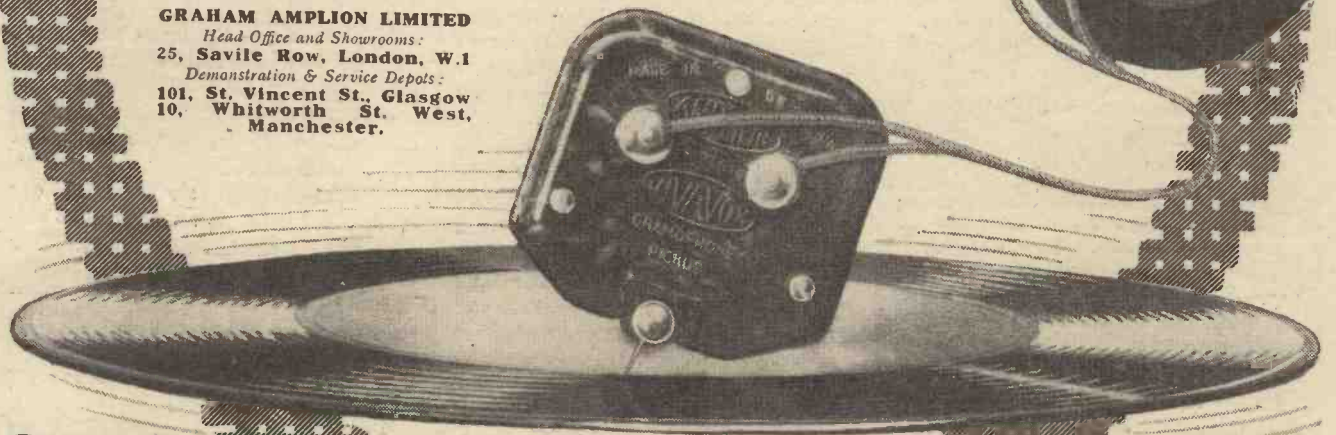

Gramophone Music at its Best

In Lighter Vein—continued

in its mirror-like surface? That thing, dear reader, was yourself as the valve-maker imagines you. He is so used to receiving letters saying that his valves must be rotten because their filaments won't stand a mere 100 volts when H.T.+ is inadvertently connected to L.T.—, that he takes possibly a rather bilious view of humanity at large.

He therefore makes the valve reflect a distorted—and on that account often very flattering—image of the beholder in order to discourage this business of seeing what really is inside it. For the same reason he has invented the glowless filament. He declares that the valve contains a filament, a grid and a plate. If anyone wishes to verify this statement there is nothing for it but the coke-hammer, and that means ten and sixpence, or fourteen shillings, or eighteen and six, as the case may be, in the maker's pocket.

A Perfect Vacuum!

Still, there is not the slightest harm in contemplating a valve as I have suggested. If the reflected image is too horrible to be borne, the contemplation may always take place in the dark, which for all practical purposes is quite as useful as the light. The next thing to do is to obtain a perfectly clear idea of what exactly is inside the bulb. To begin with, there is a vacuum, just as there probably is in the small amount of space left by the solid growth of

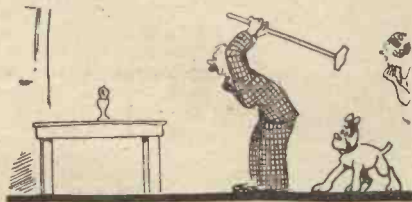

... Some people open the valve as they would an egg ...

bone from the chin upwards within the heads of politicians.

What, you ask, is a vacuum? Why, simply nothingness. All the air has been extracted, all the residual and occluded gases also, by means of the most elaborate methods known to modern science. Nothing therefore remains except a mere 4,000,000,000 molecules of gas to the cubic millimetre, a cubic millimetre being roughly about the size of the head of the pin that you rammed into your

lower chest last night to keep your dicky in place. You will see, therefore, that the interior of the valve contains practically nothing in the way of gas.

One can, of course, see the vacuum just as well as if the valve had not, like the proverbial cloud, a silver lining. It is also better observed with the bulb intact, for if it is broken the vacuum oozes out. In order, however, to examine with either the glazed or naked eye the remaining entrails of the valve, it is essential to break the bulb.

Opening a Valve

This is best done, if I may make the suggestion, with a borrowed valve, which should afterwards be returned through the post to its owner. He can then fight it out with the Postmaster-General, which saves you any amount of trouble. Some people open a valve as they would an egg, by whacking it gently over the top-knot.

Treated in this way it gives a delightful pop, and small pieces of glass can always be picked out of the face afterwards with a pickle-fork. Generally, however, the inrush of air so upsets things inside the valve that the whatyoumaycallems look rather as if they had been struck by lightning.

Attend now to Uncle Wayfarer. The proper way of opening a valve is to place it under water and to break off the pip with a pair of pliers. There are then no flying splinters of glass, no— What's that you say? What? What's that? All modern valves are pipless? Well, well, well! Didn't I tell you that makers don't want you to see what's inside?

Just a Little Patience

Anyhow, put the beastly thing in a basin and whack it gently with a spanner. In a few moments the glass will go, accompanied by a whooshing noise as the water rushes in, and you will probably find that your spanner has completely mashed everything inside the bulb. Do not be dismayed, do not be downhearted. Borrow another valve and start again.

Eventually you will succeed in your object. Remove, or, better still, get somebody else to remove, such fragments of glass as cling to the cap and feast your eyes upon the electrodes. That cobwebby thing inside all the

others is the filament. As is well known, this can be tied into knots, though why anyone should wish to do so I have never yet discovered.

What's in a Name!

The oval or circular spiral of wire surrounding the filament is the grid. It gets its name from the well-known kitchen utensil. Any cook will tell you that she invariably uses an oval or circular spiral of wire for turning steaks into burnt offerings. Outside the grid is the plate, a small metal cylinder whose name is equally apt. The word "plate," of



... invariably uses an oval or circular spiral of wire for turning steaks into burnt offerings ...

course, means flat, and anybody with half an eye could see that that was just the name to give to a cylindrical object.

The filament, grid and plate, as you will notice, are attached to stout metal supports. They are called supports because they support. The supports are sealed into a piece of glass, shaped rather like the mouth-piece of a vacuum cleaner. This is called the pinch, because it is pinched.

And That is That!

The pinch and the lower part of the bulb fit into the cap, which is again most aptly named. Cap is an abbreviation of *caput*, meaning a head (said he, remembering the lessons of his Borstal days).

Thanks to the clearness of our explanation you now understand perfectly just what the valve is, and how it functions.

READER: "But you said that you were going to tell us how it rectified."

PROFESSOR GOOP AND WIRELESS WAYFARER: "Well, haven't we?"

READER: "No."

PROFESSOR GOOP AND WIRELESS WAYFARER: "Well, anyhow, you are quite as wise as you would be after reading anybody else's explanation."

READER: "But surely—"

PROFESSOR GOOP AND WIRELESS WAYFARER: "Certainly not."



THE new Mullard "Permacore" Transformer is absolutely revolutionary in design and construction. No transformer so compact and at the same time so efficient has ever been produced. It is a master product giving better results than the best of the big ones. The reasons are these:

- (1) The iron in the Mullard "Permacore" is a specially treated and scientifically prepared material, carefully handled in manufacture to preserve its high permeability.
- (2) This high permeability allows a high flux density to be used without any possibility of saturation in an iron circuit of exceedingly small dimensions.

(3) The windings of the Mullard Transformer have been so selected that no resonant peak occurs at about 8,000—10,000 cycles as is usually the case. This eliminates all shrillness.

(4) The primary is wound with silver, the secondary with nickel. Silver for the primary has the advantage of good conductivity and no deterioration. Nickel for the secondary has the advantage of high resistance and magnetic properties.

(5) The amplification of the Mullard Transformer is high and uniform at all frequencies from 250 cycles upwards, below this limit, even at 50 cycles, giving a large percentage of its full amplification.

As pure in reproduction as the silver of its winding

Mullard

MASTER · RADIO

No shrillness. Resonant peaks eliminated.

Radio links up with the gramophone

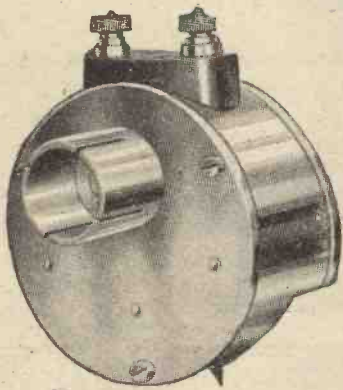

THE first time you hear the reproduction of a gramophone aided by radio you will find it difficult to believe your ears. Most probably you will look around for the singer or the player and, not finding him, you will rub your eyes and ask the why and the wherefore of this mystifying realism. Then you will be shown a little instrument that is the cause of it all. You will be told that it is the **BROWN Electrical Pick-up**, which, when fitted to the tone arm of a gramophone and connected to a wireless set and loud speaker, completely transforms gramophone reproduction. Then, probably, you will be so impressed that you will want a **BROWN Electrical Pick-up** yourself, so that your gramophone may give you purer tone, greater volume, controlled volume and freedom from needle scratch. £4 is the price of this priceless boon.



S. G. Brown, Ltd.,
Western Avenue, North Acton,
London, W.3.

1786

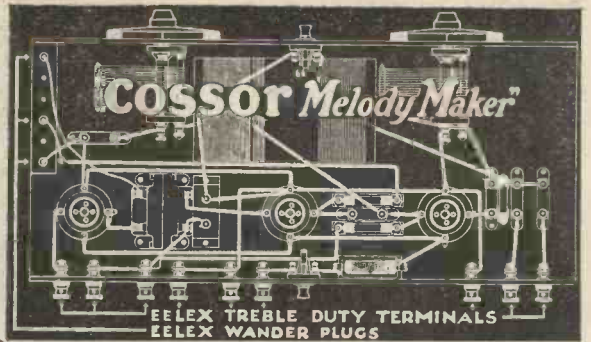

WIRELESS ACCESSORIES

are used and recommended for the Cossor "Melody Maker," the Mullard "Master Three," and the "1928 Solodyne"; also used in and recommended for all the best sets to-day.

Complete set of EELIX Terminals and Wander Plugs as required for the "Melody Maker," 3/10; Terminals, Plugs and Spades for the "Master Three," 2/10 (Plugs and Spades only, 1/4); "1928 Solodyne," 6/3 (Fuseholder 4d. extra).

Write for catalogue V26, which gives details of all the EELIX accessories.

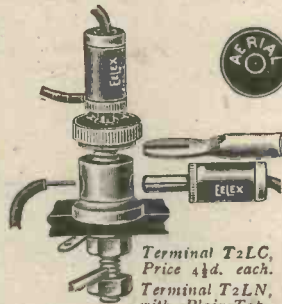

Terminal T2LC,
Price 4½d. each.
Terminal T2LN,
with Plain Top,
Price 3d. each.

J. J. EASTICK & SONS,
Eelox House, 118, Bunhill
Row, London, E.C.1.

Coloured
Spades,
Plugs, Pins
and Eyes,
2d. each;
coloured
flex 1½d. yd.



1930 CIRCUIT in 1928!!!

"P.P.V." Forges Ahead with the "1930/Three."

THE "1930/THREE," the simplest 3-valve "P.P.V." circuit, yet gives power of average 5-valve set. Just two fixed home-made basket coils, and a dozen connections, bring these reports: "Sit in my chair and hear America on speaker in comfort." "Receives 34 stations on speaker." "Eleven loud-speaker stations on indoor aerial in London." "Receives Glasgow on speaker in London." "Berlin far too loud for comfort"—and hundreds of others. The "1930/THREE," best 3-valver by "P.P.V." Designed by B. Bartram exclusively for "P.P.V." The simple, absolutely selective "build-it-in-two-hours" circuit. Just ordinary parts, obtainable anywhere. Blue prints, full size, copious instructions. Price 3/- (Royalty included). Send P.O. for 3/-, or send for further particulars, also lists of "P.P.V." circuits advertised in "P.W." since 1924. Write, wire, phone or call for lists and a bagful of wireless literature.

PRESS EXCLUSIVES. (Friends of a million amateurs.)
29, PATERNOSTER ROW, LONDON, E.C.4.

The Home For Your Wireless Set

THIS HANDSOME PIECE OF FURNITURE will keep your wireless set free from dust and locked up to prevent meddling. Think of the comfort to have no more wires across the room, no batteries on tables or carpets; you just unlock and tune in!

Our Standard WIRELESS CABINETS are made in three sizes, on mass production lines, hence the low prices, and can accommodate any receiver or panel up to 30" x 18". SOLID OAK or MAHOGANY throughout (no plywood used) and perfect workmanship guaranteed.

From £4, 15. 0.

Write to-day for free descriptive pamphlet and suggestions for adapting your receiver or panel in our Standard Cabinets.

DELIVERY from stock ON APPROVAL
Two thousand Cabinets already supplied to the utmost satisfaction of our clients.
MAKERIMPORT CO. (Dept. 20),
50a, Lord Street, Liverpool.



Model "D"



The P.M. Loud Speaker

THE Mullard Company, best known for valves, has recently extended its activities to provide home constructors with many components of high quality. Mullard grid leaks and condensers have been known and widely used for some time, and the Mullard wire-wound resistance is also



The Mullard P.M. loud speaker.

well established. Two recent additions to the Mullard line have been the resistance-capacity-coupling unit already reviewed in these pages and the Mullard P.M. loud speaker illustrated herewith, which has been submitted to test in this laboratory recently.

The P.M. loud speaker is a most interesting instrument, giving pure and clear reproduction free from the boom and woolliness which characterise some types of cone speaker, and yet giving an excellent rendering of the lower tones for which the cone type of speaker is famous. In design the instrument differs from the average cone type in several particulars.

The cone itself is concealed behind a kind of circular sound reflector which works in conjunction with the recessed back plate in distributing

=====

A MONTHLY REVIEW OF TESTED APPARATUS

(NOTE: All apparatus reviewed in this section each month has been tested in the Editor's private laboratory, under his own personal supervision.)

=====

the sound. The cone itself is made of a special form of fabric and is quite concealed from view at any angle, while the front and back plates of the sound reflector are a moulded material with a pleasantly mottled red and black effect.

Three leads are provided, any two of which can be connected to the receiver. Three different combinations are possible, 1 and 2, 1 and 3, and 2 and 3, and one of these combinations will be found to give the best results with the particular receiver used. Tested in a set consisting of a high-frequency valve, detector, one resistance and one transformer stage with a super-power valve in the output the speaker was found to give very pure reproduction over the whole register.

So far as volume is concerned, no trace of overloading was to be detected until volume had been pushed beyond that which was more than adequate for a large room. It is certainly

a very pleasing and efficient speaker, capable of giving justice to the best modern sets.

Some "Clix" Components

Messrs. Lectrolinx, Ltd., have submitted for test and report a number of their specialities, including a particularly useful Clix multi-plug adaptor which has the appearance of a valve base with a screw top. This, when undone, reveals four terminals to which wires can be connected. One very convenient use of this multi-plug

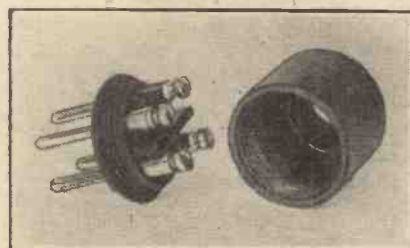

An ingenious multi-plug adaptor.

was shown in last month's issue where it was used to connect the push-pull amplifier to any existing set. Many other uses of this plug will suggest themselves to readers, such as making a combined H.T. and L.T. connector which is irreversible.

The Clix wander-plug which is slightly springy so as to fit the

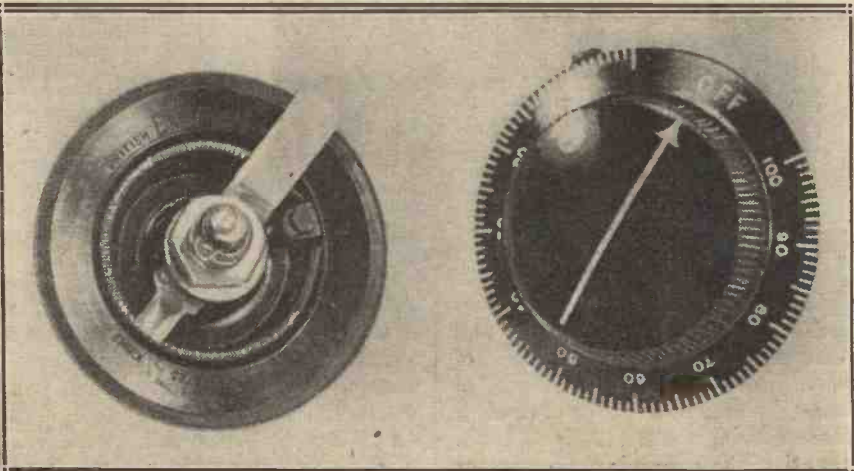

A panel-mounting variable resistance for accurate filament control (Benjamin Bros.).

What's New—continued

various sizes of holes, the Clix pin adaptor and corresponding socket, and the new Clix terminals, which are obtainable with insulated tops in a variety of colours, are most useful to the home constructor in his various activities. A particularly ingenious method of securing the flexible wire is adopted in the wander-plug and pin connector, and it is but the work of a moment to fit any flexible wire quite securely and soundly to either of these devices. Full particulars of the various Clix specialities obtainable can be obtained from Messrs. Lectrolinx, Ltd.

A Convenient Rheostat

The Benjamin Electric, Ltd., whose valve sockets are very well known to WIRELESS CONSTRUCTOR readers, are now producing a very ingenious panel-mounting variable resistance for filament control. The resistance wire is mounted not as is usual behind the panel with a knob in front, but under the knob and dial itself. The manner of doing this is well illustrated in the photograph which shows two of these rheostats side by side, one with a front view and the other from behind. The rheostat is smooth in action with



a pleasing knob and dial, and is particularly useful in portable sets and other receivers where a saving of space is of importance. It can, of course, be used in any type of receiver where a variable resistance is required. Mounting the device is quite easy, as the one-hole-fixing scheme is used. We

congratulate Messrs. Benjamin upon a very ingenious component.

The Oldham C.L.G. Accumulator

The growing popularity of glass cell accumulators is well deserved, and the slight disadvantage in weight is more than counterbalanced by the much longer and more satisfactory

Battery - shorting owing to stray leads can be avoided by the use of a good cable-connector, the one shown here being of the seven-line type.

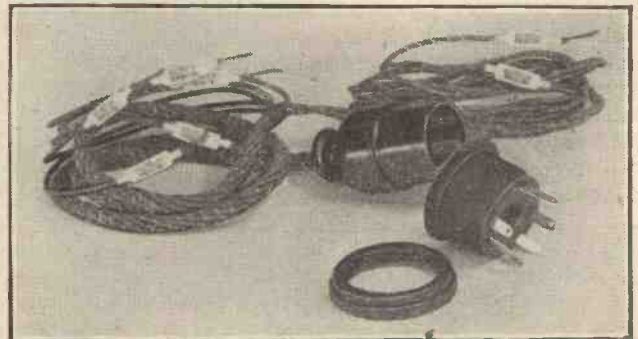

life of the plates due to the glass containers. A particularly good example of the modern glass cell accumulator made by the Oldham Company is illustrated herewith. The glass in the containers is perfectly transparent, and by moulding ridges on the inside walls of each container the necessity for separators is avoided.

Glass accumulators are becoming increasingly popular, the one shown here being the new Oldham "C.L.G."

To the right is a novel valve holder which embodies a filament resistance. (Harlie Bros.)

By moulding projections on the outside of each cell the makers have very neatly utilised a simple and inexpensive carrying device which can easily be seen from the photograph on this page. Large and convenient terminals are provided and adequate filling holes. The accumulator can

be obtained in all kinds of sizes to suit various sets, and is a thoroughly workmanlike production which after a long test can be recommended to our readers with every confidence.

A Good Battery Connector

From Messrs. Harlie Bros. we have received a specimen of their new seven-way battery connector,

complete with battery cords and identification tags. The use of a device of this type obviates the usual and somewhat unsightly terminals, while a further advantage is that all the battery cords can be removed from the receiver at once without the slightest risk of shorting one another. Indeed, all batteries can be changed completely from one set to another in a few seconds if required.

Our photograph shows how the device is made up, and the part which fixes to the set can either be screwed into a hole in the cabinet itself or secured to a metal ring which will screw on to the baseboard. We understand that a suitable metal bracket to take the device is being supplied by the makers. The cords

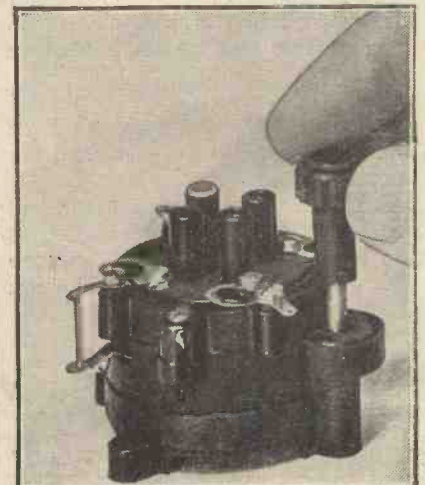

An Announcement concerning the COSSOR | MULLARD MELODY | MASTER MAKER | THREE

and the

TOREADOR P.M. RECEIVERS

A LARGE number of people wishing to construct these popular receivers are anxious to use Bowyer-Lowe components. They feel that by using products of proved performance and quality they can be sure of the best possible results. In deference to these wishes we have satisfied ourselves that, by wiring up according to the published instructions, the following components give complete satisfaction. We are therefore now in a position to give immediate deliveries of the parts listed below.

The COSSOR MELODY MAKER

	Price each
	£ s. d.
" Popular " Condensers with Two-Speed Dial and Station Recorder, '0005, No. 219B	15 6
" Whiteline " Valve-holders, No. 282	2 3
Low-frequency Transformer 3-1 ratio, " Popular " Model, No. 297	1 0 0
Panel Switch, No. 298	1 6
Variable Resister, 5 ohms, No. 289	3 0
Ebonite Front Panel, 21 x 7, drilled and polished, No. 299	16 0
Ebonite Terminal Panel, 21 x 1½ ins., No. 300	4 0

The MULLARD MASTER THREE and TOREADOR P.M. RECEIVERS

	£ s. d.
" Popular " Condenser with Two-speed Dial and Station Recorder, '0003, No. 218B	15 0
Do. Do. '0005, No. 219B	15 6
" Whiteline " Valve-holders, No. 282	2 3
Low-frequency Transformer, 3-1 ratio, " Popular " Model, No. 297	1 0 0
Panel Switch, No. 298	1 6
Broadcast Coil, No. 304	7 6
Long-Wave Coil, No. 305	8 6
Universal H.F. Choke, No. 288	9 0
Aluminium Front Panel, 18 x 7, drilled—	
Black enamelled, No. 301	6 0
Frosted and lacquered, No. 302	7 0
Coil Base, No. 306	2 6
Ebonite Terminal Panels, 2½ x 2 x ¼, No. 303	7½

You can obtain Bowyer-Lowe Components through every good wireless dealer.

Write for the Bowyer-Lowe Catalogue of Components and Receivers:

IMMEDIATE DELIVERIES



Quality Components

BOWYER-LOWE Co., Ltd., Radio Works, Letchworth, Herts.



Regulation
of voltage
by means of
WESTON
Instruments
gives improved
reception

To obtain maximum results from your receiver you must be sure that the H.T., L.T. and G.B. voltages are regulated correctly. For an exact measurement of these variable voltages use a Weston Pin-Jack Voltmeter with high-range stand. Only the Weston standard of accuracy and reliability is sufficiently fine to be of any use for such measurements.

The Weston free booklet "Radio Control" explains the necessity for accurate electrical control of your radio receiver and gives much helpful advice. Let us have your name and address.

MODEL 506 Pin-Jack Voltmeter complete with high range stand and testing cables £2:10:0

WESTON
STANDARD THE WORLD OVER
Pioneers since 1888

Weston Electrical Instrument Co. Ltd.
15, Gt. Safron Hill,
London, E.C. 1

What's New—continued

are of good quality, adequately marked, with a pleasing finish, one cable containing all seven leads. If it is desired to use this battery connector with any existing set, it is only necessary to remove the wires which now go to the various terminals and to solder them to the soldering lugs provided on the rear of this connector

An Interesting Valve Holder

From the same firm we have received a neat component consisting of combined valve holder and variable resistance which can be



The method of mounting the filament resistance on the Harlie valve holder.

obtained in 6-, 15-, or 30-ohm patterns.

The valve holder itself is of the anti-microphonic type, and not only supports the valve in a properly balanced fashion, but is free from high-frequency losses which sometimes characterise moulded valve holders. The variable resistance is mounted underneath the valve holder and is controlled by means of a knob.

The only criticism we would make of this component is that it is not possible to see the position of the moving arm once the complete device is mounted on the baseboard. Some little indicating device could be adopted with advantage. However, this is a small point and the whole device is most convenient for fixing in those cases where it is desired to save space and to incorporate a variable resistor.

An Electric Gramophone

Many readers who experiment with gramophone pick-ups will be interested in the electric gramophone, complete with Igranac-Pacent pick-up, submitted for test by the Cromwell Engineering Company. The

instrument, the general appearance of which can be gathered from the photograph, consists of a cabinet and a turntable driven by a high-grade and perfectly silent electric motor, which runs from the mains through a lamp resistance, which also serves to provide illumination to the turntable. A prolonged test showed that the motor ran perfectly uniformly, and the speed regulation was all that could be desired. The well-known Igranac pick-up is fitted, and when used in conjunction with a two-stage note-magnifier gave perfect reproduction (on a moving coil type of loud speaker) from a modern electrically recorded gramophone record. A noticeable feature is the provision of a terminal joined directly to the frame of the motor so that this can be earthed if trouble should arise with very sensitive amplifiers.

The motor, which is of the universal type, runs on any voltage from 80 to 115 D.C. or A.C., or with a series resistance (built inside the cabinet) up to 250 volts if required. The current consumption is .4 ampere. Although

primarily designed for pick-up work, a horn and tone arm are provided, so that when desired an ordinary sound box can be attached and the gramophone used as an electrically driven instrument of the ordinary type.

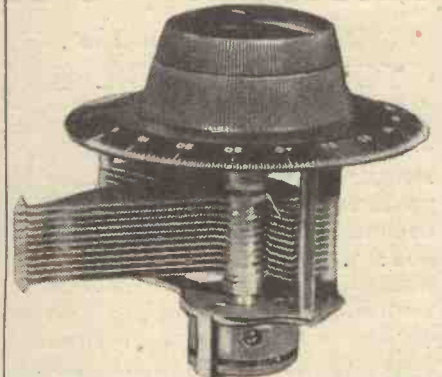

This is the well-known "K.C." variable condenser—a Dubilier product.

The price of the complete instrument, ready for operation and including the Igranac-Pacent pick-up, lamp resistance, etc., to suit the voltage with which it is to be used, is £18 10s. (in oak cabinet).



The electric gramophone of the Cromwell Engineering Co. incorporates an Igranac-Pacent pick-up.



HAPPENINGS AT SAVOY HILL



By OUR SPECIAL COMMISSIONER.

Trouble with the P.M.G.

It is an open secret that relations between the B.B.C. and the Post Office are increasingly strained. The last and most acute period of trouble between Savoy Hill and its licensing authority began on December 22nd, when Lord Wolmer, answering a question in the House of Commons, made it possible for the enemies of the B.B.C. to charge that body with not exercising the authority it enjoyed in the broadcasting of controversial matter.

There seems little doubt that the B.B.C. looked upon the handling of this question as a definite and intentional "let-down," and blamed it for most of the subsequent public rows about controversy in the programmes. There ensued a period of increasing counter-vigilance in which both sides tried to divert attacks. Apart from being in the wrong, the Post Office cannot keep pace with B.B.C. propaganda, and they were soon "in the cart." At almost every point of contact, technical as well as administrative, the Post Office and the B.B.C. are now at loggerheads.

An Extraordinary Situation

The most serious difficulties are rumoured in connection with the plans for the new scheme of regional distribution. It has always been assumed that the Post Office had agreed to the Regional Scheme in principle. Curiously enough, there was much more optimistic and intelligent discussion of the Regional Scheme two years ago, or a year ago, than there is now.

The B.B.C. information people are doing a good "turn" at their "oyster" attitude. One might think that the Regional Scheme had never been mentioned. Indeed Post Office officials have gone so far as to deny even the existence of any proposals of the kind. Why this extraordinary situation? I can only hazard a guess, and this is that the Post Office under pressure from the fighting services have decided to kill the

scheme even if the wholesale reorganisation of the B.B.C. is the result.

It will be interesting to see what the P.M.G. will tell Parliament in the first annual report on the work of the new Broadcasting Corporation. If his advisers expressed their own views the report would be a slashing attack on Savoy Hill and all its activities.

The Statement in Parliament

But when the P.M.G. faces Parliament on the subject of broadcasting, the party political motive will be in the ascendant. He will be told to give as rosy a picture as possible of the work of an organisation created by the present Government at the end of 1926.

But I wonder if he will do anything to dissipate the obscurity of

The Eternal Problem of Variety

Savoy Hill keeps diligently at work on experiments to improve variety, and there is some little progress to report since the beginning of 1928. First of all, the substitution of the word "vaudeville" is a good idea. More bright musical items and less "dud" humour is undoubtedly a right tendency.

The experiment with Andre Charlot was not a success. Charlot's personality was attractive over the "mike," but the method of presentation and the matter were not adapted for broadcasting; which goes to show that as broadcasting evolves it is more and more difficult to use stage and music hall material without specialist treatment. The more eminent

Wireless Control

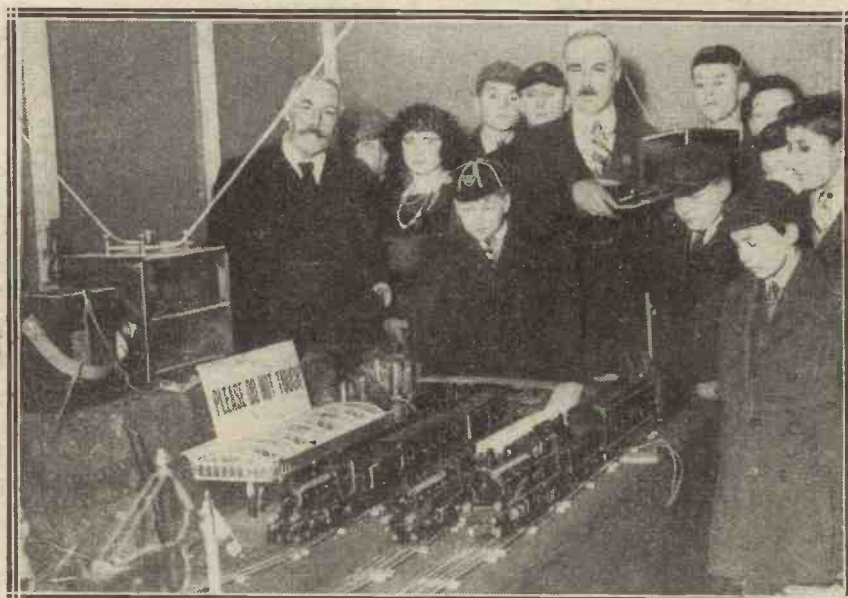

Major Raymond Phillips, the authority on wireless control, exhibiting three model trains which he controls by radio. He is holding the small portable transmitter preparatory to starting off the trains.

the position of the Regional Scheme: this is what discerning students of broadcasting will look for; nor will they be satisfied with the usual "claptrap" compliments to the Governors, who are best employed doing nothing.

and successful the stage or music hall authority, the less likely he is to be successful over the "mike," unless he spends a lot of time and energy in learning the eccentricities and limitations of a new and strange medium.

Happenings at Savoy Hill—continued

Controversy

The storm about controversy in programmes died away as rapidly as it originated. Its sudden eclipse was due to the simple fact that there was no genuine public demand. So far as the great listening public is concerned there was hardly a flicker of interest. Such feeling as there was was apprehension lest some excuse should be given to the "uplifters" to put more talk in the programmes.

No doubt the Cabinet will give the subject serious consideration, and evolve a kind of meaningless compromise built up round the blessed word "safeguards." Savoy Hill are absolutely right in their disregard of this agitation. What the public wants, and what the programmes need, is still less talk, and more entertainment of all kinds.

The Virus of Internationalism

The curious anti-Empire attitude that has crept into B.B.C. policy has frequently been criticised, and there

Turks, and Czechs. It is stated that at least one of the Dominion High Commissioners in London has made official complaint to H.M.'s Government about the B.B.C. This will be watched by Parliament probably more effectively than other things that go wrong at the B.B.C.

Week-day Services

The daily religious services broadcast by the B.B.C. in the mornings are very popular. But already the note of criticism has appeared. The listeners to this new programme feature expected that it would be as varied in character and treatment as are the ordinary religious services broadcast on Sundays.

The Nonconformists, the Catholics, the Jews, and the Salvationists looked forward to having their versions a little later on. But weeks have grown into months, and the week-day services are still retailed in the approved Church of England method. If this is meant to be permanent there will be another big public storm. Anglicans are a small minority of the listening public.

result of the Thames floods. True, there were various broadcast appeals later; but the right moment to mobilise the effective charitable instinct of the whole mass of the people

WORLD'S LEADING RADIO WEEKLY

It is a maxim in Fleet Street that advertisements are the life blood of a paper. That is true, for unless a paper has a big public support, it won't carry many good advertisements. One of the great, irrefutable facts about the success of "Popular Wireless" will be found, week by week, in its advertisement pages.

Why? Because "P.W." has the largest net circulation of any weekly radio paper in this or any other country, and because advertisers know that they get the best results by advertising in "P.W." These facts speak for themselves. Why not benefit by them and become a regular reader?

Every Thursday Price 3d.

was not utilised. The B.B.C. should consider very seriously whether it should not have automatic machinery in being ready to deal with these catastrophes and emergencies immediately they happen.

The National Concerts

Too little has been heard of the excellent season of national concerts which the B.B.C. has put on since last autumn. British artists and conductors have had their full share of the programmes, and the B.B.C. has lived down the reproach of last year's series that home products were ignored. But it is typical of the attitude of the critics that the complaint has been that the B.B.C. was not importing enough talent and that in consequence the listener was being let down.

So Savoy Hill can count on getting blamed whatever it does. Of course, it is still good copy to find fault with broadcasting and broadcasters, and not nearly as good copy to praise them. For my part I never mince matters when I think the B.B.C. goes wrong; but I try to be fair, and the case of these great national concerts should not be omitted from any fair-minded summing-up of the achievements of the B.B.C.

I hope they go on with the good work, letting it become a permanent feature of the artistic life of Great Britain and of Europe.

Sir John Reith's Future

There is a recrudescence of definite rumours that Sir John Reith has received some very lucrative and attractive offers to desert broadcasting for big business. Nothing is known as to his attitude.



Mr. Noel Maskelyne, the well-known illusionist, demonstrating his "music from the air" apparatus. The idea of obtaining "music" in this way, recently made public by Prof. L. Theremin, is not new, according to Mr. Maskelyne, and was known at least ten years ago.

were signs of a change not long ago. Alas for my optimism! I am now informed that the Dominions and Colonies overseas are getting just as cavalierly treatment as ever from Savoy Hill, which is unwearying in its attentions to Germans, Poles,

The B.B.C. and National Catastrophes

There is general feeling that the B.B.C. did not do all it might have done to help in bringing succour to those who were in distress as a

POWER

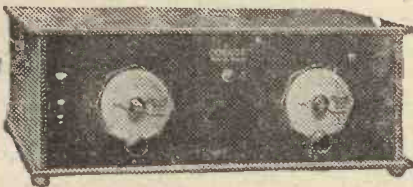
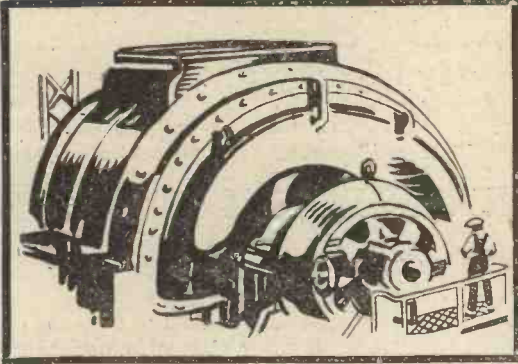

FOR YOUR COSSOR "MELODY MAKER"

CONSTANT—ECONOMICAL—SAFE

The T.C.C. book shows you how. Shows you in clear simple language how easy it is for you to build your own H.T. Eliminator. Step by step! here a diagram—there a photograph. You can't go wrong the T.C.C. way, and the Eliminator you build is a definitely efficient instrument that puts an end to Battery expense and trouble.

The T.C.C. book is free—of course. Write for it to-day and

GET YOUR POWER FROM THE SWITCH

T.C.C. CONDENSERS

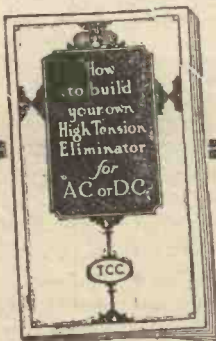

WRITE
FOR
THIS

FREE
BOOK
TODAY

Adv. Telegraph Condenser Co. Walcs Farm Rd. N. Acton. London W.3.



1800



Let these Improve your set

In their respective positions each of these three components gives that faultless service which is characteristic of all Igranic Radio Devices, and so contributes towards the efficient trouble-free functioning of your set.

The complete illustrated Igranic catalogue, List No. J484, contains full particulars of a whole range of other components which will help you to obtain better radio reception. May we send it you?

Igranic Anti-Microphonic Valve Holder



Possesses every feature essential for perfect valve suspension. The groove makes valve insertion easy in dark or awkward positions, while the sunk sockets make accidental burn-outs impossible. The springs effectively prevent microphonic noises and

shield the valve from shocks. Price 2/- each.

Igranic Tapped Triple Honeycomb Coil

This Coil, possessing the high efficiency of the Standard Igranic Triple Honeycomb Coil, is provided with two tapplings, one for aperiodic aerial coupling, and the other for centre-tapped circuits. Being mounted on a standard plug, it is particularly convenient for modernising old sets. Five sizes cover 180-3,350 metres.

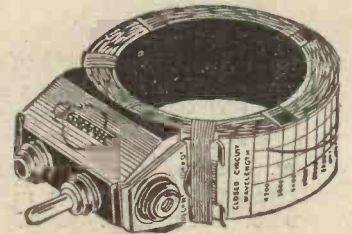

Nos.	1,	2,	3,	4,	5,
Prices.	3/9	4/3	4/9	5/6	6/5

Igranic Radio Switch

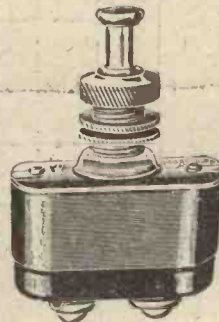

A very neat and well-constructed battery switch which gives the finishing touch to a set. Snaps on and off with a positive click, making good contact when on. The part on the panel is heavily nickel-plated, giving a very refined appearance. One-hole fixing is provided for.

Price 2/6 each.

149, Queen Victoria
Street,
LONDON, E.C.4.
Works: Bedford.



Branches: Birmingham, Bristol, Cardiff, Glasgow, Leeds, Manchester and Newcastle.



UNSUSPECTED CAUSES OF DISTORTION

Taking broadcast receiving apparatus at large, probably as much distortion is produced by run-down grid batteries as by anything else.

From a Correspondent

UNPLEASANT kinds of distortion in the reproduction of speech and music may result from a number of causes that are often unsuspected by the average listener. The trouble may develop so gradually that it is not noticeable at first; it is only when the symptoms have become poisonously bad that it is borne in upon the owner of the receiving set that all is not well with his apparatus. He may then spend some time in tracking down their ultimate cause, unless he knows what to look for.

Grid Bias Batteries

I suppose that, taking broadcast receiving apparatus at large, as much distortion is produced by run-down grid batteries as by anything else. It is rather fashionable nowadays to build the grid battery into the set. Once it has been adjusted to give the proper working potential to the grids of the L.F. valves it is apt to receive no further attention for some little time. I have actually come across grid batteries that have been *in situ* for two or even three years. New, despite the fact that it is not called upon to supply anything in the way of current to the circuits of the receiving set, the grid battery's useful life is definitely limited.

Process of "Ageing"

Minute leakages probably take place between its sockets—particularly if its surface is allowed to become covered with a layer of dust. And beyond this the moisture within the cells, a moisture essential for their activity, slowly evaporates. There is thus a continual small decline in the E.M.F. of a grid battery, though for a good many months it may be so tiny as to be practically negligible. What is known as the "shelf life" of a small-cell battery such as that generally used for grid biasing purposes is on the average not more than ten to twelve months at the outside. By the shelf life is meant the time required by the

battery when placed on open circuit (i.e. when supplying no current to a circuit) to lose from forty to fifty per cent of its original E.M.F.

How Distortion is Caused

The usual history of these small batteries is that the fall in E.M.F. is very gradual for the first six or seven months, or perhaps even a little more. Then a very rapid decline may set in, and in a comparatively short period the E.M.F. will fall right away. Not infrequently one cell becomes dead and its presence sets up such a high resistance that the total voltage of the battery may be something very small indeed.

Fig. 1 shows how the declining voltage of a grid battery causes distortion gradually to creep in. The curve is that of a typical small power valve with a high-tension voltage of 120. It is admittedly a static curve, and does not therefore represent exactly the characteristic of the valve under working conditions. It will, however, serve sufficiently well to illustrate the point. When the set is first brought into operation it is found that a negative bias of 6 volts upon the grid of the last valve gives the best results, placing the working point at A in the diagram, that is almost exactly in the middle of the useful part of the characteristic

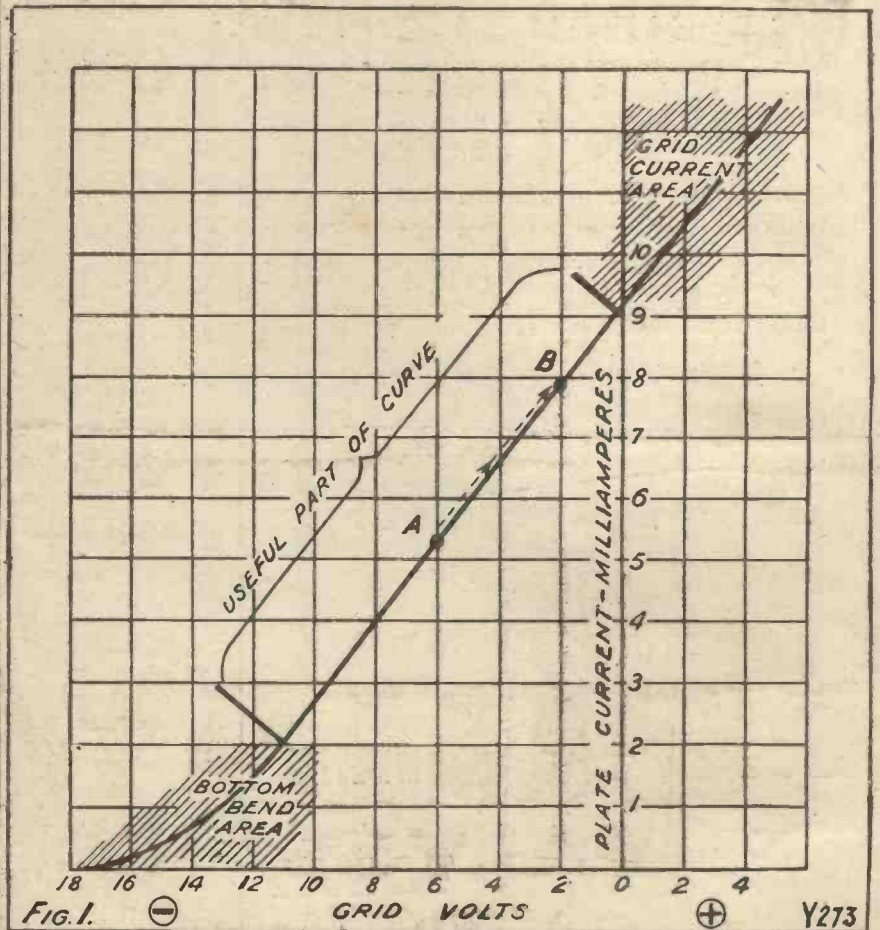

Showing how the declining voltage of a grid battery causes distortion.

**SEND COUPON
FOR YOUR
FREE
COPY**

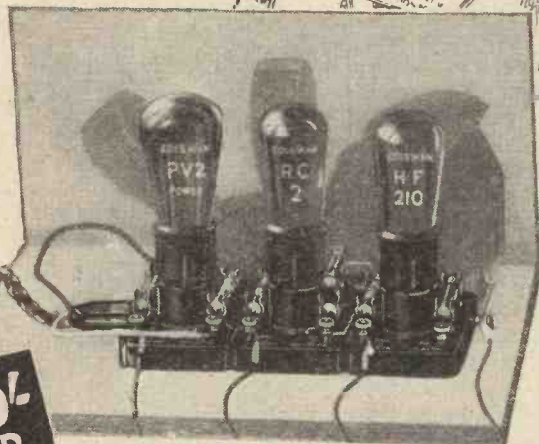

**50%
FOR
PARTS**

**BUILD THE NEW
R.C. THREESOME
IN 1 HOUR**

—brings in several stations on the Loud Speaker, with wonderful tonal purity.

The New R.C. Threesome requires only 5 wiring connections, and needs no soldering. Yet it brings in several stations on the Loud Speaker with an abundance of volume, and a purity of tone that stands comparison with sets many times more expensive and complicated. The secret lies in the Edison Valves H.F.210, R.C.2, and P.V.2. Use them and you'll get best results.

To THE EDISON SWAN ELECTRIC CO., LTD. W. Con. April (Publicity), 123/5, Queen Victoria St., London, E.C.4.

Please send, post free, presentation copies of the New R.C. Threesome Instruction Book and Blu: Print.

NAME

ADDRESS.....

**"...ONE OF THE
BEST LOUD SPEAKERS
WE HAVE EVER
HEARD...."** says

POPULAR WIRELESS.

Read also these two remarkable tributes to the superlative reproduction of the New 'One-der' Loud Speaker.

"... It is unusual to find a Loud Speaker which is capable of such characteristic and impressive reproduction..."

Prof. A. M. Low, A.C.G.I., M.I.A.E., etc.

"... Selling for the very low figure of 50/-... represents exceptionally good value."—Wireless Constructor.

PRICE £2 - 10 - 0
FULL SIZE MODEL.

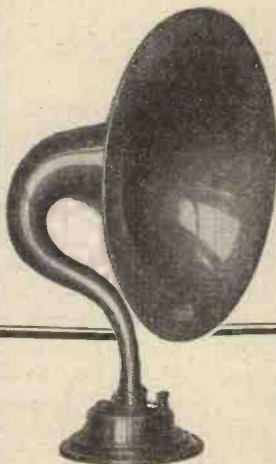

**THE NEW
EDISWAN
ONE-DER
LOUD SPEAKER**

Fully licensed under Patents Nos. 239331, 243431 & 243432.

**CHARGE YOUR
OWN BATTERIES**

**WITH THE
EDISWAN HOME
ACCUMULATOR
CHARGER**

Saves money—no trouble—for the radio and the car battery—

ABSOLUTELY SAFE.

All that is necessary is to connect Charger to lampholder or power socket, and to the accumulator to be charged, switch on current and leave for a given period until accumulator is fully charged.

There is nothing to go wrong. Safe and compact. Full instructions are enclosed with each Charger.

PRICE

£2 - 17 - 6

Complete.



For A.C. Mains only.

EDISWAN

VALVES **CLEAREST · STRONGEST**
LAST THE LONGEST

A type for every purpose

Unsuspected Causes of Distortion—continued

The shaded portions of the curve are completely useless for amplification purposes. The lower part shows a marked bend, and if we allow the working point to descend to this, a loathsome form of distortion will take place through re-rectification. This particular kind of distortion is known as bottom bending. On the other hand, should the grid bias be insufficient, a positive half-cycle may take the working point up into the other useless zone, the grid current area.

The "Danger Areas"

In this case also horrible distortion will occur, since, when grid current flows, mutilation takes place in the "upper" halves of the wave forms in the output circuit of the valve. Now supposing that the voltage of the high-tension battery remains constant and that of the grid battery falls off, the characteristic curve itself does not alter its shape. *The working point, however, moves slowly upwards, as shown by the dotted line, from A towards B, for the negative grid bias upon the grid grows progressively less and less.*

If the valve is to work a loud speaker in a room of even small size, it must be capable of dealing with what is known as a 10-volt grid swing at least. By this we mean an impulse whose "upper" half makes the grid 5 volts more positive than its normal steady potential, and whose "lower" half makes it 5 volts more negative than the steady potential. So long as the working point is at A in Fig. 1, no kind of blasting or distortion will result, for the positive half of a 10-volt grid swing will make the grid potential $-6 + 5$, or 1 volt negative, whilst the negative half-cycle will make it $-6 - 5$, or 11 volts negative.

In either case neither of the danger areas should be reached. But supposing that the grid battery is on its last legs and that the actual working point is at B in Fig. 1, that is 2 volts negative. A similar impulse will now make the grid during its positive half $-2 + 5$, or 3 volts positive; during this half-cycle grid currents will flow and distortion is bound to be present.

A safe rule is to change a dry-cell grid battery every six months. The cost is small, and besides eliminating

the possibility of one form of distortion, this precaution ensures that the H.T. battery is not unduly strained by having to supply current at an unnecessarily high rate. As the grid bias falls off the H.T. current increases, and most of us know, nowadays, that any rise in the H.T. current spells a big decrease in the life of the expensive plate battery. To put it in another way, the grid battery may be regarded as one of the best forms of insurance against both distortion and the premature demise of H.T. batteries.

H.T. Troubles

Almost, if not quite, as common as the distortion caused by neglected grid batteries is that due to senile decay in H.T. batteries. In Fig. 2 is shown a "family" of static curves for a valve of the same type as that upon which Fig. 1 is based. It will be seen that the net effect of falling H.T. potential is to move the grid-volts-anode-current curve bodily to the right. Now, what really matters in a power valve is the length of the straight or useful portion of the curve.

As the curve is moved to the right the useful portion becomes shorter and shorter. In other words the valve is able to deal with smaller and smaller grid swings. If we could so arrange things that the grid potential matters would not be so bad, for in that case the working point would always be approximately in the middle of the useful portion of the characteristic.

Length of Useful Life

We have seen that a useful life of at least six months may be expected from the grid battery; that is to say that, barring accidents, there will be no appreciable loss of E.M.F. in that time. But many users of valve sets do not take a "long" view of the H.T. question. They purchase batteries which are quite incapable of supplying the current needed by their sets for more than a comparatively brief period. When it is first installed the battery supplies the potential required on the plates for good and efficient working. But this does not last. Any set used for operating a loud speaker and employing a power valve in its last holder, as all receiving sets must where good loud speaker

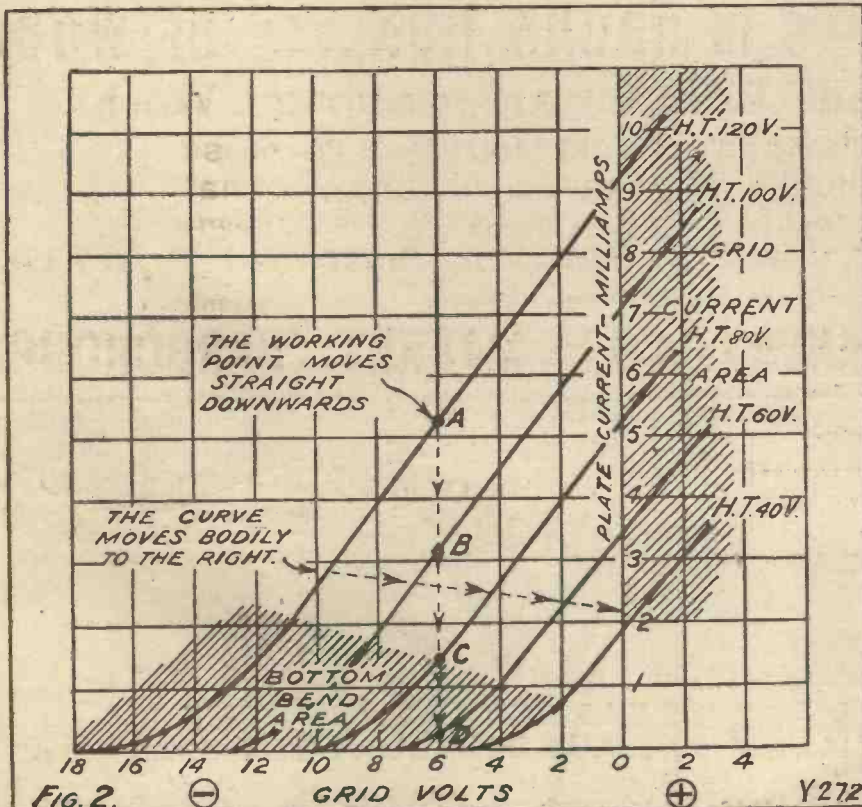

How the valve characteristic is affected by drop of H.T. voltage.



Specially wound for use with screened grid valves

Encouraged by the success of LEWCOS Binocular Coils (ordinary type), we have now produced a specially wound astatic coil for use with screened grid valves. Together they form an ideal combination. Try this new

LEWCOS success in your set.

Obtainable through all radio dealers.

Tuned Anode with Reaction.			
B.B.C. Coil	250-550 metres	Ref. BAR 5	10/-
Daventry Coil	1000-2000	BAR 20	12/-
Tuned Anode without Reaction.			
B.B.C. Coil	250-550 metres	Ref. BTA 5	10/-
Daventry Coil	1000-2000	BTA 20	12/-

The LONDON ELECTRIC WIRE CO. & SMITHS LTD.
Playhouse Yard, Golden Lane : : London, E.C.1

(Registered Trade Mark)

LEWCOS Binocular Coils

Patent No. 277876

We are now making coils for the "MASTER THREE."

Details upon request.

WIRELESS CABINETS IN SOUND QUALITY OF WOOD

Highly Polished First-Class Cabinet Work

Makers of all designs for old and new Wireless Sets as periodically announced in this journal

Special line of closed cabinets totally enclosing Batteries and Accessories

Thousands of satisfied users. Send for Illustrated Price List

Money returned if quality and workmanship not equal to our guarantee

CAXTON WOOD TURNERY CO., MARKET HARBOROUGH

Building the 1928 Solodyne ?

We claim outstanding advantages for this special "Cyldon" production. Greater selectivity, easier tuning, better control, finer adjustment, and no extra drum to buy. Built as one unit on aluminium chassis.

PRICE £3 12 6, or complete with screens, £4 10 0.
Drilled Aluminium Base 7/6. Drilled Copper Base 12/6



3 CONDENSER ASSEMBLY

The "Cyldon" Bebe Condenser is specified by the designers of the 1928 Solodyne. Built on the square law principle. Complete with knob and dial. PRICE (0001) 7/6.

Write for illustrated catalogue FREE and Post Free.

SYDNEY S. BIRD & SONS, Ltd., Cyldon Works,
Sarnesfield Road, Enfield Town, Middlesex.

Phone : Enfield 2071-2

Grams : "Capacity Enfield."

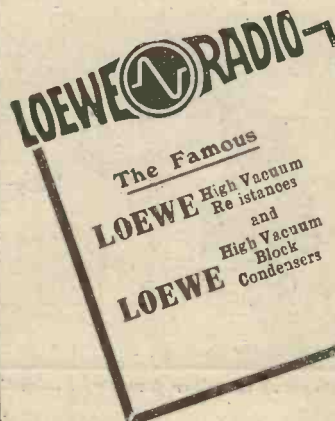

Should be installed in every wireless receiving set.

They are

- Free from atmospheric influences;
- Moisture and dust proof.
- Free from losses.
- Fully guaranteed.

Delivery from stock.

Ask for illustrated leaflet.

LOEWE RADIO COMPANY LIMITED,

4, Fountayne Road, Tottenham, London, N.15.

Telephone : Tottenham 2076.

Unsuspected Causes of Distortion—continued

reproduction is required, will necessarily pass a considerable amount of current.

An examination of the 120-volt curve in Fig. 2 will show that, with the grid of the last valve properly biased, this valve alone is passing more than 5 milliamperes of current. If the set is a three-valver the total current will probably be in the neighbourhood of 10 milliamperes, and from 12 to 20 milliamperes is by no means unusual for a four-valve set. Small, light H.T. batteries cannot possibly supply more than 5 or 6 milliamperes for any length of time without suffering from polarisation, which means that the internal resistance is increased and that the potential falls off.

Decreasing Anode Voltage

We have seen already that a falling potential means a movement of the characteristic curve to the right. The curves shown in Fig. 2 demonstrate how reproduction is affected. Supposing that the grid battery maintains its E.M.F., and that of the plate battery falls to 100 volts, the working point travels from A and B. When it reaches B the largest grid swing that can be dealt with is one of just over 4 volts. Should a 10-volt grid swing occur, the "lower" half of the wave will take the working point well down on to the bottom bend and cause distortion. If the plate potential falls to 80 volts, the working point drops to C, where matters are infinitely worse since practically any grid swing will cause distortion for the same reason. A further fall to 60 volts will bring the working point down to D, where reproduction is such as to beggar description.

Do not forget then, that if you use dry-cell H.T. batteries it is one of the worst forms of misguided policy to purchase small light ones for run-

ning a multi-valve set intended to work a loud speaker. The sensible way of regarding the H.T. problem is to look not so much at the initial cost as *at the cost per annum*. Clearly, it is uneconomical to purchase batteries which are dead at the end of about three months.

Further Causes

Apart from the fact that they have to be renewed at least four times a year, each battery will probably allow only about six weeks of really first-rate reproduction to be obtained; during the second half of its short life its potential is unstable. When switched on at the beginning of the evening the voltage may be quite good, but if it is taken again at the end of an hour or so a heavy fall is likely to be observed. The quality will therefore become worse and worse as the evening goes on.

It is equally unsound to buy too large a battery, for the question of shelf life must always be taken into consideration. If the drain is very small the battery begins to deteriorate by the evaporation of its contained moisture long before it is really run down by fair working.

I mentioned a moment ago one cause of distortion creeping in during the latter part of an evening's reception. There is another which is quite common, though it is often completely unsuspected. The local station is tuned in early in the afternoon whilst it is still broad daylight, and the set is so adjusted that full loud-speaker strength is obtained.

As time goes on a certain amount of distortion is noticed, and listeners are apt to say that the transmission is not so good during the later parts of the programme. The truth is that, owing to the coming of darkness, signal strength increases, and that

if the tuning is left exactly as it was in daylight the last valve is probably overloaded. If distortion is present, always see whether a slight loosening of the reaction coupling (or slight detuning in the case of a short-range receiver) will not improve matters. If it does, overloading is almost certainly the trouble.

I will mention, lastly, a cause of distortion, by no means uncommon, which may be very mystifying. All the batteries are found to be "fully up" when tested with the voltmeter; the transformers or other low-frequency intervalve couplings are known to be above reproach; the loud speaker gives perfect reproduction when tried with another set; and yet poor signal strength is obtained, accompanied by a great deal of distortion. The cause is quite simply that the power valve is worn out, and possibly that others in the set are on their last legs.

Loss of Emission

The life of a British-made valve is probably as long as any in the world, but it cannot last for ever. The dull-emitter, whether its filament is of the blended or the coated type, eventually suffers from a falling off in its emission. The effect of this is to move the characteristic to the right and, at the same time, to tilt it downwards, with the result that amplification is small, and that wave-forms are mutilated by the valve. The average useful working life of the British valve may be taken as about a thousand hours. This means about one year if the set is in use on the average for three hours a night. At the end of this time the valves should certainly be tested to see whether any serious loss of emission has taken place. If there is a marked falling off, they should be discarded.



A peculiar form of distortion—"Knob-Twiddler's Wrist."

Condensers found in all Star Receivers

Mr Harris's
Short-wave
Three

The
Master
Three

1928
Solodyne



JACKSON BROS.
8, POLAND ST.-OXFORD ST.
LONDON - W.1 Telephone:-
GERRARD 7414



Model
No. 44.

**Complete
OR
Kit**

The popular Ideal Cone Loudspeaker (Model No. 44) is put up in two forms - complete as illustrated and as a Home Constructor Kit with instructions for building. The Kit contains all the fine components embodied in the complete model - the Ideal 4-pole patent Balanced Armature Driving Unit, Pedestal and 16-in. Cone of gold embossed finish.

**Price
£2:2:0**

**"Ideal" Cone Loudspeaker
MODEL No. 44.**

THE "IDEAL" 4-POLE BALANCED ARMATURE UNIT

Exactly the same as the unit embodied in the above loudspeaker. With this unit you can make a cone loudspeaker equal in performance to the finest on the market. Complete with two padded washers on threaded spindle. **Price 25/-**

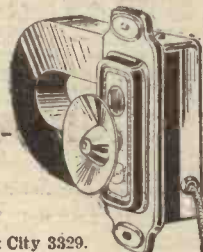

F. A. HUGHES & CO., LIMITED,
204-206, Great Portland Street, W.1.

Phone: Museum 8630 (3 lines).
Grams: Distancing, Wesdo, London.

MANCHESTER OFFICE: 185, Princess St. Telephone: City 3329.

Working off the Mains

Wherever you find constructional articles on Mains Units you will find Climax Auto-bat Components specified. They were the first mains components that made mains radio possible. Be safe. Insist on Climax. "Popular Wireless" and the "Wireless Constructor" both stipulate Climax for success.

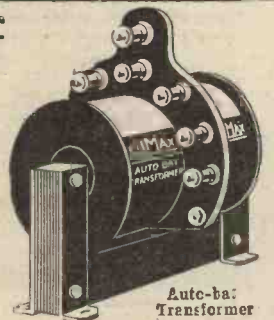

Auto-bat
Transformer

CLIMAX AUTO-BAT TRANSFORMER

200-250 volts or 100-125 volts.
Double-wave, double-wound **35/-**

CLIMAX SPECIAL CHOKE

For H.T. Supply Units **10/6**

CLIMAX HEAVY CHOKE

For Mains Receivers **21/-**

CLIMAX POTENTIAL DIVIDER

20,000 ohms or 10,000 ohms
with ten tapings **5/-**

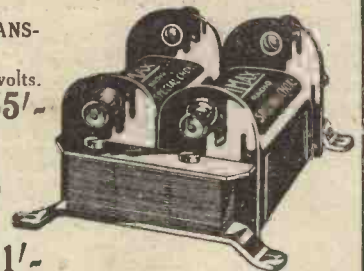

Special Choke



Potential
Divider

Complete lists upon application from any radio dealer or direct to:

CLIMAX
A YEAR AHEAD

Climax Radio Electric Ltd., Quill Works, Putney, S.W.15

OUR NEWS BULLETIN

Some of the More Interesting Happenings in the Radio World this Month

At last something definite has been decided upon by the B.B.C. in connection with the Regional Scheme. Plans for the first high-power medium-wave stations have been receiving close attention lately, and it has been decided that the most suitable site for the new London station would be in the neighbourhood of Potters Bar.

Greater Crystal Range

Tests have been carried out in Bedfordshire, Herts, and Middlesex with a specially equipped radio motor van, and the B.B.C. engineers have come to the conclusion that by having a Regional station for London working on a power of twenty kilowatts this would mean the increase in crystal range sufficient to bring in an additional one and a half million listeners.

Many New Listeners

If similar stations are erected on the outskirts of Manchester, Cardiff, and Glasgow, the increase in crystal range would cover another one and a half million, one million, and six hundred thousand new listeners respectively.

Alternative Programmes

Consequently, the number of new listeners who would in addition be provided with alternative programmes has been estimated as follows:

London	6 millions
Manchester	3 millions
Cardiff	2 millions
Glasgow	2 millions

And the number of listeners who will have a choice of two or more programmes free from any interference with the exception of oscillation would not fall far short of twenty million.

Our Dilatory P.M.G!

But so far the Postmaster-General has not agreed to the proposed Regional Scheme and for the positions of the stations, and until he has done so, of course, work cannot start. He has the matter under consideration, however, and probably his decision will depend upon the final results from the experimental station at Daventry.

Wireless and the Weather

A good deal of nonsense has been talked lately in the papers about the effect of wireless on the weather, and the secretary of the Matlock Improvement Association has led a sort of campaign demanding a close inquiry into the effect of broadcasting, etc., on the weather. It seems that quite a number of people still think that wireless waves create rainy weather.

A Broad View

According to one of the daily newspapers, an official of the Matlock Improvement Association has said that: "Professor Low is apparently the only man of science among those who have expressed their opinion on the matter during the past week who takes up a broad view of the suggested test."

(Continued on page 476.)



MAGNUM H.F. CHOKE
Embodies the following essential features:
High Inductance—160,000 μ t.
Low Self Capacity—8 μ af.
Ample Wave-length range 50/3000 metres

Dimensions:
Overall height, 2 in. Base, 2 1/2 x 1 1/2 in.
Small External field—Protected windings (no celluloid or other inflammable covering). Price 7/6
When buying an H.F. Choke, specify Magnum and ensure magnificent results.

MAGNUM GRAMOPHONE ELECTRICAL PICK-UP

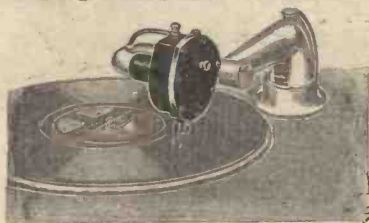

35/-

If in London bring along your favourite record and hear it rendered with a Magnum Pick-Up. The results will astound you.

Construct the F5

as described in this Issue.

	£	s.	d.
1 Mahogany Cabinet with baseboard	1	4	0
1 Ebonite Panel 16 in. x 8 in. x 1/4 in., ready drilled	0	10	0
1 Magnum Reinartz Coil	0	10	0
1 Magnum 6-pin Base	0	2	0
3 Magnum Fixed Resistors and Bases	0	7	6
2 Magnum Panel Brackets	0	2	6
1 Dubilier Mansbridge Condenser, 2 mfd.	0	4	0
1 Dubilier .0003 Condenser and 2-meg. Leak	0	5	0
1 R.I. Varley R.C.C. Unit, Type A	1	0	0
1 J.B. Var. Condenser .0005	0	11	6
1 J.B. Var. Condenser .0003	0	10	6
1 Ormond H.F. Choke	0	7	6
1 Lissen Leak, 1/2 meg.	0	1	0
1 Formodenser, as described	0	2	6
2 Push-pull Switches	0	2	6
3 Whiteline Valve Holders	0	6	9
1 Bowyer-Lowe L.F. Transformer	1	0	0
1 Terminal Panel with 10 Indicating Terminals	0	5	0
1 Terminal Panel with 2 Indicating Terminals	0	1	0
Glazite and Tags	0	1	9
	£7	15	0

MAGNUM STANDARD WAVETRAP



This little Unit is suitable for any make or type of set, and enables you to eliminate that unwanted station.

As used by Mr. P. W. Harris in "The Business Man's Four," also in the original "1928 Solodyne."

Price 15/- complete

Copper Screening Box can be supplied for the above. Price 5/-

RADIANO 3 ENVELOPE

containing Blue Print and Constructional details of this wonderfully popular set is now available.

Price 1/6

Components supplied for all apparatus described in "Wireless Constructor," "Modern Wireless," "Television," and several other technical publications. Catalogue and lists, including full constructional particulars of Magnum Screened 3, 4, and 5-valve receivers, Mullard Master Three, 1928 Solodyne, etc., will be sent on receipt of 1 1/2d. stamp.

BURNE-JONES & CO. LTD.

MAGNUM HOUSE
TELEPHONE: HOP 6257
288, BOROUGH HIGH ST.
LONDON. S.E.1

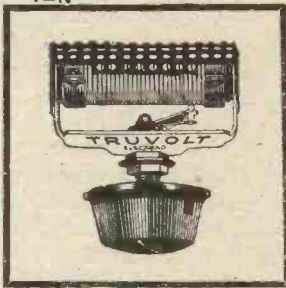

"TRUVOLT"

Variable and Fixed RESISTANCES

"Truvolt," a wire resistance which does away with doubtful resistances using carbon, paper, etc., in Battery Eliminators. Simple in construction and wonderfully efficient. Nichrome wire

resistance, low temperature coefficient, wound on asbestos covered core. No iron to rust.

"TRUVOLT" VARIABLE RESISTANCES

Type	Resistance Ohms	Current M/A	Price
200	20,000	35	} 15/6 each
250	25,000	32	
500	50,000	22.5	

These are examples. There are 15 other sizes.

"TRUVOLT" FIXED RESISTORS

Supplied in an endless range from 200 to 100,000 ohms, 25, 50 and 75 watts. Also with tappings to order. Send for list of this unique range. A post card mentioning "Wireless Constructor" will bring it.

Hamleys
Estd 1760

Telephone :
Regent 3160
(6 lines)

HAMLEY BROS. LTD.
200/2, REGENT STREET,
LONDON, W.1.

Telegrams :
"Pleasingly
Piccy."

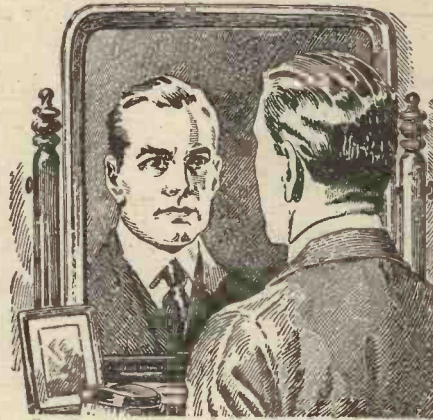

There's the Man That's Holding You Back

Yes, there's the man. You see him every time you look in the mirror. His name isn't Brown or Smith or Jones, but YOU. He's your real master—the man who decides whether your pay will be £3 a week or £5 or £15.

If you want to make good progress there's just one sure way to do it—qualify yourself to do the day's work better than any one of your fellow workers. Ability is certain to count. Your employer will pay you more money if you show him you deserve it.

The I.C.S. originated spare-time technical training by post 36 years ago, and is by far the largest institution of its kind in the world. It has teaching centres in eleven countries and students in fifty.

Write to-day for full information as to how the I.C.S. can help you in your chosen vocation. There are 360 Standard Courses, of which the following are the most important groups:—

- | | | |
|---------------------|---|-----------------------|
| Accountancy | Wireless Telegraphy (Elementary and Advanced) | Salesmanship |
| Advertising | Draughtsmanship | Scientific Management |
| Architecture | Engineering (all branches) | Showcard Writing |
| Building | French and Spanish | Textiles |
| Commercial Art | General Education | Window Dressing |
| Commercial Training | Professional Exams. | Woodworking |

There is a special booklet for each group, which will be sent free on request. Tell us the one you would like to see.

International Correspondence Schools, Ltd.
172, International Buildings, Kingsway, London, W.C.2

"MODERN WIRELESS"

Now On Sale. Price 1/-

FREE PICTORIAL BLUE PRINT

OF

Cossor "Melody Maker"

The Ediswan "R.C. Threesome"

Mullard "Master Three"

Together with a long and detailed article on these three popular sets. If you have built, or contemplate building, one of them, don't miss this magnificent opportunity of obtaining a Pictorial Blue Print Free—and detailed instructions, hints, etc., about the receivers.

"MODERN WIRELESS"

Now on Sale, offers you a really unique opportunity.

GET A COPY NOW!

ARTCRAFT RADIO CABINETS

BRITAIN'S BEST VALUE. NEW 1928 MODELS.

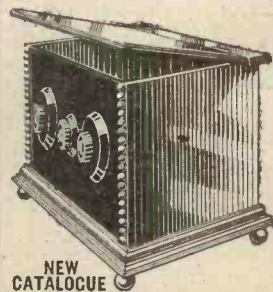

Panel Size	Baseboard Depth	Price in	
		Oak	Mahogany
9 x 6	6	6 0	10 0
10 x 8	6	8 0	12 0
12 x 8	8	12 0	16 0
16 x 8	8	14 0	19 0

Baseboards Free. Hinged Lids 1/6 extra. Add 1/- for crate. All Cabinets sent Carriage Paid.

PANELS FITTED AT STANDARD PRICES.

Obtainable from all dealers or direct from

The Artcraft Company,
158, Cherry Orchard Rd., Croydon

CUT THIS OUT FOR CABINETS

and post to us for FREE list illustrating Cabinets as shown in "Wireless Constructor," etc., etc.

NAME

ADDRESS



(Write in block letters, please.)

CARRINGTON Mfg. Co. Ltd.,

Camco Works,

Sanderstead Road, South Croydon

Telephone: Croydon 0623 (2 lines).

OUR NEWS BULLETIN

—continued from page 474

Mr. A. M. Low is primarily a motor engineer, and we cannot see how his opinion on a meteorological question can be quoted in favour of Matlock's belief. Sir Napier Shaw, F.R.S., the distinguished scientist and meteorologist, is, however, of the opinion that wireless has no effect on the weather at all.

Interesting Short-Wave Tests

According to the "Daily Telegraph," short-wave stations of all kinds are cropping up like mushrooms all over the globe, and the wireless correspondent of that journal states that the Radio Society of Soviet Russia is arranging a monthly test talk at Moscow Wireless Station, call sign S O C, on 55 metres, 37 metres, and 23 metres. Readers should look out for these tests, as they are bound to be interesting.

An "Idiotic Ban"

Mr. Winston Churchill has earned the gratitude of listeners in referring to the ban on broadcasting controversy as "absolutely idiotic." He has suggested that one hour a night

should be given to politics, the time to be apportioned to rival parties in the ratio of their strength in the House of Commons.

This suggestion has been favourably commented upon by Mr. Bernard Shaw, Captain Ian Fraser, Mr. Lloyd George, Mr. J. H. Thomas, and Mr. J. R. Clynes, and it is understood that the matter is receiving the attention of the Cabinet, for the Postmaster-General considers the question of controversy so important that, according to a statement made in the House the other day, it is receiving immediate attention of members of the Government.

Edison and Television

Thomas Edison, the great inventor, was eighty-one the other day, and it is interesting to note that, in answering a series of questions, he said that television was remarkable, but hardly applicable in his opinion for general use.

That is an opinion worth having, when one considers what Edison has done in his extraordinary life.

That Experimental 5 G B

Captain Eckersley has said that the B.B.C. is not disappointed with 5 G B. But what about listeners? Quite a number of them seem to be disappointed, for many who expected

to get an alternative programme, especially in London, are certainly not getting it. Certainly, since the new aerial went up at 5 G B, reception in London has deteriorated despite the fact that power at 5 G B has been increased.

Many listeners receive 5 G B worse than they do foreign stations which only use five or six kilowatts. It has been suggested that the best thing the B.B.C. could do would be to move 5 G B away from 5 X X and the screening masts of the latter station. But the B.B.C.'s answer, of course, is that 5 G B is experimental, and the experience they have gained with the station is an answer to those critics who suggest they should commence work on the Regional Scheme without further delay.

Some Licence Figures

An increase of 28,656 broadcast licences was recorded during December, 1927, this being the highest increase of any month since last April. New licences issued in December amounted to 245,013. The total broadcast licences issued in Great Britain and Northern Ireland has reached the figure of 2,383,726.

(Continued on page 478.)

EDDYSTONE
SHORT-WAVE COILS
FIRST AND BEST

Read what users tell us:—



Capetown, S.A. "The S.W. Coils are safely to hand, and you may be interested to hear that I have no difficulty in receiving the American, Dutch, and other S.W. transmissions."

Barnet, England. "... I should like to mention that "Eddystone" S.W. Coils are used exclusively at this station and I can recommend them to anybody."

Coventry. "Yesterday I rigged your coils in my transmitter and they gave excellent results. I am able to work with several countries I had previously never been heard in."

Perak, F.M.S. "... I am very pleased to say that the S.W. Coils and apparatus are giving every satisfaction. For several nights and mornings I have received the 5 S W transmission word perfect."

We have delighted users in India, East Africa, Trinidad, Azores, Finland, and all over the British Isles.

PRICES:			
No. 3	8-30 metres	..	2/6
No. 4	12-45 "	..	2/9
No. 6	14-70 "	..	3/-
No. 9	25-100 "	..	3/3
No. 12	40-150 "	..	3/6
No. 15	60-200 "	..	4/-

Complete Inductance Unit, 18-100 metres, with variable aerial coupling Price 20/-

STRATTON & CO., LTD., Bromsgrove St., Birmingham.



London Service Depot: 164, Charing

Webb's Radio Electric Stores, Cross Rd., W.C.2.

"1928" LOG

In two capacities:
·00035 ·0005

5/-

Also

Dual Gang
15/6

Triple Gang
£1/1/0

SPAN FULLY OPEN 3½"

WEIGHT 4½ OUNCES

BEHIND PANEL 2"

Absolutely the—

SMALLEST - 2" Behind Panel.
3½" Span Fully Open.

LIGHTEST - 4½ ounces.

and most

EFFICIENT - Perfect to Logarithmic Law.

yet produced.

Write for Literature containing full details.

CROWN WORKS, 22, CRICKLEWOOD LANE, N.W. 2.

Telephone: Hampstead 1787.

A New and Useful Work of Surpassing Beauty!

Wonderful Britain

Fortnightly Parts - 1/3 each.

The glories of our own country from Land's End to John O' Groats brilliantly described and illustrated with 1,500 photographs in superb Photo-tone.

THIS richly printed and fascinating new work will show all that is beautiful, remarkable and historic in England, Scotland, Ireland and Wales. Highways, byways, historic places and beauty spots will be described by great travel writers and illustrated with a remarkable collection of photographs printed on delicately toned paper. There is not a corner of the British Isles that has been left unexplored in the preparation of WONDERFUL BRITAIN. It will help you to get the best out of your holidays. It will help you to plan a day's run or a long motor tour, and will lead you to visit the thousand and one places which, in the ordinary way, you might easily pass by. You will be able to turn to it both as a reminder of the places you have seen and as a guide to those you ought to see.

The following list of articles in Part 1 conveys a good idea of the interesting way in which the work has been arranged.

WINDSOR CASTLE AND ITS STORY. By Rev. C. A. Alington, D.D.

SHAKESPEARE'S ENGLAND. By the Dean of Winchester.

ROMANTIC EDINBURGH. By Lewis Spence.

HISTORIC SCENES ALONG THE BRIGHTON ROAD. By C. G. Harper.

THE GLORY OF THE CATHEDRALS. By Rev. Percy Dearmer, D.D.

THE FOLK DANCES OF OLD ENGLAND. By Mary C. S. Neal.

Buy
Part 1 **TO-DAY**
1s. 3d.

LARGE SCALE ROAD MAP
of Britain's Historic Places
FREE

printed in colours on stout card in 24 sections—one section free with each part of WONDERFUL BRITAIN. The complete map, unobtainable elsewhere, would cost at least 10/- in the ordinary way. This map will be invaluable to motorists, cyclists and tourists.

A special transparent-fronted canvas case in which all the sections of this Free Map can be carried will be supplied to all regular subscribers at half price, i.e. 2/6



If you have any difficulty in obtaining a copy of Part 1 from your Newsagent or Bookstall, send 1/6 direct to the Publisher, The Amalgamated Press Ltd., Fleetway House, London E.C.4

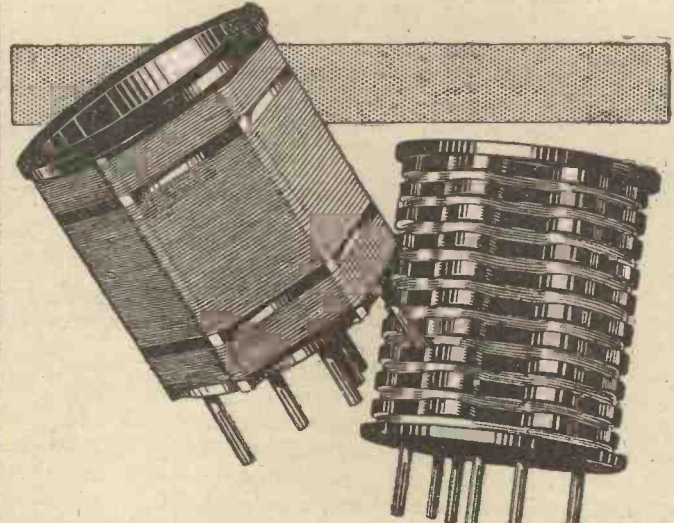

INSIST UPON SPECIFIED COILS IF YOU WANT MAXIMUM EFFICIENCY



IF you are about to construct the Mullard Master Three Receiver you should remember that there is every reason why you should adhere to the author's specification.

SELECTIVITY to the desired degree is easily obtained with Colvern Coils. A few turns to requirement should be removed from the aerial winding and the end of the wire reconnected to Pin No.4.

RANGE depends to an extremely high degree upon efficient coils and it is very important that these should have a very low high-frequency resistance. To obtain this Colvern Coils are accurate space-wound. Experience proves that the use of Colvern Coils increases the range of a radio receiver. In the case of the Master Three Colvern Coils give maximum range.

VOLUME is similarly dependant upon the efficiency of coils. Logically, the signal strength of distant stations is greatly increased by Colvern Accurate Space-Wound Coils.

Therefore be advised—adhere strictly to the author's specification, you will be most satisfied.

- Prices:—
- Broadcast Wave.**
Accurate Space-wound to give maximum efficiency. **7/6**
 - Long Wave.**
Sectional wound to give lowest high-frequency resistance. **8/6**
 - Colvern Aluminium Panel.**
is also specified for the Mullard Master Three Receiver 18" x 7" : 14 gauge; sprayed instrument black; drilled for variable condensers switch and panel brackets. **7/6**

COLVERN ACCURATE SPACE WOUND COILS

Colvern Ltd., Mawney's Road, Romford.

OUR NEWS BULLETIN

—continued from page 476

Short Wave Activities

Short-wave station reception is now in full swing, and we are constantly receiving letters from readers who seem to be finding them more and more a fascinating pastime. The American short-wavers 2 X A F and 2 X A D have been coming over lately at remarkable strength; Rome may often be heard working on 45 metres, and Berne on most evenings on 32 metres. WGY on 22 metres may be heard quite easily, and listeners will often hear 2 X A D calling 5 S W and P C J J for test purposes.

"Fool-proof Sets"

"The future of listening is in terms of fool-proof sets," said Captain Eckersley at a recent lecture given by the Institution of Electrical Engineers. "It should be the aim of those responsible for distribution to make the problem of reception as simple as possible."

Captain Eckersley went on to say that in order to make selection by the two alternative programmes as simple as possible the two transmission

strengths must be equal. This once achieved there was a maximum opportunity for the receiver to obtain one or the other programme without initial interference and possibly interference from outside sources.

Parrot Phrases

The idea of the B.B.C. buying a parrot with the reputed vocabulary of twenty words was an excellent one, but so far the bird seems to have been curiously silent. No doubt he has been suffering from microphonic fright, but let us hope that before these words are read the parrot will have proved that the money spent on him has not been wasted.

The only thing is we are frightened that his vocabulary might not be so respectable as the ideals, aims, and desires of the Olympians of 2, Savoy Hill.

Welcome News

The Post Office has done a good stroke of work in replacing the Humber Radio Station Spark System with up-to-date valves. This is welcome news for those many listeners who are troubled in that district by Morse interference. These obsolete spark transmitters cause a great deal

of trouble because they are so coarsely tuned that they easily interfere with reception over a wide band of wavelengths. Let us hope the Post Office will go ahead with this idea and replace a good many more of these obsolete and annoying spark stations.

Best Place to Listen?

Britain's best district for listening has never been satisfactorily located, but, personally, I should be inclined to award the palm to Wales. So many reports of continental broadcasting picked up direct on crystal sets in the Principality are received that the conditions there must be sumptuous. In the Swansea district there is one crystal set that has picked up no less than ten different continental stations. A crystal set, look you!

Range of Reaction

An interesting light was thrown on this subject by a friend of mine who is a wireless operator at sea. In a letter he tells me that by using excessive reaction he is able to transmit a distance of eighty miles on an ordinary one-valve receiving set. If a one-valver can do this, what can some of these two and three-valvers which are allowed to oscillate do? They must be kicking up an awful hullabaloo.

MAGNAVOX
ELECTRO-DYNAMIC
POWER SPEAKER UNIT

Manufactured under Magnavox British Patent No. 197,836 of May 24th, 1923.

R4 UNIT
£9.10.0

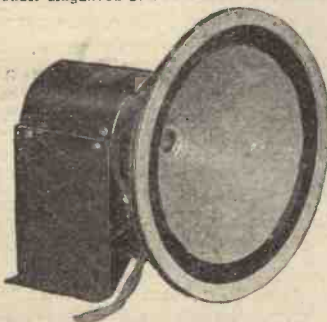

R4 UNIT
£9.10.0

The World's Finest Speakers by the oldest speaker manufacturers. A revelation in reproduction with results equal to moving coil speakers selling at five times the price. The field of the Magnavox Type R4 Unit is operated from a 6-volt accumulator or any standard trickle charger. Consumes 1/2 ampere. Resistance 12 ohms. This field current is easily available from the L.T. battery of your receiving set. The unit is supplied complete with attachment cords and built-in input transformer.

Permanent Magnet (balanced armature) Type No. M 7.K-62/6

Write for full list

Our new 1928 Catalogue and circuit supplement is now ready. Send 9d. in stamps to cover cost of postage. It's the most instructive and interesting list available.

THE ROTHERMEL CORPORATION LTD.

24-26, MADDOX STREET, LONDON, W.1.
Telephone: Mayfair 0578, 0579.

MAGNAVOX
Notice!

MAGNAVOX Dynamic Speaker Units (moving coil) are manufactured under the following patents—

BRITISH PATENTS.	AMERICAN PATENTS.
No. 197,836, May 24th, 1923.	No. 1,051,113, Jan. 21st, 1913.
Others pending.	" 1,088,283, Feb. 24th, 1914.
	" 1,266,986, May 21st, 1916.
	" 1,444,524, Feb. 6th, 1923.
Foreign Patents issued and pending.	" 1,448,279, Mar. 13th, 1923.
	" 1,524,349, Jan. 13th, 1925.
	" 1,579,392, Apl. 6th, 1926.
	" 1,582,417, Apl. 27th, 1926.
	Others applied for and pending.

Purchasers of these units through our exclusive sales representatives

THE ROTHERMEL CORPORATION, LIMITED
24-26, Maddox Street, London, W.1

are advised that they will be fully protected against any infringement actions.

WARNING

The MAGNAVOX COMPANY serves notice that infringers of the above British patent—manufacturers of moving coil speakers assembled or unassembled embodying exclusive MAGNAVOX features—will be vigorously prosecuted.

THE MAGNAVOX COMPANY
Oakland, California, U.S.A.

An Accurate and Reliable Wavemeter

Gambrell Type "D" Wavemeter meets the needs of those requiring an instrument low in price and of a high degree of accuracy. The instrument is totally enclosed in its cabinet—a Battery is incorporated within same, and a switch enables the buzzer to be put in and out of operation without disconnecting the battery leads. The buzzer is the new Gambrell Buzzer—a great improvement over any other on the market.



PRICES:
"WAVEMETER TYPE D"
 (as illustrated):
 Complete with two coils and two Charts.
 For 50 to 500 metres and 44-volt Battery
 £5 : 0 : 0
 With Coils and Charts for 20 to 500 metres
 £5 : 13 : 6
 Can be calibrated up to 7,000 metres if required.

GAMBRELL CENTRE-TAPPED COILS

Because of their efficiency and the greatly improved results which their design ensures, they are used and recommended by experts for circuits designed for selectivity, and from which the utmost results are to be obtained. Their use is not limited to centre-tapped circuits. Standard socket fitting. In any circuit requiring plug-in coils, "Gambrells" will ensure the finest possible results.

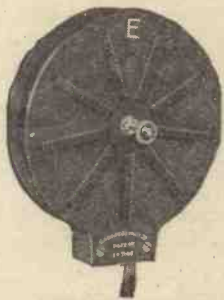

Size.	Price.	Approx. No. of Turns.	Size.	Price.	Approx. No. of Turns.
a2	4/10	80	D	6/3	100
A	5/-	25	E1	6/9	150
B1	5/3	30	E	7/9	200
B	5/6	40	F	8/6	300
O	5/9	50	G	10/-	500

Centre-Tapped 6d. extra.

GAMBRELL BROS., LTD., 76, Victoria Street, London S.W.1.



Large Power Transformer

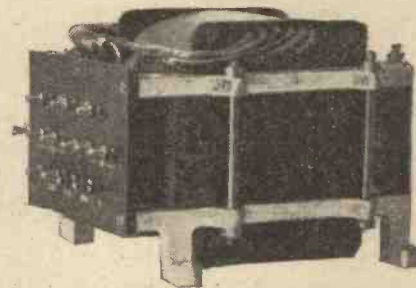

Specially designed for driving Moving Coil Speakers, large output Eliminators and Amplifiers.

These large Parmeko Transformers are very strong and robust, extremely efficient, and have a low no-load current.

A terminal panel is provided so that all connections can be conveniently taken. Suitable for directly screwing down to a board.

Standard Model.

Output. H.T. secondary, 550-0-550 volts, 100 milliamps. Rectifier filament secondary, 7.5 volts centre tapped, 3 amps. Amplifier filament secondary, 5.5 volts, 3 amps. This standard model is suitable for use with 2 R.H.1 Valves as Rectifiers and 2 L.S.5.A Valves in parallel as Amplifying Valves, the rectifying and amplifying filaments being lit by A.C. Any other lower voltage valves can be used by inserting suitable resistances in the filament winding.

Price **£3-10**

We manufacture Transformers to give any voltage and output and for all purposes. We shall be pleased to quote you for any type of Transformer, Choke, or Rectifying Apparatus.

PARTRIDGE & MEE LTD.,
 12, Belvoir Street, LEICESTER.

GOOD NEWS FOR SET BUILDERS

In response to the urgent demand for first-class sets for family use, Mr. PERCY W. HARRIS, M.I.R.E., has now prepared the

Wireless Constructor Envelopes

The first two of this series are Now on Sale, price 1/6 per envelope (by post 1/9).

Envelope No. 1.—THE RADIANO THREE. A famous loud speaker set which you can build in an hour or two—no soldering necessary and a wide range of components to choose from.

Envelope No. 2.—THE CONCERT FOUR. Made of standard parts, all easily obtainable, this is a highly-sensitive long-distance set, giving powerful reproduction of wonderful quality. Covering both long and short wave-lengths, with a switch for 3 or 4 valves, it is essentially a set to enjoy, both in building and operation.

In these envelopes you will find every detail of the set simply explained; photographic reproductions and diagrams are included, as well as a full-size Blue Print.

NOW ON SALE ————— **Price 1/6**

By post 1/9, from the Amalgamated Press, Ltd., Bear Alley, Farringdon Street, London, E.C.4.

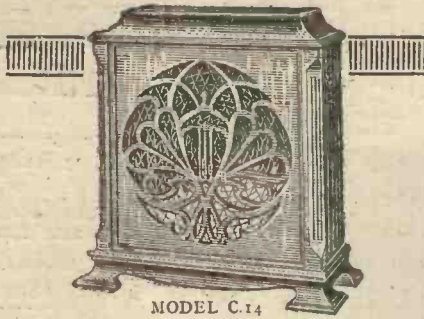

MODEL C.14

*Nothing sounder
can be said of any
Radio Set than that
it is Voiced by
"CELESTION"*

"Celestion" possesses every characteristic of an excellent loudspeaker. It gives an even response to all frequencies, both in speech and in music.

Another feature of "Celestion" is its extreme sensitivity. It can handle both weak and very heavy signals without readjustment.

"Celestion" improves with age, and is unaffected by atmospheric conditions. Further, the handsome appearance of "Celestion" breathes craftsmanship.

CELESTION

THE VERY SOUL OF MUSIC

Write for illustrated folder. Models in oak or mahogany from £5-10-0 to £25.

THE CELESTION RADIO CO.,
Hampton Wick, Kingston-on-Thames.
Showrooms:
33/35, VILLIERS ST., STRAND, W.C.2
French Agents:
Constable & Co., Paris.

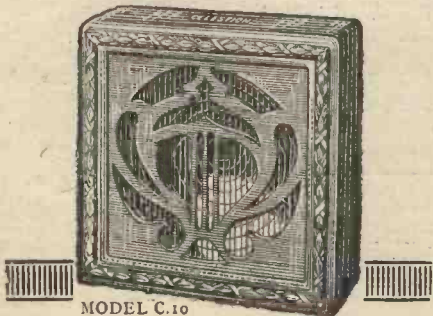

MODEL C.10

QUEER QUERIES

—continued from page 424

the set "plopped" all right, but the broadcasting was so faint that the phones had to be fastened to the head at "ear-ache" pressure before speech could be understood. Evidently something serious was wrong.

"I am sure the aerial is all right," wrote the owner of the set, "because it is very high. Being employed and living at the gasworks here I have run the aerial to the top of the highest gasometer, and it runs straight from there to the window, as shown in the sketch." One glance at the sketch solved the puzzle, for that poor aerial was surrounded completely by huge gasometers that shut it off from broadcasting as completely as any place in England can be cut off!

An Extreme Case

This was an extreme case, of course, but it will serve as a reminder of the importance of an efficient aerial. A high aerial is of value because it lifts the wire above the surrounding earthed objects, trees, buildings, etc.

But the worst form of shield is a metal one, so if your aerial runs close to a lead or iron roof, to metal piping, or any similar large metallic surface, it is not receiving all the energy it might, and in extreme cases it may receive practically no broadcast energy at all. Give your aerial a good clear "get-away" and you will find that the distant stations aren't half so distant as you thought they were.

RADIOGRAMPHONICS

—continued from page 422

the Columbia machine, a special split sleeve which fits inside the collar. The magnet windings are protected by a strongly-made bakelite case. In spite of this, the pick-up is quite light in weight. Two leads from the pick-up go to the volume control, which is intended to be placed near the gramophone itself. As evidence of the amount of thought expended by the makers in designing this component, it is interesting to note that the volume control is enclosed in a heavy metal casing, this weight being sufficient to keep it in position without any necessity for securing-screws. A long flexible lead goes from the volume control to a plug, and the procedure is as follows: The purchaser

first finds out which is the negative socket of his detector-valve holder. He then connects the tag with the white strand to the pin of the plug which makes contact with this negative socket. The plug is then inserted in the valve holder, after which the detector valve is inserted into the four sockets on the top of the plug adaptor. It will, therefore, be seen that no alteration to the existing receiver is necessary in order to use the gramophone attachment.

On test the device gave excellent results and the sensitivity is quite high. The pick-up is well damped and there are no unpleasant peaks. Moreover, the volume control really works, and the strength of signal can be decreased to a whisper. As one would expect from a firm of such high standing as Messrs. Amplion, the general finish of the attachment is extremely good, and the impression gained is that it is a component of the highest quality. We have no hesitation in recommending it.

As we go to press we have just received a specimen of the new Lissen pick-up which sells at the very attractive figure of 15/-. This unit is of pleasing finish and neat design and promises to be remarkably good value for money. We have not yet completed our tests on this component but propose to give a full report in our next issue.

USING THE 31 TESTED CIRCUITS

—continued from page 450

and those on pages 11 and 12, each have their good points. There is very little to choose on strength of signal between any of them. The cheapest to make is the lower circuit on page 10, as there is only one variable condenser and all the other circuits have two. The most selective is undoubtedly C4 (page 12). The most compact is B2.

Owing to its use of three variable condensers and the necessity for having very wide coupling between L₁ and L₂, the circuit C4, on page 12, needs a cabinet at least as big as that generally used for a three-valve set (16 in. by 8 in. by 7 in.), but for the reader who is so placed that he wants to make his accumulator last the longest possible time, while getting the great selectivity which is usually only obtainable with a set using more than one valve, C4 is excellent. An all-round, useful and quite selective

(Continued on page 481.)

USING THE 31 TESTED CIRCUITS

—continued from page 480

set which neither costs too much nor takes too much space there is a great deal to be said for B3, page 11.

L₁, L₂ and L₃ can all be plug-in coils, in fixed sockets, obviating the expense of a three-coil holder with two moving sockets. The coil L₂ should be centre-tapped, and practically all of the plug-in coil makers now sell centre-tapped coils at a very slight increase in price over the ordinary type.

The arrangement of bringing the grid leak down to the slider of a potentiometer shown in circuit B4, on page 12, can be adapted to any single-valve set, giving a slight improvement. A best position can always be found on the slider, on the one hand for best strength of signal, and on the other for smoothest reaction. The two do not necessarily coincide, and it is very useful to experiment to find which point of adjustment suits your own arrangement best.

F5

—continued from page 420

The method of attaching the series grid leak to the resistance-capacity coupler is as follows: Screw one clip underneath the G terminal of the R.C. unit and solder the other clip to a stiff wire coming from the grid terminal of the second valve holder. Arrange the length of this wire so that when placed vertically it will support the grid leak as shown in the drawings and the photographs.

Connecting Up

Before aerial, and earth, loud speaker, and batteries are joined up to this set the reaction condenser should be set at zero, the knob of the baseboard adjustable condenser screwed upwards as far as it will go (turning anti-clockwise) and both of the push-pull switches set at the IN position.

The valves to use in this set are as follows: The first valve is a resistance-capacity-coupled type, in the 2- or 6-volt varieties; the first note-magnifier a high-frequency valve (this type gives better results with the modern high-efficiency low-frequency transformer than the type of

(Continued on page 482.)

IMPORTANT

We stock Igranio, Climax, Ever-Ready, Hellesen, Siemens, Formo, Ferranti, Wearite, Ormond, J.B., Benjamin, Lotus, Mullard, Dubilier, Lissen, Lewco, Utility, Magnum, Peto-Scott, Peerless, Burndep't, Eye, Marconi, McMichael, Cosmos, Carborundum, R.I. Varley, Gambrell, Brown's, Sterling, Amplions—in fact, everything it is possible to stock.

IT IS IMPOSSIBLE TO ADVERTISE ALL THE WIRELESS PARTS NOW ON SALE, BUT IF YOU WANT THEM TRY RAYMOND'S FIRST! BE SURE YOU VISIT THE Bargain Window. New 100-page Catalogue. Profusely illustrated. Price 1/- Post FREE, allowed off first 10/- order

EXTRAORDINARY OFFER "STRAIGHT THREE"

D. and 2 L.F. Circuit

Illustration shows the assembled set.

For Local, 5 GB, 5 XX, and Continental Stations.



PARTS FOR ABOVE SET

2-Valve Components - 35/-

3-Valve Components - 42/-

Baseboard, wire, screws free.

OAK CABINET 14" x 7" and panel 13/6

Ditto 12" x 8" and panel 12/6

H. T. Batteries, 100 v., 8/11.

D.E. Valves, 5/11, 6/11; Power, 7/11.

2-Volt L.T. 4/6, 5/6, 8/6.

Loud Speakers, 15/11.

Coils, 1/- and 2/- each.

These prices are to purchasers of the Kit of parts ONLY.

We supply the parts. You can make it in 2 hours. Wiring Diagram Free with parts. Carriage extra

MUSIC CHARMER KIT (W.M.)

See Free Gift at Bottom.

.0005 Raymond Condenser (AS USED IN SET), 7/6; 7 ohm Panel Rheostat, 2/-; .0001 Reaction (Ormond) 4/-; Single Coil Holder, 8d.; .0003 Fixed 2-meg. Leak and Series Clip, 3/-; 5 Anti-Microphonic Valve Holders, 5/3; R.C.O. Unit, 7/-; L.F. Transformer (Igranio), 16/-; H.F. Choke (Burne-Jones), 7/6.

Nett Total 52/11

FREE WITH ABOVE Terminal Strip, 7 Marked Terminals, Ebonite Tube, Wander Plugs, Spade Tags, Rubber Flex and Pointer, and Oak Panel, 16 by 8.

GABINETS

Large stocks of really useful cabinets kept or made to order. Solid oak. American type, hinged lid, base board.

10 x 8 x 8 ...	8/11
12 x 8 x 9 ...	11/6
14 x 7 x 9 ...	13/11
16 x 8 x 9 ...	16/11
18 x 8 x 9 ...	19/11
20 x 8 x 9 ...	22/6
21 x 7 x 9 ...	25/-
24 x 7 x 9 ...	27/6

Carr. & Packing 2/6 extra

BULLPHONE UNITS 15/-

GRAMOPHONE OR CONE each

K. RAYMOND

27 & 28a LISLE ST., LONDON, W.C.2
Come to LEICESTER SQUARE TUBE

IMPORTANT BE SURE IT IS RAYMOND'S
THIS ADDRESS IS AT THE BACK OF DALY'S THEATRE
Phone: Gerrard 4637

WE ARE OPEN PERSONAL SHOPPERS

ALL DAY SATURDAY
ALL DAY THURSDAY
ALL DAY EVERY DAY
Hours 9 a.m. to 8 p.m.
Sat. 9 a.m. to 9 p.m.
Sunday morning 11-1

SET OF THE SEASON COSSOR MELODY MAKER COMPONENTS FOR SAME

Post £4. 10. 0 Kit. Extra

2 Ormond .0005; 2 Do. S.M. Dials; 6 T.C.C. Condensers, .001, .002, two .0003, .0001, 2 mfd.; 2 Grid Lk. Clips, B.B.; 1 Var. H.B. Rheostat; 3 Dubilier Leaks; 25, 3, 4 meg.; 3 Lotus V.H.; 1 Ferranti L.F.; 2 Panel Switches; 1 Cossor Melody Wound Coil; Terminals, Name Tabs, Glazite, 9-v. Grid Bias (all as specified). ABOVE PRICE NETT.

NOTE Drilled High-grade 21 x 7 Polished Panel, with Radion Strip. FREE with above kit.

NOTE Handsome American Cabinets, hinged lid, baseboard List: Oak, 25/-; for 18/11; Mahogany, polished, 32/-; for 22/6. If purchased with above kit, ALL CARRIAGE AND PACKING EXTRA.

ALL VALVES STOCKED.

COSSOR VALVES for ABOVE.

210 D ..	410 HF ..	610 HF ..	10/6 each.
210 RC ..	410 RG ..	610 RG ..	10/6 each.
210 F ..	410 P ..	610 P ..	12/6 each.

EDISWAN NEW THREESOME LIST OF COMPONENTS.

Three Coupling Units, Tubular Fixed Condenser, Multi-flex Cable and Plug, .0003 Variable with S.M. Dial, 2-way Geared Coil Holder, Connecting Wire, Red & Black Flex.

The lot post free 42/- nett.

EBONITE PANEL 2/6 The two with 5 Ply Baseboard above kit only.

Ediswan Valves, 10/6 each; Power, 12/6. 2 60-volt Batteries (if purchased same time) the 2 for 12/6 nett. Very good make. 2-volt 60 Accumulators (with parts), 6/11 nett. All other accessories stocked. Please add sufficient for carriage for batteries, etc.

"RADIO THREE"

RADIO "THREE" (March, '27, Wireless Constructor). All parts as specified with Terminals.

2 Ormond S.L. Variables, with Friction Gear; 3 Coil Sockets; T.C.C. .0003 and Clips and 2-meg. Leak; 3 Benjamin Valve Holders; 3 Fixed Resistors and Base; On-and-Off Switch; Geophone 1st Stage L.F.; B.T.H. 2nd Stage L.F.; Engraved Strip, with Terminals and Nuts; 2 BL Terminals for Front Panel; 3 Gross Pinch-on Spades; Rubber Flex. £4/10/0 lot. Post Free U.K.

ABOVE KIT, with first-class SUITABLE Components, as advised by Mr. Harris,

£3. 0. 0 nett.

NEW ENVELOPE ISSUED BY MR. PERCY HARRIS FOR RADIO 3 NOW ON SALE HERE, 1/6. ALLOWED ON ORDER FOR PARTS.

RAYMOND'S

FOR THE

"MULLARD MASTER THREE"

NO SOLDER—ONLY 20 WIRES TO CONNECT SET OF COMPONENTS

- | | |
|---|--|
| 2 Terminal strips, 2 1/2 in. x 2 in. x 1/4 in. | 1 Master Three Coils. |
| 1 Coil base. | 1 On and Off switch (Bulgin). |
| 1 S.L.F. variable condenser, .0005 mfd. (J.B.) | 1 R.C.O. unit, type A (R.I. Varley). |
| 1 S.L.F. variable condenser, .00035 mfd. (J.B.) | 1 L.F. Transformer, G.P. (R.I. Varley). |
| 1 H.F. choke (Climax). | 1 Combined grid leak, 2 megohms, and condenser, .003 mfd. |
| 1 Anti-vibratory valve holders with terminals. | 6 Wander plugs—4 red, 4 black. |
| 1 Pair panel brackets. | Suitable length of red and black flex. |
| 4 Terminals—A, L, L.S.—L.S.+ (Belling-Lee). | 1 Ebonite bush, 2 in. diam., 1 1/2 in. hole, 3/16th in. thick. |
| 2 Spade terminals—1 red, 1 black. | |

And 3 Mullard P.M. Valves.

ABOVE KIT £6 17 6 NETT.

FREE SET OF "ABC" JUNIT. GRID BIAS, 9 VOLTS 100 VOLT E.A. (BETFISH) ALUMINIUM PANEL, 18" x 7"

CALLERS please make out your list for orders over 20/- if requiring component parts for any set and we will give you a fixed inclusive price.

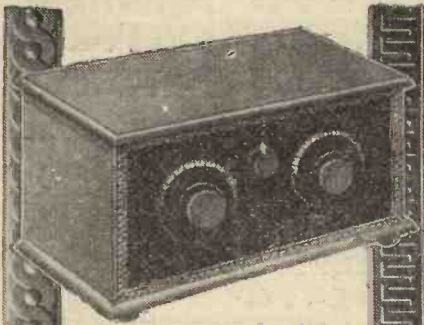

MAKE YOUR SET LOOK TWICE AS SMART

What a difference Trolite Panel Strips do make to the appearance of a radio set! And then they disguise ill-fitting cabinets, out-of-true panels and counter-sunk screws.

Trolite Panel Strips are made of insulated material in two colours, red-brown and black, and two artistic designs, as illustrated. To fix these strips you saw them to the correct lengths, cutting the ends to 45°, and fix to a Trolite panel with acetone—no screws required.

Price **9d.** per foot. Supplied in lengths of 39 in.

Most radio dealers have a supply of Trolite Strips, but if you have any difficulty in obtaining send direct to:—

F. A. HUGHES & Co., LIMITED
204-206, Great Portland Street, W.1.

*Phone: Museum 8650 (3 lines)
*Grams: Distancing, Wesdo, London

MANCHESTER OFFICE:
185, Princess Street.
Telephone: City 5329.

TROLITE

COLOURED PANEL STRIPS

—fixed in a moment.



F5

—continued from page 481

valve generally called “low-frequency”). The third valve should be either a small power valve or, if adequate high-tension is available, a super-power valve. These latter give much better reproduction than the small power valves, particularly on loud signals, but are rather greedy in their high-tension consumption.

The H.T. Voltages

Place the valves in the sockets, join up a grid-bias battery, adjusting tapping No. 1 to give the grid bias specified by the valve maker for the high-frequency type when using the anode voltage of the maximum of your battery, and set grid-bias tap No. 2 at the valve-maker's value for your output valve, also at the maximum voltage of your high-tension battery. Connect up the high-tension battery, giving as high a voltage as possible up to 120. You will get good results on anything from 80 upwards, but 120 will give much better signals than will the lower value.

High-tension positive 1 and high-tension positive 2 terminals can be joined together with a piece of wire and the maximum voltage of your battery used for both of these terminals. An additional terminal is provided here in case readers care to experiment in various anode voltages on the detector valve, but in most cases it will be found satisfactory to use the same value on all three valves. Join up your accumulator, and your loud speaker, being careful to see that the positive loud-speaker lead is connected to the positive loud-speaker terminal of the set, and switch on with the right-hand switch.

Tuning In

Tune on the left-hand condenser (looking at the set from the front), and you will soon pick up your nearest station. The reaction control should be used very carefully, and pains should be taken to prevent oscillation and consequent irritation to your neighbours by abuse of reaction. Turn the reaction condenser very slowly and very carefully and stop turning it before you have reached the oscillation point. A few experiments before or after broadcasting hours with this set will show you how to use the reaction control without

(Continued on page 483.)

NO MORE JACK TROUBLES

NOW you can eliminate the old, messy soldering troubles when fixing Jacks and Switches. The famous Lotus Jacks and Switches are being made with terminals instead of soldering tags. The terminal makes as good a permanent connection as the most expert soldering job.

Lotus Jacks and Switches are made of finest bakelite, with nickel silver springs and pure silver contacts. To establish reliable connections in any set you make, choose Lotus Jacks and Switches. They occupy the minimum space—only 1¼ in. behind the panel.

The Lotus Coil Holder holds the heaviest coil in position. The moving block cannot fall. Prevents fading away of volume. Vernier movement reduces speed of moving coil block by eight times. For left or right hand.

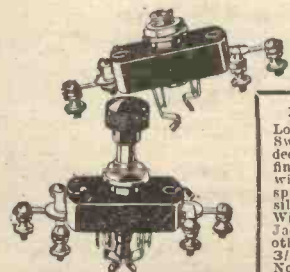

PRICES:
Lotus Jack and Switch. Only 1½" deep. Made of finest bakelite, with nickel silver springs and pure silver contacts. With terminals. Jack No. 3, 2/6; others from 2/- to 3/-. Jack Switch No. 9, 4/-; others from 2/9.
Lotus Jack Plug. Spring sleeve fitting supplied. Can be used with any Jack. Bakelite mouldings, nickel plated brass parts. Price 2/-.

LOTUS JACKS-SWITCHES-PLUGS

Made by the Makers of the famous Lotus Remote Control and Lotus Buoyancy Valve Holder.

GARNETT, WHITELEY & CO., Ltd.,
Broadgreen Road - LIVERPOOL.





A CHEAP, RELIABLE H.T. SUPPLY that RECHARGES ITSELF OVERNIGHT.

The time has come when you can rid yourself of the worry of run-down H.T. Batteries. Permanent, unfailing H.T. Supply can be yours by installing the wonderful Standard self-generating Leclanche battery which recharges itself during the night, providing an H.T. Current that is always up to voltage.

See daily demonstrations, showing the Standard Battery in use with the Melody Maker, Master Three, and the latest Frame Aerial Set.

Get this Free Book



Take the first step by sending for FREE Booklet describing every detail for installing and maintaining this super-efficient and money-saving battery

Deferred Terms

No deposit.

ORDERS OF 10/- OR OVER CARRIAGE PAID.

For 2-VALVE SETS. A.6. 90 volts.	3-5-VALVE SETS. D.6. 108 volts.	SUPER SETS. F.6. 126 volts.
25/1	37/3	69/6

Single units of 1½ volts from 4½d.

(Dept. G), WET H.T. BATTERY CO.,
12, Brownlow Street, London, W.C.1.

STOCKED BY HALFORD'S CYCLE STORES.

STANDARD



The Vital Power in Radio!

M.B. 42

A Quality Cabinet for your Set.

Full illustrated particulars from the Actual Manufacturers, V. C. Bond & Sons, 61, Hackney Grove, Mare St., London, E.8. Phone: Clissold 0883

To All Advertisers

PLEASE note that communications concerning advertising in WIRELESS CONSTRUCTOR MODERN WIRELESS POPULAR WIRELESS

must be made to

JOHN H. LILE, LTD.,
4, Ludgate Circus, London, E.C.4
(Phone: City 7261)

and NOT to the Editorial or Publishing Offices.

F5

—continued from page 482

causing trouble. Do not make experiments of this nature while broadcasting is on, and providing you can get good signals without using the reaction control, leave it alone.

The method of adjusting the set for the alternative-programme feature has been explained in the beginning of this article and should be read carefully. This scheme should not be confused with that used on sets which have push-pull switches to change from the local to the Daventry range, for in these the set must be retuned after the switch has been pushed. In the scheme used in "F5" the set can be adjusted once and for all to be properly tuned to both stations, and thus a push of the switch changes the programme without further ado.

A dozen Continental stations can easily be heard on the speaker after nightfall if the set is carefully used, while the change to the Daventry 5 X X range is simply made by changing one coil.

WITHIN THE VACUUM

—continued from page 440

If we find the thing works well, even though the bias is in excess of that "recommended," well and good, —we are lucky. We save in H.T., we increase the life of the valve filament, and we save cost.

We certainly increase the impedance of the valve, a point which should mitigate against quality in some cases, but if we take quality as our essential point, it matters not how high the bias, how low the H.T. current, for we have our results—the goal we have set ourselves—and if we attain that goal by cheaper methods than we expected so much the better.

For we must not forget that while an ordinary H.T. battery will handle 5 milliamps quite well, a larger one will deal with, say, 10, and a super-capacity with 20-25; when we take these values regularly we do not give the battery any safety limit and are operating it "all out," as it were, all the time. And current values in excess of those stated soon play havoc with the H.T. battery.

So our motto should be twofold: "Best quality and highest grid bias,"

(Continued on page 484.)

KEYSTONE GUARANTEED RADIO PARTS

The high quality of materials and workmanship put into KEYSTONE parts is reflected in their performance. To get the best out of your Receiver—you must put KEYSTONE parts into it.

KEYSTONE "MIDGET" CONDENSER

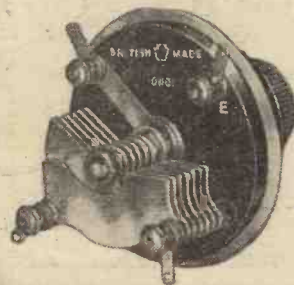

Ideal for the many positions where a small capacity condenser is required. An aluminium shield prevents hand-capacity effects, and a special taper bearing gives a beautifully smooth movement. Accurately designed and rigidly constructed, this Keystone condenser is backed by the usual Keystone guarantee of efficiency. Capacity 5/6 0001 mfd. Price

KEYSTONE NEUTRALISING CONDENSER

Used in all the popular circuits this season. These condensers have been designed by experts, and they are suitable for neutralising the electrode capacities for all types of valves. Very low minimum capacity. The wide spacing of the vanes renders accidental "shorting" impossible. Very well made from best quality material and beautifully finished.



Board mounting

5/-

Panel mounting

6/3

"RED TRIANGLE" EBONITE

The constructors of the Cosmor "Melody Maker" specified Red Triangle Ebonite because they knew the dangers of using a panel that was not guaranteed. Every Red Triangle Panel is cut dead square and is highly polished on one side—matt the other. Any size available. Sent by return —24 hours, cut panel service.

Black, ½ in. thick, 1d. sq. inch.

Mahogany Grained, ½ in. thick, 1d. sq. inch.

We drill all plates free

PETO-SCOTT CO., LTD.,

77, CITY ROAD, E.C.1, and
62, HIGH HOLBORN, W.C.1

Also at 4, MANCHESTER ST., LIVERPOOL

THE FINISHING TOUCH

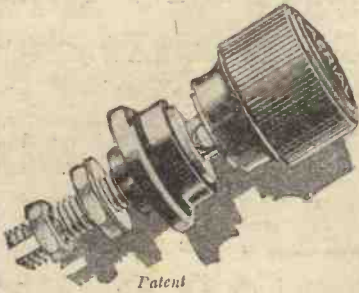

Patent

Belling-Lee Terminals are the finishing touch to any Receiver. They are a combination of Beautiful Finish and First Class Workmanship.

Belling-Lee Terminals are Bakelite insulated and made with 30 different engravings.

PRICES.

Type "B" illustrated, sold in an attractive carton carrying a year's guarantee. Price 9d. each

Type "M" as type "B" but non-insulated. Price 6d. each.

Illustrated catalogue free on request.

BELLING-LEE TERMINALS

BELLING & LEE, Ltd., Queensway Works, Ponders End, Middlesex.

WITHIN THE VACUUM

—continued from page 483

if we want to do things economically. And also, don't forget that when changing the grid bias with the set running we keep on putting that H.T. current to 40 milliamps or so every time the G.B. plug is taken out—a very bad thing for the H.T. battery. So switch off the set every time the grid bias is to be altered; don't take out the H.T. plug, this will give surges in the set that may do damage; the filament is the section that should be turned off, if you do not want to strain any part of the set.

So, in conclusion, let me reiterate my points: (1) The super-power valve is for carrying loud signals without distortion, not for amplifying weak ones till they become loud; (2) Get good purity of reproduction foremost and then keep the grid bias as high as possible consistent with that purity; (3) Turn off the valve before readjusting grid bias (or H.T. for that matter); (4) Use an H.T. battery capable of standing a little more than you will require from it, and you will run your set successfully and, above all, economically.

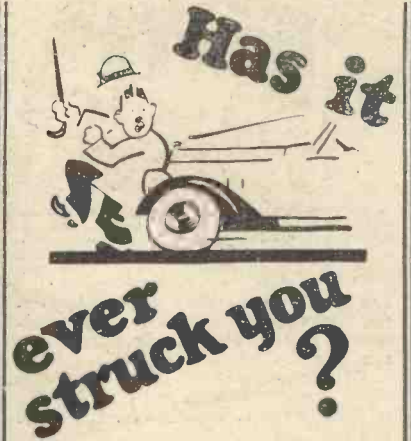

—that unless your panel affords perfect insulation, unless its dielectric constant is low, in short, unless it is perfectly efficient, you cannot get the best out of your Set. That is why you should insist on a panel which in every respect is absolutely trustworthy. There is only one—



Resiston Panels come in 13 stock sizes in black and Mahogany-grained. From 6 in. x 9 in. in black, 3.5, to 8 in. x 30 in. Mahogany-grained, 19/-.

"24 HOURS CUT PANEL SERVICE"

Advt. American Hard Rubber Co. Ltd. Fore St., E.C.

(CA) 1819

INDISPENSIBLE
for 100%
Valve Efficiency

Only Amperite supplies automatically the self-adjusting filament current your valves require. Eliminates hand rheostats. Simplifies wiring. Insist on Amperite. Accept nothing else. Price 5/-, complete with mounting. Sold everywhere. Write for Free construction data.

ROTHERMEL RADII CORP.
OF G.T. BRITAIN LD.,
24-26 Maddox Street,
London, W.1

AMPERITE
REG. U.K. PAT. OFF.

The "SELF-ADJUSTING" Rheostat

* LETTERS FROM *
* READERS *
* A "Modern Monstrosity" in 1635. *
* The "Sentry" Wave-meter. *

SIR,—In the February issue of the WIRELESS CONSTRUCTOR you report on the Rothermel-Crosley "Band-box," and condemn the maker's use of the word "acuminators" as a modern monstrosity.

Perhaps it would interest you to know that in the form "acuminated," and meaning "sharp-pointed," it was used by "Sir Thomas Browne" between the years 1635 and 1680, according to a recent glossary for his works.

I'm afraid that's one for the Americans! Yours, etc.,
North Wales. R. W. KENYON.

SIR,—Many thanks to Mr. R. W. Hallows for his fine little wave-meter described in December's issue of the WIRELESS CONSTRUCTOR. Its accuracy astounded me. Although rigged up very roughly, it is accurate to within a metre or so. I advise all short-wave chaps to build it, its cost being practically nil.

Yours faithfully,
New Barnet. B. R. S. (92).

MOVING-COIL SPEAKERS

High-class parts to assemble permanent-magnet or excited-field type Speakers. Suitable amplifiers and rectifiers, transformers. D.C. to D.C.—D.C. to A.C. A.C. to D.C. generators, petrol motor generators, fractional h.p. motors fitted with reduction gears for television experiments, electric gramophone motors as supplied to the French Brunswick Co., for Panatropes, etc.

THE CROMWELL ENGINEERING CO.
81, Oxford Avenue, MERTON PARK, S.W.20.
Phone, Wimbledon 2012. Radio G.5 PU.

The accepted Rolls Royce of Radio is that great success
DIX-ONEMETER



It is a Precision Instrument of universal use, with an ingenious system of multipliers which enable full-scale readings of any value to be made over a wide range. One millivolt to 2,000 v., or 50 ohms to 50 megohms. Mirror double scale, jewelled, knife edge. A £10 De Luxe model for 55/-. Multipliers 6/6 each. New A.C. Model now ready. ANODE METERS, panel type for showing H.T. output to Receivers, 7/-. FIVE GUINEA CABINET LOUD-SPEAKERS for 25/-. The famous Violina can be heard all day at Electradix.

VIOLA REED CONE UNITS, 15/6. WESTERN ELECTRIC balance arm, 10/-. BROWN'S "A" 13/6. Pick-up Parts, Magnet and Bobbins, 1/2; ditto in case, 1/6. Special Sk. Adjustable Unit, 8/-. Marvels of the Microphone 6d. Our new 72-PAGE CATALOGUE is now ready. Over a thousand bargains are listed and hundreds illustrated. Send 4d. in stamps to

ELECTRADIX RADIOS,
218, UPPER THAMES STREET, LONDON, E.C.4.
Telephone: City 0191

EVERYTHING RADIO ON EASY TERMS

WOOLDRIDGE RADIO CO. LIMITED,
6 & 2 LISLE STREET,
LEICESTER SQ., LONDON, W.C.



HURRAH!

If you want to lengthen the life of your battery, If you want to build an eliminator, If you want the best value, use

1 mfd. 2/6
2 mfd. 3/6
4 mfd. 5/3

Tested on 500 volts D.C. (working voltage 240 d.c.).

A BETTER CONDENSER

HYDRA

ALL CAPACITIES MADE Obtainable at all good dealers or direct from:—
LOUIS HOLZMAN
34, KINGSWAY, LONDON, W.C.2
Telephone: Holborn 6209

WHEN replying to advertisements please mention "Wireless Constructor," to ensure prompt attention. **THANKS!**

For YOUR Wireless!
The RADIOLA BUREAU

Fully described in "POPULAR WIRELESS," page 416, Oct. 22nd, 1927:— is a magnificent production dignified and graceful style . . . appeals strongly to us . . . worthy of the term "de-luxe" . . . a good return for one's money."

PROTECTS your Set from DUST or INTERFERENCE ensuring **BETTER REPRODUCTION.**



3 ft. high, Solid Oak, or Mahogany, beautifully finished. In many sizes.

From **£5 5 0 to £15**

Sent on Approval Direct from Factory.

No need to rebuild. In sizes for every set and heaviest batteries. Full Lists FREE.

PICKETT'S CABINETS

Albion Rd., BEXLEYHEATH, Kent.

* **IMPROVING THE APPEARANCE OF YOUR SET** *
* **By Charles H. Butcher** *

Methods for "Finishing" Small Brass Parts

MUCH may be done to improve the appearance of wireless apparatus by scratch-brushing, polishing, or nickel-plating exposed brasswork, and so removing the rough finish left by tools.

Lacquer should never be used, as there is always a tendency for the film to flake from the surface of the metal and give trouble by corroding some essential point where good electrical contact is desired, such as terminals and switch contacts.

"Scratch-Brushing"

For scratch-brushing brasswork a circular brush of hard brass wire, operated by a small lathe or polishing head, is required. In operation this brush is kept well moistened with some medium which will produce a foam—soap and water, vinegar and water, horse-chestnut extract, or a solution of cream of tartar (one ounce per gallon of water) being recommended for use.

This foaming medium is allowed to flow upon the brush in a slow stream, the bulk of the liquid being stored in a small tank placed upon a shelf above the polishing head. The upper surface of the brush should rotate towards the operator, and the brasswork is presented to the lower part of the brush so that the extreme points of the wire fall upon the surface of the metal. The speed of the brush should be regulated to suit the brass, which may vary in quality and composition.

Method of Cleaning

Brass parts to be scratch-brushed must be cleaned and freed from grease by immersion in a strong, boiling solution of common washing soda. They are then washed in water, dipped for two or three seconds into nitric acid diluted with an equal volume of water, and again washed and dried. The scratch-brush is then applied until the desired effects are obtained, and the finished work is well-rinsed in clean, cold water and allowed to dry in warm boxwood sawdust.

Treated in this manner the brass acquires a fine yellow tint with a characteristic sheen. Some good

(Continued on page 486.)

NOT EVEN THE BEST OF VALVES CAN GIVE THEIR BEST

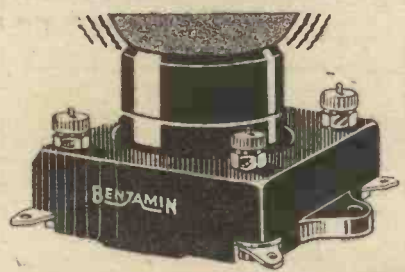

UNLESS THEY ARE FLOATED ON

BENJAMIN

ANTI-MICROPHONIC VALVEHOLDERS

Price 2/- each.
From all Radio Dealers.

Every wave of vibration quenched. The slightest shocks absorbed. Microphonic noises finally eliminated. Reception made clearer. The lives of Valves prolonged.

These 5 essentials are Benjamin features:—

- (1) One-piece Valve sockets and springs; no joints or rivets to work loose.
- (2) Valves free to float in every direction.
- (3) Valves can be inserted and removed easily and safely.
- (4) Valve legs cannot possibly foul the baseboard.
- (5) Terminals and soldering tags provided.

The Benjamin Electric Ltd.
Brantwood Works,
Tarrif Road, Tottenham, N.17.



"Hear that!"... a bellowing roar... then a screech. "What a row!"—the loud speaker fairly writhes in agony. "Something wrong to-night," you say, and switch off in disgust!

How often you have wondered why it is that the perfect reception you had last night should have developed into a harsh, distorted discord to-day! But, lift up the cover of the cabinet and consider how difficult it must be for all those sensitive units to work in perfect harmony unless you can control them with microscopic accuracy.

Sifam Radio Meters solve all these difficulties for you. You can trace distortion, correctly regulate valves and be warned of falling H.T. and L.T. long before it has time to let you down. Get a Sifam Radio Meter to-day and ask your dealer to show you the complete range. Send a P.C. for FREE leaflet, "Detecting Distortion," to Dept. C., The Sifam Electrical Instrument Co., Ltd., 10a, Page St., Westminster, S.W.1



RADIO METERS

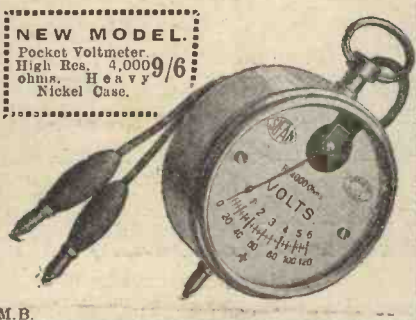

NEW MODEL.
Pocket Voltmeter.
High Res. 4,0009/6
ohms. Heavy
Nickel Case.

EVERYTHING WIRELESS ON EASY PAYMENT TERMS

Send list of requirements, and best monthly terms will be quoted by return.

TELEVISION

Make your own Television. All parts supplied on cash or Easy Payment Terms. Send for detailed list of parts required.

The P.D.P. Co., Ltd.
Dept. C.) 41, Great Tower Street, London, E.C.3.

WET H.T. BATTERIES

Solve all H.T. troubles.
SELF-CHARGING, SILENT, ECONOMICAL.
JARS (waxed) 2 1/2" x 1 1/4" sq., 13 doz.
Zincs New type, 1 1/4 doz. SAGS 1 2 doz.
Sample doz. (18 volts), complete with bands and electrolyte, 4/3, post 9d.
Sample unit, 6d. 16-page booklet free. Bargain list free.
AMPLIFIERS 1-Valve 19s 2-Valve 30s.
2-Valve All-Stat'on Set 24.
C. TAYLOR, 57, Studley Rd., Stockwell, London

IMPROVING THE APPEARANCE OF YOUR SET
—continued from page 485

effects are to be obtained by the use of a satin finish in conjunction with the scratch-brush. For this purpose the brass is first scrubbed in soapy water to remove dirt, and then immersed for five to ten seconds in a mixture of equal parts of hydrochloric acid, nitric acid, and common salt, from which it is immediately transferred to sour beer and brushed, using a brush of very fine brass wire. The finished work is rinsed and dried as before.

Polishing

To obtain a good polished surface, the metal is first "sanded" with Trent sand, or glassmakers' sand, which has had the greater part of the cut taken out of it. This operation, which removes surface imperfections and renders the brass even in colour, is carried out with the aid of a "bob," or wooden disc covered with leather, which is fitted to the spindle of the polishing head. The brass-work is pressed against the lower part of this revolving bob, on to which a slow stream of sand is allowed to fall from the hand of the operator.

When properly sanded, the work is submitted to the true polishing operation or "liming," for which Sheffield lime is used as the polishing agent. This lime soon loses its power if exposed to the air for any length of time, and should therefore be kept in airtight tins. It is used in the unslaked state, merely finely powdered and freed from irregular particles by sifting through muslin.

A leather "buff" is employed in the actual polishing operation, and the lime should be used with a smear of lard oil until all the marks made in the sanding operation are removed. The surface of the metal is then "glossed up" with dry lime on a calico "mop." Milled surfaces may be polished by the use of a thick paste of whiting and water, which is spread over the metal and brushed off with a circular brush, composed of soft hair, running at a high speed.

Nickel-Plating

The highest possible polish should be given to the metal before plating, as traces of existing tool marks cannot be obliterated once the nickel has been deposited. All traces of grease

(Continued on page 487.)

Used the world over



Columbia
No. 4780, 60 volts type: 22/6.

This statement is literally true, and the reason is that Columbia High Capacity Batteries are the cheapest and most efficient in the world. They save you money! The 60 volts type weighs 13 lbs., as compared with 5 lbs. in other batteries of the same voltage. This means that you are getting more than three batteries for the cost of two. Ask your dealer for Columbia—the battery that lasts.

Price of 60 volts type: 22/6.

Don't hesitate to write to us if you are unable to obtain Columbia Batteries from your dealer.

Columbia High Capacity Batteries are manufactured by the National Carbon Co., the world's largest battery manufacturers and are sold under the full guarantee of this Company.

J. R. MORRIS

15, Kingsway, London, W.C.2.
Scotland: J.T. Cartwright, 3, Cadogan St., Glasgow

TELEVISION!

YOU will naturally want to keep *au fait* with all the latest developments in Television. You will want the **FACTS**—not the **Fancies**: and you will want to know what authoritative scientists like Sir Oliver Lodge and Dr. Roberts have to say about the Television problem.

You will find the best and most authentic news about Television in the leading weekly **Wireless paper**

"POPULAR WIRELESS"

Keep an eye on "P.W." every week and you will learn the facts about Television.

Would



you believe it?

—but there are many people who try to track down a fault in every component without realising that trouble may be due to an inefficient panel. A panel which is in every way trustworthy is the foundation of trouble-free reception. That is why you should insist on—



Resiston Panels come in 13 stock sizes in black and Mahogany-grained. From 6 in. x 9 in. in black, 3/5, to 8 in. x 30 in. Mahogany-grained, 19/-.
"24 HOURS CUT PANEL SERVICE"

Adot. American Hard Rubber Co. Ltd. Fore St., E.C. (A) 1819

WATES
UNIVERSAL TEST METER

Milliammeter, 0-36 Milliamps. Voltmeter, 0-6 and 0-120 Volts. Think of the advantage of this instrument. You can test your receiver for distortion. Find H.T. consumption. Test voltage of H.T. and L.T. Batteries. Accurate. Dependable. High Resistance. WET H.T. BATTERY CO., 12-13, Brownlow St., High Holborn, LONDON, W.C.1.

8/6
POST 3d
OR C.O.D.

The WHITELINE VALVE HOLDER

Mechanically and Electrically Perfect.

Bowyer-Lowe



TELEPHONE: 2131

REPAIRS

Any make of L.F. Transformer, Loudspeaker or Headphones repaired and despatched within 48 HOURS—TWELVE MONTHS' GUARANTEE with each repair. 4/- Post free.

Terms to Trade.
TRANSFORMER REPAIR CO.,
Dept. "C,"
214, High Street, Colliers Wood, London, S.W.19.

PLEASE be sure to mention
"Wireless Constructor"
when communicating with
Advertisers. THANKS!

IMPROVING THE APPEARANCE OF YOUR SET

—continued from page 486

and tarnish must also be removed, otherwise a good adherent film will not be obtained.

The preliminary preparation of the metal for the electro-plating bath commences with the removal of any loose scale with the aid of a soft bristle brush. The work is then placed in the electro-chemical cleaner for the removal of grease and oil, and then rinsed in water, dipped in dilute acid to destroy traces of alkali from the "cleaner," once more rinsed in water and immediately transferred to the nickel electro-plating bath.

The Alkali Bath

From the moment the brass leaves the cleaner it should not be touched with the fingers unnecessarily until the finished deposit is ready for polishing. It is also necessary to add that the work should never be placed in the electro-plating bath until the current is "on."

The electro-chemical cleaning process is preferable to any other method of treatment for the removal of grease and oil, and is less liable to attack solder (if present). In this process the work, which forms the cathode, is suspended in a bath containing an alkaline carbonate in solution, carbon rods being used as anodes.

The most suitable proportions for the bath are 8 oz. of soda ash and 2 oz. of caustic soda per gallon of water; the temperature should be 90°-100° F., and the E.M.F. from 3 to 6 volts. The process itself is partly chemical (due to the formation of free alkali at the cathode) and partly mechanical (due to the production of a vigorous evolution of hydrogen at the cathode, which tears the oil and grease from the surface of the metal, and, at the same time, removes any thin films of oxide).

Quickly Done

The actual time occupied by the process varies from one to ten minutes, according to amount of cleaning to be done. A double-throw switch should be connected in the circuit, so that the brass under treatment may be changed over from cathode to anode, for ten to fifteen seconds, at the completion of the cleaning process, in order to remove traces of zinc or tin derived from any solder which is present and re-deposited upon the polished surface of the brass.

(Continued on page 488.)

Economise in floor space

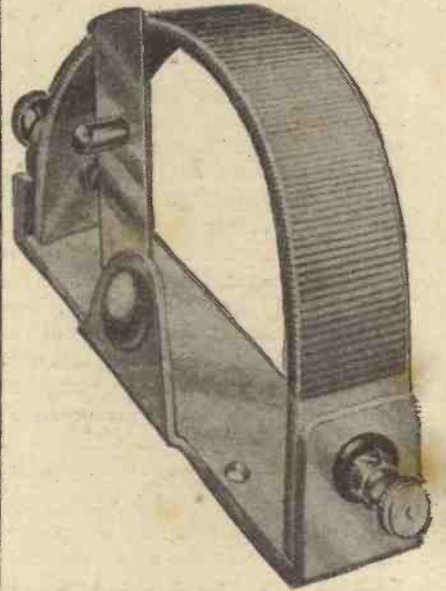

The "PEERLESS" VARISTOR stands up on the baseboard, taking only a fraction of the usual space. It can be fitted on an already crowded panel. The adjustable phosphor-bronze arm is easily accessible. The windings are of best-quality resistance wire, wound tightly on insulating fibre. Terminals are fitted in the most convenient position. You can buy 5 types—3, 6, 10, 15 and 20 ohms. The "Peerless" Varistor is fine for the Cossor "Melody Maker."

From all good dealers or direct:—

PEERLESS VARISTOR

BEDFORD ELECTRICAL & RADIO CO., LTD.
22, Campbell Road, Bedford.
LONDON: 21, Bartlett's Bldg., Holborn Circus, E.C.4
GLASGOW: 113, St. Vincent St., C.2

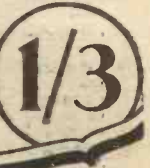

HINTS AND TIPS ON
THE USE OF A PICK-UP
 By A. JOHNSON-RANDALL

A GRAMOPHONE pick-up should be handled with the same care as one employs in the case of the sound-box. See that it fits the tone arm snugly, and arrange it at an angle of about sixty degrees to the horizontal surface of the record. Try various angles until you get the best results.

When you use a pick-up for the first time you may be a little worried over the little "dithers" you hear from the device as it is travelling around the grooves in the record. If you have purchased a pick-up of good make do not be alarmed at these irritating sounds, because if you have arranged the leads from the pick-up in such a manner that the lid of the gramophone can be closed, the only sounds that you will hear will be those from the loud speaker itself. These little buzzes and dithers will not be reproduced via the loud speaker.

It is a good plan to keep the gramophone at a distance of several feet from the loud speaker, and in addition to closing the lid it is always advisable to shut down the sound baffles on the front of the gramophone cabinet.

Use various needles in the pick-up, just as you would if you were employing the usual sound-box, and if a particular record sounds a little harsh with, say, a "loud" needle, try a "half-tone" instead.

Always try to keep dust out of the pick-up, because this may settle between the vibrating armature and

the magnet poles and produce effects which may be put down to distortion in the amplifier or to scratches on the record itself.

If your amplifier distorts or blasts on local broadcasting it is highly probable that it will do so when you attempt to use it in conjunction with a gramophone. Therefore, you must pay attention to such points as correct H.T. voltages and proper grid bias, etc., if you wish to get maximum efficiency. Perhaps your set utilises one of those cheap, nameless transformers which cut out all the bass when used on broadcasting. If so, your gramophone reproduction will be just as disappointing, because although the richness and depth of tone is on the record, your amplifier will not be able to reproduce it, and, consequently, the resulting music will sound high-pitched and tinny. Therefore, do not blame the pick-up or the record, but set about improving your amplifier until you feel sure that it is able to do justice to the high musical standard of the gramophone recording-room.

"RADIOTORIAL"

The history of a word that means much. "Radiatorial" is rather an unusual word—but since it was coined nearly five years ago, by a "P.W." staff man, it has come to represent the best radio advice the amateur can get. Every week in *Popular Wireless* you will find a selection of radio questions and answers—not a few "faked" items—but very seldom less than four or five columns of bona fide radio problems, with comprehensive and "to-the-point" answers. By reading "Radiatorial" you cannot fail to get an all-round grasp of radio. Why not start this week? "Radiatorial" alone is worth the threepence charged every Thursday for a copy of

"POPULAR WIRELESS"

The Paper That Never Lets You Down.

IMPROVING THE APPEARANCE OF YOUR SET

—continued from page 487

For the electro-plating bath, pure nickel sulphate should be used in preference to nickel ammonium sulphate, as it gives a deposit which is much easier to finish and is less likely to become "pitted" or liable to strip.

This bath is prepared by dissolving 3 lb. of pure nickel sulphate, 1 oz. of common salt, and 1 oz. of boracic acid in 1 gallon of water. The boracic acid is added to reduce the evolution of hydrogen and to improve the physical character and adhesion of the deposited metal. As the freshly prepared solution does not give the best results, it is advisable to run the bath for a few hours before starting on the work in hand.

Finishing Off

A current density up to 8 amps. per square foot of surface will give the best results, the E.M.F. being 2 to 3 volts and the temperature of the bath about 60° F. Plates of cast nickel of the very best quality should be used as anodes.

The nickel deposits obtained are hard and permanent, but possess little or no metallic lustre. They must therefore be "finished" by buffing them with Sheffield lime and a trace of lard, mopping the polished surface with dry lime to bring up the final lustre. Tripoli compo, which is an abrasive, should never be used except for very hard and rough deposits.

It should also be borne in mind that the success of the nickel-plating process largely depends upon the preliminary preparation of the brass, and that once deposition has started the work must not be exposed to the air any oftener or any longer than is absolutely necessary.

INDEX TO ADVERTISERS

	PAGE
American Hard Rubber Co., Ltd.	484, 487
Amperite Bheostat	484
Artercraft Company, The	475
Bedford Electrical & Radio Co., Ltd.	487
Belling & Lee, Ltd.	484
Benjamin Electric, Ltd.	485
Bird, Sydney S., & Sons, Ltd.	471
Bowyer-Lowe Co., Ltd.	463, 487
Brown, S. G., Ltd.	460
Burne-Jones & Co., Ltd.	474
Bond, V. C., & Sons	483
Carrington Mfg. Co., Ltd.	475
Caxton Wood Turnery Co.	471
Celestion Radio Co., The	480
Cossor, A. C., Ltd.	414
Cromwell Engineering Co.	484
Climax Radio Electric, Ltd.	473
Colvern, Ltd.	477
Dubilier Condenser Co. (1925), Ltd.	454
Eastick, J. J., & Sons	460

	PAGE
Electradix Radios	484
Edison Swan Electric Co., Ltd.	460
Formo Co., The	476
Gambrell Bros., Ltd.	479
Graham Amplion, Ltd.	457
Garnett Whiteley & Co., Ltd.	482
Hamley Brothers, Ltd.	475
Holzman, Louis	485
Hughes, F. A., & Co., Ltd. (Trolite)	482
Hughes, F. A., & Co., Ltd. (Loud Speaker)	473
Igranic Electric Co., Ltd.	467
International Corr. Schools, Ltd.	475
Jackson Bros.	473
Lissen, Limited	451, 453
Loewe-Radio Co., Ltd.	471
London Elec. Wire Co. & Smiths, Ltd.	471
Magnavox Company, The	473
Makerimport Co.	460
Marconiphone Co., Ltd.	413
Metro-Vick Supplies, Ltd.	Cover lii
Morris, J. R.	486
Mullard Wireless Service Co., Ltd.	Cover li, 459
"Modern Wireless"	475
Partridge & Mee, Ltd.	479

	PAGE
Peto-Scott Co., Ltd.	488
P. D. P. Company	486
Pickett Brothers (Cabinet)	485
"Popular Wireless"	486
Press Exclusives	460
Raymond, K.	481
Radio Service (London), Ltd.	484
R. I. & Varley, Ltd.	Cover iv
Rothermel Corporation, Ltd.	478
Sifam Electrical Inst. Co., Ltd.	486
Stratton & Co.	476
Taylor, C.	486
"Television" Magazine	454
Telegraph Condenser Co., Ltd.	467
Transformer Repair Co.	487
Wet H.T. Battery Co.	483, 487
Weston Elect. Instrument Co., Ltd.	463
Woolldridge Radio Co., Ltd.	484
"Wonderful Britain"	477
"Wireless Constructor" Envelopes	479

All communications concerning advertising in "Wireless Constructor" must be made to John H. Lile, Ltd., 4, Ludgate Circus, London, E.C.4. Telephone: City 7261.

Does the Power Station keep your set going?



Does it supply you with music as well as light and other home comforts?

With the Met-Vick 5 Mains Set this is now possible. It is just plugged into a lamp socket or wall plug and switched on, like any other Electric Appliance, and all the little annoyances of accumulators that *will* run down, and H.T. batteries that cost so much and last such a short time, trouble you no more.

Inherently better than a battery operated set, the reproduction is so near perfection that to ask for more is hypercritical. Selectivity and range are outstanding features, and the controls, while quite simple to use, do respond to that little extra skill of the sympathetic operator which is so delightful.

With the Met-Vick 5, it is at last possible to obtain a wireless receiving set which will always give the satisfaction that only comes from really brilliant performance, and which will remain a constant source of pleasure, and interest to all who hear it.

Ask your dealer for a copy of Brochure 7117/9, or write to the makers.

Those who are content with the alternative programme of their Local and Daventry Stations, but who desire the advantage of Mains operation cannot do better than obtain the Met-Vick 3 Mains Set fully described in List 7117/10.

MET-VICK

SETS, VALVES & COMPONENTS

R
Z130

METRO-VICK SUPPLIES, 155, CHARING CROSS ROAD, LONDON, W.C.2.

MR. PERCY W. HARRIS GETS SUPER QUALITY WITH ANY SET

You can get just the same if you use the components this eminent wireless expert recommends. And what a list of R.I. and Varley products! First, there's the Straight Line Super Transformer, whose National Physical Laboratory Curve is your guarantee of real efficiency. (This transformer is so arranged that it can be used either as an ordinary transformer or as a push-pull input.) Then there's the Push-pull Output Transformer which has a greater area of iron core than any other on the market. Our Bi-duplex winding—now world-famous—is incorporated in the other two components specified. One of these is an Anode Resistance, and the other the Multi-cellular H.F. Choke. It is essential to use a really efficient H.F. Choke—the R.I. and Varley has a wave-length range greater than that of any other on the market—for no matter how good the L.F. Transformer or R.C. Coupler may be, distortion is bound to result if stray H.F. currents pass through the H.F. Choke.

It would hardly be possible to refer to SUPER QUALITY without mentioning our Bi-duplex wire-wound Resistance-Capacity Coupler, for this component has done more to bring real music into the homes of tens of thousands than any other on the market.

Lastly, there's our wonderful little General Purpose Transformer—costing only 15/-, which is literally sweeping the country to-day. It has been specified for the Mullard Master 3, and POPULAR WIRELESS refers to it as "An excellent transformer, which falls very little short of those in the one-pound class."



Push-Pull Output Transformer, 22/6



Straight Line Super Transformer, 25/-



Bi-duplex wire-wound Multi-cellular H.F. Choke, 9/6



Bi-duplex wire-wound Anode Resistance. Complete range of sizes up to 500,000 ohms. Prices complete with universal holder, 5/6 to 17/6.

SPECIALISTS IN
L.F. AMPLIFICATION



THE MARK OF

Kingsway House, 103, Kingsway,

BETTER RADIO

London, W.C.2. Telephone: Holborn 5303.