

The Wireless Constructor

6^D
MONTHLY

EDITED BY
PERCY W. HARRIS, M. I. R. E.
Vol. IV. AUGUST, 1927 No. 10

In this Issue

The **"NEW FAMILY FOUR"**

THE SET OF THE SEASON

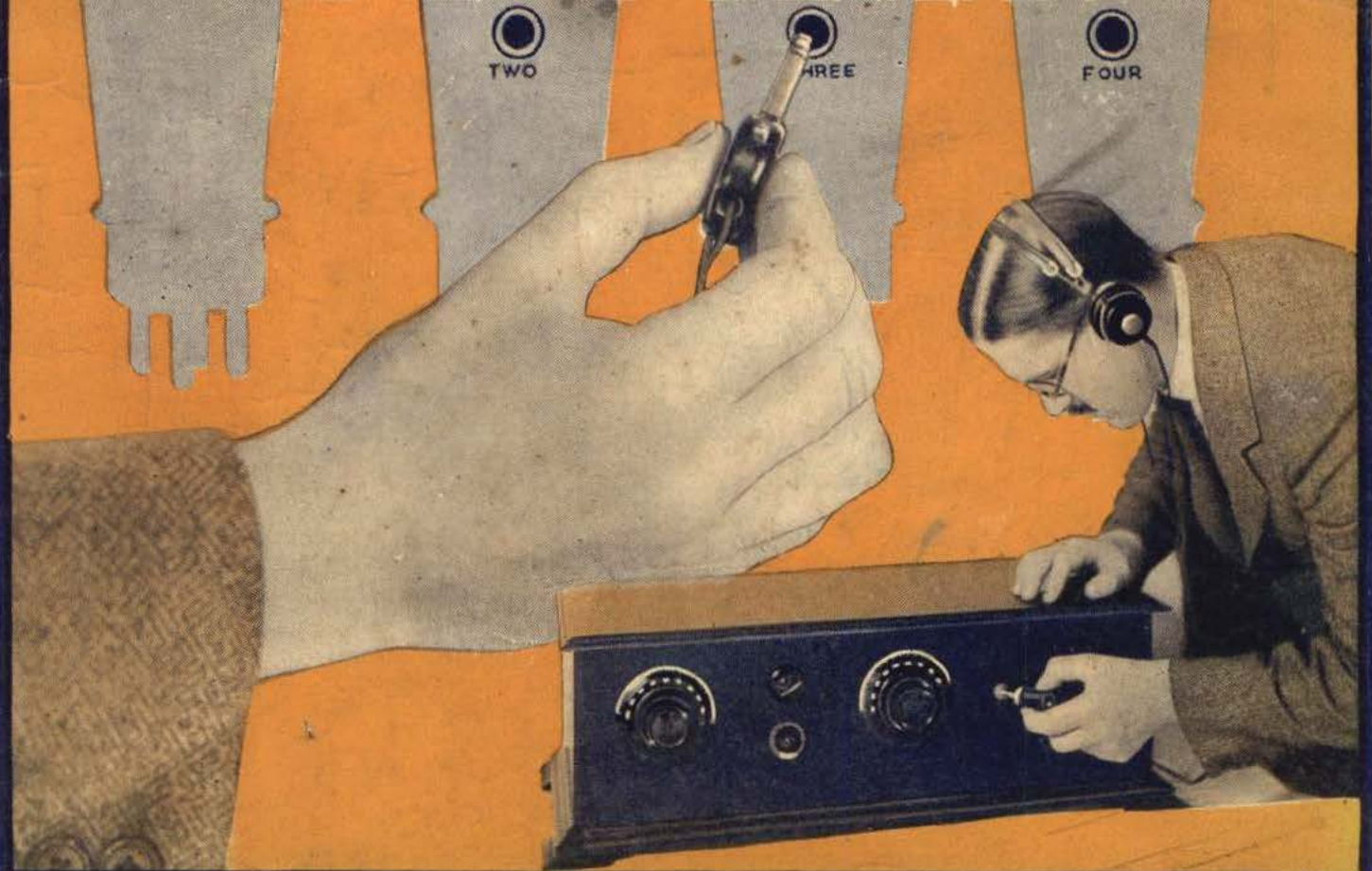

AM!

A Long Filament



with huge proportions to secure gigantic emission and the best operating characteristics

A Strong Filament

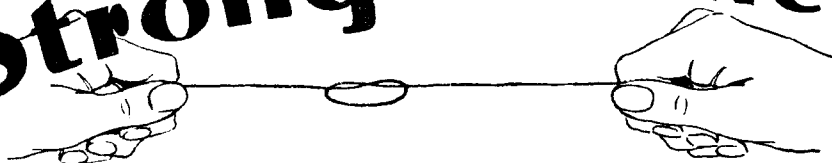

that cannot be broken except by the very roughest handling. Proved by National Physical Laboratory Test to be consistent, powerful and lasting



The Wonderful MULLARD P.M. FILAMENT

The Filament that gives you the most value for your money. Obtained only in Mullard P.M. Valves from all radio dealers.

Mullard

THE MASTER VALVE

CONTENTS

	Page		Page
The Editor's Chat	219	The Queerest Fault Ever	247
What Is a Radio-Frequency Choke ? ..	221	Electrify Your Gramophone	249
"Patience"	224	Something New With a Single Valve ..	251
A Flashlamp Valve-Saver	225	Novelties in Valve Design	255
The "New Family Four"	227	Notes and Jottings	258
Which Loud Speaker Is Best ?	234	Chats at the Work-Table	259
Happenings at Savoy Hill	235	What's New	264
Make Your Own Screened Coils	237	From Our Readers	268
Hints for Amateurs	240	Valves in the Making	271
Some Curious Rheostat Arrangements	241	Notes on the Milliammeter	274
In Lighter Vein	243	Tips for Constructors	276
Within the Vacuum	245	Our News Bulletin	278

EDITED BY
PERCY W. HARRIS, M.I.R.E.

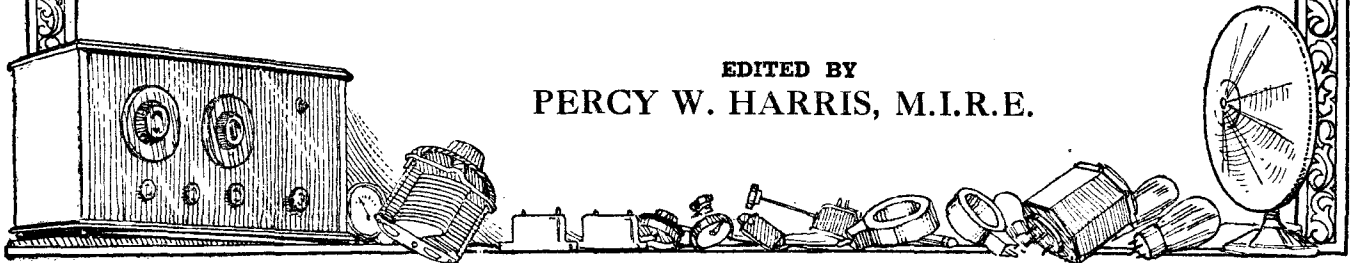

STERLING MANSBRIDGE TYPE CONDENSERS

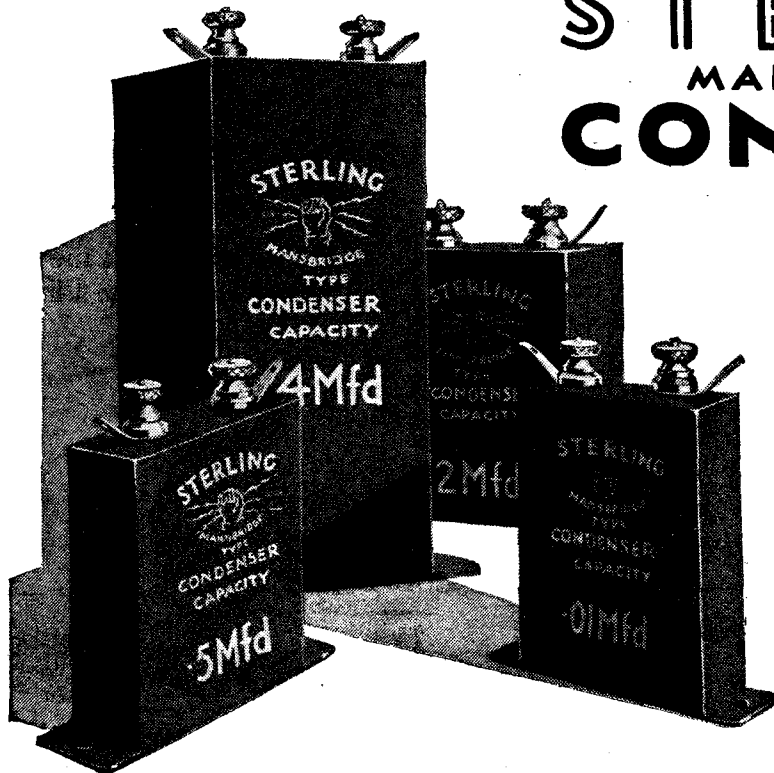

Every Sterling Mansbridge Type Condenser employs a special waxed foil-dielectric—is tested to 300 volts—possesses unique self-sealing properties whereby a puncture of the dielectric is automatically sealed—is completely enclosed in a strong steel case. Such are the features that ensure unflinching condenser efficiency for the Sterling equipped receiver.

Capacity.	Price.			Capacity.	Price.		
	£	s.	d.		£	s.	d.
0.1 mfd. ..	0	2	6	5 mfd. ..	0	3	4
0.5 mfd. ..	0	2	6	1 mfd. ..	0	3	10
1 mfd. ..	0	2	6	2 mfd. ..	0	4	8
2 mfd. ..	0	2	8	4 mfd. ..	0	10	0
25 mfd. ..	0	3	0	6 mfd. ..	0	14	0
3 mfd. ..	0	3	0	10 mfd. ..	1	0	0
4 mfd. ..	0	3	2				

Full particulars on request.

THE MARCONIPHONE COMPANY, LTD.

AND REDUCED

(Sole Agents for Sterling Telephone and Electric Co., Ltd.)
Head Office: 210-212 Tottenham Court Rd., London, W.1
Registered Office: Marconi House, Strand, London, W.C.2



Cossor gives you the sweet high notes of the Violin



Cossor gives you the majesty of the 'Cello



Cossor gives you the rich harmony of the Piano



Cossor gives you the throbbing of the Drums

IT'S not what you pay but what you get that determines whether a valve is cheap or expensive. When you buy a Cossor you get a Valve with a Kalenised filament giving such long service that you begin to wonder whether you'll ever have to buy another valve as long as you live! And at the same time you obtain a quality of reproduction which is the envy of your friends. What more can you expect from any valve?

Cossor
—the melody maker

The WIRELESS CONSTRUCTOR

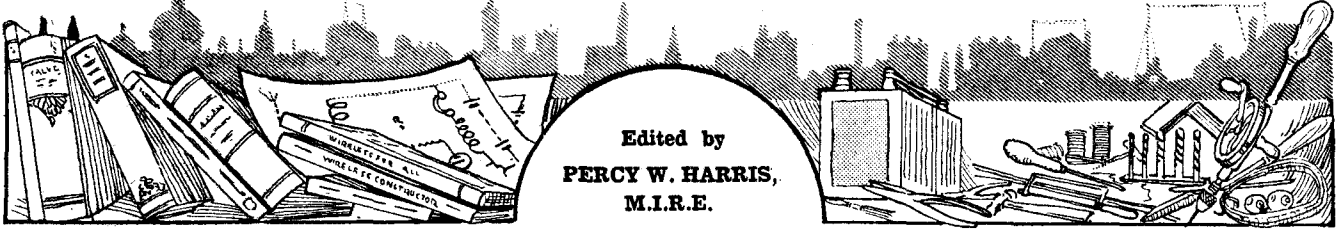

Published by the Amalgamated Press, Fleetway House, Farringdon Street, E.C.A.

THE EDITOR'S CHAT

In which Percy W. Harris, M.I.R.E., the Editor of the "Wireless Constructor," introduces the "New Family Four" and other interesting features which appear in this issue.

OUR new receiver, forming this month's cover design, and fully described in the next few pages, will, I hope, become as firm a friend of the listener as the older set it is designed to replace, the "Four-Valve Family." Its special features are many—you will find them outlined at the beginning of the article—and the results obtainable will come as a revelation to those who imagine that they are at present getting all that is to be obtained from that number of valves.

In particular, I would like to draw attention to the fact that provision is made for obtaining the full efficiency of 2-volt valves, as well as from those of the 4- and 6-volt varieties. It is a mistake to imagine, as many constructors do, that a set which is giving good results on, say 6-volt valves will necessarily give just as good results with 2-volt valves, even when care is taken to choose the correct type. In some sets, it is true, a change from one voltage value to another will not be accompanied by any appreciable change in results, but in receivers where high efficiency in high-frequency amplification is aimed at a difference is almost bound to be noticed, unless special precautions are taken.

Which Class of Valve?

Coming to more detail, it can be said, in general terms, that the coupling in a high-frequency transformer which gives good results with 2-volt valves is generally too tight for use with 4- or 6-volt valves,

and vice versa. By providing for different degrees of tightness for different types of valves the "New Family Four" can claim to be truly universal.

In speaking of filament voltages, it is advisable to clear up a few mis-

asked, and it often is, "Are 2-volt valves in all cases as good as 4- or 6-volt valves?" I can only answer "No!" The modern 2-volt valve is a wonderful production, and gives, as thousands of readers know, admirable results in a well-designed set,

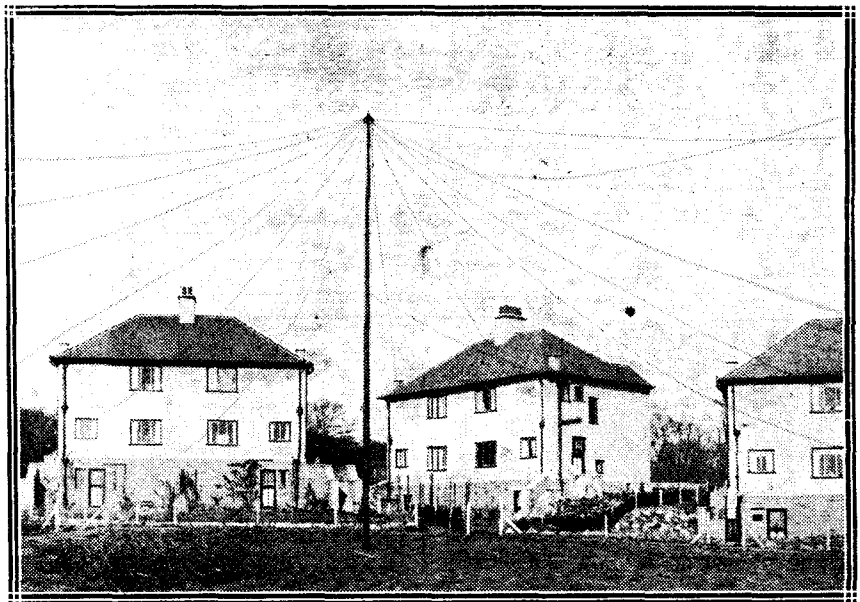

A novel "Maypole" aerial support erected at Bradford.

apprehensions which may exist. Possibly owing to the fact that the accumulator used with them is relatively inexpensive, 2-volt valves are in much greater general use than those with 4- or 6-volt filaments, the order of valve popularity being 2-, 6- and 4-volt respectively. Price, too, has something to do with it. But if the question is bluntly

but the fact remains that in certain cases the 4-volt valves are better than the 2-, and the 6-volt best of all. Whether you will notice the difference depends upon the type of set you are using and its efficiency. A single-valve detector set will show so little difference between a 2- and a 6-volt valve that the additional cost of the 6-volt variety is scarcely

The Editor's Chat—continued

worth while, particularly as the accumulator to run it is much more expensive. At the other end of the scale no 2-volt power valve has yet been brought to my notice which can give results comparable with those of a good 6-volt super-power valve with correct grid bias.

Constantly Improving

How long this state of affairs will last it is impossible to say, as valves are so constantly improving, and, in particular, great strides have taken place in the development of the 2-volt type during the last twelve months. At the present time the 2-volt valves are vastly superior to the "6-volters" of a year or two ago, and so long as they are not called upon to handle great volume without distortion, they suit all requirements of many readers. It is the 4-and 6-volt valves that show most superiority in the high frequency stages.

Home-made "Panotrope"

Do you realise what immense strides have been made in the development of gramophone music in the last year or so? Both records and machines have improved vastly. Much of this improvement is due, strangely enough, to the remarkable progress of wireless in the development of the modern microphone, for this has enabled the gramophone companies to adopt the process known as "electric recording." In this system the artistes, instead of being herded close to a large metal trumpet, as in the old days, are distributed throughout the studio, just as in a broadcasting station, the speech and music being picked up by microphones in a similar way. The sounds so picked up are magnified and applied to a delicate recording instrument which is now sufficiently

perfected to enable the tiniest shade of sound to be faithfully inscribed on the wax.

Similarly, wireless technique has helped in the development of the reproducing side of the gramophone business, and the latest machines of the big makers are wonderful examples of their kind. Comparatively few of us can purchase these expensive machines, but for a very small sum we can utilise any existing gramophone, and with an electrical pick-up device reproduce the record through our modern loud-speaker equipment. Just how this can be done is described in an article in the current issue.

Other Features

The results obtainable in this way are quite startling in their perfection, particularly on a really good modern loud speaker. It does not matter how cheap the gramophone so long as the turntable can be rotated steadily, for the electrical pick-up, together with the amplifier described, will entirely take care of the reproduction, the existing gramophone horn and soundbox being temporarily discarded.

Other features to which I would like to draw readers' attention are the description of how to wind your own coils for the popular six-pin bases, and the quite novel single-valve set described by Mr. L. H. Thomas.

Appreciations of the "Radiano" sets are still pouring in, and a selection from further letters is published in the current issue. Already I am receiving letters from the most distant dominions, expressing appreciation of the "Radiano Three," and the "Short Waver" is fast becoming a close second.

Readers' experiences with the receivers described in the WIRELESS CONSTRUCTOR are always welcome,

as are requests for any special type of set. In particular, I would like to thank the reader who wrote asking that a description should be given of a simple testing apparatus to ascertain whether one's valves are keeping "up to scratch." This is a very important requirement, particularly for the foreign and colonial reader, who has to send long distances for his valves. In response to this request I have designed such a tester, and full particulars of how to build it—it is by no means an expensive instrument—will appear in our next issue.

 * THE "ALL-BRITISH SIX" *
 * —A READER'S RESULTS *

SIR,—I have had experience with most of the multi-valve receivers recently published, and I feel that I must write and express my thanks to you for publishing the design of the above.

The receiver is made exactly to specification, and using 168 volts H.T. on the H.F. and L.F. stages and 60 volts on the detector from an Atlas D.C. eliminator, I get perfect stability all over the scale. To some people this may appear rather a high voltage, but as the valves are in the power class, I see no reason why this should not be used. The results are extraordinary, and I think it would be difficult to get better selectivity with any other type of receiver, and it is impossible to bring in any station at all if the signal strength is above static level.

I have to congratulate you on publishing the most efficient receiver, in my opinion, yet designed.

Yours faithfully,
 W. W. JARVIS.

27a, Hanover Street,
 Liverpool.

—“This concludes our afternoon concert” —

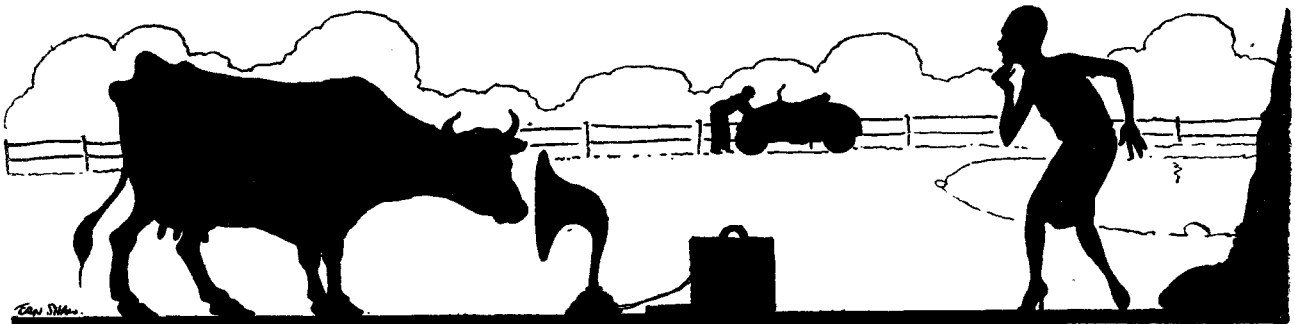

What is a Radio-Frequency Choke?

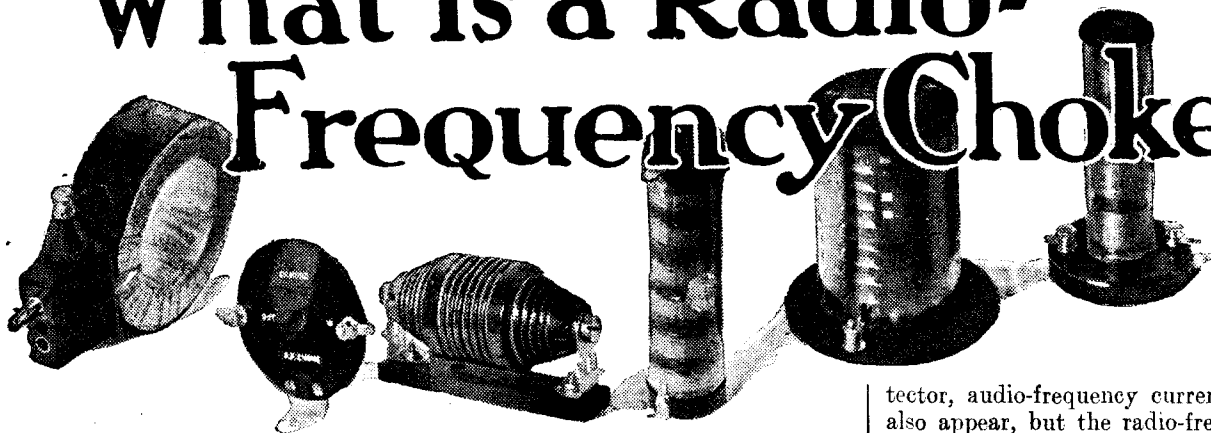

THE radio-frequency choke is a little device that is coming into much more general use than was the case a year or two ago. It can be either home-made, or commercially constructed, and in the latter class the experimenter now has a wide choice. As the functions, operation, and design of a radio-frequency choke seem to be insufficiently understood by the average home constructor, and as even some manufacturers do not seem quite clearly to realise the requirements, this article is devoted to a consideration of a few facts about, and tests of, this useful little component.

In Europe, the radio-frequency portions of our circuits have often to be designed to deal efficiently with frequencies as low as 150,000, or otherwise they cannot handle what is generally termed the "Daventry range." If here, as in America, the designer of broadcast receivers had only to deal with frequencies above 500,000 (below 600 metres) the design of receivers would be a much simpler problem, and many sets would have an appreciably greater overall efficiency.

Where Some Chokes Fail

Particularly in relation to radio-frequency chokes the necessity of catering for the Daventry range complicates matters considerably, and here the reader is warned that radio-frequency choke practice which is thoroughly satisfactory in America may be hopelessly incorrect in Europe. In the course of my laboratory tests I have handled most of the radio-frequency chokes now on the market, as well as several of the home-made variety, and on more than one occasion a choke which is perfectly satisfactory for the lower broadcast band—between 200 and 600 metres—has

An interesting account of some valuable experiments.

By PERCY W. HARRIS, M.I.R.E.

failed lamentably between 1,000 and 2,000 metres.

Although it seems rarely done, the testing of the efficiency of a radio-frequency choke in a general way can be easily carried out by every experimenter who has a few standard parts by him. A little later in this article practical details of a testing board will be given, but meanwhile let us see how a radio-frequency choke must be used, and the difficulties we come "up against."

In a simple tuned-grid circuit, coupled either directly or inductively to an aerial, radio-frequency currents are generated, and these, by applying differences of potential between the grid and filament of the first valve, appear in the plate circuit of that valve as radio-frequency currents of the same frequency, but of greater intensity. If this first valve is a de-

tor, audio-frequency currents will also appear, but the radio-frequency component is there in all ordinary receiving circuits. Indeed, we often pass them back and re-amplify them, thus obtaining reaction effects.

A Capacity By-pass

In magnetic-reaction circuits of the swinging-coil type, the reaction coil is generally placed in series with the telephones or the primary of a low-frequency transformer. Either of these devices contains a large number of turns of wire with an iron core in its field, and offers a very high impedance to the path of radio-frequency current. There is often, however, and particularly in the older types of low-frequency transformers, a certain distributed capacity in the windings giving approximately the same shunting effect as that of a small fixed condenser connected across the whole device. When, as is often the case, it is possible to obtain reaction in a single-valve circuit using the swinging-coil method, and without a separate shunting condenser, the radio-frequency component is invariably passing through the distributive capacity in the winding.

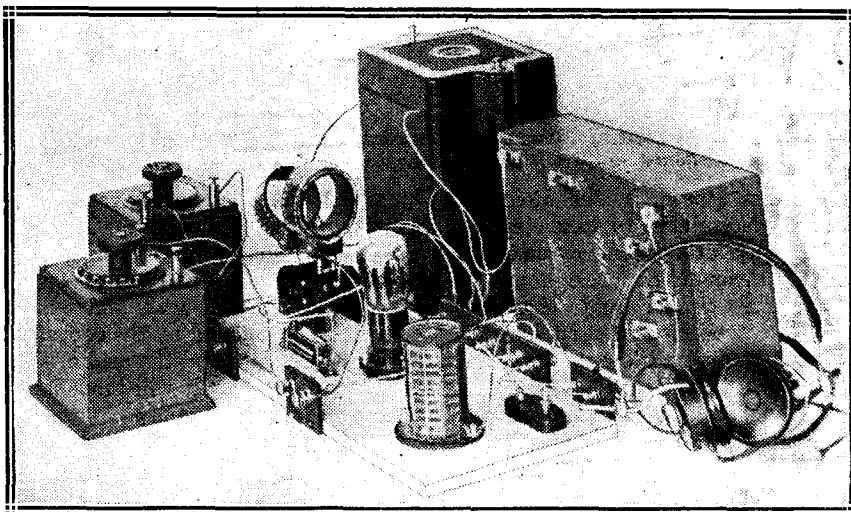

Testing a choke in a condenser-controlled reaction circuit.

What is a Radio-Frequency Choke?—continued

Many modern transformers are so constructed that the self-capacity in the winding is too low to allow the effective passage of radio-frequency current through them, and in any case, whether the distributed capacity is sufficient or not, it is generally more practical to shunt a condenser across our telephones or low-frequency transformer to act as a by-pass. When, however, as in the Reinartz circuit, we alter the value of a condenser in series with an inductance so as to vary the amplitude of the radio-frequency currents passing through that inductance, the condenser itself obviously prevents the passage of the direct current to the plate circuit. It is necessary, therefore, to feed the plate circuit with direct current from the H.T. battery by a parallel path, and if this path allows any radio-frequency current of appreciable magnitude to pass, the variable condenser designed for reaction control becomes useless, as the radio-frequency current will simply pass round the alternative path.

that any radio-frequency choke consists of an inductance shunted by a capacity (which latter, however, may be very small indeed), and is thus a circuit capable of resonance, provided the ohmic resistance is not too high. Obviously the ohmic resistance must be reasonably low, otherwise it would unduly restrict the passage of the direct current to the plate from the H.T. battery.

A Resonance Frequency

Now consider a simple circuit such as that shown in the diagram, in which we have a simple tuned-grid circuit connected to the grid and filament of a valve. A radio-frequency choke is placed in the plate circuit, this latter circuit being completed through the telephones shunted by a fixed condenser of, say, .001 mfd. and the H.T. battery to the filament.

Normally, such a circuit will not oscillate, but if, by any chance, the constants of the grid circuit, i.e., of its inductance and capacity, are so arranged that their resonance fre-

quency is the same as the resonance frequency of the circuit formed by the choke shunted by its self-capacity, we then have the ordinary tuned-grid-tuned-plate circuit, grid and plate circuits being coupled by the capacity between the plate and the grid of the valve. Such a circuit will burst into self-oscillation very easily.

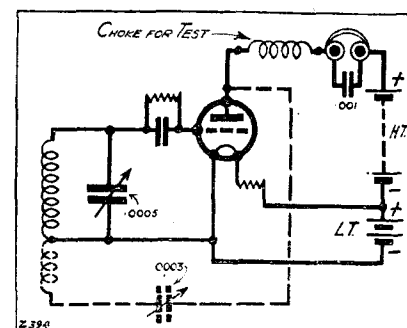

quency is the same as the resonance frequency of the circuit formed by the choke-shunt-capacity circuit the set will oscillate violently even when the reaction condenser is at minimum or entirely removed.

Two Examples

A choke was recently submitted to the WIRELESS CONSTRUCTOR laboratories for test and was found to have a resonance frequency round about 500 metres! This meant that when the choke was used in an ordinary Reinartz circuit it proved quite satisfactory from 200 up to about 400 metres, and after that reaction gradually became more erratic until the receiver "squawked" violently as the 500-metre mark was approached with zero on the reaction condenser. Up to 500 metres the amount of reaction condenser required to make the set oscillate became progressively less and less as the 500-metre mark was reached.

Another choke, also submitted for test, although quite satisfactory on the band from 200 to 600 metres, has a resonance peak which made it entirely unusable anywhere between the band from 1,000 to 2,000 metres. A further choke which had to be dealt with was so made that it had several peaks and would oscillate at several harmonics of its fundamental frequency.

Generally speaking, a choke which has a fundamental frequency of about 2,000 metres is perfectly satisfactory

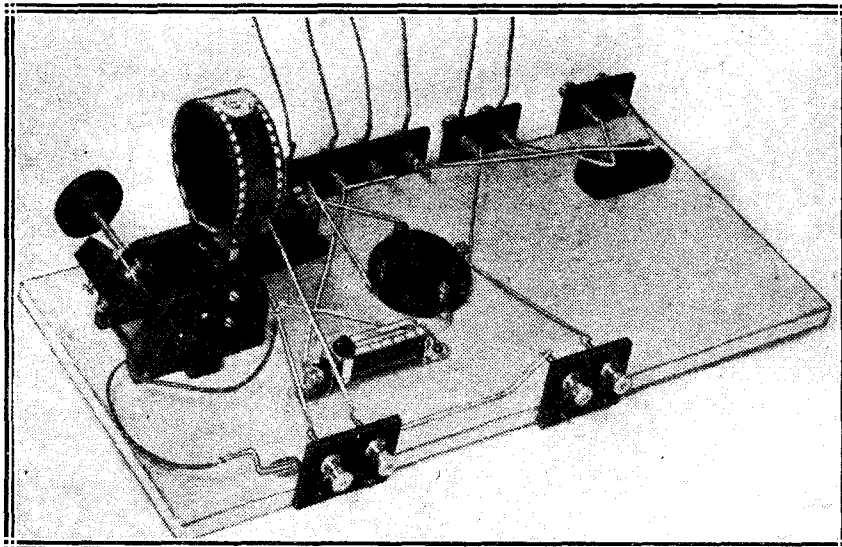

This simple board outfit will enable you to try experiments for yourself.

For this reason, in the Reinartz circuit it is essential to take steps to prevent any radio-frequency currents passing through the telephone or transformer circuit, and thus we introduce a coil of wire of sufficiently high inductance and low self-capacity to obstruct the passage. Unfortunately, it is impossible to design any coil to have no self-capacity, and every radio-frequency choke possesses this property in some measure. Bearing this in mind, it will be seen

quency is the same as the resonance frequency of the circuit formed by the choke shunted by its self-capacity, we then have the ordinary tuned-grid-tuned-plate circuit, grid and plate circuits being coupled by the capacity between the plate and the grid of the valve. Such a circuit will burst into self-oscillation very easily.

Now consider the dotted connections in the diagram. They consist, as will be seen, of a coil below the grid coil, and a variable condenser joining this

What is a Radio-Frequency Choke?—continued

for ordinary broadcast work. Quite a number of chokes on the market giving excellent results on the lower and higher broadcast bands, "peak" somewhere between 2,300 or 3,500 metres. By making up a little test board as illustrated in the photograph you can easily test out to see whether the choke you are using is satisfactory.

Simple Testing Circuit

The procedure is very simple. No aerial or earth need be connected, and all you need to do is to join up the two-coil holder, valve socket, filament resistance, variable condenser, and the other components shown, so that you can produce the circuit shown on page 222 (without the dotted components) and also a circuit with the dotted components. For the ordinary broadcast band a No. 60 coil shunted by a .0005 condenser will suit the grid circuit. The radio-frequency choke for test should be connected in circuit at the point shown in series with the telephones, which should be shunted by a fixed condenser of about .001 mfd. It is not necessary to shunt the H.T. battery, as its choking effect is negligible.

Use a valve with a high amplification factor such as one of the modern R.C. type valves, so as to make sure that the circuit will oscillate easily when the grid circuit is in resonance with the choke and its capacity. Turn the variable condenser backwards and forwards from minimum to maximum and listen for signs of oscillation. If the set bursts into oscillation (you will hear a "plop" when it does so) anywhere within the range of a 60 coil shunted by a variable condenser, the choke is unsuitable for this band.

More Elaborate Method

Complete the test with a No. 250 coil, and if the set oscillates in these conditions its resonance-point is obviously within the band of wave-lengths tuned by this condenser. This does not mean, however, that the choke is unsuitable for the Daventry range unless the oscillation takes place at a wave-length below about 2,000 metres. If the set oscillates at the very top of the condenser scale only, it may still be satisfactory, for the 250 coil with a .0005 mfd. condenser tunes to about 2,700 metres.

Some commercial chokes have been so wound that their resonance frequency comes between the two broadcast bands—that is to say, at, say, 800 or 900 metres—but it is better that the choke should be satisfactory all the way from 200 to 2,000 metres, and there are a number of chokes which meet this requirement.

The test given is a simple one which does not require any signals from outside or the use of a wavemeter, except in the case of a choke where oscillation is found to be at the upper end of the condenser scale with a 250 coil, and it is desired to find whether this oscillation-point occurs below 2,000 metres.

A still better and slightly more elaborate test is to join up the dotted components and to use a reaction coil in the moving coil holder. After a few trials a suitable reaction coil can be found and the angular relationship of the grid and reaction coil so set that there is no oscillation when the reaction condenser is set at zero, while

slight advance of the reaction condenser should immediately bring it into oscillation again. Next, increase the tuning condenser by, say, 10 degrees, and the set again should stop oscillating. A further small movement of the reaction condenser is again required to make it oscillate. Carry on throughout the tuning scale, and you will find that if the choke is satisfactory a slight increase of the tuning condenser will always require a slight increase of the reaction condenser.

Plotting the Readings

If, however, you find that at a given point of the scale an increase of tuning-condenser capacity brings the set into oscillation, you may be near a harmonic resonance-point in which the set has a greater tendency to oscillate, i.e., slightly less reaction condenser is required, although the tendency is not sufficiently pronounced to make the set oscillate in the conditions of test I. If you plot the reaction condenser readings against the grid condenser readings

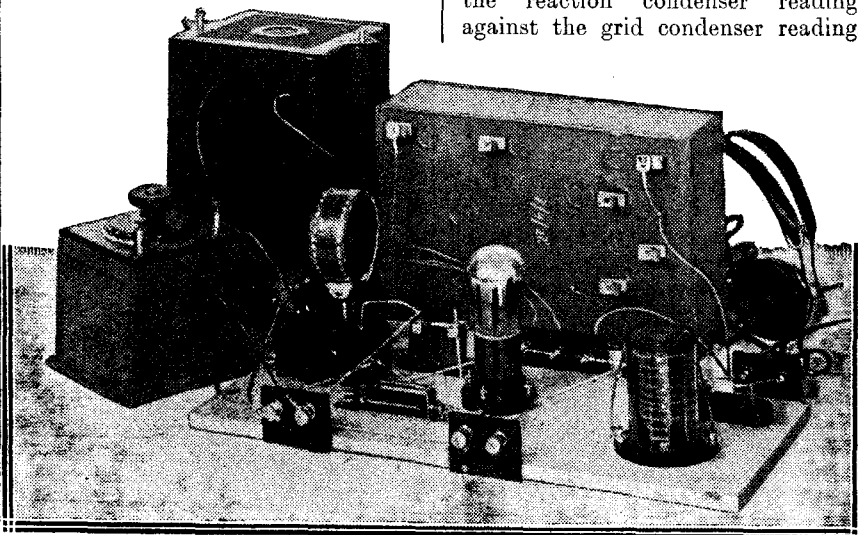

The test board used for finding the effective limits of a choke.

the set can be brought into oscillation by increasing this capacity value. The test can be commenced with, say, a 60 coil and the tuning condenser at zero and the reaction condenser at zero.

The Two Adjustments

Leaving the tuning condenser at zero increase the reaction condenser slowly until the set just oscillates. Now increase the tuning condenser from zero to, say, 5 degs., whereupon the set should stop oscillating, and a

throughout the whole scale, a satisfactory choke should give a steadily rising scale. A poor choke with resonance points will give a humpy scale.

The omission of a shunting condenser across the telephones may alter the results in either of these tests, and the presence of the reaction condenser even at zero will alter the position of the oscillation-point slightly as compared with the test without it. A few experiments will show you the difference.

"PATIENCE"

A New Game for Listeners.

From a Correspondent.

THE various wave-length shuffles (or should I say "kilocycle"?) which have been made at various times during the last few months as a result of the herculean labours of the International Radiophone Bureau, have not had the success one had hoped for. In fact, the "shuffle plan" has proved a more or less conspicuous failure.

Theoretically, the Geneva plan was good, but when the recommendations of the Committee had been made—as a result of many conferences between the representatives of various European broadcasting interests—it remained to put those recommendations into practice. Certain countries (certainly Great Britain) carried out the recommendations faithfully; alterations, as agreed upon, in the wave-lengths of certain B.B.C. stations were made. But other countries—notably Spain—were not so conscientious, and many European broadcasters failed to make the necessary alterations in wave-length, and continued as before in their own sweet, but selfish, way. Result: lack of unanimity in adopting the Geneva plan prevented the full fruits of its deliberations being appreciated in practice, and consequent failure of the principle of the plan—i.e. reduction of interference to the minimum.

That "Regional Scheme"

Lord Gainford, chairman of the B.B.C., recently stated that the use of a greater proportion of exclusive wave-lengths was imperative, while another increase in the size of the broadcasting wave-band was not possible. The only alternative was to reduce the number of broadcasting stations in Europe from 170 to 100, and he hoped such a change would be made in the near future.

There are to-day nineteen stations in Britain working on the broadcast wave-band (excluding 5 X X), and proposals have been made to decrease the number to ten, the idea being to bring every listener within range of stations giving him a choice of two programmes. This idea has been dignified by the name of "Regional Scheme." A lot has been said about it, and even more has been written about it. It has been dangled in front

of listeners in much the same way as a carrot is dangled before a donkey's nose—a tit-bit which might or might not be enjoyed.

Meanwhile Congestion Increases

Meanwhile, ether congestion grows worse, lack of alternative programmes more keenly felt, and general irritation on the part of those who want the B.B.C. to be a little more definite about the ten new stations and the much-talked-of Regional Scheme.

Wild hopes have also been given birth at the receipt of news from

the Federal Radio Commission plans to enforce a separation of 50 kilocycles in New York and Chicago, in order to solve the heterodyning problem there.

Captain Eckersley's Scepticism

According to American radio engineers, there are 950 kilocycles in the broadcast band between 200 and 545 metres. With the new system of one-half kilocycle separation, approximately 1,900 stations could operate simultaneously without sharing wave-lengths.

It has been noted during the few weeks that K D K A has been testing the system that the station tunes in very sharply at near-by points (usually "blanketed" by high power) while the transmitter radiates as much as 50,000 watts, and listeners in Michigan, New York, and the New England States have reported the

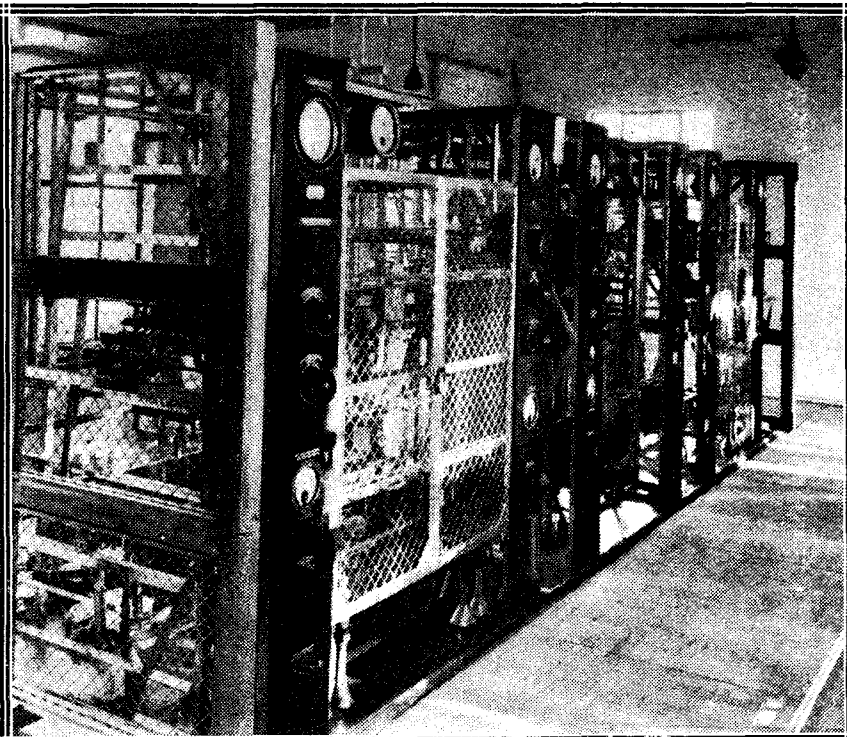

The transmitter for Australia at the Grimsby "Beam" wireless station.

America concerning another "revolutionary" system for a great increase in the technique of transmission. As it emanates from the Westinghouse people, the news of the new system has naturally aroused considerable interest, and a good deal of speculation as to its possible efficacy and possible help as regards British broadcasting.

The new system, says the statement, allows stations to operate with only one-half kilocycle separation between the wave-lengths. At present

signal strength as greater than under the ordinary transmission.

The Westinghouse Company's statement further says that "so radical is the departure from present methods of broadcasting that the engineers hesitate to forecast the great improvements in transmission that apparently will result from the general application of the system."

Well, it certainly sounds good. Captain Eckersley, however, seems sceptical. He has pointed out that

(Continued on page 286.)

Have you ever burnt out a valve through a mistake in wiring? If so, this little device will afford just the protection that you are looking for.

A FLASHLAMP VALVE SAVER

FROM A CORRESPONDENT

This Article is of practical value to every owner of a valve receiver.

WHEN a new set has been finished or when changes have been made in the wiring of an old one, it is always desirable to have some means of finding out whether the filament circuits are as they should be before inserting valves in the holders. We are all subject to occasional moments of aberration in which the silliest mistakes in wiring can be made, and such mistakes can be exceedingly costly if expensive valves are used straight away without any preliminary tests.

A small, easily made device which the writer finds exceedingly useful is shown in Fig. 1. Briefly, it consists of an old valve cap, complete with

cannot tell by inspection, as one used to be able to do, whether the valves are lighting up as they should.

Method of Making

All doubts can be set at rest by removing the valves from their holders and placing the tester in each of these in turn. It also provides a rough and ready method of gauging the condition of the accumulator. If 2-, 4-, or 6-volt bulbs are chosen, according to the accumulator used, they will light up brilliantly when the voltage is up to the mark, but will be dimmer when the battery is in a run-down state. This use for the tester will commend itself to those who do

others. Place the valve in a basin of water, hold it well under and break off the pip with a pair of pliers, when water will rush into the bulb. Break the bulb and remove as much of it as you can with the pliers. If the base of the bulb is intact it must be broken away. This is best done with an old screwdriver. All these operations and that which immediately follows must be conducted with the valve under water, which prevents splinters of glass from flying.

You are now left with the pinch of the valve to which run the four leads connected to the valve pins. Crack the pinch just as you would a walnut with the pliers and remove all the

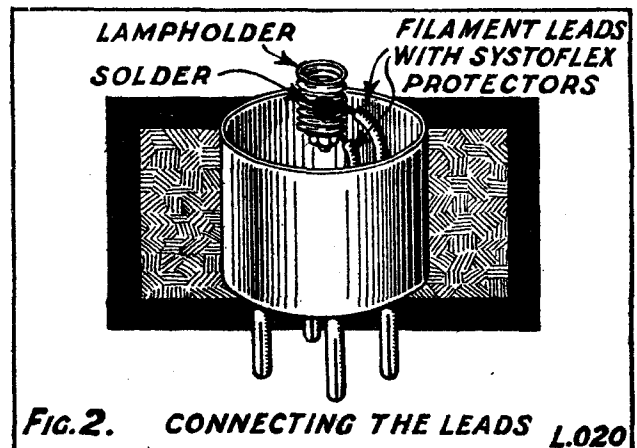
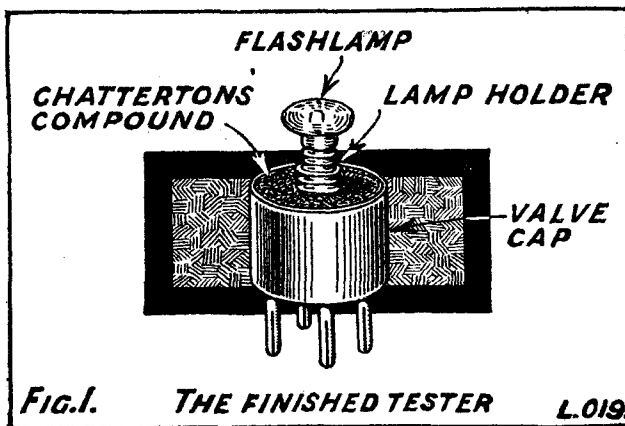

pins, in which is mounted a flashlamp holder connected to the filament contacts. Flashlamps at fourpence apiece are far cheaper than valves, and it is obviously very much better to have a short-circuit or a wrong connection in the wiring shown up by the burning out of a flashlamp than by loss of a valve. The tester is also very handy for discovering defects or disconnections in the filament circuits where glowless valves are used. Since the filaments of these give no light whatever, even in a dark room when current is switched on, one

not possess voltmeters, since with almost any kind of modern dull-emitter valve it is exceedingly difficult to tell whether the accumulator is run down from the degree of brilliance of the valve filaments.

Here is the method of making the instrument. The only requirements are a burnt-out valve, a cheap flashlamp holder, and two little pieces of systoflex, each rather less than an inch in length. The valve should preferably be of the pipless type with an ebonite cap, since these are more easily taken to pieces than most

glass, leaving just the four leads. Any little piece of glass that may adhere to the inside of the cap must be removed with screwdriver or pliers.

Preparing the Valve Holder

Now separate the leads and draw out through the small holes in the bottom of the cap those which are connected to the grid and plate pins; cut these off short. Take your lamp-holder, clean a place on its surface, apply a little flux, and run on a blob of solder. The next step is shown in Fig. 2. Place a short piece of systo-

A Flashlamp Valve Saver—continued

flex over each of the filament leads and cut off all but about a quarter of an inch of each of the protruding ends. Fix one of these ends to the central contact of the lamp-holder by means of the nut at its lower end. Solder the end of the other lead to the spot that you have tinned on the side of the holder.

Now work the holder gently down into the inside of the valve cap, taking care as you do so that the bared part of the lead attached to the central contact does not touch the body. When it is in its proper position the top of the holder is level with, or slightly below, the rim of the valve cap.

The next step is to set the holder firmly in position. This is done with the aid of Chatterton's compound or of pitch obtained from the sealing of an old flashlamp battery, grid battery, or H.T. battery. Whichever material is used, small pieces of it are placed in an old iron spoon and heated over a small flame until liquid.

Fixing the Flashlamp

The sealing material is then poured into the valve cap until this is almost full to the brim. As soon as the sealing substance has set hard the job is finished. Nothing remains but to screw in a suitable flashlamp. It should be noted that flashlamp bulbs are obtainable for all voltages from 2 to 6. If you are in doubt about the voltage of any particular lamp you will always find the figures stamped or printed on the small straight portion of the base which lies immediately below the bulb and above the threaded part.

R. W. H.

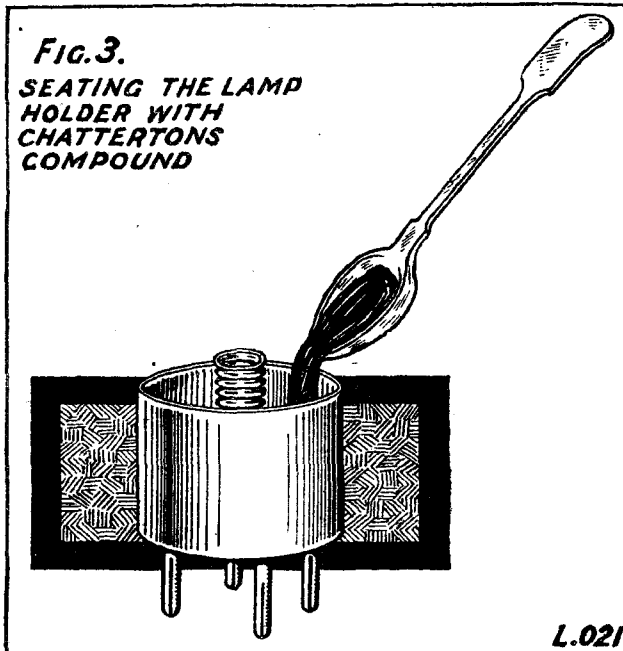

The method of fixing the flashlamp holder by means of Chatterton's compound is clearly illustrated here. If Chatterton's compound is not obtainable, the pitch from a disused dry battery may be melted down and used instead.

POPULAR WIRELESS.

Packed with interesting articles, how-to-make hints, and all the radio news worth knowing.

Every Thursday - - Price 3d.

AN "OLD OAK" STAIN FOR CABINETS

OAK, as a material for making a cabinet for the wireless set, is admirable, but it is by no means easy to work. Unless a good kit of tools is available, it is practically impossible to make an oak cabinet which will look well when finished. The wood usually sold for such cabinet work is much softer and easier to work, and it can be dressed to imitate a mahogany finish.

Greater distinction can be imparted to the appearance of the cabinet by finishing it to resemble old oak, and the process is extremely easy to carry out. The materials required are simply a tube of water-colour "Lamp Black" and a tin of ordinary clear furniture polish. The wood chosen for the cabinet should be an "imitation

mahogany," since this has a reddish tinge which is necessary to give the correct colour to the finished work.

The wood should be rubbed down with fine glasspaper till a smooth, glossy surface is obtained. Then a squeeze of the lamp black is put into a saucer, together with a small quantity of water. Make a small cloth pad and dip it in the water. Rub this over the whole surface of the wood to be treated, in order to make it just damp. Then touch the pad on the squeeze of paint and rub well into the wood again. Continue applying the paint in this way over the surface of the wood until the requisite dark shade has been obtained. The paint may tend at first to lie in dark smears on the wood.

Correct Pressure Important

A little more water on the pad will put this right and distribute the black evenly. The pad should be quite small, so that plenty of pressure can

be applied locally with the fingers as required.

Set the wood aside to dry for a few minutes and then apply the polish, spreading it evenly over the surface with a piece of soft rag. Finally bring up the polish with a large, soft cloth pad.

Methods of Polishing

Other methods of polishing may equally well be adopted when once the staining has been done. The above method is, however, simple and quite satisfactory so long as the cabinet is not to be handled much. This form of polish shows finger-marks to a certain extent, but the polish can always be renewed by rubbing over with a cloth pad. Any kind of wax polish is suitable; in fact, ordinary brown boot polish will be found excellent, giving a good lustre to the wood and effectively preserving it against damp.

A. V. D. H.

The "NEW FAMILY FOUR"

The Set of the Season

by Percy W.
Harris M.I.R.E.

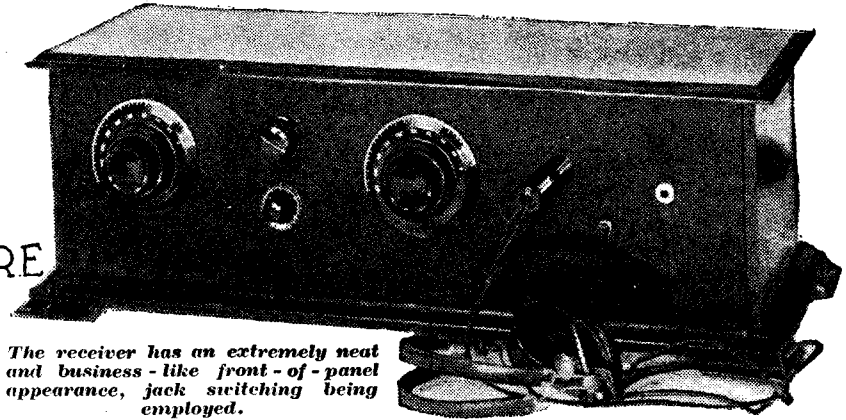

The receiver has an extremely neat and business-like front-of-panel appearance, jack switching being employed.

IT is the consistent policy of the WIRELESS CONSTRUCTOR to present to its readers month by month a series of star sets each of which fulfils certain specific requirements. For example, the man who wants powerful signals of good quality from the local station will find that "Samson—The Powerful Twin" will meet his needs. The beginner who has hitherto hesitated to try his hand at home construction finds that the "Radiano Three" gives him an admirable general-purpose set, while the more experienced amateur, in looking for a highly sensitive and selective three-valve arrangement, finds his needs satisfied by the "Signal Box."

Addition to Series

It is now our privilege to add to the series a four-valve set designed to replace the now somewhat obsolete "Four-Valve Family" receiver, while retaining all those features which have made the set widely popular. Nothing has been sacrificed for the purpose of including those features, and at the same time an opportunity has been taken to in-

TEN STAR FEATURES OF THE "NEW FAMILY FOUR."

1. Wonderful sensitivity for four valves.
2. Very sharp tuning.
3. Highest quality of reproduction.
4. Simplicity of control.
5. Two, three, or four valves can be used at will.
6. New, simplified, and highly efficient wiring system.
7. Wide tuning range—220 to 600 metres, and 1,000 to 2,000 metres.
8. Change from three valves on 'phones to four on speaker can be made in a second.
9. All components standard and readily obtainable.
10. Remarkably handsome appearance.

corporate well-tried and tested new methods of obtaining higher quality reproduction and much more sensitive and selective results.

The new wiring system, used for the first time in this set, possesses two features of particular importance.

The first is that the method is simple as well as efficient, and the second is that by following the instructions the design can be more exactly reproduced than is possible with any other method. In the usual wiring methods, where everything is above the baseboard, connections between points can be indicated on a wiring diagram and in photographs, but it is quite impossible, unless the amateur has the set in front of him, to see *exactly* how the wires pass from one point to another and the distances that separate them.

In the H.F. portion of a neutralised set exact spacing of wiring is often so important that a serious departure from it may completely upset the balance of the instrument. In the present method all the wiring passes in straight lines beneath the baseboard, and where it comes through from the underside to the top the connecting wires are taken vertically.

Leading Features

A criticism might be advanced that such a method could bring about the juxtaposition of wires in an inefficient manner, and unless the set were properly laid out this would, of course, occur. The ascertaining of the correct positions for these wires, however, is carried out by the designer, and once he has found a satisfactory method of placing them and proved its efficiency under test, the home constructor can reproduce his design with great fidelity.

Ten leading features in the "New Family Four" are briefly indicated on this page. Firstly, it is wonderfully sensitive, due to the choice of a circuit which I have proved by extended trial to be thoroughly reliable; secondly,

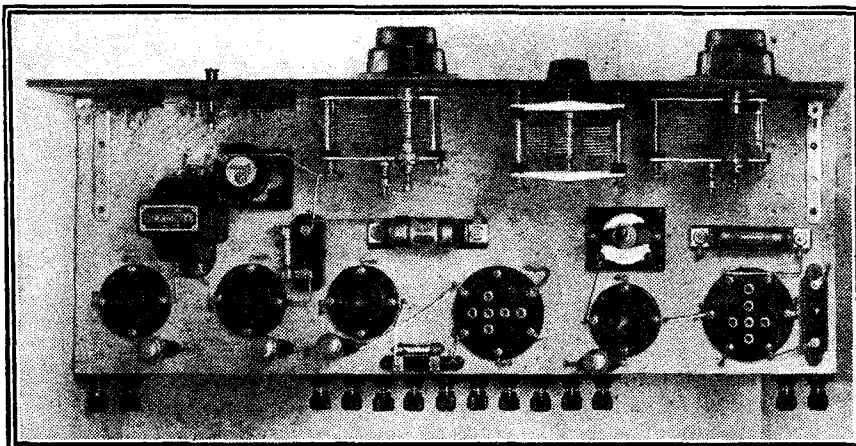

The neat appearance of the wiring can be seen in this photograph of the completed receiver.

The "New Family Four"—continued

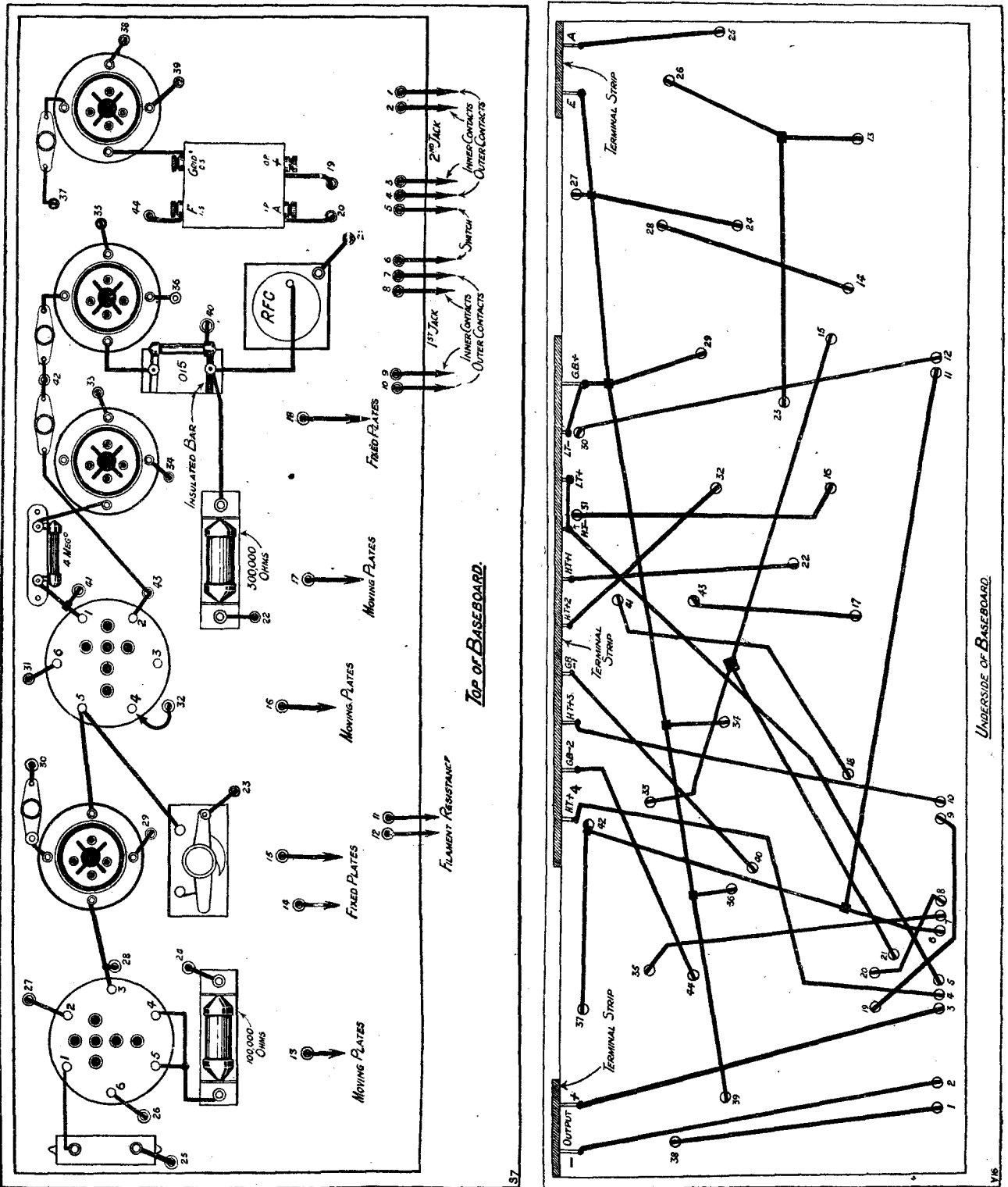

As will be noticed, the majority of the leads pass through and under the baseboard. The numbers appear at least twice in each case, showing the positions taken by each lead both below and above the baseboard. It will be appreciated that the order of numbers appears reversed in the latter case, owing to the fact that the whole plan is reversed when the baseboard is turned over.

The "New Family Four"—continued

the tuning is sufficiently sharp to give a wide choice of stations when the local is working.

The quality of reproduction due to the combination of a good modern transformer with resistance-capacity coupling, is fully up to the limits of reproduction of the modern loud speaker.

Simple to Control

By this I mean that while theoretically better results would be obtainable by using two resistance stages, nothing but the most expensive coil-driven loud speaker of the Rice-Kellogg type would detect the difference. Fourthly, the set is exceedingly simple to control, there being only two tuning dials, with a reaction knob which is only occasionally used for very sensitive work. Fifthly, by means of simple jack switching it is possible to work the set on three or on four valves, the change being effected in a moment, with the particular advantage possessed by few other sets that on withdrawing the plug from the jack the loud speaker, which can be kept permanently connected to two terminals at the rear, is automatically switched on.

This means that if you are searching for distant stations and you hear the programme sought in good strength on the telephones on three valves, and on changing into the fourth valve

socket you find it is too loud for ear-phone reception, you have only to withdraw the plug, whereupon the loud speaker is automatically connected up.

For reception of the nearest station the use of all four valves is un-

stage (resistance-coupled), obtaining a quality of reproduction which is as near perfection as anything obtainable at the present time (assuming, of course, your loud speaker is good). If at any time you want still greater volume, it is but the work of a moment

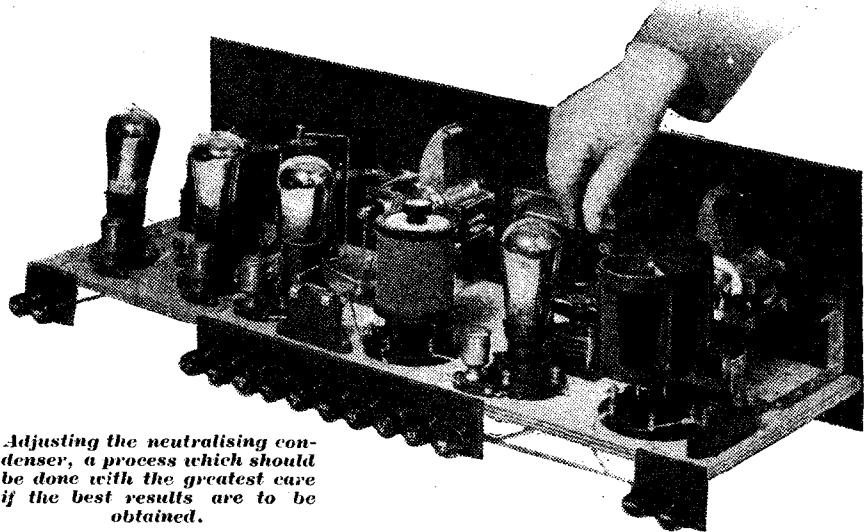

Adjusting the neutralising condenser, a process which should be done with the greatest care if the best results are to be obtained.

warranted, and, indeed, is an extravagance. The "New Family Four" gives you two alternatives, one of which will suit your particular conditions. By connecting the loud speaker to a jack plug and plugging it in the third valve socket you can work the set with one stage of H.F., a detector, and one note-magnifying

to pull the jack out and plug it into the fourth valve socket.

For Strong Signals

The other alternative, one which will appeal to you if you live within ten or fifteen miles of a station, is to take the H.F. valve out of its socket, whereupon, as a general rule, the set will

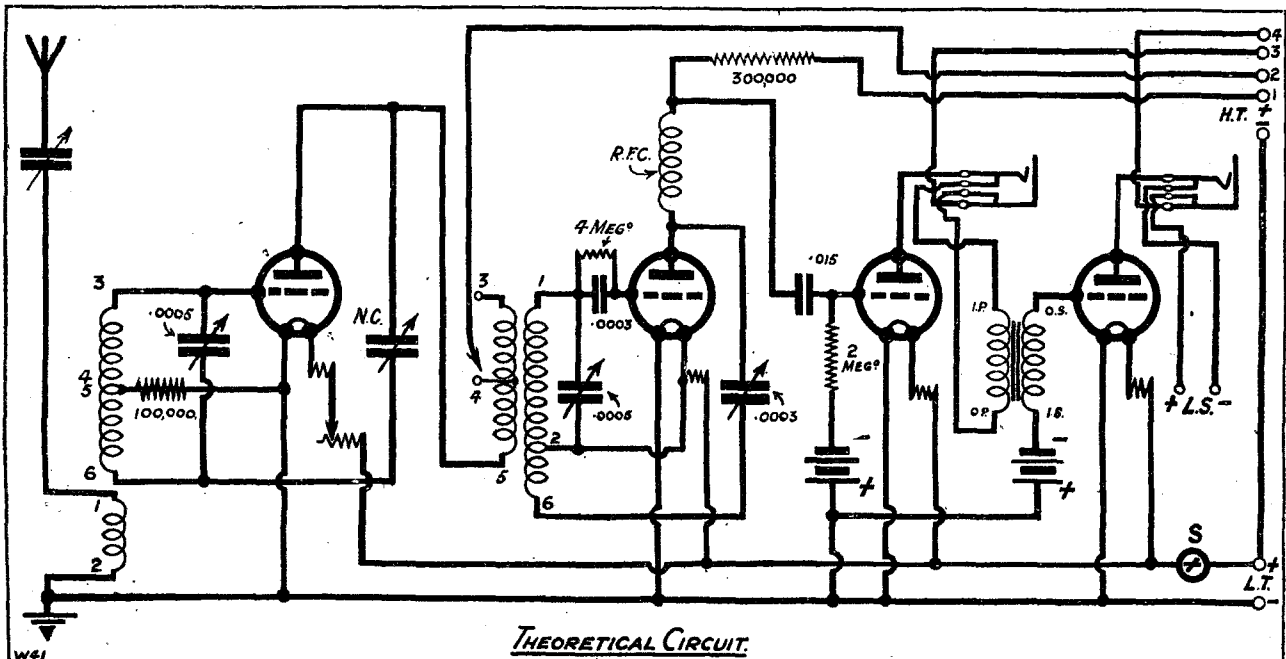

The "New Family Four"—continued

work excellently and in the same tuning conditions, on the detector and note-magnifying stages. At first thought it might occur to you that switching off the first valve filament would be a simpler and better way, but as the receiver is perfectly neutralised such an action stops signals completely even on all four valves. By removing the first valve from its socket the balance of neutralising is upset (due to the absence of plate to grid capacity) and the signals will come through and can usually be brought up to almost any desired strength with reaction control.

Whenever it is desired to listen to distant stations it is only necessary to reinsert the first valve in its socket, whereupon those stations can be tuned in. The important point about this scheme is that the neutralising adjustment is not upset, and, indeed, it is advisable, once the set has been neutralised, to lock the neutralising condenser until a change of valves is made.

Efficient Wiring

The sixth point, the new simplified and highly efficient wiring system, I have already briefly referred to above. Simply explained, it consists first of all in drilling the necessary holes in a wooden baseboard (which is slightly elevated from the base of the cabinet by means of an inverted terminal strip at the back, and panel brackets at the front), and tinning all points which have to be connected. Lengths of rubber-covered flexible wire, somewhat longer than the actual connections, are cut off, and one end of each bared and tinned.

This end is now soldered to one point of the two to be connected, and the loose wire threaded down through the baseboard hole, and up the hole nearest the other component, and pulled taut until the wire is

attention to the seventh feature, the wide tuning range. It is not generally known that a screen over a coil, particularly if the cylindrical type of screen comes quite close to the coil, considerably reduces its wave-length

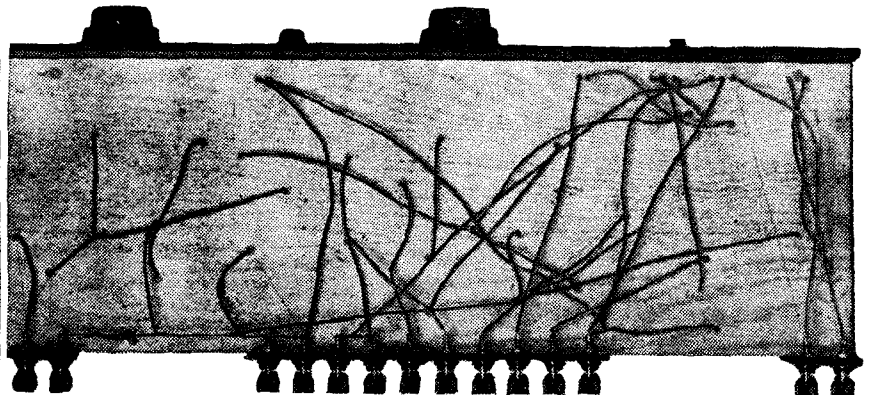

A great deal of the wiring is carried out under the baseboard, as shown in this photograph.

against the second point to be connected. When the position of this point is found, the flexible wire is cut off to the correct length, the end bared and tinned, and soldered into position. The wire thus takes the shortest path between two holes on the underside of the baseboard, and without any necessity of "dodging" any component which might come awkwardly in the way, as would be the case above the baseboard.

The Tuning Range

The few connections totally above the board are made with bare tinned copper wire, as are one or two connections beneath the baseboard, such as that between the L.T. positive and H.T. negative terminals, and between earth and L.T. negative.

I would like to draw particular

tuning range. By spacing the two coils and making one of them a "fieldless" type, the need for screening is obviated and the efficiency of the coil retained. Furthermore, the first grid circuit is coupled to the aerial inductively and not directly. With the coils used, a tuning range of from 220 metres to 600 metres, and from 1,000 to 2,000 metres, is obtained, and this, as readers know, includes all stations it is generally desired to receive.

The eighth feature—the rapid change from three valves on telephones to four on the loud speaker—is one which must be tried to be appreciated. It greatly facilitates searching, and for family use it is a boon. The person operating the set can quietly hunt for the station

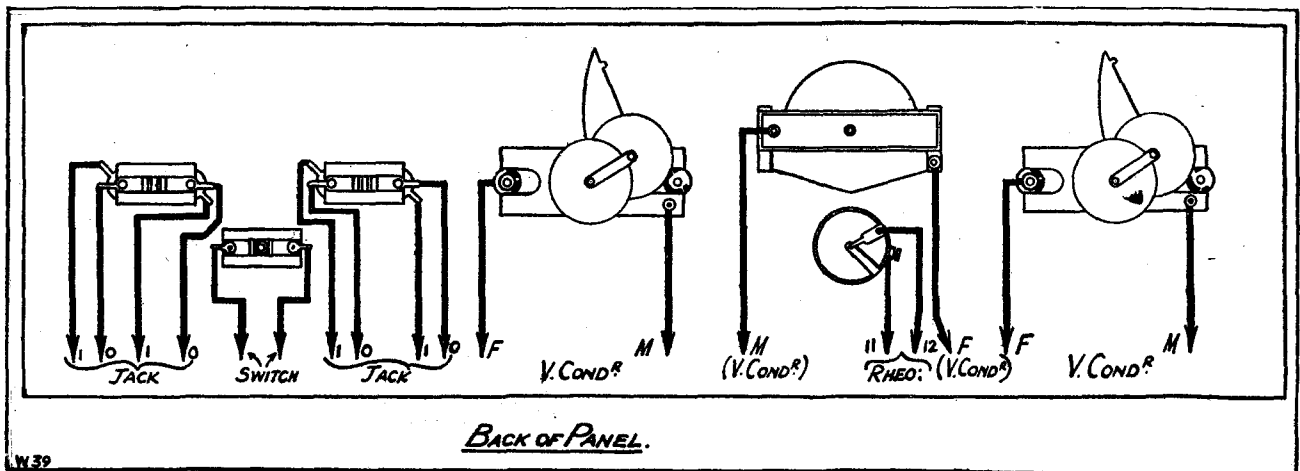

BACK OF PANEL.

The "New Family Four"—continued

required without causing any disturbance to others in the room, and then, when tuning in has been properly effected and everything is ready, withdrawing the telephone jack from the socket for three valves automatically brings four valves into use and connects the loud speaker.

obtainable—is one which will make a very wide appeal, particularly to those readers—and they are very many—who are living in countries overseas. It is always my policy to design sets to use, as far as possible, existing or standard components. Whenever new components are de-

so that if he cannot obtain one particular make of parts he should be able to purchase another. The tenth feature—the handsome appearance—will not, I think, be disputed by those who examine the photographs. While the exterior has pleasing lines, the interior, by simplicity and absence of

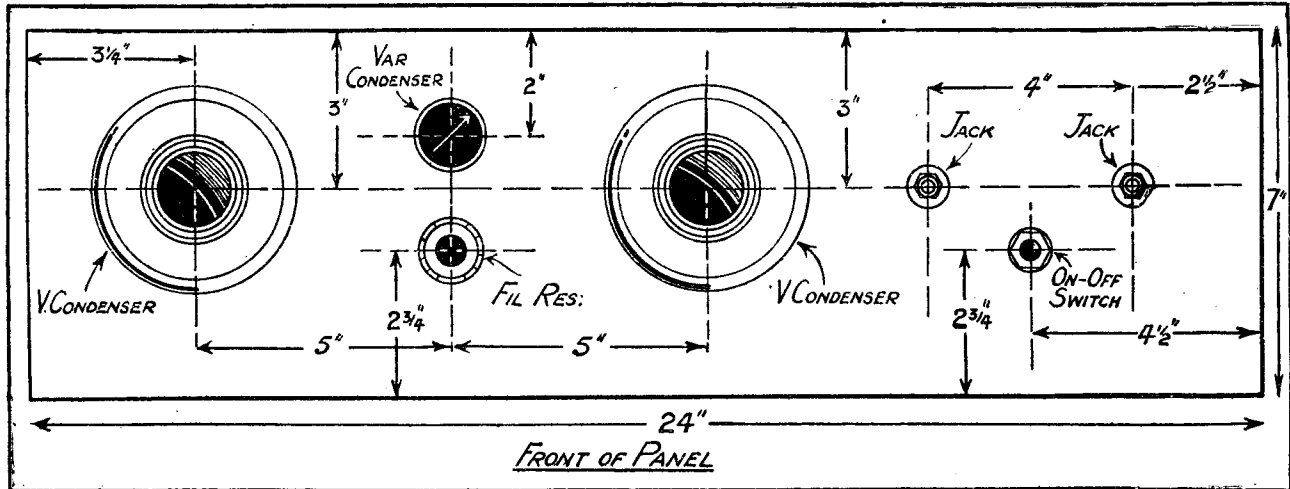

If the particular type of fixed resistor described is used, filament current can be economised very simply when using three valves by giving the resistor a slight turn in an anti-clockwise direction, whereupon it is disconnected, and the last valve filament turned out. This method is more efficient than and decidedly preferable to incorporating special wiring and a switch, while the simplicity of layout is maintained.

Standard Components

The ninth feature—that all components are standard and readily

signed for particular sets there is always a delay in obtaining them, and the more popular the set the greater the delay. Indeed, the most popular sets of all often cause such a rush on particular components that even when these are standard they rapidly run out of stock.

This has been the case in the "Radiano Three," where the demand for the X coil has been so great that at the moment of writing the manufacturers are only just catching up with orders. Furthermore, in nearly all cases, the reader has a choice of alternative makes of equal efficiency,

visible wiring, is by no means unattractive.

Consistent Results

In choosing the circuit which should be worthy of the good name of the "Four-Valve Family," I had to bear in mind a number of requirements. Sensitivity and selectivity were, of course, the primary requirements, but without reliability and, more important still, that particularly valuable feature of home-constructed sets, strict reproducibility, the two first points would have been valueless. Within the last year or so, a number

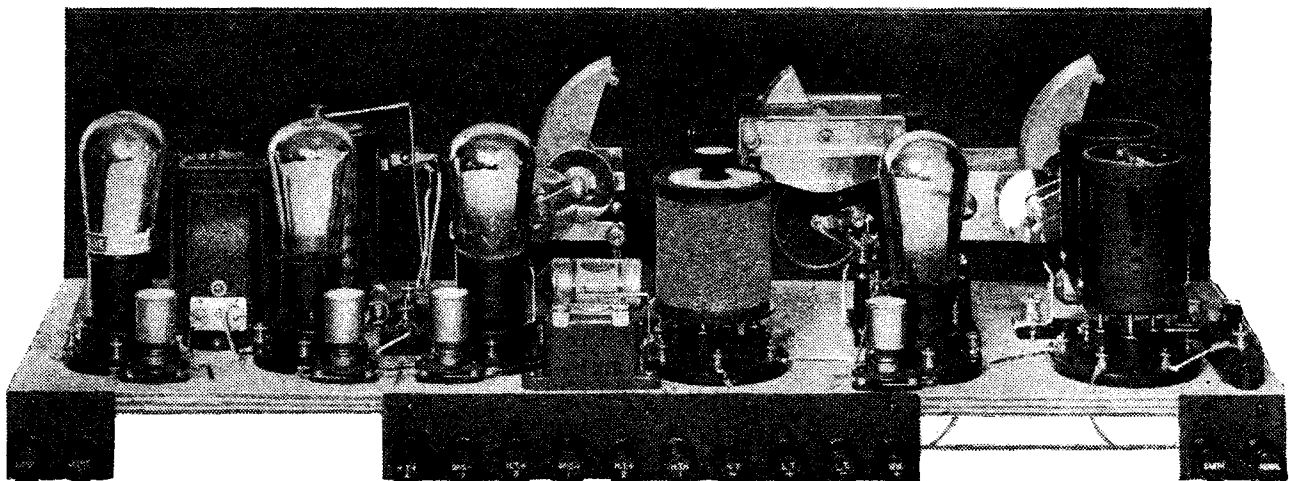

A general view of the back of the receiver, showing the disposition of the terminals.

The "New Family Four"—continued

of new circuits—the Loftin-White is but one example—have swum out into our ken, but I have so far found none which gives such consistently good results as that shown.

Well-Tried Arrangement

It is, as readers will see, the standard split-secondary circuit for the first valve, combined with special split-primary arrangement for the second valve as detector. This particular combination of a split second-

enable different transformer ratios to be used for different types of valves. For example, with 4- and 6-volt valves, which oscillate readily, one half of the primary only is used, and with 2-volt valves, which are generally more difficult to make oscillate, and which are of too high an impedance for one half of the primary, the *whole* of the primary is used (i.e., the portion designed as the ordinary primary and also that in series with it, originally designed for a neutralising winding).

powerful signals from the local station and feeding a good power or super-power valve in the last stage.

Good Quality

Every serious amateur knows that a good modern transformer in one stage gives reproduction practically indistinguishable from that obtainable when resistance-capacity is used, but when more than one stage of note-magnification is incorporated it is extremely difficult to get good quality

COMPONENTS REQUIRED FOR THE "NEW FAMILY FOUR"

- 1 cabinet to take panel 24 in. × 7 in. Interior depth 9 in. from front to back. (Areraft, Camco, Caxton, Raymond, etc.)
- 1 panel 24 in. × 7 in. (Ebonart, Radion, Raymond, etc.)
- 1 pair of small brackets.
- 1 wooden baseboard 24 in. × 8½ in. (with cabinet).
- 3 ebonite strips for terminals. Two measure 2 in. × 1½ in., and one 10 in. × 1½ in.
- 14 indicating terminals as follows: Aerial, Earth, L.T. +, L.T. -, H.T. -, H.T. + 1, H.T. + 2, H.T. + 3, H.T. + 4, G.B. +, G.B. - 1, G.B. - 2, Output +, Output -. (Belling Lee.) Plain terminals on engraved or transferred strips can be substituted if desired.
- 4 anti-microphonic valve holders. (C.E. Precision.) Any other standard type of similar form can be used if desired, such as Lotus, Burndept, Benjamin, etc.
- 4 fixed resistors of suitable value for valves. The Burndept pattern is used. If other makes are chosen they should occupy a similar small space and be rapidly removable.
- 1 variable rheostat for panel mounting. (Lissen or similar type.) Value should be 30 ohms for any valve. (See note.)
- 2 6-pin bases. (Wearite.) If other makes are used they must be of reasonably small diameter. Colvern and Peto-Scott are equally suitable among others.

- 1 Formodensor, .0005 mfd. max. (The Formo Company.) The X-L Variodensor, model G-5, is equally suitable. (Hamley or Rothermel.)
- 1 fixed condenser, .0003 mfd., with clip for leak. (T.C.C., Dubilier, Lissen.)
- 1 leak, 4 megohms. (Lissen, Mullard, Dubilier, etc.)
- 1 leak, ½ megohm. (Lissen, Mullard, Dubilier, etc.)
- 1 fixed condenser, .015 mfd., with arrangement for series leak. (Dubilier, with new series clip, Lissen with Combinator attachment, etc.)
- 1 wire-wound resistance and base, 100,000 ohms. (Mullard, R.I.-Varley, Dubilier, etc.)
- 1 wire-wound resistance and base, 300,000 ohms. (R.I.-Varley.)
- 1 baseboard-mounting neutralising condenser. (Peto-Scott, Gambrell, Polar, Jackson, etc.)
- 1 radio-frequency choke. (R.I.-Varley, Lissen, Ormond, Wearite, Climax, McMichael, etc.)
- 1 good low-frequency transformer. The Geophone 4 to 1 ratio has been used. There is room for any other standard make you choose.
- 2 variable condensers, .0005 mfd., with good slow-motion dials. Those shown are Jackson Bros. There is a wide range of alternatives, such as Geophone, Bowyer-Lowe, Ormond, Brandes, Igranic, Cyldon, Formo, Raymond, etc.
- 1 variable condenser, .0003 mfd. This

- should be fairly small in the panel space occupied. The Bowyer-Lowe "Popular" shown is very suitable.
- 1 small knob for same.
 - 1 on-and-off switch. (Igranic, Connecticut, Decko, etc.)
 - 2 double-circuit jacks. Note.—The long type of jack will occupy too much space. Lotus jacks are used in the set. Alternatives are Frost Gem Jacks.
 - 2 standard plugs. (Lotus plugs if Lotus jacks are used—others will not fit.)
 - 1 binocular or "fieldless" coil for broadcast range. (Peto-Scott, Lissen, etc.)
 - 1 standard split-primary Reinartz transformer for broadcast range.
 - 1 standard split-primary Reinartz transformer for Daventry range.
 - 1 standard split-secondary transformer for Daventry range.
 - 1 H.F. valve.
 - 1 R.C. valve.
 - 1 L.F. valve.
 - 1 small-power or super-power valve.
 - 1 grid-bias battery.
 - 1 100-volt or 120-volt H.T. battery.
 - 1 accumulator.
 - 1 pair telephones.
 - 1 loud speaker.
- Quantity of Leweos or similar flexible wire (as used for Radiano).
- 4 1 mfd. Mansbridge-type condensers (any standard make). These are used outside the set.

ary and a split primary is one I first introduced to the public in the "Signal Box," and I also incorporated it in the "Black Prince" receiver, described in "Modern Wireless" for April.

Suitable for Two-Volters

Whereas the split-primary transformer is designed to use one half of the primary winding as a true primary and the other as a neutralising winding, I have used these halves somewhat differently so as to

Reaction is obtained by what is generally termed the Reinartz method, this giving very smooth control and obviating the necessity of any swinging coils. The detector is resistance-coupled to the first note-magnifier valve, values being chosen to enable one to use the latest type of high-efficiency R.C. valve with best effect. The first note-magnifying valve is coupled to the second with a transformer, enabling us to use as the first note-magnifying valve one which will handle the large grid swings given by

with two transformers. Two resistance stages can be used, but here great care has to be taken to avoid overloading the second R.C. valve, which by its very nature is incapable of handling such big grid swings as the lower impedance type. The combination, therefore, of one resistance-coupled stage and one transformer-coupled stage gives admirable quality with high efficiency and simplicity, the volume of sound obtainable being greater than that obtainable with two stages of resistance

The "New Family Four"—continued

coupling, and the quality being to all intents and purposes as perfect as with two R.C. valves.

The jack-switching system used is very simple, both jacks being of the "double circuit" type. That is to say, when the telephone plug is pushed into the jack the two outer contacts are separated from the two inner, the telephones taking the place of the inner contacts. This means that if a primary of a L.F. transformer is connected to the inner contacts, on plugging-in both sides of this transformer are automatically disconnected from the plate and H.T. positive respectively, the connections being now made direct to telephones.

The Switching Jacks

It is usual in jack switching to make the first a double-circuit jack to cut out the primary of a transformer as just indicated, and the second a single circuit jack, one side being connected to the plate and the other to the H.T. positive. Normally, the

two contacts are "open" and when the telephones are plugged in they are simply connected on one side to the plate and on the other to the H.T. positive, thus completing the circuit from H.T. positive through the telephones to the valve.

In my scheme the second jack is exactly the same as the first—i.e., a double-circuit jack. In this case the inner contacts are joined to two terminals which in turn are connected to the loud speaker. The two outer contacts are made, as usual, to the plate and H.T. positive, so that when no jack is inserted the path from the H.T. positive is completed through the loud-speaker terminals to the plate. When the telephones are plugged-in the current goes from H.T. positive through the telephones to the plate, the loud speaker being disconnected at both terminals.

Variable Aerial Condenser

A further novelty in this receiver is the particular form of series con-

denser in the aerial circuit. The insertion of a series condenser in this position is quite common practice, and if this condenser is made of an interchangeable variety the best value can be found for particular aerials. In the "New Family Four" this condenser in the aerial is made variable within quite wide limits, and for the purpose I have the new "Formodensor," in which the capacity is varied by screwing down a knob. It is a small device, quite inexpensive, and occupying no more space on the baseboard than the ordinary fixed condenser. A special point is that a few turns of the knob will enable you to find once and for all the best value which suits your particular aerial.

Now a word as to the choice of component parts. In accordance with the usual practice in this journal, the names of those actually used in the receiver tested and illustrated in this article are given, but, save in those cases where special notes to the contrary are made, it can be taken that any other high-grade component of suitable size and value can be substituted without loss of efficiency. A few alternatives are given, but the omission of others is not necessarily an indication that they are unsuitable.

Alternative Components

The main point to bear in mind, if you should use components other than those illustrated, is that the substituted components must be of good quality and should occupy approximately the same space on the panel or on the baseboard as those illustrated. This is of the utmost importance at the H.F. and detector end of the circuit. The L.F. end is not so important, and the fact that the L.F. transformer of your choice takes more space on the baseboard than that illustrated need not deter you from using it, provided you can keep, roughly, the same relative positions as those shown.

The cabinet shown, made by the Arcraft Company of Croydon, is of polished mahogany. Excellent cabinets in other makes can be obtained, and, provided the dimensions given are adhered to, the constructor can suit his own taste as to the general design.

(Continued on page 282.)

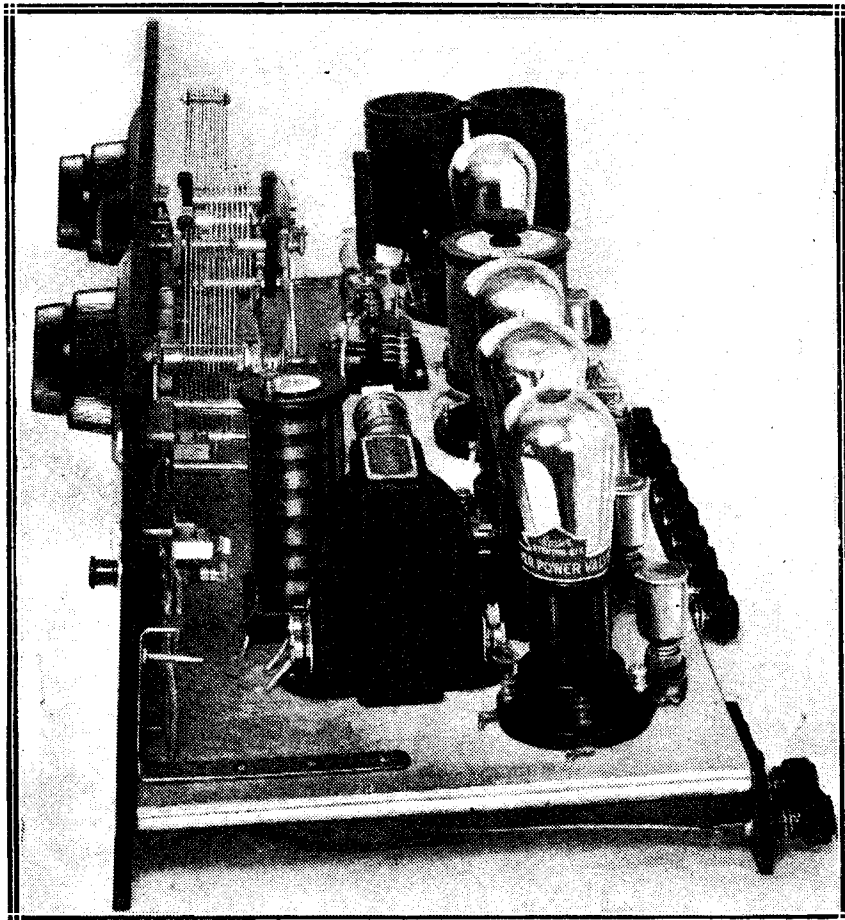

A photograph of the "New Family Four" taken from the L.F. end, showing the transformer and H.F. choke.

WHICH LOUD SPEAKER IS BEST?

An account of an interesting test.

By STANLEY G. RATTEE, M.I.R.E.

IN order to come to some definite conclusion regarding the relative merits of large and small loud speakers, a number of these instruments were recently collected, and then in conjunction with a four-valve set—comprising H.F., rectifier, and two L.F. valves—experiments were conducted along the following lines.

The Standard Adopted

The set was tuned to one station after another, using a loud speaker of normal dimensions, a small loud speaker also being connected to the set through the medium of a double-pole change-over switch, thereby permitting a change of instrument to be made for purposes of comparison. It will, of course, be appreciated that the names of the instruments used cannot be mentioned here, but in order that the reader may make comparisons the results are given elsewhere in the article in tabulated form.

The maximum signal strength obtainable from the local station was taken as the standard, and given the value of 10 for convenience in recording; the figure represented approximately the volume given by a good gramophone. The loud speaker used for this standard was of medium size, of well-known make, and possessed of no special features other than that it was a good instrument.

Larger Size Scores

For purposes of the test the question of the relative merits of the various models with respect to quality was put aside, for it will be appreciated that full load for one instrument was possibly overload for another; but so far as was technically possible each loud speaker was used to its best advantage, and every effort was made to reproduce really pleasant music and speech at the maximum volume allowable in the circumstances.

Medium- and small-sized horn types were tried against each other, medium- and small-sized cones were made to rival each other, and medium and small hornless instruments of other types were also included in the test.

Comparison, however, was not made between one class and another, but the best of each class, big and small, were matched against the corresponding competitors.

It will be seen from the table that so far as volume is concerned everything is in favour of the bigger types, the smaller models giving a signal strength in some cases as low as two, which, in fact, is only just loud enough to make itself heard two or three feet away. Even then only by listening carefully can every word of speech be understood. In defence of the small loud speaker, however, let it be mentioned that the best of these that were tried were amazingly superior to many of the less efficient big speakers.

The stations given in the table do not represent the whole of the transmissions that were tried, but are a few

It must be understood that the signal strengths given are those obtainable in the conditions of the test, and do not in any way constitute a standard for all four-valve sets; on the contrary, they are merely a con-

Name of Station.	Horn Types. Signal Strength		Cone and other Types. Signal Strength	
	Med. Size	Small Size	Med. Size	Small Size
London ..	10	8	10	6
Birmingham	8	4	7	3
Barcelona ..	6	2	6	2
Radio Paris.	8	4	7	3
Hamburg .	8	6	8	4
Copenhagen	6	2	6	2
Daventry .	9	6	8	4
Belfast ..	6	2	6	2
Newcastle .	8	4	7	3

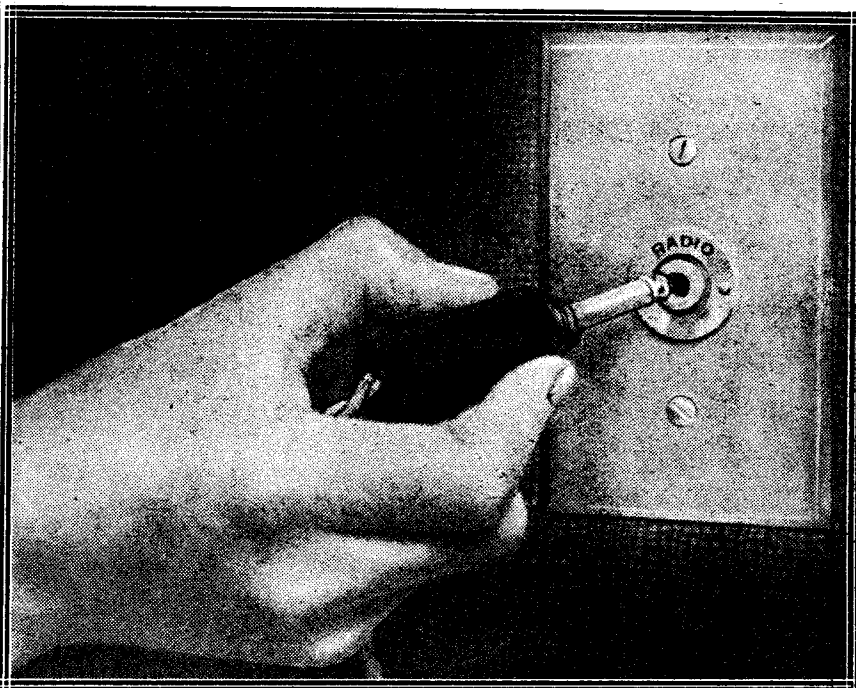

The latest wall fitting for plugging in to the programmes.

chosen at random to give some indication of the relative signal strength. Many readers are no doubt already fully aware as to how loud Hamburg should sound on a four-valve set, when used in London.

venient manner of expressing in print the amount of volume obtained, in a rough-and-ready way, but sufficiently good to show the merits of big and small loud speakers as demonstrated in the tests described.



HAPPENINGS AT SAVOY HILL

By

OUR SPECIAL COMMISSIONER.



THE B.B.C. display at the National Radio Exhibition at Olympia in September will be quite different this year from what it was last year at the same exhibition. The model studio has been abandoned. In its place there will be replicas, "life-size," of the London control room, and of two transmitters. There will also be some B.B.C. propaganda exhibits, but in only a limited form.

The Exhibition authorities have insisted that a purely engineering show from Savoy Hill was what the public would like to see at the next National Wireless Exhibition. The B.B.C. suggested at first that it should put on a developed form of the show it had given at the "Daily Mail" Ideal Home Exhibition at Olympia in the spring. This would have involved the demonstrations of "quality" reproduction from various-priced apparatus. The suggestion was not popular with the Exhibition authorities. Incidentally, the trade as a whole is not leaving Savoy Hill in any doubt as to its opposition to this new development of broadcasting policy. The future of these demonstrations is still obscure.

A New Era Begins

With the beginning of entertainment transmissions from 5 G B on August 1st, it is hoped that the B.B.C. will make accelerating progress towards the completion of redistribution. Apparently the new high-power medium-wave transmitter at Daventry is not to be properly christened or formally inaugurated. It was hoped that the anniversary of the opening of Daventry Senior, July 27th, would be turned to account. But the natural, and perhaps wise, caution of the B.B.C. engineers has prevailed. The new station is to be called "Daventry Experimental," and is to be "faded-in" without display or ceremony of any kind. The ceremonial side of the new system of distribution will be dealt with when the first of the "Regionals" is ready for regular work. 5 G B may not be permanent.

Anyway, it will set out to give a contrast programme in the Daventry service area, which includes a population of more than twenty millions. It will be particularly interesting to discover what programme material the B.B.C. will use for this first alternative service.

It is presumed that Daventry Senior will continue to relay London. There will be, of course, a temptation for the programme people at Savoy Hill to dump undesirable and dull stuff on to the new wave-length.

concert or opera from London, 5 G B should give light entertainment, and vice versa. If this policy is carried out intelligently there should be a considerable extension of the listening habit in the service area of Daventry.

Statesmanship at Savoy Hill

There is an increasing tendency in a section of the highbrow "lay" press to nag B.B.C. headquarters on grounds of alleged lack of the qualities of "statesmanship." On analysis this criticism is discovered to be

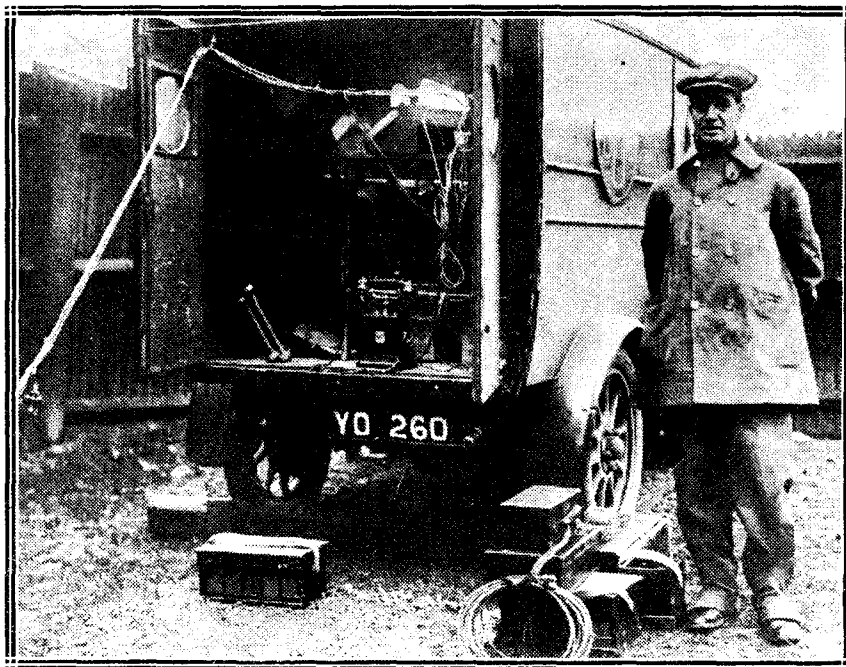

The amplifiers, etc., used by the B.B.C. when broadcasting sporting events.

This is a tendency which will have to be opposed vigorously from the start.

What the listening public will want in the big area concerned is good programme material—just as good as is given from 2 L O and 5 X X—but in distinct and continuous contrast. It is hoped, therefore, that Savoy Hill will not yield to the temptation to dump bad stuff on 5 G B in the supposed interests of 2 L O and 5 X X.

The guiding principle is not difficult. When there is symphony

directed really against the reluctance of Savoy Hill to subsidise inefficiency in other lines of activity. The "statesmanship" mentioned is dangerously akin to weak-kneed benevolence with other people's money. It is fortunate, therefore, that the B.B.C. administrators have not given way to these insistent appeals for subsidies.

No doubt broadcasting has some responsibility for the support of music and musical institutions. But the financial commitments for these objects should be measured strictly

Happenings at Savoy Hill—continued

in terms of programme values to accrue therefrom. The B.B.C. has no right to spend any money which does not promise a reward in better or more programmes. Thus, it was sound programme policy to take on Sir Henry Wood for a long contract. It would have been bad policy to have contracted disproportionate

universal requirements of the programme service. Incidentally, the B.B.C. would be well advised to depart sometimes from its policy of dignified restraint in explaining its policies. Mr. Boosey was allowed to hand out some pretty hard blows unanswered during the recent conversations with Savoy Hill. If Savoy

trouble to send in their postcards. But these were sufficiently well distributed to allow certain conclusions to be drawn. For one thing, the definite supremacy of 2LO and 5XX is established beyond all possibility of doubt.

For another thing, the relay stations are not listened to enough to justify their continuance. The third main conclusion is that only at Manchester, Cardiff, and Glasgow is there evidence of the degree of keen local interest to suggest justification for the maintenance of separate local programmes.

Thus, if the B.B.C. were to act fully on the deductions to be drawn from their referendum, they would scrap their relays at once, and also wash out the separate stations at Bournemouth, Newcastle, Birmingham, and Aberdeen.

The money thus saved would be concentrated on better programmes at the remaining few centres. But I am assured that there is no such drastic intention at Savoy Hill. The results of the referendum are not regarded as infallible. They will be a kind of guide when the time comes for taking final decisions on redistribution.

The Washington Conference

The B.B.C. delegation under Captain Eckersley leaves for Washington early in September. It is understood that the Chief Engineer will not stay throughout the whole proceedings. As soon as these are well under way, and he has attended the meetings when broad questions of policy are considered, he will come back, leaving a "locum," probably in the person of Mr. Hayes.

The new plans of distribution are so occupying the engineers at Savoy Hill that very few of them will be getting their normal holidays this summer, and Captain Eckersley will have to cut his absence in the States to the absolute minimum. As to the results of the Washington Conference, no one seems to be able to make an intelligent forecast.

One definite advance should be recorded. That is the admission of broadcasting as a respectable and adult member of the general wireless family. There will be various schemes for the equitable distribution of the various wave-bands and ether channels. Of course, nothing done at Washington will be binding.



financial responsibility in an effort to help the Queen's Hall. The "Proms." are of sentimental interest to a good many people. They are of real interest to comparatively few. When it has more funds and when the new system of distribution is established the B.B.C. may be able to run its own "Proms."

But anyway, these are in the luxury category when compared with

Hill is sure of its ground, why doesn't it publish all the correspondence?

The Listeners' Referendum

The B.B.C. were wise to cover themselves in advance of their "listeners' referendum." They said they were seeking a "cross-section" of public opinion. This is what they got. Not more than 85,000 listeners out of a potential ten millions took the

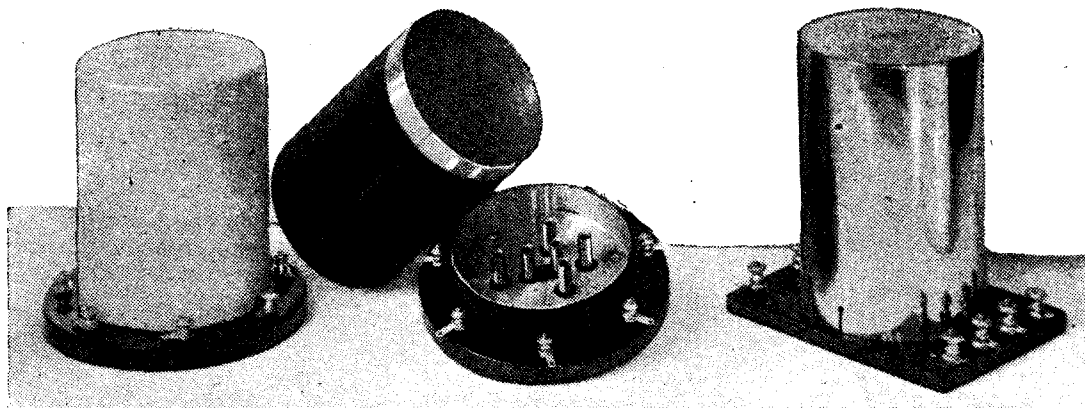

Make Your Own Screened Coils

IN this article it is proposed to give details of the windings employed in the standardised types of coils, for use both with and without screens, so that there should be no difficulty in constructing one's own coils and H.F. transformers at home.

Roughly speaking, there are only four types that need be considered. These are Aerial Coils, Split-Primary Transformers, Split-Secondary Transformers, and Reinartz Coils.

The Aerial Coil

There is no need to extol the advantages of the six-pin system of mounting, since these have already

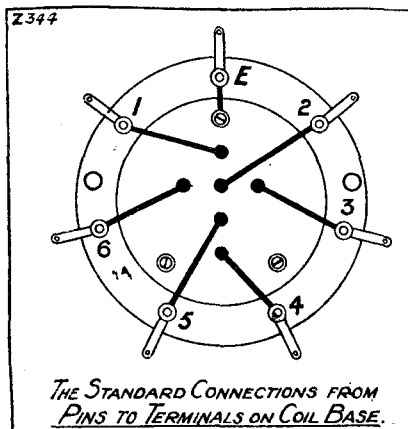

been recognised for some time. It is obvious, however, that the possible number of the arrangements of six connections is somewhat large, and unless certain standard types are decided upon there is a real danger of chaos in the coil world. There are various sets, of course, which require special coils, and to a large extent depend upon them for the good results they give, but the vast majority of screened-coil sets employ the standard types.

Some useful data for the winding of standard types.
By L. H. THOMAS.

Dealing first with the simplest type, the aerial coil, we have the connections to the base as shown in Fig. 1. These connections, in fact, are standard for all bases sold at present. The connections from the actual windings to the pins on the plug-in former, for the aerial coil, are shown in Fig. 2. It will be seen that the whole winding is arranged to come across pins 1 and 2, and the two tappings—arranged as on the well-known "X" coils—to numbers 3 and 4. The formers throughout have a diameter of 2 in., and the wire used in this case is No. 30 D.S.C. 90 turns of this wire are wound on, and the tappings are taken at 10 and 15 turns. The whole winding

should be spaced 40 turns to the inch. The object in providing two tappings is, of course, to make the coil suitable for adaptation to different lengths of aerial.

The winding mentioned, when tuned by a .0005 variable condenser,

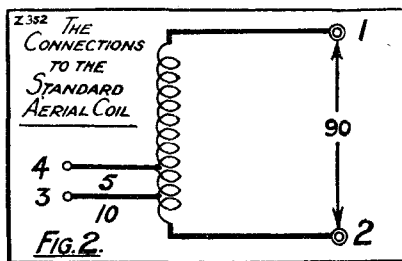

should tune approximately from 250 to 550 metres, which includes all the well-known broadcast stations on the lower band.

For the Daventry range the aerial coil should be wound with No. 40

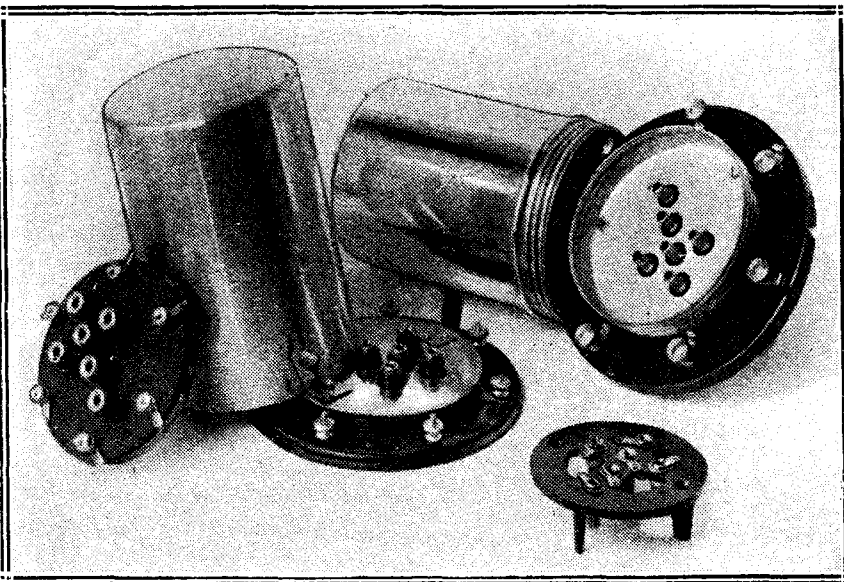

Some typical six-pin bases and screens.

Make Your Own Screened Coils—continued

S.S.C. wire, unspaced; 300 turns are needed, with tappings at 30 and 50 turns. The connections, of course, remain the same.

"Split-Primary" Transformer

We now come to the split-primary transformer, usually used in conjunction with an aerial coil. The arrangement of the windings is shown in Fig. 3. It will be seen that there are four windings in all, and two formers, fitting tightly one inside the other, are used. The outer former is of the standard 2 in. size, and the inner one

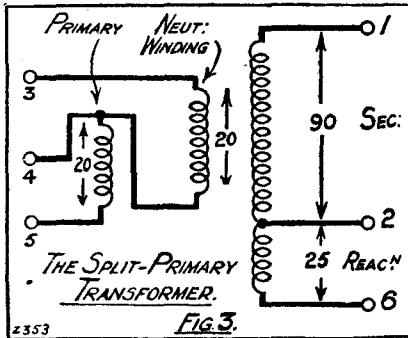

the primary winding is connected to the other end, i.e., the bottom of the neutralising winding, and the common connection is taken out to pin 4. The reaction winding, which is really a continuation of the secondary, is also wound on this small former, below the primary and neutralising windings. It consists of 25 turns of No. 30 D.S.C. The whole former is then arranged so that the primary winding comes exactly in the centre of the secondary winding when the inner former is slid into position.

For the Daventry range, the details for split-primary transformers are as follows: Secondary, 300 turns of No. 40 S.S.C. unspaced. Primary and neutralising windings, each 75 turns of No. 36 D.S.C., and the reaction winding, 100 turns of No. 36 D.S.C.

The Split-Secondary Method

The circuit diagram in Fig. 4 shows a typical H.F. stage employing split-primary coupling, and the connections for the split-primary transformer and the aerial coil are clearly shown.

The reaction winding on the split-primary transformers is only used when "Reinartz" type reaction is required on the detector valve. When no reaction is to be incorporated, or some other form employed, pin No. 6 is simply left blank. The winding is now incorporated in all split-primary transformers simply for the sake of standardisation, although it was omitted in some of the earlier products.

The next transformer to be considered is the "split-secondary" type. The connections to the windings are shown in Fig. 5. The primary winding consists of 20 turns

on an inner former as before, the beginning being joined to pin No. 1. In connection with the designation "split" secondary it will be noticed that the secondary consists of two entirely separate windings. These

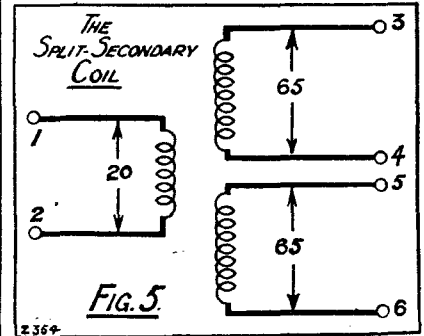

are wound almost as one continuous winding, the gap between the end of the first and the commencement of the second being only $\frac{1}{8}$ inch or less. Each of these sections consists of 65 turns of No. 28 D.S.C. wire wound unspaced on a 2-in. former. The end of the winding nearest to the top of the former is taken to pin 3. This winding is intended to tune over the 250-550 metre range when shunted by a .0025 condenser only.

has a diameter of $1\frac{1}{8}$ in. The secondary winding on a split-primary transformer is identical with the winding of an aerial coil, without the tappings, i.e., it consists of 90 turns of No. 30 D.S.C. spaced 40 turns to the inch. The primary winding and neutralising winding are similar, and both consist of 20 turns of No. 30 D.S.C. wound on the small inner former. The neutralising winding is wound on first, then covered with a layer of Empire tape, and the primary winding is wound directly over it, so that the start of the primary is above the start of the neutralising winding. The start of

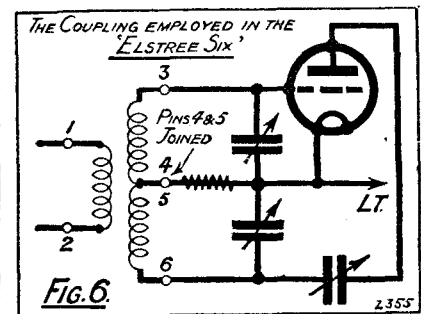

This is, of course, equivalent to tuning each half of the winding with a .0005 condenser, which is really done in the well-known "Elstree Six" circuit, the coupling employed being shown in Fig. 6. Where a centre-tap only is required, as in this case, pins 4 and 5 are, of course, joined together, but it is sometimes useful to be able to use each winding separately. The primary winding consists of 20 turns of No. 30 D.S.C. wound on a $1\frac{1}{8}$ -in. former arranged to come in the centre of the secondary.

For Daventry, the details of this coil are: Secondary, two windings of 215 turns of No. 40 enamelled wire.

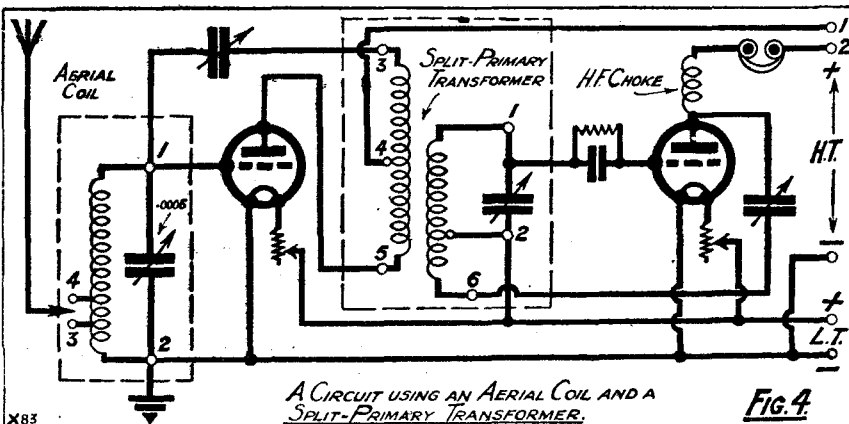

Make Your Own Screened Coils—continued

Primary, 75 turns of No. 36 D.S.C. Both these windings are unspaced.

The aerial coil employed when split-secondary neutralisation is used is a standard split-secondary transformer, the primary winding serving for the aerial circuit.

The Reinartz Coil

It will be seen that where capacity reaction is to be employed, a split-secondary coil may be used, the centre-tap being used as such. Reaction will, however, be rather "fierce," since the winding used for reaction will have the same number of turns as the grid circuit, i.e., 65 for the broadcast range. To surmount this difficulty, the Reinartz

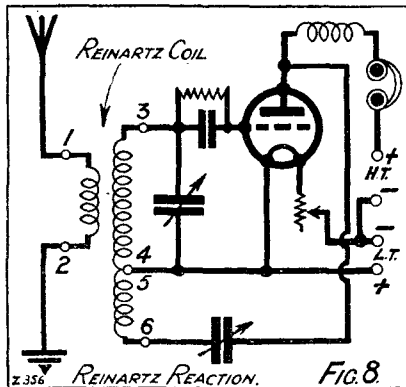

coil has been designed, and consists of a split-secondary transformer with the lower section of the secondary replaced by a special 25-turn reaction winding of the same wire and spacing.

The connections are exactly the same as for the split-secondary transformer. For the Daventry range, the reaction winding consists of 100 turns of No. 36 D.S.C. Whereas in the case of the split-secondary coil each half was supposed to tune with a .0005 condenser—or a .00025 condenser across the whole coil—one .0005 condenser across the 65-turn portion of the Reinartz coil is sufficient. The smaller—reaction—winding is, of course, that connected across pins 5 and 6.

Two possible circuits in which a Reinartz coil may be employed are shown in Figs. 7 and 8; the Fig. 8 circuit may be obtained also with a split-primary transformer, all the connections, of course, being different, but for the Fig. 7 circuit a Reinartz coil is essential.

No doubts should now exist in readers' minds as regards the coil that is needed for any particular

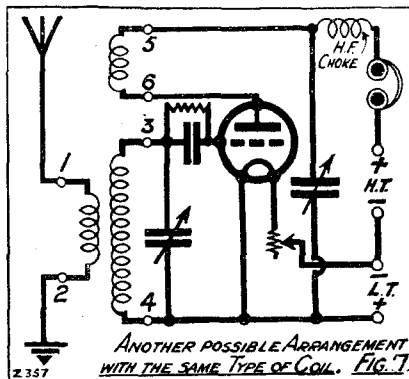

circuit, and these four standard types may be used for such a wide variety of purposes that it seems unnecessary to describe any special coils.

**ANOTHER READER'S
 RADIANO RESULTS**

STR,—I am afraid that I cannot make you a report in the technical sense, as I am only an amateur, to whom the "Radiano" system of wiring makes the hobby of wiring up a set possible.

I can, however, say, that the "Radiano Three" is just what I

wanted, and the results given are excellent. We commenced wireless with a crystal set, which was improved, and then graduated to a one-valve set which was improved from time to time, with graduation to a two-valve set. At the time we were considering rising to a three-valve set to operate a loud speaker for "family use," your article and blue print appeared in "W.C.," and was hailed with delight. We built it right away, and are more than satisfied with the results. We desired a set to give us Daventry and local stations on the loud speaker, and we have got it. We can get a number of foreign stations if we desire, but we do not.

The only difference in the components used is that we put in the set a .0005 variable condenser for reaction tuning (as we had this on hand), and this possibly accounts for the fact that we do not tune in any other English stations other than Daventry and the locals (Cardiff and Bournemouth).

We made the layout a little different so as to have the coils outside the cabinet, where they are a little more readily accessible.

Our aerial is a double one of about 40 feet, but we are proposing to convert this into a single one of about 80 feet in length in the future.

Yours faithfully,

C. W. F.

Yeovil.

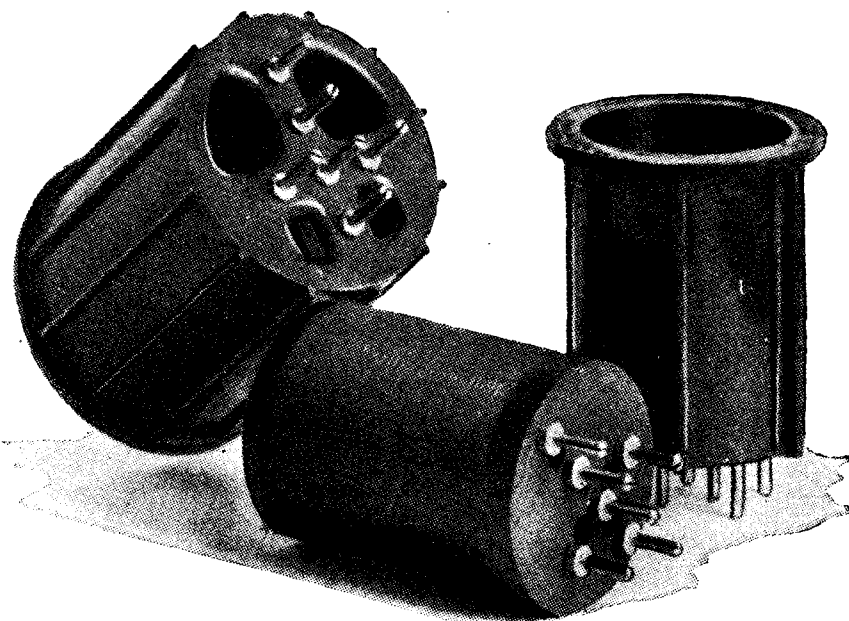

Six-pin formers ready for winding can be purchased in wide variety.

HINTS FOR AMATEURS

*Frayed 'Phone Leads—An Accumulator Idea—An Unexpected Trouble—
Dealing with Spilt Acid.*

Frayed 'Phone Leads

ONE of the minor annoyances to which the radio amateur is subjected is that of the persistent fraying of the cords of some makes of headphones. The trouble occurs particularly at the junction of the cords and the metal connecting tips.

'Phone leads which have frayed in this annoying manner generally develop more serious troubles, for the fraying of the outer covering of the leads gradually extends, with the result that the fine, flexible strands

considered. Ordinary electric lighting flex of good quality can be used, but I have a personal dislike for it, partly because of the readiness with which the outer covering of braid becomes frayed, exposing the rubber insulation to possible damage. The material which I prefer to use for the battery leads is the heavy rubber-covered single flex which is sold for indoor aerials and earth leads. The rubber of this is durable, and so long as a sufficiently heavy gauge of stranded wire is chosen, the ohmic resistance of a considerable length of it is negligible.

Unfortunately the twin-cored wire of this type is expensive compared with the single, and also is not so generally useful in the wireless workshop. Merely twisting two strands of the single wire together is unsatisfactory, because it

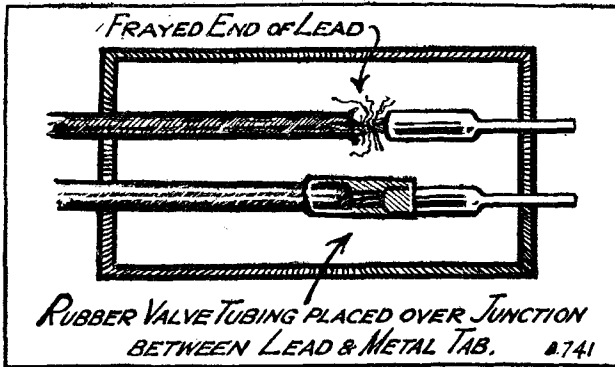

of wire become exposed and eventually break.

A good method of nipping this trouble in the bud is illustrated above. Procure a few odd lengths of ordinary bicycle valve tubing, and carefully work a piece of the tubing over the metal tip of the 'phone leads until the frayed outer covering is concealed.

In this manner any further fraying will be stopped, and when, eventually, the rubber valve tubing deteriorates another piece can readily be substituted for it.

'Phone cord junctions which are treated in this manner may be kept in good condition almost indefinitely.

An Accumulator Idea

THE best position for the accumulator when it is in use with a receiver is undoubtedly the floor, especially if it is of large ampere-hour capacity. It can then be put out of the way in a corner, and there is less risk of acid finding its way where it is not wanted. The provision of leads to the set has then to be con-

sidered. Ordinary electric lighting flex of good quality can be used, but I have a personal dislike for it, partly because of the readiness with which the outer covering of braid becomes frayed, exposing the rubber insulation to possible damage. The material which I prefer to use for the battery leads is the heavy rubber-covered single flex which is sold for indoor aerials and earth leads. The rubber of this is durable, and so long as a sufficiently heavy gauge of stranded wire is chosen, the ohmic resistance of a considerable length of it is negligible.

In addition to the two lengths of rubber flex you will need a length of stout cord. With this and the two wires a neatly plaited "battery cord" can be made up in a few minutes.

An Unexpected Trouble

A RECEIVER with neutralised high-frequency stages in which the neutralisation is not complete can cause a great deal of annoyance to its owner. Sometimes a setting of the neutralising condensers can be found which is correct for one position of the tuning condensers, while a change in the wave-length sets one or more of the H.F. valves into oscillation. I experienced this trouble recently in a receiver using standard screened coils, which should have been perfectly stable over its whole tuning range.

The omission of the shunting condensers across the H.T. battery was found to be the cause of this defect. In this particular case the filament current was supplied from 50-volt lighting mains, a potentiometer being employed in order to obtain the correct voltage tapping for the valves. From the positive end of the potentiometer a lead was taken to the negative terminal of the H.T. battery, the first 50 volts H.T. being supplied in this way. The lack of any shunting condenser across the potentiometer produced all sorts of queer effects in the receiver. Not only would it not neutralise properly, but at certain settings of the tuning condensers a loud howl was set up and the receiver was quite uncontrollable.

The inclusion of fixed condensers of 2 mfd. capacity across the potentiometer, and also across the sections of the H.T. battery proper, at once put matters right. It is significant that the H.T. battery was quite new, and that therefore the trouble was not entirely due to the high internal resistance which sometimes gives trouble with a battery which has been in use for a long time.

Dealing with Spilt Acid

ON those dreaded occasions when one spills accumulator acid upon the carpet, or upon one's clothes, trying to remove the acid with a damp cloth is useless. Indeed, the reward for such labours is a red-ink coloured patch which falls away into a hole in the course of a few days. What, then, can be done?

When the acid has suitably spread itself in the most inconvenient manner sprinkle finely powdered washing soda over the patch, rubbing the powder well into the carpet or cloth as befits the case, and then leave it until all gassing has ceased. Ordinary chalk (carbonate of lime) is another useful neutraliser. In cases where fairly concentrated acid is being handled, and has been spilled upon the hands, it is usually best to wash them at once in a copious supply of water and then to wash them again in a weak ammonia or weak washing soda solution. If burns have been received, carefully dry and apply caron oil. Though this latter remedy applies mostly to concentrated acid, the usual battery acid is easily got rid of by washing the hands in running water and then lathering well with soap, which latter usually contains sufficient alkali effectively to neutralise the acid.

SOME CURIOUS RHEOSTAT ARRANGEMENTS

IN the previous article under the above title a number of arrangements of resistance elements were shown, by means of which various manipulations of the filament-resistance value could be obtained.

Since the last article appeared many readers have found it interesting to work out all sorts of resistance arrangements, using two or more

In this concluding article the various arrangements are developed in a very interesting manner.

**By Dr. J. H. T. ROBERTS,
F.Inst.P.**

the connecting together of the two ends of the rheostat has rather a curious result, for it means that the two parts of the resistance element (to the right and to the left of the slider) are in parallel. Therefore, as the slider is moved, one of these increases whilst the other at the same time decreases. Starting from the left-hand position the resistance is, of course, zero, and as the slider is moved in a clockwise direction the resistance (which, as stated, is equal to the two portions of the resistance element in parallel) gradually increases in value until the slider reaches the (electrical)

the mid-point of the resistance element, so that the slider cannot go beyond that point, then the rheostat acts like an ordinary one, gradually increasing from zero to a maximum.

If instead of connecting together the two ends of the resistance element by means of a piece of copper wire,

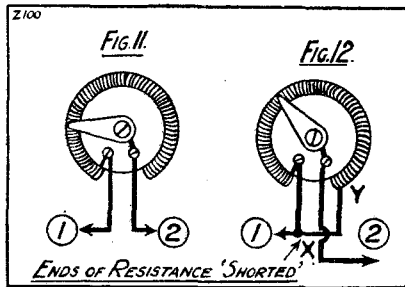

resistance elements grouped and arranged in various ways, so as to obtain all kinds of values and adjustments. Probably by now many of you will have also worked out some of those which are about to be described in the present article.

With An Ordinary Rheostat

In Fig. 11 is shown diagrammatically an ordinary rheostat with a single resistance element laid in a groove around a circular former, the terminals being at (1) and (2).

In Fig. 12 is shown the same arrangement except that the ends of the rheostat are connected together,

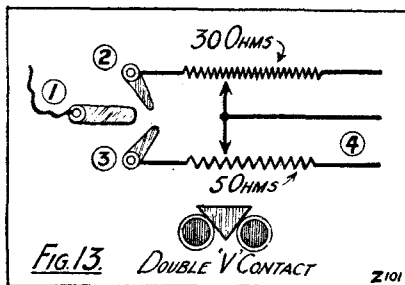

the terminals being at the positions shown at (1) and (2). If you consider this for a moment you will see that

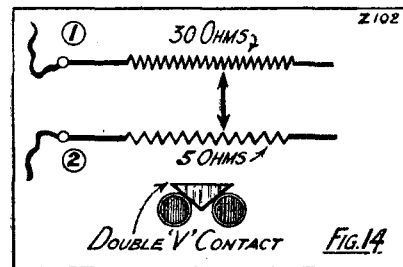

mid-point of the resistance element, after which the nett resistance gradually decreases down to zero when the right-hand zero-point is reached. If a mechanical "stop" be placed at

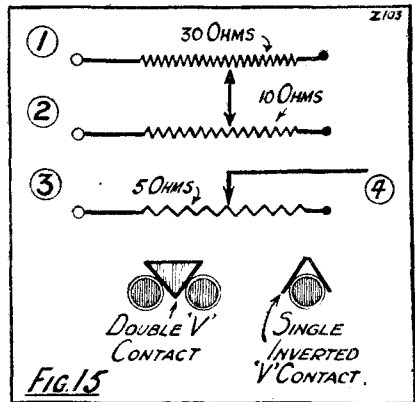

another coil of resistance wire be used to connect the ends together (between X and Y), the maximum resistance-point for the slider will be shifted towards the right-hand end of the main resistance element. The reader will find it interesting to work out the position of the maximum resistance-point when resistances of different values are connected across the two ends of the main resistance element.

Two Separate Elements

Fig. 13 shows an arrangement of two separate resistance elements

* *

A variable fixed filament resistor which could be arranged as in Fig. 12;

* *

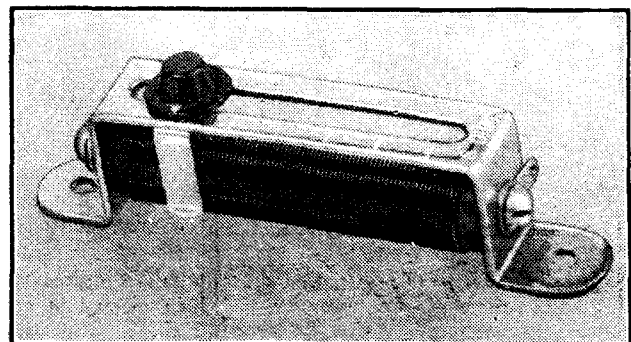

Some Curious Rheostat Arrangements—continued

mounted side by side in grooves around a circular "former" (or otherwise) with a common slider making contact with the two. One of the terminals of the rheostat is at the position marked (1) and this is connected to a contact which may be reached by the switch (2), or by the

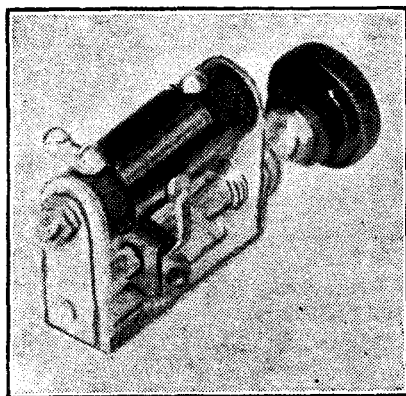

A filament rheostat having a double form of contact.

switch (3), or by both switches (2) and (3) simultaneously. Now let us see what happens when the different arrangements are used. If switch (3) is disconnected from the central contact (1), and (2) is connected to (1), we have a single 30-ohm resistance element in use, the other element being idle. If (3) is connected to (1), and (2) is disconnected, we then have

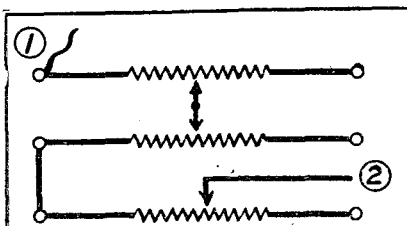

Fig. 16.

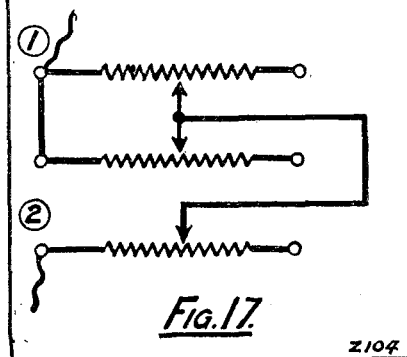

Fig. 17.

Z104

a 5-ohm resistance element in operation, the other element being idle.

If (2) and (3) are both connected to (1), we have the 30-ohm and the 5-ohm elements in parallel.

Fig. 14 shows two resistance elements of widely different values, say, 30 ohms and 5 ohms for the sake of example, with a common slider operating upon them both simultaneously and with the terminals at the positions (1) and (2). With this arrangement it is evident that the resistance in circuit is the sum of the two portions to the left of the slider, these being in series, the portions of the resistance elements to the right of the slider being idle, or "dead ends."

Three Elements in Use

Now we come to the use of three resistance elements instead of two, and here we at once obtain a considerably greater variety of possible permutations and combinations. For the sake of simplicity, values of 30 ohms, 10 ohms, and 5 ohms have been taken. In Fig. 15 these three elements are shown diagrammatically with a common slider between the 30-ohm and 10-ohm elements, and a separate slider on the 5-ohm element.

Turning now to Fig. 16 we see that if one terminal is connected to the position (1) and the other to the slider marked (2) the resistance in circuit will be equal to that portion of the top resistance element which is to the left of the slider, in series with that portion of the middle resistance element which is to the left of the slider, in series again with the portion of the lower resistance element which is to the left of the slider (2). I forgot to say that to secure this condition it is necessary to connect across the left-hand ends of the middle and lower resistance elements.

Further Complications

Fig. 17 shows one terminal at the position marked (1), the other terminal at the position (2), and the left-hand ends of the upper and middle resistances connected together and disconnected from the lower element, whilst the common slider between the upper and middle elements is directly connected to the slider on the lower element. Here a moment's consideration will show that the resistance in circuit is equal to the left-hand portions of the upper and middle

elements, these being in parallel, and the left-hand portion of the lower element being in series with the

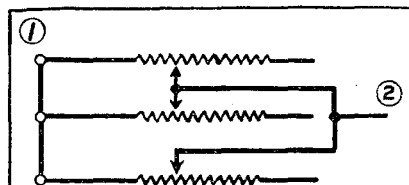

Fig. 18.

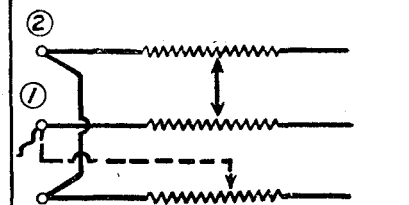
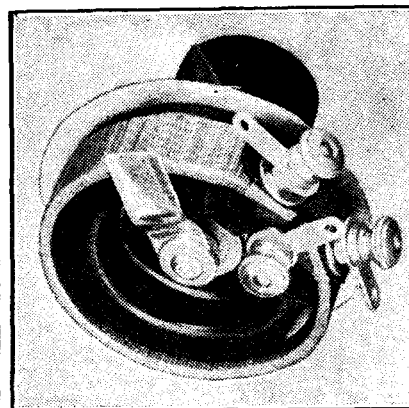

Fig. 19.

Z105

resultant of the operating parts of the other two in parallel.

In Fig. 18 another arrangement of the three elements is shown, the left-hand ends of the three elements being all connected together and to one terminal, whilst the common slider and the single slider are connected together and represent the other terminal. Here the resistance



A potentiometer is provided with connections at each end of its winding.

in circuit is the resultant of the left-hand, or operating portions of the whole three elements in parallel.

In Fig. 19 the left-hand ends of the upper and lower elements are connected together and represent one terminal of the rheostat, whilst the left-hand end of the middle element is connected to the other terminal of

(Continued on page 288.)

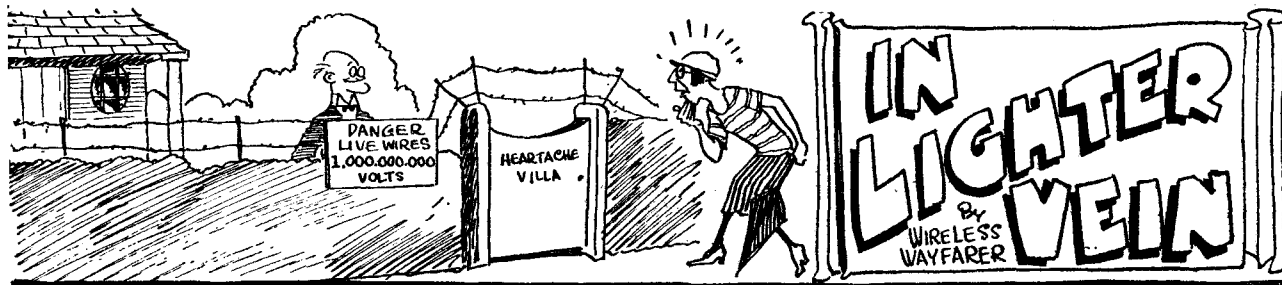

MISS WORPLE'S feelings when Professor Goop squatted in her house and turned her out are probably better imagined than described. Certainly she found herself torn by conflicting emotions; on the one hand she desired to retain so eminent a wireless authority as the professor permanently at Mudbury Wallow; on the other, she



"Myself, my wife and our nine children"

would much have preferred that he had descended on somebody else's house rather than her own. She would, I think, have made an attempt to evict him had not the Professor, after installing Mrs. Goop and the Micro-Goops on the following day, erected a wire entanglement round the garden, decorated with terrifying notices like this:

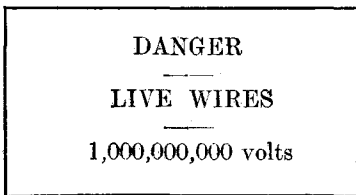

She managed, however, to interview Professor Goop one day by following him into the emporium of Mr. Snoopham, our most eminent bootmaker, whither he had betaken himself in order to buy a ham. Mr. Snoopham was engaged in telling the professor that he did not sell hams, and the professor was engaged in telling Mr. Snoopham that it was a crying scandal that he should not do so, when Miss Worple thrust in between them.

"I want my house," she snapped.

"You can't have it," resnapped the professor.

"But it's mine," cried Miss Worple.

"My good lady," said the professor

amiably, "it is an accepted maxim in this great and free country of ours that possession is nine points of the law. Myself, my wife, and our nine children are undeniably in possession of the premises. Eleven individuals at nine points each gives a total of ninety-nine, leaving one per cent. for your good self. You will perceive at once that you have not a leg to stand upon."

Miss Worple was beginning to say quite a lot when the professor shushed her into silence.

Exchange No Robbery

"An equally good maxim," quoth he, "is that which says that exchange is no robbery. I require this house at Mudbury Wallow; in return I will give you the house which I have just vacated at Little Puddleton."

Miss Worple protested that she desired to live at Mudbury Wallow, and to this the professor retorted that he could see no reason whatever for her doing so.

"So far as I am concerned," he remarked, "the matter is now at an end. These unseemly squabbles are most upsetting, and I trust, dear lady, that you will not further disturb my peace." He raised with a courtly bow the coil screen that he had inadvertently donned instead of a hat when leaving home, and skilfully edged her out of the door of the shop.

When I found him a few minutes later, he was engaged in explaining to Mr. Snoopham, who is not strictly



He raised the coil screen inadvertently donned instead of a hat.

speaking a wireless expert (since he has never yet bought the crystal set that he frequently tells his friends that he intends acquiring) exactly how a super-heterodyne does its work. "This boot," he was saying,

"represents the oscillator, which is tuned by means of the coil, represented by this gent's Oxford, and the condenser, which I will indicate by this tin of dubbin; it is connected (here the professor possessed himself of a bundle of bootlaces) by leads which run thus and thus and thus."

He was immersed in making a hook-up with elastic-sided boots, trees, tins of Blanco, polishing pads, rubber heels, and bottles of patent polish, when I dug him gently in the ribs with a bootjack and reminded him that he was due in a few moments at Captain Bucket's to demonstrate his latest, and naturally greatest, invention, the No. 4,765 Loud-speaking Crystal Set.

I should remark here that it is obviously desirable that every new

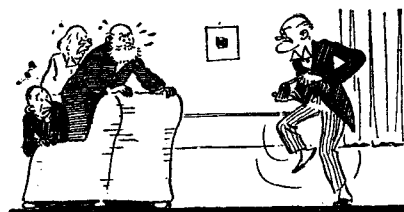

—pulled from his pocket a round object—

set should be given a name in order to facilitate reference to it at future times. Mr. Hercy Parris, however, has made such a complete corner in names that none now remains available sufficiently striking to describe apparatus developed by geniuses of Professor Goop's calibre. In recent years, for example, Mr. Parris has given us "The White Knight" (complete with moustrap), "The Jaeger Four" (for those who like woolly reception), "The Musical Box," "Tatcho, the Siamese Twin," "The All-Catcall Five," "The Owl" (a single-valver), "The Nightjar," "The Banshee," "The Twiddly Two," "The Thrilling Three," "The Fearsome Four," "The Frantic Five," and "The Syrupy Six." In the circumstances, it will be seen that nothing was left for the professor and myself but to resort to numbers. So far has this cornering of names gone that the professor was advised

In Lighter Vein—continued

by an eminent legal authority that it would be better for him not to use the term "Spadiano" for his new and highly efficient earth connection, consisting of a sardine tin provided with a terminal and buried some fifteen feet beneath the surface of the soil.

"Simplified" Hale

We have, however, decided to add to the No. 4,765 the description "Shortpath," for the professor's whole idea in simplifying the Hale circuit was to make the wiring connections much more direct. Reference to the attached theoretical diagram will show how nobly he has succeeded in his efforts. If the components are laid out upon the base-board in positions similar to those indicated in the diagram, and if the wiring is faithfully imitated, it will be found possible to make every single connection in the receiver with less than fifteen coils of Glazite, provided, of course, that the constructor exercises reasonable care, and does not waste too much in odd snippings.

Arrived at Captain Buckett's, the professor hastened to disarm criticism by admitting at once that his crystal

set contained a valve. Primpleson objected that in that case it could not fairly be called a crystal set, but receiving from the professor a well-aimed H.T. battery, which caught him upon the fifth waistcoat button, he developed an audio-frequency howl, and could not be stabilised until heavy damping had been introduced with the aid of a bucket of water.

"This set," cried the professor, "contains a crystal; therefore it is a crystal set. As you shall presently hear it operates a loud speaker; therefore it is a loud-speaker set. I will now proceed to demonstrate its wonderful capabilities."

Aided by Primpleson, Foogle, Captain Buckett, and myself he thereupon embarked upon an exhaustive test, the results of which are set out in the following remarkable report:

STATIONS RECEIVED.

CONDENSER READING.	STATION.
0	FFB§
3½	Bombay*
9	FFB§
17	Tokio*
23	FFB§
29	Yupushoff*
34	FFB§

CONDENSER READING.	STATION.
46	Pekin*
58	FFB§
64	GNF§
69	FFB§
78½	Rio de Janeiro*
82	FFB§
94	Dawson City*
100	FFB§

* Not definitely identified.
§ Full loud-speaker strength.

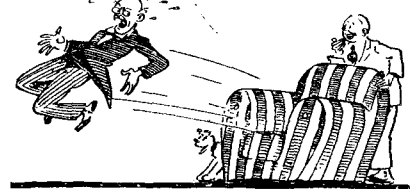

The Wayflaver Ejector Drawing Pin.

A glance at the stations brought in will suffice to show that the popularity of the Goop Shortpath circuit is assured. For years designers of receiving sets have received, from readers, bitter complaints that that splendid station FFB could not be tuned in despite the most strenuous efforts to do so. Such are the sensitiveness and selectivity of the Goop No. 4,765, that FFB can be heard to perfection at practically every setting of the tuning condenser, for the supreme difficulty has been surmounted. Unlike most stations, FFB has no definite wave-length, but skips about all over the place, transmitting not upon a wave-length but upon a wave-band.

Interference from Broadcasting

With ordinary receivers FFB's transmissions are quite spoilt at times by interference from such stations as Belfast, Newcastle, Birmingham, Milan, Breslau, and others, but with the Goop Shortpath perfect reception is guaranteed at all times.

The demonstration passed off swimmingly, but a kind of electric thrill ran through his audience when the professor said, as he switched off:

"Now, I don't want to hurry any of you dear people away, but I really must settle down at once to tackle a problem which has just been sent to me by a correspondent."

"But," protested Captain Buckett, "all these fellows are going to spend a wireless evening with me; surely you will do your problem tackling at Miss Wor—, that is to say at your own house?"

(Continued on page 287.)

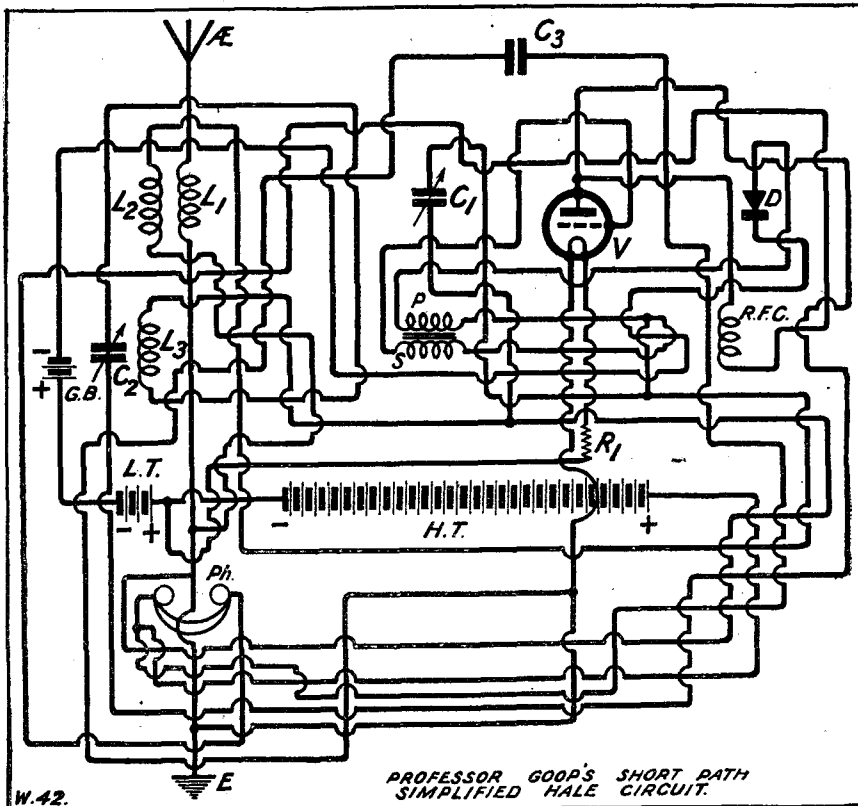

W.42.

WITHIN THE VACUUM

By KEITH D. ROGERS.

(Asst. Technical Editor of "Popular Wireless.")

✱

In spite of many assertions to the contrary, R.C. amplification with pure reproduction is not easy to obtain unless great care is taken in the design and construction of the amplifier.

✱

So much has been written lately about resistance coupling that I feel rather dubious about reopening the matter—indeed, my only excuse for so doing can be found in the letters I have received on the subject from readers. Apparently many are confused about the various values of impedances, magnification factors of the valves, and the coupling-condenser values, resistances, etc.,

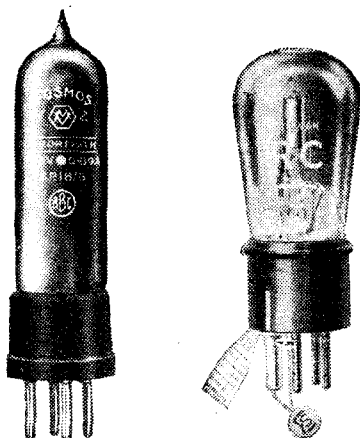

Two early 2-volt R.C. valves—the Cosmos SP18B and the Ediswan R.C.2

that go to make up an R.C. amplifier, and I am constantly asked "In what way are all these factors related?" or "How are we to choose the best values from the variety at our disposal?"

Straight Line Amplification

It is a bit muddling, isn't it? So perhaps you will forgive me talking in more or less non-technical language in an endeavour to clear up some of the doubts that seem to exist among many of my readers.

The main idea behind the use of resistance-capacity coupling is "straight line" amplification, or in other words, pure reproduction and equal magnification of *all* the musical notes. Now, without being a pessimist, let me say at once that up to the

present that is *not* possible even in a good amplifier, while in a badly designed amplifier the reproduction can be simply frightful.

The Relative Values

It all depends on the relative values of the parts used for the intervalve coupling, as well as on the valves themselves. For full amplification and good quality we need a valve with a high magnification factor, together with a high anode resistance—one having about three times the A.C. resistance of the valve. If too high a value is taken for the anode resistance the amplification curve falls off

out the amplification by the following formula :

$$\text{Amplification} = \frac{R_1}{R_1 + R_v} \times \mu$$

where R_1 = the effective resistance of the anode resistance (which should also take the grid leak following it into consideration) and R_v is the working impedance of the valve ; μ is, of course, the amplification factor of the valve.

Cutting Off the Top Notes

For some cases where very high resistances are used in the anode circuit, say .5 to 1 megohm, the R_v becomes higher and may reach four

✱

An interesting demonstration of valve making was recently given in one of the windows of the Ediswan showrooms in London.

✱

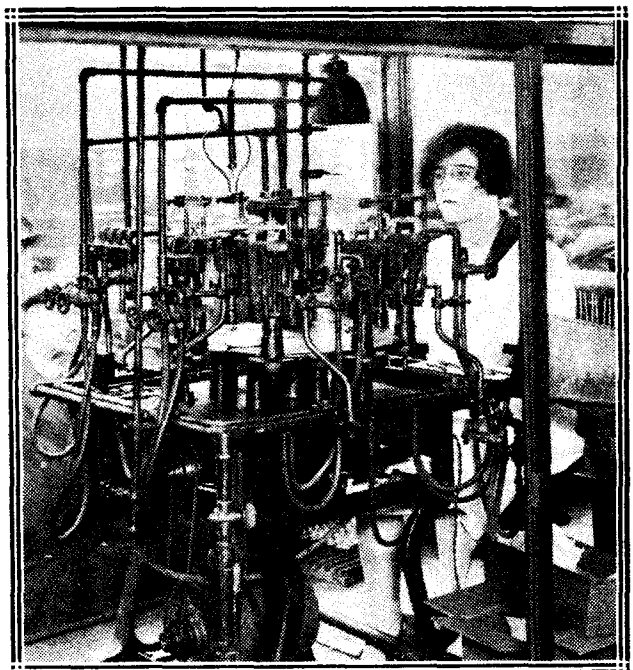

at the higher end, and we lose some of the higher frequencies and the reproduction suffers thereby.

A general rule for determining the amount of amplification obtained from a valve is to double its impedance as given by the makers in order to obtain a rough idea of the working or effective impedance, and then work

or even five times the R.C. resistance of the valve as stated by the makers. The case where double that figure is taken is a normal one where the anode resistance is about 250,000 ohms—a very useful value, in my opinion.

If a valve of the standard R.C. type ($\mu = 35$ and impedance of 75,000 ohms) is used very useful amplification and

Within the Vacuum—continued

pure results can be obtained with the anode resistance stated. This may be increased to 500,000 ohms, if desired, but then the working impedance of the valve will go up and the amplification curve will tend to drop, giving less amplification on the higher frequencies, that is on the top notes of the musical range.

The Anode Resistance

Thus we see that for good amplification we must use a high resistance in the anode, but for pure reproduction this must not be too high.

Now let us see that the other components are suitable—the grid leak and coupling condenser—for the amount of relative amplification of the various musical frequencies can be controlled by the value of the coupling condenser as compared with that of the grid leak.

This may sound absurd, but it is true, for the larger the coupling condenser the less its impedance and the more will the low frequencies be amplified. For best results the grid leak should be three or four times the resistance of the anode resistance preceding it, otherwise the full amplification possible will not be obtained, for consideration shows that the grid leak is in *parallel* with the anode resistance.

Correct Balance

This means that the grid leak can vary between 0.5 and 5 megohms for average purposes. Now, as we cannot obtain absolutely even amplification over the whole range of musical frequencies, we must compromise according to our taste. Remember, we drop a *little* on the high frequencies by reason of using a high anode resistance; this is not noticeable in the average speaker, however good it may be, but what about the low notes?

If we lower the impedance of the coupling condenser (increase its

capacity), we shall have to reduce the grid-leak value, otherwise distortion will result, but the lower we go with the grid-leak value and the higher with the condenser, the more will the low frequencies be amplified when compared with the higher ones.

The amount to which this can be carried out with success will depend on your loud speaker. If this will not reproduce the low notes there is no use in having them present in the amplifier, and so you can let the higher notes have full play and keep the size of coupling condenser small and the grid leak large in value, thereby obtaining a greater amplification over the frequencies that your loud speaker will reproduce.

"Booming" Bass

If you have one of the cone type, or one which reproduces down to 50 cycles or so, then you must lose a little overall amplification in order to provide the loud speaker with the bass it requires. The latter can then be regulated by the sizes of the coupling condenser and grid leak.

If it reproduces the bass too well, and is "booming," then decrease the condenser value a bit and *increase* the resistance of the grid leak. I have used this method of "balancing" with great success in my own sets, which are employed together with a Kone loud speaker.

A rough rule for the average horn type of loud speaker is a coupling condenser of .001 or so mfd. and a leak of 2 megohms. This will give all the bass required, and much of this will not be reproduced by the loud speaker. If more bass should be required, where a cone or similar type of speaker is used, then you can go on to .01 mfd. and .5 megohm for full bass.

Personally, I prefer to moderate the low frequencies more than this latter provides, and use a .002 mfd. condenser for coupling, together with

a 2-megohm grid leak. This gives me somewhere about 75-80 per cent of the full possible amplification, and provides quite enough bass for my Kone. I do not like too much bass, and as another precaution I use a low anode resistance and a valve with a magnification of only 20 instead of one with a high amplification. By this means I keep the high notes as far as possible, a point that is worth noting, for the Kone is not too sensitive to high frequencies. Rough practical details (that may be open to theoretical criticism) are as follows, and may be of use to others starting on resistance coupling.

First Stage.—Valve $\mu = 20$, impedance = 20,000

Anode res. = 250,000 ohms.

Coupling condenser = .003 mfd.

Grid leak = 1.0 meg.

(I find results better with the valve mentioned than with one having a μ of 35 or 30, especially as it is preceded by an H.F. stage.)

Second Stage.—Valve $\mu = 8-10$, impedance = 10,000.

Anode res. = 80,000-100,000 ohms.

Coupling condenser = .006 mfd.

Grid leak = 0.5 meg.

Contradictory Results

As a matter of fact I have tried .001 and .002 mfd. coupling condensers and 2 megohm leaks with the valves and anode resistances mentioned, and have obtained excellent results, though theoretically these leaks are on the high side.

However, I hope the foregoing will assist some of my readers in their troubles, and show that it is worth while "playing about" a little with the values of the components mentioned before blaming all the poor results obtained on the valve.

"His Master's Valve!"

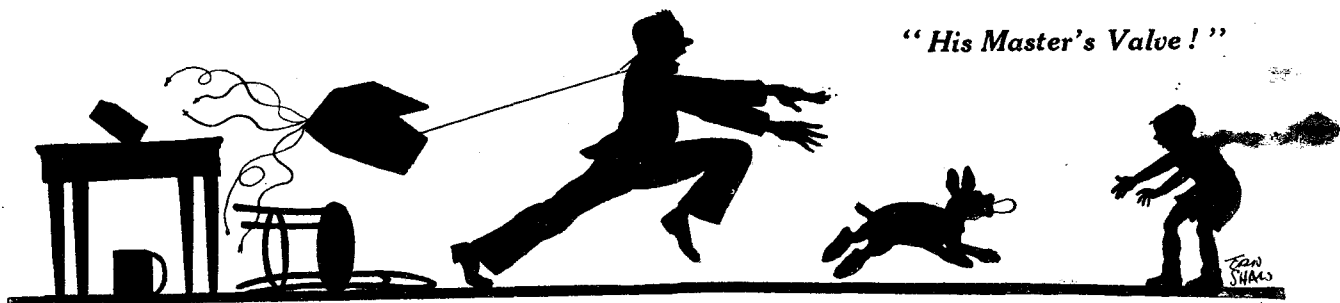

THE QUEEREST FAULT EVER!

How a very mysterious falling off in reception was encountered and remedied.

From a Correspondent.

ONE comes across some strange out-of-the-way faults at times, but I think that the one which happened recently in a set of mine well deserves the title of the queerest ever. Not only was it due to a cause that no one would be likely to suspect, but it was also of a kind practically untraceable by any ordinary test.

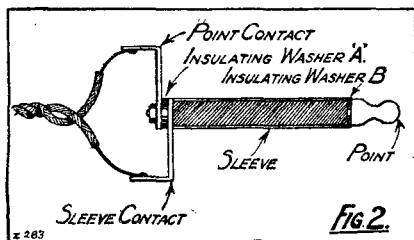

Since it is a fault which might happen to anyone, it may actually be the untraced cause of poor reception in many existing sets.

The circuit of the set in which the mysterious fault occurred is shown in the accompanying diagram. It is a well-known three-valve combination containing a neutralised high-frequency amplifier, a grid-leak rectifier and a transformer-coupled note magnifier. The symptoms were briefly as follow. Normally the set is excellent as regards both range and volume, bringing in a number of stations at good loud-speaker strength. For some weeks a slight falling off had been noticed, but this was put down for want of any other explanation to the lengthening hours of daylight.

Peculiar Distortion

Then one day it was realised that something serious was amiss. Instead of coming in with strength sufficient to overload an ordinary small power valve the local station was barely audible on the loud speaker at a few feet. Any attempt to increase the volume of sound resulted in distortion of a particularly horrible kind.

Naturally the plate and filament batteries were suspected at once, but tests made with a good voltmeter showed that both were fully "up." When a milliammeter, shunted by a

large condenser, was placed in the common H.T. negative lead the total anode current was found to be much as usual, but the needle, instead of remaining steady, kicked violently even when signal strength was small, showing all the signs indicative of valve overloading. This led one to test the grid battery which, like the others, was found to be in first-rate condition.

Perplexing Mystery

This was perplexing enough, but the mystery deepened when further tests were made. Each valve in turn was replaced by a brand new one without there being any difference in results. The L.F. transformer was tested and not found wanting.

Was there something wrong with the earth? Investigation showed that all was well here. The aerial, with its connections, was similarly absolved from blame. The filament circuits, including the fixed resistors, were next tested out and found to be in perfect order. Megger tests of the valve holders proved that they were inno-

whether a burn-out or a short had occurred in them. No defect of any kind could be found here. Every wire in the set was gone over with the utmost care, all screw-down connections being found tight, and such few soldered joints as there were in good order.

Having read so far, cover up the remainder of the article and see whether you can fathom the cause of the fault, or suggest any other steps that might have been taken to trace it. I am open to wager that not one reader in ten thousand will arrive at the correct solution. To assist you in your labours let me repeat that the defect was actually found to be in about the last place that anyone would expect to find it!

The L.S. Plug

Here is what actually happened. The only portion of the apparatus that did not seem to have been tested was the plug used for connecting the loud speaker to the set by means of the jack shown in the theoretical diagram.

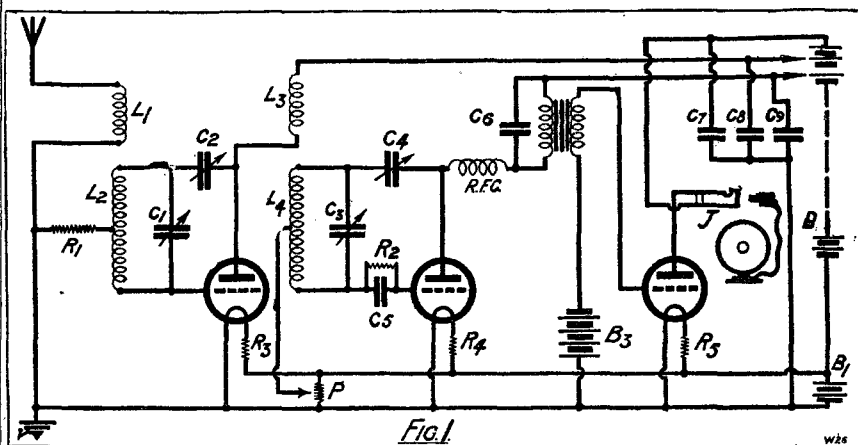

cent of any insulation leakage. Each of the condensers was next subjected to examination without anything amiss being discovered.

The coils, including the radio-frequency choke, gave similar negative results when tested for faults, as did the resistance R_1 and the grid leak R_2 . As a last hope the windings of the loud speaker were tested to see

The ordinary plug is a simple affair in which there appears to be nothing that is likely to go wrong. Fig. 2 shows its construction diagrammatically. The rounded point is attached to a metal rod, which passes through an insulating tube contained inside the metal sleeve. Between the point and the end of the sleeve nearest to it there is an insulating washer, and a

THE QUEEREST FAULT EVER!

—continued

second insulating washer, through which the insulating tube passes, is placed between the two contacts. One of these is connected directly to the sleeve, whilst the other is forced against the insulating washer marked A in the drawing by a nut screwed on to the end of the rod attached to the point.

Faulty Insulation

Tests made with a milliammeter and a portion of the H.T. battery showed at once that the insulation of the plug was defective; there was, in fact, a path of not very high resistance from the point to the sleeve. Actually the insulating washer marked A, which was a very thin one, had broken down, and this was causing all the trouble.

In the output circuit of the last valve the impedance formed normally by the loud-speaker windings was practically short-circuited, which accounted entirely for the loss in signal strength and mainly for the distortion. The kicks shown by the milliammeter were due, probably partly to the upsetting of the balance of the last valve, and partly to the fact that the resistance of the leakage path appeared to be not steady, but varying.

Partial Breakdown

It is quite possible that slight defects in the insulation of plugs—and it may be of jacks also—occur more often than is generally suspected. Those readers who have found a progressive decline in signal strength due to no cause that can be traced, or who are getting somewhat distorted reproduction from sets which should normally be blameless, may therefore be well advised to test out both plugs and jacks.

In certain plugs the washers marked A and B are very thin. A partial breakdown of A might easily occur through the accumulation on it of tiny pieces of metal worn from the point, or from the contact arm of the jack, by the insertion and removal of a tightly fitting plug. In the case of B the trouble might be due to flux splutterings or to little pieces of solder if the leads have been soldered to the contacts.

At any rate, all of this goes to show that no component can be taken for granted when a fault is being traced in the wireless receiving set. Small defects in apparently innocent components may have far-reaching consequences.

A TIP TO VALVE USERS

MANY of the modern valves bear a considerable resemblance to one another as far as external appearance is concerned, particularly valves of the same make but of different type, and in one's hurrying moments it is quite easy to pick up the wrong valve for the work required.

Modern practice in valve manufacture is to etch the details of the valve on the glass bulb, but with many of the valves to-day these details are easily obscured, leaving the valve devoid of any particulars, and unless one remembers these facts confusion may result. To see how easily the etched particulars on the glass may be removed just try rubbing the letters with the finger, when the truth of these remarks will be appreciated.

To avoid confusion in this respect it is a good plan to write out all the details of any indistinctly-marked valve on a piece of paper about an inch square, and to paste this on the outside of the bulb for easy reference.

GUARDING AGAINST LOOSE LEADS

MANY constructors nowadays avoid soldering wherever possible, and use in preference screw-down terminals for making their wiring connections in the receiving set. There is no doubt that if the surfaces of terminals, and of leads, are clean, and if the nuts are screwed really hard down, very satisfactory connections can be made in this way.

A Terminal Tip

The difficulty is to get milled nuts sufficiently tight to make them "stay put." If a lead is gripped by a nut which is merely "finger tight," the pressure upon it is not very big. You may easily test this by turning a milled nut as hard down as you can on to a lead with your fingers and afterwards seeing how much further you can turn it with a pair of pliers. Often you will find that you can give it, at any rate, another complete turn.

For this reason, the writer always removes the milled nuts from the terminals of all components to be used when making up a receiving set, substituting ordinary hexagon nuts for them. With the aid of a box spanner these can be screwed hard down on the leads, and it is seldom that any of them works loose. Where, however, the set is likely to be subjected to much jarring, or shaking, it is as well to take the extra precaution of securing each by means of a lock nut turned hard down upon it. Almost all the terminals that one comes across to-day are either 4B.A. or 6B.A., so that there is no need to get a large variety of nuts in stock in order to be able to effect the substitution of hexagon for milled.



ELECTRIFY YOUR GRAMOPHONE

Getting the best from the New Records.

By HARRY P. WOOTTON.

THE writer is one of those who until recently held the view that no gramophone reproduction could approach the quality perfection of the broadcast entertainment—given, of course, a well-designed set operating a good modern loud speaker. That he has now considerably modified his opinion is due to the introduction of the new electrical recording processes adopted by all the leading gramophone companies, together with the vastly improved reproducing machines which have come into being during the last twelve months or so. Even with the ordinary gramophone the electrical records are a great improvement, but to get the best from them requires a better reproducer and horn than are provided with the older machines.

The wireless experimenter, however, is in a particularly fortunate position, for at a relatively small cost, and by utilising his existing apparatus, he can obtain wonderful reproduction from the new records without going to the expense of buying a high-priced modern gramophone. By following the lines indicated in this article, any reader of this journal who possesses a gramophone which will rotate its turntable evenly can use his existing loud speaker to reproduce the records at any volume he desires. If he is fortunate enough to possess a modern cone-type loud speaker, which will reproduce the lowest tones, he will find that these, too, are present in the new records, and that they are in a large measure the cause of the remarkably natural reproduction which they give.

The "Pick-up"

The heart of the new system is what is called a gramophone "pick-up." This is a small device, in appearance like a gramophone sound-box, which is attached to the sound-arm and carries a needle just as does the ordinary standard reproducer. The sound-arm, however, is not used—it simply serves as a means of carrying the pick-up across the record as it

rotates. The reproduction is purely electrical, as the vibrations of the needle set up minute electric currents in the pick-up, and these are transmitted to the reproducing apparatus along wires from two terminals attached to the body of the "pick-up" itself.

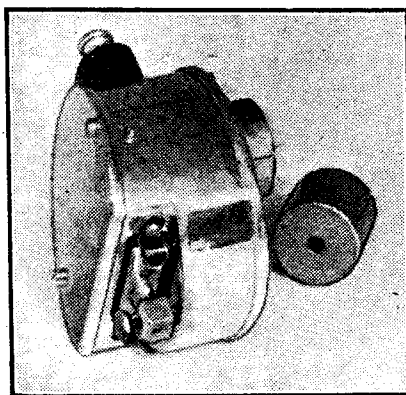

The pick-up used by the author, showing the needle holder and the tone-arm adapter.

Actually these electrical currents are strong enough to be heard clearly in a pair of telephones. It is a most interesting experiment to connect the telephone leads to these two terminals and listen to the playing of

the record as the pick-up travels along its spiral path. If, in place of the telephones, we connect the primary of an L.F. intervalve transformer, we can magnify the reproduction by an ordinary note-magnifying device, using two or three valves according to the volume required. For ordinary home use—that is to say, to give loud-speaker reproduction of adequate volume for the average living-room—two valves are adequate. For dancing purposes in a large room or hall, three valves should be used. The device can also be connected directly to grid and filament of the first valve, thus saving the cost of a first transformer. Incidentally, this latter way is quite safe and is recommended by the makers. The transformer gives a little more volume however.

The Amplifier

For the benefit of those readers who are not experienced in reading theoretical diagrams, two schematic drawings of how to wire up a suitable amplifier for this purpose are given in Figs. 1 and 2. The particular pick-up used in these experiments is that manufactured by Messrs. S. G. Brown, Ltd., the loud-speaker makers. The

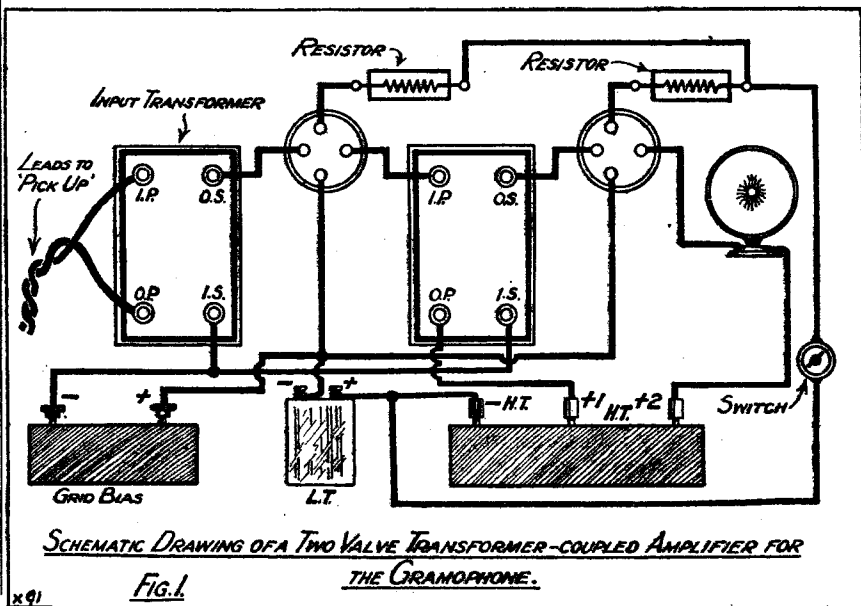

Electrify Your Gramophone—continued

price of this little device is about three guineas. Other makes of pick-up are, or shortly will be, available.

In place of the separate anode resistance, grid leak, and condenser, one of the modern resistance-coupling

second a good small power or super-power valve. If resistance coupling is used, the first valve should be a modern resistance-capacity-coupling valve of one of the leading makes, and the second a small power or, better still, a super-power valve. In either case it is advisable to use a good H.T. voltage, say 120 volts, and to use the grid bias with each valve as recommended by the makers. If, for example, both valves in the transformer-coupled arrangement are of the same type, and you put the same voltage on both, the same grid bias will be needed; but if one is an L.F. valve and the other is a super-power valve, and both have the same anode voltage, then the grid bias will be different.

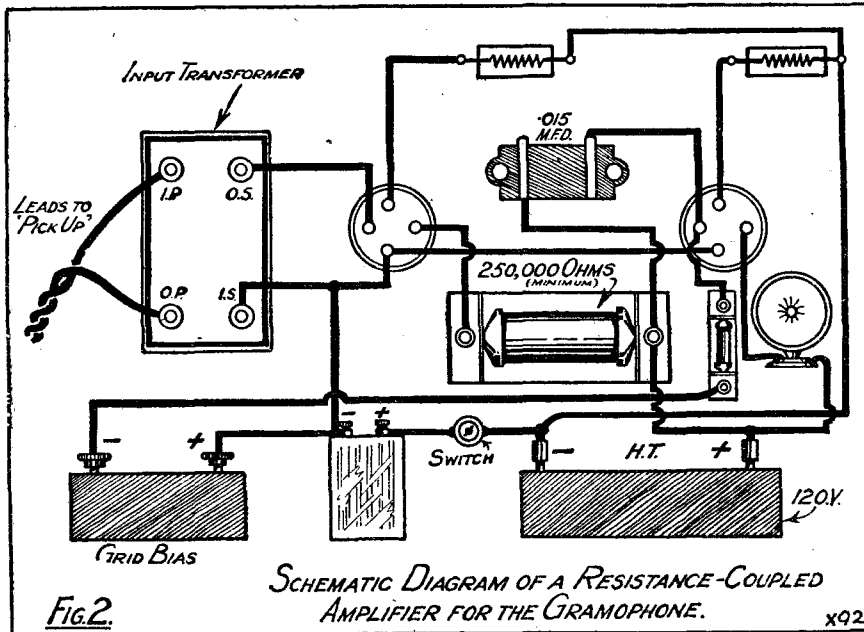

Some may possibly require a greater degree of amplification than that needed with the Brown pick-up, but as the writer has not tried the others he can only report upon the present device.

Components Required.

The actual apparatus used can either be mounted on a board (for temporary use) or fitted into a cabinet in the usual way. As the device is purely an L.F. amplifier, and there are no variable condensers or tuning controls, any simple box will do to hold the component parts. Those needed are:

One gramophone pick-up (S. G. Brown, Ltd).

One L.F. transformer of good make (first-stage type). Note: This can be dispensed with if you work direct on to the grid filament.

Two valve holders.

Two fixed resistors to suit the valves to be used.

Necessary terminal strips.

And one of the two following alternatives:

1. A good-quality L.F. transformer of the "second-stage" variety, or (2) a wire-wound anode resistance of say, 250,000 or 300,000 ohms, with a fixed condenser of .015 mfd. or .02 mfd., and a grid leak of two megohms with holder.

units can be substituted, as it contains these three elements in one instrument.

The method of joining up an experimental board in either the first or second style is shown in Figs. 1 and 2 respectively. If the transformer method is used, the first valve can be any good L.F. valve, and the

Grid-Bias Adjustment

One tapping will provide the grid bias for the first valve and the other the grid bias for the second valve. In the case of the resistance arrangement, the writer has not found it necessary to put any grid bias on the first valve, the I.S. (or L.T.) terminal of the transformer being connected directly to the L.T. negative lead. The second valve will require the same grid bias as in the transformer arrangement.

A further refinement in this apparatus is to use what is termed a

(Continued on page 283.)

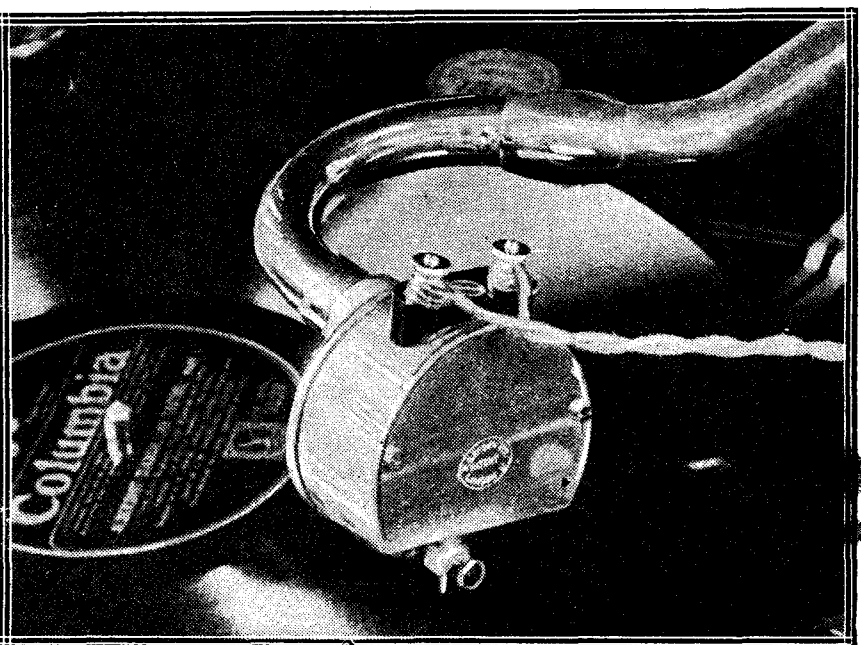

The Brown "pick-up" in use. Care must be taken that the flex does not cause the needle to drag.

SOMETHING NEW WITH A SINGLE VALVE

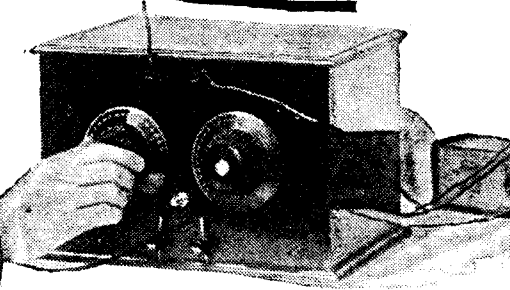

Really new single-valve circuits are rare. In this article the author, Mr. L. H. Thomas, reveals a circuit which certainly merits the label "original." Having tested it myself, I can vouch for the author's claims.
THE EDITOR.

AMONG the most popular circuits for use in receivers of the single-valve type are the "Reinartz" and its various modifications. A rather unusual form of one of these is incorporated in the receiver described in this article.

COMPONENTS USED.

Note.—While the actual makes used are indicated, any equivalent component of good manufacture can be substituted without loss of efficiency.

One ebonite panel, 12 in. × 8 in. × $\frac{1}{8}$ in. (American Hard Rubber Co.).
Cabinet for above, with loose baseboard, 9 in. deep (Cameco).
Two .00035 variable condensers with bakelite end plates and two slow-motion dials (Ormond).
One push-pull switch (Igranic).
One "Clearer-Tone" valve holder (Benjamin).
One .0003 fixed condenser and one 2-megohm leak with holder, and one .0001 condenser (Dubilier or Lissen).
Two baseboard mounting coil holders.
One H.F. choke (McMichael).
One baseboard-mounting rheostat (Lissen).
One base-mounting neutralising condenser (Peto-Scott).
One centre-tapped "C" or No. 75 coil for lower broadcast band, and one centre-tapped "F" or 300 coil for Daventry, also 35, 50, and 150 ordinary coils for aerial circuit.
One pair of panel brackets.
Eight terminals.

It is an almost universally accepted fact at the present time that, as far as receivers that do not incorporate a stage of H.F. amplification are concerned, it is preferable to use capacity-controlled reaction rather

than put up with the many inconveniences of the "swinging coil" type.

The circuit usually employed is the well-known "Reinartz" arrangement, in which the H.T. is applied in parallel with the plate and filament of the valve, an H.F. choke being inserted in the positive lead, reaction being

arranged by magnetic coupling between a reaction coil and the grid circuit, but controlled by a variable capacity between the plate and the reaction coil, or between this and the filament—i.e. in series with the reaction coil.

The "Hartley" circuit, from which the Reinartz was derived, is somewhat

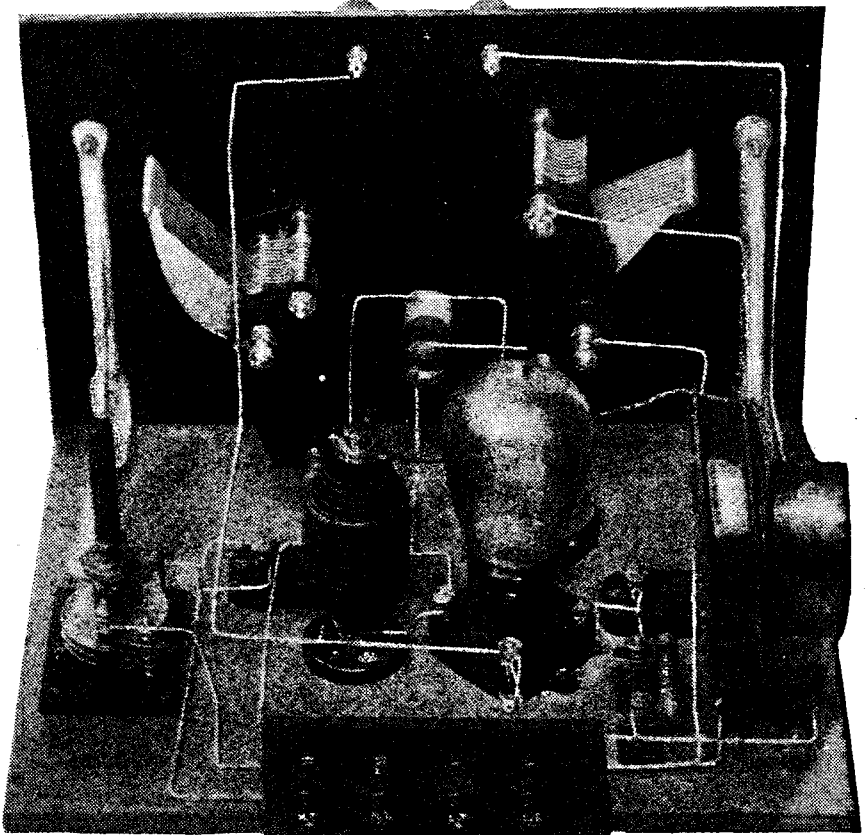

The one-valver ready for test, with valve and coils in position. Note the short plate and grid wiring.

Something New with a Single Valve—continued

similar, but in this case a centre-tapped coil is used, the whole of it being tuned, and reaction controlled by a condenser between one end of the coil and the anode of the valve. This circuit is shown in Fig. 1.

The chief disadvantages of this arrangement are that both sides of the reaction condenser are "live," and rather apt to give rise to undesirable hand-capacity effects as

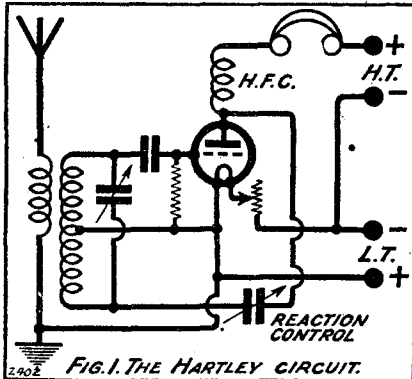

the capacity is varied, and that the variation of this capacity has a distinct effect upon the tuning of the main circuit; thus any change in the capacity of the reaction condenser necessitates a change in the tuning of the main circuit also.

The Reaction Condenser

In the receiver described, the position of the reaction condenser has been changed. Instead of arranging it in the usual way it has been inserted in the filament tap,

and a fixed condenser of small capacity has been placed in the usual position between the end of the coil and the anode of the valve (Fig. 2). A neutralising condenser is wired in series with this, but may be cut out of circuit when necessary. By arranging things in this way both of the above-mentioned disadvantages may be overcome; the moving plates of the reaction condenser may now be connected directly to earth, undesirable capacity effects being thus overcome, and it will be found that the effect upon the main tuning control when the reaction condenser is rotated over the whole of its travel is practically negligible.

Easy to Make

The construction of a receiver of this type is the most simple matter conceivable, and any trouble spent on it is certainly well repaid. The arrangement cannot be described as a "freak" circuit, and one consequently does not have to learn to operate the set, for its manipulation is perfectly conventional. There is only one main control, and the reaction control needs very little attention to keep the set in its most sensitive condition.

As will be seen from the photograph of the front of the receiver, only these two dials, a filament switch, and four terminals are mounted on the front of the panel. The battery terminals are at the rear.

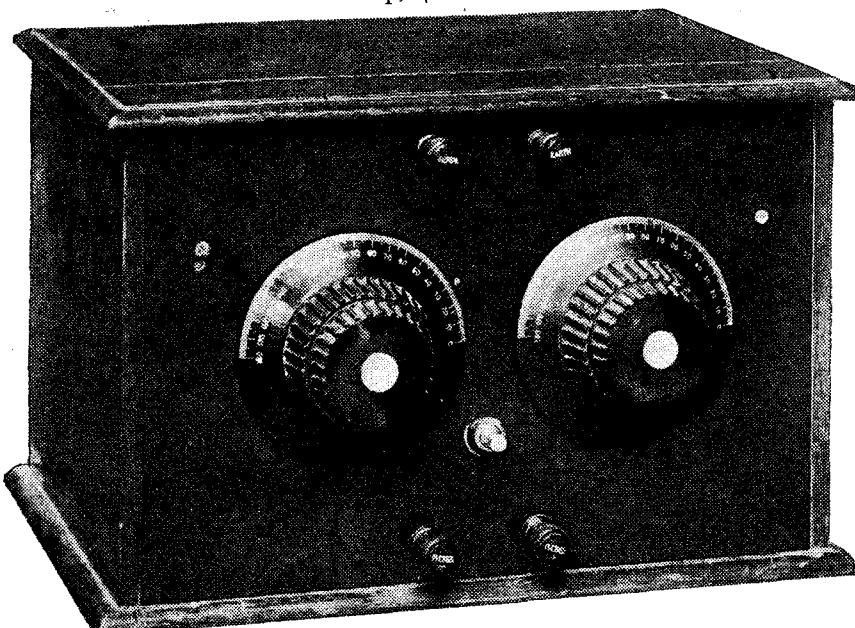

A very neat and symmetrical appearance is obtained by the placing of the aerial and earth terminals above those for the telephones.

Two coils with fixed coupling have been used in this set, but there is no reason why a split-secondary transformer with a six-pin base should

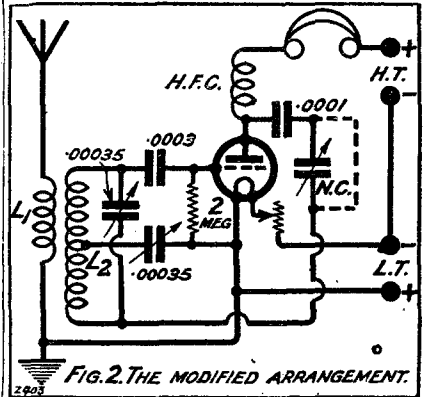

not be used. In this case the correct connections to the base would be as follows: "1" to aerial, "2" to earth, "3" to grid condenser, "4" and "5" joined together, and taken to fixed plates of reaction condenser, "6" to one side of .0001 condenser. The actual connections to the two coil holders used are quite clear from the diagrams and the list of point-to-point connections.

Constructional Details

The best method of procedure in constructing the set is as follows: First of all, drill the panel and fix the panel brackets, making a "trial" fit on the baseboard and in the cabinet. Then remove the panel, assemble the components on it, and attach leads to the filament switch and the two telephone terminals. These leads should be of ample length, left projecting in the direction of the back of the cabinet, so that no trouble arises when the wiring is nearing completion through being unable to get at one or two awkward corners. Now assemble the necessary components on the baseboard, and wire them up as far as possible. It is desirable that the spacing of the wiring should be arranged roughly to coincide with that of the original set.

One of the peculiarities of the set is that with the correct setting of the reaction control and the neutralising condenser shorted, the local station may be received at very good strength with only about 4½ volts H.T. In fact, on the preliminary tests of the receiver, using a freely-oscillating valve of the 6-volt .25 amp. class, it was possible even to make the set

Something New with a Single Valve—continued

oscillate with no H.T. at all! When the neutralising condenser is brought into circuit (it is simply set to the correct position and left alone) the set

and the flex lead from the fixed plates of the reaction condenser connected to the centre tap. A No. 35 or No. 50 coil should be placed in the L_1 socket.

zero, and rotating the main control slowly. The set should not oscillate at any point over the tuning range. If it does, reduce the H.T. slightly.

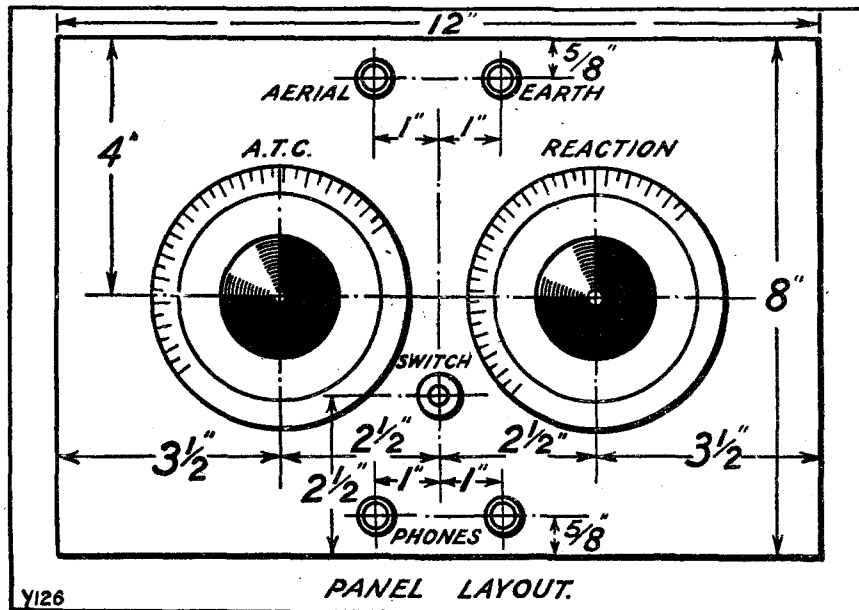

Preliminary Tests

Now set the reaction condenser so that the dial reading is about 60° . The receiver should still show no signs of oscillation. The next step is to increase the value of the neutralising condenser on the baseboard very slowly and carefully until the set just slides into oscillation with a very slight hiss. No "plop" should be heard at all. When this stage has been reached it will be found that a very smooth and fine control of reaction may be obtained by rotating the dial of the reaction condenser proper. On the original set, when some pains had been taken over finding the best setting, the set was just oscillating all round the dial when the reaction condenser was set at 60° , and "faded out" from the oscillation-point as the dial was rotated from this reading to about 30° . It was possible to set the reaction control so that the set was just below the oscillation-point over the

behaves in a perfectly normal manner, about 40-50 volts H.T. then being used.

Tuning on the main control is very critical indeed, a high measure of selectivity being obtained, and a slow-motion dial has, therefore, been used. This is practically essential, but that on the reaction control is not so necessary, and may be dispensed with if economy in initial cost is a consideration.

Suitable Valves

When the assembly and wiring have been completed, it is as well to check the wiring carefully in the usual way. The wiring of the set should preferably be checked against the theoretical diagram, since this is, in the writer's opinion, a more valuable check.

The aerial and earth should now be connected to their terminals, a valve inserted, and the batteries connected up. The valve should preferably be of a low-impedance type, having an amplification factor of about 8. Good examples of this class are the D.E.5, S.T.62, P.M.6, D.E.L.612, Cossor 610L.F., Burndy H.L.512, etc.

About 45 volts H.T. should be used for the preliminary tests, and the neutralising condenser should be left in circuit. A "C" centre-tapped coil (or a 75-turn centre-tapped) should be inserted in the L_2 socket,

If the set is now switched on, the local station should be tuned in by setting both the neutralising condenser and the reaction condenser at

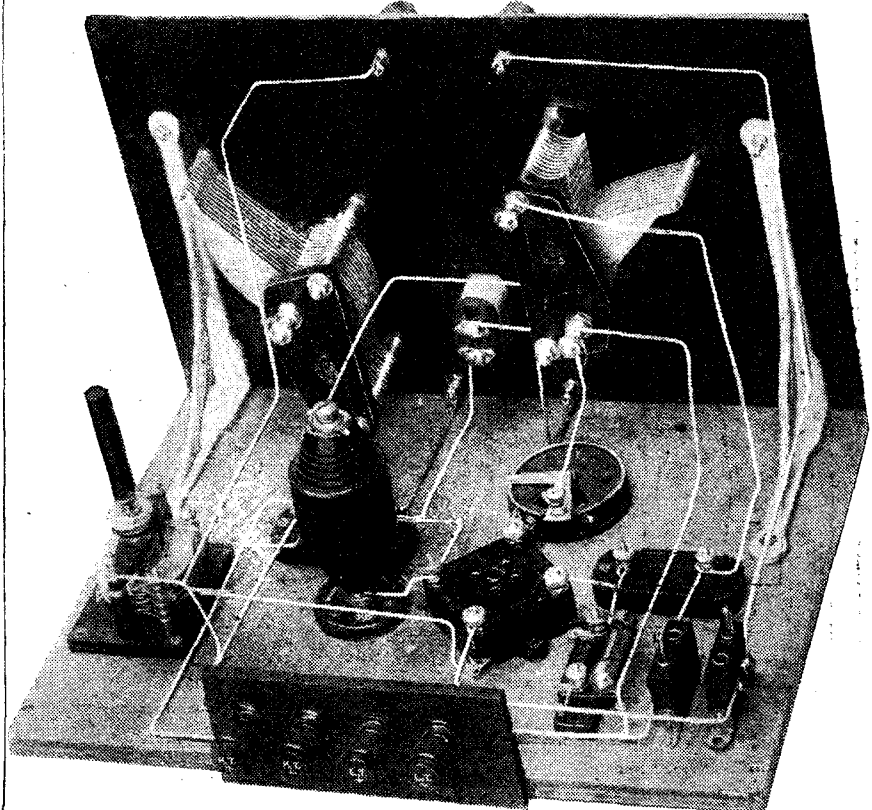

The easy nature of the wiring can be seen in the above illustration, which should be studied in conjunction with the wiring diagram when the set is being built.

Something New with a Single Valve—continued

entire tuning range, and the reaction condenser setting could, therefore, be "forgotten."

The reader should realise from the first that this adjustment will not be obtained in five minutes, but some time and trouble are necessary.

Distant stations should be picked up quite easily now; some twelve or thirteen foreign stations were heard on the first night of operation of the receiver seen in the photographs. It should be borne in mind that the most critical setting by far is that of the neutralising condenser. If this is advanced a fraction beyond the

correct position the set will burst into oscillation, and the reaction control proper will have no effect whatever upon it.

Small H.T. Value

Probably the most interesting use of the set, however, is for the reception of the local station with no H.T. or with, say, one flash-lamp battery for this purpose. The neutralising condenser should be short-circuited, and the set should on no account be switched on with the normal value of H.T., since it will probably give vent to a violent audio-

frequency howl very painful to the wearer of the headphones. The H.T. used should on no account be more than about 9 volts, and the set may possibly still be oscillating hard with this amount; $4\frac{1}{2}$ volts should be ample if a power valve is in use. With a high-impedance valve of the R.C. type 10 volts was found to be quite sufficient.

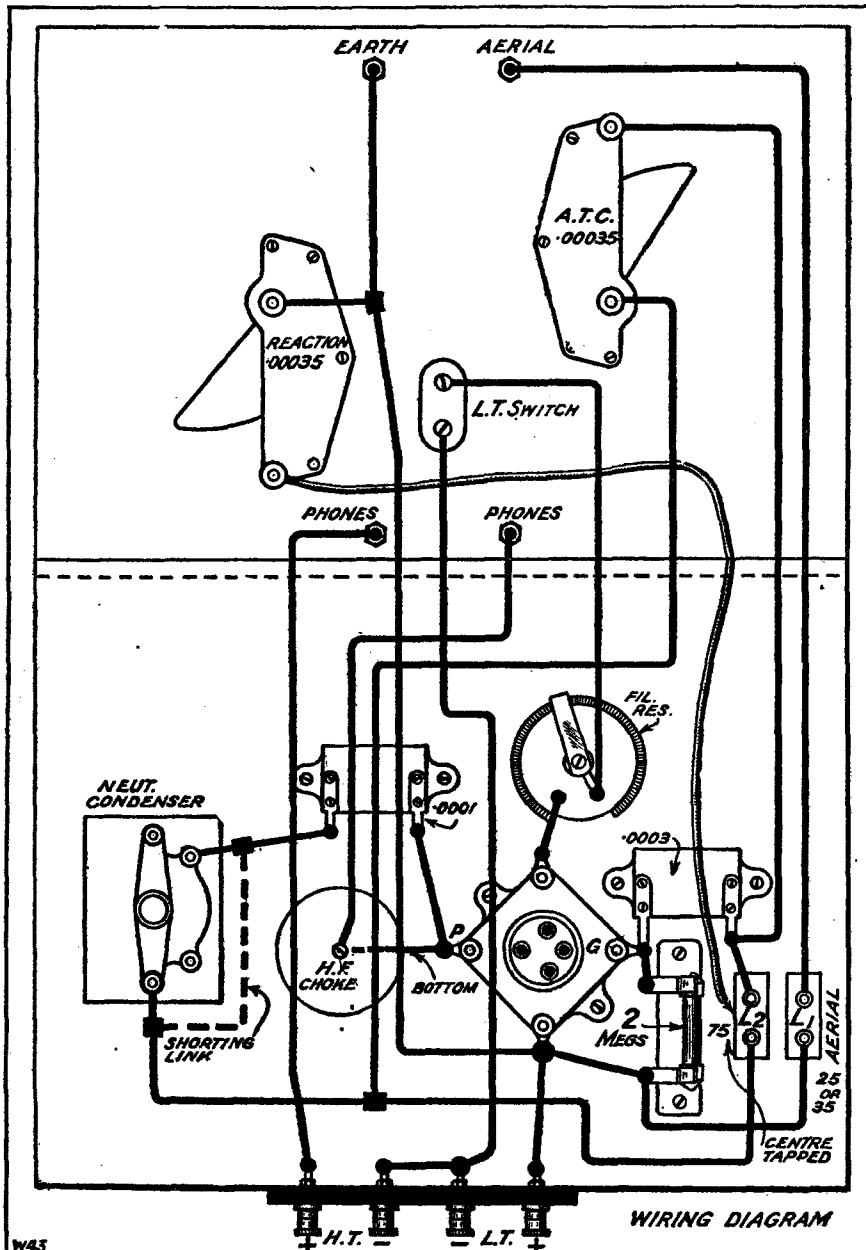

WIRING IN WORDS.

- Join aerial terminal to one side of L_1 coil holder.
- Join other side of holder to earth terminal, L.T. plus terminal, one filament leg of valve holder, and moving plates of reaction condenser.
- Join one side of L_2 coil holder to one side of .0003 fixed condenser, and to fixed plates of tuning condenser.
- Join other side of same coil holder to moving plates of neutralising condenser and moving plates of tuning condenser.
- Join fixed plates of neutralising condenser to one side of .0001 fixed condenser.
- Join other side of .0001 fixed condenser to anode terminal of valve holder, and to bottom contact of H.F. choke.
- Join remaining side of H.F. choke to one telephone terminal.
- Join other telephone terminal to H.T. plus terminal.
- Join remaining side of grid condenser (.0003) to grid terminal of valve holder and one side of 2-megohm leak.
- Join remaining side of 2-megohm leak to L.T. plus wiring.
- Join remaining filament leg of valve holder to one side of rheostat.
- Join other side of rheostat to one side of switch.
- Join other side of switch to L.T. — terminal and to H.T. — terminal.
- Join fixed plates of reaction condenser to flex lead for centre tap on coil.

The local station will be found at quite respectable strength with this arrangement.

Daventry can be quite well received in this way, although the strength obtained is not comparable with that available by using about 40 volts H.T. and setting the neutralising condenser at its *minimum* position. The reaction control should operate quite satisfactorily in this way for the longer waves, when a centre-tapped "F" or No. 300 coil will be needed for L_2 and a 100 or 150 for L_1 .

Unless a really good make of H.F. choke is used some trouble will probably occur with the reception of Daventry. If trouble should occur on the long waves through the set oscillating continuously with both the neutralising condenser and the reaction control set at zero, it may be cured by connecting the aerial directly to the end of L_2 remote from the grid. A slight loss of selectivity will probably result, but the extra damping will stabilise the set.

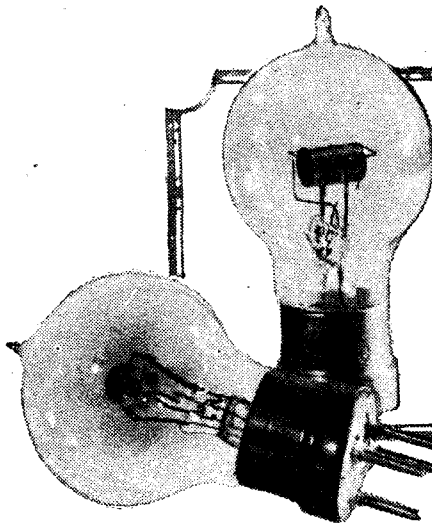

NOVELTIES IN VALVE DESIGN

Some unusual types and applications of thermionic valves which will be of interest to all readers.

By J. C. JEVONS.

THE three-electrode valve has been with us so long that one is apt to look upon it as a more or less standardised appliance for rectifying and amplifying wireless signals on well-defined lines.

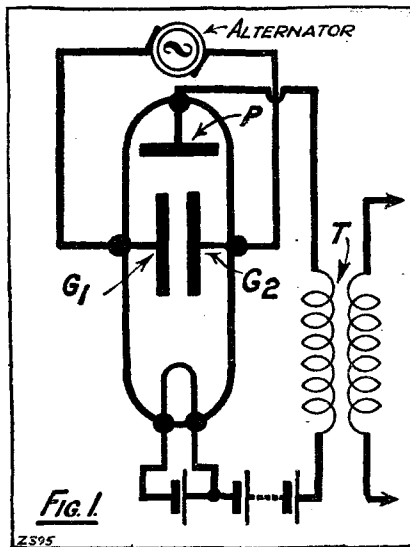

It is, of course, true that manufacturers, from time to time, make slight alterations in the shape or symmetry of the internal electrodes, usually with the object of increasing the impedance or magnification constants. Such modifications, however, are intended simply to improve efficiency, as distinct from introducing any really new principle of operation.

Recent Developments

The new Marconi K.L.1 valve, where a second or "false" filament is fed directly from the house mains, and then serves to energise the "true" filament by radiation across a vacuum, is an innovation that perhaps deserves special mention.

The production of "multiple" valves, in which several stages of resistance-coupled grid-plate-filament units are housed inside a single glass bulb, is another development of recent date. Here again the underlying idea is one of compactness or economy in manufacture. As in the previous instance, each single three-electrode stage or unit, taken separately, operates in the well-known way.

Up to the present the four-electrode valve has not enjoyed the same popularity in this country as it does abroad. Yet, from one point of view, it represents a more distinct departure from standard three-electrode practice than either of the types previously mentioned.

Two-Grid Valves

The introduction of a second grid makes a very decided difference to the ordinary "characteristics" or working curves, whilst at the same time the possible variations in the external circuit arrangements are enormously increased.

As is well known it is quite feasible, by using a small positive bias on the space-charge grid, to cut down the normal H.T. or plate voltage by more than half. In fact, in the well-known Unidyne circuit excellent results have been secured by using no higher plate voltage than that taken from the positive pole of the filament accumulator.

The use of a fourth electrode also opens out the possibility of neutralising or balancing-out internal valve capacities in a less wasteful way than in any in common use at the present time. An efficiently-balanced four-electrode amplifier, when available, will prove to be a real distance-getter, and not the delusion and snare the H.F. stage so often turns out to be nowadays.

However, instead of looking into the future, it may perhaps be more to the

point to consider one or two proposals that have already been made for developing the possibilities of the valve along unusual lines.

Transverse Grids

Fig. 1, for instance, shows a two-grid valve used as a frequency doubler. Here the two grids are placed one on each side of the normal electron stream flowing between the plate and filament. If a varying E.M.F. from the alternator is applied across the two grids, as shown, the frequency of the current in the output transformer T will be twice that of the supply.

It is clear in the first place that the electric field across the two grids G_1 , G_2 , acting at right angles to the main electron stream, will decrease the strength of the current reaching the plate. The decrease in plate current takes place irrespective of which



Compare the 20-kw. valve in the girl's hand with the latest 100-kw. type used at W.G.Y.

Novelties in Valve Design—continued

particular grid is thrown positive and which negative.

Actually the normal plate current sinks to a minimum and returns to a normal value for every half-cycle applied to each of the grids, thus giving two impulses through the output

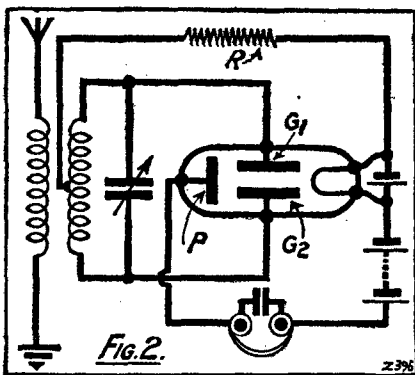

transformer for each complete cycle from the alternator.

Fig. 2 shows the same type of valve applied to wireless reception, with a grid-leak resistance inserted at R. If a polarising battery is placed across the grids so as to ensure that the transverse field will vary only in strength, but not in direction, the arrangement can be used as a simple high- or low-frequency amplifier, without rectification.

Multiple-Plate Valves

In another form of valve, shown in Fig. 3, the plate has been divided into segments, each of which is connected to a separate tuned circuit coupled in

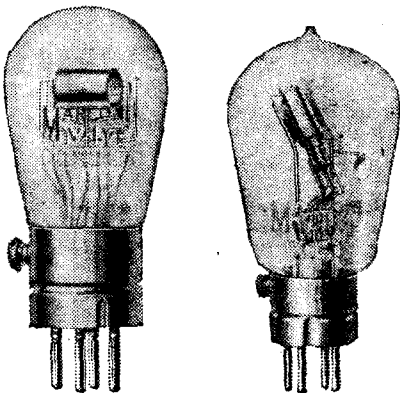

Two modern valves of unusual design. (L.) a 4-electrode dull emitter and (R.) the K.L.1 valve for operating from the mains.

turn to a telephone receiver. The actual shape of the divided plate is shown at the side of the figure. Here the object is to allow the simultaneous

reception of four separate messages, one in each of the 'phones.

In order to secure this "multiplex" result, the normal path of the electron stream between the plate and filament is controlled by two pairs of grids or deflectors (G_1, G_2 , and G_3, G_4) inside the tube. The circuit connections are not shown in the figure for the sake of clearness, but the deflectors are energised so as to give rise to a rotating field, which "spins" the electron stream around the four segments of the plate at the same rate as in a similar valve at the transmitting end.

The consequence is that four separate conversations can be modulated on four different carrier waves, the speech frequencies being split up at such a speed that the ear is unable to detect the interruption. Each listener hears his individual message as continuous speech clear from any overlap, or interruption by the others.

Rotary Control Fields

It is perhaps worth mentioning that the use of a similar rotating external field to control the movements of the discharge stream from an oscillograph tube has been suggested as a simple means for synchronising the transmitter and receiver in television apparatus.

More recently still much the same device has been used for direction finding, and particularly for analysing the direction, or source of origin, of atmospheric strays where the time of duration of the "stray" is of very short duration.

Cross-Stream Valve

Fig. 4 shows another exceptional type of valve. Here there are four electrodes, split up into two pairs of plates and filaments P_1, F_1 and P_2, F_2 . Each pair is so arranged that the normal electron stream flowing between them is mutually at right angles.

When the filaments are lit, one of the two pairs of electrodes will momentarily gain the mastery and the full normal stream of electrons will pass between this pair, the other stream being blocked.

Owing, however, to the coupling between the external coils R_1 and R_2 , the rise in current in the first plate circuit gives an inductive "kick"

to the coil in the circuit of the second pair of electrodes sufficiently powerful to cause the increased voltage across the latter pair to force an electron stream through the tube at right angles to the first.

The corresponding rise in current in the second coil reacts in turn through the inductive coupling between the coils R_1, R_2 , on the first pair of electrodes in similar fashion, and so a state of rapid alternation is set up between the two electron streams, throwing the whole system into sustained oscillation.

Television Valve

There would appear to be distinct possibilities in a novel form of optically-sensitive valve due to an American inventor, Hendrik Nakken. This combines the light-sensitive

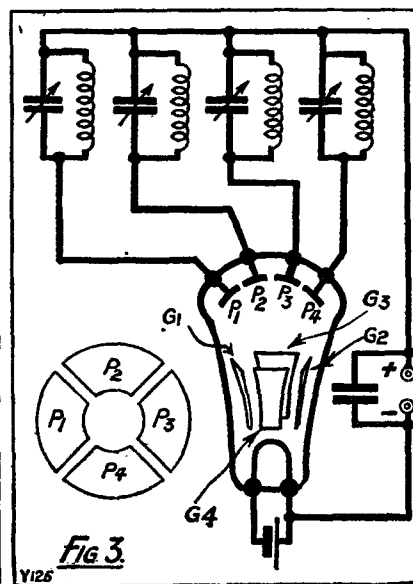

action of potassium, rubidium, etc. (as used in the standard photoelectric cell) with the amplifying properties of the thermionic valve.

When a three-electrode valve has been lit for some time, and there is no outside grid excitation, a steady state of equilibrium sets in, during which time the plate current remains constant.

If now the grid is made of some light-sensitive metal such as potassium, the impact of a beam of light will liberate electrons. This immediately causes the average grid potential to fall, and so creates a corresponding fluctuation in the plate circuit.

Novelties in Valve Design—continued

By focussing the different light and shade effects of a picture or photograph in succession upon such a photo-electric grid, it is possible to secure a direct "picture" modulation of a radiated wave. The same principle is clearly applicable to television or moving-picture transmission.

In order to prevent any interference with the photo-electric effect of the grid, due to its proximity to the glowing filament, the photo-sensitive

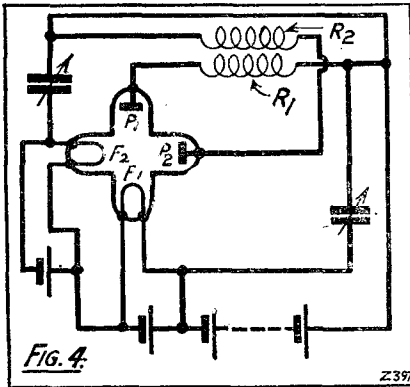

element is mounted in a special side chamber in the valve where it is well screened off from the filament.

At the same time it is joined by a metallic connection to the ordinary spiral grid surrounding the filament, so that both portions of the grid are made subject to the optical variations.

Moving Electrodes

The idea of making one or other of the inside electrodes of a valve mechanically movable in response to a suitable impulse is another ingenious departure from standard practice.

It is well known, for instance, that the impact of the electron stream against the plate has the effect of heating the latter. It is quite common, even in the small valves used for low-

powered amateur transmission, to see the anode grow red-hot under electronic bombardment from the filament.

By using a blackened nickel wire as the anode, and connecting one end to a delicate lever arrangement mounted inside the tube, it is possible to arrange that the expansion or contraction of the anode wire will open or close a switch mounted inside the valve, and so give an audible indication in some external circuit of the receipt of a wireless message.

The apparatus is initially set so that the normal electron current, together with any heat radiated from the filament, both combined, leave the switch open. The receipt of a wireless signal of some duration, such as the carrier wave of a broadcast station, will then be sufficient to upset the balance and tension of the wire anode, and by closing the inside switch cause a warning call-bell to ring.

Fig. 5 shows an example of the movable-electrode principle applied to an L.F. amplifier. In this case an outside coil or electromagnet controls the vibration of a soft-iron armature which is mounted inside the tube and is rigidly connected to a spiral grid mounted on a spring support so as to be capable of following the movements of the armature.

The relative distances separating the spiral grid, the filament, and the plate determines the value of the electron stream reaching the plate. As the armature vibrates, under the influence of voice currents flowing in the outside coil, the output from the valve will vary accordingly, thus giving a direct speech-frequency effect without the intervention of a microphone.

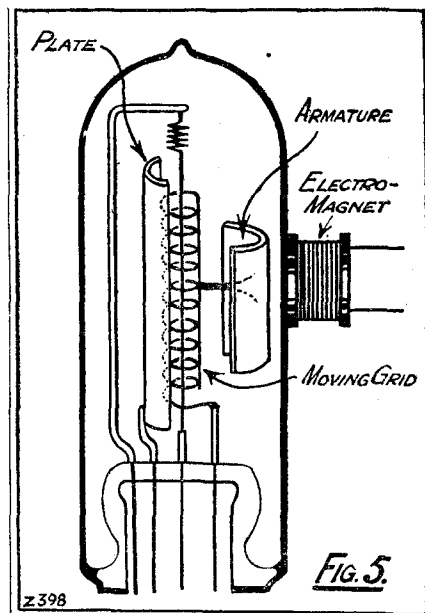

 * **CURING REACTION** *
 * **OVERLAP** *

IT is not much use trying for distant transmissions on one- or two-valve sets if the reaction control of your set is either "ploppy" or has an overlap. On some receivers the usual remedies for this, namely, trying a different-size reaction coil or altering the values of the H.T. and L.T., are of no avail. If this should prove to be so with your set, there is still another remedy worth trying.

A gridleak of 4 or 5 megohms value should be purchased and substituted for the one in the set, which is probably of 2 megohms. Even if this does not completely cure the trouble it will go a long way towards making the reaction control quite smooth.

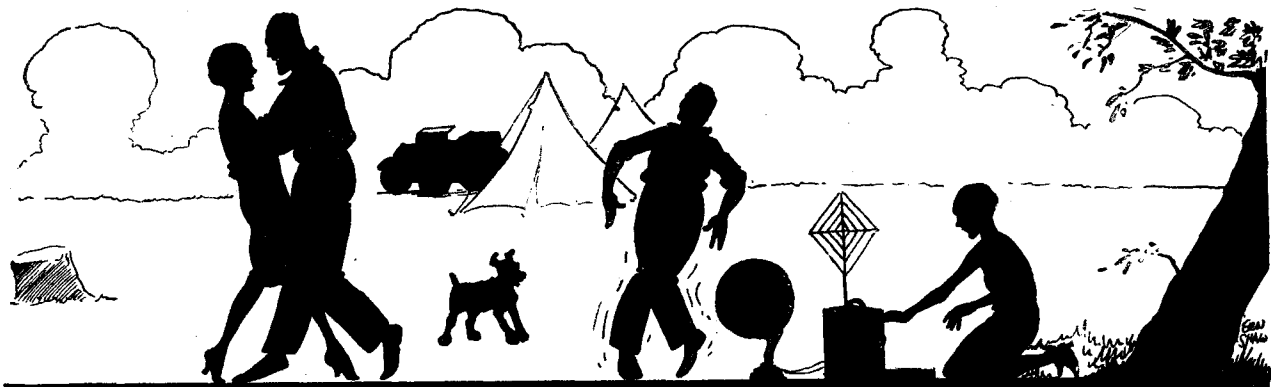

Some essentially practical notes for the set-builder who wishes to "Adopt, Adapt, and Improve."

NOTES AND JOTTINGS

By A. V. D. HORT, B.A.

The following tips include details for making a Useful Blowpipe, Adapting a Soldering Iron for fine or flexible wires, etc.

A Soldering Tip

THE tinning of the ends of the lengths of wire used in wiring a receiver, especially fine or flexible wires, will be greatly facilitated if the soldering iron is adapted for the purpose. The usual trouble encountered in this operation is that it is difficult to put a good coating of solder on the wire without rubbing it about on the iron, making quite a "business" of what should be a simple task. Fig. 1 shows how the iron can be treated. A fairly deep V-shaped groove is filed in one of the faces of the bit, and a considerable amount of solder can be melted into it without any risk of its running off.

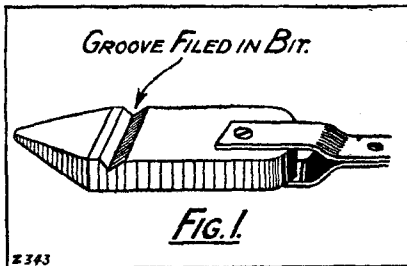

A Home-Made Blowpipe

SMALL repairs to the soldered connections in a receiver may often be carried out more quickly with a blowpipe than with a soldering iron. The iron takes a few minutes to heat up, while the blowpipe is ready at any moment. The blowpipe should be constructed as shown in Fig. 2. A piece of petrol piping a few inches long, drawn or hammered down at the end, so that there is only a small hole, is suitable for the pipe. A large hole spreads the flame too much, and requires more "wind" to keep it going. A length of rubber tubing on the other end of the pipe leads to the mouthpiece, which may consist of an old cigarette holder or pipe mouthpiece.

Fig. 3 indicates how the blowpipe is used. A candle may be used,

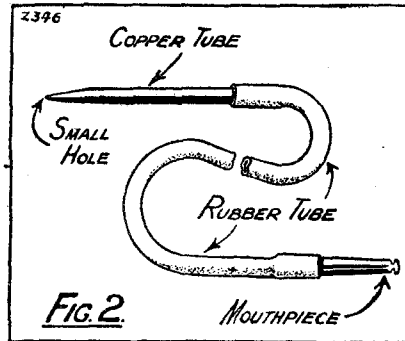

though a methylated spirit flame is preferable, as it is less sooty. The flame is held an inch or less from the work, the blowpipe inserted in the flame, and the jet of flame is directed on the work. Long and steady "blasts" are better than sharp puffs of breath. A chip of solder and a little flux are put on the joint, and the heating is continued until the solder has run into the joint.

For Short Shanks

THE terminals provided for the connections to the vanes of some types of variable condensers are rather short in the shank; only enough room for a single wire of about No. 16 S.W.G. is allowed under the head of the terminal. When a second wire is to be put on the same point this has to be soldered to the existing wire, or otherwise dealt with

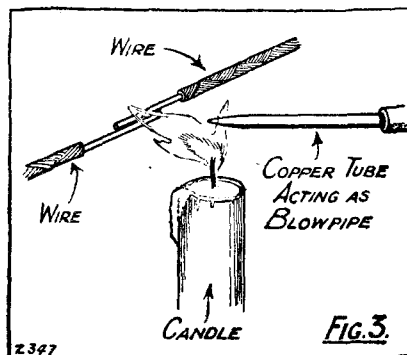

in some special manner. Fig. 4 shows how the terminal can be lengthened in a simple way. On the existing short bolt is placed a long nut or threaded bush, carrying at its other end a piece of screwed rod of the required length. The terminal head is replaced on this rod.

Preparing a Panel

WHEN preparing a panel for the mounting of the components it is sometimes necessary to cut slots in the ebonite an inch or more in length, such as those for key switches and similar parts. The usual

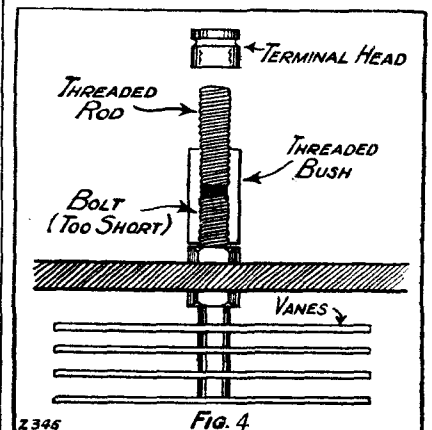

procedure adopted is to drill a series of holes close together between scribed lines, joining them up subsequently with a file. This operation is somewhat tedious to carry out, and it is difficult to make the drill holes close enough together to avoid a lot of work with the file. A simpler way, especially useful when a wide slot is to be cut, is to drill one hole at each end large enough to come right up to the scribed lines. The tip of a keyhole saw can then be inserted, and two cuts made straight down the lines. The file will only be needed if the ends of the slot are to be squared off.

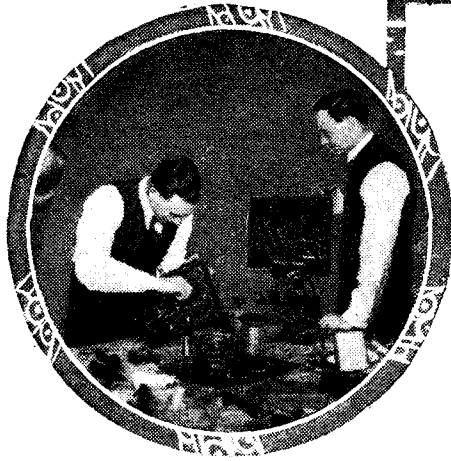

CHATS AT THE WORK-TABLE

An article of particular interest to the practical amateur.

By R. W. HALLOWS.

Don't Spoil Screws

There is perhaps no greater "give-away" of indifferent workmanship than that afforded by a glance at the heads of the screws that go to make up a wireless receiving set. The good workman drives his screws in or takes them out cleanly; the careless or unskilful man is always allowing his screwdriver to slip a little, with the result that little jagged pieces are torn out of the edges of the slots. When a screw is at all tight slipping of this kind sometimes so mutilates the head that eventually the driver can obtain no grip at all, and the thing has to be worried out with strong pliers or drilled away. When care is exercised, screws can be used, not once, but several times, which is a considerable economy when one is engaged frequently in constructional or reconstructional work. Their heads always look neat.

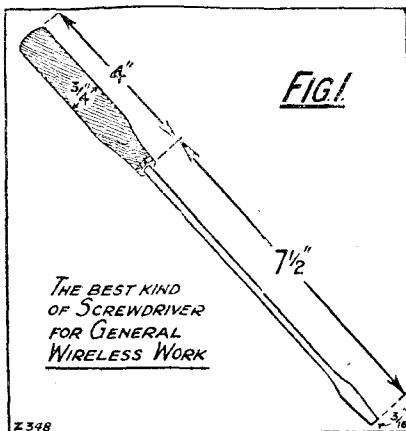

and do not invite adverse criticism by offending the eye.

Now the reasons why some people seem to be unable to drive the shortest screw into the softest wood without tearing its head to pieces are several:

- (a) Holding the screwdriver wrongly;
- (b) Lack of sufficient downward pressure;
- (c) Neglect of the screwdriver blade, so that its edge is allowed to become curved instead of straight.
- (d) Failure to use a suitable screwdriver for the job in hand.

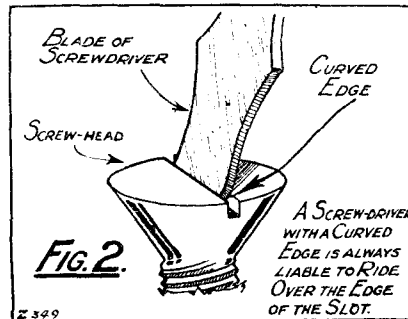

Some Useful Hints

Those who have not done much work with tools, and even a good many who have, often possess a conviction that it is easier to use a short screwdriver than a long one. Actually it is a far simpler matter to keep the screwdriver in its proper place, to exert the right amount of pressure, and to drive screws in cleanly if the tool is of fair length than if it is quite short. What I like myself for wireless constructional work is a screwdriver measuring about 11 1/2 inches over all. A tool of this kind is illustrated in Fig. 1. It has a round handle, 3/4 inch in diameter, a long, thin shank, and a blade 3/16 inch wide. It is infinitely easier to use than either a short instrument or one with a flat handle.

A screwdriver of this kind is obtainable from any good tool shop for a shilling, or a little more. When you first purchase it, or any other screwdriver, the edge of the blade will be perfectly square and straight; but if it is used carelessly it will take on a curved shape, owing to the breaking away of the corners. Fig. 2 shows how the rounding away of

the corners allows the screwdriver to ride over the edges of the slot when any force is required to turn it. Therefore, see always that the edge of the blade is straight, and that it is at right angles to the shaft. If this is so, you can apply, when driving in or extracting a screw, downward pressure sufficient to keep the blade in the notch. If the blade is curved, no amount of pressure will prevent it from tearing its way out.

Keep Straight

It is of the utmost importance that the screwdriver should always be held on a line forming a continuation of the long axis of the screw. If it is allowed to tilt, as shown in rather exaggerated form in Fig. 2, it is most liable to slip, since the blade does not obtain a proper grip in the slot. Again, the centre of the screwdriver blade must always be over the centre of the screw. When one watches an unskilled workman driving or extracting a screw, one nearly always sees that the blade of the tool is moving

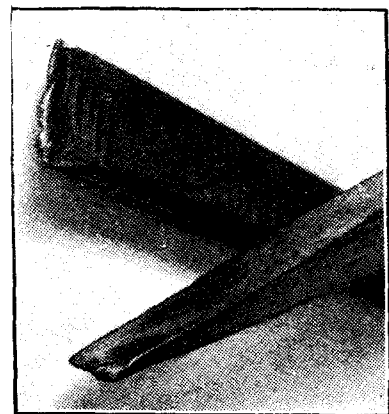

These screwdrivers have been badly handled, and badly maintained.

gradually across the head. Each turn makes it a little more eccentric, and finally it slips, damaging both the screw-head and the material into which it is being driven. Until

Chats at the Work-Table—continued

you have such skill that you have no difficulty in keeping the screwdriver central, it is just as well to use the left hand as a guide. The head of the screw is held between the thumb and the joint of the forefinger that is nearest the palm of the hand, the hand itself being turned palm upward. The grip is a fairly light one, so that the screw can revolve. Should the screwdriver

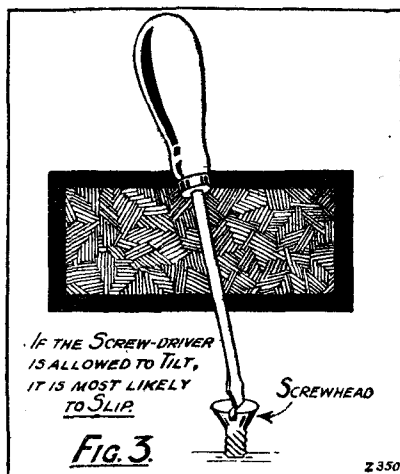

tend to become eccentric its movement is felt at once by the thumb and finger, and can be corrected.

Properly Shaped Blades

Last, but not least, we have the question of properly shaped blades. If the blade does not fit well into the slot of the screw, going almost to the bottom of it, it will never obtain a really firm grip. It must be slightly wedge-shaped, so that when pushed home there is little or no wobble. Strictly speaking, one ought to have a special screwdriver for each size of wood or metal screw that one uses; but in actual practice this kind of thing is quite unnecessary. The best tip is to make the screwdriver blade a really good fit for 4 B.A. screws. To do this place it in the slot of such a screw and hold the two up to the light. You will now easily see whether the screwdriver is bottoming properly, and whether there is much daylight between it and the vertical sides of the slot. Shape it with a file until it fits in so well that little or no daylight can be seen. It will then be found suitable for practically all the small screws that one uses in wireless work. For the larger B.A.

and wood sizes it is as well to keep a screwdriver with a broader blade—say, $\frac{5}{16}$ in. from edge to edge. This should be fitted in the way described into the slot of a 2 B.A. screw, when it will be found that it will do both for the larger wood and metal screws.

The Question of Breadth

It is very important that the breadth of the blade of screwdriver should not exceed that of the screw-head; if it does so it will make most unsightly marks upon the material into which the screw is being driven if it is of the countersunk type. It is also much harder to keep a broad screwdriver properly aligned than a moderately narrow one. But do not overdo the narrowness of the blade, for if you fall into this error you will lose a large proportion of desirable leverage. For all general purposes three screwdrivers with different widths of blade will be found to answer in wireless constructional work. That most commonly used should have a width of about $\frac{3}{16}$ inch; this answers excellently for 4, 5 and 6 B.A. screws and for the $\frac{1}{2}$ inch or $\frac{5}{8}$ inch wood-screws that one uses for fixing the components to the baseboard. Next, we have a screwdriver with a wider blade, approximately $\frac{5}{16}$ inch, used for 1, 2 and 3 B.A. screws, and for the wood-screws used for fixing the panel to the baseboard and triangular wooden supports. Lastly, there is the very small screwdriver, preferably of the jeweller's type, with a blade about $\frac{1}{8}$ inch in width, which is employed mainly for the very small metal screws that one encounters in delicate electrical apparatus. Never on any account allow your larger screwdrivers to be used as case openers! Keep them carefully

hidden, or they will certainly suffer in this way during your absence. Woman can no longer use our razors for sharpening pencils, since the safety kind are of little use for the purpose; but she can and does borrow our screwdrivers for all sorts of horrible deeds; so be on your guard. Once the shank of the screwdriver has become bent by ill-treatment it is a most difficult business to straighten it again, and if you endeavour to use a bent screwdriver you will infallibly ruin every screw that you tackle with it.

A Filing Tip

One often has to file a piece of soft metal. It may be that aluminium vanes are being shaped for a home-made neutralising condenser, or one may be removing solder from tags or from the tips of terminals. Now, in the ordinary way, nothing is more damaging to a good file than to use it for this purpose, for the metal rapidly clogs it and does away with all its keenness. Here is a tip which will be found exceedingly useful. When you have to tackle a soft metal of any kind prepare your file first of all by rubbing it over with a piece of chalk. The chalk partially fills the hollows between the teeth, but not sufficiently to prevent the file from cutting. It does, however, stop the metal from adhering, and from forming those horrible cakes which are almost impossible to remove. When the job has been done the file may be cleaned in a moment by means of a file card or a stiff wire brush that you can buy quite cheaply at any ironmonger's. The brush removes the chalk and any small chips of metal that have been lodged between the teeth. The same method is also useful for treating files

✱

The edges of screwdriver blades should be kept straight and free from distortion, otherwise screw-heads will be spoiled every time the drivers are used.

✱

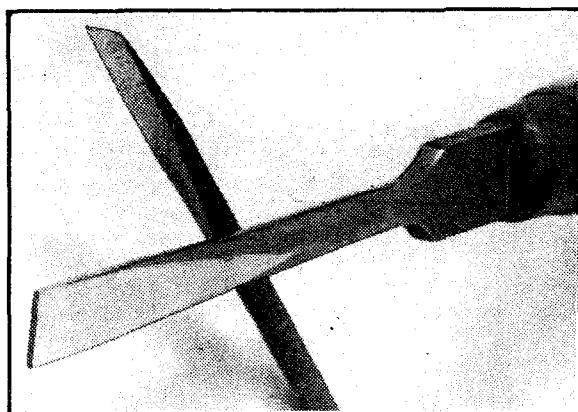

An Announcement

Concerning three new B.T.H. Valves

FOR some time past B.T.H. engineers have been engaged on the problem of increasing the efficiency of the two-volt valve. After many months of research work they have evolved a series of two-volt valves which can successfully challenge valves of any voltage so far as working efficiency is concerned, while in the matter of current consumption they are just as economical as other two-volt valves.

The Filament. The manufacture of the B.T.H. 2-Volt Valves referred to above has been made possible by the production at Rugby of a new filament which gives a useful emission at a temperature even lower than that of a dull emitter valve of the thoriated filament type. The outstanding merits of this new filament are as follows :—

1. It is longer, thicker, and consequently more efficient and durable than the ordinary 2 v. filament.
2. The filament, as mentioned above, operates at a very low temperature, and has therefore an exceptionally long life.
3. It is supported in such a manner as practically to exclude the possibility of breakage or displacement.

Life Tests. Before putting these new valves on the market they have been subjected to very careful life tests with a view to ensuring that every valve sold shall give a long useful life. These valves will give satisfactory operation right down to the point when the accumulator needs recharging. They are very definitely designed and rated at two volts, so that filament resistances are not necessary when the valves are operated from a two-volt accumulator. The continuous use of these valves at two volts will not cause any reduction in the total life of the valves.

The Power Valve. In designing the B.23 Power Valve two points were specially borne in mind :—

1. The need for a two-volt loud-speaker valve which could give results comparable to those of the world-famous B.4.
2. It was felt that the practice, introduced by some other makers, of keeping the filament current as low as 0.15 of an ampere for a loud-speaker valve involved an undue sacrifice of volume and quality for the sake of a small economy in current consumption.

It was therefore decided to use a higher filament current than was the common practice. Without going as high as 0.3 ampere, as in the case of some of the later two-volt power valves, it was found that by compromising on 0.2 ampere the desired object could be achieved. As a result we have produced a valve having a stronger filament and giving a greater emission than other makers of 2-volt power valves. In other words, we have produced a loud-speaker valve which can compare in results with the B.4. It was felt that few users would grudge the additional 0.05 ampere to secure these advantages.

TYPE B21.. 14s. 0d.
(High Frequency & Detector.)
Filament Volts 2
Filament Amps 0.1
H.T. Battery Volts .. 40 to 150
Amplification Factor 16
Impedance 32,000 ohms

TYPE B22.. 14s. 0d.
(General Purpose.)
Filament Volts 2
Filament Amps 0.1
H.T. Battery Volts .. 40 to 100
Amplification Factor 7.5
Impedance 14,000 ohms

TYPE B23.. 18s. 6d.
(Power Amplifying.)
Filament Volts 2
Filament Amps 0.2
H.T. Battery Volts .. 40 to 100
Amplification Factor 6
Impedance 8,000 ohms

The above prices are applicable in Great Britain and Northern Ireland only.



A COMPLETE RANGE OF VALVES

2 volt Valves

FOR ALL SETS AND CIRCUITS

The British Thomson-Houston Co., Ltd.

B21	{ H.F. & DET }
B22	{ General Purpose }
B23	{ Loud Speaker }

Chats at the Work-Table—continued

used for cutting ebonite, though here it is not so necessary, since ebonite filings are not usually difficult to remove with the wire brush. The great secret with files is to keep them always as clean as possible. If the wire brush is used directly after any job of filing soft metal or ebonite is done, any deposit on the blade can be removed without very much trouble. When, however, the file is used for job after job of this

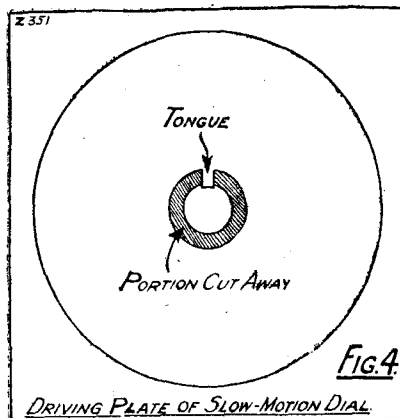

kind without any attention between times, the clogging of the teeth often becomes so serious that it is almost impossible to get rid of it, and the file must be discarded as useless for its proper job.

Uses for Old Files

Even the worst and most dilapidated of files can often be made use of for doing jobs very different from those for which they were primarily intended. A half-round tapered file, for example, makes a useful D-bit when its filing days are over. The tongue fits quite well into the jaws of the brace, and used in this way an ancient file will provide a ready means of enlarging holes drilled in ebonite. One often needs something of the kind. When, for example, jacks have to be mounted on an ebonite panel, $\frac{7}{16}$ -inch or $\frac{1}{2}$ -inch holes are needed in many cases. The biggest drill in the average home constructor's outfit is the $\frac{3}{8}$ inch, which will not, of course, make the holes needed. Put this drill through first of all, then use an old half-round file in the way suggested, and the job is very quickly accomplished. If you possess an emery wheel you can grind old flat files into useful scrapers, whilst round ones may be turned in the same way into centre punches or nail punches.

A Point About Cabinets

It is usual nowadays to have at any rate the aerial, earth, and battery terminals mounted upon ebonite strips fixed to the back of the baseboard. Many constructors attach these strips before fitting the set into its cabinet, subsequently trimming the wood at the back of the cabinet away as may be necessary in order to allow them to pass through it. This is actually not by any means the best way of conducting operations. Here is a method which I find altogether more satisfactory. Begin by attaching to the baseboard the panel but *not* the terminal strips. In the back of the cabinet cut recesses of the proper size to take the strips. Now slide the set into its cabinet, pushing it well home and seeing that it is properly in position. This having been done, fit the strips into the recesses at the back. Should they fit rather too tightly, trim them, and not the wood, down a little. Screw them to the baseboard whilst the set is in its cabinet. In this way an excellent fit is assured and a great deal of trouble is often saved.

A Terminal Question

Personally, I must say that I prefer not to have a row of battery terminals protruding at the back of the set. It seems to me that if you arrange things in this way you are rather asking for trouble in the form of a short circuit—one must never forget that the dusting sex finds it difficult to realise that any harm can possibly result when tidying up any tools that may be lying about on the wireless table by placing them *behind* the receiving set—the feminine idea of tidiness consists largely in placing things behind or beneath other things. Even the superior male may occasionally be responsible for trouble by laying on top of the cabinet a drill or some other round tool, which promptly rolls off and lands across the row of terminals at the back. In my opinion, the best and safest tip really, if you have room enough, is to place your battery terminals—this does not apply to the aerial and earth terminals—on a vertical strip mounted by means of small brackets about $\frac{3}{4}$ inch from the rear edge of the baseboard. Remove the milled tops and attach its own lead to each by means of an ordinary hexagon nut turned hard down with a box spanner. Plait the H.T. leads into a pigtail and use twin

flex for L.T. Bring each set of leads out of the back of the cabinet through a round hole of suitable size. This system makes the battery wiring practically foolproof, since it is now impossible to detach the leads from the set without disconnecting them from the batteries. I wonder how many accumulators and H.T. batteries have been ruined by short-circuits resulting from the detaching of leads from terminals at the back of the receiving set whilst they were left connected to the batteries?

Improving Slow-Motion Dials

For some reason the majority of slow-motion dials are made with large metal driving discs, which are electrically connected to the spindle carrying the moving plates. In a circuit in which the moving plates are earthed this may not matter very much. The driving disc may, in fact, act as a screen, thus reducing hand-capacity effects. On the whole, though, I do not care about metal discs, since owing to their large area they must certainly increase the minimum capacity of any variable condenser to which they are fitted. In circuits in which neither set of condenser plates can be earthed they are a positive nuisance. I showed recently how an insulating link between the condenser and the dial might be made; but there is another method of dealing with slow-motion dials which I have



The screwdriver should be kept straight, and its blade edge snugly pressed into the slot of the screw.

recently tried with great success. It consists in substituting a driving disc of insulating material for the existing metal one. The advantages of this system are that the minimum

(Continued on page 288.)

A Cornet is a Cornet—

when the Brown
is reproducing

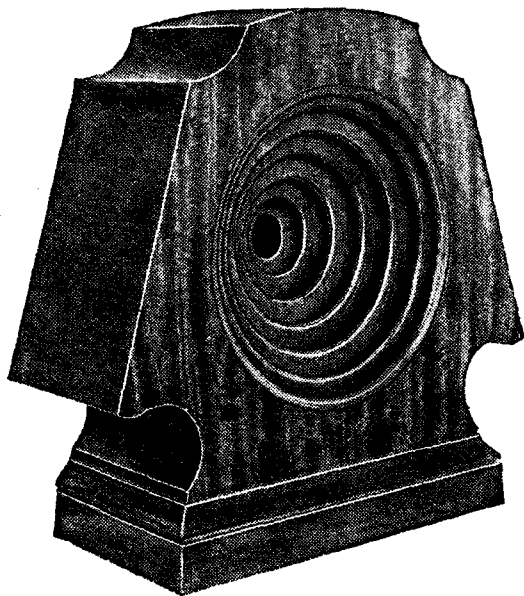

YOU know the loud speaker that has a nasty habit of giving its own version of the broadcast? Of putting in something that isn't there and leaving out something that is. Of distorting music—making a cornet sound like a saxophone.

A Brown Loud Speaker has never been guilty of any of these sins. The Brown, owing to its unique design and skilful construction, gives a faithful rendering of the broadcast. It tells the truth. The cornet *is* a cornet when the Brown is reproducing. Every tone of the human voice, every note in the harmonic scale—the Brown reproduces them all with living realism. Could you ask more from a loud speaker?

Hear the **Brown** Sphinx (shown above) at your Dealer's. It sets a new standard among loud speakers. Price **12 gns.**

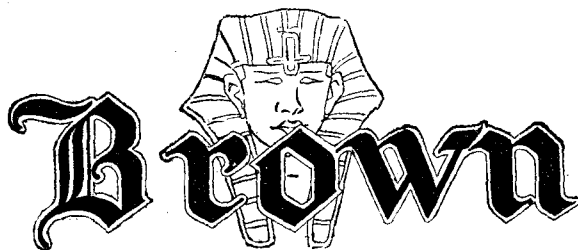

SPHINX LOUD SPEAKER

tells the truth

Advt. S. G. Brown, Ltd., Western Ave., North Acton, W. 3.

G.A. 9090



RADIO CONTROL BOOKLET—Free!

Every radio amateur requires an authoritative guide to the correct electrical operation of his receiver. Here you have the opportunity of obtaining such a booklet entirely free. Just fill in and send the coupon below and a copy will be sent to you by return.

"Radio Control" has been prepared by the Weston Electrical Instrument Co., Ltd., who, for the past 30 years, have been universally acknowledged as the leading manufacturers of accurate electrical measuring instruments. Since the inception of radio the Weston Company have examined carefully every phase in its development and with each succeeding stage of progress have designed and produced appropriate instruments to assist the efforts of radio engineers.

Now the result of many years' radio experience is placed at your disposal. "Radio Control" will show you definitely how appreciable economies may be effected in the operation of radio receivers and how improved reception may be obtained at the same time.

To-day is not too soon—cut out and post the coupon now.

WESTON

STANDARD THE WORLD OVER

Pioneers since 1888

WESTON ELECTRICAL INSTRUMENT CO., LTD.
15, Gt. Saffron Hill, London, E.C.1.

Application for free copy of booklet
"Radio Control" from

Name

Address

W.C.



Valve Holder Design

FROM Messrs. W. G. Pye & Co., Cambridge, we have received for test and report specimens of their anti-microphonic valve holder, a particularly neat and well-made component. Submitted to very careful electrical tests, its losses were found to be negligible, which cannot be said for all of the anti-microphonic valve holders now sold. The moulding is apparently of high-grade bakelite, and

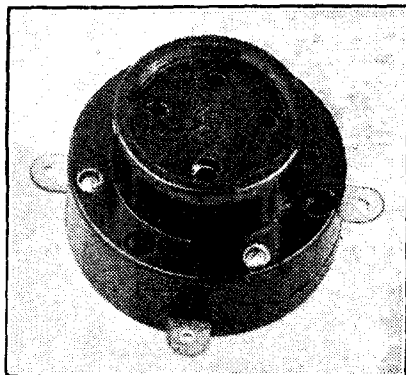

A neat valve holder. (W. G. Pye & Co.)

soldering lugs are fitted. An interesting point about this valve holder is that the space it occupies on the baseboard is less than is the case with the usual type, the holder, with the soldering lugs, falling within a circle of $2\frac{1}{8}$ in. in diameter, whereas most anti-vibratory valve holders require a circle of some $2\frac{3}{8}$ in. diameter. The device can be thoroughly recommended.

Useful Neutralising Condenser

Messrs. Jackson Bros., makers of the well-known variable condensers, have submitted for report an example of their new neutralising condenser. This consists of a small metal cylinder, in and out of which a plunger can be moved by means of a knob and a screw thread. Insulation between the plunger and the cylinder consists of a glass tube. The cylinder is secured to a solid ebonite base, and is provided with a soldering lug, while the insulating piece carrying the bush

A MONTHLY REVIEW OF TESTED APPARATUS.

(NOTE: All apparatus reviewed in this section each month has been tested in the Editor's private laboratory, under his own personal supervision.)

for the threaded rod is supported on two columns, as shown in the photograph. A very fine adjustment is obtainable with this device, and it is useful to be able to see the position of the plunger, as this gives some indication of the amount of capacity in circuit. It is a well-made little device, and can be recommended for all the standard circuits in which a small neutralising condenser is required.

A Geared Coil Holder

From the Edison Swan Electric Co., Ltd., we have received for test a handsome three-coil holder with reduction gearing of an unusual type (see the photograph below). This coil holder is a really substantial and efficient instrument, the finish and

material used being of the best. No attempt has been made to cut down the weight, but as it is designed to mount flat on a baseboard behind the

This useful neutralising condenser employs a glass tube, which allows the relative position of the moving parts to be seen during operation. (Jackson Bros.)

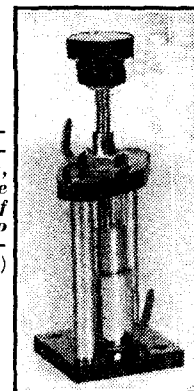

panel its weight is not important. Electrically this holder is of a very high grade, and it is a handsome and very efficient component.

A Sensitive Micro-Ammeter

The Weston Electrical Instrument Company's galvanometer illustrated in the accompanying photograph is

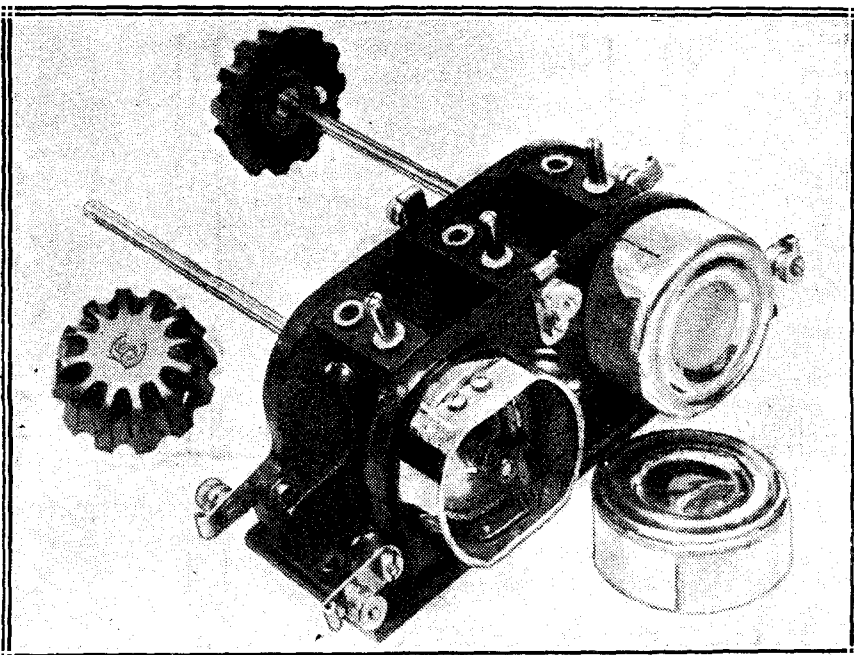

The Edison three-way coil-holder referred to above.

What's New—continued

an extremely sensitive instrument designed for use as a micro-ammeter. There are thirty scale divisions on each side of a central zero, each division being the equivalent of two micro-amperes. In common with all this company's instruments it is excellently finished, and although, of course, by no means a cheap instrument—it costs approximately £10—it is well worth its cost to the experimenter.

Protection Against Burn-Out

A very useful protective device has been fitted so as to guard the windings against a burn-out in the event of wrong connections. To use this device the left-hand knob—alongside the nameplate—is first depressed, and if the reading is reason-

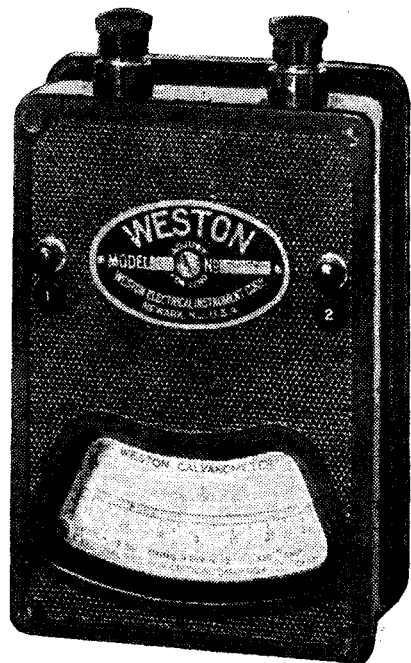

The Weston galvanometer.

ably small, the right-hand knob is depressed and the correct reading taken. If, on the other hand, a large reading is given when the left-hand knob is pressed, it is an indication that the current is too large.

The particular instrument shown is in almost daily use in the WIRELESS CONSTRUCTOR laboratory for the purpose of taking accurate measurements of the values of grid leaks, anode resistances, etc., the efficiency of crystal detectors, and many other tests requiring an accurate and sensitive micro-ammeter. It can be

thoroughly recommended to all who need a high-grade instrument of this type.

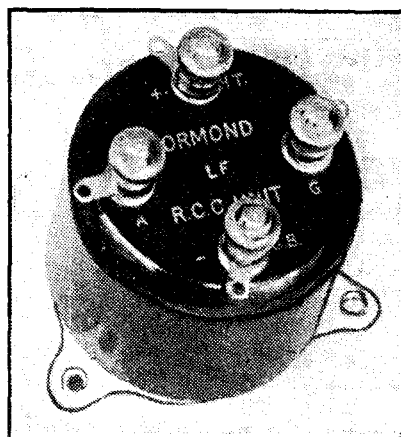

A neat R.C.C. Unit. (Ormond.)

A Neat Resistance-Capacity Unit

From the Ormond Engineering Co. we have received the Ormond L.F. R.C.C. Unit, consisting of a small insulated case (see photograph) attached to an aluminium base provided with three projections for screw-holes for securing to a baseboard. The top of the casing carries four equally spaced terminals for H.T. positive, grid, grid-bias negative, and anode respectively. The unit contains an anode resistance, coupling condenser and grid leak, so that those who desire to try resistance-capacity coupling can substitute this for their present transformer, provided, of course, they use the correct valves and high tension.

The unit is obviously designed for use with the new high-magnification R.C. valves which work satisfactorily

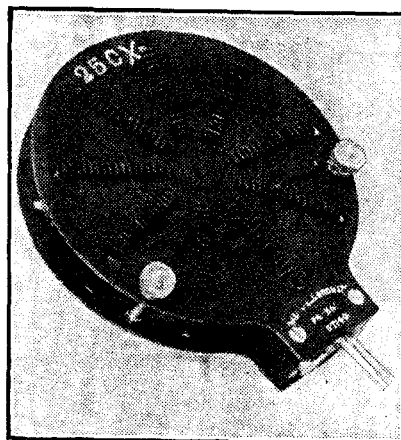

A 250-turn Gambrell "X" coil.

with a very high anode resistance, this being in the neighbourhood of two megohms in the specimen we tested. The condenser uses mica as a dielectric (which is as it should be, in such units) and the leak, although of a higher value than we should personally use, will probably give satisfactory results. This is a useful little component of general utility.

Coil For "Radiano Three"

The tremendous demand for X coils for the Radiano sets has led to a shortage in many parts of the country which has inconvenienced numerous readers. All who have built the "Radiano Three" will be interested that the Gambrell X coils—of

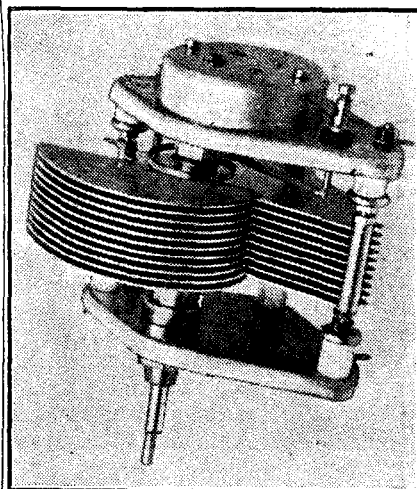

The Pye low-loss condenser.

which a 250 type is shown in our photograph—are equally as satisfactory as that shown in the original design, and can be substituted for that make of coil whenever desired.

The tappings in the case of the Gambrell coils are taken to two terminals on each side of the mounting, as shown, the proportion of windings being the same as in the type recommended.

A Geared Condenser

W. G. Pye & Co., Ltd., have sent us their low-loss geared condenser, a photograph of which appears on this page. Differing in many respects from other condensers on the market, it bears evidence of considerable thought in design, and electrical tests show that its efficiency is very high. The end plates are of stout stamped brass, with an efficient cover to protect the gear mechanism. The connection to the rotor vane is made by a

What's New—continued

soldered pigtail, and these plates are definitely insulated from the metal end plates—quite an unusual feature. The insulating material between the fixed plates and the end plates is porcelain, and the dimensions of the insulators are such that the field passing through the solid material is very small. A 3-in. direct-drive dial is provided, with a small knob

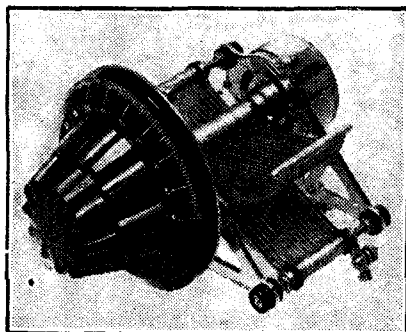

The Ediswan variable condenser.

for the vernier, which gives a very fine movement. One turn of the small knob is approximately equal to one division of the large dial scale. Electrical tests show that the efficiency is of the highest order.

The only criticism we would make is that the knob and dial are not worthy of such a fine instrument. A 4-in. dial would, in our opinion, be preferable.

Low-Loss Condenser

The Ediswan Company have submitted for test an example of their latest variable condenser of low-loss pattern, with brass plates and reduction gearing. The appearance of the condenser can be gauged from the above photograph. A particularly handsome knob and dial is fitted.

The moving plates follow the general convention of being connected to metal end plates, which are of cut-away formation, and nickel plated, and a metal disc insulated from the end plates is provided for earthing purposes.

The reduction gearing is of rather unusual pattern and departs from the usual convention of friction gearing by using rather an elaborate arrangement of a worm gear and cogwheel under an efficient dust cover.

The metal rods carrying the fixed plates pass through the metal end

plates, but are insulated from them by ebonite bushes of reasonable dimensions. On test for H.F. losses the condenser was found to reach a high standard.

A noticeable feature of this condenser is its great weight, the .0005 mfd. straight-line frequency pattern with knob, dial, and plate weighing 1 lb. 14 oz., and for this reason we recommend those readers who purchase it to use a substantial panel, as, in our opinion, this weight is too great to be carried on a $\frac{3}{16}$ -in. panel, a $\frac{1}{4}$ -in. being the better thickness, particularly as "one-hole fixing" has been adopted. Provided this condenser is not used on too thin a panel it can be recommended as an efficient instrument.

Useful Condenser Attachment

The Dubilier Company have submitted for test a new attachment or clip which they are producing for their condensers to enable the grid-leak resistance to be connected in series when required. The illustration shows the clip, consisting of a strip of insulating material, one end of which can be screwed under one of the condenser terminals, the other carrying a clip and terminal. It is designed to be used in conjunction with the ordinary condenser clips supplied by this firm, and, as will be seen from the photograph, has a very neat appearance. As an example of its use, readers are referred to the "New Family Four" in this issue, where it is used on the coupling condenser between the detector and the

first note-magnifying stage. In this case, the terminal connected to the ordinary clip is joined to the grid of the first note-magnifying valve, the terminal to which the insulated clip is connected being joined to the plate of the detector valve—though the radio-frequency choke—and to one end of the anode resistance. A leak is inserted between the clips, and the grid-bias battery is connected to the terminal on the insulated clip.

The price of the clip is 6d., and as when using it it is possible to dispense with the separate grid-leak holder there is a saving in both space and cost. Altogether it is an excellent little attachment which can be thoroughly recommended.

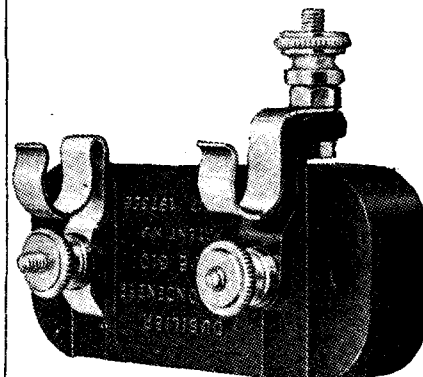

A Dubilier insulating clip in position.

* **FITTING PANEL** *
* **METERS** *

WHEN a flush-fitting meter has to be mounted on a panel by means of three bolts passing through a flange round the meter, it is as well *not* to drill all these holes before mounting the instrument. One hole should first be drilled and the meter fixed into position by a nut and bolt through that hole. The next hole can now be drilled while the meter is in place. This will ensure that the hole is in the right place, and the nut and bolt will pass through easily. Next drill the third hole, and put the last nut and bolt in.

If all the holes are drilled first, unless very accurate measurements are made, the holes in the meter and the panel will probably not coincide.



A useful mica fixed condenser.

IGRANIC sets a new standard in purity of amplification.

Purity with volume has been the result of correct designing in the new Igranic Three-Valve Resistance-Capacity Amplifier.

The wonderful possibilities of this form of coupling have been realised to the full in this amplifier through the use of wire-wound anode resistances, mica condensers and noiseless grid-leaks of the correct values.

Sufficient amplification to operate the largest domestic loud-speaker is obtained and the unit may be used on either a valve or crystal receiver. Smooth volume control is a special feature.

It is very compact, comprising three stages of amplification enclosed in an attractive bakelite cover. It may be built into a receiver or used separately.

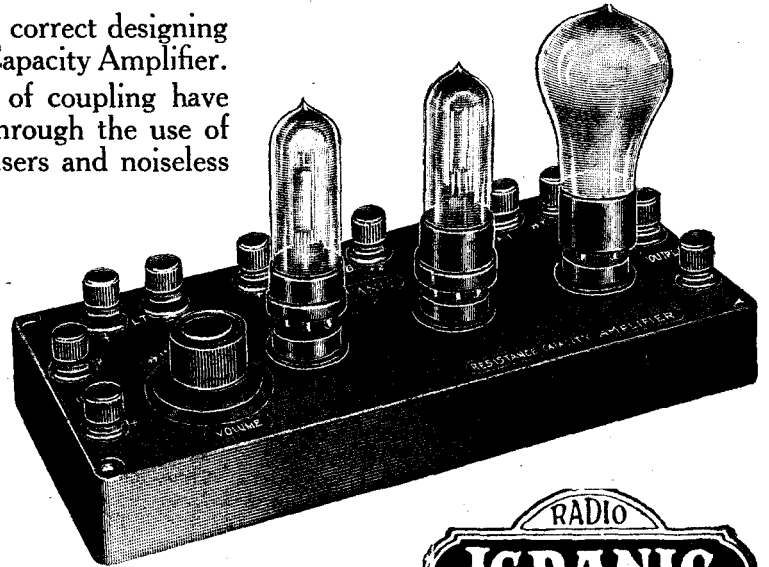

Write for list J.253.

IGRANIC ELECTRIC CO. LTD

149, QUEEN VICTORIA ST., LONDON

Works: BEDFORD.

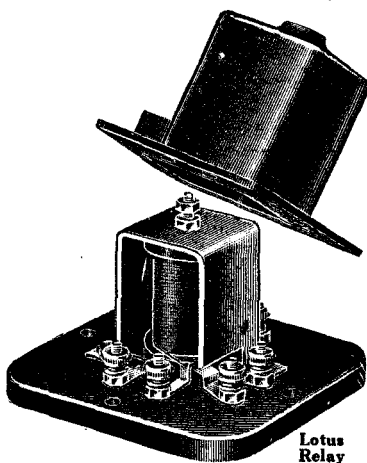

Simultaneous Reception in every room!

You can have simultaneous reception in every room in your home without interference by installing the Lotus Remote Control.

Lotus Relay

Complete outfit for wiring two rooms 30/-
Each additional room . . . 7/6

THE LOTUS REMOTE CONTROL

Write for FREE BLUE PRINTS and instructions how to wire two rooms in half an hour to Dept. W.C. 4, Garnett, Whiteley & Co., Ltd., Broadgreen Road, Liverpool.

FREE!

9 FINE DESIGNS 25 SIZES ARTCRAFT CABINETS

MADE IN OAK AND MAHOGANY.

"Artcraft Popular Type" Cabinets

Panel Size	Depth	Price in	
		Oak	Mahog.
9 x 6	6	6/0	10/0
10 x 8	6	8/0	12/0
12 x 10	8	12/0	16/0
14 x 10	8	14/0	19/0
16 x 8	8	14/0	19/0
18 x 12	9	21/0	29/0

Baseboards Free Hinged Lids 1/6 extra.

CARRIAGE PAID.

Grate and Packing 1/- extra.
Radiation, Resistor and Ebonart Panels at Standard Prices.

THE ARTCRAFT COMPANY,
156, Cherry Orchard Rd., Croydon.

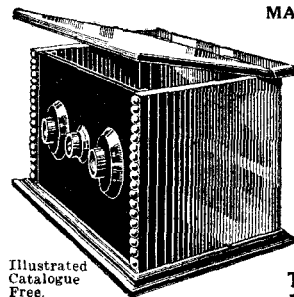

Illustrated Catalogue Free.

HYDRA CONDENSERS

will stand a peak pressure of 600 volts D.C. Voltage. In your set they make all the difference and absorb all the dry battery poises from your up to 10 mid. All capacities 2 mid. 3/9. 4 mid. 6/- etc. etc. From your dealer or direct from

Louis Holzman
109, KINGSWAY LONDON W.C.2
PHONE: HOLBORN 6209

THE FINEST CONDENSER MONEY CAN BUY

FROM OUR READERS

A selection of letters to the Editor dealing with radio topics of general interest to all listeners.

A Loud-Speaker Filter

SIR,—Re filter, as per WIRELESS CONSTRUCTOR, June, 1927, issue, I have just completed same and can thoroughly recommend it to all your readers, as it is a great asset to users of valve sets. Shall be pleased to hear of a good H.T. eliminator for D.C., 240 volts, in one of your coming issues.

Wishing the CONSTRUCTOR the success it deserves.

Yours faithfully,

E. RAPERPORT.

124, Cannon Street Road,
London, E.1.

"Radiano" in Bristol

SIR,—I feel I must add my small tribute to the wonderful powers of the "Radiano Three," and to the efficiency of the "Radiano" wave-trap.

Using an indoor aerial the strength and purity are excellent on the 'phones, while the H.T. used leaves an ample margin for loud-speaker work if necessary.

I am situated very high, and previous to building the wave-trap could cover at least forty degrees on the dial without cutting Cardiff out (about 35 miles), and could get nothing lower on the waveband.

full 150 ditto in the reaction, I was still getting Cardiff together with Daventry. With the trap in circuit this was put right. I also found that by reversing the 150 and 250 coils the Daventry wave came in undistorted.

However, I am enclosing a rough copy of my chart so that you may see my results up to date.

Apologising for taking up so much time, and wishing you and the WIRELESS CONSTRUCTOR every success.

Yours faithfully,

W. J. FLETCHER.

12, Ramsey Road,
Horfield, Bristol.

no information whatever regarding the filament voltage, filament current, and voltage amplification factor or impedance.

The nearest approach to satisfactory nomenclature is that applied to Burndept valves, but, obviously more can be done to indicate the vital factors relating to voltage amplification and impedance.

The problem is a difficult one, and perhaps a satisfactory solution would be too complicated for general use by the public. The question, however, deserves full investigation and, in my private capacity, I shall be only too happy to forward any British suggestions to an American industry which has honoured us by an invitation to co-operate with them.

I am, etc.,

JOHN SCOTT-TAGGART.

Aldwych,
London, W.C.2.

WAVE	PLACE	TIME	REMARKS
326.1	Birmingham	7. 45 p.m.	Using wave-trap, faint but clear.
353	Cardiff	8 p.m.	L.S. strength.
375	Madrid (U R)	11 p.m.	Loud as Cardiff on 'phones.
394.7	Hamburg	11 p.m.	Good, but liable to fade.
468.8	Langenberg	11 p.m.	Excellent on 'phones.
491.8	Bournemouth	8 p.m.	Splendid.
1,600	Daventry	8 p.m.	Clear, but interference from Cardiff.
1,600	Daventry	8 p.m.	Good, Cardiff cut out.
1,600	Daventry	8 p.m.	Using wave-trap, clear of Cardiff.
1,760	Radio Paris	Sunday Morn.	Excellent.
2,650	Eiffel Tower	8 p.m.	Quite good and clear.



The Contessa Maria Cristina Bezzi Scali, recently married to Senatore Marconi.

With the trap I not only cut Cardiff out, but brought in Birmingham, which, although faint, was clear and undistorted.

I found that using a 250 Edison Bell centre-tapped in the aerial, with

Standardising Valves

SIR,—The Radio Manufacturers' Association of America have formed a Vacuum Tube Committee to consider attempts to standardise valve nomenclature.

They have approached three Radio Engineers in this country who have been closely associated with valve development, with a view to co-operation in this matter.

As one of those approached, I am requesting the hospitality of your columns to invite from valve manufacturers, radio societies, and members of the public suggestions towards the solution of the problem of classifying in a convenient manner the different types of valves used to-day.

Any suggestions sent to me will be forwarded to the Committee in the United States.

How far it is practicable to classify the large number of British valves it is difficult to say. The fact remains, however, that nearly all types convey

A Hampshire "Radiano"

SIR,—I thought it might interest you to know the results I've had with the "Radiano Three" described by Mr. P. Harris in the WIRELESS CONSTRUCTOR for March.

The components used were as stated, except for the transformers, which were both Brandes first and second stage, and a three-way Loriostat in place of fixed resistors.

I have used Marconi-Osram valves, the 1.8-2 volt type (H.F.) as detector, and 2 D.E.P.215 in the last two stages.

The stations I've received are as follow: All the main B.B.C. stations except Cardiff; Radio-Paris, Hilversum, Berlin, Brussels, Barcelona, Langenberg, Madrid (E A J 4), San Sebastian (E A J 8), Oslo, Toulouse (P T T), Munich, Frankfurt-on-Main, Berne, also a station very near the latter whose call sign is S A S B, but was very weak and almost unidentifiable.

From Our Readers—continued

There have been about a dozen other stations which I have not yet recognised. I may mention that I had to use a wave-trap, the "Radiano Silencer," as described in the April issue, to cut out my local station, which is Bournemouth.

I consider the "Radiano Three" to be the best set this side of five valves both in power and distance getting.

Yours faithfully,

R. WEST.

No. 9, Flushard's Estate,
St. Catherine's Road,
Lymington, Hants.

The "Baby Giant"

SIR,—May I congratulate Mr. Rattee on the design of the "Baby Giant."

There is no doubt that this receiver really does receive the distant stations.

In broad daylight I logged Nottingham and Birmingham at loud-speaker strength, and six other stations.

I might add that I have wound an H. F. transformer myself.

Yours faithfully,

S. G. BUTTAL.

Arnesby Road,
Lenton, Nottingham.

"Radiano" Successes

SIR,—Having built the "Radiano Three," described in the WIRELESS CONSTRUCTOR, I find it is the best three-valve I have yet built, consisting of det. and 2 L.F. The set is very clear, selective, and powerful. I use a P.M.I.H.F. for detector and two P.M.I.L.F. for L.F. stages, and only 60 H.T. volts throughout. The stations to date on a 30 ft. twin about 30 ft. high are 16 on the loud speaker and about 40 on the headphones. I enclose a list of stations received. The foreign stations have not been identified. Wish your paper every success.

Yours faithfully,

W. L. WILSON.

Dronfield,
Sheffield.

MIDDLE WAVES.—London, Birmingham, Manchester, Sheffield, Nottingham, Leeds-Bradford, Newcastle, Bournemouth, Dublin, Glasgow, 5 German, 3 French, 1 Spanish.

LONG WAVES.—Daventry, Hilversum, Radio-Paris, Eiffel Tower, 2 German.

SHORT WAVES.—K D K A Pittsburgh, 5 X A F Schenectady, 3 German, 2 French.

A Southampton Reader's Appreciation

SIR,—Additional letters to those in the WIRELESS CONSTRUCTOR of recent issues may seem superfluous, but as a newcomer to the ranks of radio enthusiasts I am tempted to write you my opinion of this set—my first venture. I may say here that I had studied the subject for months before embarking on the job. In view of the great increase in popularity of R.C. coupling and the tendency to deprecate transformer coupling, I think the results are splendid. I am using Brandes' transformers in both

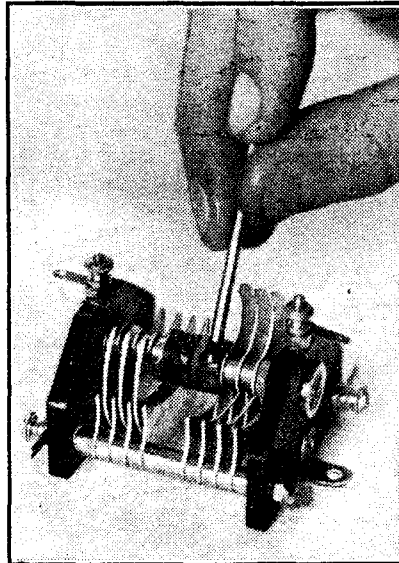

A new neutralising condenser designed by Messrs. Peto-Scott, Ltd.

stages, otherwise the components are as specified. The loud speaker is Brandes' "Ellipticon," and with the valves (Det., S.T.21A, 1st L.F., S.T.22, 2nd L.F., P.M.2) I am using H.T. values of 90 and 120, and G.B. values of $-4\frac{1}{2}$ and -12 . The set seems to be ultra selective, for seven or eight stations can be received on the lower wave-lengths on the loud speaker, with quite fifteen on the 'phones at varying strengths. On the Daventry range that station comes in with a power and purity that is highly commendable, while Radio-Paris is strong when 5 X X is not working. Eiffel Tower, at the very end of the condenser scale, is very weak in loud speaker but intelligible on 'phones.

I am now waiting for a Radiano receiver with one H.F., Det., and two or three L.F. stages R.C. coupled. Thanking you for many hours' pleasant recreation.

Yours truly,

B. C. BEVIS.

19, New Road,
Southampton.

A Schoolboy's Results

SIR,—It gives me great pleasure to write and tell you what good results I obtain from the "Radiano Three."

I receive nearly all the B.B.C. stations and many foreign stations, including some which I have been unable to pick up with sets using one H.F. stage, all on the loud speaker.

It may interest you to know that I am only fourteen.

Yours faithfully,

E. A. MARLAND.

5, York Road,
Long Eaton, Notts.

On the Short Waves

SIR,—Please accept my thanks for the description of the "Radiano Short Waver" in WIRELESS CONSTRUCTOR for June, 1927. Last night I wired this circuit up with a scratch set of components, with the addition of another note-magnifier. Using home-made bare wire coils, six aerial, four grid, and six reaction, with one turn of the dial I received signals from S U C, W I Z, 2 X A F, 2 X A D, W I K, S B 1 A W, K D K A (on a wave-length below 2 X A D), not to mention the scores of stations in Europe.

I can obtain reaction all over the dial, using three turns aerial, two turns grid, four reaction; the grid condenser is a .0003. I should like to know what the minimum wave-length is. 2 X A D comes in at about 40 deg., using the four turns for grid, and their wave-length is about 22 metres.

I think that my success with this receiver is due to the very smooth reaction control, which I find very simple to operate; there is no hand-capacity whatever, even when using the two-turn coil.

I'll conclude wishing you and WIRELESS CONSTRUCTOR even greater success than you enjoy at present.

Yours faithfully,

F. ROBERTS.

Oldham, Lanes.

From Our Readers—continued

Another Success

SIR,—I built this set yesterday afternoon, and at 1.30 I picked up W G Y without the slightest trouble. I remained with him till 2.45. The signals were strong and very clear, except for a slow fade at frequent intervals.

The handling of this set is simplicity itself, the reaction is wonderfully smooth, and altogether it is the most perfect little set I have had yet.

I may say, however, I departed a little from your description and instructions.

You will notice, from a photo enclosed of my "Radiano" set, I made my own coils after the style of your "Special Five" set, but with four pins only, and the aerial coil I slid along on two supports. With seven turns each on the double and five on the aerial, W G Y, working on 33.7 metres, came in about 55 on the tuning condenser. Anyone interested in short-wave work cannot do better than build this wonderful little set. Easy to build, easy to handle, I am confident it will give absolute satisfaction.

You will observe I did not use flex to wire it. I used 18-gauge tinned wire, and soldered all joints with rosin solder, an improvement on the flux method to my mind, especially for a sensitive set of this nature.

Yours faithfully,
J. J. McCONOCHIE.

Stroud Green,
London, N.S.

An Old Favourite

SIR,—I thought you would like to know the results I have obtained after building the All-Concert De Luxe last November. I have received all the B.B.C. main stations on the loud speaker and numerous foreign. And, apart from this, 69 amateur stations, ranging over England, Wales, Channel Islands, France, and Holland. From 180 to 30.2 metres, four of these on the loud speaker. I am using Mullard valves, 2-volt, with Super-Success Transformer and Ormond low-loss square-law vernier condensers. Does this constitute a record?

Yours faithfully,
Weeley, A. P. SUMMERS.
Clacton-on-Sea.

Short-Wave Successes

SIR,—Since writing re the "Radiano Three" I have received the following

short-wave stations at remarkable strength. I discovered that the best way to couple the aerial to the set was to attach a short length of insulated wire to the A terminal, and then just hook the aerial lead-in round the insulation. I use two home-made coils of 5 and 9 turns each, wound on a 1 lb. jam jar and interlaced with thin string, 16 D.C.C. The station P C J J was heard first on Friday evening, when it roared in at a greater strength than the local.

Every night since 5th, when working: 2 X A F, K D K A—fair loud speaker. 6 U G, Cheltenham; 5 D C, Blackpool; ? 5 L V, Clacton-on-Sea; 6 L L, London; 5 A D, London; 2 X Y, Leeds; 5 U W, Wolverhampton; 6 U Z, —.

Thanking you again.

Yours faithfully,
W. J. JAMES.

1, Winslow St.,
Walton, Liverpool.

The "Powerful Twin"

SIR,—Having built the "Samson," perhaps you might be interested to know the results obtained, but first I should like to definitely say, "that both for quality and quantity it is the finest two-valve set I have ever heard. The volume is indeed remarkable." I receive London at fair loud-speaker strength, Bournemouth very good, and Manchester fairly well. Madrid, excellent volume loud-speaker; also Barcelona, and Radio-Toulouse. Langenberg very good. Berlin fair. I get Madrid on indoor aerial at very good loud-speaker strength. I have found it an advantage to have variable rheostat control on front of the panel, otherwise the set is built exactly as in WIRELESS CONSTRUCTOR, which I have always taken. Offering my congratulations on this very fine set.

Yours faithfully,
W. E. CHAPMAN.
83, Albany Road, Roath, Cardiff.

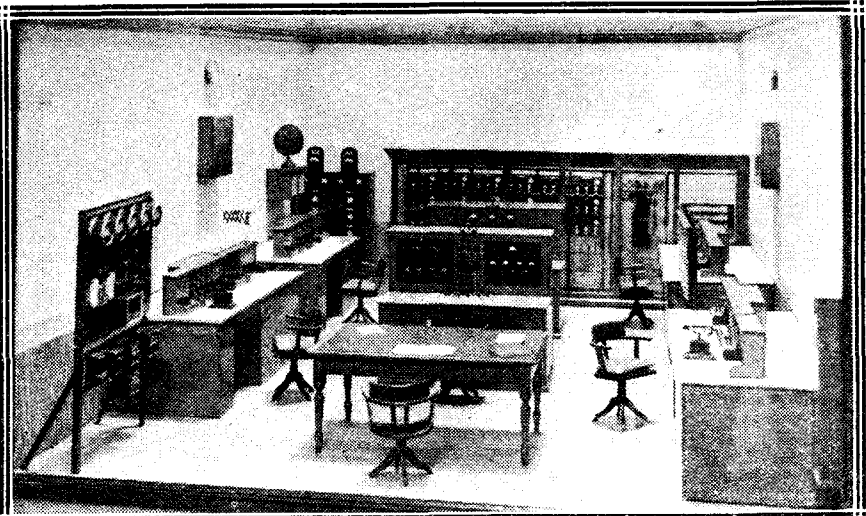

A model of the control room at 2 L O which was used by the B.B.C. for exhibition purposes.

One Valve Results

SIR,—I feel compelled to write and express my appreciation of "A High-Efficiency Single-Valver" in your April number, which I have just completed building. The range and tone (i.e.—distance range) are truly remarkable to me. I am a fourth-year student and constructor, having built dozens of sets previously.

Every success to your magazine.
Yours truly,
ROBT. E. JAMES.

29, Patrick Road,
West Bridgford, Nottingham.

A TRADE ANNOUNCEMENT

Mr. W. A. Appleton, M.B.E., M.I.R.E., wishes to state that, having resigned his directorship in Messrs. Radio Instruments, Ltd., he is in no way connected with the present amalgamation between Radio Instruments, Ltd., and Varley Magnet Co., having transferred his interest in R.I., Ltd., to the latter company. He is now trading in business in his own name at Gloucester House, 19, Charing Cross Road, W.C.2.

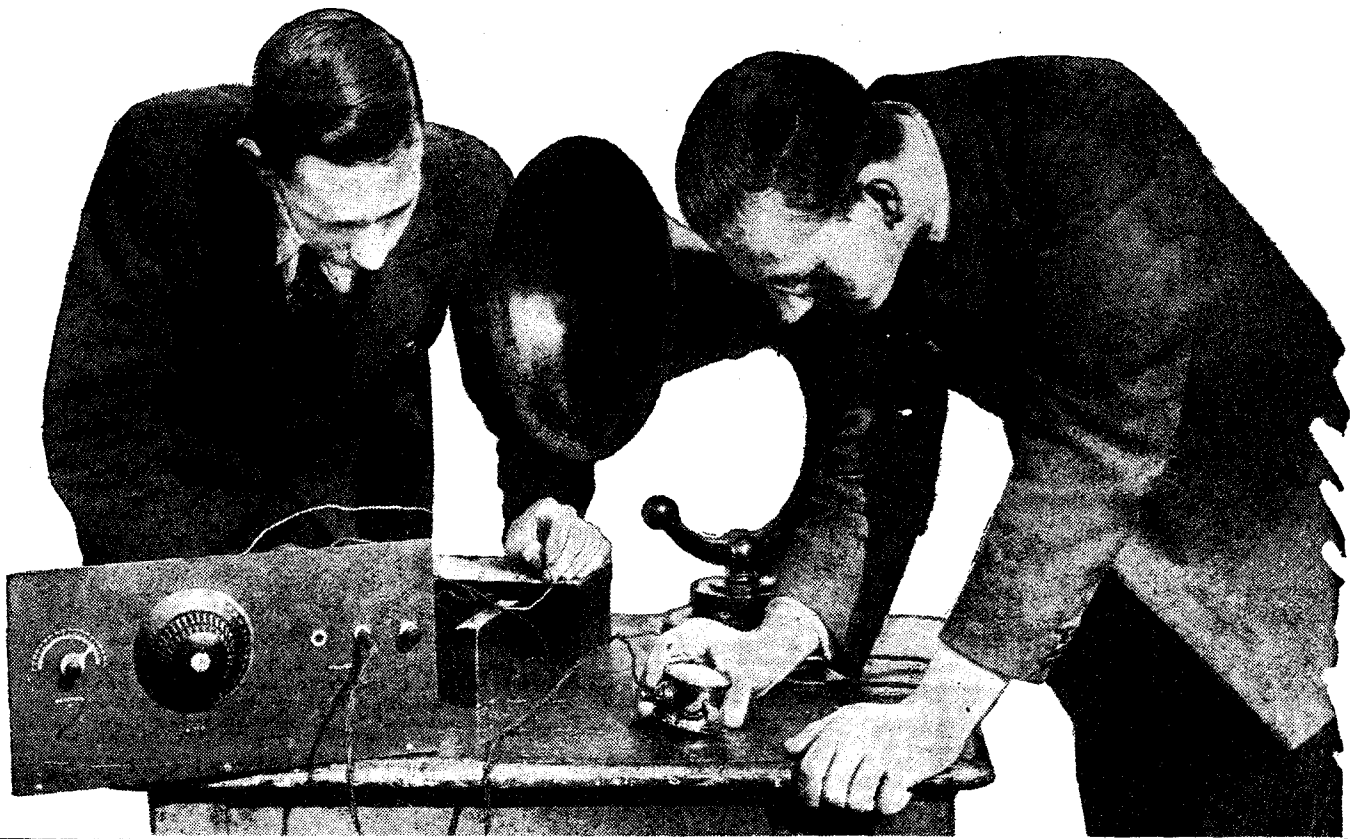

“POPULAR WIRELESS”

Britain's Leading Weekly Radio Journal

SINCE the inception of Broadcasting hundreds of thousands of amateurs have made their own sets—a great majority of them from constructional details published in “POPULAR WIRELESS,” of receivers designed by the leading experts of the day.

REGULAR contributors include such well-known writers as Captain ROUND, Captain ECKERSLEY, M.I.E.E., G. V. DOWDING, Grad.I.E.E., PERCY W. HARRIS, M.I.R.E., K. D. ROGERS, A. JOHNSON-RANDALL, J. F. CORRIGAN, M.Sc., A.I.C., and many others.

IF you have not placed a regular order with your newsagent for “P.W.” do so now, and keep abreast with the latest developments in all phases of Radio.

REMEMBER—“P.W.” is published every Thursday, price 3d.—for value for money it is unequalled.

HOW COSSOR VALVES ARE MADE

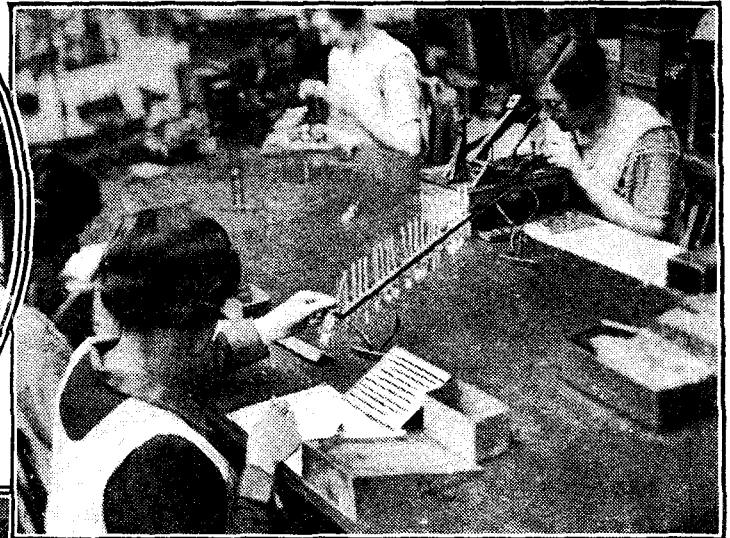
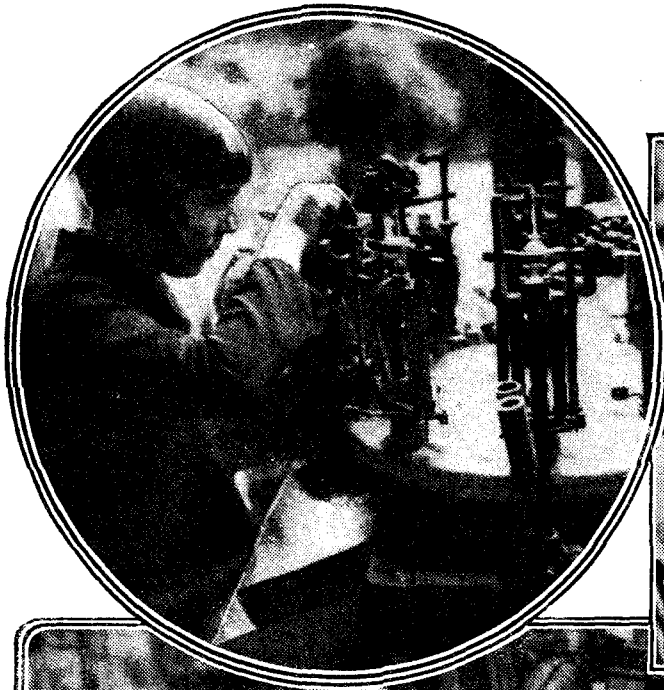

The manner in which the various valve-manufacturing operations are dovetailed together is illustrated above. It will be seen that as one operator finishes with the glass stem it is passed across the bench to be prepared for the next stage in manufacture.



This illustration shows how the connecting wires are passed through the "pinch" for connection to the electrodes.

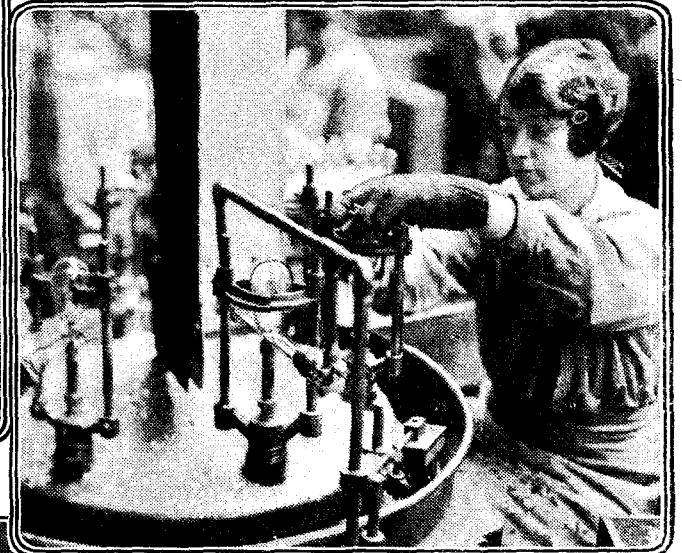

Girls are chiefly employed to operate the machinery, as many of the operations require nimble fingers.

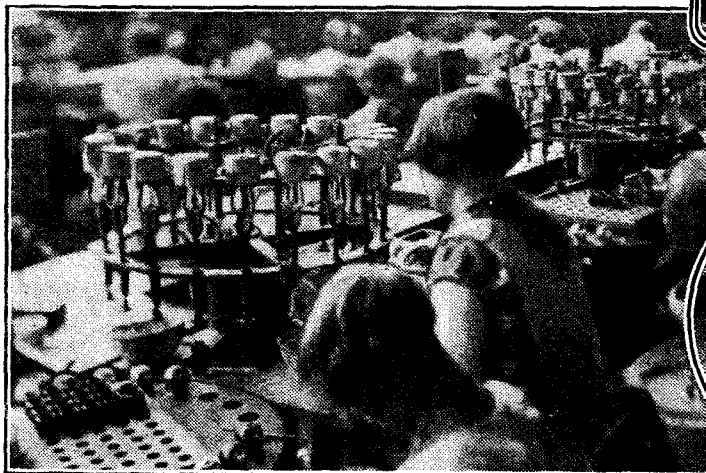

After the bulbs have been exhausted the valves have to be "capped" before passing to the final tests. To the right is shown the apparatus used for checking the electrical efficiency, each valve being carefully tested before passing out.

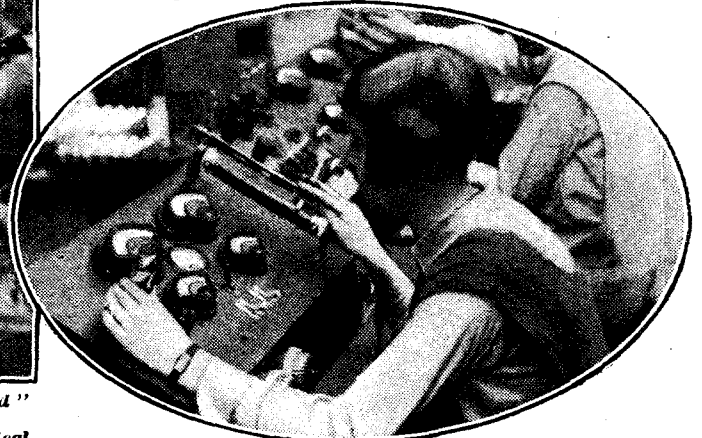

Photographs by courtesy of A. C. Cossor, Ltd.

scores every time

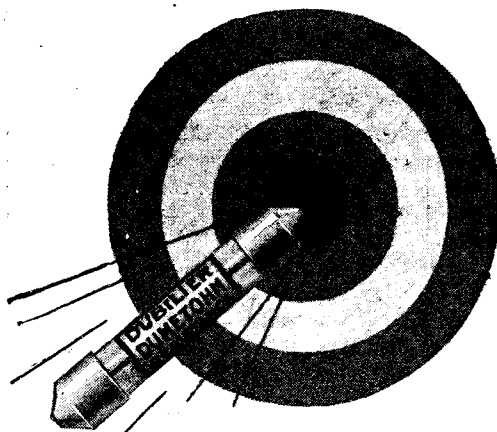

easily the most popular resistance in the country!

AND the reason?—

Because the resistance element is of a special metallic nature, made by a process known only to ourselves.

Consequently every Dumetohm after passing our strict tests is guaranteed to be and to remain noiseless and constant in operation. People no longer say "a Grid leak please" they ask for a Dumetohm—in itself the surest possible proof of popularity.

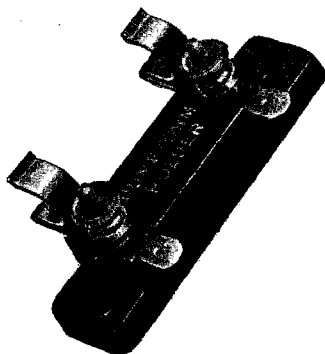

N.B.—The soldering of leads to a Dumetohm is liable to result in injury to the resistance unless carefully done.

The Dumetohm holder with its terminals and soldering tabs costs only 1/- and makes a sound workman-like job. 2 ins. between fixing hole centres.

The Dumetohm is made in standard resistances of 0.25, 0.5, 1, 1.5, 2, 3, 4 and 5 megohms and costs 2/6.



Adv. of the Dubilier Condenser Co. (1925), Ltd.,
Dacon Works, Victoria Road, North Acton. W. 3.

21 days test at our expense

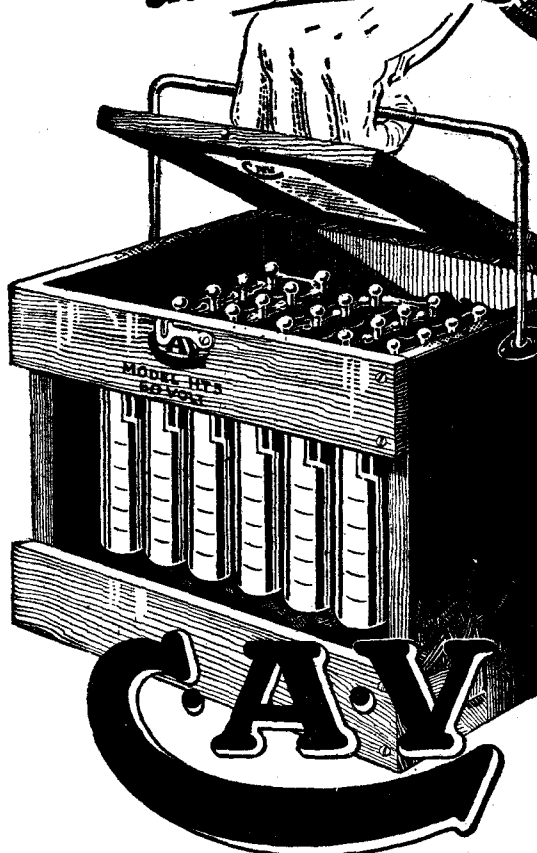

1927 IMPROVED MODEL H.T. ACCUMULATOR

TO prove our absolute confidence in these accumulators, we guarantee, if you are not satisfied, to accept return within 21 days from purchase date, and refund money in full provided battery is returned intact to the Agent from whom it was purchased.

C.A.V. H.T. Accumulators represent an epoch-making advance as compared with dry batteries. When dry batteries are down they are done, and frequent renewals make them more expensive. C.A.V. H.T. Accumulators will last for years, and only need recharging approximately every four months. They give bigger volume and are silent in operation. Every Accumulator is supplied fully charged ready for use, absolutely complete in case, and with distilled water filler, all included in the price, viz.: Model H.T.3.

60 Volts 60/-

Size 8½ ins. by 7 ins. by 7¼ ins. high.

30 and 90 volts also supplied at pro rata prices

Catalogue supplied on application.

C.A. Vandervell & Co., Ltd.
ACTON, LONDON, W. 3.

Telephone: Chiswick 3001
Private Branch Exchange

Telegrams
"Vandervell-London"

NOTES ON THE MILLIAMMETER

Some valuable hints for the amateur constructor.

By A SPECIAL CORRESPONDENT.

Most experimenters nowadays realise the value of having a milliammeter wired permanently into the H.T. supply of the receiving set, or easily inserted by

his set is improved if the instrument is shunted by means of a condenser of at least 1 microfarad capacity shown in dotted lines as C_5 .

The most satisfactory way of using

In the first place the leads from the condensers must be connected to the H.T. — lead on the receiving set side of the milliammeter and not on the battery side of the instrument. Secondly, the negative terminal of the milliammeter (usually the one which is unmarked) is connected directly to the negative end of the H.T. battery.

Useful Indicator

Wired in this way, the milliammeter is of the greatest possible assistance in operating any valve set. If, for example, a fault occurs the milliammeter narrows down the field in which it is to be sought. When the H.T. current is shown to be normal there is probably nothing wrong with either the filament circuits or plate circuits, and the source of the trouble should be looked for in the grid circuits or in the aerial-earth system. Supposing that the milliammeter indicates a flow of current that is below normal, and that all the filaments are glowing as they should, then one of the plate circuits is at fault. You can discover which it is by switching off the valves

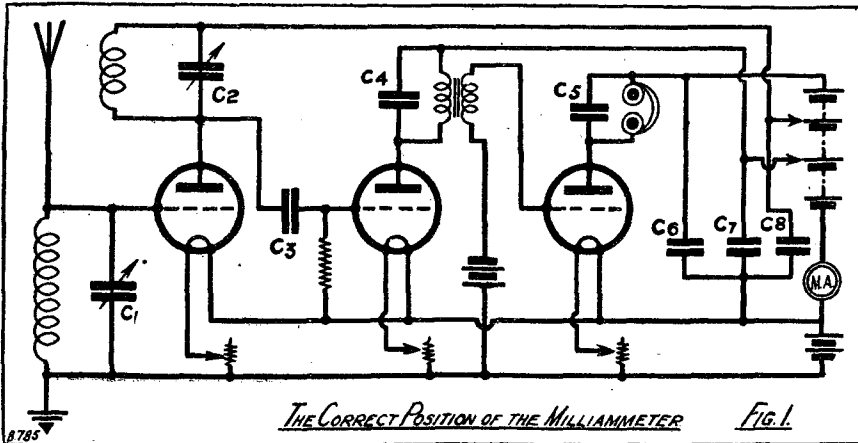

removing a link between two terminals. In the up-to-date set in which different anode potentials are supplied the most convenient position for the milliammeter is in the lead connecting H.T. negative to L.T. positive.

Unwanted Coupling Effect

There is, however, one point about placing the milliammeter in this position which may not have been generally noticed by experimenters. In both Figs. 1 and 2 the milliammeter is shown in the lead between the H.T. and L.T. batteries. At first sight there is not much difference between the two circuits, but if they are examined carefully it will be seen that in Fig. 1 the instrument is arranged so that the resistance of its windings is shunted by the condensers C_6 , C_7 , and C_8 , whilst in Fig. 2 no capacity shunt exists.

Wired up in this latter way the milliammeter may give rise to a good deal of trouble in multi-valve sets owing to the unwanted resistance which it provides, the coupling of circuits provided by its inductance, or to oscillations set up in the windings, which have, of course, a natural wave-length of their own. Any experimenter who has his milliammeter in the position shown in Fig. 2 will probably find that the working of

the milliammeter is to mount it on an H.T. battery distributing box, which should also contain the condensers shunting the various portions of the battery. Fig. 3 shows the wiring of such a box. There are two important points to remember in making it up.

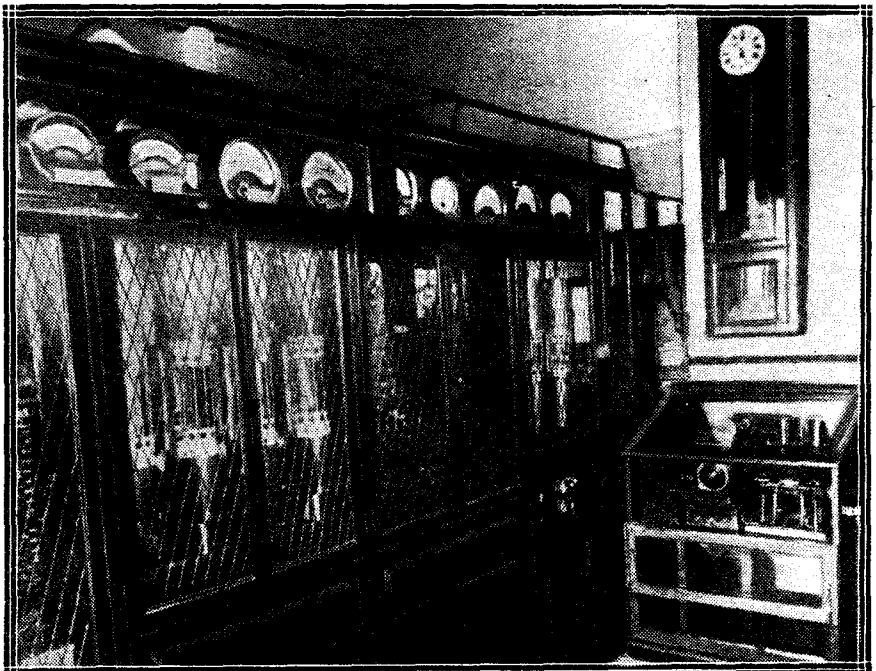

The transmitting apparatus at the Colombo (Ceylon) broadcasting station.

Notes on the Milliammeter—continued

one by one and watching the needle of the milliammeter. When the rheostat belonging to the valve whose plate circuit is faulty is turned to the off position the milliammeter will show little or no drop in current.

Detecting Oscillation

To use the milliammeter to the best advantage one should know the normal current passed by each individual valve as well as the total for the whole set. It then gives to the operator the same sort of guidance about the condition of his set as a patient's temperature gives to a doctor. There are two other extremely useful purposes served by the milliammeter when used in the way mentioned. It provides an infallible indication of the presence of oscillation in the detector circuit when condenser and grid-leak rectification is used. As the set approaches the oscillating-point the needle of the milliammeter shows a steady fall, which may amount to several milliamperes when full oscillation is reached. When reaction is "fierce" the milliammeter makes a sudden sharp dip as the set goes into oscillation with a tell-tale "plock." If the

coupled than they were when oscillation began. It will then jump back to its normal reading.

The milliammeter again provides a

meter permanently in circuit it will also tell you whether or not your filament current is completely switched off.

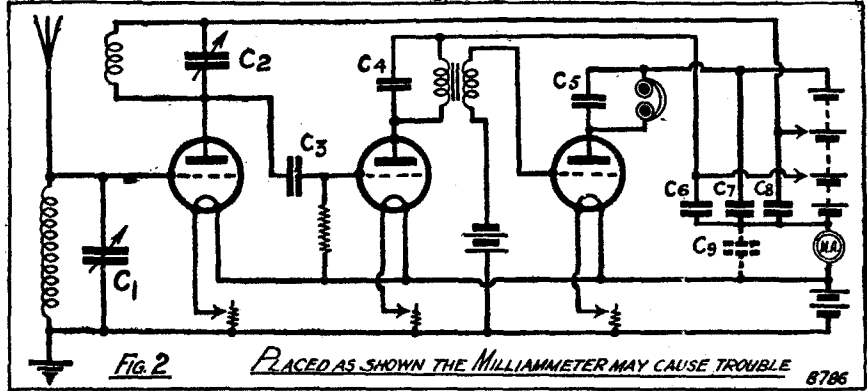

most valuable indication of the correctness of the grid biasing voltage used on the note-magnifying valves. Placed in the position shown in Fig. 1, its pointer should be perfectly stationary during reception. If, however, the needle flicks sharply, showing a current change of perhaps a milliampere or more when loud sounds or high notes occur, then rectification or overloading is taking place on the note-magnifying side,

Sometimes in a multi-valver it happens that an on-off switch is not included which switches off all the valves—one or more rheostats doing this service.

A milliammeter in the anode circuit will tell you at a glance if every valve filament is switched off, for until this is so, or unless there is a leak somewhere, a current flows from the H.T. supply.

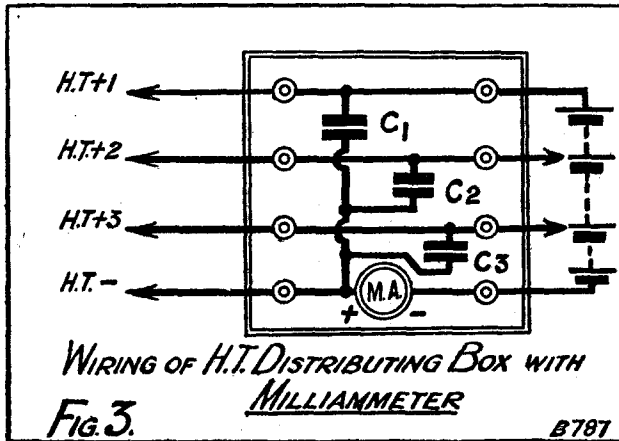

*
A distributing box for the H.T. supply, together with a milliammeter, forms a most useful accessory.
*

needle dips gradually as reaction is increased and rises just as gradually when the coupling is loosened, you may be satisfied that your reaction arrangements are as they should be. When overlap is present the milliammeter will show it up in the following way. As reaction is increased the needle will suddenly dip. If the coupling is now gradually loosened the needle will remain deflected until the coils are much more loosely

and either the grid bias requires adjustment or the L.F. valves are not up to dealing with the grid swings reaching them.

You can also watch the actual H.T. consumption and compare it with that which should be expected according to the published information of the makers.

Should considerable increases be noted you can suspect the existence of a leak somewhere. If you have the

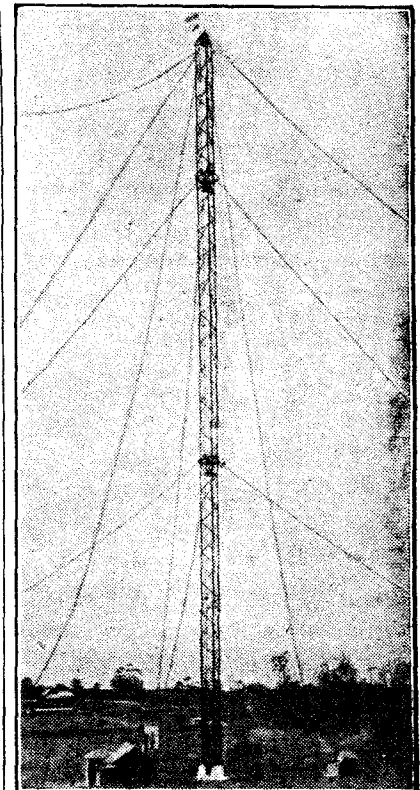

The 400-ft. mast at the Sidney broadcasting station.

TIPS FOR THE CONSTRUCTOR

Some useful ideas for the amateur set-builder

Transformer Terminals

In a good many makes of L.F. transformer there is a tendency for the terminals to work loose in their seatings. When this happens it may easily lead to the component being put out of action through the breaking of a lead, since the shank of the terminal turns a little when the milled nut is being tightened down. Where some kind of locknut is provided it is always as well to see when the transformer is brought into service that this is tight in the case of each terminal. Sometimes, however, there are no locknuts, the shanks of the terminals rising straight out of square seatings, as shown in the drawing. The remedy is to run a thin nut on in the way indicated, turning it hard down against the base of the seating by means of a spanner.

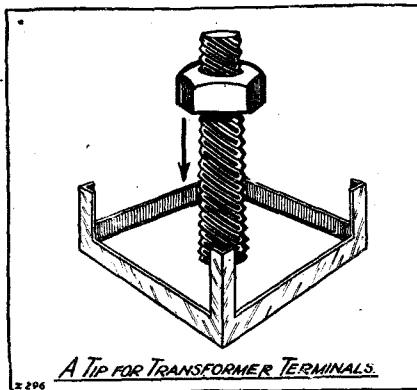

Whenever the writer is dealing with a new transformer he makes a point of examining its terminals before it is wired up into the set. If it is found, as is frequently the case, that locknuts are required, these are put on at once as safeguards against further trouble, for expensive instruments may easily be damaged if this simple precaution is neglected.

Water-pipe Earths

It is not always an easy matter to solder earth wires to a water pipe owing to the cooling influence exerted by the water. However, the job can generally be managed, provided a heavy soldering-iron is employed for the purpose. Many amateurs use a small soldering-iron, and

then give the job up in despair. It is evident that an instrument is needed which will store a large amount of heat in order to overcome the cooling effects of the water-pipe.

When attempting to solder earth leads to water pipes, always be sure at first that the surface of the pipe is thoroughly bright and clean. Give the surface of the wire which has to be attached, and the pipe itself, a thin layer of good electrical soldering flux. Tin the wire heavily, and then bind it tightly round the pipe. Have the soldering-iron well heated to a just visible redness, and then lay it on to the junction of the wire and pipe for about a quarter of a minute. Provided the soldering-iron contains enough heat, you will generally find that a perfect joint will result. However, if such is not the case, do not despair. Try again. A soldered earth is a thing worth having, and, with a few trials, you will soon be able to attain this desired end.

Illuminating the Panel

THE tendency in modern valve sets is to enclose all components and valves within the cabinet, leaving on the vertical panel only those parts which are required for tuning and other control.

With receivers so designed it is not unusual for the panel to be more or less shadowed.

The reason for this difficulty lies not so much in the fact that the dials are in a vertical position, as that a peculiar light and shade effect is produced, which renders the thin white markings of the condenser dial difficult to see.

It is a good plan to mount a flashlamp bulb on the face of the panel in such a position that when alight it will illuminate the dials; a small "on-off" switch should also be mounted on the panel in any convenient position. One side of this switch should then be connected to one side of the L.T. terminals of the set, say L.T.—; the other side of the switch should be connected to one side of the lamp, the other side of the lamp being connected to the L.T. positive terminal of the set.

A Tweezer Tip

THE inaccessible bolt or nut in a receiver has an uncanny habit of coming adrift; or again, when the components of a new receiver have been mounted, small terminals have to be taken off and replaced as the wiring proceeds, and some of these are sure to be awkwardly placed. A small pair of tweezers is sometimes useful for steering a terminal head into position, but more often than not the head slips out of the tweezers at the critical moment. There is a way of getting over this difficulty, by using the tweezers in a different manner from the normal. The tweezers used should have sufficient spring for the points to be normally about $\frac{1}{4}$ inch apart. The points are inserted in a nut or terminal head, and they will then hold it quite securely. The points should not project through the nut, so that its lower side can be rested lightly on the bolt, when rotation of the nut will start it on the thread. (See Fig. 1 below.)

For Fine Soldering

WHEN fine wires have to be soldered in a rather inaccessible position, it is often difficult to get the tip of a soldering-iron of ordinary size down into position. A useful method of overcoming this difficulty is to bind

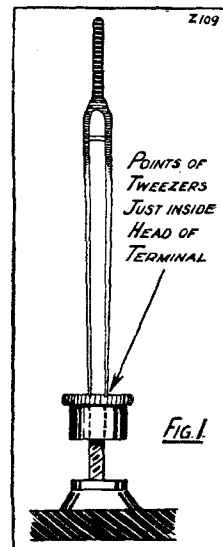

Threading on a terminal head which is situated in an awkward position can often be done with the aid of tweezers. Alternatively a length of threaded rod, screwed halfway into the nut, can be employed for the purpose.

a few turns of really stout wire round the head of the iron, leaving a projecting tip. This can be tinned, and then makes quite a good "iron" for soldering fine wires in grooves where the iron itself is too big to enter.

**SILENT
IN USE**

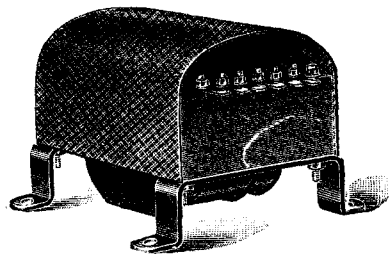

**GUARANTEED
ONE YEAR**



THE POWER TRANSFORMER IS ABSOLUTELY SILENT. IT IS FREE FROM ALL A.C. HUM, AND WHEN INCORPORATED IN BATTERY ELIMINATORS GIVES A DEAD SILENT BACKGROUND WITH IMPROVED RECEPTION. MADE IN THREE TYPES, WORKING SILENTLY AND GUARANTEED FOR ONE YEAR IT CANNOT FAIL TO GIVE ECONOMICAL SERVICE AND LASTING SATISFACTION.

No. 675. The filament winding of this Transformer gives a voltage of 6 (3-0-3) and is centre tapped, making it suitable for use with Marconi U5, B.T.H. or S.P. 42 valves, using a suitable resistance in the last instance. The anode winding gives 150 volts, either side of the centre tapping (150-0-150) for use in H.T. eliminators for A.C. Mains of 200, 220, or 240 volts.
PRICE £1 15 0

No. 676. Transformer is similar to the No. 675, but has in addition a 3.5 volts centre tapped winding for heating the cathodes of K.L.I valves. It is for use in H.T. Eliminators for Receiving Sets taking their current direct from A.C. Mains of 200, 220 or 240 volts.
PRICE £1 17 6

No. 677. Transformer, designed for heating the cathodes of K.L.I valves, and is for use on A.C. Mains of 200, 220, or 240 volts. The secondary winding is centre tapped, giving a voltage of 3.5. For any number up to and including 5 valves the voltage is constant, no rheostat being required.
PRICE £1 10 0

W. G. PYE & CO.,

GRANTA WORKS, CAMBRIDGE, ENGLAND

T.C.C. Condensers

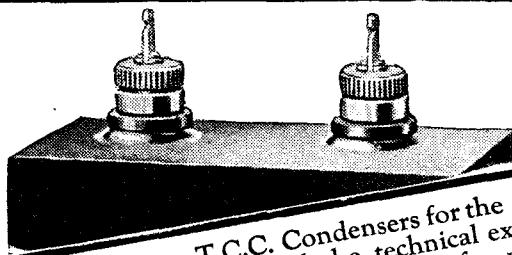

YOU will choose T.C.C. Condensers for the same reason which has caused the technical experts to use them in circuit after circuit, for years. That reason is the unfailing reliability and utter accuracy of the T.C.C. An insulation that is proof against breakdown. A capacity which never varies—the atmosphere cannot penetrate its stout metal case. A constant Condenser. A guaranteed Condenser. From .009, 2/-, to 2 mfd., 4/8.

Standard for 20 Years

G.A. 9106

CENTRE-TAPPED COILS and HOLDER

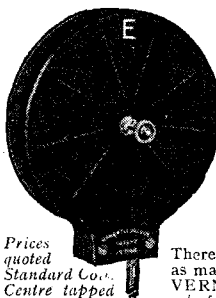

Universal Coils—use not being limited to centre-tapped circuits, fit any standard socket, easily interchangeable, and occupy minimum baseboard space.

Size.	Price.	Approx. No. of Turns.
a2	4/10	18
A	4/10	25
B1	5/-	30
B	5/3	40
C	5/6	50
D	5/9	75
E1	6/3	100
E	6/9	150
F	7/9	200
G	8/6	300
	10/-	500

Prices quoted Standard Coils. Centre tapped 6d. extra.

There is no neutrodyne condenser with as many good points as the NEUTRO-VERNIA. Cap. Range, approx. 2/38 m/mfds. Will not Short. Dust and Damp proof. Price 5/6

Coil Holder, specially designed for Gambrell Centre-Tapped Coils, does away with flexible leads. 1/9

Write for Booklet (G.F. 12) Free!

GAMBRELL BROS. LTD.
76, Victoria Street, London, S.W.1

CUT THIS OUT FOR CABINETS

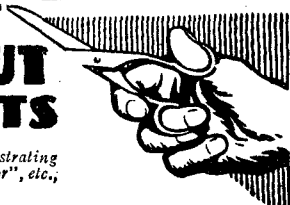

and post to us for FREE list illustrating Cabinets as shown in "Wireless Constructor", etc., etc., and for our additional Bulletin No 2.

NAME

ADDRESS



(Write in block letters, please.)
CARRINGTON Mfg. Co. Ltd.,
Camco Works,
Sanderstead Road, South Croydon.
Trade enquiries especially invited.
Telephone: Croydon 0623 (2 lines).

OUR NEWS BULLETIN

Some of the More Interesting Happenings
in the Radio World this Month

An Ether Traffic Cop

At a recent conference at Lausanne, the Union Internationale de Radiophonie decided to put a "detective" on the trail of broadcasting stations that wander from their wave-lengths. A permanent central station is to be established, with all-night watchers, equipped with wave-meters. And woe betide the transmitter that is caught touring the ether on the wrong kilocycle!

Are Some Stations Unlucky?

The Eiffel Tower is making a name for itself as an unlucky broadcasting station. Only last year a young airman was killed because his plane touched the aerial wire—he was trying to fly through the arch—and recently another fatality occurred there. One of the operators was turn-

ing on the power for the daily programme when he touched a live wire, and was electrocuted.

Short-Wave Schedules

Readers who like to dive deep down into the short waves for their broadcasting will be interested in the following schedule, recently issued by the G.E.C. of Schenectady, N.Y.

2 X A D, working on 22-02 metres, relays the W G Y evening programme every Sunday, Monday, Wednesday, and Friday. Also the one-hour tea-time programme at 4 p.m. E.S.T., on Tuesdays. Each Saturday at 1.45 p.m. *British* summer time, the arrangements for the ensuing week are sent by Morse (I.C.W.) and by telephony from 2 X A F, on 32-77 metres.

New Nautical Announcers

In order that they may keep in touch with one another when fishing in icy waters, Hull trawlers are being equipped with wireless telephone apparatus. The skippers will do the announcing, I'm told—and I expect they will do a lot of denouncing, too! Just fancy overhearing the "Unity's" skipper politely telling the "Boy Tom" what will happen if he cuts across his forcibly described bows again! What a refreshing change it would be from Daventry's shipping forecast!

New Air Ministry Station

Although radio is never quite "in season" when there is no R in the month, there is enormous radio activity going on just now all over Europe.

At home here, the Air Ministry is erecting a powerful Marconi station at Croydon for telephony, C.W. and I.C.W. to aircraft, on wave-lengths from 800 to 2,000 metres. Up-to-date direction-finding and remote control will make this one of the best-equipped air-stations in the whole world.

(Continued on page 280.)

MAGNUM SCREENED THREE RECEIVER

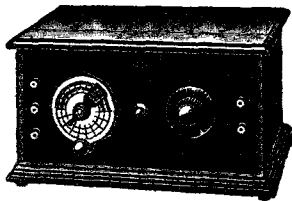

A new constructional set which can be supplied as a kit for Home Construction or as a completely wired Receiver. This model is the 3-valve set of a series of highly efficient receivers which are the result of considerable research in our Laboratories with the object of producing Receivers simple to construct and operate. As many as fifty stations have been received on the 3-valve model. Screened coils are employed, selectivity being of a high order.

Complete Kit of Components for Magnum Screened Three - £9 0 0
Any parts supplied separately as required. The Set ready wired and Aerial tested - £11 0 0
Plus Marconi Royalties - £1 17 6
Constructional Booklet giving full particulars and details free on application. Blue Print - rs. 6d.
Particulars of Magnum Screened 4- and 5-valve Receivers will be ready shortly. Register your name for particulars.

CONSTRUCT THE NEW FAMILY FOUR RECEIVER.

As described in this issue by Mr. Percy W. Harris.

	£	s.	d.
1 Mahogany Cabinet and Baseboard.....	2	2	0
1 Bbonite Panel, 24" x 7" x 1/2", ready drilled	0	14	0
2 J.B. Geared Condensers, .0005 mfd.....	1	13	0
1 B.L. Popular Condenser, .0003 mfd.....	0	10	0
1 Special Knob for above.....	0	0	9
1 R.L. Varley Multi Choke.....	0	9	6
1 Gecophone L.F. Transformer, 4-1.....	1	0	0
4 Bundept Fixed Resistors and Bases.....	0	10	3
4 Vibro Valve Holders.....	0	10	0
2 Wearite 6-pin Bases.....	0	5	6
1 Dubilier Wire-Wound Resistance and Base, 100,000 ohms.....	0	5	6
1 Varley Wire-Wound Resistance and Base, 300,000 ohms.....	0	11	0
1 Neutralising Condenser, baseboard type...	0	5	0
2 Angle Brackets.....	0	2	6
2 Lotus Jacks and 2 Plugs.....	0	9	0
1 Push-Pull Switch.....	0	1	6
1 Lissen Rheostat, panel type.....	0	2	6
1 Formodenser, as described.....	0	2	6
1 T.C.C. Fixed Condenser, .0003.....	0	2	4
1 Dubilier Leak, 4 megs.....	0	2	6
1 Dubilier Fixed Condenser, type 610, .015 mfd.....	0	4	6
1 Split Primary H.F. Transformer 250/550	0	10	0
1 Binocular Coll.....	0	13	6
1 Terminal Panel, 10" x 1 1/2" with Belling-Lee Terminals, as described.....	0	10	0
2 Terminal Panels, 2" x 1 1/2" with Belling-Lee Terminals, as described.....	0	4	0
Connecting Wire.....	0	2	3
	£12	5	0

Any of the above parts supplied separately as required. Components supplied for all sets described in this issue.

Note.—Where a complete set of parts is ordered, Marconi Royalties at 12/6 per valve holder are payable.

BURNE-JONES & CO., LTD.,
Manufacturing Radio Engineers,
MAGNUM HOUSE,

288, Borough High St., London, S.E.1.
Telephone: Hop 6257.
Telegrams: "Burjomag, Sedist, London."
Cables: "Burjomag, London."

MAGNUM R.C. UNIT

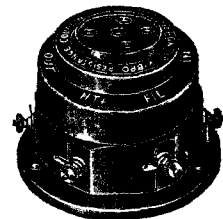

A new development to meet the modern demand for high-quality reception and simplicity in set construction.

This unit contains a Resistance, Leak, and Condenser of a special design to eliminate all possibility of variation due to climatic conditions. The elements are sealed inside the Container which is a Bakelite Moulding and, as shown in illustration, embodies a Magnum Vibro Valve Holder. A highly efficient 3-valve Receiver can be simply and cheaply constructed by the use of two of these units.

In neat carton with fixing screws and circuit diagram, **price 10/6.**

SIZE { Height 1 1/2 in.
Overall Diameter 3 in.

Send stamp for comprehensive range of lists, including latest star sets described in several radio publications.

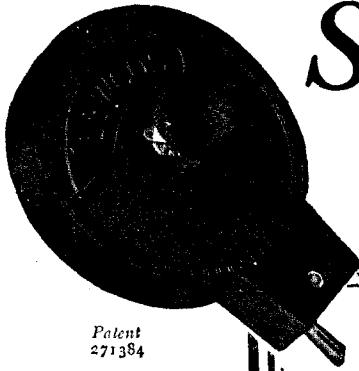

Patent
271384

Something new in Centre Tapped Coils!

Two Centre Tapped Coils for B.B.C. and Daventry Ranges have now been added to the famous range of LEWCOS Plug-in Coils. Wound with Litz wire they maintain, in construction and performance, the same high standard of efficiency as the ordinary type Inductance Coil. All wireless dealers stock or can obtain them for you.

No.	Minimum W/L	W/L with '0005 Condenser	Price each
C.T. 60	188	555	3/6
C.T. 200	595	1,960	5/3

The LONDON ELECTRIC WIRE CO. & SMITHS LTD.,
Playhouse Yard, Golden Lane, London, E.C.1.

LEWCOS

Registered Trade Mark

Centre Tapped Plug-in Coils

JUDD



**STEEL PLATE
ACCUMULATORS**
FOR
HIGH TENSION

Only 1/- per volt.

*Absolutely Noiseless.
No Acid. No Fumes.
Last a Lifetime.*

BATTERIES, LTD., REDDITCH
LONDON OFFICE:—220, Shaftesbury Avenue, W.C.2.

WIRELESS CONSTRUCTOR

Advertisement Rates

- 1 Insertion - - - - £60 0 0
per page and pro rata
- 6 CONSECUTIVE Insertions 55 0 0
per page and pro rata
- 12 CONSECUTIVE Insertions 50 0 0
per page and pro rata
- ONE INCH single col. (2 1/4" wide) 2 5 0
- Minimum Space, half-an-inch 1 2 6

IMPORTANT. Copy and Blocks must be in hand by 20th of each month for issue published 15th day of the following month.

ALL communications respecting advertising must be made to:—

JOHN H. LILE, Ltd., 4, Ludgate Circus, London, E.C.4
Phone: CITY 7261.



A GREAT ADVANCE "INDIVIDUAL-GANG" CONTROL CONDENSER

again to the fore!

FIRST we gave our customers a highly efficient and low-priced Variable Condenser and L.F. Transformer. Now we lead in the design of a Gang Control Condenser with individual adjustment which has all the advantages of the ordinary Gang and Single Condensers without ANY of their disadvantages.

**CROWN WORKS, Dept. 6,
Cricklewood Lane, N.W. 2.**
Phone: 1787 Hampstead.

Manchester: Mr. J. B. Levee, 23, Hartley St.,
Levenshulme. Phone: Heaton Moor 475.

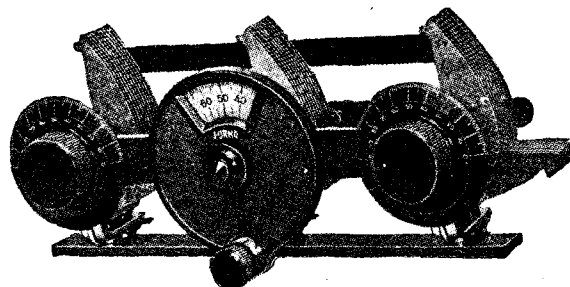

TWIN GANG £2:12:6
TRIPLE-GANG £3: 3:0
TUNE with the centre dial until you hear your station.
ADJUST with the side dials for maximum signal strength.

**IT'S SIMPLE!
IT'S EFFICIENT!!
IT'S GOOD!!!
IT'S FORMO!!!!**

OUR NEWS BULLETIN

—continued from page 278

“The Merrier We’ll Be!”

Hungary hopes to have a high-power “Hello” on the air by the end of this year, and Italy is embarking on a regional scheme, the first link in which will be the new transmitter at Milan. Another Dutch station, with studio in Amsterdam, is to start up shortly on 1,870 metres. At least a dozen other European stations are being planned, and some nice Portuguese programmes are now on the air from a new station at Lisbon (on 303 metres).

There will thus be plenty of ether excitement to tune in to, when all these new announcers clear their throats and start to tell the world.

Too Poor to Listen-In

Hoping to help invalids who are too poor to listen-in, the Middlesbrough branch of “Toc H.” has embarked upon a good scheme. Members are giving their services to make up and instal wireless sets in the homes of the sick and bed-ridden poor, providing that others

who can afford it will come forward with spare parts or spare cash.

Subscriptions will be gratefully received for Toc H. by the Rev. A. Bostock, St. Paul’s Vicarage, Middlesbrough.

Wireless Picture Service

A regular public wireless service for passing pictures between Berlin and Vienna came into operation on July 1st. The system used has been developed by the Telefunken-Karolus-Siemens people, who have tried it with success in experiments with Rome, Rio de Janeiro, and other distant cities. The wave-length used is about 50 metres.

Colour by Radio

Talking of wireless pictures reminds me that the Americans now claim to be able to send radio views in colours, as well as in black-and-white. The principle employed is similar to that used for colour printing, so that a three-colour print requires three separate transmissions, these ultimately being blended. The system has been used successfully between San Francisco and New York.

“Proms” of Promise

Unless there is a hitch at the last moment, the long-drawn-out feud

between the B.B.C. and Chappell’s will bear good fruit after all. For when Sir Henry Wood conducts the first of the Broadcast “Proms,” on August 13th, he will have an all-star orchestra under his baton. Drawn from the Wireless Orchestra, the New Queen’s Hall Orchestra, and the London Symphony Orchestra, these favourite musicians are a guarantee of good fare for the microphone.

A Capital Scheme

There is a proposal afoot to form a national broadcasting company in Belgium, with a 10-year licence and a chairman nominated by the Government. The present stations would be taken over and developed, and for the purpose three million francs will be required. The question is, will the Belgians consider this is a capital scheme?

The British Association Meetings

Listeners who remember the previous broadcasts will be interested to know that the ninety-seventh annual meeting of the British Association will be held in Leeds this year. The meetings will start on August 31st, and conclude on September 7th, 1927.

SAVOYARD.

Repeated features in many valuable Sets.

RESISTOR & BASE

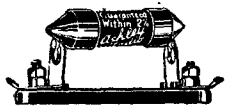

Price 2/6 complete

ALL-PURPOSE JACKS



Prices 1/3 to 2/9

A comprehensive range of useful Components is described and illustrated in our latest pamphlet, a copy of which will be sent you on request.

BY the excellence of their performance in the newest circuits, these Components have gained the confidence of expert constructors the world over. The majority of users appreciate that their purchase represents the best possible value for money. *If unobtainable locally, we send post free.*

VALVE-HOLDER, 1/3

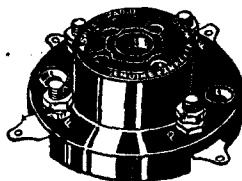

Adopted by the B.T.H. for their R.K. Loud Speakers—a remarkable tribute to its high quality.

Ashley Radio

GUARANTEED COMPONENTS

ASHLEY WIRELESS TELEPHONE CO. (1925) LTD.
FINCH PLACE, FALKLAND STREET LIVERPOOL.

X. L.

VARIO-DENSERS

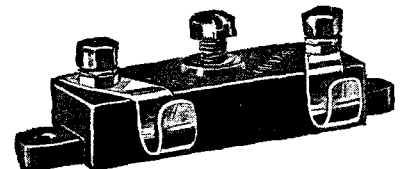

The X.L. Vario-Denser is designed primarily for use where accurate values or adjustments are required. Genuine Bakelite casing, all metal parts phosphor-bronze nickel-plated and the best imported India mica obtainable make up the construction. Dust and moisture proof casing, extreme micrometer advance, broad and positive capacity range adjustment, and exceptional accessibility in close quarters are the exclusive features that make critical adjustments a pleasure with X.L.

Suggested Uses for X.L. Vario-Densers.

- Neutralising Condensers in Neurodyne Circuits.
- Grid Condensers.
- In Super Heterodyne Set as regeneration Condenser and for tuning Filters.
- Series Condenser in Aerial Circuit.
- X.L. Vario-Densers are specified in the original LOFTIN-WHITE Circuit.

MODEL “G” VARIO-DENSER

Made in three variable capacity ranges:
Model G-1 ‘00002 to ‘0001 mfd. Model G-5 ‘0001 to ‘0005 mfd.
Model G-10 ‘0003 to ‘001 mfd.

Complete with grid leak clips. PRICE each 6/6.
The second edition of our 1927 Radio Components List is now ready
Send a P.C. for your copy. Free and post free

Hamleys
Estd 1760
HAMLEY BROS LTD

200-202, REGENT STREET, LONDON, W.1.

Telegrams: “Pleasingly, Piccy.”

Telephone: Regent 3160 (6 lines).

EXCHANGE DEPT. REOPENED

IF YOU WANT TO BUY NEW PARTS, WE ARE WILLING TO ACCEPT SOME YOU DO NOT REQUIRE IN PART EXCHANGE.

Not more than 4/- in each & you spend allowed for in old parts. Owing to the thousands of letters received...

IMPORTANT LEADING DISTRIBUTOR OF

EISEN & G. SURINDETT. WEARIE, DUBLIER, EDISON BELL COSMOS, MULLARD, COSSOR, EDISWAN, B.T.H., MARCONI, STERLING, GAMBRELL, MAGNUM, EVER-READY, RESISTOR, T.C.G., IGRANIC, FERRANTI, LEW-COS, "J.B." BENJAMIN, LOTUS, NEWBY, P.Y.E., C.E. PRECISION, EUREKA, UTILITY, FORMO, BOWYER-LOWE, OLVERN, R.L. BERNARD, POLAR, T.C.G., PETO-SCOTT.

STANDARD LINES

Belling-H.E. Terminals Climax H.F. Choke 8/6 Climax Pott. Divider 5/6 Everymag 2/6 2/6 Excellent Oscillator 2/9 Formo Twin Gang 52/6 Formo Triplic 63/- Formo Vernier Dial 6/- Gear-w 2-way 2/11 Hunt's V-meter, D.I.B. D/R 7/6 Igranic S.W. Coils 10/- Lewcos Battery leads 5/6 Precision H.F. Choke 7/- Sterling Phone Cord 1/6 Silk L.S. Cords, 12 ft. 2/- Utility Switches. Unimic Coils, 5/- Base 2/6 Vernier Dials, 2.11, 3.6, 5.9 Voltmeters D.I.B. 6/8 3/1 Battery Boxes, 63-v. 3/- Brunet L.F. 3.1, 5.1 7/11 Choke, H.F. Ormond 7/6 Clix stocked. Clix Sockets, ebonte 1/4 Postalt Sets 3/6, 10/6 Dublier Univane 25/- Engraved Terminal Strips 1/- Everymag 4 Booklet 1/- Gambrell C.T. Coil-holders, 1/9

Glazite, 5 colours, 10 ft. 1/2 Grid Bias Clips, pair 8d. H.T. & L.T. 4-way Leads 2/- Igranic Preset Res. 1/8 Induct. Coils from 1/3 Insulated staples, 50 for 1/- Junt, 10 feet 1/6 Lotus Remote Control 30/- Loud Speaker Units 10/9 Micro Bar Amplifier 34/- Microfux Vernier Dial 5/9 Micrometer Detectors 2/- Oldham 2-v. O.V.D. 5/6 Panel Brackets, pair 1/6 Peerless Coil Formers 1/4 Polar Junior, -0005-0003 1/9 Screen and Base, 6-pin 7/6 Siemens 60-v. H.T. 15/6 Siemens at the Best 1/6 Simplex Lead-in 1/6 1/6 Switches, De Luxe 1/6 2/- Switches, Push & Pull 1/6 Switches, Rumber 1/6

ACCUMULATORS. 2-v. 40, 7/11; 2-v. 60, 9/6; 2-v. 80, 12/6; 2-v. 100, 14/6; 4-v. 40, 13/11; 4-v. 60, 17/11; 4-v. 80, 23/6; 6-v. 60, 26/6; 6-v. 80, 35/6. ALS another good make, 1/6 extra on each of above. Post 1/6 each. ASHLEY JACKS & PLUGS Fit panels & to 3 thick, one-hole fixing. S.C.O., 1/3 S.C.C., 1/6 O.D., 1/9 S.C.S., 1/9 F.D.C., 2/3 Phone Plugs, 1/6 Valve-holder, 1/3 Ledward Res., 2/6; Base, 1/-

HEAD FITCH (Success). -H.F. and L.F. Chokes, each, 10/6. Midget Neut. Condenser, 7/6 Black L.F. Transformer, 2/11 BENJAMIN Battery Switch, 1/3 Valve Holder 2/9; with Grid Leak, 5/3; with Condenser and Leak, 7/- Rheostat, 2/9 BOWYER-LOWE -Dual Var. Condens. 2/6 Popular -0005, -0003, 10/6 each. Neutralising Unit, 9/- Triple gang, 23/10/0 H.F. Transformers, 9/- ea. Neutralising condenser, 7/- Valve holder

BRETWOOD -Grid Leak de Luxe, 3/6; with condenser, 4/6. Anode, 3/6. BROWNIE No. 2. Latest model, 10/6. Complete with pair of high-class phones, 4,000 ohm value B.I.L. Aerial wire, lead-in, Daventry Coil, the lot, 18/11. 2-Valve Amplifier, 63/- 4-way Phone Boards, 3/- Daventry Coil, 2/9 BURNEDET ETHO-VERNIER DIAL (with Etholog Station Indicator, 18-1, 9/-

CARBORUNDUM. Detector only (No. 30), 5/- Stabilising Detector Unit, with No. 4 Detector, 12/6. CELESTON Loud Speaker, Oak, 110/-; Do. "A2", 130/-; Do. "A3", 150/- Mahogany same price; walnut extra. CLIMAX. - Potential Divider, 5/- Special Choke, 10/6 Shock Absorbers, 3/- pr. Earth Tubes, 5/- L.L. Insulators, 1/- pair EVER-READY ADDEDNEE COILS, & Former & Base, 5/- 6-pin Base, 1/6 Former only, 4/- Screen and Base, 8/6 S.P.H.T.P., 9/6 S.S. do. 9/6 2-Tonoidal, 19/- DUBLIER Durohona Wire-wound 20,000 to 100,000 ohm resistances, 5/- each; Base, 1/6 200,000 ohms, 8/- Vol Control Unit, H.F., 7/6 Dumetolam Holder, 1/- DUBLIER MANSBRIDGE. 1, 2/6; 2, 3/8; 25 to 3, 3/1; 4, 2/6; 5, 3/6 1 mid., 4/-; 2 mid., 6 3 mid., 8/- DUNHAM "ALL-WAVE" TUNER will enable you to dispense finally with troublesome Vernier coil-holders and sets of coils. It is adaptable to any set already made, and covers all wavelengths from 150 to 2,000 metres, and is complete with reaction. "All-wave" Tuner, 9/6. Complete with full instructions and blue prints.

ELECTONE PRO-GRAMME SELECTOR. Programme comes on automatically at desired time, 27/6. EVER-READY H.T. Pinstar 66-v. 9/6; Do., 108-v. 15/6 Standard 66-v. 12/6; 108-v., 21/- L.T.3, 7/6 (43-v.). Flash Lamp, 4/6 6/- dozen. Grid Bias, 9 Tap, 1/6 P.M.X. (G.P.), 6/-; P.M.S.B. (R.C.), 6-v., 14/-; P.M.5, 6-v., 18/6 Super Power Valve for last L.P. Stage, P.M.253, 4-v., 22/6; P.M.256, 6-v., 22/- WE RECOMMEND THEM

BRITISH RADION LATEST VALVES Type 2-v. 15H.F. or L.F. 2-v. Power 4-v. 1H.F. or L.F. 4-v. Power 6-v. Power Post 6d. each. NEW SINGLE-VALVE CIRCUIT. (H. Cons., Aug. 27.) Two -0005 Nos. 3 Ormond Var. Conds. with Friction Dial, at 12/- Push-pull, Igr., 2/6. Benj. V.H., 2/9. Dublier -0003, 2 meg. and holder, 6/-; -001, 2/6. 2 B.B. Sol. Stand., 3/- Lissen B.B. Rhbo., 9/6 McMichael H.F. Choke, 9/- Neutralising B.B., 5/- Centre-tapped C. and F. (long and short wave), 35-50 and 150, for Aerial Circuit, 3 Terms., Wire, etc. Total, 23/7/6. Sent post free for 23/7/6 (Three pounds seven-and-sixpence). American Cabinet, 12 ins. by 8 ins., with baseboard, 3 hinged lid, solid oak, 12/11. Drilled panel, Matt, 5/-; Polished, 7/6. Both post free.

THE NEW FAMILY FOUR. (P. W. Harris.) I have all parts in stock. Perhaps you would like to use up some of your existing parts. In this case, please say what you actually need, and I will give a fixed inclusive price.

LOG-MID-LINE Try our NEW VARIABLE CONDENSERS, made on the Log-Mid-Line principle. -0005 or -0003, with a 4-in. Triotide Dial, the best you can buy, for the moderate price of 5/11 each, post free

LOG-MID-LINE Try our NEW VARIABLE CONDENSERS, made on the Log-Mid-Line principle. -0005 or -0003, with a 4-in. Triotide Dial, the best you can buy, for the moderate price of 5/11 each, post free

LOG-MID-LINE Try our NEW VARIABLE CONDENSERS, made on the Log-Mid-Line principle. -0005 or -0003, with a 4-in. Triotide Dial, the best you can buy, for the moderate price of 5/11 each, post free

LOG-MID-LINE Try our NEW VARIABLE CONDENSERS, made on the Log-Mid-Line principle. -0005 or -0003, with a 4-in. Triotide Dial, the best you can buy, for the moderate price of 5/11 each, post free

LOG-MID-LINE Try our NEW VARIABLE CONDENSERS, made on the Log-Mid-Line principle. -0005 or -0003, with a 4-in. Triotide Dial, the best you can buy, for the moderate price of 5/11 each, post free

LOG-MID-LINE Try our NEW VARIABLE CONDENSERS, made on the Log-Mid-Line principle. -0005 or -0003, with a 4-in. Triotide Dial, the best you can buy, for the moderate price of 5/11 each, post free

LOG-MID-LINE Try our NEW VARIABLE CONDENSERS, made on the Log-Mid-Line principle. -0005 or -0003, with a 4-in. Triotide Dial, the best you can buy, for the moderate price of 5/11 each, post free

LOG-MID-LINE Try our NEW VARIABLE CONDENSERS, made on the Log-Mid-Line principle. -0005 or -0003, with a 4-in. Triotide Dial, the best you can buy, for the moderate price of 5/11 each, post free

LOG-MID-LINE Try our NEW VARIABLE CONDENSERS, made on the Log-Mid-Line principle. -0005 or -0003, with a 4-in. Triotide Dial, the best you can buy, for the moderate price of 5/11 each, post free

LOG-MID-LINE Try our NEW VARIABLE CONDENSERS, made on the Log-Mid-Line principle. -0005 or -0003, with a 4-in. Triotide Dial, the best you can buy, for the moderate price of 5/11 each, post free

LOG-MID-LINE Try our NEW VARIABLE CONDENSERS, made on the Log-Mid-Line principle. -0005 or -0003, with a 4-in. Triotide Dial, the best you can buy, for the moderate price of 5/11 each, post free

LOG-MID-LINE Try our NEW VARIABLE CONDENSERS, made on the Log-Mid-Line principle. -0005 or -0003, with a 4-in. Triotide Dial, the best you can buy, for the moderate price of 5/11 each, post free

LOG-MID-LINE Try our NEW VARIABLE CONDENSERS, made on the Log-Mid-Line principle. -0005 or -0003, with a 4-in. Triotide Dial, the best you can buy, for the moderate price of 5/11 each, post free

LOG-MID-LINE Try our NEW VARIABLE CONDENSERS, made on the Log-Mid-Line principle. -0005 or -0003, with a 4-in. Triotide Dial, the best you can buy, for the moderate price of 5/11 each, post free

R.I. AERIAL TUNING INDUCTION 39/6. R. Element Detector, 1-Hole Fixing, 6/6 Multi Ratio L.F., 25/- Standard Ratio, 25/- Reactive Anode Unit, 25/- New H.F. Choke, 9/-

SPEAKING LOUD SPEAKER. Speaks for itself. Price, 50/- SHAW'S GENUINE HERTZITE. Made from special formula in sealed boxes, with signature. Gold Label, 1/-; White do., 8d.

RADIO MICRO. 2-v. 5/11. Power, 10/- 3.5-v. .06, 5/11. Super Power, 12/- Post 6d. valve. SUCCESS. Chokes H.F., 10/6; Super, 18/6; Super Tapped, 22/6; L.F., 10/6.

UTILITY SWITCHES. Anti-cap., 2-v., 3/6; 3-w., 4/6; 4-w., 5/-; 2-w., 6/-; Lever Pattern, 2-w., 4/-; 3-w., 5/-; 4-w., 6/6; 6-w., 8/-; FILTITS. Variable Condensers stocked.

VARIETY. All Chokes and Anodes stocked. WEARIE 2-way geared, 5/- B. of Panel, 7/6 Countryside Four, set of Binocular Coils, 15/- Rotary Coil Switch, 2/6 M.C.3 Aerial and Transformer Coils, wound on Rayonol formers, ready for use, 3/- pair. Post 6d. M.C.4 Ditto B.B.C., 10/6 set. 5XX, 2/6 set. H.F. Choke, 6/6.

HELLESEN (post free), 66-v., 12/6, 99-v. 21/- Grid Bias, 9-v., 2/- 4-v., tapped 11-v., 2/- LOTUS V. Holders, 2/3; with Terminals, 2/6 2-way Coil Stand, 7/-, 8/- 3-way, 10/6, 12/-

NEUTRALISING. Peto-Scott, 5/-, 6/3, 7/6. Ormond, 4/-, Bowyer-Lowe, 7/- Magnam 5/-, McMichael, 4/9 Reaction (Ormond) -0001, 4/-, J.B., 3/6. PEERLESS -6 or 30ohm Rheostat, 2/6. Fixed Resistors (State Valves), 1/3

MULLARD VALVES. P.M.H.F., 2-v., 14/-; P.M.2, 2-v., 14/-; P.M.2, 1-v., 18/6; P.M.3, 4-v., 14/-; P.M.3A (R.C.), 4-v., 14/-; P.M.4, 4-v., 18/6; P.M.X. (G.P.), 6/-; P.M.S.B. (R.C.), 6-v., 14/-; P.M.5, 6-v., 18/6 Super Power Valve for last L.P. Stage, P.M.253, 4-v., 22/6; P.M.256, 6-v., 22/- WE RECOMMEND THEM

BRITISH RADION LATEST VALVES Type 2-v. 15H.F. or L.F. 2-v. Power 4-v. 1H.F. or L.F. 4-v. Power 6-v. Power Post 6d. each.

NEW SINGLE-VALVE CIRCUIT. (H. Cons., Aug. 27.) Two -0005 Nos. 3 Ormond Var. Conds. with Friction Dial, at 12/- Push-pull, Igr., 2/6. Benj. V.H., 2/9. Dublier -0003, 2 meg. and holder, 6/-; -001, 2/6. 2 B.B. Sol. Stand., 3/- Lissen B.B. Rhbo., 9/6 McMichael H.F. Choke, 9/- Neutralising B.B., 5/- Centre-tapped C. and F. (long and short wave), 35-50 and 150, for Aerial Circuit, 3 Terms., Wire, etc. Total, 23/7/6. Sent post free for 23/7/6 (Three pounds seven-and-sixpence). American Cabinet, 12 ins. by 8 ins., with baseboard, 3 hinged lid, solid oak, 12/11. Drilled panel, Matt, 5/-; Polished, 7/6. Both post free.

THE NEW FAMILY FOUR. (P. W. Harris.) I have all parts in stock. Perhaps you would like to use up some of your existing parts. In this case, please say what you actually need, and I will give a fixed inclusive price.

LOG-MID-LINE Try our NEW VARIABLE CONDENSERS, made on the Log-Mid-Line principle. -0005 or -0003, with a 4-in. Triotide Dial, the best you can buy, for the moderate price of 5/11 each, post free

LOG-MID-LINE Try our NEW VARIABLE CONDENSERS, made on the Log-Mid-Line principle. -0005 or -0003, with a 4-in. Triotide Dial, the best you can buy, for the moderate price of 5/11 each, post free

LOG-MID-LINE Try our NEW VARIABLE CONDENSERS, made on the Log-Mid-Line principle. -0005 or -0003, with a 4-in. Triotide Dial, the best you can buy, for the moderate price of 5/11 each, post free

LOG-MID-LINE Try our NEW VARIABLE CONDENSERS, made on the Log-Mid-Line principle. -0005 or -0003, with a 4-in. Triotide Dial, the best you can buy, for the moderate price of 5/11 each, post free

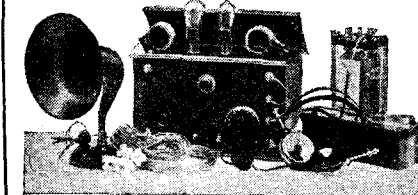

THREE-VALVE LOUD-SPEAKER SET NOTE THE WONDERFUL VALUE. TRY ONE OF THESE!

(The set shown is two-valve.) Gets Local, Daventry and many Continental stations.

THIS MAGNIFICENT 3-VALVE SET (D. & L.F.), includes Handsome Polished American-Style Cabinet (all parts enclosed), 3 Dual Emitter Valves, Tuning Coils, H.T. & L.T. Batteries, Aerial Equipment, Leads, Loud Speaker or Horns, Tax paid. £ s. d. 5196 Car. & Pkg. 7/6

LISSEN PARTS. Variable Grid Leak, 2/6; Lissenstat, 10/6; Major, 7/6; Minor, 3/-; Fixed Leaks, 1/- Valve-holder, 1/-; Mica Condensers, 1/-; -002 to -006, 1/6; H.F. Choke, 5/6; Switches, 2-way or key, 1/6; S.P.P. Pull, 2/6; D.P.D.T. Pull, 2/6; Rheostats, 7-35 ohms, 2/6 each; Lissenola, 13/6; L.F. Transformers, 8/6.

PETO-SCOTT (Keystone, Coxep). Neut. B.B., 5/-; P.M.3, 4-v., 14/-; Midget, 4/6. Special 6-pin Base, 2/9. Coxep screws and Base, 9/6. Coils stocked for all sets. L.F. TRANSFORMERS. Ferranti A.P.3, 25/-; A.F.4, 17/6; Eureka Concert, 25/-; 2nd Stage, 21/-; Raby 1st or 2nd, 15/-; Reflex, 15/-; Formo Abundant 10/6; Success (Black), 20/-; Royal, 20/-; Ormond, newest model, 15/6; Marconi, "Ideal", all stages, 25/- each; C.A.V., 15/-; Pye, 17/6; Gambrell, 2 stages, 25/6; Ideal Junior, 18/6; R.I., 25/-; Ormond Ratio, 25/-.

ORMOND Square Law Low-Loss. -0005, 9/6; -0003, 8/6; (1/6 each less no vernier); Friction Geared, -0005, 15/-; -0003, 14/6; -00025, 13/6. Straight Line Frequency Friction Geared, -0005, 20/-; -00035, 19/6. S.F.F. -0005, 12/-; -00035, 11/-; 50 LAW LOW LOSS DUAL, -0005, 16/- each. Ormond Friction Dial, 10/-; Filament Rheostats, Dual, 2/6; 6 ohms or 30 ohms, 2/-; Potentiometer, 400 ohms, 2/6. Standard, -0005, 5/-, -0001, Reaction, 10/-; Air Dielectric, 2/-; Neutralising, Naut. dymne, 2/-; Twin Gang, -0005, 32/-; Triple, 40/-.

MULLARD, COSMOS, MARCONI, B.T.H., EDISWAN, COSSOR VALVES. The latest always in stock. THE NEW NO. 3 FORMO OR FINSTON S.L.F. CONDENSER -00025, 5/8. -00035, 5/8. -0005, 6/- With 4" Dial. With Friction 55-1 4-in. Dial, 6/- ea. extra. ORMOND NEW 5/- GEARED DIAL 5/- LOW LOSS SQUARE LAW.

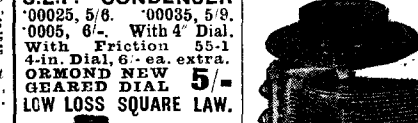

This variable Condenser is simply marvellous value. It cannot be equalled in price or quality. -0003 4/11 each -0005 By Post 5/11. With VERNIER 1/- extra. LISSEN LATEST 2-WAY CAM VERNIER 4/6

BRITISH HEAD- PHONES - BROWN'S FEATHERWEIGHT, 30/- BROWN'S 'A', 30/- TYPE (R.W.), 30/- B.T.H., 15/-, STERLING, 20/-, 22/6. SIGNAL BOX (H. Cons., May, '27). Ormond Friction S.L.F., -0005, and two -00035, 59/- 2 6-pin Neut. Conds., 5/-; 3 W.B. Bases, 3/-; Neut'ma, 5/6; V.H., 6/-; 3 Resistors, 7/6; -0001 and base, 3/6; R.F. Choke, 9/- both McMichael; Varley 100,000 Ohm, and Base, 7/6 3 On-and-Off, 4/6; Carbourod Unit, 12/6; R.I. Multi, 25/-; Ferranti, 25/-; Terminals with strips, 4/-; -015, Post 4/-; Glite, 2/4. Post free.

GLITE. All parts as specified. SIGNAL BOX. Kit of parts, all highest quality and specially selected re efficiency. Post free 5/5 15s.

With handsome 4" TRIOTIME 7/6 dial and knob. With Geared Dial, 11/6. CABINETS. Large stocks of really useful cabinets kept, or made to order. Solid oak, Glass finish, American type, hinged lid, baseboard. Post 1/6 each extra. 8 x 6 x 7 ins. deep... 6/11 10 x 8 x 8 ins. deep... 8/12 12 x 8 ins. deep... 10/6 14 x 7 ins. deep... 12/6 16 x 8 ins. deep... 14/11 Extra quality in Oak or Mahogany, 5/- each extra, worthy of any set.

STANDARD WET H.T. BATTERIES. Economical, no charging, permanent, silent in action. Size 11 in. by 18 in. 90 volt. 60 cell battery. Complete sets of components, 21/-; A standard wandler plug can be plugged in every cell. Jars, 1/3 per doz.; Sacs No. 1, 1/6 per doz.; Sacs No. 1, with Terminals, 2/3 per doz.; Sacs No. 2, 3/6 per doz.; Sacs No. 2, with Terminals, 3/9 per doz.; Zincs (new model), 1/- per doz.; Rubber Bands for insulating 12 No. 1 Sacs, 6d. box; Ditto, 12 No. 2 Sacs, 6d. box; Electrolyte, sufficient for 20 cells, 9d. BOOKLETS FREE ALL CARRIAGE FORWARD

K. RAYMOND 27 & 28A, LISLE ST., LEICESTER SQ., W.C.2 Hours: 9.15 to 7.45. Back of Daly's Theatre. Saturday: 9 to 8.45 Nearest Tube, Leicester Square Sunday: 11 to 1 Phone: Gerrard 4637.

SETS REPAIRED OR RECONSTRUCTED Panels Drilled. Low Charges.

CALLER'S COLUMN

AERIALS.—100 ft. 7/2d Hard drawn, 1/11. Extra heavy, 2/2. Phosphor 4 1/2 strands, 1/7. Ebonite stock, Special 1/1000s Aerials, phosphor, with ebonite separators and rubber rings (12 ft. x 8 strands), total 100 ft. 5/6. O.V. 2/6. Rubber Lead-in, highest quality, 10 yds. 1/-; 10 yds. 1/3; 10 yds. 1/6. Extra heavy, 2d. and 3rd. B. B. Twin Flex (best), 6 yds. 10d.; 12 yds. 1/6; 36 yds. 4/-; Ins. Hooks, 2 for 1d. Egg Insulators, 2 for 1d. Ins. Staples, 4 a 1d. Earth Tubes, Copper, each, value 2/3. Chimax, 5/- (also at 2/6).

EASY FIX AERIALS, with 2 insulators and lead-in, 1/3. EBONITE HEAD E.A. Stock sizes, 6 x 6 and 7 x 5, 1/3; 8 x 6, 1/6; 9 x 6, 1/9; 10 x 8, 2/9; 12 x 6, 2/9; 12 x 8, 3/6; 12 x 9, 4/-; 4" x 4" x 1/2" CUT TO SIZE while you wait at 1d. per sq. inch 3/16th and 3d. sq. inch for 1 in. Special cheap panels for Crystal Sets. TERMINALS. Nickel W.O. Pillar, 'Phone, 1/- doz. (3 for 4d. with N. do.); Brass do., 10d. doz., 11c. each; N. N. do., 2/6. All high quality Valve-Pins, with nuts, 2 a 1d. Ormond Screws, 6 or 4 B.A., 6d. dozen with nuts, washers 12 a 1d. Red and side, 3d. pr. plug and Socket, Red or Black, 3/4d. Wandler Plugs, Red or Black, 3/4d. pr. (Large, good). 'Phone Control Knob, 1/6. Flange panel sockets and nuts, 4 for 4d., 10d. dozen. Brass Spade Tags, 6 a 1d. Nickel Solder Tags, 4 a 1d., 2 and 4 B.A. Rod, 3d. foot. Nickel V. Rings, 4 a 5d. Nuts, 1d.; 8d. dozen. Stop Pins, 2 a 1d. H.T. BATTERIES. No cheap and nasty batteries sold here; only highest quality here; prices 4d. (Trade test award best given) 60-v., 6/-; 100-v., 11/9. Thera, 60-v., 5/6; 100-v., 10/-; Everready, 66-v., 9/6; 108-v., 15/6. Others from 1/- to 1.5 L.T. Hellesten's, 2/6; Adco, 1/8; B.T.H., 2/-; Efig, 2/-; British, 1/6. F.A.S.I. L.I.S. 4.5 British, 6d.; 3 for 1/3. SOLDIER, with Resin, 2d. foot. 1/16 sq. Bus Bar, 2 feet, 1d. Finned standard 16 and 18 gauge round, 9d. per lb. D.C.C. 1-b. 20 gauge, 8d.; 22 gauge, 9d.; 24 gauge, 10d.; 26 gauge, 11d.; 28 gauge, 1/-; 30 gauge, 1/1.

WANSBRIDGE CONDENSERS. 'Hydra' 1 1/2, 2/9; 2 mfd., 3/9. 0-1 mfd., 25 and 5, 2/3. S.F.F. (R.W.) on Potentiometer, D.P.D.T. 1/3; S.P.D.T. 8d. and 10d. 8d. quality. Panels, switches, with Ebonite handle, worth double price. D.I.B. O.T. D.T. Insulating tape, 4 1/2. Copperfoil, 4d. foot (6 in. wide). Grid Bias Clips, 6d. Panel Brackets, 9/4d., 3 pr. Shoring, 1/6, 3d. PERMANENT DETECTORS. Red Diamond (a taper), 2/- Lion Micro (latest, cannot be equalled), 2/6. Brownie, 3/-; Enclosed Kay Ray, 1/-, 1/3. Service Micro-meter, with crystal, 2d. 4/6. CRYSTALS. Super-zinc, 1/6; Shaw's sealed genuine Hertzite, 1/6; Wyrray 1/6. HEAD- PHONE CORDS. Cord, 1/-, 1/3, 1/6. L.S. Cords, 1/6, 1/9, 4-way H.F. and L.T. leads, 2/-; Lewcos Stocked COIL PLUGS. Ebonite on Base, 6/4d. 7/4d. Lotus, 8d. Burne-Jones, 1/9. Low Loss, 8/4d. Panel, 6/4d. Various types. SEE LIST OF STANDARDS. 2-way, 2/3. 2/6. 2/11 up. 3-way, grand value, 5/11. Back of panel from 2/11. All ebonite.

AMPLION £6.0.0 LATEST CONE LOUD-SPEAKER BEFORE YOU PURCHASE ELSEWHERE LET ME QUOTE YOU

There's no "waiting" with ORMOND

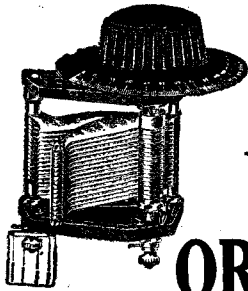

HOW annoying it is—waiting for signals, while you fruitlessly turn the dial in a vain endeavour to tune in to distant stations. One moment you almost get your station, the next you are whirled away to some other far removed. Fit an Ormond Condenser, however, and you will never have trouble in tuning—no tiresome twiddling of the dial. With an Ormond, precise tuning adjustments are a simple procedure.

The new Ormond "No. 3" S.L.F. Condenser is the precision Straight Line Frequency Condenser with a greatly reduced frame and highly finished Bakelite end plates. Specially shaped vanes give high maximum and low minimum capacity with TRUE S.L.F. readings throughout the full 180 degrees scale. No bunching of half the wavelengths between 0 and 27 degrees—all stations are spread evenly over the dial. Supplied either with 4-inch Bakelite Plain Dial or 4-inch Bakelite Friction Control Dial. Each is engraved in 180 single degrees, showing 0 at the shortest wavelengths—stations are still referred to in metres—and towards 180 for longer wavelengths. Easy to mount. One-hole fixing. Terminals and Soldering Tags for connections.

Complete with 4-inch Plain Dial:
 -00025 mfd. - 5/6
 -00035 " - 5/9
 -0005 " - 6/-
 With Friction Control Dial (ratio 55-1) 6/- extra respectively.



199-205, PENTONVILLE ROAD, KING'S CROSS, LONDON, N.1.

Telephone: Clerkenwell 9344-5-6.
 Telegrams: "Ormondengi, Kinross."

Factories: Whiskin Street and Hardwick Street, Clerkenwell, E.C.1.

Continental Agents: Pettigrew & Merriman, Ltd., "Phonos House," 2 & 4, Bucknall Street, New Oxford Street, W.C.1.

THE "NEW FAMILY FOUR"

—continued from page 233

It will be noticed in the list of components that two plugs are specified. Strictly speaking, only one is required for telephones, but it is so often useful to be able to compare loud speakers on such a set, or to use the loud speaker on three valves only, that the second plug is recommended, and a special method of wiring it up will be explained later.

Another point requiring mention is the choice of coils. On the ordinary broadcast range, the first coil must be a binocular, as this avoids interaction and sharpens tuning. For the Daventry range, however, practical experiment has shown that the first coil is preferably a standard split-secondary coil, and on this range the split-secondary coil is recommended in preference to the binocular, for this particular set.

Choice of Valves

The choice of valves can safely be left with the constructor, provided that he chooses well-known standard and reliable makes. It is necessary, however, that the first valve should be one specifically designed for high-frequency amplification; that the second should be a resistance-coupling valve; the third a low-frequency valve; and the fourth either a standard power, or better still, a super-power valve.

Readers who do not care to go to the expense of a 120-volt battery can use an H.T. battery of a lower voltage than this figure, but in so doing will sacrifice some strength and quality.

The constructional work on the "New Family Four" is perhaps easier than on any other multi-valve set I have yet described. First of all, the panel is drilled to take the components shown, and these are mounted and the panel laid aside for the time being.

The first step in regard to the baseboard is to mount the terminal strip as shown. The top of the baseboard will be supported by this terminal strip an inch and a half from the table. If now the panel brackets are so fixed that the baseboard is held one and a half inches above the bottom edge of the panel, you will get the necessary platform effect. It is, however,

advisable not to attach the panel to the baseboard yet.

Having now prepared the baseboard in this fashion, lay out your components exactly as shown in the photographs, and screw them in place. Next with a pencil mark the positions for the holes shown and drill them. When this has been done tin all points to be soldered, and you can begin the wiring.

There are a few connections above the board which do not pass through it at all. These can be carried out with any suitable stiff, tinned wire. Such connections in the set illustrated were made with Junit self-soldering wire, which is quite convenient for the purpose. There are also one or two connections underneath the board made with the same stiff wire. Where several wires have to be joined you will find it convenient to bring them up to a common point and, after baring the wires, twist them together and solder them.

Results Obtained

This completes the constructional details, and many readers will be able to operate the set right away. In the next issue a number of other interesting and practical hints on manipulation will be given.

TEST REPORT.

	First Dial	Second Dial
Langenberg	155	132
Bournemouth	160	137
London	123	93
600-metre shipping	180	160
Ecole Sup. de P.T.T.	152	130
Frankfurt	145	122
Stuttgart	130	102
Danzig	80	45
French station		
? Bordeaux	71	38
Manchester	132	103
Toulouse	133	105
Rome	150	126
Milan	108	74
Dublin	105	73
Breslau	104	72
Newcastle	102	70
Nuremberg	98	63
Toulouse	74	36
Munster	64	23
Vienna	170	146
Madrid	128	100
Swedish Relay ..	53	6

LONG WAVE.

Hilversum	13	67
Daventry	98	129
Radio-Paris	115	145

NEW
LIGHT
RIGID
LOW LOSS

PEERLESS COIL FORMERS

You can now make radio coils the equal of or better than the most expensive makes. Wind them on the scientific Peerless Coil Former—new, light, rigid, and low loss. There are two sizes (A) 2½ in. x 1½ in., and (B) 3½ in. x 2½ in., each only 1/4 (sold packed flat). All good dealers or direct:—

The Bedford Electric & Radio Co., Ltd.
22, Campbell Road, Bedford.

ELECTRIFY YOUR GRAMOPHONE

—continued from page 250

“scratch filter,” which appreciably improves reproduction and reduces the scratch which many people have looked upon as inseparable from gramophone reproduction. The scratch, when analysed, is really a rather high-pitched note, and if we connect across the input terminals a circuit so tuned that it will by-pass this particular scratch frequency, and permit others to pass through, we shall have largely achieved our aim. Such a scratch filter can be made up by connecting across the input terminals of the first L.F. transformer a 1,500-turn plug-in coil, in series with a fixed condenser, the value of which is best found by experiment. It will generally be found to be in the neighbourhood of .008 mfd. The C.A.V. Multiple Fixed Condenser of the .001 to .015 mfd. pattern can be used very successfully in this filter. Many will have large plug-in coils of this size and, if not, they can be obtained from the Igranic Company or Burndept.

The Scratch Filter

The connections to this scratch filter are very simple. One side of the 1,500-turn coil goes to one input terminal of the first transformer, the other side of the coil goes to the “O” terminal of the multiple fixed condenser, and the other side of the condenser (which has been bridged to give the capacity required) to the second input terminal of the L.F. transformer. A trial should be made with .008 mfd. and then .006 and .01 tried to see which of the three reduces the scratch to the lowest value. You will not be able to eliminate it entirely, but, especially when a good deal of magnification is used, it can be cut down well below the strength which would cause annoyance.

For use in dance halls or large rooms where great volume is required, some form of volume control is advisable, as two valves may not give enough strength and three too much. The Dubilier Duvalcon device lends itself very well to this arrangement, and can be connected across the input terminals or, if no transformer is used, across the first grid filament.

Experimenters should not forget that, apart from the use of a volume control, very considerable changes in volume are obtainable by changing the type of needle.

PUTS POWER

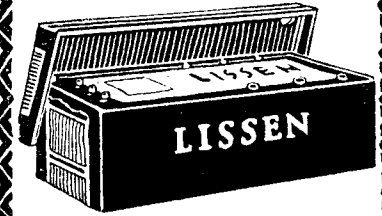

into your set.

YOUR valves and loud-speaker have real power and clean, smooth-flowing energy behind them if you are using a LISSEN New Process H.T. Battery in your set. This strengthens the electronic emission of each valve and makes volume bigger, loud-speaker tone fresher, and reproduction smoother and more life-like than you have ever known it before. The power of the LISSEN New Process Battery never lessens, even under the drain of the longest programme.

The price of the LISSEN New Process Battery was first 10s. 6d. (2s. 6d. lower than its real value, but made possible by the LISSEN direct-to-dealer method of distribution). Then profits were drastically cut till the price was as low as 7s. 11d. This reduction was announced in this paper among others. The demand was so overwhelming that we had to discontinue advertising. But now you should be able to get the LISSEN New Process Battery without trouble, but in case of difficulty send direct to factory, mentioning your usual dealer's name and address. No postage charged.

LISSEN

New Process H.T. Battery

Rated at 60 volts but reads 66. Size 9½ in. x 3½ in. Comes direct to dealer from factory. Reaches you fresh and packed full of energy.

7/11

LISSEN LIMITED,
26-30, FRIARS LANE, RICHMOND, SURREY.

Managing Director: THOMAS N. COLE
L.320.

Ideal Holiday Reading

Enlarged Summer Holiday Number of

The
LONDON MAGAZINE

Best Stories, Articles and Pictures

Buy a Copy T O - D A Y .

PICKETT'S CABINETS

For Your HOME Radiola! Wireless Furniture 3 ft. high—taking your Set, Batteries, etc., complete. BUREAU Models from £3 3 0. "RADIOLA" Jacobean from £5 5 0. "Radiola" Queen Anne from £6 15 0. High Grade Work and finish GUARANTEED. GRADUAL PAYMENTS arranged.

Lists of Cabinet Designs No. 21 FREE. Pickett's Cabinet (W.G.) Works, Bexleyheath.

the big 3

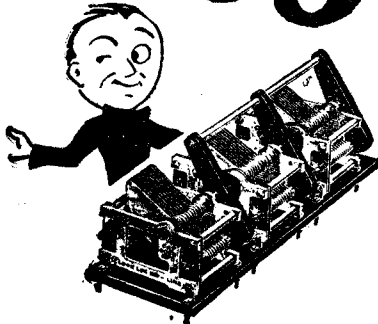

CYLDON GANG CONDENSERS

The gang condensers most constantly specified by radio journals. Logarithmic units for correct tuning. 2-Gang £2 10s. 3-Gang £3 10s. 4-Gang £4 10s.

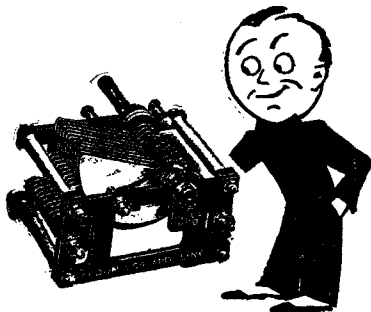

CYLDON LOG MID-LINE CONDENSERS

The first condensers to be designed on the logarithmic principle. Better than Square Law and Straight Line Frequency. Spread all stations evenly over dial. Makes possible "one-dial control" in multi-tuned circuits. The condenser of the future.

PRICES:
 '001 .. 21/- '0005 .. 17/6 '0003 .. 16/6
 '00025 .. 16/- '0002 .. 15/6
 With 4" Knob Dial. If dial is not required deduct 2/-.

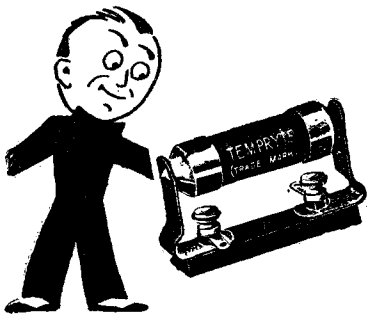

CYLDON TEMPRYTES

The proved best means of valve control. Functions perfectly with any type of valve. Cannot overheat filament. Noiseless. Tested and guaranteed to give perfect performance.

Cyldon Temprytes Holder Mountings
 2/6 each 1/6 each

CYLDON

CYLDON products can be obtained from stock, by return; and do not believe any statements to the contrary. If any difficulty 'Phone: Enfield 0672. Wire: Enfield 0672, or use the C.O.D. system.

SYDNEY S. BIRD & SONS,
 Cyldon Works,
SARNESFIELD RD., ENFIELD TOWN, MIDDLESEX

A SIMPLE STORAGE SYSTEM

WHILE many experimenters use classified boxes and sets of drawers to store their nuts, screws, and terminals, comparatively few have any convenient system of storage for large parts. Every experimenter sooner or later accumulates quite a collection of such objects as filament resistances, fixed resistors, valve sockets, plug-in coils, and the like, which are generally pushed into a large drawer and jumbled about indiscriminately.

A much better plan is to obtain a number of cardboard boxes measuring about 12 in. long (open boot boxes serve excellently), and to lay them side by side under the largest table in the room. One box can be kept for filament resistances, another for valve sockets, the third for coil sockets, a fourth (the largest box available) for plug-in coils, and so on. The time saved by such a system is very large, and one soon gets into the habit when dismantling a set of throwing the old components into their respective "bins."

Storing Variable Condensers

More delicate components, such as variable condensers (the plates of which are very easily bent), are better kept on shelves side by side. Valves are best kept in eggstands, into which they fit excellently. If a nest of small drawers is available (excellent little sets can be obtained at any toolshop) it is best used for fixed condensers, grid leaks, and small components which are frequently needed for interchange purposes.

BY-PASS AND 'PHONE CONDENSERS

THERE are, no doubt, many home constructors who sometimes wonder why a telephone condenser is used in some circuits and not in others. When the true facts are known the rule is one of the simplest. In the early days a fixed condenser was sometimes connected across the 'phone terminals of a crystal set with a view to improving the clarity of the signals; at other times it was connected across the output terminal of an L.F. amplifier for the same reason, and though this condenser is

still sometimes used for a similar purpose it is generally more usefully used as a "by-pass" for high-frequency currents.

In the popular form of single-valve set which incorporates a reaction coil variably coupled to either a grid or anode coil, reaction control being obtained by varying the coupling, it will usually be found that a fixed condenser is connected across the 'phone terminals, or, if a transformer-coupled note-magnifier follows the detector, then the condenser will be found connected either across the primary winding, or else from that end of the primary winding which is taken to one side of the reaction coil, to L.T. negative.

A "Non-Resisting" Path

The omission of the condenser in circuits using reaction of this type generally leads to the choking up, as it were, of the high-frequency pulsations in the anode circuit of the detector valve. The effect of such a condition is to make it difficult to make the receiver oscillate with a conveniently small reaction coil, in a satisfactory manner, and to overcome this objection a telephone condenser is used as described. The inclusion of this condenser is to permit the high-frequency fluctuations in the anode circuit of the valve, which are needed to produce a reaction effect, to take a relatively non-resisting path back to the battery, instead of being choked by the poor H.F. conducting properties of the telephones, or primary winding, as the case may be.

With No Reaction

In all straight circuits with the reaction coil in series with an impedance or resistance, it is advisable to provide a by-pass condenser to ensure satisfactory control with a suitably small reaction coil. In certain other circuits, even though reaction is not used, it is often found that the inclusion of a small fixed condenser will give improved results, and an example of this fact will be found in most reflex circuits where the 'phones are connected in the anode circuit of the reflexing valve.

When, on the other hand, no reaction is used, a telephone condenser does not become a necessity, except in special circuits. It may, however, sometimes be found to improve the tone of signals, and for this reason is sometimes provided, though generally in the case of telephone reception the actual improvement is hard to detect.

WATCH GRID BATTERIES

SINCE one of the main duties of the grid battery is to prevent a flow of current from filament to grid by applying a sufficient negative potential to the latter, the battery itself is not under load, that is to say it supplies no current whether the set is in use or not. One might expect, therefore, at first sight that it would last indefinitely.

Actually the insulation of dry batteries can never be quite perfect, and minute leakages do occur which cause them to become run down in time even if they are not being used. What is called the "shelf life" of a small dry battery, that is to say its life if it is simply stored and not used, is not, as a rule, much more than a year, for, in addition to the small leaks already mentioned, the chemicals in both the electrolyte and the depolariser deteriorate as time passes. Thus, though the grid battery may be regarded as practically upon open circuit in the receiving set it has a definitely limited life.

This means that at the end of, say,

six months a nominal grid bias of 9 volts negative may be perhaps only 8½; after a year it may have fallen to 7, and in eighteen months it may be something quite small. Now, from one point of view the grid battery may be looked upon as the cheapest form of insurance for the H.T. unit. By spending a shilling or so on a grid battery you can cut down the H.T. drain so that you are using only what is necessary and no more. The smaller the load upon the H.T. battery the longer its life. If you halve the load you do much more than double the length of its useful working career. Since the potential of the grid battery is always slowly falling it follows that the current taken from the H.T. battery must be gradually increasing. If one and the same grid battery is kept in use for eighteen months or so an original H.T. load of, say, 8 milliamperes may have risen unsuspected to 10 or 12 or more.

In addition to the harm done to the H.T. battery there must also be considered the effects upon the performances of the receiving set. Owing to the fall in the grid-biasing potential the note-magnifiers will no longer be able to deal properly

(Continued on page 286.)

**Eleven
 Blue Prints
 for 6d!**

*An invaluable Handbook for
 Radio Constructors.*

The "Best Way" Pictorial Blue Prints book contains an up-to-date and comprehensive range of blue print diagrams drawn in a simplified pictorial style. The amateur constructor cannot possibly go wrong when building up a set on the lines of any of the circuits with which the book deals. There are 11 circuits in all. Buy a copy to-day.

**'BEST WAY'
 PICTORIAL
 BLUE PRINTS
 BOOK**

6d. At all Newsagents, etc.

CHOSEN FOR THE

NEW

"FAMILY FOUR"

described in this issue of the "Wireless Constructor."

Construct the new "Family Four" with the components recommended by Mr. Percy Harris. The J.B. True Tuning S.L.F. Condensers used will give you even spacing of stations in accordance with the new B.B.C. Kilocycle plan. For accuracy in tuning, efficient workmanship, and delightful finish J.B. Condensers are unsurpassed.

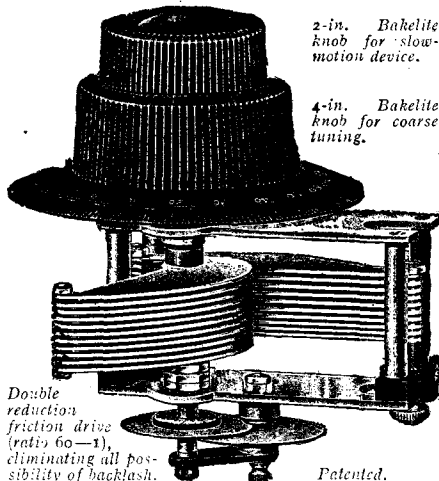

2-in. Bakelite knob for slow-motion device.

4-in. Bakelite knob for coarse tuning.

Double reduction friction drive (ratio 60-1), eliminating all possibility of backlash. Patented.

Prices, complete with dial: '0005 mfd. 16/6; '00035 mfd. 15/6; '00025 mfd. 15/-. For Short Wave Receivers, '00015 mfd. 15/-. The J.B. S.L.F. complete with 4" Bakelite Dial. '0005 mfd. 11/6; '00035 mfd. 10/6; '00025 mfd. 10/-. For Short Wave Receivers, '00015 mfd. 10/-. The J.B. Neutralising Condenser. Remarkable value, 3/6.

JACKSON BROS.
 8, POLAND ST.-OXFORD ST.
 LONDON - W.1. Telephone: GERRARD 7414

"MODERN WIRELESS"

Among the many attractive features in the July issue of "Modern Wireless" are:

DEVELOPMENTS IN SCREENING

By G. P. KENDALL, B.Sc.

MY MULTI-VALVER

By Captain H. J. ROUND, M.I.E.E.

WHICH IS THE BEST AERIAL?

and articles by Capt. P. P. Eckersley, M.I.E.E., Percy W. Harris, M.I.R.E., G. V. Dowding, Grad. I.E.E., E. J. Simmonds, M.I.R.E., Prof. D. Fraser-Harris, M.D., D.Sc., and other leading experts.

SECURE YOUR COPY NOW

On Sale Everywhere

Price 1/-



X.L. VARIO-DENSERS

The X.L. Vario-Denser is designed primarily for use where accurate values or adjustments are required. Genuine Bakelite casing, all metal parts phosphor-bronze nickel-plated, and the best imported India mica obtainable make up the construction. Dust and moisture-proof casing, extreme micrometer advance, broad and positive capacity range adjustment, and exceptional accessibility in close quarters are the exclusive features that make critical adjustment a pleasure with X.L.

Suggested Uses for X.L. Vario-Densers

Neutralising Condensers in Neutrodyne Circuits. Grid Condensers. In Super Heterodyne Set as Regeneration Condenser and for tuning Filters. Series Condenser in Aerial Circuit. X.L. Vario-Densers are specified in the original LOFTIN-WHITE Circuit.

- MODEL "G."
 G. 1. '00002 to '0001 mfd.
 G. 5. '0001 to '0005 mfd.
 G. 10. '0003 to '001 mfd.
 All with Grid Leak Clips
 List Price - - 6/6 each

- MODEL "N." (Without Clips.)
 '0000018 to '00002 mfd.
 List Price - - 4/3 each

Obtainable from all high-class dealers. If in difficulty write us direct.

THE ROTHERMEL

RADIO CORPORATION OF G.T. BRITAIN, LTD.
 24-26 Maddox St., Regent St., London, W.1.
 Telephone - - - - - Mayfair 578-9.
 Telegrams - - "Rothermel, Wesdo, London."

£3 down buys the "SOCIABLE FIVE" Portable Set

This fine Set, manufactured by the famous firm of PETO-SCOTT CO., Ltd., using 5 valves, has a range of 250-2,000 METRES.

Ideal for Indoor and Outdoor use.

Write for full particulars to

New Times Sales Co.,
 77, CITY ROAD, E.C.1.

9105

TO ADVERTISERS

ALL communications concerning advertising in the "Wireless Constructor," "Modern Wireless," and "Popular Wireless," must be sent to

JOHN H. LILE Ltd.,
 4, LUDGATE CIRCUS, London, E.C.4
 (Phone: CITY 7261)
 and NOT to the Editorial or Publishing Offices.

WATCH GRID BATTERIES

—continued from page 285

with grid swings of the size once within their powers. Distortion will gradually creep in to the loud speaker's output, and the owner of the set may wonder how it is that he no longer obtains the purity of which he was formerly so proud.

The grid battery should certainly be tested with a high-resistance voltmeter every few months. A test made with a low-resistance moving iron instrument is of no value whatever, since it will most likely give false readings, and it will certainly do the battery no good, for such instruments frequently require anything up to a quarter of an ampere of current for a full-scale deflection.

"PATIENCE"

—continued from page 224

every receiver (according to the new American system) would have to have a frequency converter, and he asks the pertinent question: Will the transmitters be capable of handling frequencies down to two a second? They will have to, according to P. P. E., if the scheme is to work.

And, again, supposing the scheme *did* work, would all European stations adopt it?

Until further technical details are to hand, however, criticism must be guarded; the only trouble is these revolutionary systems, when announced, are prone to give us all heart attacks and bring even more forcibly to our minds the need for the Regional Scheme in this country, or some practical scheme which will reduce wave-length congestion and make the ether "fit for listeners to wallow in."

WHEN replying to advertisements please mention "Wireless Constructor" to ensure prompt attention. THANKS!

THE NAME DOES NOT ROTATE



THE FINISH IS PERFECT THROUGHOUT

Made with 30 different engravings, and used by the manufacturers of all the best battery eliminators. Standard large insulated model (Polished black Bakelite) Type B, 9d. each. Popular Model (non-insulated) Type M, 6d. each. Illustrated Catalogue free on request. Obtainable from all Dealers, but in case of difficulty send your order to us, enclosing your dealer's name and address.

BELLING-LEE TERMINALS

BELLING & LEE, LD., Queensway Works, FONDERS END, MIDDLESEX.

AMPLIFIERS: 1-VALVE 19/-; 2-VALVE, 30/-
 2-Valve All-Station Set, 24/. Approval willingly
 Wet H.T. Batteries—Jars, Zincs and Sacs complete,
 3/6 per doz. (18 volts) Post 9d. extra. Sample 6d.
 3 doz. upwards post free, in divided cartons.
 Bargain List Free.
 C. Taylor, 57, Studley Rd., Stockwell, London.

The HOME for your WIRELESS SET

OUR STANDARD CABINETS are DUSTPROOF and house the whole apparatus, leaving no parts to be interfered with. Made on mass production lines, hence the low price. Provision is made to take panels from 16 by 7 up to 30 by 18in. Special Cabinets for the ELSTREE SOLODYNE, NIGHT HAWK, ALL BRITISH 5IX, etc., now ready. Write for free particulars. **MAKERIMPORT CO.** Dem 20 50a, Lord Street, LIVERPOOL.

REPAIRS

to HEADPHONES, LOUD SPEAKERS, TRANSFORMERS, COILS. First-class workmanship only. That is just the vital difference. We are specialists with almost 30 years' experience in every form of intricate and accurate coil winding, and we guarantee that work entrusted to us will be returned to you as good as new, if not better. This is no idle claim, but the unsolicited opinion of scores of satisfied clients. **THE VARLEY MAGNET COMPANY** (Proprietors: Oliver Pell Control, Ltd.) BLOOMFIELD ROAD, WOOLWICH, S.E. 18. Telephone: Woolwich 0388.

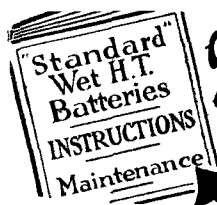

Why not economise by using a Wet H.T. Battery?



Thousands of Wireless users are getting better reception at LESS cost by using the STANDARD WET H.T. BATTERY. Our POPULAR MODEL, 90 volts.....21/-

Write for booklet, sending valve particulars. We recommend suitable battery.

WET H.T. BATTERY CO., 12, Brownlow Street, W.C.1. Phone: Chancery 7846.

IN LIGHTER VEIN

—continued from page 244

"This," said the professor, "is now my house. Much as I like the one in which I first took up my abode on reaching Mudbury Wallow, I vastly prefer this. It stands upon higher ground, the aerial is better; the atmosphere appears to me to be more salubrious. You, my dear Captain Bucket, may have 'Heartache Villa' in exchange, since I have already presented my old house, 'The Microfarads,' to Miss Worple, and then everyone will be satisfied. I regret that I must busy myself now. Professor Goop is now closing down. Good-night, good-night."

The assembled company, especially Captain Bucket, appeared to be a little reluctant at first about taking their departure, but when the professor pulled from his pocket a round object, which he described beamingly as his latest high-explosive bomb, most of them melted rapidly away. Only Captain Bucket, Goshburton-Crump and the Rev. Aloysius Tosher lingered.

"Long have I waited," said Professor Goop affably, "for an opportunity of testing the qualities of this bomb. At present it is perfectly harmless, but when I withdraw the safety catch"—here he twiddled something—"it is timed to detonate in five seconds."

The lingerers took the count. Long before the fourth second was up the last of them was outside the front door, which, under the professor's directions, I bolted and barred.

"Aaaaaah!" sighed the professor, "And now we can settle down to work. Little did I think that the Easter egg presented to me by my family would serve such a useful purpose."

I am hoping that the professor is settled at last in Mudbury Wallow. Meanwhile, I have refrained from asking him round to my own house, which stands higher and has an even better aerial than Captain Bucket's. If he *should* happen to drop in I have a kind of feeling that the Wayfarer Evictor Drawing Pin, placed in every chair, will have an even more pronounced effect than the Goop Easter Egg Bomb.

WIRELESS WAYFARER.

Popular Wireless

IS THE LEADING RADIO WEEKLY

On Sale every Thursday Price 3d.

Much more than a Portable Set is this Peto-Scott Portable Set.

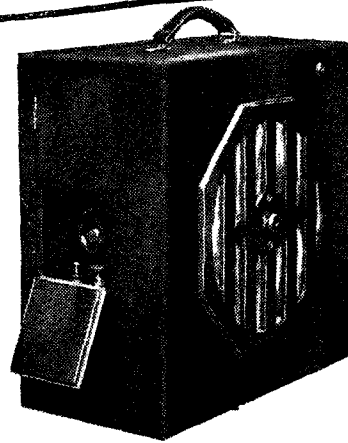

AT last! Here is a Set that is, at the same time, ideal for indoor and outdoor use—the Peto-Scott "Sociable Five." It is extremely portable, yet its elegant, polished cabinet is fit to take its place in any room. It is simplicity itself—only one control. Good loud-speaker reproduction 120 miles Daventry or 30 miles from local station—without changing coils. Superb tone. Good volume. Headphones may be used if desired.

SEE WHAT YOU GET

Fully guaranteed and complete with Osram and Cossor Valves, Celestion Loud Speaker, Litzendraht Frame Aerial, Pye Transformers, Keystone Gang Condenser, Oldham Non-spillable Accumulator, Hellesen 99-volt H.T. Battery.

Marconi royalties **£29 10s.** paid. Price

Send for free Art Brochure

A Brochure describing the "Sociable Five" will be sent free for the asking. Don't delay—write to-day.

Keystone "Multi-Neut" Condenser for Mr. P. W. Harris' 4-valve Family Set - - Price 6/6

Send for particulars of other components, also 6d. for "Pilot Manual" which gives details of Pilot Service.

PETO-SCOTT CO. Ltd.
77, CITY ROAD, LONDON, E.C.1.
62, HIGH HOLBORN, W.C.1.
LIVERPOOL—4, Manchester Street.



IS YOURS A NOISY NEIGHBOURHOOD?

Vibrations from passing traffic—often inaudible to the human ear—destroy tonal purity and should be counteracted by installing Benjamin Valve Holders which completely disperse all microphonic noise.

Valve sockets and springs are made in one piece with no joints or rivets to work loose and cause faulty connections. Valves are free to float in every direction and can be inserted and removed easily and safely. Valve legs cannot possibly foul the baseboard. Terminals and soldering tags are provided.

BENJAMIN

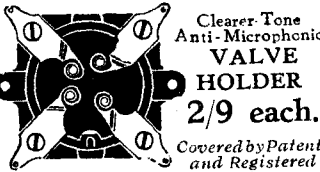

Clearer Tone
Anti-Microphonic.
**VALVE
HOLDER**
2/9 each.

Covered by Patents
and Registered
Designs.

THE BENJAMIN ELECTRIC LTD.
Brantwood Works, Tariff Road, Tottenham, N.17

Read

"Popular Wireless"
Every Week.

**A
Warning**

It has recently been brought to the notice of the Directors of D.A.R. Ltd. that certain injurious statements have been made concerning the preparation known as DAR of which they are the proprietors and manufacturers.

The Directors of D.A.R. Ltd. claim that DAR is a preparation which removes all sulphation from the plates of a storage battery and is not only a remedy for, but a permanent cure of sulphation. DAR is not a dope, contains nothing of a metallic nature, and cannot injure any part of a battery. Statements to the contrary are untrue and action will be taken against all persons making or repeating such statements; in fact, a writ has, in one instance, already been issued.

D.A.R. LTD.

Australia House, Strand,
London, W.C.2.

CHATS AT THE WORK-TABLE

—continued from page 262

capacity of the condenser is not increased by the presence of a metal plate, that hand-capacity effects are eliminated, and that there is no need to set condensers back from the panel. Hand-capacity effects in circuits in which neither set of plates is at high-frequency earth potential are caused by the fact that the actuating knob is attached to a metal spindle carrying a small metal pulley in contact with the rim of the metal disc, which is itself connected to the spindle of the moving plates. There is thus electrical connection between the last and the spindle to which the actuating knob is fixed. By using a driving disc of insulating material this connection is broken, and a satisfactory solution of the problem is reached.

Suitable Material

The best material that I have found so far for making the insulating driving discs is erinoid, which can be obtained in sheets about $\frac{1}{16}$ inch in thickness. The original metal disc is used as a pattern, and an erinoid disc of exactly the same size is cut from it. In the majority of dials the disc is shaped as shown in Fig. 4, the tongue fitting into a slot and locking the disc solid with the bush which grips the spindle of the moving vanes. This tongue may be cut in the following way. Measure first of all the diameter of the hole in the disc. We will suppose that this is $\frac{5}{8}$ inch. On the erinoid disc scribe out a circle of this size. Now measure the length of the tongue, which we will take as $\frac{1}{2}$ inch. Subtract double its length from the diameter of the scribed circle. If the tongue is $\frac{1}{8}$ inch long and the scribed circle is $\frac{5}{8}$ inch in diameter, this leaves $\frac{3}{8}$ inch.

Take a drill of this size and run it through the centre of the disc. Mark out the tongue and file away the portion of the material shown shaded in Fig. 4. When the rim of the disc has been slightly bevelled off with emery-cloth it will be found that a dial made in this way gives an excellent drive.

SOME CURIOUS RHEOSTAT ARRANGEMENTS

—continued from page 242

the rheostat and is also connected to the lower slider, the common slider between the upper and middle elements not being directly connected. Here it will be seen that the operating or left-hand portions of the upper and middle elements are in series with one another, whilst the operating or left-hand portion of the lower element is in parallel with the resultant of the above-mentioned portions in series.

Seventeen Different Arrangements

Space does not permit of further diagrams, but there are many other ways of arranging these elements, which the reader can think out for himself. It is important to notice that with the three elements, using a common slider between two of the elements, a great number of variations can be obtained using only two control knobs.

If three control knobs are used, each operating a slider on one of the resistance elements, that is to say, if the three resistance elements are operated entirely separately, and if a terminal or connection is provided to each of the sliders, still further arrangements may be made, but the reader will find it amusing to think these out for himself.

Before concluding this subject it may be useful to give a number of simple numerical examples. Suppose we take two resistance elements of values 30 ohms and 5 ohms respectively (for the sake of simplicity) and call these A and B. Then we can arrange these as follows: A alone, B alone, A and B in series, A and B in parallel, and the maximum values, when arranged in this way, will be 30, 5, 35, and $4\frac{2}{5}$ ohms respectively. Now take three elements of values, say, 30, 10, and 5 ohms, and call these A, B, C.

Then some of the arrangements we can make are as follows: A alone, B alone, C alone, A and B in series, A and B in parallel, B and C in series, B and C in parallel, A and C in series, A and C in parallel, A, B, and C in series, A and B in series in parallel with C, A and C in series in parallel with B, B and C in series in parallel with A, A, B, and C in parallel. Values will be obtained as follows: A, 30 ohms, B, 10 ohms, C, 5 ohms: A and B in series, 40 ohms, A and B in parallel, $7\frac{1}{2}$ ohms, B and C in series, 15 ohms, B and C in parallel, $3\frac{1}{3}$ ohms, A and C in series, 35 ohms, A and C in parallel, $4\frac{2}{5}$ ohms, A, B, and C in series, 45 ohms, A and B in series in parallel with C, $4\frac{1}{3}$ ohms, A and C in series in parallel with B, $7\frac{1}{5}$ ohms, B and C in series in parallel with A, 10 ohms, A and B in parallel and in series with C, $12\frac{1}{2}$ ohms, A and C in parallel and in series with B, $14\frac{2}{5}$ ohms, B and C in parallel and in series with A, $33\frac{1}{3}$ ohms, and A, B, and C in parallel, 3 ohms.

By carefully choosing the actual values of the three resistance elements a whole series of values may be obtained from about 3 ohms to about 50 ohms.

It will be seen that in the foregoing 17 different arrangements of three resistance elements are given.

INDEX TO ADVERTISERS

Artcraft Co., The	Page 267	Gambrell Bros., Ltd.	Page 277	Ormond Engineering Co., Ltd.	Page 282
Ashley Wireless Telephone Co., Ltd.	280	Garnett, Whiteley & Co., Ltd.	267	Peto-Scott Co., Ltd.	287
Batteries, Ltd.	279	Hamley Brothers, Ltd.	280	Pickett's Cabinet Works	283
Bedford Elec. and Radio Co., Ltd.	283	Holzman, Louis	267	"Popular Wireless"	271
Belling & Lee, Ltd.	286	Igranic Electric Co., Ltd.	267	Pye, W. G., & Co.	277
Benjamin Electric, Ltd.	287	Jackson Bros.	285	Raymond, K.	281
Bird, Sydney S., & Sons.	284	Lissen, Ltd.	283	R. I. & Varley, Ltd.	Cover iv
Brown, S. G., Ltd.	263	London Elec. Wire Co. & Smith's, Ltd.	279	Rothermel Radio Corp'n., Ltd.	286
British Thomson-Houston, Co., Ltd.	261	"London Magazine"	283	Taylor, C.	286
Burne-Jones & Co., Ltd.	278	Makerimport Co.	286	Telegraph Condenser Co., Ltd.	277
"Best Way" Wireless Books.	285	Marconiphone Co., Ltd., and Reduced ..	217	Vandervell, C. A., & Co., Ltd.	273
Carrington Mfg. Co., Ltd.	277	Metro-Vick Supplies, Ltd.	Cover iii	Varley Magnet Co.	286
Cossor, A. C., Ltd.	218	Mullard Wireless Service Co., Ltd.	Cover ii	Weston Elec. Instrument Co., Ltd.	263
D. A. R., Ltd.	287	"Modern Wireless"	285	Wet H.T. Battery Co.	286
Dubilier Condenser Co. (1925), Ltd.	273	New Times Sales Co.	286	WIRELESS CONSTRUCTOR Advt. Rates ..	279
Formo Co., The	279				

Resistance Coupling IS the right way to true reproduction

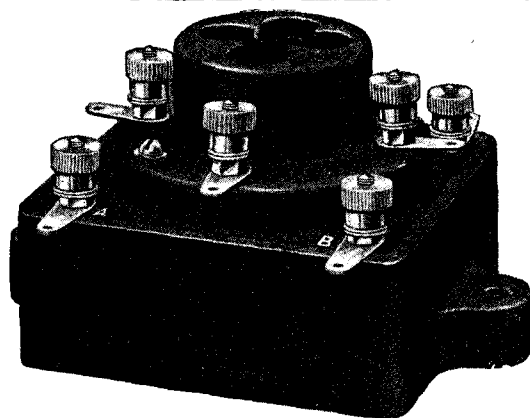

Quality of reproduction has no relationship to quantity of amplification, but only to the shape of the amplification—frequency curve.

Curves and statements have been published comparing a transformer with a resistance unit employing high anode resistances and a high impedance valve.

SUCH COMPARISONS SHOW—

For the TRANSFORMER:—

The Distortion on Low Notes (due to insufficient primary inductance).

The Distortion on High Notes (due to resonance in windings).

For the High Anode RESISTANCE UNIT:—

No Distortion on low notes.
Distortion on high notes (due to the relatively low impedance of the valve capacity shunting the high anode resistance).

Note—The “Cosmos” Resistance Unit *does not* use high anode resistances for this very reason.

The “Cosmos” Shortpath Low Impedance High Voltage Factor Valve does not need high anode resistances to obtain good amplification.

The “Cosmos” Resistance Unit has a high value coupling condenser and normal grid leak thereby bringing in those low notes which make music.

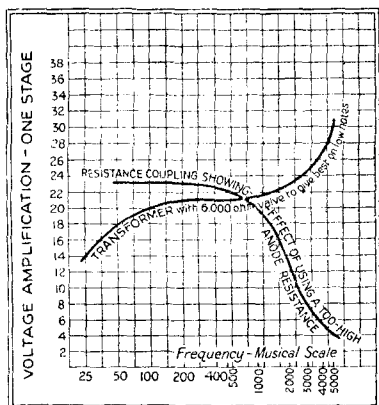

The Curves show the distortion effects in the amplification—frequency curves of a good transformer, a high anode resistance unit and the “Cosmos” Resistance Unit using low anode resistances and large coupling condenser.

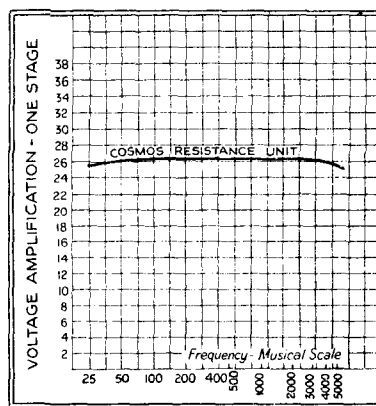

These are comparable

This is incomparable

Cosmos UNIT

FOR RESISTANCE CAPACITY COUPLING

Advt. of Metrovick Supplies Ltd., 155 Charing Cross Road, London, W.C.2

R
P82

The New



RESISTANCE CAPACITY COUPLER



BI-DUPLEX WIRE-WOUND

This new R.I. and Varley component is the *only* wire-wound coupler on the market to-day. But it is far more than this; it is *wire-wound on the famous Bi-duplex system* in which every turn of wire is separated by pure silk, and in addition every turn and layer air-spaced in a special manner, thereby ensuring maximum tonal purity, and a volume much greater than anything which has yet been attained with Resistance Capacity Coupling.

Every detail of this new component has been carefully designed to give maximum efficiency—to mention but one feature, it is fitted with a high-grade condenser containing over 40 sheets of ruby mica—and every part has been perfectly matched and balanced so that it is practically impossible for anyone using this component to fail to obtain that combination of tonal purity and volume which places the R.I. and Varley Resistance Capacity Coupler in a class by itself, far and away ahead of anything hitherto accomplished.

- | | | |
|---------|---|------|
| Type A. | Suitable for use after valves with A.C. Resistance (Impedance) of 15,000-40,000 ohms | 20/- |
| Type B. | Suitable for use after valves with A.C. Resistance (Impedance) of 30,000-100,000 ohms | 22/6 |

Leaflet with circuits supplied with each instrument.

THE MARK OF BETTER RADIO

R.I. & Varley Ltd., Kingsway House, 103, Kingsway, London, W.C.2.

