

The Wireless Constructor

6^D
MONTHLY

EDITED BY
PERCY W. HARRIS, M. I. R. E.

VOL. IV.

MAY, 1927

No. 7

The "SIGNAL BOX"

A THREE VALVE
SET - WITH FIVE
VALVE RESULTS

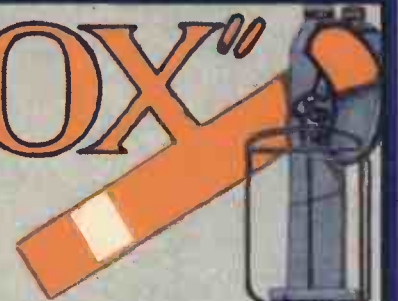
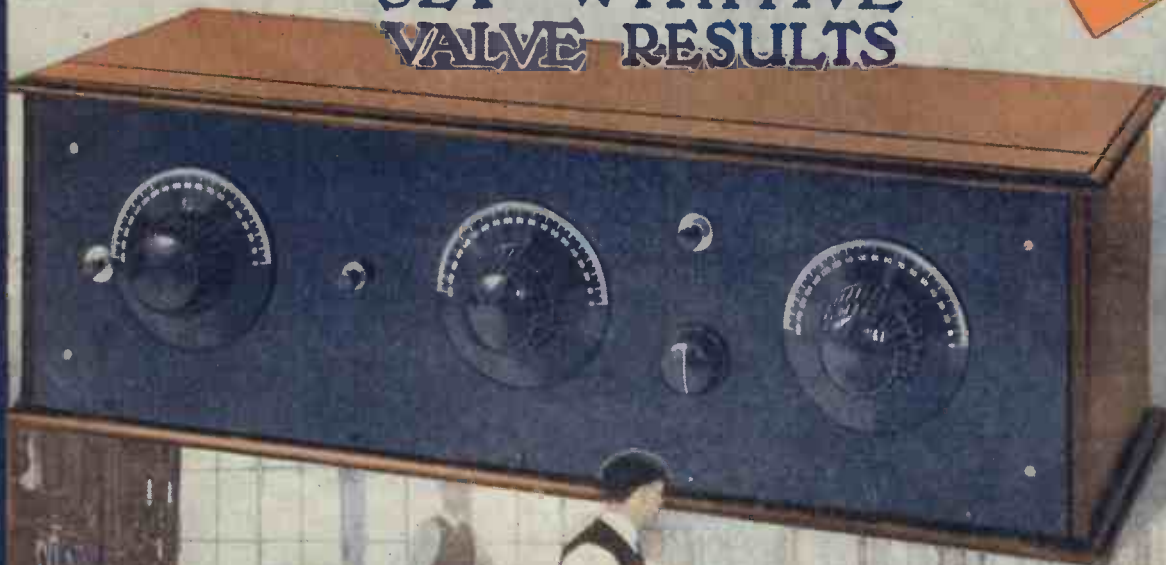



*Patents
applied
for.*

The **Pure Music**
Speaker

HARMONIC RESPONSE

The Mullard Pure Music Speaker gives true reproduction for one fundamental reason that it is highly sensitive to harmonics, the number and strength of which provide the characteristics whereby both voices and instruments are distinguished one from the other.

Walk into a radio dealer, listen to the Pure Music Speaker, and the first few words spoken or sung or the first few bars of music will convince you that you are listening to the one speaker which completely satisfies the sense of hearing.

The only Speaker responsive to harmonics.

PRICE £6 - 6 - 0

Mullard
MASTER · RADIO

THE MULLARD WIRELESS SERVICE CO., LTD., MULLARD HOUSE, DENMARK ST., LONDON, W.C.2.

CONTENTS

	Page		Page
Editor's Chat	3	Within the Vacuum	32
The "Signal Box"	5	The "Selector Two"	38
In Lighter Vein	11	Jacks in Resistance Amplifiers	40
Notes on Neutralisation	13	Happenings at Savoy Hill	42
The "As You Like It" Crystal Set	17	Choosing Your Accessories	46
Cartoon	20	A Listener's Diary	53
The Note-Magniplex	21	What's New	56
Faults In Jacks	28	Our News Bulletin	72
New Lamps for Old	29		

EDITED BY
PERCY W. HARRIS, M.I.R.E.

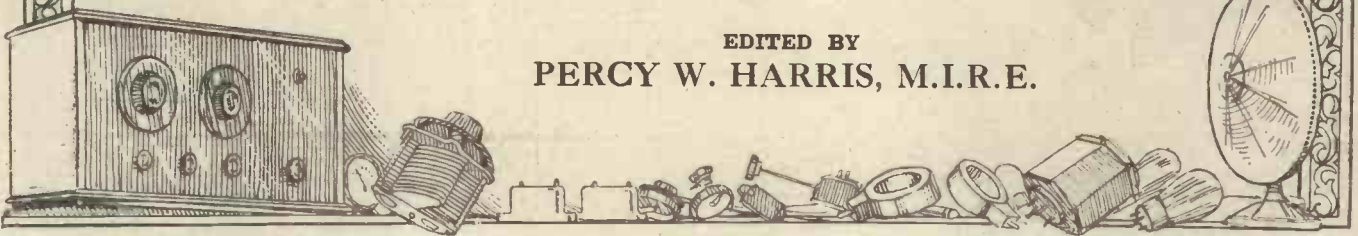

Build this K.1 3-valve receiver
for A.C. mains from

Marconiphone and STERLING Radio Components

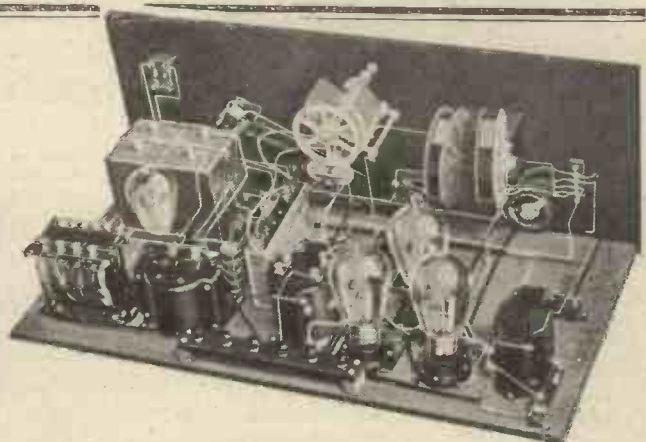

Operated entirely from the house electric supply, this highly efficient broadcast receiver for loud speaker reproduction can be constructed easily from Marconiphone and Sterling components, in combination with Type K.L.1 Marconi valve. Send coupon (accompanied by 6d. in stamps) for book containing complete constructional details together with full size wiring plan.

Marconi type K.L.1 is a general purpose valve employing a new principle in radio valve design. The electrons are not emitted from the filament but from a separate cathode heated by thermal radiation. Operating through the Marconiphone Power Transformer, it permits of almost any type of wireless receiver being worked direct from A.C. mains, thus dispensing with accumulators and H.T. batteries. Type K.L.1 valve - - 30/-

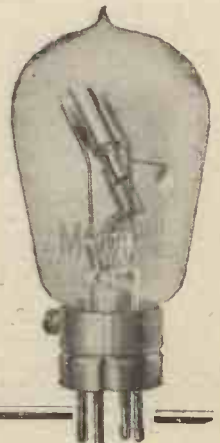

THE MARCONIPHONE COMPANY, Ltd.
Head Office: 210-212, Tottenham Court Road, W.1
Registered Office: Marconi House, Strand, W.C.2

To THE MARCONIPHONE COMPANY, LIMITED,
210-212, Tottenham Court Road, London, W.1.
Please send copy of K.1 Constructional Book with full size wiring plan,
6d. stamps enclosed.

Name

Address

Town County

USE BLOCK LETTERS.

THE VALVE WITH THE HIGHEST VACUUM!

Fit S.T.'s and hear your set spring into new life. You will be amazed at the flood of warm, living music you can get from station after station you have never even heard before on other valves.



2-volt.	4-volt.	6-volt.
S.T. 21A (Res. Cap.) 0.1 amp. amplification 35 14/-	S.T. 41A (Res. Cap.) 0.1 amp. amplification 35 14/-	S.T. 61A (Res. Cap.) 0.1 amp. amplification 40 14/-
S.T. 21 (H.F.) 0.1 amp. 14/-	S.T. 41 (H.F. and Det.) 0.1 amp. 14/-	S.T. 61B (H.F. and Det.) 0.1 amp. 14/-
S.T. 22 (L.F. and Det.) 0.1 amp. 14/-	S.T. 42 (Power) 0.1 amp. 18/6	S.T. 62 (Power) 0.1 amp. 18/6
S.T. 23 (Power) 0.15 amp. 18/6	S.T. 43 (Super Power) 0.25 amp. 22/6	S.T. 63 (Super Power) 0.25 amp. 22/6

Send us the test certificate cut from an S.T. valve box with name and address, and we will put you down for a year's free subscription to the great new journal "ELSTREE RADIO NEWS," No. 1, of which will be sent by return.

S.T. LTD, 2, Melbourne Place, Aldwych, LONDON, W.C.2
(next to Australia House).

The WIRELESS CONSTRUCTOR

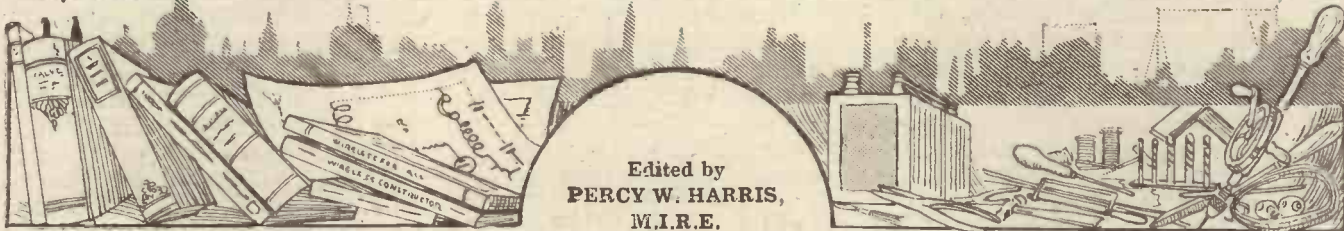

Published by the Amalgamated Press, Fleetway House, Farringdon Street, E.C.4.

THE EDITOR'S CHAT

In which Mr. Percy W. Harris, M.I.R.E., the Editor of THE WIRELESS CONSTRUCTOR, has something to say to readers concerning the contents of this issue, and a development of the Radiano system.

A STEADILY increasing number of listeners, tired of waiting for suitable alternative programmes from the British stations, are turning to Continental reception, whenever the local station ceases to please them. Provided the set is reasonably sensitive and selective, it is not difficult to find a Continental programme of music to one's taste, either on the ordinary broadcast band or on what is generally known as the "Daventry" range. This range, by the way, deserves more attention than is generally given to it, for it is quite a mistake to imagine, as do so many listeners, that there is nothing to hear other than Radio-Paris and Daventry. Excellent programmes of music are regularly given by Konigswusterhausen and Hilversum, while as a curiosity Moscow is regularly received in this country. The programmes consisting largely of unintelligible talks!

A Magnificent Receiver

The "Signal Box" described for the first time in this issue is pre-eminently the receiver for the man who wants to reach out while retaining good quality and a simplicity of operation. Although, as will be seen from the cover of this issue, there are three dials, two only are used for tuning, the third being reserved for reaction. The extraordinary good quality of this receiver is largely due to the method of rectification used, and while in the past crystal detectors have frequently been a source of trouble, the adoption in the "Signal Box" of a permanent detector removes

the disadvantage of instability which attaches to the older forms of crystal.

The "Selector Two"

High selectivity in a receiver is in far greater demand to-day than at any time previously in the history of the art. Many people find a simple two-valve set meets most of their needs, being economical both to build

not claim any sensational points in design it is a thoroughly workmanlike job, with the sound merits of simplicity construction and operation.

A Useful Amplifier

That an L.F. amplifier can be something more than the usual box with one or two valves, transformer or resistance coupled, is shown by Mr.

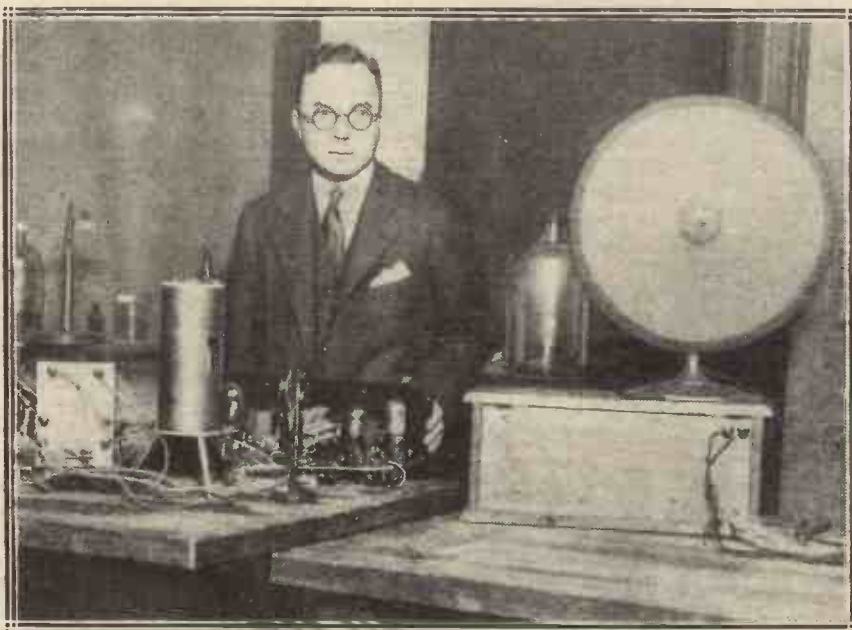

Prof. Stockburger, an American who is tackling the problem of television, shown with some of the apparatus he uses.

and to run. A set with selectivity far above the average for the number of valves, is the "Selector Two," which Mr. A. S. Clark, of "Midget" fame, describes in this issue. While it does

R. W. Hallows, M.A., who describes this month a highly ingenious amplifier with a multitude of possibilities. Adaptable to any existing receiver, whether crystal or valve, the results

The Editor's Chat—concluded

it gives will come as a surprise to many experimenters who have not realised the great advances in valve and transformer designs that have come about in the last year or so.

New Lamps for Old

THE WIRELESS CONSTRUCTOR "Modernising" articles are already proving very popular with our readers and have brought hundreds of letters (from all parts of the United Kingdom and from many countries abroad) asking for specific sets to be brought up-to-date. A careful analysis of the requests so far sent in show that the set the "All Concert-de-Luxe" heads the list, and accordingly a description of how to bring this set up-to-date is given this month. The changes can be made in an evening, and the exterior appearance of the set is scarcely altered. Both sensitiveness and selectivity are greatly increased, and the conversion can be carried out at quite a low cost.

Latitude of Adjustment

THE WIRELESS CONSTRUCTOR has always been famous for its crystal sets. This month a further addition to an interesting series is made by Mr. G. R. Stanley, in his "As You Like It" Crystal Set. A crystal set which gives good results on one aerial is not necessarily suited to another, and the most popular sets have always been those which give a latitude of adjustment by which the experimenter can find an arrangement to suit his own particular conditions.

It is, for example, possible to compare single layer windings with the multi layer types as represented by the ordinary plug-in coils. To judge from experiments conducted recently in my laboratory, I am firmly of

the opinion that readers will find little difference between the modern H.F. multi-layer coils and the single layer varieties when using a crystal detector.

The Radiano Short-Waver

Next month a feature of THE WIRELESS CONSTRUCTOR will be a Radiano "Short-Waver," with many interesting possibilities. In addition to its very high efficiency on the short waves, it is adaptable in a few moments to the ordinary broadcast wave-length range, and, in fact, the time taken to change from W G Y on 32 metres to Radio-Paris on 1,750 metres is scarcely longer than it takes to tell you!

SOME READERS' APPRECIATIONS

SIR,—Having built the "Radiano Three," described in the March WIRELESS CONSTRUCTOR, I am writing to tell you that I have had America every night since. The stations heard were KDKA (every night), 2XAF (once), and a station two nights later with a call sign WIOB or WYOB.

Yours truly, P. H. CURTIS.
Kington Langley, Wilts.

EDITOR'S NOTE.—This station is apparently a new arrival on the short-wave band. It does not figure in our lists.

SIR,—With reference to the letter on page 451 of the March issue, I am grateful to Mr. Alston for his

appreciation of the results he has achieved with the "All British Six," but I should be glad if you will allow me to point out that the "little trouble" he mentions was caused through, using different H.F. transformers other than those specified.

In a design of this character, with three H.F. stages, constructors are liable to have trouble if they experiment with various types of transformers, or depart from the original lay-out.

Yours faithfully,
H. E. HASSALL.
London, W.C.2.

[Editor's Note.—We have much pleasure in printing Mr. Hassall's letter, which reached us about the same time as the following communication from the London Electric Wire Company.]

SIR,—With regard to the use of Lewcos Screened Transformers in the "All British Six," I feel sure that you will be interested to know that a receiver of this nature was recently built by Mr. Emerson, the winner of the first prize at the Amsterdam Wireless Exhibition, using Lewcos Coils, and he has written to us giving us his appreciation of the results.

I mention this as I believe there are some coils which will not work satisfactorily in this circuit owing to the capacity coupling, but as far as Lewcos Transformers are concerned, these will give excellent results in any circuit of the "All British Six" type.

Yours faithfully,
FOR THE LONDON ELECTRIC WIRE COMPANY AND SMITHS LIMITED,
G. BURNAND,
Sales Manager.
London, E.C.1.



Broadcasting the description of a "Rugger" match.

THE SIGNAL BOX.

A Three-Valve Set
That Gives Five-
Valve Results.

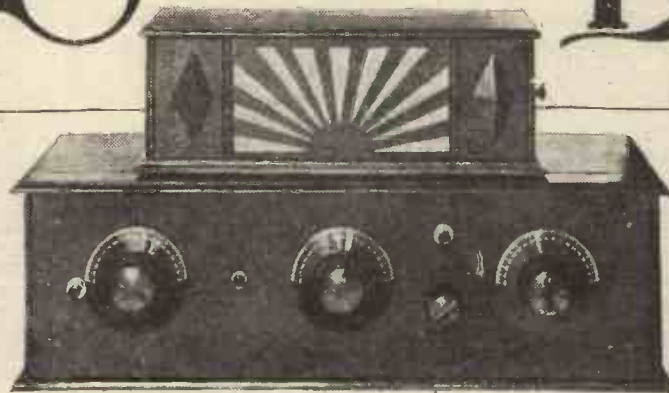

By
The Editor.

THE "Signal Box" has fascinated me more than any other receiver I have designed. From the first I expected great things from it, but I was really unprepared for the surprising sensitivity demonstrated by the finished model. It is, as you will find from an examination of the theoretical diagram, a further improvement on the original Hale circuit, first described in my article in "Popular Wireless" last autumn. "Samson," who, I am pleased to say, has already made a host of friends, has already demonstrated the remarkable purity and sensitivity of the Hale circuit, and a widespread demand for a set with a stage of H.F. preceding it led to the experiments which culminated in the "Signal Box."

Screening Inefficient

In sitting down to design this receiver I had in mind certain requirements which were by no means easy to fulfil. Naturally I desired the tuned circuits to be of high efficiency so as to give both sensitiveness and sharpness of tuning, while a freedom from "pick-up" and interaction of coils was also sought. While screened coils have a number of merits, I was anxious to avoid the use of the metallic screens, if possible, as the losses introduced by these screens are quite considerable. Laboratory experiments showed that the efficiency of the single layer H.F. transformers on the popular six-pin standardised bases, could be retained and interaction avoided by adequate spacing, and for this reason the "Signal Box" is slightly larger than such a receiver could be made if screened coils were used. By adopting the spacing shown

in the photographs, the efficiency of the receiver is distinctly higher than would have been the case with a smaller cabinet using screened coils.

The next stage in the development of the receiver was the choice of a suitable neutralised circuit. So far

This is by far the most sensitive and selective three-valve receiver I have yet designed. It combines an enormous undistorted volume of music from the nearest station with a distance-getting power that is astonishing. It can be recommended unreservedly both to the D.X. enthusiast and the man who simply wants the local station with good quality.

Percy W. Harris

designers using the standard six-pin H.F. transformers have relied either upon the "split primary" method or the "split secondary." When using the "split primary" method a tapped aerial coil has been used,

neutralisation being effected by a winding on the primary side of the second six-pin transformer and reaction applied by a coil connected to the low-potential end of the secondary winding and to a condenser joined to the plate of the detector valve. When using the split secondary method, two identical H.F. transformers have been used, the primary of the first acting as the aerial coupling coil, and the primary of the second as the coupling to the next valve. Reaction effects in the detector have been obtained by the well-known method of connecting the lower end of the secondary of the second transformer through a variable condenser to the plate of the detector valve.

The H.F. Side

I have experimented a great deal with both of these methods, but neither gives as good results as that adopted in the "Signal Box." In this scheme a split secondary transformer is used to connect the aerial to the first valve, neutralisation being effected by the standard split coil

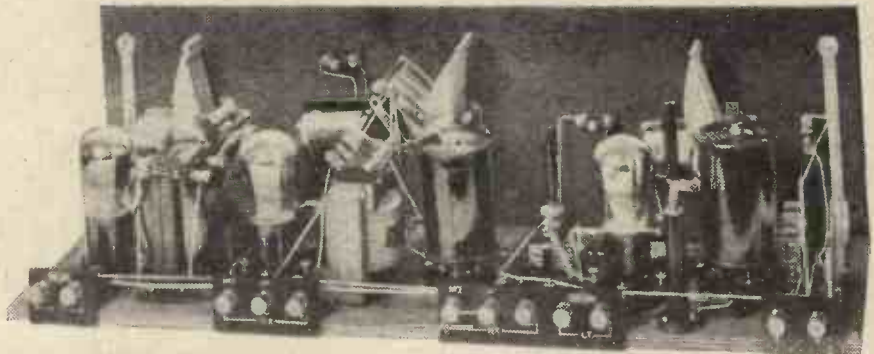

As will be seen by the above, no space is wasted and the lay-out has been carefully thought out.

The "Signal Box"—continued

method. As the connection from the H.F. valve to the detector valve a "split-primary" transformer is used, but instead of using the split primary of this transformer for neutralising, one half only is utilised, and that as a true primary of a H.F. transformer.

sharper; the scheme seems to suit a wider variety of valves than the conventional methods, and we have the great advantage that if the coupling given by one half of the primary of the transformer is insufficient, it can be increased by using

and plate of the H.F. valve an additional condenser so as to bring

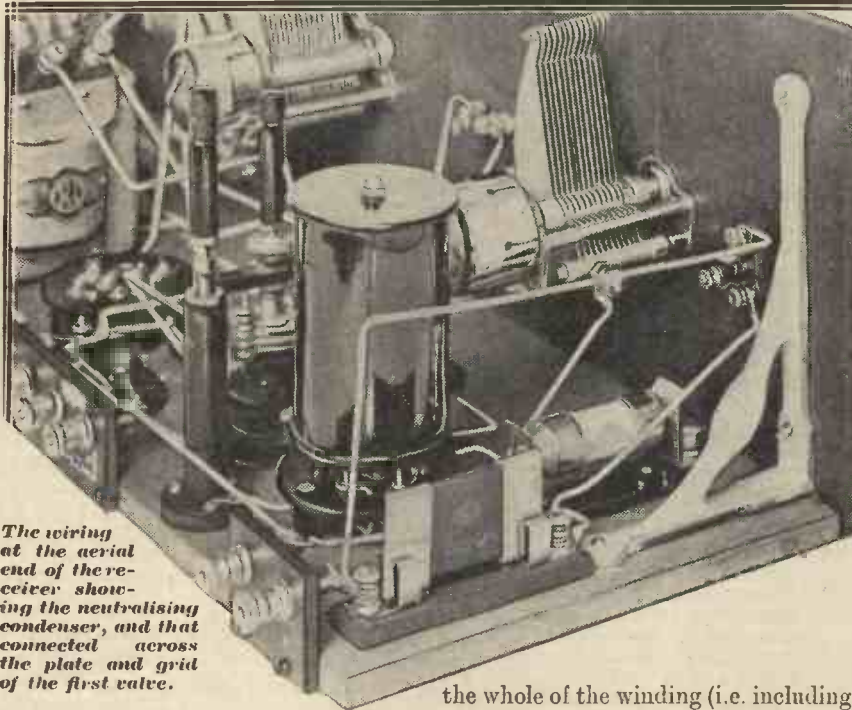

The wiring at the aerial end of the receiver showing the neutralising condenser, and that connected across the plate and grid of the first valve.

Reaction is applied in the standard manner adopted with the split primary coil.

There are several advantages in this method, not only when applied to this particular receiver, but to ordinary sets with one stage of H.F. Neutralisation seems much

the whole of the winding (i.e. including the part that normally serves as the neutralising winding).

While neutralisation of this receiver is very sharp and "clean cut," the amount of neutralising capacity required is very small and in fact is of a value comparable with that of the valve itself. For this reason it is necessary to place between grid

COMPONENTS REQUIRED.

- 1 panel (Ebonart).
- 1 pair brackets (Cameco).
- 1 oak cabinet (Cameco).
- 1 variable condenser '0005 mfd. Ormond S.L.F.
- 2 variable condensers '0003 mfd. Ormond S.L.F.
- 2 standard coil bases (Colvern).
- 1 neutrovernier condenser (Gambrell).
- 1 neutralising condenser (Peto-Scott).
- 4 valve sockets (Lotus).
- 4 fixed resistors (Magnum).
- 1 condenser stand and '0001 mfd. condenser (McMichael).
- 1 radio frequency choke (McMichael).
- 1 100,000 resistance and base (Varley).
- 3 on and off switches (Deeko).
- 1 carborundum unit (Carborundum Co.).
- 1 L.F. transformer (multi ratio) (R. I., Ltd.).
- 1 L.F. transformer (Ferranti).
- 4 terminal strips (A.E.)
 - L.T.—, L.T.—, H.T.—, H.T.—, H.T.—, H.T.—, H.T.—, H.T.— } Magnum.
 - G.B.—, G.B.—, G.B.—, G.B.—, G.B.—, G.B.— } Magnum.
 - L.S.—, L.S.—, L.S.—, L.S.—, L.S.—, L.S.— } Magnum.
- 1 fixed condenser '015 (Dubilier).
- Glazite wire.

Note: It is advisable to use two separate grid bias batteries for G.B.—1 and G.B.—2. This will require two G.B.— + leads from that terminal.

1 microfarad or 2 microfarad condensers may be connected outside the set between H.T.—1 and L.T.—, and H.T.—2 and L.T.—. These condensers can then be used for other sets when required.

Coils needed.—(250-600 metres).—
 1 standard 6-pin H.F. transformer (split secondary type), 250 to 550 m.
 1 standard 6 pin H.F. transformer (split primary type), 250 to 550 m.

Davenport range.—1 standard 6 pin H.F. transformer (split secondary type), 1,000 to 2,000 m: 1 standard 6 pin H.F. transformer (split primary type), 1,000 to 2,000 m.

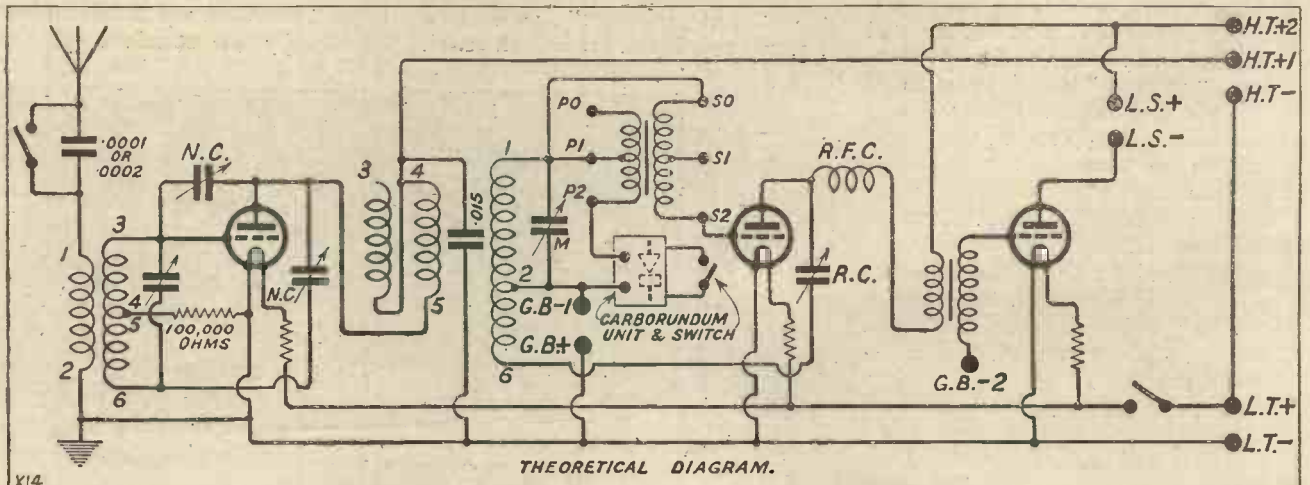

THEORETICAL DIAGRAM.

The "Signal Box"—continued

the total capacity of the valve itself, plus this additional condenser, nicely within the range of the actual neutralising condenser used. There are several advantages in this method which will be obvious to the more advanced experimenter, but it is sufficient at the moment to point out that the value of the additional

received from 2 L O is very great and for the benefit of those who like figures I may say that any ordinary crystal set (not a specially designed low-loss affair) will give over a hundred microamperes of rectified current in the 'phones. With so strong an initial signal you can imagine that when the "Signal Box" is tuned to

tion is that, on changing over from shorter wave band to the Daventry range, no resetting of the neutralising condenser is necessary, the receiver remaining stable over the whole condenser scale.

Improving the Hale Having found a really satisfactory

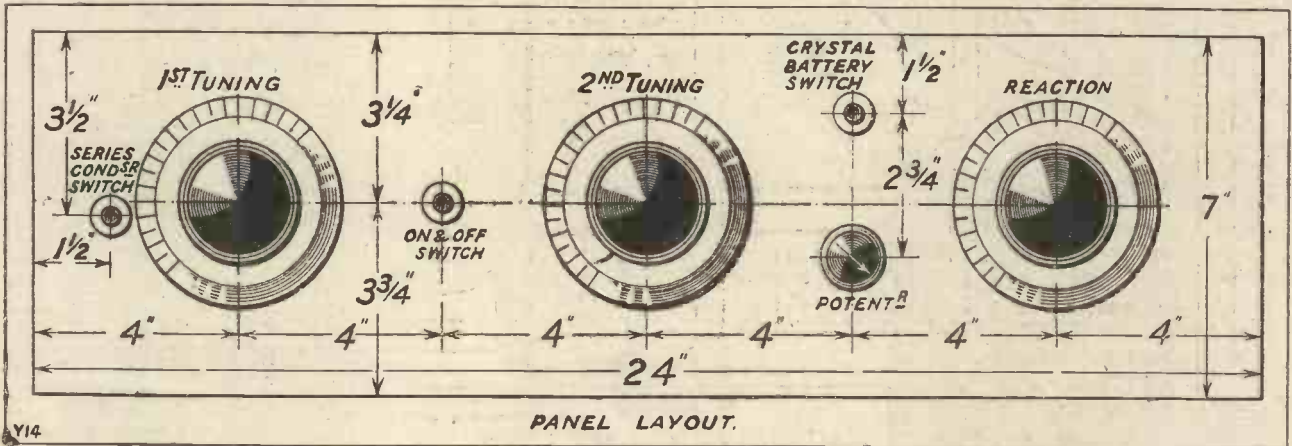

capacity can be so set that a perfect neutralisation point is found for any valve about half-way through the travel of the neutralising condenser. In fact, the neutralising is so fascinating a task when the local station is nearby that one carries out the process several times from the sheer joy of doing it.

For example, on my aerial at Wimbledon the strength of signals

2 L O a super-power valve is needed to handle the output without distortion, the volume given being quite sufficient to fill a big hall. If, now, when the set is neutralised, the fixed resistor of the first valve is removed, the result is dead silence, while a slight turn of the neutralising condenser will at once make the station audible in the loud speaker.

Another proof of correct neutralisa-

and reliable H.F. circuit with the advantage that any standard make of six-pin transformer could be used, I then proceeded to find what could be done to improve the Hale circuit itself. The only point that needed attention here was the rectifier, which, as readers know, is a crystal. While there are numerous crystal rectifiers which have given us excellent results in the Hale, they are occasionally

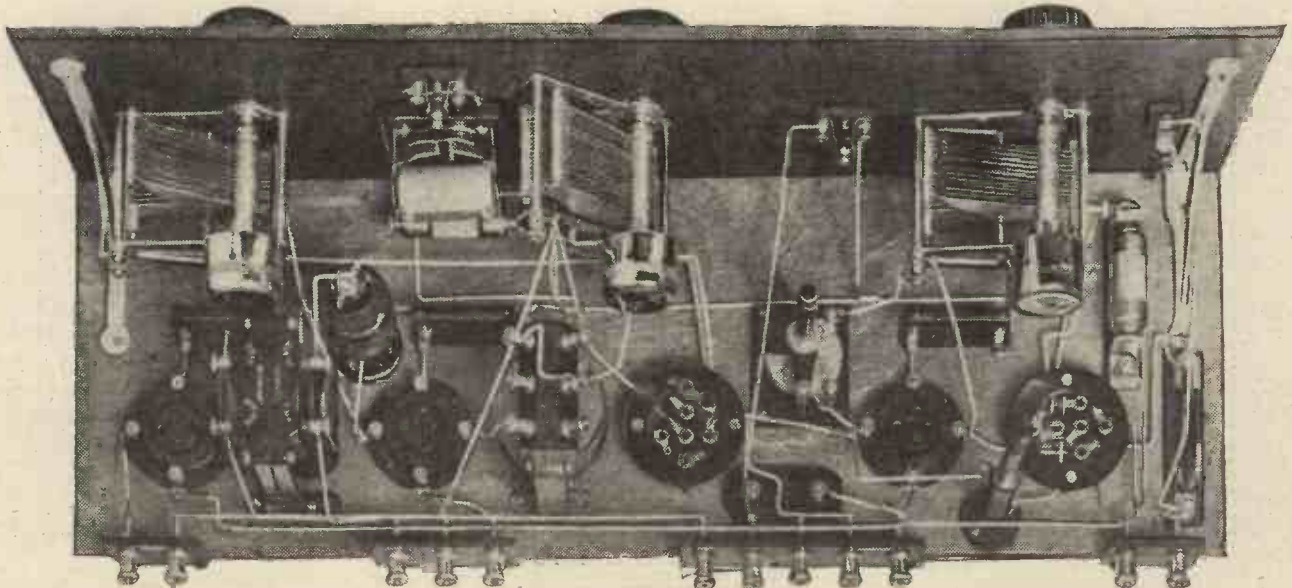

This photograph should be carefully studied, and the lay-out followed as closely as possible if really satisfactory results are to be obtained.

The "Signal Box"—continued

troublesome to adjust, and a letter from a reader in the North of England to the effect that he was getting very good results with the carborundum

detector, variation of the potentiometer brings about a continuous variation of the effective resistance of the detector itself, and thus we have

I have, however, introduced one modification into this unit which I trust will be incorporated by the manufacturers themselves in future. Unfortunately, as designed, there is no provision in the unit for switching off the cell, which continuously discharges itself through the potentiometer (having a resistance of about a couple of thousand ohms), whether the set is used or not. While the cell can be taken out of the clips at the end of an evening's entertainment, it is not a desirable practice and, indeed, is generally inconvenient.

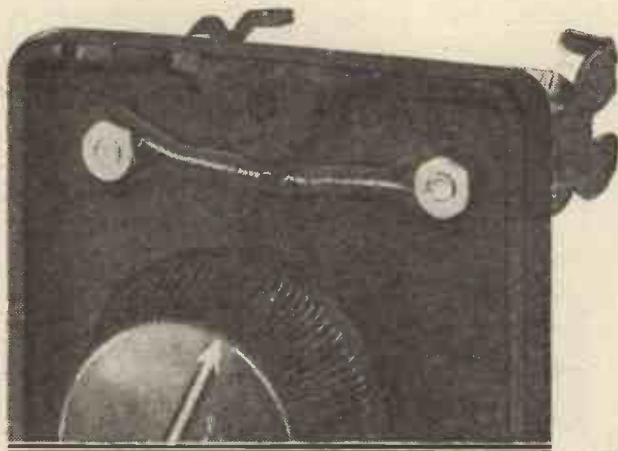

The battery connections of the carborundum unit before adapting for the "on-off" switch. If left like this the battery is constantly being discharged through the potentiometer.

Inserting a Battery Switch

If you examine the back of a carborundum unit you will find two wires come through the moulding from the potentiometer to the terminals of the clips. By undoing one of the clip nuts and removing the wire, and by

unit, led me to experiment to see what could be done in this direction.

Now the carborundum unit sold by the Carborundum Company Ltd. consists of the actual detector itself, a potentiometer, a condenser and a pair of clips to take a single dry cell. The carborundum detector is exceedingly stable and, in fact, contact is made under quite an appreciable pressure, but one does not get a real advantage from its use without potentiometer control. The unit is just as simple to use as any other crystal detector, and the whole device is mounted on the panel by the one-hole-fixing method. Two terminals are provided corresponding with the ordinary crystal terminals and it is only necessary to turn the potentiometer knob backwards and forwards until best signals are heard.

Fine Reaction Control

Practical trial of this unit in the Hale circuit immediately demonstrated a very important advantage and one which places the carborundum detector far ahead of any other for use in this circuit. The crystal detector introduces damping into the Hale circuit and consequently has a bearing on the reaction control. For this reason resetting the crystal in the Hale circuit nearly always alters the reaction setting. It is best, as those who have tried the circuit know, to experiment with the crystal setting until the best combination of sensitivity and reaction control is obtained. With the carborundum



This illustration shows a few of the many transformers which have been used with success in the "Signal Box."

here an additional and extremely fine reaction control and a method of adjustment to suit the particular valve and transformer we are using.

filing two slots in the moulded composition on which the parts are mounted, the cell-potentiometer circuit will be broken and wires taken out to a simple on-and-off switch. The enlarged photographs show how this is done. It is now a simple matter

How the wiring of the detector unit is modified to include the "on-off" switch. The inclusion of this switch saves the battery and is really a necessary alteration.

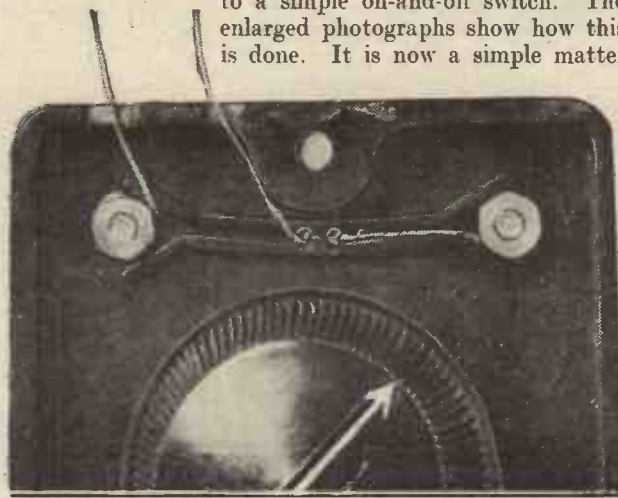

The "Signal Box"—continued

to push in the switch and cut off the battery.

You will notice I have chosen two transformers for this receiver, the R.I. tapped model and the Ferranti. Experience has shown that the R.I. transformer suits the Hale circuit very well, as one can choose tapplings to suit the peculiar conditions, although there are a number of other

transformers which work very well indeed in this circuit. The second transformer is not so critical as the first, and can be of any good reliable make. In passing, I should mention that the Ferranti is not recommended for the first position as it contains a condenser across the primary winding, which reduces its efficiency for this particular circuit. Some transformers do not work so well as others in the Hale portion of the circuit, but this must not be taken as an indication that the transformer which does not give so good a

performance is an inferior instrument for general use. It must always be remembered that the method of use of the transformer in the Hale circuit is unusual and differs from normal practice. If one set out to design a transformer specially for this circuit it might possibly prove quite unsuitable for normal use.

You will notice that there are three small push-pull switches on the panel. One is for switching the valves on and off, the second to switch off the

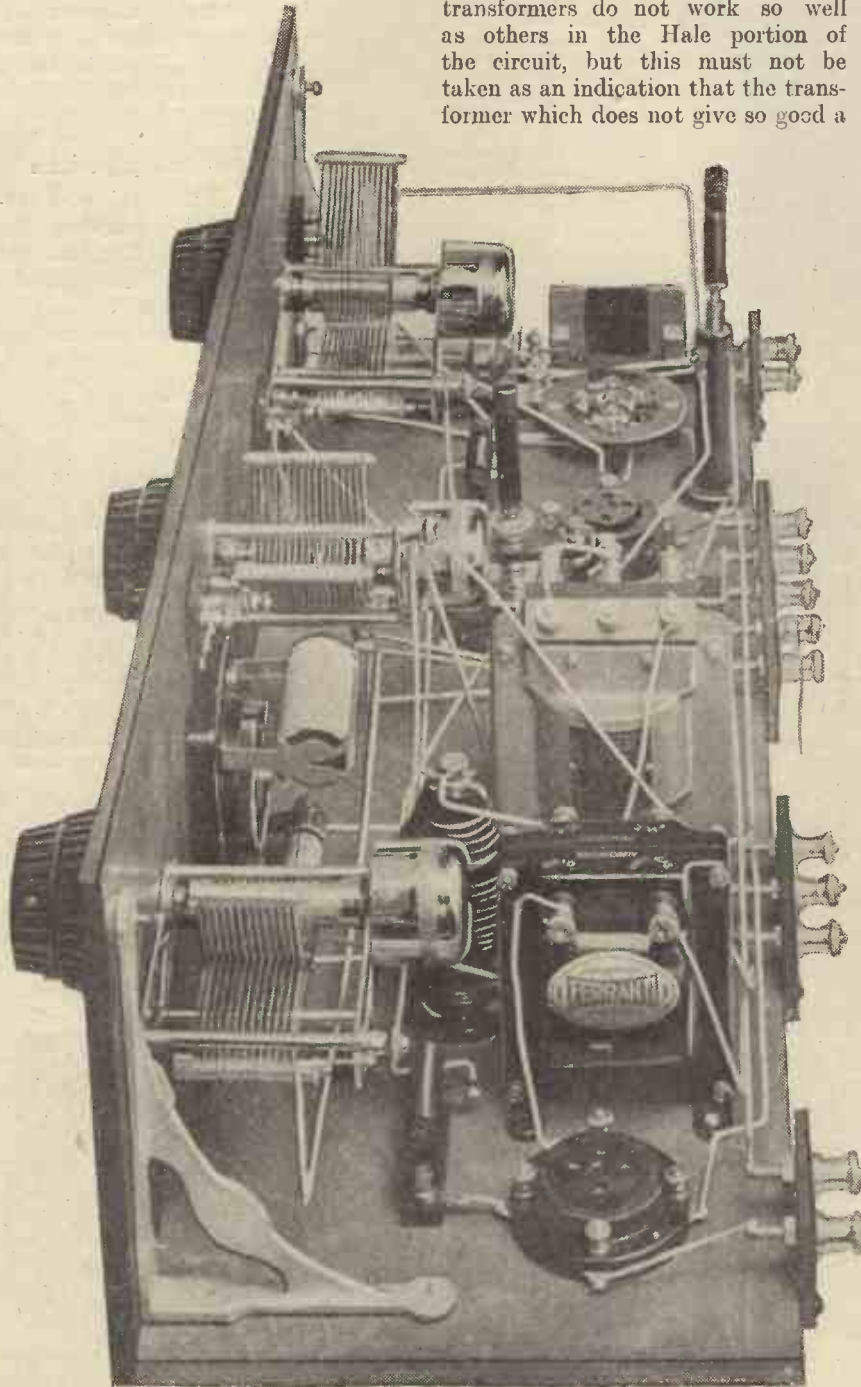

This photograph, taken from the L.F. end, clearly shows the relative positions of the variable condensers, detector unit, and the two L.F. transformers.

TYPICAL READINGS.

	First Dial.	Second Dial.
Kiel	0	10
Malmo	11	22
German Relays	26	35
Dortmund	28	45
Relays	41	61
Nuremberg	48	67
Barcelona	58	80
Dublin	62	83
Breslau	63	85
Cardiff	77	98
London	80	103
Madrid	83	105
Tammfors	84	107
Stuttgart	90	111
Hamburg	95	118
? German	103	126
Frankfurt	107	130
Brunn	112	134
Ecole Sup., de P. T. T.	118	141
Langenberg	120	142
Berlin	123	145
Bournemouth	126	147
Aberdeen	128	150
Rosenhugel	131	153

Note : Above stations were all received on the loud speaker on one evening. Many others were heard but could not be identified.

battery of the carborundum unit, and the third is rather novel in its application. The primary winding of the split secondary transformer suits the average aerial excellently, but owing to the wide range of wave-lengths covered by these six-pin coils when they are used without screens, it will be found that somewhere within the tuning range there may be a "dead-spot" when the aerial tuning suddenly goes "flat."

The Series Condenser

This is due to the fact that at this particular point the primary winding in conjunction with the aerial exactly tunes to the wave-lengths you are desirous of receiving, and this automatically makes the coupling far too tight.

In such circumstances there is an easy cure—insert a series condenser. This condenser will reduce the signal strength somewhat, but will give you

(Continued on page 62).



WHY that fellow Goshburton-Crump should have chosen the ridiculous hour of 2.30 p.m. for the informal meeting held in his rooms to discuss the subject of his next lecture to be given before the Mudbury Wallow Wireless Club, I do not know. So far as I was concerned, it meant that I had to bolt my breakfast and that even so I arrived just too late to secure a chair. If a man asks a dozen fellows round to his rooms he might at least see that there are twelve chairs instead of only eleven.

To my mind, also, any well-bred host who found one of his guests chairless would at once offer his own. Goshburton-Crump did, as a matter of fact, give up his seat to me, though not exactly of his own free will. When he had got on to his hind legs to address the meeting, I quietly removed his chair, into which I sank with a little sigh of relief, for I was



... His fall was broken by the hats

feeling quite fatigued after my three hundred yards' trot from my place to his. Do not imagine that I played the old schoolboy trick of allowing him to sit down upon the floor. I would scorn to do anything of that kind. In order to break his fall, I arranged in a pile, at the probable point of impact, the ten hats of his other visitors, which were lying upon a table at my elbow. It is just little acts of thoughtfulness as this that are the real signs of perfect breeding.

At Length He Sat Down

When Goshburton-Crump did sit down after a somewhat lengthy oration, his fall was to no small extent broken by the hats, but equally the hats were to no small extent broken by his fall. Moved by some strange impulse, the whole crowd of

them turned on me and had not my natural resourcefulness come to my aid I should probably have had rather a bad time of it. When Tootle flung an H.T., battery at my head, for example, I ducked neatly and it caught Sir K. N. Pepper upon the fifth waistcoat button. Believing like a wounded elephant, Sir K. N. Pepper seized a handy earth tube with which he aimed a saucy swat at Tootle. I contrived, however, to give Pimpleson a slight push which sent him into the line of fire and the earth tube alighted with a thud upon his ear.

"Boys Will Be Boys"

At this moment I observed Captain Buckett advancing upon me brandishing a loud-speaker horn. Just as it was about to descend I dodged behind the Rev. Aloysius Tosher, who was next instant bonneted by the bell. A second or two later they were all hard at it, and seeing that they were so busily engaged, I slipped through the french window and left them to it. I watched the disgraceful scene through the window and when they all appeared to have had enough, I returned.

"Well, well," I said, with a cheerful smile, "boys will be boys, of course; but is there not an old rhyme about dogs delight to bark and bite? I am so glad that Miss Worple is not here to witness this rather painful exhibition." None of them had the energy to be actually offensive, and I had no difficulty in securing the most comfortable chair in the room into which I dropped gratefully. When they had dusted each other down and Mr. Glump had disentangled Tootle's tresses from his watch-chain, we settled down to business once more.

"I propose," said Pottleson, "that the next lecture shall be given by Wayfarer." I assumed a modest look. "What about one on how to take valve curves?" "If," bleated the Rev. Aloysius Tosher, "it was on how to take valves, I should say that he was just the man for the job."

This is the sort of gratuitous insult that you get from people of that kind when you try to help them. I had, of course, borrowed half a dozen valves from Aloysius, explaining at the time that new valves were always harsh and rough until they had been



... I decided to use a watch ...

properly broken in. Still, I had had them for only eight months, and though I had done my best to expedite matters by using them for three or four hours every night since, I could not conscientiously say that the breaking-in process was complete. However, I ignored this rude interruption and begged Pottleson to proceed.

More Apparatus Required

Pottleson said that everyone ought to know how to take valve curves, ought, in fact, to make a practice of taking them regularly. He had no doubt, he continued, that all members of the club would do so but for the fact that I had borrowed every measuring instrument in the place. This being so I was clearly the only person qualified to give the lecture. When he had finished I expressed my



... The valve promptly blew up! ...

willingness to comply with the wishes of the assembly, but explained that before I could give the lecture I should have to ask for the loan of a few more small pieces of apparatus.

A groan went up from all of them; I suppose they were feeling their

In Lighter Vein—continued

wounds a bit. "I have practically everything I want," I said, "except an accumulator, an H.T. battery, a grid battery, a valve holder, a rheostat, some squared paper, and a supply of wire. If some of you will kindly

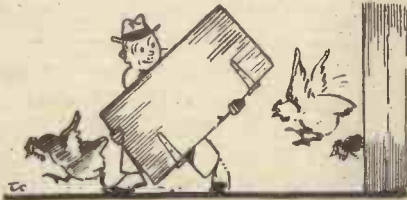

The "blackboard" came from Miss Worple's hen-house

arrange to lend these things, all will be plain sailing. And, by the way, I shall also need a number of valves of various types."

I am sorry to say that the community spirit is not nearly so much in evidence as I should like in the Mudbury Wallow Wireless Club. It was a long time before I secured offers of the loan of the trifles that I needed. The meeting, in fact, turned quite nasty when I said that to be on the safe side I had better have two of everything, and no small difficulty was experienced in obtaining what I called volunteers, but they, for some queer reason, preferred to call victims.

Most Successful

I think that I can say without undue immodesty that my lecture was the most successful that has yet been given at the clubhouse. I took a great deal of trouble over the preparations,

spending no little time in making the neat valve-testing outfit, of which the details are given in one of the drawings so that readers who desire to make up this exceedingly handy piece of apparatus for their own use will have no difficulty in doing so. I was a little handicapped, both in my demonstration and in making up the valve tester by the fact that only one voltmeter was available.

The Demonstration Commences

Since this, though it read only from 0 to 5 volts, had to be pressed into service for taking the plate potential I decided, following the old Army principle of "going through the motions," to use a watch, deftly borrowed from Sir K. N. Pepper's waistcoat pocket, as a substitute for the voltmeter responsible for measuring the grid potential. This is an excellent tip, which I give free of all charge. I can assure you that valve curves taken with the aid of a watch, or even if need be of a speedometer or a petrol gauge, are in every way as useful and as accurate as those made by the more finicky normal methods.

Again, I can strongly recommend the hook-and-eye connection for leads. Not only does it greatly facilitate the task of connecting and disconnecting wires, but also it lends to the readings obtained just that liveliness which prevents one from feeling that there is anything dull about curve taking.

I began my lecture by explaining to my audience why static valve curves

were of such supreme importance. They formed, I said, extremely pretty and appropriate decorations for wireless dens when pinned up on the walls; no eye could fail to be pleased by their graceful lines. The very fact, I told them, that valve curves were taken under conditions which could not by any conceivable chance be repeated in actual working, was of vital importance. Do not curves show you one way in which valves never behave? If you can go on discovering all the things that valves never do you will arrive in time, by a

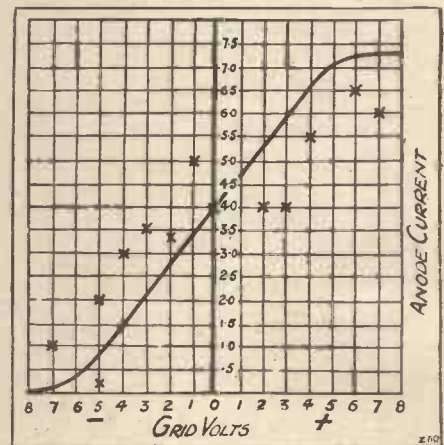

Eventually we got all the dots in . . .

process of elimination, at a thorough understanding of the things that they really do.

To illustrate the working of the elimination process I placed one of Pottleson's valves in the holder and connected the H.T. leads to the filament terminals. The valve promptly blew up amidst rounds of applause, in which all but Pottleson joined. We have now discovered, I continued, that the filament of a valve will not stand a potential of 100 volts. Will it stand 99.5? Let us see. I proved to them conclusively that one of Mr. Glump's power valves would not. We will now proceed, I said, by dropping half a volt at a time, to discover all the potentials that a valve filament will not stand.

We Take Some Curves

When we have done this we shall arrive by elimination at a knowledge of what its limitations are. I then prepared to go on with the good work, having by me a large supply of valves which I had borrowed during the

(concluded on page 71)

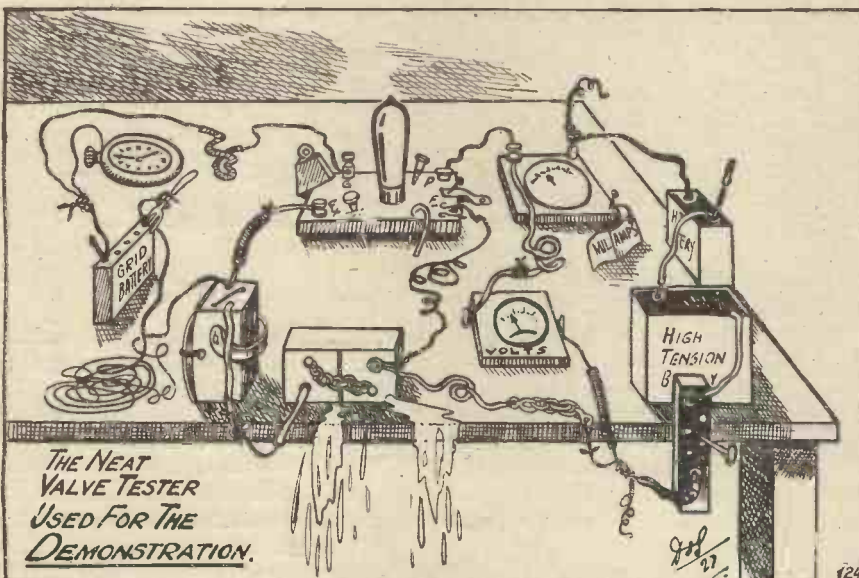

THE NEAT VALVE TESTER USED FOR THE DEMONSTRATION.

NOTES on NEUTRALISATION

An article which deals with the subject in a thoroughly practical manner.

HIGH-FREQUENCY amplification without neutralisation was carried out for a long time with low-capacity valves and stabilising resistances, but several factors have told against the use of this older method. Firstly, special low-

capacity valves are rather more expensive to construct than normal valves. Secondly, the amount of

tion valve and attempt to get all the tube should give you and your troubles will begin, particularly if you are



By
 Capt. H. J. ROUND,
 M.I.E.E.

insistent on obtaining really perfect whole condenser range.

The Rice Balance.

Let us take a simple circuit, such as the Rice neutralised arrangement shown in Fig. 1. C_3 is the ordinary neutralising condenser, and superficially if this is set to equal the valve grid-plate capacity in the usual way the circuit will be balanced, but this is not quite true, for the valve grid has a capacity to earth which may easily amount to '00003 mfd., quite comparable with the tuning condenser at its smallest value; and now if we re-draw the circuit as in Fig. 1a (leaving out the actual valve but inserting C_1 equal to its capacity) we have the well-known Wheatstone bridge arrangement. The two inductive arms, each of which is half the value of the tuning coil, if they were arranged in the ideal way, should permit of a balance of C_1 and C_3 , so that between A and B at no frequency will there be any potential difference,

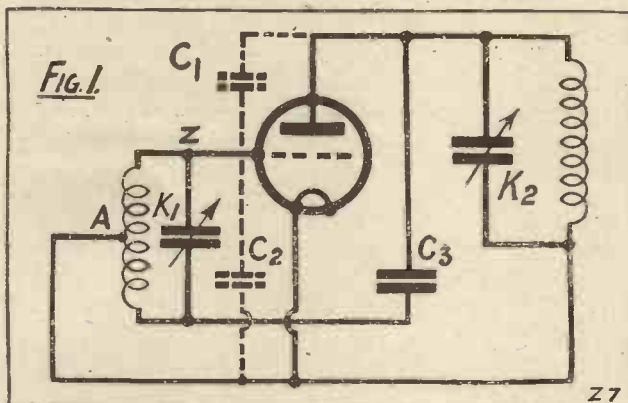

This diagram of the Rice neutralised arrangement shows the connections in thick lines, and stray capacities in dotted lines. C_1 represents the grid-to-plate capacity, and C_2 the grid-to-earth capacity, which may easily amount to '00003 mfd.

amplification per tube was limited, and finally the use of resistance for stabilising meant flatter tuning, and in broadcasting we are out for the sharpest curve we can get within limits.

The Straight Eight

But, as many may have found out, neutralising is not too easy, although my own experiences have shown that it is not at all difficult to do providing one does not attempt to get anything but a small magnification per tube. Thus in the Straight Eight, as I deliberately set out to use six circuits to get the necessary filter curve, the amount of magnification required in each of the five circuits was quite small to get a big amplification over all, and the problem was not at all difficult except for "parasitic oscillations," which I will consider later. Now take a modern high-magnifica-

In this diagram the same Rice neutralised arrangement has been re-drawn as a Wheatstone Bridge. The valve itself has been omitted, but its grid to plate capacity is represented by C_1 . The other points are marked so that comparison with the circuit shown in Fig. 1 will make the arrangement quite clear.

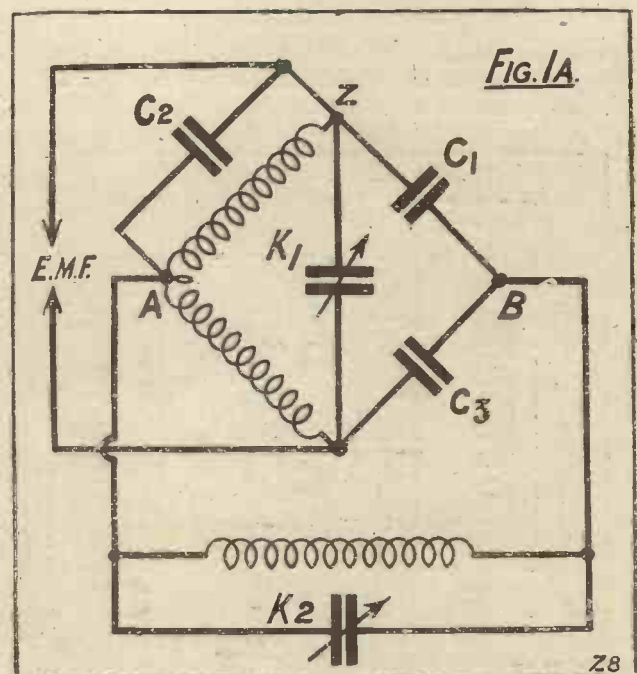

Notes on Neutralisation—continued

and, of course, vice versa; any potential difference across A and B will give zero potential difference across K_1 , the tuning condenser. I

bridge must be balanced by an equal capacity across the other arm.

In addition to these, various unequal stray capacities, and even unequal eddy current losses (say, in the shields) in the two halves of the coil, will upset the otherwise perfect balance.

These capacities and stray capacities, too, have various losses associated with them, and these will still further tend to upset the ideal balance, which is constant over the whole range of frequency. But there is

clearly the necessity for attending to all these points to get perfect neutrali-

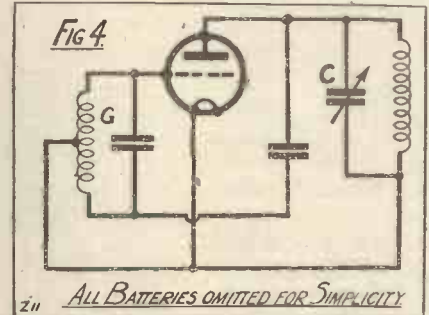
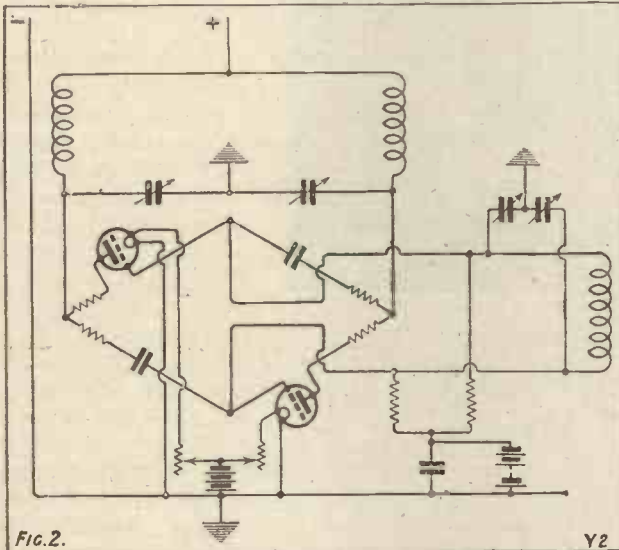

sation, and I give in Fig. 2 one of his bridge diagrams for his patent No. 241298 of 1924. His work indicated strongly that a nearer approach could be made to the perfection required by arranging his valves in pairs, although with care one valve could be simulated by condensers.

In Fig. 3 I represent this Franklin circuit, and in Fig. 3a the bridge that

shall show presently that this is not the only necessity for good working, but it is one of the necessities, and we

a more serious error in this arrangement due to lack of recognition of the exact way our valve is connected. Examine Fig. 1a again, and although no potential across K_2 gives a potential across the whole coil, it is producing this effect by two equal and

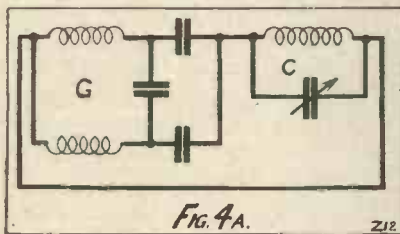

can see at once that the capacity C_2 , representing the valve grid to filament capacity, across one of the arms of the

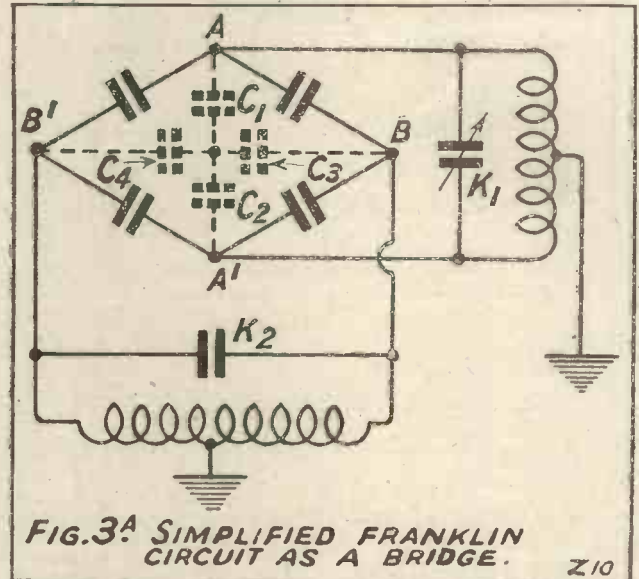

opposite currents from the two halves of the coil; therefore there is still some potential across half of the coil, and it is across half of the coil that our input grid to filament is connected.

The Franklin Bridge

Mr. C. S. Franklin has shown

it represents lettered similarly (shown on the two halves of the coil). The stray capacities are shown in both diagrams, and providing the inductances are tapped symmetrically, the whole arrangement is likely to be in perfect balance. Very successful amplifiers have been constructed like this, particularly when further precautions to prevent parasitic oscillations are taken, but the arrangement is actually a treble bridge due to the earth position in the centre of the coils. It is perhaps a little more complex than the Rice method. I will return to this question of other

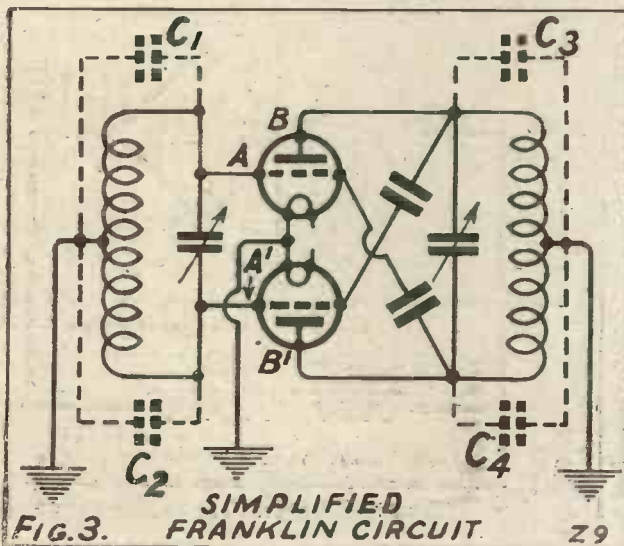

Notes on Neutralisation—continued

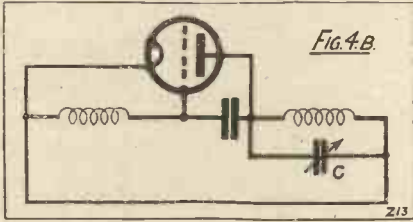

neutralising circuits after considering the question of "parasitic" oscillations.

All through this discussion of

input coil which can build up round the circuit, but if we imagine a much shorter wave induced into it, and if by chance this wave is anything like in tune with the two arms of the input coil oscillating in parallel, that is with the open ends going positive and negative together, energy can flow back easily through the two condensers representing the valve capacity and the neutralising one.

Let us look at it in another way. In Fig 4b I have drawn the circuit,

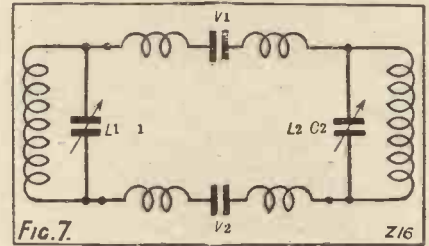

Fig. 7.

Smith, in their patent No. 260321 of 1925, insert resistances R_1 and R_2 , as shown in Fig. 5. Personally, I

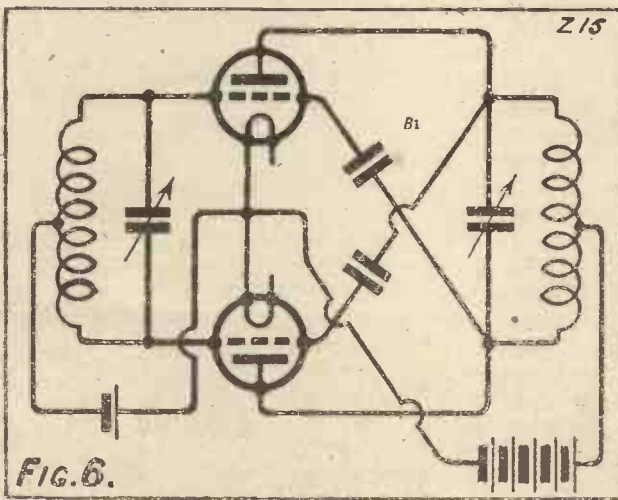

FIG. 6.

This symmetrical circuit helps to show how parasitic oscillations can occur. For further simplification it has been re-drawn as Fig. 7, in which the valve capacities are represented by condensers.

This is further re-drawn in Fig. 9, where it will be seen that oscillation can occur round the external leads in which the two batteries are situated.

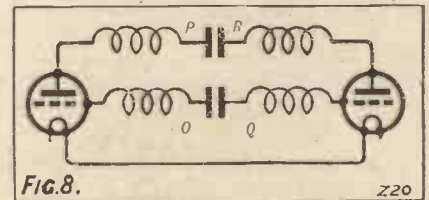

Fig. 8.

think a third one, R_3 is a good thing to have also, thus only leaving the valve capable of oscillating at the

neutralisation we have imagined our wave being forced into the input tuned circuit and producing equal potential positive and negative across its terminals, and all that we have worried about is that there should be no potential across the output, due

but with the two halves of the inductance paralleled and the two condensers as one and then inserted the valve. We can now see we have some form of Hartley oscillator, which is known to oscillate quite violently, and to make quite certain these oscillations cannot take place, Messrs. G. M. Wright and S. B.

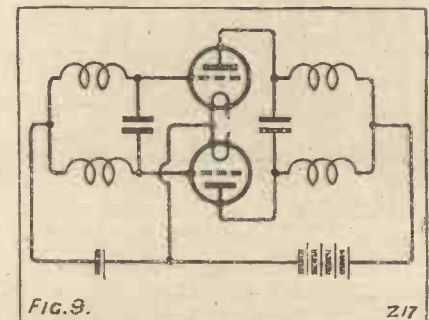

Fig. 9.

normal wave-length if the neutralising is displaced. Just as a matter of interest let us examine how a Franklin bridge circuit can perform oscillations,

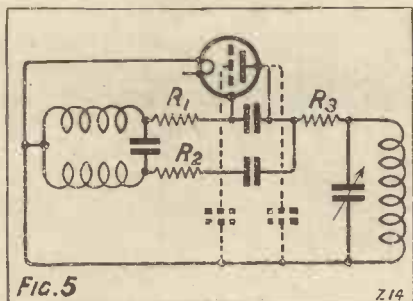
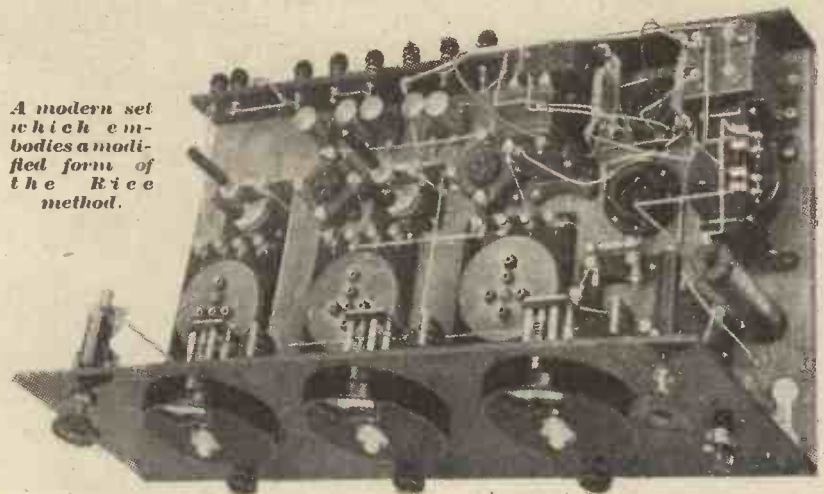

Fig. 5

to valve capacities or vice versa. But we have no right to say that our system always produces a potential on the input coil which is as convenient as this. Let us take the Rice neutralised arrangement of Fig. 4 and redraw it as in Fig. 4b. If the coil C has a normal oscillation in it, it will put no current back into the

A modern set which embodies a modified form of the Rice method.



Notes on Neutralisation—continued

and how these can be stopped, Messrs. Wright and Smith, in their patent, clearly indicate the two main forms of parasitic oscillation possible, and I cannot do better than quote their words and diagrams.

"We have found that the cause of instability is due to the existence of second and third modes of oscillation, which are not balanced out by the bridge connection.

"The simplest circuit to consider is the symmetrical 'push-pull' arrangement of Fig. 6. If the valves be represented simply as condensers,

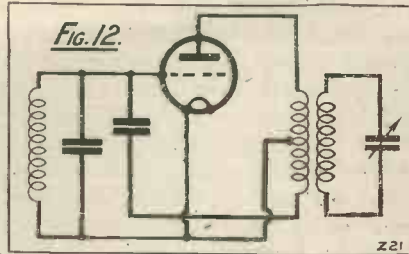

for a two-valve oscillator for the generation of very short waves. The anti-reaction condensers are connected between OR and QP, and it is obvious from inspection of the figure that the said anti-reaction condensers cannot balance out the reaction through the valves for this mode of oscillation. If $C_1 = C_2$ and $V_1 = V_2$ and the inductances represented by L_3 are all equal, then from the symmetry of the figure, the points O and R and the points P and Q will be at the same potential when oscillations

and such circuits have a strong tendency to break into oscillation generally at short wave length.

"The 'push-pull' circuit of Figs. 6, 7 and 8 can be also redrawn as shown in Fig. 9."

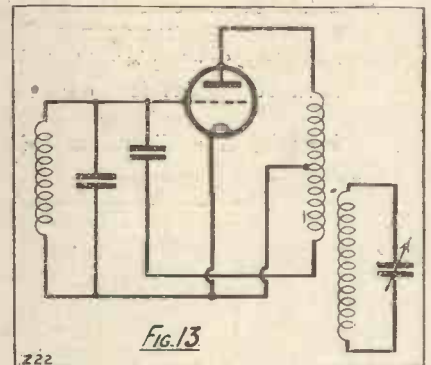

In Fig. 9 the anti-reaction condensers B_1 and B of Fig. 6 have been omitted. It can be seen that a third mode of oscillation exists round the circuit formed by the two valves

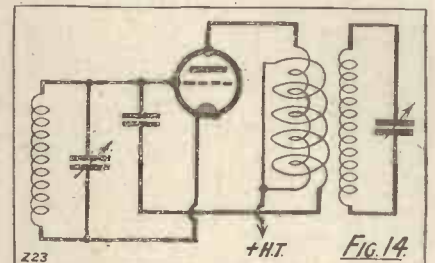

acting in parallel and the battery loop. "In this case it will be seen that the anti-reaction condensers B_1 and

(Concluded on page 70.)

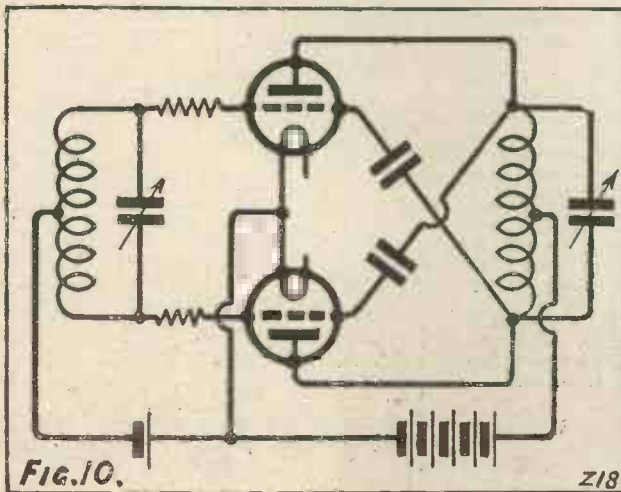

and the anti-reaction condensers B_1 and B_2 be omitted, the circuit becomes that shown in Fig. 7.

"In this figure L_1 , C_1 and L_2 , C_2 are the grid and anode tuned circuits, V_1

occur. Consequently connecting these pairs of points by condensers or any other type of impedance will have no effect whatever upon the oscillations.

"The second mode of oscillation is one cause of the instability of anti-reaction circuits of the foregoing type,

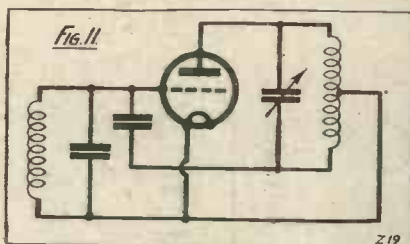

and V_2 are the two valves, while L_3 represents the inductances of the connecting leads. It will be apparent from the figure that a second degree of freedom exists, the mode of oscillation being round the closed circuit formed by C_1 , L_3 , V_1 , L_3 , C_2 , L_3 , V_2 , L_3 . This circuit may be again redrawn, as shown in Fig. 8.

"It will be seen that this circuit is the same as that usually employed

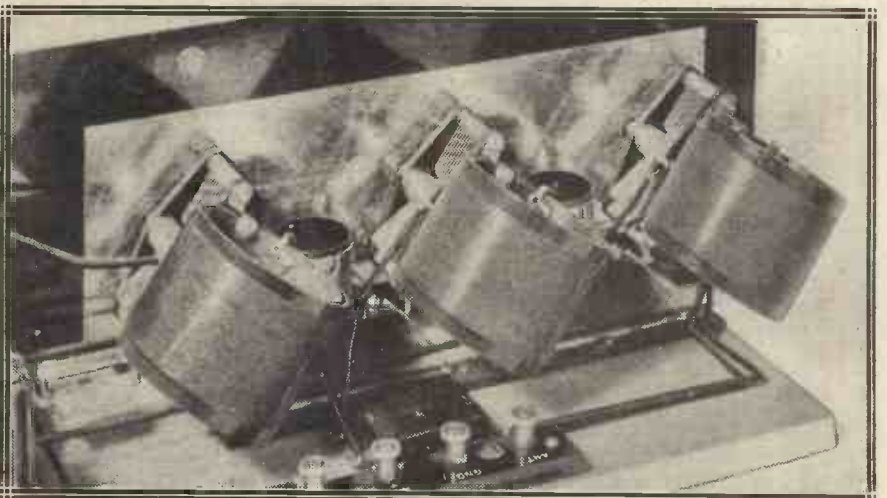

Three coils mounted at the angle prescribed by Prof. Hazeltine to reduce interaction.

The "As-You-Like-It" Crystal Set

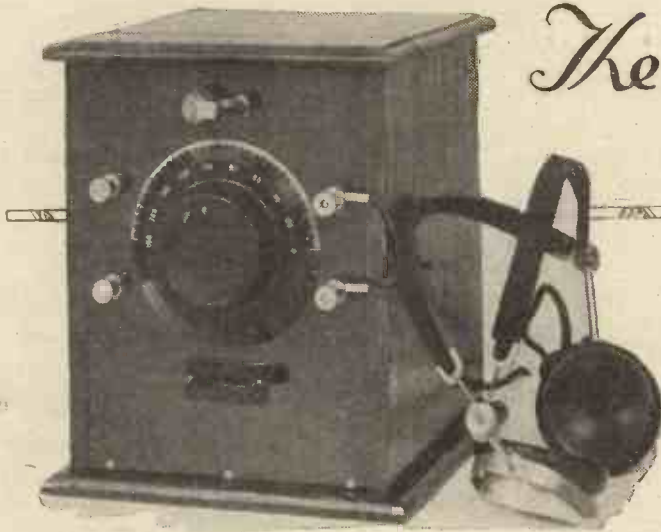

A novel and efficient change-over receiver for switching over to the local or to long-wave broadcasting.

By G. R. STANLEY.

THE title of "As-You-Like-It" was given to the little set illustrated for the simple reason that a variety of arrangements may be tried by the turning of a switch. For example, the set may be fitted with coils suitable for local station work and long-wave reception, when, by changing over from one to the other, either the local or Daventry station may be received. Or, again, comparative tests may be made of inductive and direct coupled circuits either upon the short wave-lengths between 250-600 metres, or the long waves.

The set as photographed is suitable

COMPONENTS AND MATERIALS NEEDED

- Ebonite panel, 6 in. × 8 in. × $\frac{3}{8}$ in.
- Cabinet, and baseboard 6 in. × 6 $\frac{3}{4}$ in. × $\frac{3}{8}$ in.
- .0005 S.L.F. condenser.
- "Polar" Crystal Detector.
- Nine-point "Utility" Switch (Wilkins and Wright).
- Coil socket for baseboard mounting.
- Six-point coil and base, as specified (Collinson Precision Lever Co., Ltd.).
- Four Terminals, connecting wire, etc.

for local station reception on the one hand, and long-wave work on the other, but by retaining the cylindrical coil and changing the plug-in coil for one numbered 35 or 50, the comparative efficiency of the cylindrical and plug-in coils on the same station may be tried. The cylindrical coil is so wound as to bring about an inductively coupled aerial circuit, with a crystal tapping arranged at the centre of the secondary winding, and coils of this type may be purchased for either short or long waves.

Readers will no doubt remember "The Span Space Three," designed by Mr. G. P. Kendall, and it will be remembered also that special coils

fell within the constructional requirements. One of these types of coil, namely, the aerial coil, is used in the set under discussion, and by glancing at the theoretical circuit the numbers of L_1 and L_2 will be recognised as corresponding with those of L_1 and L_2 in "The Span Space Three."

This coil is wound on the standard screened coil former, and consists of

a primary winding of 20 turns and a secondary of 90 turns, with a centre tap, both being of No. 34 D.S.C. wire. These coils are wound in single-layer formation, with a space of about $\frac{1}{8}$ in. between the end of one and the beginning of the other, both being in the same direction. The primary is connected to pin 2 (beginning of winding) and pin 5 (end), and the secondary to pin 1 (beginning) and pin 4 (end). The centre tap on the secondary is connected to pin 3.

Reverting once more to the circuit diagram, S is a nine-point "Utility"

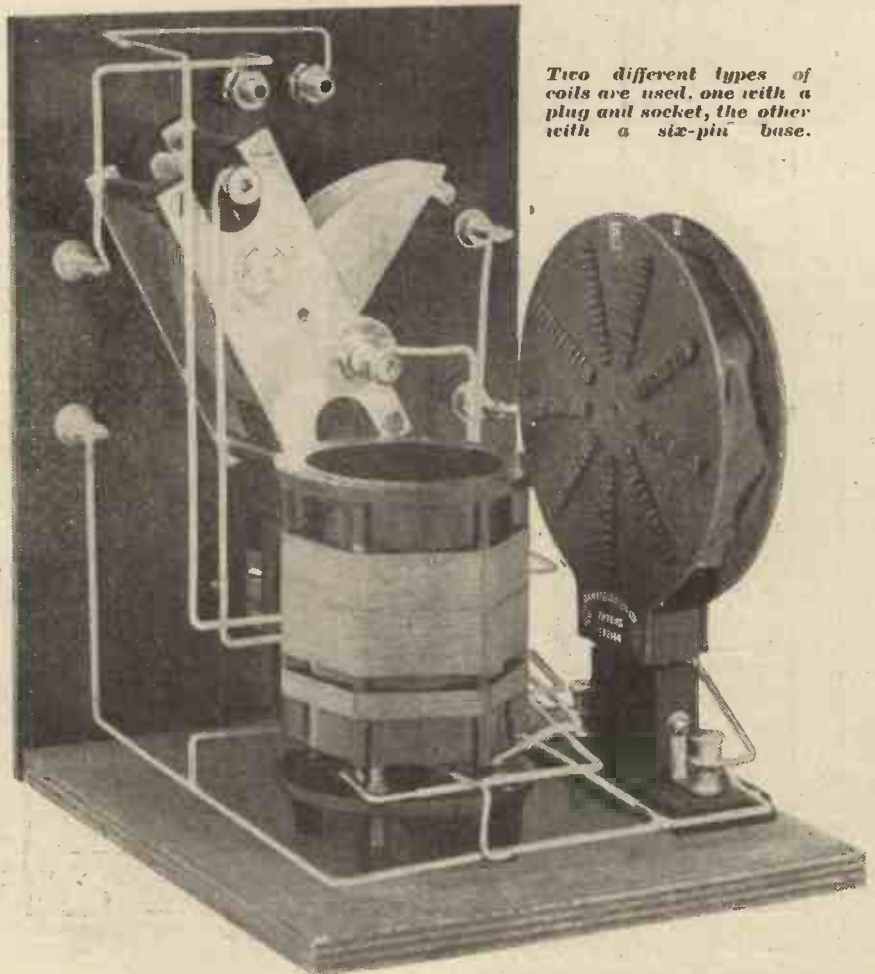

Two different types of coils are used, one with a plug and socket, the other with a six-pin base.

The "As-You-Like-It" Crystal Set —continued

switch which, upon moving the arm (not shown) allows of the centre contacts 1, 2, 3, being connected to either 4, 5, and 6, or 7, 8, and 9.

Imagining 4 and 1, 5 and 2, and 6 and 3 being connected as three pairs, an inductively coupled, crystal tapped circuit results, while a direct couple arrangement is given by connecting 7, 8, and 9 to 1, 2, and 3 respectively.

The Coils and Switch

L_1 and L_2 are shown with the numbers given to the pins to which they are connected; these pins being situate on the former upon which the coils are wound, the same numbers also appear upon the base, as shown in the practical wiring diagram.

It must be fully understood that though the coils L_1 and L_2 give a split secondary arrangement, they are quite distinctive from the type of split secondary coil associated with screened coils, the connections to these latter being entirely different, and useless for the arrangement here described. But suitable coils for use as L_1 and L_3 in the present set may be obtained ready wound for either long or short wave reception.

The third coil L_3 is a plug-in coil of ordinary type, and for the reception of 5 XX should be either a No. 150 or 200 according to individual aerials, and for the shorter wave-lengths it should be either a No. 35 or 50, the size again being dependent upon the aerial.

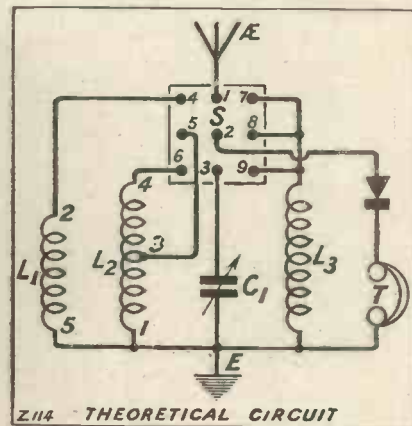

As to components required, these are given in a separate list and have been chosen in such a way as to keep the initial outlay as low as possible without impairing overall efficiency. The "laying-out" of these components upon both panel and base-board will be best understood from the photographs and drawings while the wiring up will be found perfectly straightforward.

It will be noticed in the practical wiring diagram that the switch S is free from those numbers given in the theoretical circuit, and the reason for this is that since the actual switch does not bear any numbers, to add to the wiring diagram something which does not exist would complicate matters for the constructor. So long as the connections, as shown, are copied nothing further will be required.

Signal Strength Measurements

The connections to the coil base should also be followed with care, and, furthermore, this should be very carefully wired, as with the connections so near together it is a simple matter inadvertently to make two exposed wires touch, and so short-circuit a part or the whole of the coils.

The operation of the set is similar to any other crystal receiver, and, after adjusting the crystal detector, tuning is performed in the ordinary way. The switching arrangement is such that with the connections as given, moving the arm (seen in the photographs) to the right gives the inductively coupled circuit utilising the coils L_1 and L_2 , while moving it to the left brings about a direct coupling by way of L_3 .

The effective results of these two forms of coupling will be found to be somewhat interesting and to the

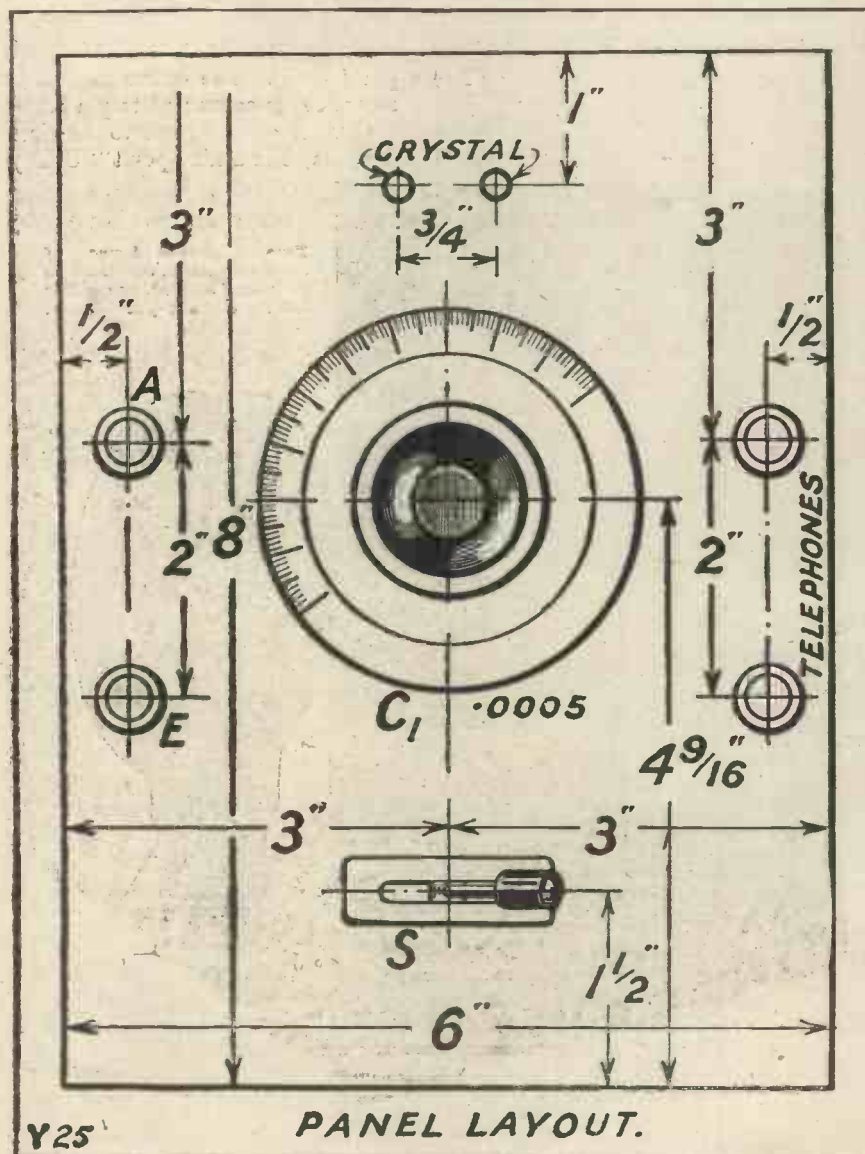

The "As-You-Like-It" Crystal Set—concluded

more advanced reader the following results of actual rectified current produced will prove enlightening.

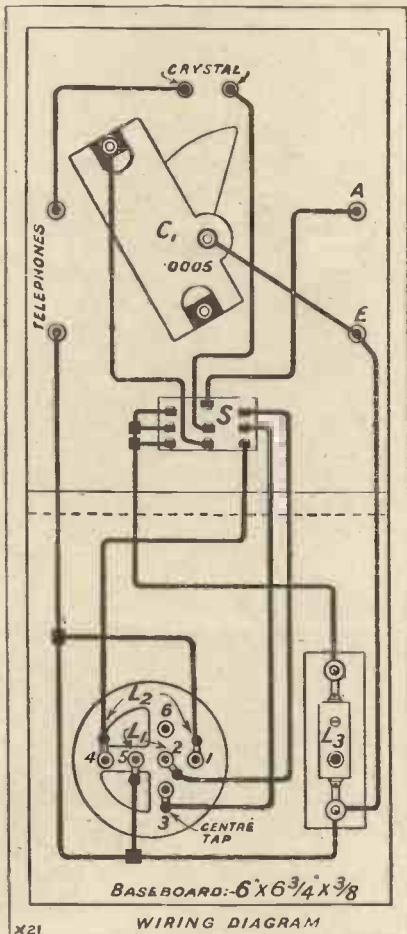

The set was connected to an aerial (other than my own) in south-east London, about 12 miles from 2 L O. The aerial was below the average as to size, and somewhat screened by trees, and in order to obtain some definite information as to possible signal strength with the circuit arrangements of the set, a microammeter was connected in series with the telephones. London was first tuned in, using the inductively coupled circuit and after finding the most sensitive spot on the crystal, the microammeter gave a reading of 35 microamps. Without in any way upsetting the adjustment of the crystal the circuit was changed for a direct coupled one, when London was again tuned in, a reading of 31 microamps being obtained.

An Interesting Comparison

In case the crystal adjustment may have been disturbed in the process

of changing over, the operation was repeated, using direct coupling first and inductive coupling second, but even then the readings were as before, indicating that in the circumstances inductive coupling gave the better results, though a difference of 4 microamps would not be noticeable in the 'phones. The reception of Daventry in the south-east London district is at all times difficult where a crystal set is concerned—on my own aerial 5 XX is not even audible on a single-valve set—but notwithstanding this fact, the coils were changed and at about 11.30 p.m., when signals would be about their loudest, the microammeter was connected in circuit. Direct coupling was chosen for the first reading, and after a very patient adjustment of the crystal detector, 11 microamps were obtained, whereas with the inductively

coupled arrangement a reading of 17 microamps was produced.

A good make of plug-in coil was chosen for the experiments, the same make being used throughout, and though possibly the differences between the readings given above would be hardly audible in a pair of telephones, the increased rectified currents certainly shows the value of a change-over circuit.

For Different Conditions

This difference between results given by different methods of coupling might prove of importance where the receiver is to be used at considerable distances from the local station and from 5 XX; and possibly one switch position will be preferable for one of these stations, and the opposite position for the other, the receiver thus giving maximum results from both stations.

POINT-TO-POINT CONNECTIONS

Join A to top centre contact of S; middle centre contact of S to crystal; bottom centre contact of S to fixed vanes of C₁.

Join left-hand top, middle and bottom contacts of S to one side L₃; other side L₃ to E, moving vanes of C₁. 5 of L₁, 1 of L₂ and lower telephone terminal. Remaining telephone terminal to cat's-whisker.

Join top right contact of S to 2 of L₁; centre right contact of S to 3 centre tap; bottom right contact of S to 4 of L₂.

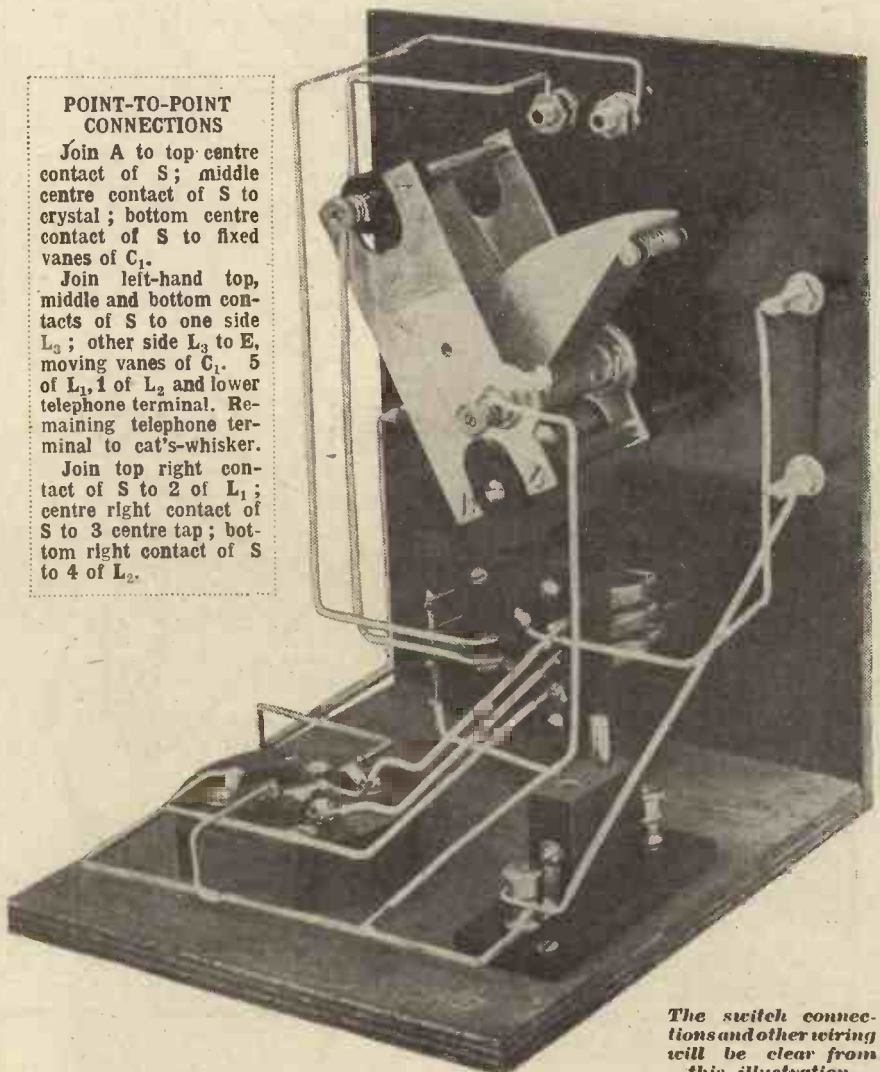

The switch connections and other wiring will be clear from this illustration.

THAT GRAND AND GLORIOUS FEELING!

WHEN A GOOD MANY HOURS
OF PATIENT TOIL ARE
REWARDED WITH EVIDENCE
THAT YOUR NEW SET —
- DELIVERS THE GOODS!



GEN SHAW

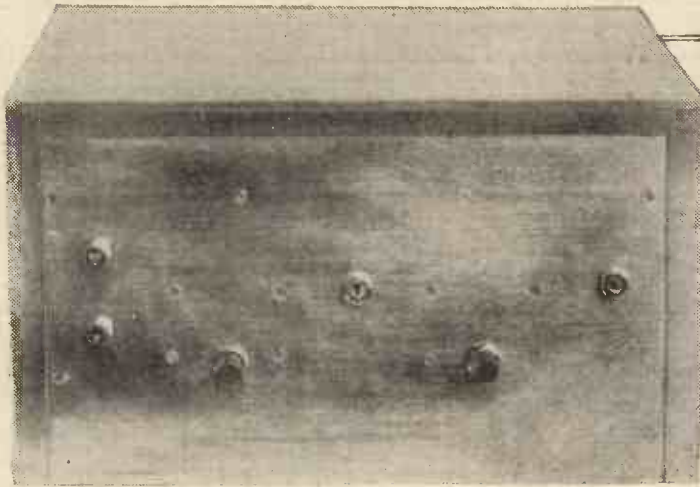

The NOTE MAGNIPLEX

This two valve instrument, which is virtually six L.F. amplifiers in one, can be used with any receiving circuit. Six different degrees of amplification are obtainable at will.

By R. W. HALLOWS, M.A.

To the experimenter it is an enormous advantage to have on the bench a good L.F. amplifier which can be used with any kind of valve receiver. In his preliminary hook-ups, he need then incorporate only H.F. and rectifying stages; having got so far all that he has to do is to deliver the output to the note-magnifier in order to obtain the necessary volume of sound.

The note-magnifier as a separate unit is not, however, of any great use, unless it is exceedingly flexible, allowing great variations in the degree of amplification to be obtained at will. In some cases only a small amount of magnification is required; in others, more is needed and in others again it must be very big indeed. One could possibly approach this desirable state of affairs by making an amplifier containing three transformer-coupled valves so arranged that one, two, or three of them could be used at will. There are, however, serious objections to the use of such a system. To begin with, three valves are needed, and only three degrees of magnification are possible.

Resistance or Choke Coupling

It is, again, very difficult indeed to obtain stability where more than two transformers are used and in any case two transformers can give all that normal valves can handle. It is also desirable for reception of really good quality of the local station's transmissions that either the resistance-capacity or the choke-capacity method of coupling should be used on the L.F. side. With either of these all magnification must be done within the valve itself, since no voltage step-up is obtained in the coupling. If we have a means of changing over at will from a transformer to either of these couplings a solution of the

problem is in sight, for two different degrees of amplification are obtainable from each stage. With the resistance-capacity or choke-capacity circuit in use the valve has to undertake the amplification unaided; when a change is made to the transformer it is assisted by the step-up given by the turns ratio between primary and secondary windings.

Switching Complications

There is one rather great disadvantage about the use of resistance-capacity coupling in such an amplifier. Owing to the high resistance in the plate circuit when this coupling is in use a considerably greater H.T. voltage is required than with the transformer. The switching arrange-

ments would therefore have to incorporate a means of altering the H.T. voltage, if not also the grid-biasing potential. Not only does switching

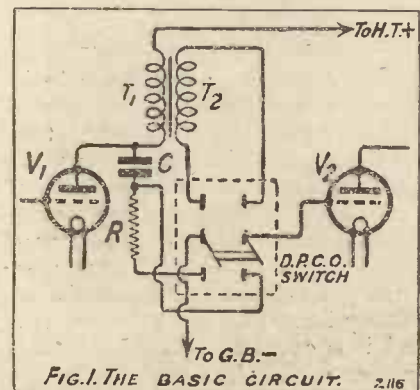

become a very complicated business, but each stage must include both a transformer and a resistance capacity unit.

Matters are simplified when choke,



The complete amplifier with grid bias battery and valves in position, ready for housing in its cabinet.

The Note-Magniplex—continued

capacity coupling is adopted as an alternative to the transformer. Provided that the resistance of the windings of the L.F. choke is of the same order as those of the transformer primary, there is no need to make any change in battery voltages. But why should we not go a step further and do away altogether with the need for a separate choke? After all, the primary of the inter-valve transformer is a choke, and if its inductance value is sufficiently high, it will give excellent results when used as a choke for reactance capacity coupling.

The Basic Circuit

Fig. 1, in which is seen the basic circuit of the Note-Magniplex, shows a simple means of obtaining two different degrees of amplification from a single transformer coupling. When the D.P.C.O. switch is turned downwards the secondary of the transformer (T_2) is cut out. V_1 has now in its plate circuit a choke consisting of the primary (T_1) of the transformer, and it is coupled to V_2 through the condenser C . The grid of V_2 is connected to the grid-leak R , which in its turn is connected to the negative of the grid battery. On turning the switch over to the upward position the grid-leak and grid condenser are cut out, the grid of V_2 being now connected to grid battery negative via the secondary windings of the

circuit it becomes (neglecting losses) that due to the amplification factor of V_1 multiplied by the step-up ratio of the transformer. Thus if V_1 produces an actual amplification of 5 and the turns-ratio of the transformer

and it is necessary that its plate circuit impedance should be of a high order. For this reason it is undesirable to use a transformer with a big step-up ratio, for since the number of turns in the secondary is

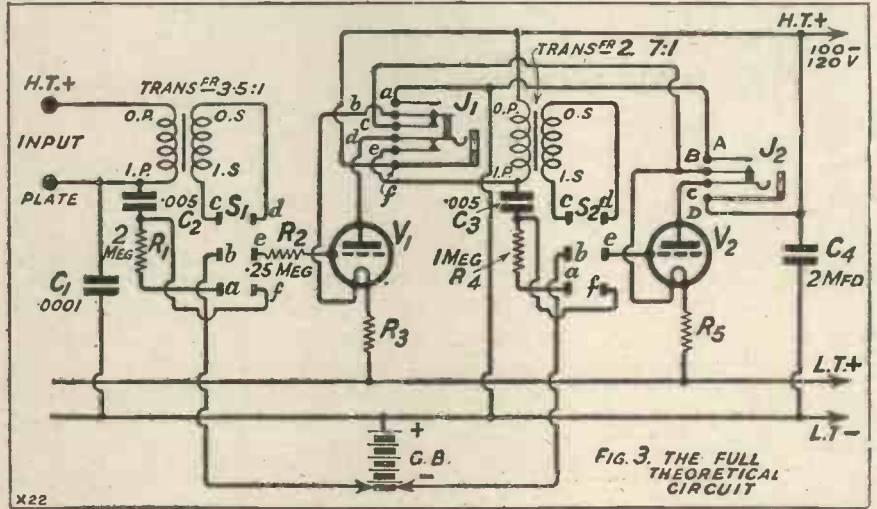

is 3, the magnification of the voltages reaching the grid of V_2 is 5 with the switch in the downward position, and 15 when it is turned upwards.

The Jack Arrangement

Fig. 2 shows in simplified form how the circuit can be developed and applied to a two-valve amplifier. By means of jacks either one or both note-magnifying valves, each of which

definitely limited by several important factors, it follows that a high ratio can be obtained only by reducing the number of turns in the primary; this means reducing its inductance and therefore its impedance at a given frequency. Since the first L.F. valve is one of the power type with a comparatively low impedance, a transformer with a big step-up ratio can be used to couple it to the second, and a high degree of amplification is thus obtainable when both valves are in use. The fact that both these valves are of the power type is one of the most important of the strong points of the Note-Magniplex.

Power Valves Advised

For good loud speaker reception it is essential that the input to the instrument should be from a power valve, since those of the "first L.F." or "high magnification" types cannot deal with grid swings big enough to produce the desired volume of sound without distortion. The Note-Magniplex is not designed to give enormously loud reproduction of the local station's transmissions, though this may be obtained if arrangements are made for using a super-power valve in the last holder. It is designed to give a volume of sound that is just comfortably within the capabilities of the ordinary power valve, from either the local station

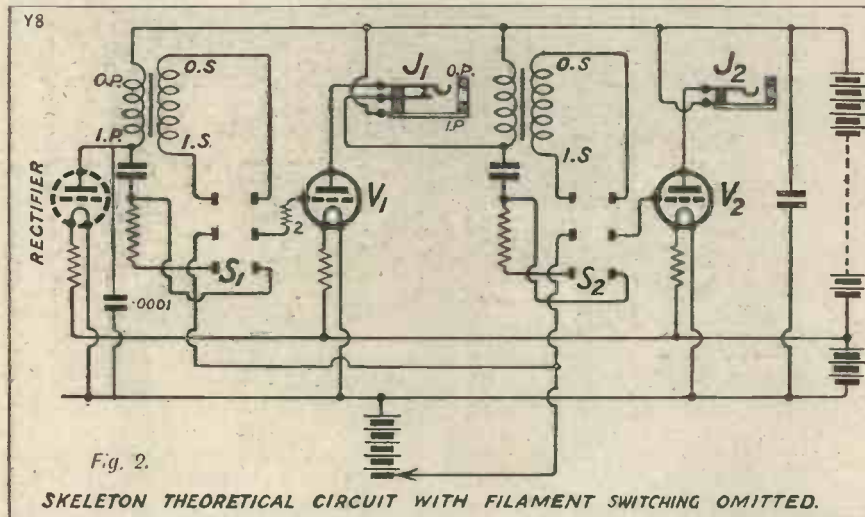

transformer. Thus in the first position of the switch the magnification obtainable in the voltage swings reaching V_2 is that due solely to the amplification factor of V_1 . When the transformer secondary is thrown into

is of the power type, can be used at will. The first transformer, which couples the amplifier to the rectifier, has a comparatively low step-up ratio; the rectifier will usually be a valve of the medium impedance class,

The Note-Magniplex—continued

or from a distant station. In other words, the volume can always be worked up to power-valve limits, and the same signal strength can be

and the step-up ratios at the figures already indicated, the magnification theoretically obtainable is as under :

- A. 6
- B. $3.5 \times 6 = 21$
- C. $6 \times 6 = 36$
- D. $3.5 \times 6 \times 6 = 126$
- E. $6 \times 7 \times 6 = 252$
- F. $3.5 \times 6 \times 7 \times 6 = 882$

The amplifications obtained in actual working, though high, are somewhat less.

It is exceedingly interesting when using the amplifier to notice the effect of making the various changes. With the plug in the first jack, and with S_1 in the "in" position, a signal of bare telephone strength is tuned in. Pulling out S_1 brings it to respectable loudness. The plug is now removed from J_1 and placed in J_2 , both switches being in the "in" position. A distinct strengthening of the signal is again noticeable. Next S_1 is pulled out; the signal is now probably audible at small volume on the loud speaker. By pushing in S_1 and pulling out S_2 it is brought up to moderate loud speaker strength, and when both

are working comfortably within their limits.

Good Transformers Essential

For the local station either one choke or both are generally used, and owing to the very high primary inductance of the transformers employed, extraordinary pure reception is thus obtained.

To make the Note-Magniplex a success it is essential that large and heavy transformers containing plenty of wire should be used. Those seen in the photographs are Igranic Super-audioformers of the latest pattern. These weigh between three and four pounds apiece. The primary inductance of the 3.5 to 1 model is 75 henries, and that of the 7 to 1 model 20 henries. That they contain a considerable amount of wire is shown by the fact that the D.C. resistance of the secondary winding is of the order of 22,000 ohms.

It is quite possible that there are other makes of transformers that would give quite good results in the Note-Magniplex, though if the reader decides to make use of such he must

LIST OF COMPONENTS.

Panel 12 in. \times 7 in. (this may be of $\frac{1}{2}$ inch mahogany, provided that the input terminals are mounted in panel bushes. The only other "live" parts in contact with the panel are the frames of the jacks, both of which are at the same potential).

Baseboard 12 in. \times 10 in. -

2 valve holders (Wearite).

2 push-pull D.P.C.O. switches (Wearite).

1 double filament and 1 single filament jack (Edison Bell).

2 6-ohm. filament resistors (Igranic "Pre-set").

Grid leaks of 2 megohms, 1 megohm, and .25 megohm (Marconi).

2 clip-in fixed condensers .005 mfd. (McMichael).

1 fixed condenser .0001 mfd. (Edison Bell).

1 2-mfd. fixed condenser (T.C.C.).

1 pair grid battery clips (Bulgin).

1 3 $\frac{1}{2}$:1 and 1 7:1 L.F. transformer (Igranic Super-audioformers).

2 Belling-Lee indicating terminals ("H.T. plus" and "P").

Glazite for wiring.

obtained from distant stations as from the local one.

Amplifications Available

The full circuit is seen in Fig. 3. The two switches, S_1 and S_2 , which are of the neat push-pull type, perform the function indicated in Fig. 1, choke capacity coupling being brought into use in both cases when the switch is in the "in" position. The first jack is of the double-filament and the second of the single-filament pattern. If the loud speaker plug is placed in J_1 , the filament of V_1 lights up, and the path from H.T. positive to the plate of the valve is through the windings of the loud speaker, V_2 being cut out altogether. When the plug is withdrawn from J_1 connection from the plate of V_1 to the inter-valve coupling is made, and when it is inserted into J_2 both valves light up and are brought into action. Both V_1 and V_2 are valves of the small power class, which may be taken as giving an average amplification of about 6. The first transformer has a ratio of 3.5 to 1, and the second 7 to 1. The following combinations, which are shown on the table on the following page, are illustrated diagrammatically in Fig. 4.

Taking the valve amplifications

switches are out the volume of sound is usually as big as could be desired. Owing to the extreme flexibility of the amplifier signal volume can be so adjusted upon any transmission that neither the last valve nor the loud speaker are overloaded, but both

realise that alterations in the lay-out may be necessary, for an amplifier giving a very high degree of magnification is always apt to be unstable unless the arrangement of both the components and the wiring is such that interaction effects are minimised.

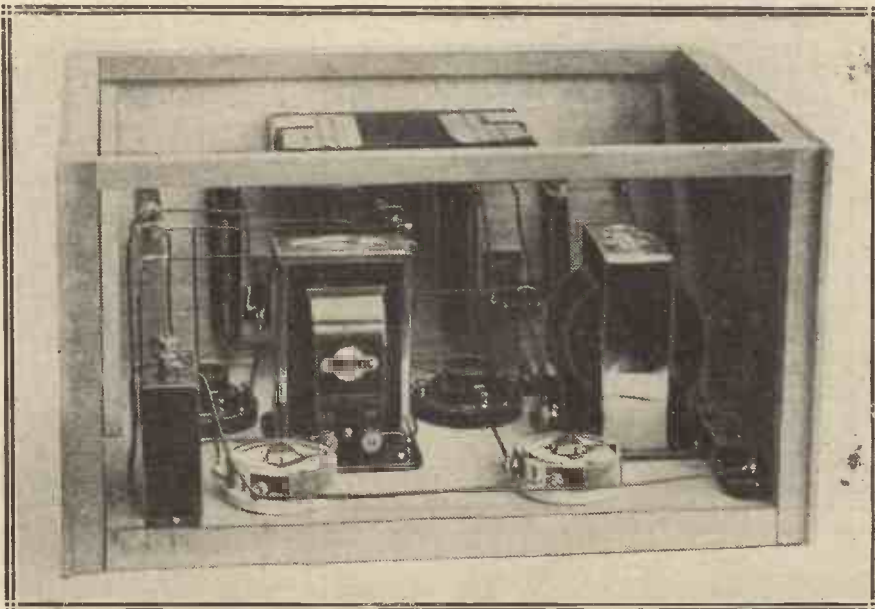

The Magniplex with the components wired up and the case ready for the fixing of the top and back.

The Note-Magniplex—continued

The lay-out and the choice of the components used in the Note-Magniplex are the results of a great deal of experimental work; the reader is advised to adhere strictly to them, for if he does so he will be sure to obtain good results with a minimum of trouble.

Constructional Details

The cabinet seen in the photograph was home made at a cost of rather less than eight shillings. A complete set of the mahogany pieces required to construct it can be obtained from Messrs. Hobbies, Ltd., for 6s. 6d.

The drilling lay-out of the panel is shown in Fig. 5. The grid leaks R_1 and R_2 , the condensers C_2 and C_3 , and the grid battery are mounted at the back of the panel, as shown in the wiring diagram seen in Fig. 6. The

holes needed for the screws fixing these components to the panel are not shown in the lay-out, since the spacing will differ according to the holders used

spaced $4\frac{1}{4}$ inches apart; that is $2\frac{3}{8}$ inches on either side of the vertical centre line of the panel, and $1\frac{1}{8}$ inch below the top of the panel.

	Plug	S ₁	S ₂	COMBINATION
A.	J ₁	In	—	One valve, choke-coupled.
B.	J ₁	Out	—	One transformer and one valve.
C.	J ₂	In	In	Two valves, choke-coupled.
D.	J ₂	Out	In	Two valves with one 3.5: one transformer and one choke coupling.
E.	J ₂	In	Out	Two valves with one choke and one 7:1 transformer coupling.
F.	J ₂	Out	Out	Two valves with 3.5:1 and 7:1 transformer couplings.

for the condensers and resistances and the type of grid battery adopted.

The grid battery seen in the photographs is the Ever-ready 9-volt, and for this the holes for the screws are

Having drilled the panel and fixed it to the baseboard we are ready to begin the work of construction. This is quite easy so long as it is carried out in the way indicated on next page:

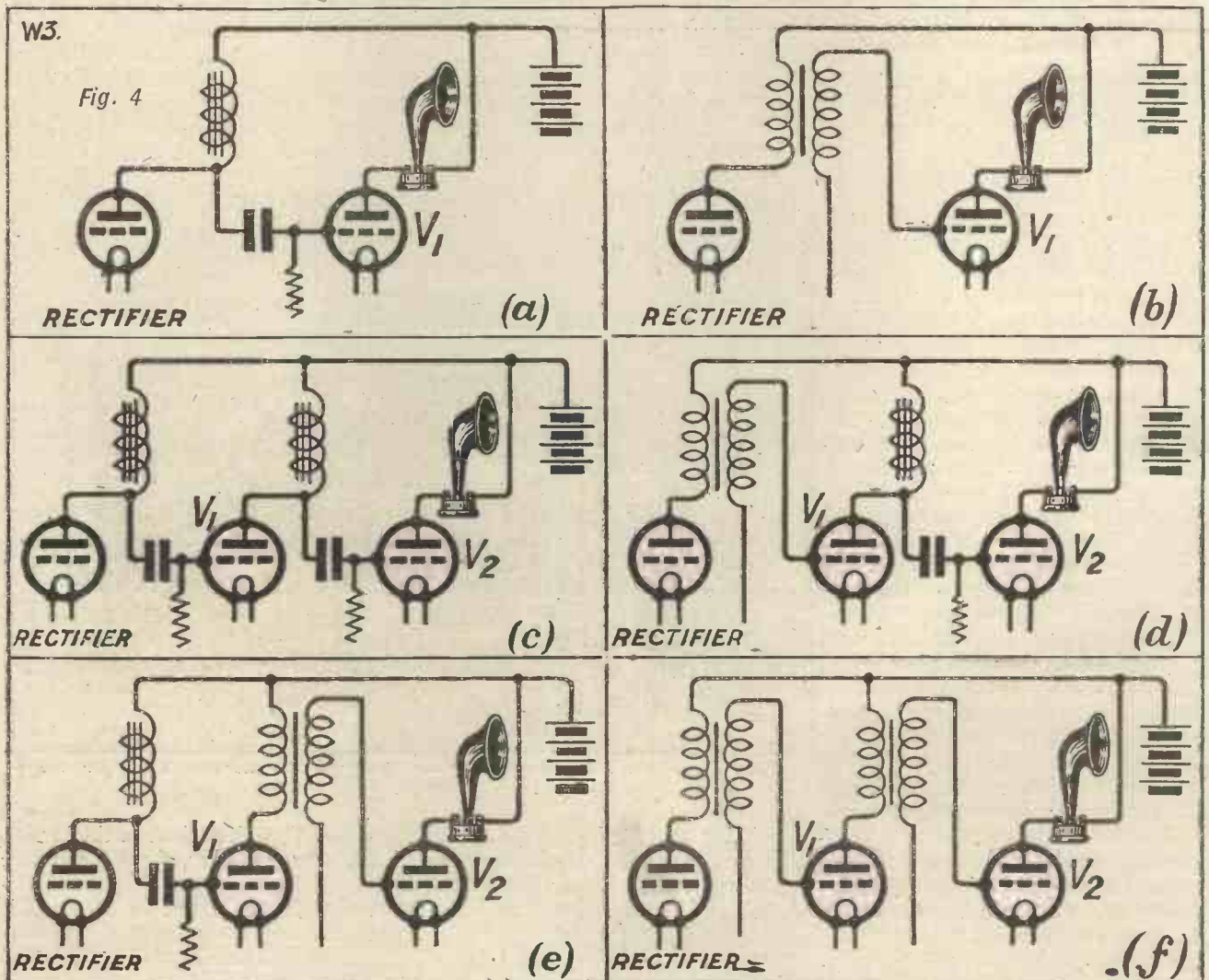

The Note-Magniplex—continued

STEP 1.—Mount terminals and R1, C2, S1, J1, C3, R4, S2 on panel. Connect "plate" terminal to C2a, C2b to R1a, C2b to S1f, R1b to S1a, C3a to J1e, C3b to R4a, C3b to

A certain amount of soldering is unfortunately unavoidable since, so far as I know, no manufacturer has yet evolved jacks provided with terminals. Those, however, who dislike

point the best method is that illustrated semi-diagrammatically in Fig. 8. When the first wire that has to be soldered is being fixed, an inch or rather more is bared and a connection is made to the jack point about half an inch from the end. It is then quite easy to make soldered connections by means of butt joints to the bare portions of the wire lying on either side of the jack point.

Preliminary Tests

It will be noticed that in the wiring of the amplifier no H.T.— connection is shown. Since the Note-Magniplex is intended to be used with a valve set it is presumed that a connection between H.T.— and either L.T.+ or L.T.— will exist within the set, and a further connection within the amplifier is thus unnecessary. It is in fact a distinct advantage not to have such a connection since its absence means that the amplifier can be used without alteration with any kind of valve set, it being a matter of no importance how H.T.— is connected in the latter.

Having completed the wiring, make your preliminary tests by connecting an accumulator to the L.T. leads of the amplifier and placing in the holders either valves whose filaments give a visible glow or flashlamp testers. Insert the plug into each jack in turn to see that the valves light up

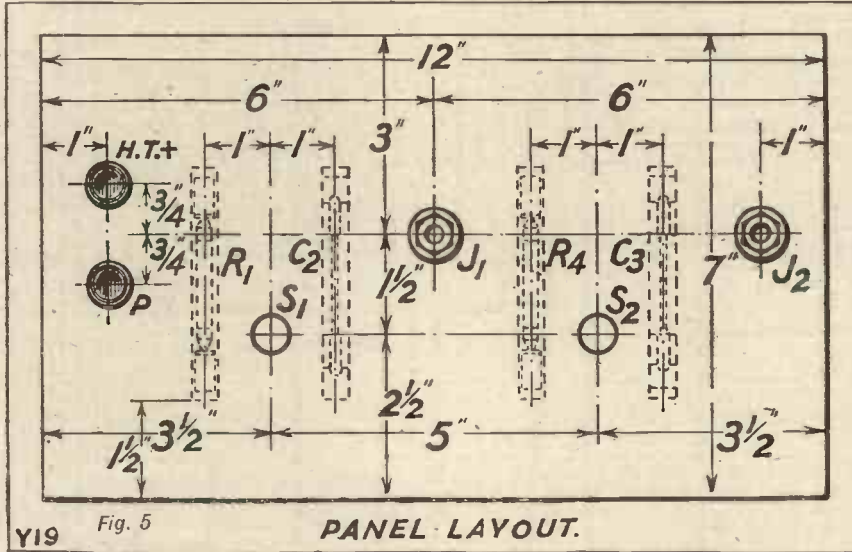

Y19 Fig. 5

PANEL LAYOUT.

S2f, R4b to S2a. To C3a fix a lead about 8 inches in length; this will be connected later to transformer 2 IP.

STEP 2.—Mount the valve holders, the resistors (R3 and R5) and R2 on the baseboard.

Connect V1g to R2a. R2b to S1c, V2g to S2e; to S1c a lead 6 inches long (for transf. 1 IS), to S1d a lead 4 inches long (for transf. 1 OS), to S2c a lead 4 inches long (for transf. 2 IS), to S2d a lead 4 inches long (for transf. 2 OS). S1b to S2b.

STEP 3.—Connect J1f to J2d, J1d to V1p. J1c to J2b, J2b to V2F—, J1b to V1F—, J2c to V2p, J1a to J2a.

STEP 4.—Mount the grid battery.

Connect J1a to GB+, S1b to GB—.

STEP 5.—Mount transf. 1, transf. 2, C1 and C4.

Connect "plate" terminal to transf. 1 IP, H.T.+ terminal to transf. 1 OP, transf. 1 IP to C1a, C1b to C4a, C4a to J2a, C4b to J2d, S1c to transf. 1 IS, S1d to transf. 1 OS, S2c to transf. 2 IS, S2d to transf. 2 OS, C3a to transf. 2 IP, C4b to transf. 2 OP, R3a to R5a, R3b to V1f+, R5b to V2f+.

STEP 6.—Connect a flex lead to C4b for H.T.+ connection; a flex lead to C1b for L.T.— connection; a flex lead to R3a for L.T.+ connection.

soldering or who like to have as few soldered joints as possible in their wireless apparatus, can obtain, by ordering them specially from Messrs. Wright and Weaire, push-pull switches fitted with terminals instead of soldering contacts.

Where in the wiring scheme two or more connections are shown to a jack

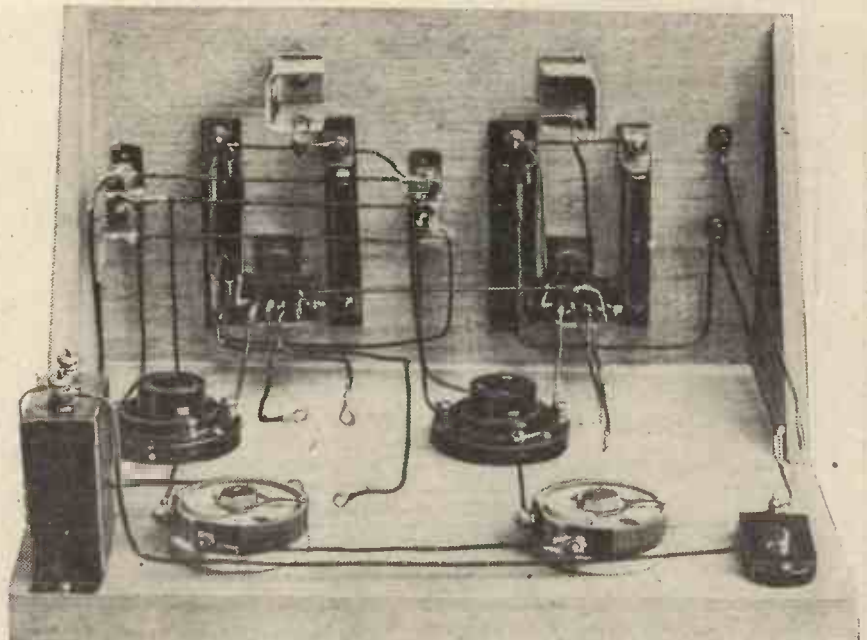

A photograph taken with the transformers removed to show the connections to the switches.

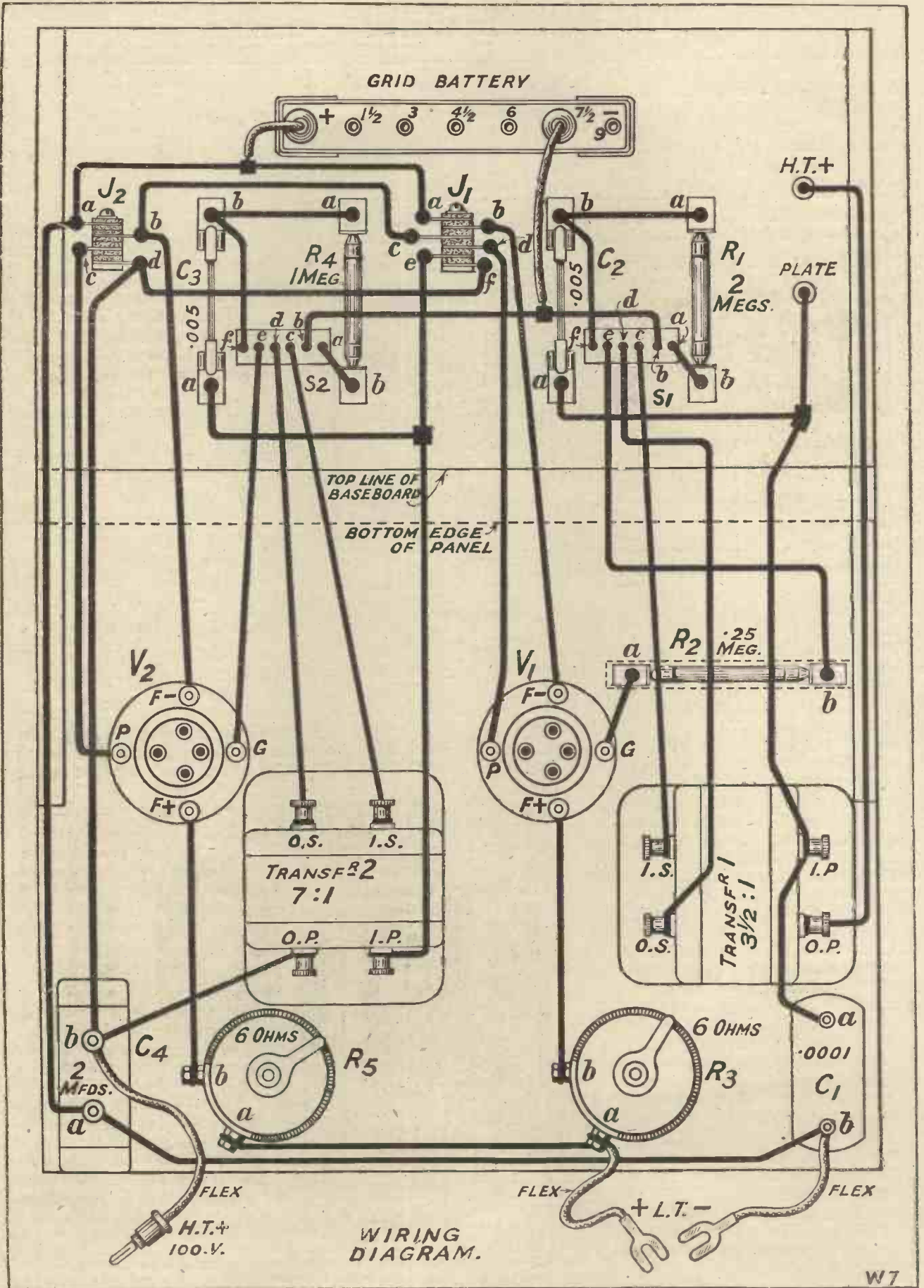

The Note-Magniplex—continued

properly. Next connect the negative terminal of a small H.T. battery to the positive or negative of the L.T. battery according to your preference and take the H.T.+ lead of the amplifier to the positive of the H.T. battery. If all is well the valves will light up as they should when the plug is inserted into the jacks, and clicks will be heard in the telephones

have tried the amplifier, though it might possibly be required for short-wave work. If the addition of this capacity does not suffice, a 25 megohm resistance may be wired between the grid of V_2 and the point of S_2 , a second twisted wire condenser being used between the grid terminal of V_2 and 1S of the second transformer if required. I must say, though, that I have never found the slightest tendency to instability in the amplifier even when it was being called upon to bring very weak signals up to respectable strength.

For the home-made cabinet the following wood parts are required :

- 1 piece of $\frac{3}{8}$ in. mahogany $13\frac{3}{4}$ in. \times $10\frac{1}{2}$ in. for top.
- 2 pieces of $\frac{3}{8}$ in. mahogany $7\frac{1}{2}$ \times $10\frac{1}{2}$ in. for sides.
- 1 piece of $\frac{1}{4}$ in. white wood or plywood $13 \times 7\frac{1}{2}$ in. for back.

The frame is made of $\frac{1}{2}$ -inch square strip-wood of which the following lengths are needed :

- 4 pieces 12 inches long.
- 4 pieces $9\frac{1}{4}$ inches long.
- 4 pieces $7\frac{1}{2}$ inches long.

strip-wood by means of a few small screws. This having been done, attach the side frames to the instrument by means of screws driven into the edge of the baseboard and into the wooden

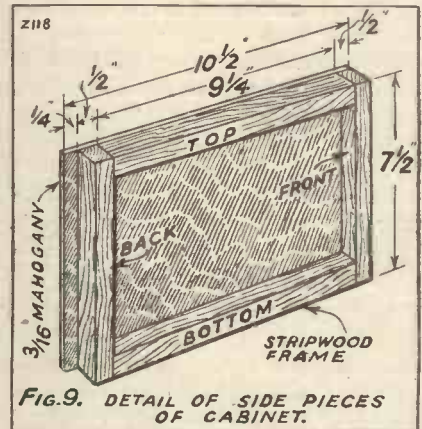
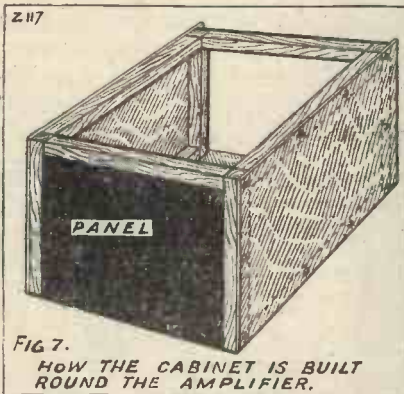

panel supports. The front edges of the side frames must be exactly flush with the panel. Lay one of the 12-inch lengths on top of the panel and fix it to the side frames by means of a single fine $1\frac{1}{2}$ -inch screw driven in at each end. A second 12-inch length is placed between the tops of the strip-wood uprights at the rear of the panel in the same way. To the underside of the cover attach by means of
(Concluded on page 71.)

or the loud speaker as this is done. The amplifier may now be connected to the receiving set and tested.

The Cabinet Construction

It is, by the way, most important that the L.T. battery of any set used in conjunction with it should be earthed. Should any signs of instability be observed when a high degree of magnification is being applied to a weak signal by using both transformers, this can usually be overcome in the following simple way. Attach short pieces of insulated wire to the grid terminal of V_1 and 1S of the first transformer and twist

Fig. 7 shows how the cabinet is built up round the instrument. Begin by making the side frames, as shown in Fig. 9, fixing the mahogany to the

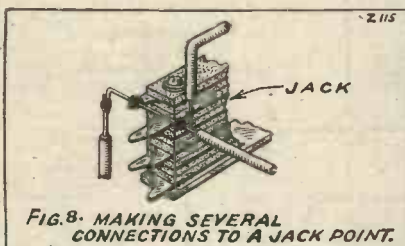

them together, taking care that the free ends do not come into contact with one another. This forms a small variable parallel capacity (the tighter you twist the greater will be the capacity), which should carry off any unwanted H.F.'s not stopped by the resistance of R_p . Actually, I have not found it necessary to use such a capacity with any set with which I

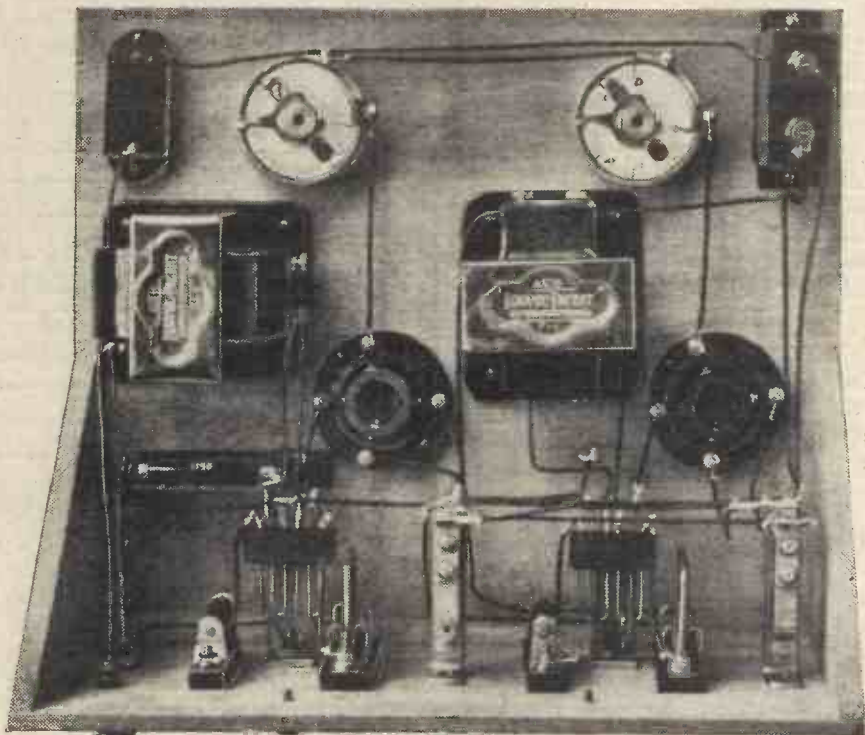

FAULTS IN JACKS

Some useful hints for the radio constructor.

WHEN you are fitting new jacks, or if you are using for a receiving set under construction old jacks which have seen a certain amount of service, it is always as well to make quite sure first of all that they are in thorough working order, for some rather puzzling faults may occur if they are not.

Take, for example, the single closed-circuit jack, shown in Fig. 1, which is frequently used to enable

contact with leaf E. When the plug is inserted there must be breaks between leaves B and C, and D and E, and contact must be made between leaf B and leaf A.

In Fig. 3 double- and single-filament jacks are seen in positions in which they are commonly employed. When both jacks are in order the insertion of the plug into J_1 switches on the filament of V_1 , the first note-magnifier, and connects the plate of this valve

not to examine it first of all. I was rather puzzled on trying out the set to find that when the plug was half-way into J_1 both the low-frequency valves lit up, though the filament of V_2 ceased to glow when it was pushed right home. A careful examination of the jack disclosed that leaf C was bent too far upwards, with the result that in a certain position of the plug leaf B was making contact with both leaf A and leaf C.

L.T. Current Wasted

Had the upward bend of this leaf been a little more pronounced, both V_1 and V_2 would have been switched on even when the plug was right home. Now, with glowless valves, the results of this might have remained

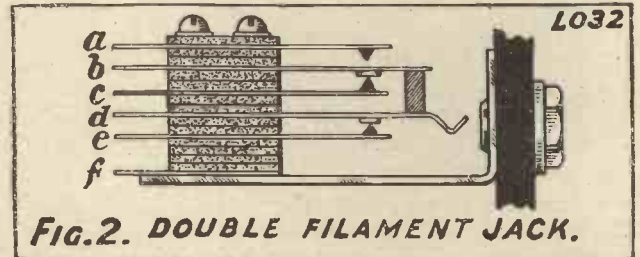
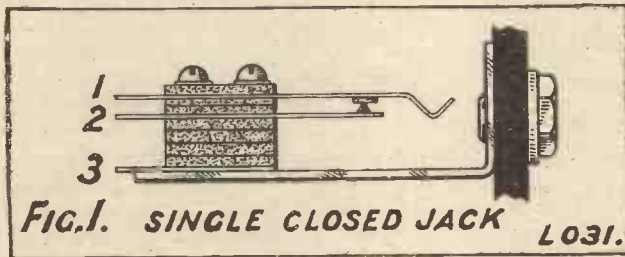

the last note-magnifier in a set to be cut out at will. The first fault that may arise is the failure of the points in leaves Nos. 1 and 2 to make proper contact owing to leaf No. 2 having become bent slightly downwards. Should there be a poor contact at this point the set will not work properly, if at all, when all the valves are in use, since the plate circuit of the last but one will be defective. The puzzling part of this fault is that the set will work as it should if the plug is pushed into this jack so that the last valve is not brought into use. You may, therefore, get loud signals on three valves, and none at all on four.

Further Faults

A different fault which may develop in jacks of the same kind is caused by leaf No. 2 having become bent so much upwards that it continues to make contact with No. 1 even when the plug is inserted. This may give rise to curious effects in a resistance-coupled amplifier if contacts Nos. 2 and 3 are taken to different tappings of the high-tension battery.

Similar faults may arise in other types of jack. In Fig. 2 a double-filament jack is shown. Here the points to examine are these. When the plug is not inserted leaf B must make contact with leaf C and no contact with leaf A. Leaf D must make

through the telephones to high-tension *plus*, cutting out the primary of the intervalve transformer. Similarly, if the plug is thrust into J_2 , both valves light up, the intervalve transformer is in circuit, and the output of V_2 passes through the telephones or loud speaker. When making up a set some time ago, I placed a new double-filament jack in the position of J_1 , being foolish enough

undetected for some time, with the result that as much as .25 ampere of current might have been flowing to no purpose through the filament of V_2 when this valve was out of use.

In J_2 the only fault that is liable to occur is an upward or downward bend of leaf No. 1. An upward bend may lead to there being no contact between leaves Nos. 1 & 2 when the plug is inserted. R.W.H.

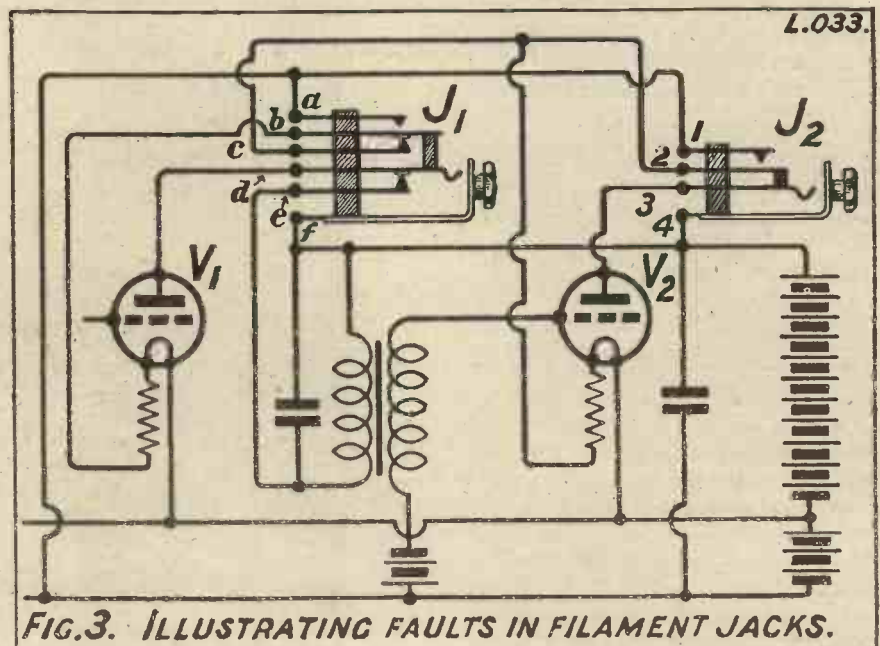



A CAREFUL classification of all the postcards sent in by readers in reply to my request that they should let me know which set they wanted "modernised," shows that the "All Concert-de-Luxe" tops the list, the votes for this set being much larger than for any other. For the benefit of those readers who are not

Full details are given in this article for modernising that famous receiver, the "All Concert de Luxe." By PERCY W. HARRIS, M.I.R.E. (Editor).

popular vertical panel, and was the first set to use the 16 in. by 8 in. size

holder, three valve windows (you must remember that this set was designed in the days of bright emitter valves), dual filament resistances for the three valves, and certain switching arrangements which require a little explanation. On the left of the panel was placed a "Utility" double-pole, double-throw switch for placing the aerial condenser in series or in parallel with the aerial tuning inductance, while a similar switch on the opposite side of the panel served to switch over from telephones to loud speaker.

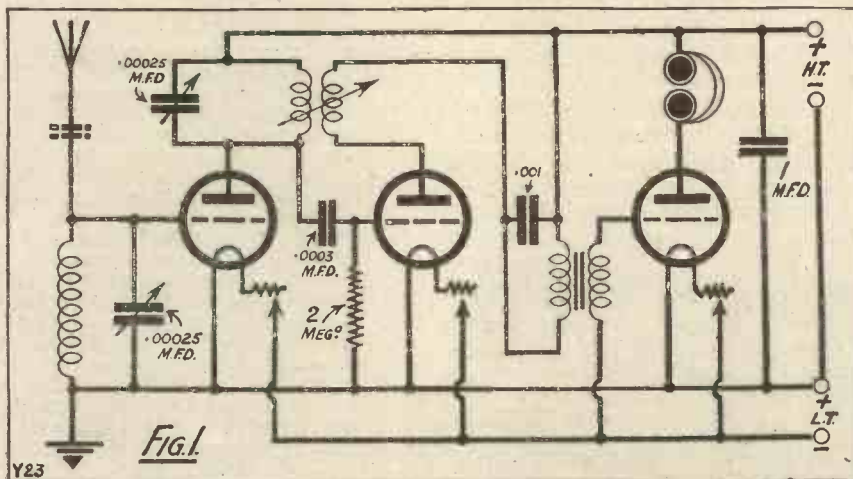

Appreciable Losses

The filament switch was of a double variety, one portion switching off the H.F. valve and the other the detector and L.F. valves. Stability was obtained by connecting the grid return of the H.F. valve to the positive end of the valve filament. The damping by grid current thus introduced served to "hold the set down." Although such a method introduced appreciable losses some of these could be subsequently compensated by reaction on the tuned anode coil.

acquainted with the set I should explain that the "All Concert-de-Luxe" was a modification and an improvement upon the original "All Concert" set which itself appeared in "Modern Wireless" three and a half years ago, and was subsequently reprinted in my book, "Twelve Tested Wireless Sets."

The Original Set

The "All Concert-de-Luxe" was published in one form only—as a Radio Press constructional envelope, and did not appear in any radio journal. The "Four Valve Family" set was also published only in "envelope form," and both of these are now out of print.

The "All Concert-de-Luxe" receiver was one of the first sets with the now

of panel, which has long since become standardised. The front panel carried two condenser dials, a two-coil

A front view of the modernised "All Concert de Luxe" which was one of the first receivers in which a vertical panel was employed.

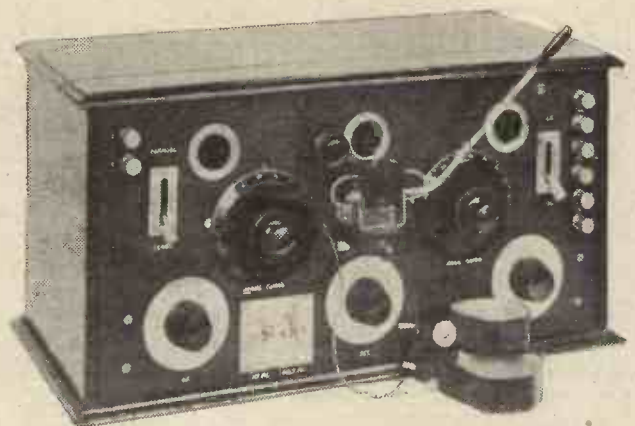

NEW LAMPS FOR OLD—continued

Inside the set, the valves, H.T. and L.T. terminals and the tuning coil, were carried on an ebonite bridge strip, together with the grid leak. The front of the panel carried aerial and earth

As this article is primarily to supply the needs of those readers who have already built the set successfully, there is no need to dwell upon the sensitivity of the set which was considered

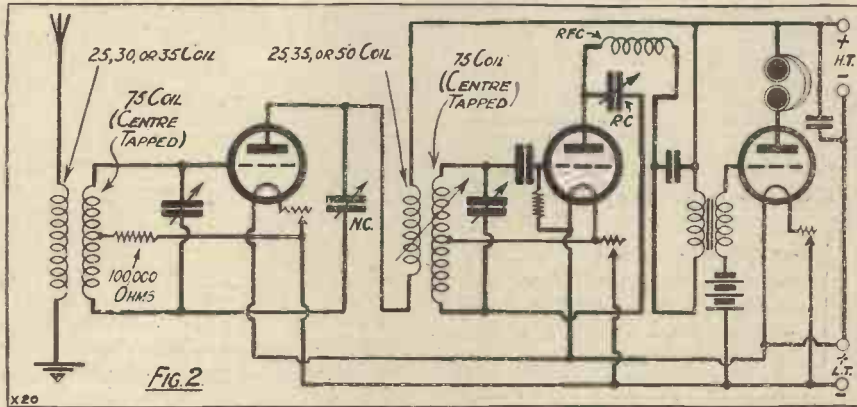

terminals on the left and on the right three pairs of terminals, two pairs being for telephones in parallel and the third for a loud speaker. The convenience of the switch to change over in a moment from telephones to the loud speaker, should signals be too strong for the former, was one of the most popular features in the set.

Other details in this receiver were of standard design and due to the fact that the modern power valve had not

very high for the number of valves employed. A simplified circuit omitting the switches is given in Fig. 1. Filament resistances were placed in the negative legs of the valves and not in the positive, as is the practice at the present time. A .001 mfd. condenser was placed across the transformer primary, reaction on to the tuned anode being obtained in the conventional manner. A Mansbridge condenser of 1 mfd., or so, was

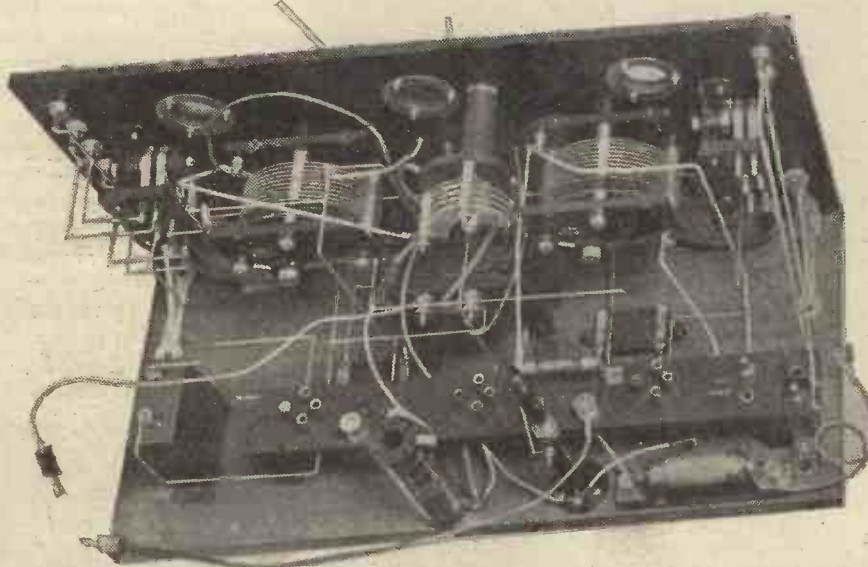

This back-of-panel view of the "All Concert de Luxe" shows how the new components are placed.

been introduced no separate grid bias was provided, as the drop of about two volts in the filament resistance when using 4-volt valves and a 6-volt accumulator, was generally considered sufficient for this purpose.

placed across the H.T. terminals.

The Tuning Condensers

It should be noticed that this receiver has two tuning condensers of .00025 mfd. (Many readers used

MODERNISING GUIDE.

Remove all wires connected to series-parallel switch, the first variable condenser and aerial and earth terminals.

Leave wire from coil socket to grid but remove wire from coil socket to L.T. positive.

Take new leads from aerial and earth terminals to the two terminals of the new coil socket.

Take a new lead from the wire joining the grid and coil socket to fixed plates of first variable condenser.

Make a flexible lead from one terminal of the 100,000 ohm resistance for the centre tap of the centre-tapped coil.

Take a wire from the other terminal of the 100,000 ohm resistance to L.T. negative.

Make a new lead from the old coil socket terminal, not yet connected, to moving plates of first variable condenser.

Take a lead from the top soldering lug of the neutralising condenser to the moving plates of the first variable condenser.

Remove lead from first plate socket to fixed condenser.

Disconnect the flexible lead running from the plate of the second valve to the moving coil, and connect the plate leg so freed to one terminal of the reaction condenser.

Remove flexible lead running from the fixed coil to the transformer lead.

Remove the wire going from the moving plates of the second variable condenser to H.T. positive.

Connect a new flexible wire from the moving plates of the second variable condenser to the fixed coil terminal, which was previously connected to the transformer lead.

Disconnect the lead going from the transformer to the moving coil, and join this terminal of the transformer to the top soldering lug of the radio frequency choke.

Take a lead from the bottom soldering lug of the radio frequency choke to the plate of the second valve. Take a lead from the plate of the first valve to one terminal of the moving coil.

Join another flexible lead from the remaining moving coil terminal to the positive H.T. lead (there is a convenient wire just behind the panel).

Remove the wire going from the IS terminal of the transformer to L.T. negative.

Take a flexible lead from IS of the transformer to a wander plug for grid bias negative.

Connect a flexible lead from the L.T. negative terminal to a grid bias positive plug.

Drill a small hole in the panel alongside the coil holder, between it and the dial of the first variable condenser.

Take a flexible lead from the centre tap of the fixed coil to the wire joining the centre rheostat to the filament leg of the second valve holder.

NEW LAMPS FOR OLD—continued

·0003 mfd.) The disadvantages of the set judged by modern standards are :

1. Relative inefficiency on the H.F. side.

a coupled aerial circuit neutralised by the Rice method, followed by H.F. transformer coupling and a combination of capacitive and

kinds and types of valves, and to vary the selectivity.

Any Valves Suitable.

This is a very useful arrangement, as it enables the reader to use any valves he already has in his possession and to obtain from them the highest efficiency. As the set now stands its efficiency has been very greatly increased, the selectivity sharpened up to a surprising extent, and a very smooth control of reaction obtained. A further advantage is that both dials now read approximately the same throughout the whole of their range. Even with the original ·00025 variable condensers, the tuning range is from 250 to 575 metres, and the need for the series-parallel switch is thus removed—in fact, this switch is now out of circuit altogether.

Additional Drilling

The exterior appearance of the set has been scarcely changed and the only difference the reader will notice is the provision of a small knob for reaction to the left of the centre valve window. A small hole has also been drilled to the left of the two-coil holder to take the additional flexible lead connected to a centre tapped point on the lower coil. Inside the set a few changes of wiring

(Continued on page 66.)

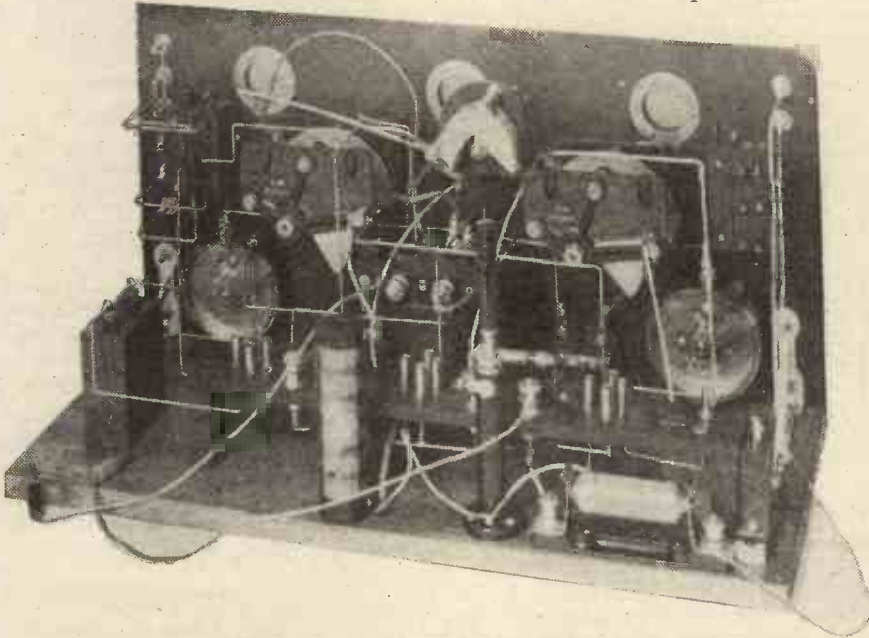

Back-of-panel view of the modernised "All Concert de Luxe."

2. Lack of selectivity.
3. Inability to use power valves with grid bias.

Preliminary Details

In attempting to modernise this receiver so as to bring it up to a higher standard of performance, there were several difficulties to be overcome. Firstly, the design of the set is compact, leaving very little room for the introduction of new parts; secondly, it was desired that the set should be brought up to date with a minimum of expense and with as few changes as possible in the wiring.

A number of circuits were considered and the simplest change would have been to neutralise the H.F. valve to obtain stability—this being a more efficient method than introducing losses by grid damping—and to react on the anode as before.

Method of Neutralizing

This was done, as readers of "Popular Wireless" may remember, in the modernising of the "Four-Valve Family" Receiver. Experiments showed that still better results could be obtained by changing the circuit quite radically, while using the same parts with the addition of one or two more components. The modernised "All Concert-de-Luxe" thus has

inductive reaction. The particular point of interest in this arrangement is that the two-coil holder is used to carry the primary and secondary of the transformer, which in this case are ordinary plug-in coils. The coupling between primary and secondary can be varied to suit different

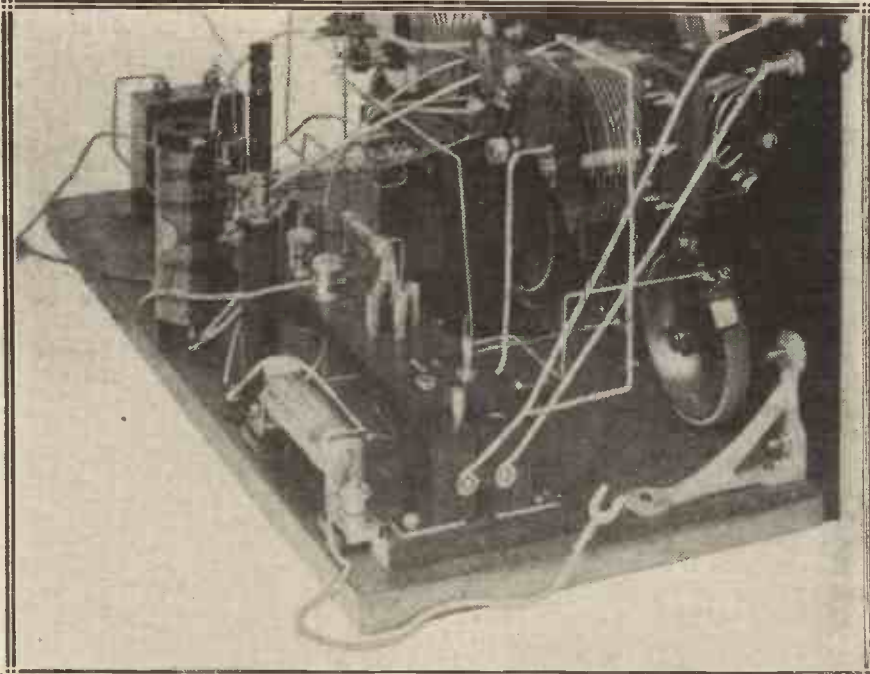

Showing the new coil socket for the aperiodic coupling.



The new B.T.H. high mag. valve recently placed on the market.

WITHIN THE VACUUM

The problem of transformer saturation—concerning new valves.

By KEITH D. ROGERS

(Assistant Technical Editor "Popular Wireless")



The B8, recommended by the makers to follow the B8 in R.C. circuits.

I HAVE recently received a number of letters from readers complaining that they are having distortion trouble with their sets, and as a great many cases point to unsuitable components, especially in connection with valves and the impedances in their anode circuits, I want to discuss a few of the points raised.

It appears that quite a number of constructors are using receivers where two transformer stages are employed, and though I must admit that very great volume can be obtained by this method, yet it should be realised that satisfactory results are possible only if suitable valves and transformers are employed.

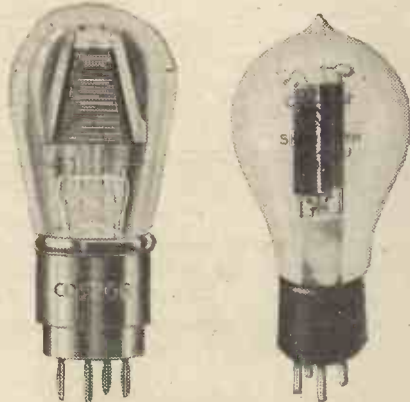

Left: showing the internal construction of the Cossor 610D, a useful L.F. valve. Right: The Cosmos double wave rectifier.

It is usually recognised that a good transformer is essential if the best results are to be obtained, but it is not often realised that even a good transformer may be quite unsuitable for use with certain valves.

Distorted Results

Let us take a case in point. A reader wrote to me saying that he was using two transformers of very well known make and "suitable for first or second stage amplification."

He was suffering from a peculiar distortion of the louder passages, especially the high notes. He was using power valves for both L.F. stages, and furthermore power valves with low impedances, and therefore taking quite an appreciable amount of anode current. Why then was he not obtaining the volume and clarity that the use of such valves made him expect?

Cause of Saturation

The answer is that he is causing his second transformer to become "saturated." This is a peculiar term and one not easily understood, but it can be briefly explained as follows:

In the primary of a transformer are a number of turns of more or less fine wire wound round an iron core. In order that the valve in the primary circuit shall have enough plate current the resistance of the wire in the transformer primary must not be too great. That's obvious, isn't it?

Furthermore, in order to obtain the required magnetic flux or field in the transformer there must be a large number of turns of wire and a suitable amount of iron core. If, however, the number of turns is too great or the core too small it will be found that the core will be "saturated" and will carry no more lines of force, and possibly the steady plate current of the valve will be insufficient as well, due to the D.C. resistance of the primary wire.

Now, if the plate current is such that the flux in the core is about as much as the core will carry and then this plate current is modulated, the changing of the flux will not be a faithful reproduction of the modulation owing to the "traffic jam," so to speak, in the iron core. Distortion is therefore bound to occur, especially in the louder passages.

To avoid the distortion the primary winding and the transformer design must either be such that the point of

saturation cannot be reached, or else we must use a valve of higher impedance and demanding less plate current to avoid the same ill effects.

In the case of the writer to whom I referred, the particular transformer he was using "saturated" at just under 4 milliamps and the valve he was using required 6 milliamps at least for satisfactory operation. Result—distortion due to the saturation of the transformer.

The Remedy

The cure for this is to grade the valves through the set so that the valve in the primary circuit of the second transformer can be one not needing more than 3 milliamps and to grid bias it so that it will carry the maximum grid voltage swing.

Unfortunately this may have the effect of cutting down the volume of reception, but this cannot be helped unless a different transformer is used—designed for second stage work and capable of dealing with more current.

(Continued on page 70.)

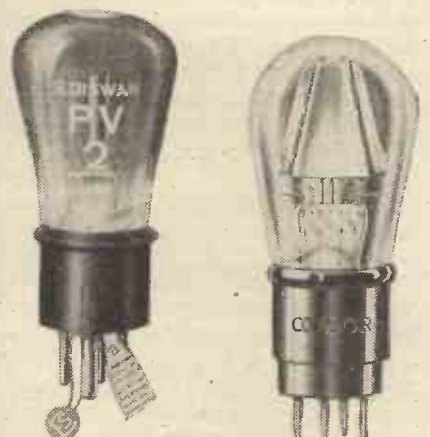

Two useful last stage valves. The Ediscan 2-volter, and the Cossor Sten-tor Four, which would be useful as a last stager following several stages of amplification.

The Selector Two.

A two valve receiver specially designed for DX broadcast reception on 'phones. For loud-speaker reproduction a one or two valve L.F. amplifier can easily be added.

By A. S. CLARK.



THE two-valve set, described in this article, has been designed for the man who desires a small set built on modern lines. It is, however, quite straightforward as regards both operation and construction, and the cost of the components is strictly reasonable. Tuning is really sharp, so that reception of distant stations is free from interference, which may,

needed to the filament through a resistance. This resistance helps towards stability by preventing what are generally termed "parasitics," which are oscillations occurring at a very high frequency.

The H.F. valve is coupled to the

An aperiodic coil is used in the plate circuit of V_1 , and is fairly closely coupled to the grid coil of the detector valve. A winding for obtaining reaction is incorporated in the usual manner.

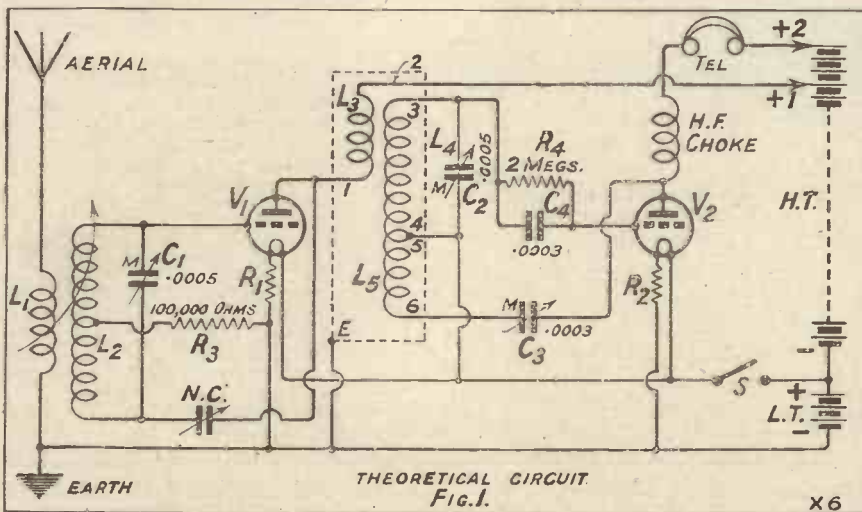

When tried about eight miles from 2 L.O., as already indicated, the tuning was found to be very sharp, no interference being experienced from the local station. This is rather exceptional, seeing that only one stage of H.F. amplification is used. The slow-motion dial which is fitted to the first tuning condenser, was a necessity for tuning-in distant stations, since in many cases the movement of a degree on the dial tuned-out the station. The reaction control was smooth, and generally the set was found to be easy to operate and stations could easily be tuned-in.

The general appearance of the set is conventional, and, in accordance with modern practice, the panel has been kept as clear as possible, only three tuning dials and two terminals for telephones being mounted on it. The "on-and-off" switch is fitted to the back of the set on the terminal

to all intents and purposes, be treated as though it did not exist. The portion of the first condenser dial covered by the local station at eight miles, is hardly more than that covered by a distant transmission.

detector by means of a standard Reinartz screened coil. The screening of this coil stops unwanted back coupling and so prevents any troublesome oscillation due to such coupling.

Neutralised H.F.

In order to ensure that distant stations may readily be received, the circuit chosen employs one H.F. valve, and a detector valve working on the leaky grid condenser method. The theoretical circuit is shown in Fig. 1, from which it will be seen that there is an "aperiodic" aerial coil, variably coupled to the grid coil of the first valve. The whole of the secondary coil is tuned and is tapped at the centre, this point being con-



The three condenser controls and two terminals are the only components which appear on the panel of the "Selector Two."

The "Selector Two"—continued

strip. This not only helps to keep the panel clear, but avoids long leads to the panel which would complicate the wiring. The aerial and earth terminals are also at the back, thus all the leads are kept conveniently out of the way. The top of the cabinet opens to facilitate the insertion of valves, coils, etc.

Care has been taken to allow plenty of room for the insertion of valves and coils to avoid crowding of the components.

A list of the components required will be found on this page together with the names of the particular makes used in the original receiver. It is not necessary to keep strictly

- COMPONENTS REQUIRED.**
- Mahogany panel, 18 in. × 7 in. × $\frac{1}{4}$ in. (Ebonart).
 - Cabinet with baseboard, 18 in. × 8 in. × $\frac{1}{4}$ in. for above panel. (Caxton Wood Turnery Co.).
 - 2 .0005 square law variable condensers (Igranic Electric Co., Ltd.).
 - .0003 square law variable condenser (Igranic Electric Co., Ltd.).
 - 2 ordinary 4-in. dials, 0-100 (Igranic Electric Co., Ltd.).
 - Slow motion friction geared dial (Formo).
 - 2 dial indicators (Deeko).
 - 9 insulated terminals marked Aerial, Earth, 'Phones, 'Phones —, H.T.1, H.T.2, H.T. —, L.T. +, L.T. — (Belling-Lee).
 - Push-pull "on and off" switch
 - Strip of ebonite, 6 in. × 2 in. × $\frac{1}{4}$ in.
 - Strip of ebonite, 2 in. × 2 in. × $\frac{1}{4}$ in.
 - 6-pin coil base and screen (Efesca).
 - Reinartz coil (Efesca).
 - Dimic coil and mount (L. McMichael, Ltd.).
 - Unimic coil and mount (L. McMichael, Ltd.).
 - 100,000 ohm resistance and mount (Dubilier).
 - .0003 fixed condenser with grid lead clips (Dubilier).
 - 2 megohm grid leak (Dubilier).
 - 2 anti-vibration valve holders.
 - 2 resistors (Amperite).
 - Neutralising condenser (Magnum).
 - H.F. Choke (Varley).
 - Glazite wire.
 - Screws, etc.

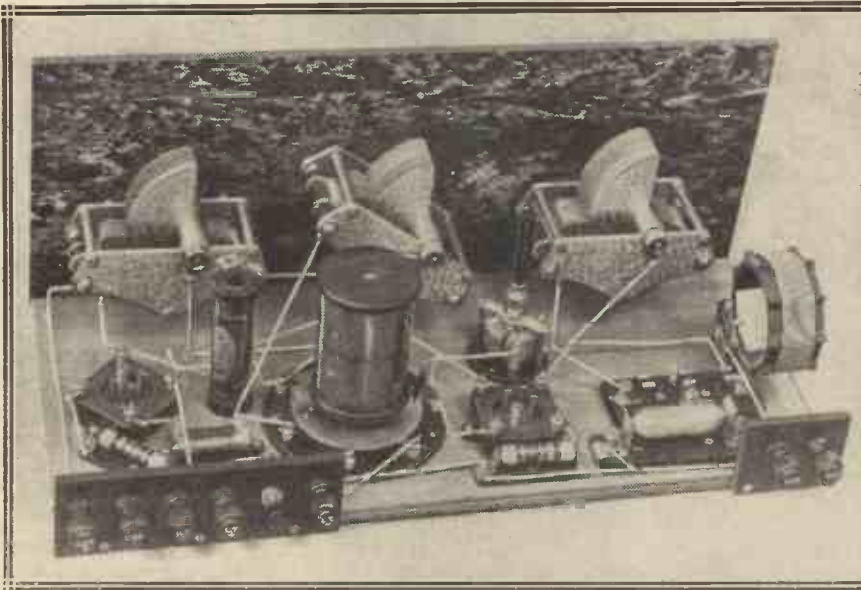

The lay-out has been given much consideration and should be adhered to as far as possible.

Although the baseboard is fairly large for a two-valve set, it will be seen, on examining the back of panel photographs, that there is not much space to spare. The components are arranged in such a manner that the wiring is kept as short as possible.

to these makes since others of similar type and good quality will give just as satisfactory results.

Naturally, a black panel may be used if desired, but the black dials on the red of the mahogany-coloured panel give a pleasing appearance.

With regard to the sizes of the Reinartz coil, the Dimic and the Unimic, these depend on several points, and are dealt with fully later in the article. Although a 2-megohm

(Continued on page 36.)

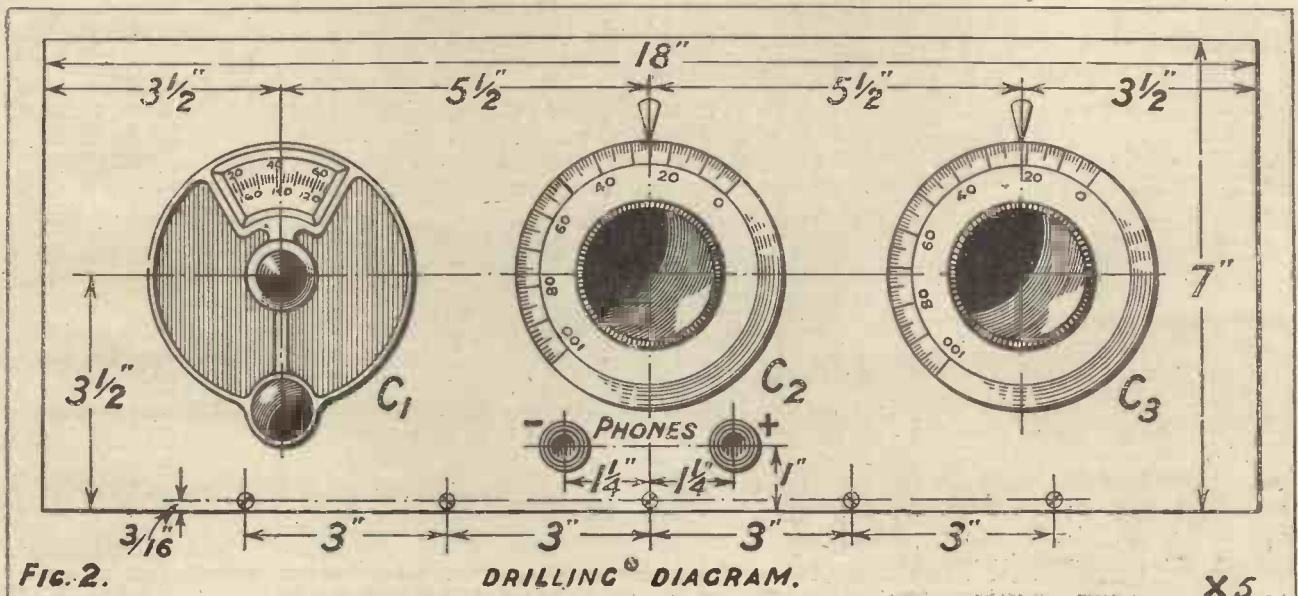

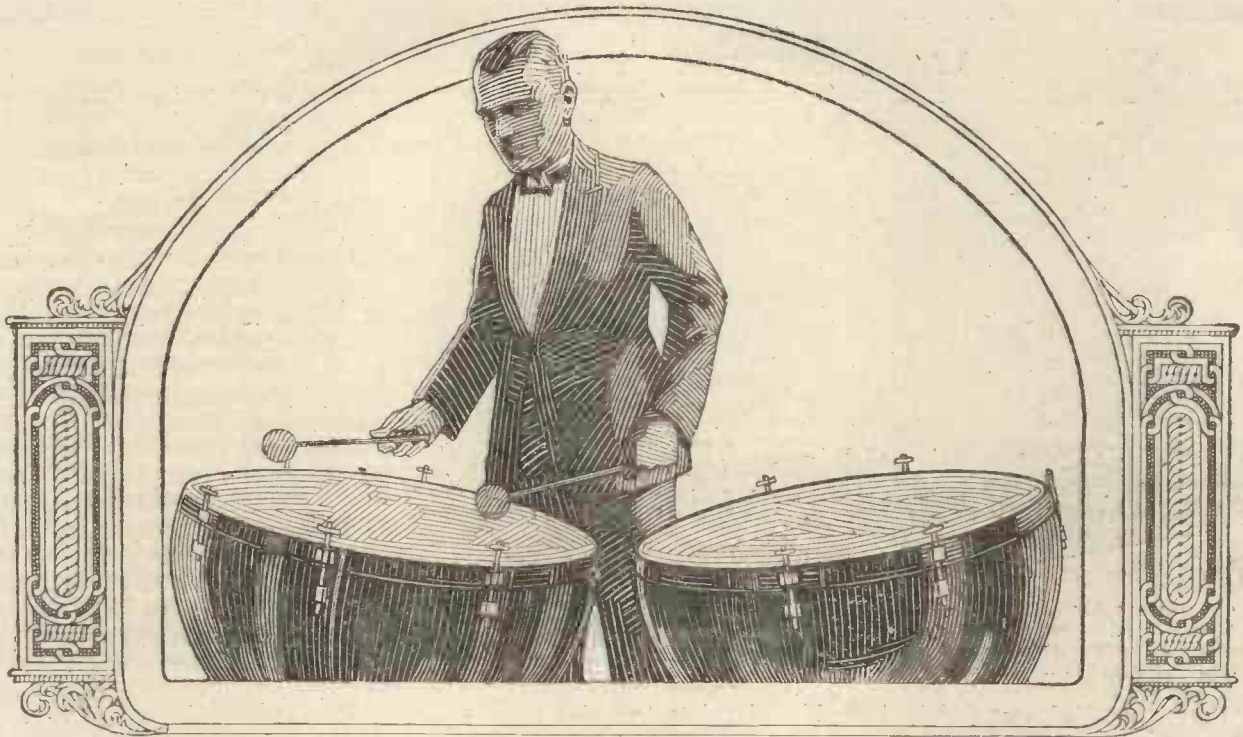

The music of the drums

—Let the new Cossor R.C. Valves
bring out their full, mellow tones

EXPERTS in sound reproduction have always admitted the shortcomings of Radio. They have known that, owing to technical difficulties, the elusive low notes, more often than not, have been entirely lost. This is why wireless music is so frequently thin and colourless—the lower registers are missing. But now Cossor—by another stroke of genius—has evolved a far better valve for Resistance or Choke coupling which ensures an equal amplification of all notes—from the deep rolling chords of the organ to the shrill pipe of the flute.

These wonderful new Cossor R.C. Valves herald the dawn of a new era. With their aid it is now possible for wireless to be practically indistinguishable from the original. Every inflection of the voice and each varying shade of tone is faithfully recorded by the Loud Speaker.

Get acquainted with these wonderful Valves today—there is a great musical treat awaiting you—such volume and grandeur of tone that you must be thrilled at the heights to which Radio has now risen.

Cossor R.C. Valves

THEIR outstanding success is, in great measure, due to their Kalenised filament. Although glowing almost without heat this filament emits such a torrent of electrons that Cossor R.C. Valves possess an amplification factor much higher than that of any other make of valve. Whilst—due to the patented method of construction—microphonic noises are definitely abolished.

- For Two Volts:**
210R.C. Impedance, 70,000 ohms Amplification factor, 40. Consumption 1 amp. 14/-
- For Four Volts:**
410R.C. Impedance 80,000 ohms Amplification factor 40. Consumption 1 amp. 14/-
- For Six Volts:**
610 R.C. Impedance 80,000 ohms. Amplification factor 50. Consumption 1 amp. 14/-

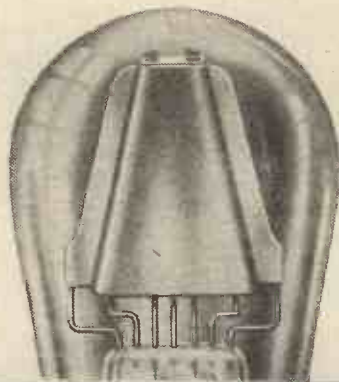

Other Cossor Valves

THERE is a complete range of Cossor Valves available for 2, 4 and 6 volt accumulators all consuming 1 amp. There are also the famous Cossor Stentor Power Valves—Stentor Two, 215P (Consumption 15 amp.) 18/6; Stentor Four 410P (Consumption 1 amp.) 18/6; and Stentor Six, 610P Super Power Valve (Consumption 1 amp.), 22/6 From all Wireless Dealers

**Cossor Valves are
100% British**

Cossor 2, 4 & 6-volt Valves

The "Selector Two"—continued



The "Selector Two" with valves and coils in position. The H.F. transformer is hidden by its screen, and the Unimic coil is shown tightly coupled to the H.F. grid coil.

grid-leak is specified, as explained further on, it is sometimes desirable to use a different value.

The resistors have to be chosen to suit the valves, and no particular value is therefore given for them.

Commence by marking out the panel in accordance with the drilling diagram of Fig. 2. Do this on the back, taking care to keep the measurements correct. The centre variable condenser has been mounted at an angle in relation to the others to allow room for making connections to the two telephone terminals, which are situated just below it.

Mounting the Components

Templates are provided with the variable condensers, and these should be used once the points for the condenser spindles have been located. Mark the positions for the dial indicator holes after the condensers and their dials have been mounted. This will avoid possible errors.

First mount the variable condensers, telephone terminals and dial indicators on the panel. Then put the terminals and the switch on the terminal strips which are to go at the back of the baseboard. Now insert the baseboard in the cabinet and proceed to screw the panel and the strips of ebonite to it. When this is finished, the baseboard and panel are removed from the cabinet, and the components mounted and wired on the baseboard.

This is done with Glazite wire, which is insulated, and so obviates any trouble should two wires touch.

In all points to which wires are to be soldered before you commence to fix the wires. Follow Fig. 3 for the wiring, and study the back of panel photographs when making the connections.

There are two interesting points in connection with the wiring. It will be seen that the moving plates of the condenser C_1 are connected to the grid of the valve V_1 . At first this condenser was connected the other way round, but hand capacity effects were rather bad, so it was connected as shown in the diagrams. The other point is that it is necessary that the end of the coil L_2 , which is nearest to the aerial coil, should be connected to the grid of V_1 . If the

other end is connected to this point results are distinctly poor.

The L.T. battery must be left to the discretion of the constructor, since it depends entirely on the valves to be used. With regard to the H.T. battery, one of the standard size 60 volt ones will be found quite suitable. But if small-power valves are utilised a higher voltage may be used. Any general purpose types of valves can be used, or, if desired, small power valves. If the latter are employed, one of the special H.F. valves should be used in the first stage. Some of the best results obtained by the author were heard when using an .06 type of valve for the detector and one of the $\frac{1}{4}$ ampere type of small-power valves for the H.F. valve.

Necessary Coils

A short-wave Reinartz coil will cover the lower band of broadcast wave-lengths, and if it is desired to listen to Daventry and long-wave broadcasting, a long-wave Reinartz coil will be required.

For the lower band, a No. 1 Dimic coil will be suitable, whilst the aerial coil may be a No. 25 Unimic. If a No. 35 is available it may be tried, since it is just possible that it might suit the particular aerial better.

The Dimic coil for the long-wave band will be a No. 4, and it should be used with a No. 100 or No. 150 aerial coil. It is probable that the No. 150

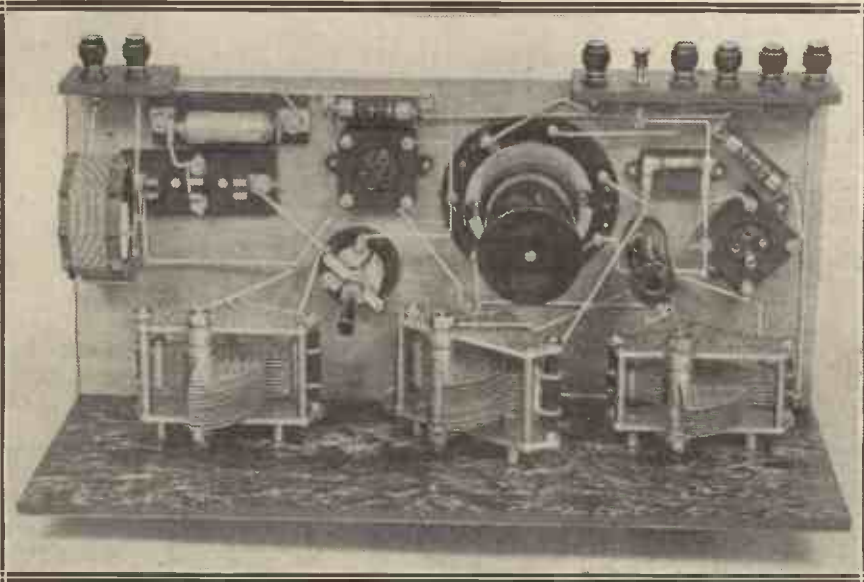

In conjunction with the wiring diagram on the next page this photograph will greatly facilitate the process of connecting up the components.

The "Selector Two"—concluded

coil will be found the most suitable for all aerials.

Neutralising

To neutralise the set, connect batteries, but do not connect the aerial and earth. Set the reaction dial at zero, and the second tuning condenser at a fairly low value. Now rotate the first condenser, and if the set oscillates (you can judge this by listening in the 'phones) adjust the neutralising condenser so that the set will not oscillate at any position of the condensers unless reaction is used. The setting of the neutralising condenser, once found, will not need to be altered, except when valves are changed.

It may be said here that it is not necessary to have a very good aerial

to obtain satisfactory results. The aerial coil should be fairly closely coupled to the coil L_2 . Since the first variable condenser has the sharpest tuning, it must be revolved slowly and the second condenser moved backwards and forwards to make sure that they are both in tune. The reaction condenser should be adjusted so that the set is just off oscillation.

If the reaction control is not all that is to be desired, it may be improved by using a 4 or 5 megohm grid leak in place of the specified value of 2 megohms. This will not, however, be found of any advantage on the local station, in fact, much stronger signals were obtained from 2 L O at 8 miles, when using a grid leak of .5 megohms.

WIRING INSTRUCTIONS.
 Join 'phone + to H.T. + 2.
 Join 'phone - to one side of H.F. choke.
 Join other side of H.F. choke to A of V_2 and fixed plates of C_3 .
 Join moving plates of C_3 to terminal 6 of L_5 .
 Join fixed plates of C_3 to one side of C_4 and R_4 , and to terminal 3 of L_4 .
 Join moving plates of C_2 to F + of V_1 to terminal 6 of L_5 ; terminal 5 of L_5 to terminal 4 of L_4 ; terminal 4 of L_4 to F + of V_2 to one side of S.
 Join other side of S to L.T. + and H.T. -.
 Join remaining sides of C_4 and R_4 to G of V_2 .
 Join fixed plates of C_1 to moving plates of N.C. and one side of L_2 .
 Join fixed plates of N.C. to terminal 1 of L_3 and A of V_1 .
 Join moving plates of C_1 to G of V_1 and remaining side of L_2 .
 Join two sides of centre tap L_2 together and to one side of R_3 .
 Join aerial to one side of L_1 .
 Join earth to remaining side of L_1 , remaining side of R_3 , one side of R_1 , B of coil screen, L.T. - and one side of R_2 .
 Join terminal 2 of L_3 to H.T. + 1.
 Join remaining side of R_1 to F - of V_1 .
 Join remaining side of R_2 to F - of V_2 .

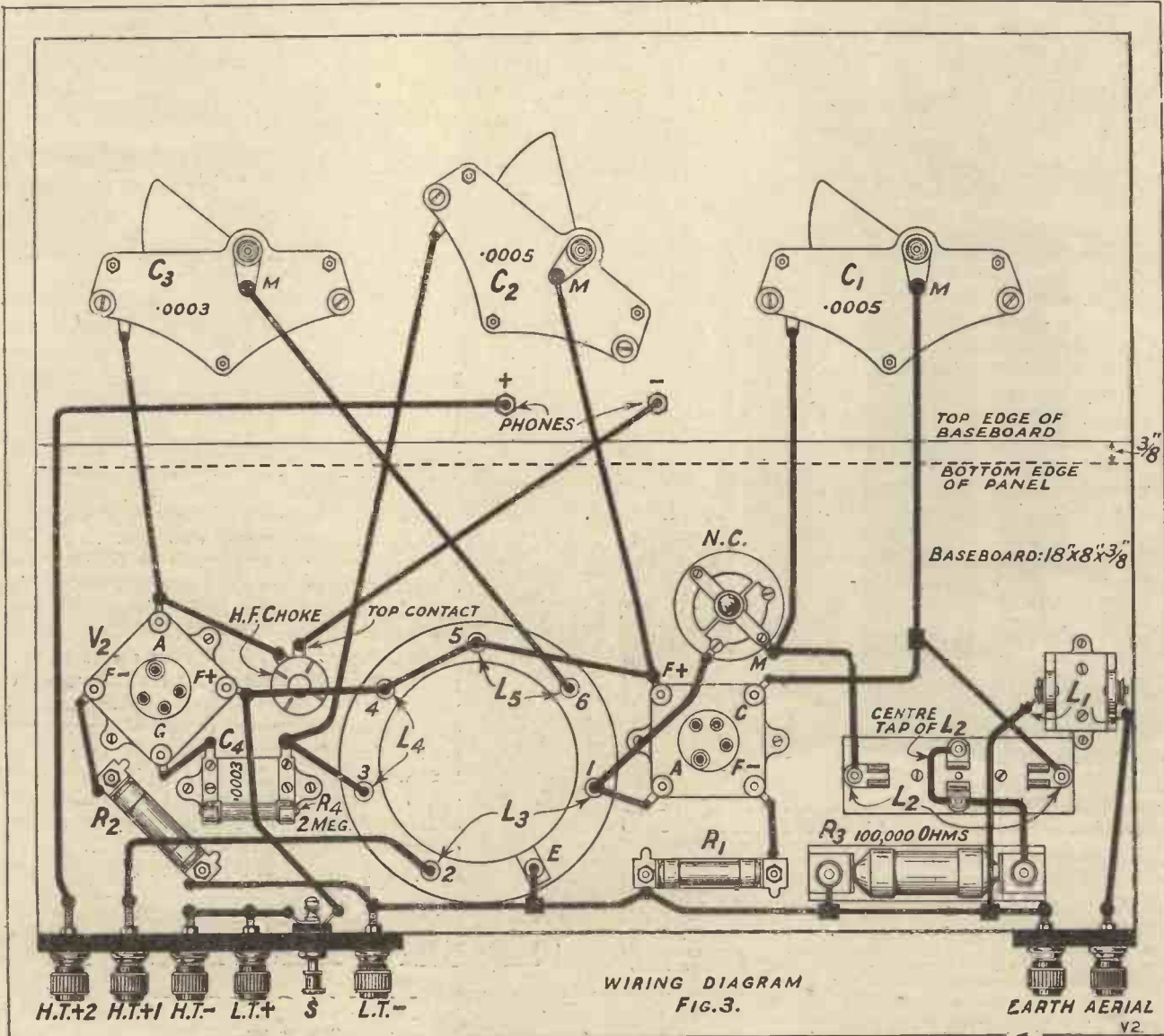

WIRING DIAGRAM FIG. 3.

Here is a better way of R.C.

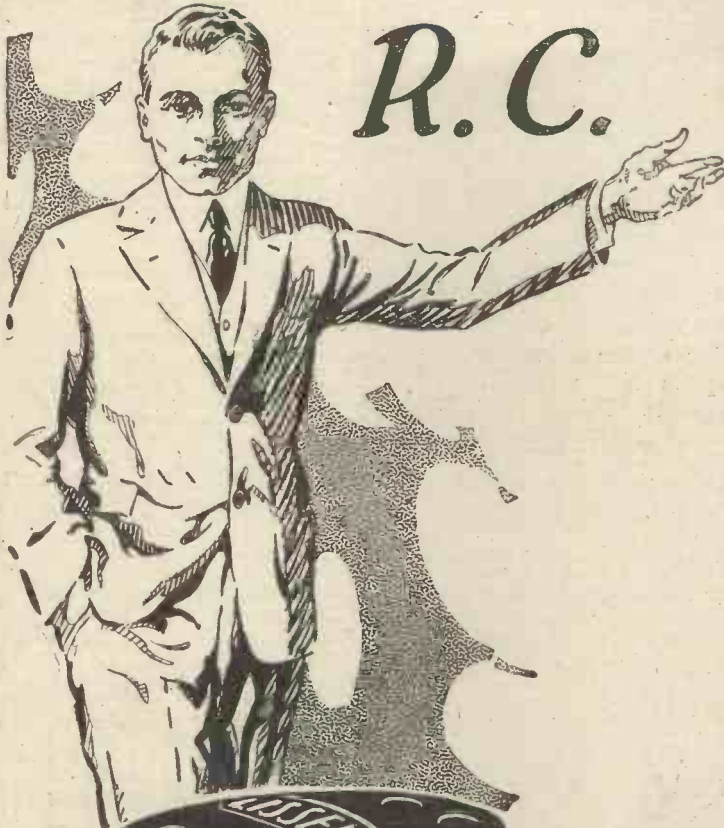

LISSEN TRANSFORMER 8/6

The LISSEN Transformer fully amplifies every note, every tone, every harmonic, and every over-tone against a background free from noise. The windings, etc., are protected from atmospheric conditions and damage by an ebonite moulding that totally encloses them. Soldering tags are fitted. The turns are wound to a ratio of 3:1 and the resistance ratio is 4:1. Can be used with equal success as an L.F. Choke by connecting the I.P. and O.S. terminals together. Guaranteed for 12 months. We challenge comparison of it against the most expensive transformer or choke you can buy on money-back terms if you fail to prefer the LISSEN.

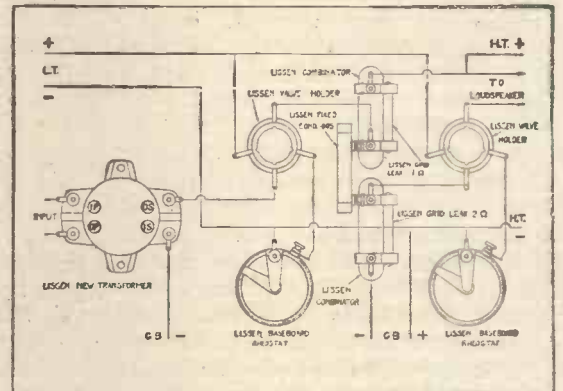

N.B.—To be fair to patentees, users before building any receiver should ascertain whether it is the subject of any circuit or other patent, and if so, should obtain the permission of the patentees to construct the receiver and pay any royalties that may be demanded.

MUCH ADVICE has been given you in the radio journals on the building of a resistance capacity amplifier for your crystal set. But it has been left to LISSEN to tell you how to make the best type of r.c. amplifier and how to make certain of good results.

If you build a 2-valve resistance-capacity coupled amplifier to follow your crystal set you will probably be disappointed with its results. A 2-valve r.c. amplifier provides no greater amplification than a 1-valve transformer-coupled amplifier after a crystal set. The first stage in the r.c. amplifier gives no appreciable step-up, no matter how high the amplification factor of the valve may be.

You should use a transformer in the first stage to get the full magnification from a valve possessing a high amplification factor. Then the second stage can be resistance-capacity coupled with good results. With a transformer in the first stage you may make certain of success with no chance of disappointment. LISSEN make an excellent transformer for use in the first stage. For the second stage the LISSEN Combinator and Fixed Condensers and Resistances should be used to provide the resistance capacity coupled stage. With these any r.c. unit can be built in two minutes at a total cost of 5/6. The filament current of the valves may be regulated by variable rheostats (you will find LISSEN most suitable) to suit the valves and the circuit used and the conditions of reception prevailing. This adds slightly to the cost, but helps you to make sure of results. Any dealer selling LISSEN parts will give you further advice if you need it.

**LISSEN LIMITED, 26-30
MANAGING DIRECTOR**

building an Amplifier

THE LISSEN COMBINATOR (Right)

The fixed condensers and resistances required for the r.c. circuit are simply clipped into this Lissen Combinator—a convenient holder designed to take them quickly without soldering. Tags are fitted so that condenser connections can be soldered if desired. Combinator can be used with leak in parallel to form a unit for standard grid leak rectification, without soldering, 1/- each.



A COMPLETE R.C. UNIT (Left)

Shows Lissen Combinator, fixed condenser and fixed resistance linked up as a complete r.c. coupling unit for H.F. or L.F. amplification. Resistance on the right acts as a grid leak; can be 2 megohms; the resistance on left acts as an anode resistance; can be 1 megohm.

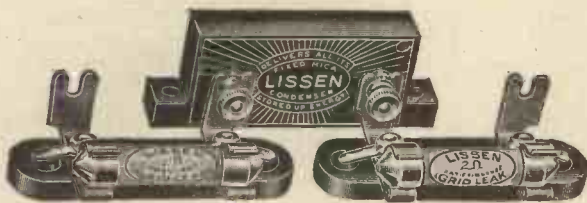

TUNED ANODE COUPLING (Right)

Parts shown linked up as a tuned anode coupling. Condenser can be .002, grid leak can be 2 megohms. Tuned anode coil and its condenser are connected up between the three terminals of the condenser and high-tension positive. L.F. CHOKE OR 80,000 OHMS RESISTANCE COUPLING. For these change the value of the condenser to .005.

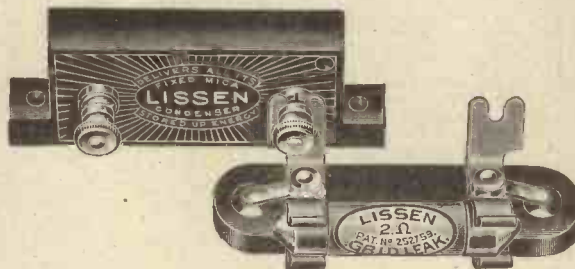

SOME HINTS FOR R.C. CIRCUITS

Fixed condensers used in r.c. circuits should be absolutely leak proof, otherwise 50% of the volume will be lost. Lissen Mica condensers are guaranteed leak proof. They never vary, deliver all their stored-up energy, and are guaranteed accurate to within 5% of their marked capacities.

Illustration shows Lissen Fixed Resistance (or leak as often called) mounted on Lissen Condenser with the grid leak clips given free with every condenser. It is essential that Fixed Resistances used in r.c. circuits are capable of standing a big voltage, and that the one in the grid leak circuit does not alter or vary and is silent. You can connect a 1/2 megohm Lissen Fixed Resistance in circuit with a 220-volt main supply and leave it there indefinitely without any change taking place or noise developing. This test is equivalent to an 880-volt test on a 2-megohm resistance. Lissen resistances have also been tested by exposing them to sun and rain on the factory roof. Their resistances never altered.

Lissen Mica Condensers.
 .0001 to .001, 1/- each (much reduced).
 .002 to .008, 1/6 each (much reduced).
 Note the new improved case which enables condenser to be mounted upright or flat.

Lissen Fixed Resistances.
 All resistances previously 1/8, NOW 1/-.



From all good dealers or direct if difficulty (C.O.D. if desired).

FRIARS LANE, RICHMOND, SURREY.
THOMAS N. COLE.



LOW CAPACITY, LOW LOSS

Valves in r.c. circuits should be mounted on Lissen valve holders which have all superfluous ebonite cut away. This means low loss and low capacity, and therefore stronger, clearer signals. Illustration shows valve holder ready for baseboard mounting; to use on panel bend springs straight. Patented. 1/- each (previously 1/8).

TO REGULATE L.T.

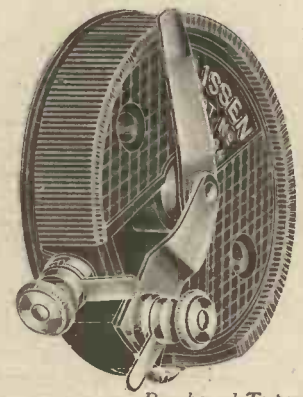

Baseboard Type

As explained in the left hand page it is advisable to regulate the filament current in r.c. circuits with variable rheostats. The baseboard type of Lissen Rheostats now cost actually less than most fixed type resistors and the panel type no more. These are the prices:—

Baseboard Type.

7 and 35 ohms rheostat and 400 ohms potentiometer, 1/6 each (previously 2/6). (No knob, dial and pointer, but provided with 2 holes for baseboard fixing.)

Panel Type.

7 and 35 ohms rheostat, 2/6 (previously 4/-).
 400 ohms potentiometer, 2/6 (previously 4/6).
 35 ohms dual rheostat, 4/6 (previously 6/-).

L316a.

JACKS IN RESISTANCE AMPLIFIERS

By R. W. H.

The increasing popularity of jacks for L.F. switching in wireless sets emphasises the need for this short but useful article.

It has been stated by more than one writer that jacks, which are becoming increasingly popular on the low-frequency side of the receiving set, should not be used in resistance-capacity coupled amplifiers. This is

of affairs is avoided. The anode resistance is connected to the 120- or 150-volt socket of the high-tension battery, but the body of the jack is connected to a socket giving a lower voltage. Thus, when the plug is in-

The Connections to H.T.

It might be thought at first sight that whilst the plug was being pushed into J_1 that part of the high-tension battery which lies between the two tappings would be practically short-circuited through the telephone or loud-speaker windings, since on its way in the point of the plug it makes contact with the top arm of the jack, which at this instant is still in contact with the second arm.

Adaptable for Filament Control

A moment's thought will show that no harm can be done even if the plug is left half-way in for some moments. The resistance R_1 is interposed between the high-voltage tapping and the middle arm in J_1 . Hence, even if the combined resistance of R_1 and of the telephone or loud-speaker windings is only 50,000 ohms, not more than one milliampere of current can flow when the potential difference between the two tappings is 50 volts.

The method recommended is just as easily adopted where filament-control jacks are used, the body of the first jack being connected, as before, to the lower voltage high-tension battery tapping.

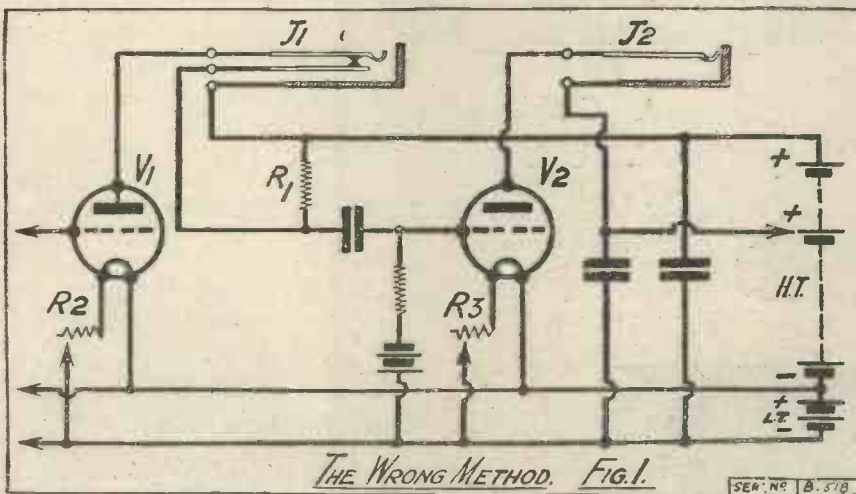

quite true if the method of wiring generally laid down (and seen in Fig. 1) is adopted. Owing to the drop in voltage which takes place across the resistance, it is necessary that the battery voltage for resistance-coupled valves should be from 120 to 150 volts for the best results.

If J_1 is wired as shown in the first diagram, the resistance R_1 is in series with the internal resistance of V_1 when the telephone or loud-speaker plug is inserted in J_2 . When, however, the plug is thrust into J_1 , only the resistance of the telephone or loud-speaker windings is in series with that of the valve.

A Simple Alteration

Since this resistance is very much less than that of R_1 , the voltage on the anode of the first valve may be high enough to cause damage, for many valves rapidly lose their emission if the plate voltage greatly exceeds the maximum figure given by the makers.

By making the simple alteration seen in Fig. 2, this undesirable state

is avoided. The anode resistance is connected to the 120- or 150-volt socket of the high-tension battery, but the body of the jack is connected to a socket giving a lower voltage. Thus, when the plug is inserted into J_2 , a suitable voltage to compensate for the drop across R_1 is applied to the first valve, and when the plug is in J_1 the voltage reaching the anode through the telephone or loud-speaker windings is automatically adjusted to the proper figure.

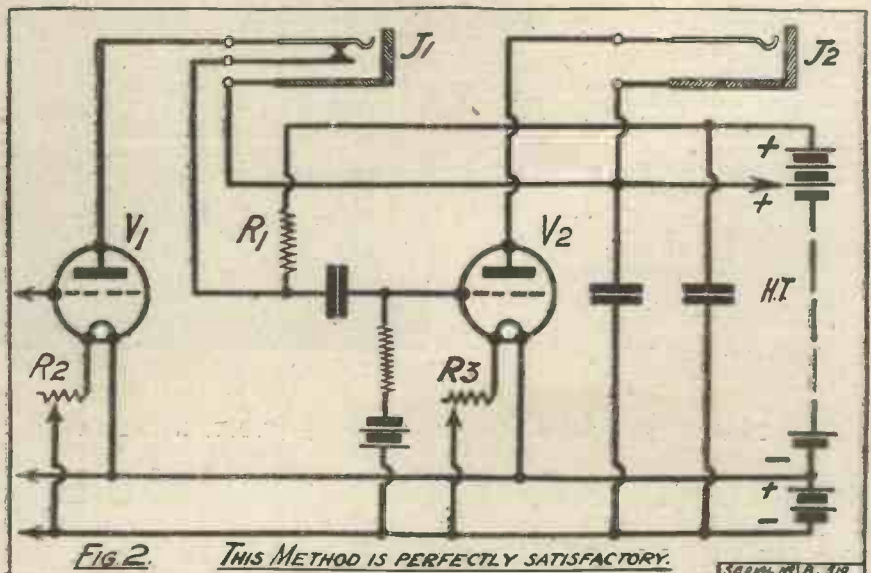

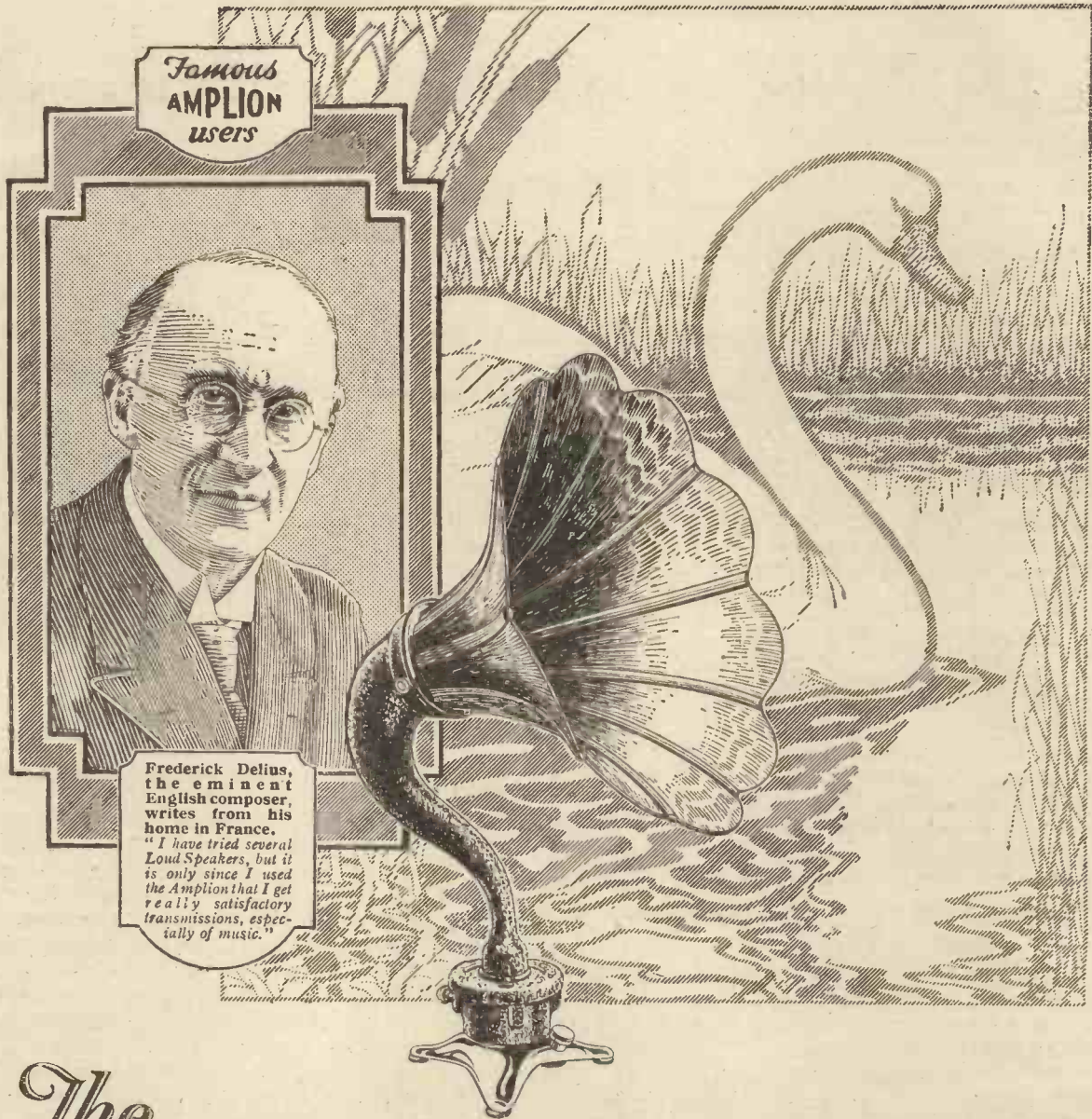

Famous
AMPLION
users



Frederick Delius,
the eminent
English composer,
writes from his
home in France.
"I have tried several
Loud Speakers, but it
is only since I used
the Amplion that I get
really satisfactory
transmissions, especially
of music."

The **SWAN- NECK DE LUXE**

With Solid Oak Flare. Type A.R.88.0

The graceful Swan-Neck models are acknowledged as essentially efficient types; they are provided with units of a size carefully balanced with the acoustic duct and undoubtedly represent the greatest value in vertical "horn" Loud Speakers.

£4.15.0 **AMPLION**

Other Models from
38/- to £13.13.0

The World's Standard Wireless Loud Speaker.

Announcement of Graham Amplion Limited, 25 Savile Row, London, W.1



This informative survey of events at Broadcasting Headquarters deals with the policy governing future programmes, the Queen's Hall proposals, "Daventry Junior," and other items of interest to listeners.

Happenings at Savoy Hill

By OUR SPECIAL COMMISSIONER

As I have been free with my warnings of unfortunate possibilities under the new régime, it is only fair that I should now make it clear that in my opinion the Corporation has made an excellent start. The Governors of the B.B.C. deserve warm praise for their intelligent abstention from interference with the delicate machine for which they are now ultimately responsible. They have wisely devoted most of their effort during the first three months to a careful study of the many aspects of the work. There would appear to be no doubt that Sir John Reith is still as much the absolute monarch of the B.B.C. as he was under the Company. It is, of course, highly important that a service such as Broadcasting in England should be managed on autocratic lines, at least, so far as its executive is concerned. Any unnecessary interference from the nominal heads, by weakening the autocracy, would inevitably cripple the service itself.

Programme Changes

But, while maintaining autocracy on its management side, the B.B.C. is still adaptable and resilient to legitimate movements of public opinion. For instance, although the partial press campaign of mid-January was as irrational as most of its predecessors, the programme builders at Savoy Hill wisely worked on the principle that there might be a little fire where there was so much smoke. Hence the introduction of more variety, and a more frequent "swinging the changes" in every main programme. But this process went too far. There soon arose well-grounded complaints that the

main programmes were unduly a succession of "tit-bits," the pattern being that of the patch-work quilt. As soon as the reasonableness of this complaint was shown, the programme builders modified their policy and reintroduced the sound principle of artistic unity in each of the main

topical talk in the middle. Of course this timing does not please everybody, but on the whole it appears to meet the wishes of most listeners under the limitations of the present system of distribution.

The Queen's Hall

Interested quarters have been trying to rush the B.B.C. into a costly commitment over the Queen's Hall and the London Symphony Orchestra. It is true that the B.B.C. should not be indifferent to the fate of these great institutions, and should perhaps urge the P.M.G. to "cough-up" some of the reserve of licence revenue he is holding. But as for the B.B.C. making itself solely responsible for the maintenance of these institutions, the commitment would be out of all proportion to the value to be received by listeners. The maximum programme value of the Queen's Hall and the L.S.O. is not greater than £10,000 a year. There is little danger of the B.B.C. being rushed into disproportionate expenditure.

Daventry Junior

Daventry Junior has commenced its tests at long-last. The strike last year, and the change-over in control of the B.B.C., combined to delay these by a whole twelve months. But now, if the Post Office and the

(Continued on page 44.)

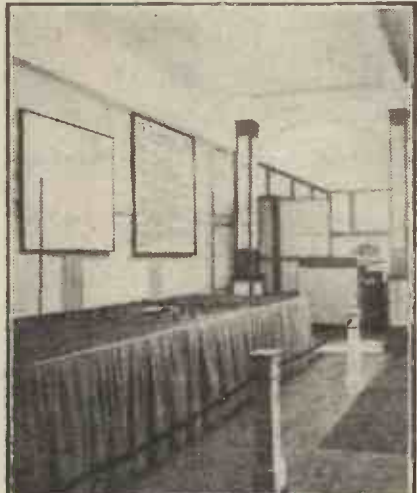

Daventry in miniature. To the left of the picture is a large scale model of B.B.C.'s famous high-power station.

periods. The withdrawal of the 8.45 classical recital made it possible to give two main entertainments each evening, the one running from 7.15 to 9, and the other from 9.30 to close-down, with the news bulletin and the



This photograph of a model B.B.C. studio shows the present system of draping.

Radio without Batteries

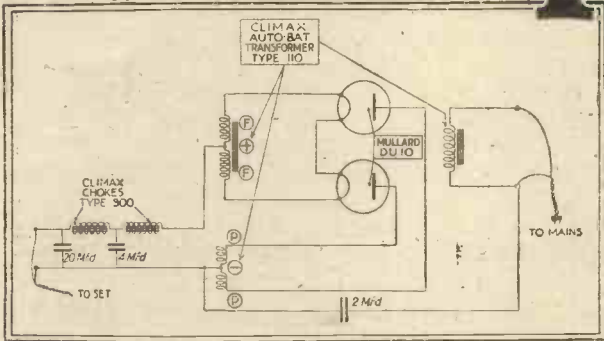

You will find the circuit diagram illustrated above, and which appears in No. 2 issue of "Radio For The Million," quite simple to work from. All the necessary connections are clearly indicated and it will take very little time for you to build yourself this simple money-saving unit.

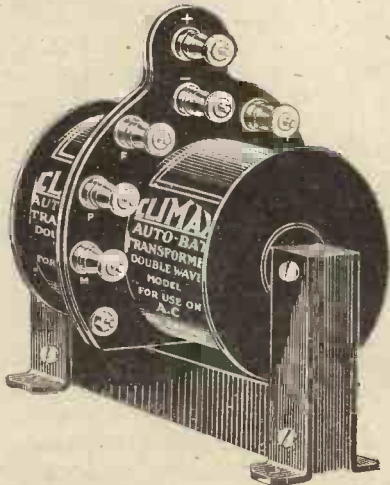

THE CLIMAX AUTO-BAT TRANSFORMER. For reliable, efficient and powerful transformation in H.T. supply units for A.C. Mains. Supplied with complete instructions for building H.T. Battery Eliminators.

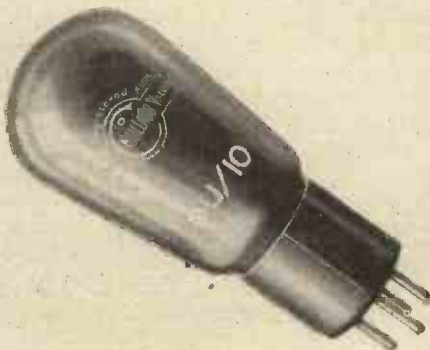

BUILD OR BUY

THE CLIMAX AUTO-BAT POWER UNIT

This unit will supply 110 milliamperes at 120 volts, rectified and smoothed current from A.C. Mains.

THE DRAKE P.M. RECEIVER

See "Radio For The Million," No. 2 issue.

By employing a powerful choke directly in the plate-filament circuit of the rectifying valves (Climax Prov. Pat. No. 5883/27) a very large rectified current can be obtained without injury to the rectifying valves. The rectified current obtained is practically rectangular in wave-form. The fluctuations of anode voltage and current in the rectifying valves are reduced from two or three hundred per cent to less than five per cent. The rectifying valves can, therefore, be operated much nearer to their maximum output while the resultant rectified current can be smoothed much more completely. The Wiring diagram of the Climax Auto-bat Power Unit for A.C. mains shows the arrangement of the rectifying and smoothing circuit, which must be strictly adhered to.

To build up the A.C. Unit the following components are required:

1. Climax Auto-bat Transformer, Type 110 Price 35/-
Specify voltage of supply mains when ordering.
- 2 Climax Heavy Chokes, Type 300 Price 21/- each
- 2 Valve Holders
- 2 Mullard D.U.10 Rectifying Valves Price 20/- each
- 6 4-mfd. Smoothing Condensers or equivalent
- 1 2-mfd. Condenser.
Mullard Mansbridge Condensers are specially recommended.
- 1 Double-pole Electric Light Switch.

It is essential that only

MULLARD D.U.10 Rectifying Valves be employed.

Complete Climax Power Unit in oak case	£9	7	6
Plus Marconi Royalty			12
Plus 2 Mullard D.U.10 Valves	2	0	0
	£12 0 0		

The exceptionally large rectified and smoothed current of 110 milliamperes will supply the complete H.T., L.T. and grid bias requirements of a multi-valve set, using Mullard 100 milliamperes receiving valves with filaments connected in series. The wide range of Mullard 100 milliamperes valves enables each stage of the receiver to be provided with a valve exactly suited to its requirements. Full particulars, together with blue prints of a typical three-valve receiver working on this system are given in "Radio for the Million," March Issue. By special arrangement with the publishers a copy of this most interesting publication can be obtained free of charge by using the coupon provided below.

CLIMAX

CLIMAX RADIO ELECTRIC LTD., Head Office & Works: Quill Works, Putney, London, S.W.15. 'Phone: Putney 2599. Showrooms: 257, High Holborn, London, W.C.1. 'Phone: Holborn 2538. All Communications to Head Office.

FILL IN THIS COUPON

The Editor, "Radio for the Million," 63, Lincoln's Inn Fields, London, W.C.2.

PLEASE SEND ME FREE a copy of the second issue of "RADIO FOR THE MILLION," complete with blue prints.

Name (Block letters).....
Address.....

W. Con.

Happenings at Savoy Hill—concluded

other wireless services are reasonable, there should be no further delay in establishing the first alternative high-power service. The B.B.C. have promised November, but this forecast is believed to be over-cautious. July is suggested as a reasonable possibility. The new transmitter will serve roughly the same area as 5XX (unless Captain Eckersley succeeds in getting 50 KW). Thus the programme will be alternative for about 22 million people within crystal range, and for the whole country with valve sets.

If this is carried out successfully, there should be a new boom in wireless in the large areas concerned. What has been standing in the way for two years has been the absence of just these facilities for contrast in programme values.

Sports Broadcasts

The running commentaries on sporting events in progress, although introduced only at the beginning of this year, are already an established and necessary part of the Broadcasting

with a great flare of trumpets from the lay press, appears to have encountered difficulties. First of all there have been inquiries about how it came to be known as the Listeners' Committee, and what title it had to that description. The right name is the Wireless Organisations Advisory Committee, and it should be said in fairness to the members that they have always used the right name. Nevertheless, the term Listeners' Committee sticks in the public mind. In point of fact, the constituency represented by these zealous people is quite small, and they would be the first to admit this. Nevertheless, it is of advantage that there should be some committee of the kind, however slender may be its auspices.

The Wireless Journals

It has been suggested that the addition of representatives of the wireless journals would be a great help. The objection to this is that there is so much valuable information imparted at the meetings of the committee that if one wireless journal were represented then all should be—which is *reductio ad absurdum*. I gather from a member of the Wireless Organisations Committee that, while the officials at Savoy Hill, with whom they come immediately in contact, treat them fairly and courteously, there is obviously hostility in other quarters. This will be gradually worn down. Lieut.-Colonel Moore Brabazon and Sir Ernest Hodder Williams are two new recruits for the committee, the former from the Radio Association, and the latter from the Wireless League.

Lighter Programmes?

There is to be a more determined effort this year than ever before to maintain interest over the summer period. Of course, the crux of the problem is light, snappy, "summery" programmes, with an absolute minimum of solid nourishment. I gather that the B.B.C. plans are in the right direction, but have not gone the full distance required. There should be no half measures. A complete holiday from talks and policy statements by Government departments should be decreed from the middle of June to the end of September.

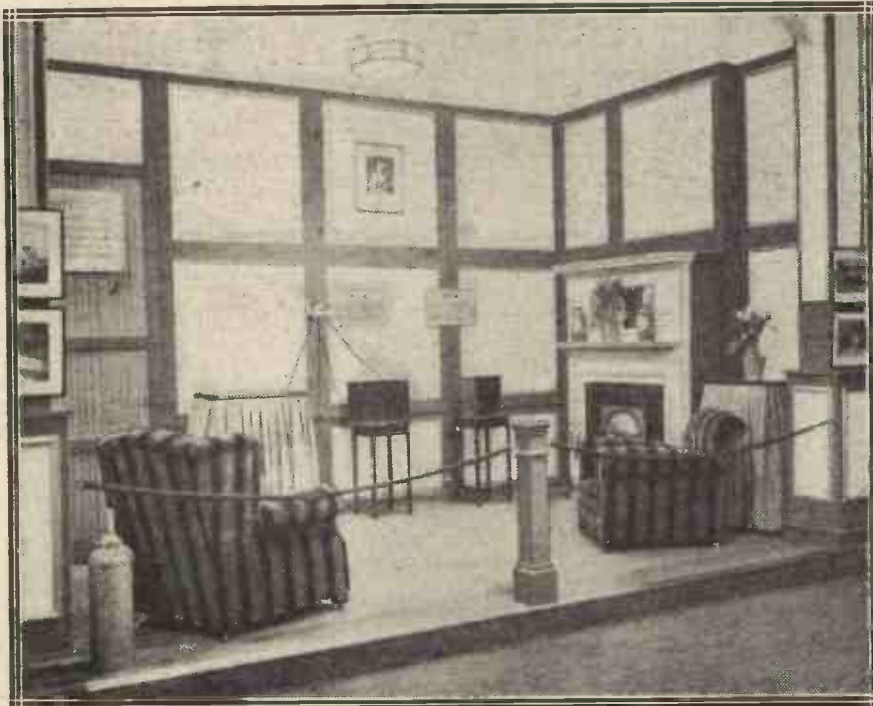

Three receiving sets were included in this "drawing room" which formed part of the B.B.C.'s recent exhibit at Olympia.

I have not heard exactly what the B.B.C. propose to put out on Daventry Junior. It is understood, however, that it is not to be the dumping ground for all the unpalatable talks which are now forcibly included in the 2LO and 5XX programmes. It is more likely that there will be a compromise arrangement pending the beginning of more of the new high-power regional transmitters.

Contrasts in Programmes

Thus, for instance, Daventry Junior will not be confined to talks to farmers, the shipping forecast, and talks on beetles. An endeavour will be made to provide a genuine daily contrast in terms of entertainment.

Service. I am glad to hear that the B.B.C. are planning to extend the practice of concurrent description in various new directions. There are to be visits to places of historical and contemporary interest. This type of programme item fulfills at last the function of the microphone in bringing the world of interest and events into the homes of listeners. There is, of course, a great deal to be done even before the era of television arrives, if it ever does. Sporting events and great occasions abroad as well as at home are included in the plans of the B.B.C.

The alleged Listeners' Committee, which came into being in January

IMPORTANT ANNOUNCEMENT!

The CYLDON Research Dept. have produced an entirely new type of Variable Condenser named

CYLDON LOG MID-LINE

This new condenser is a great advance over all others, and easily surpasses in performance the Square Law and Straight Line Frequency types.

It is designed on the

LOGARITHMIC PRINCIPLE

The shape of the vanes is approximately between square law and straight line frequency.

When multiple tuned circuits were first simplified by the ganging of condensers, the square law pattern was the nearest approach to perfection, but we realised that the tuning was limited to a portion of the scale. At each end was silence due to the out of balance, owing to the shape of vanes following a straight line wave-length curve.

Our Research Dept. immediately tackled the problem, and after many months' extensive experiments, we produced a new shape vane following a logarithmic law, which has very decided advantages over all other condensers.

With these new Condensers tuned circuits are balanced over the entire scale.

In multi-tuned circuits, all dial readings are identically the same, when two or more condensers are in use.

Stations are much more evenly distributed over the whole scale.

THIS NEW CYLDON ACHIEVEMENT IS THE FIRST VARIABLE CONDENSER MADE IN THIS COUNTRY ON THE LOGARITHMIC PRINCIPLE.

Constructors who have gang condensers of the square law pattern will appreciate that this new advance in design was not foreshadowed until the advent of gang circuits, and we think they will appreciate that as the science of Radio progresses, new inventions must necessarily come.

This new condenser is such a great improvement that in future all our gang condensers will be built up with Log mid-line units. They are the latest and greatest advance in condenser design, and there is not the slightest doubt that the Condenser of the future will be the Cyldon Log Mid-Line.

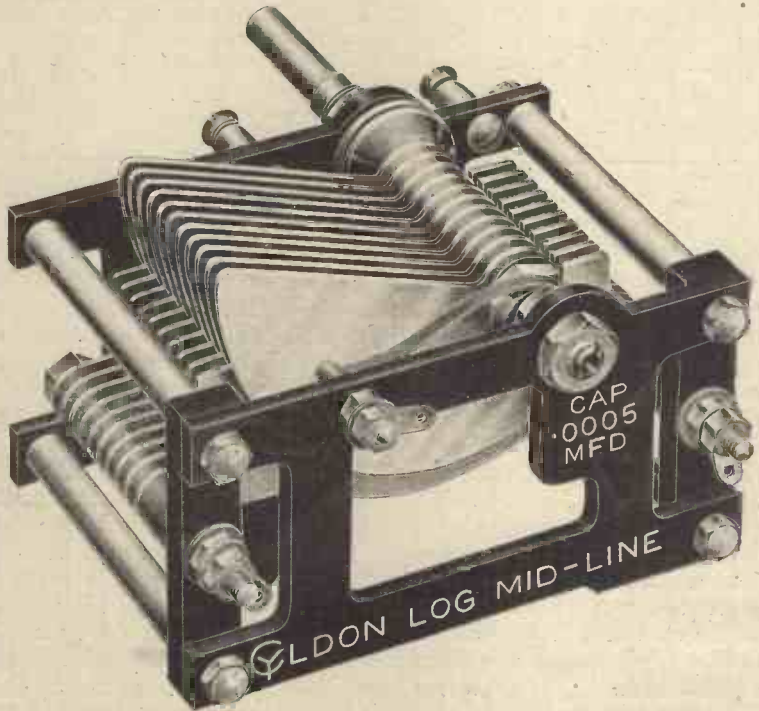

PRICES:

*001	21/-
*0005	17/6
*0003	16/6
*00025	16/-
*0002	15/6

With 4 in. Knob Dial. If dial is not required, deduct 2s.

NEVER MIND WHAT YOUR CIRCUIT IS-GET

CYLDON

(pronounced Sit-don.)

LOG MID-LINE CONDENSER

From your dealer or direct from:—

SYDNEY S. BIRD & SONS

Cyldon Works, Sarnesfield Rd., Enfield Town, Middlesex
Telephone: Enfield 0672.

CYLDON

TEMPRYTES

THE BEST MEANS OF VALVE CONTROL. PRICE 2/6 EACH. MOUNTING 1/6 EACH
FULL PARTICULARS & VALVE CHART FREE ON REQUEST

CHOOSING YOUR ACCESSORIES

After having decided upon the set to be built, the constructor has the difficult task of making up his mind about the accessories he will use. This article will be of interest and assistance to all readers.

By THE EDITOR.

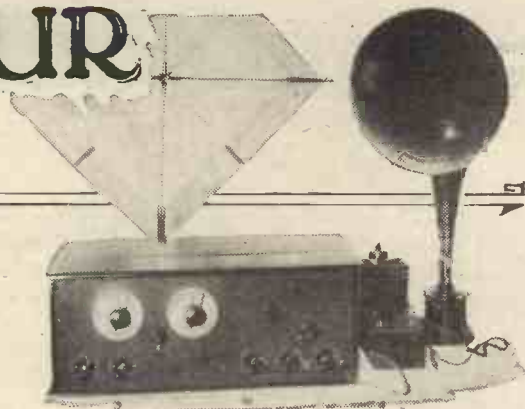

THE writer of an article describing how to build a wireless receiver must necessarily confine himself to the description of building the actual instrument, as otherwise the space occupied by the article would be much too long. For this reason the query department of THE WIRELESS CONSTRUCTOR frequently receives letters asking how to choose the various accessories necessary with every wireless set.

A Compact Guide

In addition to the receiver itself, we require valves (and sometimes a crystal detector), a battery to supply current to the filament of the valve, a second battery to provide the H.T. current for these same valves, a small battery to give a "biasing voltage," as it is called, to the grids of the note-magnifying valves, and some means of making the output of the receiver audible, i.e. telephones or a loud speaker.

The present article is an attempt to provide a compact guide to the choice of these accessories without attempting to influence in any way the personal taste of the purchaser, for there are many varieties of each. Some general rules, however, can be laid down, and their application may save a good deal of time.

First of all, a few words on the choice of a crystal detector. Here you have to choose between either the "cat's-whisker" type of detector or the "permanent" type. Both kinds have special advantages.

Cat's-whisker Class

With a good crystal a very large number of sensitive spots are obtainable on a given specimen, and careful searching with the cat's-whisker will enable you to find many other good places should one fail. Again, a worn or insensitive crystal can be changed very easily, and a very large

number of commercially available crystals are open to your choice. Practically all of the crystals sold for this type of detector are made of re-crystallised galena. Remember that the slightest contact of the cat's-whisker upon the crystal face will suffice, and the sensitive surface is injured by constant scratching.

A great disadvantage of the cat's-whisker type of crystal detector is that it is easy to destroy sensitiveness by a jolt or other vibration, and once the sensitive spot has been lost one must search again for another. On the point of sensitivity, a well-chosen galena crystal carefully adjusted is not beaten by any other form.

Semi-permanent Type

These detectors are practically always enclosed, generally in some form of cartridge, and in the best types a means of adjustment is provided. Such detectors are made up of two different crystals held in contact with one another by a fairly firm

spring. The types of crystals used are such that a fairly strong pressure can be used, and such a contact is not easily displaced by vibration. On the rare occasions when such detectors lose their sensitivity it can generally be restored by carefully lifting one crystal off the face of the other and letting it down again. The reliability of this type of detector is really astonishing, and I have used one daily in a crystal set followed by note magnifiers to work the family receiver on the local station for as long as three months at a time without readjustment. A crystal receiver fitted with this type of detector is as near fool-proof as such a receiver can be made. As far as sensitivity is concerned, while it is not generally as great as can be obtained with careful and expert choice of a sensitive spot by means of a cat's-whisker on the galena crystal, the average user is likely to get better results from this type than with the other.

(Continued on page 49.)

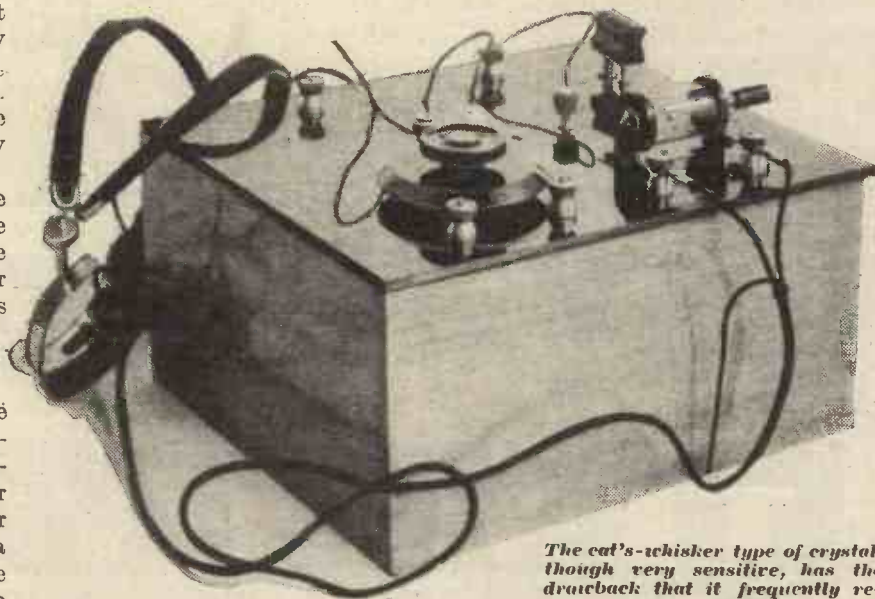

The cat's-whisker type of crystal, though very sensitive, has the drawback that it frequently requires adjusting.

THIS IS THE CONDENSER

•0005

With 4 in. Bakelite Knob and Dial and Anti-capacity Shield

20/-

With Dual Indicator Dial which acts as Anti-capacity Shield

21/6

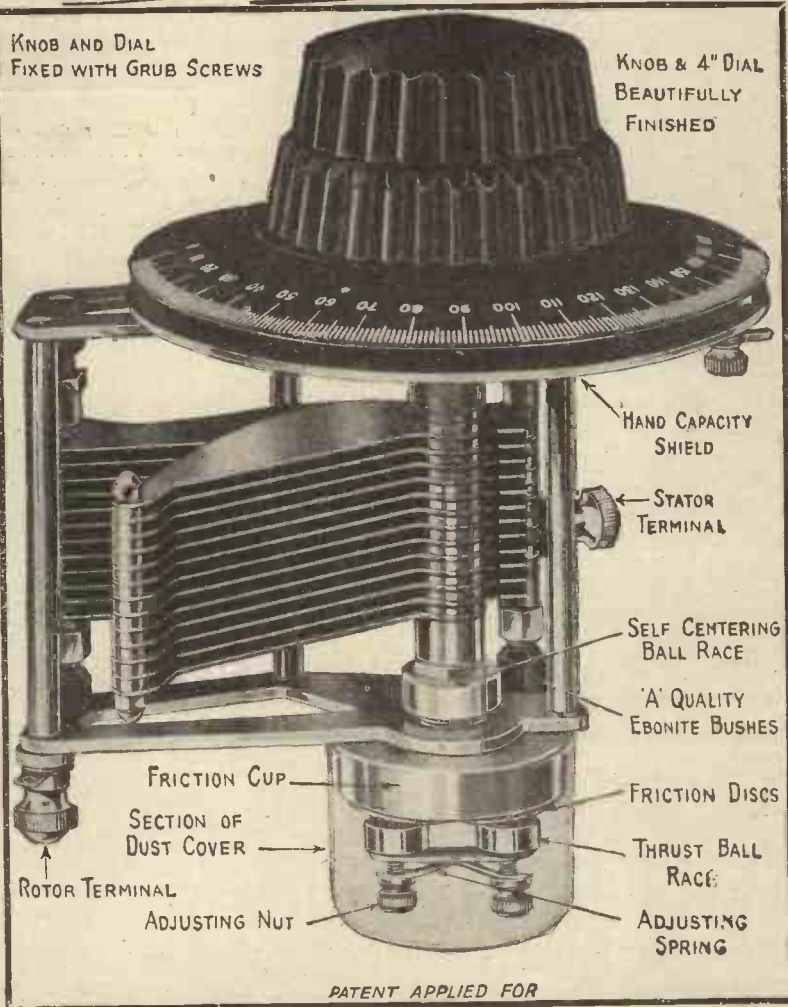

•00035

With 4 in. Bakelite Knob and Dial and Anti-capacity Shield

19/6

With Dual Indicator Dial which acts as Anti-capacity Shield

21/-

PATENT APPLIED FOR

Ball bearing Slow-Motion Friction Drive with the ideal ratio of 55 to 1, making precise tuning adjustments a simple procedure. Radio-frequency dielectric and eddy-current losses reduced to the minimum. Robust construction and unequalled finish—the result of the knowledge and experience accumulated during the 25 years' British Manufacturing. Every refinement embodied—Anti-capacity Shield, one-hole fixing, tags, terminals, etc. Prices no deterrent to your possessing this peer among condensers.

199-205 Pentonville Road

Telephone: Clerkenwell 9344-E.6

Factories: Whiskin Street & Hardwick Street, Clerkenwell, E.C.1



King's Cross, London, N.1

Telegrams: "Ormondengi, Kinross".

Continental Agents: Messrs. Pettigrew & Merriman, Ltd., "Phonos House," 2 & 4 Bucknall Street, New Oxford Street, W.C.1

Specially

recommended

FOR THE "SIGNAL BOX"

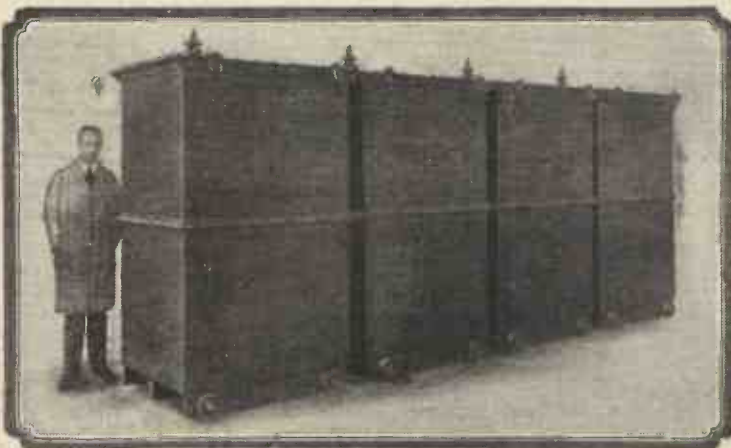

A bank of four Dubilier Mansbridge Condensers supplied for the Government Radio Station at Rugby.

A Natural Corollary

Some of the largest Mansbridge Condensers the world has ever seen—a natural corollary to the combination of Dubilier and Mansbridge. See that your Mansbridge Condensers are genuine Dubilier Mansbridge Condensers. No other kind of Mansbridge Condenser carries the Dubilier guarantee.

0.01 to 0.1 mfd.	2/6	1.0 mfd.	4/-
0.125 " 0.2 "	2/8	2.0 "	5/-
0.25 " 0.3 "	3/-	3.0 "	8/-
0.4 " "	3/3	4.0 "	10/-
0.5 " "	3/6	5.0 "	12/-

Other capacities are listed on page 12 of our Catalogue, post free on request. All Dubilier Products carry our full guarantee, and we shall be pleased to fill your order direct if your dealer cannot supply.



Advert. of the DUBILIER CONDENSER CO. (1925), Ltd., Ducon Works, Victoria Road, N. Acton, W.3.

M.C. 270

Save One and Sixpence per Valve

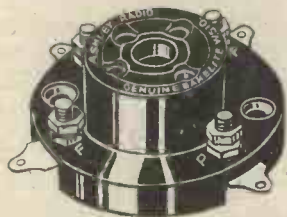

PRICE 1/3 each

Beyond the Detector stage, to pay more than 1/3 for the valve holders is extravagance. The belief that "shock absorbing" devices are necessary in every stage is a definitely exploded fallacy. For H.F. and L.F. stages there is nothing better than the new Ashley Valve Holder. Constructed throughout of genuine bakelite and non-oxidising metal, the valve sockets are surrounded by air throughout 90% of their length. Sockets and connections are stamped complete out of one piece, pressure being made for wiring to terminals or soldering to tags. Moreover, a special safety groove is provided to ensure the valve legs engaging with the corresponding sockets.

STANDARD VALUE RESISTANCES



PRICE 2/6 each
(with clips)

50,000 ohms to 1 megohm.

Ashley Radio

Exhaustive tests by the National Physical and other world famous laboratories have produced highly satisfactory reports. Each Resistance on completion is subjected to a prolonged ordeal during which it is under pressure at a minimum of 230 volts.

Guaranteed accurate within ten per cent. Superior to wire wound. Differs in construction from all others.

If your dealer cannot supply we send post free.

Ashley Wireless Telephone Co. (1925) Ltd.
Finch Place, London Road, Liverpool

The Choice of Experts.

GAMBRELL COILS & NEUTROVERNIA CONDENSERS

These have been specified and used in practically every set of outstanding merit.

GAMBRELL CENTRE TAPPED COILS

These are universal coils, their use not being limited to centre tapped circuits. They can be plugged into any standard coil socket. Are readily interchangeable. Baseboard space occupied is very small compared with other types.

Size.	Price.	Approx. No. of Turns.	Size.	Price.	Approx. No. of Turns.
a/2	4/10	18	D	6/3	100
a	4/10	25	E1	6/9	150
A	5/-	30	E	7/9	200
B1	5/3	40	F	8/6	300
B	5/6	50	G	10/-	500
C	5/9	75			

Prices quoted are for Standard Gambrell Coils. Centre tapped coils, 6d. extra.

NEUTROVERNIA CONDENSERS

These are ideal universal units for use as balancing condenser, capacity reaction control or verier condenser. Capacity range approx. 2/38 m/mfds. For panel or baseboard mounting, Price 5/6. Can be fitted with direct readings dial, enabling a return to be made to exact settings previously logged. Price 1/8 extra.

Illustrated Folders Nos. 16 & 18 Free.

GAMBRELL BROS. LIMITED.

76, Victoria St., London, S.W.1.

Parr's Ad.

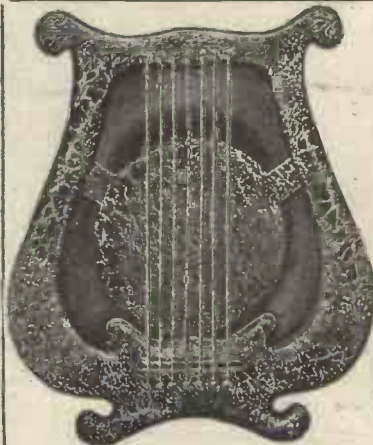

"ETHERPLUS" Radio Speaker

This new "Etherplus" Loud Speaker combines an artistic and revolutionary design with exquisite tonal qualities and ample volume.

Fixed Retail Price
£3 : 10 : 0

From all dealers or from

M. & A. WOLFF
9-15, Whitecross Street,
London, E.C.1.



Choosing Your Accessories—continued

Valves

On first glancing through the makers' catalogues there seems to be an appalling number of valves made, and a suitable choice might at first seem to require expert knowledge. Closer examination shows that the choice is not so difficult. Valves are now made to work off 2, 4, and 6-volt accumulators, with or without filament resistances, and a number of different types are made for each voltage. Speaking generally, I have found that better results are obtainable on the 4 and 6-volt types than with the 2-volt, but it is most important to emphasise that this does not apply to all makes, and that some 2-volt valves are distinctly better than other 4 and 6-volt types.

"Can I run my set entirely from

and one needs three to give the right voltage, even when a single valve is used, for each cell will give at a maximum when new $1\frac{1}{2}$ volts. As the voltage drops immediately they begin to be used, it will be seen that if two cells were provided the voltage would be only sufficient for the valve when the cells were new. By using three cells with a total of $4\frac{1}{2}$ volts together with a filament resistance to cut down the current, an adequate reserve of voltage is available for deterioration.

A Useful Comparison

Makers' catalogues show that dry batteries ($4\frac{1}{2}$ volts) recommended for filament lighting (and of a size to run a single valve) cost about 7s. 6d. to 10s. It must be remembered that when these cells are exhausted there

necessary to run a .06-ampere valve, and I have in front of me an excellent accumulator, selling at 5s. 6d. per unit, which will run such a valve for well over 200 hours with a single charge. Compare this with the dry battery method. Using dry batteries you will have to spend at least 7s. 6d. every few months for replacements.



The permanent detector is easily mounted in the set.

Using accumulators, the first cost will be 10s. or 11s., and at the end of, say, three months' use they can be recharged for a few pence each. In addition to this, remember that the voltage of the accumulator remains constant throughout its useful discharge, and you will not have the constant fiddling with filament resistances so necessary with dry cells.



Two examples of permanent detectors, the one on the left being capable of adjustment should this be deemed necessary.

dry batteries and dispense with a messy accumulator?" is a question often put to wireless experts. It is certainly possible, if you are prepared to put up with certain disadvantages. Valves are now available which consume only one-sixteenth of an ampere each (they are generally called .06-ampere valves), and up to four of these can be run from three large dry cells connected together in series. But remember, whereas the voltage of an accumulator remains practically constant throughout its entire useful discharge, that of a dry cell falls steadily, so that in order to keep the valves properly adjusted a variable filament resistance is needed, with constant attention to maintain the adjustment. There is also a danger of running the valves too brightly and thus injuring their filaments.

Reserve of Voltage

A good rule is to take a quarter of an ampere as the maximum safe current from dry batteries for filament lighting. If more than this current is required, additional batteries must be added in parallel.

Dry cells of a size adequate to run valve filaments in this way are costly,

is no further use for them, and they must be thrown away.

You will now see that although the use of dry cells avoids the "messy accumulator," as it is sometimes called, the annual cost of running your set from this kind of supply is very much higher than in the case of an accumulator. Let us take the case of a single-valve set with a .06-ampere dull emitter running from dry cells. I could not recommend you to pay less than 7s. 6d. for the three dry cells to run this valve, whereas there are a number of excellent accumulators costing but 5s. or 6s. each per cell which will run such a valve far better and can be recharged for a few pence. Two 2-volt accumulators will be



A well-known semi-permanent or adjustable "permanent" detector in a dismantled condition, showing the two crystals and the spring for supplying the necessary contact pressure.

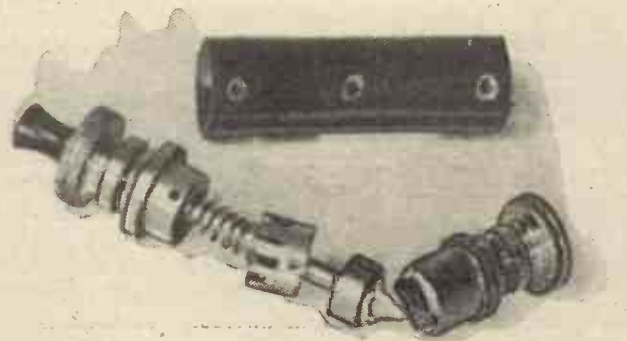

Choosing Your Accessories—concluded

accumulator has nothing to do with its voltage. I have in front of me as I write two accumulators, each of 2 volts. One costs 5s. 6d, and the other nearly a sovereign. The more expensive is very much the larger, and the difference between them is that while both give out current at a steady pressure of 2 volts, the larger cell can give out current for much longer before a new charge is needed, and, what is also very important, can give very much stronger current without injury.

Choosing an Accumulator

When you are choosing an accumulator you want to ascertain its "actual ampere-hour capacity." If, for example, you see an accumulator referred to as "30 ampere-hour actual," this means it can give a constant current of one ampere for 30 hours before it requires a new charge. It is not, however, necessary to take this exact current, but larger and smaller currents can be taken as required. For example, it will give half an ampere for 60 hours or two amperes for 15 hours. To find how long you can take a given current from an accumulator without requiring a new charge, divide the current taken into its total ampere-hours capacity. For example, three amperes divided into 30 gives 10, i.e. the cell will give three amperes for 10 hours continuously before a new charge is required.

One important point must now be taken into account. The ordinary wireless accumulator should never be discharged at a rate exceeding a tenth of its actual capacity, and in the case of the accumulator to which we have just referred (30 ampere-hour capacity) three amperes will be the maximum safe discharge. This rule does not apply to the small accumulators specially designed for running dull emitter valves, such as those of the .06-ampere variety, as these cells are made to give a very low current discharge over long periods. In such cases you should look at the maker's label and observe carefully the maximum current that can be taken from the cell without injury.

Referring again to the 5s. 6d. accumulator of which I have been speaking, current as strong as half to one ampere can be taken owing to its special construction, but in another

make of about the same size the maximum current recommended is less than half an ampere.

Another point in the choice of accumulators is whether the containers should be of glass, celluloid, or of moulded material. All three types have their good points. The celluloid containers are light and enable one to examine the condition of the plates and electrolyte, but this is a doubtful advantage, as the plates can become very bad without showing signs except to an expert, while when they really look bad very little can be done to restore them. On the other hand, celluloid containers are more easily broken, and there is no question that the acid has an effect on the celluloid.

The second type, with glass containers, has all the advantages of visibility for what they are worth, but is very heavy. On the other hand, my own experience is that

level, a matter which can be noted at once in celluloid or glass containers. Opinions differ, but my own recommendation is to use the glass containers where portability is not a consideration, and either the celluloid or the moulded container type when you must take your batteries backwards and forwards to a charging station.

Use Two Batteries

If you are running your set from an accumulator the choice of the size is important, but first of all let me recommend you to buy two accumulators of the voltage required for your set, so that you will always have one for use when the other is being charged. Nothing is more annoying than to find that, just as a most interesting item on the programme is

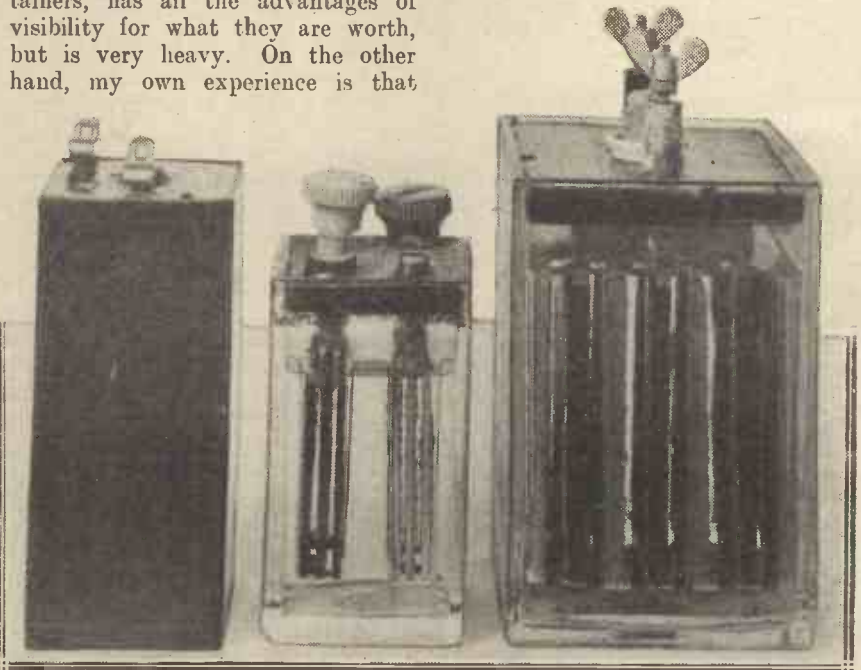

Three classes of L.T. supply. The dry cell (1½ volts), the small 2-volt accumulator, and a larger 2-volt accumulator capable of running a large set.

accumulators in glass containers keep in good condition much longer than those in celluloid, and if you charge your own cells the additional weight is not important.

Advantage of Glass

The accumulators in moulded composition cases are growing in popularity, as they are neatly made, strong, and the containers themselves can be produced very cheaply. The only disadvantage of such cells is that it is not easy to observe the acid

beginning, your single accumulator is running down and you will receive no further programmes for two or three days.

Let us assume you have a four-valve set with a total filament consumption of, say, one ampere. I would recommend an accumulator of not less than 40 ampere-hours actual capacity. This will run your set for three hours a night for a fortnight quite comfortably.

A further article on the choice of accessories will appear next month.

Cosmos

RADIO COMPONENTS

Mean BETTER Radio

From the moment you install a "Cosmos" Component into your set, the difference in appearance and performance is remarkable.



THE "COSMOS" PERMACON.

Guaranteed accurate capacity, lowest possible losses and light in weight. Mica dielectric—each condenser tested at 500 volts. Nickel plated finish.



THE "COSMOS" RESISTANCE COUPLING UNIT.

Together with the "Cosmos" S.P. Blue Spot Valve, gives real purity of reproduction, far superior to that of L.F. Transformer Amplification.

Economical in first and operating costs, takes up little space in set, is sturdily constructed, has permanent resistance values, and allows for simple wiring.

PRICES :

THE "COSMOS" RESISTANCE COUPLING UNIT

Type "O" (Unit alone), 8/6
 Type "V" (as illustrated), 10/6

THE "COSMOS" RHEOSTAT

In the following types :
 Single Wound, 6'0 ohms, 1'0 amps., .. 4/6
 Double Wound, 2'0 ohms, '4 amps. or 34 ohms, '2 amps., 5/-
 Potentiometer, 300 ohms, 6/-

"COSMOS" PERMACON

·0001 mfd.	1/6
·0002	1/6
·0005	1/6
·0003 .. (with clips for grid-leak)	1/8
·001	1/8
·002	1/10
·005	2/8
·01	3/9

"COSMOS" ANTI-VIBRATION SPRING VALVE HOLDER

Price for Panel or Baseboard Mounting, each 2/9



THE "COSMOS" RHEOSTAT.

Sturdy construction and having a reliable smooth movement. Contact arm cannot be easily damaged owing to the unique design. Occupies small space, one-hole, fixing together with a handsome knob and dial.



"COSMOS" ANTI-VIBRATION SPRING VALVE HOLDER.

The shock-absorbing element in the "Cosmos" Valve Holder is a separate spiral spring for each leg giving maximum elasticity.

METRO-VICK SUPPLIES LTD.

(Proprietors : Metropolitan Vickers Electrical Co., Ltd.)

METRO-VICK HOUSE,

155, CHARING CROSS ROAD, LONDON, W.C.2.

HARDLY a Set is described in the Wireless press nowadays in which the Designer does not use and recommend T.C.C. Condensers. He knows that he is safe in specifying T.C.C., for the twenty years' Condenser experience behind it ensures a never-failing reliability. He knows that only the most exacting standard of accuracy can possibly pass the stringent T.C.C. tests. Follow the experts' lead—specify T.C.C. Condensers in your next set.

T.C.C. Condensers

Advt. Telegraph Condenser Co., Ltd. Wales Farm Road, North Acton. W.3. G.A. 8542

**Recommended and used by
Mr. PERCY W. HARRIS, M.I.R.E.
in the
T.C.C. H.T. ELIMINATOR**

The BRADLEYOHM TYPE F. RESISTANCE

10,000 to 500,000 ohms.

Here is the only Variable Resistance giving constant and unvarying plate voltage supply for H.T. Eliminators. The Bradleyohm No. 10 has a resistance of 10,000 to 500,000 ohms, and is used as standard equipment by all important Eliminator manufacturers. Read what Messrs. E. K. Cole, Ltd., makers of the well-known "ECKO" units, have to say:—"We should like to express our complete satisfaction with this component, as out of many similar articles we have had under test, it is the only one which has proved itself in every way suitable for our H.T. Units. We might especially mention that we have found the Bradleyohm constant as regards its current carrying capacity after being on test for 9 months." The scientifically treated Graphite Discs used in the Bradleyohm are the secret of its success.



Used as standard equipment by all large eliminator manufacturers. Type 10 E. 10,000 to 500,000 ohms. List Price 9.6 each.

The second new and enlarged edition of our 1927 Catalogue of high-class American Radio Apparatus and Circuit Supplement is now ready. Send 9d. in stamps to cover cost of postage and secure your copy of this most interesting 64-page list immediately.

ROTHERMEL

RADIO CORPORATION OF GT. BRITAIN, LTD.,
24-26, Maddox Street, Regent Street, London, W.1.
Telephone: Mayfair 578-9. Telegrams: "Rothermel, Wesdo, London."

PRICE
7/.

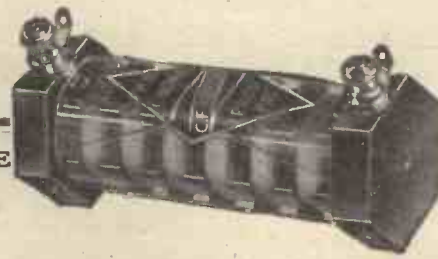

PRICE
7/.

—and now, the C.E. PRECISION H.F. CHOKE

A new C.E. PRECISION component which fully maintains the high standard of quality and workmanship associated with this name. The special method of manufacture ensures a maximum efficiency over a wide range of wave lengths, with a minimum H.F. resistance and self-capacity.

C. EDE & CO., Ltd., BYFLEET, SURREY.

There are also the C.E. Precision Rheostats, Dual Rheostats, Potentiometers and Grid Leaks. The C.E. Precision Floating Valve Holder, anti-capacity and non-microphon. c. is illustrated here; price 2/3 each.



Telephone:
Byfleet 226.

Telegram:
Ceprecise, Byfleet.

INDEX TO ADVERTISERS

Ashley Wireless Telephone Co., Ltd.	48	International Corres. Schools, Ltd.	61
Batteries, Ltd.,	64	Jackson Bros.	59
Bedford Electric and Radio Co., Ltd.	66	Liasen, Ltd.	38, 39
Belling and Lee, Ltd.	70	Makerimport Co.	70
Benjamin Electric, Ltd.	68	Marconiphono Co., Ltd.	1
Bird, Sydney S., and Sons.	45	Metro-Vick Supplies, Ltd.	51
Bowyer-Lowe, Ltd.	62	Mead Cycle Company	68
Brown, F. G., Ltd.	57	"Modern Wireless"	65
Burne-Jones & Co., Ltd.	60	Mullard Wireless Service Co., Ltd.	Cover ii
Carrington Manufacturing Co., Ltd.	61	New Times Sales Co.	67, 71
Caxton Wood Turnery Co.	71	Ormond Engineering Co., Ltd.	47
Climax Radio Electric, Ltd.	43	Peto-Scott Co., Ltd.	60
Collinson Precision-Screw Co., Ltd.	55	Pickett's Cabinet Works	63
Cossor, A. C., Ltd.	35	"Popular Wireless"	63
Dubilier Condenser Co. (1925) Ltd.	48	Pye, W. G., & Co.	63
Ede, C. & Co., Ltd.	52	Radio Instruments, Ltd., Cover iv	
Eton Glass Battery Co.	71	Raymond, K.	67
Forno Co., The	64	Rothermel Radio Corporation, Ltd.	52
Garnett, Whiteley & Co., Ltd.	Cover iii	S. T., Ltd. (Valves)	2
Gordon, Fredk. J. & Co., Ltd.	71	Taylor, C.	70
Graham Amplion, Ltd.	41	Telegraph Condenser Co., Ltd.	52
Gambrell Brothers, Ltd.	48	Vandervoll, C. A. & Co., Ltd.	59
Holzman, Louis,	61	Valco, Ltd.	64
Hamley Brothers, Ltd.	61	Varley Magnet Co.	67, 71
Igranic Electric Co., Ltd.	57	Weston Elec. Instrument Co., Ltd.	53
		White, Percy	71
		Wolff, M. and A.	48

Some interesting comments and jottings on the reception of programmes from British and Foreign Stations.

A LISTENER'S DIARY

From a Special Correspondent

Freak Reception—K D K A on a Crystal—Why not a "DX" Ballot?—The "Skip" Effect

READERS of THE WIRELESS CONSTRUCTOR probably know that a few weeks ago the "Daily Mail" organised a ballot in an attempt to ascertain what programme items were most popular with listeners. It has been pointed out before in this journal that the B.B.C. have admitted that they have been influenced in the arrangement of their programmes by the requests made by listeners who write to them, and they have also admitted that they often receive "some thousands of letters a week."

A Vote for More Fun

We have suggested that "some thousands of letters a week" is rather vague; and in any case even a thousand letters a day would not offer a real indication of the needs of the majority of listeners, seeing that there are over two million licenced listeners in the country and, with an average of three in the family who listen to the programmes, that means at least six million people who are interested, to a greater or lesser extent, in the quality and general arrangement of broadcasting programmes.

But the result of the "Daily Mail" ballot is of general interest to all who care two pins about the programmes broadcast by the B.B.C., for 1,285,083 listeners took enough trouble to enter the competition and to vote. The result of the voting is shown in the table printed below, and a cursory glance at it will show that it really means a vote for two main things: (1) For more fun in the programmes; and (2) for fewer features which need sustained attention. The figure of 1,285,083 is a big one, and it cannot be ignored, for it is quite reasonable to suppose that more than one member in a family had a hand in deciding how the votes should be recorded when sent in. Supposing the number of votes is multiplied by

two, that gives us a figure of 2,570,166, which is substantial.

The B.B.C. are to be congratulated on their promise to translate the voting into programmes based on the wishes expressed by listeners who entered the "Daily Mail" competition, and these special programmes will commence on April 25th.

Attempts have been made before to ascertain by ballot the needs of listeners, and although much interesting information has been gained, it has really been of no value, owing to the smallness of votes compared with the number of listeners. But in this latest ballot, the voting was comparatively heavy and there seems to be no doubt about it that variety and concert parties are the most popular features among the majority of listeners.



Attitude and Altitude! Suspended high in the air this workman is shown tightening up the mast of the new Langenburg station.

Between the first and second items there is a difference of 60,000 or so in the voting, while readings and recitations come last in popular favour. Talks, scientific and informative, come a little higher on the list than we anticipated, but the low position in the voting of long plays will not come as a surprise to many people.

Although, perhaps, not so valuable, it would be very interesting to take a ballot among DX listeners with regard to the reception and popularity of continental and other stations, for these days there can be no doubt that DX listeners are becoming more and more numerous.

The Editor frequently receives letters from readers giving details of excellent results obtained with one or two valve sets from stations far distant from this country.

And numbers of letters are also received dealing with quite startling feats of freak reception. A recent example, which was given some publicity in the Press, was a listener's report that he had received Madrid in this country with the simplest of crystal sets. Other letters from readers state that they have heard Berlin and Vienna on crystal sets.

A Classic Example

Possibly the most curious example of freak reception is one which occurred about two or three years ago when KDKA was working on 320 metres. There is no doubt about it, this station was heard in Great Britain on a crystal set, and it is one of the classic examples of freak reception. Of course, our readers are aware that the crystal will not rectify or give signals which can be heard unless the voltage changes applied to it exceed a definite minimum value, and from that it can be shown, quite easily, that the required voltages cannot be produced by any station of a stated

A Listener's Diary—continued

power at more than a certain distance under normal working conditions.

The Madrid station, for instance, was received on a crystal set, but at the same time it was far beyond the range of the normal working of a crystal set for reception in this country, for with the exception of, say, 5XX, a crystal set cannot give reception at distances more than fifty miles or so under normal circumstances.

KDKA on a Crystal

KDKA was received "at a distance of 3,000 miles" on a crystal set; and all these feats have, from time to time, given the newspapers a good deal of cause for exciting comment. But, for instance, in the case of KDKA, reception was not at a distance of 3,000 miles, nor 3,000 yards, nor 3,000 feet. What really happens in nearly every instance where the crystal set has received signals at these freak distances, is that there has been a valve set in the immediate neighbourhood receiving the same transmission, and the operator of that set has worked his receiver while it was slightly oscillating. Therefore, the valve set's aerial played a dual role and became a collector and radiator of oscillations and these radiations were picked up by a nearby crystal set.

**"DAILY MAIL" BALLOT.
HOW LISTENERS VOTED.**

Order.	Item.	Subject.	Votes Cast.
1	No. 12	Variety and Concert Parties	238,489
2	" 3	Light Orchestral Music	179,153
3	" 4	Military Bands	164,613
4	" 8	Dance Music	134,027
5	" 14	Talk : Topical Sports and News	114,571
6	" 1	Symphony Concerts	78,781
7	" 7	Solos : Vocal and Instrumental	72,658
8	" 5	Opera and Oratorio	60,983
9	" 16	Outside Broadcasts	51,755
10	" 10	Short Plays and Sketches	49,857
11	" 13	Talk : Scientific and Informative	30,919
12	" 6	Glees, Choruses, Sea Shanties	30,445
13	" 2	Chamber Music	27,467
14	" 11	Revuees	27,059
15	" 9	Long Plays	17,576
16	" 15	Readings and Recitations	2,717
Free votes not recorded			4,013
			1,285,083

Listeners were given a form containing the names of sixteen different types of programme material, and voters were asked to indicate those items they preferred, apart from the forecast. The result of the voting in these "personal preferences" is given in the above table.

There is one further explanation of freak reception which often applies when crystal reception takes place from say Hamburg, Madrid or Paris. A peculiar irregularity in the Heaviside layer may temporarily create a kind of concentrating "mirror," throwing a beam of energy on to the area in which reception is abnormally

good, just as Marconi's beam reflectors increase signal strength many times.

Freak results can be obtained also with a valve set if there is another unstable valve set being used in the immediate vicinity and which the operator is mishandling to the extent of producing slight oscillation.

It must be remembered, also, that a valve receiving set can produce very peculiar effects upon the signal strength of other sets in the neighbourhood, and sometimes over a very large area, even though that particular set is not oscillating so strongly as to create audible noises. The set can absorb energy, acting as a kind of wave trap, and when this occurs the alteration of the tuning controls may cause a crescendo and diminuendo in signal strength in other receivers.

The "Skip" Effect

These curious increases and decreases in signal strength have often been noticed by amateurs and have given them, no doubt, a good deal of food for thought, and possibly some worry in connection with the efficiency of their sets, while all the time the trouble has been due to a neighbour's valve set.

Another freak effect which sometimes gives rise to abnormal reception, is due to what is known as the

(Continued on page 69.)

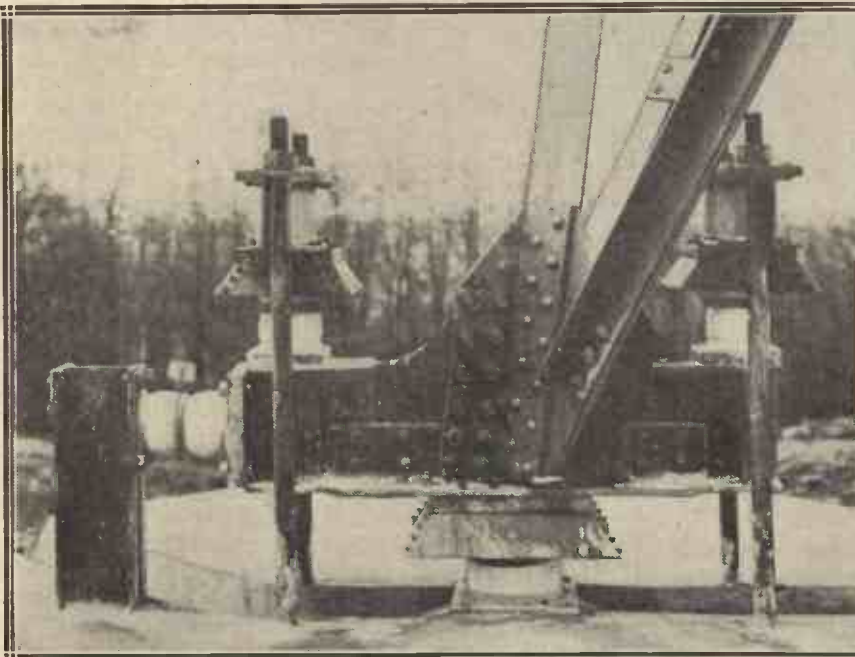

This illustration shows how the giant masts of the Langenburg (Germany) station are anchored.



A Copy for the asking

BY sending three halfpenny stamps to cover cost of postage and packing we shall be pleased to post to you ONE FREE COPY of the most valuable book describing the standard coils for every modern type of receiver. Pin Connections are given for every type of Standard Six Pin Coil.

COLVERN COILS

☐ The former is constructed of the highest quality genuine moulded Bakelite, ensuring a completed inductance of extremely low high-frequency resistance.

☐ Colvern Low Loss Inductance Formers may be purchased in two styles; wound to standard specifications, or unwound for home-winding.

☐ Supplied in varying types to suit every purpose—for use with or without standard screened coils.

☐ Wound on costly and extremely accurate machinery which permits the production of space-wound coils to a high degree of uniform accuracy.

☐ The only Skeleton Six-pin Former fitting into Skeleton Base with a consequent higher ratio efficiency than any other similar type of coil.

☐ Universally approved by the expert set designers on the Press and with leading manufacturers.

☐ The only range of coils allowing the use of an interchangeable primary winding.

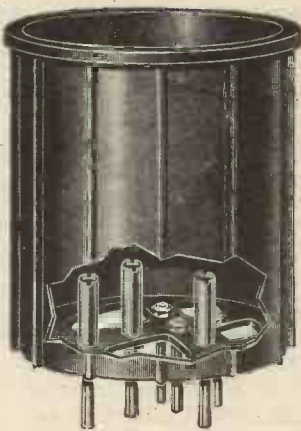

This reproduction indicates the internal pin arrangement of the Colvern Featherweight Former to accommodate the Colvern Interchangeable Primary.

THE COLLINSON PRECISION SCREW CO., LTD., Provost Works, Macdonald Rd., WALTHAMSTOW, LONDON, E.17.



TEST UNDER WORKING CONDITIONS

It is essential that the variable voltages applied to a radio set, which are under your own control, must be regulated while the set is actually in operation. Open circuit tests, that is, tests made direct from the battery terminals, are useless, as the voltage drop due to resistance in the circuit is very misleading.

In order to ascertain correctly the actual voltage applied to the valve electrodes readings must be taken from different points in the circuit with a Weston Model 506 Pin Jack Voltmeter, which is supplied with a High Range stand, Pin Jacks and Long Testing cables. These enable you to reach any part of the set and take accurate high and low tension readings.

For voltage adjustments which, you must remember, are equally as important as tuning adjustments, only a Weston instrument is sufficiently accurate to be of any use. Weston Instruments are standard the world over, and on their unvarying reliability you may depend entirely for more economical and efficient operation of your set. Full detailed information supplied on request.

WESTON Model 506 Pin Jack Voltmeter

Price complete with testing cables

£2 : 10 : 0

WESTON
STANDARD THE WORLD OVER.
Pioneers since 1888

Weston Electrical Instrument Co. Ltd.

15, Gt. Saffron Hill,
London, E.C. 1



WITH the steady reduction in current requirements of modern valves has come a growing demand for small accumulators capable of delivering sufficient current for two or three valves consuming but a tenth of an ampere each. The Oldham O.V.D. cell, a two-volt unit selling at 5s. 6d. is a well-made accumulator, capable of supplying a single two-volt, 1 amp. valve for 100 hours without a recharge, or more valves for a proportionately

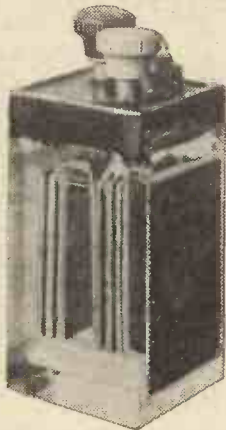

In this accumulator (Oldham O.V.D.) the negative and positive plates are not interleaved, but are made up into two separate blocks.

reduced time. The average man rarely uses his receiver for longer than three hours a night so that the battery in question can be relied upon to supply three valves, using one-tenth of an ampere for practically a fortnight without a recharge. A special feature which commends itself to us in regard to this battery is the ability to stand a fairly heavy rate of charge, a very important point in these days when most accumulator charging stations seem to charge all accumulators, whatever their size, at a uniform rate to suit their own convenience. The makers claim that the cell can be charged in eight hours, but in our laboratory it has been charged on more than one occasion with a higher rate than this without any apparent injury. An examination of the photograph will show two sets of plates. Whereas the usual accumulator has positive and

A MONTHLY REVIEW OF TESTED APPARATUS.

(NOTE: All apparatus reviewed in this section each month has been tested in the Editor's private laboratory, under his own personal supervision.)

negative plates interleaved, in the O.V.D. three positive and three negative plates are made up into two separate blocks so as to allow a penetration of acid without any risk of short circuit in between plates. The container is of stout glass, and large insulated terminal knobs are fitted. A soundly made accumulator which can be recommended to all dull emitter users.

Filling Funnel

Messrs. A. J. Dew & Co., have sent us a funnel which should prove of particular utility for filling accumulators.

Constructed of a clear compound similar to celluloid in appearance, it remains unaffected by acid, while the diameter of the stem is of a size suit-

able for introduction in the vent holes of most accumulators.

This funnel is certainly a useful accessory to have handy when it is required to pour acid or distilled water into accumulators, since it



Another (rear) view of the National Illuminated Vernier Dial.

enables the job to be done quickly and without spilling.

A Useful Twin Condenser

A particularly handsome and well-made twin condenser, the two parts of which can be tuned together or separately at will by means of an edgewise control, is the "Bruno," of American origin, and sold in this country by The Rothermel Corporation, Ltd. In the United States there is a growing popularity for edgewise control by means of a drum projecting through the front of the panel, a method which, in our opinion, has much in its favour. Although there are several condensers of this type on the American market, all are not

(Continued on page 58.)



The National Illuminated Vernier Dial, reported upon in our last issue.



Now they have music whenever they want it

TIME was when they had to wait till Father came home. They couldn't have day-time Wireless then, for no-one could operate the complicated valve set. All that is altered, nowadays. Now they have music whenever they want it. There is no secret about it either; its just that wonderful **BROWN** Ideal Wireless Set, you know.

Even the kiddies can work a Loud Speaker with this new Set . . . it's so simple. It has, in fact, changed the whole idea of Wireless. All valves and accumulators are dispensed with; first cost is, thus, last cost—except for an inexpensive 4½ volt dry battery which last for months. Nothing can go wrong—nothing ever needs replacing.

New radio joys await you if you live within 15 miles of a B.B.C. Station (Darenty 30 miles)—the range of the **BROWN** Ideal Wireless Set. Complete with outdoor or indoor aerial and **BROWN** Loud Speaker, £12 10s. There is also a model with Frame Aerial and **BROWN** Loud Speaker (range, 3 miles B.B.C. Station and 18 miles Darenty). Price, £15.

S. G. BROWN, LTD., Western Avenue, North Acton, W. 3
Retail Showrooms: 19, Motimer Street, W. 1; 15, Moorfields Liverpool.
67, High Street, Southampton. Wholesale Depots throughout the Country.

Brown

IDEAL WIRELESS SET

'Simpler even than a Gramophone'

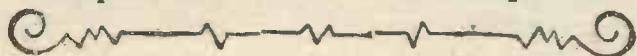

G.A. 8419

*This transformer gives
you correct voltage
for your*
K.L.1 VALVES



**IGRANIC-PACENT
FILAMENT TRANSFORMER**

You do not need rheostats to reduce output voltage for your K.L.1 Valves if you use an Igranic-Pacent Filament Transformer.

This transformer gives the correct 3.5 voltage specified by the valve-makers, and this remains constant whether one or four valves are used.

The shrouding prevents A.C. hum. Input terminals are sunk to obviate risk of shock. Made in two patterns for 100 to 110 volts and 200 to 220 volts. Both types are suitable for operating one, two, three, or four valves.

Price 30/-

Write for list J.232.



149, Queen Victoria Street, London.
Works: Bedford.

What's New—continued

mechanically sound, as we know from our own tests. The "Bruno," however, is particularly strong and well made—in fact, critically examined, it will give pleasure to anyone who delights in examples of sound construction. The two halves of the condenser, or rather one should say the two separate condensers, are mounted on a cast aluminium frame, and the two drums with knurled edges are brought through an ornamental "window"

over this figure and thus a margin of safety is provided.

Manufacturers would do well to realise that when purchasing a condenser of a nominal rating the buyer has a right to expect that this figure will be attained.

Another Condenser.

A well designed inexpensive condenser of the modern low-loss type

capacity .0005 mfd. was found to be accurate and the one-hole-fixing method gave quite satisfactory results. This condenser can be recommended to those who require an inexpensive

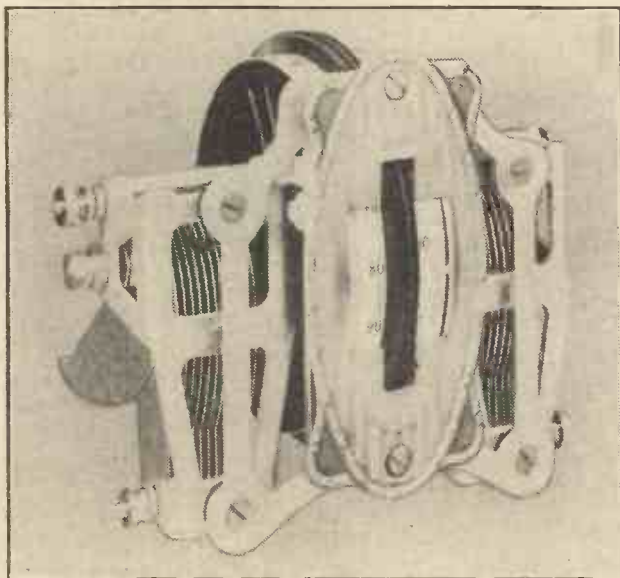

To left and right are photographs of the "Bruno" twin-condenser, each half of which (capacity .0005 mfd.) can be rotated separately if desired. This condenser is very well made, and forms a useful accessory.

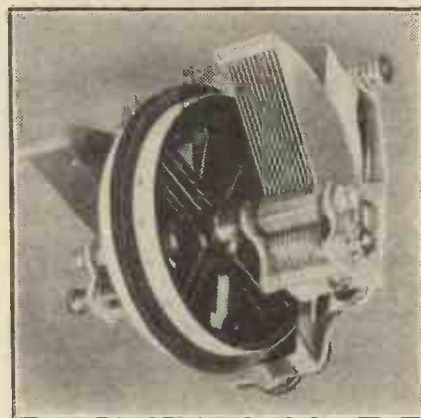

yet efficient instrument for incorporation in any published design.

The same makers have submitted a series of grid leaks which, being rather better made than many now sold, are shown in a dissected form. Practical measurements showed the actual resistance of a grid leak rated at 2 megohms—the most popular variety—was sufficiently near the rated figure to give satisfactory results. A nominal 1/2-megohm leak was within a 20 per cent. accuracy, but a 5-megohm nominal was outside the even rough-and-ready limits one generally associates with commercial grid leaks.

of antique finished bronze. This window also acts as a drilling template for the two securing screws holding the parts into the panel. The condensers themselves have brass vanes and are of the straight-line frequency type. Nominally rated at .0005 mfd. each, on actual test they were found to measure just slightly

is that submitted to us by the maker of the "Etherplus" brand of wireless components. The design is sound electrically and mechanically, and on practical tests in a receiver was found to operate smoothly and silently, positive contact between moving plates and frame being made by means of a pigtail. The rated

Useful Jacks and Switches

Messrs. Garnett, Whiteley & Co., Ltd., who are well-known for their "Lotus" valve sockets, produce an
(Continued on page 60.)



The Etherplus grid leak, in dissected and complete forms.

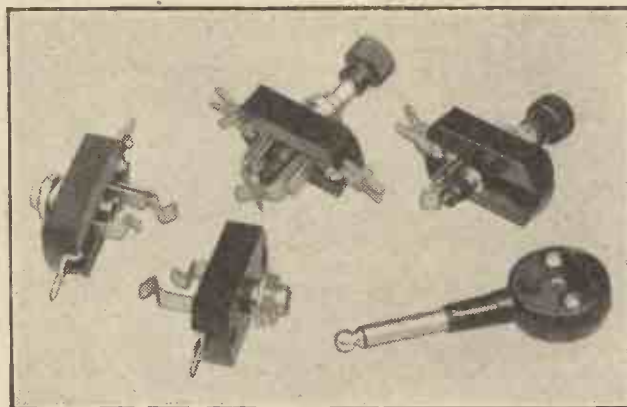

Examples of useful "Lotus" components.

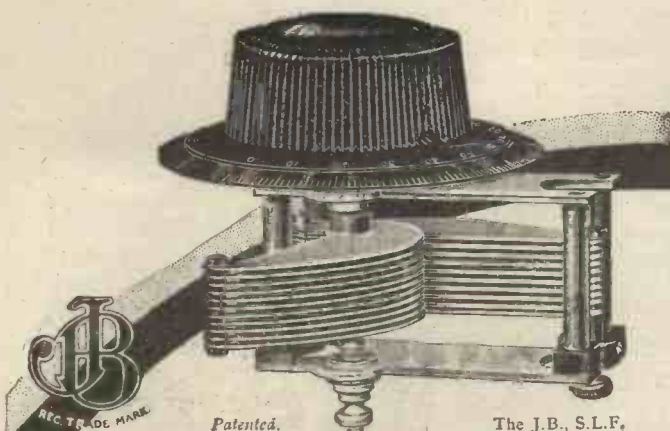

Patented.

The J.B., S.L.F.

J. B. Condensers for the MULLARD P.M. CIRCUITS

No matter what set you build, insist on J.B. Condensers for real efficiency in tuning.

J.B. True Tuning S.L.F. Condensers are ideal for the "COMBINE 5." Wireless enthusiasts who are interested in short wave Receivers cannot do better than use the specially designed .00015 mfd. J.B. Models.

The J.B., S.L.F. complete with 4 in. Bakelite Dial

- .0005 mfd. .. 11/6
- .00035 mfd. .. 10/6
- .00025 mfd. .. 10/-

For Short Wave Receivers

- .00015 mfd. .. 10/-

The J.B. True Tuning S.L.F. complete with 4 in. Bakelite Dial

- Double reduction friction drive, ratio 60-1, eliminating all possibility of backlash.
- .0005 mfd., 16/6; .00035 mfd. 15/6; .00025 mfd. 15/-
- For Short Wave Receivers .00015 mfd. .. 15/-

JACKSON BROS.
8, POLAND ST - OXFORD ST
LONDON - W.1. Telephone: - GERRARD 7414

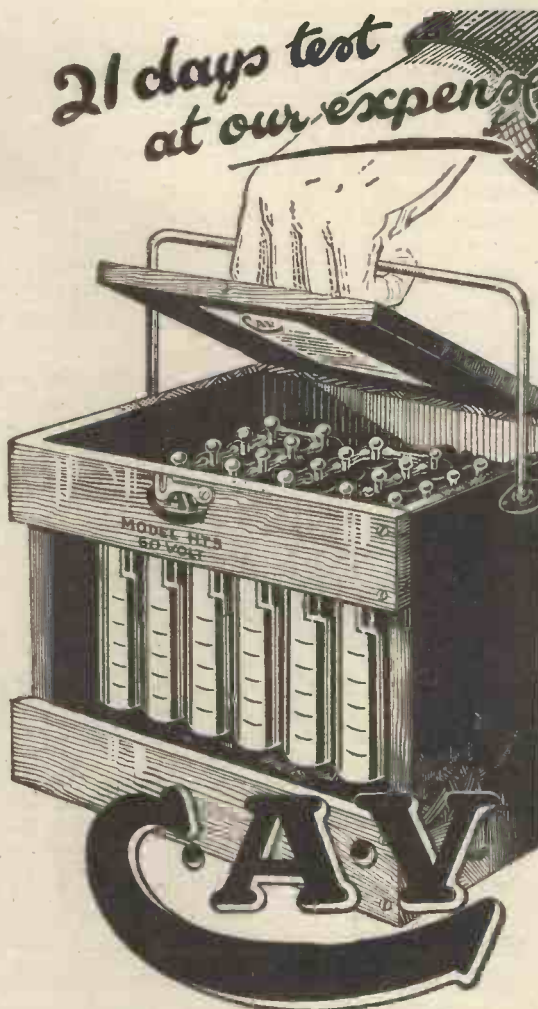

21 days test at our expense



1927 IMPROVED MODEL H.T. ACCUMULATOR

TO prove our absolute confidence in these accumulators, we guarantee, if you are not satisfied, to accept return within 21 days from purchase date, and refund money in full provided battery is returned intact to the Agent from whom it was purchased.

C.A.V. H.T. Accumulators represent an epoch-making advance as compared with dry batteries. When dry batteries are down they are done, and frequent renewals make them more expensive. C.A.V. H.T. Accumulators will last for years, and only need recharging approximately every four months. They give bigger volume and are silent in operation. Every Accumulator is supplied fully charged ready for use, absolutely complete in case, and with distilled water filler, all included in the price, viz. : **Model H.T.3.**

60 Volts 60/-

Size 8½ ins. by 7 ins. by 7½ ins. high.

30 and 90 volts also supplied at pro rata prices

Catalogue supplied on application.

C.A.V. Vandervell & Co., Ltd.
ACTON, LONDON, W. 3.

Telephone: Chiswick 3861 (Private Branch Exchange)

Telegrams: "Vanuvia-Act-London"

£1 DOWN!



EMERALD WAVEMETER

Patent Nos. 28566/25; 30172/25; 10326/26.

A Precision Instrument of Laboratory Standard.

DIRECT READING - NO CHARTS REQUIRED.

Every instrument calibrated by Capt. Tingey, M.I.R.E., against a Quartz Crystal specially tested by the N.P.L. Accurate to one-sixth of one per cent.

EXTREMELY versatile in its many applications, and undoubtedly the best wavemeter ever offered to the public, this splendid instrument should be in the hands of every radio enthusiast. A folder giving full details is available and will be sent free on application.

DON'T DELAY - WRITE TO-DAY.
New Times Sales Co.,

77, City Road, London, E.C.1.

P.S. 8133

700 LAUGHS FOR 7d.

Buy the **MERRY MAG.**

Best Stories, Jokes, and Pictures for Holiday Reading.

Now on Sale, 7d.

WHAT'S NEW

—concluded from page 58

excellent and very useful line of jacks and jack switches adaptable for a wide variety of purposes in radio-set construction. Some of the types will be seen from the photograph (on previous page). In general, the push-



One of the "Wearite" Binoocular Coils, (a report on which appeared on page 522 of last month's "Wireless Constructor.")

pull variety of switch consists of a robust moulded Bakelite block, with a plated one-hole-fixing bush and nut, and a convenient knob. At the back of the block are fitted the spring contacts

of the usual jack switch type, a wide variety of switches being obtainable. These switches can be recommended to readers as sound, well-made components.

We have also tested a well-made "Lotus" line of jacks in all of the usual forms, i.e. open circuit, closed circuit, double circuit, with and without filament control, etc. These can be used in any set where jack switching is called for. As the "Lotus" jacks do not project so far from the back of the panel as most makes, they can often be used in converting a set where space does not permit of the ordinary type being fitted.

A New Vernier Dial

An interesting vernier dial of rather unconventional yet pleasing appearance is the Kurz-Kasch, an American production sold in this country by the Rothermel Radio Corporation. It is known as the "Aristocrat," and is moulded from Bakelite. The vernier ratio is 14—1, and the appearance of the instrument is rather enhanced by the absence of the customary central metal boss taking the end of the condenser shaft. The shaft itself is gripped by a split bushing—a

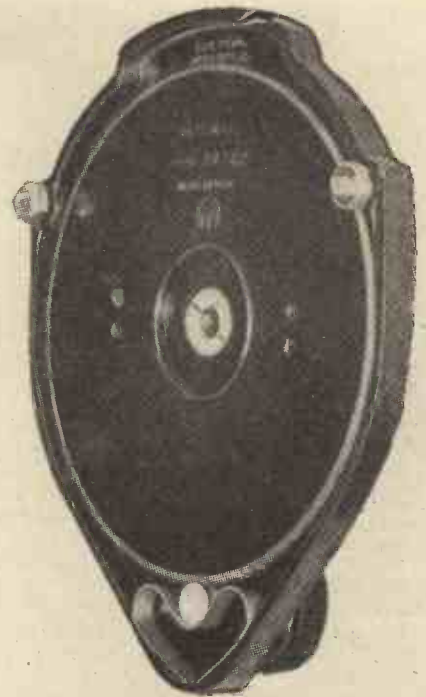

Owing to a transposition of instructions the photograph of the front of the Kurz-Kasch dial appeared in our last issue in the report of the International velvet vernier dial. A photograph of the back of the Kurz-Kasch dial is reproduced herewith.

good scheme—preferable to the conventional grub screw method.

MAGNUM SCREENED COILS

REDUCED PRICE

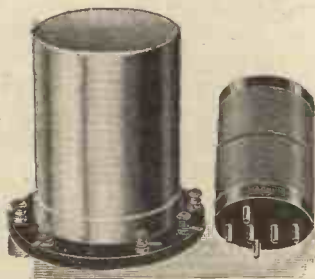

No. 1050.

NEW STANDARD COILS AND PRICES.

MAGNUM Screening Box, complete with 6-pin base (Standard spacing and cross formation). 12/-.

Split Primary, Split Secondary, Reinartz and Aerial Coils at standard prices.

Construct the Razor-Sharp Wavemeter

as fully described in R.P. Envelope No. 14. Price 1/6.

Complete set of parts, including 2 coils £4 4 0

Or the Instrument ready wired and tested £5 0 0



CONSTRUCT The "SIGNAL BOX"

as described in this issue by Mr. PERCY W. HARRIS.

1 Mahogany cabinet with baseboard	£1 16 6
1 Ebonite Panel, 24 x 7 x 4, ready drilled	14 0 0
3 Magnum Resistors and bases	7 6 0
1 Magnum Neutralizing Condenser	5 0 0
1 Magnum S.S. H.F. Transformer	10 0 0
1 Magnum S.P. H.F. Transformer	10 0 0
2 Magnum Angle brackets	2 6 8
3 Magnum "Vibro" Valve holders	7 6 8
5 Magnum Engraved Terminal Panels	6 3 3
2 6 Pin bases	3 0 0
1 Ormond Geared Condenser '0005	15 0 0
2 Ormond Geared Condensers '0003	1 9 0 0
3 Push-Pull switches	4 6 6
1 Carborundum Crystal detector and battery	12 11 0
1 M.H. Choke	9 0 0
1 M.H. Condenser '001 and base	4 0 0
1 R.I. Multi Ratio Transformer	1 5 0 0
1 Ferranti A.F.3 Transformer	1 5 0 6
1 Gambrell Neutrovernier	5 6 6
1 Varley Resistance and base	7 6 6
1 Dubilier Condenser type 610	3 0 0
Glazite	2 4 4
	£12 5 0

Any of above parts supplied separately as required. NOTE.—"Fall Front" Cabinet can be supplied in lieu of above. Price 60/-.

NOTE.—Where a complete set of parts is ordered Marconi royalties at 12/6 per valve holder are payable. Send stamp for comprehensive range of lists, including latest star sets described in several Radio publications.

BURNE-JONES & CO., LTD.,
Manufacturing Radio Engineers,
MAGNUM HOUSE,
288, Borough High St., London, S.E.1.
Telephone: Hop 6257.
Telegrams: "Burjomag, Sedist, London."
Cables: "Burjomag, London."

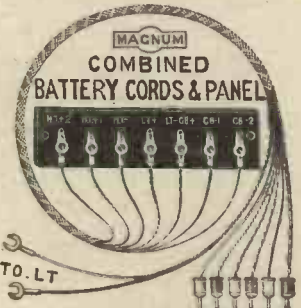

A new development in Battery Connections, obviating terminal panels and permitting of sub-baseboard wiring. Price **7/6**

MAGNUM CALIBRATED RHEOSTAT
FOR BASEBOARD MOUNTING.



The solution to the controversy which has been raging for some time past as to the relative merits of Fixed and Variable Filament Resistances. The New Magnum Calibrated Rheostat combines the advantages of both types. As will be seen from the illustration the Resistance value is variable from Zero to Maximum, the 6 ohm type being marked off in steps of 1 ohm each, the 30 ohm type in steps of 5 ohms each. It is only necessary to ascertain the resistance required for the particular valve used; the rheostat is then set at that value. When changing to another type of valve, the purchase of an extra Resistor is unnecessary.

Price No. 1, Zero to 6 ohms, 3/-
,, No. 2, Zero to 30 ohms, 3/-

For Better Radio
Hammarlund
PRECISION
PRODUCTS

"MID-LINE" CONDENSER

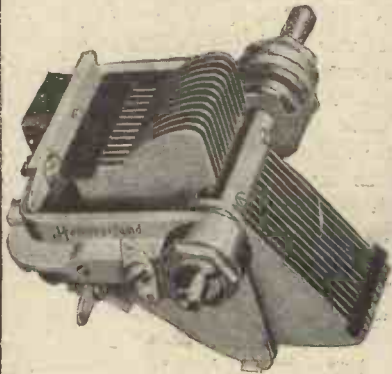

Don't be Misled!

The so-called "Mid-line" Condenser is not new. It was originated almost 12 months ago by the Hammarlund Manufacturing Co., makers of Precision apparatus, who were the first to produce this new type of condenser, which overcomes the shortcomings of other types. The same condenser was advertised by us first in October, 1926.

ALL of the established Hammarlund features are included: soldered, non-corrosive brass plates with tie-bars; rib-reinforced aluminium alloy frame; minimum dielectric; one-hole mounting with anchoring screw; bronze clockspring pigtail; friction band brake that places no strain on bearings.

In addition, there are two new advanced features: Adjustable ball and cone bearings and a full-floating rotor shaft. This shaft supports no weight. Its length may be adjusted without cutting to accommodate any type of dial. It may be entirely removed and a longer shaft (metal or bakelite) inserted for coupling other condensers in tandem—for mounting a variable primary coil, or gears or pulleys or cams for operating individual condensers in multiple.

This removable shaft also makes it possible to mount the condenser for either clockwise or counter-clockwise operation, without affecting its efficiency in any way. The condenser frame is drilled for either panel or baseboard mounting and also provides for the direct attachment of coils.

These exclusive features make the Hammarlund "Midline" the world's first universal condenser, readily adaptable to any and all conditions.

The "Midline" is much more compact and even stronger than previous Hammarlund models. The span of the condenser, with plates fully open is only 4 inches.

STOCKED IN THE FOLLOWING SIZES:

•000275 Single - 24/-	•00035 Dual - 43/6
•000275 Dual - 26/6	•00005 Single - 26/6
•00035 Single - 25/-	•00005 Dual - 44/6

REFUSE SUBSTITUTES! INSIST ON THE ORIGINAL!

The 2nd edition of our 1927 Radio Catalogue is now in the press. Send a P.C. for copy to be sent you when ready. It is fully illustrated and printed on fine art paper and costs you nothing!

Hamley's
ESTD 1760
HAMLEY BROS. LTD.

Telephone: Regent 3160 (6 lines)

Telegrams: Pleasingly, Picky.

200-202, REGENT STREET, LONDON, W.1.

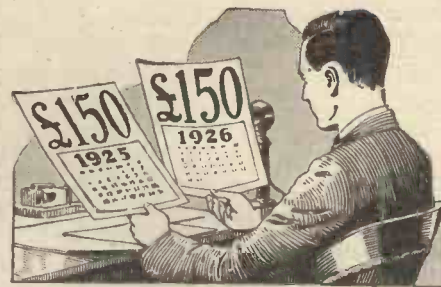

"Two years' delay cost me £300"

"I was £3 a week poorer for fully two years because I hesitated so long about

starting an I.C.S. Course. That's clear enough. Since I wkoed up and began my vocational training with the I.C.S. I've been given a rise of £150 a year, but I'm certain I would have got it two years sooner had I started my I.C.S. Training when I first thought of its possibilities.

"It's strange that so many young men fail to see that they don't get more money because they don't qualify for it—that they are losing £ s. d. all the time through neglecting to obtain a special training."

Get out of the rut by taking an I.C.S. Course. It will provide you with a sound and practical training in your own home and in your own time, all by correspondence and at a cost well within your means. There are no real difficulties and no heavy demands upon your time. The I.C.S. method is simple and practical. Let us tell you just how you can use it to your own great advantage.

Write to-day for full information as to how the I.C.S. can help you in your chosen vocation. There are 360 I.C.S. Courses, of which the following are the more important groups:—

The I.C.S. is the oldest and largest correspondence school in the world

WIRELESS ENGINEERING (an entirely new Course)

- | | | |
|---|---|---|
| Advertising
Architecture
Building
Commercial Art
Commercial Training
Draughtsmanship | Engineering (all branches)
French and Spanish
General Education
Market Gardening
Plumbing | Professional Exams.
Salesmanship
Showcard Writing
Textiles
Window Dressing
Woodworking |
|---|---|---|

(Please mention the subject in which you are most interested.)

International Correspondence Schools, Ltd.
172, International Buildings, Kingsway, London, W.C.2

HYDRA CONDENSERS
will stand a peak pressure of 600 volts D.C. Voltage. In your set they make all the difference and absorb all the cracking and noise from your dry battery. All capacities up to 10 mfd. 2 mfd. 3.9, 4 mfd. 6/-, etc., etc. From your dealer or direct from

Louis Holzman
109, KINGSWAY LONDON W.C.2
PHONE: HOLBORN 6209

THE FINEST CONDENSER MONEY CAN BUY

CUT THIS OUT FOR CABINETS

and post to us for FREE list illustrating Cabinets as shown in "Wireless Constructor," etc., etc., and for our additional Bulletin No 2.

NAME.....
ADDRESS.....



(Write in block letters, please.)
CARRINGTON Mfg. Co. Ltd.,
Camco Works,
Sanderstead Road, South Croydon.
Trade enquiries especially invited.
Telephone: Croydon 0623 (2 lines).

THE "SIGNAL BOX"

-continued from page 10.

the sharper tuning that you need. Normally you will not want to use it, but occasionally you will need it, so the on-and-off switch is provided for bringing it into circuit in a moment.

Although there are three dials, tuning is effected solely on the first two, the third serving for reaction. I can say unhesitatingly that I have never before handled a receiver in which the reaction control is so delightfully smooth.

Once the detector potentiometer has been set at its best position (I will tell you how to do this a little later), the reaction control is so smooth that the usual "plonk" when the set goes into oscillation is entirely absent, the only sign of oscillation being the distortion of the signals and the carrier-wave whistle.

Components Used

A list of components actually used is given in the attached table. While any good make of variable condensers can be adopted, with any good fixed

resistors, valve-holders, radio frequency choke, on-and-off switches, etc., I recommend you to take particular care in choosing the bases for the six-pin coils, and the neutralising condensers. Choose neutralising condensers which are uniformly progressive in their capacity variation. The newer types have a plunger which is moved in or out of a metal cylinder, thus giving a uniform increase of capacity from one end of the scale to the other; or else small moving plates which are interleaved with fixed. I have used one of each kind in this set and I prefer the plunger type for the actual neutralising.

Transformer Connections

You may wonder why the first condenser has a value of .0003 mfd. and the second .0005 mfd. The reason is that the split secondary windings were designed for use with a double .0005 condenser (giving an effective tuning capacity of .00025 mfd. only) while the split primary type were designed to tune with a single .0005 mfd. condenser. By using the .00035 mfd. we are sure of covering an adequate range with the split secondary, while the .0005 condenser, of course, suits the split primary winding.

An advantage of using these coils

without screens, where possible, is that the tuning range for a given coil is far greater. In the adjoining table you will find the dial readings for 24 stations I have picked up on the loud speaker in one evening, from which you will see that a really excellent tuning range is available.

Do not attempt to vary the layout of this receiver in order to adapt it to some particular panel or cabinet you have on hand. The spacing of parts is most important, and the simple wiring so obtained is one of the reasons for the success of the instrument.

The wiring diagrams and photographs will show you clearly what to do, and in fact the wiring up of the set is particularly easy, as so many leads are short and direct. If you use a transformer other than the R.L. connect O.S. to grid, I.S. to I.P., and O.P. to crystal. When you test out the receiver try these connections first of all and then try connecting I.S. to O.P., and I.P. to crystal. Which of these two connections will work the better you must find by trial.

Choice of Valves

The first valve can be any good H.F. valve, and although the set

(Continued on page 64.)

A Well Built Precision Instrument

PURE REPRODUCTION versus MUSH

If you want pure reproduction and not mush, you must use Bowyer-Lowe Super-Heterodyne Transformers which are world famous for their silent background.

Each set of Transformers is complete with instruction booklet, illustrating how to construct a 7 valve set.

Send for Full Particulars.

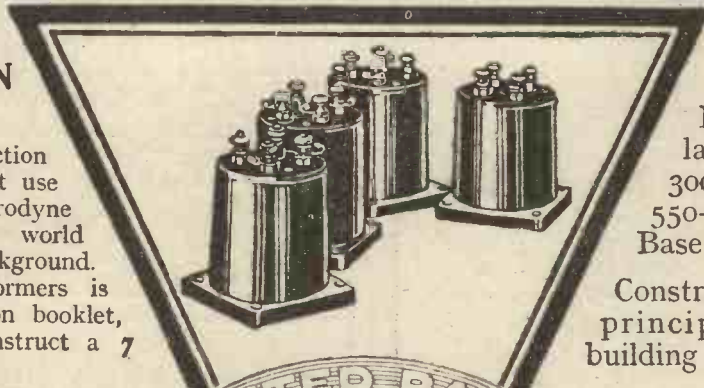

Set of 4 Transformers
£4-0-0

Interchangeable Oscillator Couplers—

300-600 metres **£1-0-0**
550-2000 " **£1-0-0**
Base - - - - **4-0**

Constructor's Kit containing principal components for building a 7 valve set
£10-0-0



ANNOUNCEMENT BY THE BOWYER-LOWE CO LTD LETCHWORTH HERTS

THE HALL MARK



OF QUALITY.

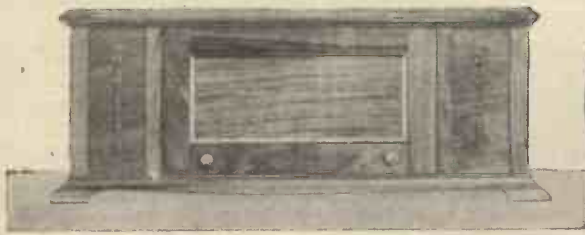

FIVE VALVE RECEIVER

No. 750. Showing Door Closed

This receiver is a very handsome piece of furniture and its circuit of two stages of balanced high frequency, detector and two stages of low-frequency ensure selectivity, ease of tuning and faithful reproduction.

PRICE £32 - 10s. Royalties £3 - 2 - 6

PORTABLE



No. 750. Showing the unique disappearing door open. These receivers are fitted with the FAMOUS PYE I.F. DISTORTIONLESS TRANSFORMERS.

NOW REDUCED IN PRICE

2.5:1 17/6

4.0:1 17/6

6.0:1 £1

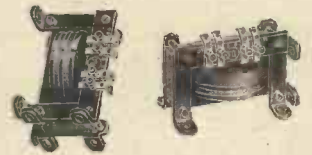

RECEIVER

This No. 555. Five Valve Portable Receiver of extremely efficient design and first class finish, receives Daventry anywhere in the British Isles. No AERIAL or EARTH are required, it being self-contained. Its simplicity makes it ideal for Motorists, Yachtsmen, Bungalow dwellers and Picnic Parties.

OUR COMPLETE CATALOGUE
WILL BE SENT ON APPLICATION

PRICE - £30 - 12 - 6
Complete with all accessories and Royalties Paid.

W. G. PYE & CO., Estd. 1893
CAMBRIDGE, ENGLAND.

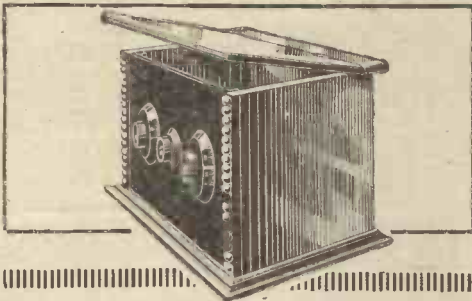

Popular Type.

ARTCRAFT CABINETS FOR RADIO RECEIVERS.

Artcraft Cabinets are made in Oak or Mahogany, properly hand French Polished, and are of very attractive and pleasing design. BETTER VALUE IS UNOBTAINABLE.

WRITE NOW for ILLUSTRATED CATALOGUE. POST FREE. All Artcraft Cabinets are guaranteed.

"Artcraft Popular Type" Cabinets		
Panel Size Depth	Price in Oak	Price in Mahog.
9 x 6 x 6	6/0	10/0
10 x 8 x 6	8/0	12/0
13 x 6 x 6	10/0	14/0
12 x 10 x 8	12/0	16/0
14 x 10 x 8	14/0	19/0
16 x 8 x 8	14/0	19/0
18 x 12 x 9	21/0	29/0

Baseboards Free. Hinged Lids 1/6 extra.

EBONART, RADION AND RESISTON Panels supplied and fitted free at standard prices.

Owing to increased railway charges enclose 1/- extra for crate. All above Cabinets delivered passenger train FREE. Delivery by Return Guaranteed.

Special sizes made to order. Estimates free.

Cabinets for R.C. Threesome: Oak, 15/6. Mahog. 20/- Solodyne from 45/-

THE ARTCRAFT CO., 156, Cherry Orchard Road, Croydon. Phone: Croydon 1981.

Parr's Ad.

"POPULAR WIRELESS"

THE PROGRESSIVE RADIO WEEKLY



All the leading set designers and other experts write regularly for "Popular Wireless" and both broadcasting and technical developments are chronicled in a manner which will appeal to all classes of radio enthusiasts.

On Sale Every Thursday

Price 3^d

Place a regular order with your newsagent for "Popular Wireless" NOW

THE "SIGNAL BOX"

—continued from page 62.

works with 2, 4, or 6-volt valves, I personally find the best results are obtained with the 6-volt types. Very good combinations to use are (giving them in alphabetical order):

- Burndept — H512, HL512, LL525.
- Cossor—6-v. 610 H.F., 610 L.F., and Stentor Six. (These valves are new arrivals in the 6-volt class).
- Mullard—PM5X, PM6, PM256. ST.—ST61B, ST62, ST63.
- Osram or Marconi—DE5B, DE5, DE5A.

You will see that in all cases I have recommended a super power valve for the last stage, as I am a great believer in these valves for really strong signals, but it must not be forgotten that they make a considerable demand upon your H.T. battery which, if of the dry cell type, should be of large capacity. Otherwise it is preferable to use an H.T. accumulator. Although there is a separate tapping for the H.F. valve I use 120-volts throughout, as I find this gives the best all-round results. If you do not

care to use a super power valve in the last stage, use an ordinary power valve; it will give quite as good results on anything but very loud signals.

Tuning in

I have tested the set out with 2, 4, and 6-volt valves, and know that it works quite well with all of these ranges.

As soon as you have built up the set, the following steps should be taken to adjust it.

(1) *If you are within twenty or thirty miles from a main station.* Connect up your batteries (being careful to adjust the grid bias on the last valve as given in the maker's instructions). The grid bias for the second valve should be set at, say, 3 volts, regardless of what the makers say, as this valve works in a peculiar manner. Set your reaction condenser at zero and be careful to put the split secondary transformer in the first socket and the split primary in the second. Set your first push-pull switch so that the fixed condenser in series with the aerial coil is short-circuited. Place the arrow of the potentiometer about half-way round its travel and the battery "on." Adjust the moving plate of the small

condenser between grid and plate at a half-way position, and the neutralising condenser also about half-way through its travel. Connect aerial and earth, loud speaker, etc., and tune in the local station not too loudly. Now vary the knob of the potentiometer until you get the best signals. Next tune in the local station at full strength (if the family will allow!) and carefully remove the fixed resistor in the first valve, when the local station will be heard very feebly. Carefully adjust the neutralising condenser until you hear nothing whatever of the local station, or, if you are very close to it (within a mile or two), until it is at its feeblest strength. If all is well, you will find that you can pass through a silent point in neutralising, and "out the other side." If the neutralising point seems right at one end or the other of the condenser try a new adjustment of the condenser between plate and grid.

Station after Station

You can then experiment with the delightful reaction control, and you will soon be tuning in station after station.

(2) *If your nearest station is a good way off.* As an alternative method, (Continued on page 66.)

VALCO MAGIC!

WILL MAKE YOUR BROKEN VALVE AS GOOD AS NEW.

ALL TYPES OF VALVES REPAIRED AT HALF LIST PRICES (minimum charge 5/-).

Satisfaction Guaranteed or Money Refunded

An unsolicited testimonial from one of our many satisfied customers. SEAFORD, 18/1/27.—I am pleased to say the repaired Valve arrived safely, and works very well. Thanking you very much.—G.J.

Weco, S.P.'s and low capacity types not repairable. Minimum D.E. current 0.15 amp. when repaired.

VALCO LTD., Dept. "C.," TABOR GROVE, WIMBLEDON, S.W.19.



STEEL PLATE ACCUMULATORS FOR HIGH TENSION

Only 1/- per volt.

Absolutely Noiseless. No Acid. No Fumes. Last a Lifetime.

BATTERIES, LTD., REDDITCH

LONDON OFFICE:—220, Shaftesbury Avenue, W.C.2.



ULTRA LOW LOSS S.L.F.

Single .0003 & .0005 μ F 7/6

Twin gang .. 24/6

Triple gang .. 33/6

Dial 1-16 .. 6/-

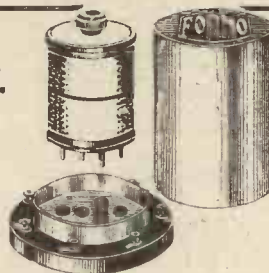
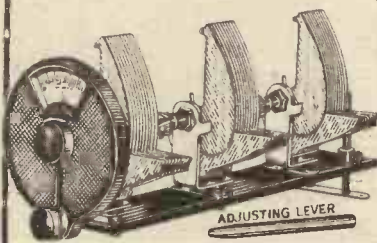

TRANSFORMER SHROUDED 10/6

SCREEN AND BASE 9/-

Coils for all circuits in stock.

Crown Works, Cricklewood, N.W.2. Tel. 1787 Hamp.

Mr. J. B. LEEVE, 22, Hartley Street, Levenshulme, Manchester.



"MODERN WIRELESS" 1/-

NOW ON SALE PRICE

"The Black Prince" is the name given to the latest set designed by Mr. Percy W. Harris, M.I.R.E. It is a four-valver of quite exceptional merit, and full constructional details are given in the issue of "Modern Wireless" now on sale, price 1/-. Get your copy at once and start to build—



The Black Prince

DO5
1927

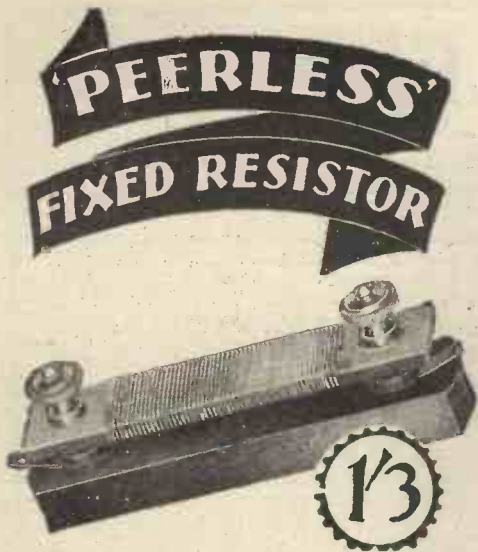

**Efficient, Neat
and Cheap**

YOU CAN SEE from the illustration what a neat job this "Peerless" Fixed Resistor is. The Base is solid insulation and the former a strong impregnated material that atmospheric conditions will not affect. The wire is wound evenly and firmly and terminals and soldering tags are fitted. One hole fixing. A very thoroughly assembled and finely finished unit in all.

OTHER BEDFORD PRODUCTS :

- "Peerless" Dual Rheostat 3/9
- "Peerless" Junior Rheostat . . . 2/6
(already over half a million sold)
- "Peerless" Resicon Variable Condenser, from 15/- to 18/-
(Dial and Vernier 2/6 extra)
- "Peerless" Master Switch 2/9
- "Peerless" Valve Switch 3/-

From all good dealers or direct.

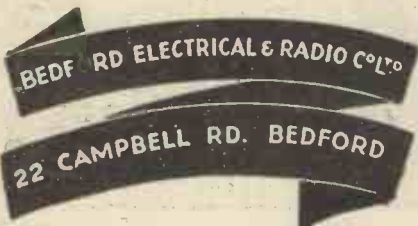

THE "SIGNAL BOX"

—concluded from page 64.

and one which is quite satisfactory disconnect aerial and earth, set the reaction condenser at minimum and the other adjustments as previously described. Now set the middle dial at about half-way through its travel, and swing the first dial backwards and forwards. If the set does not burst into oscillation at any point, try lower positions on the condenser scales, and, in fact, search about to see whether you can make the set oscillate, merely by bringing the dials into tune with one another. If you cannot, all is well, but if the set is found to oscillate at any dial setting, adjust the neutralising condenser until it is quite stable. To check up that all is well connect aerial and earth and tune in some distant station near the bottom of the condenser dial to see whether the set will oscillate when the station is just in tune. If it does, the correct setting of the neutralising will soon be found.

Split Secondary

As the first coil is of the split secondary type, its windings are identical with the now popular binocular coils. You can use these coils effectively if you wish to in the first socket, provided that you substitute for the first condenser one of .0005 mfd. capacity, as these binocular coils have been wound to suit a .0005 mfd. and not a .00035 mfd. condenser. The Ormond S.L.F. is actually made in .00035 mfd. but if other makes are used a .0003 mfd. will suit just as well.

Tuning in on the Daventry range is just as simple, and is only necessary to substitute long-wave split primary and split secondary coils for the short waves, when you will hear Radio-Paris, Daventry, Hilversum, Königswusterhausen, Moscow, and others, with great ease all free from one another.

NEW LAMPS FOR OLD

—continued from page 31.

have been made and the following new parts have been added:

- One Peto-Scott panel mounting midget condenser.
- One Gambrell Neutrovernier (base-board mounting type).
- One Varley Split Coil type H.F. choke.

One 100,000 anode resistance in holder.

One Wearite baseboard mounting single coil socket.

The anode resistance, neutralising condenser and H.F. choke are mounted just behind the valve strip in the very small space available. The coil socket is screwed to a small piece of wood of such a thickness that the top of the coil socket is brought level with the socket fixed in the valve strip. The Midget condenser for reaction is mounted in a 3/8th in. hole, just to the left of the centre valve window as explained. The new circuit is shown in Fig. 2. It will be noticed that the aerial is now removed from direct connection to the first grid circuit and goes to earth through a separate coil which can be a 25, 30 or 35, the correct coil being found by experiment with your own particular aerial. The grid coil for the lower broadcast band is a centre tapped 75 of any good make, and a 100,000 ohm resistance is connected between the centre point of this and the negative L.T. lead. The primary of the H.F. transformer is a 25, 35 or 50 plug-in coil of the ordinary type in the moving coil holder, while the secondary is a second 75 centre-tapped coil of any good make. The centre tap of this coil is taken by a flexible lead through the panel to a wire from the centre filament resistance, this being a convenient joining point. The plate socket of the detector valve is joined to the reaction condenser, the other side of which goes to the lower end of the centre-tapped coil, and to the radio frequency choke in series with the primary of the L.F. transformer. Although the fixed condenser of .001 mfd. across the primary is no longer required it is left in circuit and will do no harm.

The Modernising Guide

In the original set the IS of the transformer is connected to negative L.T. In the new arrangement this lead is disconnected and a new lead taken from IS to the negative wander plug of a grid bias battery. The positive wander plug of this battery is joined to the negative L.T. terminal.

As readers making use of this article already possess their sets it is not necessary to give a full wiring diagram of the whole receiver. The method has, therefore been adopted of giving written instructions of how to change the set, and if the "modernising guide" is followed readers will have no difficulty whatever in

(Continued on page 67.)

NEW LAMPS FOR OLD

-continued from page 68.

effecting the changes in a comparatively short time. Several photographs of the re-wired set are shown, the new wiring being carried out with Glazite, so as to show up thicker than the original bare wiring.

If the above instructions are carefully followed, it will not be necessary to remove any component from its place, nor will it be necessary to unscrew the valve strip. The Midget condenser used for reaction has three terminals, two of which are joined to the fixed plates and one to the moving. The terminals you should use are one (either one) of the terminals going to the fixed plates and the terminal going to the moving plates. This latter is placed behind the ebonite disc.

Neutralising

When you have completed the wiring changes and checked them carefully, place a No. 30 coil in the first socket, a centre-tapped No. 75 in the original socket, take the flexible lead from the 100,000 ohm resistance and connect it to the centre tapped point on this coil, place a 75 centre-tapped coil in the fixed socket on the front of the board and connect the flexible lead from the negative valve lead to this. Place a No. 50 (for trial) in the moving coil socket and join up your batteries as before. Take a grid bias battery of a value to suit the valve and H.T. you are using (the valve makers slip or box will tell you the value to use) and plug-in at the correct value. Set the neutralising condenser at the minimum position (this means turning as far as possible in an anti-clockwise direction) and, if you are within ten or twenty miles of the nearest station, tune this in on the loud speaker as loud as possible. For this test the reaction condenser should be set at the minimum position. Coupling on the coil holder should be fairly tight.

As soon as you have tuned-in this station, switch off the filament of the H.F. valve and, at the same time, switch over to the telephones. Without altering the tuning condenser, listen carefully to see whether you can hear your local station. If you can, carefully turn the knob of the neutralising condenser one way or the other until the sound is either completely extinguished or reaches a minimum value. In most cases

FORMO or FINSTON S.L.F. CONDENSERS



With handsome dial and knob... 7/6 By Post: 7/11.

ANOTHER GOOD MODEL S.L.F., with 4-inch Dial, .0005 and .0003 each 8/11. By post 6/5.

LOW LOSS SQUARE LAW

.0003 and .0005 4/11 each. By Post, 5/11. With Vernier 1/- extra.

PARTS IN STOCK FOR THE ELSTREE SIX, SOLOVNE, MEWFLEX, ELSTREEFLX, 1927 FIVE and ALL THE CHIEF CIRCUITS

S.T. VALVES

LEWCOX, BOWYER - LOWE, FINSTON, COLVERN, WATMEL, MAGNUM SCREENED COILS.

ACCUMULATORS.

2-v. 40, 7/11; 2-v. 60, 9/6; 2-v. 80, 12/6; 2-v. 100, 14/6; 4-v. 40, 13/11; 4-v. 60, 17/11; 4-v. 80, 23/6; 5-v. 60, 26/6; 5-v. 80, 35/6. ALSO another good make, 1/6 extra on each of above. Post 1/- each.

CRYSTAL and ONE VALVE AMPLIFIER (L.F.) in handsome polished cabinet, tested for use, 22/6. Post 1/6. (With D.E. valve, 30/-). Or Complete Set, valve, H.T., L.T., units, aerial equipment, 5XX coil, 45/11; Post 2/- Extraordinary Offer!

ASTOUNDING 2-Valve Amplifier in L.F. or COMPLETE with valves, polished box, tested for use, H.T. and L.T. 12 valves 18/11. Units, 44/6. Carriage 1/6. ALL CIRCUITS, PARTS, COILS and SETS STOCKED.

HEADPHONES, all 4,000 ohms. N. and K. Standard Pattern 7/11 pair. N. and K. Genuine new lightweight, 11/6; 13/6. Dr. Nesper, 10/6 and 12/11. Telephone, adjustable genuine (20" model), 14/11. Brunet, 11/6; 12/11, 14/6, 3 models. ERICSSON (Continental) E.V., 7/11 pair. (Post 6d.)

BRITISH HEADPHONES. - Brown's Featherweight, 20/- Brown's A Type (Red), 30/- B.T.H., 15/-. Sterling, 20/-

GANG Dial .0005. ORMOND, with dial .. 32/- CYLON, no dial .. 60/- Triple .0005. ORMOND, with dial .. 40/- CYLON, no dial .. 70/- IGRANIC, no dial .. 75/- BOWYER-LOWE, no dial 70/-

IGRANIC TRIPLE - HONEY-GOMB INDUCTION COILS. 30, 2/9; 40, 3/8; 50, 2/9; 60, 3/-; 75, 3/8; 100, 3/8; 150, 3/9; 200, 4/-; 250, 4/6; 300, 4/8; 400, 5/8; 500, 7/-; 750, 9/6; 1,250, 14/-; 1,500,

CANNERS' Large stocks of really useful cabinets kept or made to order. Solid oak or mahog. finish. American type, hinged lid, baseboard. Post 1/6 each extra.

8" x 6" x 7" deep... 8/11 10" x 8" x 8" deep... 9/11 12" x 8" x 8" deep... 10/6 14" x 8" x 8" deep... 13/6 16" x 8" x 8" deep... 18/11

DETAILED LISTS FOR POSTCARD

STOP!! - Adjustable 4,000 ohm Headphones (Nesper pattern), double leather headbands, 7/11 pr.

TANDCO H.F. CHOKE, 3/3.

SETS OF COMPONENT PARTS

RADIANO "THREE" (March, 27, Wireless Constructor) parts as specified with Terminals. 3 Ormond S.L.F. Variables with friction gear, 29/6; 3 Coil Sockets, 5/3; T.C.O. .0003 and Clips and 2-meg. Leak, 5/10; 3 Benjamin Valve Holders, 8/3; 3 Fixed Resistors and Bases, 7/6; On and Off Switch, 1/6; Geophone 1st Stage L.F., 24/-; Brande, 2nd Stage L.F., 17/6; Engraved Strip, with Terminals and Nuts, 3/6; 2 B.L. Terminals for Front Panel, 1/6; 1 Gross Pinch-on Spades, 1/-; Quantity Rubber Plug, 6d. Total, £3 5 0. Post free for £4 12 6 nett.

BALLOON 3 V. H. Leyner, A.M.I.E.E., 19/2/27. Original parts Ormond, .0005 S.L.F., 1 S.M. Dial; Ormond P.M. Vernier; 15 ohm Igr. Res.; 2-way c.o. Switch, W. & W.; Benj. c.o.; 2 C.A.V. L.F.; 2 Lotus V.H.; Benj. .0003 with leak and valve-holder; 2 Fixed Resistors, .001; Dubilier; B.I. Choke (H.F.); 4 Terminals, Strip, Wire, Screws, etc. List total, £4 15 0. Sent post free for 85/- Second Selection 65/- all enamel components.

EDISWAN R.C. THREESOME. Set of Parts: 2 Ediswan R.C. units, 7/2 each; 1 Ediswan P.V.2 Valve, 18/6; 2 Ediswan R.C. 4.2 3 Lotus Variables, Y.H. at 2/6; 3 Fil. Rheostats at 2/6; 9-v. Grid Bias, 2/-; Lotus 2-way L.L., 7/-; .0005 Tuning Condenser, 6/11. The lot, post free, £3 19 6. (List price, 9/15. With cheaper, but good) rheostats, valve-holder and 2-way, 69/6.

M.C. "THREE." "A.W." Feb. 5, '27. 2-.0005 Variable Condensers, Geared or with S.M. Dials, at 16/-; 2-.004 and 1-.001 Fixed Dubilier, at 3/- 9/-; T.C.O. .0003, with a 2-meg. Grid Leak, 4/10; .0001 Ormond Reaction Condenser, 4/-; 15 Lotus Valve Holders, 7/6; 1 P. Varley 11 P. Choke, 8/6; B.T.H. Transformer, 2/- (L.F.), 17/6; 3 Resistors, 3/9; 2 Special Coils, ready for use, 4/-; 11 Belling Lee Terminals, 4/2; Terminal Strip, drilled, 1/-; Push-Pull, Benjamin, 1/3. Total, 99/6. Post free, 25/- net. With cheaper condensers, valve holders, terminals, and fixed condensers, 67/6.

T.O.C. MANSBRIDGE. .0003 S.P. -.00025 S.P. -.01, -.02, 2/6 each; 1-.20, 2/5, 3/- each; 5/-, 3/6, 1 mfd. 3/0; 2 mfd., 4/3.

L.F. TRANSFORMERS. Ferranti A.F.3, 25/-; A.F.4, 17/6; Eureka Concert, 25/-; 2nd Stage, 21/-; Baby 1st or 2nd, 15/-; Reflex, 15/-; Formo shrouded, 10/6; Success (Black), 21/-; Royal, 20/-; Ormond, 18/6; 4 terminals, 15/6; 1 deal, all stages, 25/- each; C.A.V., 15/-; Pye, 17/6; ditto Telephone, 15/-; Gambrell, 2 stages, 25/6; Ideal Junior, 18/6; R.I., 25/-; Multi-Ratio, 25/-.

ORMOND Square Law Low-Loss. .0005, 9/6; .0003, 8/6; 1/16 each less no vernier; Friction Geared, .0005, 15/-; .0003, 14/6; .00025, 13/6. Friction Lenses, Frequency Friction Geared, .0005, 20/-; .00035, 19/6. S.L.F. .0005, 12/-; .00035, 11/-; SO. LAW LOW-LOSS DUAL, .0005, 16/- each. Ormond Friction Dial, 10/-; Filament Rheostats, Dual, 2/6; 6 ohms or 50 Ohms, 2/-; Potentiometer, 400 ohms, 2/6. Standard, .0005, 5/-; .0001 Reaction, 4/-; Air Dielectric, 2/-; Neutralising, 4/-; Neutrodyne, 2/-; Twin Gang, .0005, 32/-; Triple, 40/-.

MULLARD, COSMOS, MARCONI, B.T.H. EDISWAN, COSSOR VALVES. The latest always in stock.

NEUTRALISING CONDENSERS. Peto-Scott, 5/-, G/3, 7/6 Osmond, 4/-, Bowyer-Lowe, 7/-; MAGNUM, 5/-, Serwat, 2/6; 3/6. McMichael, 4/9. Reaction (Ormond) .0001 4/-.

RADIO MICRO (Guaranteed genuine). 3.5-v. .06 a., G.P. .. 5/11 1.8-v. 2-a., G.P. .. 5/11 1.8-v. 3-a., Power .. 8/6 3.5-v. 1-a., .. 9/6 1.8-v. 2-a., .. 10/6 Post 1/- each per valve.

World's Most Wonderful Crystal "WYRAN" 1/6 MAGNUM. Neutralising Condenser, 5/- Single Coil Mount on base, 1/9. Complete H.F. GAMBRELL CENTRE-TAPPED COILS. B.B.O., 6/-; 5XX, 8/3. 60X, 6/9; 250X, 8/9. B.B.O. or 5XX H.F. Transformers, 7/- each. ALL PARTS STOCKED

"J. B." with 4" Bakelite Dial. True S.L.F. Tuning 11/6 .0005 mfd. 16/6 10/6 .00035 mfd. 15/6 10/- .00025 mfd. 15/6 For Short Waves: 10/- .00015 mfd. 15/-

CALL HERE FOR LISSEN, BENJAMIN, RADIO-MICRO, COSMOS, MULLARD, EDISWAN, MARCONI, COSSOR, OSRAM, JACKSON'S (J.B.), DUBILIER, McMICHAEL, SPOONER, BEARD & FROCH, BOWYER-LOWE, LEWCOX, IGRANIC, EUREKA, ORMOND, UTILITY, FORMO, EDISON, BELL, FERRANTI, R.I. POLAR, NEWBY, P. & M. MAGNUM. WE HAVE THE GOODS! CALL AND SEE US. ALL LINES IN DEMAND STOCKED. SPECIAL TERMS. RADIO CLUBS. GENUINE EXPERIMENTERS. BE SURE YOU ARE AT RAYMOND'S!

LISSEN PARTS (Coils subject to delivery). Var. Gd Lk., 2/6; Lissenstat, 10/8; Major, 7/6; Minor, 3/7; Fixed Leaks, 1/-; Valve-holder, 1/-; Mica Condensers, 1/-; .002, 2/6; .001, 1/6; L.F. or H.F. Choke, 10/-; Switches, 2-way or key, 1/6; S.P.P. Plug, 2/6; D.P.D.T. Pull, 2/6; Rheostats, 7-35 ohms, 2/6 each; B.B. 1/6. Coils, 35 3/3; 40, 3/3; 50, 3/6; 60, 3/6; 75 3/6; 100 4/-; 150, 4/3; 200, 5/-; 250, 5/6; 300, 6/6; 400, 7/6; 500, 8/6; 750, 9/6; 1,000, 10/6; 1,500, 11/6; 2,000, 12/6; 3,000, 14/6; 4,000, 16/6; 5,000, 18/6; 7,500, 21/6; 10,000, 24/6; 15,000, 27/6; 20,000, 30/6; 30,000, 35/6; 40,000, 40/6; 50,000, 45/6; 75,000, 52/6; 100,000, 60/6; 150,000, 70/6; 200,000, 80/6; 300,000, 95/6; 400,000, 110/6; 500,000, 125/6; 750,000, 150/6; 1,000,000, 175/6; 1,500,000, 210/6; 2,000,000, 240/6; 3,000,000, 280/6; 4,000,000, 320/6; 5,000,000, 360/6; 7,500,000, 420/6; 10,000,000, 480/6; 15,000,000, 540/6; 20,000,000, 600/6; 30,000,000, 700/6; 40,000,000, 800/6; 50,000,000, 900/6; 75,000,000, 1050/6; 100,000,000, 1200/6; 150,000,000, 1400/6; 200,000,000, 1600/6; 300,000,000, 1800/6; 400,000,000, 2000/6; 500,000,000, 2200/6; 750,000,000, 2500/6; 1,000,000,000, 2800/6; 1,500,000,000, 3200/6; 2,000,000,000, 3600/6; 3,000,000,000, 4000/6; 4,000,000,000, 4400/6; 5,000,000,000, 4800/6; 7,500,000,000, 5400/6; 10,000,000,000, 6000/6; 15,000,000,000, 6600/6; 20,000,000,000, 7200/6; 30,000,000,000, 8000/6; 40,000,000,000, 8800/6; 50,000,000,000, 9600/6; 75,000,000,000, 10800/6; 100,000,000,000, 12000/6; 150,000,000,000, 13500/6; 200,000,000,000, 15000/6; 300,000,000,000, 17000/6; 400,000,000,000, 19000/6; 500,000,000,000, 21000/6; 750,000,000,000, 24000/6; 1,000,000,000,000, 27000/6; 1,500,000,000,000, 30000/6; 2,000,000,000,000, 33000/6; 3,000,000,000,000, 36000/6; 4,000,000,000,000, 39000/6; 5,000,000,000,000, 42000/6; 7,500,000,000,000, 48000/6; 10,000,000,000,000, 54000/6; 15,000,000,000,000, 60000/6; 20,000,000,000,000, 66000/6; 30,000,000,000,000, 72000/6; 40,000,000,000,000, 78000/6; 50,000,000,000,000, 84000/6; 75,000,000,000,000, 96000/6; 100,000,000,000,000, 108000/6; 150,000,000,000,000, 120000/6; 200,000,000,000,000, 132000/6; 300,000,000,000,000, 150000/6; 400,000,000,000,000, 168000/6; 500,000,000,000,000, 186000/6; 750,000,000,000,000, 210000/6; 1,000,000,000,000,000, 234000/6; 1,500,000,000,000,000, 258000/6; 2,000,000,000,000,000, 282000/6; 3,000,000,000,000,000, 306000/6; 4,000,000,000,000,000, 330000/6; 5,000,000,000,000,000, 354000/6; 7,500,000,000,000,000, 378000/6; 10,000,000,000,000,000, 402000/6; 15,000,000,000,000,000, 426000/6; 20,000,000,000,000,000, 450000/6; 30,000,000,000,000,000, 474000/6; 40,000,000,000,000,000, 498000/6; 50,000,000,000,000,000, 522000/6; 75,000,000,000,000,000, 546000/6; 100,000,000,000,000,000, 570000/6; 150,000,000,000,000,000, 594000/6; 200,000,000,000,000,000, 618000/6; 300,000,000,000,000,000, 642000/6; 400,000,000,000,000,000, 666000/6; 500,000,000,000,000,000, 690000/6; 750,000,000,000,000,000, 714000/6; 1,000,000,000,000,000,000, 738000/6; 1,500,000,000,000,000,000, 762000/6; 2,000,000,000,000,000,000, 786000/6; 3,000,000,000,000,000,000, 810000/6; 4,000,000,000,000,000,000, 834000/6; 5,000,000,000,000,000,000, 858000/6; 7,500,000,000,000,000,000, 882000/6; 10,000,000,000,000,000,000, 906000/6; 15,000,000,000,000,000,000, 930000/6; 20,000,000,000,000,000,000, 954000/6; 30,000,000,000,000,000,000, 978000/6; 40,000,000,000,000,000,000, 1002000/6; 50,000,000,000,000,000,000, 1026000/6; 75,000,000,000,000,000,000, 1050000/6; 100,000,000,000,000,000,000, 1074000/6; 150,000,000,000,000,000,000, 1098000/6; 200,000,000,000,000,000,000, 1122000/6; 300,000,000,000,000,000,000, 1146000/6; 400,000,000,000,000,000,000, 1170000/6; 500,000,000,000,000,000,000, 1194000/6; 750,000,000,000,000,000,000, 1218000/6; 1,000,000,000,000,000,000,000, 1242000/6; 1,500,000,000,000,000,000,000, 1266000/6; 2,000,000,000,000,000,000,000, 1290000/6; 3,000,000,000,000,000,000,000, 1314000/6; 4,000,000,000,000,000,000,000, 1338000/6; 5,000,000,000,000,000,000,000, 1362000/6; 7,500,000,000,000,000,000,000, 1386000/6; 10,000,000,000,000,000,000,000, 1410000/6; 15,000,000,000,000,000,000,000, 1434000/6; 20,000,000,000,000,000,000,000, 1458000/6; 30,000,000,000,000,000,000,000, 1482000/6; 40,000,000,000,000,000,000,000, 1506000/6; 50,000,000,000,000,000,000,000, 1530000/6; 75,000,000,000,000,000,000,000, 1554000/6; 100,000,000,000,000,000,000,000, 1578000/6; 150,000,000,000,000,000,000,000, 1602000/6; 200,000,000,000,000,000,000,000, 1626000/6; 300,000,000,000,000,000,000,000, 1650000/6; 400,000,000,000,000,000,000,000, 1674000/6; 500,000,000,000,000,000,000,000, 1698000/6; 750,000,000,000,000,000,000,000, 1722000/6; 1,000,000,000,000,000,000,000,000, 1746000/6; 1,500,000,000,000,000,000,000,000, 1770000/6; 2,000,000,000,000,000,000,000,000, 1794000/6; 3,000,000,000,000,000,000,000,000, 1818000/6; 4,000,000,000,000,000,000,000,000, 1842000/6; 5,000,000,000,000,000,000,000,000, 1866000/6; 7,500,000,000,000,000,000,000,000, 1890000/6; 10,000,000,000,000,000,000,000,000, 1914000/6; 15,000,000,000,000,000,000,000,000, 1938000/6; 20,000,000,000,000,000,000,000,000, 1962000/6; 30,000,000,000,000,000,000,000,000, 1986000/6; 40,000,000,000,000,000,000,000,000, 2010000/6; 50,000,000,000,000,000,000,000,000, 2034000/6; 75,000,000,000,000,000,000,000,000, 2058000/6; 100,000,000,000,000,000,000,000,000, 2082000/6; 150,000,000,000,000,000,000,000,000, 2106000/6; 200,000,000,000,000,000,000,000,000, 2130000/6; 300,000,000,000,000,000,000,000,000, 2154000/6; 400,000,000,000,000,000,000,000,000, 2178000/6; 500,000,000,000,000,000,000,000,000, 2202000/6; 750,000,000,000,000,000,000,000,000, 2226000/6; 1,000,000,000,000,000,000,000,000,000, 2250000/6; 1,500,000,000,000,000,000,000,000,000, 2274000/6; 2,000,000,000,000,000,000,000,000,000, 2298000/6; 3,000,000,000,000,000,000,000,000,000, 2322000/6; 4,000,000,000,000,000,000,000,000,000, 2346000/6; 5,000,000,000,000,000,000,000,000,000, 2370000/6; 7,500,000,000,000,000,000,000,000,000, 2394000/6; 10,000,000,000,000,000,000,000,000,000, 2418000/6; 15,000,000,000,000,000,000,000,000,000, 2442000/6; 20,000,000,000,000,000,000,000,000,000, 2466000/6; 30,000,000,000,000,000,000,000,000,000, 2490000/6; 40,000,000,000,000,000,000,000,000,000, 2514000/6; 50,000,000,000,000,000,000,000,000,000, 2538000/6; 75,000,000,000,000,000,000,000,000,000, 2562000/6; 100,000,000,000,000,000,000,000,000,000, 2586000/6; 150,000,000,000,000,000,000,000,000,000, 2610000/6; 200,000,000,000,000,000,000,000,000,000, 2634000/6; 300,000,000,000,000,000,000,000,000,000, 2658000/6; 400,000,000,000,000,000,000,000,000,000, 2682000/6; 500,000,000,000,000,000,000,000,000,000, 2706000/6; 750,000,000,000,000,000,000,000,000,000, 2730000/6; 1,000,000,000,000,000,000,000,000,000,000, 2754000/6; 1,500,000,000,000,000,000,000,000,000,000, 2778000/6; 2,000,000,000,000,000,000,000,000,000,000, 2802000/6; 3,000,000,000,000,000,000,000,000,000,000, 2826000/6; 4,000,000,000,000,000,000,000,000,000,000, 2850000/6; 5,000,000,000,000,000,000,000,000,000,000, 2874000/6; 7,500,000,000,000,000,000,000,000,000,000, 2898000/6; 10,000,000,000,000,000,000,000,000,000,000, 2922000/6; 15,000,000,000,000,000,000,000,000,000,000, 2946000/6; 20,000,000,000,000,000,000,000,000,000,000, 2970000/6; 30,000,000,000,000,000,000,000,000,000,000, 2994000/6; 40,000,



600,000 last year!

Sales of this famous valve holder for the past 12 months have exceeded 600,000—a sales record that speaks for itself! The enormous popularity of the BENJAMIN is mainly due to the following five vital features:

1. Valve sockets and springs are made in one piece, with no joints or rivets to work loose and cause faulty connections.
2. Valves are free to float in every direction.
3. Valves can be inserted and removed easily and safely.
4. Valve legs cannot possibly foul the base-board.
5. Both terminals and soldering tags are provided.

Install BENJAMIN yourself—you will improve reception and treble the life of your valves.

BENJAMIN
Clearer-Tone Anti-Microphonic
VALVE HOLDER
Patent No. 259,431 Reg. Design No. 714,847
PRICE 2/9 EACH

THE BENJAMIN ELECTRIC LTD.
Brantwood Works, Tariff Road, Tottenham, N. 17

NEW LAMPS FOR OLD
—continued from page 67.

you will be able to adjust this neutralising condenser until you hear nothing whatever from the local station even through the telephones. The set is then properly neutralised. Switch over to the loud speaker, light the H.F. filament again, and try using the reaction condenser. You will find a very steady build-up of strength until the oscillation point is reached. Fortunately, you need not worry if you make the set oscillate, as, when it is properly neutralised in the manner described, a negligible amount of energy will get into the aerial, and you will not disturb your neighbours. At the same time oscillation should be avoided, as it will only distort your signals.

Fine Adjustments

When you are not situated sufficiently near to a station to practise the above method, proceed as follows: Disconnect aerial and earth, and move the first condenser backwards and forwards to see whether the set will burst into oscillation at any point. If it does so, adjust the neutralising condenser until there is no oscillation at any setting of the condensers. Now restore aerial and earth connections, and tune in to a weak station, this time using the reaction condenser to bring the set up to a state of oscillation until you hear the whistle of the heterodyned carrier wave. Now carefully vary the first condenser. If the set is properly neutralised, a movement backwards and forwards of your first condenser will not alter the heterodyne note except at the exact point of tuning, when it will give a slight "chirp," or, more likely, stop oscillating completely. If the heterodyne note alters when you move your first condenser, readjust the neutralising condenser until the note remains steady with any variation of the first condenser, except when it is exactly in tune.

Operating Hints

As soon as the set is neutralised, you can use it as before, and you will find that it is appreciably more sensitive and the selectivity will be very considerably increased. Interesting experiments in selectivity can be made by varying the coupling between the moving and the fixed coils. Loudest signals will be obtained with a fairly tight coupling between these coils, and the weaker the

coupling the sharper the tuning. The best coupling between these coils will be different for several kinds and makes of valves, and once you have found the correct coupling for your particular valve, and the degree of selectivity you require, you need not change it.

Sharpening Tuning

In the original "All Concert-de-Luxe" the purpose of the switch to cut off the H.F. filament was to enable you to economise current when listening to the local station, as the valve capacity was quite sufficient to hand on signals from the first circuit to the second for local station work. In neutralising this receiver, this valve capacity, which previously enabled us to cut off the H.F. filament when listening to the local station is blanced out, and all three valves must be used all the time. While this is a disadvantage from one point of view, the current taken by modern valves is so small compared with that of the old bright emitters, that I am sure readers will not grudge this slight extra current in return for the many advantages possessed by the modernised instrument.

If, at any point of your tuning range, the aerial tuning suddenly becomes very flat, change the aerial coil for one of a larger or smaller size. The reason for this flatness is, that with the particular coil with which it occurs at one point, the aerial and the coil together tune to the wave-length you desire to receive, and when the aerial is thus tuned coupling becomes much too tight.

Undistorted Reception

While you can use your existing valves excellently in the modernised set I would suggest that you, if you still use the bright emitters, substitute for them the more modern type, using H.F. valves for the first and second sockets (the modern H.F. valves generally make excellent detectors), and either a small power valve, or if you live close to a station and like a big undistorted volume, a super-power valve in the last socket. The super-power valve, while not giving any louder signals than the ordinary type, enables you to get a much greater volume without distortion than is possible with the ordinary valve. Even with one stage of note magnification, much of the distortion on loud signals, generally put down to overloading the loud speaker, is due to overloading the last valve.

(Concluded on page 69.)

PICKETT'S CABINETS

For Your HOME Radiola!
Wireless Furniture 3 ft. high—taking your set, batteries, etc., complete.
BUREAU Models from £3 3 0
"RADIOLA" Jacobean from £5 5 0
"Radiola" Queen Anne from £6 15 0
High Grade Work and Finish
GUARANTEED. GRADUAL PAYMENTS arranged.
Lists of Cabinet Designs No. 21 FREE.
Pickett's Cabinet (W.C.) Works, Boxleyheath.



TO ADVERTISERS

ALL communications concerning advertising in "The Wireless Constructor," "Modern Wireless," and "Popular Wireless," must be sent to

JOHN H. LILE Ltd.,
4, LUDGATE CIRCUS, London, E.C.4
(Phone: CITY 7261)
and NOT to the Editorial or Publishing Offices.

WE TRUST YOU

You only remit a trifling deposit in advance and ride a Mead "Marvel" 49A Cycle one month. Afterwards you pay balance in small monthly instalments. Paid FREE on carriage paid.
"MARVEL" 490-24 19s. 6d. CASH.
Satisfaction guaranteed or money refunded.
Factory-soiled cycles CHEAP. Accessories and Tyres at popular prices. Write TO-DAY for Illustrated Catalogue of 28 new season's models, also special offer of sample cycle.



Mead CYCLE CO., Inc. (Dept. 8895.)
SPARKBROOK, BIRMINGHAM

NEW LAMPS FOR OLD

—concluded from page 68.

If you use a super-power valve, remember that you will require about 120 volts, and a bigger H.T. current than your ordinary valve. You will notice that I have not made any separate H.T. tapings on this receiver, as with a neutralised set it is advisable to use a fairly high H.T. voltage on the H.T. valve as well as on the note magnifier.

Test Report

The following stations were identified within two hours, and at least as many more were heard but not identified. The stations were all picked up on the loud speaker.

Munster	39 degrees
Mahmo	46 "
Breslau	80 "
Dublin	81 "
London	96 "
Glasgow	112 "
Frankfort	119 "
Langenberg	137 "
Bournemouth	141 "
Berlin	146 "

These stations were all received without any interference from London at seven miles distant.

Long-Wave Reception

Using a 75 in the aerial, a centre tapped 250 in the grid socket, a centre tapped 250 in the fixed socket of the coil holder, and a 150 in the moving coil holder, the following stations were received, all on the loud speaker with the exception of Moscow.

Moscow	70 degrees
Hilversum	79 "
Konigswusterhausen	102 "
Daventry	140 "
Radio-Paris	160 "

A LISTENER'S DIARY

—concluded from page 54.

"skip-effect." It seems that when the waves radiate from the aerial they travel outwards and upwards until they strike the Heavside layer, which again reflects them forward and downward, thus creating sometimes a very large blind area between the transmitting aerial and the point at which the waves reach the earth's surface by reflection. It is worth recording, however, that Senatore Marconi disagrees with much of the published data on "skip" effects.

COMBINE EFFICIENCY & ECONOMY

We invite you to compare the components advertised below with similar articles on the market. In every case you will find we are supreme in quality and price.

COPEX "POPULAR MODEL"

Copper Coil Screen and Base.



This screen and base is made from high-grade copper—the best metal for screening coils. Terminals are arranged in such a manner that it is impossible to "short" them when replacing screen. Perfect electrical and self-cleaning contact. Screen and interchangeable 6-pin base. (Patent No. 259459).

9/6

KEYSTONE H.F. CHOKE



The extremely high efficiency of this choke is due to a unique form of low-capacity winding. Range, 300/2,000 metres. Recommended for use in the "Solodyne Five," "All British Six," and many other efficient receivers. Especially suitable for split-coil circuits. Price 8/6

KEYSTONE FIXED RESISTOR



No. 4 for '25 amp. valves with 6-volt accumulator. No. 17 for '06 amp. valves with 4-volt accumulator. And in many other values. Price 2/6 Resistor only 1/9. Base, 9d.

KEYSTONE "MIDGET" CONDENSER

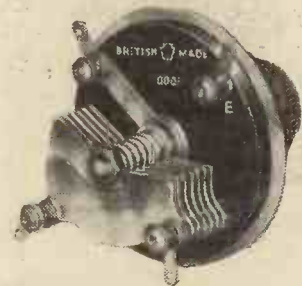

Ideal for the many positions where a small capacity condenser is required. An aluminium shield prevents hand-capacity effects, and a special taper bearing gives a beautifully smooth movement. Accurately designed and rigidly constructed, this Keystone condenser is backed by the usual Keystone guarantee of efficiency. Capacity 0001 mfd. Price 5/6

KEYSTONE NEUTRALISING AND BALANCING CONDENSERS

Used in all the popular circuits this season. Designed by experts. Suitable for all types of valves. Low minimum capacity. The wide spacing of the vanes renders accidental "shorting" impossible. Very well made from best quality material and beautifully finished.

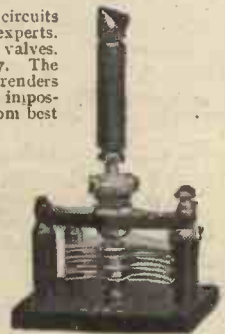

Board mounting, 5/=-

Panel mounting, 6/3

Balancing Condenser, similar to the illustration but having two sets of Fixed Vanes instead of one 7/6

THE FINEST SET YOU CAN BUY

THE "SOLODYNE"—5 Valves—1 Dial—50 Stations



By merely rotating the single tuning dial, station after station is brought in at full loud-speaker strength. Despite its amazing efficiency, the "Solodyne" is wonderfully simple to operate, and an inexperienced member of the family can easily tune in from 30 to 50 stations on the loud speaker.

Finished instrument, as illustrated, aerial tested by CAPTAIN TINGEY, M.I.R.E. £27 10 0
Royalties £3 2 6

Special Offer to Home Constructors.

You can easily build a set exactly similar in appearance and performance to the above. Under the famous Pilot Service you are definitely guaranteed good results, and you may always rely on free advice and assistance from our Technical and Service Department. Full details of the "Solodyne" and many other up-to-date receivers appear in the Pilot Manual, 24 pages, fully illustrated. Copy will be sent on receipt of 3d. in stamps.

All our products are obtainable from good dealers. In cases of difficulty, please write to us direct, giving the name of your usual retailer.

This splendid set is fully described in a beautifully illustrated art booklet, copy of which will be sent free on application.

PETO-SCOTT CO., LTD.,

Head Office: 77, City Road, London, E.C.1.

Branches:—LONDON—82, High Holborn, W.C.1. WALTHAMSTOW—230, Wood Street. PLYMOUTH—4, Bank of England Place. LIVERPOOL—4, Manchester Street. P.S. 8,27.

WITHIN THE VACUUM

—concluded from page 32.

Several new valves have been brought to my notice. Among the 2-volters two more resistance-capacity valves have made their appearance, namely the BTH. B8 and the ST21A. The B8 appears to me to have an unnecessary high impedance of 180,000 ohms, while the amplification factor is given as 50. At 100 volts on the plate and the correct grid bias for maximum grid swing it only takes 20 microamps from the H.T. battery. It should be used with a 2 to 5 meg-ohm anode resistance, while the filament rating has the peculiar figures of 1.8 to 2.8 volts. As yet I cannot report upon their operation, but it would appear to me that there will be a likelihood of L.F. oscillation taking place while it will probably be difficult to get more than one valve of this type working in an amplifier without distortion.

While I am in favour of high amplification I must say I think this can be overdone, especially where the grid swing of the valve is going to be so seriously limited as to make it almost useless except in expert hands.

The ST21A I hope to report upon in due course, as yet I have not had an opportunity of testing it, though it certainly promises to be a useful little amplifier.

The Cossor Range

I have just completed some thorough tests with the Cossor 6-volt series of valves, and must say I am very favourably impressed with the results obtained. The resistance-capacity coupling valve (RC610) has a *mu* of 50, and an impedance of 80,000 only, and makes an excellent anode bend detector when followed by a 500,000 ohm resistance-coupled stage. I do not care for two RC610 valves working together unless used on weak transmissions, as the amplification is too formidable for the following valves if the first L.F. is given anything like the maximum grid swing it can handle.

The H.F. valve (610 H.F.) is an excellent H.F. amplifier, and is suitable for all classes of circuits, being easily neutralised in neutrodyne sets. I also found it makes a good first stage L.F. resistance coupling valve following the R.C. as anode bend detector. The H.F. valve has of course an impedance of 20,000 and a magnification factor of 20.

The L.F. valve is a good detector for

transformer coupling if a low impedance is required (8,000 ohms) and makes a good amplifier in transformer-coupled sets. The Stentor Six, the last of the series, needs no further introduction, and though it takes rather a lot of milliamps from the H.T. battery it is well worth its cost of running if a large output is required.

NOTES ON NEUTRALISATION

—concluded from page 16.

B₂ (Fig. 6) will not nullify this tendency to oscillate; in some cases it will even tend to exaggerate this mode of oscillation. This oscillation is usually of short wave length.

"We have found that the circuit can be made stable by damping the oscillatory paths taken in these two modes of oscillation. One method of damping these oscillations is by inserting a series resistance between the high potential end of the grid inductance and the grid of the valve. The complete 'push-pull' circuit then becomes that shown in Fig. 10."

The Neutrodyne Balances

In such an arrangement as the Rice balance of Fig. 1 it does not seem essentially different to reverse the balancing arrangement over, that is, to put the split coil in the plate circuit, and I think this is a preferable method.

It is well known that the arrangement of Fig. 12 is similar in action to Fig. 1, but naturally great care will have to be taken to wind our windings exactly over the other, as an arrangement such as Fig. 13 would obviously not balance.

The nicest arrangement of this type is a modification of the above. A double spiral primary is connected as in Fig. 11, and now the secondary winding can be almost any geometrical relation to the primary without the balance being upset. We still have the plate capacity to earth as abnormal, but stray capacities are likely to be much more symmetrical. I should think that the neutrodyne condenser would be best arranged as an old valve, and then the plate capacity and also stray losses would be more nearly equal.

Such circuits might, when using high magnification valves, very easily tend to give parasitic oscillations, and here the Wright-Smith method of resistance insertion will cure any trouble.

THE HEAD DOES NOT COME OFF

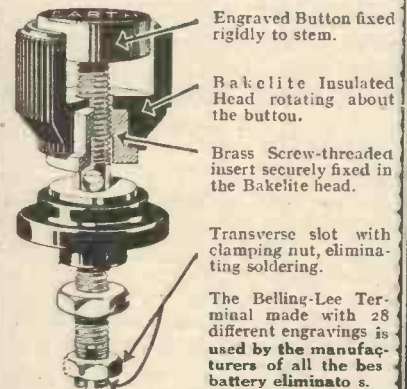

Engraved Button fixed rigidly to stem.

Bakelite Insulated Head rotating about the button.

Brass Screw-threaded insert securely fixed in the Bakelite head.

Transverse slot with clamping nut, eliminating soldering.

The Belling-Lee Terminal made with 28 different engravings is used by the manufacturers of all the best battery eliminators. Standard Model (Bakelite-insulated) (Type B) 9d. each. Popular Model (non-insulated) (Type M) 6d. each.

Patent No. 248921. Regd. Design No. 715424.

Illustrated Catalogue free on request. If you cannot get these at your dealer's, send your order to us enclosing his name and address.

BELLING-LEE TERMINALS

Belling & Lee, Ltd., Queensway Works, Ponders End, Middlesex.

AMPLIFIERS: 1-VALVE 19/-; 2-VALVE, 3/-.
2-Valve All-Station Set, £4. Approval willingly.
Wet H.T. Batteries—Jars, Zincs and Sacs complete.
3/6 per doz. (18 volts). Post 9d. extra. Sample 6d.
3 doz. upwards post free, in divided cartons.
Bargain List Free.
C. Taylor, 57, Studley Rd., Stockwell, London.

The HOME for your WIRELESS SET

OUR STANDARD CABINETS

are DUSTPROOF and house the whole apparatus, leaving no parts to be interfered with. Made on mass production lines, hence the low price. Provision is made to take panels from 16 by 7 up to 30 by 18 in. Special Cabinets for the ELSTREE SOLODYNE, NIGHT HAWK, ALL BRITISH SIX, etc., now ready. Write for free particulars.

MAKERIMPORT CO.
(Dept. 20), 50a, Lord Street, LIVERPOOL.

ADVERTISEMENTS

As far as possible all advertisements appearing in "Wireless Constructor" are subject to careful scrutiny before publication, but should any reader experience delay or difficulty in getting orders fulfilled, or should the goods supplied not be as advertised, information should be sent to the Advertisement Manager, "Wireless Constructor," 4, Ludgate Circus, London, E.C.4.

IN LIGHTER VEIN

—concluded from page 12.

afternoon from all my fellow clubmen who were not at home. The junior members of the audience were becoming wildly enthusiastic. At this point, however, Goshburton-Crump proposed that the elimination experiment should be taken for granted in order to allow me more time for dealing with the subject of curve taking.

I showed them how a dot should be made upon the chart as each reading was obtained. My new system is to take curves in much the same way as we played paper cricket when we were lads at school. On a sheet of paper write down a large number of figures such as 2.03, 6.51, and so on. Your assistant calls out "grid volts 1 negative"; you then shut your eyes and dab with a pencil. The reading so obtained is recorded upon the chart and when as many as are required have been marked, a curve with artistic sweeping lines is drawn in the manner mentioned.

WIRELESS WAYFARER.

THE NOTE MAGNIPLEX

—concluded from page 27

short screws the remaining two 12-inch lengths of strip-wood, placing them so that they fit inside the front and rear cross members of the frame and hold the cover in the proper position. As both the cover and the sides project 1/4 inch beyond the rear of the frame and the baseboard, the back fits in flush. It is secured by means of a couple of screws, one being driven into the strip-wood upright on either side. The lid can thus be lifted off when required which enables one to change the valves or to make most of the adjustments ordinarily needed. If, however, it is necessary to lay the set right open, the back can be removed in a moment by taking out its two holding screws.

The cabinet may be given an oil finish, but I much prefer to use the Non-As-Esi French polish, which is very simple to work and produces in a few moments a really glass-like surface.

A Correction

In last month's issue (page 519) the filament consumption of the SS7A and SS11A valves was given as 1 amp. This should, of course, have been .25 amp.

CAXTON WIRELESS CABINETS

THOUSANDS OF SATISFIED CUSTOMERS.

All Polished with new enamel that gives a glass hard surface that cannot be soiled or scratched. Ebonite or Radion Panels Supplied and Perfectly Fitted at low extra cost. SENT FREE—Catalogue of Standard Wireless Cabinets in various sizes and woods.

Elstree "Solodyne"

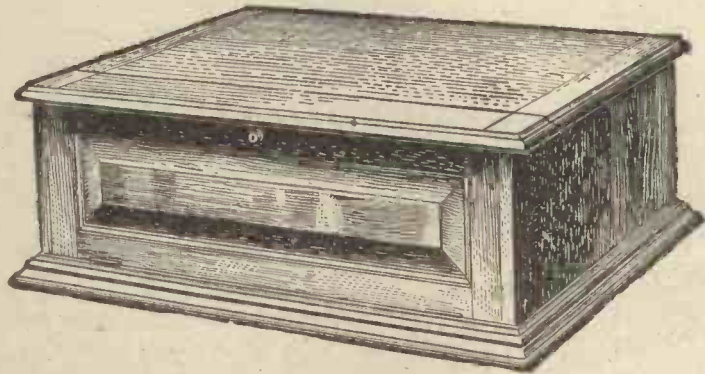

Specially designed for this famous Radio Press Circuit. All details and dimensions conform to their specification, enabling constructors to follow the layout without difficulty.

PRICES:

Light Fumed Oak 61/- Dark or Jacobean Oak 65/- Real Mahogany 68/-

Prices include either "full front" with handsome solid raised panel, as illustrated, or beaded doors, allowing ample space for tuning controls, etc. Glass panelled doors can also be supplied at 3/- extra.

CASH WITH ORDER. CARRIAGE PAID U.K. PROMPT DELIVERY.

Packing Case 5/- extra repaid if Case returned within 14 days Carriage paid to Works.

CAXTON WOOD TURNERY CO., MARKET HARBOROUGH.

£5 DOWN BUYS THE "SOLODYNE"

COMPLETE WITH ALL ACCESSORIES. NOTHING MORE TO BUY.

This masterpiece of Radio design has now been brought within the reach of all those who desire to bring the world's best programmes into their own home.

Send to-day for illustrated Art Brochure, and particulars of deferred payment terms.

We will gladly demonstrate the "SOLODYNE" in your own home without charge or obligation.

The New Times Sales Co., 77, CITY ROAD, E.C.1.

8133

LECLANCHE POROUS POTS

Genuine miniature porous pots for wet H.T. to fit 2 1/2 x 1 1/2 Jar, registering 1-4 volts: 3/- per doz. Non-conductive Glass Jars 1/- doz., Waxed, 1/3 per doz. Sacs 1/6 doz. Zincs 1/- doz. Send 1/6d. stamp for Price List and Instructions Carriage and Packing extra

Trade Inquiries: THE ETON GLASS BATTERY CO. Dept. E. 46, St Mary's Road, London, E.10.

WIRELESS ROOM



For experiments, assembling, etc. Strongly made in sections. Easily erected in two hours.

8 ft. x 6 ft. 170/- Floor 20/-
9 ft. x 7 ft. 195/- " 36/-
12 ft. x 8 ft. 275/- " 50/-

Every kind of wood or asbestos building. LISTS FREE. PERCY WHITE (Dept. C), Thames St. Works, Staines

ELECTONE The Listener's Greatest Comfort

Automatically gives the items that appeal to you, eliminates the boring ones, and shuts off the set for the night. Saves valves and current. Simplicity itself to attach and operate. GET THE BEST OUT OF YOUR PROGRAMME

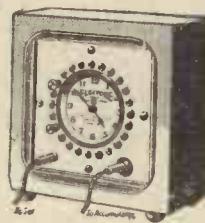

Ask your dealer or write to sole manufacturers Price 27/6 FREDK. J. GORDON & CO., LTD., 92, Charlotte Street, LONDON, W.1.

REPAIRS

to HEADPHONES, LOUDSPEAKERS, TRANSFORMERS, COILS.

First-class workmanship only. That is just the vital difference. We are specialists with almost 30 years' experience in every form of intricate and accurate coil winding, and we guarantee that work entrusted to us will be returned to you as good as new, if not better. This is no idle claim, but the unsolicited opinion of scores of satisfied clients.

THE VARLEY MAGNET COMPANY (Proprietors: Oliver Pell Control, Ltd.), BLOOMFIELD ROAD, WOOLWICH S.E.18 Telephone: Woolwich 0888.



ALL APPLICATIONS FOR ADVERTISING SPACE IN "WIRELESS CONSTRUCTOR" MUST BE MADE TO THE SOLE ADVERTISING AGENTS, JOHN H. LILE, LTD., 4, LUDGATE CIRCUS, LONDON, E.C.4.

Chosen for the "COMBINE"

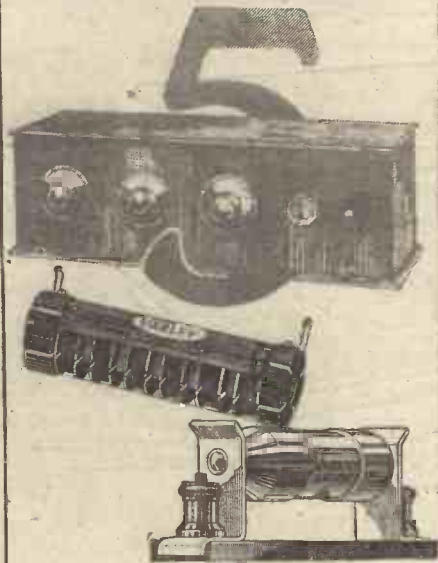

Varley Bi-Duplex Wire Wound Components continue to triumph! Included in that popular receiver, the "Combine Five," Varley Anode Resistances and H.F. Chokes prove, by sheer merit, that they are unsurpassed in the Radio World to-day.

Our policy has always been to introduce Radio components only after severe and searching tests—tests which have convinced us that each particular component has been a real contribution to Radio design. The success of that policy is now evident.

Varley Bi-Duplex Wire-Wound Anode Resistances ensure absolute purity of tone and perfect reception in ALL circuits where resistance capacity coupling is used.

The efficiency of any circuit employing one or more stages of high frequency is greatly increased by using Varley H.F. Chokes.

Varley Bi-Duplex Anode Resistances made in a complete range of sizes up to 500,000 ohms, prices 4/- to 16/-.

The Varley Multi-cellular H.F. Choke, 9.6.

The Varley Multi-cellular H.F. Choke (Split Coil Type) 12/6.

Write for particulars of the new Varley Tapped Resistances.



THE VARLEY MAGNET CO.

(Proprietors Oliver Pell Control, Ltd.)

Granville House, Arundel Street, London, W.C.2
Telephone: City 3393

OUR NEWS BULLETIN

The B.B.C. has not yet been able to announce the date of Daventry Junior's first full-dress programme, but the expectations are that this cannot possibly take place before July. In the meantime listeners will be hearing the rehearsals of this experimental transmitter upon the 300-600 metre wave-band, and in view of the effect that these tests will have upon British broadcasting, they will probably prove quite as interesting as proper programmes.

Alternative Programmes for every Set

The fact that Daventry should be sending out two programmes upon different wave-lengths is in itself rather intriguing, but, of course, this is only a beginning. Where the scheme will end nobody knows, for only by experiments with different powers and wave-lengths can a solution be found to the problem of alternative programmes for every set in Britain.

Marvels of the Beam

All this talk about the Marconi re-organisation has overshadowed the story of the latest "beam" exploits. It has been stated that experiments show that the beam services can handle telephony (i.e. broadcasting) just as well as they can the dots and dashes of the Morse code, for which they were originally designed. Moreover, the two classes of traffic can be sent (so 'tis said) at the same time, on the same beam!

Filter circuits at the receiving end would disentangle the talking from the tapping noises, and, of course, the further possibilities of world broadcasting will be endless!

Radio to the Rescue

Twenty minutes after an appeal had been broadcast from the local station, a Manchester listener turned up to give some of his blood for a hospital patient who was seriously ill.

Twenty minutes! We've had twenty years of wireless life-saving thrills, but it still seems an incomparable gift of the gods, doesn't it?

Let down by Langenburg

I hear that the Germans are not altogether pleased with their high-powered station at Langenburg. Reception has been far below expectations in some districts, notably

around Cologne, and disappointed listeners there have not hesitated to kick up a bit of an *eau-de-Cologne* about it!

As a result, there is a proposal on foot to cover this area with a separate relay station, using a power of approximately four kilowatts.

Smelling the Aerial!

Rather a queer story comes from Homewood, Illinois, where the aerial tower of W O K pushes up into the clouds. Apparently one evening the engineers there were electrified to notice that a big Blimp was hovering over the station! Its manoeuvres suggested that the pilot imagined that the aerial-tower was a mooring-mast (there is an air-plane station a few miles away), and despite the shouts of the wireless staff, the dirigible descended till it was level with the mast, and then slowly nosed ahead and deliberately *smell* at the aerial.

The station staff, thoroughly indignant, bellowed at the Blimp for all they were worth. And the giant "cigar," apparently satisfied with its investigations, finally faded away into the night!

Britain's First Radio Vicar

When the Rev. H. R. L. Sheppard preaches his promised farewell sermon from St. Martin-in-the-Fields, on Easter Sunday, listeners will lose one of the finest broadcasting personalities discovered by the B.B.C. Whatever one's own views about broadcast religion, there could be no two opinions about "Dick" Sheppard, for the sincerity of the man reached every aerial in the country. His host of microphone friends will not readily forget Britain's first radio vicar, and they will all wish him well in his retirement.

Programmes by Trans-ocean 'Phone

The progress made by the Transatlantic radio-telephone service is now getting really interesting. I don't mean so much from the scientific achievement point of view—though Uncle Sam and John Bull are entitled to a bouquet or two over that—but the success is such that it now has great programme possibilities.

If guys over in San Francisco, Milwaukee, Oshkosh-Wis., and where-not can talk direct to Britain, in a sort of radio speak-easy, why can't the B.B.C. charter the service for 15 minutes or so? We could then judge for ourselves some of these famous first-class all-star top-notch hundred-thousan'-dolla U.S.A. radio concerts that we've heard about.

SAVOYARD.

A STEP FORWARD IN WIRELESS EFFICIENCY!

The new "LOTUS" Remote Control gives perfect reception and control from any distance and from any number of rooms simultaneously.

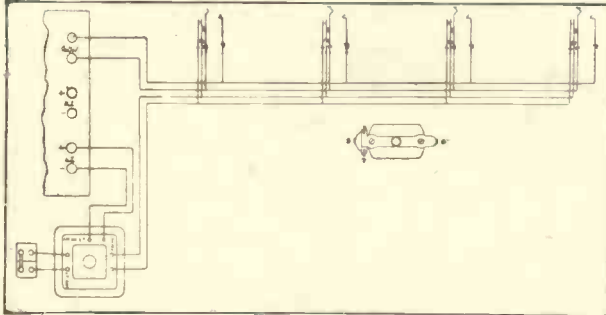

The "LOTUS" Relay is placed on or near to the Receiving Set in accordance with instructions shown on the "LOTUS" REMOTE CONTROL AND JACK CIRCUITS (free on application).



The first Relay Filament Control Wall Jack can be fitted to the wall in any convenient position in the same room as the Receiving Set and wired to the Relay and Set as shown. The Plug for use with the Wall Jack is connected to either the Loud Speaker or Phones. The second Relay Filament Control Wall Jack can be fitted in any room of the house or building in a similar manner, the four wires being continued from the first Wall Jack. There is no limit to the number of Wall Jacks

that can be so fitted in different rooms. All the rooms can listen in simultaneously and it is not possible for one room to interfere with another. The last plug to be withdrawn breaks the Filament Circuit and cuts off the Set. The Receiving Set is actually controlled from any point where a Wall Jack is wired up and by inserting or withdrawing the Plug. This Remote Control makes it entirely unnecessary to go to the Set to switch it on or off.

THE LOTUS REMOTE CONTROL

GARNETT, WHITELEY & CO., LTD., BROADGREEN ROAD, LIVERPOOL, Makers of the Famous "LOTUS" Coil Holder and "LOTUS" Buoyancy Valve Holder.

Complete outfit for wiring up two rooms:—
 1 "Lotus" Radio Relay, 2 "Lotus" Relay Filament Control Wall Jacks, 2 "Lotus" Jack Plugs, 21 Yards of Special 4-Strand Wire. Price **30/-**
 Each additional room:—
 1 "Lotus" Relay Filament Control Wall Jack 15 Yards of Special 4-Strand Wire. Price **7/6**

<p>FREE COUPON</p> <p>Please send free and post free Blue Prints and instructions for the "LOTUS" Remote Control House Wiring System and Jack Circuits.</p>	To ADVT. DEPT., GARNETT, WHITELEY & CO., LTD., LOTUS WORKS, BROADGREEN ROAD, LIVERPOOL.
	Name
	Address
	Date.....



TUNING IN HALF THE TIME



INSTEAD of finding the right wavelength somewhere about the time for "Good Night! Everybody, Good Night!" get in right at the start of the concert.

You only need the R.I. Retroactive Tuner to make your tuning such plain sailing. It cuts out all the bother of plug-in coils, and at the same time operates far more efficiently for it ensures correct aerial reaction over the whole range of wavelengths covered, that is, 175 to 4,000 metres.

In addition, the R.I. Retroactive Tuner costs appreciably less than a set of plug-in-coils with coil holder to cover the same range.

Price **39/6**

Write for the R.I. Green and Gold Catalogue.

THE MARK OF  BETTER RADIO

Advt. R.I. Ltd. 12, Hyde St., New Oxford St., London, W.C.1.

Printed and published on the 15th of each month by the Proprietors, The Amalgamated Press, Ltd., The Fleetway House, Farringdon Street, London, E.C.4. Advertisement Offices only: Messrs. J. H. Lile, Ltd., 4, Ludgate Circus, London, E.C.4. Registered for transmission by Canadian Magazine Post. Subscription Rates: Inland and Abroad, 8/6 per annum. Canada only, 7/6 per annum. Sole agents for South Africa: Central News Agency, Ltd. Sole agents for Australia and New Zealand: Messrs. Gordon & Gotch Ltd., and for Canada: The Imperial News Company (Canada), Ltd. D. K.