

The Wireless Constructor

6^D
MONTHLY

EDITED BY
PERCY W. HARRIS

Vol. 1 SEPTEMBER 1925
No. 11

CONTENTS

- HOW TO MAKE:
TWO SELECTIVE SETS:
A THREE-VALVE RECEIVER.
By A. V. D. Hort, B.A.
A SINGLE-VALVE RECEIVER.
By G. P. Kendall, B.Sc.
A TWO-STAGE CHOKE AMPLIFIER.
By John W. Barber.
TWO INTERESTING CRYSTAL SETS.
THE "MIDGET" AMPLIFIER.
By A. S. Clark.
SOME INTERESTING ANALOGIES.
By J. H. Reyner, B.Sc., A.C.G.I., D.I.C.
WHAT IS TUNING?
By D. J. S. Hazitt, B.Sc.
FAULTS IN THE FILAMENT CIRCUIT.
HUNDREDS OF PRACTICAL
HINTS AND TIPS FOR THE
BEGINNER.

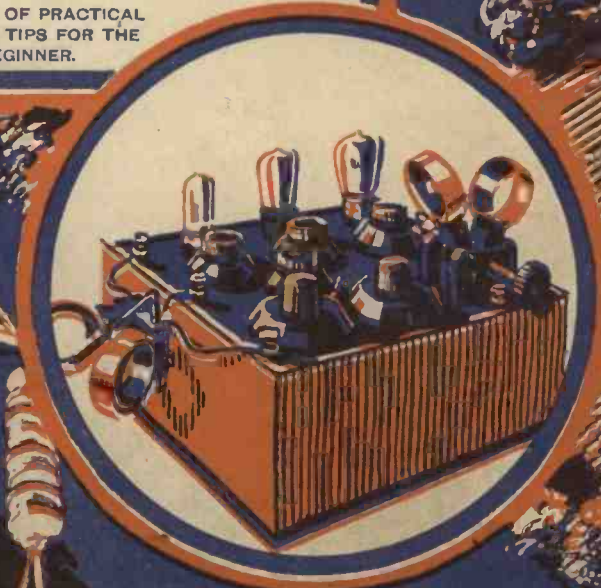

FREE BLUEPRINT INSIDE

Give your Loudspeaker
the Best—



A Good Loudspeaker

can be spoilt by the use of inferior valves.
End extravagant power consumption
and weak results by getting
real loudspeaker valves.

MULLARD Double Green Ring
Valves only require 3 amps. at 2 volts;
give increased volume; reduce current.

Accumulators last twice as long.

For still greater volume use—

MULLARD D.F.A. Master Valves
fullest capacity without distortion—ask
your dealer.

Loudspeaker Valves

- Mullard L.F. Double Green Ring Valves
- Type D.3 for 2 volt accumulators - 14/-
- Type D.06 for (2 or 3 dry cells or 4
volt accumulators) - - - 16/6
- Mullard D.F.A. 0 - - - 22/6
(for 4 volt accumulators)
- Mullard D.F.A. 1 - - - 22/6
(for 6 volt accumulators)
- Mullard D.F.A. 3 - - - 24/6
(for 6 volt dry cells or accumulators)

NOTE—The D.06 and D.F.A. 3 take only 60 milli-
amperes filament current. Ask for leaflet V.R.25

Mullard

THE MASTER VALVE

Advt.—The Mullard Radio Valve Co., Ltd. (W.C.), Nightingale Works, Balham, S.W.12

The WIRELESS CONSTRUCTOR

— Edited by Percy W. Harris —

Vol. 1. No. 11.

SEPTEMBER

CONTENTS

Selectivity with Ease of Control .. 963	A Two-Stage Choke Amplifier .. 988
By A. V. D. HORT, B.A.	By JOHN W. BARBER.
"Retribution" .. 967	What is Tuning? .. 994
Faults in the Filament Circuit .. 989	By D. J. S. HARTT, B.Sc.
By G. P. KENDALL, B.Sc.	A Selective Single-Valve Receiver .. 1002
A Simple All-Enclosed Local-or-Dauntrey Receiver .. 972	By G. P. KENDALL, B.Sc.
By F. ENGLISH.	Do You Know? .. 1009
Famous Speakers Over the Aether .. 974	By C. P. ALLINSON.
By "CARRIER-WAVE."	John Anstruther's Wireless Talks .. 1010
Director of Research of Radio Press, Ltd. .. 977	The "Midget" Amplifier .. 1015
Some Simple Experiments .. 981	By A. S. CLARK.
By J. H. REYNER, B.Sc., A.C.G.I. D.I.C.	Workshop Hints .. 1019
	A Simple Home-made Crystal Receiver .. 1024
	By B. MESSIAS.



Southall, Middlesex, June 19, 1925.

"... At the present time I can definitely say that the Duodyne is the best five-valve set I have operated, and I have made somewhere between sixty and seventy, from a crystal set to five-valve sets." F. V.

Write now for 1925-1926 Catalogue, sent post free upon request.

PETER CURTIS, LTD.
75, Camden Road, LONDON, N.W.1

Telegrams Paracurtex,
Telephone North 3112

Build Your Own Duodyne

"... May I congratulate you on the efficiency of the 'Duodyne Five'?"

On a home constructed set, using two wires, one for aerial and one for earth, in the same room as the set, I have received KDKA, WBZ, and several other American stations, on many occasions.

As a wireless engineer, I should like definitely to state that the results with the 'Duodyne' are immeasurably superior to those of any other set I have tried, with the possible exception, of course, of a Multi-Valve Super-Heterodyne.

I think it only fair to give credit where credit is so obviously due."—F. S. B., St. George's Road, S.W.

"Got WGY General Electric Schenectady 2 a.m. very clear on loud speaker, using Duodyne III; delighted with set."—Robinson, Hessele.

"I must say I am delighted with my Duodyne V. Nightly I tour the Continent."—E. B. & Co., Bradford.

"I feel it only right to let you know how satisfied I am with the Duodyne V. Broadcast Receiver. The number of different stations I have had on the loud speaker is great, and during the evenings, when tuning with 'phones, the set is alive with different stations, many of which are foreign.

I have had an American station at good strength on the loud speaker, and the American stations come through easily at 'phone strength.

I cannot praise the Duodyne V. enough for long distance work, and the instrument is a good investment for those who wish to hear other countries broadcasting on a loud speaker."—F. A., — Regiment, Colchester, Essex.

"I should like to take this opportunity of mentioning that I have made up the Duodyne V., and it is in every way a splendid circuit, and you can in fact get 'Music all round the dial.'"—J. W., London, E.15.

The above testimonials are chosen at random from among the hundreds of unsolicited letters we have received from Duodyne purchasers and constructors. These establish the fact that the Duodyne Circuit is the most efficient, simple, stable and powerful high frequency circuit available.



"I hear it's very good"

STERLING BABY LOUD SPEAKER

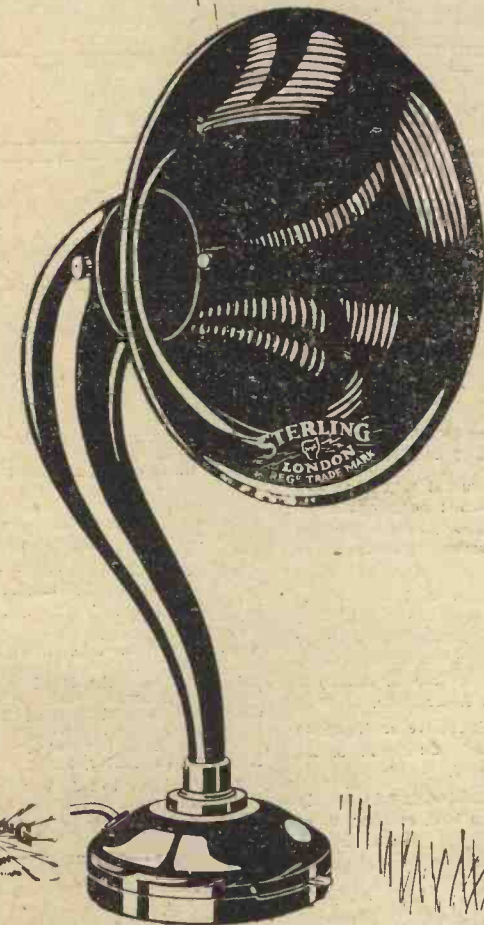

The most popular of all junior loud speakers. Gives ample volume for all usual requirements and a reproduction that is consistently faithful and pleasing in tone. In black enamel or in a particularly attractive brown tinted finish. At all dealers. PRICE 50/-

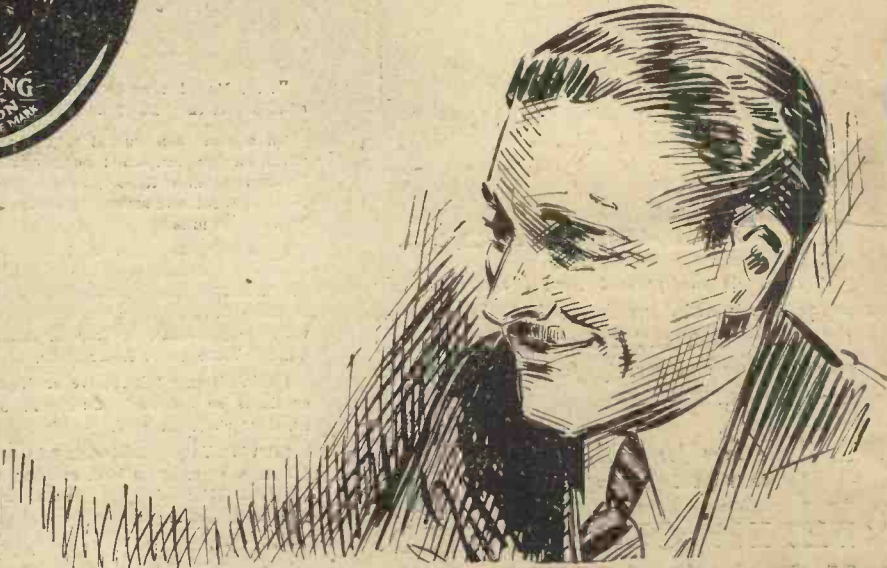

Announcement of **STERLING TELEPHONE & ELECTRIC CO., LTD.**, Manufacturers of Telephones and Radio Apparatus, etc.
210-212, TOTTENHAM COURT ROAD, LONDON, W.1 Works: DAGENHAM, ESSEX

Scientific Adviser :
Prof. G. W'O. HOWE,
D.Sc., M.I.E.E.

Advisory Editors :
Professor
R. WHIDDINGTON,
M.A., D.Sc.
Professor
C. I. FORTESCUE,
M.A., M.I.E.E.

The : WIRELESS : CONSTRUCTOR

Staff Editors :
E. H. CHAPMAN, M.A.,
D.Sc.
A. D. COWPER, M.Sc.
R. W. HALLOWS, M.A.
G. P. KENDALL, B.Sc.
A. JOHNSON-RANDALL,
STANLEY G. RATTEE,
M.I.R.E.
J. H. REYNER, B.Sc.,
A.C.G.I., D.I.C.

Vol. I. SEPTEMBER, 1925 No. 11.

Selectivity with Ease of Control

By A. V. D. HORT, B.A.

A description of a three-valve receiver used by the author for eliminating interference from the local station. Simple direct coupling may be used if desired

SELLECTIVITY as a quality of a receiver is, in the minds of many people, inseparably connected with the delicate and difficult handling of a large number of controls. Instances have come under the notice of the writer of a desire to receive distant programmes without undue interference from the local broadcasting station; but when in such cases the use of loose-couplers and similar devices was suggested as a means of attaining the desired end, the suggestion was greeted with anxious enquiries about the complication of controls which would be involved in such arrangements; inability to get good results from any station with anything more than the very simplest tuning controls was stated as an additional reason for avoiding the remedies offered. It is admitted that a fair amount of practice is required to handle successfully a three-coil holder, carrying primary, secondary and reaction coils. Any movement of either of the variable couplings makes changes in the tuning and reaction settings, and the operator has to learn what effects to expect

whenever he makes an adjustment. In the receiver to be described the advantages of an aerial loose-coupler are secured without this attendant trouble; the reaction coil being coupled to a coil in another part of the circuit, is

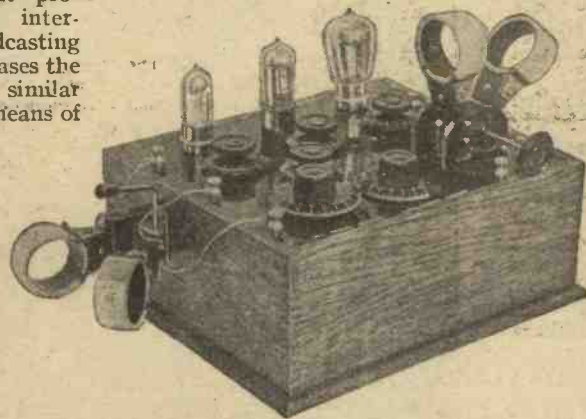

The moving socket in the left-hand coil holder carries the aperiodic aerial coil.

unaffected by movements of the aerial coil. Actual control of oscillation may be to a certain extent affected by such movements, but to a less marked degree. In addition, no extra tuning condenser is fitted in the aerial circuit.

The Circuit

Reference to the circuit diagram, Fig. 1, will show that an ordinary straight circuit is employed, comprising an H.F. valve coupled to the detector by the tuned anode method, while a stage of L.F. magnification follows the detector valve. Two positions, marked A_1 and A_2 , on the diagram, are provided for the aerial. The A_2 position is intended for use on the local transmission, or for any purpose for which selectivity is unnecessary, the aerial circuit L_1C_1 being then quite normal; under such conditions the coil L is not inserted in the holder. When it is desired to eliminate, or at any rate reduce in strength, the local transmission, in order that a more distant station may be heard, the aerial is connected to A_1 , a coil L of 35 turns or so being inserted in the holder for the lower broadcast band: this coil is untuned. If the coupling between L and L_1 is tight, the condenser C_1 will, to a certain extent, tune both coils, and no great gain in selectivity may result; but as the coupling is loosened the tuning of the circuit L_1C_1 will



"SELECTIVITY WITH EASE OF CONTROL." THE WIRELESS CONSTRUCTOR SEPT 1922

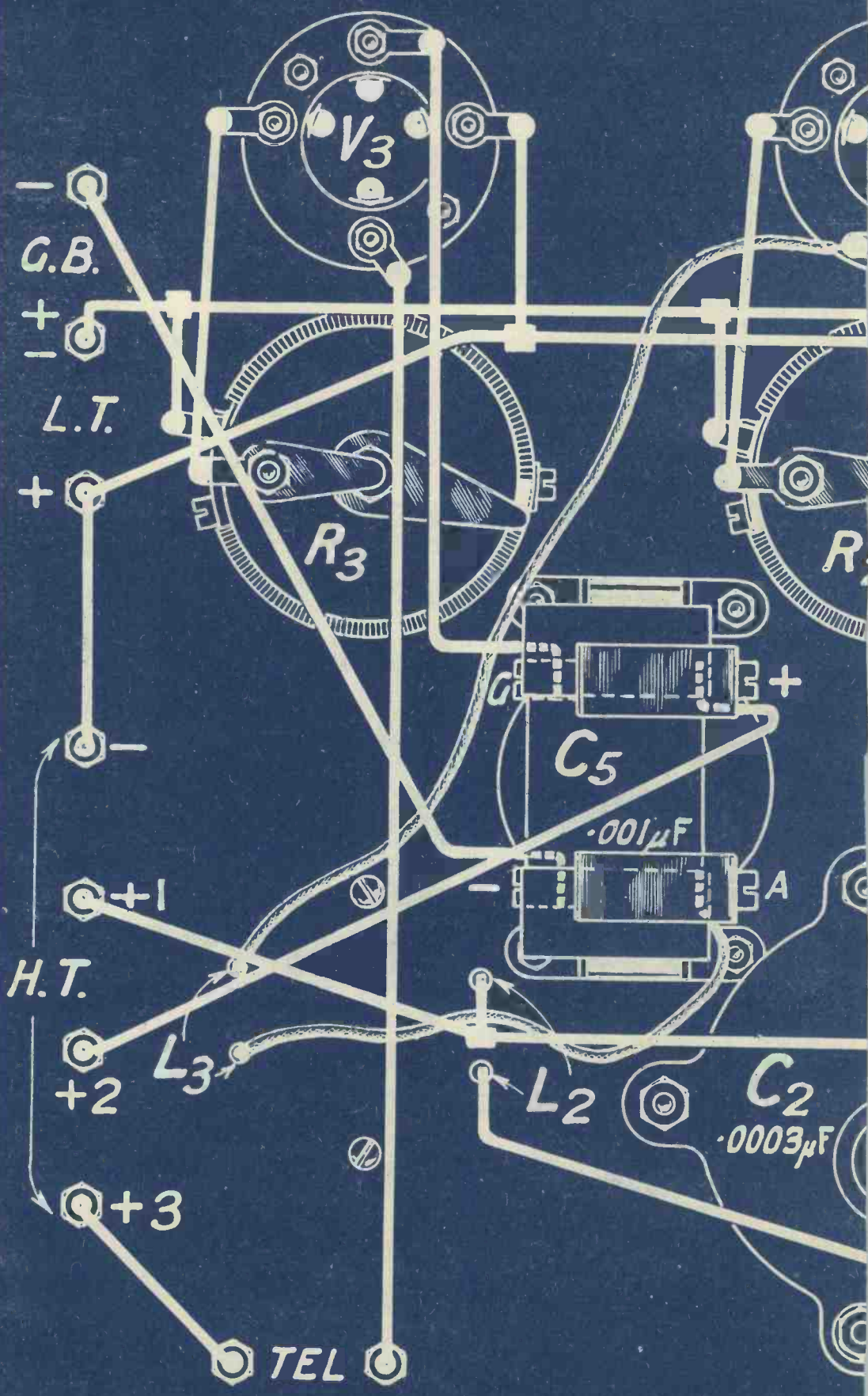

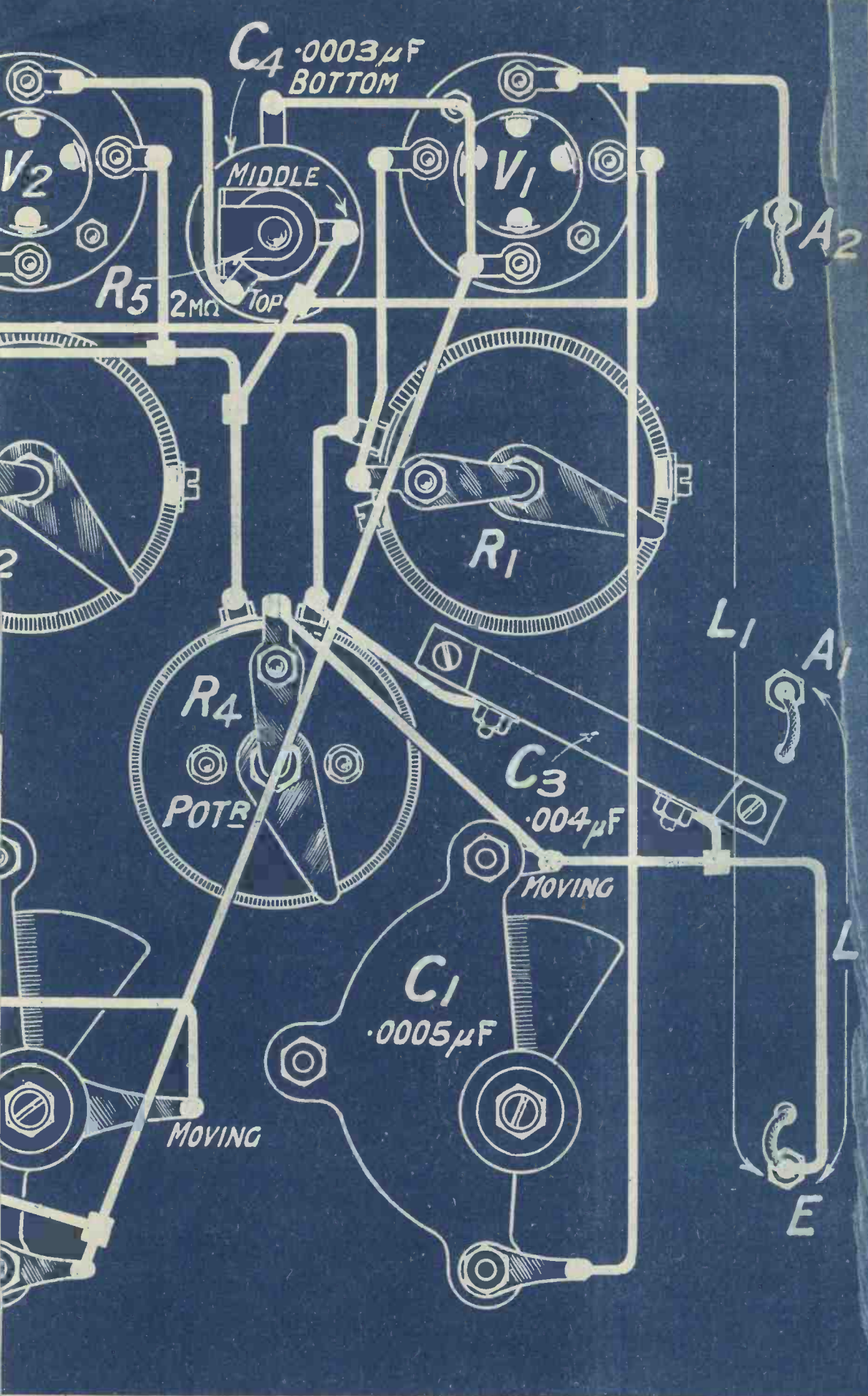

RADIO PRESS LTD. BUSH HOUSE STRAND, W.C.2. BLUE PRINT C.1019B Price 1/6

be considerably sharpened. Thus, with suitable coupling between L and L_1 , it should be possible to receive a distant station without undue local interference. Reaction effects are obtained by coupling the coil L_3 , in the anode circuit of the detector valve V_2 , back to the tuned anode coil L_2 , in the anode circuit

(Dorwood) and one 2 megohm leak (Dubilier).

One $.004\mu\text{F}$ fixed condenser (Paragon).

One I.F. transformer (L. McMichael, Ltd.). A $.001\mu\text{F}$ fixed condenser is supplied with this transformer; if the transformer used is not so provided, a condenser

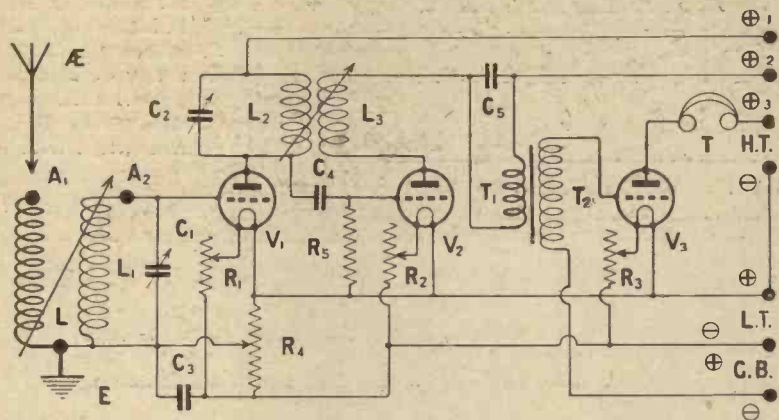

Fig. 1.—The circuit used in the receiver. Direct coupling may be used by joining the aerial to terminal A_2 .

of the preceding valve. To stabilize the H.F. valve V_1 , a potentiometer, R_4 , is provided; the condenser C_3 across its slider and negative terminal acts as a high-frequency by-pass for this part of the circuit. Free use of the potentiometer may be found necessary when the aperiodic aerial coil is in use; the H.F. valve will tend to oscillate freely when the circuits $L_1 C_1$ and $L_2 C_2$ are tuned to the same frequency, especially if the coupling between L and L_1 is loose, since under such conditions the damping otherwise introduced into the grid circuit of V_1 by the proximity of the aerial coil is considerably reduced.

Components

For those who wish to construct an exact duplicate of the set described, a list of the actual makes of components used is given here; whether or not the components specified are obtained, the parts used should be of good quality.

One $.0005\mu\text{F}$ variable condenser, square-law (Utility).

One $.0003\mu\text{F}$ variable condenser, square-law (Utility).

Three dual filament rheostats (L. McMichael, Ltd.).

One potentiometer, 300 ohms (L. McMichael, Ltd.).

One "Lotus" two-coil holder with vernier movement (Garnett, Whiteley & Co.).

One two-coil holder (Magnum).

Three valve holders, C type (H.T.C. Electrical Co.).

One $.0003\mu\text{F}$ fixed condenser

of this capacity should be obtained separately.

Twelve terminals.

Ebonite panel, 12 by 10 by

Marking the Panel

The first operation in the construction of the set is to mark out the panel. This is most easily done by using a blue-print of Fig. 2 and fitting it accurately to the panel, which should be laid on a sheet of soft paper or a table-cloth. Clamp the blue-print in position by any convenient method, and with a sharp point prick through the blue-print the exact centres of the positions at which holes are to be drilled; make sure that all the holes have been marked before proceeding. Next make a slight indentation with a centre punch and a light hammer at each of the points marked; alternatively, the pricked points may be further emphasised with the point of a sharp bradawl, a sufficient mark being made to prevent the drill point from slipping away. In drilling the holes, it is a good plan to drill them all with the size of drill used for the smallest holes, as a small drill will start more accurately in a punch mark than a large one; the larger drills will afterwards run true down the small holes made. The large holes for the one-hole-fixing components should be drilled only halfway through; the panel is then turned

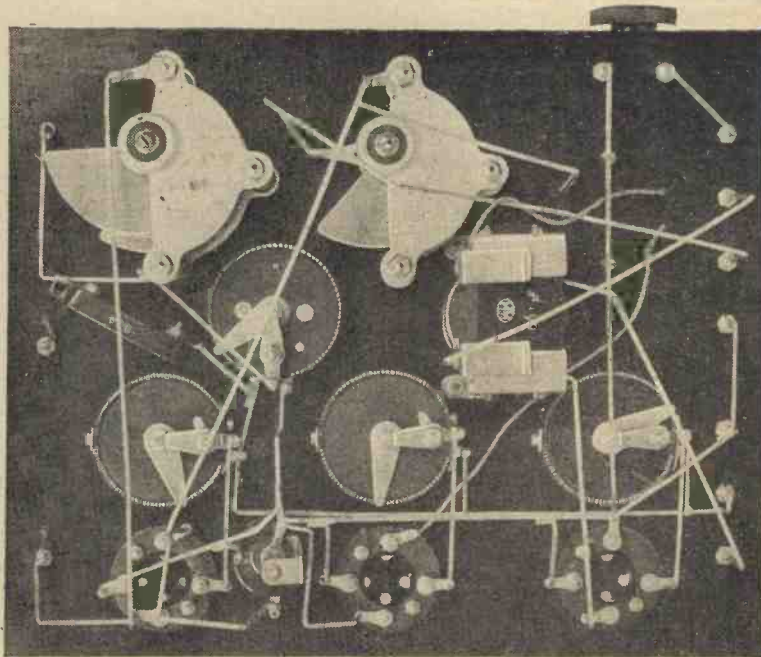

This view shows the connections to the Dorwood grid condenser and leak, also the terminal connections.

$\frac{1}{8}$ in. That used is a Radion guaranteed panel.

Cabinet to suit the above size of panel.

Square-section wire and about 3 ft. of single flex for wiring up.

Radio Press Panel transfers.

over and the holes finished from the other side, thus obviating the risk of breaking away chips of ebonite from the surface of the panel. When all the holes are drilled and the necessary counter-sinking completed, the components

may be assembled on the panel; the knobs and dials of the variable condensers and rheostats are not placed in position till the wiring has been carried out. The L.F. transformer should be secured to the panel with its four bolts before the filament rheostats and variable condenser close to it are attached, as otherwise it will be awkward to get at the nuts to tighten them up. The coil-holder which is provided with a vernier control is mounted on the panel, the other holder being placed on the end of the containing box.

When the components have been fixed in position, the wiring may be carried out. The panel may be supported upside down on wooden blocks placed underneath the edges, so that the face of the panel is not injured; the operation of soldering the connections will be greatly facilitated if the set is perfectly steady to work on. After tinning the shanks of all the terminals, and

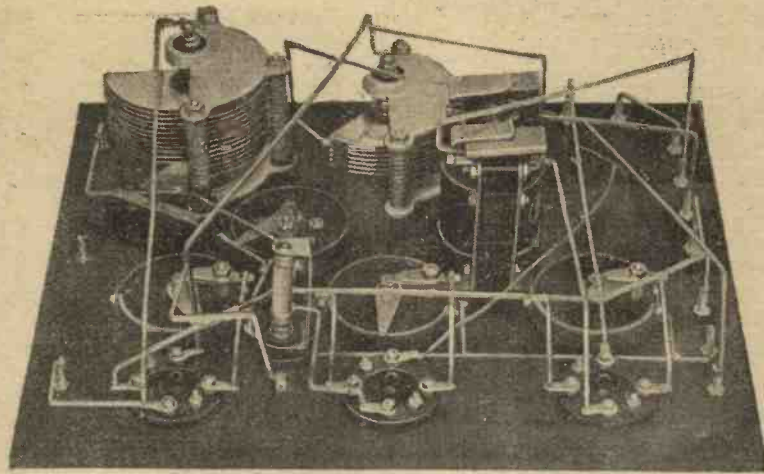

Another view of the wiring which gives a good idea of the layout.

also running a little solder on to any soldering tags, the filament circuit should be wired first, the lengths of wire being bent to shape

before soldering any part of them in position. When these wires (close to the panel) are finished, the connections to the variable

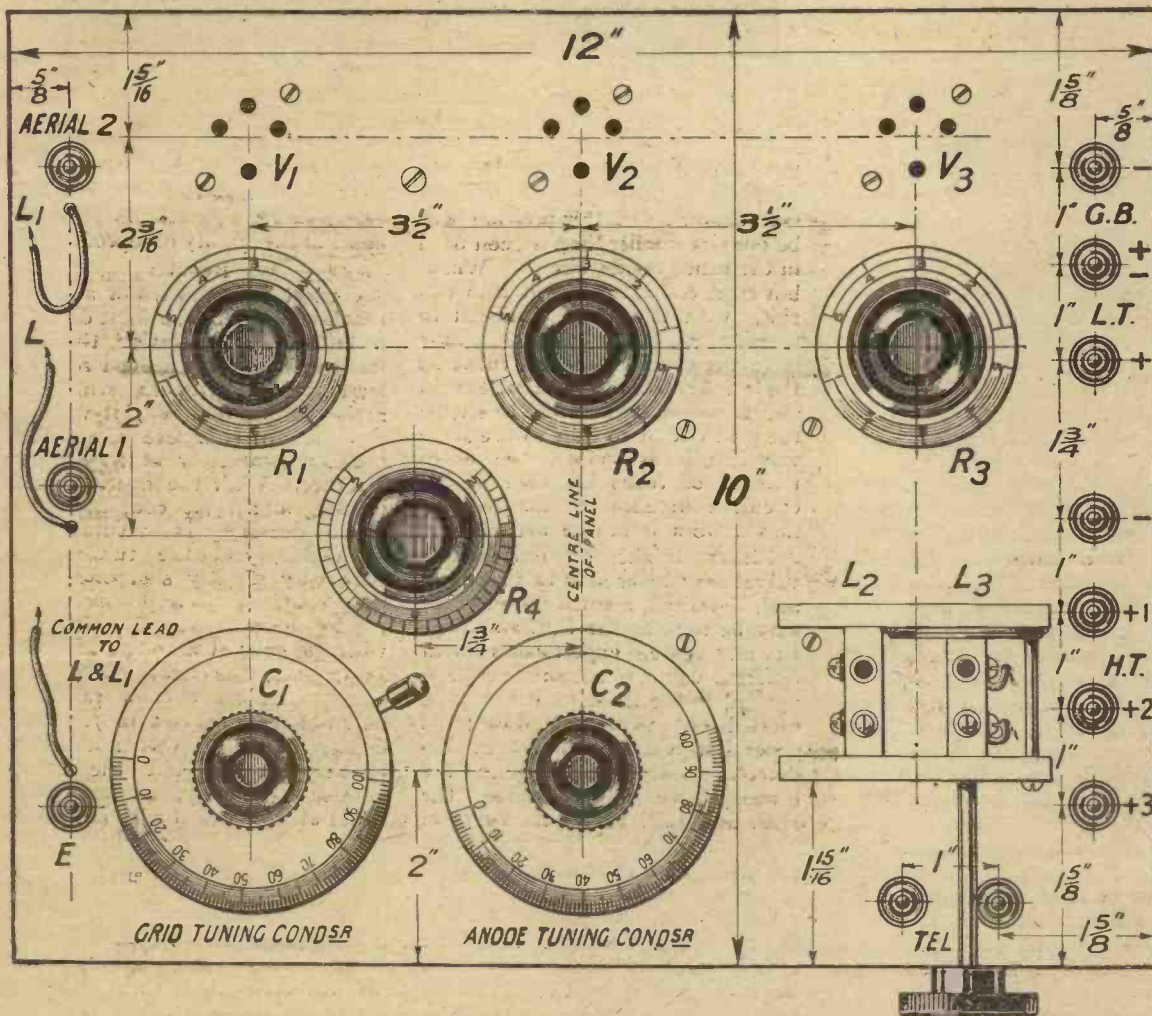

Fig. 2.—From this drawing the panel may be marked out and components mounted in position. Full size blueprint No. C1019a may be obtained price 1/6, post free.

condensers and L.F. transformer may be put on. The connections to the fixed plug of the coil-holder on the panel are made with stiff wires, the ends of the wires being pushed up through the holes in the panel and formed into loops to go under the heads of the bolts on the plug, before the other ends below the panel are soldered in place. Flex leads are taken to the moving-coil plug from one side of the L.F. transformer primary and the anode of the detector valve, the leads being brought through the panel as before. Short flex leads are soldered to the two aerial terminals and the earth terminal, and brought out through the panel, to be attached to the aerial circuit coil-holder when the panel is placed in its box; a short length of flex also connects together the two plugs of the aerial-circuit coil-holder on one side, providing a common earth connection for both coils.

Coils

When the inside wiring is finished, the knobs and dials may be placed in position and the panel mounted in its box; the loose flex leads are then connected to the aerial-coil holder. Now plug in a No. 35 coil as L_1 , a No. 50 or 75 as L_2 , a No. 50 or 75 for the anode coil, and a No. 50 as reaction, and place suitable valves in the three holders. Attach the leads from the filament battery, and see that the valves light up correctly; then detach the filament negative lead from its terminal on the set and touch it on each of the three H.T. positive terminals in turn; if, through an error in the wiring, any of the valves light up, the wiring can be checked over again, and no harm will be done, whereas if the H.T. battery were attached under such conditions, the result would be a burnt-out valve. If all is in order, the telephones, H.T. battery, aerial and earth may be connected up and the filament switched on; the reaction coil should be well away from the anode coil. At first it will be as well to search for signals with the aerial on terminal A_2 , coil L_1 being removed. If the set then functions correctly, the effect of using the aperiodic coil L_1 may be tried; before making the change, the reaction coil should be set in a position of loose coupling, and the increased tendency of the H.F. valve to oscillate when the tuned circuits are brought into resonance should not be overlooked.

With general reference to the sizes of coils to use, it may be noted here that when the aperiodic coil L_1 is not in use, and the aerial

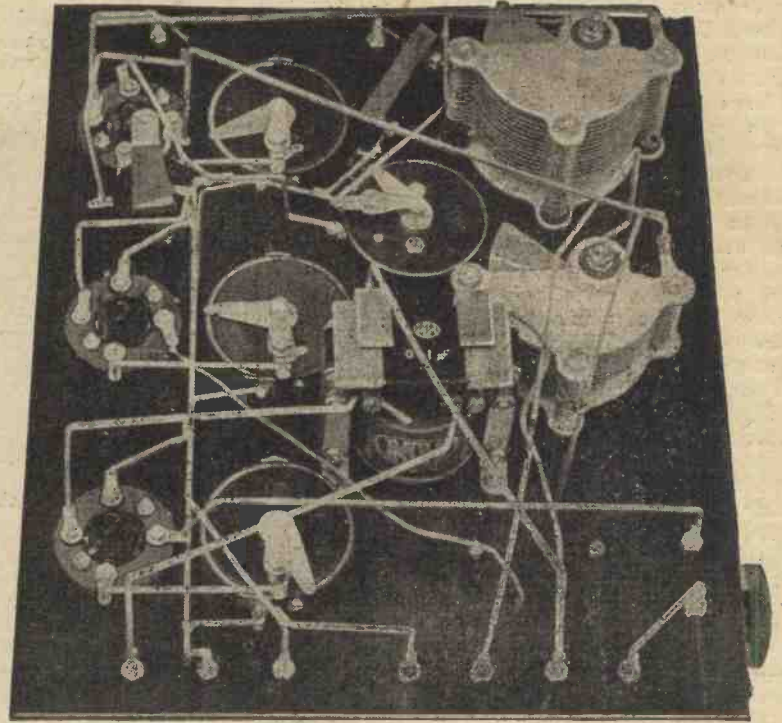

A view of the wiring taken from the battery-terminal end, showing connections to the valve sockets.

is attached direct to coil L_1 via terminal A_2 , the coil usually found suitable for this latter position will be one size smaller than the coil used in the tuned anode circuit. When, however, coil L_1 is brought into circuit, with the aerial attached to terminal A_1 , the coil used as L_1 may have the same number of turns as the tuned anode coil; this increase in size is necessary in order to enable the grid circuit to tune to the same wavelength as before, the extra number of turns included in the circuit compensating for the removal from it of the aerial.

Either bright or dull-emitter valves may be used in this receiver, and, if desired, a small power valve may be used as the L.F. amplifier. In any case, experiments with different values of the anode voltage applied to the three valves may be carried out with advantage; in general it will be found that the detector valve will require the lowest value of the three, the H.F. and L.F. valves following in the order named. If a voltage of about 60 volts or less is applied to the anode of the last valve, the grid-bias negative terminal may be joined with a short length of wire or a metal strap to the low-tension negative terminal next to it; if, however, a higher voltage is employed, the effect of various values of grid-bias should be tried. When a power valve with ample anode voltage is in

use, the application of the correct negative voltage to its grid should result in an appreciable improvement in the quality of reproduction.

Results

On test on a short, low aerial in north-west London, a short distance from the London station, the local transmission was received at good loud-speaker strength with the aerial in position A_2 ; it was impossible to eliminate the transmission completely at so short a distance. With the aperiodic coil in use, and tight coupling, only slight decrease in volume was noticeable, and the tuning was only very slightly sharpened. As the coupling was loosened, the tuning became rapidly sharper; with the coils at an angle of about 45 degrees, the local station was clearly audible over a range of only about 10 degrees on the condenser dials; it was not found possible to cut out the transmission absolutely, as something could still be heard with either the aerial coil or the anode coil removed; at a distance of a few miles the elimination would, no doubt, be more complete. There was a noticeable decrease in "mush" when loose coupling was employed; and an interesting fact was that very severe disturbance caused by telegraph instruments working within 50 yards of the receiver was considerably diminished in intensity.

RETRIBUTION!

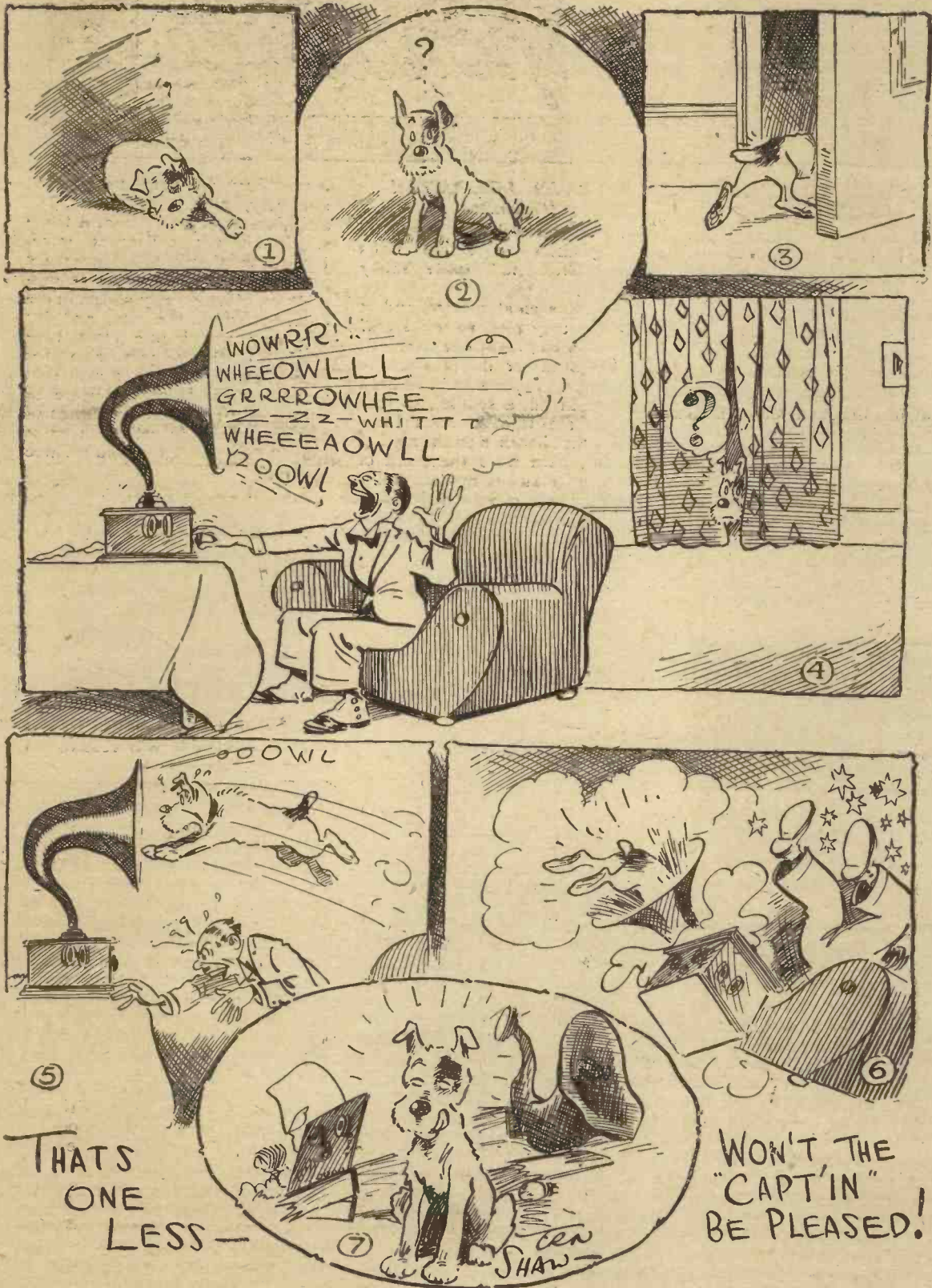

If there's any howling to be done—he can do it.



Correspondence

A POWERFUL THREE-VALVE RECEIVER.

SIR,—I enclose some photographs of the "Full Power from Three Valves" set as described by Mr. Percy W. Harris in the April issue of THE WIRELESS CONSTRUCTOR.

I made it on the "American Type," for safety in the first place, as it will be in a position where several small children would have easy access to it, which would possibly be detrimental to such things as valves, coils, etc.; and, secondly, because the cabinet was already in my possession.

The plan and elevation from rear give a good idea of the easy wiring system, and also layout of components. The transformers are: 1st stage, "Igranic"; 2nd stage, "Formo" 3-I. Filament resist-

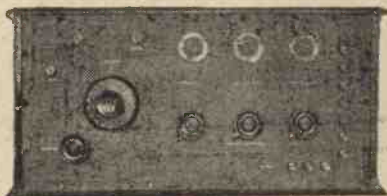

Allowable only with some designs. How Mr. Mills altered the "Powerful Three."

ances are "Alto," and coil-holder "Lotus" geared; and condenser "Devicon" square-law. So far, I have only tried it with a cheap foreign loud speaker on a medium aerial. The result was remarkable. London and Bournemouth came through splendidly, as did, of course, 5XX. Altogether, I am more than pleased with the set, and can assure you that for any future sets I may make I shall not look further than the pages of THE WIRELESS CONSTRUCTOR, which I have taken since No. 1. Wishing your book the success it deserves, and thanking you for being the means of my making so good and interesting a receiver which is so satisfactory in every way.

I am, yours faithfully,
W. T. MILLS, jun.
Hastings.

FROM AN AUSTRALIAN READER.

SIR,—I received my parcel of seven packets of Radio Press "Panel Transfers" quite safely last week.

They are a great success, and as I am the only one, to my knowledge, who has them out here yet, my set is rather above most in appearance. Some sets have been engraved at 3d. a symbol, so that you can see what a boon these transfers will be when on the market out here, both from the point of view of price and of appearance.

Wishing both of your periodicals, *Modern Wireless* and THE WIRELESS CONSTRUCTOR, to which I subscribe, the best of success.

Yours faithfully,
G. ELLIS.
Melbourne, Australia.

IN CZECHO-SLOVAKIA.

SIR,—By chance, the first copy of THE WIRELESS CONSTRUCTOR reached me, since when I have ordered your paper, and cannot do without it now. I also order all German wireless papers, but not even the . . . , the best of them, can be compared with your CONSTRUCTOR. Though my knowledge of English is very defective, I am a most enthusiastic reader.

A short time ago I built up the set described by Mr. Percy W. Harris in the April issue, "Full Power from Three Valves." I must acknowledge that this is the best set I have built. It affords me the greatest pleasure to hear every day English stations, with their wonderful programmes, passing from one to the other. We dance to the beautiful "Blues" of the Savoy Bands, of course, with a loud-speaker. I also receive very well on the set Oslo, Rome, Zurich and, of course, Vienna, with unexcelled strength, and all German transmitters in succession as they appear on the programme. The local station is not good, and therefore I do not want to speak about it. But it roars!

The set is built solely of English components; these are obtainable

here. They are very, very good; and very, very, very dear! The set, however, is a magnificent thing which all my colleagues envy. I wish to thank Mr. Harris for his very intelligible mode of description, which greatly assists in the construction of the sets, and for the very useful and clear blue prints. I thank you also for having enabled wireless amateurs to make their hours of leisure so exceedingly agreeable by means of a very high-grade set, such as is the "Full Power from Three Valves."

I am, yours truly,
ALFRED GROLICH.
Brunn, Czecho-Slovakia.

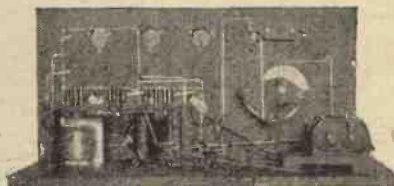

A neat layout, with simple wiring. The back of Mr. Mills' receiver.

SEVEN-CIRCUIT CRYSTAL SET.

SIR,—I have recently made up a "Seven-Circuit Crystal Set" to instructions given by Mr. Percy W. Harris in THE WIRELESS CONSTRUCTOR in December, 1924. I am delighted with this set, especially so as I am rather deaf (degree of deafness is such that I cannot hear ordinary speech in an average room) I have tried out many crystal sets of various makes, but the Seven-Circuit set is the only one from which I can get really good definition. I might add that my variable condenser is very poor, and possibly I should get even better results with a high-class condenser.

I am using an outdoor aerial—length about 50 ft., height 28 ft., and T.M.C. headphones. This is the first wireless receiver I have ever constructed, and I feel that I owe you my thanks for the publication of such clear instructions and such an efficient set.

Yours faithfully,
FRED G. STEVENS.
London, S.W.8.

Faults in the Filament Circuit

By G. P. KENDALL, B.Sc., Staff Editor

When a valve fails to light, it may not be due to a broken filament. Test the wiring as outlined in this article before rejecting the valve

IT is an unpleasant sensation, truly, when one switches on a set and observes that one or more of the valves fail to light; perhaps only exceeded in disagreeableness by one's feelings when that blue flash is observed which denotes a slight confusion as to which were the L.T. and which the H.T. terminals. One's first thought is that the valve in question has fallen a victim to somebody's misguided efforts in the way of dusting, or that it has become a casualty in some other way, and it is a considerable relief to discover that it lights up all right when placed in, perhaps, another socket of the same set, or in a different set.

It is then concluded that there is some sort of fault in the filament circuit of that particular valve, and one generally sets about the location of the trouble in a rather more confident manner than is justified by the difficulty of the task. As a matter of fact, the filament circuit can develop some extremely puzzling faults, ranging from a refusal to light up on the part of the valve to mysterious crackling and sizzling noises.

Change the Valves Round

Take, first, the simple case of a failure to light up on the part of a particular valve in the set. Of course, the first thing to do is to make sure that the valve itself is not defective, and this can be done by inserting it in one of the other sockets of the set, where it may be found to light correctly, or, alternatively, it may be tested by placing a pair of leads upon its filament pins which have been taken directly from the terminals of a suitable battery. By "suitable," I mean a battery of approximately the correct voltage for the filament of that particular valve. With most ordinary bright emitters, for instance, a four-volt accumulator will serve perfectly well, while for the type of dull emitter taking .06 ampere a two-volt supply will generally show a sufficient glow to indicate that the valve possesses a whole filament.

Separate the Pins

This latter method of testing is somewhat to be preferred, since by its aid one can make quite certain that the filament of the valve is intact or otherwise, which it is not safe to assume merely because the valve does not light up when inserted in an ordinary socket. As a matter of fact, it is quite possible for a valve to fail to light when inserted in a socket for the simple reason that the pins require separating by means of a knife blade to ensure that they make good contact in the socket. This point should always be attended to in a case of the type which we are considering.

Assuming now that we have decided that the valve is intact, and that its pins are making proper contact in the socket, the reason

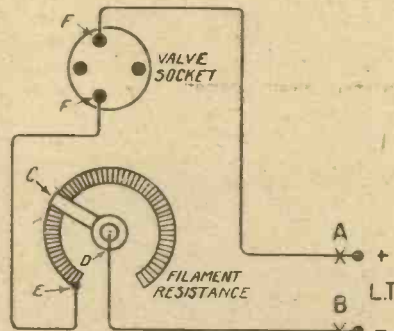

Fig. 1.—The points where faults may occur are indicated at A, B, C, D, and E.

for its failure to light must naturally be sought in a fault in the filament circuit of the receiver itself. The actual location of this fault will in many cases be apparent upon quite a superficial examination being made of the underside of the panel, but one can get a general idea where to look by noticing whether it is merely one valve which is affected or alternatively all the valves in the set. If all the valves refuse to light it is probable that the fault will be found in the wiring, very likely at the points marked A and B in

Fig. 1—that is to say, where the wires are soldered to the two low-tension terminals. One of these may have come adrift, and inspection alone will serve to locate the trouble.

The Filament Rheostat

If, however, only one valve is affected, the trouble will be found in the wiring peculiar to that valve alone, and further inspection should be made. If no kind of trouble can be discovered, suspect the filament rheostat at once, and examine it carefully to see whether the moving arm makes good contact with the resistance element at all points of its travel, and also whether the connections to the rheostat are intact. If the trouble is not obvious to the eye, the point may be settled with the aid of the telephones and dry cell test, the test being made across the two wires which lead from the filament rheostat; the knob of the rheostat should be turned to various points as the test is carried out. Full-strength clicks should, of course, be obtained from a rheostat in proper order.

Wiring to the Socket

If the rheostat proves to be in proper working order, attention should be directed to the wiring beneath the valve socket, and the two wires to the filament legs should be given a sharp pull to ascertain whether they are properly soldered in place. If no sign of a fault can be discovered at any of the points previously mentioned, the valve socket itself should fall under suspicion, and probably the best thing to do is to apply at once the telephones and dry cell test between the wires connected to the valve legs beneath the panel and the elements of the socket upon the surface of the panel. Faults taking the form of a disconnection inside the valve socket itself are only at all likely in the case of certain special types of valve sockets, wherein a complicated assembly is embodied in the design.

Flickering

We have so far considered merely faults of such a nature of a complete break in the filament circuit, but a few words may perhaps be useful concerning those which result perhaps merely in a visible flickering of the valve, or at any rate in audible noises. If at any time the set develops noises which resemble atmospherics, but which cannot be removed by any of the usual steps, such as the provision of a new high-tension battery and so on, it is reasonable to suspect that there is some defective contact in the filament circuit, and the first point to which attention should be directed is the filament rheostat. If it is of a type which can be readily taken to pieces, do so, and clean up all the rubbing contacts with fine emery or glass paper, giving them a slight smear of vaseline before re-assembly.

The Moving Contact

Further, see that the end of the moving finger is rubbed bright, and that its track upon the resistance element is clean and bright.

If the treatment of the filament rheostat indicated does not cure the trouble, examine the pins of the valve, and, if necessary, open them out with the blade of a pen-knife, to ensure that they may give good contact with the socket, and if the trouble still persists, try a different filament accumulator.

Two Interesting Questions Answered

What effect upon reception have telephone wires running near to an Aerial?

If the telephone wires are parallel or almost parallel to the aerial, they screen it to some extent and thereby reduce its practical efficiency. In the case of a transmitting aerial, induced currents may be set up in the telephone wires, and the telephone subscribers have been known to overhear the transmissions. If the aerial can be erected as nearly as possible at *right angles* to the telephone wires, the effect of the latter is reduced to a minimum.

What precautions should be taken to ensure the clearest reproduction by a Loudspeaker?

Assuming that distortion has been eliminated as far as possible in the circuits of the receiver itself,

first turn the adjusting screw of the loudspeaker until the best result is obtained, and then experiment with various sizes of fixed condenser across its windings. In the case of a low-resistance instrument the requisite capacity may be quite large, a possible value being $0.25 \mu\text{F.}$, and it will often greatly improve the performance of the loudspeaker when provided. The effect is less marked with the high-resistance type, but is nevertheless present, and should be taken into account. A good value in this instance is $0.005 \mu\text{F.}$

A very important adjustment to obtain the most satisfactory results is that of the volume or loudness of the signals: it is utterly useless to apply an input power large enough for a Magnavox-Senior to one of the "baby" or "junior" varieties of

loudspeaker, for the inevitable result is severe distortion from the ruthless overloading. Always adjust the strength of the signals to such a point that the loudspeaker is taking just as much as it will carry without beginning to distort seriously, and never give it more. It is a most senseless proceeding to pile on valve after valve until the diaphragm is rattling against the pole-pieces and the horn is ringing with all sorts of notes and their harmonics, and yet it is all too common. If it is necessary to reduce the signal strength even when a moderate number of valves are in use, it should be done by slightly de-tuning the receiving circuits, which often reduces distortion, rather than by turning down the valve filaments, which may increase it.

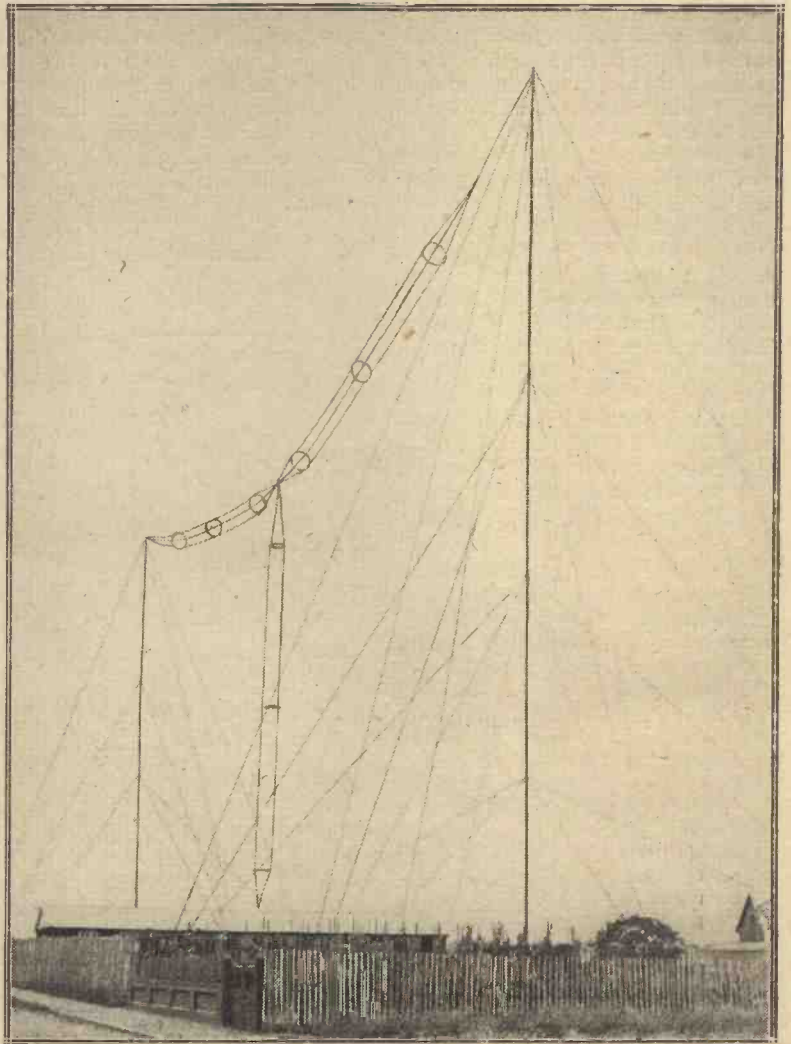

The Bournemouth station, situated as it is on high land, is quite free from screening. The photograph shows the "sausage" aerial and lead-in.



What Our Readers Think of the "Resistoflex"

Same opinions on a two-valve receiver described by Mr. John Scott-Taggart in our first number

SIR,—I have been a reader of THE WIRELESS CONSTRUCTOR since it started, but I must say how surprised I am not having read any letters about the Resistoflex Circuit which was described in the first number. I have had very good results with it, having received all the main British stations as well as one or two Continental ones, but have not been fortunate enough to get their call sign. I had a lot of trouble to get Aberdeen until just recently, and then I received it nearly as loud as I get London through, which is good 'phone strength. It works the loud-speaker well from Birmingham without any distortion at all—in fact, various friends have remarked on the pure tone it renders. But now I should like to go a step further by adding another valve to it so as to enable me to get more distant stations with 'phones and to receive one or more extra stations on the loud-speaker without having to alter my present circuit.

Yours faithfully,

W. F. CARTWRIGHT.

Birmingham.

[Any single-valve low-frequency amplifier may be added to this set; many suitable designs will be found in back numbers of this JOURNAL.—ED.]

* * *

SIR,—I feel that yourself and also your readers will be interested in the results I have obtained from the 2-Valve Resistoflex Receiver described by Mr. John Scott-Taggart in the November and December issues of THE WIRELESS CONSTRUCTOR. Following the instructions, I have built the set up, and have received the following stations: Petit Parisien, Madrid, Barcelona, Bournemouth, Cardiff, Glasgow, Manchester, and Aberdeen, and one night I got a German station, after London had shut down, which was giving the Presidential election results as they

received them. I could have heard this on a loud-speaker.

Yours faithfully,

S. J. W.

East Ham, E.6.

* * *

SIR,—It may interest you to know that I am obtaining excellent results from a "Resistoflex" two-valve Receiver which I made from instructions given in Nos. 1 and 2 of THE WIRELESS CONSTRUCTOR. I may say that I am quite a novice, and that this is the first set I have attempted. The local station comes in very strongly on the loud speaker, and I have obtained very good 'phone signals from several other British stations, including Bournemouth, Cardiff, Newcastle, Glasgow (all very clear), and on one occasion one of the Paris stations. Everyone who has heard this set was greatly struck by the purity of the reception. This is one of the great features, and another is the sharpness and ease of tuning. There is an entire absence of noise, and the local station can be brought in on 'phones as sweetly as on a crystal. I am only 3 miles away from that station.

Yours faithfully,

W. DUNCAN.

Sydenham, S.E.6.

* * *

SIR,—It is with great pleasure that I have put pen to paper to congratulate you on the "Resistoflex" Circuit, described in Nos. 1 and 2 of THE WIRELESS CONSTRUCTOR. I immediately set to work and made it up, and the results were simply marvellous.

Of course, all Paris stations come in at loud-speaker strength, with no aerial, but simply the earth wire fixed to aerial terminal.

With indoor aerial, in a 12-foot back room on the second storey of an hotel near the centre of Paris, I receive Chelmsford quite well in the 'phones.

The aerial is about 40 ft. long set zig-zag fashion across the

ceiling, and the earth is just a piece of wire wound round the tap

Considering I am using dull emitters and cardboard condenser, and a very cheap make of grid leak I consider these results just wonderful.

I have not yet a complete set of coils for the shorter wavelengths, my aerial condenser only registers 10° for the P.T.T., Paris, so cannot expect to receive 2LO on these. I forgot to mention that my coils are also of a very poor quality, which only goes to make the results all the more incomprehensible, and, again, my H.T. battery is of only 80 volts.

THE WIRELESS CONSTRUCTOR is in great demand amongst my French colleagues.

Wishing you every success.

Yours faithfully,

CHAS. DAUNTON-SHAW.

Paris.

* * *

SIR,—I have made the Resistoflex receiver as described by Mr. John Scott-Taggart in the November, 1924, issue of THE WIRELESS CONSTRUCTOR. On a 40ft. high aerial seven miles from 5IT, I received 2LO, 2ZY, 5NO and 6BM during an interval at 5IT, at good 'phone strength. Loud-speaker reproduction is perfect, especially as regards purity, while the volume is sufficient to be heard all over the house.

On a temporary aerial, 15 ft. high, 50 ft. long, two miles from 5IT, the loud-speaker can be heard and speech followed in all the downstairs rooms, while on an inefficient aerial and earth I have heard Aberdeen, Radio-Paris and Hamburg. As regards selectivity, I can cut out 5IT with 8 degrees either way on the A.T.C., and London and Manchester have been heard with a silent background, with 5IT working two miles away.

Concluding, I would like to say that it is the clearest set I have ever handled.

Yours faithfully,

Birmingham. F. C. BROOK.

A Simple All-Enclosed Local-or-Daventry Receiver

By F. ENGLISH



A simple crystal set which can be closed up when not in use. Coils for both short- and long-wave broadcasting are incorporated

The telephone receivers are packed away in the left-hand compartment.

THE receiver about to be described certainly cannot be said to contain an original circuit, since it is one which has been utilised in countless types of crystal sets, but the complete instrument does possess one or two outstanding features which may make it of interest to numerous readers. As will be seen from the photographs which accompany this

article, it is very compact, and the fact that the closed case is not in any way cumbersome, and, incidentally, possesses a handle, certainly suggests portability.

As a matter of fact, this receiver has been found to be very useful as a portable set for those who have no objection to wearing the headphones out of doors. If you were to ask me what range it has, I would

most surely reply "the average range for a crystal set," by which it is understood that nothing exceptional is claimed for it. However, it has been tested at 12 miles from 2L.O., and quite good signals were received on two pairs of headphones. On this occasion it was taken out as a portable receiver on a day's outing.

Summer Outings

There are many occasions when a small party will go out and be

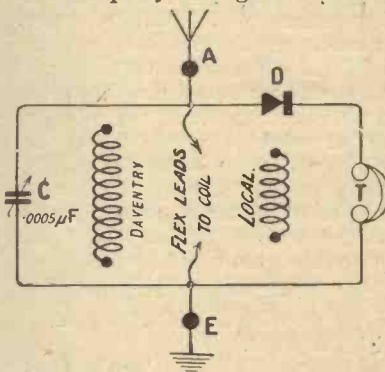
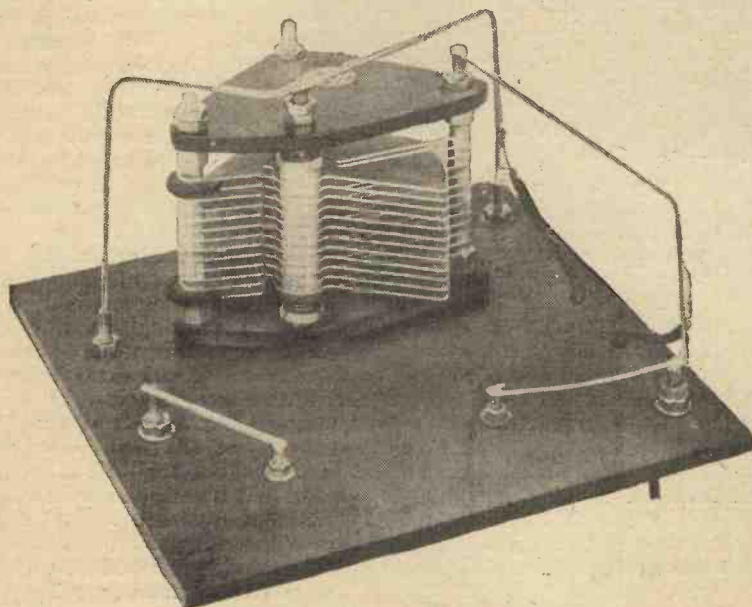

Fig. 1.—The flexible leads may be joined to either coil, as desired.



Nothing to be frightened of in the wiring !!

able to enjoy the countryside and still be not too many miles from a broadcasting station for a crystal receiver. On such occasions this set will be found to serve the purpose of those who do not mind donning the 'phones to enjoy the programme. Of course, there are many who will say that listening-in in the open is nothing unless one employs a loud-speaker, but I am inclined to think there are lots of people who will disagree with this statement.

It is not always that the entire party desire to listen-in, since some like to go for a ramble, and so on; yet if one or two do wish to, then it is possible just to stretch oneself on

the grass, place the headphones in position, and adjust the receiver. It must, however, be borne in mind that not too much should be ex-

placed in the left side of the lid. I give below a list of the components used in the original receiver, but it should be borne in mind that it is not imperative to use exactly the same makes, as long as all the components are of reliable manufacture.

duced to exactly half-scale. It is thus a simple matter to mark out a panel from it, by simply measuring off the distances and doubling each. When drilling, take care not to scratch the surface of the panel, as this will spoil its shiny appearance.

When drilling has been finished, the parts may be mounted on the panel, the arrangement of them being clear from Fig. 2.

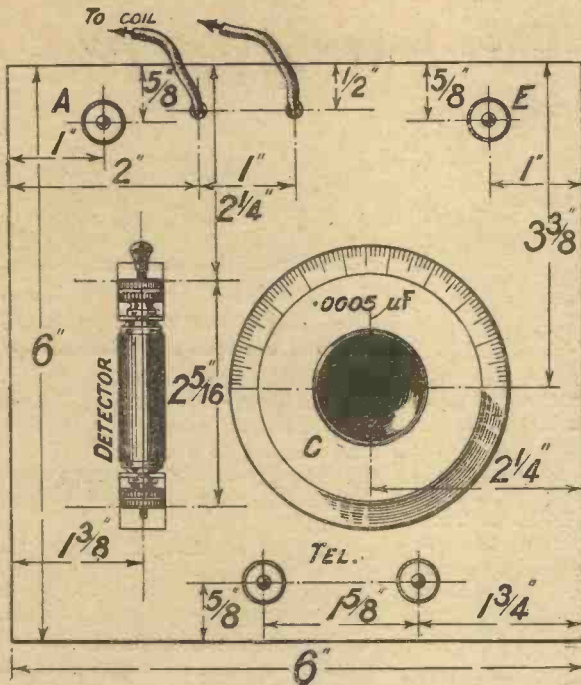

Fig. 2. — How the panel is drilled. This drawing also shows how to mount up the parts.

pected or too great a range asked of any crystal set.

The set itself is extremely simple to construct, and can be put together by the veriest novice after a short study of the diagrams included in this article. One of the now numerous types of "permanent" detectors has been incorporated, since these have a distinct advantage over the catwhisker type, which necessitate frequent attention and adjustment.

Coils

A circuit diagram is seen in Fig. 1, where two coils are shown, one marked "Local" and the other "Daventry." The first coil is to be used when one desires to listen to a short-wave station, while the larger coil is brought into use when it is desired to receive the long-wave station, which is now at Daventry.

Provision has been made for the two coils to be contained inside the lid of the case. Connections to the coil it is desired to use are made by means of flexible leads brought up through two small holes drilled in the panel. When soldering these two flexible wires to the aerial and earth terminals respectively, care should be taken that they are amply long enough to reach to the coil

condenser, square-law pattern. (Any good make will suit. That used was of the one-hole fixing type.)

One crystal detector (Radio Instruments, Ltd.). Any make of detector will suit quite well, preferably one of the semi-permanent type.

Two panel mounting coil sockets (L. McMichael, Ltd.).

Four terminals.

Necessary wire for wiring-up.

Radio Press panel transfers.

Drilling

The panel is drilled as shown in Fig. 2, this drawing being repro-

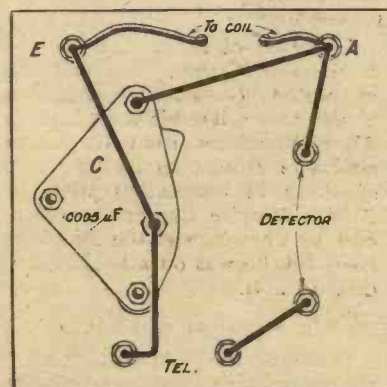

Fig. 3. — Eight soldered joints only are called for.

The Coil Sockets

The coil-sockets are each mounted in the lid of the case by one fixing screw brought through from the outside of the box. When assembling the receiver, it must be borne in mind that the coils must be placed far enough apart to permit of two of them being placed in the lid, also that they must be so arranged that the knob of the condenser will not foul a coil when the case is closed and fastened. Also, the crystal detector should be mounted in such a position that it will fit in between the two coils when the box is closed. If components of a different make are employed, try them on the panel before drilling it, with the coils in the case, to ensure that sufficient space is allowed for mounting each part.

Wiring

The wiring of the receiver takes very little time, as there are so few wires to put on. I would advise you to solder the wires into position, as it is really more satisfactory to do so. The necessary connections will be seen in Fig. 3, in which diagram it is also made clear as to where the two flexible leads to the coil socket are joined.

The set when completed presents a neat and compact appearance, and to those readers who prefer a completely enclosed receiver without loose wires, etc., this one should certainly make an appeal, since when not in use it can be any closed up and put away without fear of damage or of losing the coils.

As regards the aerial, when the set is to be used in the open, this may consist of a length of rubber-covered flex, slung between two convenient trees, or alternatively, from the branch of a tree to the aerial terminal of the set. The earth lead may be taken to an iron spike driven in the ground, or alternatively, the lead may be taken to an iron fence if such is at hand.

ERRATUM

We are asked to point out that in the advertisement of Messrs. L. McMichael, Ltd., appearing on page 897 of our last issue, the price of their Bright Emitter Filament Rheostat was wrongly given as 5s. This should be 5s. 6d.



H.R.H. The Duke of York, whose speech at the Empire Day Banquet, last year, was broadcast.

THE battles between the "high-brows" and "low-brows" will no doubt be waged for all time in matters of wireless, for no two people's tastes are alike in music, but with the exception of some of the bores who waste our afternoon current on too many occasions it is safe to say that the British Broadcasting Company has found the highest speakers in the land ready to voice their appeals or opinions before the microphone.

Royalty

From the very commencement of broadcasting, royalty has taken the deepest interest in matters wireless, and nearly every member of the Royal Family, including His Majesty, has been heard, directly or indirectly.

Last year the Duke of York spoke at the Empire Day Banquet, and the Duchess, who is equally interested in wireless, spoke at Glasgow, while H.R.H. Prince Henry spoke at the same city last



Miss Lilian Baylis, who is well known in connection with her work at the "Old Vic."

Famous Speakers Over the Aether

By

"CARRIER-WAVE"

month when laying the memorial stone of the Glasgow Hospital.

Amongst other members of the royal family may be mentioned the Marquess of Cambridge, G.C.B., best known as the Duke of Teck. Soldier and sportsman too, he spent some time in India, serving in the 17th Lancers, as well as being with the 1st Life Guards later in South Africa.



Lady Rosalie Neish, whose talks on beauty have appealed to lady listeners.

The Earl of Athlone, brother of H.M. the Queen, and recently appointed Governor-General of South Africa, like his wife, Princess Alice, broadcast from the actual studio in November last at 2LO, speaking in connection with the British Empire Cancer Campaign; and, as Chairman of the Middlesex Hospital, he was on a subject very dear to him.

Society's Interest

Some of the foremost peers of the realm have been heard, including Field-Marshal Earl Haig, the late Lord Curzon, the Marquess of



H.R.H. The Duchess of York, whose voice was heard by many when she spoke at Glasgow.

Londonderry, who spoke at Belfast early in the year on "Ulster's Contribution to the Empire," and the Marquess of Aberdeen and Tenaire, who opened the Aberdeen station.

The Earl of Balfour, who spoke at a dinner of the National Institute of Industrial Psychology, is specially interested in the broadcasting of classical music. He is himself a clever organist, his favourite composers being Schumann, Brahms, Bach and Grieg, as well as Handel, and he was largely instrumental in founding the English Handel Society.

Familiar Names

The Earl of Reading, Viscount Grey of Fallodon, and the Earl of Meath are all now familiar names to listeners-in. The latter, as founder of Empire Day, has done much to increase the interest of the public in the Empire, and he is a firm believer in broadcasting as a means to this end.

Lord Riddell is another ardent broadcaster, his speech on "Popularity and Posterity," given at



The Rt. Hon. Ramsay MacDonald, M.P., who has been heard both in a political and private capacity.



The Rt. Hon. Stanley Baldwin, M.P., whose voice was heard during the last election.

LO, being exceedingly interesting. Two lord mayors, Sir Louis Newton and Sir Alfred Bower, have been heard, while on the feminine side we have had the Duchess of Atholl and Lady Rosalie Neish, amongst others. The latter lady is the wife of the Registrar to the Privy Council, but she is also a talented novelist and playwright, as well as journalist, and her talks on beauty were of interest to lady listeners.

The Political Arena

Naturally the era of wireless has proved an immense asset to politicians on all sides, and during the last elections people had unique opportunities of hearing the claims of all parties. Amongst those who have appeared before the microphone may be mentioned The Rt. Hon. and Mrs. Stanley Baldwin, The Rt. Hon. Ramsay MacDonald, both in official and private capacity, the Rt. Hon. Arthur Henderson, and the former Minister of Labour, the Rt. Hon. Tom Shaw. Although, as he admits himself, a "self-



Mr. Milton Hayes, a well-known speaker, who tempers wisdom with humour.

A brief account of some of the more famous celebrities who have, from time to time, addressed the enormous wireless audiences from various stations of the British Broadcasting Company.

made" man, starting life as a cotton-weaver, to-day he is one of the best linguists in the country, and, having travelled extensively all over Europe, he has a practical knowledge of the conditions of the workers of whom he speaks.



Mr. J. C. Stobart, the Director of Education to the B.B.C.

Lady Astor, Mrs. Philip Snowden and Miss Margaret Bondfield have also been heard over the aether. The last has certainly proved herself one of our finest women speakers, in Parliament or out of it, and she is the first woman in history to be a member of the British Government. The work, too, of Lady Astor needs little comment.

Other prominent politicians include the Rt. Hon. Noel Buxton, Sir Kingsley Wood, Sir Halford Mackinder, the Rt. Hon. G. N. Barnes (who has been so closely associated with the League of



Field-Marshal Earl Haig, who appealed on behalf of the Fund for Ex-Service Men which bears his name.

Nations conferences), the Rt. Hon. Sir William Joynson-Hicks, the Rt. Hon. J. H. Clynes, M.P., and the Rt. Hon. J. C. Smuts.

Science and Art

The first names which come to one's mind in science must naturally be Sir Oliver Lodge, one of the pioneers himself in wireless history, Dr. J. A. Fleming, F.R.S., and Sir William H. Bragg, and it is safe to say that all three are authorities on their subjects.

One of the best series was that of the seven lectures given by Sir Oliver Lodge, amongst them "Solving the Secrets of the Aether," and also "The Birth of a Star." He has occupied many important positions in the world of science, but chief amongst them was that of Principal of the University of Birmingham during nineteen years. Generally speaking, scientists are apt to specialise on one particular



Mlle. Suzanne Lenglen, the famous tennis player, has spoken to the unseen audience on occasions of her visits to England.

branch, but Sir Oliver has made himself an authority on electricity, mechanics, mathematics, psychical research, as well as tackling the problems of dispelling fog and making rain; but it is his work with wireless that will take his name down to posterity.

Dr. Fleming's name is for ever bound up with the thermionic



Mr. George Bernard Shaw, the famous writer, who has been heard.

valve, and Sir William Bragg is one of our foremost physicists and authorities on sound.

On the question of education few will deny the claims of Mr. J. C. Stobart, the Director of Education, as also the talks of Sir Johnston Forbes-Robertson, the veteran actor, in his transmissions to schools. Another famous artist is Lilian Baylis, M.A. Oxon, whose fine work at the "Old Vic." has won such wide appreciation.

The Literary Side

Here, too, have we heard the giants, from the earliest literary man to recognise the claims of wireless, Mr. William Le Queux, to Bernard Shaw. Sir Hall Caine, Hilaire Belloc, Sir Arthur Conan Doyle, Rosalie Masson, G. K. Chesterton, Charles Sarolea, the Belgian writer, Emile Cammaerts, another Belgian writer and composer of the famous war poem "Chantez, Belges, Chantez!" which served such purpose in the war, Miss Marjorie Bowen and Mr. John Drinkwater. The latter's plays, "Abraham Lincoln" and "Oliver Cromwell," will always entitle him to a place amongst the high gods of literature. Other names are H. G. Wells, E. V. Lucas and Stacy Ammonier.

One must not forget the sporting element, for which have been obtained Mlle. Suzanne Lenglen, who broadcast on both her visits to England; Major Tosswill; "Plum" Warner, the famous cricketer; while of equal importance may be mentioned Mr. Allen Walker, whose famous lectures all over the world have met with outstanding success. He has just returned now from a trip to Canada, where he has met with huge enthusiasm.

It would not be fair to conclude our list of speakers, but a few out of the host, without making a few remarks about Milton Hayes, a humorist in whose priceless "meanderings" there is a whole world of subtle wisdom. Fortunately for us his best efforts have been literally "put on record," for the Columbia Co., to whom much gratitude is due, has enabled us to hear his best speeches, and we have had them over the aether by the same medium. Hear him discuss the Far East, with his little talks about the Unspeakable Turk, and the profiteers who "talk in millions and think in Yiddish," while the man who could describe the abilities of a certain statesman "if he only had the courage of his wife's convictions" is worthy indeed of the best of them. Yes, place Milton Hayes on our list of most important speakers, for he gives us at times the "powder" of philosophy 'neath the "jam" of humour.

Travel

There is just one more branch of discovery for which the wireless speaker is to be thanked, and that is on the subject of travel, when to hear the man who has "actually been there" gives a thrill in itself.

As instances one thinks instinctively of Lieut.-Col. Gordon Casserly, F.R.G.S., who penetrated into the heart of the old Moorish capital, Fez, and Lord Headley, the only Mohammedan peer who has made the pilgrimage to Mecca, the Holy Land of Mohammedanism. Dr. William M. McGovern was in active danger of losing his life



Sir Oliver Lodge, whose scientific talks have been greatly appreciated.

when he went in disguise to Lhasa, in Tibet; and another brave explorer who has spoken from 2LO is the Rev. Father Jackson, who lived amongst the Burmese in Rangoon. Last, though by no means least, comes Lady Norah Bentinck, daughter of the Earl of Gainsborough, who has travelled through five continents, and talks interestingly on all of them.

A Screw-Driver Bit for Small Screws

WHERE a large number of small wood screws have to be removed and the constructor has a hand brace in his possession, a small screw-driver bit for use with this will be found to save much time. A suitable bit is readily made from a 3-in. length of $\frac{3}{8}$ in. diameter silver steel. This is filed to give two flats necessary for inserting in the screw heads and is then heated to past the red-hot stage in a Bunsen flame. It should then be quickly dipped into cold water to quench it, and should then be carefully cleaned with emery paper

and again inserted into the flame, but this time only into the edge of the flame. The colour changes should be noted, when it will be observed that it will first turn yellow and then gradually to a blue and a dark plum colour. When turning to a plum colour it should again be quenched, when it will be found to be of the requisite hardness not to break when inserted into somewhat stiff screws. Inserted in a hand brace in place of a drill much time will be saved in both inserting and withdrawing screws.

J. U.

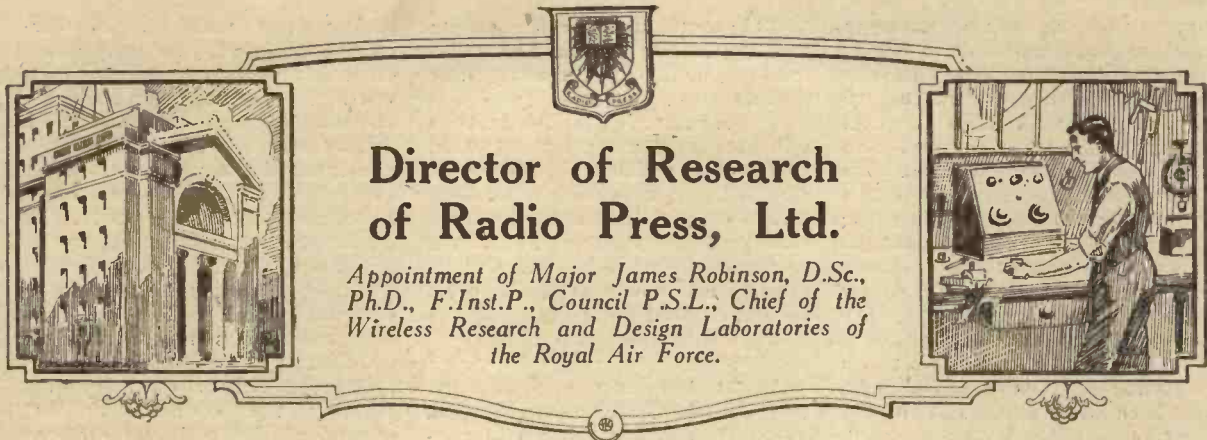

Director of Research of Radio Press, Ltd.

Appointment of Major James Robinson, D.Sc., Ph.D., F.Inst.P., Council P.S.L., Chief of the Wireless Research and Design Laboratories of the Royal Air Force.

WITH reference to the great new laboratories which Radio Press, Limited (the proprietors of *Modern Wireless*, *THE WIRELESS CONSTRUCTOR*, *Wireless Weekly* and *The Wireless Dealer*, and a large number of wireless handbooks) are establishing at Elstree, 12 miles north of London, readers of this journal will have noticed that two highly important posts have been advertised. The post of Director of Research and Chief Engineer carries with it a salary of £2,500 per annum; while the second, that of Deputy Director of Research, carries a salary of £1,700 per annum.

The Appointment

The first position, taking into consideration the extra remuneration in the nature of royalties, payment for publications, etc., will be the highest paid wireless staff appointment in this country. We are happy to be able to announce in this issue that this important post has been filled by the appointment of Major James Robinson, D.Sc., Ph.D., F.Inst.P., Council P.S.L. Dr. Robinson is, at the present moment, the Technical Wireless Head of the Royal Air Force, a position of unusual responsibility; he has handed in his resignation to the Air Ministry, and is joining Radio Press, Limited, on August 15. Just before his appointment he was offered a very high administrative post at the Air Ministry in London, a tribute to the very successful manner in which he has carried out his work at the Royal Air Force Wireless Laboratories at Farnborough, where the research and design work is carried out. We are happy to say that in spite of this additional inducement for him to remain in a career in which he had achieved such success, he has chosen to take

up the new post created by the Radio Press.

Maintaining Pre-eminence

It has been a matter of surprise to many that a publishing firm should acquire the freehold of seven acres of land for the purpose of building laboratories on it, and also that it should engage a



Major James Robinson, D.Sc., Ph.D., F.Inst.P., who has been appointed Director of Research of Radio Press, Ltd.

staff of such high qualifications. The reason is that we intend to ensure that in the years to come our periodicals and publications will remain pre-eminent in their respective fields. We feel that when the readers of this paper and our other publications realise the great sum of money which is being spent in order to give the very best in our papers, they will in return support us by reading regularly our journals and recommending them to their

friends, and, what is equally important, buying the goods advertised in these papers.

Test Department

Already the Radio Press has in existence a Test Department which carries out the testing of readers' sets. We have just received figures which indicate that the giving of a service to our readers is by no means a profitable undertaking. It may surprise readers to learn that on every set we test and repair we lose an average of £2, while it costs us 8s. 6d. to answer every written enquiry addressed to the company. Even on the present limited service we are losing in this department at the rate of £3,000 per annum, and it may well be asked on what commercial or other grounds we are justified in carrying out work which no other wireless papers are attempting. The reply is that sooner or later the readers of our papers will appreciate that the technical articles, constructional designs and the information generally in our papers is produced by the most qualified staff obtainable. It is extremely difficult, particularly for the beginner, to tell the difference between a good design and a bad design; between a sound technical article and one written by a novice.

Proofs

Leading experimenters will give their views on our work, and we are content with their opinion. In the case of the broader public, it is our aim and object to do what we can to enlighten them regarding what is behind every Radio Press publication. It is no use our merely stating facts which any other organisation can state. We have to prove our contentions, and the easiest way, in the case of set designs, or, in fact, any other technical information, is to offer

to prove to our readers the accuracy of our information and the efficiency of our sets and circuits. A very big step towards doing this was to offer to put right at a nominal fee any sets made from Radio Press designs which did not give the results expected. It is always possible for a man who has made up a set which does not work to blame the design or the designer. The Radio Press, however, so far as their own designs, etc., are concerned, forestall any criticism by placing the actual set on exhibition for two weeks after it has been described, and if the effectiveness of the set is challenged, offering to demonstrate it to any suitable and appropriate representative of the wireless public. Most of the sets, as a matter of fact, have been demonstrated before different radio societies. We go further, however, and if any reader makes up a set according to our design, and it does not work, we are prepared to tell him what is wrong and, if it is desired, put the set right, a small fee being charged, which, however, only covers a fraction of the total cost of testing. If there is any criticism of a Radio Press set, let the criticiser approach the Radio Press themselves, and they will satisfy him.

Testing Work

What more could any firm of publishers do? When the new laboratories at Elstree are ready, the existing services will be further extended, and, needless to say, the annual loss on this branch of our business will be greatly increased. We believe, however, that the increased prestige and influence of the Radio Press journals and publications will help largely to defray this heavy expenditure which in any case could not be undertaken by any organisation which did not concentrate entirely on the publication of radio literature. By owning a group of wireless papers, the Radio Press are able to possess a highly-paid and efficient staff, the cost of which is distributed amongst the papers, each deriving the benefit of this staff.

Apart from the testing of apparatus and the willingness of the laboratories to accept responsibility for what is published in the Radio Press papers, these laboratories will undertake the testing of manufacturers' products, and will report these tests in an impartial manner in the pages of Radio Press periodicals. Readers will have already seen that we do not merely print the pleasant things we have to say, but also the unpleasant, and no

small amount of work is being done to improve the standard of radio components in this country by these reports.

In addition, the laboratories will provide data and information and articles which will give precise results based on actual work done in the wireless laboratories, which, as regards equipment, will be second to none. The laboratories will be entirely and solely at the disposal of our readers.

Details of Dr. Robinson's Career

James Robinson was born at Seghill, in Northumberland, in 1884. His earlier work was concentrated on physics and mathematics, and he obtained his B.Sc. with distinction in both subjects, in 1906. He was awarded a Fellowship of his University, and in 1907 he studied physics on the Continent. In 1909 he obtained the degree of Master of Science (M.Sc.), and also that of Doctor of Philosophy (Ph.D.), the latter being a science degree for his work in physics.

He lectured for a number of years in mathematics and continued research work in physics. About 1909 he commenced wireless work, and it is interesting to notice that he was associated at this period with Mr. Morris Airey, who is now Technical Adviser to the Admiralty, and Dr. Brydon, who is Technical Adviser to the Army. Abroad, one of Dr. Robinson's fellow students was Dr. Hoyt Taylor, who is now Technical Adviser in wireless to the United States Navy. From 1910 to 1912 Dr. Robinson was lecturer and demonstrator of physics at the University of Sheffield, and after this period he was senior lecturer in physics at a college in the University of London. Dr. Robinson at this time became an Examiner in Physics at the University of London.

Researches

During the last ten years Dr. Robinson has concentrated on wireless work of an essentially practical character. In 1915 he was transferred from the Infantry to the Navy for wireless duties, and was mentioned in dispatches, and also awarded the M.B.E.

Much of Dr. Robinson's early wireless work was in connection with direction-finding, and he was the first to fit wireless direction-finding equipment to aeroplanes his system being used throughout the war in the Royal Air Force. Dr. Robinson's direction-finding system, which bears his name, is very largely used commercially

to-day. His principal direction-finding work, however, was carried out many years ago, and since the war he has been engaged in general research and design work in connection with wireless reception and transmission; direction-finding has only been a small part of his activities, although his position has during the last few years prevented him from publishing details of his work. The great difficulties in connection with wireless reception on aircraft has necessitated the production of apparatus of a very high standard of efficiency, and possibly the excellent training-ground which the Royal Air Force has provided is the explanation of why so many of our leading radio engineers to-day have come from the Royal Air Force.

At Biggin Hill

When stationed at Biggin Hill, the Wireless Experimental Establishment of the Royal Air Force at the end of the war, Dr. Robinson was made Chief Technical Assistant to the Commandant for general wireless experimental work. In 1920 the establishment was altered in character and its importance increased. Dr. Robinson then became Chief Experimental Officer. In 1922 the Wireless and Instrument Design Establishment of the Royal Air Force was moved to Farnborough, and Dr. Robinson became head of this important department.

Practical Experience

As the technical head in wireless matters of the Royal Air Force, Dr. Robinson has been in charge of wireless laboratories carrying out not merely general research work, but actual design of instruments and apparatus. His work has, therefore, been essentially practical, which places him in a different category from those scientists who have studied the art of wireless from the theoretical point of view and have done little practical work.

On different occasions two leading universities in this country have offered professorships to Dr. Robinson, which he has declined owing to his preference for practical work, which is a somewhat unusual attitude in the case of those who have won such high scientific distinction.

Dr. Robinson is now a D.Sc., a Ph.D., and F.Inst.P. (Fellow of the Institute of Physics), a Member of the Council of the Physical Society of London, and is a committee member of the Radio Research

(Continued on p. 985.)

LISSENIUM

THE LISSEN WIRE RHEOSTAT

THE advantages of the fine control obtainable with the LISSENSTAT are now widely recognized and appreciated.

Although so essential for successful distant reception, it is not necessary for the filament temperature to be regulated so minutely when the receiver is used primarily for the reception of a near-by station. In such cases the control obtainable with a reliable wire rheostat is sufficient, whilst the ability to obtain a definite scale reading is of advantage when the set is used as a "family" receiver.

LISSEN LIMITED have consequently introduced a wire rheostat for use in cases where the fine control of the LISSENSTAT is not so essential.

THE LISSEN WIRE RHEOSTAT is made in two resistances: 7 ohms for bright valves and 35 ohms for dull emitters. The action is smooth and silent and the control is the finest it is possible to obtain with a rheostat of this type.

The new Lissen Potentiometer enables the experimenter to increase considerably the interest of his work and improve his reception at a very low cost

THE NEW LISSEN WIRE RHEOSTAT AND POTENTIOMETER are similar in design and are mounted by the Lissen One Hole Fixing Method. The former is of moulded heat-resisting compound and all fittings are nickel-plated. A photo-engraved dial is fitted and the combined knob and pointer is specially recessed so that it fits down flush with the dial when mounted.

THE LISSEN WIRE RHEOSTATS (7 or 35 ohms) 4/-
THE LISSEN ROTARY POTENTIOMETER 4/6

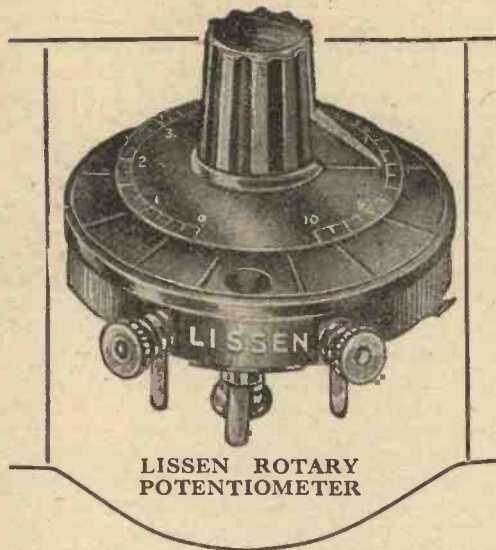

LISSEN ROTARY
POTENTIOMETER

THE LISSEN ROTARY POTENTIOMETER

THE resistance of a potentiometer need not be very large in order to control grid potential. If the resistance is too low, however, it will cause an appreciable drain on the L.T. Battery, and when a small capacity accumulator or dry cells are used in conjunction with dull emitters, the current wasted by an unsuitable poten-

tiometer can be a considerable portion of the total current used.

The new LISSEN ROTARY POTENTIOMETER has a total resistance of 400 ohms, so that it could be left in circuit for weeks without causing the accumulator to run down. When used with a six-volt accumulator the total current flowing in the potentiometer circuit would be only 15 milliamperes.

The use of a potentiometer is essential in most multi-valve circuits, but it can also be of extreme value in the most simple receivers; even some crystals can be made more sensitive by giving them a very small potential controlled by a potentiometer.

LISSEN LIMITED

LISSENIUM WORKS,

30-32, FRIARS LANE, RICHMOND, Surrey

**Phone: Richmond 2285 (4 lines).*

**Grams: "LISSENIUM, LONDON"*

LISSEN PARTS—WELL THOUGHT OUT, THEN WELL MADE

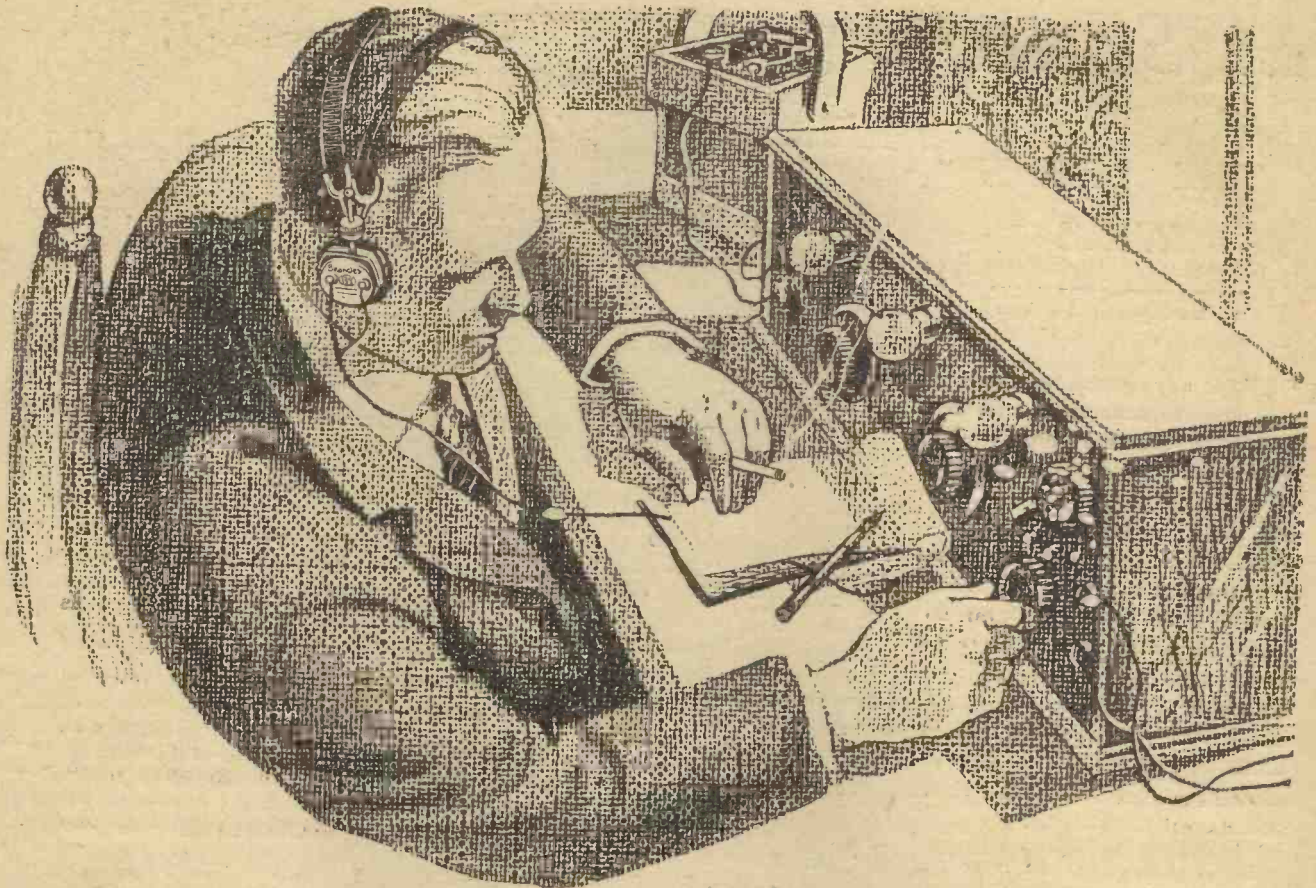

Matched Tone
TRADE MARK
Headphones

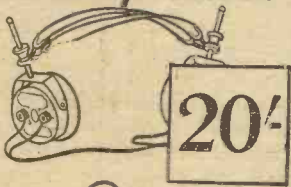

British manufacture. (B.B.C. stamped.)

All Brandes products carry our official money-back guarantee, enabling you to return them within 10 days if dissatisfied. This really means a free trial.

Bill, Senior, deftly whirls the dials with the hand of a master. Now a complete circular movement, now carefully "feeling" over a sensitive spot. Sometimes an exclamation of annoyance, and finally a grunt of satisfaction. With the help of his Brandes that almost indistinguishable tinkle of a distant station which was nearly eluding him swells to clearly defined volume and clarity. Bill sighs with satisfaction and thinks how much pleasure the *Matched Tone* receivers have continually given him. Always it is the same. He knows that Brandes bring every possible distant station within range of his set with unflinching accuracy.

Ask your dealer for Brandes

Brandes

The name to know in Radio

Brandes Limited, 296, Regent Street, W.1.

Works: Slough, Bucks

Some Simple Experiments

By J. H. REYNER, B.Sc., A.C.G.I., D.I.C., Staff Editor

An understanding of the fundamental principles involved in Wireless Telegraphy and Telephony is very helpful in obtaining good results

This article describes several simple experiments which can be carried out with a minimum of apparatus, and which will give a very clear idea of the underlying principles

WHILE the average broadcast listener does not wish to trouble himself with a host of technicalities, there are several fundamental principles of wireless telegraphy and telephony which can be readily understood.

It is proposed in this article to describe one or two small experiments which can be carried out with a very small amount of apparatus, yet which will demonstrate the effective principles very clearly.

There are three essentials in a wireless system. First of all there is the transmitter. Secondly, there must be a receiver at a distant point. Thirdly, there must be a medium through which the necessary signals may be transmitted from the sending station

to the receiving point.

These experiments are designed to illustrate how this may be done.

Simple Pendulum

In the first place it will be desirable to obtain some idea of an oscillating system. The apparatus required for this experiment is as follows:—

A short length of thin string or twine, and one or two small weights of a few ounces each. A length of the twine should be stretched fairly

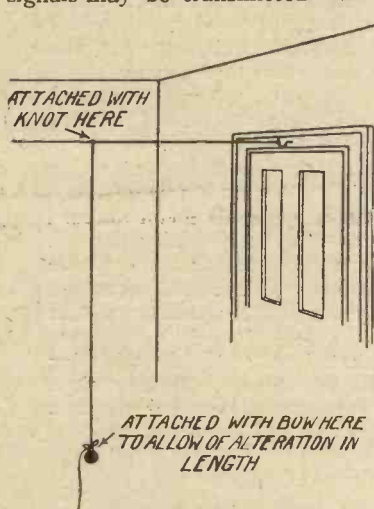

Fig. 1.—How the twine and weight are attached to the triatic for Experiment 1.

tightly across the room between two convenient points at a height of about 6 ft. from the ground.

The arrangement is illustrated in Fig. 2, and is called a "triatric."

Now cut off a length of about 3 ft. of twine and attach a weight to one end. The other end should be attached to the "triatric" across the room about 1 ft. from the wall, as shown in Fig. 1.

We now have a simple pendulum which, in a modified form, is used in clocks and similar instruments. If the weight is drawn to one side and released again, it will swing from side to side with a rhythmic motion.

Now a pendulum has several very interesting properties. The first of these is that the *time* taken by each swing is exactly the same, although, owing to air friction, the *size* of the swings gradually decreases until the pendulum comes to rest.

Experiment 1

Draw the pendulum slightly to one side and release it as previously described. Count the number of complete swings in 5 seconds. Now reduce the length of the pendulum to about 2 ft. and again count the number of swings in 5 seconds. It will be found that in the second case the number of swings is considerably more than it was for the 3 ft. pendulum so that the time occupied by each swing is less. Similarly if the length is increased to 4 ft. the time of swing will be longer.

We see, therefore, that the time of a swing depends upon the length of the pendulum.

An Oscillating System

We have in this simple experiment all the essentials of an oscillating system, that is to say, the weight, when drawn to one side and released, will swing to-and-fro about its mean position, or, in other words, it will oscillate.

It is with oscillating systems such as this that wireless is primarily concerned.

The next experiment, therefore, will show how such an oscillating system may be made use of in the transmission of signals.

Experiment 2

A second length of twine should now be cut off about 4 ft. in length, and a second weight, preferably

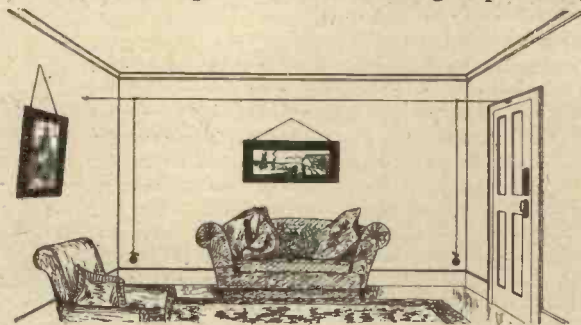

Fig. 2.—The triatic, with two pendulums attached, is used to illustrate tuning.

equal to the first, should be attached to one end. This pendulum should now be attached to the other end of the "triatric" across the room as illustrated in Fig. 2.

Now start the first pendulum swinging and note the effect. It will be found that the second pendulum will bob about slightly, but will not commence any definite oscillations.

Now adjust the second pendulum to the same length as the first, that is to say, 3 ft., and repeat the experiment. It will be found, in this case, that after a very short time the second pendulum will commence to

swing and definite oscillations will be built up, so that the two pendulums will be swinging together.

Thirdly, reduce the length of the second pendulum to 2 ft. and again repeat the experiment. It will be found in this case that, as in the original case, the pendulum will not build up into any definite oscillation.

Necessity for Tuning

We see, therefore, that the second pendulum will only commence to oscillate if it is adjusted to the same length as the first.

Experiment 1 showed that the time of swing was dependent on the length of the pendulum, from which it will be clear that the essential condition is that the two pendulums shall have an equal "period" or time of swing.

In other words, the two pendulums must be *tuned* to the same period or frequency.

Corresponding Electrical System

The two pendulums as arranged in the above experiment constitute a mechanical model of the condition of affairs obtaining in a broadcasting system.

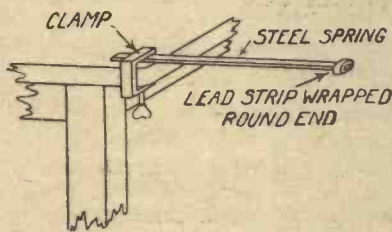

Fig. 3.—The apparatus necessary for the third experiment.

The first pendulum represents the transmitting station, the second pendulum the receiving station, and the "triatric" stretched across the room represents the medium by which the signals are transmitted.

This medium, in the case of wireless signals, is what is known as the "aether," and is, of course, invisible.

The disturbances produced at the transmitting station are in the form of strains which are set up in the aether, and these travel through the aether at a velocity of 186,000 miles per second until they reach the receiving station. In the case of the analogy just considered, the motion of the first pendulum produces tiny strains and disturbances in the triatic, which are transmitted thereby to the second pendulum.

As long as the second pendulum has exactly the same length as the first pendulum, that is to say, as long as it is *in tune*, these minute disturbances will cause the second pendulum to build up into a state of oscillation. Until the two pendulums are so adjusted as to have the same period, however, the successive impulses received by the second pendulum from the triatic will not arrive at the correct moments, and the result will be that no definite oscillation is produced.

Similarly in an electrical system, no response will be obtained unless the receiving system is tuned to the same period as the transmitter. This point is referred to later.

Experiment 3

Another very interesting field for experiment lies in a further investigation of the tuning of wireless circuits. Here we may construct again a very simple practical analogy. The pendulum, however, which was used for the first two experiments does not lend itself to a ready explanation of the properties of tuning. For this purpose it is better to use the apparatus described below.

For this experiment, therefore, it is necessary to obtain a short length of thin steel or phosphor bronze

strip about 12 in. long, 1/4 in. wide and 1/32 in. thick. Secondly, several pieces of strip lead will be required. These pieces should either be in the form of lead strip about 1/4 in. wide and 1/8 in. thick or in the form of a piece about the same thickness which may readily be cut up into the requisite strips.

Now take the piece of sheet steel, and clamp it to the edge of the table illustrated in Fig. 3. Take a piece of lead and wrap it round the end of the steel strip. Lift the end of the steel strip slightly and release it. The spring will oscillate up and down about its mean position.

Adjust the weight of the lead piece at the end of the steel strip so that the vibrations occur sufficiently slowly to enable them to be counted fairly easily, and note the number of vibrations in 5 seconds.

Now attach another piece of lead strip identical with the first on the end of the spring, and again count the number of vibrations in 5 seconds. It will be found that the oscillations are considerably slower. We can, therefore, say that the heavier the weight at the end of the steel strip, the slower will be the oscillations produced.

Elasticity and Inertia

It will be advantageous at this stage to consider the exact mechanism of this oscillating system. In the first place the end of the spring is raised, and this strains the steel spring to a certain extent. There is thus a certain energy stored up by reason of the elasticity of the steel. When the spring is released it will return to its normal condition. In doing this, however, the weight at the end will acquire a certain "momentum," and this will cause the spring to overshoot the mark and take up a position on the opposite side of the zero position. This point is illustrated in Fig. 4.

The position of affairs is now similar to that which existed originally, viz., that the spring is strained from its normal position and again a certain amount of energy will be stored due to the elasticity thereof. The spring will, therefore, swing back in the opposite direction, and will continue to oscillate in this manner until brought to rest by air friction and such like causes.

Now, it has been seen that the time of this oscillation depends upon the weight at the end of the spring. We have, however, another method at our disposal

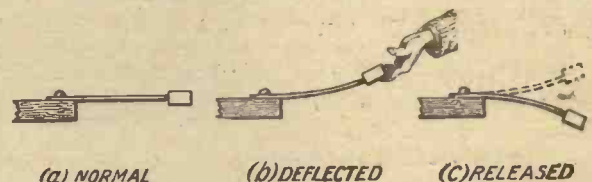

Fig. 4.—If a spring is clamped at one end and loaded with a weight at the other it will be capable of being set into oscillation.

for varying the period of the oscillation, which consists in varying the elasticity of the spring.

This may be done in several ways. We may replace the existing spring by a second and different spring, or we may alter the length of the spring already being used. This is the more convenient arrangement in this case.

If the spring is readjusted so that the free length overhanging the edge of the table is only about half what it was originally and the time of the oscillations again observed, it will be found that the oscillations are now considerably quicker.

Hence we may say that the period of the oscillation depends upon the weight at the end of the spring and the elasticity of the spring itself.

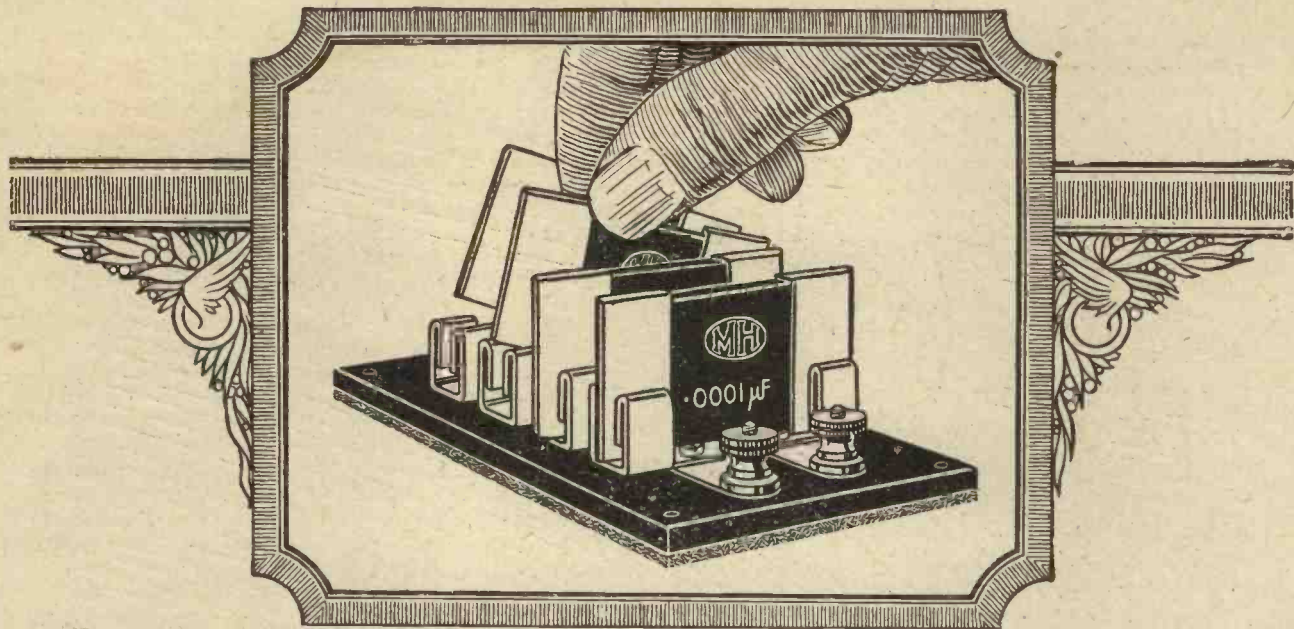

The New **MH** Condenser Test Panel

The **MH** Condenser Test Panel is fitted with four condensers of the following capacities:—·0001, ·0002, ·0004 and ·0008, and by the simple expedient of clipping or unclipping, no less than fifteen variations of capacity are obtainable, viz. :—

- | | | | | |
|-------|-------|-------|-------|-------|
| ·0001 | ·0002 | ·0003 | ·0004 | ·0005 |
| ·0006 | ·0007 | ·0008 | ·0009 | ·0010 |
| ·0011 | ·0012 | ·0013 | ·0014 | ·0015 |

Experimenters operating radio circuits employing critical values will appreciate the great advantage of being able to obtain the exact capacity to suit any particular condition. Exact capacity results in greater distance, more volume and clearer signals. Any one or more of the values shown may be required. Having determined the exact value required, you can order an **MH** Condenser of the required value with the certainty of perfect results.

Price, complete with 4 condensers, 4 terminals on polished ebonite, baize covered base	11/6
Base Board only	5/-

FIXED CONDENSERS.

Two clips are supplied with each condenser.

- | | |
|---------------------------|-----------|
| 0'0001 to 0'001μF. | 1/9 each. |
| 0'0015 to 0'01μF. | 2/3 each. |
| 0'015 to 0'04μF. | 2/6 each. |

FIXED CONDENSERS.

Mounted on ebonite bases, with terminals, any value.

- | | |
|---------------------------|-----------|
| 0'0001 to 0'001μF. | 2/9 each. |
| 0'0015 to 0'01μF. | 3/3 each. |
| 0'015 to 0'04μF. | 3/6 each. |

Works :—

WEXHAM ROAD, SLOUGH

Phone : SLOUGH 199

L.M. MICHAEL LTD

Manufacturers of Wireless and Scientific Apparatus

London Showrooms :—

179, STRAND, W.C. 2.

Phone : CENTRAL 6988

Head Office :— HASTINGS HOUSE, NORFOLK STREET, STRAND, LONDON, W.C. 2. Phone : CENTRAL 8272/3
TELEGRAPHIC ADDRESS : RADIETHER, ESTRAND, LONDON CABLE ADDRESS : RADIETHER, LONDON.

Hurclays Ad. 1276

In replying to advertisers, please mention THE WIRELESS CONSTRUCTOR.

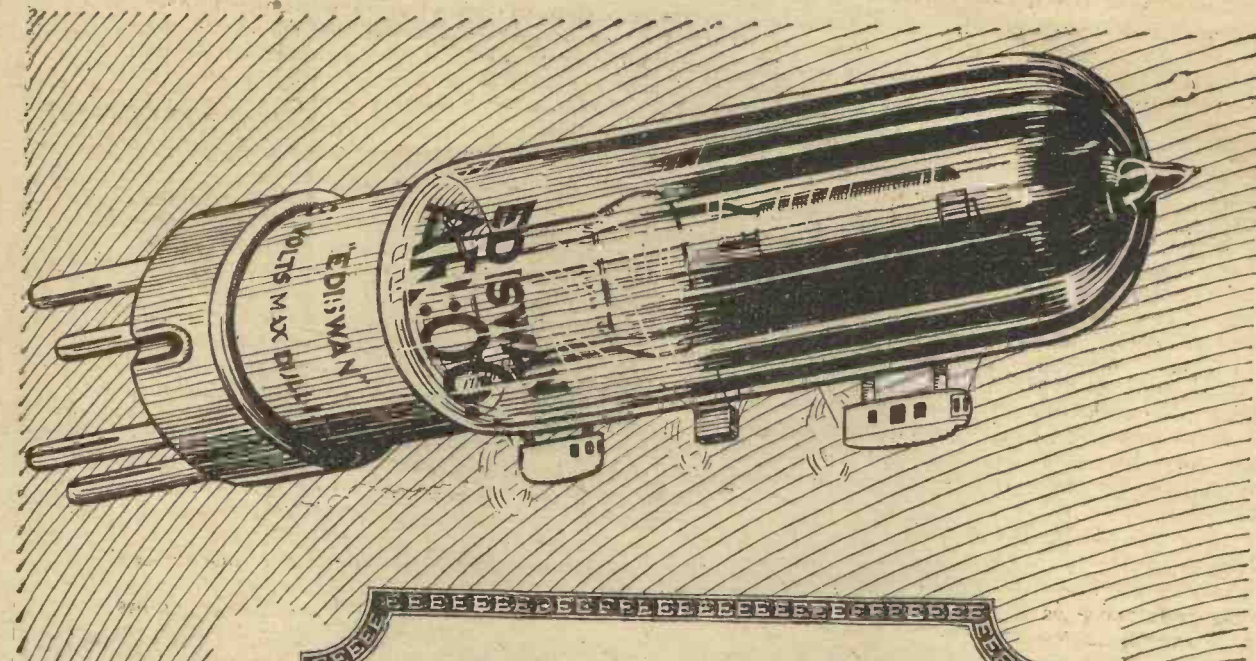

**1st Class Travel to EVERYWHERE
on the *Ediswan* Line**

FURTHER than England, further than Europe—right round the world Ediswan Valves will take you at your bidding. Seated in a comfortable armchair the musical treasures of France, Germany, Holland, America are yours without effort.

Ediswan Valves give you first-class travel on these aerial trips. Their wonderful construction ensures undistorted reception of the programmes and a true perspective of their merits.

PRICES OF EDISWAN VALVES

P.V.5D.E. 22/6, Fil. Volts 5	R. 8/-	...	Fil. Volts 4
P.V.6D.E. 18/6, Fil. Volts 1-8-2	A.R.D.E. (L.F. or H.F.) 14/-		
P.V.8D.E. 22/6, Fil. Volts 3			Fil. Volts 1-8-2
A.R. (L.F. or H.F.) 8/-	A.R.O.6 (L.F. or H.F.) 16/6		Fil. Volts 2-5-3
	Fil. Volts. 4		

WARNING
As it has been brought to our notice that repaired Valves have been sold for genuine Ediswan Valves, we advise purchasers to make sure of getting the Genuine Ediswan Valves packed in red cartons.

EDISWAN
Will Improve
ANY SET
VALVES

Ask your dealer for particulars, or write to
THE EDISON SWAN ELECTRIC CO., LTD.,
123, QUEEN VICTORIA STREET, LONDON, E.C.4

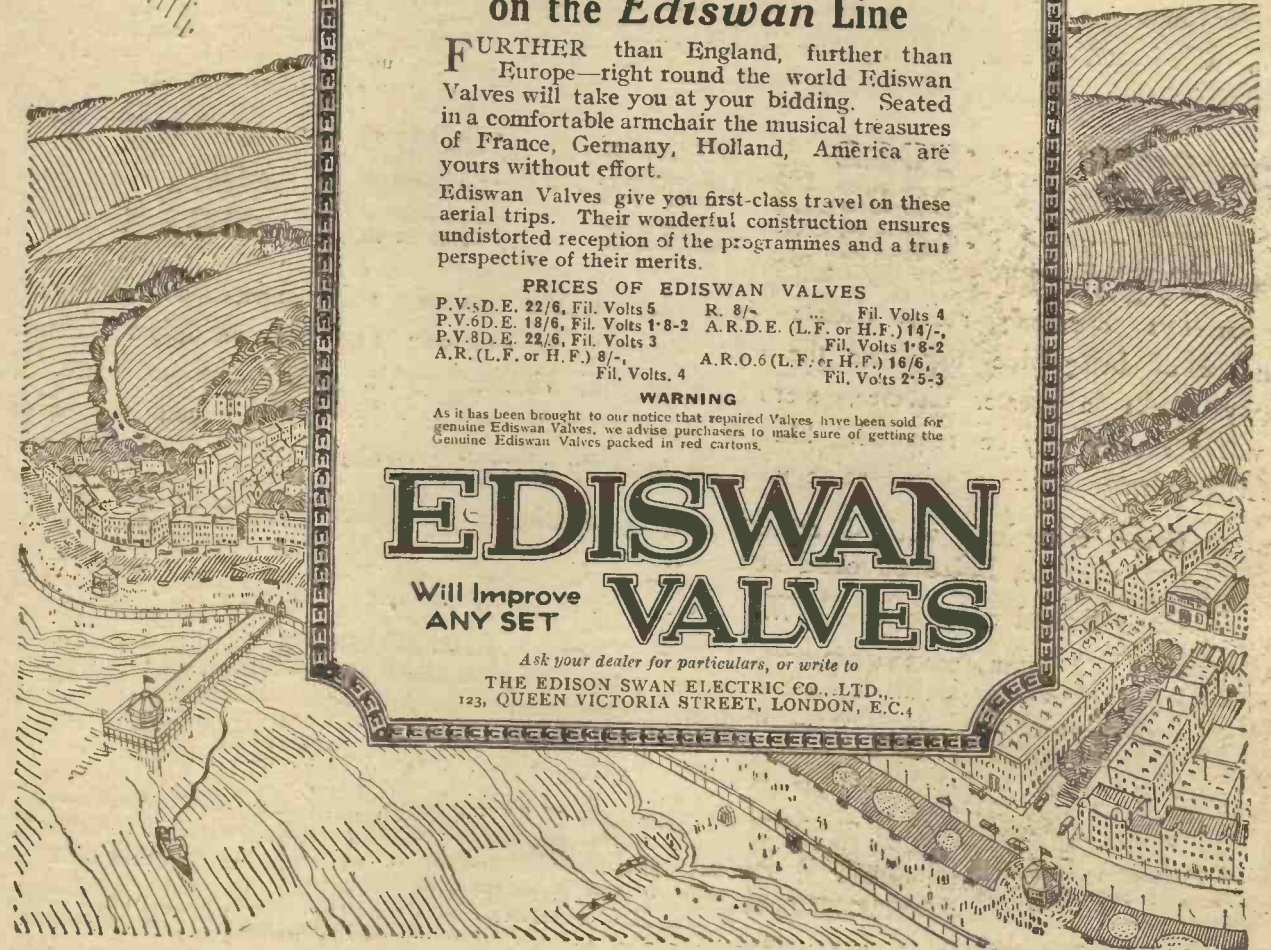

Electrically Oscillatory Circuits

Let us consider now the condition of affairs in an electrical circuit such as is used in a wireless set. Reduced to their simplest form the various circuits are composed simply of a condenser connected across an inductance coil.

Now the condenser possesses a certain capacity for storing electricity. This is analogous to the steel spring. If we charge this condenser and allow it to discharge through the inductance, a certain current will flow through the coil. The inductance, however, possesses the property of electrical inertia similar to the inertia of the weight at the end of the steel spring. This means therefore that the current which is produced by the discharge of the condenser continues to flow after the condenser has been completely discharged, and will thus charge up the condenser once more in the opposite direction.

The cycle of events will then be repeated, and the condenser will continue to discharge and charge up again in this manner until all the energy has been expended.

Period or Frequency

It will be seen that in this case the energy is alternately stored in the condenser as an electric charge and in the inductance as an electric current. This, therefore, is exactly analogous to the steel spring where the energy was stored alternately in the elasticity of the spring and in the momentum of the moving weight.

Just as the period of the mechanical vibrations was determined by the values of the elasticity of the spring and the mass of the weight, so in the case of the electrical oscillations the period or frequency is determined by the values of the capacity of the condenser and the inductance of the coil.



Tuning-in a wireless concert on board the s.s. "Perth." Ships can now get their orchestral entertainments from the shore!

It was seen in Experiment II that in order for the receiving system to respond to the transmitted oscillations it was necessary for the periods of the two pendulums to be identical. In an electrical system the same condition applies, viz., that the electrical period or frequency of the receiving system shall be the same as that of the transmitting station, and this is what is really done in the process of tuning in.

Further Experiments

These experiments demonstrate a few of the fundamental principles underlying communication by wireless methods. There will be several possible developments of these experiments which will readily suggest themselves to the reader.

For example, an interesting experiment can be made with the two pendulums in Experiment II by finding out the amount by which the length of the second pendulum can be varied before it fails to respond to the impulses set up by the oscillations of the first pendulum. This demonstrates the property known as "selectivity." The reader is recommended to conduct these experiments for himself and to try and obtain all the information possible from them. He will find it very helpful in explaining the unseen and therefore somewhat more complicated phenomena which takes place in a wireless receiving set.

In a future issue further mechanical experiments will be given which will explain some of the other electrical occurrences. One of these will be an experiment to illustrate the propagation of electrical waves through space, showing in rather more detail just how the currents in the transmitting aerial are made to produce the electro-magnetic waves which affect the receiver.

If any reader in making these experiments comes across any effect which he is unable to explain I shall be glad to elucidate the problem, and I shall also be pleased to try and devise a simple experiment to explain any of the phenomena which occur in a wireless receiver, if any reader so desires.

Director of Research of Radio Press, Ltd.

(Concluded from page 978)

Board, and also a member of the Wireless Board. These latter Boards are respectively national and Service committees, and membership implies eminence in wireless work. The Wireless Board acts, more or less, as a final authority on wireless matters in this country, and has on it representatives of the fighting Services. As a member of the Wireless Board, and also in his official capacity as head of the Wireless Research Laboratories of the Royal Air Force, Dr. Robinson has intimate knowledge of the results of the latest wireless research work carried out by the Army and Navy, as well as that carried out under his own control.

In conclusion, we wish to express the opinion that under Dr. Robinson's able direction, the Research Laboratories of the Radio Press, at Elstree, will become not merely an adjunct to a commercial company, but something in the nature of a national institution. The whole of the work done by these laboratories will be published and available for all students and investigators, a state of affairs which is very different from that which exists in Service laboratories or those run by the larger wireless companies, when the work has, for obvious reasons, to remain confidential. The fact that the work of the Laboratories will be published exclusively in Radio Press publications will not lessen the national value of the work.

Wireless on Our Lightships



Trinity House is fitting the lightships with wireless so that the lonely watchers may be able to enjoy the broadcast programmes

Above: Some of the crew listening-in on deck.

Right: Officers tuning the receiver.

Below: Ship No. 67, the latest to be equipped with wireless, being fitted at Harwich.



When first resting the set, it is a use the direct-coupled and after the batteries are connected to the project as indicated in the illustration the panel layout, the valve should be inserted in its sockets, first turned the filament to the "off" position. In form of coupling, the holder will hold the aerial whilst the reaction coil the top socket. The aerial should be adjusted to

In order that we may tune to these B.B.C. stations whose wave-lengths are

the wavelength of the station it is desired to receive (preferably that of the nearest station during the operation), the reaction coil should be separated as much as possible from the aerial coil before turning the valve. With this done, tune the valve to a suitable degree of selectivity, and slowly turn the reaction coil until the desired station is heard. If nothing at all is heard, move the reaction coil a little away from the fixed coil and gradually bring it up to the station. When signals have been heard, even though weak, the reaction coil should be set to the position for the loudest results. If the reaction coil moved a little away from the fixed coil until signals are heard, taking great care, the set is now made to receive. If the adjustment of the reaction coil does not increase the strength of the signals, the

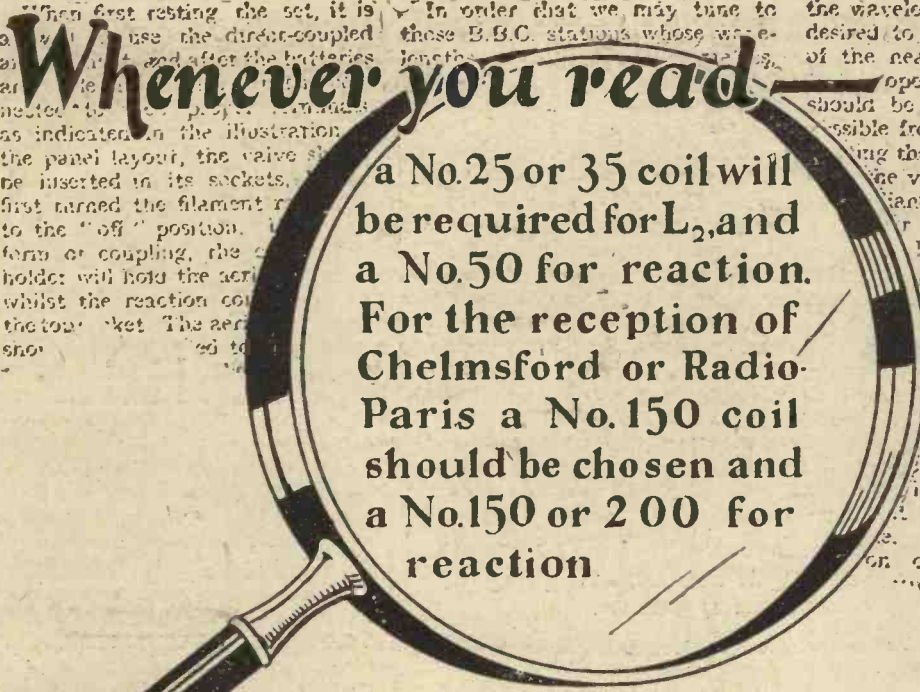

Whenever you read
 a No.25 or 35 coil will be required for L₂, and a No.50 for reaction. For the reception of Chelmsford or Radio-Paris a No.150 coil should be chosen and a No.150 or 200 for reaction.

- resolve to go one better and use IGRANIC Coils of the specified sizes.

Igranic Coils set the standard by which others are judged. In addition to the usual plug-in type, they are also obtainable in the special Igranic Gimbal type, by means of which a wide range of precise and accurate adjustment is made possible. The Gimbal type Coil is mounted upon two gimbals or studs positioned diametrically so that it is rotatable about its own axis. Igranic plug-in and Gimbal type Coils are obtainable in nineteen and twenty sizes respectively, giving wave-length ranges of from 100 to 23,000 metres, and include intermediate sizes of 30, 40 and 60 turns.

Then there is also the Igranic Concert Coil, which is specially designed for receiving B.B.C. music, and is obtainable in four sizes, giving wave-length ranges of from 100 to 1,100 metres approximately. For short-wave reception you cannot do better than adopt the form of coupling made possible by the Igranic Unitune Aperiodic Fixed Coupler. It sharpens selectivity and overcomes the difficulty of obtaining reaction on short wave-lengths. It is made in 2 sizes, minor for 75 to 180 metres, and major for 300 to 600 metres.

All reputable dealers stock Igranic Coils.

IGRANIC RADIO DEVICES
 include: Variable Condensers, Fixed Condensers, Filament Rheostats, Intervalve Transformers, Variable Grid-Leaks, Variometers, Variocouplers, Coil Holders, Potentiometers, Vernier Tuning Devices, Switches, etc., etc.
 All carry IGRANIC guarantee.

Write for **COMPANY** List Z 643

Branches:
 BIRMINGHAM: 73-74, Exchange Buildings. CARDIFF: Western Mail Chambers. GLASGOW: 50, Wellington Street. LEEDS: Standard Buildings, City Square. MANCHESTER: 30, Cross Street. NEWCASTLE: 90, Pilgrim Street.
Works: BEDFORD.

149, Queen Victoria Street, LONDON

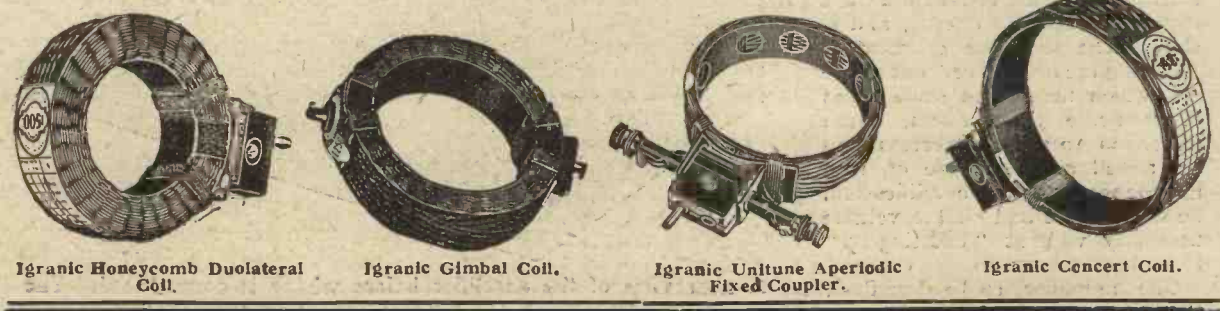

Igranic Honeycomb Duolateral Coil.

Igranic Gimbal Coil.

Igranic Unitune Aperiodic Fixed Coupler.

Igranic Concert Coil.



In this amplifier everything is enclosed, thus giving the whole a handsome appearance.

A Two-Stage Choke Amplifier

By

JOHN W. BARBER

MUCH interest would appear to have been aroused by the publication in the April issue of this Journal of a single-valve amplifier unit employing the reactance-capacity or choke system of intervalve coupling, and several enquiries have been received by the author for a complete two-stage amplifier upon similar lines. The writer has, therefore, designed and constructed the amplifier illustrated in this article, with a view to satisfying the expressed need.

It was felt that an instrument of handsome appearance, preferably all-enclosed, would be appreciated, in view of the fact that such an amplifier could, if necessary, be placed in a position where many would see it, as, for example, when it is desired to provide wireless music for a dance or other such purposes, without the owner of the wireless equipment feeling in the least fearful lest his apparatus may be criticised. Again, carrying the present example to a further stage, the music one hears from a loudspeaker, when the set is operated by a man of quite average ability, is frequently far from what one would tolerate oneself, and it strikes one that the operator is "getting the last ounce" out of the set, which may, with some types of iron-core transformers, cause distortion to set in, whereas had he added another stage of, say, impedance-capacity amplification, he would have had all the volume necessary without "boosting-up" to such an extent.

The amplifier to be described, therefore, may be added to any

existing receiver, provided that the set does not already contain more than one stage of transformer-coupled note magnification, and may be added to a crystal set in one of two different ways, to be described in greater detail later.

H.T. to L.T. Connection

A point which has arisen in connection with the article previously referred to (*THE WIRELESS CONSTRUCTOR*, Vol. I, No. 6, April, 1925) is the connection of H.T. — to L.T. +, and several readers appear to have had difficulty on account of this connection. It will be clear that this connection will depend on the corresponding connec-

tion in the receiver, and should be made according to it. If the H.T. — and L.T. — terminals of the receiver are joined internally, do the same in the amplifier; but should the terminals H.T. — and L.T. + of the receiver be joined, make sure that the amplifier conforms to this scheme also.

A Phenomenon Explained

The writer would like to take this opportunity of thanking those who wrote to him regarding the "Unit Choke Amplifier" and to explain a point which two, at least, brought up. In this issue will be found a letter in which the writer stated that, using a detector valve, choke

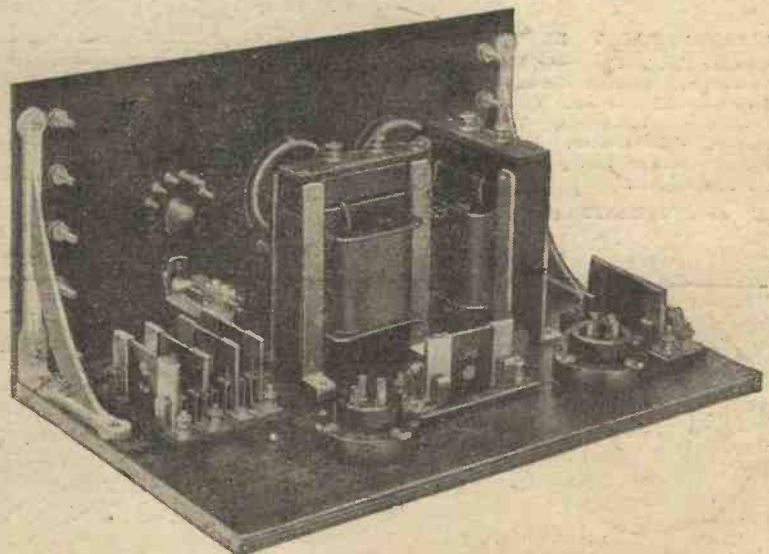

A near view of the amplifier before wiring is commenced. The condensers on the left are those for tone-control.

A further article dealing with reactance-capacity amplifiers. In this amplifier, which is built on the American principle, a tone-control unit is incorporated, thus enabling several condensers to be placed across the loudspeaker in turn, as necessary.

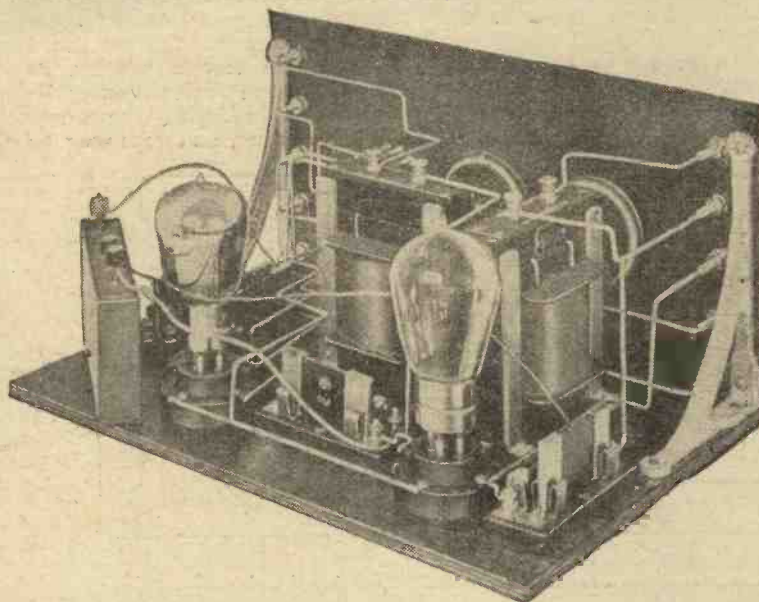

Showing the position of the valves and grid-bias battery when the amplifier is completed

amplifier, and transformer amplifier, three valves in all, and not turning on the detector filament, a shriek is heard from the loudspeaker. This may be explained by the fact that the low-frequency portion of such a circuit may have a tendency to oscillate at audible frequency; such oscillation may, however, be overcome by connecting a resistance across the choke coil, and this is, in effect, accomplished by switching on the detector valve. When the low-frequency portion of the circuit consists of, firstly, the transformer, with the choke for the second stage, the whole system is far less likely to oscillate; but should it do so, the remedy remains the same, and the trouble will be cured in both cases by switching on the detector valve.

In the present amplifier a "tone-control" switch has been incorporated, by means of which one of four fixed condensers, of the clip-in type, may be shunted across the loudspeaker jack. It is thus possible, by a suitable selection of condensers, to control the tone of the reproduced music or speech to suit varying voices, and so on.

Components

As is usual in this Journal, I am giving below a list of the parts necessary to build this instrument, together with the makers' names. Other pieces of apparatus may be substituted for those mentioned, and of the chokes I have tried the Success and the Grelco are quite

suitable for this instrument; it is my advice that one of these makes be used, unless the constructor has experience of another make which gives real satisfaction.

One panel, 14 in. by 7 in. by $\frac{1}{4}$ or $\frac{3}{8}$ in. thick. I have used Radion Mahoganite here, as this matches up well with a mahogany cabinet, 9 in. deep, inside, from front to rear.

One Cabinet (Camco).

One pair of brackets (Magnum).

Two low-frequency choke coils ("Grelco"—Grafton Electric Co., Ltd.).

Two valve-holders for board mounting. I have used Magnum Vibro sockets here.

Two dual filament resistances (Burndept Wireless, Ltd.).

Ten terminals, Magnum large type.

One single filament jack, with plug (Burne-Jones & Co., Ltd.).

Two grid-leak and condenser bases.

Four bases for clip-in condensers only.

Two .01 μ F clip-in fixed condensers.

Two grid-leaks of $\frac{1}{2}$ or 1 megohm.

Selection of clip-in condensers for tone control.

(The above five items supplied by L. McMichael, Ltd.)

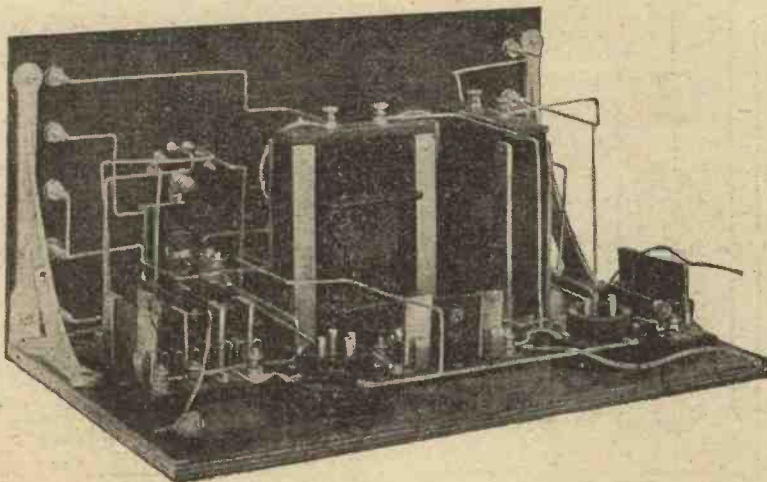

This view, used in conjunction with that on the opposite page, will show how wiring is carried out. The flexible leads are for connection to the grid-bias battery.

Three Clix or H.T. battery plugs. One switch-arm and studs (Bowyer-Lowe Co., Ltd.).

One set of Radio Press Panel Transfers.

Square-section wire for connections.

are employed, as it is essential that the edges of the panel and the corresponding ones of the baseboard should be in correct register, as otherwise some difficulty may be experienced in fitting the whole into the cabinet, and gaps may be

brackets, the panel should be removed and the terminals, filament resistances, switch and jack mounted in position.

Panel Wiring

The wiring on the panel itself should be effected before re-assembling the panel to the baseboard; and here it may be mentioned that a full-size wiring blueprint may be obtained, in order that the wiring may be more clearly followed. In the diagram given (Fig. 4), as in the blueprint, the baseboard and panel are shown as if both were lying flat on the table, with the wiring extended. Thus the photographs of the rear of the amplifier will be useful when wiring up, as they will show how the wires actually look and what respective positions they occupy.

Scheme of Connections

As regards wiring on the panel, the procedure followed was first of all to join the two L.T. terminals, then to connect this bus-bar to both filament resistances.

The two positive L.T. terminals

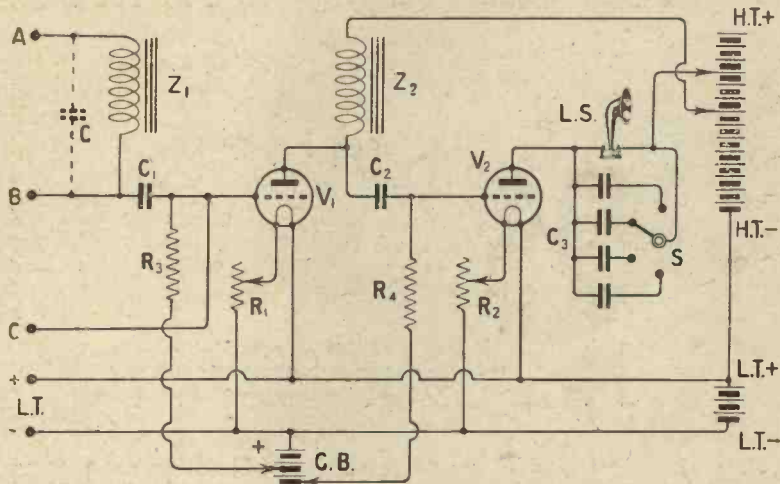

Fig. 1.—The theoretical connections of the amplifier. The dotted condenser C will probably be found across the telephone terminals of the receiving set: if this is not so, a fixed condenser of say 0005μF should be joined as shown.

Constructional Work

As far as the panel is concerned, very little work is called for, there being very few holes to drill. Little comment is necessary here, and should the constructor so desire, he may obtain a full-size blueprint and drill his panel directly from it. Care should be taken when attaching the panel to the baseboard, even when the brackets specified

caused to appear due to straining of the wood. In this case it was found necessary to remove the side fillets in the cabinet in order to allow the brackets to be placed at the extreme edges of the panel, this being desirable in view of the position of the terminal rows and other components. Having, then, carefully drilled the necessary holes for securing the panel to the

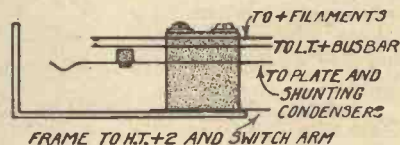

Fig. 2.—Showing connections to the jack.

are then joined together, the wire on its way joining up to one of the filament contacts on the jack.

The H.T.+ 2 terminal is then

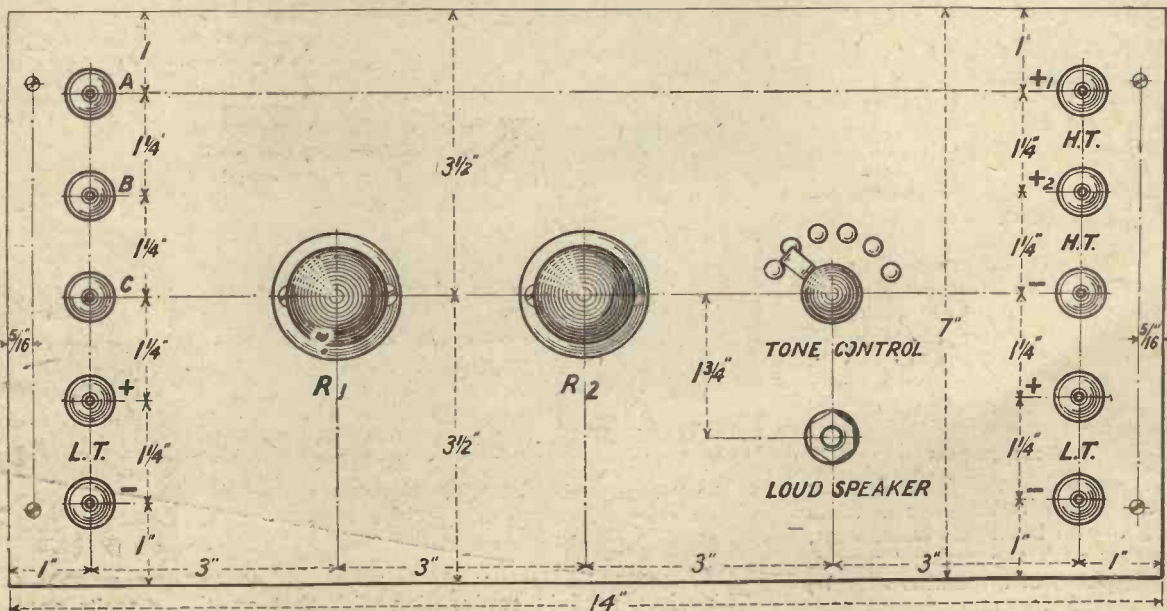
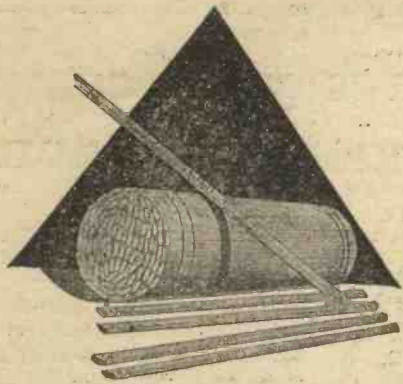

Fig. 3.—A scale drawing of the panel with necessary dimensions for drilling. If desired, a full size blueprint may be obtained, price 1/6 post free. Ask for No. C1020A.



GLAZITE

REGD.

now packed in
2-foot lengths

YOU can now obtain GLAZITE in two-foot lengths, four pieces (one each red, blue, yellow and black) in a sealed envelope for 1/-. Each envelope contains enough wire for the construction of a one or two-valve set. The different colours facilitate "back-of-panel" wiring.

"Glazite" eliminates the old insulating sleeving. It consists of tinned copper wire covered first with cotton then with heavy insulating material. "Glazite" is flame-proof and damp-proof, and will not deteriorate in any way.

It possesses high dielectric strength and is flexible. See that the LEW Seal is intact.

Send a post card for the Glazite leaflet and name of nearest stockist

20% REDUCTION IN PRICE OF 10-FT. COILS

The retail price of GLAZITE in 10-ft. (1 1/8 S.W.G.) coils has been reduced from 1/6 to 1/2 per coil. GLAZITE is now actually cheaper than the old method employing insulating sleeving.



Our mark is a

guarantee of quality

The LONDON ELECTRIC WIRE CO.
AND SMITHS LTD.

(Makers of Electric Wire for over forty years)

Playhouse Yard, Golden Lane, London, E.C.1

Telegrams: Electric, London. Telephones: Clerkenwell, 1388, 1389, 1390, 1391

Judd

FAMOUS FORMO

New Season's Productions

THE NEW FORMO-DENSOR

AN ULTRA LOW-LOSS SQUARE LAW
200-1 FINE TUNING RECORDING DIAL

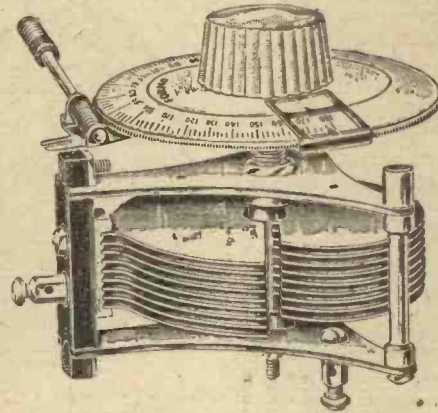

FORMO-DENSOR

Complete with Fine
Tuning Recording Dial

17/6

FORMO-DENSOR

Without Dial

10/6

FINE TUNING

RECORDING
DIAL

ONLY 7/6

A precision condenser of advanced design, suitable alike for laboratory and general use, and essential for short wave work:

It's a waste of time and money to endeavour to obtain selectivity with the usual forms of condenser.

The new Formo-Densor is the last word in condenser design, and this brief specification will indicate its superiority and logical design.

It is of correct rated capacity and gives "straight line" tuning. The rotor and stator vanes are of equal area, thereby eliminating surplus area of the stator, and reducing stray capacity, and both stator and rotor are homogeneously attached to their supports under great pressure.

There are no spacing washers and the stator is held at one point only, its attachment being insulated and isolated to the greatest possible degree from the body of the condenser.

The rotor is grounded and the independent skeleton frame presents the minimum possible surface to the stator.

Hand capacity effects are nil, and self-capacity and losses are immeasurable in practice, and, as the stator support is remote from the rotor, there is no jump in capacity when the rotor passes this point.

The frame, being independent, cannot be distorted when mounting. Since the ultra low loss characteristics of the Formo-Densor will render audible many more stations than the ordinary so-called low loss condensers, it is essential to have an extremely sensitive control, and the Formo Fine Tuning Recording Dial has been designed to give the remarkably low ratio of 200 to 1, by means of which it is possible to separate stations with HAIR-SPLITTING exactitude, while a station once tuned in is logged on the dial and can be easily found again.

THE NEW FORMO "PERFECTION" L.F. TRANSFORMER

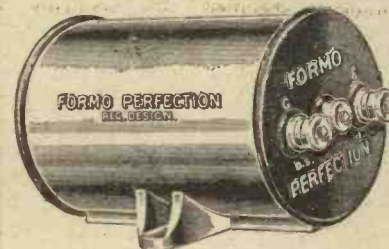

A MASTER PRODUCTION

Full, rich, mellow reproduction of voice or music with the utmost fidelity, its strongest appeal is to the most critical.

The Formo Company's new transformer, the "PERFECTION," is in every way a superb instrument. Its 30,000 turns of comparatively heavy wire ensures immunity from breakdown and the turns are correctly proportioned between the windings, and the iron core is exactly balanced, resulting in perfect reproduction of voice or music over the widest possible band of frequencies with a dead silent background. The primary and secondary terminals are remote from each other and their connections are marked, while for mounting two holes only are required.

30,000 Turns PRICE 21/-

THE EVER POPULAR

FORMO SHROUDED MODEL

12,500 Turns PRICE 10/6

FORMERLY 18/-

This highly popular model needs no introduction, and its phenomenal success remains unabated, in fact, is rapidly increasing, as at the new price of 10/6 it is undeniably the utmost value in Radio that money can buy. The Formo Shrouded Transformer is giving honest and faithful service to thousands of listeners in every quarter of the globe. Although the price has been reduced, its high quality will be maintained, and it will remain the same in every particular.

ILLUSTRATED LISTS ON REQUEST

THE FORMO COMPANY

(ARTHUR FREEN & CO., LTD.)

Cricklewood, London, N.W.2



A generous guarantee ensures your complete satisfaction in buying Burndept Components

WHEN buying components for your set, it gives you great confidence to know that the apparatus is absolutely efficient; and it gives you greater confidence to know that the components you have chosen are fully guaranteed. That is why so many home constructors decide on Burndept products, each of which is accompanied by a guarantee label bearing this wording:

"The component registered in our books with the serial number stamped on the back of this label is guaranteed against defects in material and workmanship for a period of 12 MONTHS from date of manufacture: if such defects develop it will be replaced or repaired free of charge upon return to factory with this tag."

With this guarantee of efficiency you are certain to get good results. Every Burndept Component is rigorously tested before it is packed.

The Burndept range of components is fully described in an illustrated catalogue which will be sent free on request. We shall be pleased to put you in touch with the local Burndept agent who will advise you regarding the best components to use in your apparatus.

POST THE COUPON TO-DAY



No. 226.—High-Ratio Intervalve Transformer (4:1). The best general purpose Transformer

24/=

No. 333.—Low-Ratio Intervalve Transformer (2.6:1). For all stages of power amplification

24/=

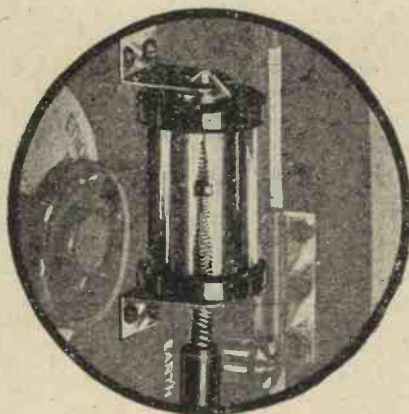

No. 215.—Crystal Detector, for panel mounting, in carton with drilling template 4/=

No. 216.—Crystal Detector, specially mounted for experimental use 11/6

Burndept Audio-Frequency Transformers amplify steadily and evenly. They have no "resonance peaks" and cause no distortion of speech and music. These Transformers are all of one pattern, being completely enclosed in a steel casing which not only enhances their appearance but also protects the coil from damage. Moreover, this casing enables Transformers to be placed quite close together without causing "howling." Screw terminals and soldering lugs are provided. Correct connections are indicated on an ivory tablet let into the top portion of the steel casing. Every Transformer is tested with 2,500 volts applied winding to winding and frame, and a current of 50 milliamperes is passed through the windings. The insulation resistance exceeds 300 megohms.

A crystal detector is a component which one likes to set and then forget. Consequently, the Burndept Crystal

Detector is very popular. It rarely requires re-adjustment and gives the best results obtainable by crystal rectification. The cat-whisker is controlled by a micrometer screw movement which enables fine adjustments to be made with ease. The sensitive synthetic crystal and all moving parts are enclosed in a glass tube.

The convenience of being able to use bright or dull-emitter valves without altering one's set in any way will be appreciated by all amateur wireless engineers. This is easily accomplished by fitting the Burndept Dual Rheostat, in which one half of the element is wound to a resistance of 5 ohms and the other half to a resistance of 25 ohms. The first half is used to control the filament current of a bright valve, and the whole 30 ohms resistance, to control a dull-emitter valve. The resistance wire, which is wound on a special flexible former, cannot be displaced, and as the windings yield slightly to the brush, perfect contact is made and a smooth "silky running" effect is obtained.

The Burndept range includes everything for radio reception, from components to complete installations.

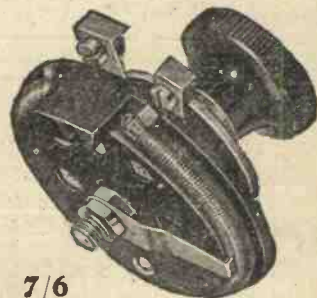

No. 222.—Burndept Dual Rheostat, 5-30 ohms, for panel mounting, in carton with drilling template 7/6

BURNDEPT

WIRELESS LIMITED

Head Office—Aldine House, Bedford Street, Strand, London, W.C.2

Telephone: Gerrard 9072

Telegrams: "Burndept, Westrand, London"

BRANCHES at Birmingham, Brighton, Bristol, Cardiff, Exeter, Glasgow, Leeds, Manchester, Newcastle, Northampton and Nottingham

CUT HERE

To BURNDEPT WIRELESS LTD.
Aldine House, Bedford Street,
Strand, London, W.C.2

Please send me a copy of the
Burndept Components Catalogue

NAME

ADDRESS

DATE.....Wireless Constructor, Sept.

joined to the arm of the selector switch and to the tag which connects to the frame of the jack.

The panel may now be put on one side and the remainder of the components mounted in position on the baseboard, as shown in the drawing. When this has been done, the leads from the filament resistances to the respective tags on the valve holders should be cut and bent to shape, and secured to the resistances. The panel may then be secured in position and the remainder of the wiring completed. As will be seen from the diagram,

flexible leads, ending in Clix or battery plugs, are brought from the lower ends of the gridleaks and from the L.T. — bus-bar, to form the connections to the grid-bias battery, which is stood on end in the rear right-hand corner of the box.

The loudspeaker leads are joined up to the plug, care being taken that the lead marked in red (the positive lead) is joined to that screw on the plug which is marked +.

Test the Wiring

Having completed the wiring, join up the low-tension battery,

place the valves in their sockets, plug in the loudspeaker, and turn on the resistances. If the valves light correctly, switch them off and join up the H.T. battery.

Connecting to a Set

The amplifier may then be connected up to the receiving set, as indicated in the drawings. In the case of a crystal receiver, the amplifier may be joined up in one of two ways, the first, shown on the left in Fig. 6, consisting of joining the crystal receiving circuit across the terminals of the choke coil itself.

(Concluded on p. 1028.)

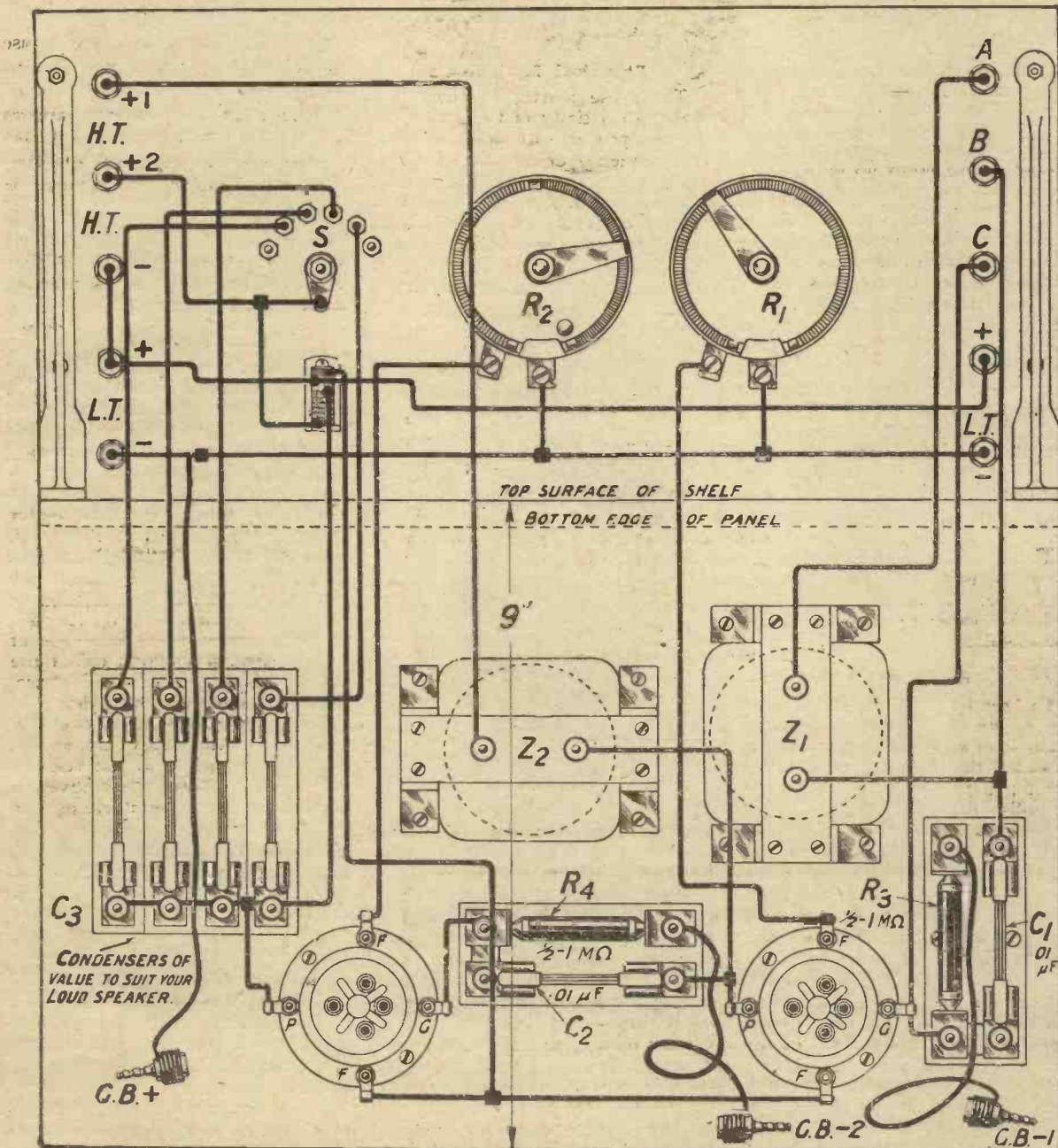
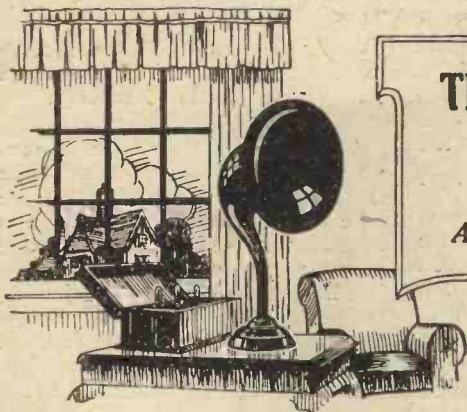

Fig. 4.—The wiring is carried out as this drawing shows. The connections on the panel should be effected first, as explained in the article. Blueprint No. C1020B.



The Tuning of a Circuit: What it Means and How it is Accomplished

By D. J. S. HARTT, B.Sc.

A discussion of the various factors involved in the process of tuning a circuit, written especially for the beginner.

THERE are many readers who will be familiar with the meaning of the "tuning" of a circuit and the various methods by means of which this is achieved, but there are others, no doubt, who have very hazy ideas on this subject. For the benefit of these, I shall devote this short article to an elementary discussion of the various factors involved in "tuning" and the different ways which are in common use.

Now, all the circuits by means of which we "tune" our receivers have what are termed *inductance*, *capacity* and *resistance*. We are not, however, particularly concerned with the latter in this discussion, since in most cases the resistance of the circuit will have little bearing on its wavelength. It is mainly when we are considering efficiency and selectivity that we have to take into account the resistance. Thus the inductance and the capacity are the main considerations.

An Example

To render the understanding easier, we will take a parallel example of a more concrete nature. Consider the balance wheel of a watch; here we have a wheel carefully balanced and mounted in bearings as free from friction as is possible. To the axle of the wheel is mounted one end of a fine spring, known as the hair spring. Now, the rate, period or frequency at which the wheel will vibrate or oscillate will depend on the weight of the wheel and the tension on the spring; or more correctly, on the "inertia" of the wheel and the "elasticity" of the spring. The inertia may be defined most simply as a quality in virtue of which any change in the motion of the wheel is opposed, and the elasticity of the spring is its power of rebound from any change of state or form produced in it.

Electrical Equivalents

Thus, the inertia of the wheel and the elasticity of the spring are the two properties which determine the frequency or number of vibrations per second of the wheel. These two mechanical properties, inertia and elasticity, correspond respectively to the electrical properties, inductance and capacity, of a circuit. Similarly, the inductance

have no appreciable effect on the frequency.

One cannot, of course, always obtain the exact parallel, but this simple analogy will, I hope, help to clear away any difficulties which the reader may experience in the conception of these somewhat vague properties, the inductance and capacity. We are now in a position to consider more clearly the meaning of the word "tuning."

What Tuning Means

We have seen that the frequency of the electrical oscillations of a circuit depends on its inductance and its capacity, but in this country, where each broadcasting station is allotted a definite *wavelength*, we are more accustomed to think in terms of this factor than of the frequency. There is, however, a very simple relationship between the two. As a basis for our theory of the transmission of electrical disturbances through space we assume the existence of a hypothetical medium called the *aether*, which pervades all space, and it has been shown that the velocity of propagation of these electrical disturbances through the aether is the same as the velocity of light. Thus we have a certain number of complete oscillations or *waves*, passing a given point in the aether per second, so that to each wave a certain length may be assigned, and it is obvious that the relationship between the frequency and the wavelength is expressed by:—

$$\text{Frequency} \times \text{wavelength} = \text{velocity of propagation.}$$

In this way, when we know the frequency of the electrical oscillations, we can assign to them a definite wavelength. Thus when we say that a circuit is "tuned" to a definite wavelength, we mean that the natural electrical oscillations of that circuit occur at a frequency corresponding to that

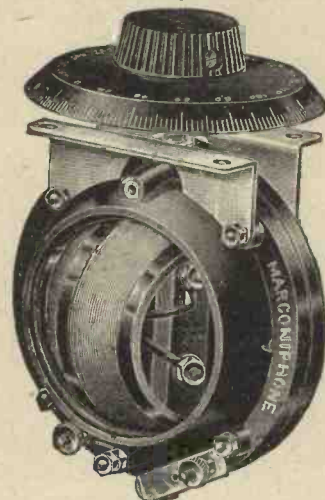

A modern commercial type of variometer.

and the capacity determine the frequency of the electrical oscillations in a tuning circuit.

We can quite easily imagine the effect of friction in bearings of the balance-wheel; it will not have any appreciable effect on the frequency of vibration, but will reduce the length of the swings or oscillations—that is, will give a weaker oscillation. Now, the friction may be looked upon as corresponding to the high-frequency resistance of the tuning circuit, and we may infer from this analogy that resistance in a tuning circuit will tend to reduce the strength of the electrical oscillations, but will





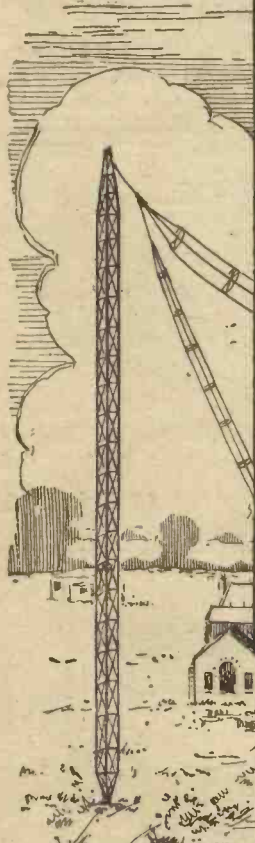

DAVENTRY

can be heard best on

B.T.H. RADIO Apparatus

IF you want to hear Daventry as well as it can be heard, buy B.T.H. Radio Apparatus. Your local dealer will be glad to demonstrate that any one of the receivers, or combinations of apparatus, scheduled below will do what we claim for it. He will also give you details of prices, which range from 35/- for the "Bijou" Crystal Set to £137 10s. 0d. for the Six-Valve Super-Heterodyne Cabinet.





 up to 100 miles	{ A plus K A plus I plus J B plus K B plus I plus J D plus J	
 up to 200 miles	{ C plus K C plus I plus J D plus K D plus I plus J	
 over 200 miles	{ E plus K G E plus F H	

See illustrations at foot for key to letters.
Insist on B.T.H.—the Best of all.





2362



 Bijou
Crystal Set
A



 Model A
Crystal Set
B



 Valve Crystal
Set
C



 2 Valve
Set
D



 Portable
Set
(Super-Met)
E



 Portable Amplifier &
Loud Speaker
F

 3 Valve
Cabinet
G

 6 Valve Cabinet
(Super-Met)
H

 2 Valve
Amplifier
I



 Loud
Speaker
J

 Phones
K

"CLARKE'S" "ATLAS" Radio Specialities

PERFECT TUNERS:

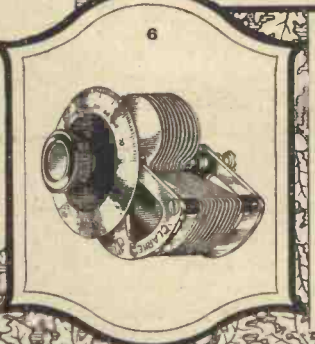
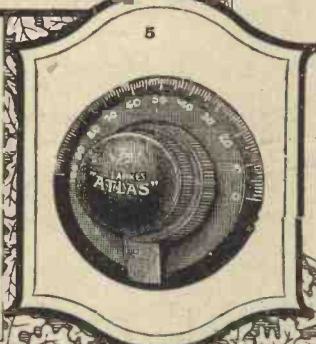
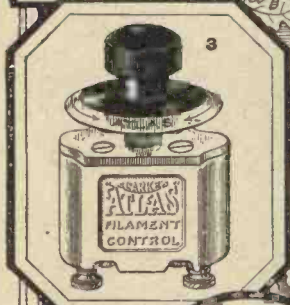
1. "Atlas" Aperiodic Coupler (Prov. Pat. No. 15,753).—Definitely cuts out local station and brings in others close in wave-length. Sets can be calibrated irrespective of various lengths of aerials. Don't scrap your old coils, simply insert our aperiodic coupler into the core and you have a perfect tuner. Suitable for all wave-lengths. Greatly increases the selectivity of your set and is indispensable for eliminating interference. Price 7/6 each
2. "Atlas" Low-Loss Coils (Patent No. 215,053) embody all that is known of low-loss coil design. The patent twin-wire winding offers a double surface path for H.F. currents. These coils give real meaning to phrases like "Maximum inductance and signal strength," "Minimum self-capacity," etc. Unequaled for distance and selectivity. Prices from 5/- to 15/-
3. "Atlas" Filament Control (Patent No. 16,427).—Silently efficient. Makes economy a pleasure and station-finding easy. Gives absolute and constant control of bright or dull-emitter valves. Soon saves its cost in current alone. Is quite "wire-less"; cannot possibly "pack," and is good for years of steady service. 50 ohms resistance. One-hole fixing. Price 6/6 each
4. "Atlas" Fixed Condensers.—Made with strong Bakelite casings. The carefully-selected copper foil and mica sheets are held under pressure by countersunk screws and nuts. All values; constant values. Strong soldering tags are attached, and metal parts are heavily nickel-plated. Tested to 1,000 volts prior to dispatch. Price from 2/- to 3/-
5. "Atlas" Vernianob (Patent applied for).—Makes ordinary variable condensers into super Vernier Condensers giving "finest" vernier control. 50 to 1 ratio. Special split bush allows of fitting to condensers having either 3/4-inch or 1/2 inch diameter spindles. Push-pull principle abolished. Fine and coarse movement independent of each other. The station you want can be logged with certainty—a big advantage over separate-vane vernier control. Price 10/9 each
6. "Atlas" Square Law Low-Loss Condensers (Prov. Pat. No. 5030/25).—The lowest of low-loss "square-law." The insulation between vanes is outside the electrostatic field, giving lowest dielectric losses. The Rotor is ground to the frame, giving freedom from hand-capacity effects. Fitted with "skeleton" end plaques. Zero capacity negligible. Supplied in all usual capacities. Price from 10/6 to 13/6



Sole Manufacturers:

H. CLARKE & CO. (M/cr), Ltd.
Radio Engineers
Atlas Works, Old Trafford
MANCHESTER

Telephone:—683 & 793 Trafford Park
Telegrams:—"Pirtoid, Manchester"

We make them good.

Good judges make them famous

wavelength and determined by the relationship given above. Expressed in a more simple way, when we tune our receiver to the wavelength of the local broadcasting station we alter the electrical "length" of our aerial circuit to correspond with that of the transmitting station, and our aerial circuit is then said to be in tune or in resonance with the incoming oscillations.

Now, as to the more practical side of the question, I shall deal with the methods in common use by means of which we can tune our circuit to any definite wavelength, taking as an example the aerial circuit, which may be used in conjunction with any receiver, crystal or valve,

Natural Wavelength of the Aerial
The aerial itself will have a certain amount of capacity and

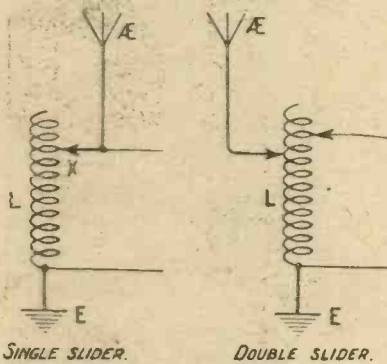

Fig. 1.—Two simple methods of tuning.

inductance, and thus have a definite wavelength of its own, but the majority of aerials in use for broadcast reception have a natural or fundamental wavelength very much lower than the ordinary wavelengths used for broadcasting. We thus have to increase this wavelength by the addition of further inductance and capacity, and this is accomplished by connecting a tuned circuit to the aerial and the earth.

The Simplest Way

One of the simplest methods is to vary the inductance of the aerial circuit only, and the simplest way of doing this is to wind a single-layer coil of insulated wire on a cylindrical cardboard or ebonite former, and to bare the turns for a short width along the whole length of the inductance. A sliding contact is then arranged to make connection with the bare portion of the wire. The arrangement may be connected as is shown in Fig. 1, where the slider is indicated by an arrow. The

leads shown to the right of the coil are connected to the detector.

This arrangement, which is known as a "single-slider" coil, constitutes one of the simplest of tuning devices, which, although not used

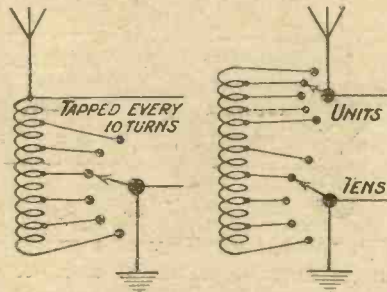

Fig. 2.—Here tuning is effected by means of tapings, brought out to stud switches.

very much nowadays, was extensively employed in the earlier days of wireless. It has several disadvantages which counteract its simplicity, as, for example, the difficulty of securing a reliable and smooth contact between the sliding device and the bared turns of wire. The possibility also of neighbouring turns short-circuiting through the bared portions of the wire and so causing serious inefficiency must not be overlooked. There is also the fact that a considerable number of the turns are superfluous for certain adjustments when the slider is far from one end of the coil. The losses due to the existence of these turns are referred to as "dead-end" losses, and may seriously impair the efficiency of the tuner.

Two-Slider Coil

An elaboration of the single-slider coil consists in the use of two sliders. One method of using such

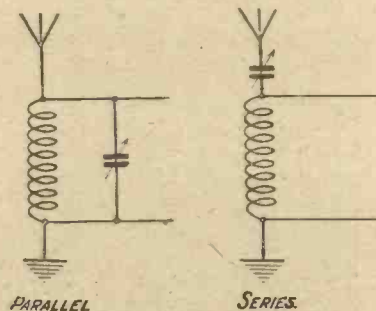

Fig. 3.—Two methods of joining up a variable condenser.

an arrangement gives the tuner shown in Fig. 1. By adjusting the slider connected to the aerial any number of turns may be connected in the aerial circuit, and, similarly, any number of turns may be

connected across the detecting device by varying the position of the second slider. This will usually provide a more selective tuner, though sometimes a loss in signal strength may result. The selectivity will increase as the number of turns in the aerial circuit is decreased, and there may be in some cases a reduction in signal strength. Such a circuit is useful when interference is experienced and some loss of volume is not such a serious disadvantage. With this arrangement the number of turns across the detector can be made to determine the wavelength to which the circuit is tuned. The same remarks regarding the drawbacks of the single-slider system apply in the case of a double-slider coil, and the arrangement is not used to any great extent nowadays.

A further scheme for varying the inductance consists in taking tapings from the coil at suitable turn intervals and connecting these to

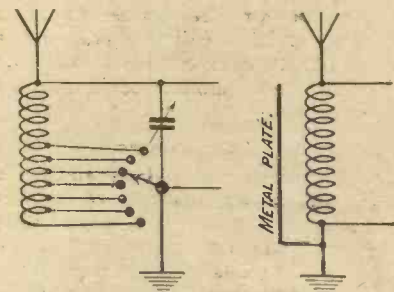

Fig. 4.—Left: Use of condenser with tapped coil. Right: Tuning by means of a metal plate.

the contact studs of a selector or tapping switch. A switch arm connected as shown in Fig. 2 then provides a means of varying the inductance by including in circuit any number of turns in convenient steps, such as every 10 turns. A finer adjustment is provided by the use of a second switch, the studs of which are connected to tapings taken from each turn at one end of the coil. This gives us a more convenient and certain means of varying the inductance than does the slider method, and is much more used in practice. The disadvantage of "dead-end" effects is, however, still present, and the difficulty of making the tapings again restricts the use of this method.

Use of a Variable Condenser

The number of tapings may be reduced if a tapped coil is used in conjunction with a small capacity variable condenser as shown in Fig. 4. Here both the inductance and the capacity may be varied,

and this method of tuning represents an advance on those previously considered, except that "dead-end" effects will in some cases still be present. These may be avoided by using a fixed inductance and tuning the circuit by varying the capacity by means of a variable condenser as in Fig. 3. This is the method that is most commonly used nowadays, and has much to commend it on account of its simplicity. The coil may be mounted on some plug-in device, such as is used in the commercial types of plug-in coils, so that coils of different inductance values may be rapidly interchanged. In this way it is possible to cover a large wavelength range.

Series or Parallel

Note that the condenser may either be connected in parallel or in series with the coil, as shown in Fig. 3. In general, a larger value of inductance is needed with the condenser in series, but the best position for the condenser in a given aerial circuit depends on the electrical characteristics of the aerial and should be found by actual trial.

Variometers

A further method of tuning a circuit is by the use of a continuously variable inductance, that is to say, an inductance which may have any value between two limits, and not be variable only in steps, as is the case with a tapped inductance. Such a continuously variable inductance is provided by means of the device known as the variometer, which generally consists of two coils supported one inside the other, the outer coil usually being fixed and the inner one capable of rotation, so that in one position its windings are in the same "sense" or direction as those of the outer coil. In the other position the windings are in the opposite direction. The former position gives the maximum inductance and the latter the minimum, while a continuous variation is possible through the intermediate positions.

Although the variometer is used to a fair extent, its popularity is necessarily restricted by certain drawbacks inherent in the design. First there is the difficulty of securing a close coupling between the two windings in all positions of the rotor coil. If such a close coupling is not possible, then the inductance range and, therefore, the wavelength range is correspondingly small. A further serious drawback lies in the fact that for the minimum wavelength position a far greater amount of wire is

used than would normally be needed if an ordinary type of coil were used. The high-frequency resistance is thus correspondingly in-

some provision is made for using the two coils constituting the variometer in series for the higher wavelength range, and in parallel for the lower wavelengths, and one well-known type of instrument embodies this principle in an ingenious manner by means of a cam switching device on the rotor spindle.

Lastly, there is still another simple method of tuning which is useful in some cases. This consists in mounting close to a coil a metal plate, usually of copper, so that it can be moved backwards and forwards across the coil. When this arrangement is used in a tuning circuit eddy-currents are induced in the metal plate, and this has the effect of lowering the apparent inductance of the coil, and therefore the wavelength, when the plate is brought closest to the coil.

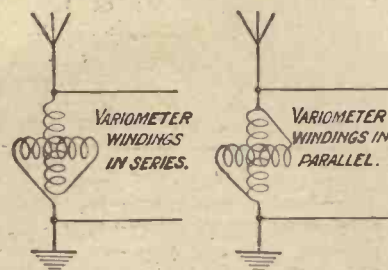
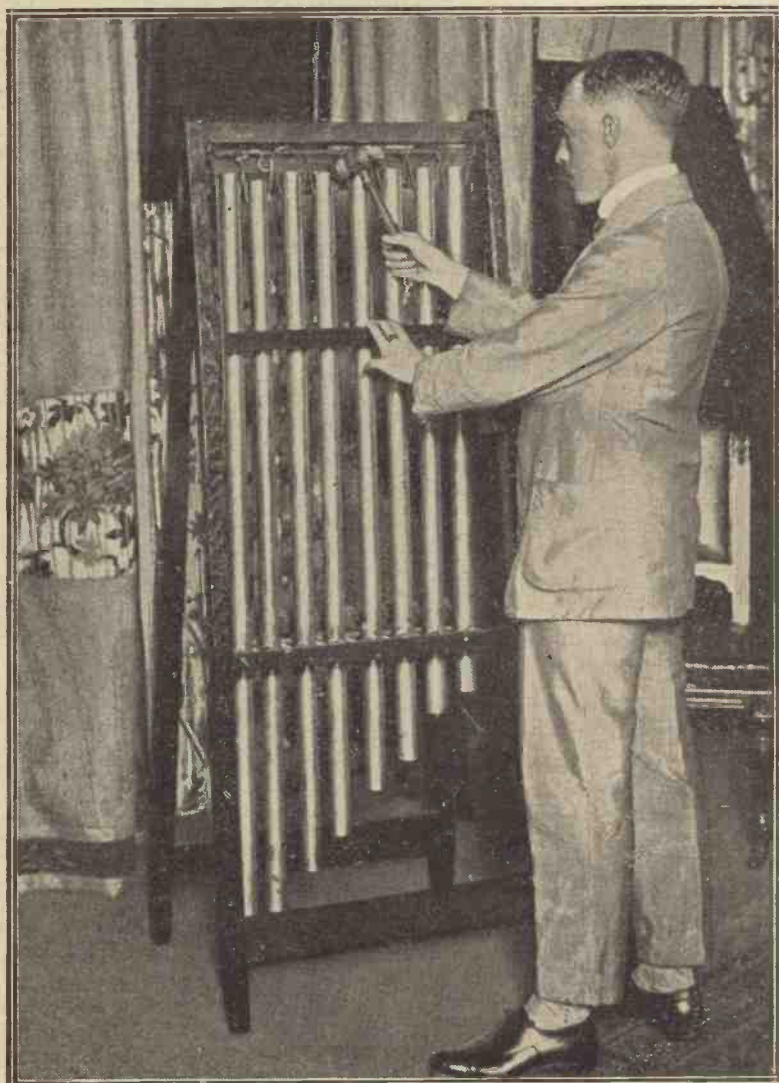
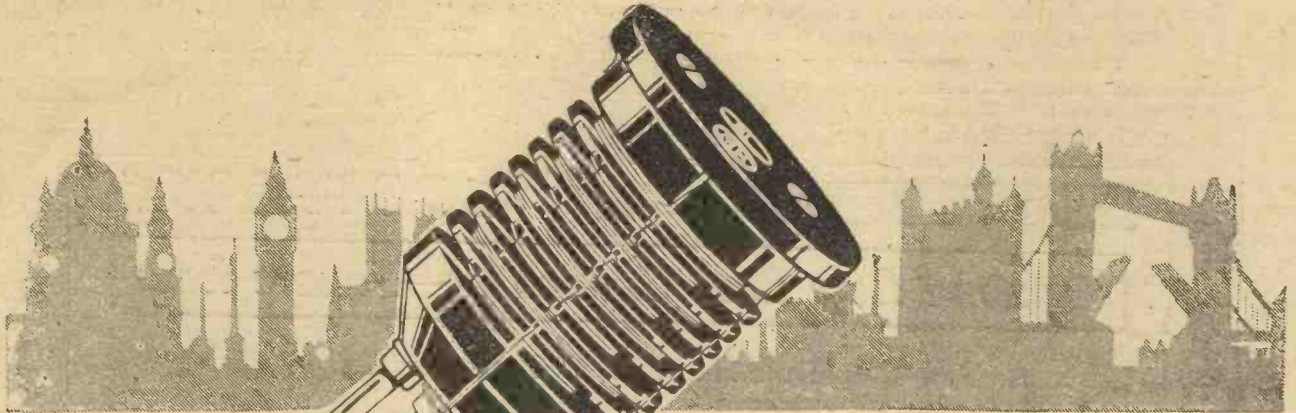

Fig. 5.—The windings of a variometer may be joined in series or parallel as shown.

creased and selectivity and signal strength suffer. These defects are to a certain extent counteracted if



Wireless in Australia. The announcer at 3LO, Melbourne, is here seen sounding the studio chimes.



Selectivity and distance

LOOK at the shape of a McMichael **MB** H.F. Transformer, observe the divisions carrying the windings, note the staggered slots conveying the leads.

*The reason, elimination of losses.
The result, greater selectivity and reception of distant stations hitherto unobtainable.*



H.F. TRANSFORMERS

Supplied in six ranges of wavelengths, covering from 80 to 7,000 metres.

No. 00	80 to 150 metres	10/-	No. 2	550 to 1,200 metres	10/-
No. 0	150 ,, 300 "	10/-	No. 3	1,100 ,, 3,000 "	10/-
No. 1	330 ,, 600 "	10/-	No. 4	2,500 ,, 7,000 "	10/-
A5, Neutrodyne Unit (Broadcast Wavelength)		each 10/-			
No. 3 Transformer is suitable as a Neutrodyne Unit for 5XX					
The Complete set in handsome case, Nos. 00-4		55/-			

Any number of each transformer can be supplied matched at NO extra charge, if requested at the time of ordering.

OBTAINABLE FROM ALL DEALERS.

"The Transformer that made High Frequency Amplification popular."

Your dealer can also supply you with the two latest **MB** Components, the **MB** H.F. Rectifier Unit and the **MB** H.F. Damper. Both are auxiliaries of the **MB** Transformer.

For full details of these write for 16-page booklet on High Frequency Amplification and Allied Neutrodyne and Supersonic (Super-Heutrodyne) Reception.



Works :-
WEXHAM ROAD, SLOUGH
Phone : SLOUGH 199

L.M^cMICHAEL LTD

Manufacturers of Wireless and Scientific Apparatus

Head Office :- HASTINGS HOUSE, NORFOLK STREET, STRAND, LONDON, W.C. 2. Phone: CENTRAL 8272/3
TELEGRAPHIC ADDRESS: RADIETHER, ESTRAND, LONDON

London Showrooms :-
179, STRAND, W.C. 2.
Phone: CENTRAL 6988

CABLE ADDRESS: RADIETHER, LONDON.

Barclays Ad.

In replying to advertisers, please mention THE WIRELESS CONSTRUCTOR.

TWENTY-FIVE YEARS  MANUFACTURING EXPERIENCE

"ORMOND" "ORMOND" "ORMOND" "ORMOND" "ORMOND" "ORMOND" "ORMOND" "ORMOND" "ORMOND"

ENGINEERING COMPANY

Ormond Low Loss Condenser—Square Law

A New Departure in British Condenser design, giving the following advantages:—

- (1) Practically negligible losses. (2) One-hole fixing—one $\frac{3}{8}$ " diam. hole is needed to fix this condenser to panel. (3) Rigid construction—cannot warp; end plates of stout aluminium, perfectly flat. (4) Fixed vanes, supported by $\frac{1}{4}$ " ebonite strips. (5) Smooth action, spindle tension is maintained by a specially designed friction washer. (6) Moving vanes and end plates are at earth potential. (7) One-piece knob and dial—supplied loose. Secured by 4 BA Set Screw.

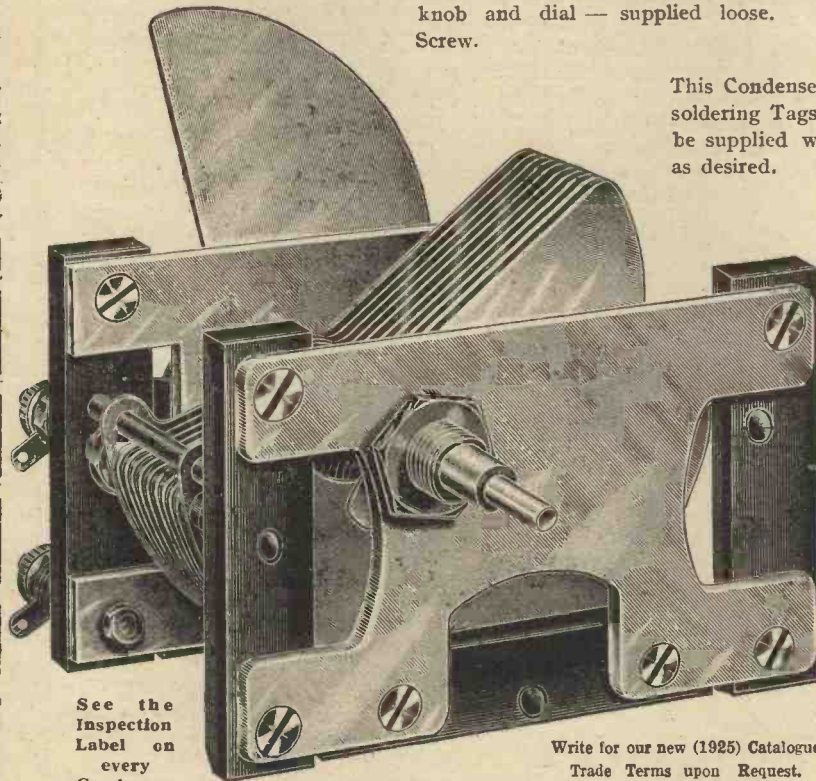

This Condenser is fitted with optional soldering Tags, or Terminals, and can be supplied with or without Vernier as desired.

There is no variation in price, the prices being the same as our ordinary Square Law Condensers.

Supplied in the following sizes—

Size:	Price with Vernier.	Price without Vernier.
.00025	8/-	6/6
.0003	9/-	7/6
.0005	9/6	8/-
.001	10/6	9/-

All Cheques and Postal Orders should be crossed and made payable to "The Ormond Engineering Co."

We specialise in turning Brass and Steel Screws and Machined Parts and Accessories of all descriptions.

See the Inspection Label on every Condenser

Write for our new (1925) Catalogue Trade Terms upon Request.

199-205, PENTONVILLE RD. KING'S CROSS, LONDON. N.1.

Factory:— Whiskin Street, Clerkenwell, E.C.1

THE BEST MEANS —
ORMOND

Telegrams:— "ORMONDENGI. KINCROSS."

Telephone:— CLERKENWELL 9344(3lines).

"ORMOND" "ORMOND" "ORMOND" "ORMOND" "ORMOND" "ORMOND" "ORMOND" "ORMOND" "ORMOND"



"A Unit Choke Amplifier"

Some readers' experiences with an amplifying unit employing choke-capacity coupling, which was described in the April issue of this Magazine

SIR,—As one more interested in perfect loud speaker reception of the local broadcast programmes than other forms of "wireless" reproduction, I read with the greatest pleasure the article by Mr. J. W. Barber in the April number of THE WIRELESS CONSTRUCTOR. Like Mr. Barber himself, I have often been amazed at the so-called purity of reproduction on the loud speaker, differing in almost every case with other persons' ideas of what it should be. So little impressed have I been generally, that I refused to consider the use of a L.S. at all. The article in question so attracted me, that here at last a promise of something really creditable in reproduction could be achieved, that I decided to build the units exactly in every detail as given. This I did, and I must say that the results have justified all that Mr. Barber claims for the "Unit Choke Amplifier." So pleased was I after a trial on a "Dinkie" that I straightaway purchased a Sterling "Primax." Everyone who has heard it has remarked on the excellent quality of the reproduction. Music is invariably good, as also is speech, except that at times some parts of "Radio Plays" S.B. from London come in a little thickly, or otherwise where the players are attempting to give expression to some abnormality characteristic of the part in the play. Whether the use of other values of condensers would overcome this I have not sufficient knowledge to say. Be it so; I must say that so far yet, I have heard nothing that can even approach the reproduction, let alone surpass it. I am using a

modified "Flewelling" one-valve set of good purity itself, with two stages of the amplifier. My aerial, though very efficient, is only an inside one about 80 ft., and 5 miles from 2 ZY, so that one stage is hardly comfortable. With both, however, volume is all that can be desired. I use a "Mullard" detector valve in the set with a Cossor Pi in the first stage without grid-bias and a Mullard D.F.A.0 power valve in the second stage, with 6 volts G.B. I work from a 4-volt accumulator and use H.T. Voltages 56, 62 and 82 respectively. One point I notice on these voltages, the set works quite well even without G.B., and whether the G.B. terminals are shorted or not. I hesitate to dash into print on wireless matters, being but a novice in the science, but rely on the Radio Press publications absolutely, none of which I fail to read as they appear. However, as Mr. Barber expressed a wish that anyone trying the "Units" might write and let him know the results I felt that at least I must write to congratulate him on putting such a wonderfully pure amplifier before your readers. I shall watch with great interest any further attempts he may make to deal with this side of broadcast reproduction.

Yours faithfully,
Manchester. F. BOOTH.

SIR,—I have much pleasure in informing you that I have been using the choke amplifier described by Mr. John W. Barber in April WIRELESS CONSTRUCTOR, with great success, little loss of signal strength being apparent, compared to transformer coupling, whilst the quality is much improved.

I am using the usual one-valve detector, followed by two-note magnifier, comprising, first, the

choke, and then the ordinary transformer amplifying circuit.

I agree with your correspondent, Mr. Bousfield, that varying the value of the resistance makes practically no difference. Another point is that in using the amplifier as choke first and transformer second, and not switching on my detector valve, the L.S. gives a fairly good shriek, whereas by using the amplifier as transformer first and choke second, no such effect was noticed.

I should be glad to know if any other of your readers have noticed this, and can account for it.

Wishing your production the best success.

Yours faithfully,
ARNOLD H. WRIGHT.
Clapton, E. 5.

SIR,—Just a few lines to let you know of my experiences with the Choke Amplifier unit, as described by Mr. John W. Barber in the April issue of your valuable journal. I made the unit exactly as described, and attached it to my two-valve set, which comprised one H.F. and a detector valve, with reaction on the anode coil. The result was exceedingly good, and I decided to add a second unit in order to obtain good volume for the loud speaker, and the resulting signals are all that can be desired, both for purity and volume. I have tried the set against that of a friend which uses two note magnifiers, transformer-coupled, and although his set gives greater volume, all agree that mine has the laurels for purity.

I am so pleased with the results that I intend to re-build the whole outfit upon one panel, so that it may be used by anyone at home by simply switching on the filaments.

Thanking you for publishing such a good amplifier, and wishing you continued success.

Yours faithfully,
Oldham. J. G. A.

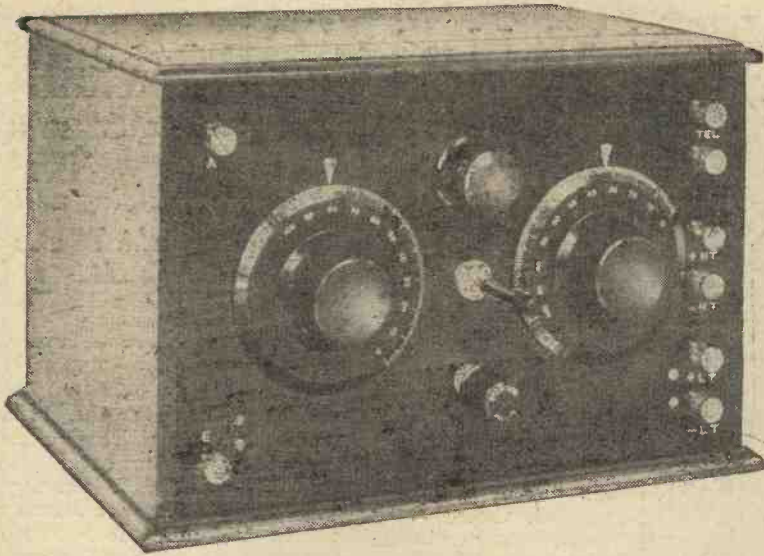

Low-Loss and the Reinartz Circuit

A SELECTIVE
SINGLE-VALVE
RECEIVER

By G. P. KENDALL,
B.Sc., Staff Editor

THE original form of the circuit which is associated with the name of John Reinartz was a somewhat complicated affair, involving the construction of several windings with numerous tappings, yet its very special merits won it very speedy recognition among American experimenters. In its original form, its main attractions were simplicity of operation, a good degree of selectivity, and a delightfully smooth and definite control of reaction. Its sensitivity to continuous wave signals when the set was in the oscillating condition was good, while upon damped wave signals, such as spark and telephony, it did not compare very favourably with an ordinary single-valve reaction circuit.

Improvements

A number of improvements have been made in the original Reinartz circuit, some with a view to making the set easier to construct, and others with a view to improving its efficiency upon spark and telephony signals, while retaining the original attractive reaction scheme, until it has now assumed a form something like that illustrated in Fig. 1.

Upon reference to the diagram it will be seen that the circuit has a general resemblance to one of the "aperiodic aerial" single valve circuits with which we are now familiar, the winding L_1 representing the aperiodic aerial coil, and the coil L_2 the fully tuned secondary winding. The coils L_1 and L_2 are, of course, coupled together magnetically, in many cases by winding them upon the same former,

Reaction

The method of obtaining reaction is one of the very special characteristics of the Reinartz circuit, and it will be seen that there is included in the anode circuit of the valve a choke coil, and that from the plate of the valve a variable condenser is connected to the aerial terminal, so that high frequency impulses which have been passed through the variable condenser will therefore flow through the winding L_1 back

to the filament circuit, and will thus convert the winding L_1 into a form of reaction coil. Since we can regulate the strength of these high frequency impulses by adjusting the capacity of the condenser C_1 , it will be seen that we have here a very convenient means of governing the reaction. This arrangement is commonly described as a combination of magnetic and capacity reaction.

The more recent improvements

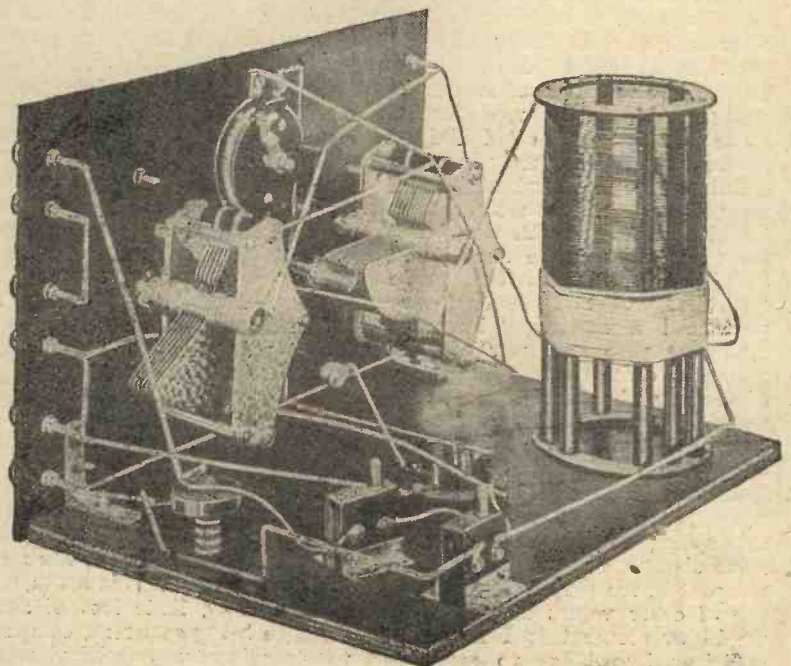

Note the flexible leads to the choke coil socket. A shorting plug is used in the other socket for reception on the 300-500 metre band. The choke should be a No. 200 or any larger sized coil available.

At a distance of 6 miles from 2LO, Bournemouth has been heard without interference from London with this set. On the same evening Radio-Toulouse, Madrid, Hamburg, Munster, Ecole Supérieure, Birmingham, Glasgow, Newcastle, and Belfast were heard after dark.

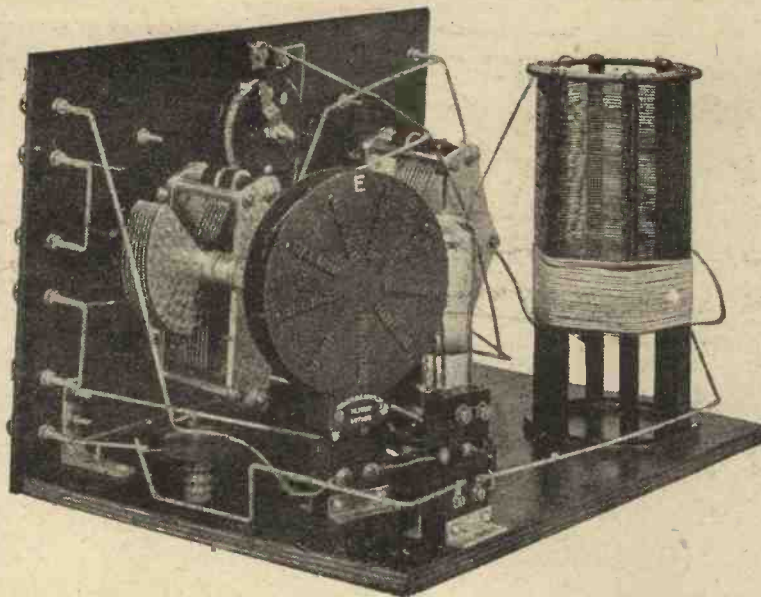

in the Reinartz circuit have concerned mainly the actual arrangement of the windings L_1 and L_2 , with a view to improving the performance of the circuit on telephony signals, upon which, of course, the receiver must not be operated in the oscillating condition. A number of coils have been devised for the circuit, in which the two windings are interwoven in a variety of ways, and several of these have proved extremely successful in giving the circuit the improved performance upon telephony which

is desired. The name of Dr. E. H. Chapman is commonly associated with one of the most successful methods of winding the coil, and in his arrangement both the primary winding L_1 and the secondary L_2 are wound on simultaneously in some such form as that of a basket coil, the wire being fed in from two bobbins simultaneously.

In Reinartz receivers where this method of interweaving of primary and secondary is adopted, it will be found that the performance of the set becomes quite comparable

with that of an ordinary single valve reaction set as regards strength of signals and ability to cover long distances, while the very great advantages of a beautifully smooth and simple control of reaction and a considerable increase in selectivity are retained.

Various improvements and simplifications have thus resulted in a form of Reinartz circuit which can be embodied in a receiver which will give results quite equivalent to those of a good single valve reaction circuit of more conventional type, and the possibilities of obtaining increased selectivity in this way are most attractive. Now, if the other factors in the circuit are kept constant, the selectivity of a Reinartz receiver will depend mainly upon the actual number of turns employed to couple the secondary winding L_2 to the aerial, these turns being represented by L_1 in the diagram. The larger the number of turns employed the louder will be the signals within certain limits, but the lower the selectivity, and it will be found in a good Reinartz receiver that the number of turns can be reduced until the selectivity becomes quite reasonably high without any serious loss of signal strength.

I believe that the effect varies upon different aeriels, but in general it may be said that, starting with only a very small number of coupling turns, signal strength will increase up to a certain point as these turns are increased, and beyond this point little or no

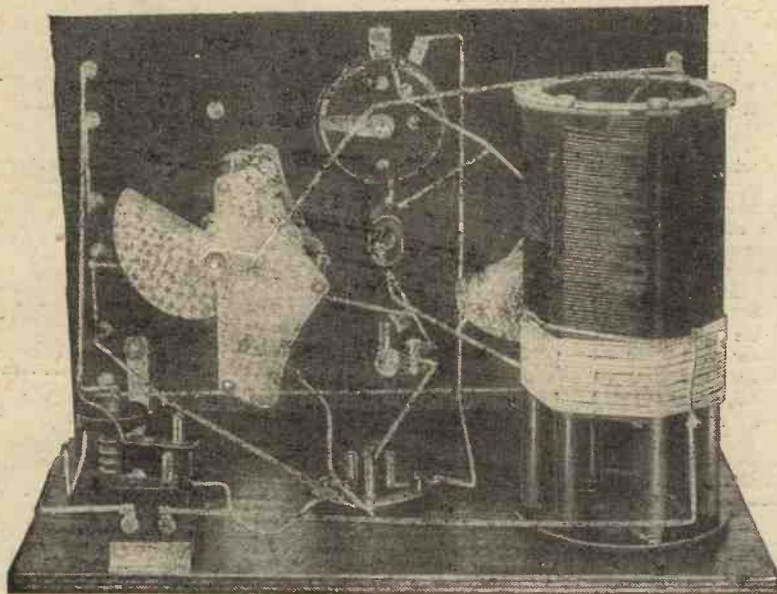

The combined grid leak and condenser simplifies the wiring considerably.



The Dull Emitters which made the Portable Set possible

SO long as bright emitter valves were the only ones available the really portable Receiver was impracticable. No one wanted to carry big 6-volt accumulators out into the country for the pleasure of enjoying a Radio concert in the meadows—it wasn't worth the trouble. And even when the first dull emitters became more popular their extreme fragility rendered them unsuitable for the inevitable rough handling which every Set must get when carried from place to place.

And so the portable Receiver lagged in development. But with the introduction of the Wuncell, summer Radio becomes a new delight. It is now quite easy to design a three-valve Receiver which can be fitted into an attaché case complete with a 2-volt unspillable accumulator. Such a Receiver will give at least 10 to 12 hours reception on one charge. And, what is more important still, the Wuncell

valves will not be harmed by the vibration and rough usage to which such a Receiver will be subjected.

The reason for this lies in the design of the filament and its method of manufacture. Instead of being a long straight filament, it is arched and further stayed at its centre with a third support. Instead of obtaining low current consumption by thinning down the filament at the risk of fragility, the Wuncell filament is manufactured under an entirely new process. This permits an exceptionally high electron emission at a temperature of only 800 degrees—when the Wuncell Valve is working its glow is practically invisible in daytime. Even in the dark, it is no more apparent than the luminous figures on a watch dial. As a result, therefore, we have every confidence in saying that the Wuncell Valve is quite as robust as even the well-known Cossor Bright Emitter.



Wuncell Dull Emitters

Made in two series: Types W.1 and W.2 for 2-volt accumulators. Types W.R.1 and W.R.2 with additional resistance, so that valves can be used with either 2-, 4- or 6-volt accumulators.

W.1 and W.R.1 are for use as Detectors or L.F. Amplifiers. W.2 and W.R.2 are specially designed for high frequency amplification. All Wuncell Valves consume only .3 amps., and require a plate voltage of 20-80 volts.

Note Reduced Prices:

W.1 14/- W.R.1 16/-
W.2 14/- W.R.2 16/-



A new Valve

The Cossor Loud Speaker Valve W.3

When used with a good low frequency Transformer this new W.3 valve gives an immense volume of pure and undistorted sound. Its use renders a second stage of L.F. amplification practically superfluous. The design embodies all the well-known Cossor principles and the valve is therefore quite free from microphonic noises. Filament voltage, 1.8 volts; filament consumption, .5 amps.; plate voltage, 50-150 volts.

18/6

the long life Dull Emitter

Cossor Wuncell

A. C. Cossor, Ltd., Highbury Grove, N.5.

Gilbert Ad. 8159

difference will be noticed upon the addition of turns. Selectivity, however, appears to decrease progressively as the number of turns is increased, and it is, therefore, a matter of compromise to select the best number of turns for any given

designs. Where, however, the question of selectivity is a vital one, as in the case of sets used within a short distance of a main broadcasting station, it is necessary to realise that a certain amount of experimenting with the number of

ject of this article seem to suggest that the circuit is one which is decidedly critical to coil losses, to a greater extent even than a normal instrument. It seems, in effect, that the result of using a really low-loss coil for the secondary winding, and reducing losses as far as is reasonably practicable throughout the circuit is to enable a still smaller number of turns to be used for the winding L_1 , without loss of signal strength, and with a corresponding gain in selectivity.

These various points are well illustrated in the receiver which is shown upon these pages, and those readers who make up similar sets will discover that a Reinartz receiver upon these lines is an instrument whose capabilities entitle it to a very much greater degree of consideration than it usually receives from the home constructor.

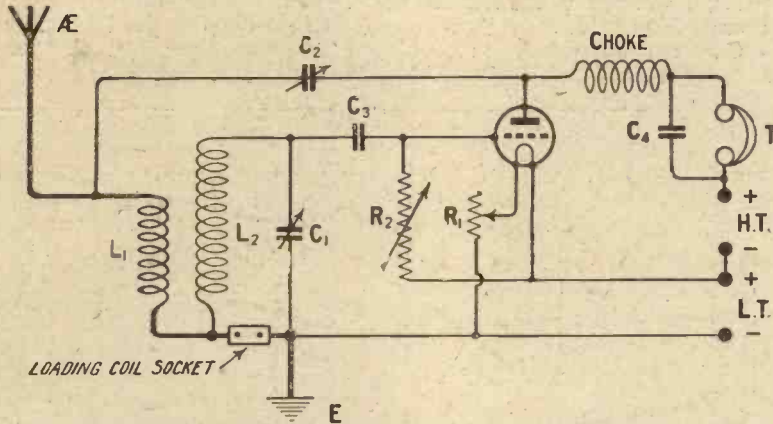

Fig. 1.—To receive Daventry with this circuit a No. 150 coil is inserted in the loading coil socket. The choke then serves as a reaction coil, being coupled to the loading coil. A vernier condenser is connected in parallel with C_1 .

set, and to some extent for any given aerial. Where the question of selectivity is not of the greatest importance, of course it is possible to decide in advance upon a convenient number of coupling turns, and this is usually done in practical

turns will be needed before the exact combination of good signal strength and highest selectivity is obtained.

Recent Experiences

My recent experiences with the instrument which forms the sub-

Sensitivity and Signal Strength

As regards sensitivity and signal strength, I think the instrument compares a little more than favourably with the best of simple direct-coupled reaction circuits, and as an example of its powers I would mention that recently, when Glasgow provided the after-hours experimental transmission, I was able with the single valve in this set to receive the whole transmission at

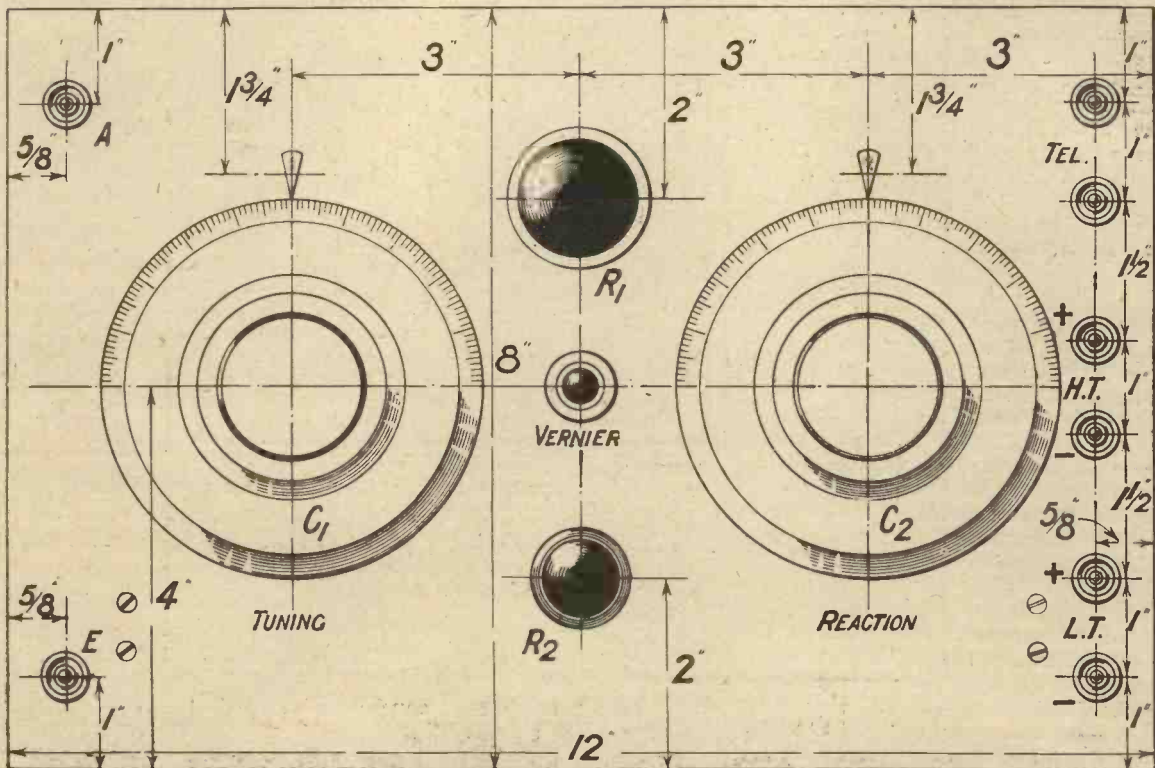

Fig. 2.—When drilling the panel, note that the positions of the dial indicators will depend upon the size of the dials employed.

good strength, even the under-modulated transmission being quite loud and clear. The addition of two stages of resistance-capacity note magnification to the set gave quite adequate loudspeaker results from Glasgow on this occasion. In this connection I should mention that I live in a locality (S.W. London) which is decidedly unfavourable for long-distance reception.

Turning to a more detailed consideration of the set, it will be observed that it is built upon the plan of a vertical ebonite panel, carrying just the necessary number of controls and terminals, all the other parts of the set being mounted upon a wooden shelf, attached to the ebonite panel by means of small angle brackets. Looking at the set from the front, there will be seen upon the panel the two large dials of the condensers, the left-hand one being the tuning condenser and the right-hand one being the reaction condenser, while between the two will be seen the small knob of a vernier condenser which is connected in parallel with the tuning condenser for fine tuning purposes. Above this knob is the filament rheostat, and below it is the variable grid leak control. It should be mentioned that I have found a variable grid leak quite an advantage in the Reinartz circuit, since it gives one the power to obtain a very fine control of reaction, and also to so arrange the functioning of the valve that the desired degree of smoothness of reaction control is obtained. The particular variable grid leak employed is a Bretwood of the latest pattern, with which a grid condenser is combined.

Low-Loss Coil Former

A very special feature of the set is the low-loss coil and coil former, and for the purpose I have used one of the special formers marketed by Messrs. Collinson's Precision Screw Co., Ltd. The former consists of a sort of squirrel-cage arrangement, with two thin ends of ebonite rods to support the winding. With this former it is very easy to produce a highly efficient winding, the turns of wire being separated from each other by an amount determined by the pitch of the thread which is cut in the ebonite rod. In the one which I used the winding runs about sixteen turns to the inch, which I find gives quite an effective amount of spacing.

Components

Good types of low-loss condenser

and low-loss valve socket have been chosen, and a telephone condenser of $.001\mu F$ completes our list of principal components. For the convenience of the constructor who may wish to obtain the necessary parts, I will repeat the list in full tabular form below.

One ebonite panel, $12 \times 8 \times \frac{1}{4}$ " (American Hard Rubber Co., Ltd.).

One Polar neotrodyne condenser (Radio Communication Co., Ltd.).

Eight terminals (Burne-Jones & Co., Ltd.).

One low-loss coil former, $3\frac{1}{2}$ " diameter by 7" long (Collinson's Precision Screw Co., Ltd.).

One $.001\mu F$ fixed condenser ("Dorwood," Herbert Bowyer & Co., Ltd.).

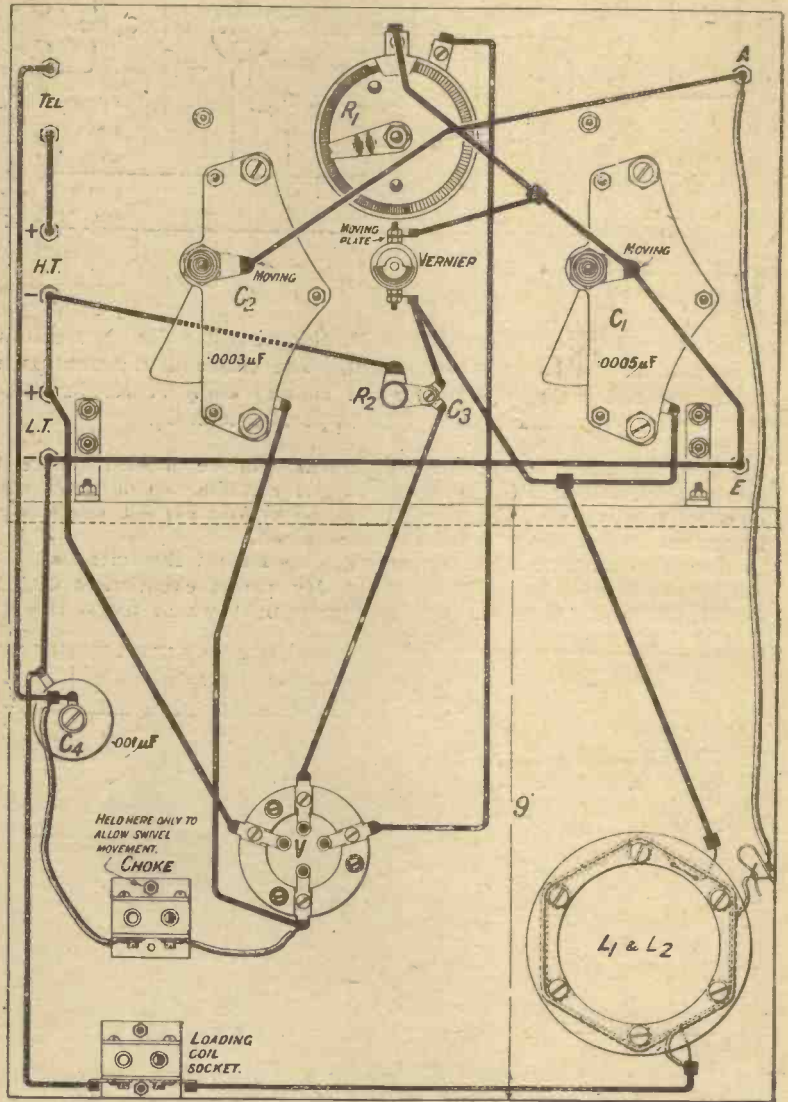

Fig. 3.—The connection from the aerial terminal to the beginning of the winding L_1 is flexible and carries a spring clip so that it may be attached to any tapping point which may later be made on this winding.

- One cabinet ("Camco").
- One variable condenser, square law type, $.0005\mu F$ capacity (Igranic Electric Co., Ltd.).
- One variable condenser, square law type, $.0003\mu F$ capacity (Igranic Electric Co., Ltd.).
- One combined variable grid leak and condenser (Bretwood).
- One dual filament rheostat (Burne-Jones & Co., Ltd.).

- Two board-mounting single-coil sockets (Burne-Jones & Co., Ltd.).
 - Two small brass angle brackets.
 - Quantity square tinned copper wire for connections.
 - Radio Press panel transfers.
 - $\frac{1}{2}$ lb. No. 20 enamelled and $\frac{1}{4}$ lb. No. 20 d.c.c. wire.
 - Two "Decko" dial indicators (A. F. Bulgin).
- (Concluded on p. 1030.)

TRADE DECKO MARK

DIAL INDICATORS
SIMPLY DRILL ONE HOLE AND FIX AT ANY POINT OF DIAL. BEAUTIFIES THE PANEL. OBTAINABLE FROM ALL THE BEST DEALERS.

A.F. BULGIN & CO.
9-11 CURSITOR ST.
CHANCERY LANE E.C.4.

R.R. P.B.
Price 9/- per Pair

"BREAK-NOT"
BATTERY TESTER
THE IDEAL
HYDROMETER
FOR ALL WIRELESS
ACCUMULATORS.

716

The "BREAK-NOT" HYDROMETER is the recognised standard of quality in battery testers and should be in the hands of every user of an accumulator. Being packed in unbreakable carton the Break-Not is the only practical instrument to keep in the tool box without fear of damage.

Liberal Terms to the trade.

S. GUITERMAN & CO., LTD.

35/6, Aldermanbury, London, E.C.2

ELECTRADIX RADIOS

The increasing scope of wireless apparatus has necessitated a wide increase in our already large and comprehensive stock in London.

Our new July edition of our famous Catalogue of Radio Bargains now contains 500 illustrations of radio sets, components, and electrical instruments of great interest. Many of these are unobtainable elsewhere and our prices are the very lowest.

The experimenter on short waves, the expert transmitter or the crystal novice will all find it advantageous to have a copy of

"The CATALOGUE that SAVES YOU POUNDS"

Its scope ranges from a 5s. pair of British Headphones or a 12s. 6d. Milliammeter to a 30,000 volt Generator, and covers all requirements.

If you cannot call and inspect goods in our showrooms between 9 a.m. and 6 p.m. it will pay you to send 4d. for our Catalogue at once. Goods promptly despatched all over the world.

LESLIE DIXON & COMPANY, LTD.
9, Colonial Avenue, Minories, E.1.
Phone: Avenue 4168. Teleg: (Electradix Ltd.)
Colonial Avenue is the first on left down the Minories from Fenchurch Street or Aldgate Underground Station

Harclays Advt

Just out of reach—
Because your phone leads are too short.
A PHONEREEL
will allow you to move freely about the room and take your seat wherever is most pleasant, no matter where the set is placed.

If you possess a Loudspeaker this is a convenient method of transporting it into the garden or any room in the house that you desire, the wire being run out as you walk along, free from knots and tangles.

Each Phonereel carries four pairs of terminals and twelve yards of good quality flexible twin wire.

Price complete 15/- Trade enquiries solicited
"Fit a Phonereel and listen in Comfort"

J. MERRETT & Co.
Trowbridge, Wilts.



Brown



From the tiniest nut to the finished Loud Speaker

THE non-technical visitor to the works of S.G. Brown, Ltd., will be amazed at the large number of processes and the magnitude of the equipment necessary to produce BROWN Loud Speakers and Headphones.

To many a pair of headphones consists merely of a couple of coils in each ear-piece, together with a circular magnet and a diaphragm. But see even the simplest type of BROWN headphones—the famous featherweight F Type—manufactured under ideal conditions, and you will appreciate that parts ground to 1/1000 part of an inch must obviously give infinitely better results.

And it is the same with BROWN Loud Speakers.

Not only has their design—based on the world-famous A Type Headphones—been proved superior for sensitiveness and tonal purity—but their success is due in no small degree to the wonderful accuracy of the many manufacturing processes.

Remember that your Loud Speaker should be an investment—the few shillings necessary to obtain a BROWN will be more than repaid to you by the increased enjoyment of hearing really true-to-life reproduction and by the knowledge that you own an Instrument capable of giving you many years of service.

Types and Prices:

H.1.	120 ohms	£5 5 0
	2,000 ohms	£5 8 0
	4,000 ohms	£5 10 0
H.2.	120 ohms	£2 5 0
	2,000 ohms	£2 8 0
	4,000 ohms	£2 10 0
Q.	£15 15 0 in all resistance.	

From all Dealers or can be demonstrated at the following Showrooms:

- 19, Mortimer Street, W.1.
 - 15, Moorfields, Liverpool.
 - 67, High Street, Southampton.
- Depots (Wholesale only):
- 13, Bushy Park, Bristol.
 - 5, Wilson's Court, Newcastle-on-Tyne.

S. G. BROWN, LTD. — Victoria Road, N. Acton, W. 3

Gilbert Ad. 3:66

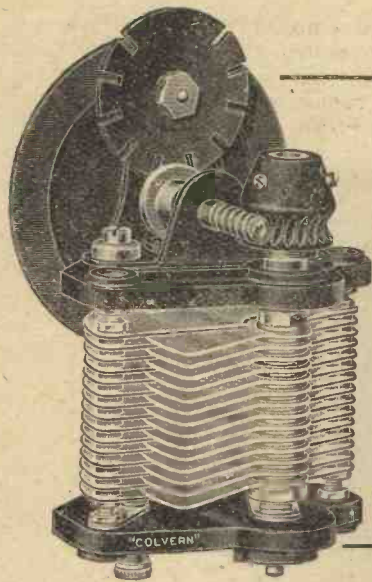

Imagine an analytical chemist without his scientific balances or an engineer without his micrometer!

Similarly, you will never tune a receiver with a direct drive condenser once having experienced the accurate tuning of the Colvern Selector Mechanically Controlled Precision Condenser.

Obtaining Hairbreadth Tuning

THE Colvern Selector Low Loss Precision Condenser is an instrument which gives the precise adjustment so essential to obtain perfect reception, whether on loud signals, such as the local broadcast, or transmission from low-powered distant stations. The mechanical method employed ensures accuracy to 1/20th of a degree; and, a further consideration, the eye is not called upon to supplement imagination. The scale interval is readily readable to that small difference in capacity—1/3,600th part of the total capacity available.

It is when working upon weak distant transmissions that the necessity for such critical and accurate adjustment is vital. Many excellent circuits have been discarded because they required a more critical tuning adjustment than available apparatus afforded. Equally efficient circuits were condemned as uncontrollable, since existing apparatus could not give the essential final adjustment.

This new Colvern Low-Loss Coil Former is the experimenter's ideal of what a really good coil former should be.

You'll only have to see its design and perfect construction to realise the superiority of the Colvern L.L. Coil Former. Made of high-grade ebonite throughout. The supporting rods of the Former are threaded, which permits the even spacing of wiring and the use of bare or enamelled wire. This reduces the self capacity of the coil to an absolute minimum. Length 7in. Diameter 3 1/2in. Wavelength range 200 to 530 metres.

Price: 5/6.

Capacity reaction circuits such as the Reinartz, ultra short wave receivers, and the short wave stages of Super Heterodyne Receivers, require hairbreadth tuning, obtainable only by such mechanical means as the Colvern Selector provides.

The dial of the Colvern Selector is divided over the full circle, and provides 360 degrees value for each rotation of the index. This enables 1/20th of a degree to be actually located; AND ANY PREDETERMINED CALIBRATION CAN BE RE-LOCATED TO THIS ACCURACY AT WILL.

The Colvern Selector Low Loss—
Reading to 1/3,600th of capacity
Capacity '0005 mfd. ... £1 1 0
" "0003 mfd. ... 1 0 0

Type F, without gear attachment—
Capacity '0005 mfd. ... 15 0
" "0003 mfd. ... 14 0

One hole fixing. Other capacities if required. Descriptive Folder upon request.

COLLISON PRECISION SCREW CO. LTD., Provost Works, Macdonald Road, Walthamstow, London, E.17

Telephone - - - Walthamstow 532

COLVERN SELECTOR LOW LOSS

Barclays 1239

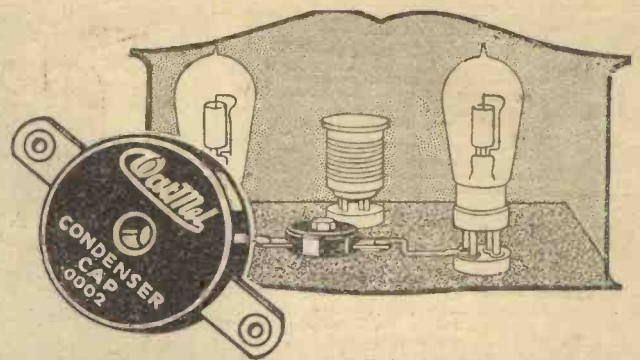

DISPEL FAULTS & TROUBLES Fit the New Watmel Condenser LOW LOSS — HIGH GRADE

MANY of the faults and troubles in radio reception are due to faulty Condensers. The Watmel Research Department have produced a perfect condenser—perfect in that it overcomes the faults common to its predecessors. Designed to meet the present-day radio enthusiasts' requirements in the matter of capacity, symmetrical design, freedom from noise and absolute minimum of "edge loss." Further there is no wax used in the construction of the Watmel which renders it immune from temperature changes and consequent dielectric loss. Therefore if you wish to incorporate the perfect condenser in your set, you can do no better than to fit a Watmel.

Capacities for Standard Grid Condensers.

'00005 to '0005 2/3 each.

Standard Fixed Condensers.

'002, '001 2/3 each '002, '003 3/6 each

Combined Grid Leak and Condenser is 3/- each

Watmel Watmel Wireless Co., Ltd
332a, Goswell Rd.
LONDON, E.C.1

Representative for Lancashire and Cheshire.
MR. J. B. LEVEE, 23, Hartley Street, Levenshulme, MANCHESTER

"A.D." (Air Depolarising) HIGH TENSION BATTERIES

NOISELESS REGENERATIVE VISIBLE CONNECTIONS

20 cell 40 cell 60 cell
10/- 18/6 27/6

One pair Wander Plugs free with each battery

Place your Order with your Dealer early



60 cell Battery

LARGE PRIMARY CELLS FOR VALVE HEATING "A.D." RADIO CELL (No. 222)

100 ampere hour capacity.

Accumulator charging eliminated. Ask your supplier for full particulars. Used with sal-ammoniac like a House Bell battery.

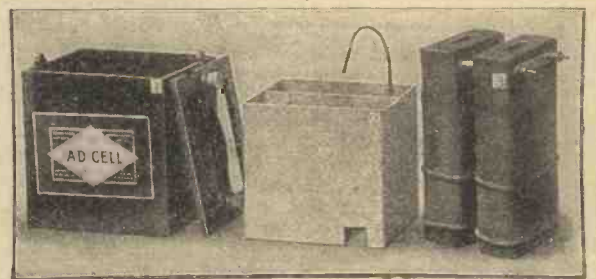

Container

Zinc

Carbon Electrode

MANUFACTURERS OF ALL TYPES OF PRIMARY CELLS
LE CARBONE, Coventry House, South Place, London, E.C.2.
Works: PORTSLADE, SUSSEX

Note the Construction C.A.V. TRANSFORMER

Constructed with one primary winding with a secondary winding on either side—therefore, minimum self-capacity with greater amplification which remains constant over a wide band of frequencies.

No. 5150 High Ratio for 1st stage 27/6
No. 5151 Low Ratio for 2nd stage

From all good Wireless Dealers. Write for particulars of C.A.V. Loud Speakers, H.T. & L.T. Accumulators, Crystals, etc.

C.A. Vandervell & Co., Ltd.
ACTON VALE, LONDON, W. 3.



Do You Know—?

By C. P. ALLINSON

THAT the insulation resistance between adjacent turns of double cotton covered wire may be as low as two or three megohms. Enamelled wire will give infinity readings, even when twisted together twenty or thirty times.

* * *

That certain substitutes for ebonite contain sawdust and a phenol compound. The last is closely related to carboric acid. When drilled or filed the characteristic smell is at once evident.

* * *

That ordinary solder is not suitable for fixing small platinum contacts or pieces of platinum foil to electrical apparatus, as it dissolves platinum very easily.

* * *

That if you halve the inductance in an oscillatory circuit you do not halve the wavelength to which it will respond. For this you must halve the capacity also. If only the inductance is to be altered a quarter the value only will be required to get the circuit to tune to half the wavelength to which it was previously in resonance.

* * *

That the anodes of most valves are made of nickel.

* * *

That the limiting factor in ultra short-wave reception is generally the inter-electrode capacity of the valve. This, together with stray capacities existing in the set, may be large enough to prevent the receiver from going below a certain wavelength, even with the smallest practicable inductance. That is why it is necessary to build special receivers for these waves.

* * *

That, not only is leaky grid condenser rectification voltage operated, but it also makes use of the amplifying properties of the valve.

* * *

That tuned circuits were first used in the Lodge-Muirhead system of wireless telegraphy. This system

was probably also the first to use a counterpoise or earth screen, as it was then called, instead of an earth.

* * *

That the enamel covering on enamelled copper wire has an insulation breakdown voltage of approximately 28,000 volts.

* * *

That substances that are non-conducting to electrical currents are transparent to wireless waves and *vice versa*. That is why receivers are shielded, when necessary, with metal sheets. Copper sheet is usually used, as it is the best known conductor after silver. The latter is too expensive to use for general electrical work.

* * *

That wireless waves less than one-tenth of an inch in length have been generated and measured.

* * *

That a wireless impulse would travel seven times round the earth in one second if it were powerful enough.

* * *

That the atmosphere becomes progressively more and more positive as one goes higher. Just above the ground the potential gradient may be as much as ten or more volts per metre height.

* * *

That a valve has been produced in America that will work directly off A.C. electric light mains. No hum or interference is experienced, and by its use the need for accumulators is done away with.

* * *

That an inductance wound with Litzendraht does not always have a lower H.F. resistance than one wound with solid wire, especially at the higher frequencies. While if one single strand is left unconnected at either end or becomes broken anywhere the H.F. resistance may rise several hundred per cent.

* * *

That the earpieces of some cheap Continental headphones contain a

chemical compound that is absorbed into the system through the skin. After varying periods of wear a painful rash may break out. Moral—Buy British 'phones.

* * *

That the unit of potential—i.e., the volt—was named after the scientist Volta, who made the first electric battery, or pile, as it was then called. Similarly, the working unit of current is called after Ampère, a pioneer investigator in electrical research work.

* * *

That the famous angle of 57½ degrees associated with the Hazeltine Neutrodyne is correct only for the particular coils used. You cannot stop interaction between any coils by placing them at that angle. The angle will be different for every coil, according to its length and diameter.

* * *

That one of the poles of D.C. mains is usually earthed. This is generally the negative. If, therefore, a live positive wire is to be handled, the experimenter should make quite sure he is insulated from earth, otherwise a serious shock may result.

* * *

That losses in metal end plates of a badly designed variable condenser due to eddy currents may be far greater than those due to dielectric losses in insulating end plates of even indifferent composition.

* * *

That the hand generator out of a "megger" is a useful means of supplying H.T. to a small C.W. transmitter. The voltage generated may be either 500 or 1,000 volts.

* * *

That a grid condenser and leak do not usually give any improvement in a transmitter when powers of 10 watts or less are used.

* * *

That a choke in the H.T. negative lead as well as in the positive lead in transmitting on the short waves will give an improvement, even on waves as high as 120 metres.

* * *

That a very good transmitting grid leak can be made from a jam jar filled with tap water. Two carbon electrodes are used, and can be placed nearer together or further apart as required, while more or less water may be used.

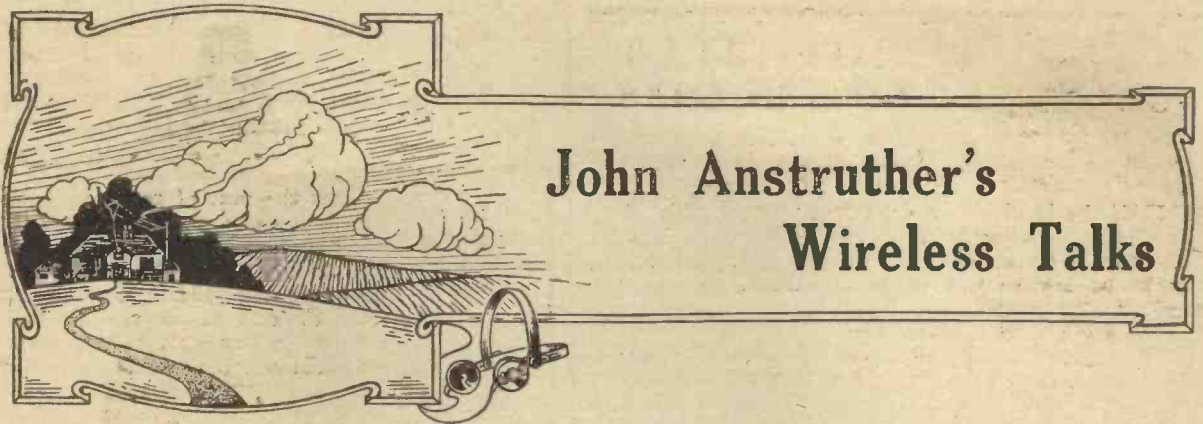

John Anstruther's Wireless Talks

"SOME time ago," said Painter, when we had taken our seats in John Anstruther's comfortable den and were rejoicing in the draught provided by the electric fan which he had rigged up, "we just briefly touched upon valves and you told us then that you would set apart an evening before very long for a discussion of them and of the way in which they do their work in the receiving set. I wonder if we could devote this evening to that fascinating subject?"

"I am quite ready" said John, "if the meeting is willing. What do you say? Who's in favour of valves as to-night's subject?"

Everyone assented to the suggestion with enthusiasm, and we settled down to one of the most interesting discussions that we have had so far.

"First of all," said John, "I want all of you to get quite clearly the idea that the valve, when it is used as an amplifier, acts as a delicate relay. Now, who can tell me—perhaps you can, Ainsworth—just what a relay is?"

What a Relay Is

Ainsworth thought for a moment, and then answered: "Well, that is rather a poser, for it is a bit of a business to define a relay just in two or three words. Still, here is a possible definition which I think you may find good enough for the present purpose: A relay is a piece of apparatus which enables a very small amount of energy to control perfectly a much greater amount of energy. In the perfect relay the output corresponds precisely to the input, except that it is very much greater."

"In spite of Ainsworth's modesty," smiled John, "I think that he has given us a very good definition of a relay for practical purposes.

"In saying that a small input

regulates a much larger output, Ainsworth implies that a relay *amplifies* the energy put into it, and that is, in effect, what happens. A simple example of mechanical relay which every one of you has seen (though possibly, if the weather was rough, he has not examined its working very carefully) is the steam steering gear of a ship. In the old days, before steam was harnessed for the purpose, the rudder had to be moved against the force of the water by sheer strength, a tiller being used in small boats and a steering-wheel in larger ones. In those days when the weather was dirty four

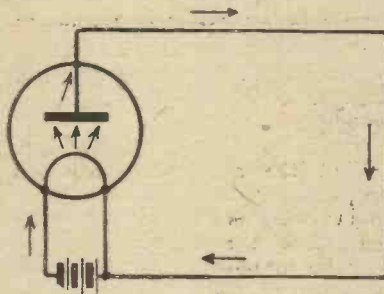

Fig. 1.—Illustrating the principle of the Fleming Valve.

or five men might be required at the steering-wheel of even a moderate-sized ship, to guide the vessel. To-day the steering-wheel is quite a small affair, which can be moved, even in the roughest weather, by the exercise of a very small amount of energy. It is not directly coupled to the rudder; it controls a steam engine, which does the hard work. When the quarter-master of the ship turns the wheel this way or that, he has to apply only just the energy necessary to operate the throttle or the valve-gear of the auxiliary engine. Yet so precise is the control that the engine copies exactly the movements which he makes with the

wheel, turning the helm just as he desires in this direction and in that. By means of this relay a child could probably control the enormous power necessary for steering one of the biggest Atlantic liners."

The Received Signal

"So far," said Richmond, "I think we all follow. Will you show us now just how the valve does its relay work?"

"The impulses brought in by the aerial," John went on, "are, as you know, very feeble indeed. They take the form of waves whose crests and troughs we may regard as being respectively of positive and negative signs. I shall have more to say about the question of positive and negative presently; for the moment we will take it that I use these terms here to indicate that the crest of a wave and its succeeding trough rise and fall by equal amounts above and below an imaginary line representing zero potential. Now, how can we obtain some idea of the amount of energy brought in by these waves in their unamplified form?"

"I suppose, by using a crystal set and measuring the rectified current delivered to the telephones," said Morris rather hesitatingly.

"Yes," said John, "that method gives us a very fair idea of the state of affairs. Even when a strong signal is coming in, the crystal set is, on the average, not passing more than from 10 to 20 micro-amperes through the telephone receivers. You have only to examine a crystal curve, such as the one which we discussed at our last meeting, to obtain an idea of the small voltages which produce this amount of rectified current. Very distant signals, such as those which come from across the Atlantic, and even from our own broadcasting stations more than thirty or forty miles away from

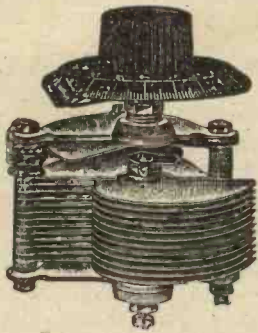

W. 124

"UTILITY" COMPONENTS

YOU can incorporate a Utility component in the certain knowledge that it will do its job thoroughly and well. For this reason, "Utility" Wireless Specialities are the result of the utmost care both in design and manufacture and represent the last word in radio efficiency.

"UTILITY" CONDENSERS

Scientifically Designed, with Close Spacing, Large Adjustable Bearings and Perfect Insulation

"UTILITY" COIL-CHANGING UNIT

Provides an instant means of changing from one Broadcasting Station to another or from one inductance coil to another. It is attached to the panel by our usual method of one-hole fixing. As the illustration shows, it is only necessary to plug in coils in the ordinary way.

W.C. 155 Price 7/6 each

Get a complete list of "Utility" components and prices by writing to-day to

WILKINS & WRIGHT
Utility Works

Kenyon St., BIRMINGHAM

Tel. Central 2334. Tel. Ad. Utility, B'ham.

PRICES. SQUARE LAW OR ORDINARY PATTERN.

No.	WC	Pattern	each
No. WC 123	'001	...	12/6
No. WC 124	'00075	...	11/9
No. WC 124	'0005	...	10/6
No. WC 125	'0003	...	8/9
No. WC 145	'0002	...	7/9
No. WC 146	'0001	...	7/6

Vernier 2/6 extra. Fitted with Radion Dials

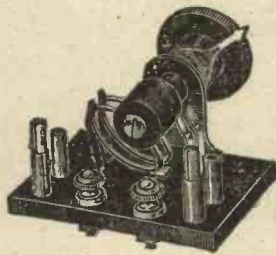

SUCCESS OSCILLATOR UNIT
PRICE 21/-

The "SUCCESS" Superforma

An Intermediate Frequency Transformer for Super-Heterodynes

The outstanding feature of the "Success" Superforma is the incorporation of a 0003 Variable Condenser as an integral part of the unit. The fact that it is tunable is a consideration which enables the experimenter to balance up the stages for himself, after the set is built, and to tune out interference. That the "Success" Superforma is tunable considerably increases the selectivity of the receiver, gives greater amplification and generally improves the efficiency of any Super-Heterodyne Receiver. By turning the small knob, the tuning condenser may be locked in position.

"SUCCESS" SUPERFORMA. Price 30/-

If your dealer cannot supply, send direct to

BEARD & FITCH, LTD., 34, AYLESBURY ST., LONDON, E.C.1
Telephone: Clerkenwell 8941
North of England Branch: 1, DEAN STREET, PICCADILLY, MANCHESTER
Telephone: Central 8240

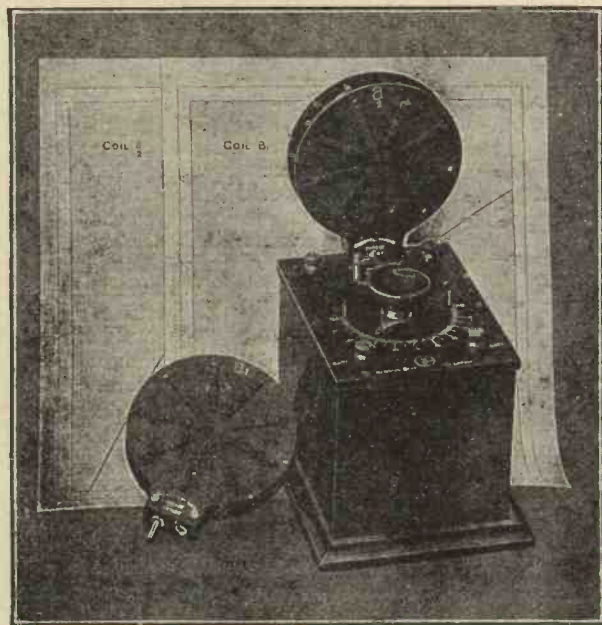

The New **GAMBRELL WAVEMETER** (Type "C"); 50-500 metres. Additional ranges if required.

COMPLETE AS ILLUSTRATED
£14/10/0

The New GAMBRELL WAVEMETER (TYPE "C")

IMPORTANT

EACH GAMBRELL WAVEMETER is calibrated against standards.

EACH GAMBRELL COIL supplied with the wavemeter has a separate chart.

EACH GAMBRELL CALIBRATION CHART is hand drawn for the particular instrument with which it is supplied, thus eliminating all sources of error due to variations in coils, condensers, etc.

Additional coils up to 7,000 metres and down to 25 metres if required.

Full working instructions are supplied.

Leaflets on application from:

GAMBRELL BROS., LTD.
76, VICTORIA STREET LONDON, S.W.1
Telephone: Victoria 9938.

the aerial of the crystal set, are not, as a rule, sufficient to produce any response in the telephones. Though extraordinary results may be obtained in especially favoured localities or with very carefully-built sets, the crystal range of a main broadcasting station does not in ordinary circumstances exceed about twenty miles for good reception.

"Just why," I asked, "does the valve when used as a high-frequency amplifier enable us to pick up and tune in these feeble impulses?"

"Simply because it is one of the most delicate relays that we know," John answered. "You are all familiar with the appearance of a wireless valve, and with the parts of which it is composed. Within the bulb we have, first of all, the filament, and between it and the plate lies the grid, which is most often in the form of a spiral

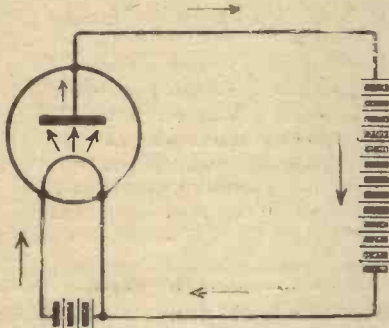

Fig. 2.—The insertion of the anode battery will increase the electron stream.

of wire. When the filament is heated to a sufficiently high temperature, it flings off electrons. Any filament, even that of an electric lamp, does this. In the ordinary way these electrons would describe a brief curved path through the vacuum within the bulb and then return to the filament. The electron is, as you know, a minute charge of negative electricity, and as such it is attracted by a positive charge and repelled by another electron. If we so arrange matters that there is upon the plate of the valve a strong positive charge, then, many of the electrons, instead of merely leaping from the filament and then returning to it again, will be attracted across the intervening space to the plate. In this way we shall obtain an electron stream through the valve from filament to plate. That is the principle of the two-electrode or Fleming valve." John made a quick sketch (Fig. 1) on a sheet of paper from his writing-pad and passed it round.

"But," objected Painter, "I

don't see how the valve that you have shown is going to work. You have only got a filament battery, and you have not made its plate positive."

Positive and Negative

"That is just what I wanted you to say," said John, with a laugh. "All sorts of people nowadays use the words positive and negative very loosely, as if they were absolute terms; as a matter of fact, they are not. They are just as purely relative as the words *above* and *below*. Now, if I were to describe the top of Mont Blanc as being so many thousand feet *above* and the surface of the Dead Sea as being so much *below*, you would at once say: 'Above or below what?' In topography we use a certain sea-level as our zero, or datum, line, and measure heights and depths with reference to it. The words 'above' and 'below' are relative and have no absolute meaning in themselves, as a moment's thought will show you. For example, the surface of the Dead Sea is *above* its bottom, yet both are *below* sea-level. It is just the same with positive and negative. You must always use these terms as referring to a zero, or datum, point. Now, in the wireless valve potentials are—or rather, should be—measured with reference to the negative end of the filament. If you will glance once more at the diagram, you will see that the plate of the valve shown there is connected to the positive end of a 6-volt battery so that the plate

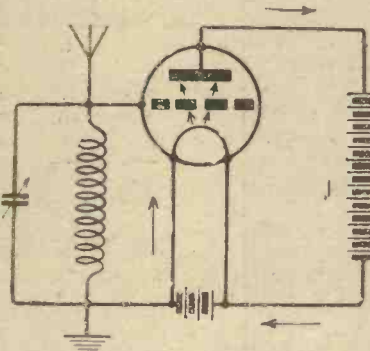

Fig. 3.—How the grid acts as the control electrode.

potential is 6 volts positive with respect to the negative end of the filament. There will, therefore, be an electron stream through the valve, and though it will not be a very dense one, we can increase it by using, as I am showing in the drawing that I am making at the moment (Fig. 2), another battery, wired in series with that which heats the filament, and

connected between the positive end of the latter and the plate. But we still have a valve which cannot amplify because it is not a relay. It was the insertion of the grid that changed the whole outlook of wireless. In the third drawing, which I will now pass round, you will see a three-electrode valve containing this simple, but very wonderful, little addition. I have shown a tuned circuit consisting of

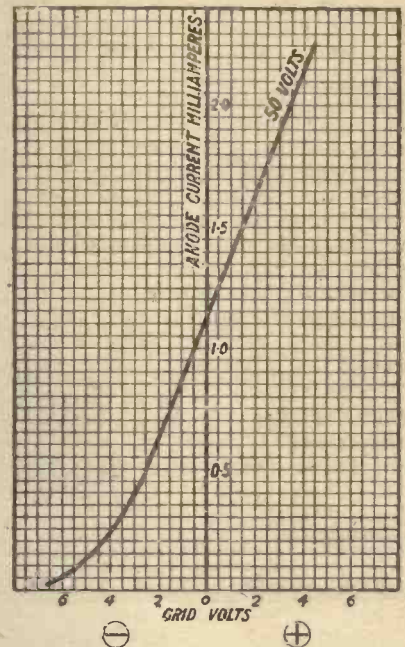

Fig. 4.—A characteristic curve of a general purpose valve.

a coil and a condenser placed between the grid and the negative terminal of the filament battery. The aerial is connected to the top of this circuit and the earth to its lower end. I cannot now explain how the tuned circuit works, it will suffice to say that it sorts out the frequency or wavelength that we want from those that we do not, and enables us to apply the effects of the crests and troughs of its waves to the grid of the valve."

Effect of Grid Potential

"Will you tell us," queried Morris, "what is the effect upon the grid of applying a crest or trough to it?"

"If you look at the circuit," said John, "you will see that the grid is connected *via* the inductance to the negative end of the filament. This we agreed to regard as our zero, or datum, point; thus, when no impulses are coming in, the grid is at zero potential, or at the same potential as the negative end of the filament. When a crest arrives it causes, say, a positive

charge to be applied to the grid; we may then say that the crest of a wave makes the grid positive as regards our zero point. On the other hand, a trough brings about the assembly upon the grid of an excessive number of electrons, and therefore makes its potential negative with respect to the same point."

"And how," asked Ainsworth, "does this produce a relaying effect within the valve?"

"We saw just now," replied John, "that positive charges attract electrons, whilst electrons are repelled by other electrons, that is, by negative charges. When the grid is made positive—I can use the term by itself now so long as we all understand to what it refers—it exercises an attractive force upon the electron stream from the filament to the plate. Electrons fly towards the grid, but, owing to their speed, the majority of them pass through its meshes and come under the influence of the attraction of the plate, for which they now make. The effect of a positive potential upon the grid, then, is to increase the electron stream through the valve. As we shall see presently, the rise which takes place in the plate current will be proportionate to the positive potential that reaches the grid. The succeeding half-wave, or trough, makes the potential of the grid fall below zero, just as the positive half-cycle caused it to rise above.

How the Grid Controls the Electron Stream

"Now, since electrons repel electrons, the assembly of these tiny bodies which takes place upon the grid under the influence of a wave-trough causes it to exert a strong repellent force upon the electrons that leave the filament. If we make the grid sufficiently negative, we can check their flow altogether so that nothing passes from filament to plate. This complete stoppage of the electron stream does not actually take place in an amplifying valve. What does happen is that there is a decrease in the plate current. Thus the crest of a wave and its following trough cause the plate current to rise and fall above and below its normal value. In a well-designed and properly adjusted amplifying valve the rise and fall are exactly equal, and they take the form of a "wave" of precisely the same shape as that which reaches the grid of the valve. The great difference between the two is that the "wave" produced in the plate circuit is of far greater amplitude than in the grid circuit; or, in other words,

that the incoming impulse is much magnified by the relaying action of the valve. I am going to give you a curve now—though I know that everyone shies at curves—to explain the process more definitely."

"Just one moment," I said, "before we come to the threatened curve. You told us that the incoming impulses in the grid circuit represent changes of potential or voltage. In the plate circuit the changes seem to take place not in the voltage, but in the current flowing. Surely, if we apply the output of an amplifying valve to another valve, it is voltage varia-

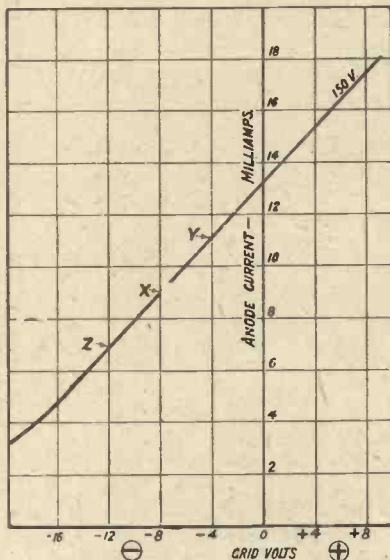

Fig. 5.—A curve of a power valve, to illustrate the effect of grid-bias.

tions that we want. How is this managed?"

"That is too big a subject to go into for the moment," said John. "I will just say that the coupling that connects one valve to another is so arranged that fluctuations in the plate current produce potential changes across it. It is these potential changes that we apply to the grid of the following valve. And now for the curve!"

MAKE YOUR OWN CRYSTALS

Sir,—Your contributor may be clever enough to advise people on making crystals, but perhaps in your next issue he will tell me how to get the smell of sulphur out of my oven!

WIRELESS WIDOW.

A Valve Curve

John was busy for a moment or two searching amongst his files for a suitable valve curve. Then he passed round to us the one seen in Fig. 4, which is actually the curve of a well-known general-purpose valve.

"I will just ask Morris," he said, "to tell us what changes in the plate-current impulses arriving upon the grid of the valve make. What is the plate current when the grid is at zero volts?"

"One-decimal-one-five milliamperes," Morris replied.

"Now see what it is if a crest whose value is one volt positive reaches the grid."

Morris traced out the curve with his pencil, and announced that the plate current would then be 1.40 milliamperes.

"And what current," John asked, "passes under the influence of the succeeding trough, which is one volt negative?"

"Decimal-nine milliamperes," said Morris. "I see now just what happens. You get a rise of .25 milliamperes above normal when the grid is made one volt positive, and a fall of .25 milliamperes below normal when it is made one volt negative."

Work on the Straight Portion

"That's it," said John; "and if you care to trace out the effects of other voltages, you will find that an impulse with crest and trough values of two volts would raise and lower the plate current by .5 milliamperes, and so on. Of course, if you get on to the bent part of the curve, as you do in this case, with a four-volt potential swing, you will not find that the rise and fall in current are equal."

Morris traced out the readings from these last figures, and announced that, whilst a potential of four volts positive raised the current by a whole milliamperes, the following trough lowered it only by .9 milliamperes.

"That," said John, "just shows you how important it is always to work on the straight part of the curve. There is another point, too. You will remember that we saw that when the grid becomes positive electrons are attracted by it. Some of them actually do not pass through it and go on to the plate, but remain to set up a current in the grid circuit. This grid current, as it is called, has also a mutilating effect upon waves, causing a flattening of their crest"

(Concluded on p. 1018.)

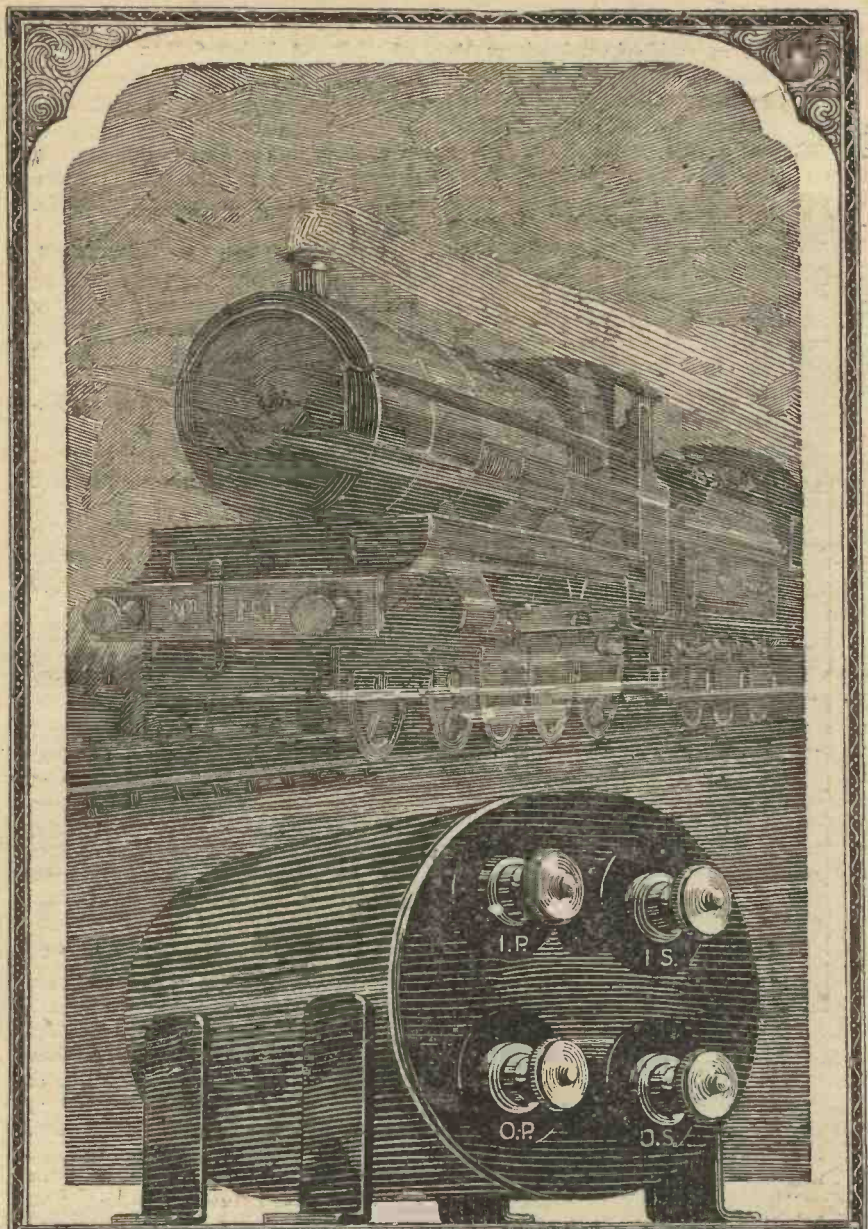

Power!

SPEED, and yet more speed, clamours the user of the railways. And so Science and Industry work hand in hand to evolve a locomotive capable of delivering that extra power which means more miles added to the daily run.

Volume and yet more volume is the insistent demand of the wireless enthusiast. First a sufficiency of sound to fill a small room. Then a fullness that could be heard through closed doors. And now to-day everyone wants a mighty volume of sound, readily controllable suitable even for outdoor recreation.

Of all the transformers on the market, there is none enjoying a greater reputation for volume and clarity of tone than the Eureka. Its colossal sales testify to its correct design and sterling workmanship. When you choose the Eureka you are endorsing the choice of Britain's leading technical experts.

Concert Grand, 30/-

No. 2 (for 2nd stage) 22/6

EUREKA

"Radio Press Envelopes make set building easy"

Wireless set building is an entrancing hobby. Yet, like all other hobbies, it possesses one or two little snags, obstacles the novice has to encounter. Radio Press Envelopes, however, will guide you safely to success. You cannot possibly fail to understand the complete instructions and illustrations they contain.

RADIO PRESS ENVELOPES

- | | Price. | Post |
|---|--------|------|
| 1 How to Build an S.T. 100 Receiver ... | Free. | 1/6 |
| By John Scott-Taggart, F.Inst.P., A.M.I.E.E. | | |
| 2 How to Build a 4-Valve Receiver ... | 2/6 | 2/9 |
| By Percy W. Harris, M.I.R.E. | | |
| 3 How to Build the "Simplicity" 3-Valve Set ... | 2/6 | 2/9 |
| By G. P. Kendall, B.Sc. | | |
| 4 How to Build the All Concert-de-Luxe Receiver ... | 2/6 | 2/9 |
| By Percy W. Harris, M.I.R.E. | | |
| 5 How to Build the Omni Receiver ... | 2/6 | 2/9 |
| By John Scott-Taggart, F.Inst.P., A.M.I.E.E. | | |
| 6 How to Build the A B C Wave Trap ... | 1/6 | 1/9 |
| By G. P. Kendall, B.Sc. | | |
| 7 How to Build a 2-Valve Amplifier-de-Luxe ... | 1/6 | 1/9 |
| By Herbert K. Simpson | | |
| 8 How to Make a 1-Valve Reflex Receiver ... | 1/6 | 1/9 |
| By Herbert K. Simpson | | |
| 9 How to Build an Efficient Single Valve Set ... | 1/6 | 1/9 |
| By Herbert K. Simpson | | |
| 10 The Twin-Valve Loudspeaker Receiver ... | 2/6 | 2/9 |
| By John Scott-Taggart, F.Inst.P., A.M.I.E.E. | | |
| 11 An Adaptable Crystal Set ... | 1/6 | 1/9 |
| By Percy W. Harris, M.I.R.E. | | |

RADIO PRESS PANEL CARDS

- | | | |
|--|-----|-----|
| 1 How to Make the W.1 Receiver ... | 1/- | 1/3 |
| By Herbert K. Simpson | | |
| SIMPLEX WIRING CHARTS | | |
| 1 For 2-Valve Set ... | 1/- | 1/3 |
| 2 For 3-Valve Set ... | 1/- | 1/3 |
| 3 For 4-Valve Set ... | 1/- | 1/3 |
| RADIO PRESS WIRELESS PANEL TRANSFERS.. 6d. 8d. | | |

All above can be obtained from Wireless Dealers, Booksellers—or direct from Dept. W.

RADIO PRESS, Ltd.
BUSH HOUSE, STRAND,
LONDON, W. G. 2



Barclays
Ad.

The "Midget" Single-Valve Amplifier

By
A. S. CLARK

This instrument is designed to meet the demand for a suitable Amplifier for the "Midget" single-valve receiver described in the May issue of "The Wireless Constructor"



The amplifier is contained in a similar cabinet to the set with which it is designed to be used.

THE amplifier which is described in this article is designed for use with the "Midget" single-valve receiver, which was described in the May issue of THE WIRELESS CONSTRUCTOR. So many letters have been received from readers asking for details of an amplifier for this set, which has proved quite popular, that the existence of this instrument seems justified, although it adds one more to the list of amplifiers which have been described.

Its Uses

The amplifier is not designed with the idea of producing loud-speaker results, although these may be obtained when the set is worked near to a broadcasting station (say

up to five miles), but rather to make the more distant stations more pleasant to listen to. The "Midget" receiver is quite capable of bringing in many distant stations, one or two readers even receiving

American broadcasting on it, so that the addition of this amplifier will bring these more remote stations up to very good 'phone strength.

Although it is primarily designed for use with the set already referred to, this note magnifier may be used to increase the strength of any crystal set or single-valve receiver, except perhaps a reflex set, there being often certain factors which make the adding of a stage of note magnification to a single-valve reflex set not always a success.

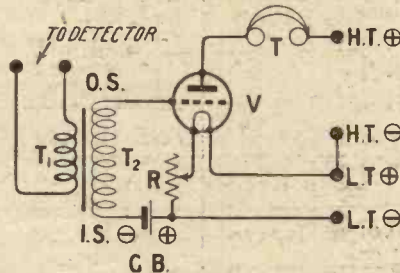
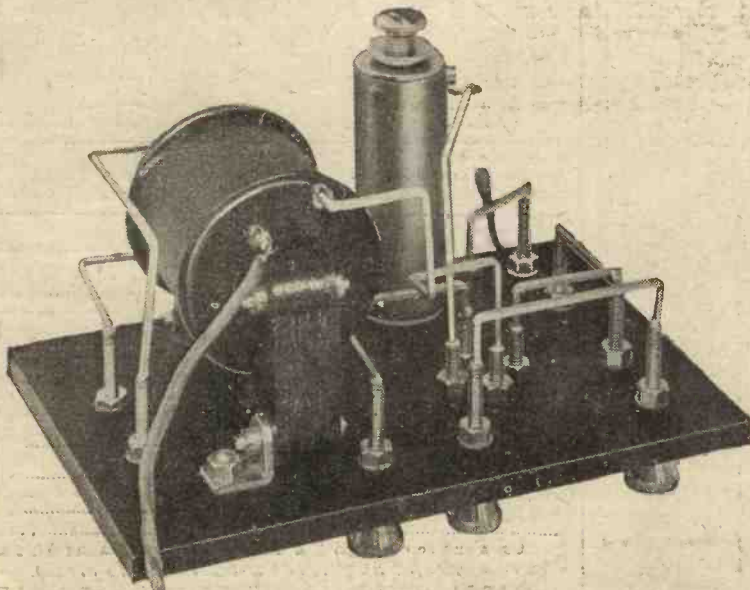

Fig. 1.—The circuit is the one most usual in amplifiers.

The Design

As will be seen from the photographs, the amplifier is built on exactly the same lines as the original set. The cabinet used is identical and the panel of the same size. This gives the two units, when coupled together, a very neat and uniform appearance. Due to the use of a similar-size cabinet to that of the receiver, it was not possible to use one of the larger types of transformers, but the one employed gives very good results for telephone reception.

Grid-bias is always desirable on an amplifier, and as the grid-bias battery does not need any attention for extremely long periods, it is housed in the back of the cabinet, but is always easy to get at since the cabinet is provided with a sliding back. No telephone condenser is incorporated, as the only use of such a condenser in this case is for tone control, and is, therefore, very seldom required with telephones. Also a high-tension shunting condenser is not used, as this should be considered part of the high-tension unit and kept with it outside the receiver.



If the square wire is carefully bent, the back of the panel will look as attractive as the front.

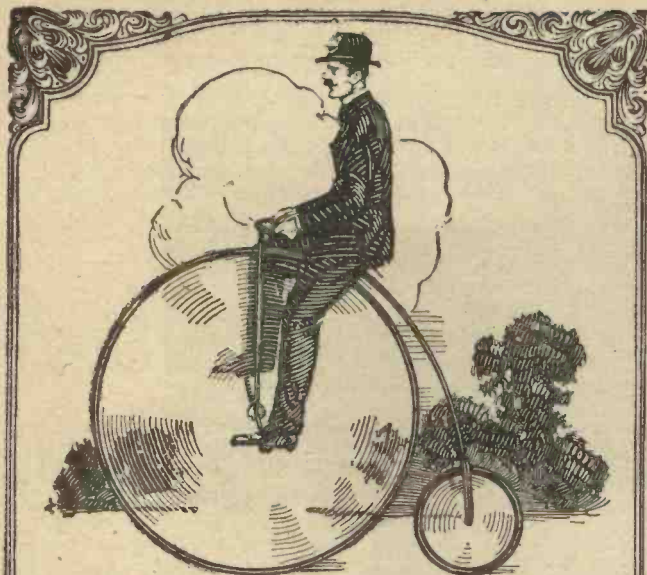

20 Years ago

BEFORE the old "penny-farthing" ceased to be a familiar feature of the landscape, T.C.C. Condensers were being chosen by discriminating electrical equipment manufacturers. To-day still finds it favoured by Broadcast instrument manufacturer and amateur alike as the recognised Mansbridge Condenser. Throughout the whole of its long history there has never been the slightest deviation from the high standards originally set for accuracy, permanence and dependability.

Telegraph Condenser Co. Ltd.
Mortlake Road, Kew, Surrey

Supplied in all values
from .0001 mfd. to 2 mfd.

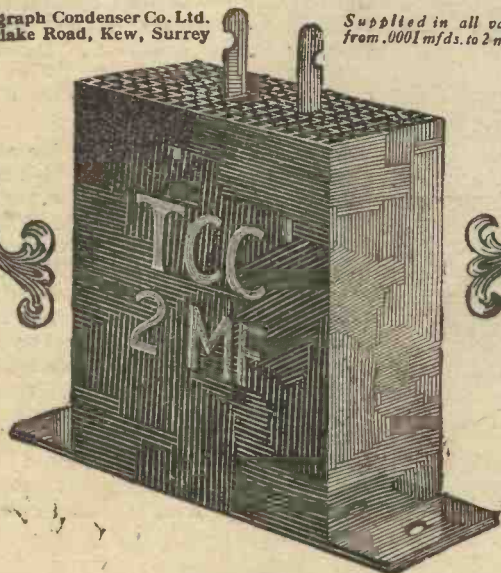

G.A. 3189

For Better Results on all Loop Circuits

use the **Bodine Basket Weave Loop**

THE Bodine Loop graces the most attractive home surroundings. Its design is unusually artistic, and its English mahogany finish and silk covered wire make it strikingly handsome in appearance. The Bodine is very responsive to directional setting, giving great selectivity and allowing you to easily tune out undesired local stations. In order to secure full advantage of this feature, it is fitted with a calibrated satin silver dial marked off in degrees. You can log the setting of any particular station and return without trouble at any time. The loop is also fitted with an insulated handle that allows you to tune in conveniently without disturbing its magnetic field by body capacity. It is designed that the lowest possible absorption losses throughout and the wire is double wrapped in silk.

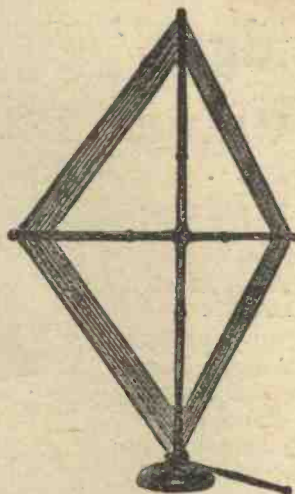

THE BODINE IS MORE BEAUTIFUL IN APPEARANCE AND MORE EFFECTIVE IN DESIGN.

Model B. 12 Standard Loop . . . 45/-
Model B. 12 T.S. Tapped Loop . . . 52/6
with 5 point tap switch

COLLAPSIBLE AND PORTABLE.
All models of the Bodine Loop are 2 ft. square when erected, and can be folded in an instant to fit into a box 3 1/2 in. by 6 in. by 18 in. Sliding sleeves cover the joints at the centre and hold the loop rigidly extended; the wires are always taut.

Our new 32-page catalogue of American radio apparatus is now ready. It contains exhaustive information on Super Heterodyne Components, together with an introduction by A. J. Haynes (of the Haynes Griffin Radio Service). Write for your copy immediately, enclosing 6d. in stamps to defray cost of postage.

R. A. ROTHERMEL LTD.
24-26, Maddox Street
LONDON, W.1
Telephone: Mayfair 578.



AT LAST !!

A really permanent
Crystal Detector

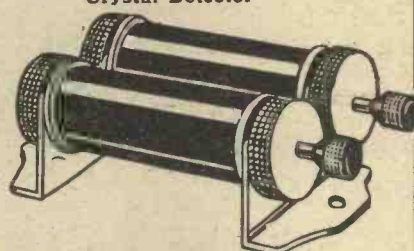

The DETECTIKON

A Low Impedance
Parallel Detector
The only Always
Permanent
Detector
Listen in while
tuning in

PRICE
4/6

DETECTIKON

Patentees and Manufacturers: **The DETECTIKON Co.,** 43, GRAFTON STREET, W.1 Trade supplied through wholesale houses only.

CABINETS CASEWORK CABINETS

WRITE AT ONCE for our illustrated list of 100 varieties of cabinets or radio sets, including many described in "MODERN WIRELESS," "WIRELESS WEEKLY," and "WIRELESS CONSTRUCTOR," etc., or "phone C.erkenwell 6903.

NAME
ADDRESS

Write
in
Block
Letters
Please

Cut along here and post in unsealed envelope bearing 4d. stamp.
TRADE ENQUIRIES ESPECIALLY INVITED.

CARRINGTON MANUFACTURING CO., LTD.
18/20, Normans Buildings, Mitchell St., Central St., E.C.1

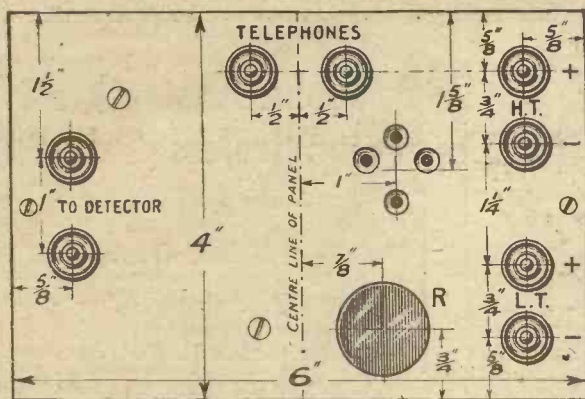

Fig. 2.—The drilling of the panel should be in accordance with the dimensions given in this diagram.

The Circuit

The circuit, which is quite standard, is shown in Fig. 1, and does not call for much comment. It is not altogether necessary to have a separate terminal for high-tension negative, as this is already joined to low-tension positive in the set with which the amplifier is used, but it was included for ease of connecting when the amplifier is used with a crystal set.

The total cost of the amplifier is very reasonable, and it is just the sort of thing for the beginner in constructional work to make a start on, as the drilling is very simple and there is no complicated wiring to be carried out.

Components Required

Before carrying on with the description of the actual work of construction, it is proposed to give a list of all the component parts used, together with the names of the manufacturers of those actually incorporated in the original instrument. It is not necessary to keep to this latter list if other components equally good and of a similar nature are available.

One ebonite panel 6 in. by 4 in. by 1/4 in. (Paragon).

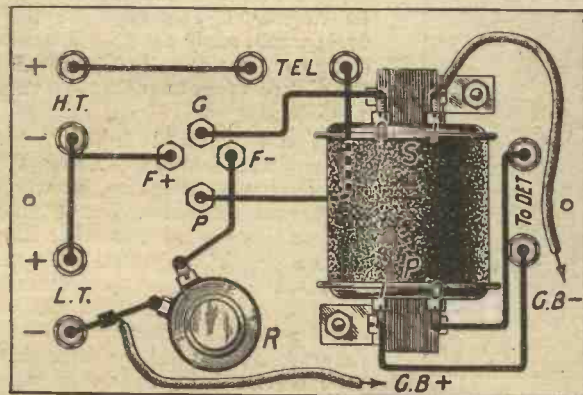

Fig. 3.—The wiring may be started with confidence by the absolute beginner.

One "Supra" low-frequency transformer (Wates Bros.).

One Lissenstat Universal (Lissen, Ltd.).

Eight nickelled terminals (Burne-Jones & Co., Ltd.).

Four nickelled valve legs (Burne-Jones & Co., Ltd.).

One suitable cabinet (Carrington Mfg. Co., Ltd.).

Square wire, screws, etc.

One packet Radio Press Panel transfers.

copied exactly. Do not use too much flux, and it is best to tin points to which connection is to be made before commencing to attach the wires. The two pieces of flex are for connection to the grid-bias battery; one is connected straight to the I.S. terminal of the transformer, and the other to the negative low-tension wire. The wiring is very quickly finished, and as soon as it is done the panel may be screwed to the box by two screws, and it is ready to test.

Connecting Up

In Fig. 4 the complete scheme of connecting the amplifier to the set is made clear. The two terminals marked telephones on the original receiver should be connected to the two marked "To Detector" on the amplifier. It will very often be found an advantage to change these two wires round, and they should always be tried both ways.

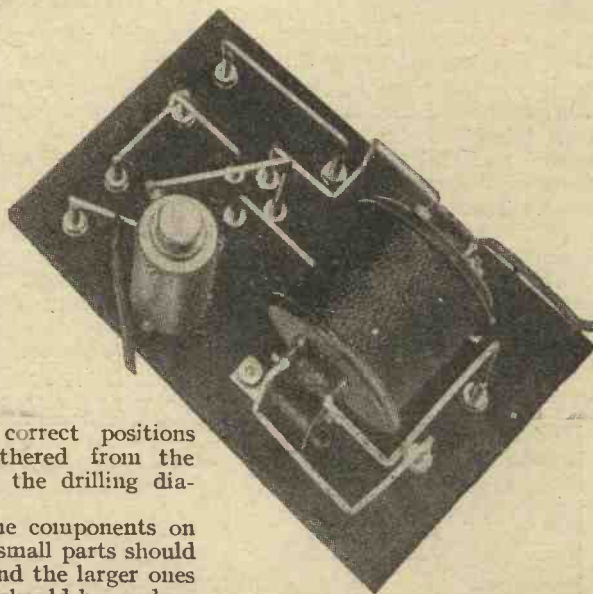

This photograph clearly shows the simplicity of the wiring.

Drilling the Panel

In Fig. 2 a drilling diagram of the panel is given. From this all the necessary holes are easily drilled, care being taken to get them in the correct places. The position of the two fixing screws for the transformer will vary if a different transformer is used.

When all the holes are drilled, the next step is to put on the panel transfers. These are fixed in the usual way, the necessary transfers and their correct positions being easily gathered from the photographs and the drilling diagram.

Now mount the components on the panel. The small parts should be put on first and the larger ones last. Nuts only should be used on the shanks of the valve sockets, and no washers, as when they are used it makes it much easier for a leak to occur between them. Washers can be used in all other cases.

Wiring

The wiring is carried out with the usual square wire, and may be made to look quite neat with a little care. The connections which have to be made are shown in the wiring diagram of Fig. 3, and this diagram should be

It is distinctly better to have a higher value of high-tension on the second valve than on the first; so a second tapping should be made to the high-tension, as shown in Fig. 4. It will not be necessary to make any connection to the terminal marked "H.T. —" on the amplifier. The value of the grid-bias will vary with the amount of high-tension employed and with the type of valve used, and should, therefore, be found by trial. The flexible wire which goes to the I.S. terminal of the transformer is connected to grid-bias negative, and the other flexible wire goes to the positive of this battery.

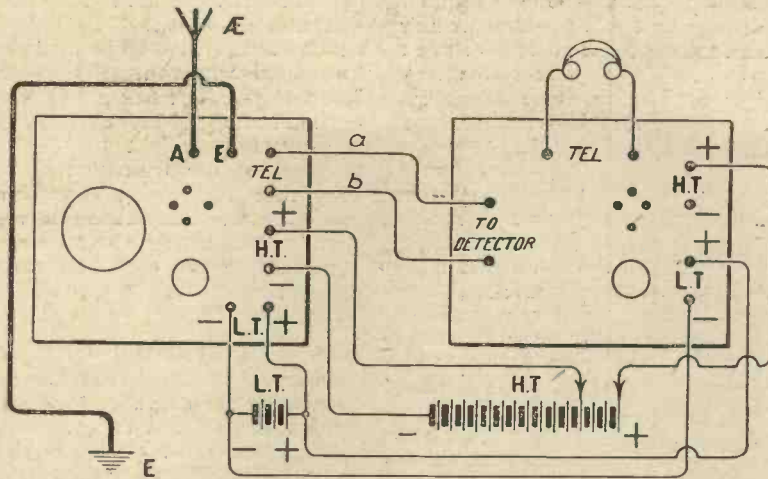

Fig. 4.—The necessary connections for adding the amplifier to a set are indicated above.

Connecting to a Crystal Set

When the amplifier is connected to a crystal set, it will be necessary to have a connection made between H.T. negative and the high-tension battery. The wires marked *a* and *b* are connected in this case to the two telephone terminals on the crystal set. All the other connections to the amplifier remain the same. There is nothing to do to work the amplifier except, when it is completely connected up, to turn on the filament of the valve to the correct brilliance. Now, if there are signals going through the primary, they will come out of the

amplifier clearly and well amplified. The effect of varying the high-tension and filament current should always be tried so as to be sure that the best results are being obtained.

Results

The amplifier was tested with both bright and dull emitter valves, when connected to the "Midget" receiver. All stations previously received were brought up to extremely good volume in the telephones, whilst London was too loud for the 'phones and just capable of working a loud speaker.

WIRELESS IN AUSTRALIA

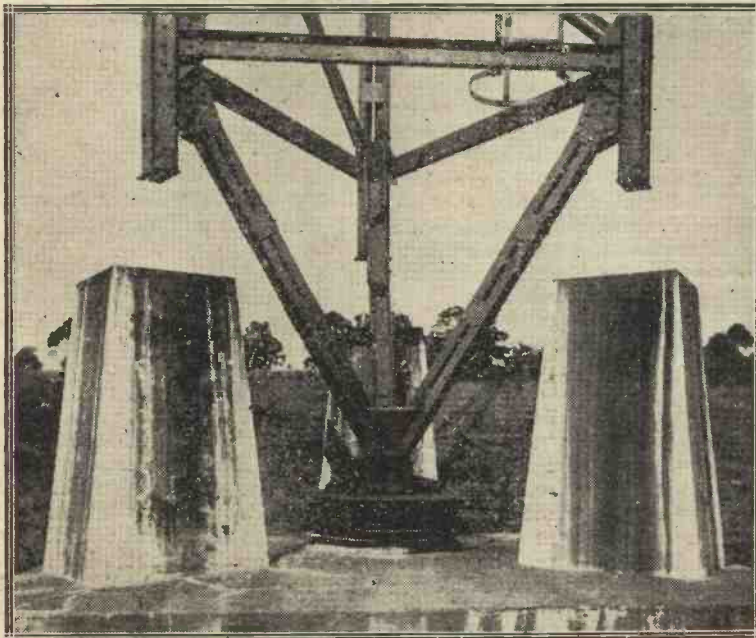

The base of one of the 400 ft. masts at Pennant Hills, near Sydney, where the high-power station will form one of the links in the Empire Wireless Chain.

**John Anstruther's
Wireless Talks**

(Concluded from page 1013)

With high-frequency valves, where the potential swing is small, we can usually work with the grid at zero potential, or very slightly positive or negative. But the case is quite different with note magnifiers, where we may get a very big swing indeed. Here we must move the whole valve curve bodily over to the left by using a high-plate potential, and instead of working with the grid at zero volts we must give it a negative bias by means of a small battery."

"As we have made the plunge with the curves," said I, "might we have another one to illustrate this?"

John rummaged again in his file, and produced the curve which you see in Fig. 5.

"This," he said, "is a curve of a power valve, and will serve very well to show what I mean. If we apply a negative bias of 8 volts to the grid of this valve, the working point will be that which I have marked X. Now, perhaps Cartwright will tell us what happens first of all when no impulses are coming in, and then when an impulse with a potential swing of plus or minus four volts arrives?"

I took the curve and worked out that the normal plate current with 8 volts negative grid bias would be nine milliamperes. The crest of a wave with positive and negative values of four volts would make the grid four volts negative instead of eight, at which point (I marked it Y) just over 11 milliamperes would be flowing. The negative half-cycle would carry the grid potential down to minus 12 volts (Z), reducing the plate current to rather less than 7 milliamperes.

"You see," said John, "that the positive half-cycle leaves the grid four volts negative, at which point grid current will not flow, so that there is no distortion from that cause. The negative half-cycle carries the grid potential down to 12 volts negative, but as we are still on the straight portion of the curve, we again obtain no distortion. Well, so much for the valve as an amplifier. I hope all you fellows have a clear idea of how it works now."



Practical Workshop Hints

Working Mahogany—Bushing Terminals—Filling Holes in Panels—The Drill Outfit—Coil Holders—Mourning Terminals

Readers who make their own cabinets, or who use mahogany and other hard woods bushed with ebonite for the panels of receiving sets, may encounter certain difficulties in their constructional work. Those who are not used to hard woods may make rather a mess of the apparently simple task of driving in screws. When it is being inserted into soft wood, a screw may be made to force its way in, even if the pilot hole is a small one and not very deep; but this method will not do for woods like mahogany and teak. Here it is essential before inserting screws to make holes of good size, and to make

them deep enough to take the full length of the screw. A good tip, if you have a drill plate, is this. Pass one of the screws that you are going to use through it until you find the hole into which

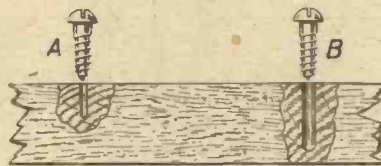

Fig. 1.—Drill a deep pilot hole for screws in hardwood.

it just fits. Then make your pilot holes in the hard wood with a drill two or three sizes smaller.

If this method is used, quite fine screws can be driven into hard wood without any risk of breaking them or of spoiling their heads; but if the holes made are too small and of insufficient depth, trouble is very likely to arise.

Not everyone knows that metal screws can be used quite well for fixing components to a baseboard made of hard wood. When this is done, the holes should be made with a drill intermediate between the tapping and the clearance size for the particular screw in use. For a 4B.A. screw the clearance size is No. 26, and the tapping No. 34; if holes are made with a No. 30 drill, the screws can be turned in without any difficulty, and they

The Final Result, "Powquip wins through being Quietly Efficient"

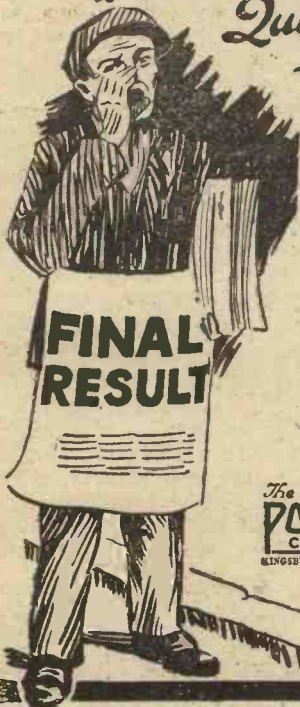

The two words, "quietly efficient," express the final result obtained by all who use

- POWQUIP -

TRANSFORMERS

The quality and workmanship of every part is the best obtainable. Each Transformer has to pass eight distinctive tests, and carries a written guarantee for one year.

PRICES:

Bucks ... 12/- Manchester 15/6
Standard 14/6 Shrouded ... 18/-

The POWER EQUIPMENT COMPANY LIMITED
KINGSBURY WORKS, KINGSBURY LANE, THE HYDE, HENDON, N.W.A.

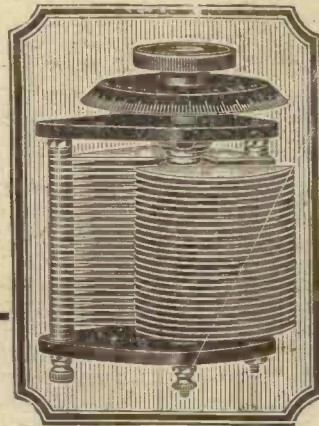

SQUARE LAW	
'001	9/6
'00075	9/-
'0005	8/-
'0003	6/9
'00025	6/9
'0002	5/6
'0001	5/3
Vernier	4/6
STANDARD	
'001	8/6
'00075	8/-
'0005	7/-
'0003	5/9
'00025	5/9
'0002	5/-
'0001	4/9
Vernier	4/-
J.B. SQUARE LAW WITH VERNIER	
'001	14/-
'0005	12/6
'0003	11/3
'00025	11/3



Conserving Signal Strength

Recent experiments have shown that there is no great advantage in tuning the primary circuit. It has also been demonstrated that in consideration of losses and resistance in the aerial system itself, losses in the primary circuit do not seriously affect signal strength. But losses are of great importance in the secondary circuit—that is, in the grid circuit of the first valve. There it is important that inductances and con-

densers should be low-loss. Quantitative experiments prove that low loss in the circuit can increase signal strength as much as 30 per cent. Therefore the implication is obvious—incorporate low loss condensers. Tune the primary—it helps selectivity—but be zealous about the condenser tuning the Secondary. See it bears the mark J.B. and you will secure the utmost signal strength.

JACKSON BROS.
8, POLAND ST-OXFORD ST
LONDON - W.1.
(First Floor) Telephone: GERRARD 7414

Burcuys & A.

ULTRA LOUD SPEAKER
REGISTERED TRADE MARK



2,000 ohms
27/6

ASK YOUR DEALER FOR THEM

Should you have any difficulty in obtaining same, write direct to

EDWARD E. ROSEN & CO.
661, Harrow Rd., Kensal Green, London, N.W.
with the name of your Dealer.

2-VALVE AMPLIFIER, 35/-
1-Valve Amplifier, 20/- both perfect as new; Valves 4/6 each; smart Headphones 7/6 pair; new 4-Volt Accumulator, celluloid case, 13/-; new 60-Volt H.T. Battery, guaranteed 6/-; 2-Valve All-Station Set, £4. Approval willingly.
C. Taylor, 57, Studley Rd., Stockwell, London

BROAD CLEAN CONTACTS

Thin wire ends clipped into Collett tags become broad, flat contacts; helpful in your sets. There are types for screw terminals, types for soldering, each designed to do its job well. Tell your dealer they must be Collett Tags. Ask him to show you the ten types made or send us P.O. 1/- for complete sample outfit.

COLLETT'S EXCEL TERMINAL TAGS

S. H. COLLETT MFG. CO.,
52-54, Hampstead Rd., N.W.1.
Telegrams: Auto-use, London

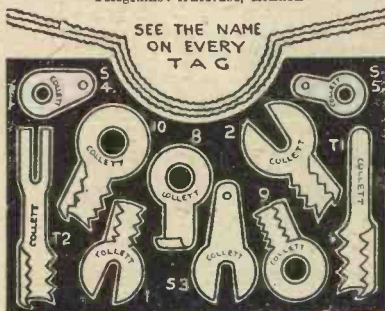

obtain a very good hold in the wood. Similarly, holes made with a No. 38 drill will allow 6B.A. screws to be used, the tapping size of these screws being No. 43, and the clearance size No. 34.

Bushing

When ebonite bushes are inserted into mahogany panels a little care is required in making the holes for them. The best tool to use for the purpose is an auger bit. Most 4B.A. bushes require a 1/2-in. hole in the panel, whilst for 2B.A. bushes a hole 3/8 or 7/16 in. in diameter may be needed. Having marked the

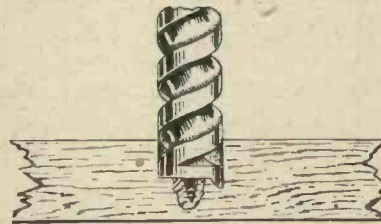

Fig. 2.—Making large holes in hard wood.

centre, carefully insert the screw-point of the bit, and turn it in until the hole is about 1/4 in. in depth. Do not go any deeper, for if you take the bit right through from one side, it will tear away the wood as it comes out, making a very unsightly job. Instead, turn the panel over and complete the drilling from the other side. The screw-point of the bit will have come through, and the hole made by it will indicate the exact centre required. Holes made in this way are perfectly clean-cut, and the bushes fit neatly into them. Provided that seasoned hard wood is used, and that the bushes are of good quality, panels made of hard wood, such as 1/2-in. mahogany, are quite efficient, and if they are well finished up, the appearance of a set so constructed leaves nothing to be desired. When making "hook-ups," I generally use a mahogany panel if the set is of large size, since wood is very much cheaper than ebonite. Once the design has been found to give satisfactory working, the mahogany panel can be used, if desired, as a pattern for an ebonite one made upon the same lines. In this way, one avoids the risk of spoiling an ebonite panel.

"Botching"

Speaking of botching, reminds me of a tip which is quite useful when you have made one or more screw holes in a panel which are found later on not to be in the required positions. Let us suppose that the holes in question are

for 6B.A. screws. In the B.A. series it fortunately happens that the clearance size for any screw is the tapping size for one two numbers down the scale. Thus the 6B.A. clearance holes referred to can be tapped 4B.A., and if the holes already made by the countersink are enlarged, 1/4-in. 4B.A. screws may be inserted into the holes. From the side of the panel visible in ordinary circumstances, they look as though they were screws fixing some component in place. In the same way, unwanted 5B.A. holes can be filled with 3B.A. screws, 4B.A. with 2B.A., and so on. If the holes have not been countersunk, there are two ways of botching them which give quite good results. The first is to drop a good blob of black sealing-wax into and around them, working it in before it sets with a wet finger.

The Surplus Wax

The surplus wax can be removed just before it is hard with the blade of a penknife, and if this is done carefully, the fact that botching has been done is hardly noticeable unless the panel is inspected carefully. The other method is to plug the holes with short pieces of ebonite rod, which may be cemented in position with Chatterton's compound, the ends being trimmed off and polished later when the compound has set hard.

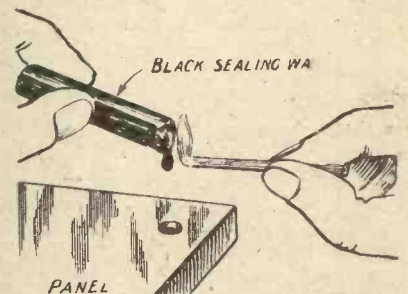

Fig. 3.—Filling up a hole with sealing-wax.

The Drill Outfit

I mentioned just now that for screws of the B.A. series the tapping size for any particular number is the same as the clearance size for a screw of the next number but one. In wireless work we very seldom use anything larger than 2B.A. or smaller than 6B.A. The full range of clearance and tapping sizes from 2 to 6B.A. is as under:—

B.A.	Tapping.	Clearing.
2	26	12
3	30	19
4	34	26
5	39	30
6	43	34

Necessary Sizes

It will be seen that if we desire to have a drill outfit capable of dealing with all the B.A. sizes that we are likely to use, seven drills will suffice—Nos. 12, 19, 26, 30, 34, 39 and 43. We can reduce the number if we confine ourselves, as many constructors do, to the even sizes, Nos. 2, 4 and 6. In this case the only drills necessary will be Nos. 12, 26, 34 and 43. With the help of these, we can perform all the drilling operations necessary for the insertion of screws whether tapped or passed through clearance holes. To this small outfit we must add a $\frac{1}{4}$ -in. drill, since this size is suitable for the spindles of certain components which do not require metal bushes; and a $\frac{3}{8}$ -in. drill to make the holes necessary to take the metal bushes of such components as are fitted with them. The outfit should also include three plug, or second-cut, taps for Nos. 2, 4 and 6 B.A., if we confine ourselves to the even sizes, and additional ones for Nos. 3 and 5 if we wish to be able to deal with the odd-numbered sizes as well. In an emergency, if you wish to fix a component with screws for which you have not a tap, do not forget that you can drive them into plain holes, even in ebonite, provided that you make these of the right size. For 4 B.A. screws a No. 28 or 29 drill may be used, and if the screw is previously lubricated with a little turpentine

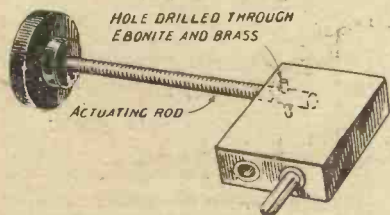

Fig. 4.—Securing a coil socket to the actuating rod.

it will go in quite easily, and will hold well once it is in place. For 2 B.A. screws inserted in this way a No. 14 drill is suitable, for 3 B.A. No. 22, for 5 B.A. No. 32, and for 6 B.A. No. 36.

Pinning Rods

In the wireless set one is not infrequently worried by spindles and actuating rods which insist upon working loose. This trouble occurs most often in the case of coil stands of the type provided with actuating rods made from 2 B.A. studding, which are often fixed into the moving holders in a very insecure way. Sometimes the

studding is merely screwed into the ebonite, in which case it is bound to work loose when the coils used are heavy. Sometimes a setscrew is employed, and sometimes, again, there is a lock-nut. None of these devices is really satisfactory, for they all tend to become loose in time and to give trouble. By far the best way to secure rods or spindles is to

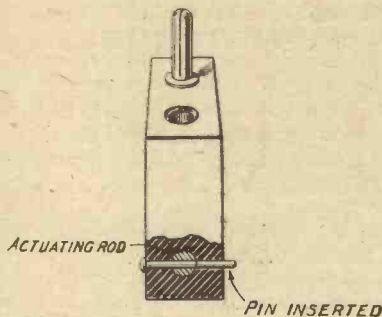
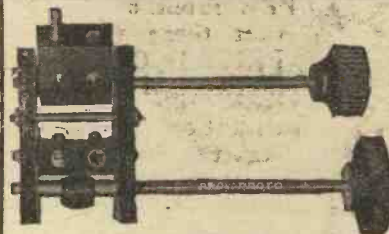

Fig. 5.—How the pinning is done.

pin them. When this has been done they simply cannot work loose, and the job remains a sound and satisfactory one to the end, provided that it is carefully done. In Figs. 4, 5 and 6 are seen the various stages in pinning a rod to a coil-holder. The rod having been driven in as firmly as possible, a small hole is made through both ebonite and brass. A tightly-fitting pin with a head at one end is then inserted, its headless end is cut off, and it is finally riveted over as seen in Fig. 6. There are several important points about pinning. In the first place, the pin must not be too small or too weak, or there may be risk of its breaking. At the same time, it must not be too large, or it will weaken the brass rod through which it runs. For 2 B.A. studding or plain rod of about the same diameter I generally use pins made from No. 18 copper wire, such as is used for making the connections of wireless sets. Cut off a short piece of this, and see that it is quite straight. Place it in a vice, wrapping it first of all in paper to prevent its being injured by the jaws, leaving $\frac{1}{8}$ in. or rather less protruding. With the round end of a ball-pene hammer (the useful type seen in Fig. 6) tap the protruding end of the wire gently so as to form a small head upon it. If you find this operation at all difficult, a brass gimpin pin may be used instead of the wire. The hole made through the body of the coil holder and the rod should be such that the pin is just a gentle driving fit into it. For No. 18

Quality RADIO COMPONENTS

PLEASE NOTE NEW ADDRESS BELOW



Prov. Protected.

CAM-VERNIER COIL HOLDER

Price 9/-; on base 1/- extra.

With Reaction Reverse and Shorting Switch incorporated, 12/6; postage 4d.

DUPLEX COILS

Postage 3d. each. Set post free.

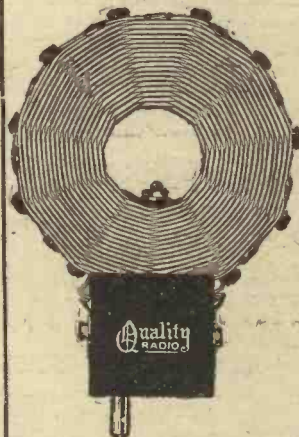

25	1/6
35	1/9
50	2/0
75	2/3
100	2/9
150	3/0
175	3/6
200	3/9
250	5/3
300	6/0

PANEL COIL HOLDER

(no base)

Back connections eliminating flex.
2 way 3/-
3 way 5/-
N.P. 1/- extra.

Post 3d.



Drilling template with all

GOSWELL ENGINEERING Co., LTD.

95, White Lion Street, London, N.1

Liberal Trade Terms. Phone: North 3051

Progress

A FEW months ago the House of Graham announced that there would be **NO REDUCTION IN THE PRICES OF CURRENT AMPLION MODELS DURING 1925.**

This intimation was not restrictive as regards improvements or the introduction of new models, and three modified midsummer types are now being placed upon the market, **AT THE SAME PRICES.**

They are the New Junior de Luxe A.R. 114; Standard Dragon A.R. 19; and Concert Model A.R. 23.

A brief survey of the novel and exclusive details of construction will show the following points:

- (a) Larger capacity of sound conduit in the two latter types.
- (b) Increased substance of insulating bushes between ducts and trumpets, improving the non-resonating qualities.
- (c) Greater convenience and stronger assembly by the provision of a threaded metal termination to the Horn, which now screws directly into the rubber bush without other attachments. The Horn itself follows the popular AMPLION design, but the leaves are united by metal ribs of crystalline finish, thereby affording exceptional rigidity and mechanical strength with an enhanced appearance.

In the attainment of Better Radio Reproduction *Progress* is always led by

THE
WORLD'S
STANDARD

AMPLION

WIRELESS
LOUD
SPEAKER

Obtainable from *AMPLION STOCKISTS, Wireless Dealers and Stores.*

A Visit to the AMPLION Stand at the Royal Albert Hall Radio Exhibition (Sept. 12-23) will prove of great interest.

Patentees and Manufacturers:

ALFRED GRAHAM & CO.
(E. A. GRAHAM)
St. Andrew's Works, Crofton Park,
London, S.E.4

For Summer Radio you can use a Home type of Loud Speaker with your existing set by extending leads into the garden, and to hear an AMPLION in the open air will delight you.

*Get your
AMPLION NOW!*

The New
DRAGON
Type A.R. 19

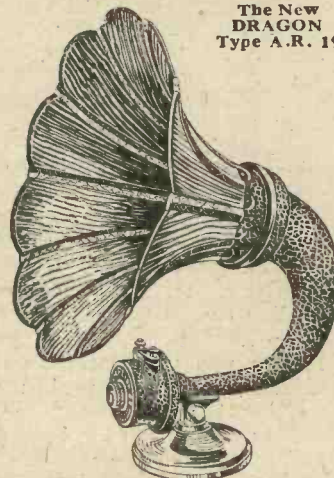

Magnum "Vibro" Valve Holders

A non-microphonic and anti-capacity valve holder, specially designed for "Super Hets." Indispensable to all users of dull emitter valves. **PRICE 5/-**

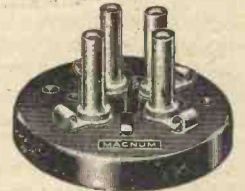

It is not always necessary to use anti-phonic valve holders, but it IS essential, for maximum efficiency, to reduce all stray capacities to a minimum.

The Magnum Anti-capacity Valve Holder

was designed with this fact in view, and is undoubtedly the most suitable for present-day radio practice. Made from solid ebonite, specially channelled. **PRICE 2/6**
Packed in neat carton.

Does the Programme of your local station always suit your taste?

The Magnadyne

will open up your field of audition to some forty British and Continental Broadcasting Stations, reproducing their programmes with perfect clarity and ample volume.

It is an All-British Design for use with British valves. For efficiency, selectivity and reliability, it cannot be equalled.

The Magnadyne employs our Magnaformers incorporating the latest development in intermediate frequency coupling devices, resulting in maximum sensitivity and freedom from distortion.

PRICE (5 Magnaformers and 1) £5 per set (oscillator Coupler)

Send on 7 days' approval against cash. Carriage and packing FREE on retail orders value £3 and over.

Send stamp for particulars and descriptive leaflets.

BURNE-JONES & CO., Ltd.

Magnum House,
296, Borough High Street, London, S.E.1
Telephone: H p 8287. Telegrams: "Burjomag,"
Sedist. London. Cables: "Burjomag, London."

TRADE ENQUIRIES INVITED

S.W.G. copper wire a No. 55 Morse drill will be found to give a splendid fit. If you use a gimpe pin, pass it through the holes of the drill-plate in order to find the most suitable size. Now drive your pin into the hole as far as it will go, and cut off the protruding end so that rather less than $\frac{1}{8}$ in. projects beyond the surface of the ebonite.

Riveting

Lay the head of the pin as shown in Fig. 6 upon a block of metal—the jaws of the vice will do quite

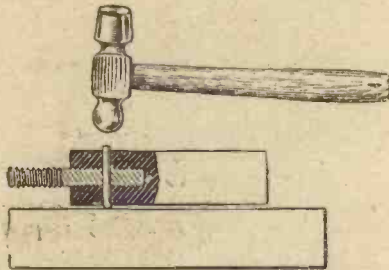

Fig. 6.—Riveting with a ball-pene hammer.

well—and rivet the protruding end gently over until the pin is firmly fixed. The operation, if carried out as described, is quite a simple one, and it gives excellent results. Pinning may be used for a great many other jobs, and applications of this useful method will suggest themselves to the constructor.

Mounting Terminals

Perhaps the most usual method of mounting terminals upon an ebonite panel is to pass their shanks through clearance holes and then to secure them with nuts. This method has the advantage of being quick, but it is not ideal, since the terminals are apt to work loose, partly from the effects of soldering wires to them, when, if they are heated up, they may become slack in the holes, and partly from the twist implied to them when making and unmaking connections. If clearance holes are used, terminals are best secured in the way shown in Fig. 7. A washer is placed, first of all, upon the shank, and this is followed by a nut, which is turned hard down upon it. The reason why a washer is used is this: ebonite is a slightly elastic material, which gives a little under pressure. In course of time it seems to lose its elasticity when compressed, as may be seen when nuts which have held wires down against the surface of an ebonite panel are removed; the wire will be found to have made quite a deep notch for itself.

By using a washer, we obtain a larger bearing surface than we get with a nut alone, and experience shows that the combination gives a secure hold for the terminal. Above the nut should be placed a thin lock-nut to prevent any turning from taking place when the screwed head of the terminal is clamped hard down or slackened off. When connections are soldered to the shanks of terminals, a point should be made of going round all nuts and lock-nuts subsequently with a B.A. spanner, and giving each a slight turn down to fix it firmly. If these precautions are observed, terminals are not likely to shift in ordinary circumstances. Personally, I find that the best method of all of fixing terminals is that seen in Fig. 8.

Tapped Holes

Here a tapped hole is made in the panel for the shank, a nut and washer being used to make all secure. I have never known a terminal mounted in this way work loose, even after years of hard use. If terminals are situated in positions such that their nuts can be reached easily with a spanner or a pair of nut pliers, working loose is not a matter of enormous importance, since in these circumstances they can be tightened up again without much trouble. But where terminals are so placed that their nuts are inaccessible when wiring has been done, I strongly recommend this second method as being

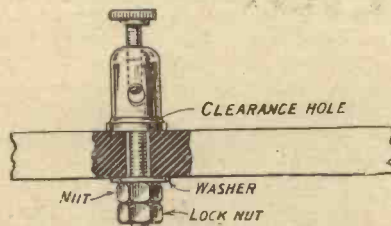

Fig. 7.—Mounting terminals securely.

the most satisfactory that I have ever used. Some constructors may urge against it that it involves considerable labour in the tapping of holes. This is not actually the case if tapping is done by what I call the time-saving method. The holes are made rather larger than the standard tapping size. For 4B.A. terminals I generally use a No. 32 drill, which, though it is two sizes larger than that laid down, allows quite a full thread to be put on to the ebonite. Having made the holes, I mount a 4B.A. plug tap in the chuck of the hand-drill and simply run it through

each hole. The extra time required to mount a couple of dozen terminals in this way is not more than five or six minutes. When using a tap in the hand drill, insert its point into the hole, see that you are going straight, and then give the crank one rather slow turn. Now make half a turn backwards to allow the tap to clear itself, and then turn it straight in at moderate speed without any pause. Before going on to another hole, wipe the tap on a piece of rag so as to remove fragments of ebonite from it. A little turpentine used as a lubricant makes the process quite easy as

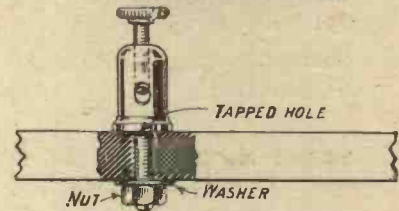
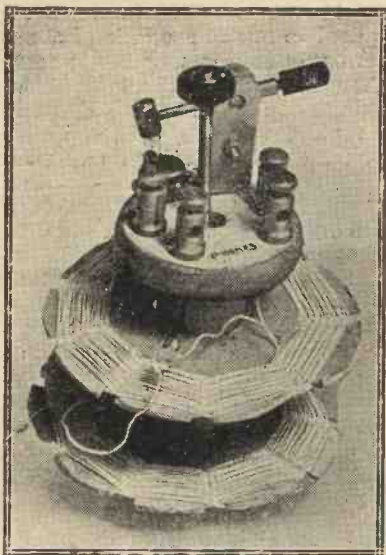

Fig. 8.—A very good method.

well as preventing the tap from becoming unduly heated.

The Screwdriver and Other Bits

Not every amateur constructor knows that he can obtain a screwdriver-bit for his brace. The use of this tool leads to a great saving of time, particularly when dismantling old sets or pieces of apparatus. The screwdriver-bit costs only a few pence, and it will be found well worth the outlay. I wonder, too, if those who possess spiral-ratchet screwdrivers—a splendid tool for the wireless man—know that quite a variety of bits are obtainable for use with them. In the first place, there is an exceedingly handy countersink, which fits into the holder in place of the ordinary screwdriver. To use it, one simply sets a little catch in the handle at the "in" position, and then works the tool up and down in the ordinary way. As these countersinks cut ebonite very well indeed, one can make hollows for a large number of screws in a very short time. Further, one can get all the heads level by making a definite number of downward pushes at each hole. Another handy fitting for the spiral-ratchet screwdriver is a set of drills. These are obtainable so far, I believe, only in inch-fraction sizes, but they enable one to do very quickly awkward jobs which might be found very difficult with the hand-drill. I am told that the makers of the spiral-ratchet screwdriver are putting on the market a set of box spanner bits for B.A. screws, but these I have not yet seen.



The upper coil may be varied in position with respect to the lower, thus effecting tuning.

IN looking through the pages of various wireless periodicals one frequently comes across small crystal sets which might be described as "stunt" sets, and the present receiver will no doubt come under such description, as it is certainly of a novel and very inexpensive type. The base upon which the set is built is an empty wire reel, upon the centre portion of which the coils are mounted. Such a wire reel will usually be found in the lumber box, and

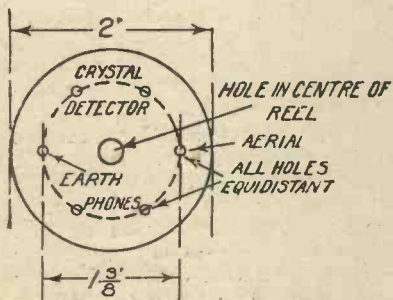

Fig. 1.—How the top of the reel is drilled to take the terminals and crystal.

almost any size will do, the particular size used in this case being about 3 in. long with ends of 2 in. diameter. All that will be required in addition to the reel are:—

One crystal detector. (This should be small in order to take up very little room on the end of the reel.)

Four telephone terminals.

About 4 in. of No. 4 B.A. screwed rod.

A Simple Home-Made Crystal Receiver

By B. MESSIAS

A description of an interesting crystal set, which our contributor has made from an old wire bobbin and a few odds and ends

One small ebonite knob.

Quantity of No. 30 d.c.c. wire.

Two cardboard formers, the construction of which will be described later.

Decide which is the best end of the reel and saw this off close to the body and rub the end down

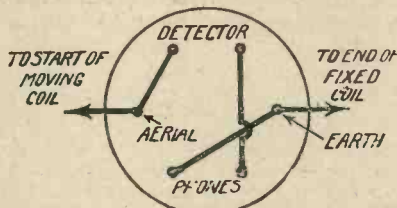

Fig. 2.—Showing the necessary connections.

with glass paper so as to obtain a clean surface. This is to be used as the base for mounting the terminals and detector, and is drilled as shown in Fig. 1. When these holes are drilled the terminals and detector are to be mounted in position, when this portion of the apparatus may be put on one side until the completion of the coils and other details.

Coming now to the remaining portion of the wire reel, a saw cut is to be made down the centre of the spindle to within a 1/4 in. from the base, and the whole then cleaned with sandpaper to present a smooth finished appearance.

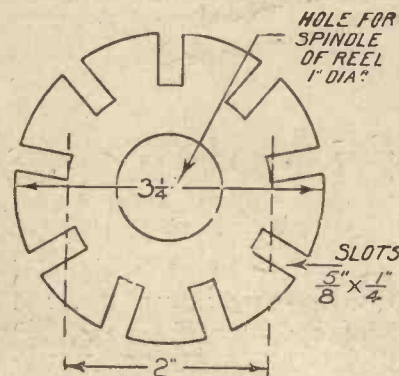

Fig. 3.—Details of the cardboard coil-formers.

Coil Formers

The cardboard formers which are used for winding the coils should be about 4 in. in diameter with a hole cut in the centre of sufficient size to permit the centre portion of the wire reel to pass through. Nine slots are cut from the circumference of the cardboard former to such a depth that the inside diameter of the coil is equivalent to the diameter of one of the ends of the wire reel. This will be clear from the drawing of the coil former. Two pieces of cardboard are cut in this manner, and 30 turns of 30 d.c.c. wire are wound in and out of the slots of each piece of cardboard. One of these coils is then glued to the base of the reel and acts as the stationary coil.

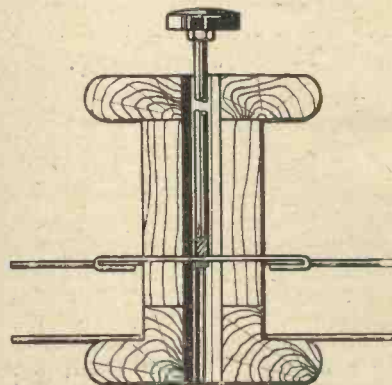
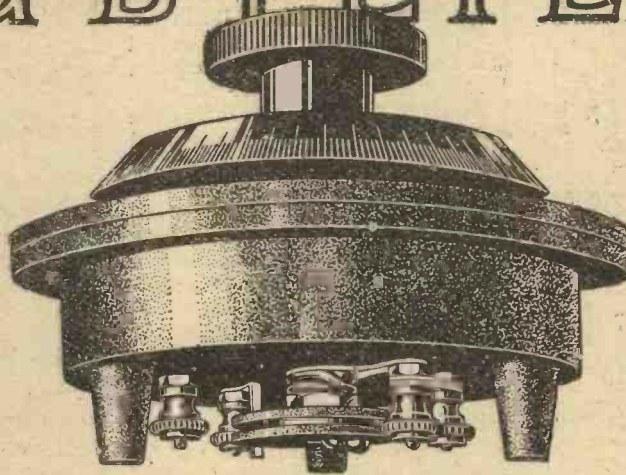

Fig. 4.—Showing how a piece of thick wire is used to secure the moving coil to the actuating rod.

The most important part of the construction is now to be attempted, namely, the mounting of the second coil, which gives the variometer tuning effects. Firstly, take a piece of fairly flat wire about number 20 gauge, or slightly less than the width of the saw-cut in the spindle of the wire reel, and make a loop in the middle of it of such a diameter that it will just pass down the hollow of the spindle. Allow this piece of wire to project out about half an inch each side of the spindle of the reel, and then turn

DUBILIER



MANSBRIDGE VARIOMETER 12/6



OR those occasions where it is more suitable, and for those people who prefer it, the Dubilier Condenser Company are now producing a Variometer. It was designed by C. F. Mansbridge, Esq., the originator of the Mansbridge Paper Condenser. It will thus be seen that the usual guarantee implied by the name of Dubilier is in this case re-inforced by the well-known name of Mansbridge.

The Dubilier Mansbridge Variometer is remarkably compact; it is 4½ inches in diameter, and the overall depth is only 3 inches. It is equipped with three feet which enable it to be used standing on the experimenter's table, while it can easily be mounted on a panel if required. The Variometer consists of two pairs of D shaped coils, one pair being fixed, while the other is rotated by means of the knob. Connection to the moving coils is made through a phosphor-bronze spiral wound on a bobbin made of insulating material—a device which is also incorporated in the Dubilier Vanicon range of Variable Condensers.

The induction ratio is unusually high at 20:1, and the Variometer will cover all the broadcasting wave lengths up to 1800 metres. Full particulars are given with each instrument.

Suitable for experimental use or panel mounting, the Dubilier Mansbridge Variometer is sold at the low price of 12/6.

When purchasing, be sure that you safeguard yourself and specify—

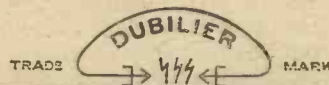

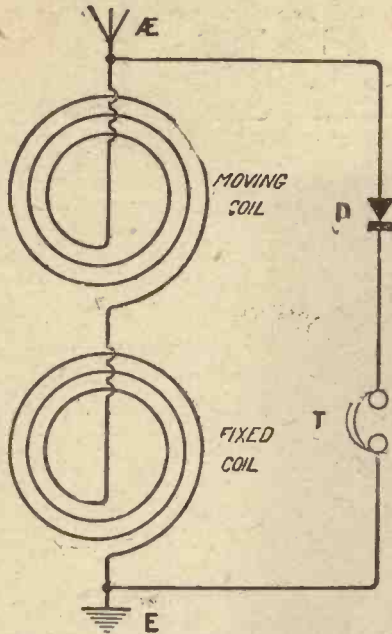

Fig. 5.—The theoretical circuit diagram. The end of the moving coil is joined to the beginning of the fixed one.

the free ends at right angles downwards. Remove the wire and solder the loop to one end of the screwed rod.

The second coil is now to be placed in position over the spindle of the reel and the piece of wire is placed on the top of it, the ends being pushed through holes in the cardboard former of the second coil and flattened out underneath, thus securing the coil in position. The end of the reel upon which the terminals and detector are mounted is now placed over the free end of the screwed rod and glued into its original position on the spindle of the reel; the ebonite knob may then be fixed in position on the free end of the screwed rod. Connections are to be made as shown in the drawing, and it is recommended that all joints should be soldered carefully. The two coils are to be connected up in the following manner: The free wire at the beginning of the movable coil is joined to the aerial terminal, while the end of the movable coil and the beginning of the fixed one are joined together. The end of the fixed coil goes to earth. The remaining connections are, earth to one terminal of the phones, aerial to catwhisker side of detector, crystal cup to remaining 'phone terminal.

How to Tune

Connections are now complete, and the set may be connected up and

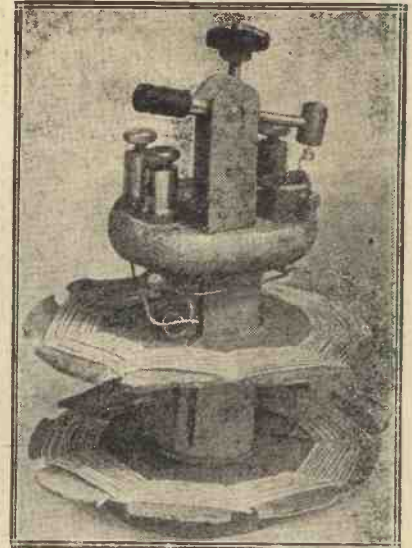

Another view of the set, showing the mounting of the crystal detector. Tuning is obtained by varying the coupling between the coils by means of the ebonite knob on the screwed rod, which is pulled up or down to obtain the best results. If reasonable care is taken in the construction of this set, it will prove quite efficient and capable of very good reception, which will no doubt well repay the time and trouble spent.

Templates for Coil-Winding Formers

WHEN basket or honeycomb types of coils are to be wound on pegs inserted in the periphery of a wooden rolling-pin or other convenient cylindrical former, some difficulty may be experienced in marking out the holes for the pegs accurately, especially if the angle between adjacent pegs is not an exact number of degrees. This trouble can be overcome in a simple manner as follows: Round the cylinder wrap a strip of paper, and cut it where the ends overlap, so that the strip exactly encircles the cylinder and no more, as in

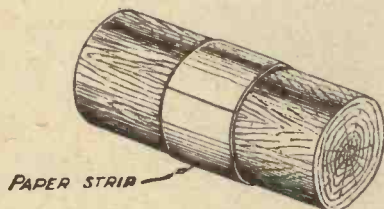

Fig. 1.—The paper strip is wrapped round the wooden cylinder as shown.

Fig. 1. Then lay the strip out flat and divide it up by geometrical construction, or simply with the help of a graduated ruler, into

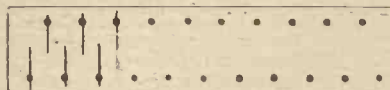

Fig. 2.—The paper strip is removed and divided up as shown into the required odd number of equal sections

the required odd number of equal sections; it is convenient to locate one peg at the extreme end of the strip, as shown in Fig. 2, which indicates the marking for a double row of pegs; note in this case that as the two ends meet round the cylinder, the other end is not marked. When this paper template is completed, glue it on to the cylinder and drill the holes for the pegs at the marked points, taking care that the direction taken by every hole forms a true radius of the section of the cylinder, as otherwise the pegs will not stand in proper alignment.

A. V. D. H.

The One-Valve Reflex

SIR,—In reference to the One-Valve Reflex Set described by Mr. Percy W. Harris in THE WIRELESS CONSTRUCTOR for February, you may be pleased to hear that I have received all main and relay stations at very good strength indeed, to say nothing of fourteen Continental stations, every one being as clear as a bell. Liverpool is my local station, and comes through on a loud-speaker well.

I hope I am the first to tell you that America has been received on this set, for on January 31, or rather February 1, at 12.30 a.m., I picked up WJY (New York City) at good signal strength broadcasting either the time or chimes from some church; then, again, I also received the Canadian station, CNRA, but that night there was too much oscillation going on to get things clearly.

Wishing both you and your paper, THE WIRELESS CONSTRUCTOR, which ought to be called "The Amateur's Friend," all future prosperity. Yours faithfully, Birkenhead. RONALD G. PHILLIPS.

K. RAYMOND

HULLO EVERYBODY!

ALL GOODS POST FREE U.K. except where stated. Foreign orders over £10 post free, otherwise please send ample for post, etc. Trade orders U.K. less 20 per cent., post extra. Open all day Saturday.

SUNDRIES. Reflex Coils. Made under licence "Burndept" Patent No. 168249.

Aerial 7/22 100 ft. 2/6	3-way coil stands 2/9	2-way nickel 4/6	3-way nickel 4/11	2-way geared 5/6	2-way Shipton cam 6/-	3-way Shipton cam 7/6	2-way Polar cam 6/-	3-way Polar cam vernier 9/-	2-way cam vernier 3/6	Coil-plugs plain, 2 for 1/3	Sharpest wedge, 2 for 1/3	Do. Edison Bell, 2 for 2/-	Do. Nickel sides, 2 for 1/6	Do. fitted fibre, 2 for 1/6	Ebonite do. 4/11	Edison Bell do. 10/-	Fixed Condensers: Edison Bell 0/1 1/3	0001 up to 0003 1/3	002 up to 005 2/-	Grid lead and clips 1/3	0003 and grid tank 2/6	Dubilier: 0001 to 0005 each 2/6	001 to 006 each 3/-	2 or 3 meg Grid Lead 2/6	Anode res. on stand 5/6	(50, 70, 80, 100, 900 ohms)	3 mfd., T.C.C. 4/8	1 mfd., T.C.C. 3/10	25 T.C.C. 3/6	Spade tags doz. 6/0	Bus Bar, 1/16th sq., 12 ft. 1/-	Solid Rod Valve Holders: Bretwood do. 1/3	H.T.C. under panel 1/6	H.T.C. over panel 1/6	Raymond Rheostat 1/6	R.I. Detector 6/-	Twin Flex, 12 yds. 2/9	Red and Black, 12 yds. 2/9	72 in. Phone Cord 1/11	Loud Speaker Coils. 1 1/2 Eureka Gravity Detector 6/6	D.P.D.T. Panel 3/-	S.P.D.T. 3/-	LISSEN Minor 3/6	Lissenstat 7/6	Universal 10/6	Switch, 2 way 2/9	Sens. Parallel 2/6	Anode Res. 3/6	Variable Grid Leak 2/6	Choke 10/6	Lissen L.F. T.1 30/-	Lissen L.F. T.2 25/-	Lissen L.F. T.3 16/6
------------------------------	----------------------------	------------------------	-------------------------	------------------------	-----------------------------	-----------------------------	---------------------------	-----------------------------------	-----------------------------	-----------------------------	---------------------------	----------------------------	-----------------------------	-----------------------------	-----------------------	---------------------------	---	---------------------	-------------------	-------------------------------	------------------------------	---------------------------------------	---------------------------	--------------------------	-------------------------------	-----------------------------	-------------------------	--------------------------	--------------------	---------------------------	--------------------------------------	--	------------------------------	-----------------------------	----------------------------	-------------------------	-----------------------------	---------------------------------	------------------------------	---	--------------------------	-------------------	------------------------	----------------------	----------------------	-------------------------	--------------------------	---------------------	------------------------	------------------	----------------------------	----------------------------	----------------------------

Electricity at your finger tips

Know the facts in Electricity. They mean more money and better position for you. "APPLIED ELECTRICITY" will tell you all you need to know about Electricity.

APPLIED ELECTRICITY BLUE PRINT DIAGRAMS

4,100 PAGES. 3,300 ILLUSTRATIONS

These books tell you all about—MAGNETISM—Induction—Experiments—Dynamoes—Electric Machinery—Motors—Armatures—Armature Windings—Installing of Dynamoes—Electrical Instrument Testing—Practical Management of Dynamoes and Motors—Distribution Systems—Wiring—Wiring Diagrams—Sign Flashers—Storage Batteries—Principles of Alternating Currents and Alternators—Alternating Current Motors—Transformers—Converters—Rectifiers—Alternating Current Systems—Circuit Breakers—Measuring Instruments—Switchboards—Wiring—Power Stations—Installing of Telephones—Telegraph—Wireless—Bells—Lighting—Railways. Also many Modern Practical Applications of Electricity and Ready Reference Index.

THE LATEST PRACTICE FILL IN COUPON AND SEND TO-DAY

To the SALES DEPARTMENT

The American Technical Society
42, Theobald's Row,
LONDON, W.C.1

Dear Sirs,
Please send me (free) a copy of your 12-page booklet on "APPLIED ELECTRICITY" giving particulars of this work, published in eight volumes, and terms of payment.

Name.....
Address..... T.W.C.



TEST THIS HAND DRILL ON YOUR NEXT PANEL AT OUR EXPENSE

Just say on a post-card: "Send Hand Drill for eight days' trial." It will come by return post. Use it as much as you like, and if quite satisfied on the eighth day, remit 5/6 or return drill. Set of 9 assorted twist drills 1/6

NIBSOL'S
24, King Edward's Road, Birmingham

LOUD SPEAKERS.

C.A.V. Tom-Tit 30/-	C.A.V. Junior 55/-	Sterling Baby 55/-	Sterling Dinkle 30/-	Amplion Junior 27/6	Amplion Dragonfly 25/-	Amplion do. Hi. 50 50/-	Amplion De Luxe 65/-	Amplion AR19 105/-	Dulcevox 42/-	True Music Minor 21/-	Ultra 27/6
---------------------------	--------------------------	--------------------------	----------------------------	---------------------------	------------------------------	-------------------------------	----------------------------	--------------------------	---------------------	-----------------------------	------------------

Transformers L.F.

Eureka Concert Grand 30	Eureka Second Stage 22.6	Igranite Shrouded New Model 21/-	Formo Shrouded 10/6	General Radio 83 15/-	Super Success (black) 21/-	Brunet Success, 3-1 Or 5-1 13/6	Cr. 12 8/6	Wates Supra 12/6
-------------------------	--------------------------	--	---------------------------	-----------------------------	----------------------------	---------------------------------------	------------------	------------------------

Terminals, complete: Philar. doz. 1/3	W.O. 1/3	'Phone 1/1	Nickel 9d. doz. extra 5/6	Voltsmeter each 5/6	Rheostat and Dial 2/3
--	---------------	------------------	---------------------------------	---------------------------	-----------------------------

Adjustable. (4,000 ohms)

Dr. Neeser 12/6	Telefonken 16/11
-----------------------	------------------------

Valves.

B.T.H., Ediswan, Mullard, Cosmor, Marconi, Bright, D.E., 76 and power valves all stocked.

Igranite Coils.

Coils—25 5/8, 35 5/8, 50 5/8, 75 5/8, 100 7/8, 150 7/10, 200 8/8, 250 8/8, 300 3/5, 400	Rheostat 4.6. 30 ohms 7/-
---	---------------------------

Ormond.

L.F. Transformer 14/-	Special Rheostat 2/-
-----------------------------	----------------------------

Sterling.

Variable Condenser with vernier: 0005 25/6	00025 22/6	Non Pong V.H. 4/3	'Phones 20/- & 22/6	Primax Loud Speaker 27 15/-
--	------------------	------------------------	---------------------------	-----------------------------------

ERICSSON E.V. (Continental)

4,000 ohms 12/-

Headphones.

British, 4,000 ohms. 22/6	Athol V.H. 1/3	Athol Coil Plug 1/3	T.C.B., 6 ohms 4/-	T.C.B., 30 ohms 4/-	T.C.B. Poten (300) 5/6	Shipton do. (600) 4/6	Shipton 7 ohms 3/-	Shipton 30 or 60 ohms 3/-	Woodhall parts stocked. Dubilier Variable. Dubilier Fixed 610 type.
---------------------------	---------------------	---------------------	--------------------------	---------------------------	------------------------	-----------------------	--------------------	---------------------------------	---

Michrom vernier 2/6

Gambrell coils stocked. Paragon panels obt. ind. Watmel Grid Leak 2/6

YOUR PANEL DRILLED FREE WITH 25' order (retail)

0008 20' 12/-	0003 21' 12/-	Gazette 10 ft. 12/-
---------------------	---------------------	--------------------------

WEST-END LEADING STOCKIST FOR Edison Bell, JACKSON'S (J.B.), Polar, Igranite, Ellvill, Peerless, Eureka, Magnum, Burndept, Lotus, Dubilier, Marconi, Dorwood, Sterling, Success, B.T.H., McMichael, Lissen, Woodhall, Utility, R.I., Bowyer-Lowe, Amplion, Formo, Brunet, Ormond, Peter Curtis parts, etc. Send your lists and I will quote you lowest prices. Many goods practically unobtainable elsewhere can be supplied at short notices to retail customers. Impossible to advertise all lines stocked.

7, GRAPE STREET, SHAFTESBURY AVENUE, W.C.2

New Oxford Street end.
NOTE! Grape Street is between Prince's Theatre and Mudd's Library.
1 minute Tottenham Court Road Tube. 3 minutes Holborn Tube. 2 minutes Palace Theatre.

RAYMOND CALLERS' COLUMN ONLY

Variable Condensers SQUARE LAW LOW-LOSS

One-hole fixing. With Vernier: 001 8/6	0005 7/6	0003 7/-	Ebonite ends. Without Vernier: 001 7/6	0005 5/9	0003 5/3
--	----------------	----------------	--	----------------	----------------

ORMOND "AMERICAN"

001, 1/2; 0005, 2/6; 0003, 7/6; 00025, 6/6 (with vernier 1/6 each extra).

JACKSON BROS. "J.B."

Square Law: 001 9/6	0005 7/6	0003 6/9	00025 6/6	J.B. Standard: 001 8/6	0005 7/6	0003 5/9
---------------------------	----------------	----------------	-----------------	------------------------------	----------------	----------------

ACCUMULATORS.

2-v. 40-amp. 9/6	6-v. 60-amp. 11/6	4-v. 40-amp. 11/6	4-v. 60-amp. 19/6	4-v. 80-amp. 24/6	6-v. 60-amp. 29/6	6-v. 80-amp. 35/9
-----------------------	------------------------	------------------------	------------------------	------------------------	------------------------	------------------------

EVER-READY.

108 volts H.T. 20/-	60 volts H.T. 12/6
--------------------------	-------------------------

"MAGNUM."

All parts stocked.

Thorpe K4 (Unitary 5-pin) Valves

Genuine, each 14/3	5-pin holder 1/6	Set Parts (one valve) 45/6	Ditto (two valves) 66/6
--------------------------	------------------------	----------------------------------	-------------------------------

ERONITE.

Cut to size. 3/16th id. sq. inch 1/4 id. sq. inch

"LOTUS."

Geared 8.1, 2-way 7/-	Geared 8.1, 3-way 10/6
-----------------------	------------------------

McMichael's Triple Rheostat 22/6

Burndept Parts.

Gen. Purposes 5/-	Dual 7/6	Detector 4/-	Rheostats 5/-, 7/6	Antiphonic V.H. 5/-
-------------------	----------------	--------------------	--------------------------	---------------------

Success choke 10/6

SECOND-HAND

Quantities of nearly new and second-hand goods on sale. Cheap prices. Old parts bought or taken in part exchange.

Various Amerian

Accuratone dials 17/6	Pico 20-1 6/9	Ultra Vernier 13/6	Success Microtone 6/6	Super-het parts (stocked) or obtained.	Westminster coil winder 4/-	Coil winder, 46 spoked 1/6	A.B.C. wave trap parts 20/-	Igranite Unitary minor 7/6	Ditto major 9/-
-----------------------	---------------------	--------------------------	-----------------------	--	-----------------------------------	----------------------------------	-----------------------------------	----------------------------------	-----------------------

POLAR.

R.C.C. Unit 15/-	Microtone 5/6	0305 or 0003 10/6
------------------------	---------------------	-------------------------

HT. Batteries. (Various makers)

60-v. Ever Ready 12/6	108-v. 20/-	60-v. B.B.C. 8/11	36-v. 5/6	16.5 2/9	8-v. (grid blas) 2/-
-----------------------------	------------------	------------------------	----------------	----------------	----------------------------

Accumulators. (Well-known makes)

2v. 40a. 7/6, 8/6	4v. 40a. 13/6, 15/11	4v. 60a. 17/6, 19/3	4v. 80a. 22/6, 23/6	6v. 60a. 25/11, 27/6	6v. 80a. 33/-	6v. 100a. 33/6
------------------------	---------------------------	--------------------------	--------------------------	---------------------------	--------------------	---------------------

Square Law Variable Condensers.

0005 5/-	0003 4/6
----------------	----------------

D.P.D.T. Panel 10/6

S.P.D.T. China 1/3

S.P.D.T. Terminal, 1d. dozen, 10d.

Valve sockets. 4 for 3d.

Stop or valve pins 4d.

Washers 12s. 1d.

Nuts 6s. 1d.

Spade Lugs 6s. 1d.

Spade Terminals, 4 for 1d.

Do. Red or Black 11d.

Copper foil, foot 3d.

Red and black flex, 12 yards, 1/6

Aerial 7/22 100 ft. 1/11

Battery clips 3s. 1d.

Sleeving, yard 10d.

Wander plugs, pair 2d.

Contact studs complete 2s. 1d.

'Phone cords, 6 ft. 1/3

Knobs 10d.

Knobs and pins 10d.

Empire tape, 12 yards, 6d.

Valve Holders 8d.

Plug and Jack 2d.

7/22 Aerial, 50ft. 1/11

Ins. Hooks, 2 for 1d.

Loud speaker coils, 14, 18, 24 Ins. Stators, 1s. 1d.

Flush panel sockets (nickel and nuts) 1d.

Rheostats, special 9d.

Vernier condensers 1/9

Turner switches 30d.

Shorting pins 10d.

Variometer, 250/950 1/6

Anticap ditto 10d.

Solid rod standard 1/-

Good quality (ditto) 8d.

Hank 1/16 sq. Bus Bar, 6d.

Lead-in (10 yards) 1/-

Ebonite discs 1/-

Unbreakable knobs 3d.

Adhesive tape roll 2d.

Tap aerial 100 ft. 1/10

TWIN Bell wire, 3d. 2d.

BRUNET 4,000 ohm phones 15/6

Ebonite Coil Plugs.

Fitted Fibre 7d.

Plain 41d.

Shaped 6d. & 7d.

Edison Bell 11d.

Loud Speakers 15/9

4,000 ohm phones 5/6

3-way coil stands 3/6

Special Rheostats 4/-

Crystals, best 6d.

Enclosed detectors 8d.

Extra large do. 1/-

2-v. 40 accumulator 7/6

EBONITE

Stock sizes 3/16th.

6 x 6-7 x 5 each 1/20

8 x 6-9 x 6 each 3/12

10 x 8-12 x 8 3/3

12 x 9 5/6

12 x 12 5/6

14 x 10 5/6

1/2 in. also stocked.

HOURS OF BUSINESS

Daily 9 a.m. to 6 p.m.

Sundays, 11 to 1 p.m.

Open all day Saturday

Two shops, one always open.

Telephone (private line) Gerrard 2821.

A Two-Stage Choke Amplifier

(Concluded from page 993)

The terminals marked T E I, are joined to A and B, so that the crystal detector is joined to terminal B on the amplifier. In the drawing the lower telephone terminal of the crystal set is assumed to be joined internally to the crystal detector. In this case, it will probably be found necessary to join the I.T.— terminal to earth, and the connection should then be modified by taking a wire from I.T.— to terminal A of the amplifier.

terminal which is joined, inside the receiver, to H.T. +, is connected to terminal A of the amplifier. The H.T. + terminal on the receiver still connects to a tapping on the H.T. battery, but it is not necessary

plug and jack, as the act of withdrawing the plug only switches off the amplifier valves, it being necessary to control the receiving set by its own rheostat or switch. This arrangement was adopted in view of the fact that it might be desirable at times to listen on the valve receiver alone, without the amplifier, and had the loudspeaker jack controlled all filaments, a readjustment of the accumulator leads would have been necessary.

Results

On test, connected to a standard crystal receiver in south-east Lon-

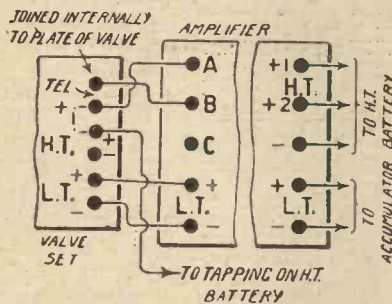

Fig. 5.—How to connect up to a valve set.

The other method, which may also be tried, consists of joining the crystal circuit directly across the grid and filament of the first amplifying valve, as shown on the right in Fig. 6. When the amplifier is connected to a crystal set, the loudspeaker plug may be used as a control switch, to turn the set on or off as desired, it then not being necessary to upset the adjustment of the rheostats.

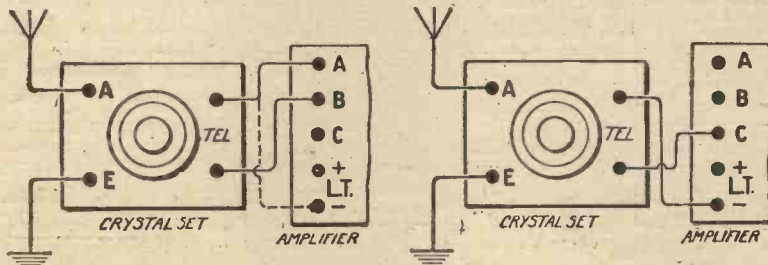

Fig. 6.—Two methods of connecting the amplifier to a crystal receiver. On the left, the crystal set is joined across the choke, while on the right, the crystal goes directly to the grid.

Connecting to a Valve Set

When connecting to a valve set, the telephone terminals of the receiver are joined to the A and B terminals on the amplifier in such a way that the telephone

receiver, and make the two correspond, otherwise you may need a new accumulator!

In this case, it is not possible to control the whole receiving equipment by means of the loudspeaker

don, about 5½ miles from that station, good loud-speaking was obtained on a low aerial (12 ft. high), about 120 ft. long when the set was connected up as shown in the left-hand drawing of Fig. 6. With the dotted connection omitted, a high-pitched whistle was obtained, and it was therefore necessary to make this connection permanently when the crystal set was joined up in this manner.

The second method of connecting was then tried, and results were, if anything, slightly louder than in the first case. Using these connections, the amplification obtained from the first stage is simply that of the valve itself, the first choke being inoperative.

Connected to a single-valve set, with reaction, very loud signals were obtained, even on the low aerial, but when the main 40 ft. high aerial was used the signals were too loud for the room in which the tests were made, purity at all times being excellent.

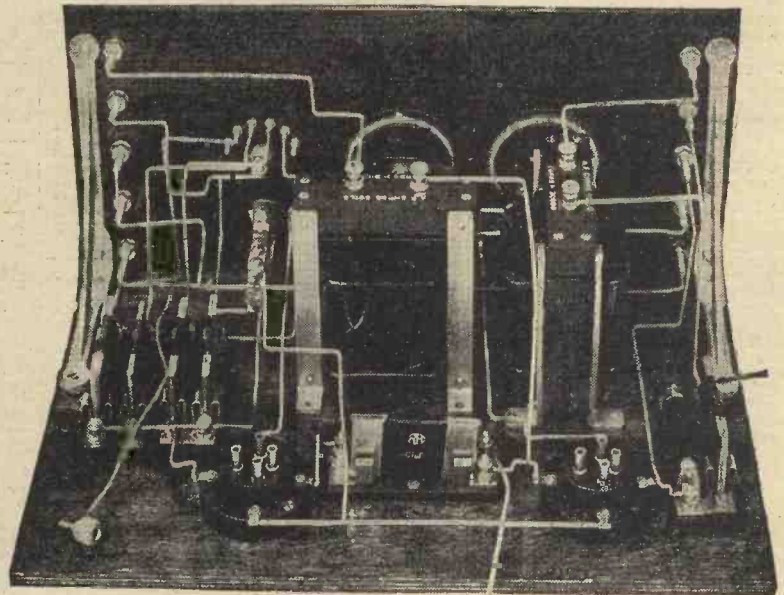

A further view of the wiring, showing the connections to the tone-control switch and condensers.

TRADE DECKO MARK
BASEBOARD VALVEHOLDER
 SAFETY SOCKETS. CAPACITY.
 REDUCE TO THE ABSOLUTE MINIMUM.
 OBTAINABLE FROM ALL THE BEST DEALERS



PRICE 2/3 EACH
 IN CARTONS.

A.F. BULGIN & CO.
 9-11 CURSITOR ST.
 CHANCERY LANE E.C.4.

Full of Good Things.
 Radiax newest Components
 for newest circuits as well as
 a large range of general ac-
 cessories and small parts,
 are described and priced.
 Enclose 3d. stamps. State
 if list of Receiving Sets
 —completed and for con-
 structors—is
 also required

RADIAK LTD
 Radio House,
 Percy St.,
 London W.1. Phone—Museum 450.
 Barclay's Ad.



*The Home for Your
 Wireless Set!*

**MORRIS SOLID
 OAK STANDARD
 CABINET WITH
 LOCKS,**
 to lock up any set
 and batteries with
 panel up to 36" x 18"
 Sent on approval
 Trade supplied
 Price carriage paid
 and packing free:
 22" wide inside £4 15
 25" " " " £5 0
 36" " " " £8 0

MAKERIMPORT CO.
 (Dept. 20)
 50a, Lord Street,
 LIVERPOOL

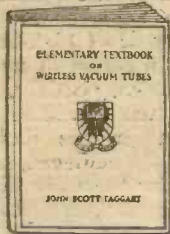
Fundamentals

To obtain maximum results from a valve set you should have a clear knowledge of the fundamentals governing the functioning of a valve. "Elementary Textbook on Wireless Vacuum Tubes," by John Scott-Taggart, F.Inst.P., A.M.I.E.E., tells the enthusiast all about the valve in a lucid manner. The fundamental principles of the valve are dealt with fully, and the text is profusely illustrated with graphs and circuit diagrams which make the subject a pleasant and simple study. No serious experimenter or constructor can afford to do without this book.

PRICE - 10/-

Post Free 10/6

Obtainable from all Bookstalls,
 Newsagents, your local Wireless
 Dealer, or direct from Dept. W.

RADIO PRESS, LTD.
 Bush House, Strand, LONDON, W.C.2

Barclays A1.

**Stop that
 FILAMENT
 VIBRATION!**

get purer tone
 by using this
 shock absorbing
 valve holder

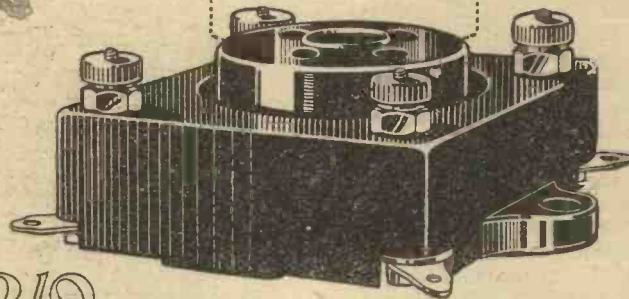

2/9 EACH

This new shock-absorbing
 di-socket prevents the trans-
 mission of outside noises and
 vibrations to the fila-
 ments. The effects of street
 traffic, indoor footsteps and
 resonance (often inau-
 dible to the human ear
 and yet constantly causing
 distortion), are completely
 dissipated because the valve

is securely floated on deli-
 cately adjusted springs. So
 strongly constructed are these
 springs that the tightest valve
 can be inserted or removed
 without fear of damaging
 them. **EACH SPRING
 HAS ONE TURN ONLY.**
 Bakelite construction ensures
 high insulation, low capacity
 and sturdiness.

There are terminal connections for the experimenter and soldering tags for the permanent set. The Benjamin Clearer Tone Valve Holder is easily cleaned—little or no dust can collect in the sockets.

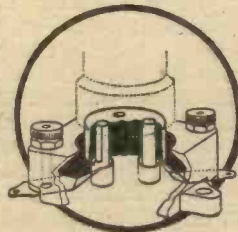

Sectional View

The springs themselves form the valve-pin sockets. No soldered joints—all on solid metal piece from tag to valve leg. No flexible wire connections. The spring supports are not affected by stiff bus-bar wiring. **FOR GOOD RECEPTION WITH DULL EMITTER VALVES BENJAMIN CLEARER TONE ANTI-MICROPHONIC VALVE HOLDERS ARE ESSENTIAL**

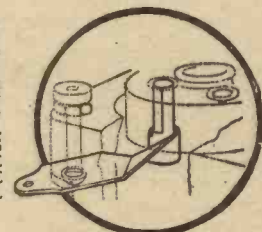

Spring Feature

BENJAMIN CLEARER TONE VALVE HOLDER

(ANTI-MICROPHONIC)

Pats. Pending

FROM YOUR DEALER OR DIRECT FROM

THE BENJAMIN ELECTRIC LIMITED
 Brantwood Works, Tariff Road, TOTTENHAM, N.17

The Benjamin Battery Switch gives perfect battery current control, 2/- each

Low-Loss and the Reinartz Circuit

(Concluded from page 1006)

The construction of this little set is a very simple matter, practically the only points requiring explanation being those concerned with the winding and the mounting of the low-loss coil. The type of former which I used was 7 in. long, the fixed rods being threaded for about only 5 in. of their total length, and the remaining 2 in. left plain. Upon a former like this the procedure is to secure the end of the No. 20 enamelled wire to one of the rods at the point where the threading begins—that is to say, at 2 in., approximately, from the end of the former. We then proceed to wind on the wire, spacing the turns one thread apart upon the supporting rods as one proceeds.

When two or three turns have been wound on, it will be found that the rods of the former are beginning to bend inwards, and the glass or ebonite supporting ring or disc supplied by Messrs Collinson should be inserted in the middle, whereupon the winding may proceed without any further difficulty. If preferred, of course, this stiffener can be inserted before winding commences, but it is usually easier to wind one or two turns first. Winding should now proceed until 65 turns have been put on, when the wire can be cut off and the end secured. This constitutes the winding L_2 , which we have referred to as the secondary winding; and now, on top of this, at the lower end—that is to say, at the end at which we commenced the winding—a further winding, which is to represent the coil L_1 , is put on.

The Second Coil

This is a winding of No. 20 cotton-covered wire, which is wound in the same direction as, and on top of, the first 20 turns of the enamelled wire, the correct number of turns to put on for a start being 20. The connections to this winding will become plain from an inspection of the separate diagram of the coil which is provided. The finished coil can be fastened to the baseboard at the position illustrated in the photographs by passing two small brass screws through the

two holes provided in the lower end ring into the wooden shelf.

One other point: carefully observe that one of the two single coil sockets is attached to the shelf by means of a single screw, in order that the socket may be revolved, and, further, that the connections to this socket are made with pieces of flexible wire with the same end in view.

Operating the Set

We come now to the question of the operating of the set, and of experimenting with the number of turns in the aerial circuit to secure the very best results. After finish-

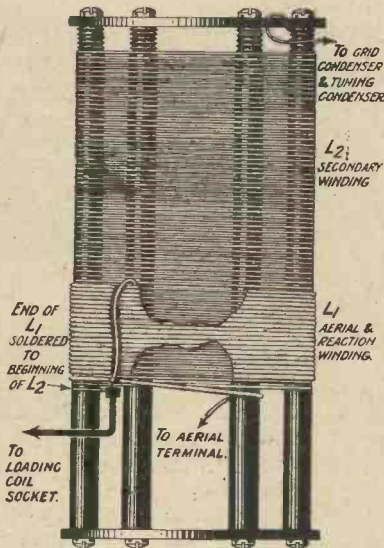

Fig. 4.—The ends of the windings may be passed round the rods to secure them.

ing the set, the constructor will, of course, be anxious to see how it works with the provisional number of turns which I give for the aerial and reaction winding, and the batteries should therefore be connected up, aerial and earth connected, a shorting plug inserted in the loading coil socket, and a No. 200 (or larger) in the choke socket.

Practically any general-purpose valve will work satisfactorily in this set, whether of the bright or dull emitter type, and a rather low value of anode voltage should be applied. Something in the neighbourhood of 30 or 40 volts will generally be correct, but this point must be attended to after the set has been put into operation. Those who live at a fairly short distance from a main broadcasting station, say up to 30 miles, will be able to pick up their local station by setting the right-hand condenser (the reaction

control) at its zero reading, and by then revolving the left-hand condenser till signals are picked up and tuned in to the loudest point. The reading of the right-hand condenser may next be gradually increased, slight adjustments being made upon the left-hand one as this is done, in order to ensure that the best setting is being kept, until presently a point is found at which the set breaks into oscillation.

When this happens the right-hand condenser should be quickly withdrawn to the point at which self-oscillation ceases, and a final adjustment should be made upon the left-hand condenser.

Smooth Oscillation Control

The only adjustment requiring much care is that which concerns the reaction control, and its smoothness or otherwise. With most general-purpose valves it will be found that with the preliminary adjustments which I have indicated the set will pass into oscillation with only a slight click, and it should be the aim of the operator to remove this click entirely, so that the set slides almost imperceptibly into the oscillating condition. To achieve this end, careful adjustment of high-tension voltage and filament current is necessary, and also, possibly, some attention to the variable grid leak. As soon as this desirable condition has been achieved, search may be made for the more distant stations, the receiver being set to the point at which it is just on the verge of starting to oscillate, and this condition may be maintained with a little careful adjustment of the reaction condenser as the left-hand condenser is revolved in search of signals.

Coils for 5XX

To receive Daventry with this set, remove the shorting plug from the loading coil socket and insert a No. 150 or equivalent coil. If a very large coil has been in use as the choke, replace it with say, a No. 100, which now serves as a reaction coil. Set this coil at right angles to the loading coil and proceed to tune on the left-hand dial. Increasing the reading of the right-hand dial and varying the angle between the coils will now give a sufficient amount of reaction to enable 5XX to be received clearly.

Next month, I will explain how some simple and fascinating experiments may be carried out with a few tappings on the aerial winding L_1 to obtain the maximum of selectivity and signal strength.

Don't

experiment with your battery—if it's a Peto & Radford "B.D." in "Dagenite" container—it's perfect.

We have been experimenting for over 35 years and now our invention "Dagenite"—the acid-proof, leak-proof, and practically unbreakable container—supersedes the old ebonite construction and helps you to enjoy worryless wireless.

Pay a visit to your local Radio dealer and ask him to give you full particulars or write direct to us for latest lists, etc.



PETO & RADFORD

(Proprietors: Pritchett & Gold and E.P.S. Company, Ltd.)

Head Offices and Showrooms:—

50, GROSVENOR GARDENS,
VICTORIA, LONDON, S.W.1

Telephone - - - - Victoria 3667 (5 lines)
Telegrams - - - "Storage, Sowest, London"

Wireless Enthusiasts

for Sharp Tuning, Clear Speech
and Maximum Strength

Price, 4/3 to 1/7
each according
to wavelength

use

"TANGENT"
Tuning COILS

Catalogue & name
of nearest dealer
on request

GENT & CO.

LTD. Estd 1872
"Faraday Works"
LEICESTER

LONDON—25, Victoria Street, S.W.1
NEWCASTLE-ON-TYNE—"Tangsat" House, Blakett Street



INSIST UPON
SHIPTON'S
PRODUCTS
AT YOUR
DEALERS

7 ohm Rheostat
with fuse 3/-
30 ohm Rheo-
stat ... 3/-
60 ohm Rheo-
stat ... 3/-
Potentiometer
600 ohm 4/8
Variable
gridleak 3/-
Patent com-
bined aerial
and earth
switch 3/6



PRODUCTS

Don't choose radio components indis-
criminately. Buy wisely—Shipton's. Using
Shipton Components in your radio receiver,
you make certain of best possible results
at all times.

Other Shipton Products in preparation

E. SHIPTON & CO., LTD.

37, TOTTHILL STREET, WESTMINSTER, S.W.1
Phone: Victoria 3171. Grams: Rentimes, Parl
Also at 14, KING-ST, COVENT GARDEN, W.C.2

Barclays Ad.

To Save Your Valves and yield PURE signals



Fitted into an Antipong Valve
Holder, no dull emitter valve
will ever make strange noises off
its own bat. Antipong cures
any microphonic tendencies in
valves, and by reason of its
unique low loss design helps to
give greater signal strength.

It is ideal for short wave
circuits.

"Antipong" lengthens the life
of ordinary as well as dull

emitter valves by protecting the
filament from accidental jars.

The four valve legs are sup-
ported on Phosphor Bronze
springs, each attached to a
Bakelite Ring which will not
melt under the soldering iron.
Universal fitting.

Air insulation of valve legs
reduces losses to the absolute
minimum. Fit "Antipong"
in all your sets.

The Bowyer-Lowe "ANTIPONG" Valve Holder

(Proc. Pat. 24405/24.)

Obtainable from all good
dealers or direct from

3/-

Bowyer-Lowe Co., Ltd.,
Letchworth

EXPERTS SAID:

"Give us a vernier control to all the plates."



RESISTAFORMERS

It has been our constant aim to reduce as much as possible the number of controls necessary in receiving sets, and at the same time to effect whatever economy may be possible for the home constructor. Our latest achievement in the Resistaformer illustrated here, which is an untuned H.F. Transformer, designed primarily for use in Super Heterodyne circuits, but equally successful in all receivers using H.F. Amplification. The use of this Resistaformer renders any variable condenser unnecessary, and still further economy is effected by the fact that each Resistaformer covers a broader band of wavelengths than the usual H.F. Transformer. Correct in design and robust in construction, these units bear our usual guarantee of efficiency.

WAVELENGTH RANGES:

250-500 metres. 800-3000 metres. 1000-7000 metres

PRICE 10/- each

NEUTROFORMERS

These are H.F. Transformers for use in Neutrodyne circuits and have been specially designed for this work, to the specification of Radio Press Ltd.

No.	Wavelength Range (metres)	Price (s. d.)
No. 1	200-600 metres	10 00
No. 2	600-900 metres	10 00
No. 3	900-1500 metres	10 00
No. 4	1500-2300 metres	10 00
No. 5	2300-7000 metres	10 00

These wavelengths are reached with a variable condenser of the value of .0003 mfd.

H. F. TRANSFORMERS

A High Frequency Transformer of the highest grade, having a centre air core and with the windings carried in parallel grooves. Made from best quality ebontite cut from the solid and hand-polished. Very selective, with a high amplification factor. These transformers can be supplied matched for two or three stage or high frequency amplification without extra charge. Wavelengths and prices as for Neutroformers.

BEFORE introducing our new De-luxe Square Law Condensers we asked more than 30 of the principal Radio Engineers in this country whether they would prefer a single-plate vernier or a vernier movement to all the plates. Without exception they asked for a smooth working vernier movement to all the plates. They said that a single plate vernier does not always allow the user to tune in a station at the same reading of the dial—that it is impossible to keep an accurate log of transmitting stations for easy reference—that a single plate vernier produces proportionately greater variations of capacity at the lower reading of the scale than on higher wavelengths.

Based on these insistent demands we have produced in the Peto-Scott De-luxe Square Law Condenser, an exceptionally fine instrument. Its rubber-tyred drive gives the smoothest possible movement with a total absence of backlash. Its solid ebontite end plates of robust construction ensure a complete protection to its mechanism. Its specially cut plates ensure an accurate square law reading. The whole instrument is splendidly finished, all metal parts being well plated and highly polished.

PRICE, .0005 mfd., 21/-
.0003 mfd., 18/6



Going to build a Super Heterodyne?

Next season everyone will want to build a Super-Het. Possessing a selectivity which is almost unbelievable and a range of several thousand miles, it is certainly the limit in Receiving Sets. Send for a copy of our Keystone Super-Het. Folder, and read how easily and economically you can build one up from standard matched Keystone parts, all British made, and designed for use with British Valves.

SEND FOR THESE BOOKS:

PETO-SCOTT'S WIRELESS BOOK, post free 1/6, containing more than 80 different circuits and a full explanation of Radio suitable for the man who is about to build a Set. Not an advertisement, but an invaluable book of reference.

PETO-SCOTT'S CATALOGUE, post free 3d., containing 48 page fully illustrated. Shows all the latest components. You save pounds by buying from Peto Scott's and get delivery by return.

THE PILOT CHART, post free 3d., contains illustrations of more than 30 different Receiving Sets, such as the All Concert De-luxe, the Six-Valve Transatlantic, the S.T. 100, and many others. Complete specification of all parts required for every instrument, together with detailed prices.

PETO-SCOTT UNETE FOLDER sent free of charge. Shows full details of the new system for instantly and economically assembling any circuit with standard components. The ideal method for the experimenter or school teacher.



THE PETO-SCOTT CO., LTD.,

Registered Offices, Mail Order and Showroom

77, CITY ROAD, LONDON, E.C.1

LONDON—62, High Holborn, W.C.1. WALTHAMSTOW—230, Wood Street
PLYMOUTH—4, Bank of England Place. LIVERPOOL—4, Manchester Street

P.S. 3177

Radion Valve Prices are still the lowest

For Guaranteed British — Made Valves.

If you have any difficulty in being served, don't be "put off." We will be pleased to give your orders prompt attention.



FREE!

This book, free on request, gives useful information and curves of RADION VALVES. Write to-day.

Radion D.E. '06

A wonderful, efficient 3-volt "very dull" filament valve.

10/6

Radion D.E. '34

A 2-volt dull emitter of fine performance.

10/6

Radion G.P.

A 4-volt bright valve that only consumes '48 amp.

7/-

Radion Pyramid (1) Valve

The power valve de luxe. Can be used with largest loud-speaker without valve distortion. Filament robust; works at low temperature, ensuring long life. Special construction gives highest efficiency and mechanical strength. Fil. volts 5.5; Fil. amps. '34; Anod. volts 50-100; Neg. Grid-Bias 3-9.

22/6

From United Dealers or Direct Post Free. Don't let any dealer try to sell you something dearer. There are no better valves; our curves PROVE IT. Buy RADIONS and save money.

New VALVE REPAIR Prices

We are the only British firm of valve manufacturers who will repair valves for you. (We can successfully repair practically every make).

BRIGHT EMITTERS 5/-

DULL EMITTERS 7/6

from service dealers or post free from us. Power valves at half the cost of British standard current prices for the same type when new.



RADIONS LTD., BOLLINGTON, Near MACCLESFIELD



JUNIT Wire simplifies your wiring work. The stick of solder is not needed (that frees one hand). Place the wires in position, moisten with flux, touch them at the junction with a soldering iron, and they prove to they "stay" put. Junit wire carries its own solder, that's the secret.

No. DG/L (18 w.g.) 3 yd. coils 6d.

No. DG/2 (17 w.g.) 1 ft. lengths 2d.

See it at Wembley, Barr & Read's Stand, Palace of Housing and Transport.

Ask your dealer or write to:—

REXO ENGINEERING CO. 2 RAVENSCOURT SQ., LONDON, W.6.

TUNING

Keen as a Razor!



Successful reception of distant radio demands the utmost tuning accuracy. Every radio enthusiast of experience appreciates this fact which accounts for so many having incorporated the Microhm Vernier Condenser into their receivers. They have proved it to be an instrument capable of sharp and accurate tuning always, with the greatest ease of adjustment. Until you have fitted the Microhm into your set, you cannot know what fine tuning really is. For a negligible outlay you can greatly improve upon present results. Remember it must be the—

MICROHM VERNIER CONDENSER

For use in parallel with aerial and anode tuning condensers.

Indispensable for "Neutrodyne's."

MICROHM ENGINEERING CO. VARSITY WORKS, COLLEGE ST., LONDON, E.9
Phone OLISSOLD 2887
Scottish Agents: KEITH & IRWIN, 35, Robertson Street, Glasgow, G.2

Barclays 1316



Without doubt, Radio Press books have proved themselves the best guide to the wireless enthusiast. They contain no muddling complications, and are written in a manner that makes the reading thoroughly interesting. You cannot fail to understand a Radio Press book. The authors are all wireless experts with wide experience in the enthusiast's wants.

No.		Post Price Free
1	Wireless for All .. By John Scott-Taggart, F.Inst.P., A.M.I.E.E.	9d. 11d.
2	Simplified Wireless .. By John Scott-Taggart, F.Inst.P., A.M.I.E.E.	1/- 1/2
3	How to Make Your Own Broadcast Receiver .. By John Scott-Taggart, F.Inst.P., A.M.I.E.E.	1/6 1/8
4	How to Erect your Wireless Aerial .. By B. Mittell, A.M.I.E.E.	1/- 1/2
5	The Construction of Wireless Receiving Apparatus .. By P. D. Tyers.	1/6 1/8
6	The Construction of Crystal Receivers .. By Alan L. M. Douglas.	1/6 1/8
7	How to Make a "Unit" Wireless Receiver .. By E. Redpath.	2/6 2/8
8	Pictorial Wireless Circuits .. By Oswald J. Rankin.	1/6 1/8
9	Wireless Valves Simply Ex- plained .. By John Scott-Taggart, F.Inst.P., A.M.I.E.E.	2/6 2/8
10	Practical Wireless Valve Cir- cuits .. By John Scott-Taggart, F.Inst.P., A.M.I.E.E.	2/6 2/8
12	Radio Valves and How to Use Them .. By John Scott-Taggart, F.Inst.P., A.M.I.E.E.	2/6 2/8
13	500 Wireless Questions Answered .. By G. P. Kendall, B.Sc., and E. Redpath.	2/6 2/8
14	12 Tested Wireless Sets .. By Percy W. Harris, M.I.R.E.	2/6 2/8
15	More Practical Valve Cir- cuits .. By John Scott-Taggart, F.Inst.P., A.M.I.E.E.	3/6 3/10
16	Home-Built Wireless Com- ponents ..	2/6 2/8
17	Wireless Sets for Home Constructors .. By E. Redpath.	2/6 2/8
18	Tuning Coils and How to Wind Them .. By G. P. Kendall, B.Sc.	1/6 1/8
21	Six Simple Sets .. By Stanley G. Rattee, M.I.R.E.	1/6 1/8
22	Switches in Wireless Cir- cuits .. By Oswald J. Rankin.	1/6 1/8
24	Wireless Faults and How to Find Them .. By R. W. Hallows, M.A. Elementary Text-Book on Wireless Vacuum Tubes	10/- 10/6
	By John Scott-Taggart, F.Inst.P., A.M.I.E.E.	

Obtainable from all Bookstalls, News-
agents, your local Wireless Dealer,
or direct from Dept. W,

RADIO PRESS, LTD.
BUSH HOUSE, STRAND,
LONDON, W.C.2

Barclays Ad.

Dull Emitter Valve Users !

A dry battery gives a
fluctuating output and is
a constant expense. Use
an Oldham Portable and
non-spillable Accumula-
tor. 2 volts, 10 amp.
hours (actual) 12/6
From all Dealers

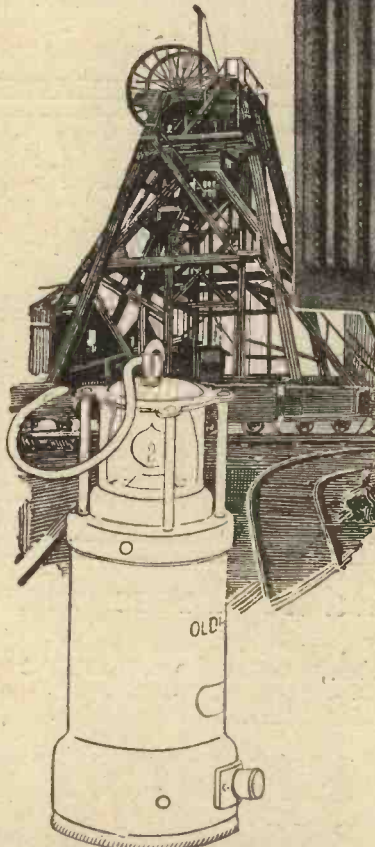

Type C. L. Accumulators

(illustrated above.)

	£	s.	d.
2 v., 10 amp. hrs. continuous		8	9
4 " 10 " " "		17	6
6 " 10 " " "	1	6	3
2 " 20 " " "		11	1
4 " 20 " " "	1	2	2
6 " 20 " " "	1	13	3
2 " 40 " " "		16	1
4 " 40 " " "	1	12	2
6 " 40 " " "	2	8	3

From all Dealers.

Oldham & Son, Ltd.
Denton, Manchester

LONDON: Hazlitt House
Southampton Bldgs., W.C.1



Reliability

—the biggest factor
in any accumulator

It is perfectly true that you cannot tell how much your Accumulator has cost you until it is worn out. And how long it lasts depends on how well it has been made and how well it is treated.

If it is an Oldham you may know that it has been made under the same conditions and from the identical materials as the accumulator used in the famous Oldham Miner's Lamp. Obviously, reliability in an Oldham is more than a catch phrase. An Oldham Accumulator will outlast two ordinary accumulators—and its initial cost will be little, if any, more.

It is a real economy, therefore, to choose an Oldham and get an accumulator fitted with plates made under the special activation process. Such a purchase is a positive insurance against failure of filament current.

Your own Wireless Dealer stocks them, and will supply one ready charged.

Gilbert Ad. 3179

"FAMA" DUTCH VALVES

CHEAPEST & BEST

AMPLIFIER Fil. Volts 3.8 to 4 Anode „ 30 to 100 Amps. 0.5 4/6 Post Free	POWER (DOUBLE GRID) Fil. Volts 4 to 6 Anode „ 100 to 250 Amps. 0.3 <i>The Loud Speaker.</i> 8/6 Post Free
DETECTOR Fil. Volts 3.8 to 4 Anode „ 20 to 60 Amps. 0.5 4/6 Post Free	0.06 D.E. Fil. Volts 1.8 to 3 Anode „ 20 to 100 Amps. 0.06 <i>The Dry Cell Valve</i> 9/6 Post Free

EXTRA LIBERAL TRADE DISCOUNTS
 Keenest Quotations to the Trade for all Wireless Components. Write for Price List

H. D. ZEALANDER & CO.
 ST. JOHN'S HOUSE, 124-127, MINORIES, LONDON, E.1
 Phone, Avenue 1492

DORWOOD CONSTRUCTOR'S GAUGE



REGISTERED.
 BRITISH MADE

1/9

 FROM YOUR DEALER,
 OR POST FREE FROM
 MAKERS.

NOTHING gives your panel more character and finish than neat accurate setting out of the parts. The Dorwood Gauge is indispensable to constructors. It comprises a Valve template,—contact Stud Spacer to any radius,—B.A. tapping and clearing drill gauges,—3 in. Rule and Square. Made in hard plate, silvered and finely engraved.

Sole Makers—
DORWOODS, 274a, Kentish Town Road, London, N.W.5

The Bronel Permanent Detector

THE BRONEL PERMANENT DETECTOR IS ABSOLUTELY & DEFINITELY PERMANENT



5/- Get one! to-day!

FITTED with adjustable screw which gives 1" extension, thus allowing it to be fitted to existing clips.

THERE IS NOTHING TO ADJUST AND IT IS ALWAYS SET

5 YEARS SOLID GUARANTEE

From all Wireless Dealers or post free from—
Wm. R. BOWMAN LTD.
 47, MARK LANE LONDON, E.C.3

As used in the Crystal valve Set described in July issue of *The Wireless Constructor.*

SEND A SUBSCRIPTION

for your favourite Wireless Journals PROMPTLY DELIVERED. POST FREE.

MODERN WIRELESS	
Twelve months	15/-
Six months	7/6
WIRELESS WEEKLY	
Twelve months	32/6
Six months	16/3
THE WIRELESS CONSTRUCTOR	
Twelve months	8/6
Six months	4/3

Notice to the Trade
THE WIRELESS DEALER
 Issue No. 1 ready Sept. 12th
 12 months Subscription rate: 7/6 (U.K.) 10/- (Abroad)

Radio Press, Ltd. (Dept. W), Bush House, Strand, London, W.C.2

—A New Radio Press Handbook—

Messrs. Radio Press, Ltd., wish to announce the publication on
SEPTEMBER 1st of

"RADIO ENGINEERING"

by J. H. REYNER, B.Sc. (Hons.),
 A.C.G.I., D.I.C., Staff Editor of "Wireless Weekly," "Modern Wireless" and "The Wireless Constructor."

This book will fill a gap in Radio literature. It is a remarkable collection of data on every phase of radio engineering, giving information hitherto unpublished in book form. The book is in nine sections under the following headings:—

Radio Calculations and Measurements, Tuning and Radiation, Thermionic Valves,

Radio Transmitters, Radio Receiving Apparatus, Designs of Masts and Aerials, Telegraphy and Telephony, Miscellaneous.

There are, in addition, 196 pages of general mathematical, electrical and physical tables. The whole book, comprising 484 pages, 314 illustrations, and 111 tables, will prove invaluable to the serious experimenter.

A COMPLETE REFERENCE LIBRARY FOR 15/-
 TO BE PUBLISHED ON SEPTEMBER 1st. ORDER YOUR COPY NOW & SECURE EARLY DELIVERY

ADVANCE ORDER FORM
 Radio Press Ltd. Please supply copies of "RADIO ENGINEERING" Price 15/- (15/- post free) for which I enclose remittance of (Name) Address



Make your own Components!

Wireless components are expensive, and an enthusiast can appreciably lower the cost of building a set by making his own. Such things as grid leaks, fixed and variable condensers can be easily constructed at home with the minimum of expense and trouble.

Among the many books published by Radio Press, Ltd., is one called "Home-Built Wireless Components." With the aid of this useful book you will find it an easy matter to build your own components.

You require no more tools than those to be found in every wireless man's workshop. Besides, it will give you great satisfaction to be able to say that you built everything in your set except the valves.



Obtainable from all Bookstalls, Newsagents, your local Wireless dealer, or 2/8 direct from Dept. W.

RADIO PRESS, LTD.
Bush House, Strand, W.C.2

"Home-Built
Wireless Components"
PRICE 2/6

Barclays Ad.

Wait Until You've Tried One!



Don't think you have obtained the best results from your set until you have tried

The New "C.A.C." Valve

Then you will immediately determine to specify C.A.C. Valves for your regular use, as no other valve will give such delightful results.

Our Sample Scheme, whereby every valve user has the opportunity to test these valves at a reduced price, definitely ends on August 31st. Why not send for a sample NOW?

And, remember, every valve is guaranteed by us for three months from date of purchase, a distinct indication of the confidence we place in our products.

"POPULAR WIRELESS" says:—

"C.A.C. Radio, Ltd., have commenced their valve activities admirably, FOR WE HAVE RARELY DISCOVERED SUCH ALL-ROUND CAPABILITY IN VALVES CATEGORISED AS 'ALL PURPOSES.'"

WE ASK YOU TO CONFIRM THIS OPINION.

Type G.P. BRIGHT EMITTER, 7/6 each. Sample price, 6/- each
4 volts. '6 amps.

Type D.E.2 DULL EMITTER, 12/- each. Sample price, 9/- each
1'5-2 volts. '25 amps.

Your local Dealer will supply you with samples at the reduced price. If he is out of stock, send direct to us, giving your Dealer's name and address, and you will receive the valves by return of post.

The "C.A.C." is the Valve you will eventually use

C.A.C. RADIO LIMITED

Branches:
79, Old Christchurch Road,
BOURNEMOUTH
Central Street, LEEDS
10, Rupert Street, London,
W.1
79, Mark Lane, London,
E.C.3

10, RANGOON ST.,
CRUTCHED FRIARS
LONDON, E.C.3

Telephones:
Rangoon Street—Royal 4300
(2 lines)
Mark Lane—Royal 4301
Rupert Street—Gerrard 3063
Bournemouth—
Bournemouth 3546
Leeds—Leeds 2626

Urgent Notice to Wireless Dealers

Send your subscription immediately for No. 1 (Exhibition Number) of this new Radio Press Trade Monthly

The WIRELESS DEALER

AND MANUFACTURER

Edited by JOHN SCOTT-TAGGART, F.Inst.P., A.M.I.E.E.

PUBLISHED SEPTEMBER 12th

YOU know how Radio Press, Ltd., has built up trade for you by means of its publications. Its knowledge of what the public wants is unrivalled.

The whole General and Technical Knowledge of the Industry possessed by Radio Press is immediately available to you through the columns of the new paper.

The Radio Press has a following of 400,000 and will bring the Public and the Trade together in a manner which no other Publishers could emulate.

RADIO PRESS RESEARCH AND TEST LABORATORIES under the supervision of **MAJOR JAMES ROBINSON, D.Sc., Ph.D., F.Inst.P.**, and a Fully Qualified Staff, will provide a wealth of information of great value to every dealer.

LOOK FOR "WIRELESS DEALER" TEST REPORTS and Advance Information of what Radio Press is going to do to enable you to cope with fresh demands.

Every Dealer, if he is to maintain his position in these competitive days, must have the very latest and best information relative to technical developments in wireless.

He must also keep himself informed of the practical progress made by manufacturers in following these developments, their influence upon wireless practice and the consequent public demand.

RADIO PRESS, more than any other publisher, is able to supply this invaluable information, because the public taste and demand is largely created by its other periodicals—"MODERN WIRELESS," "THE WIRELESS CONSTRUCTOR," and "WIRELESS WEEKLY."

As a methodical business man, you will appreciate the advantage of an easy and inexpensive arrangement, whereby all this vital information reaches you regularly and without further effort on your part.

We are pleased to guarantee this for a year for the small payment of 7/6, which hardly covers the cost of the paper on which the periodical is printed.

Copies can be obtained only by entering a subscription. It will not be available to the public and will therefore not be on sale at bookstalls. The Subscription List is now open. Kindly complete the form below and post, together with remittance of 7/6 (10/- abroad) and ensure the receipt of copies for twelve months from No. 1.

SUBSCRIPTION ORDER FORM

RADIO PRESS, LTD.,
SALES DEPARTMENT.

Please enter my/our name for a twelve-months' Subscription to "THE WIRELESS DEALER," commencing with No. 1, September 12th, 1925. Enclosed is remittance of 7/6 (10/- abroad).

NAME.....

ADDRESS.....

ADVERTISERS

The season when the demand for radio components will be at its maximum looms ahead.

The old maxim that "the early bird—" is indeed, very applicable to your future advertising. Are you ready to give the buying public details of your product when the rush is at its height?

There will be more and more radio enthusiasts next season, all eager to buy quality components. The greater percentage of these will read "Modern Wireless," "Wireless Weekly," and "The Wireless Constructor."

Get your advertisement in one or all of these wonderful media early, thereby ensuring maximum returns.

FOR RATES AND OTHER PARTICULARS WRITE THE ADVERTISEMENT MANAGERS

BARCLAYS ADVERTISING LTD.
BUSH HOUSE · STRAND · LONDON · W.C.2

Three New Ideas solving Three Ideas Wireless Problems



Wireless enthusiasts all the world over have wanted to (1) find faults instantly, (2) have a grid leak which showed, on a dial, the resistance in the circuit, (3) fit a coil-holder which automatically reverses leads.

Here you are then—

- 1. **RAPINET BATTERY-LESS FAULT DETECTOR**
A compact and scientific instrument. Shows where trouble lies—in a tick—by a click. No batteries. No trouble. Get one to-day. Not a luxury but a necessity. You can carry it like a fountain pen in your pocket. **PRICE 3/6 EACH**
- 2. **RAPINET CALIBRATED VARIABLE GRID LEAK.**
Good and reliable. The only Grid Leak that is calibrated. Dial indicates exact resistance in circuit. Now obtainable from all leading wireless firms. A boon to every wireless "Fan."
- 3. **RAPINET AUTOMATIC REVERSIBLE COIL HOLDER.** Reverses reaction in a trice. Panel mounting. Simply solder connections permanently under panel. Automatically reverses leads. It's just on the market! Get yours now. **Prices: Single Holder, 1 9 Two way 4 6; Three way 7 6**

If unable to obtain from your local dealer write direct to
RAPINET LIMITED
39-47 Grotton Road, Earlsfield, LONDON, S.W.18
Eatchmere 4223. All trade enquiries to above address.



You, also, can increase your salary

"After 17 years with a London engineering firm, I was receiving only £4 10s. od. a week, but becoming an I.C.S. student in Civil Engineering, I quickly got an appointment at £1,000 a year, which steadily increased to £2,500!"

Many thousands of such messages from grateful students have been received by the International Correspondence Schools, the originators of

SPARE TIME STUDY BY POST

The I.C.S. Diploma is known, valued, respected, in every country. It is an insurance against unemployment, and wins prosperity and happiness for its owners.

SIR HAROLD BOWDEN, MANAGING DIRECTOR OF THE RALEIGH CYCLE CO., LTD., NOTTINGHAM, says:—

"The Diploma of the I.C.S. in the hands of an ambitious man can carry him far, as it has carried thousands. To possess this qualification is proof of a sound, thorough, and specialised education in the subject representing that man's vocation."

The I.C.S. originated spare-time technical training by post 34 years ago, and is by far the largest institution of its kind in the world. It has teaching centres in eleven countries, and students in fifty.

Write to-day for full information as to how the I.C.S. can help you in your chosen vocation. There are 300 I.C.S. Courses, of which the following are the most important groups:—

- | | | |
|---------------------|----------------------------|---------------------|
| Advertising | Engineering (all branches) | Professional Exams. |
| Architecture | French and Spanish | Salesmanship |
| Building | General Education | Showcard Writing |
| Commercial Art | Market Gardening | Textiles |
| Commercial Training | Plumbing | Window Dressing |
| Draughtsmanship | | Woodworking |

International Correspondence Schools, Ltd.,
172, International Buildings, Kingsway, London, W.C.2.

A Silent Background

is essential if long distance reception is desired. The use of a grid leak containing carbon is bound to produce a noisy background. In a variable grid leak, especially the resistance material used must be constant when in use.

Such a variable grid leak is the "BRETWOOD" GRID LEAK

Successfully used and recommended everywhere.

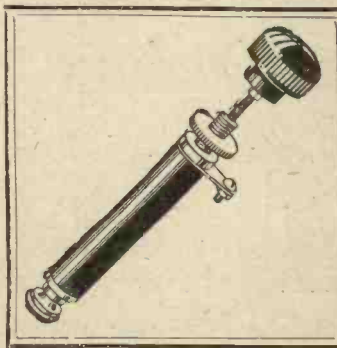

As Changeable as the Weathercock

is a well-known expression. It is peculiarly applicable to the carbon compression type of variable grid leak. A carbon leak examined under a powerful microscope shows minute arcing between adjacent particles when a current is flowing. Thus, slowly, portions of the leak may be consumed, while its use is bound to result in noisy operation of the receiver, and atmospheric conditions change its effective resistance.

The only variable grid leak which is so constant in action as to admit of its being actually calibrated is the "Bretwood." The substance used is silent in action and constant in use. For better reception fit a "Bretwood."

PRICE 3/- POSTAGE 3d.

BRETWOOD LIMITED

12-18, LONDON MEWS

MAPLE ST., LONDON, W.



SPECIALITIES are obtainable from most Wireless Dealers.

"CROIX"

The world's greatest
TRANSFORMERS
over 500,000 in use



one year's guarantee

RATIO $\frac{5}{1}$
9/6

RATIO $\frac{5}{1}$
9/6

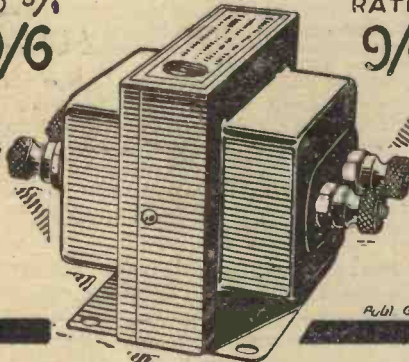

Publ. G. Cordonnier

an opinion.

Under the heading of "TESTED FOR THE TRADE" *The Broadcaster*, April issue, said:—

"Externally, the workmanship and finish are exceptionally good. The stated turns ratio is 5 to 1.

"On trial, in the first stage of low-frequency amplification—following a valve detector—the results obtained were quite satisfactory, there being a good build-up of signal strength and no appreciable distortion. In direct comparison with standard instruments about three times more expensive than the "Croix," the volume obtained with the latter was very commendable, considering its size."

FROM ALL WIRELESS DEALERS SPECIAL TERMS TO FACTORS

Sole Distributors for England, Scotland, Ireland and Wales:

The WHOLESALE WIRELESS CO.

103, FARRINGTON ROAD, LONDON, E.C.

Telephone: Clerkenwell 5312

British Colonies, Dominions and Dependencies:

A. VANDAM, Caxton House, Westminster, London, S.W.

SUPER SETS and ACCURACY

For efficient results, absolute accurate capacity and low loss are essential.

You must therefore fit THE

Dorwood Precision Condensers

which are guaranteed by our work's laboratory test. The only grid condenser having a three point connection.

The DORWOOD has often been used in sets described in Radio Press publications. This is another guarantee of its efficiency.

GET DORWOOD PRECISION CONDENSERS

direct from us if your dealer cannot supply at once, post free at list prices as follows:—

PRICES:

Capacities '0001 to '0009 MF. with or without Grid Leak Clip	2/6
" '001 to '006	2/-
" above '006 to '01	4/6

Sole Manufacturers **HERBERT BOWYER & CO.** 1a, Railey Mews, Leverton Street, LONDON, N.W.5

YOURS FOR 20/-



Send 20/- to-day, together with your order for the "Tonyphone," and this wonderful set, which receives all B.C. stations, will be delivered complete, including all accessories. You pay a further £1 each month afterwards. The total cost is only £15 9s., or if you prefer, £14 6s. cash.

"Tonyphone" Super Two-Valves Complete with Accumulator. H.T. Battery, Aerial, 1 pair 4,000 ohms Headphones, and two Valves—one High Frequency and one Detector. All Royalties paid. Send to-day and enjoy broadcasting NOW.

BRITISH ENGINEERING PRODUCTS CO.
(Battery Dept.), WINDSOR HOUSE, VICTORIA STREET, LONDON, S.W.1.

B.S.A.

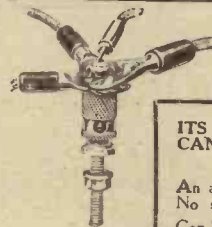

'PINORSPADE' TERMINAL

(Patent applied for)

ITS STRIKING ADVANTAGES CAN BE SEEN FROM THE ILLUSTRATIONS

An absolute positive electrical contact. No screws or loose parts to get lost.

Can be used to instantly connect or disconnect accumulators, batteries, etc., also in place of a switch.

INSTANTANEOUS GRIP

Simply press down milled sleeve and insert wires or spades.

3" x 4" B.A.
5d. each

In either Nickel-plated or Gold Lacquer Finish

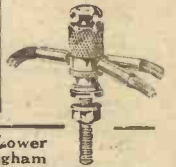

1/2" x 2" B.A.

7d. each

In either Nickel-plated or Gold Lacquer Finish

THE TURNER TOOL MFG. CO. Shadwell Street and Lower Loveday St., Birmingham

YOUR SET COULD BE IMPROVED

BY INCORPORATING

BURWOOD

All Metal Parts Nickel-Plated.

MINIMUM CAPACITY VALVE HOLDERS

Acknowledged an exceptionally efficient holder for BASEBOARD mounting, and a TRUE fitting. A QUALITY component at a reasonable price.

Neatly boxed & fully guaranteed. 1/3 From al. dealers or post free

BURWOOD (CONCESSIONAIRES) Ltd.

Great Queen Street, London, W.C.2

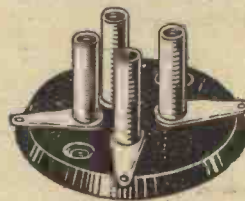

FINEST EBONITE.

SAY NO! to Substitutes.

THE EDITOR of "POPULAR WIRELESS" says that "the DEXTRAUDION



stands very high in the '06 or dry battery class, and is able to hold its own against any other. In a H.F. capacity its performance was distinctly commendable although, in our opinion, it functioned much better as an L.F. Amplifier. As a detector 39 volts H.T. gave optimum results."

The Dextraudion 3v. '06 Valve is non-microphonic and it has an exceptionally long life

THE PRICE IS 16/6

"DEXTRAUDIONS" make good sets excellent and indifferent sets better!

OTHER TYPES	}	2	35	-	14/-
OF		2	4	-	18 6
DEXTRAUDIONS	}	3	12	-	21/-
		4	4	-	8/-

Order from this advertisement or write for 44 page Radio Catalogue, post free if you mention "The Wireless Constructor."

ECONOMIC ELECTRIC, LIMITED.

Registered Offices: 10 Fitzroy Square, W.1 Showrooms: 303 Euston Road, N.W.1 Branch Works: Twickenham

STOP THAT LEAKAGE!



Greater power for your set is ensured by using FLUXITE for soldering. A soldered circuit is one unbroken piece of metal—leakage is impossible. A soldering job with FLUXITE is simplicity itself. Anyone can undertake it without fear of failure. It is the stand-by of the

amateur and the indispensable assistant of the man whose business is soldering.

Ask your Ironmonger or Hardware Dealer to show you the neat little

FLUXITE SOLDERING SET

It is perfectly simple to use, and will last for years in constant use. It contains a special "small space" Soldering Iron with non-heating metal handle, a Pocket Blow-lamp, FLUXITE, solder, etc., and full instructions. Price 7/6. Write to us should you be unable to obtain it.

Price 7/6



FLUXITE SIMPLIFIES SOLDERING

All Hardware and Ironmongery Stores sell FLUXITE in tins, price 8d., 1/4 & 2 s.

Buy a Tin Today!

FLUXITE, LTD. (Dept. 330), West Lane Works, Rotherhithe, S.E.16

ANOTHER USE FOR FLUXITE Hardening Tools & Case Hardening ASK FOR LEAFLET on improved methods

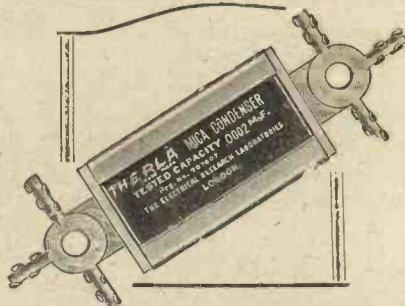

Thera means Efficiency

Every individual Thera condenser is tested for capacity by Faraday House — and guaranteed — and for all that the price of the Thera is less than that of many inferior products.

PRICE:

- '0001 mfd. to '0015 mfd., 1/3 each.
- '002 mfd. to '006 mfd., 2/- each.

SMALL things are apt to be overlooked, yet in most cases they are the root cause of many troubles that occur. This is so in Radio. Consider fixed condensers as an example. Although quite small components, if at all defective they play havoc with the efficient functioning of other components. Then in the matter of capacity, condensers of indefinite value may easily prevent the efficient working of the rectifying valve. Weak and distorted reception is the result! Therefore incorporate into your receiver THERLA Fixed Condensers, the capacities of which have been proved by individual test within very accurate commercial limits. This unique test is made by the Faraday House Testing Laboratory. This is your guarantee. It means ultra-efficiency.



Sole Distributors.

REC'P No 457042

Telephone: Regent 1140;

SEL-EZI WIRELESS SUPPLY CO., LTD. 6, GREEK STREET, LONDON, W.1 and 20, OLD HAYMARKET, LIVERPOOL

THE PANEL DE LUXE



THE advantage that a Radion Panel confers on a Receiving Set is much more than merely adding a gold case to a watch. Rather, is it comparable to the addition of that delicate compensating balance wheel mechanism which ensures split-second accuracy. If you aim at 100 per cent. efficiency for your Set you'll naturally start with a Radion Panel. With dials to match.



Radion is available in 21 different sizes in black and mahogany. Radion can also be supplied in any special size. Black 1d. per square inch, mahogany 1 1/2d. per square inch.

RADION

American Hard Rubber Company (Britain) Ltd.

Head Office: 13a Fore Street, London, E.C. 2 Depots: 120 Wellington Street, Glasgow, 116 Snow Hill, Birmingham. Irish Agents: 8 Corporation Street, Belfast.

Modern Wireless

"MODERN WIRELESS" means a great deal more than mere radio journalism to the enthusiast. It is the source of valuable advice and instruction.

To those who wish to obtain the last ounce of efficiency from their sets it is indispensable. It gives confidence to the constructor, making the building of sets a pleasure.

The articles are fascinating, embracing, as they do, subjects of intense interest to every wireless man. The authors are all experts in radio, and, being familiar with the enthusiast's troubles know how to cope with them.

Furthermore, "Modern Wireless" is produced by Radio Press, Ltd., a concern known throughout the world as publishers of dependable wireless literature. It is edited by John Scott-Taggart, F.Inst.P., A.M.I.E.E.

Words are inadequate to convey the attractions "Modern Wireless" offers. You must buy a copy to appreciate fully its unparalleled value.

ON SALE EVERYWHERE

How to make

"A Selective Four-Valve Set," by E. J. Marriott, illustrated below. This constructional article will appeal to the fastidious set builder. The set is handsome in appearance and will make a wonderful addition to your existing furniture. Accumulator and batteries are self-contained in the cabinet, thereby adding to its neatness.

"Modern Wireless" contains full instructions on how to build this receiver with full wiring details.

**Buy Your
Copy
To-day**



**One
Shilling
Monthly**

SELECTION FROM CONTENTS

AUGUST

- The Wireless Engineer and his Work.
By W. H. Eccles, D.Sc., F.R.S.
- Large or Small Aerials? By J. H. Reyner, B.Sc., A.C.G.I., D.I.C.
- How to make a Selective Four-Valve Set. By E. J. Marriott.
- How to make a Self-Contained Three-Valve Receiver. By John Underdown.
- Using the All-Enclosed Super-Heterodyne. By G. P. Kendall, B.Sc.
- A Selective Circuit for Broadcast Reception. By A. D. Cowper, M.Sc.
- A Choke-Coupled Two-Valve Receiver. By D. J. S. Hartt, B.Sc.
- A Crystal Receiver with Inductive Coupling. By E. F. Burnett.
- Two-Valve Circuits Worth Trying.
- Choosing a Radio Set.



ADVERTISEMENT OF RADIO PRESS, LTD., BUSH HOUSE, STRAND, LONDON, W.C.2

Barclay's Ad.

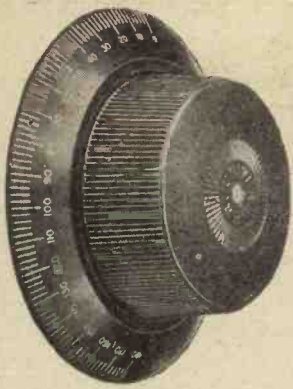

Make your Set Micro-Selective

Be able to get those elusive DX stations readily, clear and loud. Be able to get any stations you have logged by merely setting the dials at the proper numbers; simply replace your dials with Pelican UNIVERNIERS without otherwise altering your set.

It does away with Vernier Condensers

Simply buy good plain condensers and fit with Pelican Univernier dials. The Pelican Univernier will make the finest receiver 100 per cent. more selective. The large single knob gives continuous 12 to 1 or alternatively direct control at will. The 12 to 1 ratio is proved the most efficient for selective control.

Pelican UNIVERNIER complete 6/-
at your dealer or post paid on receipt of P.O.

PELL CAHILL & CO., Ltd.
64, Newman Street,
LONDON, W.1

Telephone: Museum 9236. Telegrams: "Pelcarad, Wesdo, London."

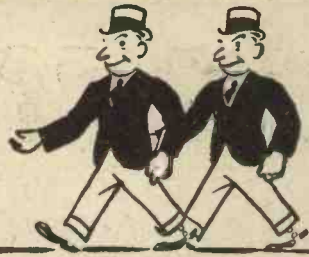

DOUBLES

Every single one of us (as they do say) has somewhere in this world a double.

And yet how rarely do we meet these doubles—even in the world of things material and mechanical! There are two sockets that look alike—and have all the difference of a thousandth of an inch hugely yawning between them; two exactly similar plugs, of which one's a fit and the other's a miss!

But how simply can you ensure having exact counterparts—in the Plugsocket CLIX!

The Plug of one CLIX smoothly slips into the socket of the next CLIX or CLIX Adapter—and there is firmly held with full surface contact. That's the CLIX secret. Simple? But it's withheld from every kind of switch, plug or terminal but CLIX.

Retail Prices:

- CLIX with Locknut 3d.
- CLIX Adapter with Locknut 2d.
- CLIX Insulators (6 colours) 1d. each.
- CLIX Bushes (6 colours) 1d. pair.



AUTOVEYORS LTD., 84 VICTORIA STREET, LONDON, S.W.1

A Combined Soldering Iron and Blowpipe

Specially designed for the Wireless Mechanic



3/11
POST FREE

The "AMSOL" Combined Soldering Iron and Blowpipe is attached to an ordinary flexible gas tube and works for you at 70% LESS COST THAN ELECTRICITY. Only 7 1/2" long, it is fitted with a neat, solid copper hammer bit, which heats to soldering point in less than one minute and retains a constant and uniform temperature. By unscrewing the bit, you have a powerful Blowpipe. Money returned if not absolutely satisfactory.

Of all retailers or direct from

F. ANDERSON & CO., Sole Distributors
REGENT HOUSE, KINGSWAY, LONDON, W.C.2
Trade Enquiries Invited

THE "SECURITY" VALVE HOLDER

(Proc. Pat. No. 2187/25).

ANTI-CAPACITY

PROTECTS THE VALVE

METAL DRILLING
TEMPLATE Included.

OBTAINABLE FROM ALL RETAILERS & FACTORS.

Advert. of Williams, Ellis & Co., London.



PRICE 1/- NETT

The New MAXEL Accumulator

Specially designed for Wireless GUARANTEED TWELVE MONTHS.

If you live too far away to call and see the Battery Mail your Order to us for the size you want. We will willingly return your money if you are disappointed.

	AMPS.			
	40	60	80	110
2 VOLT	7/6	9/6	11/6	14/-
4 VOLT	15/-	18/6	22/-	25/6
6 VOLT	22/6	27/-	32/6	37/6

Packing 1/- extra per battery.

H.T. Batteries 60 volt 7/6 post free

MAXEL ELECTRICAL CO. 28, Clipstone Street Great Portland Street, W.1
Telephone: MUSEUM 708.

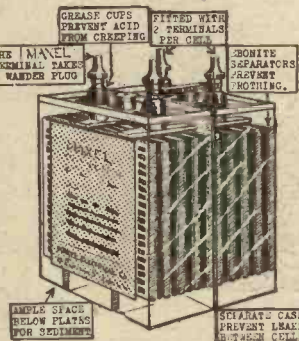

YOU MUST FIT

a "SCIENTIFIC" NON-METALLIC HORN to get the GREATEST VOLUME and PUREST ARTICULATION.

Their tuneful rendering of music is sweet-toned and melodious. Their faithful articulation of speech is almost human.

Attractive Old Bronze Finish.

(Please state diameter of ferrule required)

	Approximate Hk. Ferrule	Post etc.
SMALL SWAN-NECK	16 in. 8 in.	5/6 1/3
with Petal Flare	16 .. 10 ..	7/3 1/3
SMALL WESTERN pattern	19 .. 10 ..	7/3 1/3
MEDIUM WESTERN pattern	21 .. 11 ..	8/3 1/3
with Petal Flare	21 .. 12 ..	9/3 1/3
LARGE WESTERN pattern (as illus.)	24 .. 14 ..	12/3 1/3
CURVED HORN, for Amplion Junior 6-	12 .. 12 ..	11/3 1/3
with Petal Flare	13 .. 13 ..	12/3 1/3
LARGE SWAN-NECK	24 .. 13 ..	14/3 2/-
with Petal Flare	25 .. 15 ..	15/3 2/-
LARGE DEMONSTRATION	MODEL 48 .. 36 ..	58/6 extra

TRADE ENQUIRIES INVITED.

SCIENTIFIC SUPPLY STORES.

126, NEWINGTON CAUSEWAY, LONDON, S.E.1. (Phone: Hop 4177)
Branches: 80, Newington Causeway, S.E.1; 7, St. George's Circus, S.E.1
16, Manette St., Charing Cross Road, W.1; 207, Edgware Road, W.2;
94, Church Road, Upper Norwood S.E.23.



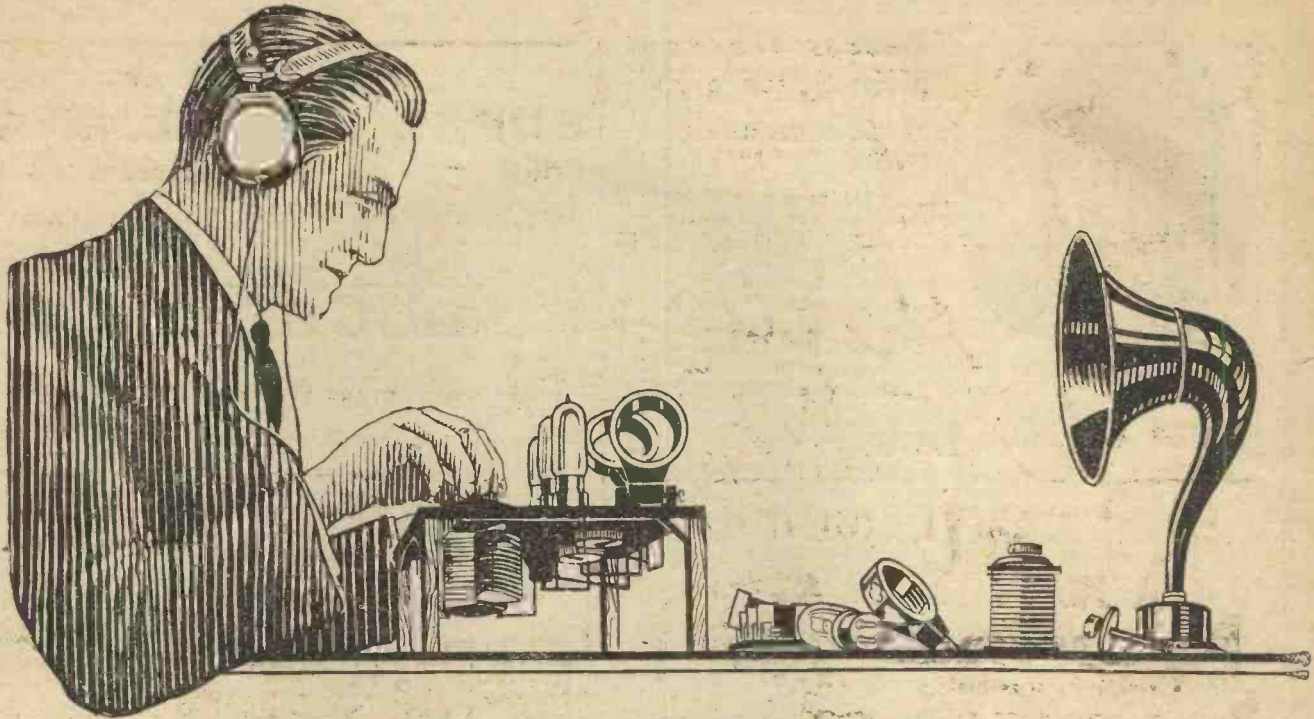

New delights every week

6^{d.}

EVERY WEDNESDAY

Buy or order a copy from your Newsagent or any Bookstall



"Wireless Weekly" will keep you busy. You cannot help becoming enthusiastic over its contents: everything is so new, so out of the ordinary.

"Wireless Weekly" is the experimenters' weekly. It is of special value to every enthusiast who desires to do more than merely "listen in."

Its contents are informative on every subject which directly interests the experimenter, and contributed by men who are particularly suited to write for him. Every one of the contributors is an expert in radio. "Wireless Weekly" is edited by John Scott-Taggart, F.Inst.P., A.M.I.E.E., and produced by Radio Press, Ltd., publishers of dependable wireless literature.

Wireless Weekly

ADVERTISEMENT OF RADIO PRESS, LIMITED, BUSH HOUSE, STRAND, LONDON, W.C.2

Barclays Ad.

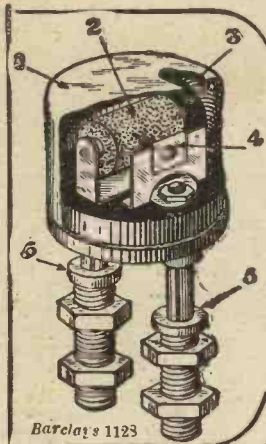

CONTINUOUS RECEPTION
in any position at all times, owing to the special design of both crystal and catwhisker, being always in contact
GUARANTEED TONE—VOLUME—PURITY.

- Some Novel Features:
1. Nickel-plated, detachable, dust-proof cover.
 2. Special "Harlie" super-sensitive crystal.
 3. Ebonite wheel for rotating crystal. No fumbling about adjusting, just turn the wheel—simplicity itself.
 4. Catwhisker on slider for covering whole surface of crystal. Shock-proof.
 5. Nickel-plated sockets for panel mounting.
- Obtainable from all dealers or direct from patentees and manufacturers. **PRICE COMPLETE 5/6**
Don't tickle the crystal—use

Harlie
FOOL-PROOF
DETECTOR

Provisional Patent 26791/24
Generous Trade Terms. Telephone: Clissold 5061.
HARLIE BROS., 36, WILTON ROAD, DALSTON, LONDON, E.8

Barclays 1123

**SPECIALISTS IN
SUPER HETERODYNE**

British and American Components and Kits.

VAST STOCKS.

24 HOUR SERVICE.

The very nature of the Supersonic Heterodyne circuit demands **SKILLED ASSISTANCE BY EXPERTS** for successful results, and we place our resources at your disposal.

**THE BRIGHTON RADIO STORES,
163, Western Road, BRIGHTON**

Patent Applied For.

The **WL COIL HOLDER**

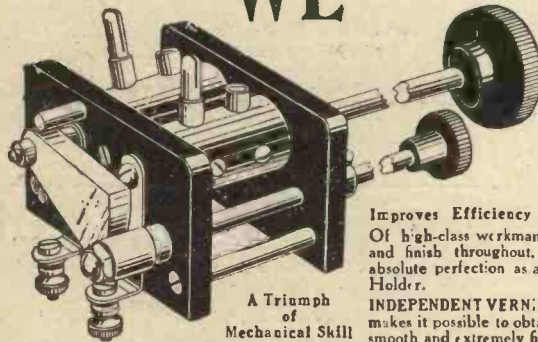

PRICES.	
2-Way	9/6
3-Way	13/6

Improves Efficiency of Any Set. Of high-class workmanship, material and finish throughout, it represents absolute perfection as a Vernier Coil Holder.

A Triumph of Mechanical Skill

INDEPENDENT VERNIER CONTROL makes it possible to obtain a perfectly smooth and extremely fine adjustment.

WESTERN LABORATORIES LTD., 11, Hanbury Rd., Acton, LONDON, W.3

SOLDERED JOINTS SUPERSEDED!

You can easily connect up the most complicated set entirely without use of solder, with the

PATENT

"KRISCROS" CONNECTORS

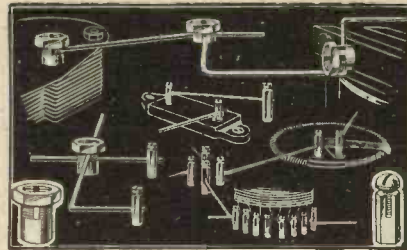

Strong and perfect joints. Used by Mr. Percy W. Harris and other leading experts. A "Kriscros" for every standard thread. **No Solder.** Prices: 1/6 to 3/- per doz. *Send for List.*

Kriscros Co., 50, Gray's Inn Road, W.C.1

A Single-Valve Set for Daventry

RADIO PRESS ENVELOPE No. 9

A Single-Valve Receiver

By **HERBERT K. SIMPSON**

Price 1/6

Post free 1/9

Now that the high-powered station has permanently settled, there are many people who will no doubt wish to enjoy the programmes transmitted.

The Single-Valve Set described in Radio Press Envelope No. 9 will receive 5XX at excellent strength anywhere in Great Britain. It will also receive your local station, thus giving you the choice of two programmes.

Carefully adjusted, many other B.B.C. and Continental stations can be heard nightly. You can use a dry emitter valve without any alteration to the set, thus enabling an accumulator to last for many weeks without recharging, or the use of a dry battery if desired.

Radio Press Envelope No. 9 contains full instructions on how to build this wonderful set, with many illustrations, wiring diagrams and blue prints.

Radio Press Envelope No. 9 is obtainable from all Bookstalls, Newsagents, your local Wireless Dealer, or direct from Dept. W

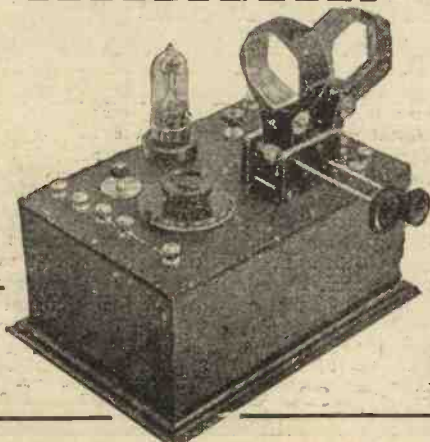

**RADIO PRESS, LTD.,
Bush House, Strand, London, W.C.2**

Barclays Ad.

Index to Advertisers

	PAGE		PAGE		PAGE
American Hard Rubber Co.	1039	Dixon (L.) and Co.	1007	Oldham Accumulators	1033
American Technical Society	1027	Dorwoods	1034	Ormond Engineering Co.	1000
Anderson and Co.	1041	Dubilier Condenser Co., Ltd.	1025	Pell, Cahill and Co.	1041
Autoveyors, Ltd.	1041	Economic Elec., Ltd.	1039	Peto and Radford	1031
Beard and Fitch, Ltd.	1011	Edison Swan Elec. Co., Ltd.	984	Peto-Scott Co.	1033
Bedford Electrical Co.	1044	Falk, Stadelmann and Co.	Cover iii	Portable Utilities Co., Ltd.	1014
Benjamin Electric, Ltd.	1029	Fluxite	1039	Power Equipment Co., Ltd.	1019
Bobin (M.)	1044	Formo Co.	991	Radiax, Ltd.	1029
Bowman (Wm.), Ltd.	1034	Gambrell Bros.	1011	Radio Instruments, Ltd.	Cover iv
Bowyer and Co.	1038	Garnett, Whiteley and Co.	1044	Radians, Ltd.	1032
Bowyer-Lowe Co.	1031	Gent and Co.	1031	Rapinet, Ltd.	1037
Brandes, Ltd.	980	Goswell Engineering Co.	1021	Raymond (K.)	1027
Bretwood, Ltd.	1037	Graham (A.) and Co.	1022	Rexo Engineering Co.	1032
Brighton Radio Stores	1043	Guiterman (S.) and Co.	1007	Rockwood Co.	1044
British Engineering Products Co.	1038	Harlie Bros.	1043	Rosen (Ed.) and Co.	1020
B.T.-H. Co., Ltd.	995	Igranic Electric Co.	987	Rothermel (R. A.)	1016
Brown (S. G.), Ltd.	1007	International Correspondence Sch.	1037	Scientific Supply Stores	1041
Bulgin (A. F.) and Co.	1006, 1028, 1044	Jackson Brothers	1019	"Sel-Ezi" Wireless Co.	1039
Burndept, Ltd.	992	Kriseros Co.	1043	Shipton (E.) and Co., Ltd.	1031
Burne-Jones and Co.	1022	Le Carbone	1008	Sterling Telephone & Elec. Co., Ltd.	962
Burwood Concessionaires	1038	Lissen, Ltd.	979	Taylor (C.)	1020
C.A.C. Radio, Ltd.	1035	London Elec. Wire Co.	991	Telegraph Condenser Co.	1016
Carrington Mfg. Co.	1016	McMichael (L.), Ltd.	983, 999	Turner and Co.	1038
Clarke (H.) and Co.	996	Makerimport Co.	1029	Vandervell (C. A.) and Co.	1003
Collett (S. H.)	1020	Maxel Electrical Co.	1041	Watmel Wireless Co.	1008
Collinson's Precision Screw Co., Ltd.	1008	Merrett (J.)	1007	Western Laboratories, Ltd.	1043
Cossor (A. C.), Ltd.	1004	Michrom Engineering Co.	1032	Wholesale Wireless Co.	1038
Curtis (Peter), Ltd.	961	Mullard Radio Valve Co., Ltd.	Cover ii	Wilkins and Wright, Ltd.	1011
Detectikon Company, The	1016	Nibsol's	1027	Williams, Ellis and Co.	1041
				Zealander (H. D.)	1034

ROCKWOOD SPINTITE WRENCHES
IDEAL FOR THE RADIO CONSTRUCTOR



Write for Pamphlet W.C.
Rockwood Co. Ltd.
147 Queen Victoria St. LONDON.

TRADE DECKO MARK
HEAVY GAUGE
VALVE WINDOWS
MAKE A FINISH OF THE HIGHEST QUALITY, FOR SETS OF DISTINCTION, OBTAINABLE FROM ALL THE BEST DEALERS.

A.F. BULGIN & CO.
9-11 CURSITOR ST.
CHANCERY LANE E.C.4.

PRICE 6^s EACH
N.P. 20. OR 25. EACH
IN PACKETS

"F.A.R." L.F. Transformer
(SHROUDED)
RATIO 5 to 1. 15/-
Of all Dealers or
M. BOBIN, 21 Warwick Lane, London, E.C.
Telephone: Central 4872.

A GOOD RECEIVING SET IS WORTH THE BEST

The "Lotus" Cut Geared Vernier Coil Holders
P. Pat. 23897

ARE THE BEST

PERFECT RECEPTION AT LAST!

Made from Bakelite Mouldings with nickel plated parts

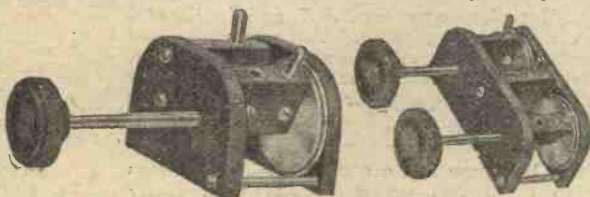

Retail Selling Prices:

Two-way, 7/- Three-way, 10/6

Vernier Movement Actuated by Three Sets of Encased Precision Cut Gears

Representing a Reduction of 8 to 1
MOVING BLOCK CANNOT FALL

Garnett, Whiteley & Co., Ltd.
Lotus Works, Broadgreen Road, Liverpool

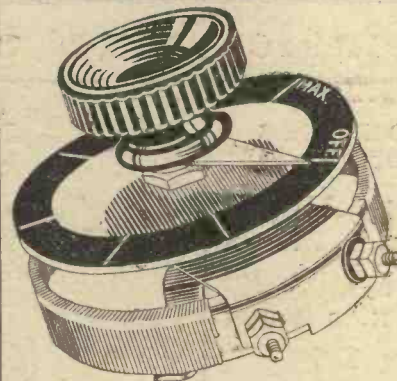

Made in three types
6, 15, or 30 ohms.
Size—
1 1/4 in. dia.
1/2 in. high
2/6

Peerless in name and reputation

As soon as you use the "Peerless Junior" Rheostat you will find it gives the full degree of faultless service that the name implies. The resistance element is immune from damage and will safely carry the current of two valves. An off position is provided and definite stops are so arranged that it is impossible for a short circuit to occur. Complete with handsome engraved nickel dial and one-hole fixing. Made in three types. *From your dealer, or*

The Bedford Electrical & Radio Co., Ltd.
22, Campbell Road, Bedford

ACCURACY

IS ESSENTIAL IN YOUR EXPERIMENTAL CIRCUITS



THE standard components you include in your experimental circuits should be above suspicion. Specify EFESCA One-Hole-Fixing Components throughout and you know that you can rely upon their accuracy. Efesca Components are the ideal of the home constructor—for simplicity, for accuracy, and for efficiency.

The Efesca Aerial Tuning Unit

The Efesca Aerial Tuner (illustrated) covers a wavelength range of 150 to 2,600 metres, in conjunction with a .001 condenser. Thus it eliminates the need for additional coils when changing over from the local station to the High Power Station, a simple turn of the switch sufficing. The Efesca Aerial Tuner incorporates studs and tapping switch complete as illustrated. There is no tedious soldering up of tappings, and it is fixed to the panel by the Standard Efesca One-Hole-Fixing. Price complete 19/-.

Other Efesca components in the same range are the Reaction Unit, and alternative H.F. Couplings, in addition to first and second stage L.F. Transformers.

OTHER TYPICAL EFESCA COMPONENTS

ANTICAPACITY SWITCH
—A patent change-over switch in which capacity is automatically eliminated. Price 8/- each.

SQUARE LAW CONDENSER
—Capacities .001, .0005, .0003 and .00025 mfd. With Vernier .001, .0005, .0003 and .00025 mfd. Prices from 9/- to 17/- according to capacity.

VERNISTAT (Patent)—An extremely delicate filament control. Resistance 5 ohms. Price 6/- each.

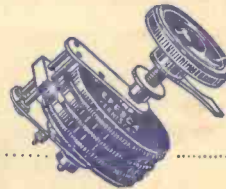
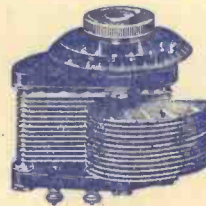
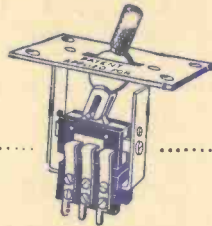

EFESCA

COMPONENTS

WHOLESALE ONLY:

FALK, STADELMANN & CO., Ltd.
83, 85, 87, FARRINGDON ROAD, LONDON, E.C.1
And at MANCHESTER, GLASGOW and BIRMINGHAM

See our Exhibit at the Albert Hall, September 12th to 23rd.

Efesca Components and Efescaphone Receiving Sets are sold by all Wireless dealers and electricians.

Send for Catalogue 522, illustrating and describing the complete range of Efesca Components and Efescaphone Sets.

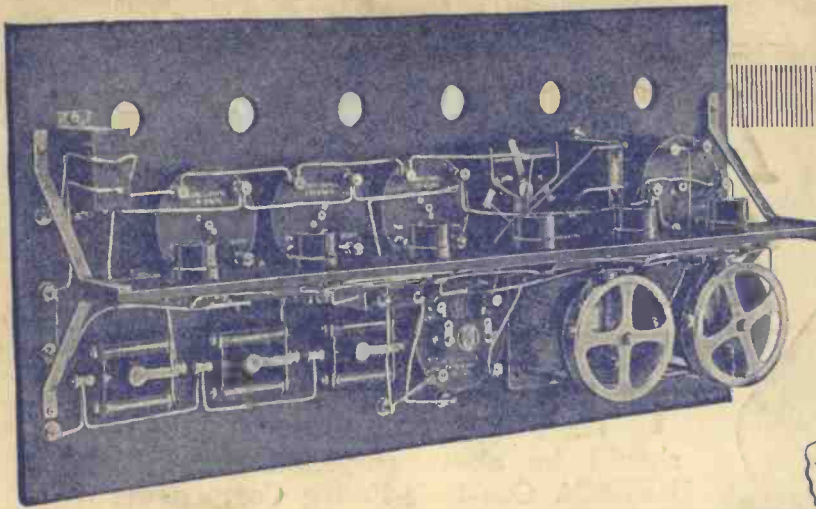

THE SUPER-HETERODYNE PARTS YOU WANT

In placing the R.I. Super-heterodyne parts on the market many thousands of enthusiasts will receive the benefit that they have already enjoyed from the designers of the first high frequency intervalve components placed on the British market.

The R.I. Super-heterodyne Transformers will become famous for their remarkable stability and minimum stray field losses. It is essential in super heterodyne circuits that the energy from the primary circuit of intervalve transformers be transferred as fully and quickly as possible to the grid of the succeeding valves.

In the R.I. units there is a greater freedom from self-oscillation with a maximum amplification per stage. The R.I. winding eliminates sharp amplification peaks, and enables easier tuning.

PRICE PER SET OF 3 TRANSFORMERS

£3 0 0

THE R.I. OSCILLATION COUPLER

Consists of a specially wound anode and grid circuit and the efficiency of the Coupler is such that practically no attention need be paid to filament and anode voltage, due to the adjustments necessary not being critical. In addition to this, there is a smaller winding which can be connected in the earth lead of the aerial or frame coil circuit.

It is intended that a variable air condenser should be connected across the grid coil, the capacity of this condenser being '0005.

PRICE 25/-

THE R.I. COMBINED OSCILLATING UNIT

Comprises a low-loss efficient variable air condenser of '00025 mfd. capacity connected to the most efficient grid anode and coupling circuit.

The windings are all of 9/38 double silk stranded and enamelled wire; therefore the efficiency of this coupling is as high as possible in the dimensions.

Panel mounting is by one-hole fixing.

PRICE 35/-

The R.I. FILTER

PRICE 25/-

We feel confident that there are no units on the British market giving the same quality and results as the R.I. Super-heterodyne units.

With each set of components a full diagram of connections is given, which enables one to get the best out of the Super-heterodyne circuit.

Full Particulars Free on Application.

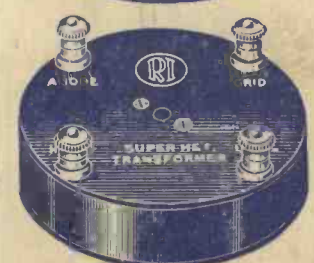

12 HYDE ST. NEW OXFORD ST. LONDON W.C.1.

Contractors to the Admiralty and all Government Departments