

# The Wireless Constructor

6<sup>D</sup>  
MONTHLY

EDITED BY  
PERCY W. HARRIS

## CONTENTS

Vol. 1. No. 7.

MAY, 1925

### HOW TO MAKE:

A THREE-VALVE PORTABLE SET.  
*By Percy W. Harris, M.I.R.E.*

A TWO-VALVE RECEIVER FOR  
DISTANT RECEPTION.  
*By John W. Barber.*

A SIMPLE SET FOR THE INVALID.  
*By Stanley G. Rattee, M.I.R.E.*

A MIDGET SINGLE-VALVE  
RECEIVER.  
*By A. S. Clark.*

SECRETS OF LONG DISTANCE  
WORKING. *By Percy W. Harris, M.I.R.E.*

STRANGE INSTRUMENTS BEFORE  
THE MICROPHONE.  
*By "Carrier-Wave."*

NOTES ON FRAME AERIALS.

A TALK ABOUT CATWHISKERS.

CARBORUNDUM AS A WIRELESS  
CRYSTAL.

HUNDREDS OF PRACTICAL  
HINTS AND TIPS FOR THE  
BEGINNER.

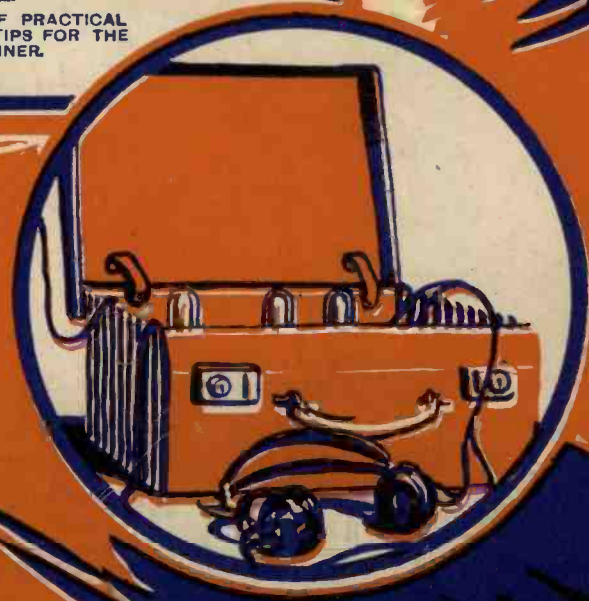

1/6 BLUEPRINT FREE INSIDE

# VOLUME

THE  
 great cathedrals  
 of the world were built  
 by men who loved their  
 labour. They sought to express  
 the beauty and lofty grandeur that  
 is associated with architecture,  
 and they were successful. You  
 can have beauty and grandeur in  
 the volume of your loudspeaker  
 reception. Just take out your last  
 L.F. stage valve and insert a  
 MULLARD D.F.A. MASTER VALVE.  
 These valves have been specially  
 designed for maximum power  
 work with a low temperature long  
 life filament for minimum current  
 consumption.

MULLARD D.F.A.O. for 4 volt  
 accumulators, 26s. each.

MULLARD D.F.A.I. for 6 volt  
 accumulators, 30s. each.

MULLARD D.F.A.3. for dry cells  
 or accumulators, 6 volts, 32s. each.

Ask your Dealer for Leaflet V.A.4



**Mullard**  
 THE MASTER VALVE

# The WIRELESS CONSTRUCTOR

— Edited by Percy W. Harris —

VOL. I. No. 7.

MAY

## CONTENTS

Why not Build a Portable Set? .. 693 By PERCY W. HARRIS, M.I.R.E., Editor.	An Easily Controlled Two-Valve Receiver .. 633 By JOHN W. BARBER.
Broadcasting in Japan .. 608	A "Midget" Single-Valve Receiver 642 By A. S. CLARK.
Strange Instruments before the Microphones .. 610 By "CARRIER-WAVE."	John Anstruther's Wireless Talks .. 652
A Simple Set for the Invalid .. 614 By STANLEY C. RATTEE, M.I.R.E.	Carborundum as a Wireless Crystal 657
A Shunting Box for the H.T. Battery .. 621 By JOHN W. BARBER.	Practical Workshop Hints .. 659
Secrets of Long-Distance Reception .. 626 By PERCY W. HARRIS, M.I.R.E.	A Chat on Frame Aerials .. 664 By C. F. ALLINSON.
How to Finish Off the Ends of Wires 630	Some Modern Aerials .. 668 Catwhiskers I Have Met .. 671 By R. W. HALLOWS, M.A.
	An Experimenter's Desk .. 674

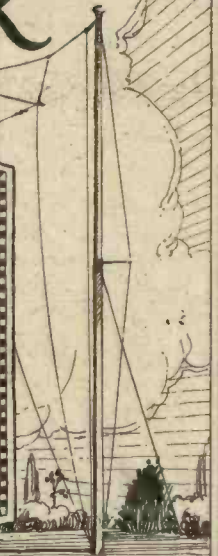

### TAPPED REACTANCE UNITS.

As illustrated in "Modern Wireless" (February issue) p. 3, and described by Mr. G. P. Kendall for replacing H. F. Transformers and converting Transformer coupling to T. A. T. Type A. Having special resistance in series with last stand for high wave-lengths, 15/- post free.

Type B. As above, but including Grid Leak and C.R. Unit, 21/- Post Free.

### MAGNUM H.F. TRANSFORMERS. With Protected Windings.

The most efficient H.F. Transformer obtainable. (See report in "Wireless Weekly.") 7/- each. Postage 3d.

Guaranteed correctly matched 14/- per pair. Postage 3d.	
No. 0	150-300
0A	250-525
1	300-600
2	650-1200
3	1100-2000
4	2500-5000

NOTE:—No. 4 size is specially recommended for super heterodyne circuits.

Special winding for Anglo-American fix referred to as "Neurodyne Units." Per set 0/- 3/- post free.

### EBONITE COIL FORMER (Cross Type)

As used by Mr. G. P. Kendall, 3/- post free

Use MAGNITE Crystal for better reception. 1/- post free.



## MAGNUM

### Construct the PORTABLE RECEIVER

As described in this issue by MR. PERCY W. HARRIS.

1 Leather Carrying Case as described ..	18 6
1 Radion Mahogany Panel, 12x7x 1/8 Drilled ..	11 0
1 C.A.V. Intervalve Transformer	1 7 6
8 Terminals lacquered and complete ..	1 4
3 Burndept Anti-Phonic Valve Holders ..	15 0
1 Special Var. Condenser, as described, '0005 ..	10 0
1 Special Var. Condenser, as described, '0003 ..	10 0
1 Microstat. H Resistance ..	2 9
1 Rothermel Potentiometer ..	6 9
1 Lissen X Coil ..	6 4
2 Coil Plugs and Sockets ..	1 0
1 Dubilier Condenser '0003 and Grid Leak ..	5 0
1 Peto Scott Condenser '0003 ..	2 6
1 H.T. Battery, 60 volts ..	13 6
1 Oldham Unspillable Accumulator, 2 volts, 10 A.H. ..	12 6
2 Wood Strips ..	0 4
4 yds. No. 16 sq. sec. T.C. Wire ..	0 6
1 Set Radio Press Transfers ..	0 6

£7 5 0

### BURNE-JONES & CO., Ltd.

MAGNUM HOUSE, 296, Borough High St., London, S.E.1

Telephone: Hop 6257. Telegrams: BURJOMAG, Secist London. Cables: BURJOMAG, London. Mail order Dept: 288, Borough High Street, London, S.E.1. All correspondence to 296, Borough High Street, please.

### A.B.C. WAVETRAP

Complete and ready for use. £2 17 6

Complete set of components for construction above exactly as described in Envelope No. 8. £2. Send for list.

Will eliminate your local station at 1 mile range.

COIL FORMER for A.B.C. Wavetraps cut from ebonite tube to author's design, 5/3 Postage 3d.

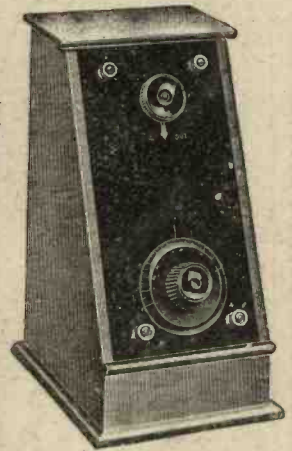

### MAGNUM ANTI-CAPACITY VALVE HOLDER

An entirely new design made from best quality SOLID EBONITE specially channelled. As used on Radio Press sets 2/6 each post free.

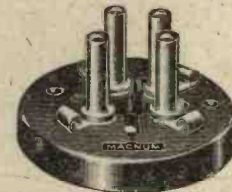

Anode Coils wound and tapped as used in the Simplicity 3 and T.A.T. 8/- post free.

Carrriage and Packing FREE on Retail orders value £3 and over. Send stamp for illustrated list and set of leaflets dealing with Radio Press Circuits.

Barclays Ad. 601

# for Sunny days are near — and Radio is here

Sterling radio has a place in outdoor life, for everywhere on sunny days it is ready to provide the constant charm of music, song and speech. On the river, in the garden, by the sea—what prospects of happy pleasures it opens up for spring and summer!

Convenient apparatus giving perfect results will enhance the enjoyment of broadcast reception—that is why the Sterling way is the sunny way in radio.

Test the truth of this claim where you will, for Sterling products have a world-wide reputation for unfailing efficiency and convenient simplicity. Dealers everywhere are ready to demonstrate.

*Sterling publication No. 364c gives full particulars of Sterling Radio apparatus. Ask your dealer for a copy.*

## STERLING RADIO FOR THE SUNNY DAYS SO NEAR

Advt. of **STERLING TELEPHONE AND ELECTRIC CO., LTD.**  
210-212, Tottenham Court Road, London, W.1      Works: **DAGENHAM, ESSEX**

### The STERLING "DINKIE" Loud Speaker

The little fellow with the loud voice. A loud speaker without equal in its class. Small in size but big in volume—small in price but big in value. "Dinkie" reproduces clearly, loudly and in perfect tone all that is broadcast. In brown tinted finish. **PRICE 30/-**



### The STERLING "BABY" Loud Speaker

The most popular entertainer in the world, giving ample volume for all usual requirements and a reproduction that is consistently faithful and pleasing in tone. In black or brown tinted finish. **PRICE 55/-**



### THE STERLING "ANODION-ONE"

A highly efficient one-valve receiver giving splendid results often at considerable distances under favourable conditions. The tuning units available for this set cover a wave-band of 275-7600 metres. With B.B.C. coil, but without accessories. **PRICE £7:7:0**



*At your  
Radio Dealers*



# The WIRELESS CONSTRUCTOR

Scientific Adviser:  
Prof. G. W. O. HOWE,  
D.Sc., M.I.E.E.

Advisory Editors:  
Prof. R. WHIDDINGTON,  
M.A., D.Sc.  
Prof. C. L. FORTESCUE,  
M.A., M.I.E.E.

Staff Editors:

E. H. CHAPMAN, M.A.,  
D.Sc.  
A. D. COWPER, M.Sc.,  
R. W. HALLOWS, M.A.  
G. P. KENDALL, B.Sc.  
S. G. RATTEE,  
Member I.R.E.

Vol. 1

MAY, 1925.

No. 7.

## Why Not Build a Portable Set ?

ENJOYING RADIO IN THE OPEN AIR

By PERCY W. HARRIS, M.I.R.E., Editor

*A good portable set must be carefully designed. This article shows you how to build a compact, highly sensitive and easily-handled receiver*

AS I write this article Easter is drawing near. By the time the WIRELESS CONSTRUCTOR reaches your hands, this spring-time holiday will be over, and at present it is beyond my prophetic powers to say whether the country will be bathed in warm sunshine or drenched in icy showers. Anyhow, for your sake (and for mine) I hope it will be fine.

At Easter time we think of the open air, and many of us spend a good part of the holiday in the open country, walking, cycling or motoring. As the year grows older and more and more bright, and fine days occur, we frequently find ourselves, as the evenings draw on, many miles from home and glad of a rest.

It may be that we are visiting friends and relatives in the country, and in the evening want some form of relaxation. What better fills this need than radio? Of course you have your own set

at home, and do not want to take it away. Probably it would not

luggage. How can we set about making one?

The set you will see illustrated in this article is not merely a receiver packed into a bag with the necessary battery supply, it has been specially designed for the work it is destined to perform. The requirements of the set were, firstly, that it should give good loud signals from the nearest broadcasting station (even if this were fifty or a hundred miles away), with a very small aerial, such as could be made by throwing an insulated wire over a tree; secondly, that it should be very easy to manipulate even by the unskilled; and, thirdly, that it should be really portable in the true meaning of the word. It

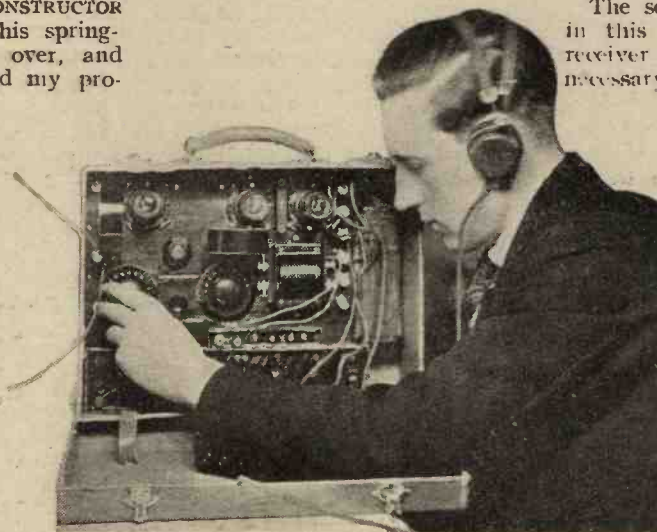

A member of Radio Press staff operating the Portable Receiver. All batteries are in the case.

be convenient to move it, and so it would be very handy to have some form of portable set that could be slipped on the luggage rack of the railway train or dropped in behind the car as part of the ordinary

was also desirable that when connected to a properly erected aerial it should bring in all of the B.B.C. stations and several of the Continental, so that if it should be taken into a remote village where



wireless is practically unknown, it would give a proper demonstration of the value of broadcast reception. Experience tells me that for satisfactory working in all conditions three valves are required—one for high-frequency amplification, the second as a detector, and the third for low-frequency magnification. The high-tension voltage can of course be supplied by the conventional dry battery, but I am not much in favour of the use of dry cells for filament lighting of even a single-valve set.

**The Circuit**

The first point to decide was the circuit, and for this I chose the well-known tuned-anode method of high-frequency amplification, using for the aerial tuning instead of the usual plug-in coil, a tapped coil, so that semi-aperiodic aerial coupling could be used. The advantages of this form of aerial coupling are that not only is a wide band of wavelengths covered with one coil, but the selectivity is increased and good results are obtainable on all kinds of aeri-als. The Lissen X coil filled the bill quite well, and was therefore incorporated in the design. For the anode coil another plug-in coil was used (75 turns is quite suitable), this latter coil being placed at right angles to the X coil.

**Reaction**

You may perhaps ask on examining the photographs, where is the reaction coil and how is reaction obtained? The answer is that with a semi-aperiodic aerial coupling and a sharply tuned anode circuit the set will oscillate quite freely when the grid circuit and the anode circuit of the high-frequency

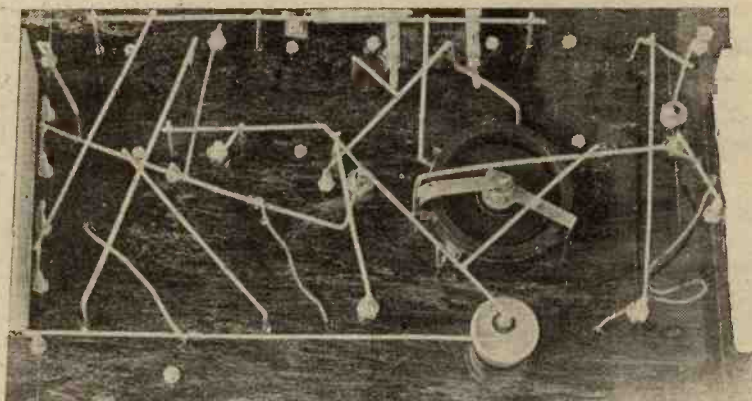

A photograph of the back of panel wiring. This photograph should be studied in conjunction with the wiring diagram.

valve are in tune with one another. If we keep the set just off the oscillation point then we shall get the maximum reaction effect without self oscillation. As a matter of fact, the tendency to oscillate can be easily controlled by means of a potentiometer, and such an instrument is therefore included. Reaction control is thus obtained by a movement of the potentiometer knob. At one end of its travel the set will be very stable and will show little tendency to oscillate; at the other end the set will oscillate freely, and some intermediate point will be found where the set can be kept off oscillation with maximum sensitivity. That the sensitivity of the set is really high is indicated by the fact that on an outside aerial of average dimensions all of the B.B.C. stations can be heard at good strength, three or four of them being audible on the loud speaker in a small room, and the remainder at good strength in the telephones.

A number of Continental stations are also heard, and by sitting up until two o'clock I found it possible to hear a band selection from one of the American broadcasting stations on a wavelength just below that of London. It will thus be seen that the receiver has ample sensitivity, so that even with the



The three batteries used.

smallest of portable aeri-als the nearest station can be heard at excellent strength.

**One Filament Resistance**

The second point making for simplicity was the use of one filament rheostat for all valves. It is true that this method is not the ideal, and the advanced experimenter may prefer to have a separate filament control for each valve, but in practice the arrangement will be quite efficient for such a set. If you have three valves of the same make, you will find they all work at the same filament voltage in whatever part of the circuit they may be used. Again, simplicity dictated the use of one high-tension terminal for all three valves.

**The Layout**

The layout of the set is somewhat different from the normal, for by placing the low-frequency transformer above the panel, by using special variable condensers (the

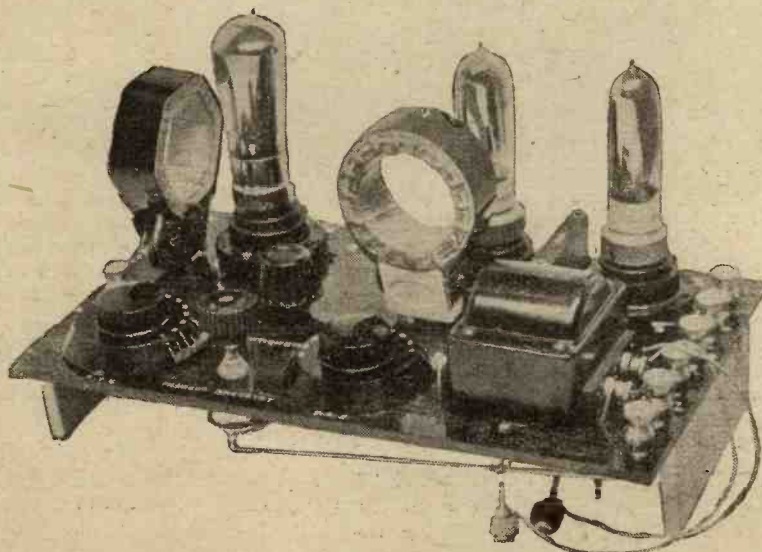

The instrument panel removed from the case.

whole of the mechanism of which is concealed inside the dials alone), and by one or two other special arrangements, the wiring projects only about one inch below the panel itself. This means that when the panel is placed in a suitable case there is room for valves on the top of the panel without

already indicated, it has been possible to construct the whole of the three-valve set on a panel measuring only 12 in. by 7 in. This gives ample room for the high-tension battery and an accumulator of the non-spillable type in a bag which is not too large to be carried conveniently. The actual

One panel of guaranteed ebonite (Radio Mahogany was used), 12x7x1/8 or 1/4 in. Two special variable condensers, one of .0005μF in the aerial circuit, and one of .0003μF in the anode circuit (Portable Utilities, Ltd. Dial-o-condensers). Two coil sockets for panel mounting.

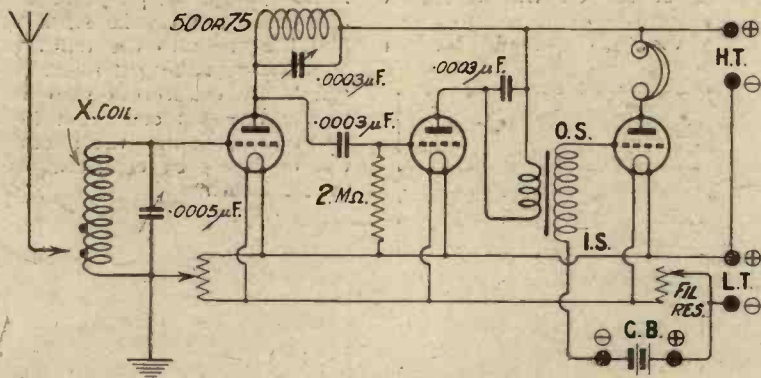

Fig. 1.—The theoretical diagram.

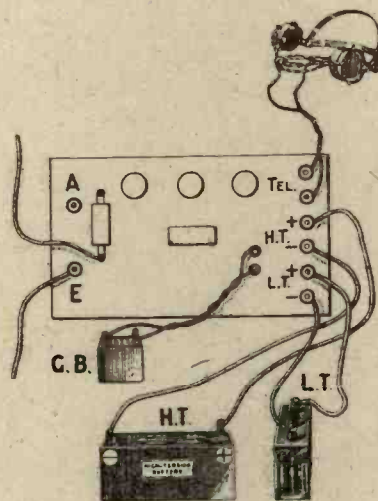

Fig. 2.—Battery connections.

obstructing the lid. So far as the valves are concerned, these are naturally to be treated with the greatest care, and for this reason three "Antiphonic" or antivibratory valve sockets are used. I do not recommend the ordinary type of valve-holder, as the jars and jolts inseparable from a portable set are likely seriously to damage the valves and their filaments.

disposition of the parts will naturally depend on the case to be adapted.

**Components Used**

Here is a list of the components I have incorporated in the set. It is, of course, possible to change several of them, but if you desire to make changes, it is well to see that those you substitute are of the correct size and are not too bulky.

- Three valve sockets, "Antiphonic" (Burndep, Ltd.).
- One first-stage intervalve transformer (C.A.V.).
- One fixed condenser, .0003μF, with clips (Dubilier).
- One 2 meg. grid leak (Dubilier), with single clip.

By a suitable choice of components and by the arrangements

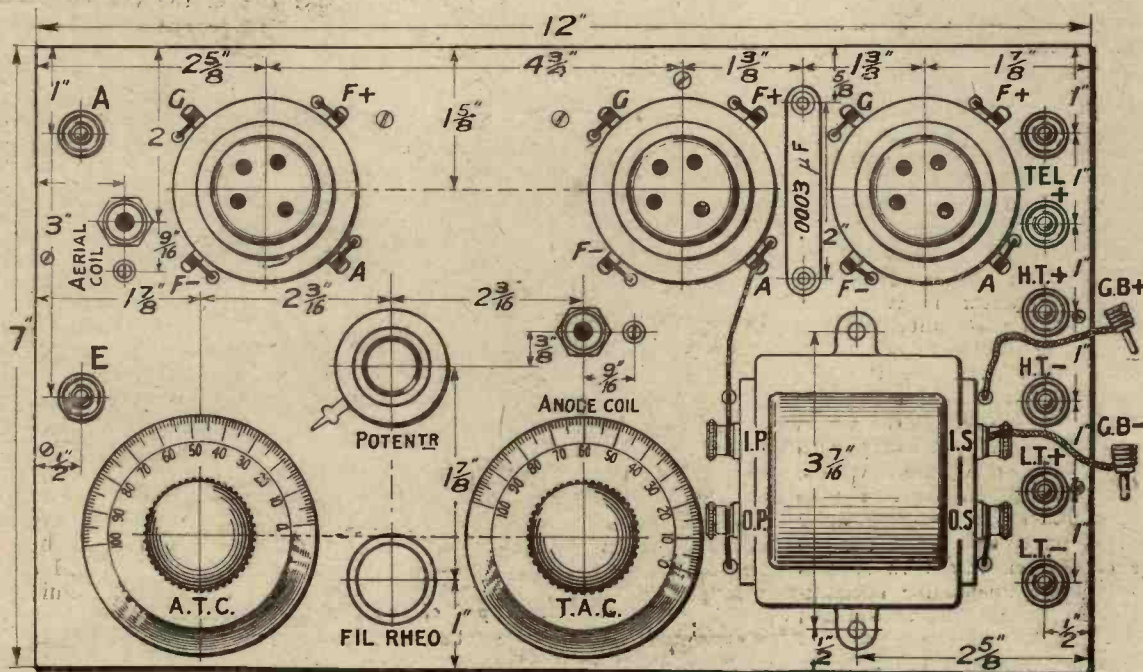

Fig. 3.—Dimensions and markings of top of panel. Blueprint No. C1012A can be obtained from Radio Press Ltd., price 1/6 post free.

One filament resistance (Microstat, Wates Bros.).

Eight terminals and nuts.

One fixed condenser with panel socket, .0003 $\mu$ F (Peto-Scott, Ltd.).

One potentiometer (R. A. Rothermel, Ltd.).

One Lissen X coil.

One No. 75 coil. (If you want to get 5XX, then you will also need a No. 150 coil for the aerial and a 200 or 250 for the anode.)

one ampere, as this is the maximum safe rate of discharge of the type of accumulator indicated. The maximum economy of current will, of course, be obtained by using the .06 type of valve which, with the accumulator shown, will run for about fifty hours without a re-charge. Against this, of course, you must set off the additional weight of the extra accumulator. Three Wuncells will run for ten

that the sockets for the aerial coil should be so arranged that the projecting pin is connected to the earth side. This is very important, as the Lissen X coil is so made that the earth side of it is connected to its socket (corresponding to the pin on the panel socket). The Lissen X coil has two terminals in addition to the plug and socket, one connected to the sixth turn, and the other to the tenth turn. You will probably get much better results by connecting your aerial to the terminal connected to the tenth turn, though the selectivity will be higher by connecting it to the sixth turn.

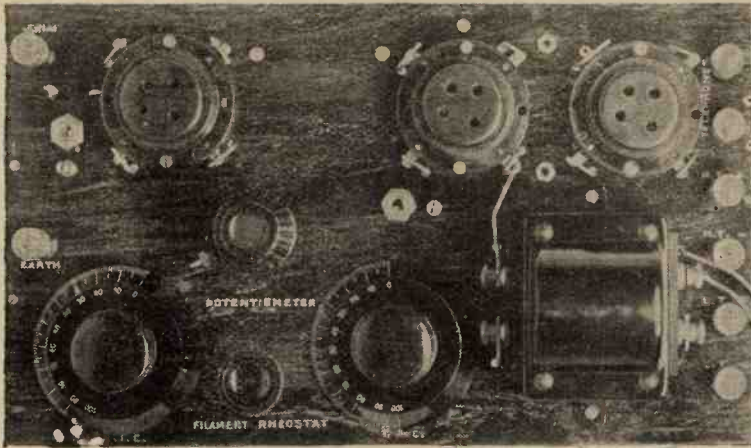

A mahogany finished panel improves the appearance.

One high-tension battery of suitable dimensions. (That shown is a General Radio Co. "Radiobat.")

One unspillable accumulator, 2 volts (Oldham & Sons, Ltd.).

Three valves.

One grid bias battery (Ever-Ready.)

Two Clix sockets or wander plugs for same.

**Valves**

So far as the valves are concerned, you have a wide choice, but whatever make they are they must be of the dull emitter type so as to run from a small accumulator, such as that shown. I recommend you to choose dull emitters which will work from a 2-volt accumulator if you want the maximum portability. If you prefer to use the .06 type of dull emitter you will require two unspillable accumulators of the size shown. Personally I have found the set to work excellently with the new Cossor Wuncell valves, the three of which together take slightly under one ampere at 2 volts. I have also used the .06 type of dull emitter with success by using two unspillable accumulators. Mullard, Marconi-Osram and British Thomson-Houston all make valves suitable for working from a 2-volt accumulator. Whatever valves you choose the total current should not exceed about

hours without a re-charge on this accumulator, which is probably as much amusement as you will require in a week-end holiday.

**Constructional Work**

The photographs and drawings, together with the free blueprint presented with this issue will give

**Chelmsford**

When using the X coil the aerial terminal of the set will be left free, but if you are desirous of receiving 5XX you will substitute for the X coil a No. 150, in which case the aerial should go to the aerial terminal proper, as marked. Be particularly careful of your connections to the potentiometer. All potentiometers have three terminals and the order is not always the same. Examine your potentiometer and you will find that one terminal (often the central terminal) is connected to the slider while the other two terminals are connected to the ends of the windings. In wiring up notice that one end of the winding goes to the positive bus-bar, or common connection to all three valves, and the other end of the winding goes to the negative bus-bar. The slider

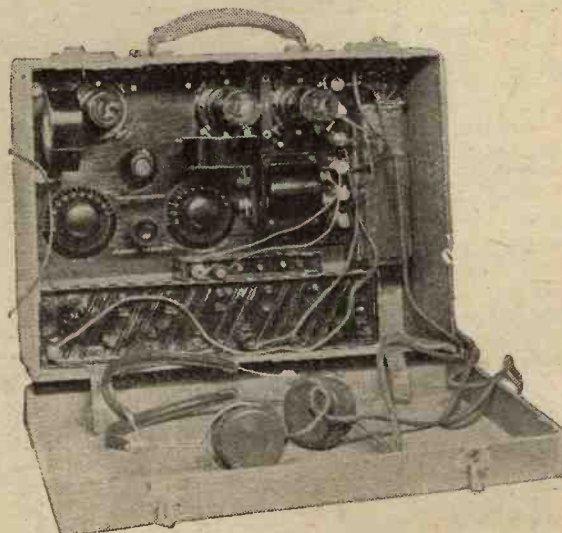

A "close-up" of the complete receiver with batteries in place.

you practically all the constructional data you need, but I should like to point out that it is essential

is connected to the variable condenser in the aerial circuit and to earth.



**The Variable Condensers**

The special and highly portable variable condensers in this set are very simply fixed by drilling a hole to take the spindle and securing this to the panel by means of the nuts provided. You will find on the central spindle several washers. These are placed there to enable the dials to be held just off the top of the panel and to allow them to be turned without touching the panel. To mount the condenser, drill a central hole and a further hole about an inch to one side of it. Pass the flexible lead from the variable condenser through one hole and the central spindle through the other. The flexible connection is made to the moving plates and the central spindle to the fixed plates. Notice that the flexible lead on each condenser must be soldered to a piece of the stiff wire at a suitable point.

**Supports**

When you have finished wiring up the panel, screw to it two pieces of wood of just sufficient depth to hold it off the table in such a way that the wiring of the underside does not touch the table. You should then choose a suitable container from among the bags available and make whatever arrangement suits you for securing the panel to the box and the high tension battery and the accumulator in place. To use the set it is merely necessary to open the box, connect the aerial (which may consist of a piece of rubber-covered flex thrown over a tree) to the correct terminal on the Lissen X coil (generally the tapping of the tenth turn) and connect the flexible earth wire to the earth terminal. This earth wire may consist of 20 ft. or 30 ft. of flexible rubber-covered wire thrown on the ground, or may consist of a shorter length fixed to a suitable earth tube, for which purpose I can recommend the Climax Earth Tube, consisting

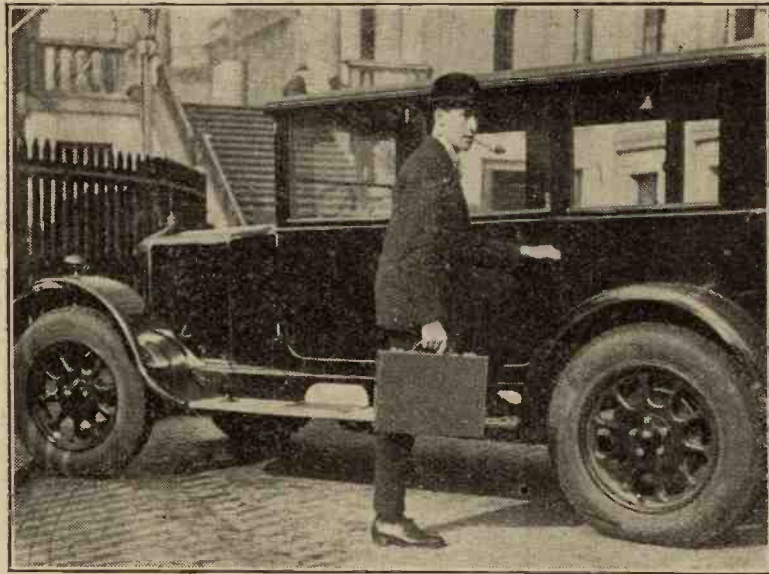

Motorists will appreciate the advantages of the self-contained outfit.

of a copper rod easily driven into the ground.

Tuning is effected by turning the knob of the filament resistance down until the valves light up. If you are using a two-volt accumulator, there is no danger of burning out your valves and the filament resistance can be screwed down as far as it will go without exercising force. Do not be misled by the lack of light with the Wuncell valves if you use them, as these valves give practically no light at all when turned on. In broad daylight it is impossible to see if the filaments are turned on at all, and even in a darkened room it is only just possible to distinguish a slight red glow. If you are using the '06 type of valve and two accumulators, you should exercise care in turning the filament resistance on so as not to burn these valves too brightly.

When you are taking this set out it is just as well to include in

the kit a small loud speaker, for the volume obtainable will be ample to operate it from the local station.

**SPECIAL NOTICE**

**Query Department**

Owing to the enormous increase in correspondence as a result of the publication of this Journal, the above department is temporarily unable to deal with further queries, although every effort is being made to provide further facilities and new staff.

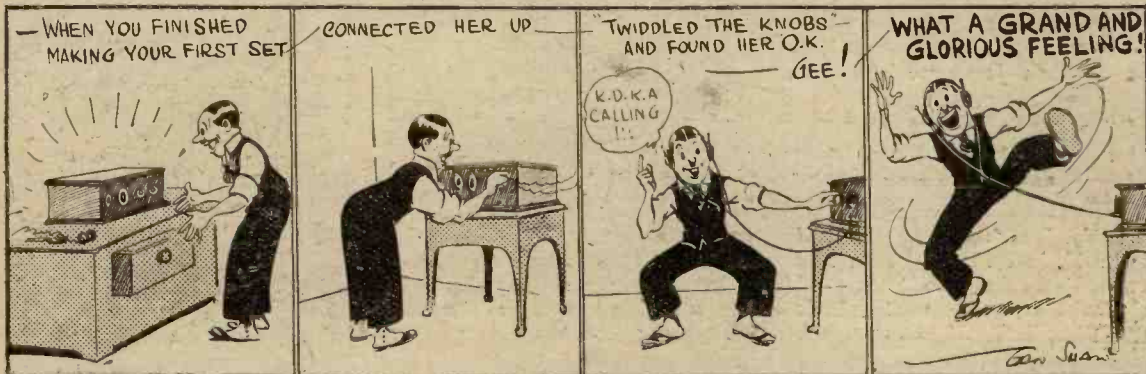

Have you ever felt like this ?

"THE WIRELESS CONSTRUCTOR" 3 V

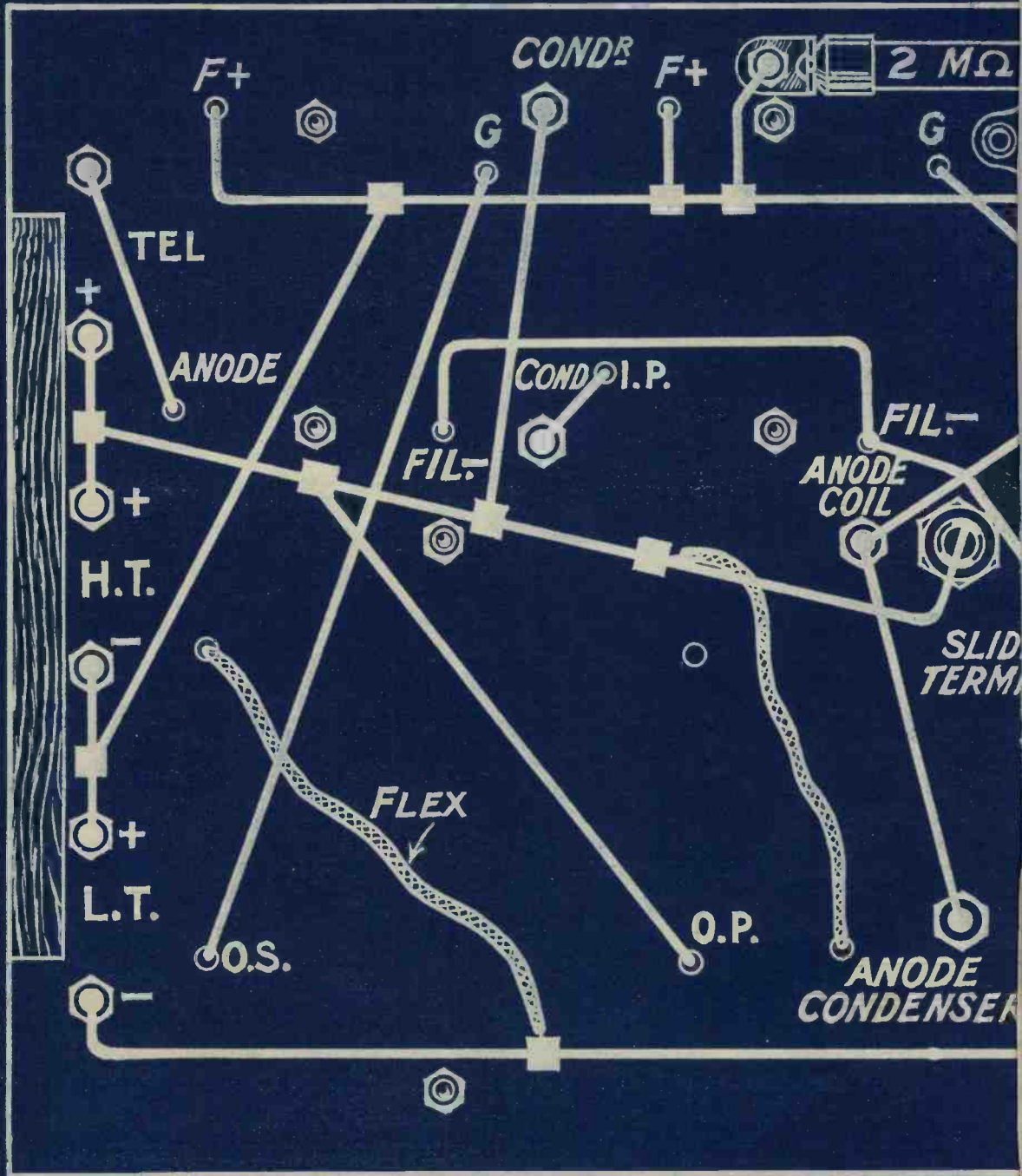

RADIO PRESS LTD., BUSH HOUSE, STRAN

**VALVE PORTABLE RECEIVER.**

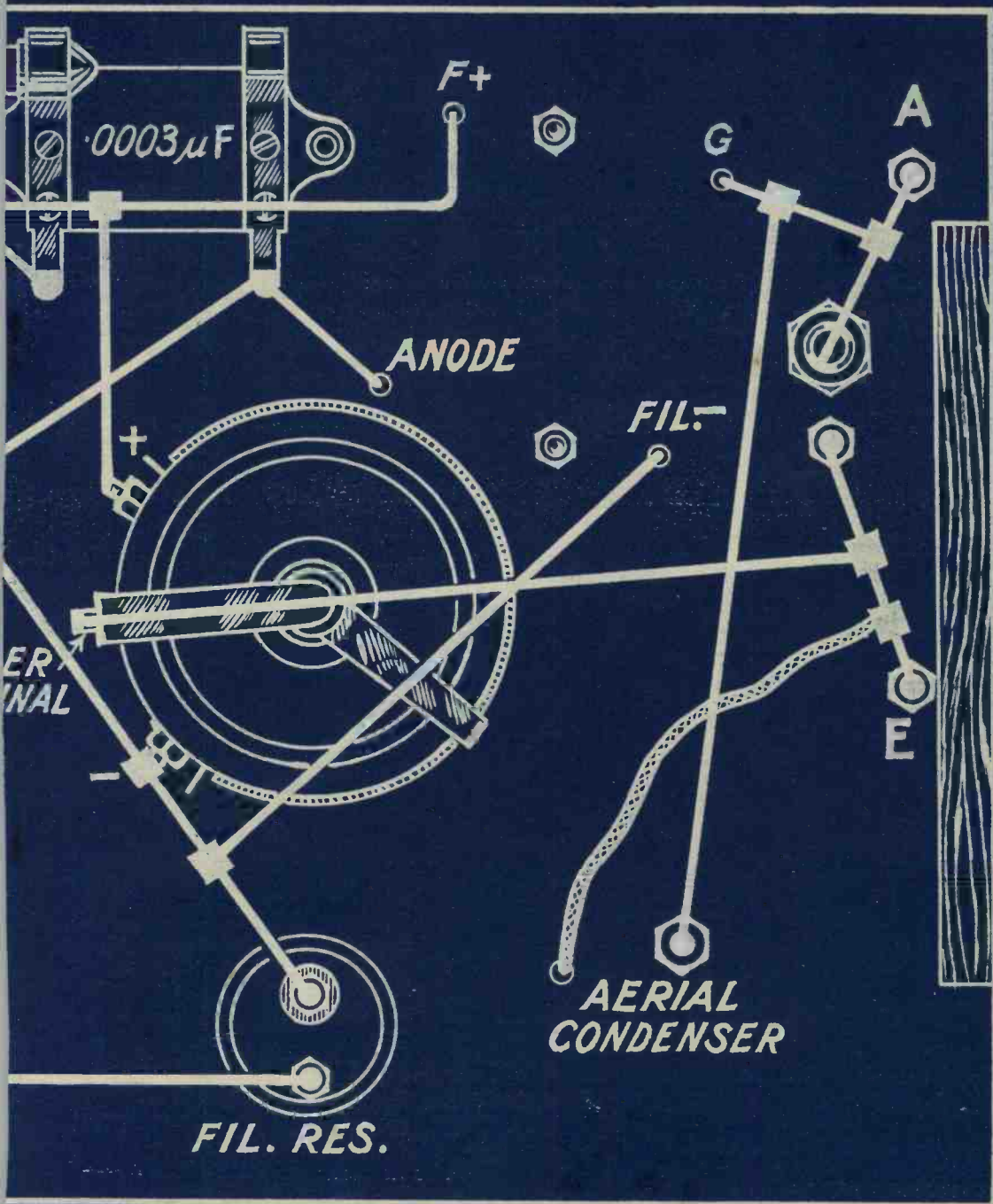

o, W.C.2. Blue Print C.1012. PRICE 1/6.

# Beneath the Shadow of Fujiyama

JAPAN TAKES TO BROADCASTING



Viscount Goto broadcasting a message through the microphone.



Mr. Kojiro Yoshimura's troupe rendering "Maganta."



Above:—Mr. Chikufu Takamine, a famous Japanese musician, broadcasting.

Below:—A trio of players—Mr. Seifu Yoshida, Mrs. Yoshida and Miss Makise.

**J**APANESE scientists have always taken a keen interest in wireless-telegraphy and telephony. Some of the earliest wireless telephony experiments were conducted in Japan, the system being known as the Teishinsho, the chief feature being

a special form of arc generated between substances, one of which was a crystal. Furthermore, Japanese liners were some of the first to carry wireless telephony installations.

It is therefore not surprising, that broadcasting has taken a firm hold upon the public of this distant land. Our photographs illustrate some well-known Japanese people before the

microphone. So far, few technical particulars are available, but we notice that a Western Electric microphone figures in all the particulars.

It will be decidedly interesting to see whether at any time Japanese broadcasting can be heard in this country. Low-power Morse signals from New Zealand have been heard on several occasions, so that there is a good possibility of the broadcasting coming through on such a wavelength as that used by KDKA (68 metres).



# THE ACCUMULATOR THAT ACCUMULATES!

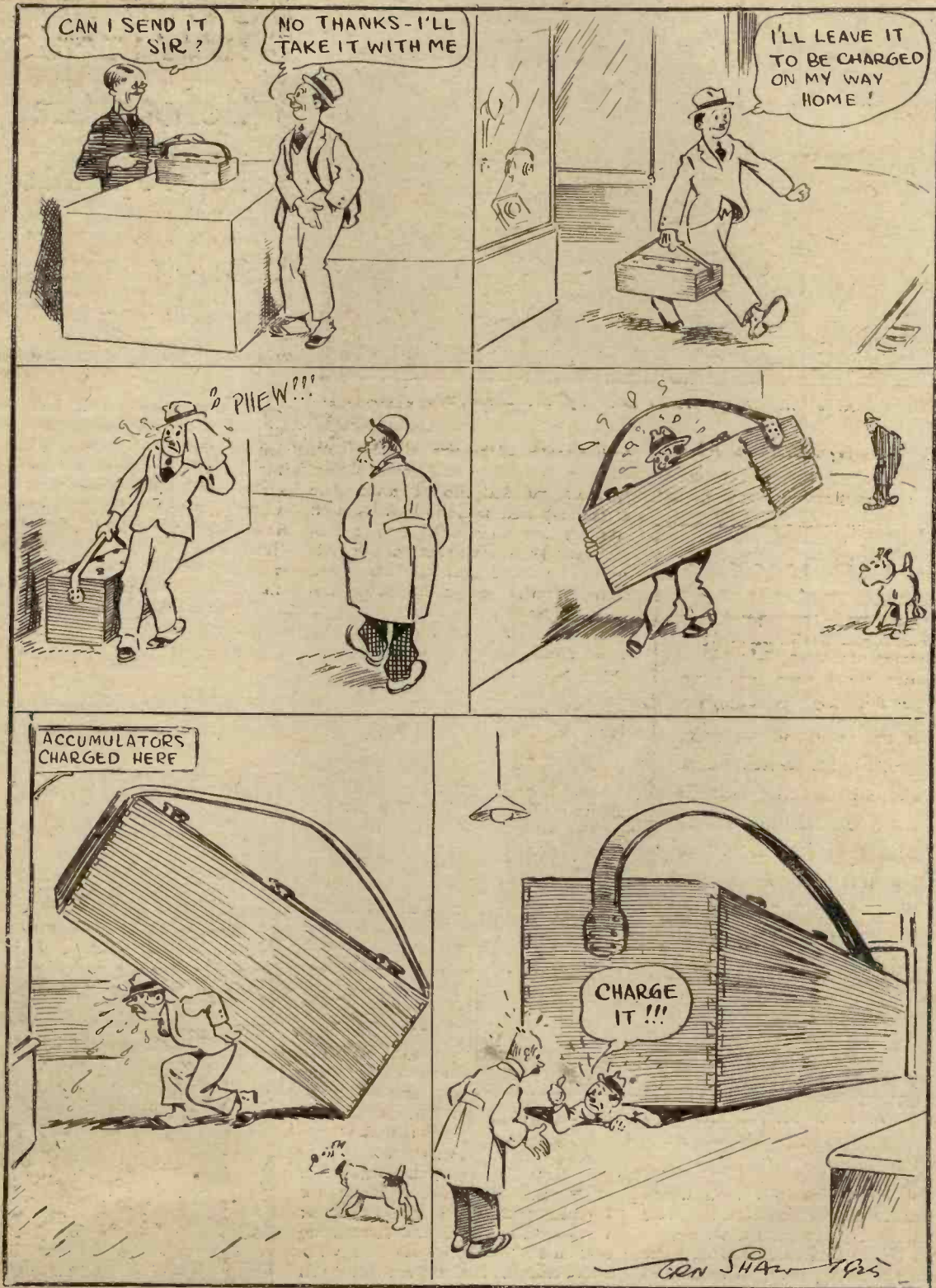

It grows on you!

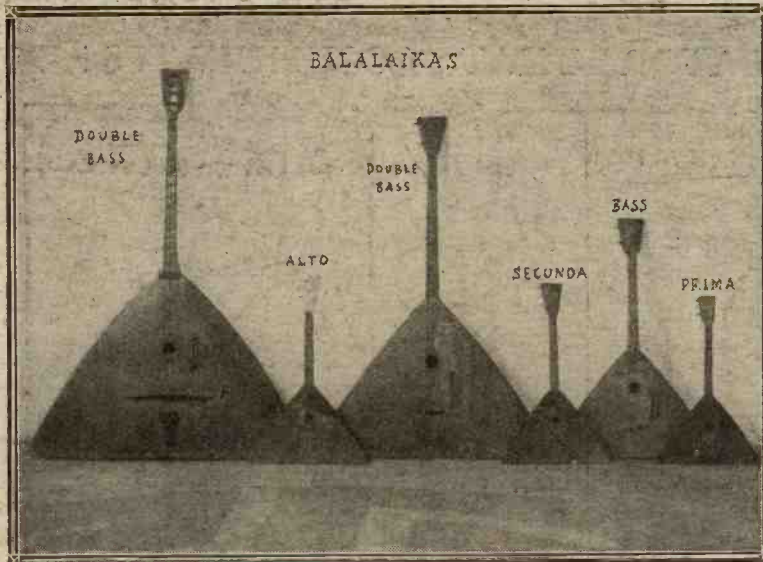

A collection of the instruments used by the Balalaika Orchestra.

PROBABLY every traveller has experienced that moment, when, half-way up a stiff ascent, he halts to survey not only the summit of his climb, but the arduous ground he has just covered. So, too, might the listener-in, who looks back on the thorny path covered by the pioneers of entertaining a world.

Instrumental music and the stage owe their beginnings to the priestcraft of the world, for, whatsoever be the nation, the priests and witch-doctors have had to



A member of M. Vladimoff's Orchestra playing the Goosli.

devise strange sounds with which to distract its peoples from the more useful task of earning a living.

To the monks can be traced the first morality play, which has developed into the "Grand Guignol" of to-day, while the cinema, the Cinderella of the arts, is due to a natural curiosity in

other nations' affairs, so that the "magic lantern" and the zoetrope of our youth has become the "super-production" of every film renter.

Wireless, once divorced from its scientific value, has appealed most strongly through the innate laziness, or, at least, the disinclination, of the average man to "turn out" again for the outside entertainment, and from the first song sent to us from Writtle by that "arch-entertaininger" Captain Eckersley, the armchair audience was made for all time, and it is to this audience that the B.B.C. has striven to appeal, tickling its palate with divers and strange sounds before the microphone.

**The Organ**

One of the earliest of the instruments to be heard outside of the actual studio was the pipe organ, and though the best medium for broadcast music, a fine exponent was found in Mr. Frank Armstrong and his "golden pipes" at the Æolian Hall. He has probably given more concerts than any other organist, and the results were excellent, considering the nature of the instrument. Experiments

**Strange Instruments Before the Microphone**

By "CARRIER-WAVE"

were also made with the organ at the National Institute of the Blind, where it was played by Mr. William Wolstenholme, the blind organist, and Mr. Goss Custard, the best results, however, being obtained when Mr. Stanton Jefferies, then Musical Director of 2LO, as well as a famous organist, made the broadcast of organ music a revelation, probably by his use of the gamba and reed stops.

**The Power of Jazz**

From the atmosphere of the church to the dance of the ball-room is a far step, but very early



Mr. Will Van Allen, a well-known exponent of the banjo, mandoline and ukulele.

*Have you wondered what the Balalaika looks like? Do you know what a Domra is? This article both explains and illustrates these instruments and many others.*



Old world music was broadcast recently, when the Chaplin Trio, seen above, gave a special studio performance.

was the compelling power of jazz recognised, and the Savoy bands being but a stone's throw, as it were, the best was "good enough" for the B.B.C. The Savoy Havana and Orphean Bands have become firmly established in London by the sheer artistry of their performance, jazz though it be. This is not surprising, as the players are not imported merely from America, but drawn from all quarters of the globe, and new instruments and formations are being constantly welded into the whole combination. It is reckoned that in the course of an evening the band use some forty different instruments. Chief amongst them

is the two-manualled piano, which gives the power and effect of two instruments without requiring two players or losing in precision. The two manuals can be coupled like those of an organ, or played separately. Though first used by the Savoy bands, these pianos are now in use in most of the big dance bands of America.

**A Great Russian Band**

In considerable contrast, but equally popular, is the orchestra formed by the national instruments of Russia — the domra, balalaika, and the goosli. Here, again, the B.B.C. went to the most famous band in the world, that formed by M. Vladimir Vladimoff, a former Russian diplomat, and a friend of M. Andreeff, who had revised the use

of these instruments in pre-war days. Balalaika bands have been imitated, but there can be no comparison between them, for M. Vladimoff's orchestra, at present also the only one in England, is composed of old Russian instruments, without the addition of any



Mr. Cramer, a member of the Balalaika Orchestra, is soloist at Bournemouth on Hawaiian instruments.



Mr. Thomas Dickie, of the B.B.C., and his contra bassoon.

but is played with a keyboard as well as the medium of the strings. Like most of the stringed instruments, they carry well over the aether, and M. Vladimoff, heard again last month, is always assured of a welcome before the microphone.

**The Hawaiian Instruments**

Though it is a wide step between Europe and the Pacific Islands, few people know that the national instruments of Hawaii have originally sprung from the Spanish and Portuguese guitars, especially the "ukulele," which, though now the national instrument, was originally copied from the guitars which the Portuguese sailors of the seventeenth century often enforced upon the natives instead of money. The native words "ukulele," or in the sailors' slang, "bounced pay," were gradually applied to these instruments. These too gained improvement, and became the Hawaiian steel guitar, which are here reproduced by the courtesy of Messrs. Hawkes, the makers of the finest modern types of all stringed and jazz instruments. The improvement of the Hawaiian guitars was made by accident rather than design. While being played by a young native, Kekuku, at Honolulu, a screw was broken. Picking up the first thing handy, an ordinary steel bolt from the railway track, Kekuku started to repair his instrument. The steel bolt slipped along the strings, and the effect fascinated not only Kekuku, but other players. At first a steel knife was used, but this required sterner stuff for strings than gut, so that steel wires and a fixed slide made the guitar

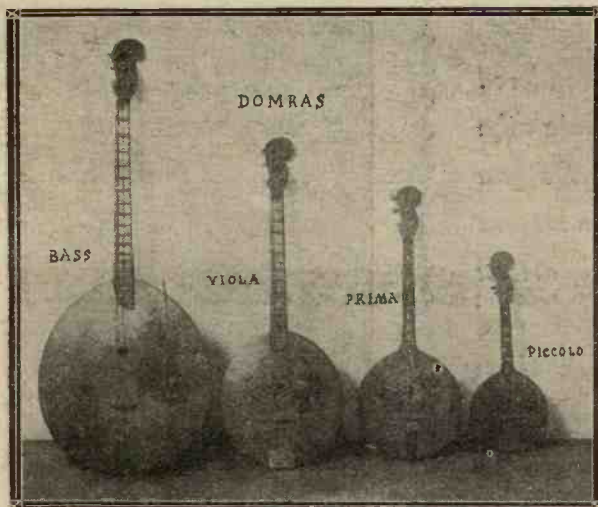

A collection of Domras. These instruments were originally developed from the Tambur of the Persians and Arabians.

of to-day. Mr. Cramer is an adept on this, as well as the balalaika, for he is, too, a member of Vladimoff's orchestra.

**Mr. Will Van Allen**

Another expert on the strings is Mr. Will Van Allen, once known as the "Musical Tramp," when he could hold an Allhambra audience for months with his manipulation of the banjo, mandoline, and the

was made with Mrs. Violet Gordon Woodhouse, and the success with this 18th century instrument led to further recitals, notably the most recent one, when the famous Chaplin Trio broadcast old-world music for a special studio performance of the "Beggars Opera," which they accompanied, as they had done throughout its four years' run at the Lyric Theatre, Hammer-smith. The three sisters have made

"ukulele," on which he is a great authority. All of these he has played before the microphone, with tremendous success.

**Old-World Music**

Naturally the piano has been the most tested instrument, but a still more interesting experiment was made when an attempt to broadcast the harpischord and the old world instruments took place. For the former the first



The Balalaika Orchestra, which is now so popular among listeners-in. M. Vladimoff is seated in the centre of the group.



a special study of the harpischord, (Miss Nelly Chaplin) the viola da gamba (Miss Mabel Chaplin) and the viola d'amore (Miss Kate Chaplin), the immediate forerunners of our modern piano, violoncello and violin, of which they are also noted exponents. Amongst the many experiences are the revivals

Nancy Lee, the latter being no longer connected with the B.B.C. The harp, however, is equally successful, in the hands of Miss Sidonie Goossens,



Miss Nellie Norway, the only lady bell soloist, who has been heard several times from the London station.



Mr. Frank Armstrong, the well-known organist, at the Æolian Hall Organ.

of Olda Dances, a year or so spent in France playing to the troops with Miss Lena Ashwell's Concert Parties and their present engagement at the Lyric Theatre for "The Rivals."

Another famous player of the viola d'amore is Mr. Percy Frostick, at the Leeds-Bradford station. A prodigy violinist at Queen's Hall, and known subsequently all over the world as violinist as well as conductor, Mr. Frostick has made a special study of this instrument. He possesses a particularly valuable specimen. This has six strings, with a corresponding number of wire strings running under the bridge and finger-board, which are known as sympathetic strings, the vibrations of which give the tone a singularly beautiful quality. Though it may be termed a semi-obsolete instrument, many musicians have recognised its value, amongst them Berlioz, Meyerbeer, who wrote a big obligato for it in "Les Huguenots," and Charpentier, who used it in his score of "Louise." Mr. Frostick broadcast recently the second Sonata of Ariosti (1716), and several modern solos which were vastly improved by being thrown a century back, though this was due as much to the artistry of the player as to the instrument.

the harpist at 2LO, and of Miss Jeanne Chevreau, the brilliant young harpist of the B.N.O.C., whose solos at 2LO formed a very enjoyable item



Mr. Percy Frostick, with his viola d'amore.

Another unique experiment was made by the B.B.C. in order to avoid the use of a double-bass. This was overcome by using the contra bassoon, and though this instrument has very few exponents, luckily Mr. Thomas Dickie, of the London Symphony Orchestra, was at hand. The particular instru-

ment which he uses is the only one of its kind in England. Other players are Mr. Charles Draper, of the Royal Albert Hall, and Mr. Foote, A.R.C.M. Mr. Dickie has made the playing of this instrument a fine art, and its importance at 2LO cannot be minimised.

Amongst the strange instruments also may be placed the bells of Miss Nelly Norway, though they have given most beautiful effects. She enjoys the distinction of being the only lady bell soloist, and was the first to specialise as an individual artiste at the famous Maskelyne and Devant Home of Mysteries. Her bells have been heard several times at 2LO, and have unique effects over the aether.

**Broadcast Stunts**

We have had various experiments at the Zoo, from the first attempt to discover whether the elephant obeyed the voice or the stick of the keeper, to the sounds of the hyenas and parrots, not forgetting the nightingales wooed and won by the 'cello of Miss Beatrice Harrison.

Then, too, comes the booming of Big Ben, though now a regular artist and "on the staff" of the B.B.C. Several stunts also have been in the way of queer visitors, including the Indians who were brought over last year to illustrate the big famous Lasky film "The Covered Wagon," and they were persuaded to come to 2LO and give their famous war-cries.

**The Orchestra**

The strings of course invariably broadcast best, as evidenced by the 'cello solos of Mr. Cedric Sharpe, Miss Daisy Kennedy and Miss

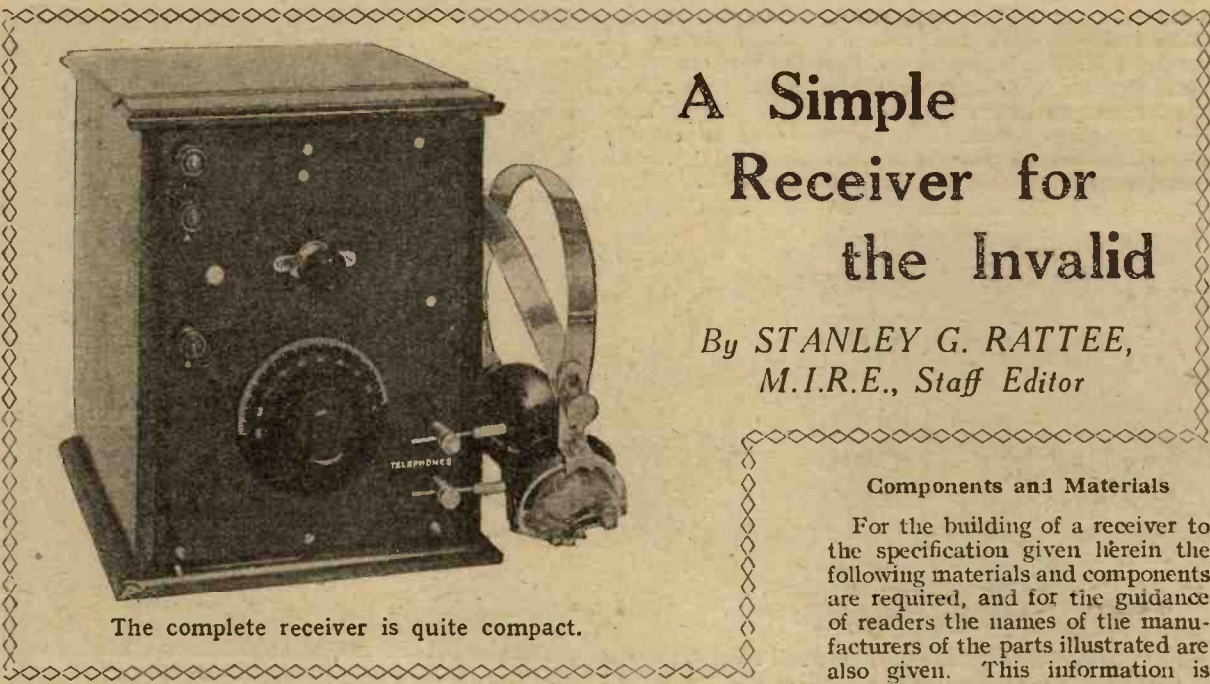

The complete receiver is quite compact.

# A Simple Receiver for the Invalid

By *STANLEY G. RATTEE, M.I.R.E., Staff Editor*

### Components and Materials

For the building of a receiver to the specification given herein the following materials and components are required, and for the guidance of readers the names of the manufacturers of the parts illustrated are also given. This information is intended merely as an assistance to readers, and does not necessarily imply that other makes of the same values may not be substituted; on the contrary, so long as the components are of good make, the reader may make his choice with the full knowledge that his results will be the same.

One ebonite panel measuring 6 in. by 8 in. (That in the photograph is a Radion "Mahogany" panel and is  $\frac{3}{8}$  in. thick.)

One permanently adjusted

**T**HE receiver to be described is one designed for the special consideration of the infirm or aged, or for those people who, not having any interest in the adjusting of their apparatus, wish only to turn a knob to receive the broadcasting. In view of these conditions, everything in the way of adjustment which can be fixed is adjusted to give the best result and then protected by the containing box to prevent mishandling or interference.

The receiver is made up with a special low-loss coil, arranged in such a way as to permit auto-

is enclosed within the box and, after being adjusted for the correct position, all further control of the valve filament lighting is given by the "on" and "off" switch seen in the photograph. Apart from this switch, the only other control which the operator is called upon to operate is the variable condenser, and, since a low-frequency valve is used to amplify the signals, tuning need not be carefully carried out for loud signals, though with proper tuning results will, of course, be even louder.

### Chelmsford

Allowance is made for the inclusion of a loading coil when it is desired to receive the Chelmsford station, and, whether or not this coil is used, the operation of the receiver remains precisely the same, the only difference in the manner in which it is used being that for the reception of the 300-500 metre station the aerial is connected to the lower terminal of the three seen on the left of the set, whilst for the reception of Chelmsford (with the loading coil added) the aerial is connected to the top terminal.

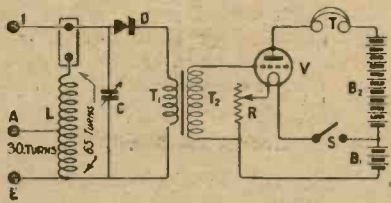
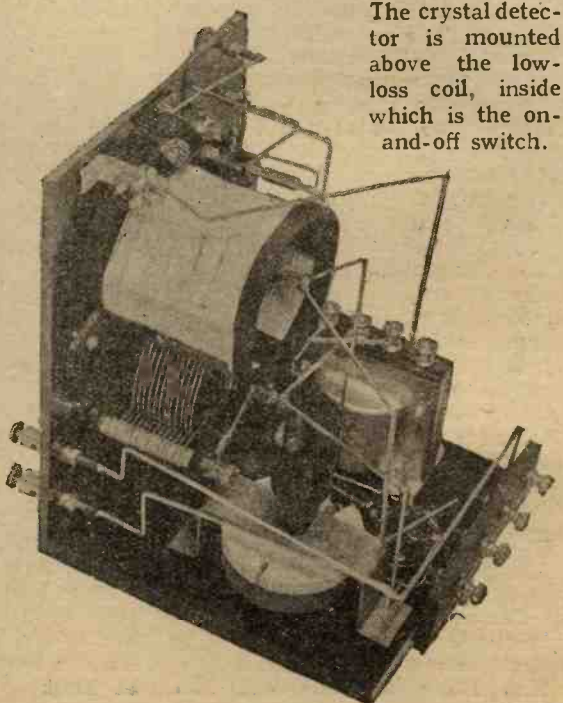

Fig. 1.—The circuit in theoretical form.

coupling, with the consequent selectivity which such an arrangement gives. The tuning circuit is followed by a permanently adjusted crystal detector, which is, again, followed by a low-frequency transformer-coupled valve; the circuit, in short, is a crystal receiver with one low-frequency stage.

### Enclosed Filament Resistance

In order to make the operation of the receiver as simple as possible, the filament resistance for the valve



The crystal detector is mounted above the low-loss coil, inside which is the on-and-off switch.

# LISSENIUM

BUILD WITH ALL  
LISSEN PARTS—  
THERE IS ONE FOR  
EVERY VITAL PLACE



## DON'T MIX YOUR PARTS

With all Lissen Parts  
your receiver will give  
Results which would  
never be possible with  
Mixed Parts



RECEIVERS WHICH ARE FITTED  
WITH LISSENSTAT CONTROL ARE  
EQUIPPED FOR THE FINEST  
DETECTION POSSIBLE.  
LISSENSTAT MAJOR  
(pats. pending) gives the  
most acute tuning  
possible. **7/6**

LISSENSTAT MINOR (pats. pend-  
ing) is replacing many thousands of  
inefficient rheostats. Pro-  
vides LISSENSTAT con-  
trol at a popular price **3/6**

Ask for  
**LISSENAÇON  
COILS—**  
the Coils which  
intensify Tuning



WITH THE LISSEN VARIABLE GRID  
LEAK YOUR RECEIVER WILL  
YIELD THE UTMOST SENSITIVITY  
WHICH CORRECT GRID  
POTENTIAL UNDER ALL **2/6**  
CONDITIONS IMPLIES

IT IS WORTH WHILE FITTING  
LISSEN FIXED CONDENSERS, TOO.  
MADE WITH SCRUPULOUS CARE—  
ACCURATE TO WITHIN 6%—THEY  
NEVER VARY — NEVER LEAK.  
THEY DELIVER ALL THEIR  
STORED UP ENERGY.

·0001-0009.....	2/-
·001-002.....	2/6
·004-006.....	3/-

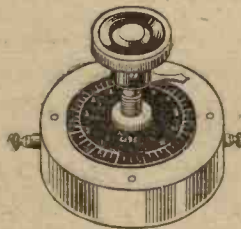

On short wave work where tuning  
is so critical the LISSEN MICA  
VARIABLE CONDENSER with its  
open scale and delightful tuning  
characteristics fills a great need.

Negligible minimum, maximum rated  
at ·001. THIS LISSEN CONDENSER  
GIVES YOU EVERY CAPACITY YOU  
WILL EVER NEED—IT SUPER-  
SEDES ALL OTHER CONDENSERS  
—AND IT IS TOTALLY **17/6**  
UNLIKE THEM

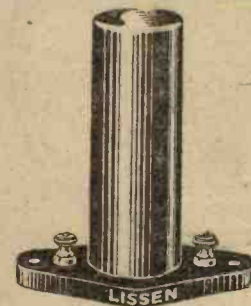

TO BUILD UP PURE SOUND AND  
YET RETAIN VOLUME THE LISSEN  
L.F. CHOKE IS RAPIDLY GAINING  
FAVOUR. This method of L.F. cou-  
pling gives the purity of resistance  
capacity coupling without the ne-  
cessity for a large H.T. voltage and  
is also very suitable  
for power amplifica- **10/-**  
tion



THE LISSEN T1 TRANSFORMER  
WILL AMPLIFY A WHISPER TO A  
GREAT DEGREE OF LOUDNESS IN  
A BACKGROUND OF ABSOLUTE  
SILENCE. It is the Transformer  
which should be particularly used im-  
mediately behind the detector valve.  
The LISSEN T1 TRANSFORMER is  
distortionless, for one reason, because  
the impedance of the transformer is  
obtained by means of the exceptional  
coil used and not by the use of a heavy  
iron core which always tends to distort.  
THE LISSEN T1 TRANSFORMER  
has a most expensive coil—IT WOULD  
AMPLIFY BY ITSELF **30/-**  
WITHOUT ANY IRON  
CORE AT ALL

Write for Text Book  
of Lissen Parts  
**FREE** to Readers of  
'Wireless Constructor'

# LISSEN LIMITED

30-32, Woodger Rd., Gold-  
hawk Road, Shepherd's  
Bush, London, W.12

Telephones : Riverside 3380, 3381, 3382, 1072

Telegrams : " LISSENIUM, LONDON "

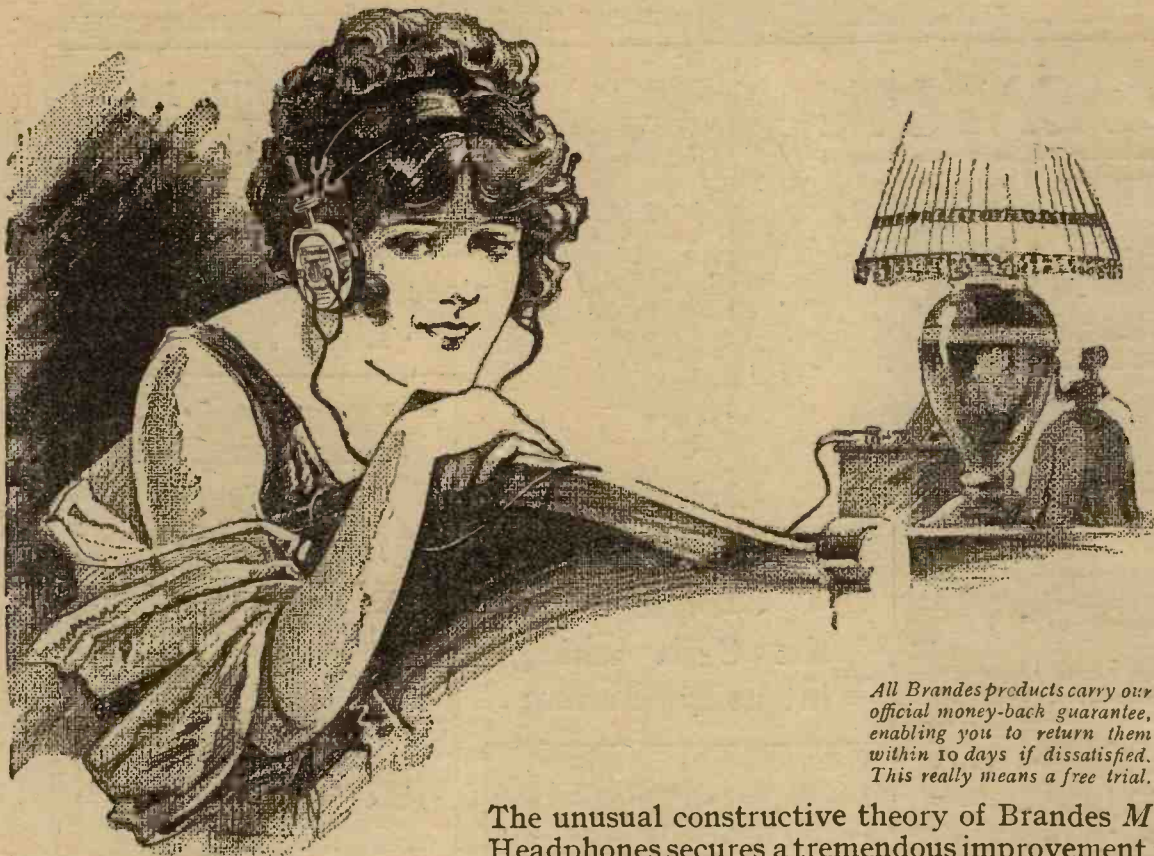

Brandes Superior  
Matched Tone  
Headphones  
PRICE NOW

20/-

All Brandes products carry our official money-back guarantee, enabling you to return them within 10 days if dissatisfied. This really means a free trial.

The unusual constructive theory of Brandes Matched Tone Headphones secures a tremendous improvement in accuracy, sensitivity and volume. A simple explanation is this: strike the same note at the same instant on any two musical instruments of the same kind. It's a hundred chances to one against both notes being of the same strength and pitch. Consequently, they jar, and you would much rather hear one alone. If both notes were exactly similar it would be pleasing, and you would have greater volume and clarity. Brandes, with both receivers matched to exactly the same degree, achieve the desired end. Ask your Dealer for Brandes.

The Table-Talker is another Brandes quality product at moderate price. Its full round tones are wonderfully clear and pleasing. The horn is matched to the unit so that the air resistance produced will exactly balance the mechanical power of the diaphragm. This means beautiful sound balance. Gracefully simple of line, it is finished a shade of neutral brown and is twenty-one inches high.

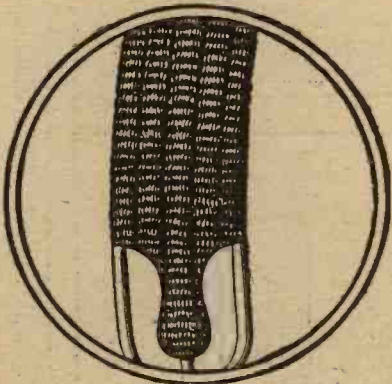

.....every one of these advertisements will show an added advantage in the construction of Brandes Headphones.

The headbands are made of piano wire covered in soft, corded webbing. At both ends the wire is firmly clamped together so that the original shape may be easily bent to fit the natural line of the head without fear of injuring the headband. They mean comfort without hard and irritable constriction.

British Manufacture  
(B. B. C. Stamped).

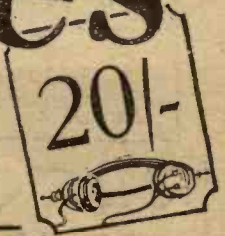

Table-Talker  
42/-

# Brandes

The Name to know in Radio

Brandes Limited, 296, Regent Street, W.1  
WORKS : : : : Slough, Bucks



## Superior "Matched Tone" Headphones

TRADE MARK

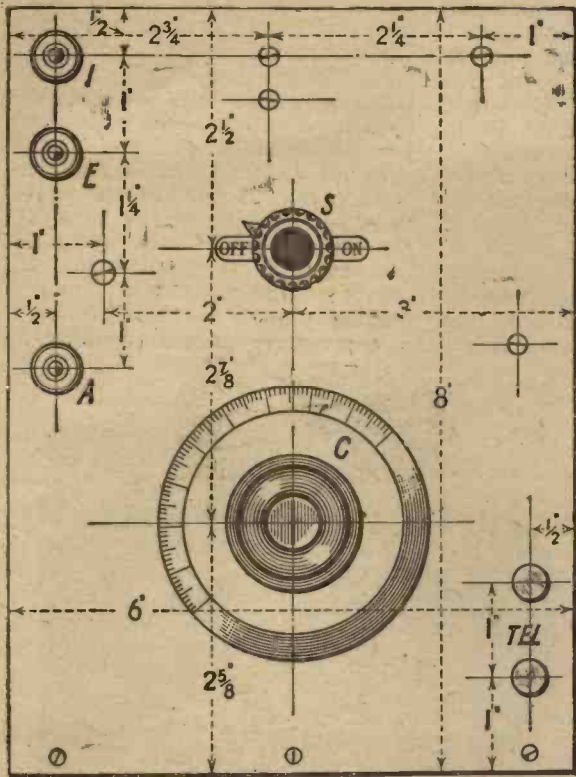

Fig. 2.—The drilling diagram. Note that very few holes are required.

prepare the coil, which is wound upon a former similar to that used in the ABC wavetrap.

As these formers are easily procurable from most retailers, it is not recommended that the constructor make one himself and for that reason no dimensions for the former are given. To wind the coil, first drill a small hole in the side of the former and through this thread the end of the reel of No. 22 wire and twist it round in such a way that it is held secure. With some one holding the reel of wire, hold the former in the two hands and, after taking up the slack, turn the former towards you so that the

wire winds itself upon the former, taking care that the turns are tight and are wound straight. Proceed in this manner until 30 complete turns are wound, when, with the thumb of the left hand holding the turns so that they do not unravel, make a 6 in. loop with the wire in the right hand and twist it round until the twist reaches the former, when proceed to wind a further 35 turns, making in all 65 turns upon the former.

With these 65 turns successfully wound, leave about three spare inches and cut the wire, securing it from untwisting in the same way as was done with the beginning of the winding.

**The Circuit**

The circuit of the receiver is shown in theoretical form in Fig 1, and it will be seen that if we short-circuit the loading coil socket and connect the aerial to A and the earth to E, the total number of turns in circuit is sixty-five. With this arrangement of connections we are using what is called auto-coupling, which arrangement gives a considerably higher degree of selectivity than would be the case were we to connect the aerial to terminal 1, still retaining the earth at E.

If, on the other hand, we insert

a loading coil in the circuit, we may make our aerial connection to the terminal 1, still with the earth at E, and so dispense with auto-coupling in favour of direct coupling, for upon the longer wavelength the chances of spark interference are fewer and the call for selectivity less important.

Still another arrangement is that, with or without the loading coil, the aerial may be connected to 1 with the earth to A, leaving E perfectly free, and it is largely a matter of experiment to ascertain which is the best arrangement for each individual aerial, and to retain the best connections for further use upon that particular aerial; if the set is taken to a friend's house for trial upon any other aerial, then the connections as given above should be again tried.

**The Panel**

The panel should be drilled in accordance with the instructions given in the panel layout, and with all the drill holes made with countersinking when necessary, the

crystal detector (Radio Instruments, Ltd.).

One .0005µF square-law condenser (Jackson Bros.).

One low-frequency transformer (Formo).

One valve socket for board mounting (Burne-Jones).

One ABC wavetrap coil former (Burne-Jones).

One coil-socket for board mounting (McMichael).

One filament resistance for board mounting of a suitable type for the valve it is intended to use, i.e., bright or dull emitter (Metropolitan-Vickers).

One strip of ebonite, 4 in. by 1 in. by 1/4 in.

One baseboard measuring 6 in. by 6 1/2 in. by 3/8 in.

Nine terminals.

One short-circuiting plug.

One containing box (Camco).

One "On and Off" jack (Frost-Rothermel).

Quantity of connecting wire.

Half-pound No. 22 d.c.c. S.W.G. wire for winding the coil (Burne-Jones).

One set of Radio Press panel transfers.

One strip of ebonite measuring 4 in. by 1/2 in. by 1/4 in.

**The Coil**

Before commencing to drill the panel, it is probably better to

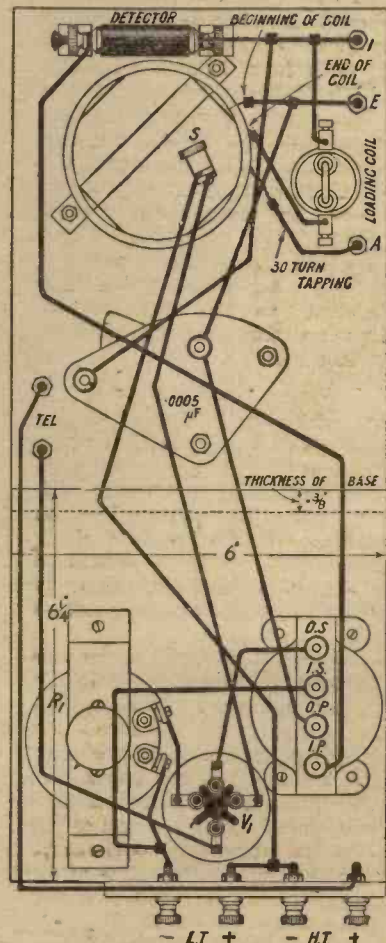

Fig. 3.—This shows the wiring as if the panel and baseboard were "flattened out."

components may be mounted. In connection with this work, it is advocated that the "on" and "off" switch be mounted first as the projections from this are situated *inside* the coil when the latter is mounted.

With the switch in position the variable condenser should next be mounted, after which the coil should be secured to the panel in the following manner: Place the coil over the switch and between the lower edge of the former and the coil winding, insert the ebonite strip whose dimensions are  $4 \text{ in.} \times \frac{1}{2} \text{ in.} \times \frac{1}{8} \text{ in.}$ , and secure temporarily by means of two 6 BA screws as is shown in the photographs. Now position the coil, by sliding it about, until it clears the moving vanes of the variable condenser, when the two 6 BA screws should be tightened up. The mounting of the remainder of the components upon the panel depends upon the constructor's inclination, and when all have been mounted, attention should be given to the baseboard.

Before securing the panel to the baseboard, the ebonite strip, measuring  $4 \text{ in.} \times 1 \text{ in.} \times \frac{1}{8} \text{ in.}$ , should be fitted with four terminals equally spaced, and the whole secured to the baseboard, as shown in the photographs, by means of two wood screws. With this done, the panel should be secured to the baseboard by three further wood screws and the mounting of the components upon the baseboard proceeded with in the order most convenient to the constructor, though no alteration in position must be made.

#### Wiring the Receiver

The wiring-up of the set should present no difficulty, in that every component is easily accessible, even with a large soldering iron. The wiring must be carried out in accordance with the practical wiring diagram, and all leads should be well spaced from each other, in addition to being kept as short as possible.

With regard to the connections to the coil, these are made in the following manner: The thirty-turns tapping is connected to terminal A, whilst the two ends of the low-loss coil are connected, one to one side of the loading coil socket, whilst the other end of the low-loss coil is connected to the earth terminal F, the moving vanes of the  $0.0005 \mu\text{F}$  condenser, and one side of transformer primary.

#### Operating the Receiver

Having decided upon the type of valve to use insert it in the valve socket. turn the "on" and

"off" switch to the "off" position and the filament resistance also to an "off" position, and connect a suitable accumulator giving the required voltage. Turn the switch "on" and test the lighting circuit by means of the filament resistance; assuming all is well, connect the H.T., the telephones, short-circuit the loading coil socket, connect the aerial to A and the earth to E. Now adjust the valve to a suitable degree of brilliancy and slowly turn the condenser dial until the local station is heard, when adjust

the lid of the box should be lifted, and the short-circuiting plug in the loading coil socket substituted for a No. 150 plug-in coil, tuning being again made with the variable condenser. The aerial must be joined to terminal 1.

It will be found that in time, it is necessary to readjust the filament resistance, indicating that as the accumulator is running down less resistance is required in the circuit; further, before finally leaving the set as a fool-proof instrument try readjusting the cry-

This photograph clearly shows the position of the coil socket for the Chelmsford coil.

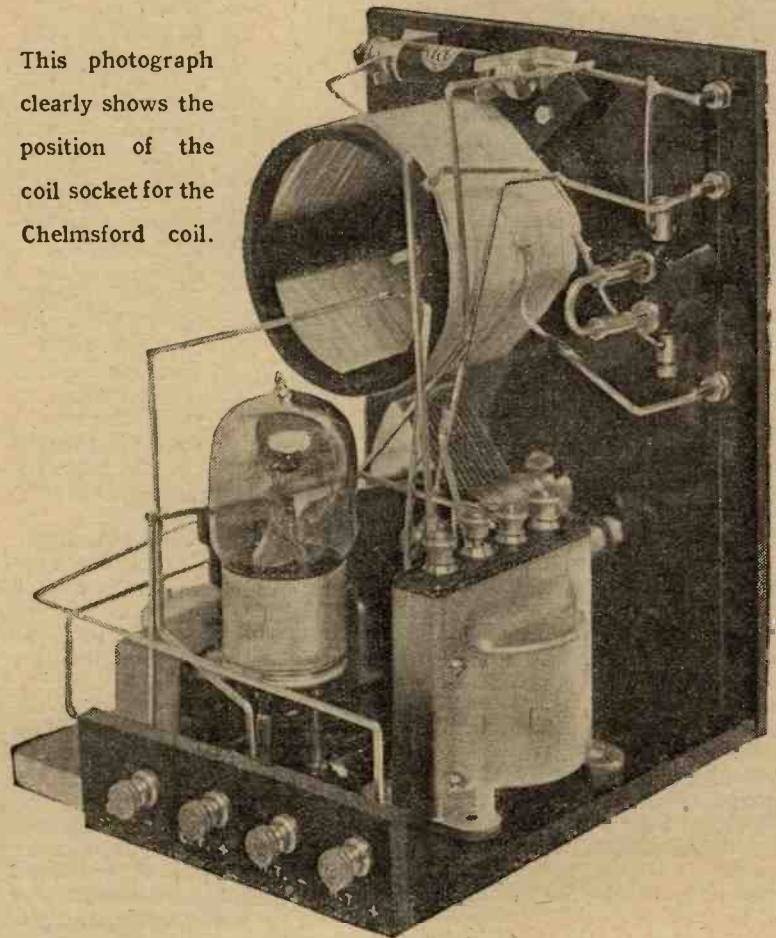

the filament resistance of the valve for the best results. With these obtained, again turn the condenser for the very best signals, and with these obtained change the aerial and earth connections as suggested above for the loudest results.

Having decided upon the best arrangement, turn the switch "off" leaving the filament resistance alone and place the set in its containing box. It will now be found that all that is required to operate the set is to turn on the switch and tune upon the variable condenser. If it is desired to receive Chelmsford,

stal detector in accordance with the instructions given by the maker.

#### Results Obtained

Using the receiver in S.E. London upon both indoor and outdoor aerials really excellent signals were obtained from both the old and the new 2LO stations, signals, when using the outdoor aerial, being audible on the loud speaker at small room strength. Using the same aerials with a No. 150 coil in the loading coil socket good signals were obtained from Chelmsford in both cases.

(Continued on page 650.)

# Duodyne

## The LONG RANGE LOUD SPEAKER RECEIVER

Guaranteed Range under average conditions:

- DUODYNE III Headphones ... 3/4,000 miles.
- DUODYNE V Headphones ... 4/5,000 miles.
- Loud-Speaker ... 1/1,200 miles.

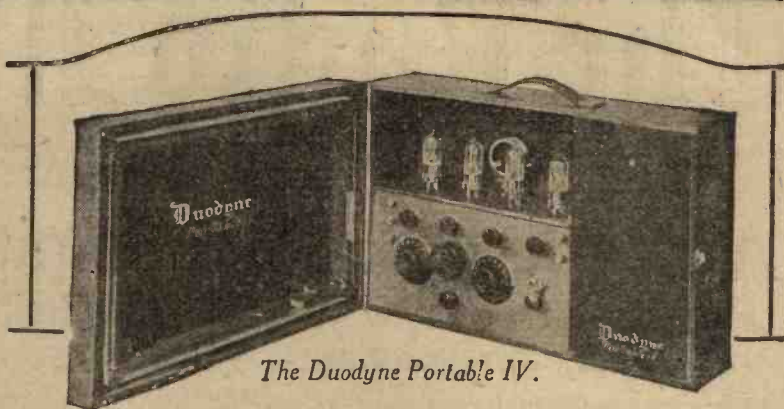

The Duodyne Portable IV.

"... With an indoor aerial on my Duodyne III I receive all B.B.C., most Continental, and four American stations nightly, whether London is on or not. Tuning is absurdly simple, as there is 'music all round the dial'..."

### Increasing the Range, Selectivity and Stability of your Super Heterodyne Receiver

The present rising popularity of the Super Heterodyne Receiver has revealed a surprising absence of suitable intermediate frequency transformers. Three or four stages, employing tuned transformers with a steep resonance peak, encourages the inherent tendency of the intermediate long wave stages to burst into self-oscillation.



Experiment has also discovered that, in all super heterodyne work the efficiency of the long wave amplifier contributes largely to the success of the complete receiver.

Where provision is made for three intermediate stages, it is suggested that two should be tuned and the remaining stage—preferably the second—aperiodic. In the case of four intermediate stages, alternate stages of tuned and aperiodic are advised.

This arrangement introduces a very desirable compromise, and permits comparatively accurate balancing up of the long wave intermediate frequency amplifier. The Curtis Constant-Tuned H.F. (Aperiodic) Amplifier provides a very efficient aperiodic coupling. It is designed with the four-pin plug-in mounting, and is interchangeable with the ordinary plug-in transformer.

The efficiency of this Curtis production is proved by its remarkable performance in the famous Duodyne Receivers. Its use in the long wave intermediate amplifier will stabilise this very important unit and will give you the control over the tendency to self-oscillate.

Finally, in such cases where an H.F. Valve is employed in front of the first detector, the Curtis Constant-Tuned H.F. (Aperiodic) Amplifier is particularly efficient. It gives just the required amount of amplification and selectivity without adding another control.

Full information and diagrams can be obtained upon request.

- Type A 300 to 800 Metres. Price 15/-
- Type B 800 to 3,000 Metres. Price 17/6
- Type C 2,500 to 7,000 Metres. Price 18/6

(Specially designed for Super Heterodynes)  
Postage 6d.



### The design and methods of manufacture of the PARAGON - CURTIS ONE - PIECE MICA CONDENSER

can alone guarantee uniform accuracy under all conditions and at all temperatures.

- .0008 to .0006 ... .. 2/6 each.
- Grid Condenser with clips ... .. 2/9 "
- Grid Leak ... .. 1/6 "

### TWO STAGES OF HIGH-FREQUENCY AUTOMATIC TUNING

THE extraordinary range and simplicity of operation, exclusive to the DUODYNE RECEIVERS, must make an irresistible appeal in Imperial and Continental markets.

### A CHILD CAN TUNE IT

The DUODYNE CABINET.—The Duodyne V is also supplied in French Polished Oak Cabinet with folding doors, enclosed valves and tuning coils. Self-contained batteries. Instrument only .. ..

£27

The DUODYNE III. (Instrument only) Panel Type .. £10 0 0

The DUODYNE V. (Instrument only) Panel Type .. £18 18 0

The DUODYNE PORTABLE IV.—25/30 miles loud-speaker on self-contained frame. The most efficient and powerful portable .. .. £21 0 0

**BUILD YOUR OWN DUODYNE**—the genuine long-distance Receiver. Circuit diagrams, layout & SIMPLIFIED WIRING CHART, detailed instructions and list of essential components in sealed envelope

1/6

### PARAGON EBONITE PANELS.

Radio Quality. Post Office Specification.

"The Best Made."

Used by "Modern Wireless," "Popular Wireless," and other Technical Journals.

Uniform Fine Grain, Dead Matt Finish, Non-Metallic Surface  
Sold by ALL Dealers in sealed carton only.

Sales Organisation:

## PETER CURTIS, LTD.

IN ASSOCIATION WITH

THE PARAGON RUBBER MFG. CO., LTD., HULL  
75, CAMDEN ROAD, N.W.1.

Telegrams: "PARACURTEX." Phone: NORTH 3112.  
BIRMINGHAM: 76, Newhall Street. Central 7236.  
MANCHESTER: 312, Deansgate. Central 5095.

# The Radio Mail

For sensitiveness  
use  
Wuncell  
Valves

Published periodically in the interest of Valve Users

## A new type of Dull Emitter Experts declare new Wuncell Dull Emitter likely to revolutionise Valve design

TO produce a Dull Emitter Valve which operates with a glow that is almost invisible in daylight is a feat that has just been accomplished by the London firm of A. C. Cossor Ltd. This new Valve—called the Wuncell because it requires only one cell to operate it—is certainly the nearest approach to the ideal of a "cold valve" that we have yet seen. Viewed under working conditions the filament could just be seen glowing in daylight, while in a dark room it could readily be likened to the embers of a dying match.

Asked to give some approximate idea of the actual temperature, a representative of the firm stated that, according to pyrometer tests, the reading was 800 degrees as against the 2,000 degrees required by Bright Emitters and even some types of Dull Emitters. For our benefit actual tests were made between the amount of heat (or light) generated by a Wuncell and other types of Valves. The differences were most marked, and demonstrated to the lay mind in a very striking manner that such a low filament temperature must mean a vastly increased life for the Valve.

### The British Valve still the best

But it was on actual Broadcasting tests that this new Wuncell showed that, so far as this country is concerned, we have nothing to fear from Continental Valve manufacturers. For the purposes of demonstration a good four-Valve set was used. For the first Valve—which acted as a high-frequency amplifier—a Wuncell type W.2 was used, while for the last stage one of the new Wuncell Loud Speaker Valves was used as a power amplifier. The other two Valves were the standard W.1 Wuncells.

Connected to a fairly good aerial in North London, 2LO had to be considerably de-tuned even for three Valves in order to prevent "blasting" from the Loud Speaker, while with the fourth valve in operation every B.B.C. main station, with the exception of Cardiff, was brought in with incredible volume and exceptional purity. Cardiff

owing to our close proximity to 2LO—could not be tuned in. The following Continental stations were also received at good Loud Speaker strength: Hilversum (a Dutch broadcasting station with call sign HDO), Bremen on 330 metres, Zurich, Radio Iberica of Madrid, and a further Continental station which could not be identified owing to "fading" but which corresponded in wave-length to Vienna.

### Wuncells just as sensitive as Bright Emitter Valves

The result of these tests certainly demonstrated that the new Wuncell Valves are not one whit less sensitive than standard Bright Emitter Valves. Another remarkable feature of these Wuncell Valves was their complete freedom from microphonic noises. It has hitherto always been an inherent disadvantage of other dull emitters that even footsteps in the room or other slight vibrations are communicated to the Valve to cause ringing noises in the headphones or Loud Speaker. All the usual tests, such as tapping the table on which the receiver was placed, adjustments of the rheostat, etc., failed to produce the slightest suggestion of a microphonic noise.

We understand that the reason for this improvement is to be found in the special Wuncell method of mounting the filament. Instead of being supported between two electrodes, spring apart to counteract expansion and contraction, its filament is arched (following standard Cossor practice) and supported at the centre by a third electrode. No doubt, too, the grid—cleverly designed and very rigid—is a contributory factor to this result.

### Use Wuncells along with Bright Emitters in the same Set

We were most impressed, not only by the very neat appearance of the Wuncell, but with the vast amount of forethought and research work that must obviously have been put into its construction. For instance, because it was realised by the designers that

many multi-valve users would like to try out one Wuncell in conjunction with their ordinary Valves, a special base was designed. This base carries a resistance in series with the filament to permit the valve being used with either a 4- or 6-volt accumulator. Normally, of course, the Wuncell functions at rather less than 2 volts. This excellent idea gives any amateur a chance of trying out one of these new Dull Emitters and comparing its behaviour with the Bright Emitters he may be using. At any later date—by the use of a small screw—the resistance can be short-circuited and the Wuncell used at its correct current of 2 volts. It is worth while noting, too, that all Wuncell valves are being supplied with the new black low-capacity base in which air only is used at the dielectric between the leads to the four valve legs.

Experts that have witnessed demonstrations of Wuncell valves have expressed their satisfaction at the production of a Dull Emitter which can compare most favourably with the best Bright Emitters. It has always been felt that hitherto a sacrifice of at least 20 per cent. in volume has been the price that must be paid to obtain the conveniences offered by Dull Emitters.

## Valves to be in sealed boxes

### One well-known manufacturer definitely decides to issue all future Valves in sealed cartons only

A move of the utmost importance has been made by A. C. Cossor Ltd.—the well-known British Valve manufacturers. They have decided that, in order to protect the public and to ensure their Valves being used in absolutely new condition, they are now sealing every Valve in its carton at the Works. Asked how it would be possible for the shopkeeper to be certain that he was selling a sound Cossor Valve, a member of the firm explained to a representative of the *Radio Mail* that this was a matter which had certainly presented some difficulties. Various methods had been carefully tried out, including sealing the legs of the Valves and other devices, but none had proved so satisfactory in practice as the method they were now adopting. This consists of wrapping the Valves in a very generous covering of cotton wool, after having first brought two copper wires from the filament legs to two studs on the end of the box. When a customer wants a Cossor Valve, these two brass contacts are placed in series with an electric flash-lamp battery and a bulb. If the filament should happen to be damaged, the circuit will not be complete and the lamp will not light. This test can be easily carried out without breaking the seal of the box by means of a very ingenious showcard, which we understand Cossor's are supplying free of charge to all Wireless dealers.

A prominent manufacturer of Broadcast Instruments emphatically endorsed this new idea. He agreed that it was a wise move that had been long awaited. The public, he declared, welcomed any method of purchasing usable accessories under a seal. In his opinion the Wireless dealer—while not shirking responsibility—considered that the manufacturer ought to take steps to see that his (the manufacturer's) responsibility ended only when the article reached the actual user.

## How long should Valves last?

### Many keen wireless amateurs get over twelve months' service

How long a Valve lasts depends very largely on how it is used. Some men can make their sets last very much longer than others—a little care and attention now and again will prevent creases forming and the material from losing its freshness. The same applies to Valve. For instance, how many amateurs know that the use of filament switches in a Receiving Set—although a great convenience—shorten the lives of the Valves very considerably. Rheostats should be used for the purpose of turning current on and off; to throw the full load on at the turn of a switch is to cause a sudden expansion of the wire used in the filament, and to switch off suddenly is to cause a sudden contraction. No Valves built can withstand such strains indefinitely.

Treat your Valves properly and you'll find they'll last very much longer. For instance, Mr. G. H. Hasemer, of 9 Galliard Road, writes as follows:—

"I think it is only right to testify to the excellence of Cossor Valves, more particularly as far as I am concerned the P.1. On December 1, 1923, I purchased two of these Valves and they have been going strong ever since, and are functioning well now. They have been in use on an average of 2½ hours per day from date of purchase, which brings present life up to nearly 1,000 hours. How long they will last I cannot say—perhaps you can estimate. However, I shall certainly repeat a selection of Cossor P.1."

While Mr. J. Harris, of 13 Stepey Bank, Newcastle-on-Tyne, thinks that sixteen months' regular service for one Cossor Valve is something of a record. Writing on January 27, 1925, he says:—

"In September of 1923 I purchased a P.1 Cossor Valve, and wish to state that it has given me excellent service until to-day. The Valve in question has never missed the Savoy Bands, nor Official Notes of the B.B.C. Total life of Valve, sixteen months. Perhaps there are others who can beat this record, but I, as an old user of Cossors, am perfectly satisfied."

Even this record would seem to be eclipsed by a Cossor P.1 which has been doing yeoman service every day for a period of 1,700 working hours on a One-Valve Reflex Set. The owner, Mr. Harold Cooper, of 8 Cotherstone Road, London, E.W. 2, expresses his satisfaction in these terms:—

"I should like to mention that I have used a Cossor No. V. 9132 in use since last September, and averaging at four hours per day (very moderate average for afternoons and evenings) it has given over 1,700 working hours, and is still going strong, and therefore bears out conclusively all you claim in your advertisement; my circuit is One-Valve Cystal Reflex."

## Cossor Valves



The Valves that give your Set that long distance feeling!

Gilbert Ad. 2405

## Have you got down to the short waves yet?

### Get ready for the new Broadcasting Stations operating on 100 metres or less

There's lots of enjoyment to be obtained from short-wave reception. If you can read Morse, you should certainly alter your set so that you can get down to 80 metres and under. Any evening will find scores of British amateurs corresponding with their friends across the seas. The most extraordinary thing about these short waves is their tremendous power of penetration. Using but very little power, amateurs can send messages immense distances. Incidentally the tuning of short waves means

the use only of high-grade components and suitable Valves. How far American amateurs can send on short waves is a matter of conjecture—it is sufficient to say that signals have been received in this country without aerial or earth. In this connection, Mr. J. Gordon Richie, the well-known Glasgow experimenter, writes as follows:—

"10th December, 1924.

"Some time ago I wrote you concerning the excellent reception of American broadcasting obtained with two of your P.1 Valves. They have since demonstrated their capabilities in another way.

I am now using a Reinartz-type receiver on the very short waves of 80 metres and under, consisting of detector and one low-frequency, and during the past fortnight have logged 105 American amateurs, of which twenty were heard on one night without either aerial or earth. Either of my two 'Cossors,' now almost two years old, are the only Valves I have got to oscillate below about 60 metres. Considering the constant use and incidental knocking about to which these Valves have been subjected, I think this speaks highly for your products, and I am looking forward to a further period of their usefulness."



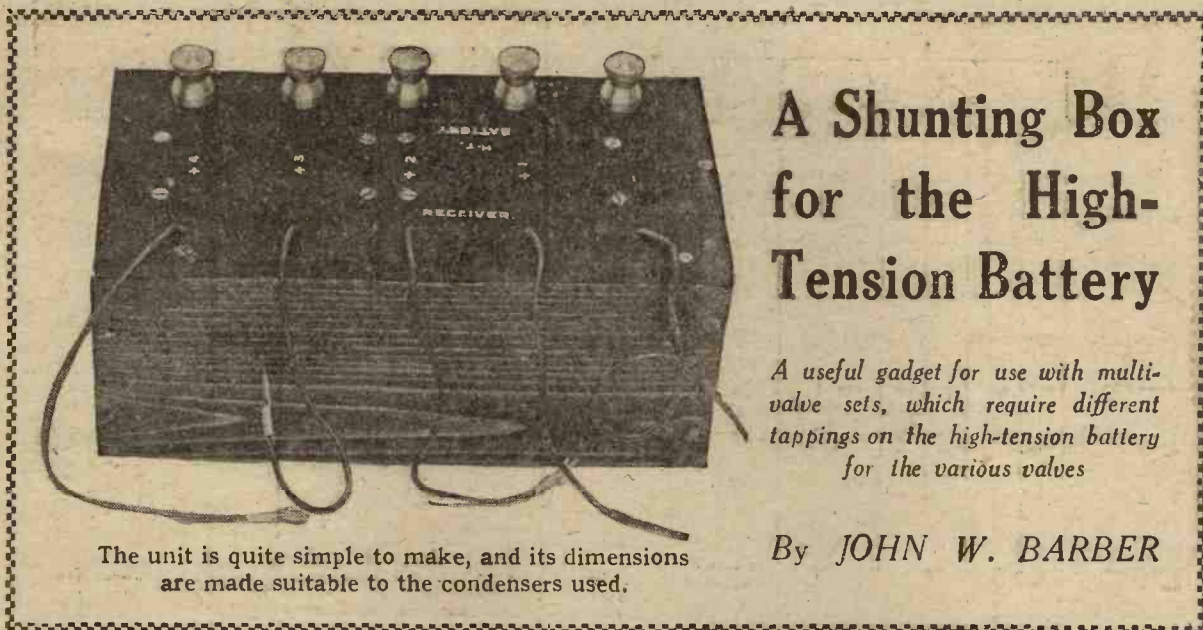

## A Shunting Box for the High-Tension Battery

*A useful gadget for use with multi-valve sets, which require different tapings on the high-tension battery for the various valves*

By JOHN W. BARBER

The unit is quite simple to make, and its dimensions are made suitable to the condensers used.

WHEN a high-tension battery is newly purchased, and, therefore, is, presumably, reasonably fresh, one can be fairly sure that noises in the receiving set are not attributable to this accessory, and must look elsewhere for the trouble. As the battery wears out, however, noises will occur, even in an otherwise quiet receiver,

or a receiver employing more valves, but which is only provided with a single terminal for the H.T. +, but when we come to consider a multi-valve set with separate high-tension terminals, perhaps, for each valve, it is obvious that our previous arrangement is useless, for the condenser cannot be joined across all the tapings at once, and thus, while the condenser quietened down one section, all the others would still be noisy.

battery; but this becomes a problem if one uses more than one set, or if one wishes to change the high-tension battery from one set to another. I have never included a condenser across the high-tension terminals in my sets, because I do not see the necessity for tying up such a condenser in each set, or, rather, one for each tapping in each set, and I have made up the box seen in the photographs in order that the shunting condensers may be kept together without any loose wires trailing all over the bench. The battery tapings are joined to the row of terminals on the right of the box, the bottom terminal

### A Condenser for each Tapping

The obvious thing to do is to connect a condenser across each tapping and the negative end of the

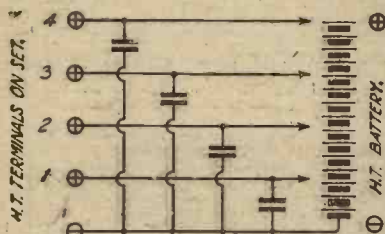
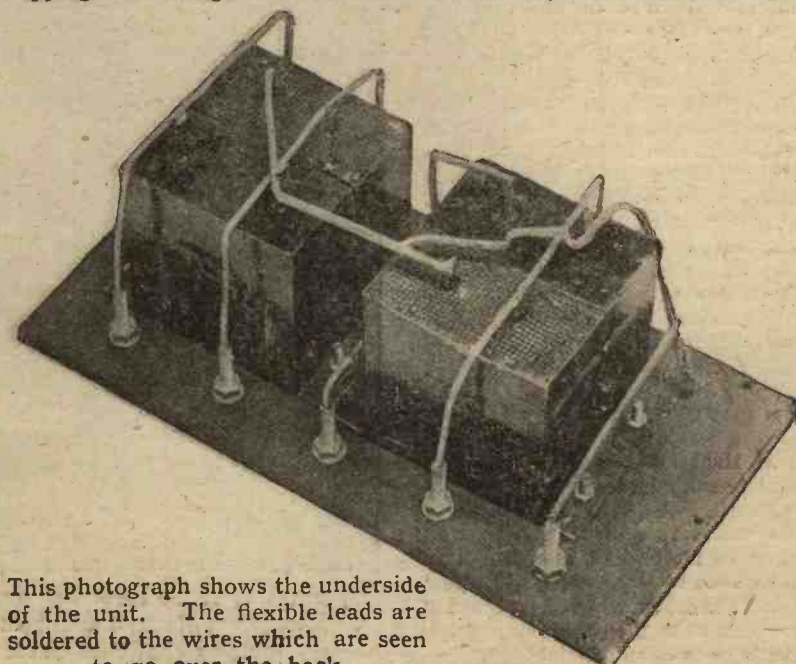

Fig. 1.—This shows the connection in the theoretical manner.

which will seriously affect the enjoyment of the musical item being received. When such noises, which usually take the form of cracklings or splutterings, are noticed for the first time after a new battery has been put into commission, they may be almost entirely eliminated by the simple expedient of joining a large "reservoir" condenser across the positive and negative tapings on the battery. This condenser, which should be fairly large, say, 2  $\mu$ F, acts as a smoothing device for the little irregularities in the supply from the battery, and we shall find that our reception is once more quiet.

### Multi-valve Sets

This remedy is quite effective in the case of a single valve receiver,



This photograph shows the underside of the unit. The flexible leads are soldered to the wires which are seen to go over the back.

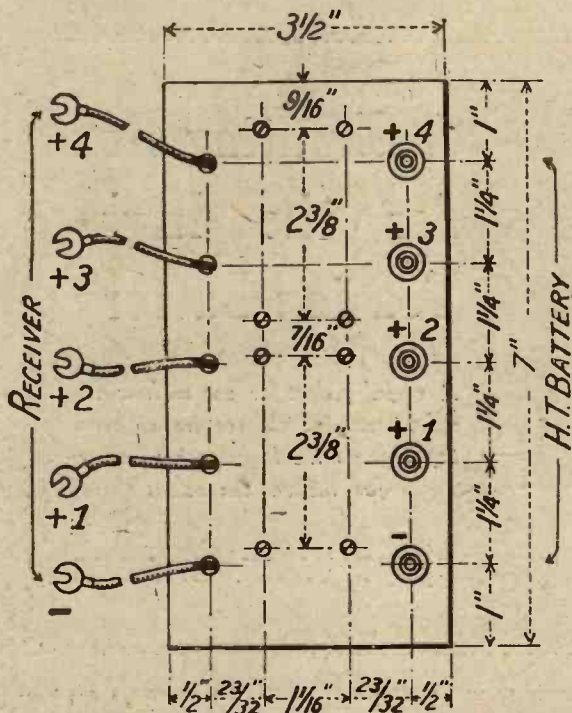

Fig. 2.—When using  $2\mu\text{F}$  T.C.C. condensers, the dimensions given above will be found quite suitable.

being that to which the negative of the battery (or batteries, if one is used for each tapping) is joined. The flexible leads which are on the left or receiver side of the unit, terminate in spade tags, which are easily slipped under the correct terminals of the receiving set.

A convenient size for the piece of ebonite upon which the condensers and terminals are mounted is 7 in. by  $3\frac{1}{2}$  in., and may be either  $\frac{1}{4}$  in. or  $\frac{3}{8}$  in. thick. This leaves sufficient room at the sides for the terminals and a row of holes for the flexible leads to pass through.

**Parts Required**

To make such a shunting box, you will require a piece of ebonite of the size mentioned, four condensers, each of 2 microfarads capacity, five terminals, eight 6 B.A. screws and nuts, some tinned copper wire for wiring up, and flexible wire for leads. The parts specified above are necessary if you want four positive tappings, but should you require more, add one condenser and one terminal for each tapping above the number given.

It may be regarded as essential in such a shunting box, to suitably mark the terminals in order to prevent possible error through wrongly joining up either to the battery or the receiver, and a simple and effective method of marking may be utilised by means of Radio Press Panel Transfers, which are placed in position as seen in the photograph at the head of this article.

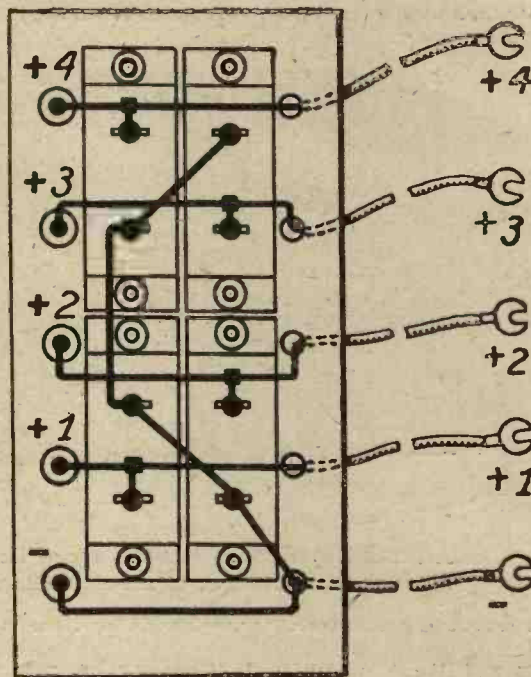

Fig. 3.—This shows how the condensers and terminals are joined up to the flexible leads.

**The Construction**

The construction of the unit is quite simple, and will be easily followed from the diagrams, while the wiring is also quite simple. If you prefer it you may replace the terminals with flexible leads ending in wander plugs, and many will consider this arrangement the more useful, as it reduces the number of connections necessary when joining

up a receiver on the test bench, or when in use.

**Fewer Tappings**

If you use this unit with a set employing, say, two H.T. tappings only, all you need to do is to leave two of the terminals free, and join up, say, H.T. + 1 and 2 and H.T. - terminals and leads to battery and set respectively.

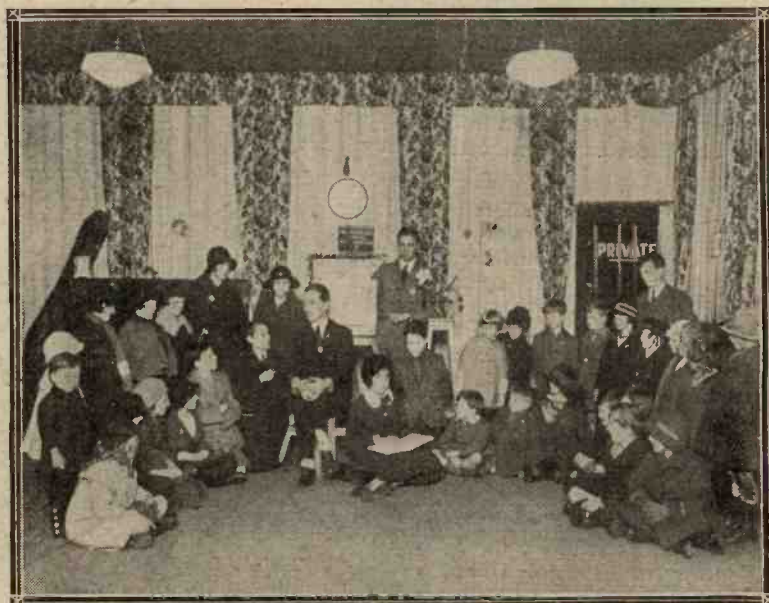

Visiting day at the Liverpool station is Saturday. Above we see a happy group of small members of the Children's Radio Circle enjoying a chat with Uncle "Pip" and Auntie Muriel.

**ACCUMULATORS CHARGED FREE IN YOUR OWN HOME**



is now famous as a most ingenious, simple, and absolutely efficient Home Battery Charger for use with Direct Current electricity supply.  
**ULINKIN** Charges your accumulators whenever you have lights, electric heaters, irons, or vacuum cleaners in use in any part of your house, without consuming any extra current.  
 It is simple to fix and use and positively conforms to all regulations of electricity supply and insurance Companies. It does not interfere in any way with your lighting circuit, and (most important of all) it does not necessitate interference with fuse wires.



**ULINKIN JUNIOR**—For charging wireless accumulators of any voltage up to 5 amps. Complete with instructions and cable for connecting **12/6** Junior Model. Post Free

**ULINKIN STANDARD MODEL**—The famous Home-Charger, as illustrated with ammeter, complete with cable and instructions for charging accumulators up to 5 amps. on D.C. supply from 50 to 300 volts **42/-** Carr. Free

Standard Model

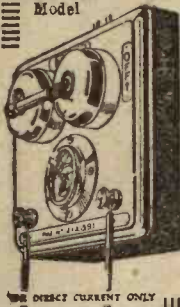

**ULINKIN SENIOR**—For garages, workshops, large houses, etc., for charging accumulators of any voltage up to 10 amps. Complete with ammeter, cable and instructions **52/-** Carr. Free

**SIMPLE TO FIX AND USE**  
 Saves its cost within a few weeks yet lasts a lifetime

*Illustrated Pamphlet and full particulars post free on request*

**GRAN-GOLDMAN SERVICE Co.**  
 (Dept. C.7)  
 71, FLEET STREET, LONDON, E.C.4

TRADE ENQUIRIES INVITED



**The FAMOUS FORMO L.F. TRANSFORMER**  
 —a pioneer product

Incorporate the Famous Formo L.F. Transformer into your set and you will discover that it brings a remarkably rich quality into the reproduction of your loud speaker.

It is this performance, consistent, reliable and of pleasing excellence, that comes by your choice of this Famous Formo Component. Those experimenters—who have learnt wisdom at the cost of bitter experience—build the Famous Formo L.F. Transformer into their sets consistently.

They know only too well that the search for good speech and music reproduction ends abruptly—it begins and ends with the Famous Formo L.F. Transformer.

**PRICE 18/=-**

**THE FORMO COMPANY**

(ARTHUR FREEM & Co., LTD.)

Admiralty, War Office, India Office, Air Ministry, and Post Office Contractors.

Chief Office & Works: CROWN WORKS, CRICKLEWOOD LANE, N.W.2.

Resident Representatives: Scotland: Mr. Miller, 22, York Place, Edinburgh.

Manchester: Mr. J. B. Levee, 23, Hartley Street, Levenshulms.

Birmingham: Mr. H. E. Crocker, 134, Reservoir Road, Erdington.

Barclays: 984

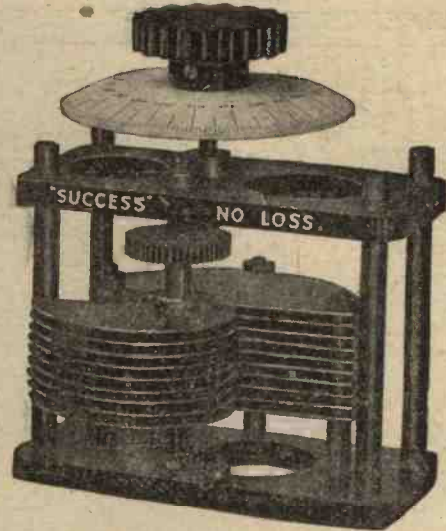

*Give your set greater range and volume*

The method of gearing the dial spindle, which besides giving a ratio of 4 to 1 and rendering a vernier unnecessary, also removes the greatest obstacle to successful long-distance work—body capacity effects. This is achieved by constructing the controlling gear of a high insulating material. The hand has no electrical connection with the centre vanes.

Aerial Condenser .0005 (approx. maximum capacity), 27/6  
 Knob and Dial, 1/6 extra.

Anode Condenser .0005 (approx. maximum capacity), 25/-  
 Knob and Dial, 1/6 extra.

Used in an "Easily Controlled Two-Valve Receiver," by J. W. Barber in the current issue.

The pre-eminent feature of the Success Noloss Condenser lies in the fact that it is the only instrument which by measurement can be called low loss. Its losses are too small to take into account. That these are really negligible conduces to extraordinary efficiency in your tuners.

No emphasis is necessary here upon the essential tuning factor being Low Loss. It need only be explained that high loss means the absorption of signal energy. This absorption dissipates the minute energy which actually reaches your aerial. The feeble oscillations pulsating through your aerial system never reach the grid of your first valve!  
 Therefore, build into your sets only those Condensers which have an actual low loss. This exceptional reduction of dielectric losses is made possible by the skeleton design of the end plates and the suitable choice of the insulating material from which these are made.  
 Copper is used for the vanes and spacing washers; resistance to H.F. currents is obviously kept down to the irreducible minimum. Finally, operation of the Success Noloss Condenser is delightfully smooth and regular.

Fitted to your tuners, the Success Noloss Condenser will tune distant stations where other types fail ignominiously. It gives you a remarkable fine control; and to those experimenters whose insatiable desire to have only the best that money can procure, have but one choice—the Success Noloss Square Law Condenser.

**SUCCESS NOLOSS CONDENSER**

Obtainable from all Dealers.

**BEARD & FITCH, LTD.**

34, AYLESBURY ST., LONDON, E.C.1.

Telephone: Clerkenwell 6041

North of England Branch: 1, DEAN STREET, PICCADILLY, MANCHESTER.

Telephone: Central 8240.

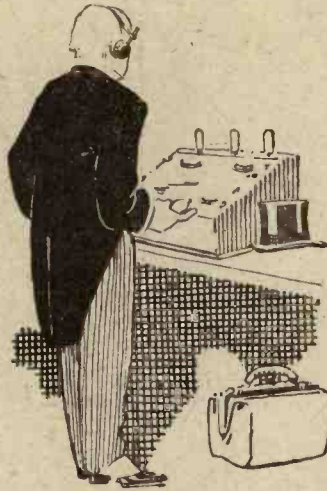

## Has your set valvular disease?

### GENERAL PURPOSE VALVES:

Type R. .... 11/- each

Filament voltage ..... 4 volts  
 Filament current..... 0.7 amp.  
 Max. plate voltage.....100 volts

Type B 3. .... 18/- each

Filament voltage ..... 1.8 volts  
 Filament current.....0.35 amp  
 Max. plate voltage.....80 volts

\*Type B 5. .... 21/- each

Filament voltage.....2.8-3 volts  
 Filament current.....0.06 amp  
 Max. plate voltage.....80 volts

### POWER AMPLIFYING VALVES:

Type B 4. .... 30/- each

Filament voltage.....5-6 volts  
 Filament current.....0.25 amp.  
 Max. plate voltage.....120 volts

\*Type B 6. .... 30/- each

Filament voltage.....3 volts  
 Filament current.....0.12 amp.  
 Max. plate voltage.....120 volts

\*Type B 7. .... 32/- each

Filament voltage.....6 volts  
 Filament current.....0.06 amp.  
 Max. plate voltage.....120 volts

*\*For use with dry cells*



The heart of your set is the valve, and in wireless a hard heart is better than a soft one. "Soft" is a euphemism for bad vacuum. A valve with a little air in it is liable to oxidation of the filament, and soon loses its efficiency. B.T.H. Valves are very highly exhausted by a special B.T.H. process. This ensures long life and maintained efficiency. B.T.H. Valves last longer and give much better results than "soft" foreign (or English) valves.

**FIT B.T.H. VALVES AND GIVE YOUR SET A GOOD HEART**

*From all Electricians and Radio Dealers.*

# B.T.H. RADIO VALVES

*Made in Rugby, England.*

*Note new reduced prices of all types.*



# Correspondence

## THE "SHORT-WIRE" VALVE PANEL.

SIR,—I have made up the "Short Wire Valve Panel" from the January issue of THE WIRELESS CONSTRUCTOR. I wish to report results obtained, although I have not had time to test it thoroughly.

I am situated, roughly, about 30 miles from Manchester and about 12 from Liverpool. I can get both these almost too loud for 'phones. I get London and have had a couple of German stations. On Monday night, at 9.50, I tuned in a station which I believe to be French. It was the opera, or some part of the opera, "Les Cloches de Corneville." I was using a 50 coil in the aerial and 75 in reaction, .0005 variable condenser in series.

Yours faithfully,  
ALBERT TAYLOR.  
St. Helens, Lancs.

## USING RADIO PRESS PANEL TRANSFERS.

SIR—I thought you might be interested in the following improved method of applying Radio Press Panel Transfers to wireless panels which does away with the hot pad business. Place the transfer on panel and moisten back with methylated spirits, press down with thumb and then apply cold water to remove paper by slowly drawing this away, leaving the transfer on panel intact.

I found that the above method takes about a third of the time occupied by adhering to the printed instructions.

Yours faithfully,  
GEORGE J. PULLIN.  
Chester.

## THE "SHARP-TUNING" SINGLE VALVE RECEIVER.

SIR,—As a first set I have just mounted the "Sharp-tuning single valve set," by Stanley G. Rattee, and beg to inform you that I have very good results with same, although being in a very bad position, as I use the electric mains for an aerial and for earth the water tap, which is three rooms away.

I have used this set with a roughly connected L.F. amplifier, but the results were too loud for phones.

With compliments to THE WIRELESS CONSTRUCTOR, to which you could add "and Encyclopædia."—  
Yours faithfully,  
Paris. DUBOIS.

## THE SINGLE VALVE REFLEX RECEIVER.

SIR,—I feel that yourself and particularly your readers, will be interested in the results I have obtained from the single valve reflex receiver, as described in THE WIRELESS CONSTRUCTOR February issue, by Mr. Percy W. Harris.

I might mention that although having a fair knowledge of wireless, gained chiefly from THE WIRELESS CONSTRUCTOR, I have not handled any set previous to this.

Last evening, the 11th, at about 8.45, I tuned in Cardiff at good strength (two pairs 'phones), which continued until they closed down. I then picked up the following stations:—

London, 2I.O., very loud.  
Manchester, fair.  
Bournemouth, very faint.  
Madrid, very clear.  
Newcastle, fair.  
Glasgow, clear.  
Belfast, very faint.  
On 2I.O. closing down I had very

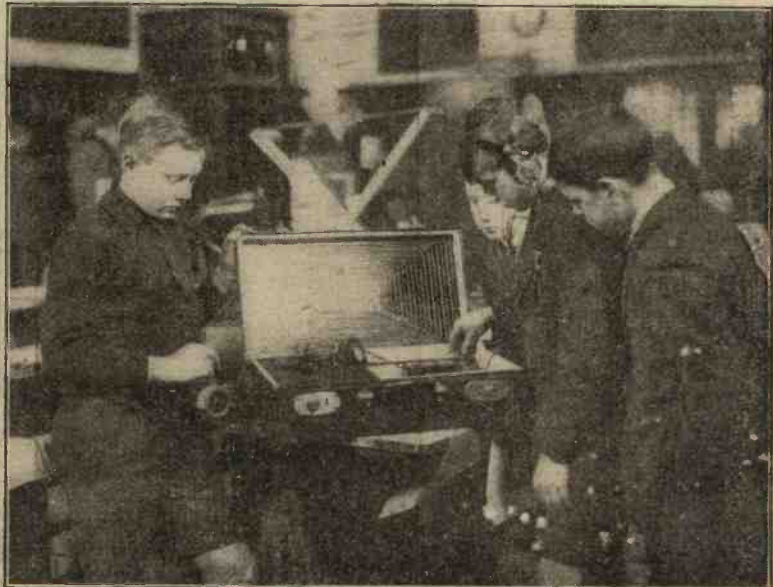

This set, made by boys at St. Paul's School, Dorking, was exhibited at the Schools' Wireless Exhibition, held recently.

In building this receiver I followed the circuit, but mounted the valve (Marconi R 5) and coil-holder on the outside of the panel, and fitted an Igranic transformer in place of a Royal.

On connecting the set to the aerial and earth I was surprised to get Madrid faintly, within five minutes afterwards getting Cardiff at good strength on two pairs of phones.

clear reception from Glasgow (dance music and close down). I then had Madrid at excellent strength until 12.15 a.m., when I closed down.

A No. 50 coil in the aerial and 75 in the reaction was used throughout the evening.

Aerial 65 ft., 7/22 copper, stranded 25 ft. high.—Yours faithfully,  
Swindon, G. HARDING.

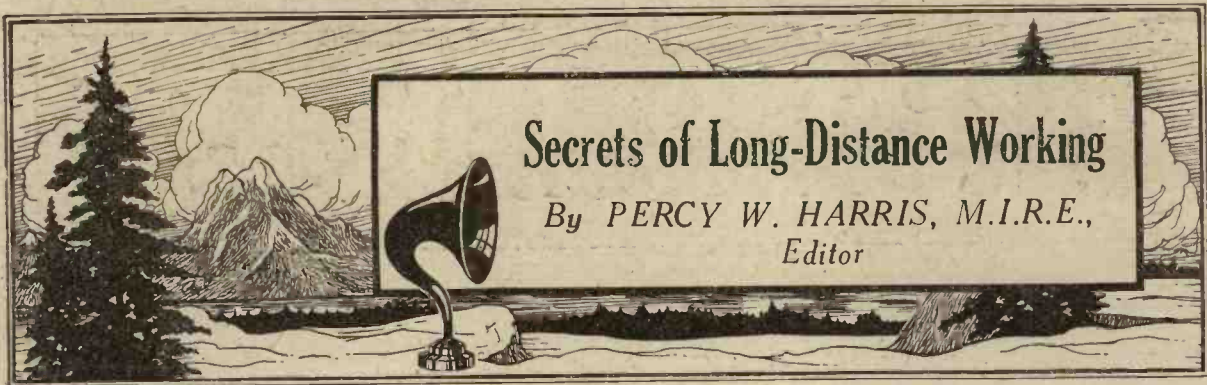

**H**AVE you, as a new-comer to wireless, wondered how it is that people with no better equipment than yourself are able to listen to stations very many hundreds of miles away, while you can only hear the nearest? Have you felt annoyed that after spending £40 or £50 on a set you cannot get such good results as some schoolboy round the corner? Have you, in fact, been reduced to a state of chronic doubt regarding the achievements of those people who say they can hear all the B.B.C. stations on a single-valve set? If you answer "Yes" to any of the above questions, then this article may help to make matters clearer.

#### Good and Bad Spots

I have already explained in a previous issue why it is that some crystal users get far better results than others. It was pointed out last month that there are good and bad spots throughout the country—that is to say, spots which differ considerably from one another in regard to the strength in which the nearest station can be heard. Sometimes such good and bad spots may be within a mile or two of one another, and at one of them a station a hundred miles away can be heard quite loudly on a single-valve set, whilst at the other there is great difficulty in hearing a station 25 miles away.

#### Highest Efficiency

While general use of a wireless set is something which can be learned very rapidly (unless it is a very elaborate multi-valve set with some special circuit), to get the highest efficiency out of even a single-valve set requires much skill. Furthermore every detail has to be "right." The aerial must be well insulated, must not run close to and parallel with the wall for any distance, the earth connection must be good and sound, the earth lead (that is to say, the lead from the

earth itself to the actual instrument) must not be too long, and the aerial must be perfectly insulated where it is let in through the wall. Given these preliminaries, the valves used must be suitable for the circuit with which they are used, the filaments must not be too bright, and not too dull, the value of the high-tension voltage must be correct,



Mr. Harold W. Arlin, the announcer at KDKA, whose voice is well known to many listeners in this Country.

the coils used must be suitable for the wavelength band it is desired to listen to, tuning must be accurate, and the control of reaction properly carried out.

#### Proper Use of Reaction

Last month Mr. G. P. Kendall, B.Sc., explained to you the use and abuse of reaction. Proper adjustment of reaction is helpful in every valve set, and the greatest sensitivity can only be obtained

when this is properly attended to. A matter which does not receive the attention it deserves is the correct adjustment of the valves, as well as their choice. Fortunately, in this country at least, the manufacturers of valves issue plenty of information regarding them, making quite clear the purpose for which they were designed.

#### Types of Valves

We have, for example, what are known as general purpose valves, which will suit either high-frequency amplifiers, detectors or note magnifiers; we have special valves for high-frequency amplification, special valves for low-frequency amplification, and what are known as power valves. Power valves are designed for low-frequency magnification only, and their sole virtue is that they can handle very loud signals, giving them further amplification, without any distortion resulting. There is no magic in the power valve, and a substitution of one for a general purposes valve will only show a marked improvement when the signals being handled are already very strong, and it is desired to distribute them at great strength from a loud speaker to a large room or a hall.

On the box in which each valve is supplied or else on the small slip on the valve, you will find certain figures. Filament voltage is given as, say, 4, plate voltage as from, perhaps, 30 to 85. Of the two the filament voltage is the more critical, and if this is attended to it is probable that your long-distance results will be greatly improved.

#### Filament Voltage

Let us consider for a moment the question of filament voltage. We will say that the filament voltage is stated as 4, and you have a 6-volt accumulator attached to your set. The current, in passing from the accumulator to the valve filament, passes through a filament resistance, and the effect of this is to reduce the voltage applied to the valve



Showing Dubilier Grid Leak Attachment in position.

## A NEW DUBILIER ACCESSORY.

To meet cases where the Grid Leak cannot be joined across the Grid Condenser, we have produced the accessory shown above. It consists of a plate of high insulation material carrying a single grid-leak clip, and it is attached to the Type 600 condenser and to the panel by a single screw.

The Grid Leak is then inserted between the clip on the attachment and the right-hand clip on the condenser.

This accessory obviates soldering of the leak, facilitates comparison of different leak values, and also ensures that a minimum of surface leakage occurs between the Grid Leak Terminal Strips.

In this, as in all cases, it is important to

***Specify Dubilier.***



The  
Dubilier Grid  
Leak Attach-  
ment.  
Price 6d.



Ducon Works,  
Victoria Road,  
North Acton,  
London, W.3.

**DUBILIER**  
CONDENSER CO. LTD

Telephone :  
Chiswick 2241-2-3.

Telegrams :  
Hivoltcon, Phone,  
London.



Another fine new "ORMOND" feature!  
 All the fine old "ORMOND" qualities  
 AND SOMETHING MORE

## SQUARE LAW CONDENSER No. 3

Best Quality EBONITE END PLATES, 1/4" thick  
 Substitution of Special Take-up Springs, so eliminating the  
 use of Thackray washers. Guaranteed spacing, .073" thick  
 ONE HOLE FIXING

This apparatus is mechanically sound and is supplied either  
 with or without vernier

### PRICES:—

Without Vernier		With Vernier	
.001	... 9/-	.001	... 10/6
.0005	... 8/-	.0005	... 9/6
.0003	... 7/6	.0003	... 9/-
.00025	... 6/6	.00025	... 8/-

### DELIVERY FROM STOCK

The "Square Law" Type Variable Condenser

THE use of a "Square Law" Condenser renders the tuning of a Receiver a very simple matter indeed. A calibration chart may be made by the following simple means: Tune in a station of known wavelength on the lower part of the condenser scale and plot it on the chart. Repeat this process with another station of known wavelength which is received on the upper part of the condenser scale. Draw a straight line through the two points and the chart is complete.

Owing to details of its design, this type of Variable Condenser possesses a negligible minimum capacity, and the specially shaped vanes give an ease of control which is entirely unknown to users of the ordinary type.

We specialise in turning Brass and Steel Screws and Machined Parts and Accessories of all descriptions. All Cheques and Postal Orders should be crossed and made payable to "The Ormond Engineering Company".

Look for the name "ORMOND" on all our products!

Write for our new (1925) Catalogue  
 Trade terms on Request

# ORMOND ENGINEERING CO.

199-205, Pentonville Rd., King's Cross,  
 London, N.1

Telegrams—"ORMONDENGI, KINCROSS"  
 Telephone—CLERKENWELL, 9344 (3 lines)

FACTORY—Whiskin St., CLERKENWELL, E.C.1  
 25 Years British Manufacturing Experience

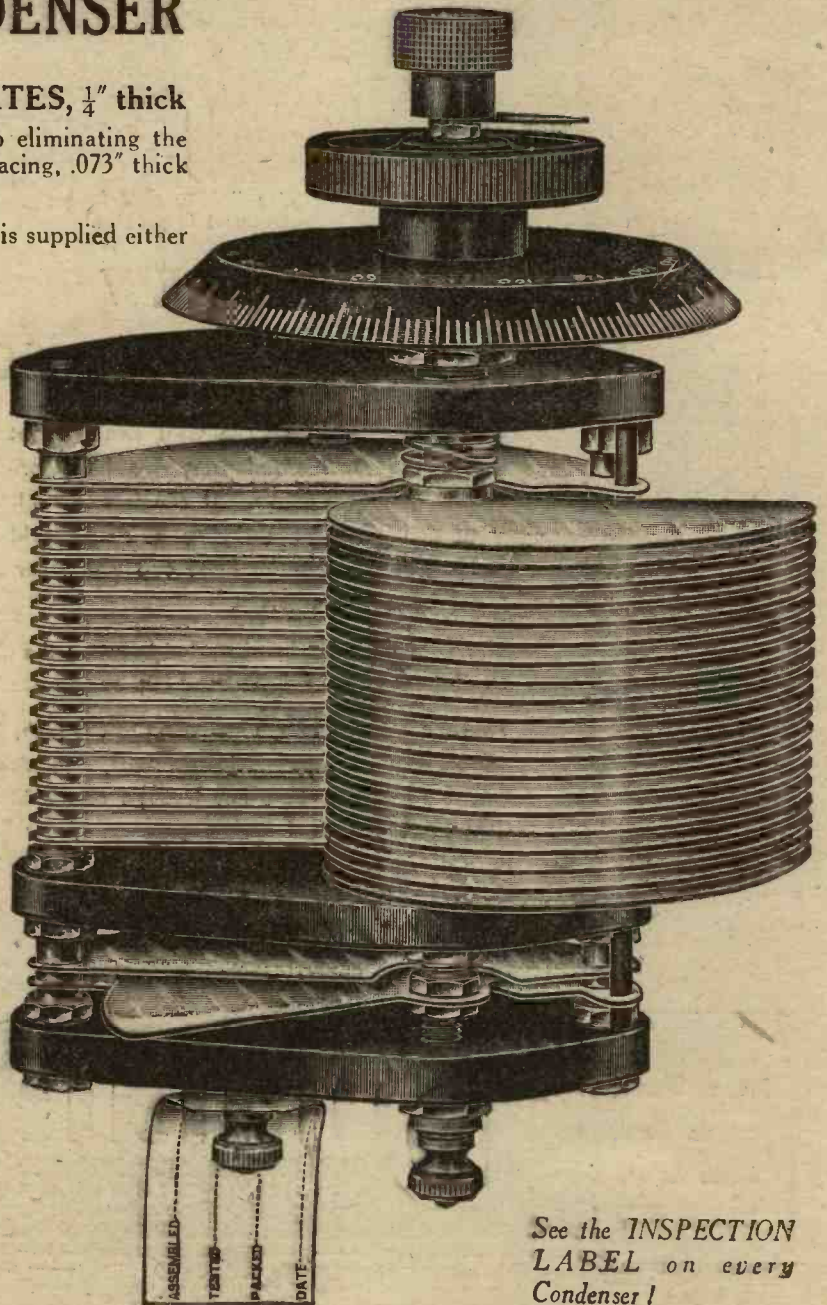
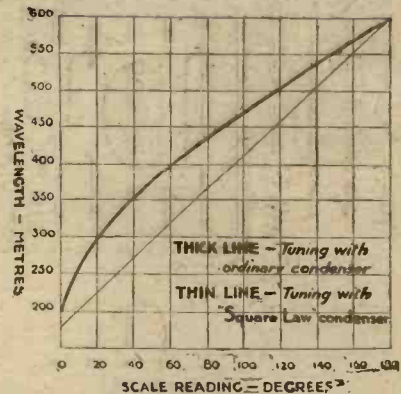

See the INSPECTION LABEL on every Condenser!



itself. With a 6-volt accumulator, a bright emitter valve, and an ordinary filament resistance the voltage will be brought down to 4 when the resistance knob is turned a little way "on." As the knob is turned round to the maximum position, so the voltage across the valve filament will rise. The best way to ascertain the correct adjustment for your valve is to buy a small voltmeter (the kind sold for testing accumulators is quite good for this purpose), and with the filament resistance on, carefully make contact with each of the filament legs. You will then see the actual voltage applied to the valve filament, and the filament resistance can be adjusted accordingly, until you get it to the figure indicated by the makers. I do not recommend this procedure with the very low consumption valves taking 0.6 ampere, but it is quite accurate enough for bright and semi-bright emitters now available. Set all your valve filaments correctly, and it is probable that your reception will be greatly improved in quality and strength. Be careful, however, not to burn the valve filaments brighter than stated by the makers. You will not notice any great difference in signals, but the brighter the valve burns above the rated voltage the shorter will be its life, and even at 11/- each, valves are too dear to waste!

### Repairing a Cracked Ebonite Knob

**E**BONITE is brittle stuff, as most of us have found to our cost at one time or another. A mishap which is very liable to occur is the cracking of the boss of a control knob into which the spindle of a condenser, variometer or rheostat is screwed. When the crack occurs the threads in the ebonite become so loose a fit for the spindle that the knob cannot be fixed. Quite a good repair can be effected in the way shown in the sketch. The boss of the knob is bound very tightly with the strong fine wire that florists use for making up "button-holes." Remember that it is essential to put the wire on very tightly indeed. Winding should always start from the top of the crack so that it may be drawn together more and more as the wire is put on. If you work the other way the job will not, as a rule, be at all satisfactory. If the crack does not gape at all when the

knob is removed from the spindle, it can often be repaired satisfactorily in another way. Remove the knob and place its boss between the jaws of a vice, tightening them until the crack is all but invisible.

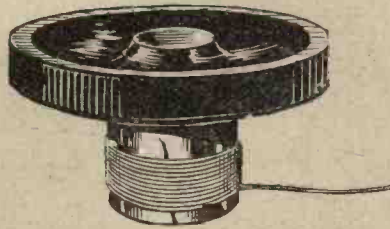

A method of repairing a cracked knob.

Now, take a very hot soldering iron and follow down the line of the crack with its point, making the ebonite run. This usually suffices to weld up the ebonite, and, provided that the knob is not forced

too hard on to the spindle, a repair of this kind will often suffice to enable it to be used satisfactorily for a long time. Cracked rheostat formers and cracked or actually broken lugs of small ebonite cast condensers may be repaired in the same way with a hot soldering iron, though, in the case of rheostats, this method is not always satisfactory, since the former may warp under the influence of the applied heat. However, when a former is cracked it is a case of desperate remedies, so that the soldering iron is well worth trying. I have in use at the present time a condenser dial which cracked several months ago and was mended in this way. In this case the soldering iron was applied to the underside only, the edges of the crack being held tightly together by placing the dial horizontally in the jaws of a vice.

R. W. H.



M. Vladimir Vladimoff, the Director of the famous Balalaika Orchestra, with his instrument.

## How to Finish Off Your Wires

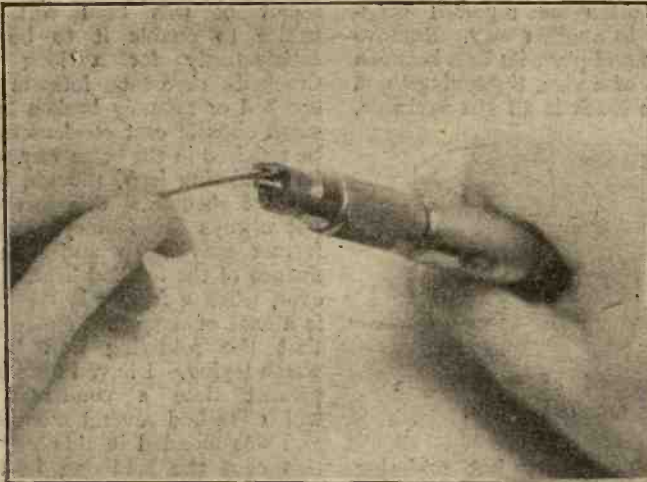

**W**HETHER or not your set has a neat and "finished" appearance depends to a large extent upon the way you

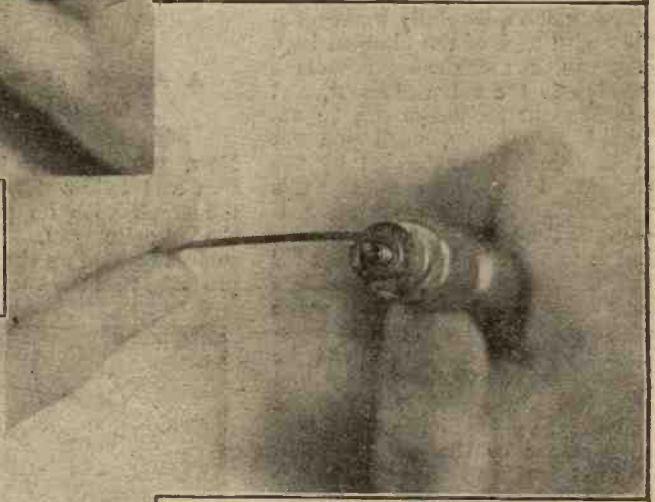

square section tinned copper wire now so deservedly popular. Fortunately this work can be simplified by the use of a small

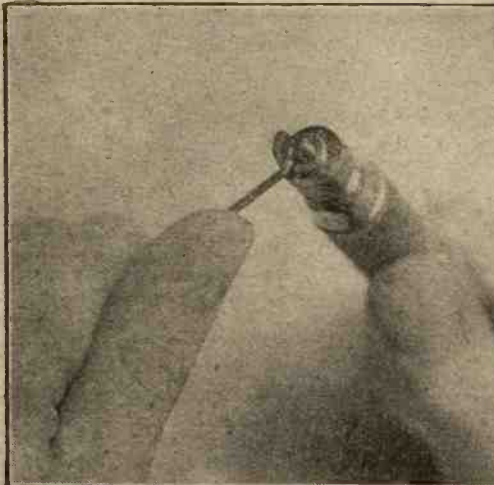

finish off the wires. Here are a few photographs that will help you.

Many constructors find difficulty in making a neat loop in the heavy-gauge

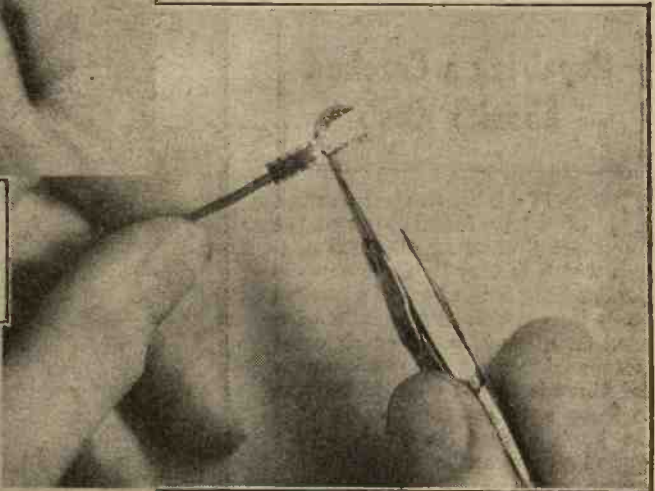

bending tool now available. Our first three photographs show the Yankee bender, one of the Yankee radio tools. A similar tool is also sold in the Wade tool outfit.

Spade terminals can be readily fixed to the ends of flexible wires by pinching them on, as shown in the fourth and fifth photographs. A good firm grip of the pliers is required.

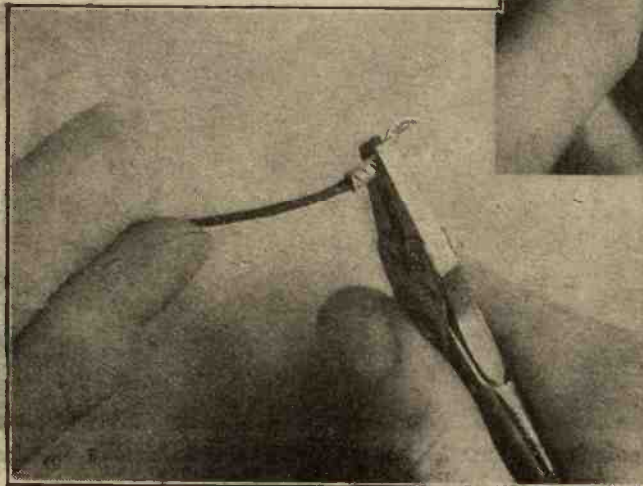

On the second page the method of using the Gibson terminals is shown. These make a strong sound contact by threading the wire through two holes, bending the wire over the top, and screwing on an insulating sleeve, which must be threaded over the flex prior to inserting the wire in the terminal holes. These terminals are obtainable in several forms and with both red and black sleeves. Other terminals, such as the

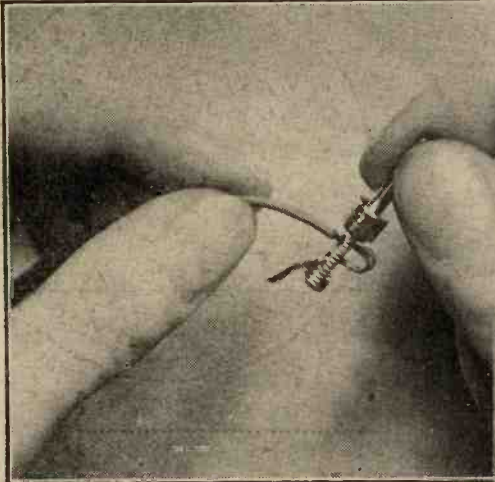
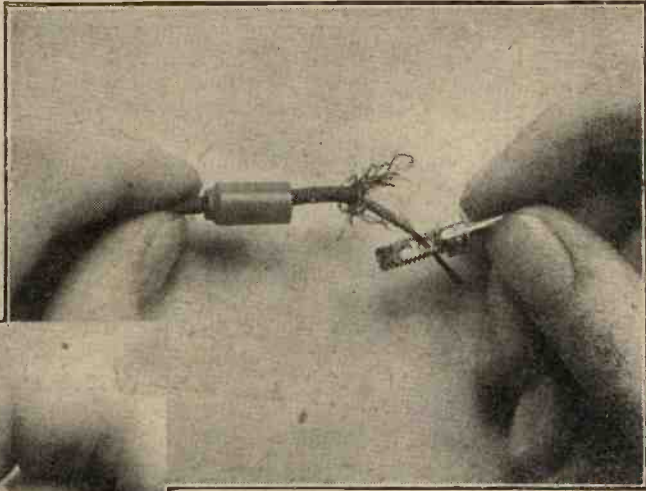

the remainder. Make sure that all strands are properly held. The best way is to clean the individual strands and solder them

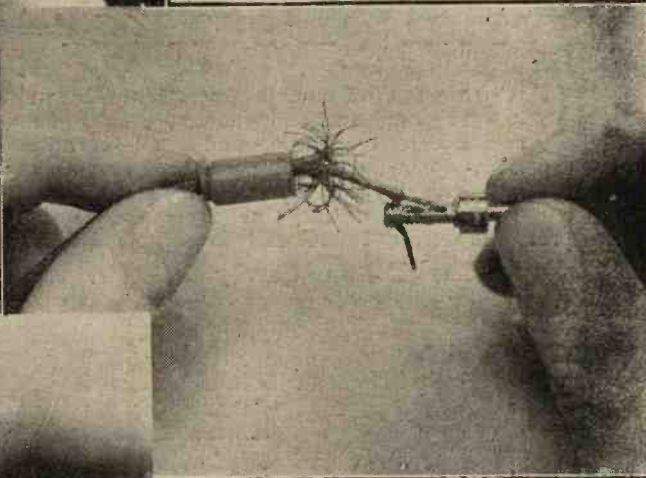

G.E.C. and the Tapa, give a similar neat finish to flexible wires.

The final photograph shows how a neat right-angled bend can be made with the

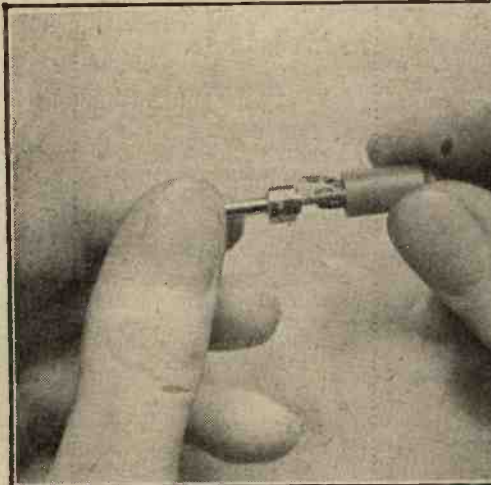

together. A still better way is to solder them to a small brass plate which can be firmly gripped beneath the screw.

wire bender. This bend can be sharp or rounded, according to how the tool is used.

One wire often badly finished off, with a resulting bad effect, is the aerial lead-in where it makes contact with the lead-in insulator. Unfortunately, the size of the screw terminal of the average inexpensive lead-in tube is too small to grip the comparatively heavy aerial wire. Usually just one or two strands get gripped, leaving

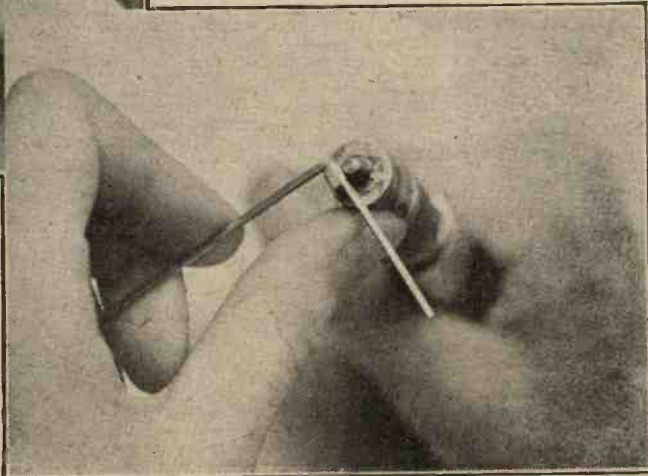

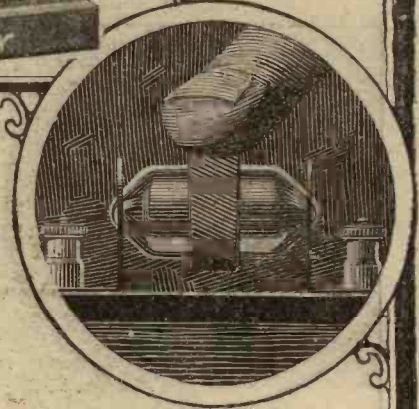

# Here's the only reloadable cartridge Crystal Detector—

**I**F the 1925 Radio Season is famous for nothing else it will be noteworthy for the heavy crop of new crystal detectors. Large and small—cheap and expensive—permanent, semi-permanent or with catwhisker—every type is represented. But one stands out from the crowd. One is so unique in its principles that it cannot fail to attract attention.

### The Eureka Gravity Detector.

The Eureka Gravity utilises all the sensitiveness of the catwhisker Detector but with none of its disadvantages. Its principle is just this: The crystal is held in a cup within the centre of the cartridge. Around the periphery of the case is placed a row of catwhisker points, each one of which is weighted at the head. When the Gravity is rotated these points are caused to drop one by one to make contact with the Crystal. Thus it is only necessary to give the Detector a twist until the loudest signals are heard.

No factory-sealed permanent Detector can ever hope to compare with the Eureka Gravity because the user can utilise any favourite piece of crystal known to be absolutely sensitive.

Besides, no crystal lasts for ever—its sensitiveness is bound to fall off in time. In any case, the present immense popularity of catwhisker contact is proof positive that any double-crystal combination is of little value under present-day conditions.

To change the crystal in the Gravity is but a moment's work. Just lift it from the spring clips, separate the two halves, lift out the old crystal and drop in a new piece, and the job is done. Quicker in fact than describing it. And the crystal is protected against dust, fingering and light.

No matter which type of Set you are using the Gravity will improve it. If it is a Reflex it will stabilise it and yield wonderful tone. Experience has proved that half the trouble in reflex Sets is due to the incorrect pressure of the catwhisker. In the Gravity this is done for you automatically. We have calculated the pressure at which the contact should be made—no more, no less.

Get your Dealer to show you one of these handsome Gravity Detectors to-day—the fact that it is a product of the manufacturers of the Eureka Transformer is a sure guarantee of its excellence.

Portable Utilities Co., Ltd.,  
Makers of the Eureka Transformer  
Fisher Street, London, W.C.1.

And from all Dealers

### Six advantages you get with no other Detector.

1. The Crystal is firmly held in a spring cup and the moving points fall to make contact with it as the holder is rotated.
2. When the Gravity Detector is in use the Crystal is fully enclosed and protected from dirt.
3. The Gravity Detector can be reloaded with a new crystal in a moment. Nothing to unscrew or solder.
4. The slightest turn of the Detector automatically brings into use a new spot on the crystal and a new contact point.
5. Nothing to wear out—the Gravity Detector will last a lifetime.
6. Stout plated spring clips are supplied and the base can be removed for fitting the Detector direct to the panel.

Complete with Crystal

**6/6**

# EUREKA GRAVITY Detector

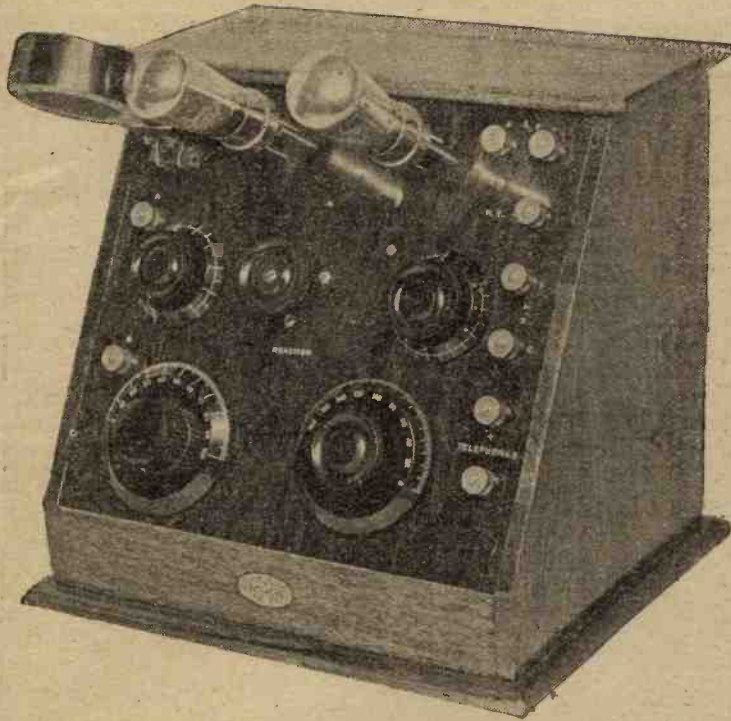

# An Easily Controlled Two-Valve Receiver

By  
**JOHN W. BARBER**

*A description of a receiver employing one high-frequency amplifier, followed by a detector valve, which is capable of receiving many distant stations in the telephone receivers*

Note the reaction control, mounted between the filament resistances.

WHILE many listeners desire a receiving equipment capable of operating a loud speaker on the local station only, a great number want a set upon which they can "go the rounds" of British and Continental stations, using the telephone receivers. It is true that remarkable results may be obtained with quite a simple set in favourable conditions, and on broadcast wavelengths a useful combination may consist of one high-frequency amplifying valve followed by a detector.

### Alternatives in Design

In deciding upon the design of such a receiver, one is faced with several possibilities; for example, the high-frequency valve may be coupled to the detector by the well-known tuned-anode method, or alternatively by the tuned transformer method, the latter offering several different arrangements in itself. Resistance-capacity coupling is not of much use upon the ordinary 300-500 metre waves, but if the receiver is to be used solely for the reception of long-wave stations, such as Chelmsford and Radio-Paris, then this form of H.F. coupling may with advantage be employed, the operation of the set being much simplified. Again, considering either of the

two "tuned" methods, we may either couple the reaction coil to the aerial coil, or to that in the anode circuit of the first valve. It is often quite erroneously stated that, by adopting the latter course, the set is rendered practically incapable of radiating, and thus the user need have no fear of

### The Method Employed

In the case of the present receiver, it was decided to employ the tuned-anode method, coupling the reaction coil to this circuit, and in order to simplify the construction and operation, a Sterling Anode Reaction Unit has been incorporated. This consists of two coils,

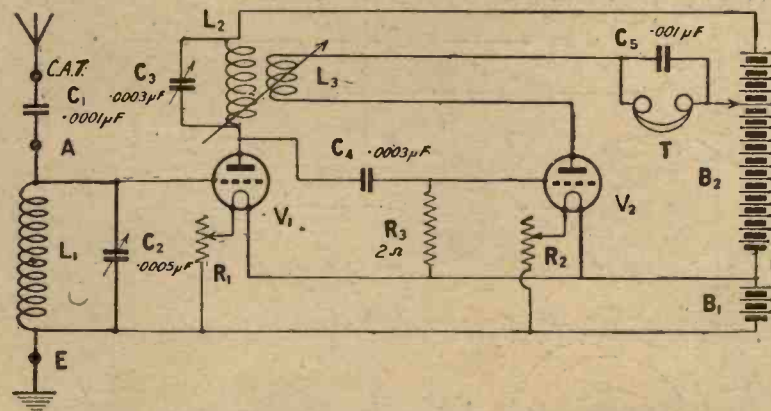

Fig. 1.—This shows the connections in theoretical form. The coils  $L_2$  and  $L_3$  are contained in one unit.

causing interference when his set is oscillating. This, however, is, far from being always the case, and whichever course is followed, the utmost care should always be taken to keep the set from oscillating.

one of which constitutes the reaction coil, and is rotatably mounted with respect to the outer or anode circuit coil, the whole being enclosed and so kept dust-free, control being effected by a knob on the front of the panel,

in this case situated between the filament resistances.

A glance at the photographs of the finished receiver will show the method of control. The variable condenser on the left is in the aerial circuit, while that on the right is shunted across the anode coil.

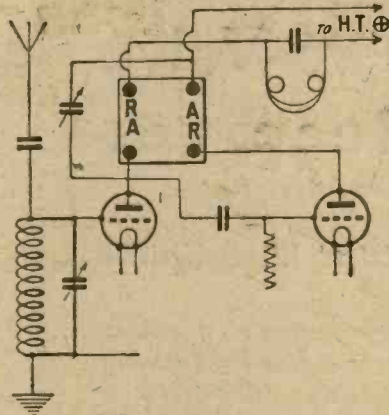
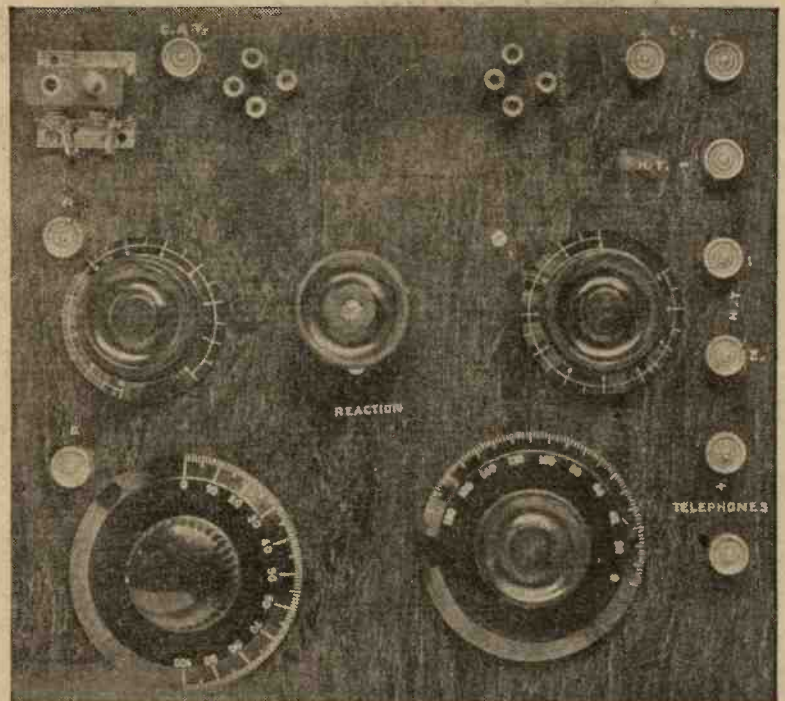

Fig. 2.—Showing how the connections are made to the Sterling unit employed.

The filament resistances are situated above these condensers, while the L.T. terminals are at the back of the panel to the right. On the left of the panel are seen the aerial and earth terminals, while the constant aerial tuning system may be employed by joining the aerial, not to A, but to the terminal

marked C.A.T., seen at the top of the panel, between the coil socket and the first valve.

simplicity in wiring which it effects. The two terminals at the back are for the accumulator, next being



This shows how the parts are mounted upon the panel. Note especially the somewhat unusual arrangement of the terminals.

The rather unusual arrangement of terminals on the right of the panel is adopted on account of the

H.T.—. The other details are made clear in the drawings and need not be gone into here.

The Circuit Diagram

The circuit arrangement of the receiver may be seen in Fig. 1. The aerial circuit comprises the coil  $L_1$ , which is plugged into the socket seen on the left of the panel, and across which is connected the variable condenser  $C_2$ . The coils in the anode circuits of the valves have been drawn diagrammatically, and the anode coil  $L_2$  is shown with the condenser  $C_3$  in parallel with it. Fig. 2 shows how the actual connections are made to the Sterling unit, which has two soldering tags marked "A" and two marked "R," the former being the connections to the anode coil, while the reaction leads are joined to the "R" tags.

Parts Required

In order to make a set similar to the one seen in the photographs, the following parts will be required, and whilst it is not essential to use the actual makes given, you should be certain that the parts you do use are of the best quality, in order that satisfactory results may be obtained.

One ebonite panel 10 in. x 9 in. x  $\frac{1}{8}$  in. or  $\frac{1}{4}$  in. (Radion Mahoganyite).

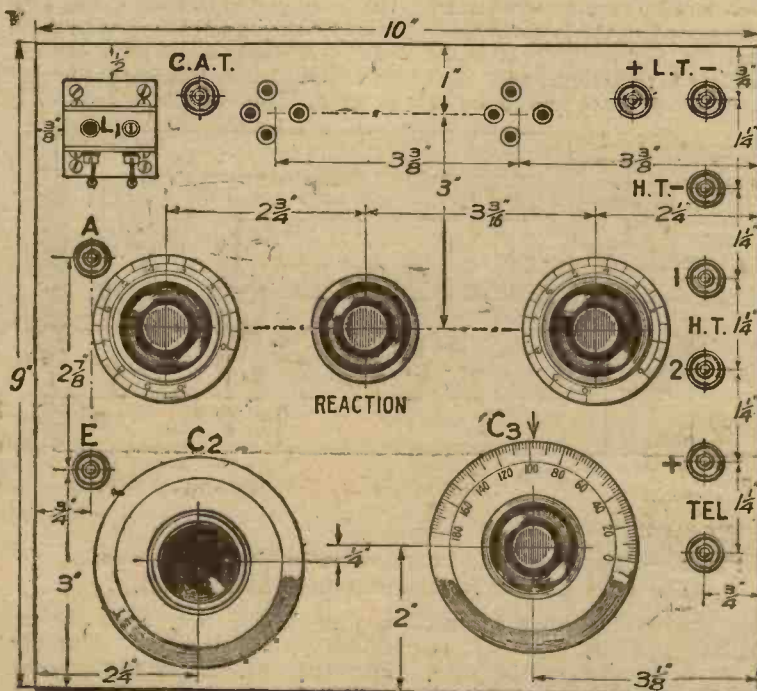

Fig. 3.—The drilling diagram. If you use components other than those mentioned, be sure you drill the holes correctly. Blueprint No. C1013A.

THE PANEL DE LUXE



THE advantage that a Radion Panel confers on a Receiving Set is much more than merely adding a gold case to a watch. Rather, is it comparable to the addition of that delicate compensating balance wheel mechanism which ensures split-second accuracy. If you aim at 100 per cent. efficiency for your Set you'll naturally start with a Radion Panel. With dials to match.

Radion is available in 21 different sizes in black and mahogany. Radion can also be supplied in any special size. Black 1d. per square inch, mahogany 1½d. per square inch.

# RADION

American Hard Rubber Company (Britain) Ltd.

Head Office: 15a Fore Street, London, E.C. 2  
 Depots: 120 Wellington Street, Glasgow.  
 116 Snow Hill, Birmingham.  
 Irish Agents: 8 Corporation Street, Belfast.

Gilbert Ad. 2454

## —a hint or two on H.F.

The old type valve holder with sockets embedded in a moulding of doubtful insulating properties is the cause of poor H.F. Amplification. Capacity effects at the valve rob your receiver of range, power and quality.

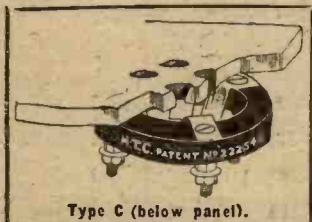

Type C (below panel).

Builders of receivers utilising one or more H.F. Stages should not lose sight of the rule governing the function of the rectifier. Simply, half the power at the detector and its output is reduced four times; twice the power at the detector gives an output four times greater.

Your H.F. Stages should hand on maximum energy. If you employ H.T.C. Low Capacity Valve Holders the maximum energy will reach the rectifier.

Throw away the ordinary type of valve holder and try the difference the H.T.C. Low Capacity Valve Holder makes. It will take you one evening to observe the difference. Those hitherto elusive stations will come in.

In multi-stage H.F. work high capacity at the valve may completely nullify H.F. amplification.

If your receivers employ the Plug-in H.F. Transformer you can only expect efficient H.F. Amplification by mounting them in the H.T.C. Valve Holder.

### Beware of Imitations

Your dealer may try to persuade you that something in stock is as good. H.T.C. Products are unrivalled for their electrical performance. If your dealer cannot supply, send direct to:—

H.T.C. ELECTRICAL CO. LTD.  
 2 & 2a, Boundaries Rd., Balham, S.W.12  
 Trade Enquiries Invit d. Phone: Battersea 374

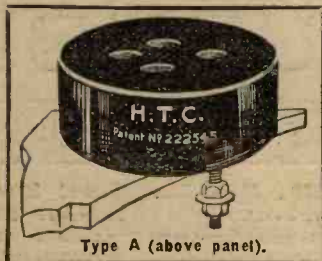

Type A (above panel).

If you would know more about removing capacities at the valve, send for a descriptive folder. Sent free upon request.

Barclays.

# Here's a severe test of a Crystal's sensitiveness—

## Receiving without a Receiving Set!

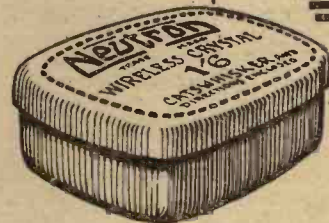
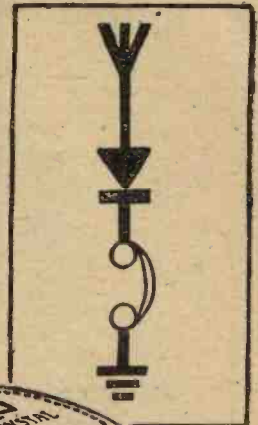

"SIRS,—I bought one of your Crystals some time ago, and made a set according to your diagram (long-distance circuit). While in New York I was using the set one evening, and while shifting the loading coils I noticed that I was getting fairly good results without any coil at all. This caused me to try what I could do without in the set, and before I finished I had the Crystal tied on a piece of ebonite 2 in. by 1 in. with a piece of 38-gauge wire and another piece of the same size wire for a catswhisker. The layout was as follows:—Aerial to crystal, catswhisker to 'phone terminal—the other 'phone terminal

to earth. With this I was able to get station W.E.A.F. very strong, music and speech. This continued for about 3 hours, until I finally switched off. I do not know the exact distance, but I should think it will not be far short of 3 miles, as station W.E.A.F. is away down Broadway, and we were laying at the White Star Pier, foot of W. 19th Street.

"Having seen the enclosed newspaper cutting, I thought it might interest you to hear of this, as it shows what your Crystal is capable of.

"Yours truly,

"(Signed) W. P. JONES."

This letter testifies to the remarkable sensitivity of Neutron Crystal. If you have been used to ordinary Crystals, change to Neutron, and note the wonderful increase in volume.



Concert Tested & Guaranteed Radio Crystal

Produced by NEUTRON, LTD., Sicilian House, London, W.C.1. Phone: Museum 2677.

Sole distributors:

V. Zeitlin & Sons,

144, Theobald's Road, London, W.C.1.

Phones: Museum 3795 & 6841.

Sold by the Best Radio Dealers. Packed in tin, with silver catswhisker. Insist on Neutron in the Black and Yellow Tin—

1/6

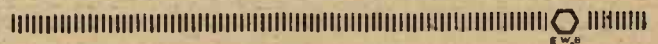

# 3 strong reasons why you should use Burndept Apparatus



**A remarkable approach to the theoretically perfect.**

Burndept Standard Condensers absorb less than 0.05 per cent. of the power applied to them! The spindle is self-aligning, the top bearing running in a flexible steel housing, and the lower bearing consisting of a steel ball running between metal cones. This patented method of construction ensures absolutely free running and permits fine tuning adjustments to be made without "vernier" attachments. The upper bearing compensates for slight wear, the capacity of the condenser remaining unchanged. Burndept Condensers are absolutely noiseless, even when used in circuits oscillating on wavelengths of 75 metres (a frequency of 4,000,000 per second). To obviate hand-capacity effects, steel snap-on dust covers are provided.

Burndept Standard Condensers, for panel mounting, with dial, knob, screws, and drilling template:

- No. 416: Capacity '0005 mfd., 30/-
- No. 417: Capacity '001 mfd., 35/-



**WHEN** we say that you will get every satisfaction in choosing Burndept Apparatus for radio reception, we do so for three reasons.

(1) Before any piece of Burndept Apparatus is put on the market, many experiments are conducted in the Research Laboratories to make sure that both design and materials used are sound from every point of view.

(2) Before Burndept Apparatus leaves the factory it is given careful tests to make sure that it will do all that it is advertised to do.

(3) When issued to the public every piece of Burndept Apparatus is accompanied by a guarantee label. Components or instruments found defective, through workmanship or material, within twelve months of purchase will be replaced or repaired free of charge.

The Burndept range includes everything for radio reception, from components to complete installations. Get in touch with your local Burndept Agent, who will be pleased to show you Burndept Components and advise you on all radio matters.



BURNDEPT LTD., Aldine House, Bedford Street, Strand, London, W.C.2  
 Telephone: Gerrard 9072. Telegrams: "Burndept, Westrand, London."  
 LEEDS: 12, Basinghall Street (near City Square). CARDIFF: 67, Queen Street.  
 NORTHAMPTON: 10, The Drapery. BIRMINGHAM: Winchester House, Victoria Sq.

*Purchase Burndept by its name—substitutes are not the same*



Suitable cabinet. That shown is of the "desk" type, made by the Carrington Manufacturing Co.

Suitable wire for connections. One packet Radio Press panel transfers.

#### Drilling the Panel

The panel is drilled in accordance with the details given in Fig. 3, and should present no difficulty. If separate valve sockets are used, it is best to use a template for marking out the positions of the holes, and several firms are now marketing excellent templates for valve sockets. I have tapped all the terminals and valve sockets into the panel, because I find it, on the whole, more satisfactory than using nuts, but this is purely a matter for individual taste, and the constructor may decide for himself as to the course to be adopted in his own case. Messrs. McMichael are now making a one-hole fixing type of resistance, which is improved in several details, and the number of holes necessary in the panel is thus reduced.

#### Wiring

If you look at the photographs on this page, you will see that one shows the back of the panel without the wire, whilst the other shows the completed set. These two should prove valuable when wiring up, as they enable you to follow every detail. The wiring diagram shows the actual connections necessary, and should in all cases be consulted during this operation. The condenser across the telephone terminals is held in place by the wiring, and therefore

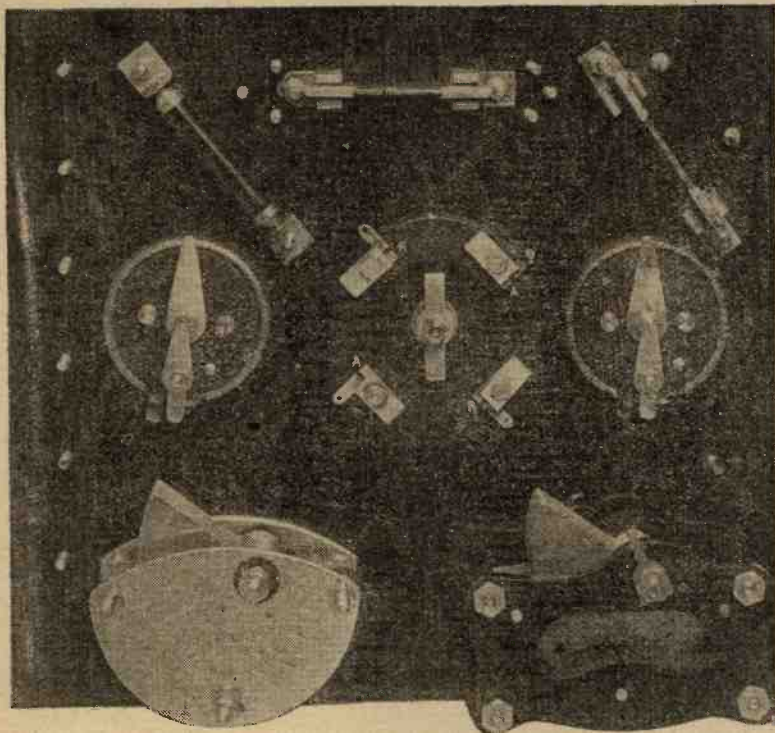

This photograph shows the back of the panel before wiring is commenced, the positions of the parts being clearly indicated.

One 0.0005  $\mu$ F. variable condenser. That shown is a new model being produced by the makers of the "Success" components, and is of a new type submitted to me for trial. It has a geared motion with a reduction of 4 to 1, giving a very smooth and regular control, while the provision of a fibre gear keeps the hands well away from metal parts in actual contact with the moving vanes. A suitable dial for the double rotation of the controlling knob is being produced. It is of the square law pattern.

One 0.003  $\mu$ F variable condenser (L. McMichael, Ltd.). Square law.

Two filament resistances (L. McMichael, Ltd.).

One Sterling anode reaction unit for broadcast range. For Chelmsford a suitable coil unit will be required, these being interchangeable on the standard adaptor.

One coil socket for panel mounting (Magnum).

One 0.003  $\mu$ F, one 0.001  $\mu$ F condenser, clip-in type, and one 2  $\Omega$  grid leak, all with clips (McMichael).

One 0.01  $\mu$ F condenser (Dubilier).  
Two sets valve sockets, or alternatively two complete valveholders; and ten nickel terminals (Magnum).

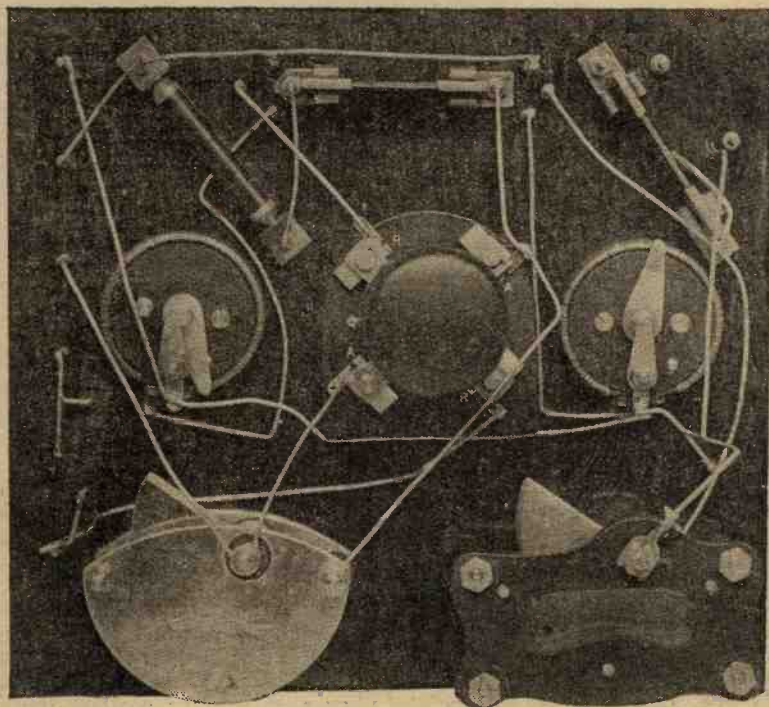

When used in conjunction with the above photograph, this view, which was taken from the same angle, will make perfectly clear the connections necessary.

is not seen in the "wire-less" photograph.

**Fixing the Transfers**

In affixing the transfers, a point which will assist the constructor is that if a touch of varnish is applied to the panel where the transfer is to be, and the usual process then followed after the varnish has become tacky, a permanent job may be made.

**Mounting the Receiver**

When completed, the set may be mounted in the cabinet, the choice of which must be left entirely to the reader. The method of securing the panel in position will obviously depend upon the manner of mounting employed, and no hard-and-fast rule can be laid down. In general, however, where the panel fits in on fillets, one wood screw in the middle of each end will suffice to retain the panel in position.

Having mounted the receiver in a suitable cabinet, turn the filament resistances to the "off" positions and join up to the L.T. terminals a suitable accumulator for the valves in use. Insert the valves and test the filament circuits by gradually turning the rheostats toward the "on" position. If the valves light correctly, turn the rheostats off again and join up the rest of the leads. As an initial test on the local station, the aerial may be joined to the C.A.T. terminal, and a number 50 coil inserted in the socket on the panel. In the case of

receiver to oscillate, for reasons already given, the effects of ignoring this rule being well known by all

mouth and Birmingham are receivable at comfortable strength, while the Postes et Télégraphes

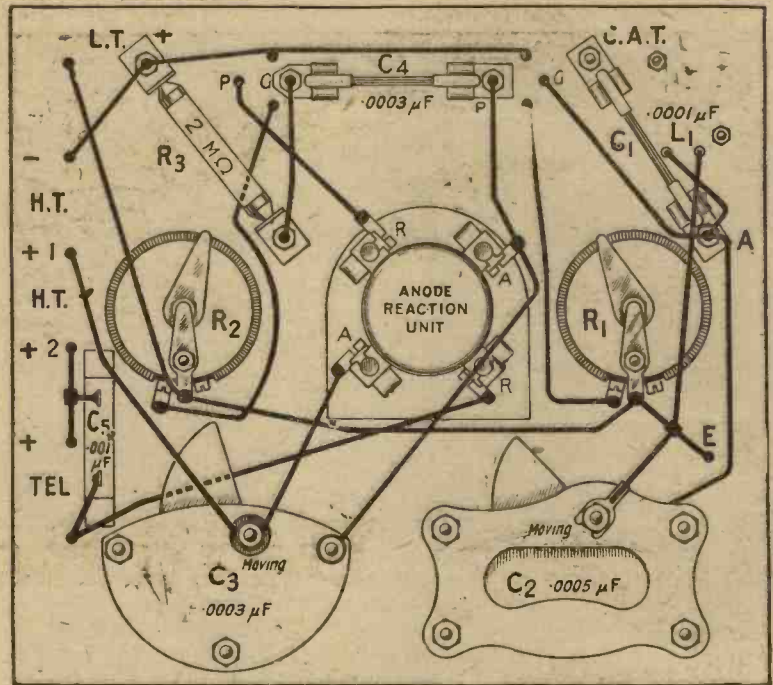
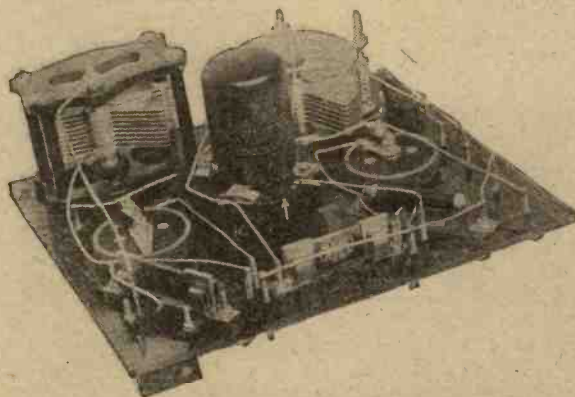

Fig. 4.—Practical wiring diagram showing the values of the components. Full size blueprint No. C1013B may be obtained. Whatever type of condenser is used for C<sub>2</sub>, note that the wire from A goes to the fixed plates.



Note how the clip-in type condensers and grid leak are secured in position.

the London station, the aerial condenser setting will be toward the lower end of the scale. The anode condenser is turned slowly over its scale until the best signal strength is obtained, when the reaction knob may be slowly rotated, careful attention being given to the setting of the right-hand condenser. Care should be taken not to allow the

listeners. A suitable filament resistance should be substituted for the bright-emitter type used here, if dull-emitter valves are to be employed.

These may be obtained from the firm mentioned in the list of components.

**Results Obtained**

The receiver is in use at my station, 6DD, situated at about five miles from the 2LO station in the Strand, which is still operating at the time of writing. Very good signals

station, although at such a distance very little benefit is obtainable from a high-frequency amplifying valve.

The receiver, which, as already stated, is designed for the reception of distant stations in the telephones, gives very good all-round results on an aerial which, very unfortunately, is badly screened by a church and many trees. Bourne-

station in Paris comes through with no interference from London, which is very pleasing, considering the proximity of my station to London. On another evening, Glasgow and Newcastle were heard at good strength, while two German stations, unidentified, also came through. After the British stations had closed, Madrid was tuned in at good strength, the reception, however, being, as usual, entirely spoilt by the efforts of oscillating fiends in the vicinity.

I shall be very pleased to hear from readers who make up this set, as I am convinced that upon a better aerial than mine it will show up remarkably well, judging by its performance in comparison with similar sets I have tried.

**Test Department**

The popularity of this department has necessitated greatly increased staff, and while it is not intended that the department should pay for itself, this fact together with the high cost of the necessary standard testing instruments compels us reluctantly to increase the cost of testing to 5/- per valve in a "straight" receiver, 10/- being charged for a "dual" valve. In addition, we cannot undertake to test any set in which a departure from Radio Press design has been made



# Dead Reckoning

TO make a long flight by "dead reckoning," to cross islands and seas without reference to land-marks or other visible guides, and finally to break through the clouds exactly above the intended spot—it is here that the pilot displays his utmost skill.

It is here, too, that he needs to feel complete confidence in the accuracy of his instruments. If he knows that they are designed and chosen with great care, then he can safely entrust his machine and himself to their unflinching performance. If not—

\* \* \* \*

This is only another instance which shows the vital importance of selecting the component parts of a machine with the utmost care.

And it is so with your wireless set.

If you desire good results and freedom from trouble, choose your components—especially your condensers—with great care.

It is certainly worth the small extra outlay to

*Specify Dobilier.*



Advt. of the Dobilier Condenser Co., Ltd., Ducon Works, Victoria Road, North Acton, London, W.3.

Telephone: Chiswick 2241-2-3.



# Cosmos Components for Efficient Radio Sets

**The Foundations—**  
of your Radio Receiving Set are sound, efficient and reliable, when the tuning circuit embodies the Components shown above.

**“Cosmos” Strip Inductance Coils** are constructed on a new principle which results in Low Resistance, Low H.F. Resistance, Robust Constructions, and Low Self Capacity. With regard to the last feature, a report on an independent test conducted by “The Wireless Trader” (issue March 4th) reads as follows:—

*“Our tests proved satisfactory, for the coil (tested on 377 metres) was found to have quite exceptionally low self-capacity. It was tested at the same time as a well known and favourite type of plug-in coil, and the decrease in self-capacity was phenomenal, the other coil having approximately thirteen times the amount of self-capacity found in the ‘Cosmos.’”*

**The “Polar” Precision Variable Condenser** is a remarkably Compact Robust Dustproof Component with low minimum capacity, low losses, high insulation and a smooth movement. The last named feature is so effective that a Vernier plate is really unnecessary, but to provide for those amateurs who require exceptionally fine tuning, a separate Vernier attachment can be obtained. The “Polar” Precision Condenser is conveniently mounted by means of one hole in the panel.

“COSMOS” STRIP PLUG-IN INDUCTANCE COILS are made in the following sizes:—

Coil No.	Inductance Microhenries.	Price. s. d.
20	12.5	4 9
25	25	4 9
35	50	4 6
40	100	4 9
50	150	4 9
75	300	5 0
100	700	6 0
150	1,000	6 6
175	1,400	7 0
200	2,500	7 6
300	5,000	8 9
400	9,000	9 9

“POLAR” PRECISION VARIABLE CONDENSERS are made in the following capacities, all having the same outside dimensions:—

Max. Capacity.	Price.
.001 mfd. .. ..	12/6 unmounted
.0005 mfd. .. ..	12/6 ..
.0003 mfd. .. ..	12/6 ..

Mounted 5/6 extra.

SEPARATE VERNIER ATTACHMENT 3/6.

YOU CAN OBTAIN THESE COMPONENTS FROM YOUR LOCAL WIRELESS DEALER ALSO “COSMOS” RHEOSTATS, POTENTIOMETERS, FIXED CONDENSERS, GRID LEAKS, VARIOMETERS, REACTANCE COILS AND ALL DETAIL ACCESSORIES

## METRO-VICK SUPPLIES, LTD.

4, Central Buildings, Westminster, London, S.W.1 R  
P21

**“HEARING IS BELIEVING”**

In conjunction with a National Advertising Campaign, Wireless Retailers are giving specific demonstrations of “Cosmos” Universal Valve Sets. You who are interested in Radio, will be delighted with the purity of reproduction obtained by this set, and will realize at once why it is called the “Musicians’ Set.”—“Hearing is believing.”

# TAKE WARNING!!

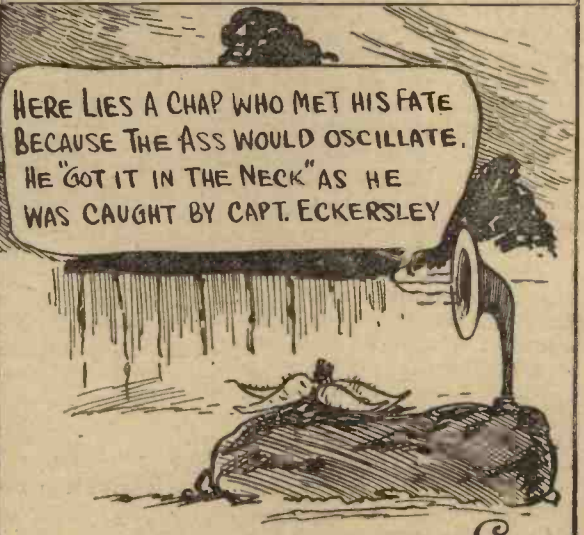
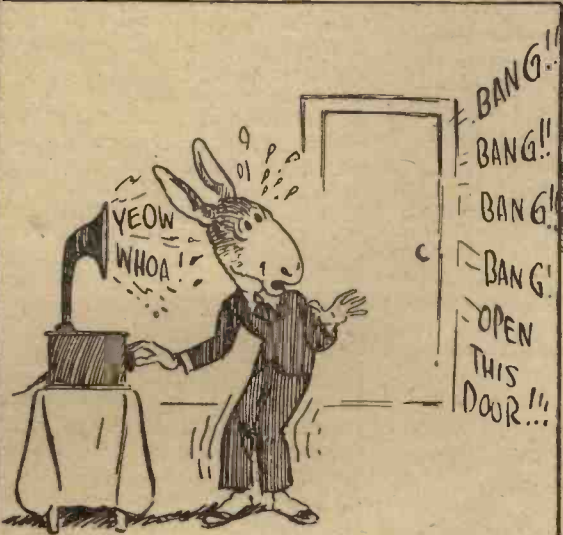
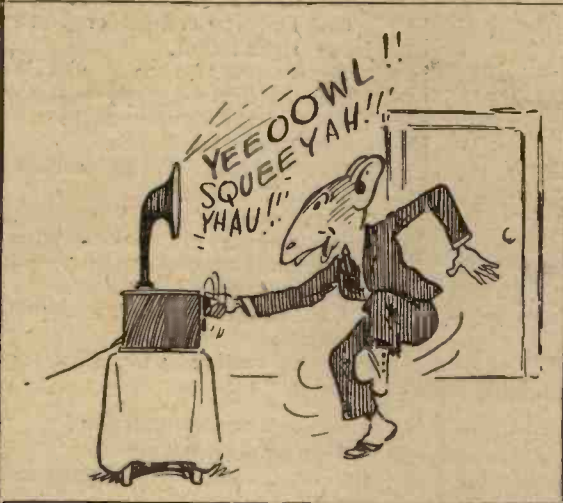
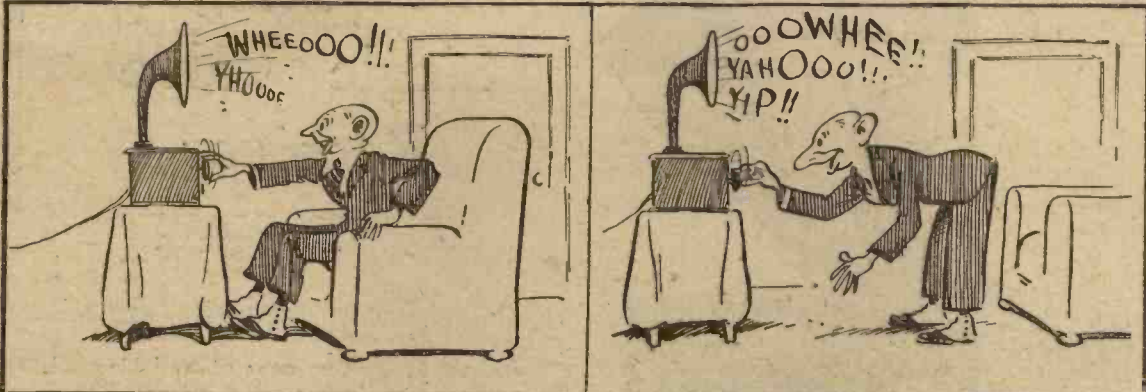

— Gen Shaw —

## THE FATE OF THE ASS-CILLATOR !!!

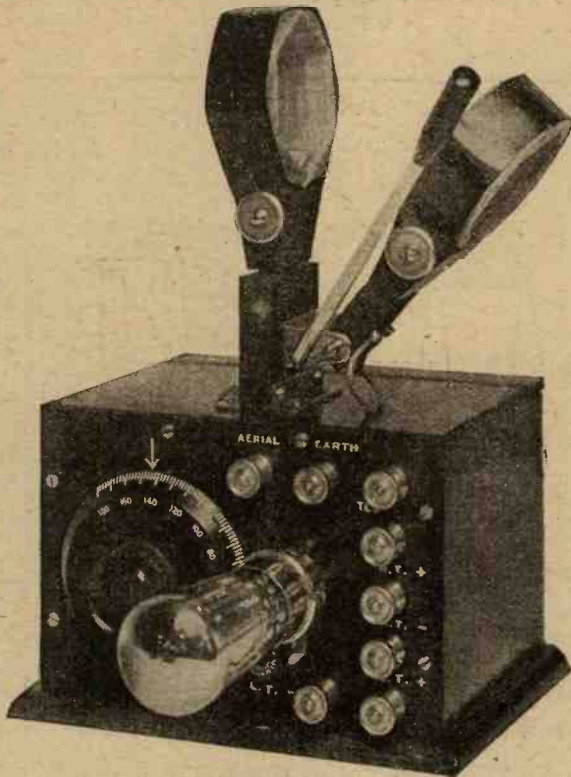

This set has a neat appearance when the valves and coils are inserted.

# The "Midget" Single Valve Receiver

By A. S. CLARK

- One .0005  $\mu$ F variable condenser (Jackson Bros.' square law).
- One two-way coil-holder (Burne-Jones, right hand).
- Eight W.O.-type nickelled terminals (Burne-Jones).
- Four nickelled valve sockets.
- One Lissenstat Minor.
- One .002  $\mu$ F fixed condenser (Dubilier).
- One .0003  $\mu$ F fixed condenser with 2 megohm grid-leak (Dubilier).
- One suitable-sized cabinet, 4 in. from front to back (Camco).
- One packet Radio Press panel transfers.
- Square-section wire, flex and wood screws.

THE single-valve receiver about to be described, although quite complete, has a panel only 4 in. by 6 in. This not only makes the set very compact so that it takes up very little room, but it also keeps the wiring quite short. And the fact that the shorter the wiring on a single-valve set the more efficient it becomes is amply proved by the good results obtained on this receiver, an account of which is given at the end of this article. The coil-holder is placed on the top of the cabinet, which is a most convenient position for it, and it allows plug-in coils to be used for any wavelengths. The Lissenstat Minor, which is used for filament control, is suitable for controlling the filaments of both bright and dull-emitter valves, providing a little care is used when working with dull emitters. Although not an inch of space is wasted on the panel, all the components will fit on with enough clearance provided that the dimensions on the drilling diagram of Fig. 2 are followed properly.

### Use of Other Components

For convenience in collecting the necessary parts together to make

this set, a list of components is given. The names of the makers are added so that the receiver may be exactly duplicated if it is so

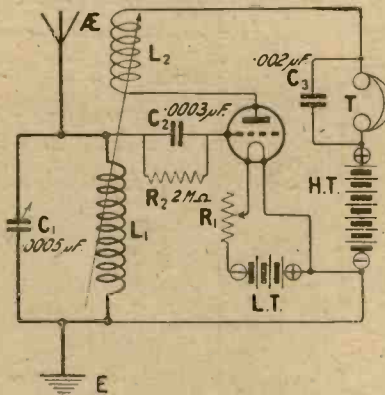

Fig. 1.—The circuit diagram, which is of the ordinary reaction type.

desired. But, should other components be used, first ascertain that they will fit in place of those used on the actual receiver.

### List of Components

One ebonite panel, 6 in. by 4 in. (Paragon).

### The Construction

Having collected together all the parts required, we can now commence the construction. The first thing to do is to drill the panel; this is done in accordance with the drilling diagram. The marking out of the panel must be done with a scribe and not with a pencil, and care taken to see that the distance from the aerial terminal to the grid socket is as marked, because this distance is the same as that of the distance apart of the soldering tags on the Dubilier condenser. It is as well, while the drill is in use, to drill the holes on the top of the cabinet for the coil-holder. This is fitted with 6 B.A. nuts and bolts, the shanks of which should be cut off close up to the nuts, as they are likely to get in the way of the wiring and some of the internal parts. Four holes also have to be drilled on the top of the cabinet for the flexible wires, two of which go to each coil.

### Mounting Components

At this stage of the construction it is best to fix the transfers, having first made quite sure that the holes are all in the correct positions. The transfers, when put on carefully and firmly, greatly help the

*This compact and efficient single valve receiver is just the set for the constructor of small means who desires to log as many stations as he can.*

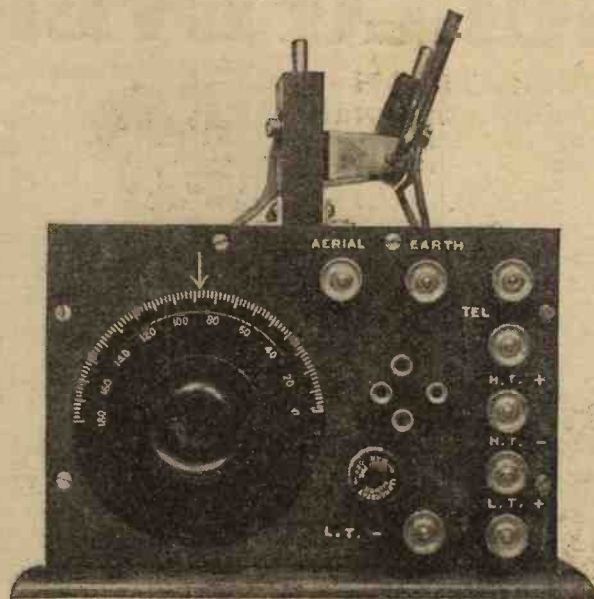

This photograph shows that every inch of panel space is utilised.

appearance of the set, and will last. The correct lettering may be gathered from the drilling diagram and the photographs; an arrow head is used as the zero indicator for the variable condenser.

Now carefully mount all the components in their right places, putting on the small parts, such as the terminals and the valve sockets, first. The terminals should have a washer placed on before the nut, but not the valve sockets, as these are close together and this would make it easier for a short to occur between them. In order to prevent damage during wiring, the condenser dial and knob should not be put on yet. It will help to keep the wiring neat if all the terminals and valve sockets have their shanks cut off to about  $\frac{1}{2}$  in. below the panel.

**The Wiring**

The wiring is now undertaken. This is not difficult, and is as shown in the wiring diagram of Fig. 3. If the photographs of the wiring are inspected, it will simplify matters, and an attempt should be made to copy it as near as possible. The soldering on of the fixed condensers is left to the last thing. The two flexible wires which go to the reaction coil, are not attached directly to the terminals from which they come, but are soldered to two short pieces of square wire, and these are soldered to the terminals. This prevents these wires sagging about too much. The short pieces of square wire should be about 1 in. long.

As the clearance for the fixed condensers is very small, it will be found that the end pieces which are provided for fixing screws must

be cut off. These are not required in this set, because, as already mentioned in the case of the grid condenser the fixed condensers are soldered straight on by means of their soldering tags. Care should be taken to see that they are placed the same way round as they are

reverse the reaction leads if they are the wrong way round.

**Using the Set**

Any type of ordinary plug-in coils may be used with this set; the correct sizes to use for receiving the different stations will be found in the test report. If it is desired one of the tapped coils for aperiodic aerial tuning may be employed, when the aerial is connected to the most suitable tapping on the coil, instead of to the terminal marked "aerial." Any general purpose valve of either the bright or dull emitter variety is suitable for this set, with a tapped high-tension battery of somewhere about 60 volts maximum, according to the type of valve used.

**Connecting Up**

Connect the aerial, earth, batteries, and telephones to their correct terminals, and after inserting valve and coils the set is ready to receive signals from one of the several stations which may regularly be tuned in on it any night. The tuning is the same as any other ordinary single valve reaction receiver. The reaction coil must only be brought near enough to the aerial coil to bring the set to the point just before it

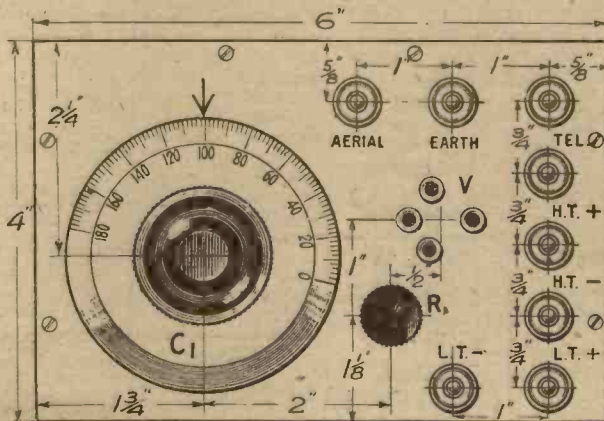
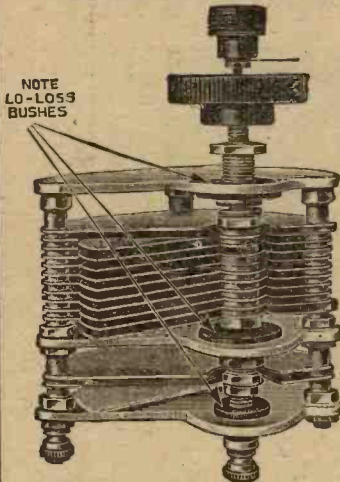

Fig. 2.—From this diagram the marking out and drilling of the panel is quite easy.

on the actual set. If this is not done, they may not clear the sides of the box, which, it may be mentioned here, are made of not more than  $\frac{1}{4}$  in. wood. The flexible wires are threaded through the holes in the top of the cabinet, and the panel screwed to the front. Connect the wires to the coil holder, and the set is completed, although it may be found necessary to

# HULLO EVERYBODY!!

**REVOLUTION IN VARIABLE CONDENSERS SQUARE LAW LOW-LOSS (SQUARE-LO-LOSS) with VERNIER**



NOTE LO-LOSS BUSHES

The only Condenser with the Low-Loss Bushes. Electrical losses reduced to a minimum.

Full capacity as rated.

Exceptional Low Capacity.

The Condenser for Short wavelengths.

**SQUARE LAW WITH VERNIER** .0005 : 7/9  
.0003 : 7/-  
Including Knob and Dial Post 6d. Set.



**RAYMOND VARIABLE CONDENSERS SQUARE LAW**

One-hole fixing. **EBONITE** Bushes. Aluminium ends. Highly recommended.

Prices include Knob and Dial.

With Vernier	Without Vernier
.001 - 8/9	.001 - 7/7
.0005 - 7/9	.0005 - 5/9
.0003 - 7/-	.0003 - 5/3

Post 6d. Set.

Ebonite ends 1/- extra. Ebonite ends 1/- extra.



**DE LUXE ORDINARY**

Complete with Knob and Dial

.001 alum. ends	6/11
.0005 "	5/6
.0003 "	4/11
.0002 "	4/6

Post 3d. Set.



**TWIN CONDENSERS**

Equal parts of .0005, .0003, and .00025. With Knob and Dial.

Ebonite Ends.	
.0005 ebn. ends	13/11
.0003 "	12/6
.00025 "	12/6

**LONDON'S LARGEST Stockist of JACKSON BROS.'**

J.B. Variable Condensers, complete with Knob and Dial.

SQUARE LAW	STANDARD
.001 - 9/6	.001 - 8/6
.0005 - 8/-	.0005 - 7/-
.0003 - 6/9	.0003 - 5/9
.0002 - 5/6	.0002 - 5/-

Other sizes as advertised by "J.B." Post 4d.

West End Stockist of Edison Bell, Igranite, Goswell (quality), Polar, Jackson Bros. (J.B.), Marconi, Cossor, Mullard, Ediswan Valves, Sterling, B.T.H., McMichael's, Lissen, Dubilier, T.C.B., Dubilier, T.C.B., Shipton parts.

**"RE-CHO"**

Crystal Set. Stopping cabinet. Fitting for Chelmsford. Splendid results. 17/-, including aerial wire, lead-in, and insulators. Post free U.K.

**BRUNET PHONES**

New Model. Black Cords. 4,000 ohms . 16/6  
Post 6d. pair.

**"ETHERON"**

Scientifically Wound Inductance Coils. Set of 5, 1,300/2,100, 2/6  
ONE for Chelmsford, 1/6

**WE GUARANTEE** the accuracy of these coils both as to wavelength and efficiency. They give selectivity of tuning unobtainable in others. Used as a High Frequency coil in tuned anode circuits, it is far in advance of the most costly H. F. Transformers.

Try "Etheron" Coils, you will be delighted with the results.

**When visiting London we pay your fare up to 2/- in the pound on our own goods.**

**BE SURE IT'S RAYMOND'S.**

**N & K**

4,000 ohms. Guaranteed genuine and stamped.

**12/11 pair.** Post 6d. pair.

**GENUINE "BRUNET"**

L.F. Transformers. 3-1, Primary 5,000, Secondary 15,000. 5-1, Primary 5,000, Secondary 25,000.

**13/6** each.

Please note new address at bottom of page. Call and see us and be paid for calling **GRAND OPENING DISPLAY.**

**OPEN WEEKDAYS, 9 to 8. SUNDAYS, 10 to 1.**

**3 COLUMNS FOR CALLERS ONLY ALL POST ORDERS FROM OTHER COLUMNS**

**TERMINALS (Complete).**  
W.O., Pillar, Phone, brass, 1d. each. Nickel, 2d. each. Stop and valve Pins, 1d. Nuts, various, 6 a 1d.  
Valve Sockets 1d., 1 1/2d.  
Flush panel do. . . 1d.  
Spade Tags . . . 6 a 1d.  
Do. Terminals 2 for 1 1/2d.  
Do. Pins 2 for 1 1/2d.  
Screws and nuts 2 a 1d.  
Switch arms . . . 7d.  
Nickel arms . . . 10 1/2d.  
Studs, complete 2 a 1d.  
Phone connectors 1d.  
2 B.A. Rod . . . ft. 2d.  
4 B.A. Rod . . . ft. 2d.  
Valve windows . . 4d.  
Washers . . . 12 a 1d.  
Shrtg. plug & sckt. 3 1/2d.  
Shellac . . . . . 5d.  
Ormond (Neutrodyne) 2/-  
Colvern . . . . . 3/6  
Success . . . . . 3/6  
Vernier (Colvern) 2/6

**ACCUMULATORS.**  
2 v. 40 amps. 7/9 9/6  
4 v. 40 amps. 13/11 16/6  
4 v. 60 amps. 17/6 18/6  
4 v. 80 amps. 22/3 23/6  
6 v. 60 amps. 25/9 27/6  
6 v. 80 amps. 33/-  
6 v. 105 amps. 38/6  
Hart's Stocked. All High Quality.

**EBONITE, 3/16 in.** Stock Sizes.  
Cut to size. 1d. sq. in.  
6 x 6 1/4 12 x 6 3/-  
7 x 5 1/4 12 x 9 4/3  
8 x 6 1/10 12 x 12 5/6  
9 x 6 2/- 14 x 10 5/6  
10 x 8 3/-  
1/4-in. also Stocked.

**SWITCH ARM, one-hole fixing.** 12 Studs, 12 Nuts, 12 Washers. . . Lot 10 1/2d.

**COIL PLUGS, EBONITE**  
Fitted Fibre . . . . . 7d.  
Wedge Shape . . . . . 7d.  
Edison Bell . . . . . 11d.  
Plaincoil Plugs . . . . 4 1/2d.  
Also 5d., 6d., 7d. each.  
Fibre Strip . . . . . 2d.  
(36 in. by 1 in.)  
Empire Tape, doz. yds. 6d.

**RAYMOND FIXED CONDENSERS.**  
.001, .0001 to .0005 . 10d.  
.002, .003, .004 . . . 1/-  
.008, 1/3, .01, 1/9, .02, 1/9.  
Ebonite Base Terminals.

**ENCLOSED DETECTORS.**  
Micrometer . . . . . 1/6  
Half Opal . . . . . 1/-  
Small Brass . . . . . 8d.  
Large Brass . . . . . 1/-, 1/3  
Nickel . . . . . 10d. to 1/6  
Burnt . . . . . 4/-  
Shaw's Genuine Hertzite . . . 10d.  
Uralium . . . . . 1/-  
All known makes.  
4 Whiskers (1 gold) . 2d.  
Gold and Silver do. . 2d.  
7 Waxed Coils . . . 1/8  
5 Waxed Coils . . . 1/3  
(For B.B.C.)

**SPECIAL!**  
Vernier 2-way Coil  
Stands . . . . . 3/3  
Geared do. . . . . 5/3

**HEADPHONES.**  
Ericsson's EV Continental  
4,000 ohms. . . . . 11/9

**SPECIAL!**  
Square Law Variable Condensers.  
.0005 . . . . . 5/-  
.0003 . . . . . 4/6  
Complete with Knob and Dial.  
Ebonite Ends, 1/- extra.

**ODDMENTS OF ALL KINDS** all cleared out daily at cheap prices. Not obtainable unless shop bears the name **RAYMOND** on windows, etc.

## K. RAYMOND,

**7, Grape Street, Shaftesbury Avenue, W.C.1**

(Opposite Lucas Lamp Corner).



NOTE NEW ADDRESS at bottom of page

# K. RAYMOND

NOTE NEW ADDRESS at bottom of page

NOTE.—ALL THESE GOODS POST FREE U.K. EXCEPT WHERE STATED. FOREIGN ORDERS MUST INCLUDE EXTRA FOR PACKING AND POST.

- Aerial, 7/22, 100 ft. .. 2/8
- 50 ft. .. 1/8
- Copper tape, 100 ft. .. 2/6
- Basket holder and plug 10d.
- Do. best quality, 2 for 2/3
- Do. spike holder, 2 for 2/3
- 2-way coil stands .. 2/9
- 3-way coil stands .. 4/6
- 2-way nickel ex. handles 3/6
- 3-way nickel ex. handles 4/9
- 2-way geared .. 5/6
- 2-way Sipton cam vernier .. 3/6
- 3-way Sipton cam vernier .. 7/8
- 2-way Polar cam vernier 6/-
- 3-way Polar cam vernier 9/-
- 2-way cam vernier .. 3/6
- Coil plugs, plain 2 for 1/3
- Shaped wedge 2 for 1/6
- Do. Edison Bell 2 for 2/-
- Do. nickel sides 2 for 2/-
- Do. fitted fibre 2 for 2/6
- Variometer and knob .. 2/6
- Ebonite variometer and knob .. 2/6
- Igranite .. 10/-
- Edison Bell .. 10/-
- Similar .. 8/11
- Edison Bell, .001 .. 1/3
- .001 up to .0005 .. 1/3
- .002 up to .006 .. 2/-
- Grid leak and clips .. 1/6
- .0003 and grid leak .. 2/6
- Dubilier, .001 to .006 3/-
- .001 up to .0005 .. 2/6
- .0003 with grid leak 5/-
- Anode res. on stand .. 5/6
- (50, 70, 80, 100,000 ohms)
- Raymond ebonite base.
- .0001 up to .0005 .. 1/1
- .001 up to .006 .. 1/3
- Grid leak and clips .. 1/3
- .01 and .02 .. each 1/9
- 2 MFD. .. 4/6
- 1 MFD. .. 3/10
- 25 MFD. .. 3/8
- BRASS PARTS.**
- Flush panel sockets, doz. 1/3
- \*Phone terminals, doz. 1/2
- Pillar, large .. doz. 1/8
- Pillar, small .. doz. 1/1
- W.O. pattern .. 1/3
- Terminals, nickel doz. 2/-
- Spade terminals .. doz. 1/-
- Pin terminals .. doz. 1/-
- Spade tags .. doz. 6d.
- Studs, nuts and washers doz. 9d.
- With switch arm .. 1/6
- Shorting plug .. 8d.
- Bus bar, 1/16th sq., 12ft. 1/-
- Nickel switch arm .. 1/3
- (with studs and nuts) 2/-
- TWIN FLEX, Etc.**
- Red and black, 12 yds. 1/11
- Miniature silk, 12 yds. 1/6
- Lead-in, 10 yds. .. 1/3
- Extra heavy, 10 yds. 2/6
- Empire tape, 12 yds. 1/-
- D.C.C. bell wire, 20 yds. 1/8
- Fibre strip, 36 in. by lin. 4 yds. .. 1/6
- Solid rod .. 1/3
- Murray .. 1/3
- Bretwood .. 1/9
- H.T.C. under panel .. 1/6
- H.T.C. over panel .. 1/9
- Barrie anti-cap .. 1/3
- Chimax, under panel .. 1/6
- Burndet detector .. 4/-
- Dual rheostat .. 7/6
- Ormond rheostat .. 2/-
- Ormond L.F. .. 14/6
- Rheostat C. & S. .. 1/3
- Do. Raymond .. 1/6

**SPECIAL!**  
**Reflex Coils.**  
35 .. 8d. 200 .. 2/8  
50 .. 9d. 250 .. 2/3  
75 .. 1/- 300 .. 4/8  
100 .. 1/2 400 .. 5/8  
150 .. 1/3 500 .. 6/8  
Unmounted.  
Post 3d. each.

**SUPER SELECTIVE**  
**Circuits**  
WATMEL Res. 10,000 to 100,000 .. 3/6  
"E.M.C." MICRO .. 4/-  
Chimax earth tube .. 5/-  
Service detector .. 2/8

**ENERGO H.F.**  
No. 1 150/450 .. 3/6  
No. 2 250/700 .. 3/11  
No. 3 450/1,200 .. 4/3  
No. 4 900/2,600 .. 4/6  
No. 5 1,600/3,000 .. 4/8

**UTILITY SWITCHES.**  
2 Pole c/o Knob type 4/-  
2 Pole c/o Lever type 5/-  
4 Pole c/o Knob type 6/-  
4 Pole c/o Lever type 7/6

**IMPORTANT NOTICE**  
**TRADE POST ORDERS.**  
**TRADE ORDERS OF NCT.**  
**LESS THAN £2 in value**  
executed from this page less 20 per cent. plus postage.  
Cash with order only.

**COUNTER ORDERS**  
**ANY QUANTITIES.**

**CRITERION**  
**CONCERT COILS.**  
Low Self Capacity. Every turn and layer airspaced.  
Perfect for Reaction.  
Mounted on Plug.  
25 .. 2/- 75 .. 2/8  
30 .. 2/3 100 .. 3/-  
35 .. 2/3 150 .. 5/-  
40 .. 2/6 200 .. 6/-  
50 .. 2/8 250 .. 6/6  
60 .. 2/9 300 .. 7/-  
Razor sharp tuning.

**L.F. TRANSFORMERS.**  
Eureka Concert Grand 30/-  
Eureka Second Stage 22/6  
Igranite Shrouded New Model .. 21/-  
Powquip, see illustrations.  
Formo Shrouded .. 18/-  
Formo Open Type .. 12/6  
Portland .. 12/6  
General Radio 83 .. 15/-  
Super Success (black) 21/-  
Royal Transformer .. 20/-

**IMPORTANT**  
By arrangement with Messrs. Bower Electric. I offer genuine 5-Pin  
**THORPE K4 17/6**  
(Unidyne Valves.)  
5-pin valve holder, 1/3  
2-valve Unidyne receiving set built complete, aerial tested and guaranteed efficient, including coils and valves for B.B.C. stations. £9 9s. 0d.  
One-valve Set, complete, £8 6s. 0d.  
sets of parts supplied from £3 15s. 0d.  
Post free U.K.

**QUALITY GOSWELL**  
**RADIO COILS**  
Far more efficient than aneycomb or any other type of coil. Exceedingly strong and rigid, mounted on standard ebonite plugs. Brown finish, no wax or shellac used. MOUNTED.  
25 .. 1/6  
35 .. 1/9  
50 .. 2/-  
75 .. 2/3  
100 .. 2/9  
150 .. 3/-  
175 .. 3/6  
200 .. 3/9 Post 3d. Coil.



**GOSWELL (QUALITY)**  
Valve Legs, Set 4 .. 1/3  
Valve Holder .. 1/9  
2-way Cam Vernier 9/-  
1-way Cam Vernier 12/6  
1-way Ordinary .. 7/6  
2-way Panel .. 3/-  
1-way Panel .. 5/-  
Basket Holders .. 1/4

**H.T. BATTERIES.**  
B.B.C. 60 volt .. 8/11  
By post 10/-  
B.B.C. 36 volt .. 5/6  
By post 6/8.  
Best made, 60 volt .. 8/11  
By post 7/11.  
Ever-Ready, 66 volt 13/6  
Ever-Ready, 36 volt 22/6  
Ever-Ready, 36 volt 7/-  
Last 3 post free U.K.

**WATES**  
**MICROSTAT**  
New Improved Model  
Post Free. 2/9  
Get those other Stations with the **STRADIO**  
H.F. Transformer (Barrel type), 6/8

**HEADPHONES.**  
Reduced Prices.  
British B.T.H. .. 20/-  
Brands' Matched Tone .. 20/-  
General Radio .. 20/-  
Brown's F Type 20/-  
Sterling's .. 22/8  
All 4,000 ohms. Highest quality finish Post free U.K.

**TELEFUNKEN.**  
Adjustable, 4,000 ohms. Only genuine when bearing No. E.H.333 on each earpiece. These phones are lighter than a feather, and simply wonderful for reception. Post price U.K. 17/11 pair.

**POLAR**  
Variable Condensers.  
.001 .. 10/6  
.0008, .0005, .00025 18/6  
Micrometer .. 5/6  
2-way cam vernier 6/-  
Post free U.K.

**IGRANIC.**  
Rheostat .. 4/6  
30 ohms .. 7/-  
Potentiometer .. 7/-  
Variometer .. 10/-  
**COILS.**  
25 .. 5/- 200 .. 8/8  
35 .. 5/- 250 .. 9/-  
50 .. 5/2 300 .. 9/5  
75 .. 5/6 400 .. 10/3  
100 .. 7/- 500 .. 10/6  
150 .. 7/10  
Post free U.K.

**"WONDER"**  
Aerial Wire, 49 strands. Special alloy Phosphor Bronze, for frame, indoor, or outdoor. Non-corroding. 110 ft., 3/8 By post, 3/8.

**"LISSEN."**  
Post free U.K.  
Lissen Minor .. 3/6  
Lissenstat .. 7/6  
Lissen Universal .. 10/6  
Push and Pull .. 2/9  
Do., 5 point .. 4/-  
Series Parallel .. 3/9  
Var. grid leak .. 2/6  
Anode Resistance .. 2/6  
See Transformers.

**LOUD SPEAKERS**  
C.A.V. Tom Tit .. 30/-  
C.A.V. Junior .. 55/-  
Sterling Baby .. 55/-  
Sterling Dinkie .. 30/-  
Amplion Junior .. 27/6  
Amplion Dragonfly .. 25/-  
Dulcevox .. 42/-  
All models stocked leading makers.

**R.I. DETECTOR**  
6/-  
All orders in rotation.

**£50 REWARD**  
given if the  
**DR. NESPER**  
PHONES SOLD HERE ARE NOT GENUINE!  
**BEWARE OF FRAUDULENT IMITATIONS!!**  
(Injunctions obtained.)  
Adjustable diaphragm detachable receivers, double leather-covered head-springs, long flexible cords, nickel-plated parts. Very comfortable fitting to the head. Per pair, 12/11. Post 3d. pair, U.K.

**STERLING**  
Square Law, with Vernier.  
001 .. 30/6  
.0005 .. 25/6  
.00025 .. 23/6  
Post Free U.K.

**MANSBRIDGE**  
**CONDENSERS.**  
Octopus, Tested at 350 D.C.  
.01 .. 2/3 T.C.C.  
.25 .. 3/- 2 mfd. 5/-  
1 mfd. 3/8 1 mfd. 3/1  
2 mfd. 4/6 .25 .. 3/6  
Post 2d. each

**"HOVIMO"**  
**CRYSTAL VALVE.**  
The "Hovimo" Crystal Valve can be adjusted in an instant, and is easily fitted to any set, being equally excellent for crystal sets, and for circuits employing crystal rectification. No batteries are required. 3/6

**LISSEN COILS**  
25, 35 .. 4/10  
50 .. 5/-  
60 .. 5/4  
75 .. 5/4  
100 .. 6/9  
150 .. 7/-  
200 .. 8/5  
Post free U.K.

**VALVES**  
Bright Emitter.  
B.T.H. "R", Ediswan A.R., Marconi Osram "R" or "R5", Mullard ORA, Cossor L.F. P1, Cossor H.F. P2, Mullard H.F., Mullard L.F. 11/-  
Dull Emitter.  
B.T.H. B3, Ediswan A.R.D.E., Marconi D.E.R., Myers, each 18/-  
Dull Emitters.  
B.T.H. B5, Ediswan A.R. "08", Mullard D.F. ORA .. 21/-  
D.E. ORA .. 21/-  
D.E. Power Valves, Marconi D.E.6 .. 22/8  
Power Valves (for .06) B.T.H. B6 .. 30/-  
Marconi D.E. 4 .. 26/-  
Mullard D.F.A. .. 26/-  
Power Valves, for B.E., B.T.H. B4, Marconi, Mullard .. 30/-  
Valves noted buyer's risk.

**"WELDBANK"**  
(Chorley Rubber Co.)  
**EBONITE**  
Test pressure 500 volts. Specific gravity 1.35. Is sold in our stock sizes.  
All orders accepted and despatched on strict understanding that place of payment is 7, Grape Street, W.C.1. Please cross postal orders and register cash.

**ACCUMULATORS**  

Rheostat with Dial Extra value 2/6  
Bretwood Valve-holder 1/9

Manchester "Powquip" 15/6  
Ormond 14/6

Shrouded "Powquip," 18/-  
Standard "Powquip," 14/6

**"R.I."**  
**NEW MODEL**  
IN SEALED BOX.  
Don't Buy Otherwise. Post 25/- Free

**FERRANTI L.F.**  
BETTER THAN THE BEST  
17/6

**EBONITE PANELS**  
3/16th in.  
6x6 .. 1/8 10x8 .. 3/6  
7x5 .. 1/8 12x9 .. 5/-  
8x6 .. 2/6 12x12 .. 5/9  
9x6 .. 2/9 14x10 .. 5/9

## 7, Grape Street, K. RAYMOND, Shaftesbury Avenue, W.C.1.

(New Oxford Street End.) (Opposite Lucas Lamp Corner.)

This photograph of the underside of the panel shows the arrangement and spacing of the wiring

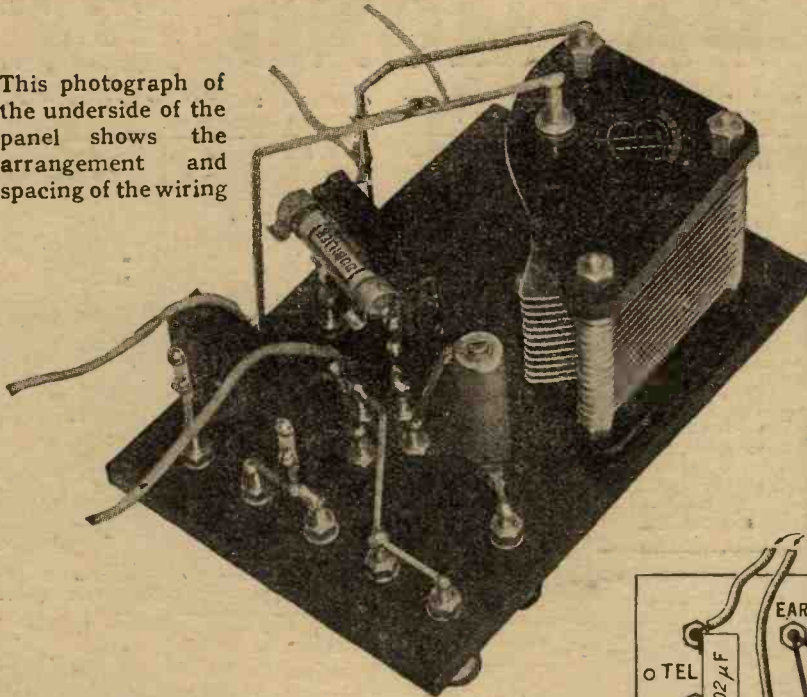

breaks into oscillation, and the coils and variable condenser adjusted simultaneously. After a little practice it will be found easy to bring in the distant stations without being a nuisance to one's neighbours.

**Further Notes on Design**

It may at first be thought that the filament resistance is placed in a very awkward position, but in actual practice this will not be found to be so. It is easily controlled with the right hand, especially if the hand is turned so that its palm is uppermost. But after using the set for the first time, the position of the rheostat will feel quite in the right place. The reader may wonder why the valve was not placed inside the set. This would have entailed the use of a larger panel, also the wiring would have been considerably longer. Whilst in its present position it is easily changed for another one of a different type, and a single valve set is the best to compare the efficiency of valves as detectors.

**Connecting Telephones**

If your telephones are marked positive and negative, that is, if one end of the cords has some red cotton wound round it (which should be the case on all telephones), this lead should be connected to the lower telephone terminal. This will prevent your telephones becoming insensitive, due to the current passing through them in such a way as to reduce their magnetism.

**Reception in General**

In testing out this receiver, all expectations were exceeded to an almost impossible degree. In fact, so many broadcasting stations of both short and long wave-lengths could be received, that it was difficult to decide to which one to listen. So that in writing this test report it is very difficult to know how to begin. To give a list of all the stations received would not be possible, because there are so many that it would have taken much longer than the time available to identify them all. So the outstanding ones in signal strength are mentioned, while the reception of the others is described collectively.

**The Local Station**

The local station is 2 LO, and it is situated about 8 or 9 miles from the testing station. At this distance the results are astoundingly loud, real moderate loud speaking being easily obtained—that is, loud speaking which could be heard on the floor below the operating room. For listening on the telephones for entertainment it was, therefore, necessary to slightly detune the receiver. These results were obtained with different makes of plug-in coils, a No. 35 or 50 being used in the aerial socket, and a

No. 50 or 75 respectively being ample to give sufficient reaction, which was very smooth.

Reception from Chelmsford in S.W. London was almost as good as 2 LO, and the selectivity of the set may be gathered from the fact that Radio Paris could be tuned in while Chelmsford was on.

**Tuned on Loud Speaker**

Results on the loud speaker were so good that an attempt was made to see how many stations could be tuned in on it without the aid of 'phones. The following are those obtained. While they did not give loud speaking their strength may be gathered from the statement that they were tuned in without placing the head almost inside the horn. They were London, Chelms-

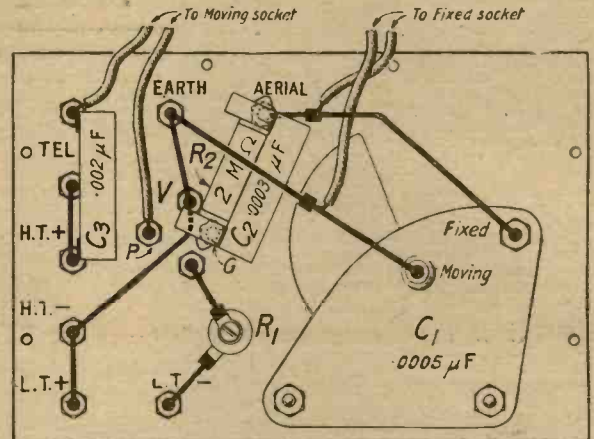

Fig. 3.—The wiring diagram from which the set is wired.

ford, Glasgow, Radio Paris and one German and one French station which were not identified. For the longer wave-length stations a 150 or 200 coil is used for aerial, and a suitable reaction coil is chosen.

**Stations on Telephones**

On the telephones it was possible to obtain all the B.B.C. main stations, and one or two of the relay, although it was naturally not easy to obtain those of a wave-length near to London while this station was working.

Four or five French stations and about the same number of German and a few other Continental stations could be tuned in with ease on any night, and most of them were up to crystal strength on the local station.

**Conclusion**

In conclusion, it should be pointed out, once more, that receiving conditions vary considerably, and at the author's house they seem above the average. In spite of this, the set described can be relied on to give good all-round results in practically any location.

# SIEMENS

## HIGH - TENSION RADIO BATTERIES

### NEW TYPE—LARGE CAPACITY

*The H.T. Battery de Luxe*



Type R. B.3, 72 Volts, with lid removed.

These H.T. Dry Batteries have been designed to meet the increasingly heavy demands which are being made upon the source of H.T. supply

*Copy of our descriptive Price Sheet 645 on application.*

**SIEMENS BROTHERS & CO., LIMITED, WOOLWICH, LONDON, S.E.18**



**MATCHED H.F. TRANSFORMERS.**

Every one guaranteed to match perfectly every other in its range. All ranges 150 to 3,000 metres and up, also special Neutrodyne Unit. Price each 7/-



**ANTI-CAPACITY VALVE HOLDER.**

Through low losses gives greatly increased efficiency, especially on short wavelengths. Fixed without metal nuts and screws. As used by Mr. P. W. Harris. Price 1/2



**NEUTRODYNE CONDENSERS.**

Minimum capacity practically zero. Low losses make high efficiency in tuning neutralising circuits. One screw fixing with 1/4" hole for spindle. Price 5/-

**WRITE FOR FREE LIST.**

Send 1d. stamp for complete Pocket List of all Bowyer-Lowe Tested Parts. 36 pp. of useful information and blanks for your own notes.



*"With your good help I hear pure music now"*

Distorted, unmusical signals will not occur when amateurs realise the importance of securing Low Losses in their sets.

To prove this, simply substitute Bowyer-Lowe Square Law Condensers for the condensers you are now using, and notice the immediate improvement in the strength and rich musical quality of your reception.

These condensers have the lowest losses and highest capacity ratios yet obtained in

condensers of any type, square law or otherwise. In addition to ease of tuning and calibration they give increased wavelength range. So great is their sensitiveness that in many cases they transform into successes sets which previously failed.

Low loss parts mean louder, clearer, purer reception.

All Bowyer-Lowe Parts are made to secure the Lowest Losses. Use them in all your receivers.

**Bowyer-Lowe Tested Square Law Condensers and Low Loss Components.**

BOWYER-LOWE CO., LTD., RADIO WORKS, LETCHWORTH.



**STUD SWITCH PARTS.**

Switch Arm, all studs, stops and screws, etc., for making any switch from 2 to 10 way. Drilling template supplied. Price 2/3



**LOW LOSS COIL FORMERS.**

For making short wave coils with minimum dielectric losses. Former is 3 1/2 in. in diameter, 6 in. long, with terminals and soldering lugs each end and bracket for fixing. Constructed of Grade "A" Ebonite and lacquered brass. Price 5/-



**VALVE WINDOWS.**

Heavily nickel plated, with rounded bezel, back plate, gauze and all nuts and bolts. A handsome finish to any set. Price each 9d.



## Amateurs Can Compare Curves.

**Research Director :** I'm glad we are stressing the importance of the curves in our advertisements nowadays.

**Advertisement Manager :** Yes, sales responded instantly.

**Research Director :** Amateurs know. They are beginning to INSIST on curves. And more than that, they know when a curve is drawn to please the eye, and when it has a real significance.

**Advertisement Manager :** I'll certainly continue to offer them.

In pursuit of this policy, we are therefore continuing to offer curves—the

### PEDIGREES of VALVES.

Write to us at once, and we'll give you two free Booklets—one giving curves, accumulator tables, etc., the other describing Valve repairs.



**Sole Manufacturers :**  
**RADIONS LIMITED, Bollington, near MACCLESFIELD.**

### REDUCED PRICES.

**RADION G.P.** An economical Bright Emitter Valve, taking only '48 amps. at 3.5 to 4 volts. **EACH 10/-**

### DULL EMITTERS

**RADION D.E. .34.** 2 volt D.E. of great efficiency. **EACH 17/-**

**RADION D.E. .06.** One of the best "very dull" fil. valves ever produced. **EACH 20/-**

Guaranteed British made in our own factory at Bollington, Macclesfield.

From DEALERS or Direct.

### VALVE REPAIRS

We are proud of our plant, our resources, our staff, our experience; and the public confidence we have gained. Our files are chock-full of testimonials. The reason is *We guarantee satisfaction*, because having actual Valve MAKERS' PLANT we can do the job *properly*. D.E.'s 2 volt type 9/-; 3 volt '06 type 10/6; Bright valves 6/6. (Postage 3d. extra.)

*We are the largest valve-repairing firm in the world.*

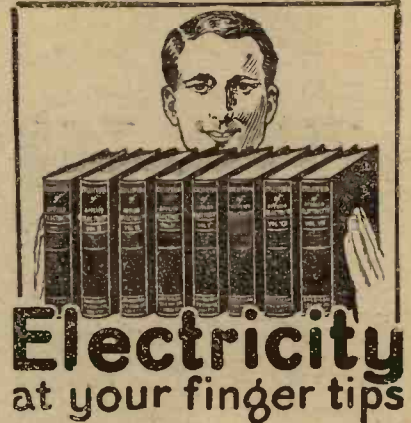

Know the facts in Electricity. They mean more money and better position for you. "APPLIED ELECTRICITY" will tell you all you need to know about Electricity.

Every important electrical subject covered so that you can understand it. Easy to study and apply. A complete, practical working course, in 8 volumes.

### APPLIED ELECTRICITY

BLUE PRINT DIAGRAMS  
4,100 PAGES. 3,300 ILLUSTRATIONS.

These books tell you all about—  
MAGNETISM—Induction—Experiments—  
Dynamos—Electric Machinery—Motors—  
Armatures—Armature Windings—Installing  
of Dynamos—Electrical Instrument Testing  
—Practical Management of Dynamos and  
Motors—Distribution Systems—Wiring—  
Wiring Diagrams—Sign Flashers—Storage  
Batteries—Principles of Alternating Currents  
and Alternators—Alternating Current Motors  
—Transformers—Converters—Rectifiers—  
Alternating Current Systems—Circuit Breakers—  
Measuring Instruments—Switchboards  
—Wiring—Power Stations—Installing—  
Telephone—Telegraph—Wireless—Bells—  
Lighting—Railways. Also many Modern  
Practical Applications of Electricity and  
Ready Reference Index.

**THE LATEST PRACTICE**  
FILL IN COUPON AND SEND TO-DAY

**FREE** TO THE SALES DEPARTMENT  
The American Technical Society  
42, Theobald's Road,  
LONDON, W.C.1

Dear Sir,  
Please send me (free) a copy of your 12-page booklet on "APPLIED ELECTRICITY" giving particulars of this work, published in eight volumes, and terms of payment.

Name.....  
Address.....  
T.W.C.

**Sets, Parts, 'Phones, Loud-Speakers**  
supplied on easy payment system.

Send for latest Catalogue just issued.

**The Wireless Distributing Co., Ltd.**  
Wireless House, Stoke Newington, Road, N.16

### EBONITE BUSHES

For mounting on Wood Panel. Perfect insulation. Price 1/- for 12 (post free)

Easily fixed by drilling a 1/4" hole.  
**DAREX RADIO Co.,**

STANDARD WORKS  
Waldram Rd., Forest Hill,  
London, S.E.23.



Trade Supplied.

### Cabinets you want! For Radio Perfection

PICKETTS—ARE USED FOR FINEST SETS  
Insulated against body capacity—an important point for tone purity and strongest signal strength.

Estimates per return post

Send for Cabinet Designs and Lists Free

CABINET (W.C.) WORKS, BEXLEY HEATH, S.E.



It is doubtful whether any aspect of wireless can assume a more intense and painful interest than that which even the best of us must at times devote to the art of fault-finding. Even the expert is liable occasionally to be so unlucky as to incorporate a component of whose history he is not quite certain, or which represents the "one in a million" chance of a dud specimen of good make, while the beginner is open to numerous risks of mistakes in wiring and assembly, and so on. It would seem, therefore, a certainty that the next of the Radio Press book series to be published will have an extraordinary vogue, since it is entirely devoted to "Wireless Faults and How to Find Them" (R.P. Series No. 24, price 1s. 6d., post free 1s. 8d.), and the very title should make it plain that this is a book which no wireless man can afford to miss.

The author is R. W. Hallows, M.A., Staff Editor, whose articles in our journals are so well known for their wide scope and thorough grasp of detail.

The assistance given by this most interesting and original little book is extremely thorough, and it is difficult to see how even the most

## Radio Press News

*A New Book which  
no one should miss*

stubborn of concealed faults can evade for long anyone who has read it and who carries out the ingenious methods of trouble tracing which the author has devised, so searching are the tests which he describes.

### Numerous Illustrations

The book has been so written and arranged that it can be understood and used with perfect ease by even the absolute beginner, who will particularly appreciate the very full and complete way it has been illustrated. Every difficult point, and, indeed, practically every point which could be made clearer by means of a diagram, is illustrated, so that there is an illustration of some sort on almost every page.

No one who has built, or who intends to build, any sort of wireless receiver should fail to obtain a

copy, for it must be remembered that when such assistance is wanted it is wanted badly, and at once: when a set goes wrong, the owner does not, as a rule, feel inclined to wait until he can obtain a book of assistance from his local bookseller or by post from the publisher, however prompt the service may be. Moreover, it is most undesirable to be compelled to absorb the whole contents of a book on fault-finding in the course of an hour or so and then try to put one's newly acquired knowledge into practice immediately. A far better plan is to study the book in a leisurely manner without the urgency produced by the presence of a defective set in the background. Then, when the day arrives for the first attempt to locate a fault, a reference to the summarised portion of the appropriate section of the book serves as an adequate reminder of the procedure to be adopted in that particular case.

### A Useful Appliance

The book opens with a chapter giving the necessary details for the construction of an extremely cheap and simple but effective little appliance which is used in conjunction with a pair of tele-

# Finston ONE-HOLE Fixed Condensers

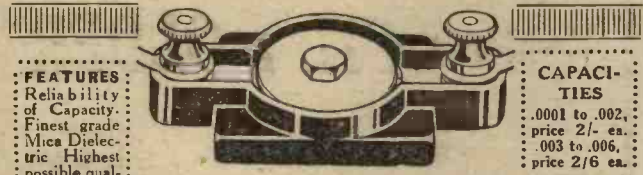

- FEATURES:
- Reliability of Capacity:
- Finest grade Mica Dielectric Highest possible quality Copper Foil. Adapted for terminal or soldered connections.

- CAPACITIES
- .0001 to .002, price 2/- ea.
- .003 to .006, price 2/6 ea.

Guaranteed within 5 per cent. of stated capacity, this accuracy has never before been obtainable by the public. The only one-hole fixing condenser on the market. Buy one. Test one. It will prove our statements and thoroughly satisfy you.

## FINSTON SQUARE LAW CONDENSERS

Aluminium top and bottom plates, high-grade ebonite composition knob and dial, cleanly engraved 0-180. Vanes 98 per cent. pure aluminium

PRICES			
.001	9/-	.0003	7/6
.00075	8/6	.0001	6/6
.0005	8/-	.00005	6/-

If your dealer cannot supply Finston Components, send your order to us together with his name and address, please!

**LIGHTING SUPPLIES CO.**  
2, FINSBURY AVENUE, LONDON, E.C. 2

## FINSTON STANDARD VARIOMETER

Another trustworthy Finston component. Extremely moderate price. Ebonite stator, high-grade ebonite moulding rotor, engraved dial and knob. PRICE 5/6

# YOU CAN LOG STATIONS

Having tuned in any distant station, you will log up the condenser readings. With J.B. Instruments you can log up fully confident that at any time you may set your condensers to correspond with your record, the signals will again come in accurately tuned.

This feature of J.B. Condensers is the outcome of a constant capacity at any given dial reading. Caused by poor quality end plates, high dielectric losses in your tuning condensers, may deprive your receiver of this capability. If you would know what a pleasure it is to handle a calibrated receiver you should fit J.B. Variable Condensers.

It is the one great precaution you can take against inefficiency. Build exclusively with J.B. Instruments; constancy in capacity enables you to log those distant stations.



SQUARE LAW			
.001	9/6	.00025	6/9
.00075	9/-	.0002	5/6
.0005	8/-	.0001	5/3
.0003	6/9	Vernier	4/6
STANDARD			
.001	8/6	.00025	5/9
.00075	8/-	.0002	5/-
.0005	7/-	.0001	4/9
.0003	5/9	Vernier	4/-

As Condenser Manufacturers we have long realised the vital electrical duty of Variable Condensers. J.B. Condensers represent both high mechanical and electrical design. J.B. Instruments are obtainable from all dealers, or direct from the manufacturers: Post, one, 6d.; two, 9d.; three, 1s.

**JACKSON BROS.**  
8, POLAND ST- OXFORD ST  
LONDON - W.1. Telephone - GERRARD 7414,  
(First Floor)

Barclays 941

phones for the greater part of the testing of the set and its constituent parts. The author then proceeds to deal thoroughly with the testing of all those of the principal components of a set which are commonly responsible for faults, such as condensers (fixed and variable), transformers, coils, detectors, and so on, passing from components actually forming a part of the set to such accessories as valves, batteries, and aerial and earth.

**A Simple Method**

These sections of the book are to be regarded as preliminary to the chapters on actual set testing, and a very useful and time-saving method has been adopted here; the author gives (and explains fully) a complete series of tests for the set under consideration, which are designed to narrow down gradually the possible area of the trouble until it is finally tracked down in a particular circuit, say, the anode circuit of a low-frequency amplifying valve, and then at last, in a particular component, perhaps the L.F. transformer. The reader then refers back to the section on the testing of L.F. transformers, and proceeds to find out exactly what is wrong with his defective specimen.

**Complete Set Tests**

A complete separate chapter is provided to explain the testing of crystal sets, and another for single-valve sets, while general tests for the common types of multi-valve sets form the subject for another section. The last chapter deals in full detail with the subject of fault-tracing in reflex circuits, which demand somewhat special treatment, as most readers are no doubt aware. The symptoms which they display and the particular types of faults which may occur are naturally somewhat different from those of "straight" circuits, but the whole matter is treated most lucidly, and anyone who has had the misfortune to incorporate a dud component in a reflex set will be able to set about its location with entire confidence with the aid of this book.

A specially valuable and time-saving feature will be found in the summaries appended to these chapters, which take the form of clearly-arranged tables, with headings for "Symptoms," "Possible Causes," &c., so that the whole provides a brief summary upon a single page of the preceding chapter. One can, therefore, use it as an aid to memory and run through the whole series of syste-

matic tests for any given set very rapidly, having previously read the whole chapter.

(Date of publication, 16th April.)

**A Simple Set for the Invalid**

(Concluded from page 618)

Various experiments were made with the aerial and earth connections, and whilst with the indoor aerial 2I.O was best received with the aerial at X and the earth at E, with the outdoor aerial, the best results were obtained with the aerial at A and the earth at F. For the reception of Chelmsford upon the indoor aerial the same conditions as with 2I.O held good, whereas with the outdoor aerial the loudest signals were given by connecting the aerial to X and the earth to A. As a matter of personal interest I shall be most pleased to hear from readers who build this little set, particular interest being expressed in their experiences with the aerial and earth connections, for it would seem from past experience that hardly any two aerials require the same connections for the best results.

Another Guaranteed **BRETWOOD** Speciality  
is our improved

## ANODE RESISTANCE



Patent No. 224295

which gives accurate readings consistently from 10,000 ohms to over 100,000 ohms. This **BRETWOOD** Component is particularly suited for the ST100 circuit (*Modern Wireless*), the super-sensitive coupling (*Popular Wireless*), and for resistance coupling, &c.

It is constructed on the same principles that have made **BRETWOOD** Components famous, and, of course, it carries the **BRETWOOD** Guarantee. Price 3s. Postage 3d.

**BRETWOOD LTD.,**  
12-18, London Mews, Maple Street,  
London, W.

All *Bretwood* specialities are obtainable from most Wireless Dealers

## BRETWOOD ANTI-CAPACITY SWITCH

Bretwood Specialities are known throughout the wireless world to be the last word in scientific achievement, and constructors will welcome news of a further Bretwood Product, an Anti-Capacity Switch, the principle features of which include:—

Absolute freedom from capacity effects—Perfect Contact—Workmanlike finish and neatness of appearance—Simple single hole fixing and Easy to make wiring connections. Special spring loaded balls in the base make the **Bretwood** Switch wonderful & smooth in action and ensure clean and perfect electrical contact at all times. It is confidently offered to wireless constructors as the Anti-Capacity Switch *par excellence*, and of course it carries the famous **Bretwood** Guarantee.

**PRICE 5/-**  
Postage 3d.



Burclays 945

ADDS CHARM AND EFFICIENCY TO ALL RECEIVING SETS.

## "LOTUS" Cut Geared Vernier COIL HOLDER



Vernier Movement, actuated by Three Sets of Encased Precision Cut Gears, representing a Reduction of 8 to 1.

**Moving Block Cannot Fall.**

"LOTUS" COIL HOLDERS are made from **BAKELITE MOULDINGS**, with Nickel-Plated Brass Barts.

Retail Selling Price **Two-way, 7/-**  
**Three-way, 10/6**

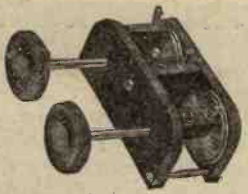

**Garnett, Whiteley & Co., Ltd.**  
Lotus Works, Broadgreen Road, Liverpool.

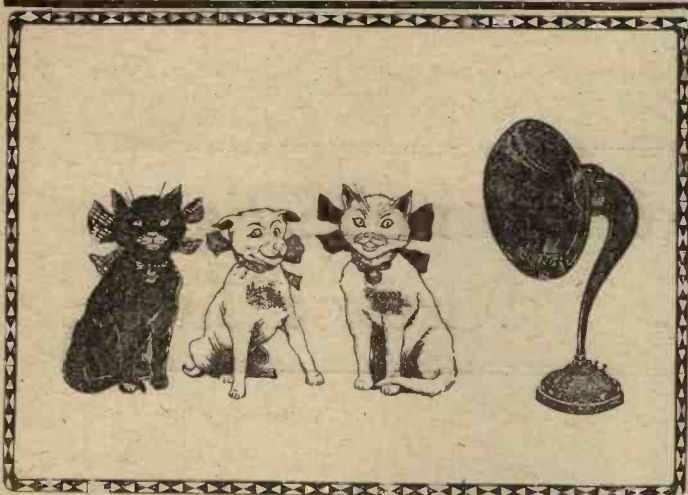

There's No Place Like Home now We've an **ULTRA**

# ULTRA

REGISTERED TRADE MARK

## LOUD SPEAKERS

□□□□ ARE THE BEST □□□□

ASK YOUR DEALER FOR THEM

Should you have any difficulty in obtaining same write direct to:—

27/6

Messrs.  
**Edward E. Rosen & Co.**  
158-160, CITY ROAD  
LONDON, E.C.  
with the name of your dealer

WRITE FOR OUR ILLUSTRATED PAMPHLET

### "BELLING-LEE"

#### INDICATING TERMINALS.

Patent No 590724

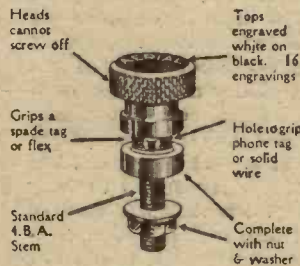

#### MULTY-KONTACT PLUGS & SOCKETS

Patent Nos. 205010 & 2874324

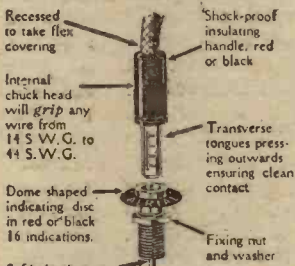

PRICE 3½<sup>d</sup>. EACH BRASS  
4½<sup>d</sup>. EACH NICKEL

PRICE 7<sup>d</sup>. per set  
NICKEL PLATED

Your dealer can supply you. In case of difficulty, write direct to—  
**BELLING & LEE, LTD.,** Queensway Works, Ponders 'nd.

## 2¾ Miles of Wire in every C.A.V. TRANSFORMER



If your aim is to reproduce the original sound transmitted without distortion, fit C.A.V. TRANSFORMERS, which are capable of a high degree of amplification from the lowest to the highest frequencies.

5150 High Ratio 27/6  
5151 Low Ratio

Write for Catalogue

**C.A. Vandervell & Co., Ltd.**  
ACTON VALE, LONDON, W.3

Just send a subscription for your favourite wireless journals

Promptly delivered through the post.

<b>MODERN WIRELESS</b> Twelve months 15/-	Six months 7/6
<b>WIRELESS WEEKLY</b> Twelve months 32/6	Six months 16/3
<b>THE WIRELESS CONSTRUCTOR</b> Twelve months 8/6	Six months 4/3

**RADIO PRESS LTD.** BUSH HOUSE, STRAND LONDON W.C.2

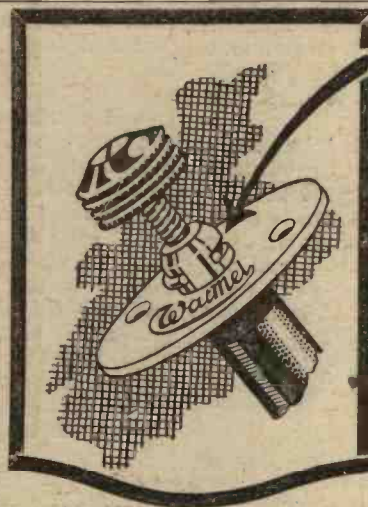

## One trouble less to puzzle you

It is the little things that escape detection. A faulty connection here, and bad contact there—all play their damaging part in robbing your receiver of its fullest power and range. Those experimenters who favour the use of the variable grid leak appreciate how it gives the final touch—clearing reception to make it rich, pure and round in tonal quality. The WATMEL is well known as the first variable grid leak which became available to the home constructor, and its consistent record for reliability to get the best out of the detector valve is without compare.



All goods of our manufacture bear this mark. It is your only guarantee.

Recessed into the collar a D shape spring presses firmly upon the controlling plunger. This device—truly a refinement which improves reception—ensures after constant use that the essential contact is always maintained electrically good.



5 to 5 Megohms 2/6  
50,000 to 100,000 Ohms 3/6  
Other Resistances to suit any circuit.

If you are troubled with poor results pay particular attention to the working of the Detector Valve. Reduce the H.T. voltage consistent with good volume and incorporate THE WATMEL VARIABLE GRID LEAK.

### WARNING!

The Watmel Wireless Co wish to notify the trade and public that their Variable Grid Leak Application No. 206098 was contested in the Comptroller's Court and on appeal; in both instances the Patent Grant was upheld and costs awarded. It is the aim of this Company to protect traders, customers and also its own interests by securing Patent protection for the novelties in its specialities, as it is these novelties, invented by experts and exhaustively tested, which are the Hall Mark of all Watmel Products.

Send P.C. for Descriptive Folder SEE THE TRADE MARK



ON EVERY GRID LEAK BEWARE OF IMITATIONS

**The WATMEL WIRELESS Co. Ltd.**  
332a, Goswell Road, London, E.C.1  
Telephone CLERKENWELL 7990

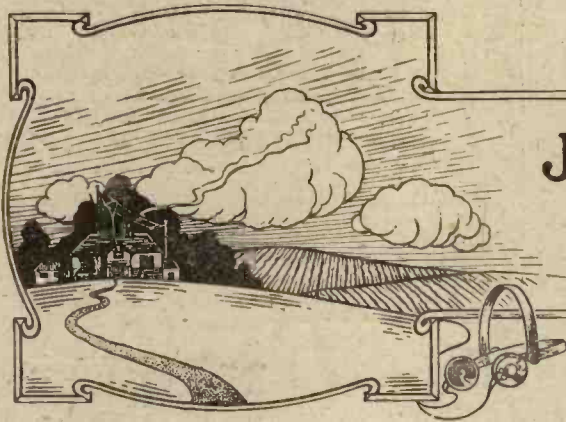

## John Anstruther's Wireless Talks

"I WONDER," asked Richmond, when we assembled for our next informal meeting at John Anstruther's rooms, "I wonder if any of you would mind if we discussed mainly problems about the crystal detector and the receiving sets in which it is used this evening?"

"Personally," said John, looking round the circle, "I think that it would be a jolly good idea, if you fellows agree. There is a lot more in the crystal and its working than most people think, and we are far too apt to regard it as a thing so simple that it is hardly worth studying. I am a strong supporter of the crystal myself, for it gives the clearest and best reception. We must not forget, too, that the vast majority of receiving sets in use at the present time employ the crystal."

The idea caught on at once, for when we came to think about it, there were quite a lot of points about the crystal upon which most of us wanted information. It was Ainsworth who started the discussion by putting the first question.

### Why the Valve is Generally Louder

"Will you tell us," he said, "just why it is that if I build two sets with precisely similar components, except that in the one I use a crystal detector and in the other a single valve, I get louder signals with the valve and have a much longer receiving range?"

"Like the crystal," answered John, "the valve can be made to rectify, but there is just this difference between the two: When you use the valve for rectifying it is doing two things at once. Besides changing oscillating impulses into impulses in one direction it is also amplifying them, or making them stronger. And then there is reaction, which cannot yet be produced in the ordinary

crystal set. On a future evening, when we come to talk about valves, we will go into this in detail. The crystal can perform only one of these two functions; it is a rectifier pure and simple, and not an amplifier. Some experiments have been made recently which show that crystals can be arranged to produce oscillations, and I am not going to say that in the future we shall not be able to amplify without valves. The current brought in by the aerial, even if you are quite close to a main broadcasting station, is only a matter of a few micro-amperes—a micro-ampere is a thousandth part of a milli-ampere, and a milli-ampere is a thousandth part of an ampere. At ten miles from 2LO, for example, the unaided crystal detector might deliver about

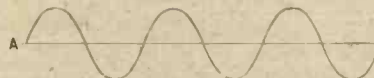

Fig. 1.—The unrectified wave.

15 micro-amperes to the telephones, whereas in the single-valve set a loud note may cause a change in the output current of as much as a quarter of a milli-ampere, that is to say, 250 micro-amperes."

### How does the Crystal Rectify?

"Now," said Painter, "I am going to ask you to explain something that I don't quite follow. How does the crystal rectify?"

"Before we deal with that question," Morris interposed, "I think that it would be a good thing if we all felt quite clear about rectification itself. What exactly does it mean?"

"Right you are," smiled John. "We will have a look at rectification first of all, and then try to see how the crystal does its job. The oscillations which the aerial brings into the set are surging up and down at what we call radio-

frequency. The rate at which they swing depends upon the wavelength. If, for example, we have a station sending upon 300 metres, the frequency will be found if we divide 300,000,000 by the wavelength; the figure 300,000,000, by the way, is the speed at which all ether waves travel measured in metres a second. Working out that simple sum, we discover that in this case the frequency will be 1,000,000 a second. Now, our ears are absolutely unaffected by such oscillations as these—in fact, we have no sense that will respond to their influences. To make them audible we must reduce their rate of undulation to something with which our ears can deal. Audible frequencies lie roughly between 15 and 15,000 a second. The detector acts as a kind of sergeant-major, forming up and marshalling these very rapid impulses and then passing on to the telephones "companies" of impulses consisting of the combined energy of hundreds or even thousands of individual radio-frequency oscillations."

### A Simple Analogy

"I want to be quite sure that I really do follow this," said Morris, as John paused for a moment to put a match to his pipe. "I wonder if you could give us a simple analogy? They do help somehow to fix things in one's mind."

"Well," replied John, when he had got his pipe into full swing once more, "I think I can. We will try a simple little experiment."

He handed Morris a copy of one of the illustrated daily papers that were lying upon the table and a very powerful magnifying glass.

"Take the paper under the light," he suggested, "and look at it through the glass."

Morris did so, and then handed the two on to the rest of us, who followed John's instructions in turn.

"When you look through the



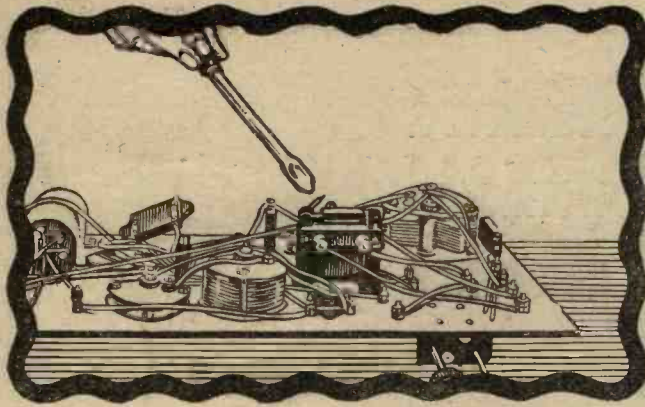

Your Soldering-iron  
can't burn or melt

# GLAZITE

THE NEW COLOURED CONNECTING WIRE

BY using "Glazite" you have none of the old insulating sleeving to manipulate or burn.

"Glazite" Connecting Wire is already insulated and is flame-proof. "Glazite" consists of tinned copper wire, first covered with cotton and then with a film of heavy insulating material.

Made scientifically "Glazite" will not deteriorate in any way, is flexible and possesses high dielectric strength.

PRICE 1/6 PER COIL  
(Length 10 ft.)

Made in four different colours; Red, Blue, Yellow and Black. Obtainable from all radio dealers. Send P.C. for "Glazite" leaflet and the name of nearest dealer with stock.



THIS  
MARK

GUARANTEES  
QUALITY

The LONDON ELECTRIC WIRE  
CO., AND SMITHS LTD.

(Makers of Electric Wire for over forty years)

Playhouse Yard, Golden Lane, London, E.C.1

Telegrams:  
Elec.ric, London

Telephone:  
Clerkenwell 1388, 1389, 1390, 1391

## Build the super set of your dreams

### THE TROPADYNE

Living in close proximity to a powerful local broadcast station you have built set after set in the hope that each would give greater selectivity than the last. To those who would secure high selectivity so that it is possible to separate stations working 5 metres apart, then, for them, the Super-Heterodyne is the ultimate receiver. Of this group the Tropadyne is the most conspicuous.

THE duties of the first detector valve and separate oscillator valve necessary in other types of Super-Heterodynes are, in the Tropadyne, performed by one valve without any depreciation of selectivity, range or volume.

Builders of Super-Heterodynes are confronted with securing accurate tuning on the long wave amplifier, and we may advise prospective builders that the efficiency of the intermediate frequency amplifier can make or mar results.

Thus the remarkable selectivity and range of the Tropadyne depends largely upon the type of long wave transformer used. If you would cut out your local station and receive a distant station working 5 metres above or below, build a Tropadyne with the Tropadyne Kit.

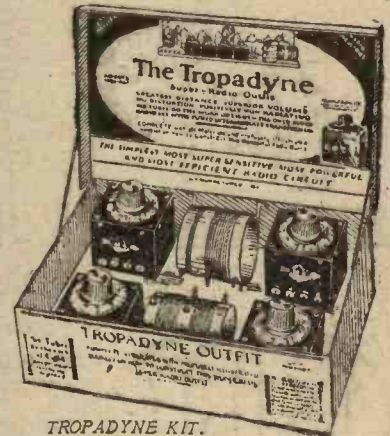

TROPADYNE KIT.

HERE is a remarkable Super-Heterodyne receiver with several new and unusual features. In the first place only six valves are used giving as much volume as the average 8-valve Super-Heterodyne. The selectivity of this set is unusual. Inequalities of the intermediate transformers have now been done away with by tuning each transformer. Another outstanding point of superiority of the Tropadyne circuit is that it practically does not radiate, thereby not interfering with other nearby receiving stations.

The Tropadyne Kit consists of 4 Tropafomers, Improved Type Oscillator Coupler and complete wiring diagrams in three colours, drilling template, and book of instructions for building the world-famous TROPADYNE RECEIVER. The Tropadyne Kit

£8 5s.

### THE TROPAFORMER

YOU can now build a Super-Heterodyne, the only Super-Heterodyne that is scientifically balanced. Heretofore, when building a Super-Heterodyne, you either made or bought the intermediate transformers. These never matched as it was impossible to make two windings to match electrically.

That matched or balanced transformers are obtainable is a misleading statement, because even though they are initially accurately balanced, when placed in the circuit they become unbalanced, due to capacity effects present in the wiring, etc.

TROPAFORMERS can be scientifically balanced by anyone. Each transformer is equipped with a straight line condenser across the secondary. Once the TROPAFORMERS are tuned they need not be touched again. The TROPAFORMER here illustrated is the only scientifically balanced intermediate Super-Heterodyne Transformer.

Price 35/-



# ROYAL

The Mark of Sovereign Quality

R. A. ROTHERMEL, LTD.

Manufacturers and Wholesale Suppliers of Electrical Goods,  
24-26, Maddox Street, London, W.1.

Telephones

MAYFAIR 678 and 679.

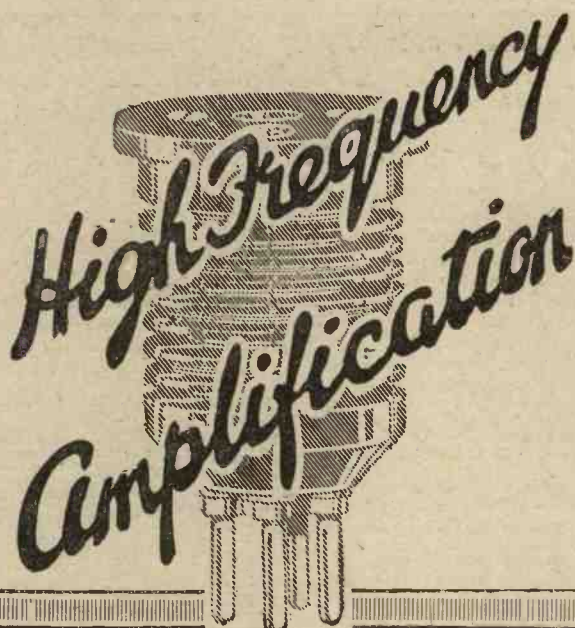

Supplied in six ranges of wavelengths covering from 80 to 7,000 metres.

- No. 00 80 to 150 metres .. 10/-
- No. 0 150 to 300 metres .. 10/-
- No. 1 300 to 600 metres .. 10/-
- No. 2 550 to 1,200 metres 10/-
- No. 3 1,100 to 3,000 metres 10/-
- No. 4 2,500 to 7,000 metres 10/-

A.6. Neutrodyne Unit (Broadcast Wavelength) each 10/-

The complete Set in handsome case Nos. 00-4 .. 55/-

Any number of each Transformer can be supplied matched at NO extra charge, if required at the time of ordering.

To obtain the maximum advantages from adding a stage of High Frequency Amplification to your receiver it is absolutely imperative that reliable high efficiency components be used. H.F. Transformers of M.H. manufacture are the first essential. These transformers are universally acknowledged to be the best.

Made of specially manufactured non-loss ebonite, precision machined and polished to the usual high finish of all M.H. products, they are of a well-balanced and pleasing appearance. The windings are carried in staggered slots, ensuring low self-capacity and high efficiency.

To ensure perfect matching they are subjected to a rigorous system of testing before being offered to the public, and any not coming within extremely narrow limits are rejected. Matching is guaranteed where specified.

**L.M. MICHAEL LTD**

Manufacturers of Wireless and Scientific Apparatus,

179, STRAND, LONDON, W.C.

Barclays 958

It makes a wonderful difference

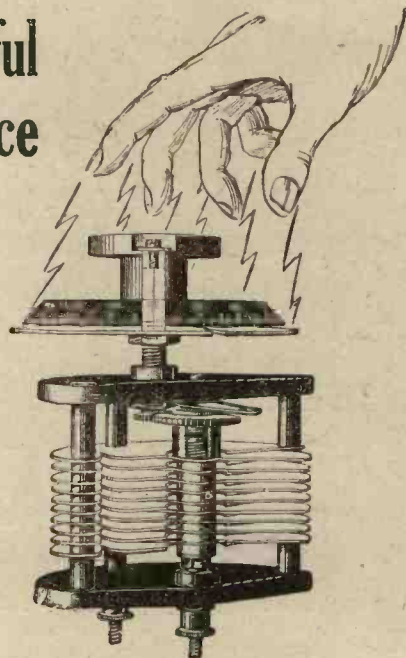

**Congratulations continue to pour in from users of the "Fulstop" Variable Condenser**

**FROM SOUTH CROYDON**

"We had a long experiment last night with your 'Fulstop' Condenser, and brought in 12 distant stations that other condensers would not look at."

**ORMSKIRK**

"I tried one of your '0005 Condensers a few weeks ago and it has proved so satisfactory that I am discarding a more expensive '0005 condenser for yours."

**LIVERPOOL**

"I replaced the 'Fulstop' Condenser in my set and in half an hour had tuned in thirteen stations. I also find it easy to get London and Bournemouth, quite separate from Manchester which I have never managed before. This speaks volumes for the Condenser."

May I therefore, once again express my satisfaction and appreciation of your condenser and method of business, which compare so favourably with other firms. A satisfied customer is the best advertisement possible and I shall always be pleased to recommend you to others."

- '001 ... 13/6
- '0003 ... 10/3
- '0005 ... 11/3
- '0002 ... 9/6

Protected throughout the World

Stocked by most Wireless Dealers but if you have any difficulty in obtaining write to

**J. H. NAYLOR, LTD., WIGAN**



VARIABLE CONDENSER

**Guaranteed to Abolish Hand Capacity**

glass," John asked, "could you see the picture as a picture?"

"I couldn't anyhow," cried Richmond; "all I could see was a collection of dots, some black, some white."

"That's what all of you found, didn't you?" John went on.

**Why we Cannot Hear H.F. Oscillations**

"The reason is that the only method we know of reproducing photographs in a way suitable for quick printing is to do so by means of dots. They are so small that when the eye sees them without the aid of a magnifying glass they run together into groups; but when we use a magnifying glass we separate them up into individuals, and then there are so many of them that the eye is bewildered and sees them as nothing but little points of light and shade. The effect is even more startling if you examine a finely made block through the microscope. Your eye is in much the same position then as is your ear to radio frequency oscillations. Neither can make anything of a message that is conveyed by vast numbers of individual dots or impulses. Remove the magnifying glass, and the dots are marshalled into groups which give a clear

impression. Apply the detector, and in the same way the impulses are passed to the ear blended into companies."

We all felt that we followed the idea pretty clearly, and now wished to know how it was done.

**What the Crystal Does**

"And now do tell us," I said, "just how this grouping and blending is done by the crystal?"

John glanced round the circle. "I am afraid that I shall be telling some of you what you know already. Still there is no harm in going over



Fig. 2.—The shaded portions of the wave are eliminated.

old ground again, and I can see that there are one or two who are puzzled about this question of rectification. By doing the grouping we have to sacrifice one half of the oscillations which the aerial brings in. Each wave, as you know, consists of a crest followed by a trough; or, if you like, a push and a pull, both of equal strength. The crystals which we use in wireless

have a peculiar property of offering quite a small resistance to one half of the wave, and an enormously high one to the other. Let us suppose that we have mounted a crystal which will pass the crests, or the positive half-cycles, easily, but which will have nothing to do with the troughs or negative half-cycles. What will the result be?"

**The Result**

He took two sheets of paper and drew two diagrams which I have copied here.

"At A," he continued, "you see the unrectified waves just as they come to the detector, whilst at B we have the same waves after they have been rectified or strained by its action. I have shaded the troughs to show that they have been eliminated. The result is that we have a succession of positive impulses delivered by the detector."

"But," objected Ainsworth, "there is no grouping here. If a million waves a second are coming in, the detector, according to you, is passing on the same number of half-waves to the telephones."

John smiled. "That is quite a sound objection," he said, "so far as it goes. The detector does pass on rapid, unblended impulses,

**CUT OUT THE "CRACKLING."**  
 PUT A LARGE  
**"OCTOPUS"**  
**Mansbridge Condenser**

ACROSS YOUR H.T. BATTERY, SMOOTH OUT THE JERKS AND GET RID OF NOISES.

**The Best By Test**

EVERYTHING  
 A GOOD  
 CONDENSER  
 CAN BE.



	s.	d.
.01	..	2 4
.05	..	2 4
.25	..	3 0
.5	..	3 4
1 MF.	..	3 10
2 MF.	..	4 8

All capacities same size face, i.e., 2in. by 1½in.

ACCURATE, NOISELESS, PERMANENT,  
 ABSOLUTELY RELIABLE, TESTED AT 350 VOLTS D.C.  
 BEWARE IMITATIONS, LOOK FOR THE TRADE MARK.

**SETS OF PARTS FOR ANY AND EVERY CIRCUIT.**

WE SPECIALISE IN GIVING THE BEST KNOWN VALUE AND SERVICE  
 WRITE YOUR ACTUAL NEEDS. GIVE US YOUR IDEAS AND LET US QUOTE

**EVERYTHING FOR WIRELESS AT ROCK-BOTTOM PRICES**

**WRITE FOR LISTS**  
 Wholesale and Retail

**RADIO "STOCKS"** (B. HAINE, Proprietor),

**RADIO HOUSE, NEWMAN STREET, OXFORD ST., LONDON, W.1**

'PHONE: MUSEUM 3205

THE  
**"Perfect" Vernier Coil-Holder**

FOR BASKET COILS.

New and Come to Stay

EASILY THE BEST ON THE MARKET.

SAMPLE ON 48 HOURS' APPROVAL 6/6 PLUS 6d. POSTAGE, OR COMPLETE OUTFIT OF

**COIL HOLDER and COILS**

(SEVEN IN ALL)

For All British Stations

POST FREE 12/6

*The Best Tuner Obtainable*  
*Results Will Surprise You.*

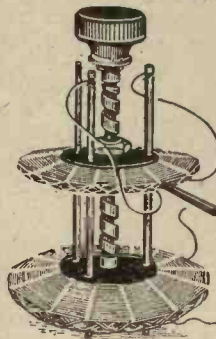

PATENTED

Micrometer Tuning.  
 Dead Close Coupling.  
 Parallel Coupling.  
 Coils Changed Instantly  
 No Coil Mounts,  
 No Hand Capacity.

No Loose Connections.  
 No "Fiddling" about.  
 Strong and Handsome.  
 Needs Small Space.  
 Extremely Simple to  
 Fix and Use.

all in the same direction. They are dealt with by the telephone condenser. What happens here is that as the impulses reach it they combine to build up a charge upon its plates. This means that what we call a potential difference is produced across the condenser, which, when a charge has been built up by a company of impulses, discharges and sends a single 'whiff' of direct current through the telephones. This 'whiff' represents the combined efforts of a vast number of small impulses."

**When the Condenser is Omitted**

"Yes, but look here," cried Painter. "How do you explain this? I find that it does not make the slightest difference to my crystal set whether I have a condenser across the telephones or not. You cannot charge up a condenser if there is not one there!"

"This is quite true," said John, with a laugh in which we all joined. "But, if I may be allowed to say so, there is always a condenser there, whether you place across the telephone terminals a 'gadjet' consisting of a number of copper plates separated by pieces of mica or whether you don't."

"How's that?" queried Morris, looking a little puzzled.

"What is there between the receivers of your telephones and the output terminals of the set?" asked John.

"Why, flex leads, of course," replied Morris.

**The Telephone Leads form a Condenser**

"Just so," said John. "If you care to examine the telephone leads, you will find that they consist of two sets of fine stranded wires or of lengths of tinsel. They are insulated from one another by a covering of cotton, silk, or some other non-conducting substance. Now, a condenser consists of two conductors separated from one another by insulating material, which we call the dielectric. Capacity between them occurs when one is at a higher potential than the other. The telephone leads form a condenser, for one of them is connected to the detector and is receiving positive impulses from it, whilst the other is earthed. And there is capacity, too, in the windings of the magnets, as well as between the receivers and your head, which is also earthed! If you take away the telephone

condenser, the grouping is done mainly by the condenser effect of the telephone leads, and in many cases it does not matter a bit whether you have a condenser or not."

As the meeting had begun rather late that evening no time remained to go further into the question of crystal sets; but, before we left him, we made him promise that on the next occasion he would deal with the question of obtaining the greatest possible degree of efficiency in the crystal receiver.

**The Hale-Lyle System**

**Radio Press Demonstration**

*In view of the interest in the Hale-Lyle system of broadcast reception, described in last month's issue of "The Wireless Constructor," Radio Press, Ltd., have arranged for demonstrations in London so that readers may hear the system in actual operation. Particulars will be sent free on receipt of a stamped addressed envelope.*

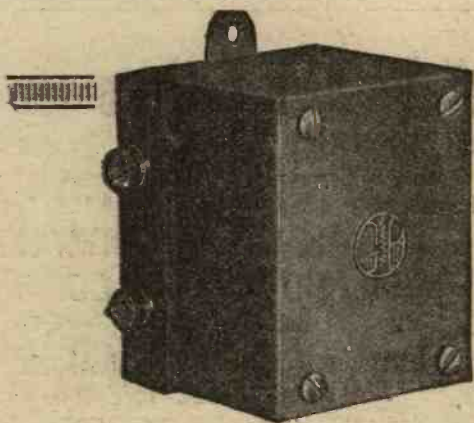

STAGE I      STAGE II  
27/6          27/6

If your dealer has not these Transformers in stock he can easily obtain same to your order

*Please write us for leaflets describing our other products*

**DIFFERENT!**

The individuality which has always been a feature of Gambrell Products is well emphasised in their new TRANSFORMER.

The design, although unusual, has not been evolved merely for the sake of being different, but in order to embody all those points essential to perfect reproduction.

*This Transformer will give you that Purity and Power you thought unattainable*

**GAMBRELL BROS., LTD.**  
76, Victoria St., London, S.W.1

Works: Merton Road, Southfields, S.W.18  
Phones: VICTORIA 9938 — PUTNEY 3641-2

Monday, 26/7

234  
656

*In replying to advertisers, please mention THE WIRELESS CONSTRUCTOR.*

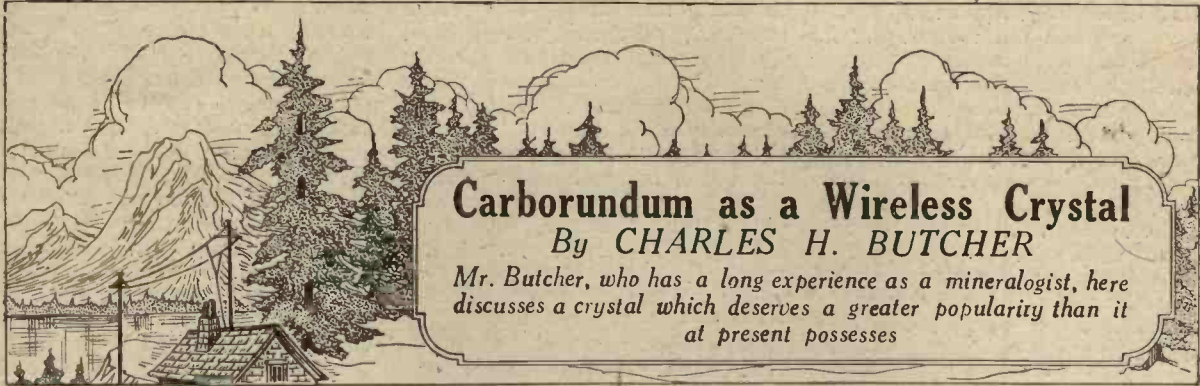

## Carborundum as a Wireless Crystal

By CHARLES H. BUTCHER

*Mr. Butcher, who has a long experience as a mineralogist, here discusses a crystal which deserves a greater popularity than it at present possesses*

IT is now nearly twenty years since the rectifying property of carborundum was discovered by General Dunwoody, of the United States Army. During this lapse of time the carborundum detector has held its place as one of the most reliable and satisfactory of crystal detectors, particularly as regards freedom from the ill effects of mechanical vibration and the close proximity of electric discharges. It is, moreover, unaffected by changes in atmospheric conditions, such as damp air and the presence of dust particles.

### Detector Design

In general design, the detector comprises a small fragment of selected carborundum, mounted in Wood's metal, pressing against the face of a steel plate carried on a steel spring. A certain amount of pressure is necessary at the point of contact for sensitive working, and this is adjusted by means of spring and screw attachments. It is only in the actual form of the latter, and in minor details, that the design of detectors may differ. Maximum rectification is only obtained when an external E.M.F. is applied across the crystal. This E.M.F., which causes the contact to become heated, is generally supplied by means of dry cells in series with a potentiometer, which can be adjusted to suit crystal fragments varying in resistance and in rectifying power.

### Telephone Resistance

Some specimens of carborundum will give excellent results without the use of an external battery and potentiometer, but out of a batch of fragments very few pieces will be found suitable. Some form of potentiometer voltage is generally necessary in order to obtain the results worthy of a carborundum detector. High-resistance 'phones are also necessary, and these should be wound to a total of 8,000 ohms, or 1,000 ohms each earpiece. The

area of contact between the crystal fragment and the steel plate should be reasonably large, and may vary from 1 to 2 square mm. in extent.

### Composition of Carborundum

Carborundum is not a natural mineral crystal, but is an artificial carbide of silicon manufactured on a large scale by the fusion of coke and quartz sand in the electric-resistance furnace. It is extensively used as an abrasive, and as a substitute for the diamond in rock

For the greater part of the time, the current is maintained at about 6,000 amperes and 125 volts, and, when the reaction is completed, the furnace is allowed to cool down.

### The Product of the Furnace

The product taken from the furnace is found in the form of rough masses of beautifully coloured crystals, with sharp edges and an exceedingly brilliant lustre. On closely examining a lump of the material it will be seen that the



His Majesty the King has had a four-valve set made for his stable lads at Newmarket. Our picture shows the receiver in the course of manufacture.

drills. In the actual process of manufacture a quantity of salt is added to the mixture of coke and sand charged into the furnace. This is found necessary in order to increase the fusibility of the product; sawdust is also added to give porosity to the charge. During the operation of fusion, which is carried on continuously for about thirty-six hours, the temperature of the mass reaches the neighbourhood of 7,000°F., and carbon monoxide escapes and burns freely around the sides and at the top of the furnace.

crystals making up the mass are hexagonal and tabular in form, with their edges modified by narrow faces of varying degrees of steepness. Individual crystals, however, are rarely found, and in the mass crystals are usually aggregated together in parallel or irregular growths. Their colour usually ranges from a deep grey to a violet purple or greenish blue and is very striking and characteristic in reflected light.

It is not the highly coloured and lustrous crystals of carborundum

which are used for wireless purposes. Indeed, the majority of the "glass-like" crystals are useless. It is fragments of silver-grey colour, with a somewhat amorphous structure, which are found to be the most efficient. The selection of suitable specimens, however, is a matter requiring careful consideration, for there are many grades of carborundum on the market which differ widely in character. The following notes may serve to give some idea of the particular grade which is likely to give the best results in practice.

**Poor Specimens**

Generally speaking, highly coloured crystals, with a brilliant metallic lustre and sharp crystalline form, have very poor rectifying properties. Where rectification is found among such material it will be noticed that the fragments in question are bluish grey in colour and have a heavy graphite deposit between the intergrown and twinned crystals. The pieces themselves are extremely hard, and break up into sharp, splintery flakes when struck with a hammer.

**The Most Sensitive Pieces**

Carborundum of a silvery-grey colour, with an amorphous formation, devoid of graphite deposits, will be found the most satisfactory in regard to sensitivity and stability. Dark-grey crystals, with a hard granular and fused appearance, and no graphite deposit, are practically useless. Those of grey colour, with a very irregular and rugged appearance, but no definite crystalline form, and with a fairly heavy graphite deposit, have a reasonable amount of rectification. In the most satisfactory fragments the amorphous structure predominates and the colour is distinctly silvery grey. Examined under the micro-

scope, the fragments will be found to have a kind of honeycomb structure, and the tiny cells formed by the intergrown, microscopic crystals may or may not show deposits of graphite. The presence of this material does not appear to influence rectification one way or the other, as specimens with and without graphite, but otherwise identical in structure, have been found equally suitable for wireless purposes.



This small receiving set, made in a match-box, costs 6½ d. in Germany!

Undoubtedly the best results are obtained by actually testing a number of promising fragments, selected for silver-grey colour and amorphous surface structure. When a good specimen has been obtained it will be found that the sensitivity of the detector is not impaired when the point of the "crystal" has been accidentally broken off,

for the characteristics of a good piece of carborundum are fairly uniform throughout its effective area. Of course, this is not always the case, and when a good point gets broken away there may be some difficulty in finding another equally good point on the same piece of material. It may be necessary to break away the greater portion of the fragment before another sensitive spot is found, but this is rarely so.

The rectifying power and resistance of carborundum vary with the temperature. At the temperature of liquid air, -190°C., its resistance is greatly increased and its rectifying power is reduced to a minimum. On heating, however, it becomes very efficient as a rectifier, and at temperatures between 400 and 500°C. its sensitivity reaches a maximum and its resistance is correspondingly reduced. It is to this property that the efficiency of the carborundum detector is largely due.

*The Twin-Valve Receiver*

SIR,—I have been using a twin-valve receiver, as described in your January issue, since January, and have nothing but praise for it.

All the main British stations, with the exception of Aberdeen, are received both loudly and clearly, as are also Radiola, Petit Parisien, and Madrid.

Altogether it is a great success, and I can thoroughly recommend anyone to build one. The Blue print and the directions make everything clear, so that there is no excuse for failure.

Wishing you and THE WIRELESS CONSTRUCTOR every success,

Yours faithfully,  
Birmingham, R. W. B.

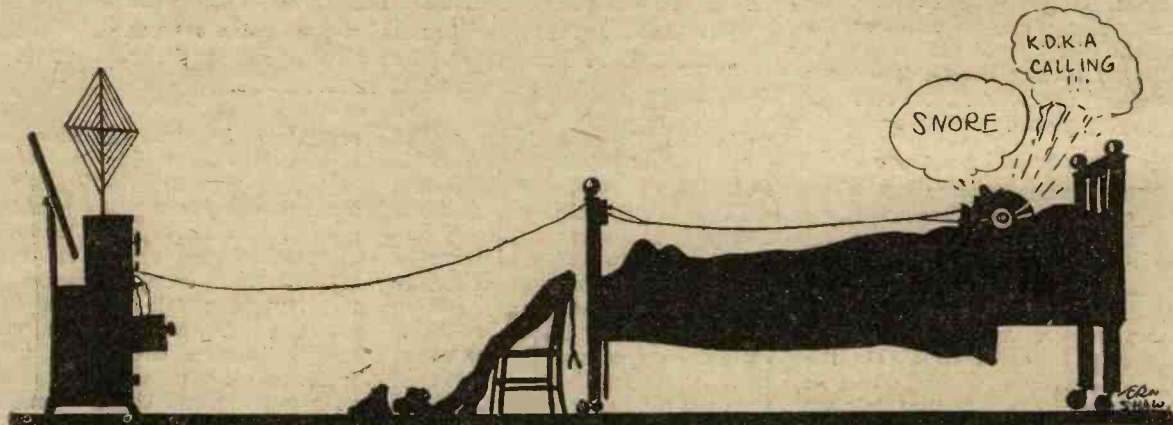

"The night shall be filled with music."



## Practical Workshop Hints

Making Large Holes—A Home-made Scriber—Scribing Circles—Finishing Wood—Centre Punches

### For Making Large Holes

**A** MOST useful tool for making large circular holes in ebonite panels is the expansion drill seen in Fig. 1. It is really designed for making holes in boiler plates, and will tackle ebonite with the greatest ease. The drill point itself is  $\frac{1}{4}$  in. in diameter, and as it is removable it can be replaced when it becomes blunt. The cutter is also removable, and a spare one can be obtained very cheaply. By means of the thumbscrew the cutter may be set at any distance from  $\frac{1}{2}$  in. to  $2\frac{1}{2}$  in. from the centre of the drill, so that holes from 1 to 5 in. in diameter can be made. This tool fits into the brace. When it is used the ebonite panel should be placed on a

thick piece of wood, so that the drill point may have something to work in after it has passed through. It is best not to go right through from one side, for if this is done the



Fig. 1.—The expansion drill.

edge of the hole on the far side will probably not be clean, since the cutter will chip the ebonite as it makes its exit. Instead, go about half-way through on one side; then turn the panel over and work from the other. In this way you can be

quite sure of turning out a perfectly clean hole. Large holes in wood such as those required when ammeters, voltmeters or milliammeters of the flush-fitting type are mounted upon cabinets are best made with an expanding bit designed for wood cutting. This is a tool made upon much the same lines as the expansion drill just described, the differences being these: Instead of the pilot drill it has a gimlet screw which pulls the tool in. The cutter has a vertical scriber point and a horizontal cutting edge. For wireless work, where the wood used seldom if ever exceeds  $\frac{3}{4}$  in. in thickness, the horizontal cutting edge is not really needed, and I find it best to remove

The Key to Success and Efficiency together with a firm assurance of distortionless reproduction is

**“POWERQUIP”**  
GUARANTEED

The Transformer that is the outcome of long Scientific Research. Perfect in construction, reliable in use, it is tested on Aerial and carries a 12 months' guarantee.  
Of all Dealers—Price 14/6 each

The **POWER EQUIPMENT COMPANY LIMITED**  
KINGSBURY WORKS, THE HYDE, HENDON, LONDON, N.W.9

### The COLVERN BRINGS IN THE DISTANT STATIONS

Fit a Colvern Independent Vernier

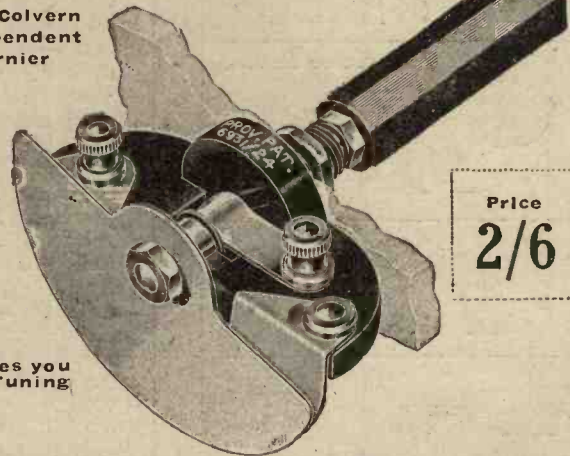

Price 2/6

It gives you Fine Tuning

### for very accurate H.F. work

Users of H.F. Receivers appreciate how extremely difficult it is to bring circuits into resonance. The large tuning condenser which permits only a comparatively large variation of capacity tends to make the accurate balancing a matter of chance. It is quite simple when searching for Distance Signals to pass over the correct dial reading. But if you use a low maximum capacity condenser which gives you very fine tuning it will come as a pleasant surprise just how easily you can tune in weak signals.

Fine tuning control reduces the search for distant stations to extreme simplicity. Use the Colvern only across reaction, fit one in parallel with your large tuning condensers and you will demonstrate how extremely sensitive your set is to fine control. Remember that a vernier should not be in association with the main condenser. Fit an Independent vernier; your dealers sell them—The Colvern.

GOLLINSON'S PRECISION SCREW CO. LTD. Macdonald Road, Walthamstow, E.17. Tel.: Walthamstow 532

Barclays

# Big Little things

The articles illustrated are selected from the great General Radio range of broadcast receiving apparatus—Small components of great importance—Each one guaranteed. Millions of General Radio parts are in the hands of satisfied users.

- 

**G.R.C. Rheostat.**  
One hole fixing. Interchangeable Resistance. Smooth action. (Can be supplied as potentiometer, 250 ohm resistance, 6/-)

5/-
- 

**G.R.C. Valve Holder.**  
Insurance against valve burn outs. Low loss—low capacity. No soldering—Table or panel mounting.

2/6
- 

**G.R.C. Jack Switch**  
Simple—safe—convenient. 8 idlerless type. For switching accumulator on-off. One hole fixing. Required on modern sets.

3/-
- 

**G.R.C. Solderless Jack**  
One hole fixing—solderless type—Use plugs and jacks for convenience.

2/6
- 

**G.R.C. 60 Condenser.**  
Takes the place of every condenser of any capacity from .00001 to .001. See it!

10/-
- 

**G.R.C. Vario-Coupler**  
A highly efficient "wound on air" variable inductance. Indispensable to amateurs.

15/-
- 

**G.R.C. Radiophone Plug**  
Takes two pairs of phones. Always use plugs and jacks for speedy convenient contact.

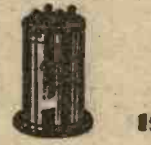
4/-
- 

**G.R.C. Audioformer.**  
The best low frequency Amplifying Transformer in the World. Three tages can safely be used together for outdoors or large halls where tremendous amplification is required.

15/-

*General Radio*

**GENERAL RADIO CO. LTD.**  
RADIO HOUSE, 235, REGENT ST. W.I.



it by grinding it away. One then uses the tool as previously described, cutting about half-way through from one side, then turning the work over and finishing upon the other. When the horizontal edge has been ground away the expanding bit can be used quite well for cutting large holes in ebonite as well as in wood. It is only necessary to make a pilot hole big enough to take the gimlet screw. Expanding bits can be obtained in various sizes, and each is sold with two cutters. A useful size is that which makes holes from  $\frac{3}{4}$  in. to 3 in. in diameter. Neither

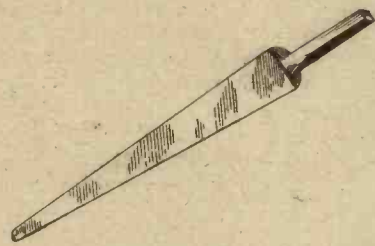

Fig. 2.—The reamer bit is useful for enlarging holes.

the expansion drill nor the expanding bit is an expensive tool, and either will be found extremely useful by the constructor.

### Enlarging Holes

Another extremely useful tool for the constructor, and again an inexpensive one, is the reamer bit seen in Fig. 2. Though really designed as a wood-working tool, it cuts ebonite very well indeed. The reamer bit, whose blade is about 7 in. in length, tapers gradually from about  $\frac{3}{4}$  in. at the shoulder to  $\frac{1}{4}$  in. at the point. Its section is D shaped, and cutting is done by the sharp edges formed by the junction of the flat and the curved surfaces. This is also a brace tool. It will be found very useful by those who have purchased hand drills whose chucks have not sufficient gape to take a  $\frac{3}{8}$  in. drill. In wireless work it is frequently necessary to make a hole of this diameter to take the bush of a spindle. Proceed in the following way: Make a hole in the required position with the largest drill that your chuck will take. Then place the panel, protected by pieces of wood, in the jaws of a vice, so that it is held vertically. Insert the point of the reamer bit into the hole made and turn the brace slowly. After a few turns withdraw the bit, and see whether the bush will enter for a short distance. As soon as the hole is large enough to allow it to do so, reverse the panel and repeat the process from the other side. By

adopting this method the hole can be made quite a good fit for the bush, for the taper of the bit is very gradual, and since the distance from the surface of the ebonite to the mid depth of the hole is only  $\frac{1}{8}$  in., its effects will hardly be noticeable. On the other hand, if the reamer is run straight through from side to side until the bush will seat itself in the hole there will be a good deal of play, since the hole will now be tapered for the full  $\frac{1}{4}$  in. of its depth. The D-bit is also very useful when an unbushed hole of medium size has been made, owing to an error, slightly out of its proper position, so that the spindle or shaft binds in it. If the hole is enlarged with a round file the resulting job is usually rather unsightly; but when the reamer bit is used it remains circular, and so does not cry aloud that a certain amount of botching has been done.

### A Home-made Scriber

A very useful scriber can be made in the home workshop in the way shown in Fig. 3. The only materials needed are a short piece of  $\frac{3}{8}$  in. round brass rod, a 6B.A. screw, and a discarded gramophone needle.

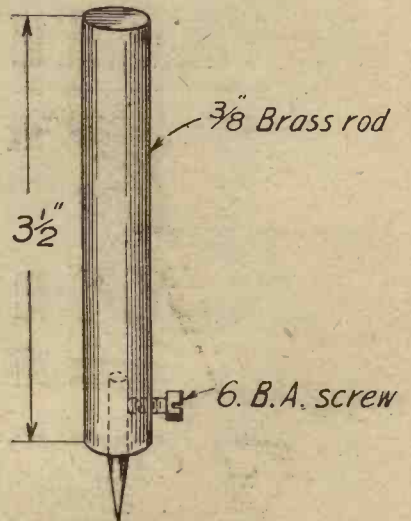

Fig. 3.—Details of the home-made scriber.

Three and a half inches is a convenient length for the rod. In the centre of one end of it drill a hole about  $\frac{3}{8}$  in. in depth into which the butt of the needle is a good fit. At right angles to this hole and running into it drill and tap: 6B.A. hole. Insert the needle as shown in the drawing, and clamp it in position with the screw. One gramophone needle will last for quite a long time as a scriber point, and when it becomes blunt it can be renewed in a moment at



no cost. This tool also makes a most useful punch for fine work if the needle, instead of being dead sharp, has its point very slightly rubbed down. Here again the advantage of having an easily renewable point is obvious.

**Scribing Circles**

Another very useful little tool which can be made up in a few minutes with the aid of a pair of terminals, two old gramophone needles and a length of  $\frac{3}{16}$  in. round brass rod is the beam compass seen in Fig. 4. This instrument is used in the following way: We will suppose that we wish to mark out a circle  $2\frac{1}{2}$  in. in diameter. Make a punch mark on the panel to indicate the exact centre of the circle required. Loosen the binding screw of one of the terminals slightly, so as to enable it to be moved upon the rod, fixing the other one firmly by seeing that its screw is turned hard down. Place the needle point of the fixed terminal on one of the inch divisions of a ruler, and move the other terminal until its point is exactly  $1\frac{1}{4}$  in. away. Then clamp it in position. Put one of the needle points into the punch mark made in the panel, and hold the terminal to which it belongs with the left

The beam compass is also extremely useful in marking out where many centres have to be punched the same distance apart from one another. The points are set at the required distance, and marking out can then be done with the greatest ease. To make a beam compass, run first of all a  $\frac{3}{16}$  in. drill through the holes in the terminals. The terminals, by the way, should be of large size. Now cut off the screwed shanks close to the body of each terminal, and in the centre of the flat surface drill a hole. No. 52 Morse drill will be found exactly right for the purpose. This hole should not run into the  $\frac{3}{16}$  in. hole already made. Insert the butt of

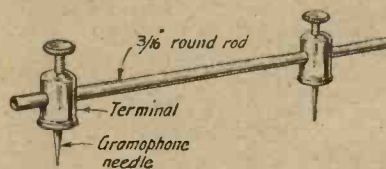

Fig. 4.—A useful gadget for scribing large circles—the “beam compass.”

the needle into it, and fix by a method known as “prick punching,” which is shown in Fig. 5. Fix the terminal tightly into the vice, and with a fine punch make three or four deep indentations in the brass round the needle. It will be found to be very tightly gripped.

**Finishing Wood**

Many wireless constructors who are fond of working in ebonite and brass do not care much about making up their own cabinets. If finished sets or pieces of apparatus are made up on panels of standard size ready-made cabinets can be obtained from a number of firms. Personally, however, I prefer to make the panel fit my design rather than the design to fit the panel, for there is then no tendency to crowd one's components. It means of course, that the panels will not fit ready-made cabinets, and one is then faced either with making the necessary cabinet oneself or of getting it made up. I have found it a good plan in this case to make rough dimensional drawings of the cabinet required and to get it made by a joiner capable of doing neat work. This is not an expensive business, and one can save a good deal by having cabinets delivered in the rough and finishing them up oneself.

**Suitable Woods**

Woods that I have found very suitable for wireless cabinets are oak, walnut and mahogany. American whitewood also looks very well pro-

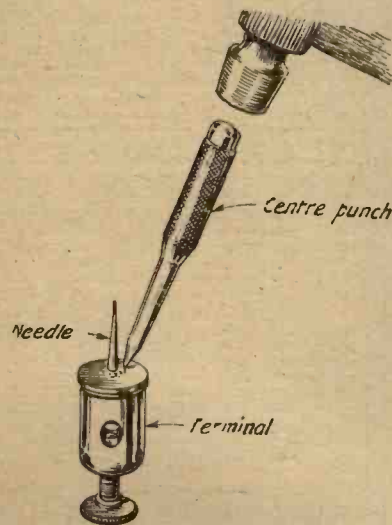

Fig. 5.—How the needle points are prepared.

hand. Take the other in the right hand, and with its needle make a small scratch on the panel. Verify with the ruler that the radius is exactly  $1\frac{1}{4}$  in., adjusting if necessary until it is. It should, of course, be exactly  $1\frac{1}{8}$  in. after the first adjustment, but this second check is advised so that there may be no possibility of an error. Now hold the two terminals as before and scratch out the complete circle.



**SOLDERING**

simplified by this new invention, which works from any wireless accumulator with a carbon soldering bit. No gas, fire or lamp needed. Everything necessary, including Flux and Solder, in stout wooden box, for 5/6.

Postage 3d.

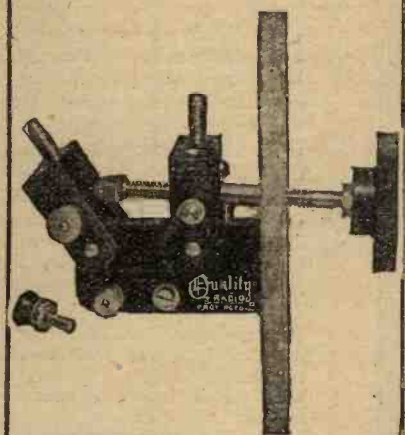

**Quality BACK OF RADIO PANEL**

**VERNIER COIL HOLDER** with detachable coloured terminals for reversing reaction.

Price 10/6. Post, 3d.

If your dealer has not got them we send post free if you mention his name and address.

**GOSWELL ENGINEERING CO., LTD.,**

12a, Pentonville Rd., London, N.1.

Liberal Trade Terms. Phone: North 3051.

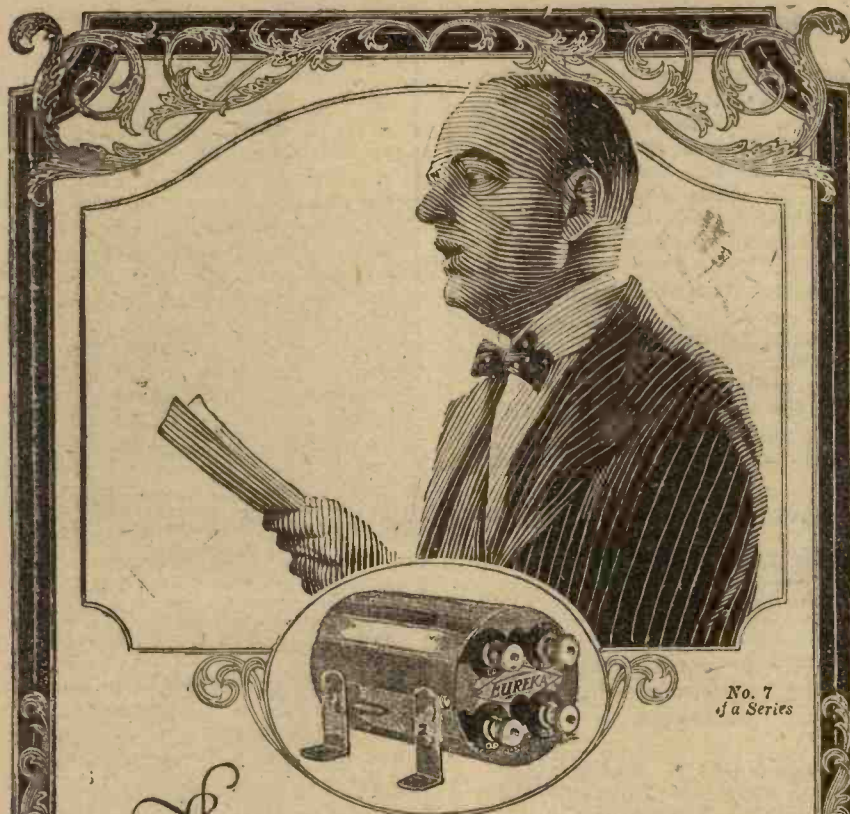

No. 7  
of a Series

# The Living Artiste

HEAR the song as the singer intended you to hear it.

Close your eyes and let your Loud Speaker reflect the real personality of the artiste. It should be easy if your Set is free from distortion. The corner stone upon which the whole structure of sound reproduction rests is the L.F. Transformer. Such responsibility is shared by no other component. And what is this Transformer? Text Books will tell you that it consists of an iron core surrounded by two separate windings of fine wire wound one over the other. They will even give the inquiring reader all the constructional details he needs. But there is very much more in the design of a good L.F. Transformer than that.

Take the Eureka Concert Grand for example. This unconventional design broke away from tradition and left the accepted theories of low frequency amplification. Its low ratio gives immense amplification—a paradox that must be tried out to be fully appreciated. Its hermetically sealed contents can be exposed to the elements indefinitely without harm. Its coppered steel case definitely eliminates interaction under all conditions. But above all its tone is a revelation to all who are music-sensitive. How much longer will you put up with the inferior Loud Speaker reproduction when for 30/- you can get the finest Transformer money can buy? One that carries a full and unconditional guarantee.

In two Models:  
Concert Grand 30/-  
Eureka No. 2 22/6  
(For second stage)

Supreme **EUREKA** for Tone

Advertisement of Portable Utilities Co., Ltd., Fisher St., London, W.C.1

G.A.  
2427

## ELECTRADIX RADIOS

"C" Valves, Air Force, low loss, 6/6 (post at buyer's risk). Wavemeters, 50/-, £4, £5 and £6. Morse Recorders, £6 10s.; Wheatstone, £8. Alternators, £3 10s. Valve Transmitters, £3. Spark Sets, 15/6. R.A.F. Steel Masts, 2/6 per 5 ft. run. Receivers: 2-valve, 2B, £2; 3-valve, Mk. 4, £3; 5-valve, £5 10s.; 7-valve Marconi, £8. All prices less valves. Bridges, £3 and £5 10s. Res. Boxes, multi-range standards, 1 to 2,000 ohms, 17/6 to 50/-. Loud Speakers, 19/-. Ebonite Horns, 8/-. A.C. Chargers, £4 10s. Charging Dynamos, £3. Marconi Rounds Valves, 3/6. Milliammeters, 27/6. Micro Ammeters, 65/-. Amp. and Voltmeters, all ranges Ohm-meters, £10. Testing Sets, £4 to £14. Condensers, L.T. to 10,000 v., 1/6 to £2. Call or write for new and enlarged catalogue. Post free, 4d.

LESLIE DIXON & CO., LTD.,

9, Colonial Avenue, Minorics, E.1.

Buses pass the door. Telephone—Avenue 4168

M W C

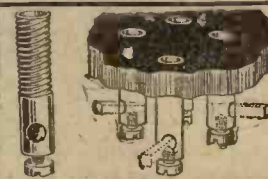

The New  
**A.G.**  
VALVE  
SOCKET  
Reduces  
Capacity  
to the  
Minimum

(Patent applied for.)

6d. set of 4. Post extra.

The simplest, neatest and most efficient Valve Mounts in existence, give maximum spacing at the most vulnerable point in any set.

SEND FOR LEAFLET & CATALOGUE

"The House for Good Radio Service."

**SPARKS RADIO SUPPLIES,**

43, GREAT PORTLAND STREET, LONDON, W.1

Telephone: Langham 2463.

## COIL WINDING MADE EASY

The Super Coil Former—No. 23929. Patent Pending.

All kinds of Honeycomb, Duolateral and Basket Coils can be completely bound together while held in position on former and pins.

No Shellac, Wax or Tape required. Two rows 25 pins, two of 13, one of 19, with full working instructions. Price 3/9 post free.

W. & A. COLLINS, 6, King's Avenue, BUCKHURST HILL. E-SEX

## YOUR CABINETS

The original House for hand-made and polished Mahogany, Oak and Teak Cabinets to customer's own design. All Timber used in my cabinets is carefully selected and guaranteed THOROUGHLY seasoned.

### YOUR PANELS

Finest quality 1/2 in. thick Siemen's Ebonite cut to size 1d. per square inch, 1/2 at 1d. per square inch. This Ebonite is guaranteed British Made to Post Office Grade "A" Specification, which is the best for wireless purposes. It is rich black in colour, takes a brilliant polish, can be threaded with ease, and possesses a high degree of mechanical strength.

SOLDERING SIMPLIFIED  
by using

RADIO **AGAR'S** SOLDER

Resin Cored.

Sample 2-oz. Box, 1/3 post free.

CLEAN TO HANDLE. NON-CORROSIVE.

**W. H. AGAR**

Manufacturer of Telephone & Radio Apparatus

19, Whitecross Place, Wilson Street, E.C.2

Tel.: London Wall 3305 Est. 1912

## NORTH WALES

If you live in North Wales  
send for our Price List

AT ONCE

**WALTER E. REYNOLDS**

4, South St., Fenton, STAFFS

vided that it is stained, for it will take a very good finish. Here is a simple and satisfactory way of finishing up a cabinet delivered in the rough. Obtain a large cork bung from two to three inches in diameter. Round this wrap a piece of the finest glass paper. You now have a tool which will enable the necessary rubbing down to be done very easily. Work carefully over each surface, not forgetting that in this case *elbow grease* is the secret of success. When you have got all the surfaces so smooth that they feel like silk when the hand is passed over them, soak a rag in linseed oil and rub them over one by one. Do not be too niggardly with the oil.

**Repeat the Process**

Leave the cabinet for two or three days to dry. At the end of this time you will probably find that owing to the soaking in of the oil the grain of the wood has risen a little. Rub down afresh until the surface is quite smooth again and oil once more. With certain woods it is necessary to repeat the rubbing down and oiling process three times in order to obtain a finish that will remain permanently good. This does not mean that you must wait

a week or more before mounting the set in the cabinet. There is not the least reason why it should not be brought into use as soon as the first rubbing down and oiling process is complete, though when oiling has been done afresh the set should stand on several layers of newspaper, so that the oil may not mark the top of the table on which it rests, or the table cloth.

**The Final Polish**

As I do not care very much about varnished cabinets, I generally obtain the final polish by using the mixture of beeswax and turpentine which housemaids make up for use upon floors. As soon as the last dressing of oil has dried in thoroughly, apply a little of this compound to the cabinet with a rag, rubbing it well in. Then use a polishing cloth. Provided that you once more administer plenty of elbow grease a handsome lasting polish will result. If beeswax and turpentine do not happen to be available, brown boot polish will do quite well, for it consists mainly, I believe, of these materials.

**The Centre Punch**

I have often heard people in a tool shop asking simply for a centre

punch and seen them take the first one that was handed out to them. For wireless work *any* centre punch will *not* do, and many constructors spoil their work by using punches that are far too coarse to make real accuracy possible. What is needed is a small fine-pointed punch, for with this you can mark your drilling centres exactly where they ought to be. Take care, by the way, when you purchase a centre punch that you get one of really good quality. Not long ago I bought one of unknown make because I had not time to go to my regular tool shop. After a very small amount of work it had ceased to have a point at all, being made of metal that was far too soft.

**Use a Small Drill First**

When a fine punch is used, as it ought to be, large drills such as those  $\frac{1}{4}$  in. and  $\frac{3}{8}$  in. in diameter should not be started directly in the little marks that it makes. Instead, place first of all a smallish drill, say, a No. 26 Morse or a  $\frac{1}{8}$  in. in the drill chuck and with it make a little hollow at the point marked with the punch. The big drill can then be put through without there being any chance that its point will slip.

**LEAVE IT TO FLUXITE**



An un-soldered wireless set is a breeding ground for those little devils of distortion and bad reception. They thrive on the delicate currents that pass through the circuit. Each un-soldered joint is a trap. One spot alone is sufficient to lower the receptive qualities of your set, so just think what is missed if all the joints are left unsoldered.

Fluxite chases away all soldering worries, and makes possible the perfect soldered joint; making your circuit one whole, solid, piece of wiring instead of twenty or thirty odd patchy lengths.

Make up your mind and solder your wiring now. It is so simple. Leave it to Fluxite. Ask your Ironmonger or Hardware Dealer to show you the neat little

**FLUXITE SOLDERING SET**

It is perfectly simple to use, and will last for years in constant use. It contains a special "small space" Soldering Iron with non-heating metal handle, a Pocket Blow-lamp, FLUXITE, solder, etc., and full instructions. Price 7/6. Write to us should you be unable to obtain it.

Price 7/6



**FLUXITE SIMPLIFIES SOLDERING**

All Hardware and Ironmongery Stores sell FLUXITE in tins, price 8d., 1/4 & 2 S.

Buy a Tin To-day!

FLUXITE, LTD., 330, Bevington St., London, S. E. 15.

ANOTHER USE FOR FLUXITE  
Hardening Tools & Case Hardening  
ASK FOR LEAFLET on improved methods

**The New MAXEL Accumulator**

*Specially designed for Wireless GUARANTEED TWELVE MONTHS.*

If you live too far away to call and see the Battery Mail your Order to us for the size you want. We will willingly return your money if you are disappointed.

	AMPS.		
	40	60	80
4 VOLT	15/-	18/6	22/-
6 VOLT	—	27/-	32/6

Special: 2v. 60a. for D.E. VALVES 9/-; Packing 1/- extra per battery.

**N.B.—Repairs to any make of Battery in 24 hours**

**MAXEL ELECTRICAL CO.** 28, Clipstone Street, Great Portland Street, W. 1  
Telephone: MUSEUM 709.

**"FAMA" THE SUPER VALVES**

"FAMA" DUTCH VALVES are GUARANTEED to be the CHEAPEST, MOST EFFICIENT & MOST RELIABLE VALVES EVER OFFERED to the PUBLIC

TYPE, TUBULAR Detector 4 volt. Amps. 5 4/3  
do. "E" Amplifier 4 do. do. 5 4/9  
0-08 DULL EMITTER 2 do. do. 0-08 11/6

**BUY THE VALVES WITH A REPUTATION**

All Valves returned post free

60 Volt High Tension Batteries. Tapped 6/9  
every 3 Volts. each.

Adjustable Diaphragm 4000 OHMS Head. 10/6  
phones. pair

**DON'T DELAY, WRITE TO-DAY.**  
**LIBERAL TRADE DISCOUNTS.**

**H. D. ZEALANDER & Co. (Dept. G.)**  
St. John's House, 124-127, Minorities, London, E. 1  
Phone: Avenue 1482. Postage Extra

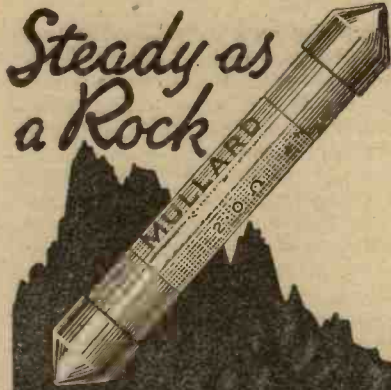

# MULLARD EVER-REST GRID LEAKS

are silent in use and constant in value. Absolutely unaffected by climatic conditions. Made in two types:

- (1) For grid leaks with suitable condensers and
- (2) For Anode circuits of resistance amplifiers.

EVER-REST Grid B  
·3 to 5 megohms, 2/6 each.  
EVER-REST Anode B  
·02 to ·01 megohms, 2/6 each.

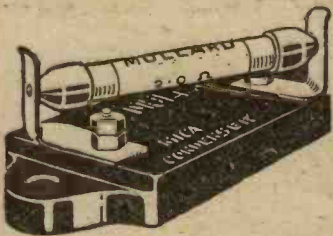

Complete with high standard and guaranteed exact capacity fixed condenser.

Grid B with ·0003 mfd. Condenser Type M.A., 5/-  
Mullard Condensers only

Type M.A.  
·0002—·004 mfd., 2/6 each,  
Type M.B.  
·005—·01 mfd., 3/- each.



Advt. (Mullard), Nightingale Lane, Balham, S.W.12.

## A Chat on Frame Aerials

By C. P. ALLINSON

*A comparison of two types of frame aerials which gives a suggested explanation as to results obtained*

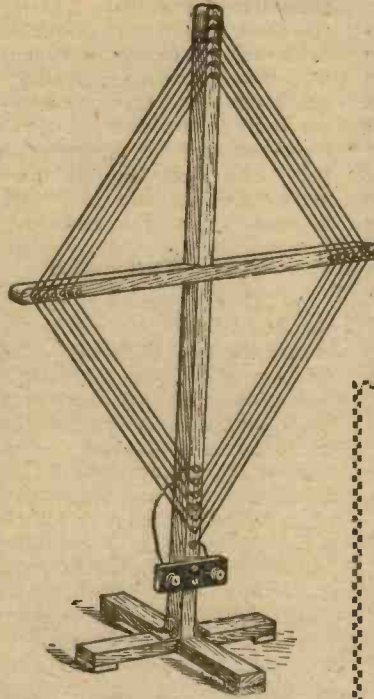

Fig. 1.—The Diamond Type.

NO doubt many listeners have tried out the frame aerial at one time or another, and have discarded it as being too inefficient. Or, where it has been installed on account of its directional properties, not being sufficiently so.

Now there are two main types of frame aerial which we may call (a) the diamond type, and (b) the box type. As will be seen from Fig. 1, the diamond type consists of a winding which is a flat spiral, every turn being larger than the one which precedes it. It is this form that the writer has found as being less efficient and much less directional than the box type frame aerial shown in Fig. 4.

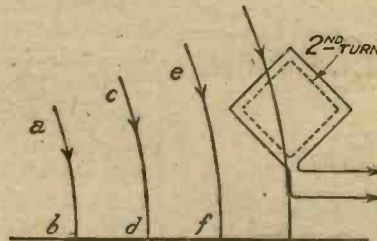

Fig. 2.—The frame is directional to the transmission.

### How it Works

It will not be amiss if we consider the action of a frame aerial. In Fig. 2 let ab, cd, ef, &c., represent successive wave trains. Then the

frame aerial (consisting in this case of one turn of wire only) is set at right angles to their plane. It is then directional to the transmission. It is not intended in this article to consider the theory of frame aerial reception, and we will therefore take it for granted that in this position, with the frame pointing towards the transmitting aerial, that each wave train will cause a maximum current to flow in the frame aerial. It is understood, of course, that this is tuned to the required frequency. As is known,

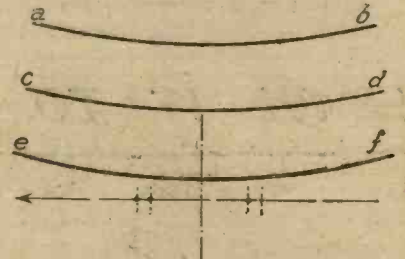

Fig. 3.—Two turns in the minimum position.

if the frame aerial is now turned through an angle of 90 deg., the energy received is a minimum.

### Adding a Second Turn

Supposing we now wind a second turn of wire inside the first, and place the frame directional to the station we wish to receive. This second turn, as is clearly to be seen, is almost entirely, if not quite, shielded by the first, and it therefore picks up but little extra energy, and practically its only effect is to increase the total inductance of the frame aerial without making it much more sensitive. If we now rotate the frame into the minimum position we can see from Fig. 3 that we present a larger conducting surface to the oncoming wave train, double in fact, resulting in an addition to the signal strength at the minimum

position. The preceding argument applies to every succeeding turn of wire added in this manner, and

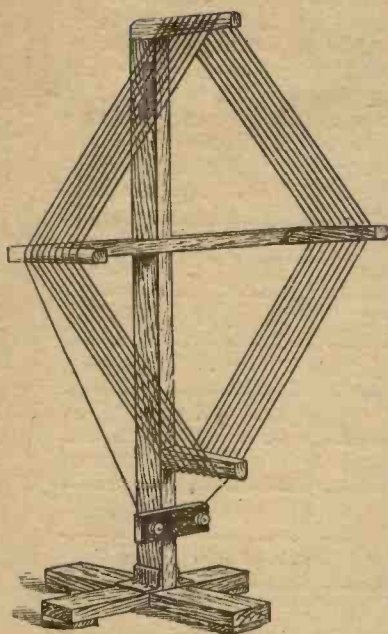

Fig. 4.—The "Box" Type.

so each extra turn detracts from the directional properties of the aerial.

Let us, however, wind this second

turn alongside and parallel to the first. With the frame directional towards the station we wish to receive, we see that the surfaces of two conductors are now presented to the wave train instead of one. An examination of Fig. 5 will make this clear. Now when the frame is rotated into the minimum position Fig. 6 shows us that only one conductor surface is exposed to the signal wave, however many turns there may be in the frame aerial, and that, therefore, any increase of signal strength that may occur in this position will be very small.

**The Box Type Better**

It would appear from the fore-

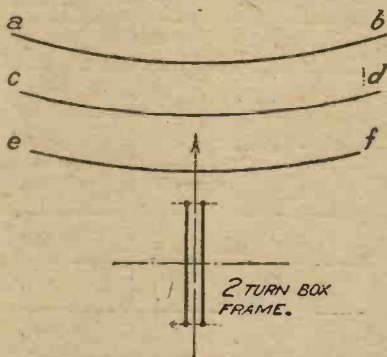

Fig. 5.—Two turns side by side in the maximum position.

going remarks that a box type frame aerial should not only be more sensitive but much more directional than an equivalent

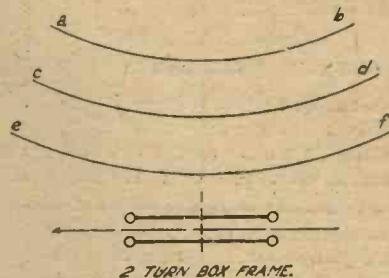

Fig. 6.—The Fig. 5 frame at right angles to the transmission.

frame aerial wound diamond fashion. This has been found to be so in actual practice by the writer in a series of experiments carried out by him. It is important, however, that the turns of wire be amply spaced, as a frame aerial with 12 turns spaced  $\frac{1}{4}$  in. showed no improvement over one with 8 turns spaced  $\frac{3}{8}$  in. It is also advisable to mount the frame aerial with one of the diagonals vertical, so that no one limb of the winding becomes parallel with the earth, thereby causing losses due to increased capacity to earth. For broadcast reception, a frame aerial

# 24000 TURNS

OF WIRE ON EVERY G.R.C. 83 TRANSFORMER

That's only one of the many reasons why it is the *best* low-frequency amplifying transformer made

ONLY

*General Radio\**

PROVIDES THIS GUARANTEE:—

*This Audio Frequency Transformer has been most carefully tested before leaving our works, and is guaranteed for one year to function efficiently if correctly used*



15/-

\*"General Radio" on a Broadcast Receiver or Component means that it is definitely guaranteed to give absolute satisfaction

Issued by the Publicity Department of the General Radio Company Ltd., Radio House, 235 Regent Street, W.1

wound with approximately 100 ft. of wire (which is the length of a standard P.M.G. aerial) has been found satisfactory.

**Controlling Oscillation**

A useful hint when using a frame aerial with several stages of H.F. which may then be rather difficult to control on account of the low

damping of a frame aerial, consists in placing a carbon compression variable resistance in the grid return lead from the frame aerial as in Fig. 7. By this means it is possible finely to control the damping introduced into the first grid circuit, and so control oscillation to a very accurate degree, which is most useful when trying to pick up weak or distant transmissions.

**Some Dimensions**

For the convenience of amateurs who have not yet tried frame aerial reception there is appended a table of suitable dimensions, number of turns and spacing of same, covering various ranges of wave length. I certainly advise the experimenter who has not yet done so to try this very interesting method of reception. He will find there is

No. of turns, spaced 1/2 in. apart.	Side of square.	Inductance.	Max. λ with .0003.	Max. λ with .0005.
2	2 ft.	16 μH	130 metres	170 metres
4	2 ft.	50 "	230 "	300 "
6	2 ft.	80 "	290 "	380 "
8	2 ft.	125 "	375 "	480 "
10	2 ft.	175 "	440 "	560 "
12	2 ft.	240 "	500 "	650 "
4	4 ft.	110 "	350 "	450 "
8	4 ft.	320 "	580 "	750 "
12	4 ft.	600 "	810 "	1,100 "

These figures are for the box type frame aerial, and do not apply to the diamond type. If the wires are only spaced 3/8 in. apart (less is not advisable), the maximum wavelength obtainable may be increased a little. A suitable size wire is 18 S.W.G. copper wire, a smaller size not being advised.



REG. NO. 457042

**TAKING the GUESS out of RADIO**

Every individual THERLA condenser tested  
:: and guaranteed by Faraday House ::

Ask your dealer for a fixed condenser and radio becomes a great guess. Insist upon Therla Fixed Condensers and take the guess out of Radio. You build not with an arbitrary guaranteed capacity but *Tested Capacity*. Therein lies the great advance from mass production with all its inefficiencies to laboratory and scientific building.

Use the Therla Grid Condenser; the Therla across I.P. and O.P.; the Therla across the Telephones; the Therla for constant Aerial Tuning; the Therla wherever a fixed condenser is employed. The Therla is more than accurate—it is tested capacity. Build with the Therla Fixed Condenser and you have a standard condenser of tested and proved capacity

FROM ALL DEALERS

PRICES:  
0001 mfd. to 0015 mfd. 1/3 each  
002 mfd. to 005 mfd. 2/- each



Sole Distributors:

**SEL-EZI WIRELESS SUPPLY CO. LTD.**  
6, GREEK STREET, LONDON, W. 1. Telephone: REGENT 1140  
20, Old Haymarket, Liverpool

The plates are composed of brass foils specially prepared, and only the finest selected Indian Ruby Mica is used for the dielectric, consequently, the dielectric losses are negligible. They have been tested at 1,000 volts and are equally suitable for ordinary reception purposes and transmitting work. By the special method of assembly moisture is entirely eliminated, and we also get the added advantage of neither an increase nor a decrease in the capacity under any climatic or atmospheric conditions.

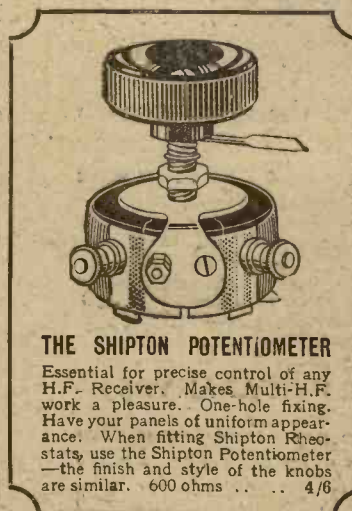

**THE SHIPTON POTENTIOMETER**

Essential for precise control of any H.F. Receiver. Makes Multi-H.F. work a pleasure. One-hole fixing. Have your panels of uniform appearance. When fitting Shipton Rheostats, use the Shipton Potentiometer—the finish and style of the knobs are similar. 600 ohms . . . 4/6

You can obtain Shipton Products from your usual dealer. If he cannot supply kindly send his name and address when sending direct.

Build Shipton Products into your Sets, you build efficiently. Shipton apparatus is designed with a practical sympathy for the experimenter's needs. Ask your dealer for Shipton Products.

**Shipton Products include:**

- SHIPTON New Type STRIP RHEO-STAT 7 ohm (with fuse) . . . 3/-
- SHIPTON New Type STRIP RHEO-STAT 30 ohm . . . 3/-
- SHIPTON New Type STRIP RHEO-STAT 60 ohm . . . 3/-
- SHIPTON New Type VARIABLE GRID LEAK . . . 3/-
- Faraday House Laboratory Test Report.

No. T/252/H. . . The gridleak submitted was tested for resistance at various positions of its handle, and the resistance varied continuously from 0.5 megohms to 6.5 megohms.

- SHIPTON New Type VERNIER COIL HOLDER (for Panel Mounting):
- 2-way . . . 4/- 3-way . . . 7/6
- Nickle-plated:
- 2-way . . . 4/8 3-way . . . 8/-
- and SHIPTON GIRDER COILS

**E. SHIPTON & CO. LTD.**  
37, TOIHILL STREET, WESTMINSTER, S.W.1  
Telephone: Victoria 3121. Telegrams: "Rent fones. Parl."  
Also at 14, KING ST., COVENT GARDEN, W.C.2  
Trade Enquiries Invited



Some  
Modern  
Aerials

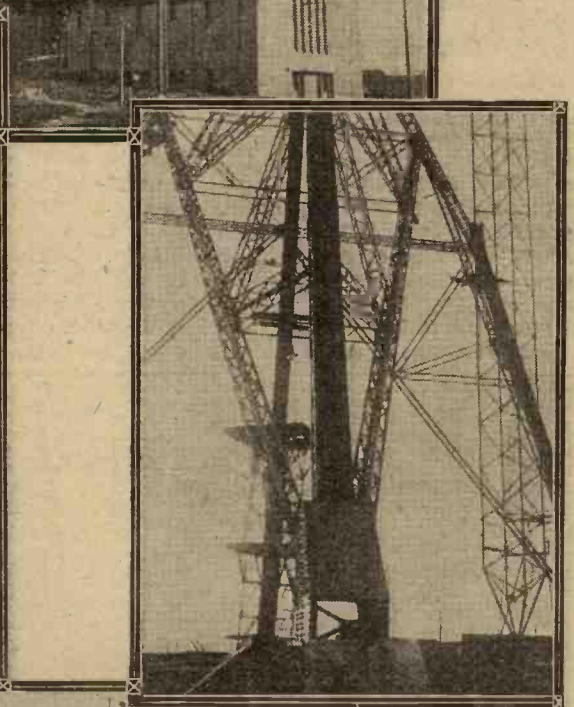
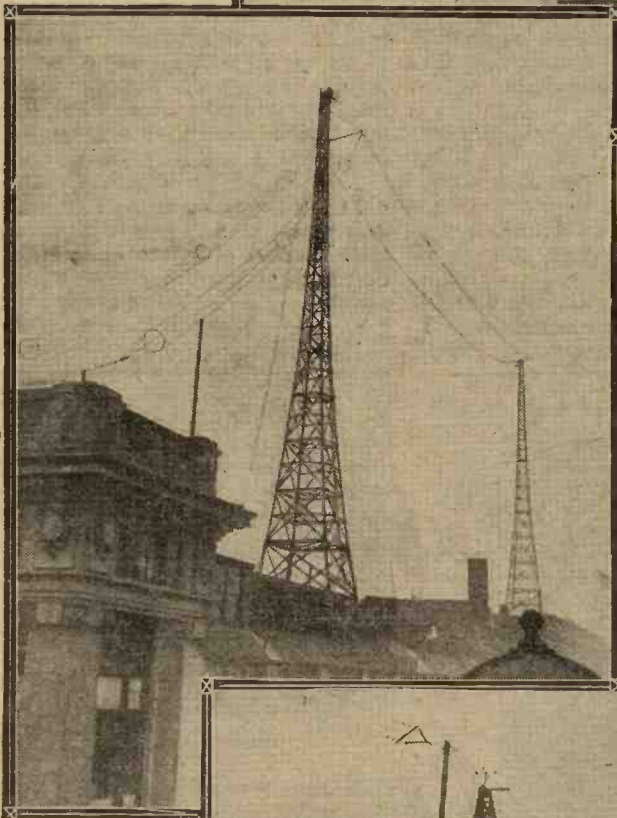
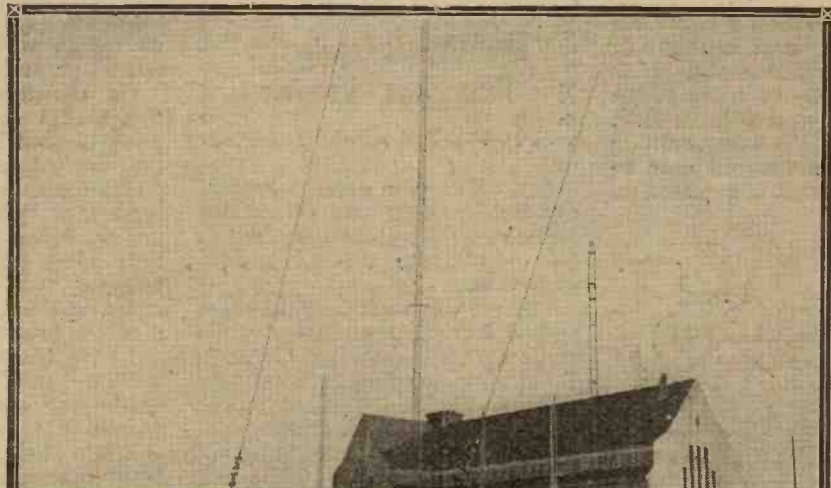

At the top of this page is seen one of the transmitting houses at Koenigswusterhausen, in Germany, where the largest station in the world is being erected. Some of the masts may also be seen, while, on the right, is a picture

showing one mast in the course of erection.

On the left:—The aerial of the new London station, at Selfridge's. The "flat-top" aerial and "cage" lead-in may be clearly discerned.

Below:— The aerial at the Royal Observatory, Greenwich.



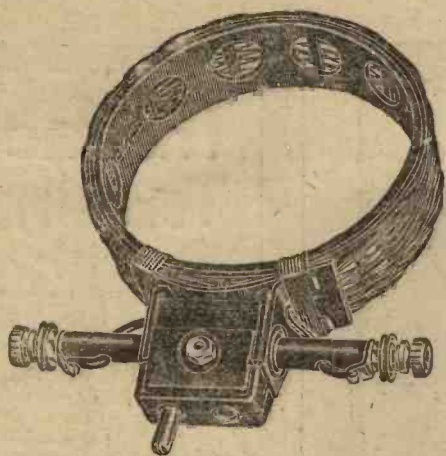

IGRANIC  
UNITUNE APERIODIC FIXED COUPLER

## For Transatlantic and short wave reception —you should use this Coupler

The many difficulties which arise in short wave reception owing to very high frequencies are greatly reduced by the use of the Igranic Unitune Aperiodic Fixed Coupler. Yet there is no difficulty in fitting it to any receiver having standard coilholders. You plug the coupler into the first grid socket, remove the aerial lead from the set and connect it to the right hand terminal on (see illustration) the plug extension area. The left hand terminal you connect to the "earth" terminal of the set and to earth.

Unitune Minor .. 80-180 metres 7/6  
" Major .. 300-600 .. 9/-

Ask your dealer about it.



include:

Honeycomb Duolateral Coils, Fixed Condensers, Filament Rheostats, Intervolve Transformers, Variometers, Vario-couplers, Bi-plug Coil Holders, Tri-plug Coil Holders, Battery Potentiometers, Vernier Friction Pencils, Electric Soldering Irons, etc., etc.

All carry the IGRANIC guarantee.

Write for List Z460

IGRANIC ELECTRIC CO., LTD.  
149, Queen Victoria Street, London  
Works: BEDFORD

Branches:

BIRMINGHAM  
LEEDS

CARDIFF  
MANCHESTER

GLASGOW  
NEWCASTLE

# The WADE WIRELESS TOOL-SET

The Wade Wireless Tool-Set removes the handicap of make-shift tools, comprising as it does 10 of the most useful and essential tools for the Wireless Worker. We illustrate two of the tools actually at work, which gives some slight idea of the utility of the set as a whole



**The Wire Bender.** This handy tool enables you to bend wire to any shape, to get at stiff wire in awkward places and bend it round pegs, terminals, etc., with ease.



**The Counter Sink.** This enables you to get the heads of your screws down flush to the surface of the ebonite, thus obviating the unsightly finish observed on many home constructed sets.

In addition you have:

- 1 Extra-long Screw-driver, which enables you to get at screws inside your set without fouling the wiring system.
  - 1 Broad Screw-driver for turning all ordinary screws.
  - 1 Wire Bender, invaluable for bending wire to any shape.
  - 1 Hammer, for Cabinet construction, straightening wire and for use generally where household hammer is far too clumsy.
  - 2 Box Spanners, 4 B.A. and 6 B.A., absolutely essential for turning nuts in awkward places. They replace pliers, which always burr the nuts.
  - 1 Counter Sink, to enable screw heads to be sunk to the panel level.
  - 1 Reamer, for enlarging holes to any diameter. Replaces numerous and costly drills.
  - 1 Bradawl, for starting screw holes.
  - 1 Double-sided File, for smoothing-off soldered joints, etc.
- All these tools fit into the Universal Holder provided.

If you can't get the tool-set from your local dealer send Postal Order to us, mentioning dealer's name

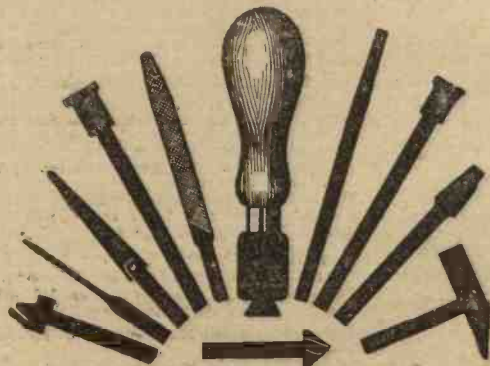

## 10'6

C.A.V. SMALL TOOLS, LTD., 181, Queen Victoria Street, E.C.4  
E.P.S. 32

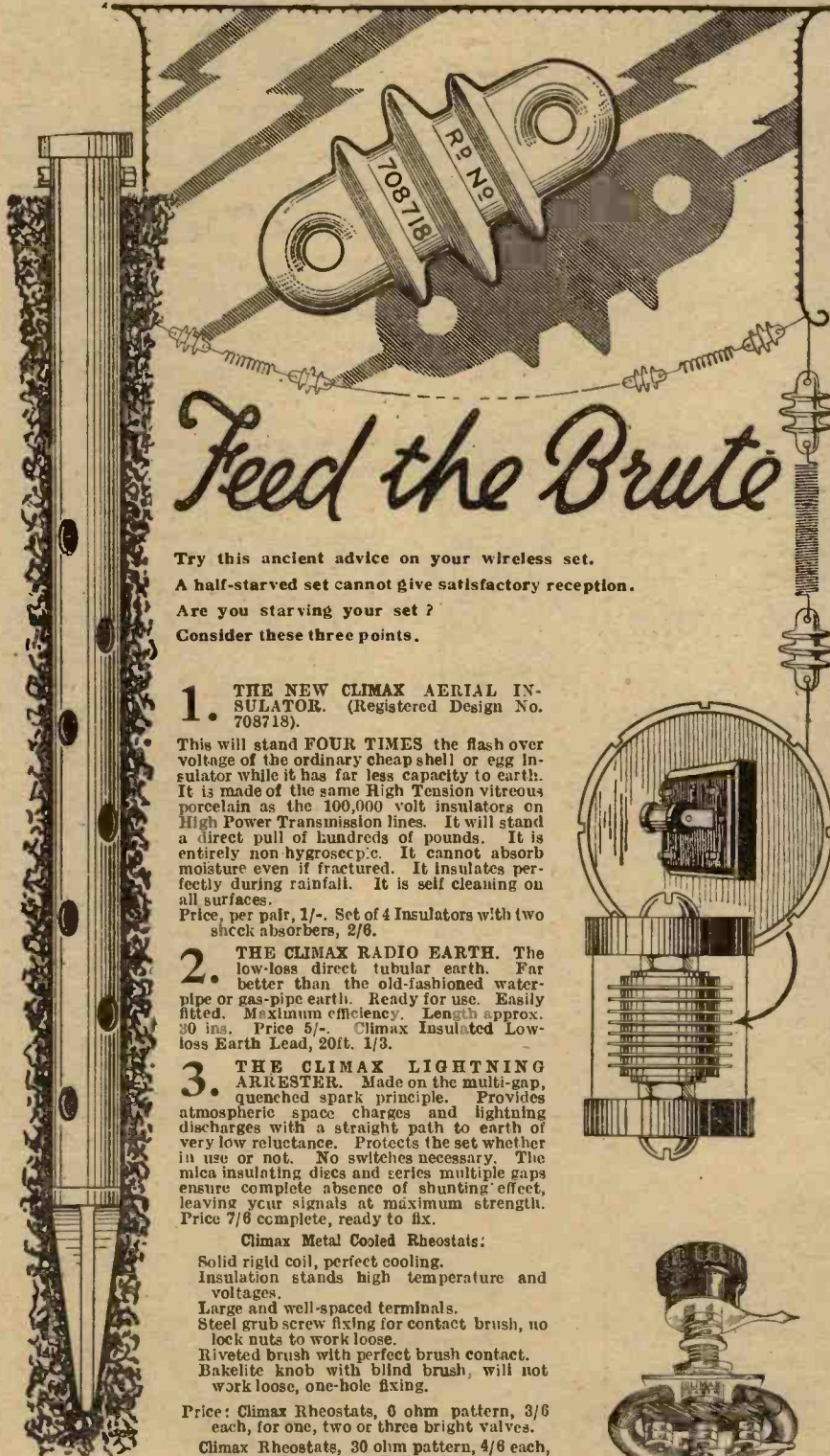

# Feed the Brute

Try this ancient advice on your wireless set.  
 A half-starved set cannot give satisfactory reception.  
 Are you starving your set?  
 Consider these three points.

**1. THE NEW CLIMAX AERIAL INSULATOR.** (Registered Design No. 708718).

This will stand **FOUR TIMES** the flash over voltage of the ordinary cheap shell or egg insulator while it has far less capacity to earth. It is made of the same High Tension vitreous porcelain as the 100,000 volt insulators on High Power Transmission lines. It will stand a direct pull of hundreds of pounds. It is entirely non-hygroscopic. It cannot absorb moisture even if fractured. It insulates perfectly during rainfall. It is self-cleaning on all surfaces.

Price, per pair, 1/-. Set of 4 Insulators with two shock absorbers, 2/6.

**2. THE CLIMAX RADIO EARTH.** The low-loss direct tubular earth. Far better than the old-fashioned water-pipe or gas-pipe earth. Ready for use. Easily fitted. Maximum efficiency. Length approx. 30 ins. Price 5/-. Climax Insulated Low-loss Earth Lead, 20ft. 1/3.

**3. THE CLIMAX LIGHTNING ARRESTER.** Made on the multi-gap, quenched spark principle. Provides atmospheric space charges and lightning discharges with a straight path to earth of very low reluctance. Protects the set whether in use or not. No switches necessary. The mica insulating discs and series multiple gaps ensure complete absence of shunting effect, leaving your signals at maximum strength. Price 7/6 complete, ready to fix.

**Climax Metal Cooled Rheostats:**

Solid rigid coil, perfect cooling. Insulation stands high temperature and voltages.

Large and well-spaced terminals. Steel grub screw fixing for contact brush, no lock nuts to work loose.

Riveted brush with perfect brush contact. Bakelite knob with blind brush, will not work loose, one-hole fixing.

Price: Climax Rheostats, 0 ohm pattern, 3/6 each, for one, two or three bright valves.

Climax Rheostats, 30 ohm pattern, 4/6 each, Universal pattern for D.E. or bright valves.

Climax Potentiometers, 300 ohm pattern, 6/- each.

Insist on the name "Climax"; if substitutes are offered, send direct to us.

INSIST ON THE NAME

**CLIMAX RADIO**

**Climax Patents Limited**  
 182, Church Street, London, W.8

Telephone: Park 2023.

When you want a new crystal—specify CLIMAX super crystal, 1/- per box.

## The Jack Terminal with 101 uses

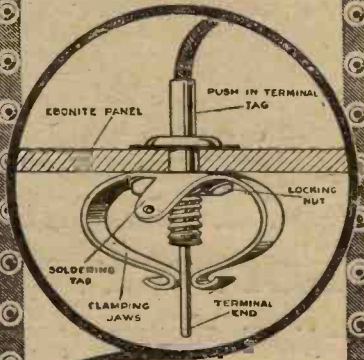

Equip your receiver throughout with S.W.C. Jack Terminals. They look well, work well, and cost but 4½d. each. Just press home the telephone terminal-tag and perfect connection is instantly made. Use them for 'phones, for your aerial, for every external lead on your receiver. All bright parts nickelled, and every terminal provided with distinguishing black or red washer.

(Slotted tags are provided so that accumulator, aerial, and other leads can be inserted and soldered, thus providing permanent tags in all cases.)

The **S.W.C.** JACK TERMINALS

Prov. Appl. No. 3352.

From your local dealer or, if any difficulty, send remittance (with 2d. extra postage) direct to sole manufacturer and patentee:

**S. WILDING COLE,**  
 116, SNOW HILL, BIRMINGHAM.

**2/3 FOR SIX**

Also sold in boxes of 12 for 4/6, complete with red and black celluloid washers for positive and negative terminals.

Trade Enquiries invited.

LOOKS LIKE THIS ON THE PANEL



# Catwhiskers I Have Met

By R. W. HALLOWS, M.A.,  
Staff Editor

MANY crystal users who endeavour to get the last ounce of efficiency out of their receiving sets give a good deal of attention to the catwhisker question, trying all kinds of types with contact points made of a large variety of metals. I do not know how many kinds of catwhisker there are on the market at present, but there must be a very large number indeed, and the crystal user's endeavour is to find the best. Actually, I believe that good results depend more upon the way in which it is used than upon the nature of the catwhisker. With most crystals the problem resolves itself into that of finding a really sensitive spot, and then adjusting the pressure of the catwhisker until the best results are obtained. Most of the popular crystals consist of galena in some

point fine and sharp. An occasional touch up with a fine file will suffice for this. In order to obtain greater stability in the crystal detector

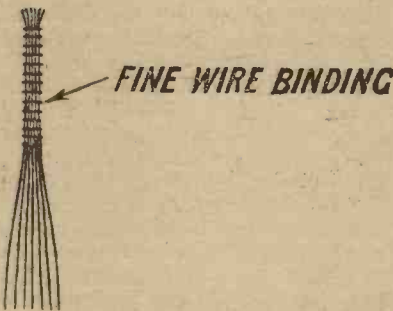

Fig. 2.—A form of whisker giving many points of contact.

with a catwhisker of this kind and a light contact it is a good tip to cover the surface of the crystal with a piece of very fine muslin, which can be secured in place by anchoring it to the contact screws of the cup with a few stitches. The fine point of the whisker penetrates the muslin easily, and once the sensitive spot has been found it is held in place by the mesh.

### A "Brush" Contact

Fig. 2 shows a kind of whisker very easily made, which makes searching for a sensitive spot a simple business, besides assuring a respectable amount of stability. To make it strip off the insulation for about an inch at the end of a

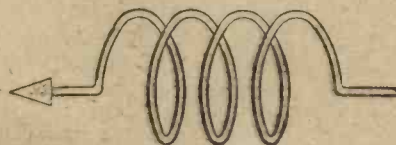

Fig. 3.—The "spear-point" type.

piece of flex containing a large number of thin wires. With a piece of fine wire bind the strands firmly together to within about  $\frac{1}{4}$  in. of the end. Snip off the little bundle with a pair of wire cutters, and the whisker is made.

The free ends of the wires should be splayed a little, so as to give

them a spread. When the multi-point catwhisker is used it will be found that in almost any position one at least of its wires is making contact with a sensitive spot, and that good results can be obtained with the minimum amount of searching.

### Another Type

A very good type of catwhisker is the spear-point pattern, seen in Fig. 3. Its great advantage is that it is easy to keep the point sharp and fine, and that it gives a very delicate contact. A very satisfactory form of spear-point whisker can be made in a few minutes in the following simple way. Take a piece of No. 30 copper wire about 2 in. in length, and flatten its end by hammering it gently. With a pair of sharp scissors cut the flat-

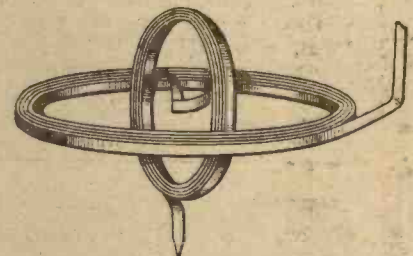

Fig. 4.—A very stable form of contact.

tened part to a point. Then coil the rest of the wire tightly round a stout knitting needle.

### The "Gyro" Pattern

One of the most ingenious catwhiskers that I have come across is the "Gyro" pattern, seen in Fig. 4. This is made from a piece of thin, flat, springy metal, wound first into a horizontal spiral, and then into a vertical spiral lying within the former. The double coils at right angles to one another take up any jars or jolts that may come the way of the detector, and once the correct adjustment has been found the point of the catwhisker will remain in place in spite of quite rough handling.

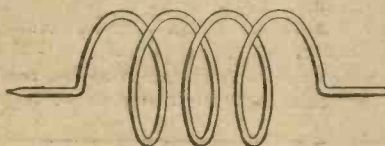

Fig. 1.—A common form of whisker.

form or other, and with galena a very light contact is generally required to give a good flow of current through the telephones. Unless the detector is so designed that very fine adjustments can be made it is not easy to obtain just the right amount of pressure between the point of the catwhisker and the surface of the crystal; further, a very light contact means that the slightest jar will disturb the setting, often arrived at after a good deal of work.

### The Spiral Type

It may be said that nearly any kind of catwhisker will work satisfactorily if it is properly used. Fig. 1 shows the spiral type, which is fitted in probably ninety per cent. of crystal receiving sets. It should be noticed that greatly increased efficiency can generally be obtained by keeping the contact

**The Best Metal**

Which is the best metal to use for the catwhisker? This depends very largely upon the particular crystal with which it is employed. Both brass and copper give good results with galena, whilst some amateurs pin their faith to catwhiskers tipped with gold or silver. My own experience is that with the majority of "ite" crystals a silver contact point gives slightly better results than any other.

**Not too Stiff**

The most important thing about any kind of catwhisker is that it should not be too stiff, for this results generally in a harsh contact. But no matter what kind of catwhisker is used it cannot perform well unless the surface of the crystal is perfectly free from dirt and grease. There is no greater mistake than to handle crystals, for if they are touched they collect a thin film of grease, which soon becomes covered with minute particles of dust. The crystal should be washed from time to time in absolute alcohol, obtainable from any chemist—do not use petrol or methylated spirit, both of which contain solid impurities, which they deposit as they evaporate. Pick up a crystal always with a pair of tweezers. Some crystals seem to lose their sensitivity in time; this can generally be restored by chipping away the old surface with the point of a penknife and exposing a new one.

## How to Fix Your Crystals into the Cups

IT is not always realised that the contact which the crystal makes with its cup is every bit as important as that between the crystal and the catwhisker. If you have a bad contact between crystal and cup you cannot hope for good signal strength, and you will find it extremely difficult to obtain any kind of stability in your detector. Some amateurs mount the crystal by running molten solder into the cup and pressing it down until the solder solidifies. This is a very bad practice, for crystals, especially those of the synthetic-galena type, are very susceptible to the effects of heat, and the melting point of solder is high enough to impair their sensitiveness. If you wish to imbed your crystal in metal, do not use solder, but purchase a stick of Wood's metal, which has a very low melting point. The best way to mount the crystal with the aid of Wood's metal is this. Grip the cup in a pair of gas pliers and place in it two or three short pieces cut from the stick. Hold it in the flame of a Bunsen burner or spirit lamp until the metal runs, then withdraw it from the flame and, just before solidification sets in, pick up the crystal in a pair of

tweezers and press it well down, holding it there until the metal has set.

**Use of Tinfoil**

If you use a cup of the type fitted with three contact screws you may find it exceedingly difficult to fit in an odd-shaped piece of crystal so that it is firmly gripped. A good way of obtaining a better hold, and at the same time a better contact, is to wrap the piece of crystal in two or three layers of tinfoil, working it well in until it follows the contours of the crystal. Take care not to touch the crystal with the fingers. When the crystal has been fixed, the tinfoil which covers its top may be scraped away with a penknife. Whether tinfoil is used or not, it is better to shape your crystal a little with the aid of an old penknife until the part to be gripped by the screws is roughly of the shape of an equilateral triangle. Most crystals can be chipped quite easily with a knife, and shaping it in this way ensures that the screws have a good surface to grip.

**The Fixing Screws**

Should you be one of those constructors for whom tapping has no terrors, you may find it an advantage to increase the number of fixing screws to four or more by drilling holes through the sides of the cup, tapping them and inserting screws. With a good number of screws it is usually quite a simple matter to fix even the most irregular crystal firmly in position.



The Savoy Bands have gained great popularity among listeners. They are seen above with a collection of their jazz instruments.

# "UTILITY" VARIABLE SQUARE LAW CONDENSERS

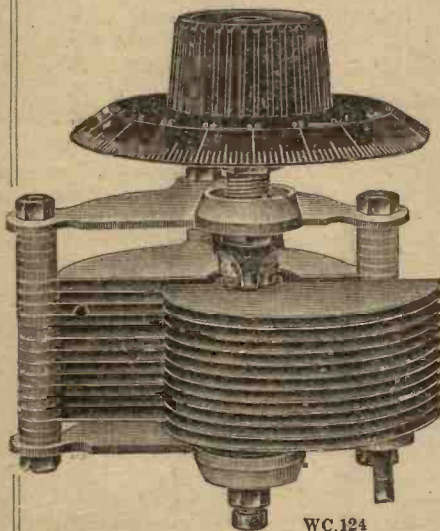

WC.124

at  
same price  
as our  
**ORDINARY**

**PRICES.**

Ref. No.	Cap.	Price
WC.123 '001	12/6	
WC.144 '00075	11/9	
WC.124 '0005	10/6	
WC.125 '0003	8/9	
WC.145 '0002	7/9	
WC.146 '0001	7/6	
Vernier		2/6 extra

# NO-CAPACITY

The "UTILITY" NO-CAPACITY SWITCH, as used in the constructional articles appearing in this journal.

Specially designed by electrical engineers to reduce the electrostatic capacity, this switch has proved to be exceptionally reliable in action and has self-cleaning contacts.

Size	Knob Type	Price
1 Pole Change over.	WC130/13/6	
2 "	WC130/24/-	
3 "	WC130/35/-	
4 "	WC130/46/-	
5 "	WC130/57/-	
6 "	WC130/68/-	

Size	Lever Type	Price
1 Pole Change over.	WC147/14/6	
2 "	WC147/25/-	
3 "	WC147/36/-	
4 "	WC147/47/6	
5 "	WC147/510/-	
6 "	WC147/610/-	

Nickel-plated, sixpence each extra.



WC.147/6

# SWITCHES

Manufactured by  
**WILKINS & WRIGHT LIMITED**  
UTILITY Works, Kenyon Street, Birmingham  
Established 1867.

Incorporate into your Radio

*Energo*

PRODUCTS  
and you will  
be satisfied

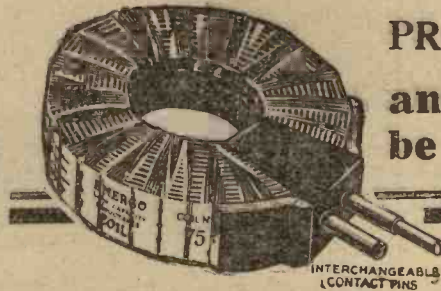

## Energo Low Capacity TUNING COILS

Sharp Tuning, Low Self-Capacity, Low Resistance, High Inductance.

These coils have been specially designed to give maximum results. Patent air-spaced winding and mounted in an anti-capacity and feather-weight method, they are particularly suitable where coil holders with loosely fitted spindles are used.

No.	Approximate Wavelength Shunted with Condenser.	
	Min. '0005	Max. '001 Price
25	85	280 3/6
35	125	450 3/9
50	140	650 4/-
75	225	975 4/8
100	300	1300 5/4
150	500	2000 6/-
200	600	2500 8/10
250	750	2750 7/1
300	1000	4000 7/5
400	1300	5250 8/3
500	1350	6500 9/-

## Energo H.F. TRANSFORMERS MATCHED

Most attractive and efficient. Wound with silk-covered wire. Made in all wavelengths.



We recommend the use of these H.F.'s shunted with a .0002 V. Condenser across primary.

No.	Wavelength in metres.	Price.
1	150-450	3/9
2	250-700	4/-
3	450-1200	4/3
4	900-2000	4/6
5	1000-3000	4/9
6	2000-5000	5/-

## Energo L.F. TRANSFORMER

For Supreme Results, Efficiency, Finish and Permanent Reliability.

PRICE 15/- EACH

The Energo L.F. Transformer is highly suitable for all circuits, and especially recommended for first stage and reflex circuits.

Purchase from your local dealer

IT WILL MAKE YOUR LOUD SPEAKER WORK.



If any difficulty in obtaining, please write direct to—

# ENERGO PRODUCTS

2, OLIVER'S YARD, E.C.1

and give us the name of your local dealer.

Barclays 954

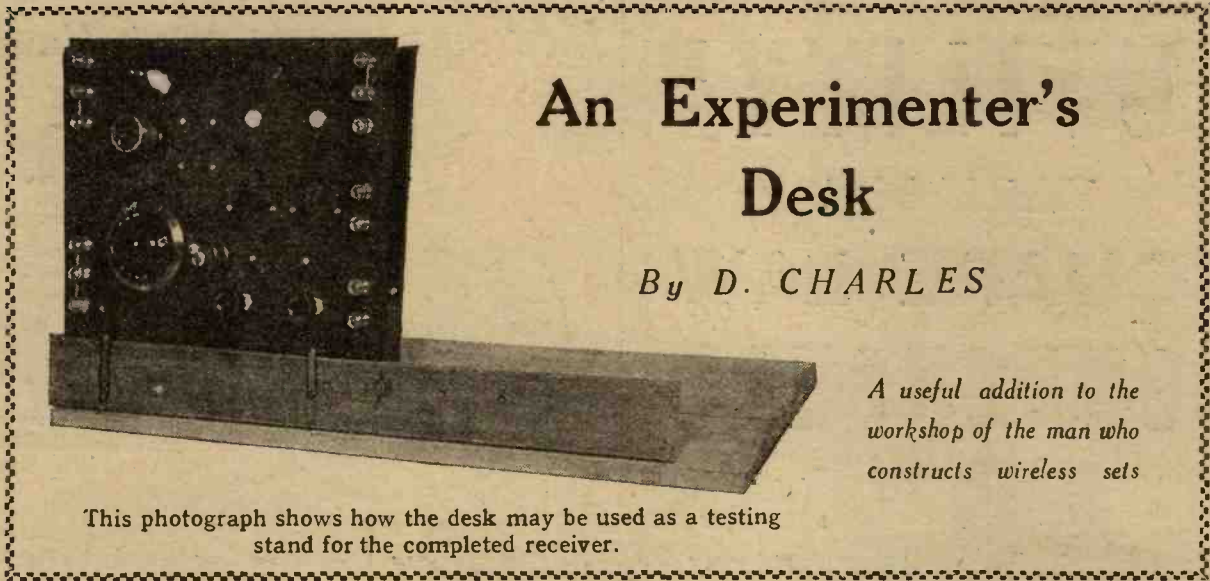

# An Experimenter's Desk

By D. CHARLES

*A useful addition to the workshop of the man who constructs wireless sets*

This photograph shows how the desk may be used as a testing stand for the completed receiver.

EVERY builder of wireless sets must have felt the need of some simple support upon which he can stand his panel during the period of construction. Then, again, on completion he will require to put his instrument through its paces, before fixing it in the cabinet, in case of possible modifications or adjustments being required.

The device illustrated fills this want very effectively, and it offers the advantages also of being most inexpensive and easy to make up. In fact, this was constructed entirely from odd "junk." It will accommodate securely any panel from eight to eighteen inches in length. Whichever size is under construction, the desk enables one to get at either side without any obstruction being present to hinder one's work.

### Varying the Size

Change of size is obtained simply by removing the bolt and fly nut securing the right-hand "leg," and refixing in the appropriate hole. The materials used are a piece of  $\frac{3}{4}$  in. board 9 in. wide and about a couple of feet long, a strip of wood the same length, between 2 in. and 3 in. wide, and a little thicker than the average ebonite panel. The legs, or struts, are of iron  $\frac{1}{2}$  in. wide and  $\frac{1}{8}$  in. thick. A piece 18 in. long is employed for each. Bent at a convenient angle by heating to redness in a Bunsen burner and bending in a vice, the short 3 in. end of one is screwed

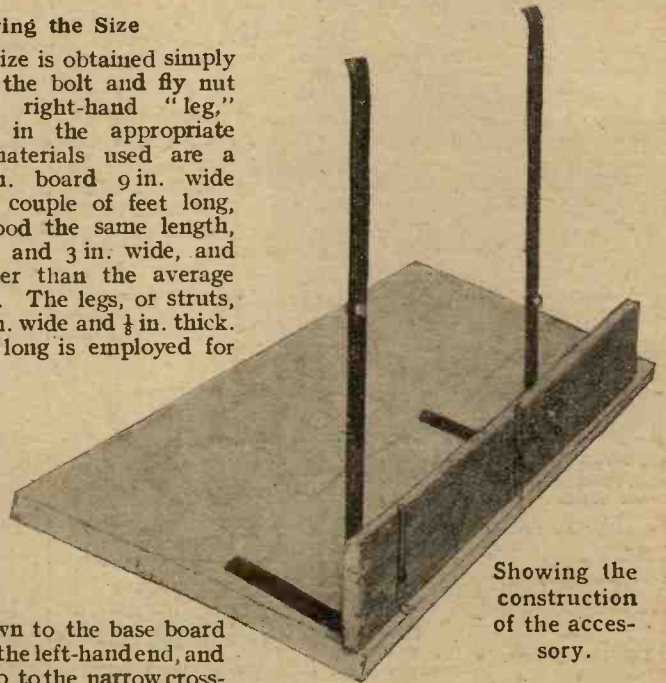

Showing the construction of the accessory.

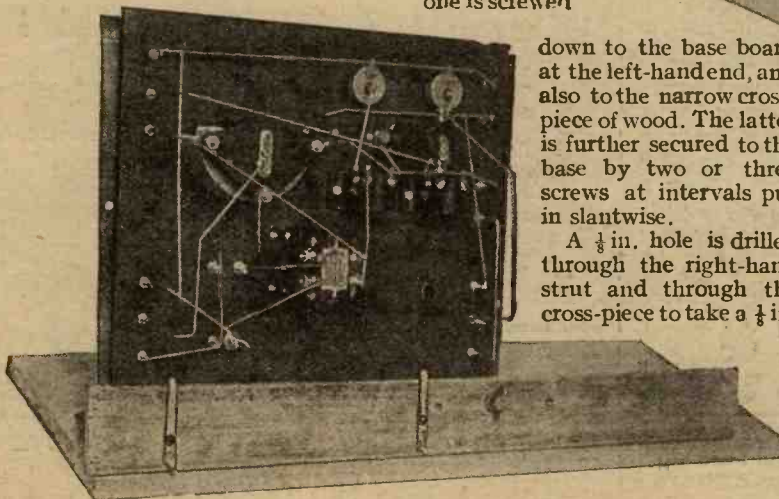

The panel is rested in this way on the desk while wiring up is in progress.

down to the base board at the left-hand end, and also to the narrow cross-piece of wood. The latter is further secured to the base by two or three screws at intervals put in slantwise.

A  $\frac{1}{8}$  in. hole is drilled through the right-hand strut and through the cross-piece to take a  $\frac{1}{8}$  in.

bolt and fly nut. This is found to give quite sufficient rigidity. Further holes in the cross-piece are bored at 2 in. intervals, so that the strut can be attached for taking panels of various sizes. It will be noticed that a cheese-head screw is put through each strut also, and secured by a nut behind. The holes for these are drilled rather outside the centre line of each iron strip, in order to allow a fair width for supporting the panel, and the purpose of the cheese-head is to prevent the same slipping sideways. Similarly, a couple of pieces of metal scrap are screwed to the cross-support further to ensure safety.

**"MORRIS" Solid Oak Standard Cabinet with locks**

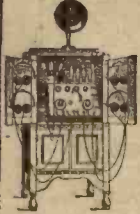

For any kind of receiver and panel. Height 3 ft. 6 ins.; depth, 15 1/2 ins. Back panel removable. Guaranteed first-class workmanship and quality. Immediate delivery from stock. Willingly sent on approval.

Prices:  
22 1/2 ins. inside width .. £4 10 0  
24 ins. .. £4 15 0  
26 ins. model de luxe .. £7 15 0  
part carriage & packing 5s. extra.

**SOLID OAK WIRELESS TABLE** with large drawer, 25 ins. by 18 ins., height 26 ins. 27s. 6d., carriage paid. Sold at most wireless stores, also at Lewis's, Liverpool, or direct from



M. Verstraeten (Dept. 20), 50a, Lord Street, LIVERPOOL

**Radio Press Envelopes**

The most complete guide to wireless construction ever devised. They contain exact size panel and wiring blue prints, complete working drawings, sheets of instructions regarding construction and working, lists of components, and many photographs on beautiful art paper showing the set and wiring from every possible angle. Every possible detail is explained and you cannot go wrong.

HERE IS THE COMPLETE LIST FOR YOU TO CHOOSE FROM:—

- 1 How to Build an S.T.100 Receiver .. 1/6  
By John Scott-Taggart, F.Inst.P., A.M.I.E.E.
- 2 How to Build a 4-Valve Receiver .. 2/6  
By Percy W. Harris.
- 3 How to Build the "Simplicity" 3-Valve Set .. 2/6  
By G. P. Kendall, B.Sc.
- 4 How to Build the All Concert-de-Luxe Receiver .. 2/6  
By Percy W. Harris.
- 5 How to Build the Omni Receiver .. 2/6  
By John Scott-Taggart, F.Inst.P., A.M.I.E.E.
- 6 How to Build the A.B.C. Wave Trap .. 1/6  
By G. P. Kendall, B.Sc.
- 7 How to Build a 2-Valve Amplifier-de-Luxe .. 1/6  
By Herbert K. Simpson.
- 8 How to Make a 1-Valve Reflex Receiver .. 1/6  
By Herbert K. Simpson.
- 9 How to Build an Efficient Single Valve Set .. 1/6  
By Herbert K. Simpson.

All above can be obtained from wireless dealers, booksellers—or direct (plus 2d postage) from Dept W

**Radio Press Panel Cards  
Wiring Charts  
Panel Transfers**

- RADIO PRESS PANEL CARDS.**
- 1 How to Make the W.I. Receiver .. 1/0  
By Herbert K. Simpson.
- SIMPLEX WIRING CHARTS.**
- 1 For 2-Valve Set .. 1/0
  - 2 For 3-Valve Set .. 1/0
  - 3 For 4-Valve Set .. 1/0
- RADIO PRESS WIRELESS PANEL TRANSFERS .. 0/6**

All above can be obtained from wireless dealers, booksellers—or direct (plus 3d. postage) from Dept. W.

**Radio Press, Ltd.**  
Bush House, Strand, London, W.C.2

Barclays Ad.

*Every part an Exclusive Feature*

**Bell-mouth Trumpet** of polished oak or mahogany. Artistic in appearance and the best possible radiator of Sound, the "insulated" wood horn possesses especial merit.

Sound Conduit provided with rubber bush to receive unit as well as connector at junction of conduit and horn, to ensure freedom from objectionable resonance.

The contour of the Sound Conduit affords a duct of considerable length, compared with the overall dimensions of the instrument, and the sweeping curve allows an unobstructed path for the sound waves.

The Conduit is hinged to the weighted electro-plated Base, ensuring stability and allowing the horn to be tilted to suit the acoustics of any apartment.

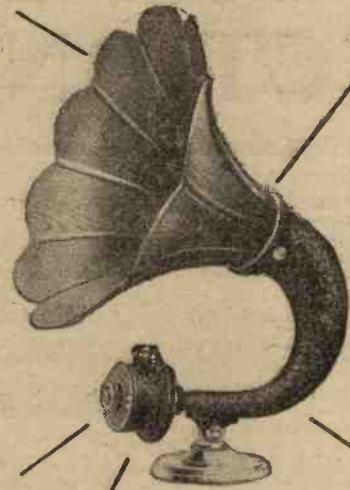

Name-plate with Type and serial numbers thereon, by which the "HOUSE OF GRAHAM" unconditionally guarantees complete satisfaction to any possessor of an AMPLION

Super Loud Speaker Unit incorporating the "floating" diaphragm. The unit is "insulated" and detachable from the sound conduit.

Making the

**AMPLION**

**The Loud Speaker Supreme**

Obtainable from AMPLION STOCKISTS and Wireless Dealers Everywhere. Illustrated Folder post free from the Patentees and Manufacturers:

**ALFRED GRAHAM & CO.**

(E. A. GRAHAM)

ST. ANDREW'S WORKS, CROFTON PARK, LONDON, S.E.4

Demonstrations gladly given during broadcasting hours at

West End Showrooms: 25-6, Savile Row, W.1

Suburban Showrooms: 79-82, High St., Clapham, S.W.4

ONLY  
**3/6**  
Each



ONLY  
**3/6**  
Each

# STILL FURTHER ADVANCES in CRYSTAL DETECTION

THERE is no such thing as a really permanent Crystal Detector, despite what you may be told to the contrary.

The nearest approach to permanency in crystal detection is that achieved by the "HOVIMO" CRYSTAL VALVE, which, in its original very simple form, is now quite well known to wireless users and investigators.

This has now been superseded by the very scientific and workmanlike new design to be known as the NEW HOVIMO CRYSTAL VALVE (illustrated above), in which is embodied all the improvements which long experience with this particular sort of Detector has suggested.

Wireless investigators have for months been endeavouring to discover just what is the combination of crystal in the HOVIMO CRYSTAL VALVE which succeeds in producing this semi-permanency, which makes louder signals, which enhances reaction when used in crystal reflex sets, but so far they have not succeeded, and the HOVIMO still remains the most successful.

Careful experiments have proved that the success of the Hovimo Crystal Valve does not lie exclusively with the combination of Crystals—but that it is the amount of pressure between the two crystals which actually "does the trick."

The NEW *Replaces the old-fashioned inefficient Detector.*

# "HOVIMO" CRYSTAL VALVE

has been designed so that this important adjustment is being made first by micrometer screw, which acts on a spring placed over the Crystal so that infinitely small alteration of pressure is possible, thus allowing each Crystal Valve to be adjusted to the particular set with which it is going to be used. Furthermore, this arrangement makes it practically impossible to crush the Crystals by over-pressure.

In the manufacture of the Hovimo Crystal Valve only loose crystals are used, so that practically all handling of them is avoided, leaving their original sensitiveness absolutely unimpaired. Any sort of fastening of the Crystals would involve the use of heat, and consequently impair their sensitiveness.

In the main, however, the NEW HOVIMO CRYSTAL VALVE "once adjusted is always adjusted," only requiring the merest touch to produce a resonant sensitivity both in straight-away crystal sets as used in millions of homes or in the more developed reflex sets, such as the S.T. 100.

In this particular set (the S.T. 100) the NEW HOVIMO CRYSTAL VALVE is absolutely ideal.

Its neat, handsome design adds to the appearance of the panel, and its one-knob adjustment works exactly as a filament Rheostat, so that control is perfect.

When buying a HOVIMO CRYSTAL VALVE the whole contents are visible—the construction can be judged—and the crystals (the vital part) inspected.

Buy Common Sense—Not Mysteries

C. MOLBACK,  
27, High Holborn, London, W.C.1.

Telephone:—CHANCERY 8391.

# "CLARKE'S ATLAS" FILAMENT CONTROL

Works on an entirely new principle. No wires to scrape and scratch. No powder to cause troublesome "Packing."

Gives astoundingly easy control of bright or dull emitters—a marvel of noiseless efficiency.

Economises current; lengthens the life of your valves, and is a deciding factor in bringing in those elusive stations. 30 ohms resistance. One hole fixing.



Price **6/6** each

From all  
good dealers

Sole Manufacturers—

H. CLARKE & Co. (Mc.) Ltd.  
Atlas Works, Old Trafford, Manchester

'Phones: 683 & 793 Trafford Park. 'Grams: "Pirtoid, Manchester."

# "YANKEE" RADIO TOOL SET

No. 105



The handiest set of tools ever made for radio work.

Takes care of all screws; reams and countersinks holes; runs up nuts; bends and loops wire; and is provided with a wrench for jack and hex, or square nuts. A touch on the ratchet shifter gives a right and left ratchet and rigid adjustment.

OBTAINABLE OF ALL GOOD TOOL  
DEALERS AND IRONMONGERS

Wholesalers invited to enquire for terms to:

MARKT & CO. (LONDON), Ltd.,  
98-100, Clerkenwell Rd., London, E.C.1.



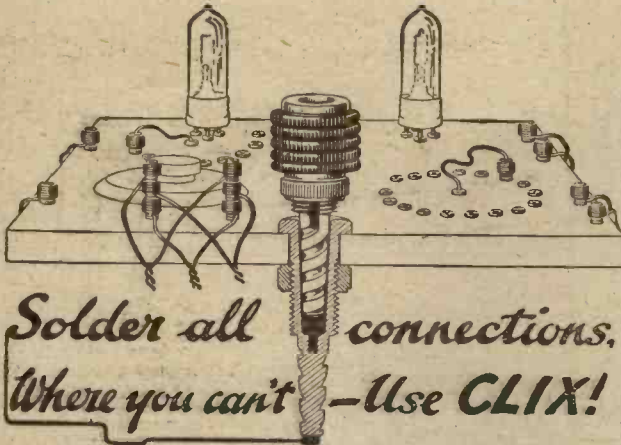

**Solder all connections. Where you can't - Use CLIX!**

**CLIX PROVIDES AN IDEAL POINT FOR SOLDERING**

**Retail Prices—**  
 CLIX with Locknut 3d.  
 CLIX Adapter with Locknut 2d.  
 CLIX Insulators (6 colours) 1d. each  
 CLIX Bushes (6 colours) 1d. pair

Obtainable from all Wireless Dealers or direct from the Patentees & Manufacturers

Perfect contact—instantaneously—everywhere. The tapered design of CLIX plugsocket ensures full surface contact in every one of its countless applications. That's why CLIX, the Electro-Link with 159 uses, supersedes all forms of Plugs, Terminals and Switches, and has standardised the wiring of all radio circuits.

**AUTOVEYORS, LTD.**

Radio Engineers and Contractors

84 VICTORIA STREET, LONDON, S.W.1

**A GUARANTEED GRID LEAK**

FOR HOME CONSTRUCTORS

2/-

DARCO "NEW PROCESS" (Patents Pending)

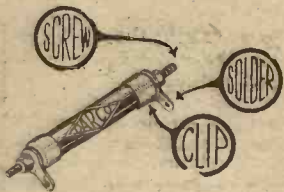

Every Darco Leak has TERMINALS and SOLDERING TAGS. You can connect it direct from grid to filament without special clips. You can fit it into any type of holder. Every Darco Leak is guaranteed, and is made in all Standard sizes, packed in neat cartons.

DARCO LTD., 77-79, High St., WATFORD.

Phones: 1432, 336.



**Stop fiddling**

Don't waste time in trying to find a live spot on the crystal. To ensure clear and perfect reception instal the world-famed TALITE (1/9) or H.H.F. Super HERTZITE (1/6) Crystals, which

are all active, super sensitive, and miss nothing. Every piece tested and guaranteed. Get one to-day and prove for yourself.

Look for the little glass tube with the red label.

From all wireless dealers, or a specimen will be sent on receipt of remittance **HARDING, HOLLAND & FRY, LTD.**

Chemical Manufacturers and Mineralogists,

52, Queen Victoria Street, London, E.C.4



**You, also, can increase your salary**

"After 17 years with a London engineering firm I was receiving only £4 10s. od. a week, but becoming an I.C.S. student in Civil Engineering, I quickly got an appointment at £1,000 a year, which steadily increased to £2,500!"

Many thousands of such messages from grateful students have been received by the International Correspondence Schools, the originators of

**SPARE TIME STUDY BY POST**

The I.C.S. Diploma is known, valued, respected in every country. It is an insurance against unemployment, and wins prosperity and happiness for its owners.

SIR HAROLD BOWDEN, MANAGING DIRECTOR OF THE RALEIGH CYCLE CO., LTD., NOTTINGHAM, says:—

"The Diploma of the I.C.S. in the hands of an ambitious man can carry him far, as it has carried thousands. To possess this qualification is proof of a sound, thorough, and specialised education in the subject representing that man's vocation."

The I.C.S. originated spare-time technical training by post 33 years ago, and is by far the largest institution of its kind in the world. It has teaching centres in eleven countries, and students in fifty.

Write to-day for full information as to how the I.C.S. can help you in your chosen vocation. There are 300 I.C.S. Courses, of which the following are the most important groups:—

- Wireless Telegraphy (Elementary and Advanced)
- Advertising
- Architecture
- Building
- Commercial Art
- Commercial Training
- Draughtsmanship
- Engineering (all branches)
- French and Spanish
- General Education
- Market Gardening
- Plumbing
- Professional Exams.
- Salesmanship
- Showcard Writing
- Textiles
- Window Dressing
- Woodworking

**International Correspondence Schools, Ltd.**  
 172, International Buildings, Kingsway, London, W.C.2.

**GRS**

**DIALS FOR ALL REQUIREMENTS**

Splendid range of superior, highly polished dials with scale 0—180 clearly engraved. These combined knobs and dials are held securely by means of a small grub screw; they fit flush to panel and the deeply fluted grip gives splendid control when making tuning adjustments.

SIZES:—

DIAL (dia.)	KNOB (dia.)	PRICE (each)
2 1/2 ins.	1 1/2 ins. (as illustrated)	1/3
2 3/4 ins.	1 3/4 ins.	1/2
2 7/8 ins.	1 7/8 ins.	1/-
3 ins.	2 ins.	8d.



**ABOUT CRYSTALS**

Wireless crystals are made in both Chemical Laboratories and Nature's Own Laboratories: diamonds and pearls are also produced by both these methods. *Would you buy a manufactured diamond?*

**G. R. S. Crystal**

is a natural Galena, each piece of which is selected, tested and guaranteed by us.

It is advisable to occasionally change and rest your crystals, and for that reason we offer:— Three small or 1 large piece in sealed boxes at 1/- each, or post free 1/4.

**G. R. S. Micro-Rheo**

(Illustration is half actual size.) Suitable for all types of dull and bright emitter valves. It is of the single-hole fixing type, and may be secured to the panel by drilling a 1-in. hole. The knob is held by means of a small grub screw and can be easily removed. Unlike some types of rheostats, the special carbon used will not pack and consequently the variation of resistance is uniform and consistent. A filament control of infinite precision, continuously variable from 0—200 ohms., price 3/6. Post free 3/8.

If you cannot obtain from your dealer, write to Dept. G.R.S.:-

**GERRARD RADIO STORES**

15, LITTLE NEWPORT STREET, LONDON, W.C.2

Trade Enquiries Invited.

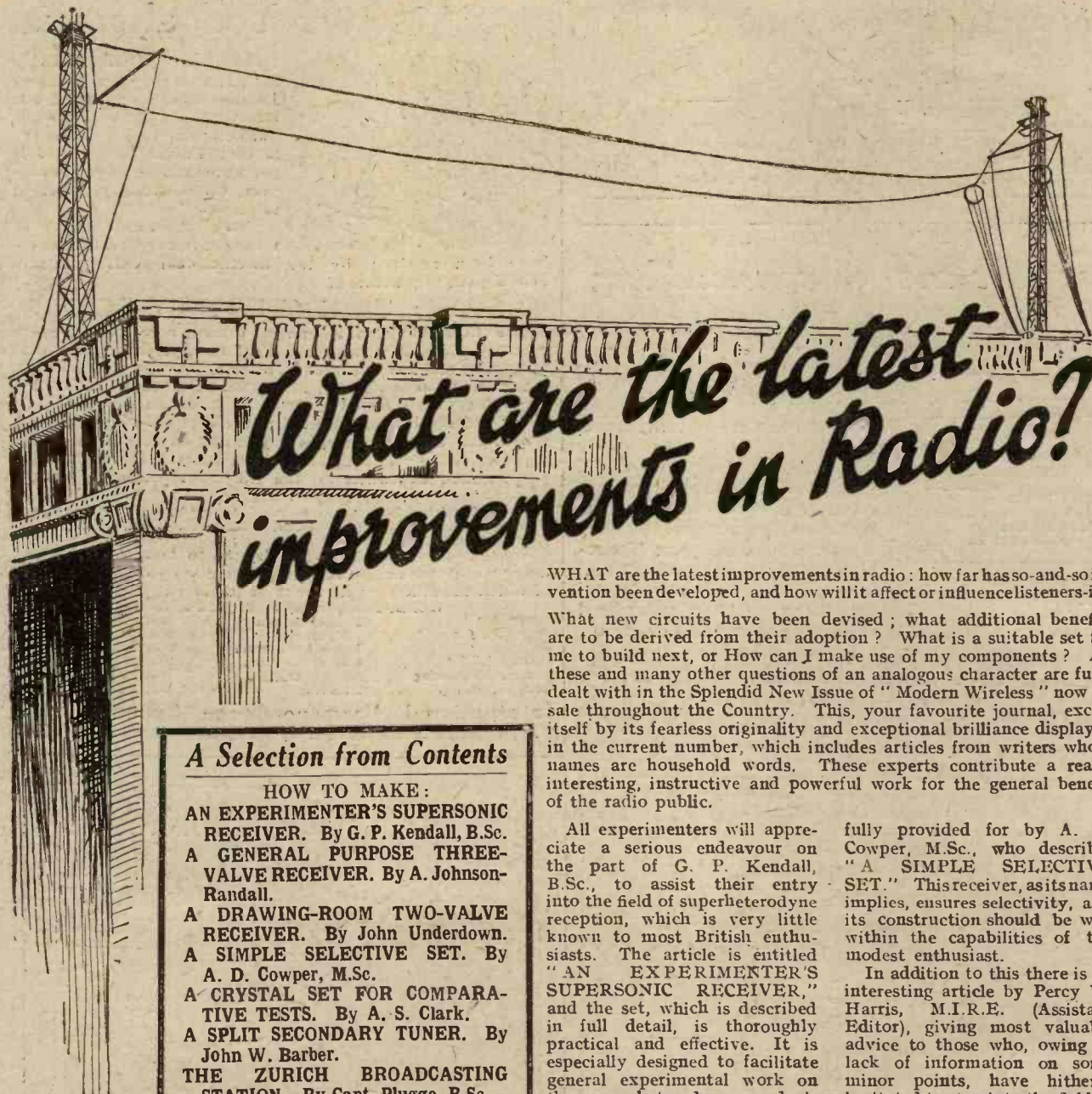

# What are the latest improvements in Radio?

WHAT are the latest improvements in radio: how far has so-and-so-invention been developed, and how will it affect or influence listeners-in?

What new circuits have been devised; what additional benefits are to be derived from their adoption? What is a suitable set for me to build next, or How can I make use of my components? All these and many other questions of an analogous character are fully dealt with in the Splendid New Issue of "Modern Wireless" now on sale throughout the Country. This, your favourite journal, excels itself by its fearless originality and exceptional brilliance displayed in the current number, which includes articles from writers whose names are household words. These experts contribute a really interesting, instructive and powerful work for the general benefit of the radio public.

All experimenters will appreciate a serious endeavour on the part of G. P. Kendall, B.Sc., to assist their entry into the field of superheterodyne reception, which is very little known to most British enthusiasts. The article is entitled "AN EXPERIMENTER'S SUPERSONIC RECEIVER," and the set, which is described in full detail, is thoroughly practical and effective. It is especially designed to facilitate general experimental work on the superheterodyne, and is used by the author himself for this purpose.

Readers desiring to construct a useful set without delving unduly into the intricacies of wireless technique have been

fully provided for by A. D. Cowper, M.Sc., who describes "A SIMPLE SELECTIVE SET." This receiver, as its name implies, ensures selectivity, and its construction should be well within the capabilities of the modest enthusiast.

In addition to this there is an interesting article by Percy W. Harris, M.I.R.E. (Assistant Editor), giving most valuable advice to those who, owing to lack of information on some minor points, have hitherto hesitated to step into the field of constructors and experimenters.

That other grades of our readers have been suitably provided for will readily be seen from a brief glance at the contents selection.

If you contemplate a new receiver, or an addition to your existing set; if you wish to augment your knowledge of wireless or test a new circuit, "Modern Wireless" will show you how, and, moreover, in the most interesting and economical manner.

## A Selection from Contents

HOW TO MAKE:

- AN EXPERIMENTER'S SUPERSONIC RECEIVER. By G. P. Kendall, B.Sc.
- A GENERAL PURPOSE THREE-VALVE RECEIVER. By A. Johnson-Randall.
- A DRAWING-ROOM TWO-VALVE RECEIVER. By John Underdown.
- A SIMPLE SELECTIVE SET. By A. D. Cowper, M.Sc.
- A CRYSTAL SET FOR COMPARATIVE TESTS. By A. S. Clark.
- A SPLIT SECONDARY TUNER. By John W. Barber.
- THE ZURICH BROADCASTING STATION. By Capt. Plugge, B.Sc.
- USING THE POTENTIOMETER. By R. W. Hallows, M.A.
- TRouble CORNER. IN PASSING.

Regular Transmissions from Continental and American Broadcasting Stations. By Capt. Plugge, B.Sc.

1/-

MONTHLY

Apr 1

Issue

BUY YOUR COPY TO-DAY!!

It is as good as a Course on Wireless.

# MODERN WIRELESS

EDITED by JOHN SCOTT-TAGGART, F.Inst.P., A.M.I.E.E.

Advertisement of Radio Press, Ltd., Bush House, Strand, London, W.C.2.

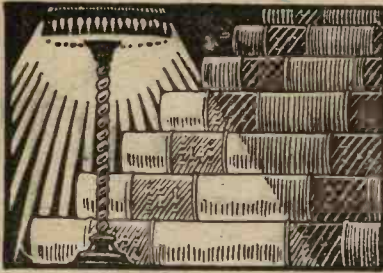

## THE BOOKS for Beginners and Experts

WITHOUT a doubt the very remarkable growth in the number of home-built Receiving Sets can be attributed to the exceptional Books and Magazines published by Radio Press, Ltd. This organisation—the largest of its kind in the world—has risen from quite modest beginnings because it was the first to realise that the crying need then, as now, was for dependable literature.

The moment a man gets really interested in Radio he is so fascinated that he immediately wants to learn more about it. Naturally he buys books and magazines—but let those books or magazines be too technical that he cannot understand and appreciate them, or let them contain inaccuracies or mis-statements, and Radio loses another promising recruit.

Radio Press, Ltd., pursues a definite policy in its book publishing which can be summed up as follows:—

(a) It publishes Books written only by authors of repute. Its Editorial Staff—both in number and in experience the strongest in the country—is well able to check every manuscript submitted and to supervise generally the publication of every Book.

(b) Each Book selected for publication must fill a definite niche in the Radio Press Series. Just as there are many grades of wireless enthusiasts from novices to experienced experimenters, so there must be various types of Radio Press Books. At the same time, however, every phase of the Science is covered so thoroughly that anyone can build up a complete library as his knowledge increases.

(c) Every Radio Press Book is printed in good style, profusely illustrated and represents particularly good value for money. While several of the more elementary ones are published at a cheaper price, the bulk of the Radio Press Series cost 2/6 each. This price permits a very high quality being maintained, and allows half-tone illustrations and, in the case of the constructional books, the fullest descriptions being given of every stage of Set building.

Make up your mind to look through the whole series at your Bookseller's or Wireless Dealer's—he has them in stock or will get them for you. It will be your first step to increased proficiency.

All Radio Press publications can be obtained from any Newsagent, Bookseller, local wireless dealers, or direct from the Publishers.

Complete List (W) Free on Application

**Radio Press Ltd.,**  
Bush House, Strand, London, W.C.2

Barclays 1231



## The Favourite of the Family—

**Brown**  
Featherweight  
Headphones  
are now  
reduced to

**20/-**

per pair.  
120 & 4,000 ohms

EVERY member of the family prefers the Brown Featherweight Headphone. Weighing but six ounces (including cords) it is easily the universal favourite. Its tone is so clear—there are no ugly projections to catch in the hair—its wide adjustable bands will instantly fit any head—it does, in fact, all that a Headphone should do for Broadcast reception.

**S. G. Brown, Ltd., Victoria Rd., N. Acton, W.3**

Showrooms: 19, Mortimer Street, W.1. 15, Moorfields, Liverpool.  
67, High Street, Southampton.

Gilbert Ad. 2416

# Brown

HEADPHONES AND LOUD SPEAKERS.

TO BE KEPT PERFECTLY FLAT.

**RADIO PRESS Wireless Panel Transfers**

The most complete set of Transfers on the Market.

Improve your own panels and give your set a distinctive appearance. The process is so simple that even a child can transfer and the designs are so numerous that you will never run out of ideas.

The Radio Press Company offers a complete set of transfers for the construction of Wireless Panels and also a complete set of transfers for the construction of Wireless Cabinets. The Radio Press Company also offers a complete set of transfers for the construction of Wireless Cabinets and also a complete set of transfers for the construction of Wireless Cabinets.

**INSTRUCTIONS**

Simply transfer the design on to a piece of paper, then transfer it to the panel. The process is so simple that even a child can transfer and the designs are so numerous that you will never run out of ideas.

Radio Press Ltd. 10, Abchurch Lane, London, E.C. 4.



RADIO PRESS ENVELOPE No 2

**HOW TO MAKE A FAMILY FOUR-VALVE RECEIVER**

FOR THE BEST RECEIVING OR LOUD SPEAKER

By PERCY W. HARRIS

EVERY POSSIBLE DETAIL EXPLAINED

2/6 NET



**The Simplicity 3 Valve Set**

SELECT YOUR STATIONS ON ONE KNOB

HOW TO BUILD AND WORK IT

By G. P. KENDALL, B.Sc.

2/6 NET



## Eliminating Spade Work!

### The Radio Press Envelope System

This unique "Radio Press" method of rendering assistance to the constructor is universally acclaimed as one of the most efficient aids yet devised. These envelopes contain working diagrams, exact size blueprints of wiring and of the panel (suitable for drilling), a set of photographs on art paper printed in a manner impossible in a book and showing the set and wiring from every useful angle, a list of components, and full instructions for the construction and operation of the set.

**R.P. Envelope No. 2**  
How to Make a Family 4-Valve Receiver. By Percy W. Harris.

This is the ideal easily-handled set for long range loud-speaker work. For those some distance from a station this set is ideal. Price 2s. 6d. (2s. 9d. post free).

**R.P. Envelope No. 3**  
The "Simplicity" 3-Valve Set. By G. P. Kendall, B.Sc.

Notwithstanding extreme ease of operation this set gives excellent results and will receive all the B.B.C. stations and many Continental ones upon the phones and will work a loud-speaker from the nearest ones. Price 2s. 6d. (2s. 9d. post free).

**R.P. Envelope No. 4**  
The "All-Concert de Luxe" Receiver. By Percy W. Harris.

A supremely handsome 3-Valve set with enclosed valves and all the latest technical improvements incorporated. Price 2s. 6d. (2s. 9d. post free).

The Finishing Touch to your Set By using "RADIO PRESS WIRELESS PANEL TRANSFERS" you can give to your set that finished appearance which makes all the difference. Not only are these transfers the cheapest and best, but they are officially used by the Radio Press Staff for their sets. Buy a packet or two from your wireless dealer, 6d. per large packet of 80 labels or Post Free 8d.

All the above are obtainable from most wireless dealers and booksellers or direct from Sales Dept. W.

**RADIO PRESS, Ltd.**  
BUSH HOUSE, STRAND  
LONDON, W.C.2

Radio Press Envelope No 4. 2/6

**All-Concert de Luxe Receiver**

HOW TO BUILD  
THREE VALVE  
CABINET SET

By PERCY W. HARRIS

Every Detail Explained

ALL THE LATEST IMPROVED VALVES AND COMPONENTS

FOR THE BEST RECEIVING OR LOUD SPEAKER



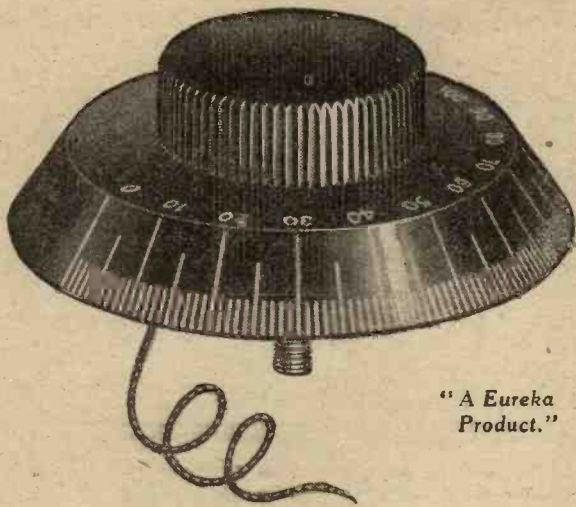

"A Eureka Product."

## Inside this Dial is a complete square law Variable Condenser!

THE wonderful new Dial-o-denser has astonished every wireless engineer who has had the opportunity of testing it. For the first time there is available a square law condenser with a minimum capacity of 3 micro-microfarads—a capacity so low as to be utterly negligible. And owing to its unique construction, its

movable and fixed vanes are not subjected to losses due to bad contact and oxydisation. The Dial-o-denser is thus a true low-loss condenser. Wherever you are using an ordinary variable condenser—expensive and bulky—remember that you can replace it with a Dial-o-denser and get vastly superior results.

### Only the Dial-o-denser gives you these advantages

1. A true square law reading.
2. A minimum capacity of 3-micro microfarads—the lowest of any variable condenser on the market.
3. All vanes—moving and fixed—totally enclosed and protected against dirt and dust.
4. A genuine low-loss Condenser through the elimination of oxydisation losses.
5. Standard 3-inch Dial no thicker than an ordinary Condenser Dial.
6. Permanent contact made by pigtail armoured connection.

Available in three values—all one price 10/-  
'0003 mfd., '0005 mfd. and '001 mfd.

Manufactured and sold only by:  
**PORTABLE UTILITIES CO., Ltd.**  
(Makers of the Eureka Transformer),  
FISHER ST., LONDON, W.C. 1.

Remember the name:



Gilbert Ad. 2513

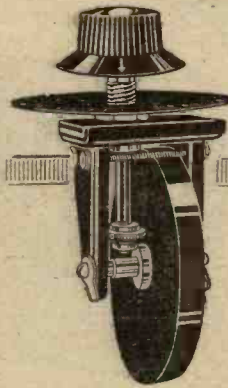

SHARPER TUNING  
LOWER LOSSES  
MICRO ADJUSTMENT  
NO HAND CAPACITY  
HERMETICALLY SEALED

### BRETWOOD VARIABLE MERCURY CONDENSER

Hand capacity is entirely abolished. This feature renders usable many excellent circuits which are difficult to control. At the same time the use of the Bretwood Condenser in an ordinary circuit will vastly improve results obtainable, and with its compactness enable better methods of wiring to be adopted, thus leading to still better reception.

THIS new variable Condenser marks a very great step forward in condenser design. Where other existing types consist mainly of mechanical tinkering, in this case of revolutionary design the various troubles inherent to the design of multiplate condensers have been solved at the root.

Tuning is exceptionally sharp, and at the same time the finest micro wave control is obtained, so that a carrier wave may be tuned in right at the peak.

Electrical losses are reduced to a minimum. As the condenser is hermetically sealed it is impossible for dust to enter. The method of mounting, by means of permanent contact against spring phosphor bronze balls which are all self-cleaning, makes the only perfect type of contact; and never fails.

Prices: '0003 mfd. 13/6 '0005 mfd. 15/- '001 mfd. 17/6

TRADE ENQUIRIES TO THE SOLE DISTRIBUTING AGENTS  
**THE WIRELESS DISTRIBUTING CO. LTD.**  
WIRELESS HOUSE, STOKE NEWINGTON ROAD, N.16.

Burelays 985

## HERE'S THE SECRET OF SUCCESSFUL H.F. AMPLIFICATION AT LAST! WITH THE

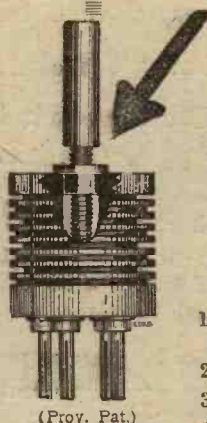

(Prov. Pat.)

# STRADIO

## VARIABLE CORE H.F. TRANSFORMER

1. Increases selectivity 100 per cent.
2. Enables absolute matching.
3. Eliminates self-oscillation.
4. Gives complete control any number of stages of H.F.
5. GIVES YOU THAT DISTANT FEELING.

9/-

9/-

May be obtained from any good dealer or, in case of difficulty, direct from:—

**STIRLINGS LIMITED,**  
17, Clarence Street,  
Kingston - on - Thames.



## What Station is it ?

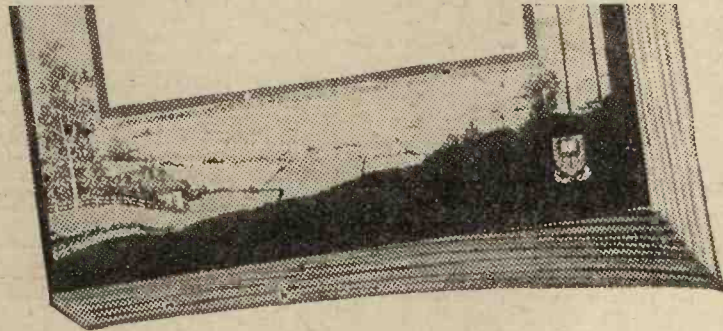

Buy a Copy from  
your Newsagent  
or any Bookstall

PRICE

**6<sup>D.</sup>**

Every Wednesday

**M**MUSIC coming through fine, and you await with some expectancy the announcer's voice. After the customary wait, characteristic of foreign stations, you hear a voice, but it defies all your efforts to interpret.

Let "Wireless Weekly" allay your disappointment.

Every week it includes complete programmes of leading Continental and American Stations.

### The FOREIGN RADIO TIMES

is exclusive to "Wireless Weekly." All details are included, the names of artists, titles of songs and music to be rendered, times, call signs and wavelengths.

The language of music is universal. Let it help you to log that foreign station. Place a regular order with your Newsagent, or buy a copy to-day!

# Wireless Weekly

ADVERTISEMENT OF RADIO PRESS, LTD., BUSH HOUSE, STRAND, LONDON, W.C.2

# Build for permanence



No architect ever passes the plans of a new building without first making sure that the foundations are correctly proportioned and capable of withstanding the strains and stresses that are likely to be met during the years to come. He builds for permanence.

And so it should be with the man who builds a Wireless Set. He, too, builds for the future. He does not want to find when his Set is finished, that a leaky ebonite panel prevents good results being obtained. He does not want to labour in vain, so he looks to his foundation—the ebonite panel.

All ebonite, unfortunately for the wireless enthusiast, is not of one recognised quality. Some is good—some is bad. Some is suitable for wireless use—some is not. How are you to tell? The only safe way is to use a guaranteed brand such as Red Triangle Panels—every one of which is positively guaranteed to be leakproof, impervious to moisture, and finished with a smooth surface which does not require sand-papering before use. But Red Triangle Ebonite—for all its advantages—is not costly. Indeed, it often costs less than the ebonite of doubtful ancestry which you may be able to buy locally. For your next Set try Red Triangle Ebonite—afterwards you'll use no other.

<b>Special Sizes</b>			
All Concert-de-Luxe, 16 x 8 x 1/2	8/-	S.T. 100, 12 1/2 x 9 1/2 x 1/2	7/-
Transatlantic V., 22 x 11 x 1/2	15/-	Puriflex 14 x 10 1/2 x 1/2	9/2
All Britain 10 x 9 x 1/2	9/-	Transatlantic IV., 16 x 8 x 1/2	8/-
Resistoflex, 12 x 8 x 1/2	6/-	Anglo-American, 36 x 9 x 1/2	20/-
P.W. Ultra Crystal Set, 10 x 8 x 1/2	5/-	P.W. Continental Set, 13 x 6 1/2 x 1/2	5/6
Neurodyne Tuner, 12 x 10 x 1/2	7/6	Neurodyne Receiver, 12 x 10 x 1/2	7/6
3-Valve Dual, 24 x 10 x 1/2	15/-	Harris Crystal Set, 9 x 9 1/2 x 1/2	4/4

Any Special Size Cut per return at 3d. per square inch.  
**PETO-SCOTT Co., Ltd.**

Registered Offices, Mail Order & Showroom:  
**77, CITY ROAD, LONDON, E.C.1.**  
Branches: LONDON—62, High Holborn, W.C.1.  
WALTHAMSTOW—230 Wood Street.  
PLYMOUTH—4, Bank of England Place.  
LIVERPOOL—4, Manchester Street.  
CARDIFF—94, Queen Street P.8.2443.



# Red Triangle Ebonite



# A Sturdy Fellow

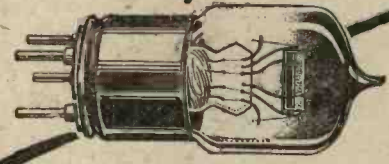

# built for hard work—

but sensitive and always reliable

The C. & S. DULL EMITTER 2v.o.2a gives increased amplification and purer reception, without distortion—NEW ZEALAND and NEW YORK RECEIVED ON A SINGLE VALVE

12/- each

(also made 0'06a, price 15/-)

Special Process Dry Batteries for the one valve:—  
227.....7/6      227L.....4/3

Post your order now to

**CRAIK & SMITH (Desk E)**

'Phone: Clerkenwell 7316. Allen Street, E.C.1  
Illustrated Catalogue Post Free.

# "ELLA"

## BATTERY CHARGERS

*They work from a lampholder*



A.C. Model

Output 6 amps. 9 volts. Complete with Pole Indicating Ammeter and all connecting leads and adapter. To standard voltages and frequencies up to 220 volts. £6 6 0



AT HOME

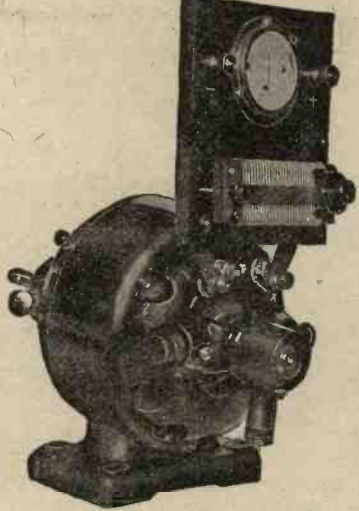

D.C. Model

Output 5 amps. 9 volts. Machine only, £5 12 6. With Switchboard Pole Indicating Ammeter and Regulating Resistance as illustrated. £6 15 0

Other voltages and frequencies £1 extra.

BATTERIES charged at home have much longer life and give better service than when charged outside.

"ELLA" Battery chargers save their cost many times over.

Write to Dept. "C" for descriptive leaflet. Trade supplied.

# LIONEL ROBINSON & CO. 3c, STAPLE INN LONDON, W.C. 2

'Phone: Holborn 6323 (Two Lines)

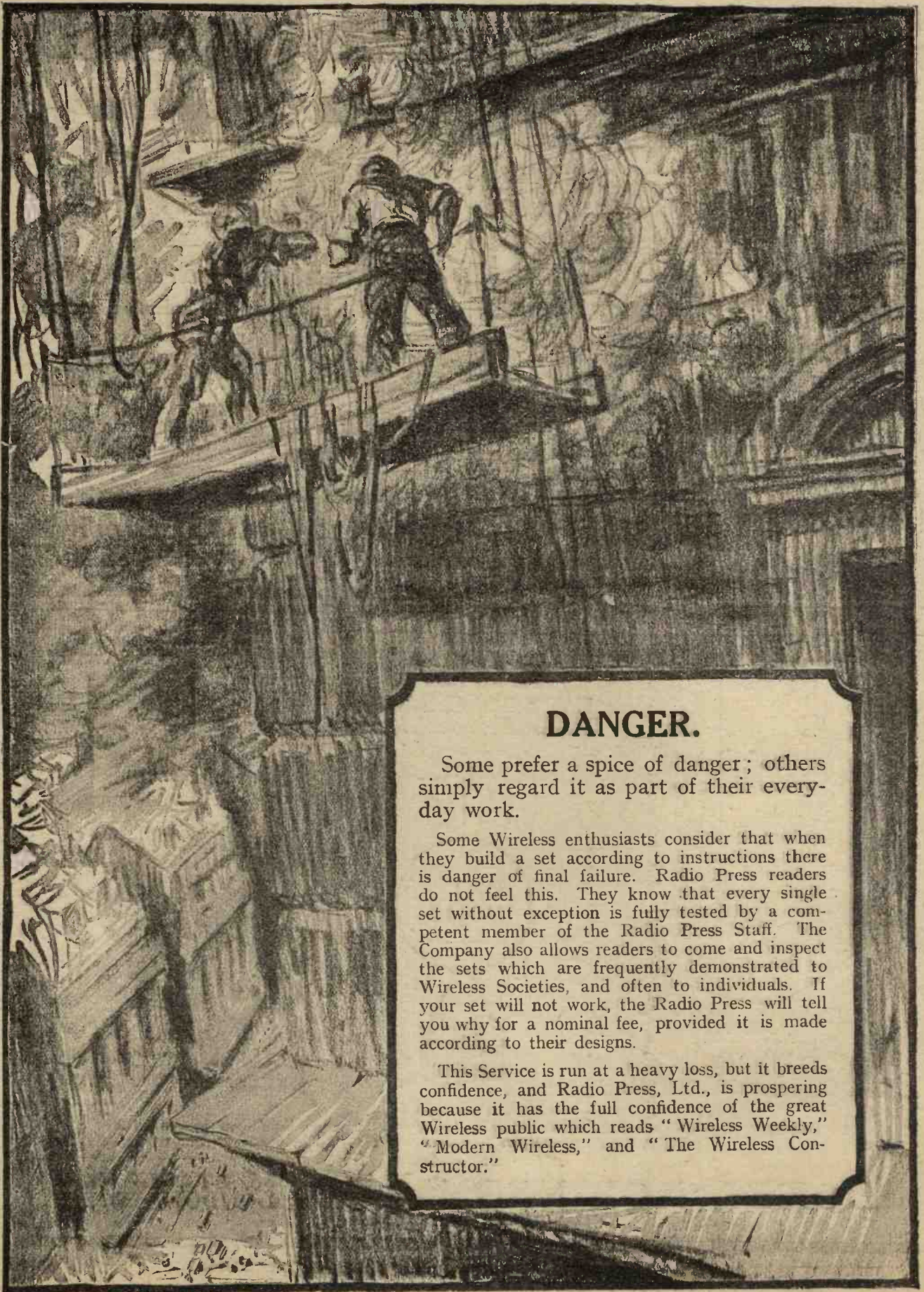

## DANGER.

Some prefer a spice of danger; others simply regard it as part of their every-day work.

Some Wireless enthusiasts consider that when they build a set according to instructions there is danger of final failure. Radio Press readers do not feel this. They know that every single set without exception is fully tested by a competent member of the Radio Press Staff. The Company also allows readers to come and inspect the sets which are frequently demonstrated to Wireless Societies, and often to individuals. If your set will not work, the Radio Press will tell you why for a nominal fee, provided it is made according to their designs.

This Service is run at a heavy loss, but it breeds confidence, and Radio Press, Ltd., is prospering because it has the full confidence of the great Wireless public which reads "Wireless Weekly," "Modern Wireless," and "The Wireless Constructor."





Don't worry  
it out yourself  
-let an expert  
help you

PERHAPS you have built a Set and you cannot get it to work—don't worry, let a Radio Press expert help you. Probably you have made some little slip in the Circuit—maybe you have mis-read the wiring instructions. All you need is a copy of

## Pictorial Wireless Circuits

By Oswald J. Rankin.

(Radio Press Series No. 8.)

This Book contains scores of different Circuits, each one of which is shown in pictorial form instead of the more technical diagrammatic manner.

Thousands of beginners have bought it and have been able to appreciate for the first time how easy it is to wire up a Set when the Circuit diagram is understood.

No matter which type of Set you are building, whether Crystal or multi-valve, and whichever type of tuning you will use, variometer or plug-in coils, you will find a wide variety of practical circuits shown in a manner even the veriest novice can readily understand.

From all Booksellers or sent post free 2d. extra direct from Publishers. 1/6

When ordering quote Series No. W.3.

Radio Press Ltd.

Bush House, Strand, London, W.C.2.



## To the Beginner— a word of advice

YOU use an Accumulator to give you a lighting service for your Valves. The total cost of your Accumulator, therefore, is not what you pay for it when you buy it in the shop. Its real price to you is the purchase price plus the number of chargings per annum. For instance, it is obviously cheaper to buy an Oldham Accumulator at 38/- which will run a 3-Valve Set for 18 days on one charge than to buy one of any other make for 35/- which will be exhausted in 13 days. The extra five days use you get from the Oldham will more than repay you for the very slight extra initial cost.

Oldham Accumulators cost more to make because only the finest material is used in their construction. The Oldham Plate—the heart of the Oldham Accumulator—is manufactured under the exclusive *special activation process*. This process is responsible for a plate of remarkable strength. One that resists buckling and sulphation. One that yields up the greatest amount of electrical energy. One that will stand idle over lengthy periods without suffering harm. No Oldham Accumulator has ever been built down to a price. Obviously there are cheaper accumulators to be bought, but it is foolish economy to choose a cheap one that costs considerably more to keep in a charged condition. Discriminating purchasers, therefore, whose purchasing wisdom extends beyond first cost, invariably select the Oldham as Britain's best Accumulator.

OLDHAM & SONS, LTD., Denton, Manchester  
London: Gt. Chapel Street, Oxford Street, W.1; and  
1, St. Mary's Place, Newcastle

# OLDHAM

ACCUMULATORS

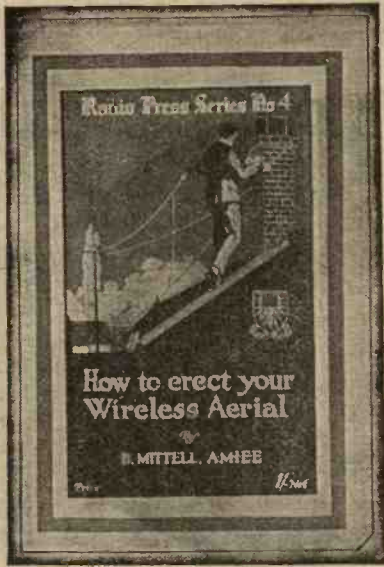

## To W.G.Y. by Easy Steps

(America)

The ultimate aim of every radio enthusiast is to span the Atlantic. The surest method of accomplishing this is by gradual advancement. Below are books instructing the beginner from erecting an aerial to building a multi-valve set.

From the time you prepare to erect your aerial you are guided by expert and practical advice ensuring success.

### HOW TO ERECT YOUR WIRELESS AERIAL

By M. Mittell, A.M.I.E.

On the erection of your aerial, simple as it may seem, will depend a great deal of the success of your receiver. By following the advice of B. Mitchell, A.M.I.E.E., who has taken a leading part in the erection of huge aerials, such as Northolt and elsewhere, you will ensure a perfect aerial, erected with the minimum of trouble and expense.—Radio Press Series No. W.4

PRICE 1/-  
or 1/2 Post Free



### THE CONSTRUCTION OF CRYSTAL RECEIVERS

By Alan L. M. Douglas

Every real enthusiast starts with building a crystal set. This book is for the man who does not want to miss anything in wireless, and so believes the best policy is to start at the beginning. Many illustrations and circuit diagrams make the book interesting and construction simple.—Radio Press Series No. W.6

PRICE 1/6  
or 1/8 Post Free

### TWELVE TESTED WIRELESS SETS

By Percy W. Harris, M.I.R.E.

This book practically eliminates the use of intricate theoretical diagrams. Instead, simple diagrams and illustrations that a child could understand are used. Every set described has been personally built and tested by Mr. Harris, who guarantees success if his instructions are carried out.—Radio Press Series No. W.14

PRICE 2/6 or 2/8 Post Free

Obtainable from booksellers and wireless dealers, or direct from Dept. W

**Radio Press, Ltd.**  
BUSH HOUSE, STRAND, LONDON, W.C.2.



# HOW TO MAKE THE SET OF YOUR CHOICE

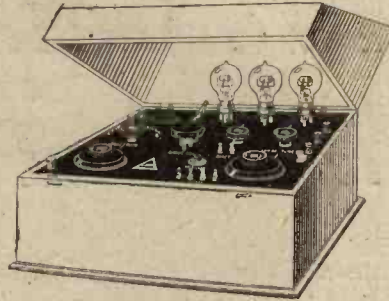

DETAILED INSTRUCTIONS AND PLAN-DIAGRAMS FREE WITH EACH SET OF COMPONENTS.

BUILD A RADIAX SET AND SAVE MONEY

No.	Complete Components	Panels drilled and fully engraved.	Cabinets high-grade mahogany polished.
31	1 Valve and Crystal	£3 0s. 0d.	11s. 6d. £1 1s. 0d
24	2 Valve Set	£2 13s. 6d.	11s. 6d. £1 2s. 6d.
26	3 Valve Set	£4 5s. 6d.	14s. 6d. £1 7s. 6d.
30	4 Valve Set	£5 10s. 0d.	18s. 6d. £1 10s. 0d.

If components and panel are ordered at same time, 12/6 per valve Marconi Royalty must be paid.

DON'T TAKE CHANCES—on design, but build a set which is replete with all modern refinements, and is a proved success.

RADIAX UNIVERSAL RECEIVERS are powerful regenerative sets which will deal efficiently with all wavelengths and embody detail refinements which few other sets, however expensive, can boast. They are wonderful for distant reception.

Radiax Receivers are supplied on Deferred Payment if required.

Complete Catalogue of Radiax Sets, Components and Accessories post free 3d.



**RADIAX Ltd.** 44, Radio House, Tottenham Court Road, London, W.1

3 minutes from Tottenham Court Road and Goodge Street Tube Stations. Phone: Museum 490

Barclays 944

## EFESCA

COMPONENTS

— for efficiency

An efficient Set depends upon reliable and soundly designed Components. Build your set with Efesca One-Hole-Fixing Components; they are made with the highest degree of accuracy and include many patent features of great value.

Ask your wireless dealer for—

## EFESCA

ONE-HOLE-FIXING COMPONENTS

Send us a P.C. to-day for Catalogue 522-11

WHOLESALE ONLY—

FALK, STADELMANN & CO., LTD.

Efesca Electrical Works,

83, 85, 87, Farringdon Road,

LONDON, E.C.1

And at Manchester,

Birmingham and

Glasgow

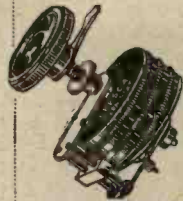

EFESCA VERNISTAT (Patent)

The most efficient and delicate filament control for H.F. and Detector Valves. Resistance 5 ohms. 5/- each



EFESCA ANTI-CAPACITY SWITCH

The design of this double pole, double throw switch eliminates capacity. Use this switch in circuits when capacity effects are fatal to efficiency.

Price 8/- each

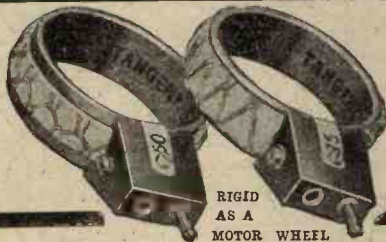

RIGID AS A MOTOR WHEEL

For Sharp Tuning and Fine Selectivity use "Tangent" Tuning Coils

The Unshrouded Coil with a guaranteed LOW SELF CAPACITY

Figs. given below are taken from the N.P.L. Report. Copy sent on application.

COIL No.	25	35	50	75	100	150	200	250
Self Capacity in Micro-Microfarads	8	9	25	31	22	16	22	22
Price	4/3	4/3	4/3	4/6	5/-	6/-	7/-	7/6

### COMPLETE SETS

4 Concert Coils (W/L 250 to 1,180) 1g/- the set  
11 Concert Coils (W/L 250 to 9,500) 67/- the set

All good dealers keep them—any difficulty write us

**GENT & CO., LTD.**

Faraday Works, LEICESTER

Established 1872

London—25 Victoria St., S.W.1.  
Newcastle-on-Tyne—"Tangent House," Blackst St.

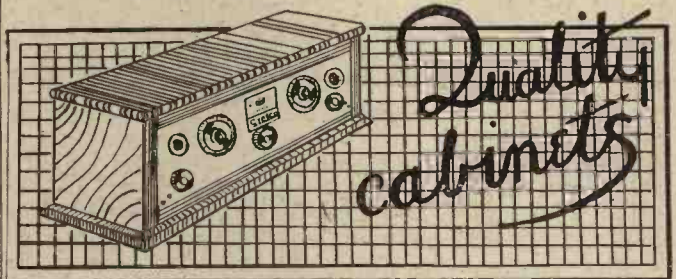

### MAKERS OF CABINETS FOR B.B.C.

Make your set a handsome addition to the drawing room by housing it in a Grelco cabinet.

These cabinets are most accurately made, and beautifully polished by hand. The lid is hinged and complete wired-up set slides in or out.

TRADE **Grelco** MARK



To take	Depth of cabinet.	Price: Mahog'y, Oak.	ebonite panel.	Special post.
12" x 8"	8"	21/-	19/6	5/6 2/-
16" x 8"	8"	25/-	23/6	7/6 2/-
20" x 8"	8"	28/6	26/6	8/- Carr. forw'd.

### POWER TRANSFORMER

An extra-heavy, high grade L.F. transformer constructed only of finest materials throughout. The liberal windings and finely laminated iron core give wonderful amplification with rich, full tone, without distortion is conspicuously absent. Rigid tests have not disclosed its equal. Ratios: 2-1; 4-1; 6-1.

Price - - - 30/-, Post 9d.  
As highly recommended by Technical Press.

Telephone: MUSEUM 261

WORKS: SLOUGH

**ELECTRIC GRAFTON COMPANY**

GRAFTON STREET.

LONDON

TOTTENHAM COURT ROAD.

L.C.P.

# The Progressive Method to Wireless Proficiency

## "SIX SIMPLE SETS"

By STANLEY G. RATTEE, M.I.R.E.

This new Radio Press publication fulfils a definite requirement of the radio public, and constitutes a graded course of instruction in the making of Wireless Receivers.

Every one of the six sets described has been built by the author himself, and each is guaranteed to give efficient results if instructions for building are followed accurately.



## The Radio Press Series of Books and Envelopes.

No.		Price
21	Six Simple Sets. By Stanley G. Rattee, M.I.R.E. . . . .	1/6
1	Wireless for All By John Scott-Taggart, F.Inst.P., A.M.I.E.E. . . . .	9d.
2	Simplified Wireless By John Scott-Taggart, F.Inst.P., A.M.I.E.E. . . . .	1/-
3	How to Make Your Own Broadcast Receiver By John Scott-Taggart, F.Inst.P., A.M.I.E.E. . . . .	1/6
4	How to Erect Your Wireless Aerial By B. Mitchell, A.M.I.E.E. . . . .	1/-
5	The Construction of Wireless Receiving Apparatus By P. D. Tyers. . . . .	1/6
6	The Construction of Crystal Receivers By Alan L. M. Douglas. . . . .	1/6
7	How to Make a "Unit" Wireless Receiver By E. Redpath. . . . .	2/6
8	Pictorial Wireless Circuits . . . . .	1/6
9	Wireless Valves Simply Explained . . . . .	2/6
10	Practical Wireless Valve Circuits . . . . .	2/6
12	Radio Valves and How to Use Them By John Scott-Taggart, F.Inst.P., A.M.I.E.E. . . . .	2/6
13	500 Wireless Questions Answered . . . . .	2/6
14	12 Tested Wireless Sets . . . . .	2/6
5	More Practical Valve Circuits By John Scott-Taggart, F.Inst.P., A.M.I.E.E. . . . .	3/6
16	Home-Built Wireless Components . . . . .	2/6
17	Wireless Sets for Home Constructors By E. Redpath. . . . .	2/6
18	Tuning Coils and How to Wind Them By G. P. Kendall, B.Sc. . . . .	1/6
22	Switches in Wireless Circuits . . . . .	1/6
	<b>Radio Press Envelopes.</b>	
1	How to Build an ST100 Receiver By John Scott-Taggart, F.Inst.P., A.M.I.E.E. . . . .	1/6
2	How to Build a Family Four-Valve Receiver By Percy W. Harris, M.I.R.E. . . . .	2/6
3	How to Build the "Simplicity" Three-Valve Receiver . . . . .	2/6
4	How to Build the All-Concert de Luxe Receiver . . . . .	2/6
5	How to Build the "Wireless Weekly" Omni Receiver By John Scott-Taggart, F.Inst.P., A.M.I.E.E. . . . .	2/6
6	How to Build the ABC Wave Trap By G. P. Kendall, B.Sc. . . . .	1/6
7	How to Build a Two-Valve Amplifier de Luxe . . . . .	1/6
8	How to Make a One-Valve Reflex Receiver By Herbert K. Simpson. . . . .	1/6
9	How to Build an Efficient Single-Valve Set . . . . .	1/6

The Radio Press Envelopes are the most complete guide to wireless construction ever devised. Every possible detail is explained, and you cannot go wrong.

All the above can be obtained from wireless dealers, booksellers—or direct (plus 2d. postage on books and 3d. on envelopes) from Dept. W.

RADIO PRESS, Ltd.,  
BUSH HOUSE, STRAND, W.C.2.

Barclays Ad.

THE MARK **L E S** OF QUALITY



L.E.S. Experimental Valve Holder  
2/6

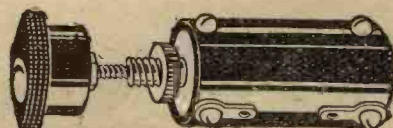

L.E.S. MICRO-CONTROL  
For any and every valve. 3/6



L.E.S. Insulated SHORTING PLUG  
9d. each

Ask your local dealer for L.E.S. components. If he cannot supply, order direct, sending us his name and address please.

Extract from report in "Wireless Weekly," March 18th.—"We can recommend this type of filament resistance, particularly for use in critical circuits requiring fine control."

FREE. 42-page CATALOGUE. Send for a copy now. Local Agent for Maidstone District:—  
E. A. GARDNER & SONS, Ltd.,  
1, 3 & 5, Brewer Street.

**LONDON ELECTRIC STORES, LIMITED**  
OXENDON STREET, HAYMARKET, S.W.1

Phone: Regent 2505 and 2506.

Barclays 951

A Triumph of  
**BRITISH ENGINEERING**

**'CHASEWAY'**

HOME BATTERY CHARGER  
for  
ALTERNATING CURRENT

Whilst others have been arguing about "Safeguarding" British Radio Industry, "CHASEWAY" engineers have been busy on the best "Safeguard," namely, giving a better article at a reasonable price.

The "CHASEWAY" DIRECT CURRENT CHARGER was produced only last September at nearly half the price of its nearest competitor and an infinitely better product—thousands sold.

Then the "CHASEWAY" GRIDLEAK caused a stir by establishing itself as the ONLY reliable gridleak on the market—a really scientific instrument—scientifically tested and guaranteed.

Now the "CHASEWAY" ALTERNATING CURRENT CHARGER has come—a real feat of engineering. The only BRITISH product of its kind. Most ALTERNATING CURRENT CHARGERS are foreign, and this BRITISH product has them all "beaten to death"—and at a lower price. Read the following points and then write for fuller details, naming the voltage and periodicity of your local supply.

- 1.—It is used by connection with the Lamp Socket or wall plug.
- 2.—It is ABSOLUTELY MECHANICAL, has no liquids, no messy chemicals, no expensive bulbs to be replaced at frequent intervals.
- 3.—It is SILENT RUNNING. SELF CONTAINED, absolutely complete. Not a vibrator or buzzer.
- 4.—It is adjustable from 0 to 5 amps. charging rate.
- 5.—It is adjustable for recharging 2, 4, 6, 8, 10, and 12 volt accumulators for WIRELESS and MOTOR requirements.
- 6.—"CHASEWAY" CHARGERS also made for recharging both L.T. and H.T. batteries and of greater capacities.

Before buying any A/C Charger ask the guaranteed "efficiency"—then you'll buy "CHASEWAY."

Send stamp for illustrated catalogue of "CHASEWAY PRACTICAL PRODUCTS."

**CHASE ELECTRICAL MFG. CO., LTD.,**  
184m, Fleet Street, London, E.C. 4.

V.P.



7 in. x 6 in. x 4 in.

Get that  
Distant Station  
with a —



**VERNIER TYPE  
CONDENSER**

INDISPENSABLE FOR  
FINE TUNING—

24 TURNS OF  
ADJUSTMENT

Max. Cap. .00001 mfd.  
Min. .. negligible.

May be  
used in

**"NEUTRODYNE"**  
CIRCUITS

**BUY ONE NOW—**

**2/6**

and capture those elusive signals

**MICROHM ENGINEERING CO.,**  
VARSITY WORKS, COLLEGE ST., LONDON, E. 9.

Phone . . . . Clissold 2887

Barclays 952

NEW MODEL CROIX  
**L.F. Transformer**  
(3-1, 4-1, 5-1)

9/6 each, Super 11/6

**Radio Panels**

BLACK MATT FINISH

- |                |      |     |
|----------------|------|-----|
| 9 x 6 x 3/16   | .... | 1/6 |
| 10 x 9 x 3/16  | .... | 2/2 |
| 12 x 10 x 3/16 | .... | 2/9 |

ALL SIZES STOCKED

POST FREE

Trade Supplied

**RADIO PANEL Co.**  
143, Fetter Lane, E.C. 4



**ARE YOU DISAPPOINTED**

in the look of that set you have just built? Why not improve it by fitting it in a well made Cabinet?

S.A.C. Cabinets are guaranteed to be the best hand-made work in seasoned wood and hand polished and to be an accurate fit for the panel dimensions specified.

Cabinets and drilled and engraved Panels supplied for any Radio Press Set or to YOUR OWN DESIGN.

SETS IN THIS ISSUE:—	Cabinet, Black Radlon Panel.
Easily Controlled 2-valve Receiver	30/- 10/6
Invalid Receiver	20/6 5/6
"Midget" Single-Valve Receiver	7/6 4/-
	Carriage extra.

Send stamp for Leaflets of Cabinets, Panels and Components.

**"S. A. CUTTERS,"**

15, RED LION SQUARE — LONDON, W.C.1

Phone: Chancery 8042.

Cabinet Works, Pimlico.

# Trap that Station!

Your local station is interesting until you get that "other stations" craze, and then it becomes a bugbear.

It is then that the need of some method of discriminating between and selecting adjacent wavelengths asserts itself.

The Radio Press Envelope, No. 6, contains full instructions for the building of the A.B.C. Wave Trap, with three different arrangements which can be brought into operation at will.

The A.B.C. Wave Trap will completely eliminate your local station and bring you in unmolested signals from any station within the scope of your set, provided your aerial and earth are of average efficiency. In actual test, within 3 miles of 2LO, the A.B.C. Wave Trap has eliminated that station and made it quite possible to receive Bournemouth without any trace of interference. G. P. Kendall, B.Sc., is the designer of this instrument, and the envelope includes instruction sheets, blue prints, and working drawings, which explain with extreme thoroughness the building and methods of using this Wave Trap.

*The A.B.C. Wave Trap will cost you but 30s. to build, inclusive of handsome cabinet and integral coils. This Wave Trap is normally constructed to operate on the 300-600 metre band.*

OBTAINABLE FROM ALL BOOKSTALLS,  
NEWSAGENTS, BOOKSELLERS, WIRE-  
LESS DEALERS, OR DIRECT FROM  
DEPT. W., RADIO PRESS, LTD.,  
BUSH HOUSE, STRAND, W.C.2

PRICE

1/6

POST FREE  
1/9

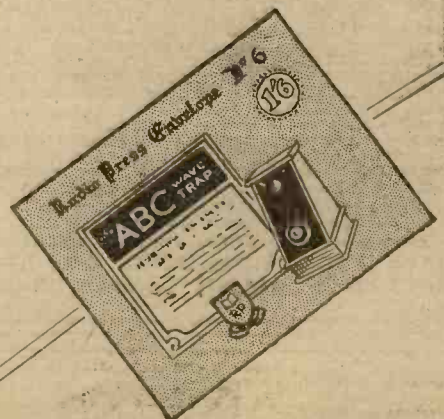

Radio Press, Ltd.,  
Bush House, Strand, London, W.C.2.

# BLAND'S BIG BARGAINS

5 Tube Knockdown Neutrodyne Kit £18-0-0  
Assembled in Cabinet - - - £40-0-0

We guarantee these sets to pick up America, and cut out your local station within a mile.

Manhattan Loudspeaker £2-10-0	Accuratone Dial (Geared 80-1) 17/6
and £4-5-0	Sciphone 4-Valve Set £16-0-0
Coleston Hornless Loudspeaker	Regina .06 Valve .. 15/-
£8-10-0	Austian 2-v. 2-amp. Valve 7/6
Freshman Rheostats 6" and 6/3	40 Steel Masts .. £1-12-0
Red Seal L.T. Batteries .. 2/8	Onia Wavemeter 25 to 25,000
Marco Low Loss Condenser .0035	metres) £4-4-0
30/-	Telefunken Adjustable Phones
Rauhand Transformer .. 25/-	Reduced to £1-0-0
Marco Push-Pull Switch .. 1/6	

FULL TRADE DISCOUNTS AND LISTS. POSTAGE EXTRA

S. E. BLAND, A.C.G.I., B.Sc. Wireless and Photographic Dealer  
82a & 97, QUEEN STREET, CHEAPSIDE, LONDON

Barclays 962

## Buy "F.A.R." the Best

THE "F.A.R." L.F. Transformer has been proved on actual test to be considerably superior to other types selling at higher prices. Renders high amplification and distortionless speech and music over all frequencies.



Shrouded, Ratio 5: 1, 15/-

Obtainable from all dealers or direct from the Sole London Agent. Trade inquiries invited

**MAURICE BOBIN,**  
21, Warwick Lane, London, E.C.4

Phone: Central 4872

## RADIO SWITCHGEAR



We specialise in all types and makes of Radio Switches for the Wireless Constructor.

Large Stocks. Smart Delivery.

Let us help you—for this and all your other Wireless Components.

**The Brighton Radio Stores**  
163, Western Road, Brighton.

50 page Illustrated Art Catalogue of our Components—Post free for the asking.



CABINETS



CABINETS

WRITE AT ONCE for our illustrated list of 100 varieties of cabinets or radio sets, including many described in "MODERN WIRELESS," "WIRELESS WEEKLY," and "WIRELESS CONSTRUCTOR," etc., or phone Clerkenwell 6903

NAME.....  
ADDRESS.....

Write in Block Letters Please

Cut along here and post in unsealed envelope bearing 4d. stamp.  
TRADE ENQUIRIES ESPECIALLY INVITED.

**CARRINGTON MANUFACTURING CO., LTD.**  
15/20, Normans Buildings, Mitchell St., Central St., E.C.1

Barclays Ad.

Don't tickle the Crystal—use the

# Harlie

## FOOL-PROOF DETECTOR

(Patent 267,124)

NEW DISCOVERY.

Continuous reception in any position at all times, owing to the special design of both crystal and catswhisker being always in contact.

SOME NOVEL FEATURES.

1. Nickel-plated, detachable, dust-proof cover.
2. Special "Harlie" super-sensitive crystal.
3. Ebonite wheel for rotating crystal. No fumbling about adjusting, just turn the wheel—simplicity itself.
4. Catswhisker on slider for covering whole surface of crystal. Shock proof.
5. Nickel-plated sockets for panel mounting.

ADVANCE WITH THE TIMES.  
Troublesome adjustment is now obsolete owing to the simple automatic movement of the Harlie Detector, which gives continuous delicate contact with the wonderful Crystal recently discovered by us and manufactured under our secret process. (Obtainable only with the Harlie Detector.)

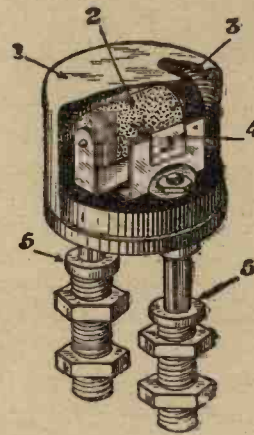

Obtainable from all dealers or direct.

PRICE  
**5/6**  
COMPLETE

Generous Trade Terms  
Showcards and Leaflets.

## HARLIE BROTHERS

183, DALSTON LANE, HACKNEY, LONDON, E.8

Telephone:

CLISSOLD 293

Barclays 931

## DID YOU BLAME "ATMOSPHERICS"

when you had friends round to hear your set and you could not find what was wrong with it?

The Radiotester will quickly trace all faults in your set and prevent aggravating disappointment.

PRICE COMPLETE

**5/9**  
POST FREE

NO MORE WIRELESS PERPLEXITIES



Is every junction perfect in your wiring? Is every section of your H.T. giving full voltage? Has your grid condenser the necessary insulation to isolate the grid from H.T.?

These, and hundreds of other questions, are answered by

## THE RADIOTESTER

Send P.O. for 5/9 for Immediate Delivery  
Descriptive Leaflet on Application

Telephone: Holb. 5064 Tel. and Cables: Ioritossa, Holb. London

The British & Colonial Industries Association, Ltd.

317, HIGH HOLBORN, LONDON, W.C.1

(Opposite Chancery Lane Tube Station)



JOHN SCOTT-TAGGART, F.Inst.P., A.M.I.E.E.  
 Editor-in-Chief of all Radio Press Publications.

# Keeping the British Radio Flag Flying

The Daily Express in its issue of November 5th, 1924, says "Among the British experts who are keeping the British Radio Flag Flying is Mr. J. Scott-Taggart, the energetic editor of several popular technical journals. It is doubtful if any other one person—unless perhaps Captain Round, of the Marconi Company—has been responsible for more original radio circuits and ideas than has Mr. Scott-Taggart."

This knowledge is placed at the service of wireless amateurs through the medium of the many books published by the Radio Press, Ltd., those of Mr. John Scott-Taggart alone reaching a total sale of approximately half-a-million.

His intimate understanding of the needs of the experimenter and his ability to deal with abstruse subjects in a lucid and concise manner, have earned for him the gratitude of many thousands of wireless enthusiasts.

If you want to know more about radio, you cannot do better than acquire the knowledge through one or more of the books of which Mr. John Scott-Taggart is the author.

Series	Price.	Post Free.
No. 1. Wireless for all ...	9d.	11d.
No. 2. Simplified Wireless ...	1/-	1/2
No. 3. How to Make Your Own Broadcast Receiver ...	1/6	1/8
No. 9. Wireless Valves Simply Explained ...	2/6	2/8
No. 10. Practical Wireless Valve Circuits ...	2/6	2/8
No. 12. Radio Valves and How to Use Them ...	2/6	2/8
No. 15. More Practical Valve Circuits ...	3/6	3/8
Elementary Textbook on Wireless Vacuum Tubes ...	10/-	10/3
and the famous		
Radio Press Envelopes :		
No. 1. ST.100 Receiver...	1/6	1/9
No. 5. "Wireless Weekly" Omni Receiver ...	2/6	2/9

Obtainable from all Bookstalls, Newsagents, Booksellers, Wireless Dealers, or direct from Dept. W., Radio Press, Ltd., Bush House, Strand, W.C.2.

**RADIO PRESS, LTD., BUSH HOUSE, STRAND, W.C.2**





□ LAW  
CONDENSERS

## YOU LOSE AT LEAST 40%

of your reception and selection by using poorly insulated or wrongly designed components. Inferior Condensers are the worst offenders. Give your set a chance and install **TELE-RADIO "NO LOSS" SQUARE LAW, BALL BEARING, VARIABLE CONDENSERS**

Notice the fine tuning! Hear the increased volume obtained! Enjoy the distant stations hitherto unobtainable. **TELE-RADIO CONDENSERS** are as necessary to your set as your dinner is to you! If your dealer does not stock them send direct to-day to the address below. We despatch immediately and post free.

**PRICES**

	Ordinary	with Vernier
.001	10/6	15/-
.00075	10/-	14/-
.0005	9/6	13/6
.0003	9/-	12/6
.00025	8/9	12/-
.0002	8/6	11/6

With brass vanes 15% extra.

## THE "MASTASTAT" FILAMENT CONTROL.



Price 3/-

THE "MASTASTAT" Filament Control is suitable for Bright or Dull Emitter Valves. No carbon granules to pack or disintegrate. Micrometer control of filament.

"Mastastat" Variable Grid Leaks, Anode Resistance and Neurodyne Condensers at the same price.

THE TELE-RADIO COMPANY, BOLTON STREET, WATERY LANE, BIRMINGHAM

### WHEN YOU BUY an L.F. INTERVALVE TRANSFORMER you should know the factors governing its EFFICIENCY. They are:—

1. A sound closed Iron Core of ample dimensions leaving the absolute minimum of air space.
2. A Long Primary winding, having correct impedance, with negligible variation of amplification, over the whole of the audible range
3. Secondary having Turns relative to Primary, times the step up required.
4. Perfect Insulation.
5. The whole correctly screened with Iron, and thorough protection of the inside from dampness.
6. Self Capacity as low as possible.

Add to these factors an outside finish that leaves nothing to be desired, an earthing nut fixing, a clearly marked Terminal Board with large Terminals, a neat leather cover, and you have the distortionless, soundly constructed, **"RENOWN,"** Ratios. 5: 4: 3: and 2 to 1. British guaranteed Price 8/4 Post Free. 30,000 TURN AMPLIFIER CHOKES 7/6. We are still repairing ANY MAKE of L.F. TRANSFORMER for 5/- post free.

TRANSFORMER REPAIR CO., HAY ST., PORTSMOUTH

### THE "SECURITY" VALVE HOLDER

(Prov. Pat. No. 2187/25).

### ANTI-CAPACITY

PROTECTS THE VALVE

METAL DRILLING TEMPLATE Included.

OBTAINABLE FROM ALL RETAILERS & FACTORS.

Advert. of Williams, Ellis & Co., London.

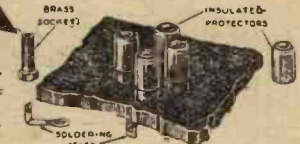
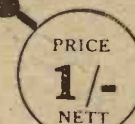

## A Revolution in H.T. Efficiency

H.T. Batteries made up of units are recognised as the ideal. The HOVIMO screw connection solves the problem of joining units without soldering.

The HOVIMO ensures perfect "sited" working—is everlasting—allows easy replacement of units—will take the ordinary wander plug—makes it possible to keep your H.T. at an equal voltage. Is British made.



C. MOLBACK  
27, High Holborn  
LONDON, W.C.1

Tel.:  
Chancery  
8391

Ask your dealer for them

1/6

Per Doz.  
From dealers or direct



## SOLDERED JOINTS SUPERSEDED!

You can easily connect up the most complicated set entirely without use of solder by using the new

### "KRISCROS" CONNECTORS

Strong and perfect joints. Used by Mr. Percy W. Harris and other leading experts. A "Kriseros" for every standard thread.

Prices: 1/6 to 3/- per doz. Send for Lst.

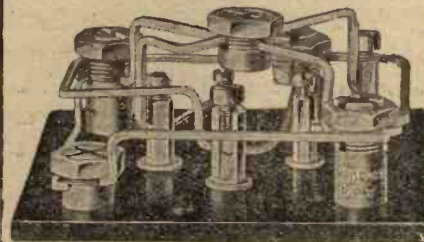

Kriscros Co., 50, Gray's Inn Road, W.C.1

SEND

# £1 Only

Send 20s. to-day, together with your order for the 'Tonyphone', and this wonderful set, which receives all B.B.C. stations, will be delivered complete, including all accessories. You pay a further £1 each month afterwards. The total cost is only £15 9s., or, if you prefer, £14 9s. cash.

### "TONYPHONE" Super 2-Valves

Complete with Accumulator, H.T. Battery, Aerial, 1 pair 4,000 ohms headphones, and two valves—one high frequency and one D-detector. All Royal cas. and.



Send to-day and enjoy broadcasting NOW.

BRITISH ENGINEERING PRODUCTS CO.  
(Battery Dept.), WINDSOR HOUSE, VICTORIA STREET, LONDON, S.W.1  
S.S.A.

## WIRELESS WEEKLY

was first in the field again with a stupendous new feature which commenced with the March 4th issue. Week by week it publishes advance details of the

### PROGRAMMES OF CONTINENTAL AND AMERICAN BROADCASTING STATIONS

giving times, names of artists, the songs and music rendered and other information of interest.

Published every Wednesday, 6d.

PADIO PRESS LTD., Bush House, Strand, London, W.C. 2

# TWO EFFICIENT SINGLE VALVE SETS

By Herbert K. Simpson.

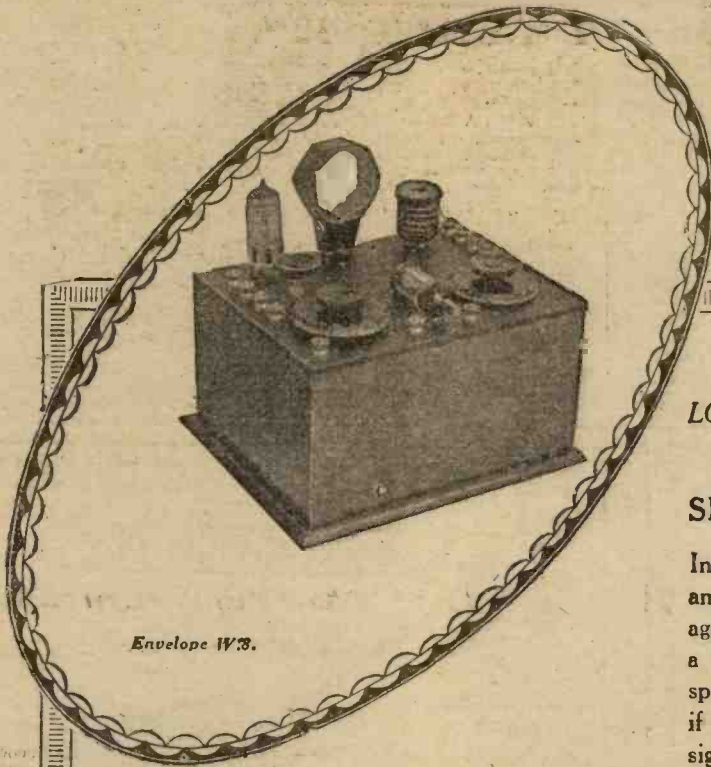

Envelope W.8.

**LOUD-SPEAKING WITH ONE VALVE.**

## Radio Press Envelope W.8 SINGLE VALVE REFLEX SET

In this set the valve functions in a dual capacity, amplifying first at high frequency, and then again at low frequency. At short distances from a B.B.C. Station it will therefore work a loud-speaker with sufficient volume for a small room if an outside aerial is used. Strong headphone signals can be obtained up to much longer distances.

UNIVERSAL WAVELENGTH RANGE.

Order these envelopes now;

**Price 1/6 each**

Post Free 1/9.

**THE IDEAL BEGINNER'S SET.**

## Radio Press Envelope W.9. SINGLE VALVE RECEIVER

This set is so easy to build and so simple to work that it forms a perfect starting point for the novice. With an outside aerial a little practice will enable quite a number of the B.B.C. and Continental stations to be received with ease. A dull emitter valve can be used without any alterations.

Will receive 5XX practically anywhere in Great Britain.

These envelopes contain full and elaborate sheets of instructions, two full-size blue prints, three sheets of photographs on art paper and a sheet of working drawings, clearly showing how to make the sets here described.

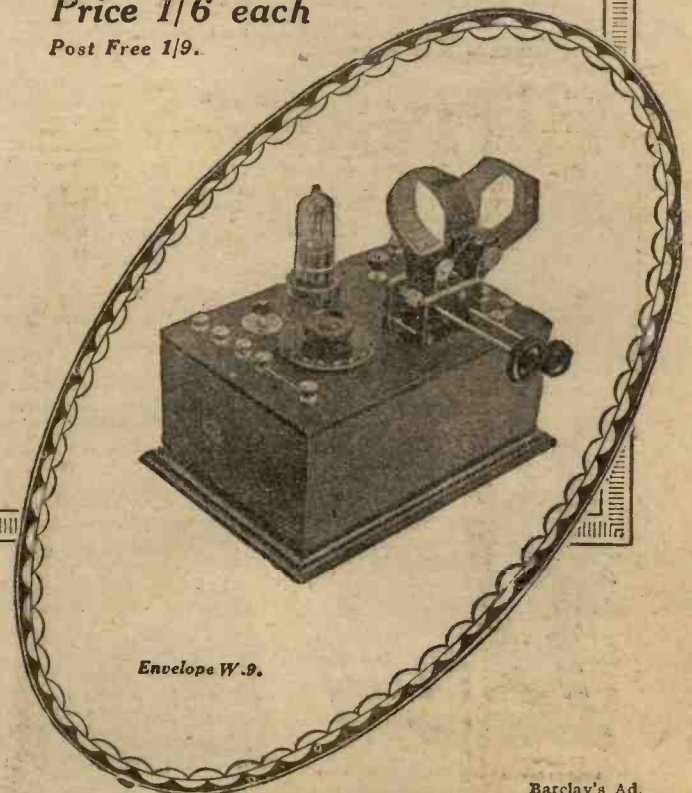

Envelope W.9.

Obtainable from booksellers and wireless dealers, or direct from Dept. W.

# Radio Press, Ltd.

The largest wireless publishers in the world,

Bush House, Strand, London, W.C.2

Barclay's Ad.

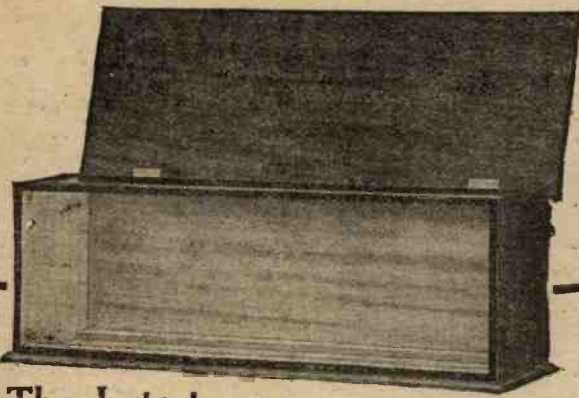

## The Latest Cabinet of Distinction

If you build a good set, then also use a good cabinet. "Cabinets of Distinction," of distinctive appearance and made of seasoned timber, beautifully french polished, and reasonable in price, have been specially designed to meet the needs of the home constructor.

Here's the latest model — Type A.M.L., especially designed for the heterodyne circuits, and perfectly finished in either oak or mahogany. It is made with a movable base board in the following sizes: 12"x7", 14"x7", 18"x7", 21"x7", 24"x10", 36"x8".

**FREE.**—Ask your Dealer for our Catalogue, showing various styles, or, if unable to obtain, write to us for name of nearest stockist.

**HENRY JOSEPH & CO., Ltd.,**  
96 & 100, Victoria St., LONDON, S.W.1.

**Wireless Weekly**

# RESULTS

Not only do results accrue from advertisements in the "Wireless Weekly," but, far more important still, is that its readers embrace the section that buys on the spot. You therefore get the twofold advantage of immediate and direct results to your advertisement.

For rates write Advertisement Managers:  
**Barclays Advertising, Ltd.,**  
Advertising Consultants & Contractors,  
Bush House, Strand, London, W.C.2.  
Telephone: City 9911 (Extn. 9).

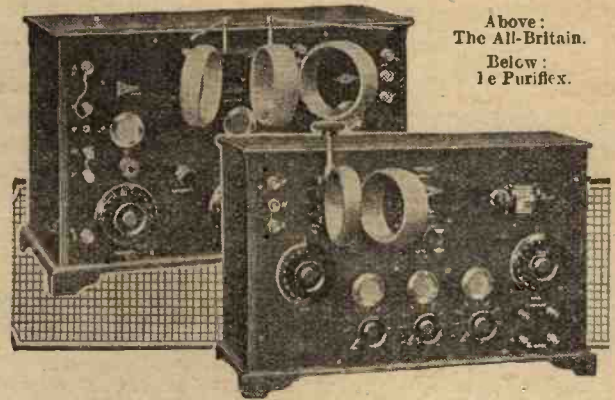

Above:  
The All-Britain.  
Below:  
The Puriflex.

## Build any Famous Radio Press Set

—do it the Pilot way and get three exclusive advantages

### 1. Cost less than any other

You save money when building the Pilot way because good components cost less at Peto-Scott's. Every component is backed by our fullest guarantee of complete satisfaction or money refunded. When you build a Pilot Set you can buy from us only those parts you actually need. And you get the added convenience of being able to obtain any maker's components from us. There is no need to send orders to half a dozen firms.

### 2. Guaranteed results

Build up any Pilot Set according to the instructions contained in our blue print and we will guarantee you perfect results. If you fall our Service Department will put your set in working order for a nominal charge. Should the trouble lie in a defective part supplied by us, we will put the set in working order to your satisfaction entirely without charge.

### 3. Professional appearance

All Pilot Sets are handsome and easy to build. Every panel is drilled, tapped and engraved ready for the components to be incanted on it. Even a schoolboy could assemble a Pilot Set in a few hours and externally it would have the appearance of a factory-built article. From the point of efficiency, too, it would be fully its equal.

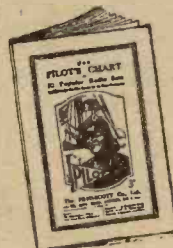

—and here is the Book to tell you about it—

The Pilot's Chart gives you the material specification of more than 30 different sets described in the various Radio Press Magazines, including such favourites as the S.T.100, the All Concert-de-Luxe, the Anglo-American and many others. Send 3d. for a copy to-day.

3<sup>d</sup>.

## Peto-Scott Co., Ltd.

Registered Offices, Mail Order & Showroom:  
77, CITY ROAD, LONDON, E.C.1

Catalogue of Components, 48 pages, fully illustrated 3d

Branches:  
LONDON—62, High Holborn, W.C.1.  
WALTHAMSTOW—230, Wood Street.  
PLYMOUTH—4, Bank of England Place.  
LIVERPOOL—4, Manchester Street.  
CARDIFF—94, Queen Street.

P.S.2423

Index to Advertisers

	PAGE		PAGE		PAGE
Agar (W. H.) .. .. .	662	Falk, Stadelmann and Co., Ltd. ..	687	Ormond Engineering Co. ..	628
American Hard Rubber Co. ..	635	Fluxite .. .. .	683	Peto-Scott Co. .. .. .	683, 695
American Technical Society ..	648	Formo Co. .. .. .	623	Pickett Bros. .. .. .	648
Autoveyors, Ltd. .. .. .	677	Gambrell Bros. .. .. .	656	Portable Utilities Co., Ltd. ..	632, 662, 681
Beard and Fitch, Ltd. .. .. .	623	Garnett, Whiteley and Co. ..	650	Power Equipment Co., Ltd. ..	659
Belling and Lee .. .. .	651	General Radio Co. .. .. .	660, 665	Radiax, Ltd. .. .. .	687
Bland (S. E.) .. .. .	691	Gent and Co. .. .. .	687	Radio Instruments, Ltd. ..	Cover iv
Bobin (M.) .. .. .	691	Gerrard Radio Stores .. .. .	677	Radions, Ltd. .. .. .	648
Bowyer-Lowe Co. .. .. .	647	Goswell Engineering Co. .. ..	661	Radio Panel Co. .. .. .	639
Brandes, Ltd. .. .. .	616	Grafton Elec. Co. .. .. .	687	Radio Stocks .. .. .	655
Bretwood, Ltd. .. .. .	650	Graham (A.) and Co. .. .. .	675	Raymond (K.) .. .. .	644, 645
Brighton Radio Stores .. .. .	691	Gran-Goldman Service .. .. .	626	Reynolds (Walter E.) .. ..	662
British & Colonial Industries, Ltd.	691	Harding, Holland and Fry ..	677	Robinson (Lionel) and Co. ..	683
British Engineering Products ..	693	Harlie Bros. .. .. .	691	Rosen (Ed.) and Co. .. .. .	651
B.T.-H. Co., Ltd. .. .. .	624	H. T. C. Electrical Co. .. .. .	635	Rothermel (R. A.) .. .. .	653
Brown (S. G.), Ltd. .. .. .	679	Igranic Electric Co. .. .. .	669	"S. A. Cutters" .. .. .	689
Burndept, Ltd. .. .. .	636	International Corres. School ..	677	"Sel-Ezi" Wireless Co. .. ..	666
Burne-Jones and Co. .. .. .	601	Jackson Brothers .. .. .	649	Sipton (E.) and Co., Ltd. ..	666
Carrington Mfg. Co. .. .. .	691	Joseph (Henry) .. .. .	695	Siemens Bros. and Co. .. ..	647
Chase Elec. Co. .. .. .	689	Kriscross Co. .. .. .	693	Sparks Radio Supplies .. ..	662
Clarke (H.) & Co. .. .. .	676	Lighting Supplies Co. .. .. .	649	Sterling Telephone and Elec. Co., Ltd.	602
Climax Patents, Ltd. .. .. .	670	Lissen, Ltd. .. .. .	615	Stirlings, Ltd. .. .. .	681
C.A.V. Small Tools .. .. .	669	London Elec. Stores .. .. .	689	Telegraph Condenser Co. ..	667
Cole (S. Wilding) .. .. .	670	London Elec. Wire Co. .. .. .	653	Tele-Radio Co. .. .. .	693
Collins (W. and J.) .. .. .	662	McMichael (L.), Ltd. .. .. .	654	Transformer Repair Co. .. ..	693
Collinson's Precision Screw Co., Ltd.	659	Maxel Electrical Co. .. .. .	663	Vandervell (C. A.) and Co. ..	651
Cossor (A. C.), Ltd. .. .. .	620	Metro-Vick Supplies .. .. .	640	Verstraeten (M.) .. .. .	675
Craik and Smith .. .. .	683	Microhm Engineering Co. ..	639	Wates Bros. .. .. .	696
Curtis (Peter), Ltd. .. .. .	619	Molback (C.) .. .. .	676, 693	Watmel Wireless Co. .. .. .	651
Darco, Ltd. .. .. .	677	Mullard Radio Valve Co., Ltd. ..	684 & Cov. ii	Wilkins and Wright, Ltd. ..	673
Darex Radio Co. .. .. .	648	Naylor (J. H.), Ltd. .. .. .	654	Williams, Ellis & Co. .. .. .	693
Dixon (L.) and Co. .. .. .	662	Neutron, Ltd. .. .. .	635	Wireless Distributing Co., Ltd. ..	648, 681
Dubilier Condenser Co., Ltd. ..	627, 639	Oldham Accumulators .. .. .	685	Zealander (H. D.) .. .. .	663
Enero Products .. .. .	673				

Patent No. 218523      OVER 300,000 IN USE      Patent No. 218523

# 2'9 MICROSTAT 2'9

THE WORLD'S LEADING FILAMENT CONTROL

Advert. of WATES BROS., LTD., 12-14, GT. QUEEN STREET, KINGSWAY, W.C.2  
 'Phone: Gerrard 575/6.      'Grams: "Zywateseng. Westeent"

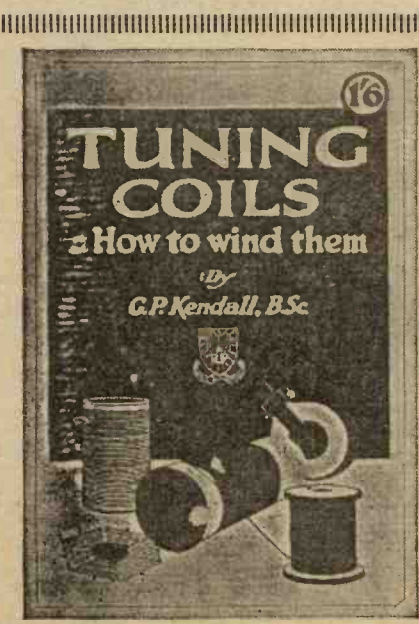

*Another Useful Book.*

## TUNING COILS AND HOW TO WIND THEM

This Book, by G. P. Kendall, B.Sc. (staff editor), contains concise details for making every type of Coil used in Wireless to-day. All necessary data, such as diameter of tubes, gauge of wire, number of turns, etc., are given—the results of the author's own experiments.

There is probably no single Component in any Receiving Set able to exert so much influence as an Inductance Coil. A highly efficient Coil (or Coils) will often make all the difference between mediocre results and really clear and loud reception.

Even if you feel that your present set is giving tolerably good results, the chances are that it will be worth your while—presuming you are using plug-in coils—for short wavelengths to use a set of home-made coils of particularly low self-capacity.

ASK FOR RADIO PRESS SERIES No. W. 18. Price 1/6.

Obtainable from all Booksellers, Bookstalls, Newsagents, and Wireless Dealers, or post free (1s. 8d.) from

**RADIO PRESS, Ltd., BUSH HOUSE, STRAND, W.C.2**

# ANOTHER NEW RADIO PRESS PUBLICATION

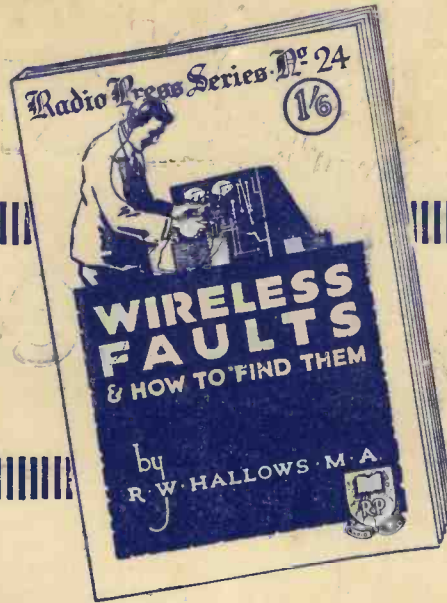

## TAKING THE TROUBLE OUT OF RADIO

**T**HAT is the object of this, the latest Radio Press book (Series No. 24). We know what it is to have a fault in the radio receiver that obstinately refuses to reveal itself. An evening wasted in futile trouble-hunting, a good programme missed and perhaps family and friends disappointed. Yet a word or two of expert advice would probably have enabled you to speedily remedy the defect, and this is what the new addition to the Radio Press publications actually does.

Entitled "Wireless Faults and How To Find Them," and written by R. W. Hallows, M.A., Staff Editor of "Modern Wireless," "Wireless Weekly" and "The Wireless Constructor," it is so complete in its scope that there are few faults likely to occur in a radio set that cannot be easily traced with the aid of the valuable advice which it contains. This makes it a book that should be in the hands of every radio enthusiast. The book is clearly written and illustrated throughout so that even the veriest beginner in radio will be able to understand it. Get a copy at once and stop all that trouble and waste of time in fault hunting.

Here is a brief description of the book's contents.

Opening with instructions for making a very effective yet inexpensive little appliance which is used in conjunction with a pair of telephones for testing the set and its components, the author proceeds to deal with the testing of every radio part likely to cause faults, and gives complete series of tests for all types of receivers from crystal to multi-valve sets. Special attention is given to the testing of reflex circuits. When purchasing ask for Radio Press Series No. (W)24 "Wireless Faults and How to Find Them"

**N**O WIRELESS ENTHUSIAST CAN AFFORD TO BE WITHOUT THIS BOOK.

Date of publication, Apr. 16th  
On Sale Everywhere

# 1/6

Obtainable from all book-sellers, wireless dealers, or Post Free 1/8 from (Dept. W) Radio Press, Ltd., Bush House, Strand, London, W.C.2

**Expert advice whenever you need it**

## Radio Press, Ltd.

BUSH HOUSE, STRAND, LONDON, W.C.2





# Better Valve Protection

**T**HE R.I. Dual Rheostat is an entirely new departure in the design of filament resistances, in order to meet adequately the needs of both bright and dull filament valves. It permits sensitive adjustment to be made in the filament current of both types of valves to the highest degree, and gives as a result longer life and smoother action.

You can use any valve with the R.I. Dual Rheostat, confident that its range of variable resistances will give you wonderfully smooth current control. An important feature in the design is the method of securing the rheostat to the panel by a one-hole fixing, which is absolutely independent of the brush contact, so that when the clamping nut is tightened the perfect, silky action of the rheostat remains the same.

The coils of high resistance wire are wound on hard, insulated cylinders of larger radiating area than any other similar type of rheostat. The coil for the bright valves has a resistance of 5 ohms, while that for the dull emitter type is 30 ohms. Both coils are clamped in a solid brass frame with the ends of the resistance winding led to milled head terminals.

The whole component is attractive in appearance, solid in construction and efficient in operation. You will like the R.I. Rheostat. It is another proof of the superiority of R.I. British components.

Another new feature is the provision of a large black circular scale, which can only be fitted in one position on the spindle. This scale affords a visual adjustment in the operation of the set, and enables the user to see at a glance which resistance is in use, while the graduations afford a safeguard against excessive current being applied to the filament of the valve.



Price 7/-



Write for Booklet, "Better Valve Protection," free on application

12 HYDE ST OXFORD ST LONDON W.C.1

Contractors to the Admiralty and all Government Departments