

The **TELSEN** **RADIOMAG**

VOL. I. RADIO'S GREATEST HOME CONSTRUCTOR JOURNAL

NO. 4

6^D



TELLS YOU HOW TO BUILD BATTERY SETS, "SUPERHETS," AND "ALL-MAINS" SETS

FOR PRECISION CONSTRUCTION WITH PERFECT MATCHING, FIT

TELSEN

1933

GANGED CONDENSERS

THE Telsen Ganged Condenser Units have been designed for use in modern receiver circuits in which accurate and simultaneous tuning of two or three circuits is obtained by the rotation of one dial. A press steel frame of great rigidity completely obviates any tendency to distortion while the Rotor and Stator vanes are let into one-piece high pressure die castings ensuring accurate spacing. All sections are very carefully matched by means of split end vanes, and trimmers are provided across each section to compensate for differences in stray capacities.

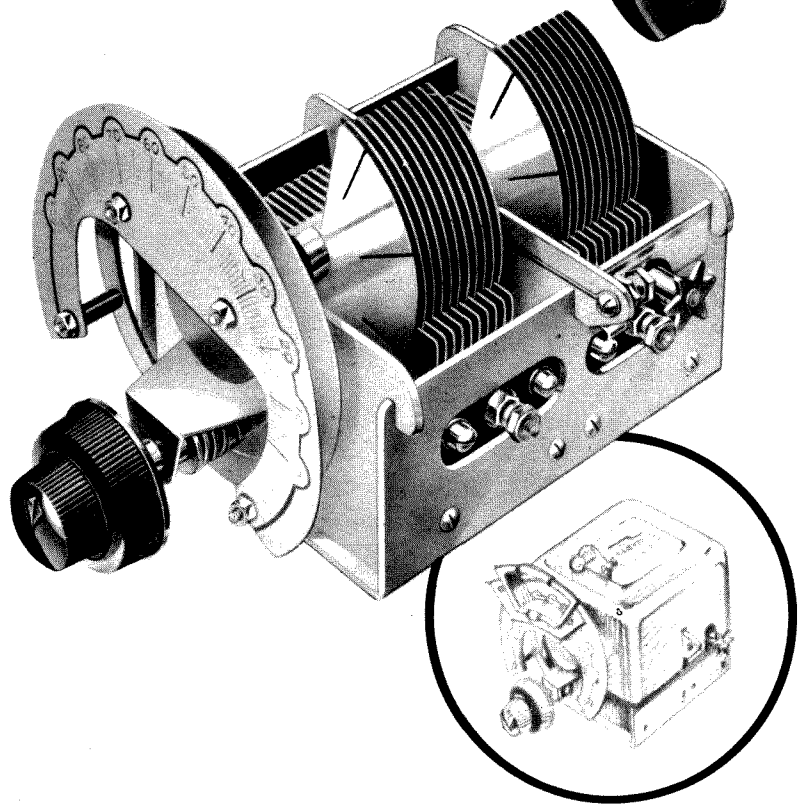
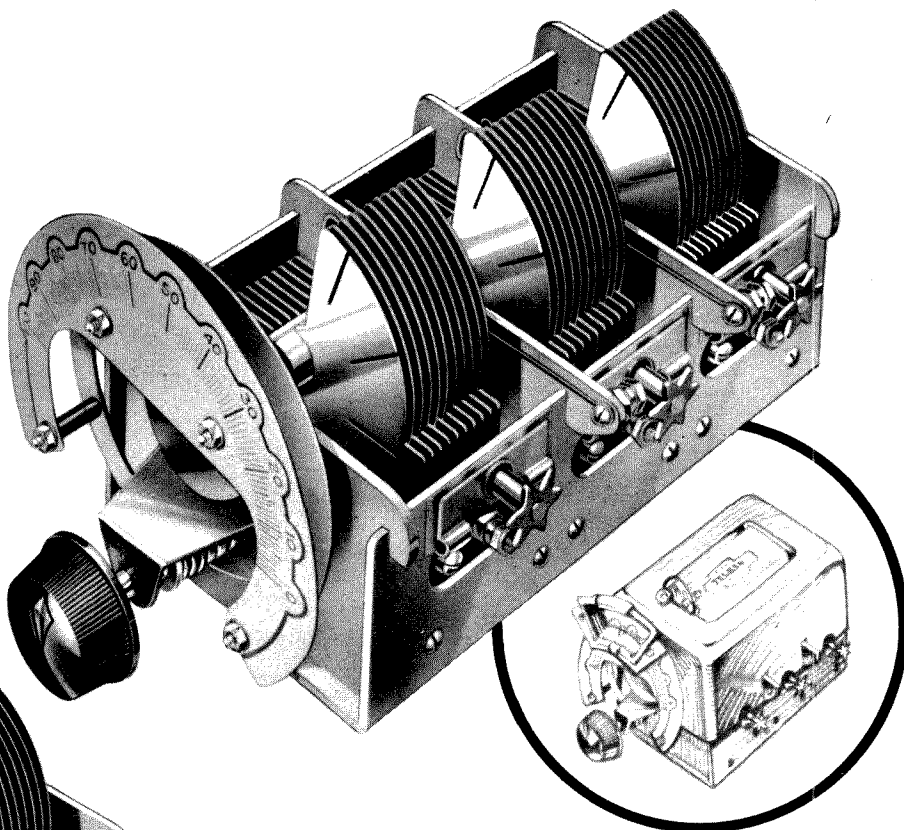

In the twin gang condenser the front section carries a variable trimmer operated by a knob concentric with the main tuning control. Both models have an attractive stove aluminium finish and are complete with Disc Drive, dust cover, escutcheon plate, pilot light, knob and two alternative tuning scales.

TWIN GANG CONDENSER No. W.306. PRICE **16⁶/₁₆**

TRIPLE GANG CONDENSER No. W.307. PRICE **22⁶/₁₆**

The reduced illustrations in the circles show the condensers when completely assembled.

TELSEN

RADIO COMPONENTS



Purveyors of Electric Lamps By Appointment



Manufacturers and Purveyors of Electric Lamps By Appointment

EDISWAN

The name that means 'EXCELLENCE'

.. "THEY ARE RELIABLE, FIRST-CLASS PRODUCTS"

"A life-test reveals the fact that their capacities well exceed those laid down as being the minimum for high-grade standard cells, and the cells discharge with consistent evenness" SAYS THE TECHNICAL EDITOR OF "MODERN WIRELESS"

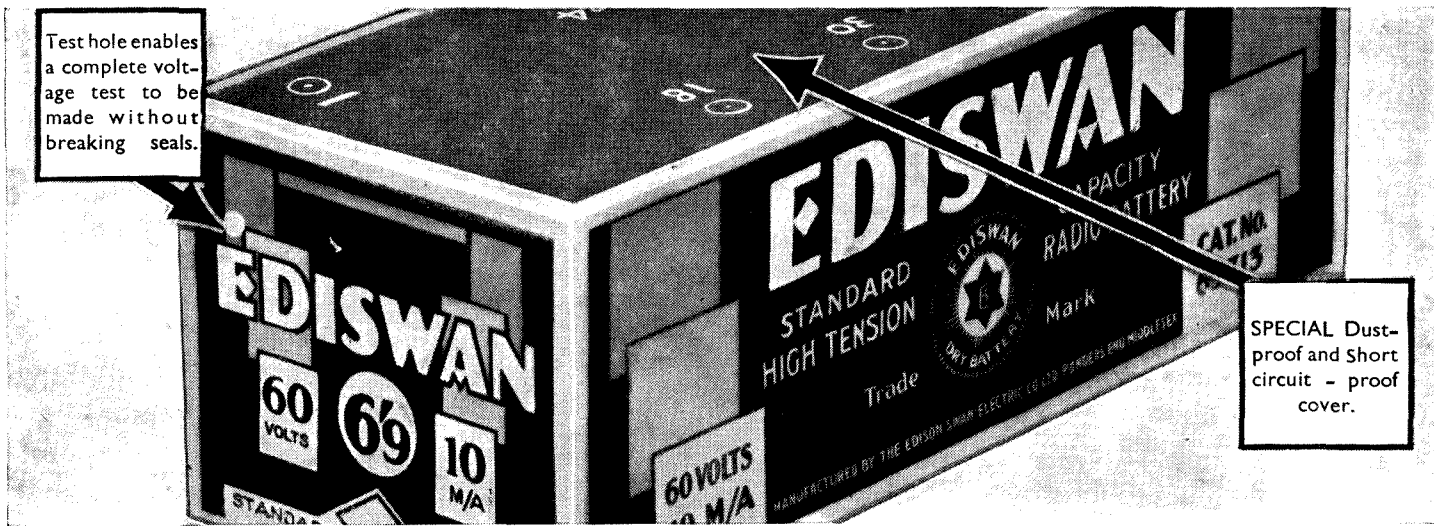

Test hole enables a complete voltage test to be made without breaking seals.

SPECIAL Dust-proof and Short circuit - proof cover.

Guarantee

The Edison Swan Electric Co. Ltd. guarantees that Ediswan Batteries are of full voltage and capacity. Should any Ediswan Battery fail to give satisfactory service, we undertake to deal with customer's complaint within 24 hours of receipt of the defective battery.

STANDARD CAPACITY
60 6'9
VOLTS

STANDARD CAPACITY
120 13'
VOLTS

9v. grid bias **1/-** **108v.** grid bias **12/-** incorporating

Standard Capacity. Where the anode current required does not exceed 10 M/a these batteries will give highly satisfactory service. If super-power valves are used, the super-capacity type should be used.

Super Capacity. These batteries have twice the capacity of the standard type and, owing to their large reserve of power, last nearly three times as long when used as replacements to standard capacity batteries.

Now—H.T. Battery worries are things of the past, for this is the battery you've always looked for; the battery which you can buy with absolute confidence, the battery which is GUARANTEED to give you a good long life and the best of service. Every single cell in every Ediswan battery must successfully pass numerous tests before it leaves the factory, and special precautions are taken to ensure perfect internal insulation between cells.

Send for your FREE copy of "How to get the most out of your H.T. Battery." Full of useful data, hints and tips.

EDISWAN Guaranteed RADIO H.T. BATTERIES

THE EDISON SWAN ELECTRIC CO. LTD.



PONDERS END, MIDDLESEX

EDISWAN - The Better Service Batteries



Purveyors of
Electric Lamps
By Appointment

EDISWAN

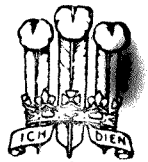

Manufacturers
and Purveyors
of Electric Lamps
By Appointment

The name that means 'EXCELLENCE'

The NEW
EDISWAN
EXTRA LIFE
ACCUMULATORS

*with
"balanced
capacity"*

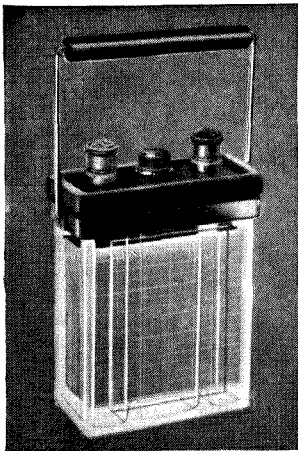

Type E.L.S.5—40 a/h capacity Price 11/0

Type E.L.S.7—60 a/h capacity Price 12/6

Type E.L.S.9—80 a/h capacity Price 15/6

Type E.L.7—60 a/h capacity Price 10/3

Type E.L.3—80 a/h capacity Price 12/3

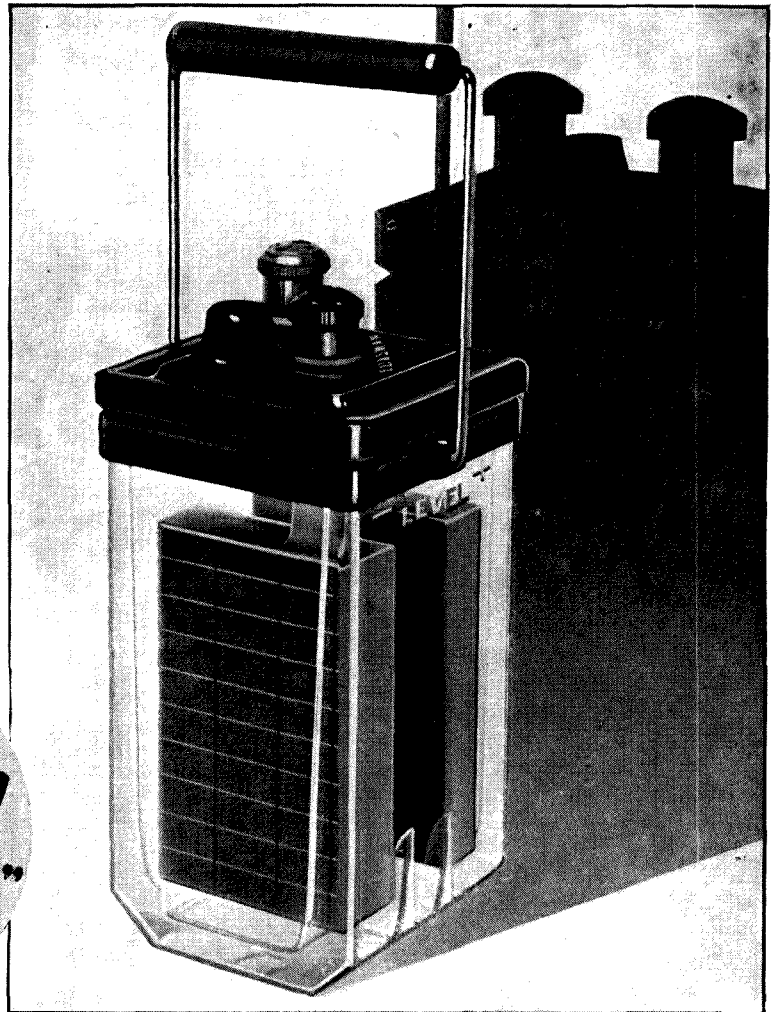
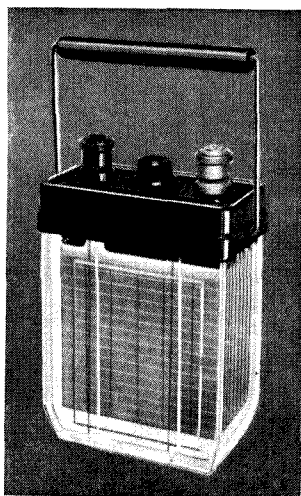

Type E.L.M.2—20 a/h capacity Price 4/3

Type E.L.M.4—45 a/h capacity Price 8/0

The new Ediswan "balanced capacity" accumulator cell is an entirely new development. Careful re-designing of the positive and negative elements to ensure an exact electrical "balance" between them obviates the uneven charging inevitable with "unbalanced" accumulators and greatly prolongs their life. Consequently they are especially suitable for slow discharge work.

Every feature of the new Ediswan cell bespeaks attention to detail. British containers of clear glass, moulded ebonite lids, screwed vents, non-corrodible and non-interchangeable connectors and a carrier which fits neatly under a moulded projection of the glass container. In addition, the E.L.S. types are fitted with "grease-cup" pillars to prevent acid creeping. See them at your radio dealers.

THE EDISON SWAN ELECTRIC CO. LTD.



PONDERS END, MIDDLESEX

EDISWAN - The Better Service Batteries



The TELSEN

RADIOMAG

Joint Technical Editors :

G. S. Brayshaw, B.Sc. (Eng.) Grad. I.E.E.
 R. G. D. Holmes, A.Inst.W.T., A.I.Rad.E.
 A. F. Poynton.

Editor :

RUPERT COLLINS

Advertisement and
 Editorial Offices :

THOMAS STREET, ASTON,
 BIRMINGHAM

EDITORIAL COMMENT

ALTHOUGH each of our previous issues has proved so outstandingly successful, never have we felt more confident of still further successes for the Home Constructor than we do in presenting this new number of *The Telsen Radiomag*.

Of especial interest in this issue are the building and operating instructions for three new and brilliantly designed Telsen circuits, for each of these a full-size Blue print will be found at the end of the book. The articles are profusely illustrated and have been purposely written in such a manner that the veriest novice cannot fail to understand their construction.

All three receivers are designed on the latest all-metal chassis principle, the Telsen "Super-Selective Four" being an efficient and highly selective 2 H.F., Detector, Pentode, Battery Receiver, the Telsen "All-Mains S.G.3" is an all-electric circuit for various mains supply, whilst to the ambitious constructor we offer the Telsen "Super Six," a remarkable six-valve "super-her" employing for the first time an entirely new circuit arrangement which is the subject of a patent of the Telsen Electric Co., Ltd. To those of our readers who build one of these remarkable receivers, we can promise, without hesitation, a new delight in radio. For the convenience of those constructors who wish to buy all the necessary components for one of these sets, a complete kit of parts can be obtained at an inclusive figure, of which details and prices will be found at the end of each article dealing with the construction of the receiver in question.

On the other hand, some readers may already possess many of the components, in which case they can obtain from their radio

dealer any remaining parts and the complete Constructor's Outfit for the particular set they have in mind. Details of these Constructors' Outfits will be found on page 40 (the last page of the coloured supplement).

Commencing on page 4, we review, complete with full technical information, the latest range of Telsen components. Each one of these is the result of much research and experimental work by our Technical Staff, the final experiments and tests resulting in a range of components, mechanically and electrically, the foremost of their kind; these now complete what is the most comprehensive range of component parts available to the home constructor, each one being a perfect example of radio engineering and British craftsmanship.

We have endeavoured to add a further point of interest to this issue by showing at the foot of each article which follows, a number of pictures taken in some of the departments in our factory. Whilst we could not hope, by this means, to convey any true conception of the magnitude of our works, we feel sure the pictures will indicate to some degree the great diversity of operations and the mechanical resources that are necessary for the production of Telsen components.

Readers who cannot obtain or who have mislaid their copies of the *Radiomag* issues No. 2 and 3, who desire them for reference purposes can obtain copies from us price 6d. each post free upon application.

All correspondence relating to the *Radiomag* should be addressed to The Editor, Telsen Electric Co., Ltd., Birmingham.

CONTENTS

	Page
A Review of New Telsen Components	4, 5, 7, 8, 9, 41, 42, 43
How to Install an Efficient Aerial and Earth	11, 12, 60
How to choose your H.T. Batteries	13, 63
The Telsen "All-Mains S.G.3"	14, 15, 17, 18, 19, 62, 63
An Easy Path to Ganging Condensers	21, 22, 23, 24, 43
Complete Illustrated Range of Telsen Components	25 to 40
The Telsen "Super 6"	44, 45, 46, 47, 48, 49
Further Practical Hints and Tips	51, 52, 53, 60
The Telsen "Super Selective Four"	55, 56, 57, 58, 59, 60
Tone Control in Selective Receivers	61, 63
Complete List of Telsen Components, giving catalogue numbers, descriptions and prices	64

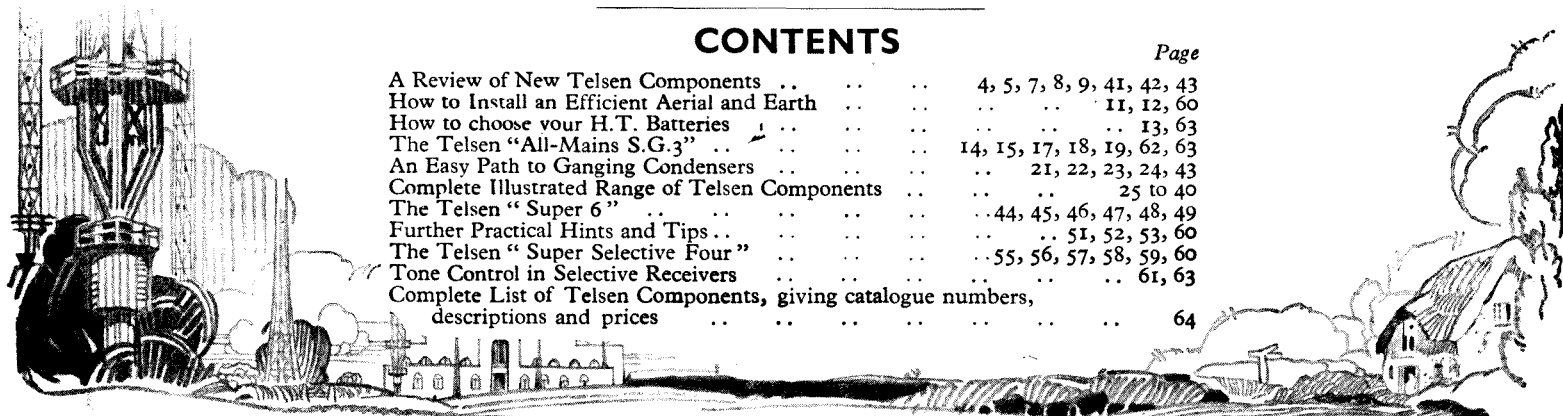

A REVIEW of NEW TELSEN COMPONENTS

THE newly developed Telsen Volume Control W.295, illustrated on page 38 in the coloured supplement, presents many points of interest and is a valuable addition to the Telsen range of components. It consists of a 50,000 ohm resistance connected to act as a potentiometer winding. The resistance element is of wire, being wound spiral fashion on a special linen bakelite former, and has a current carrying capacity adequate for all the uses to which such a device is normally put. The rotating arm is shaped so as to ensure a light yet positive contact with the resistance element, resulting in a smooth and noiseless action on turning the control knob. The disposition of the winding is so placed as to give good minimum and maximum resistance values—a most important point in this type of component.

This central spindle is insulated from the moving arm to which it is attached, and therefore it is possible to gang two or more of these controls on the same metal spindle. This feature lends itself to many interesting types of ganged controls, a typical example being the linking up of a radio volume control to that of a gramophone. The resistance assembly is housed in a neat compact moulded case with a light oak finish, and is fitted complete with a control knob. The three terminals are spaced well apart, and are rigidly assembled. Panel mounting up to a ¼" thickness is allowed for, the fixing needing two holes.

A popular application for this Volume Control is for varying the grid bias voltage applied to a variable mu screened grid valve. This application is depicted in Fig. 1, and it is clear as to the method involved in obtaining the grid bias variation needed.

Another application is for varying the volts applied to the screening grid of a screened grid valve, and so controlling the volume of a receiver. This is shown in Fig. 2.

The resistance R_1 and the volume control are placed in series between +H.T. and earth, the value at R_1 being such as to give a voltage of 80 to 100 at the point X. It is obvious that if the arm of the potentiometer is moved, the voltage applied to the screening grid can be made to vary from a maximum of 80 volts to zero. The Volume Control may be put to many other uses, the above two examples being typical of its applications, a further important innovation being described later on in this article.

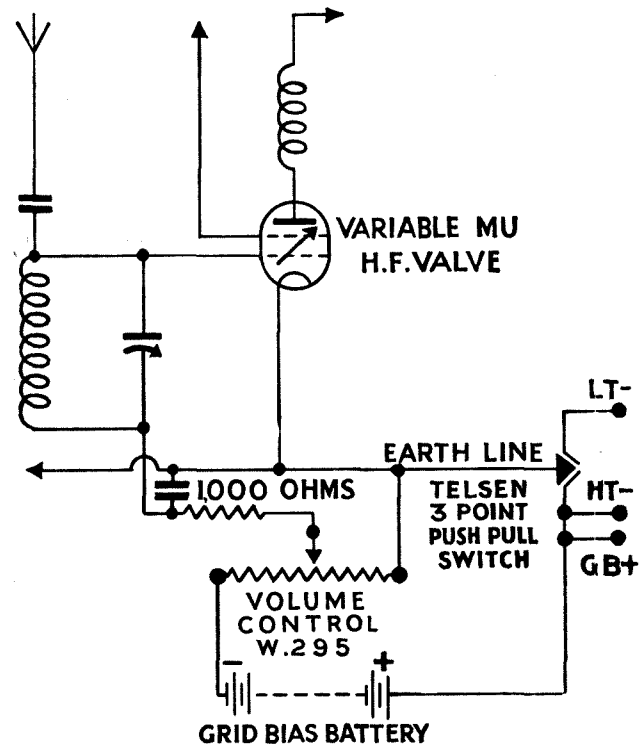
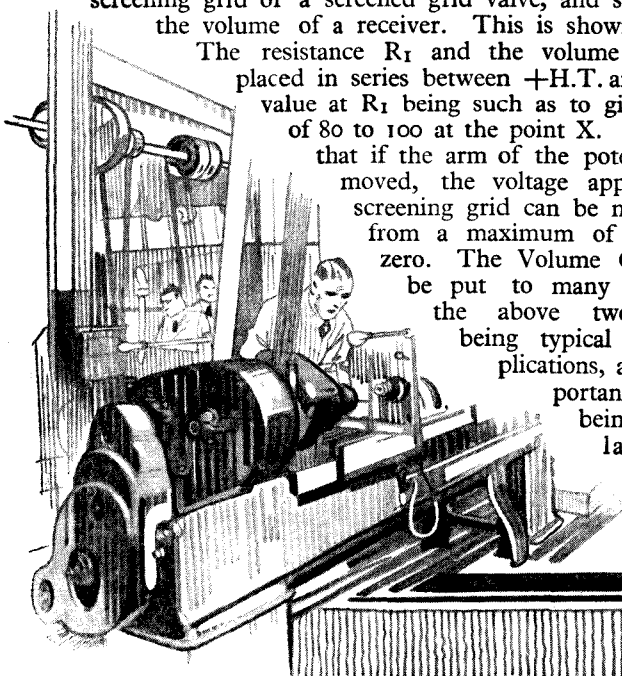

FIG. 1.

Another new component is the Telsen Mains Switch W.297. This is arranged for single hole mounting to panels up to a quarter of an inch in thickness, and is fitted with a self locating "on-off" indication escutcheon plate. The contacts have a well designed quick break action, with a rating of 750 watts—3 amperes, 250 volts. The switch is housed in a neat bakelite moulded case, fitted with two substantial terminals, the whole giving a pleasing and neat appearance.

This quick break switch is extremely suitable for all types of radio and power circuits—such as H.T.L.T. battery eliminators, gramophone motor switch, starting small electric motors, etc.

The combined Volume Control and Mains Switch, W.296, incorporates the functions of the two components just described. The mains switch is mounted on the Volume Control by means of a nickelled metal attachment. The switch arm is slotted, and engages with a metal arm attached to the insulated spindle of the volume control, so that when the control is at the minimum position the switch is open circuited,



One of the Screw-Cutting Lathes in our Tool Room

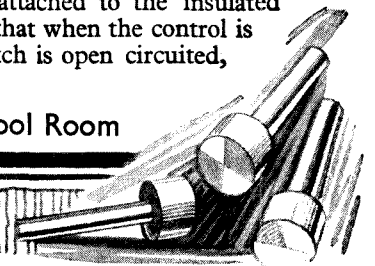

A REVIEW OF NEW TELSEN COMPONENTS—continued

but as it is turned, the switch is, by the ganged action, automatically closed. When the control is again brought to the minimum position the switch is open circuited, and thus a single knob control is obtained for both the volume and "on-off" switch. The action is very light and is silent in operation.

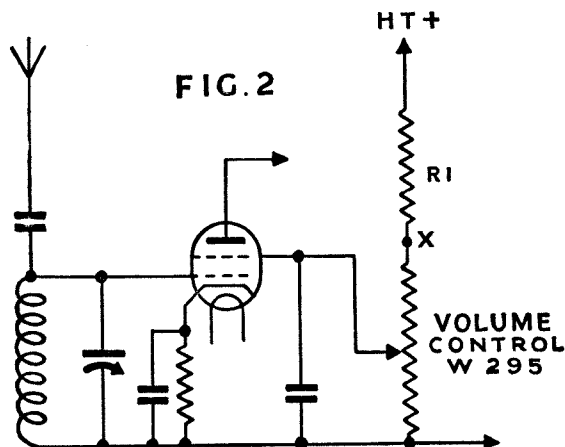

A new range of Mains Transformers has been introduced, of which the Telsen Electric Company is justly proud. When it is realised that a Mains Transformer is connected direct to the Electric Supply Mains, it is immediately apparent that such a component must of necessity be a very sound electrical and mechanical engineering job. Otherwise, it is not only a possible source of trouble, but a definite source of danger. It therefore is very important that the constructor choose his mains transformer with the greatest of care and caution. Much thought and care have been put into the design and manufacture of these Telsen transformers and they have been subjected to such stringent and definite tests as to give absolute faith and confidence in their performance.

A few of the electrical and mechanical points are now given. The first basis of design is the iron core. Silicon steel of the highest grade is used throughout in this laminated structure, the hysteresis losses accordingly being very low. The laminations are thin and being paper insulated from one another, the eddy currents are reduced to a minimum. In every case, the cores are of large cross sectional area in order to transform the power load efficiently, with a minimum loss of energy in the form of heat. So much for the core.

The next important point is the insulation of the windings from the iron core, and from one another. The design and assembly has to be very carefully carried out to obviate the risk of the insulation breaking down. The windings are wound in a rigidly constructed bobbin composed of material possessing high insulation, and good mechanical strength. All the windings are consequently well insulated from one another as well as from the iron core, thus ensuring the maximum factor of safety. The current densities in all the coils are kept very low, so that negligible power is lost in the form of heat dissipation in the copper wire. It is also worthy of mention that the dispositions of the secondary windings relative to the primary winding have been carefully studied and proportioned, as this is of considerable importance in attaining a good voltage regulation.

The careful cutting down of all power losses has resulted in a very high percentage of efficiency for the transformation of power. Finally, from an electrical engineering standpoint, the wire used in each individual coil is heavily insulated, being either enamelled wire with a covering of silk,

or else wound with two coverings of cotton. This eliminates any possibility of turns of wire shorting to one another.

Very searching tests are carried out in the Works at various stages during the assembly of the Telsen Mains Transformers, these including tests for short circuited turns, insulation and voltage flash to earth, concluding with a load test.

We will now consider the mechanical construction. Lamination buzz is eliminated by securely clamping the iron core on all eight sides by means of two substantial stove aluminium finished die casted casings. The clamping studs pass right through the laminations as well as the die castings, giving a solid and rigid construction.

The transformer leads are brought up internally to substantial terminals mounted on a very open spaced top terminal panel, which has the voltage input and output tapings clearly and fully indicated. The terminals are recessed for easy connection and permit ample accommodation for all the leads led to the different supply points of the mains receiver. Special eyelets are supplied for making neat and good mechanical and electrical connections.

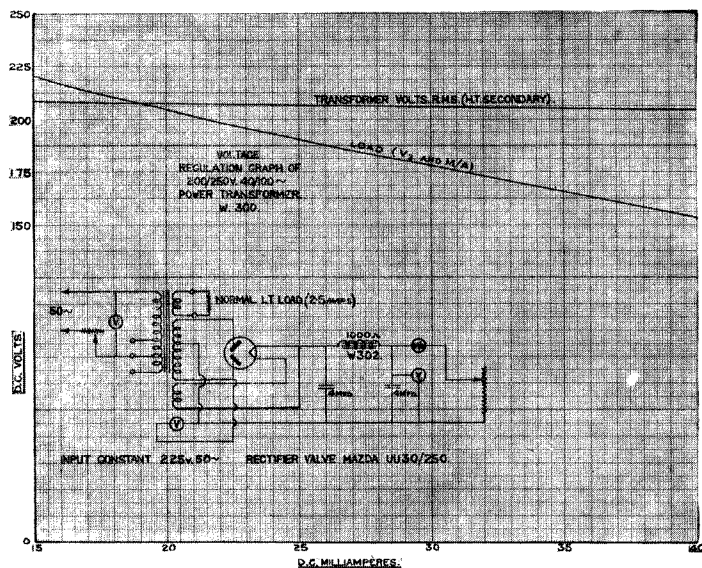

FIG. 3

A well moulded bakelite cover is provided for placing over the terminal panel, being held in position by two screws. This protects one from shocks should the top be accidentally touched. Slots are placed round the periphery of this cover so that the leads may be led out in a neat and orderly fashion.

All of these Mains Transformers present a rugged and strong appearance, and are secured in position by means of four stout bolts passing through four holes in the base of the castings.

Three models of Telsen Mains Transformers are made, namely :-

Model W.300 for 200 to 250 volt A.C. mains at 40 to 100 cycles per second.

Model W.301 for 200 to 250 volt A.C. mains at 25 to 40 cycles per second.

(cont. on page 7)

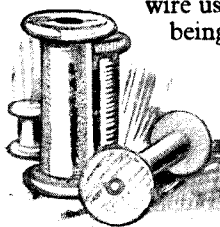

A Battery of our Winding Machines

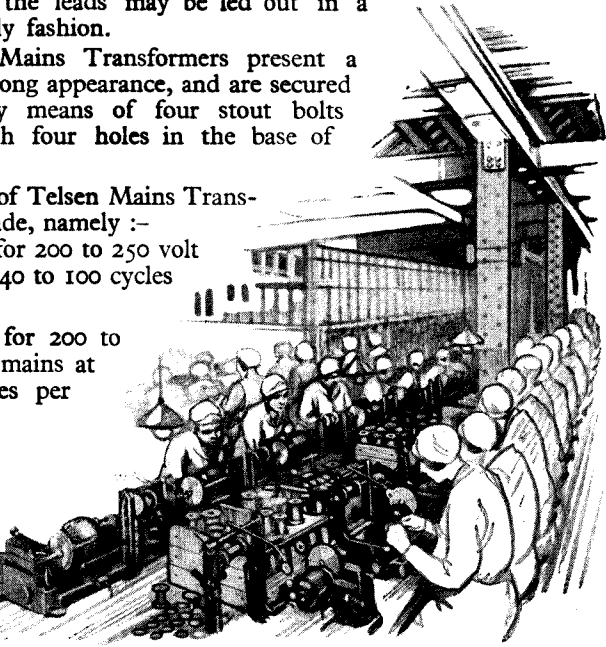

For perfect reproduction of your records, insist on the

TELSEN

NEEDLE ARMATURE

PICK-UP

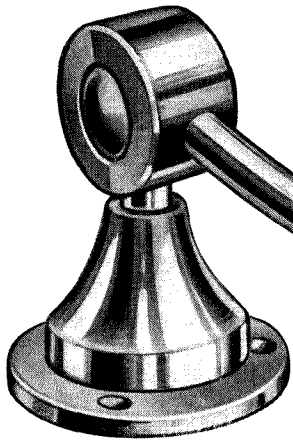

TELSEN NEEDLE ARMATURE
PICK-UP
Pat. No. 324943

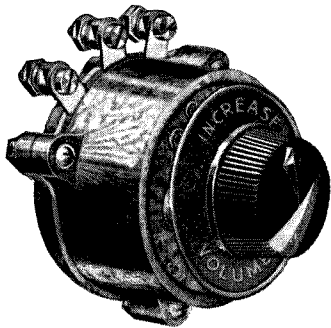

TELSEN VOLUME CONTROLS

Telsen Volume controls are made primarily in two models, 10,000 ohms and 50,000 ohms. The resistance element is entirely wire-wound with a special alloy wire of high resistivity and great mechanical strength, ensuring constant value and noiseless operation. They are adaptable to a number of different uses in both H.F. and L.F. circuits, a notable feature in their construction being that, as the contact arm is insulated from the operating spindle, two or more may be ganged on the same spindle and controlled by one knob.

10,000 ohm ..	W.298 ..	Price	3/9
50,000 ohm ..	W.295	

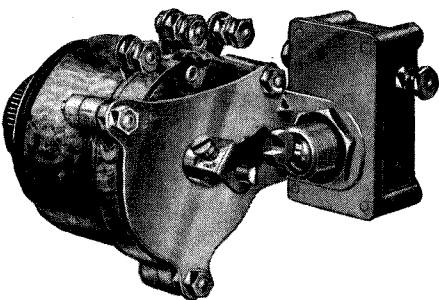

TELSEN 50,000 OHM VOLUME CONTROL, WITH MAINS SWITCH COMBINED

This consists of a standard Telsen 50,000 ohm Volume Control with a nickel finished extension bracket carrying a Telsen quick make and break switch. This is so arranged that the switch is operated at the minimum volume position. Thus the two operations of switching the receiver on or off and controlling the volume are combined into one controlled by a single knob

No. W.296	Price	5/6
--------------	----	-------	------------

as exclusively used by the
B·B·C

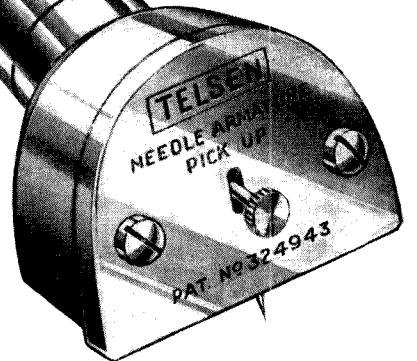

VERY carefully designed in every detail, the Telsen Needle Armature Pick-up can be thoroughly relied upon to give true and faithful reproduction of Gramophone records, the frequency response ranging from as low as 25 cycles per second up to 7,500 cycles per second. The lightness of the Needle Armature allows for perfect freedom of movement in the record grooves, so that a natural response of both the high and low frequencies is obtained, while record wear is reduced to negligible proportions. A light tracking arm, nickel finished, ensures accurate tracking of the needle point in the record groove.

No. W.317	Price	32/6
--------------	----	-------	-------------

TELSEN

RADIO COMPONENTS

A REVIEW OF NEW TELSEN COMPONENTS

—continued from page 5

Model W.291 for 100 to 110 volt A.C. mains at 40 to 100 cycles per second.

All these models have the same power output rating, as follows :—

L.T. Filament—4 volts with a centre tap in the winding, the current rating being 2.5 amperes.

Rectifier Filament—4 volts at 1 ampere.

The H.T. secondary is of the full wave type, and has two windings, each delivering 200 volts R.M.S.

When used with a Mazda Rectifier Valve type UU30/250, the rectified output is 200 volts D.C. at a load of 32 milliamperes. The graph shown in Fig. 3 gives the voltage regulation curve of the Telsen Mains Transformer W.300 when used with a UU30/250 valve. The regulation of the R.M.S. volts of the secondary windings is 1.9. per cent. taken between the D.C. loads of 15 and 40 milliamperes. This indicates that a very good and constant voltage may be obtained under working conditions. All these Transformers are suitable for sets employing two A.C. valves, or for receivers using three valves, two of which are of the A.C. type, the third taking .25 to .5 amperes. Such a set is typified in the Telsen "All Mains S.G. 3" which employs an AC/S2, AC2/HL and a pentode valve, the Pen. 425. Due allowance is made for incorporating a pilot lamp and a Telsen Hum Adjuster, the current usually taken here being .25 amperes. It should be remembered that the voltage regulation of the L.T. winding is extremely good, so that the current taken from it may be varied over wide limits without unduly affecting the voltage.

The Telsen Low Frequency Choke W.302 has been developed especially for use with the above range of transformers, and is suitable for all circuits requiring smoothing. It will be noticed that it is used in the Telsen "All Mains S.G. 3." Its rating gives an inductance of 28 henrys when a direct current of 25 milliamperes is flowing in its windings. However, a high and almost constant inductance is maintained throughout a wide valuation of the D.C. current, and a curve of a typical choke drawn from stock, and which is reproduced in Fig. 4, shows that an overload of 50 per cent. D.C. gives only a 5½ per cent. decrease

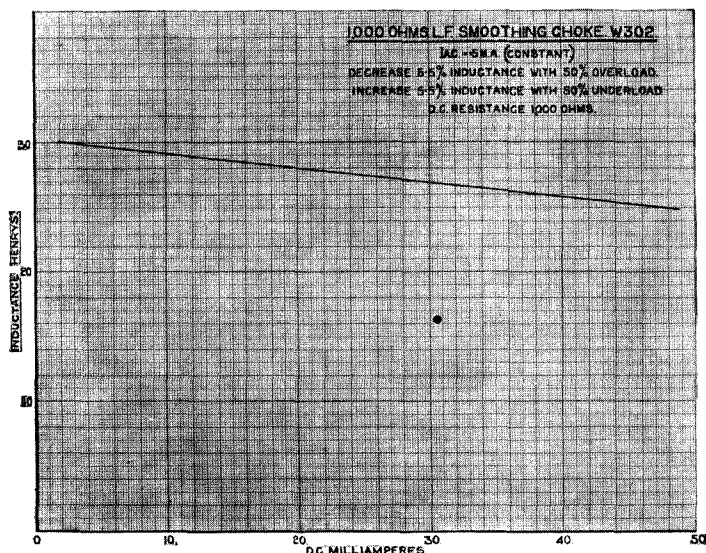
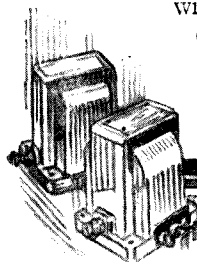

FIG. 4.

in inductance, whilst an underload of 50 per cent. gives a 5½ per cent. increase. The core of specially selected iron is air gapped, this tending to keep the inductance at a constant value. The windings are wound with enamelled wire with a covering of silk and thus there is no danger of shorted turns.



Another View of our Winding Machines

The D.C. resistance is 1,000 ohms.

The containing bakelite case is finished in light oak, thus harmonising in colour and action with the now famous Telsen Chokes and Transformers.

The Telsen Hum Adjuster W.299 is also of great value when used in A.C. circuits. Although the L.T. winding of all the Telsen Mains Transformers are accurately tapped at the correct electrical centre, many constructors still desire to use a hum balancing resistance across the filament circuit. This component fulfils such a requirement. The Hum Adjuster has a total resistance of 30 ohms. The movable arm, the head of which is slotted, having a smooth and positive movement that allows a very accurate position for minimum hum to be arrived at. It is designed for one hole fixing, insulating washers and an insulating bush being supplied with it for use in receivers where it is desired to insulate the movable contact from the earth line.

The movement is housed in a very neat and well designed bakelite moulded case, and the three terminals are well spaced from one another.

The Telsen Cartridge Anode Resistances W.263 to W.284 and Anode Resistance Holders W.286 call for little comment.

The Anode Cartridge Resistances are of the one watt type and are calibrated to within 10 per cent. of the value stated on the attractively coloured label. These components will show negligible change in resistance with the passing of time and with change of temperature. They are also noiseless in action and do not give rise to those rustling noises that are so distressing with some types of resistances. The care that is exercised in their manufacture is apparent when it is stated that to ensure a good noiseless resistance, copper is deposited on the ends of the resistance element and is forced right into the resistance material. Thus a good contact is formed for soldering on the end connections. The end metal caps of the container are heavily nickelled and form a good solid contact.

The Anode Resistance Holders are made of bakelite and are of a light oak colour. They are strong, and very neat in appearance, may be mounted upright or horizontal, and occupy very little space on the receiver chassis. The Anode Cartridge Resistances are held securely in them by means of very strong nickel plated spring clips.

The remarkable success achieved by the Telsen Matched Screened Coils introduced at the last Radio Exhibition at Olympia has led to the design and development of the Telsen Triple Ganged Condenser W.307 and the Telsen Twin Gang Condenser W.306. The high degree of accuracy shown in the factory matching of the inductance of these coils has been highly praised, and it is confidently anticipated that the remarkably close limits set in the Telsen Factory for the capacity matching of the above mentioned condensers will cause still further favourable comments.

Excellent combination of mechanical and electrical skill is shown in the design of the Triple Gang Condenser. The main chassis or framework is of steel, this having a stove aluminium finish, and because of its great rigidity, constancy of the spacing

(continued on page 8)

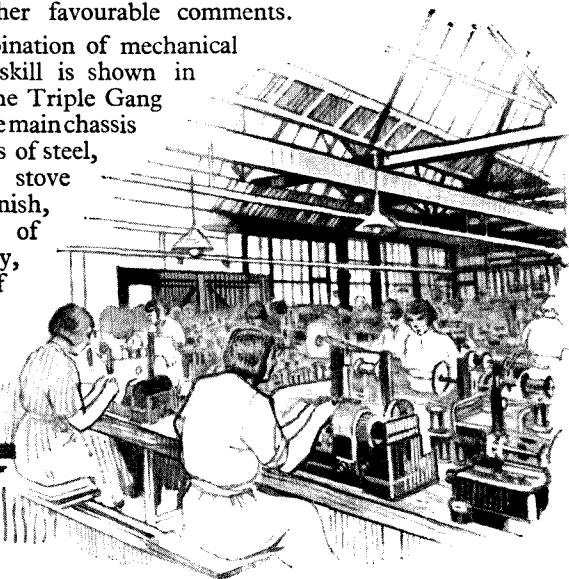

A REVIEW OF NEW TELSEN COMPONENTS

—continued from page 7

between the condenser vanes is assured and hence the constancy of the capacities.

All three sets of moving and fixed vanes are die cast, the casting being of such a nature as to ensure perfect contact between the moving vanes and the rotor spindle, as well as between the fixed vanes and their assembly plates. It is here very interesting to observe that a great amount of research and experimental work in the processes of diecasting has been carried out in connection with this question of good contact. After much intense work, the Telsen designers have so arranged their die casting processes, that the contact between the moving vanes and the rotor spindle and also between the stator vanes and the assembly plates is of such a nature that whilst a good contact is made, there are no internal stresses left in the assemblies. This is important, for if internal stresses were present, there would be a tendency for these to be released at a later date and distort the condenser assembly, causing a small alteration in the capacity values. This is rather an obscure point, and it is mentioned here in order to give the constructor a knowledge of the thorough thought and workmanship that has been brought to bear on the design of this ganged condenser.

Each set of vanes has its own earth terminal, contact being made between the terminals and the rotor spindle by means of phosphor bronze clips which maintain a light yet firm connection.

All the stators have terminals on each side of the framework, so that coils may be mounted on either side of the condensers whilst retaining the valuable asset of short connecting wires between these two tuning units.

The moving vanes at the ends of each of the three condensers are slotted radially in four positions. By bending these vanes inwards and outwards the condenser capacities may be increased or decreased. Further it is possible to adjust each condenser capacity in seven different degrees of enmeshment of the fixed and moving vanes. Thus the condensers may be accurately matched to one another.

All ganged condensers are most accurately matched at the Aston Works of the Telsen Factory, and it is therefore most important to note that these end vanes should be in no way interfered with, and also that great care should be exercised in handling, so that the vanes are not disturbed. If they are, then the accurate ganging will be disturbed and an essential feature of this component lost.

It is interesting to observe that there can be no end play in the substantial rotor spindle. This is because it is spring loaded, and its two bearings are machined to a very high degree of accuracy, another important feature of this condenser design, as it ensures a constancy of the condenser capacities.

Each tuning condenser is equipped with its own trimmer condenser, these being essential for equalising the minimum capacity in shunt with the tuning coils when the rotor is turned to the minimum position. The action involved here is fully explained in the article "An Easy Path to Ganging Condensers" contained on page 21 in this issue of the *Radiomag*, and to

which the reader is referred. These trimmers have a mica dielectric, thus keeping the dielectric losses to a minimum. They may each be given very fine adjustment by means of star shaped control wheels.

The maximum capacity of each section of the ganged condenser is .00053 mfd., the minimum capacity being of a very low order. The trimmers are each capable of giving a variation of .00005 mfd. between their maximum and minimum capacity.

Using the Telsen Screened Coils with the Telsen Triple Ganged Condenser and assuming average values for the stray capacities of the associated valve circuits, the tuning ranges available are:—

Long Wave	..	740 metres to 2,100 metres.
Short Wave	..	200 " " 560 "

An excellent slow motion device is incorporated in this design. It is powerful yet silky and smooth in action, besides possessing absolutely no backlash. The drive ratio is 7 to 1, which enables the most delicate of tuning operations to be performed. A clearly graduated scale is fitted, whilst an additional scale graduated in wavelengths is sent out with every ganged condenser. This will indicate true wavelengths when the ganged condenser is used with Telsen Screened Coils and its fitting under such circumstances is strongly advocated.

A metal cover that clips on very easily is available for totally enclosing the condenser. This keeps out dust and all foreign matter, and also protects the vanes from accidental knocks. It is easily removed. A pilot lamp holder is incorporated on the top of the cover, and is readily accessible.

The escutcheon plate is of well balanced design, having a wide aperture which gives a clear yet unobtrusive reading of the condenser scale. It has a handsome silver oxydised finish.

The same general remarks apply to the Telsen Twin Ganged Condenser W.306. This has two condenser sections, each having a maximum capacity of .00053 mfd. The back variable condenser is equipped with a trimmer condenser operated by a star wheel control, whilst the front variable condenser has a small variable compensator condenser with a maximum capacity of .00005 mfd. The control for this compensator is concentric with the main rotor spindle control, and it is of importance to notice that especial care has been taken in the design and in the assembly, so that these two spindles rotate absolutely independently of one another, whilst at the same time each maintains a smooth driving action.

The terrific increase in the number and power of the European broadcasting stations has resulted in the constructor's demand for selectivity and sensitivity becoming very exacting. The solution of this problem lies between the very selective straight multi H.F. screened grid and the superheterodyne receivers. Telsen's have, therefore, designed and perfected tuning coils to meet these needs, namely, the Telsen Band Pass Coils W.290, The Telsen Combined Band Pass and Oscillator Coil Unit W.292, the Oscillator Coil W.293 and the Band Pass Intermediate Frequency Transformer W.294. This range caters for the adherents of both the types of receivers mentioned above.

All these coils have self contained wavechange switch gear and are well screened, so that the electrostatic and magnetic fields generated in a receiver are excluded and their effects minimised to controllable limits. This is particularly called for in band pass filters, as otherwise the "square peak effect" that is so much sought after will be completely lost. It is also to be stressed that arrangements for earthing all the screens and switch rods are provided.

Power Presses In Action

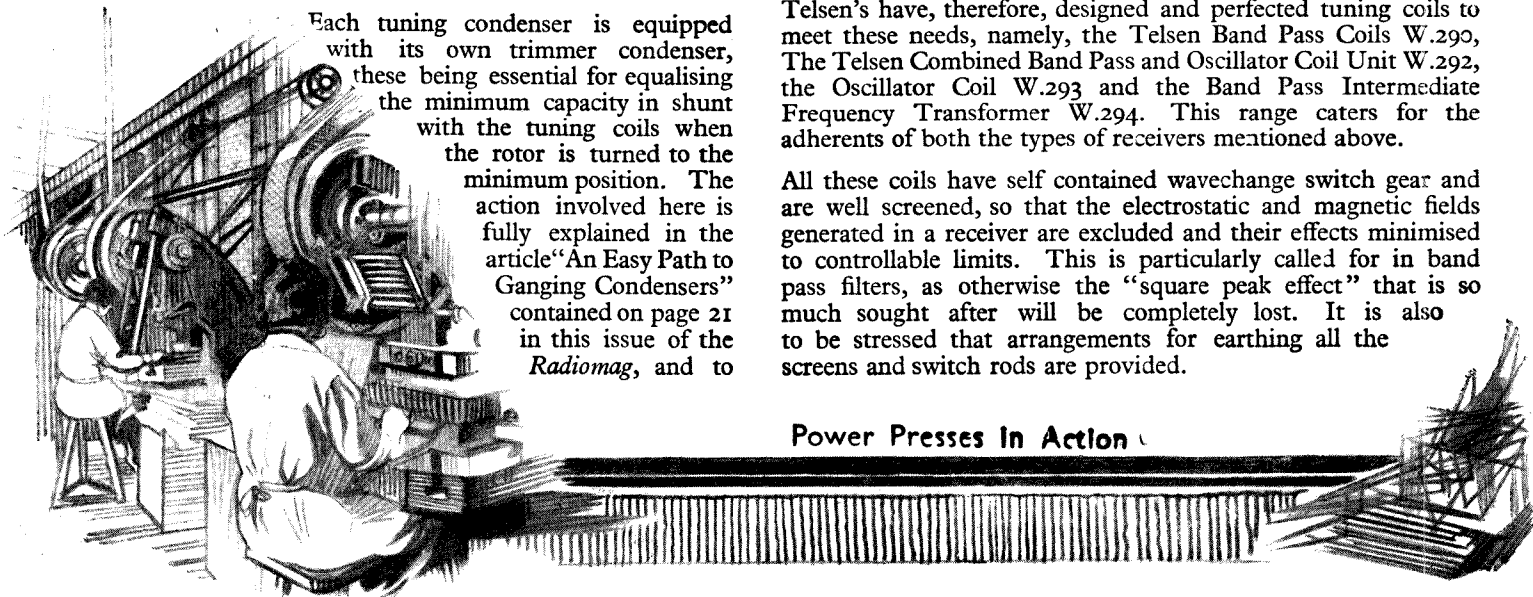

TELSEN BAND PASS AND SUPERHET COILS

—continued

Dealing first with the Band Pass Coils W.290, these are marketed in pairs. Both coils are mounted on a rigid but light metal plinth, thus allowing for accurate alignment of the switch gear

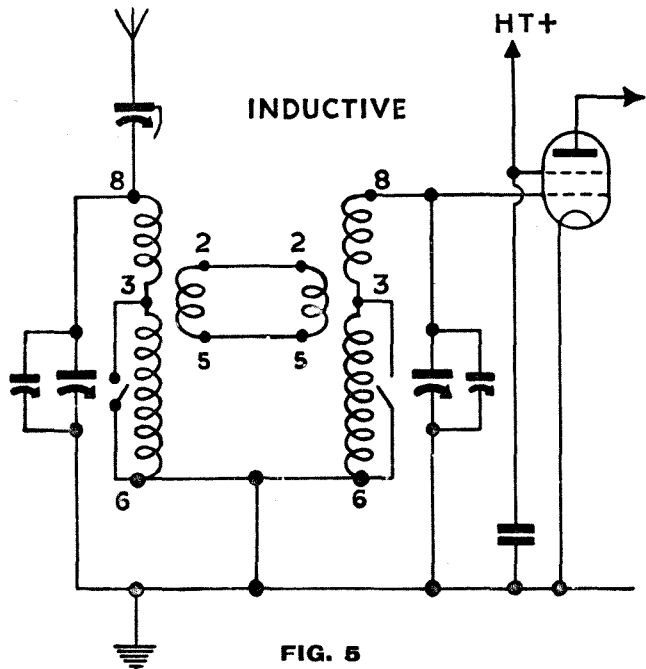

FIG. 5

and for ganged wavelength changing. The switch points are of very reliable design, giving positive yet lightly operated contact that guarantees reliable working even after prolonged use.

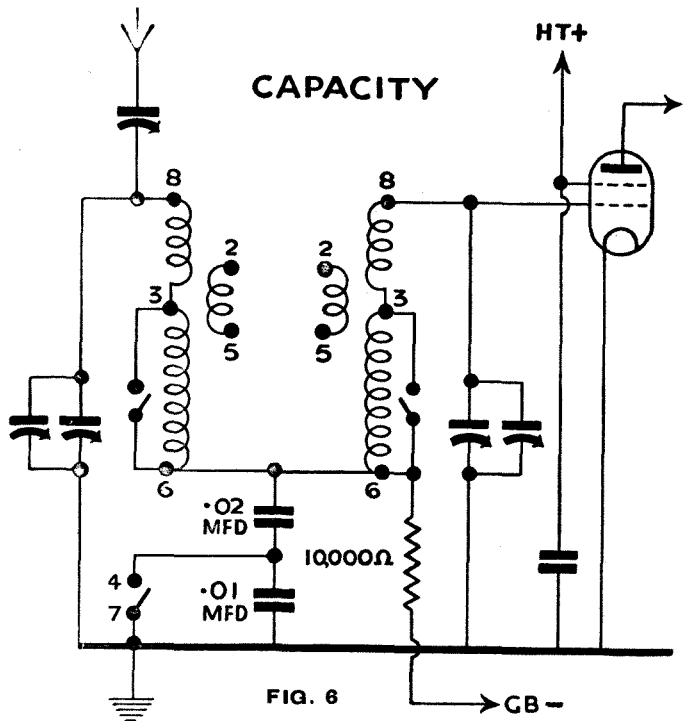

FIG. 6

The windings are wound on a ribbed former of high class bakelite finished in black, this combination reducing losses to a very low minimum. The windings are wound in accurately spaced slots in the ribs, and both coils are matched in inductance to one another with a very high degree of precision.

The unit is supplied complete with a wavelength change escutcheon with fixing screws and nuts. The control knob is of moulded black bakelite, and is of neat appearance.

The inductances of the windings are as follows, these being the values obtained with the windings completely screened.

- Medium Band 165 microhenrys.
- Long Band 2,170 "

The tuning ranges of these coils when used with a Telsen Twin or Triple Ganged Condenser, allowing an average value for the stray capacities usually associated with a receiver tuned circuit are:—

- Medium Band 200 to 560 metres.
- Long Band 740 ,, 2,100 "

There are three main uses for these band pass coils in the normal form of straight receiver, viz., the inductance, capacity, and mixed band-pass filters, each of which has advantages peculiar to the type of selectivity that is required.

It is well known that band pass filters enable high selectivity to be attained without undue attenuation of the high note frequencies, this being determined by the peak separation, and each of the above types have different effects at various wavelengths.

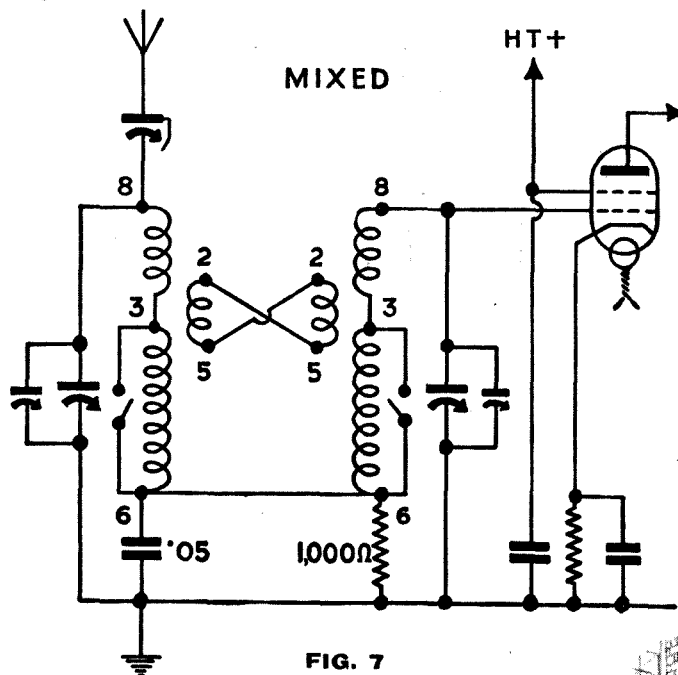

FIG. 7

Thus with the inductively coupled filter, depicted in Fig. 5, the peak separation broadens as the wavelength is decreased.

It is therefore more selective on the long wavelength range. At the same time it should be borne in mind that the efficiency is better the lower the wavelength, so a falling off in strength is experienced on the long wavelength band. In these days of highly efficient H.F. and L.F. amplification this last point is not serious, so it may be taken that

(continued on page 41)

A Power Press in operation.

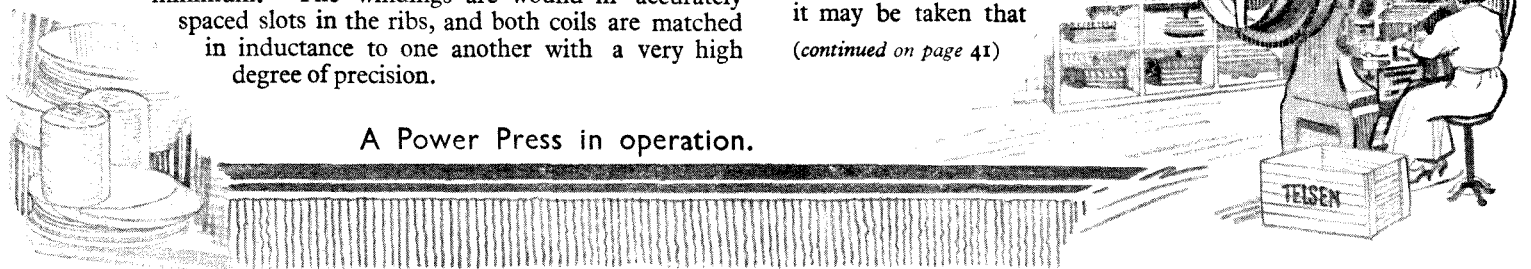



Purveyors of
Electric Lamps
By Appointment



Manufacturers
and Purveyors
of Electric Lamps
By Appointment

EDISWAN

The name that means 'EXCELLENCE'

**"RADIO
AS IT SHOULD
BE"**

means a good set and

an **R.K.**

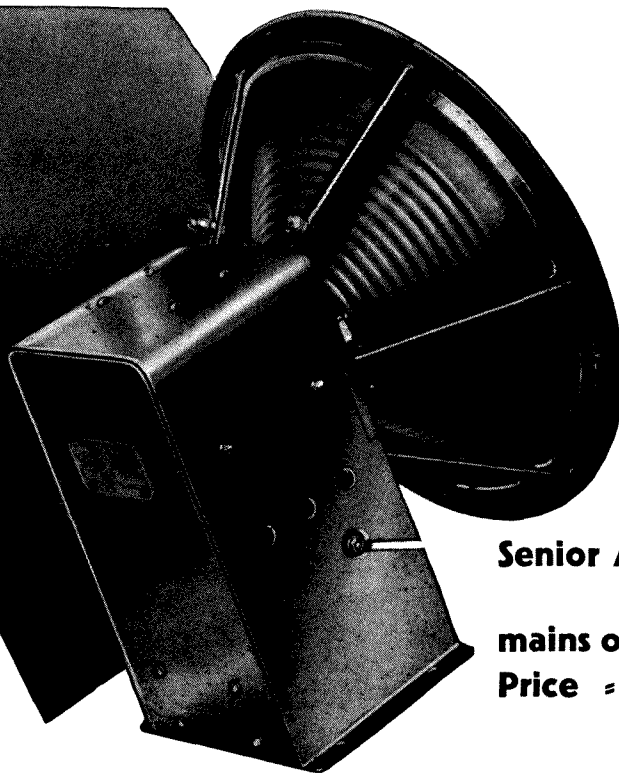

**Senior A.C. Unit
for
mains operation
Price = £7-15-0**

Now that R.K.'s are available at such low prices, there is no longer any need to put up with second-rate reproduction. In the R.K. range of speakers at prices from £2.17.6 there are models to suit all purses and purposes. Each is designed to give, in its particular sphere of operation, the characteristic R.K. balanced reproduction and fine sensitivity. All good radio dealers will be glad to demonstrate R.K.'s. A range of output transformers, specially designed for use with R.K.'s, is available.

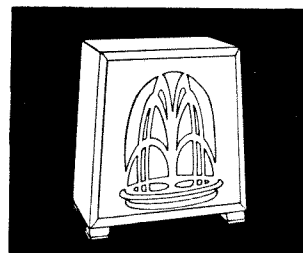

Minor R.K. Permanent Magnet Model. Prices :-
Fumed Oak "ARUNDEL" model £2.17.6
Walnut "ARUNDEL" model - £3.3.0

Senior R.K. Permanent Magnet Model. Prices :-
"WARWICK" model in Oak - £8.10.0
"WARWICK" model in Walnut £8.17.6

Senior R.K. Permanent Magnet Model. Price :-
"WINDSOR" model in Oak - £8.10.0

The above mentioned speakers are supplied complete with multi-ratio transformer.

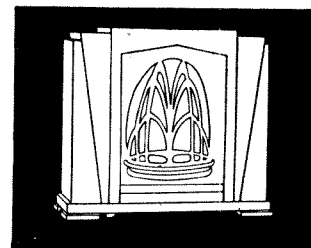
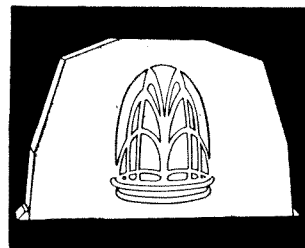

Specified by the B.B.C. for Broadcasting House.

B.T.H.
**MOVING COIL
EDISWAN RADIO**



**REPRODUCERS
100% BRITISH**

1933 MODELS

THE EDISON SWAN ELECTRIC CO. LTD.



155 CHARING CROSS RD., LONDON, W.C.2

GOOD RADIO DEALERS RECOMMEND EDISWAN

HOW to INSTALL an Efficient AERIAL and EARTH

IT may seem at first sight that any remarks on this subject are superfluous at the present day, since the practical requirements for an aerial and earth system are common knowledge, and their installation presents no great difficulties. It may be argued, for instance, that an external aerial conforms to the necessary requirements provided that it does not exceed 100 feet in length and is well insulated up to the aerial terminal on the receiver. Many apparently small details are consequently apt to be overlooked. Under modern conditions of broadcasting, the whole aerial and earth system assumes a prominent significance, and its efficiency whereby best results are to be obtained is of paramount importance. The increase during recent years, both in the number of broadcasting stations and in the power of their transmissions, has inevitably had its effect on reception conditions, and made it increasingly difficult to separate stations whose wavelengths are close to one another. The enormous strides made in modern receiver design have largely compensated for this lack of selectivity, but it is not generally realised how much the aerial and earth contribute to getting the best out of a receiver.

Too long an aerial, while making for improvement in the reception of weak or distant stations, has an opposite effect on selectivity, and makes the separation of interfering stations more difficult. If, on the other hand, it is too short, the number and strength of stations received will be reduced, but selectivity will be improved. A compromise is therefore desirable, but for the most favourable all round results it is preferable to have the aerial too long, improving selectivity by looser coupling at the receiver input, rather than impairing its efficiency by having it too short. The length recommended is from 60 to 80 feet, which should include the down-lead, and the height should be not less than 30 feet. The lead-in tube should be preferably about 12" long, the major portion being outside, so as to avoid the possibility of the down-lead touching the side of the house or any overhanging projection. The lead-in tube is usually passed through a hole drilled through the window frame, and in doing this from the inside, it is advisable to drill the hole, not horizontally but with a slight slope downwards to the outside (see sketch). In this way, the tendency for any moisture to find its way along the tube into the house will be avoided.

Outdoor Aerial. It may be said at once that a single span outside aerial invariably gives the most satisfactory results. Where space is limited, this is not always practicable, but it should be remembered that where a single span of aerial cannot be put up, two lengths or more kept apart by "spreaders" and joined to a common down-lead may reasonably be expected to be quite satisfactory. A typical two-wire aerial is shown in the

accompanying sketch. This is also a convenient method when erecting a roof aerial.

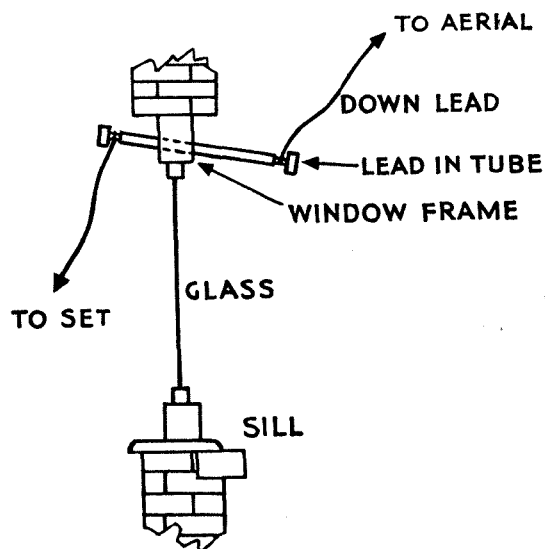

Aerial Wire. Any good quality aerial wire is suitable, but it should be stranded copper wire, and if enamelled wire be used so much the better, as this will make for greater efficiency by decreasing the high frequency resistance. Single wire is not advisable—and iron wire should definitely be avoided, as corrosion will eat it away and give rise to crackling noises in the reproduction from the speaker.

Insulators. These are made in various shapes and sizes. Not less than two should be fitted at each end of the aerial between the guy lines, and obviously the more that are used, the less chance will there be for leakage of signals to earth. At the same time, too many will add to the weight and cause the aerial to sag. Three at each end makes a good compromise, and they should be spaced about a foot apart.

(cont. on page 12)

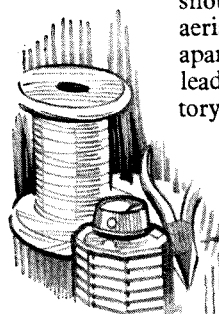

A Corner of our Aerial Coil Dept.

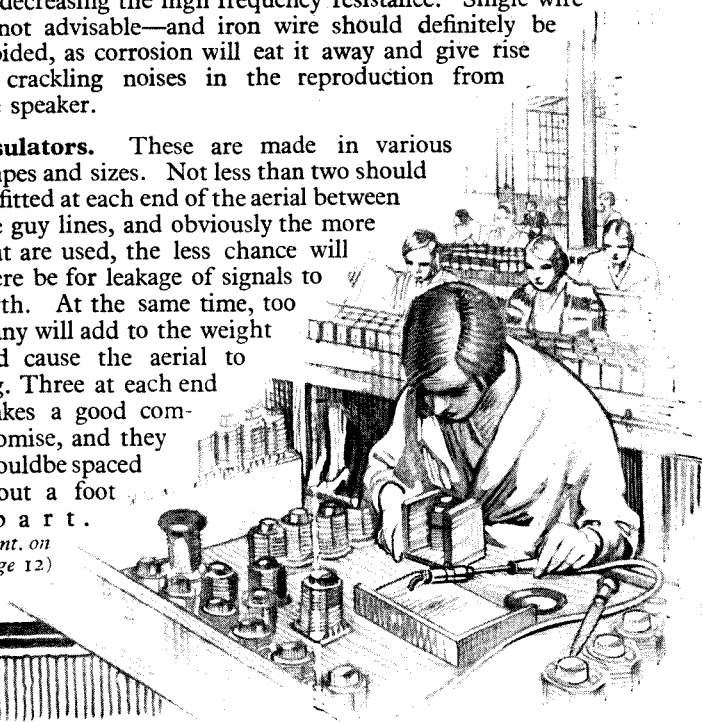

HOW TO INSTALL AN EFFICIENT AERIAL AND EARTH—continued from page 11

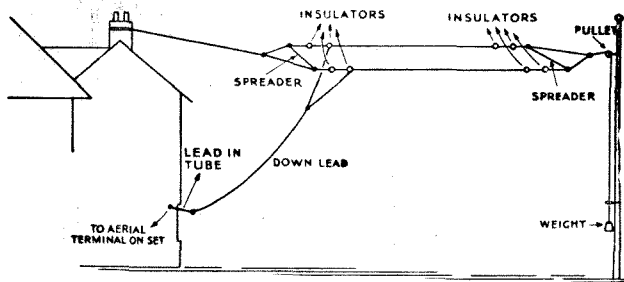

Erecting the Aerial. Facilities for fixing the aerial must necessarily depend on the space available, individual circumstances and local conditions or restrictions. If you are situated not far away from the local station, it is a good tip to bear in mind that if you can arrange for it to run in a direction at right-angles to that of the station, it will sometimes appreciably help in the cutting down of the strength of the local transmissions, which might otherwise cause excessive interference when trying to receive other stations. Conversely, the directional properties of an aerial will go a long way towards improving sensitivity on a weak station if the aerial is disposed in the direction of the station.

The first thing to do is to determine the height of the aerial, and hence the length of the down-lead from the aerial to the lead-in tube. From a 100 foot coil of aerial wire we now measure off this length and thread an insulator over the wire up to this point. Two or three twists of the insulator will be sufficient to keep it in position. We now link two more insulators to this one, spacing them about a foot apart and taking care that the connecting wires do not touch each other or the aerial wire. As a 100 foot coil is more than we need, short lengths of wire cut from the longer end will come in handy for linking up the insulators. It should be noted that there is a right and wrong way of connecting insulators as shown in the following diagrams.

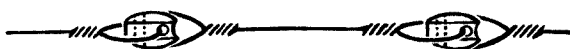

RIGHT WAY

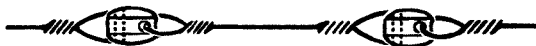

WRONG WAY

The third insulator is next anchored by a stay wire or guy line to a convenient chimney stack or wall bracket, leaving sufficient length of line so that when in position the down-lead is well clear of the house or any obstruction. To complete the receiver end it only remains to connect the down-lead to the lead-in tube terminal, taking care where enamelled wire is used to scrape away the enamel from the end of each strand before connecting to the terminal, and to screw the terminal up tight.

At the far end of the aerial, we now cut off the excess length and attach three more insulators as already described. It is well to remember here that it is better to have the aerial higher at this far

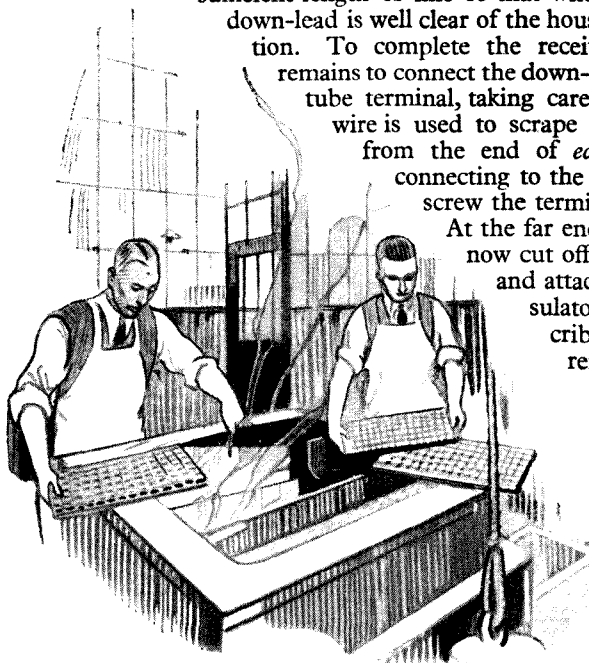

end where possible, but at the same time it should be uninterrupted height. That is, the aerial should not pass over a tree or building, which would only give it an effective height of the distance above these obstructions. For this reason it is better, if need be, to have a lower aerial with uninterrupted height, than a higher one which, from a high frequency point of view, is virtually lower. Moreover a tree, especially when wet, will make quite an effective signal path to earth, should the aerial touch it, and give rise to crackling noises and other disturbances.

We must next attach a guy line to the end insulator and haul the aerial up until the wire is reasonably taut. To make a neat and complete job of this, it is useful to be able to haul the aerial into position by means of a rope and pulley. Under "Practical Hints and Tips," a further refinement is described whereby excessive strain on the aerial, caused sometimes by high winds, is obviated.

On the inside of the house, the receiver should be installed as near to the lead-in as possible, so as to avoid a long aerial wire between the lead-in and the aerial terminal of the receiver. The wire should consist of heavy rubber-covered flex, and kept away from any telephone, electric light or mains cables.

Indoor Aerial. Where facilities do not permit of a suitable outdoor or roof aerial, resort has to be made to some sort of indoor aerial. The usual practice is to run an insulated wire round the picture rail. Where this is done, it is advisable to keep it away from the wall as much as possible.

Another method that has been used with some success is to run a number of parallel wires of small gauge (about 28 s.w.g.) across the room between opposite picture rails, connecting the ends along one side to a common lead going to the aerial terminal of the receiver (see sketch A). Old gramophone needles come in very useful for anchoring the ends of the wire on the picture rail, and if the wire used is white silk or cotton covered, it will be almost invisible; but do not forget to make bare wire connections at the places where the parallel wires join the common wire to the set. The gramophone needles should be tacked into the top of the picture rail with a slight lean towards the wall, so that the wire does not slide off (see inset).

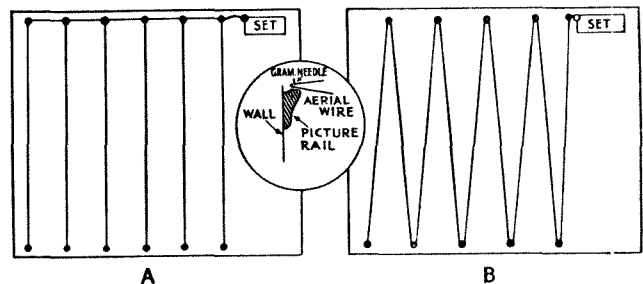

A similar method to the above, and more easily tried out, is to run a single wire zig-zag fashion between the picture rails. Start at the end of the room farthest from the set, and having placed anchoring needles at suitable intervals, fix the end of the wire to the first one and run it backwards and forwards across the room to a position above the set, where it can be run down to the aerial terminal (see sketch B). Although the aerial in this method has a "doubling back" effect, it also has a higher inductance, so that it is a matter of trial as to which method will give the most satisfactory results in individual circumstances.

(continued on page 60)

A Corner of our Self Sealing Condenser Dept.

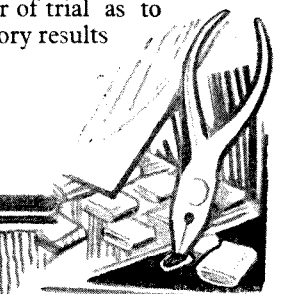

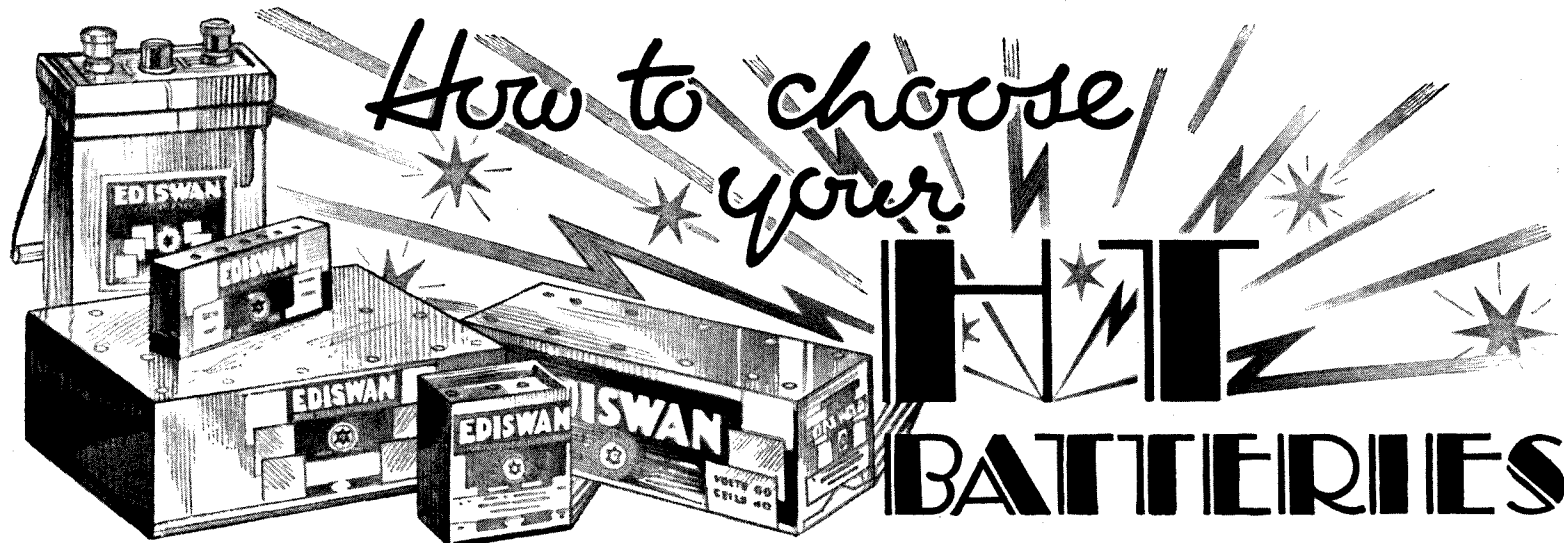

A battery set, taken valve for valve, is always inferior to an electric set in the matter of performance, due primarily to the rather limited power supply available for its operation. This applies particularly to the high tension supply, the maintenance of which forms the major portion of the running expenses of the battery operated receiver. However, the recent development of battery valves giving greatly improved power output and sensitivity, together with a moderate current consumption, as compared with former types, has made it possible to produce battery receivers having a splendid performance, especially when used in conjunction with the latest circuit technique. Two such receivers are exemplified in the Telsen "Super Six" and the Telsen "Super Selective Four" receivers described in this issue of the *Radiomag*. These two battery operated sets give sufficient output to operate a moving coil loudspeaker and with such range and selectivity as to be a revelation to those accustomed to ordinary standards of battery set performance. The performance of any battery set, however, is made or marred by its H.T. supply, and it is to be feared that most battery set users are not fully cognisant of this fact. A little care exercised in the choice and subsequent use of the H.T. battery is amply repaid in the increased satisfaction obtained, and the longer life given by it. As it is an article which has, in any case, to be replaced at some future date, there is a tendency to purchase the cheapest type of battery available, it being thought that thereby an economy is being effected. This is not necessarily true.

A battery of small capacity (i.e., having small cells) costs less than a battery of larger capacity that possesses larger cells, but the smaller battery may ultimately prove to be dearer if used to supply a receiver that requires a large H.T. current to operate it satisfactorily. It is well known that the effective capacity of an accumulator is greatly reduced if the rate of discharge is too high. For example, the quantity of current drawn from it before recharging becomes necessary, may be only 15 ampere hours, instead of the rated 20 ampere hours, if the discharge rate is beyond the rated maximum discharge value. It is not generally realised that the same thing applies to a dry H.T. battery. Thus the dry H.T. battery also has a capacity which may be expressed in ampere hours, and similarly this is reduced if the battery is discharged at an excessive rate. The full capacity for which the user has paid is not realised, hence there is an invisible source of loss, which may amount in some cases to as much as 25 per cent.

On the other hand, by using a large battery to supply a receiver having a small current demand, the user may be

involved in another source of loss. The reason for this is that if an H.T. battery is allowed to stand for more than a certain length of time, it will be found to be "run down" through internal (local) action of an electro-chemical nature. This period of time is usually referred to as its "shelf life," and varies according to the quality of the battery from about eight to fifteen months. Thus, a battery may have a sufficiently large capacity to supply current demands of a given receiver for say, 18 months, but if its "shelf life" is only nine months, it will be useless when only half of its theoretical capacity has been utilised.

In the case of the more reputable makes of H.T. batteries, the maximum economical discharge rate is stated on the battery, and if the consumption of the receiver approximates to this, the most suitable compromise is being effected between a possible reduction of capacity due to too high a discharge rate, or a loss of effective capacity through exceeding the "shelf life" by discharging the battery too slowly. Another way in which some battery users attempt to economise in the running expenses, is by purchasing batteries of very moderate voltage output. Except where space is restricted as in the case of portable receivers, the standard 120 volt size battery is infinitely preferable to the undoubtedly popular 99 or 108 volt types. The extra couple of shillings or so involved in its purchase price is more than justified by the improved volume and quality obtained.

Finally, when choosing a battery, it should be remembered that the difference between a battery by a reputable maker and a cheap battery of obscure origin, is more than that of price. The use of good quality chemicals, ample inter-cell insulation, and solid drawn zinc containers in the better class battery, ensures a long "shelf life" with freedom from annoying crackling noises.

Bearing these facts in mind, we strongly recommend that "Ediswan" batteries be used with all the Telsen Constructor Sets. For the Telsen "Super Six" and the Telsen "Super Selective Four" receivers, Ediswan 120 v. "Super Capacity" batteries, Cat. No. 69728, are suitable. Alternatively, two Ediswan 60 volt "Super Capacity" batteries, No. 69724, may be connected in series.

(continued on page 63)

High-speed Automatic Machines in action

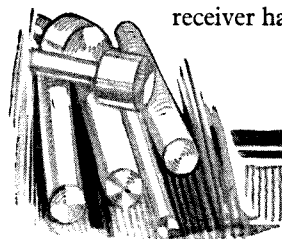



**A POWERFUL ALL-MAINS RECEIVER GIVING EXCEPTIONAL QUALITY OF REPRODUCTION
DESIGNED BY THE TELSEN TECHNICAL STAFF**

THE Telsen "All Mains S.G.3" Receiver has been evolved to meet the demand for a constructor's first class three valve mains set. Quality of reproduction and freedom from interference are undoubtedly the two primary requisites of a receiver intended for the reception of broadcasting, and it is a well known fact that the simultaneous attainment of these qualities is a matter of considerable difficulty. The Telsen Technicians have solved this problem by intensive research, and in building this set, the constructor can rest assured that he will own a receiver which will be the envy of all his friends.

In presenting the Telsen "All Mains S.G.3" no exorbitant claims are made for its performance, but it is claimed that the absolute maximum results are obtained for the number of valves used. The constructor who builds this receiver will not be slow to discover that in spite of its extreme sensitivity and selectivity, it is essentially a high quality reproduction set for both distant and local broadcasting stations, and as such, it is bound to make a very strong appeal to the music lover.

In fact, the reproduction is of such excellence, as to be comparable with that given by the finest grades of musical instruments.

A great many constructors wish their radio set to do more than receive broadcasting, by utilising it for the electrical reproduction of gramophone records. The Telsen "All Mains S.G.3" is readily adaptable for this purpose, and provision for connecting a gramophone pick-up is made at the back of the set. It can therefore be seen that this receiver is ideal for building into the form of a radio gramophone.

That portion of the low frequency amplifier which is used for the reproduction of gramophone records has a very even response over the whole range of frequencies encountered in good quality reproduction, the only limiting factors being the choice of the loud-speaker and pick-up. The Telsen Electric Company have just released a remarkably fine pick-up that is eminently suited for the "All Mains S.G.3." Full details for fitting this component are given elsewhere in this issue of the *Radiomag*.

From a brief inspection of the theoretical circuit shown in Fig. 1, it can be seen that the three valves are arranged as a combination of H.F. detector and pentode. The aerial is loosely coupled to the screened grid high frequency valve by one of the Twin Matched

Screen Coils W.287; this valve in its turn is coupled to the detector by the second screened coil. These Twin Matched Screened Coils allow of ample volume with knife edge selectivity, and in conjunction with the new Twin Gang Condenser W.306, enable the two tuned circuits to be operated simultaneously by one tuning control, thus giving the maximum ease of

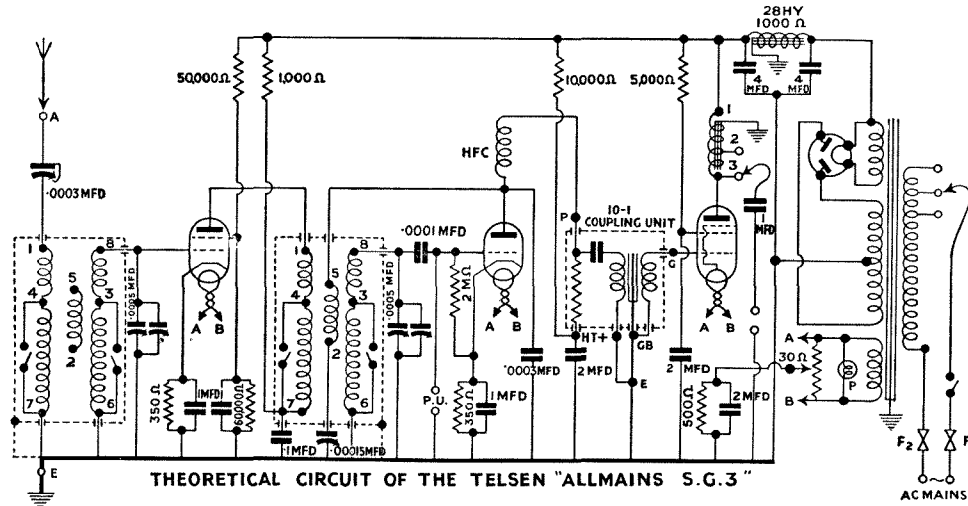
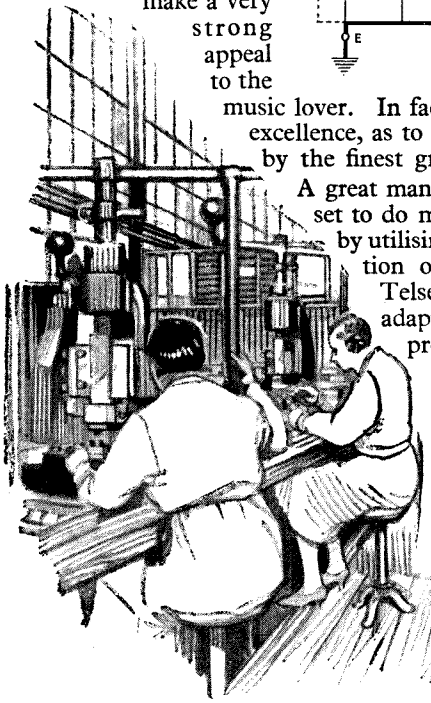
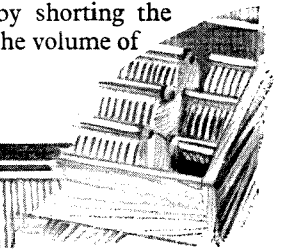

FIG. 1.

operation. A control called the "Separator" is incorporated in this receiver, and is an invaluable adjunct for aiding selectivity, especially when the set is operated in districts very near to powerful transmitting stations. This control consists of a small variable condenser of .0003 mfd. maximum capacity and is fitted with a switch that enables the capacity to be shorted out. This component is placed in series with the aerial and the loose coupled aerial coil, and by suitable manipulation, any interfering stations may, with the greatest of ease, be entirely cut out; at the same time this control may also be used for regulating the volume level. The switch which is fitted to the "Separator" comes into operation on the last $\frac{1}{3}$ of the control travel, and by shorting the condenser gives a considerable increase in the volume of



Some of our Hand Presses in action



THE TELSEN ALL-MAINS S.G.3.—continued.

reproduction. This will be found especially useful on Sundays, when a number of the weaker Continental stations can be received at full concert strength, during the B.B.C. "off" periods.

Both the long and medium wavelength bands are fully covered, the change over in range being made by switching both coils over simultaneously with one movement of a small knob on the front panel. As a further aid a volume control is included. This applies reaction to the detector valve circuit and besides fulfilling its main purpose—that of controlling volume—is a great help in gaining additional selectivity.

The pentode valve is fed from the Telsen 10—1 Coupling Unit W.215. This gives a very high step-up in amplification to the output valve, which, when used in conjunction with the Telsen Tapped Pentode Output Choke W.72, ensures that realistic reproduction which is one of the special features of this set. The output given is sufficient to operate the largest of coil driven loudspeakers at good strength.

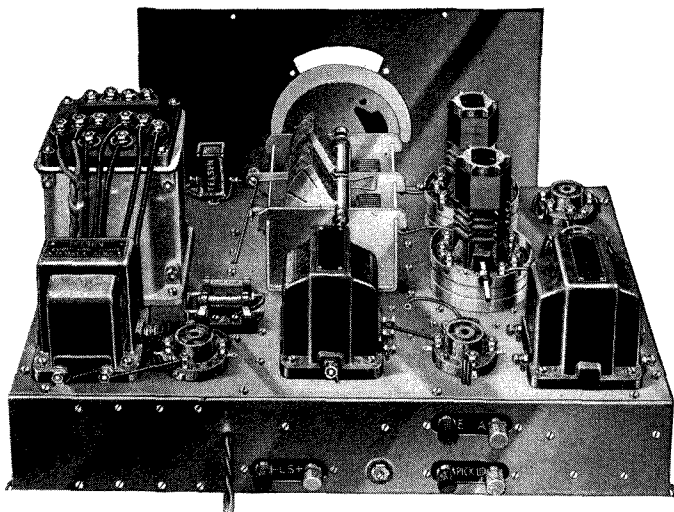

THE TELSEN "ALL-MAINS S.G.3"
Completely assembled, with Valves and Coil Screens removed, showing connections.

The power required to work the set is drawn from alternating current supply mains, so that one of the most important components included in this set is the new Telsen Mains Transformer. This power supply unit has been designed along very generous lines in order to give the most economical operating costs for the receiver. It is equipped to supply both low and high tension windings. The high tension has two windings that feed the plates of a full-wave rectifier valve. The high tension supply is passed from the valve through the Telsen 28 henry L.F. Smoothing Choke W.302. This well designed choke acting in conjunction with two large condensers, effectively smooths out the voltage ripples, giving a steady H.T. supply and so eliminating hum in the H.T. circuits. For the low tension supplies there are two windings on the transformer—one winding supplying the L.T. voltage to the heater of the rectifier, and the other winding, the L.T. voltage for the heaters of the receiving valves. The transformer is of massive construction and after a prolonged run under load, remains perfectly cool. An attractively finished bakelite cover is fitted over the panel on which the connections are made from the transformer to the receiver stages, and thus the constructor is protected from shocks that he might otherwise experience if the transformer terminals were left exposed.

Three types of transformers are available for this receiver, namely :—

200—250 volt,	40—100 cycle,	Cat. No. W.300.
100—110 "	40—100 "	" " W.291.
200—250 "	25—40 "	" " W.301.

The above range covers all the combinations of alternating voltages and frequencies that are met with in the British Isles, so that wherever a constructor has A.C. mains, a Telsen Mains Transformer can be obtained to satisfy his supply conditions. Fuses are also incorporated in the mains supply leads, and prevent the components being damaged should the wiring be wrongly connected up. A quick make-break Mains Switch W.297 is used for controlling the mains supply to the receiver, and is operated by a neat tumbler switch action on the front panel. All the most modern methods of automatic grid bias are employed throughout, grid bias batteries being entirely dispensed with, while the extensive decoupling of all the circuits ensures absolute freedom from all forms of back coupling and self oscillation. In this way the maximum amplification and efficiency are obtained from each stage of the receiver. The set is exceptionally easy to construct, and will give excellent results in any part of the British Isles where A.C. mains are available.

On examining the construction of the chassis, it will be seen that it is built throughout of metal. This is a very essential and desirable feature, for not only does it provide very efficient screening between the various circuits that are working at a very high efficiency, but also gives great mechanical rigidity and strength. The chassis is supplied in four parts, namely the front panel, front plate, top plate and the back plate; these bolt together in the simplest manner imaginable. The front plate that carries all the controls has a high class black crystalline finished surface, and gives a very smart appearance especially when seen in a cabinet. The component parts are bolted to the chassis plates and are so placed as to give the most efficient results, as well as present a clean and neat appearance.

A 1/- full size Blue Print showing the complete assembly and wiring of the Telsen "All Mains S.G.3" is given away free with this issue of the *Radiomag* which, with the help of this article, enables the set to be easily and quickly constructed. Full details are also given for making all the necessary adjustments in order to obtain the most efficient selectivity and reproduction.

A complete list of the components required for building this receiver is given at the end of the instructions; this list calls for a Constructor's Outfit W.303, which contains a complete set of metal plates and panels, tools, wire, insulating sleeving and the usual small gear needed in the construction of a receiver of this type.

Those Constructors who wish to purchase all the necessary components and accessories as a complete kit may do so by obtaining a Telsen "All Mains S.G.3" Kit suitable for their own particular supply, mains voltage and frequency. These kits will be found listed at the end of this article.

The remainder of this article deals with the complete construction and wiring of the Telsen "All Mains S.G.3," followed by an account of

(cont. on page 17)

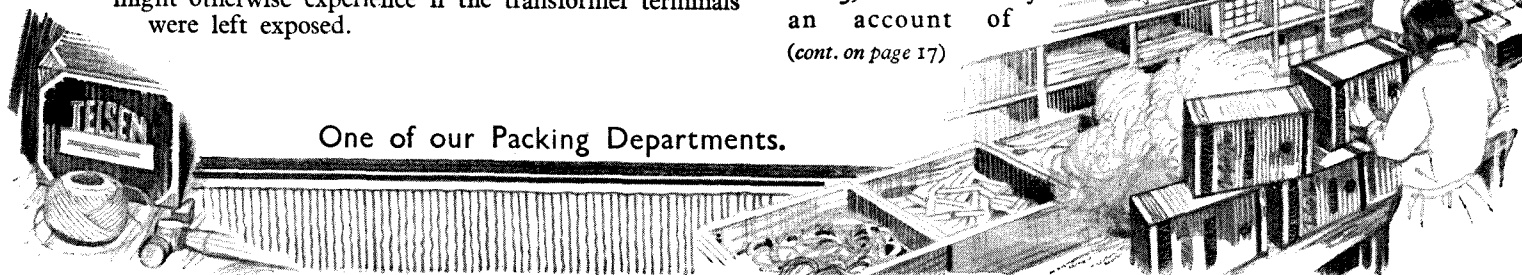

One of our Packing Departments.

TELSEN

1933 *Kit* SETS

meet every need of the Home Constructor

IN the kit sets illustrated below the Home Constructor can make his selection from the humble but staunch 3-valver to the most prominent of modern selective receivers. These 1933 Telsen kits are supplied complete (less valves), and the assembling and operating instructions have been so simplified for each particular set that even the most elementary radio constructor cannot fail to obtain successful results with these most remarkable receivers.

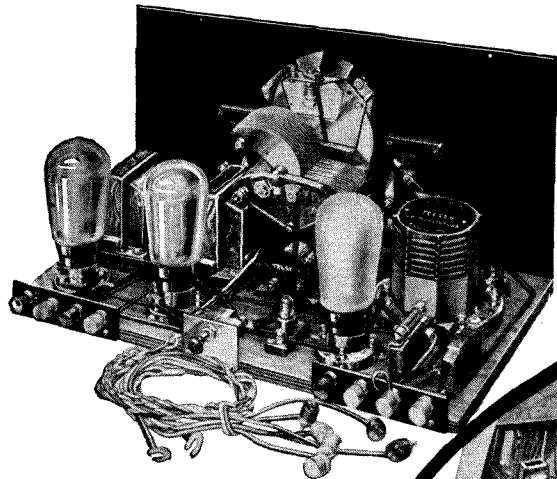

Telsen "Strala" Three Receiver
 A remarkably attractive receiver at extremely moderate cost, giving a particularly outstanding performance with regard both to selectivity and quality. All controls are mounted on a single escutcheon plate of elegant design, medium and long wave ranges are covered, and provision is made for gramophone pick-up. Complete kit of parts (less valves) **39/6**

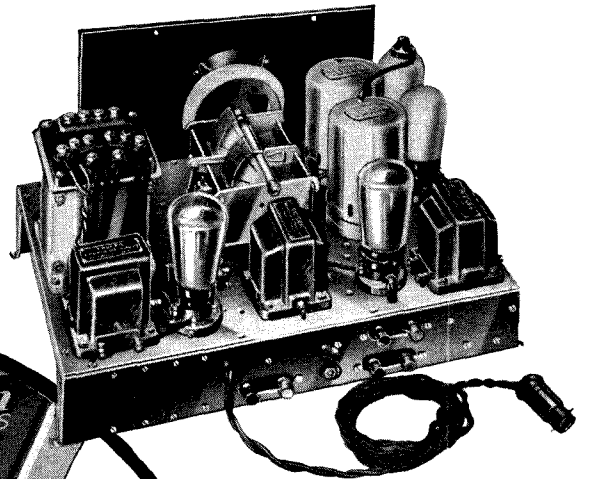

Telsen "All Mains S.G.3"
 An all mains receiver, giving unflinching service, a leader in the all mains class for the home constructor, single knob control, entirely free from hum. Excellent quality, volume, and remarkable selectivity. Complete kit of parts (less valves) **138/6**



An illustration of a Telsen Kit Set as supplied complete in carton.

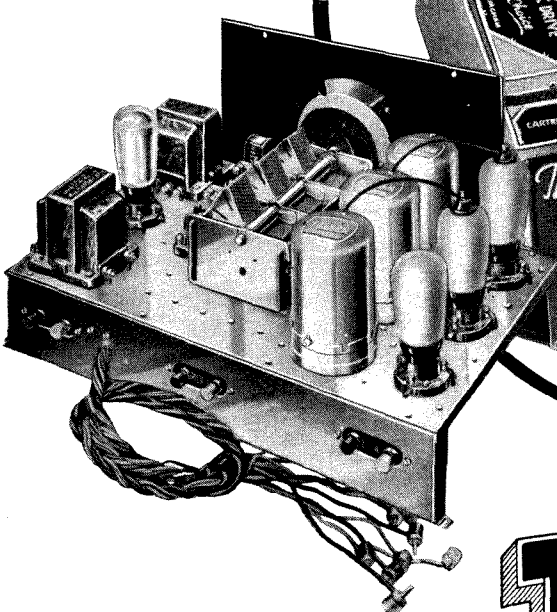

Telsen "Super Selective Four"
 The most advanced straight circuit yet designed. Three tuned circuits giving super selectivity with unrivalled quality and volume, single knob control. Easy to construct and economical to run. Complete kit of parts (less valves) **98/6**

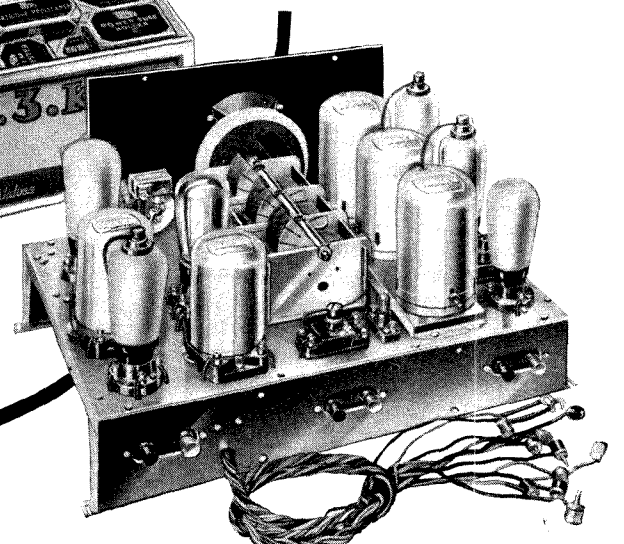

Telsen "Super Six"
 The most astounding Home Constructor's Kit ever evolved. Special patented Telsen circuit, with single knob control, low battery consumption, brilliant performance, knife edge selectivity, superlative quality and enormous power. Complete kit of parts (less valves) **118/6**

TELSEN

RADIO COMPONENTS

TELSEN ALL-MAINS S.G.3.—continued from page 15.

the best way for adjusting the set to obtain maximum results.

ASSEMBLY OF FRONT PANEL AND FRONT PLATE

Before the constructor begins the assembly of the components to the chassis, he should carefully read the part of the article on the Telsen "Super Selective Four" receiver that is to be found on page 55 of this issue of the *Radiomag*. The instructions given there for the assembly of the front panel to the front plate are applicable in every detail to the assembly needed here, and the same remarks also apply to the mounting of the various controls and components on the front panel. This assembly should therefore now be undertaken.

ASSEMBLY OF COMPONENTS ON UNDERNEATH SIDE OF THE TOP PLATE

The underneath side of the top plate, which measures $16\frac{1}{2} \times 9\frac{1}{2}$ ", is distinguished by the fact that it has turned up lips at two of its ends. To simplify the assembly, all the screw holes that are used to bolt down components are numbered, and their positions are clearly indicated in the Blue Print. The Blue Print also shows the exact positions of the components. Thus, take an Anode Cartridge Resistance Holder W.286 and, as indicated in the Blue Print, place it so that its fixing holes coincide with holes 31 and 33. Insert two cheese-headed screws provided in the Constructor's Outfit through these holes, so that the heads of the screws are on the top side of the top plate. Nuts are also provided in the Outfit, and two of these should be tightened up on to the screws. The constructor should proceed with the assembly in this manner. There are six more resistance bases to be fastened to the underneath side of the top plate, a complete list of all the numbered holes with the components being given below:—

Fit Anode Resistance Holder in holes ..	31—32
„ „ „ „ „ „ ..	11—12
„ „ „ „ „ „ ..	13—14
„ „ „ „ „ „ ..	15—16
„ „ „ „ „ „ ..	19—20
„ „ „ „ „ „ ..	23—24
„ „ „ „ „ „ ..	25—26
Fit 1 mfd. Self-Sealing Condenser in holes ..	1—2
„ I „ „ „ „ „ ..	3—4
„ I „ „ „ „ „ ..	7—8
„ I „ „ „ „ „ ..	9—10
„ 2 „ „ „ „ „ ..	5—6
„ 2 „ „ „ „ „ ..	17—8

Assemble together the .0001 mica condenser and two megohm grid leak as shown in Fig. 2, and fit this combination into holes 33—34.

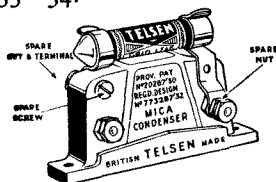

FIG. 2.

- Fit .0003 mica condenser in holes .. 28—29
- Fit Standard H.F. choke in holes .. 27—30

This now completes the assembly of the components to the underneath side of the top plate.

ASSEMBLY OF BACK PLATE

The components are assembled to this plate in a similar manner.

Fit 2 mfd. Self-Sealing Condenser in holes ..	46—47
„ 2 „ „ „ „ „ ..	48—49
„ 2 „ „ „ „ „ ..	50—51
„ 2 „ „ „ „ „ ..	52—53
„ 2 „ „ „ „ „ ..	54—55
„ I „ „ „ „ „ ..	35—36
„ Anode Resistance Holder in holes ..	37—38
„ Loudspeaker Terminal Strip to holes ..	44—45

(Care should be taken to see that the wording on the strips shows through the slotted holes provided in the back plate for this purpose.)

- Fit Pick-up Terminal Strip in holes .. 41—42
- „ Aerial-Earth Terminal Strip in holes .. 39—40

These strips are provided in the Constructor's Outfit.

Terminals should now be fitted to all these terminal strips. Looking at the outside of the back plate, the red terminals go into the right-hand holes of the strips, while the black terminals should be placed in the left-hand holes. Securing nuts are provided with these terminals. The Hum Adjuster W.299 is now fitted (see Fig. 3). To do this, first remove the lock-nut from the screwed shank and also take off one large insulating washer.

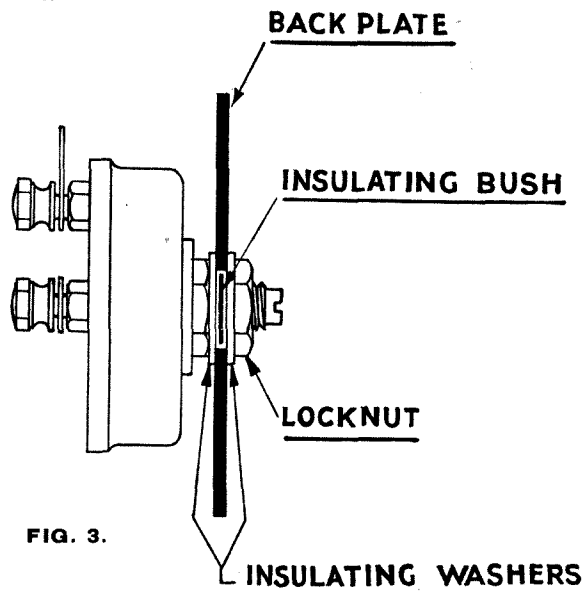

FIG. 3.

Insert the screwed shank from the inside through hole 43 and fit it into position so that the large insulating washer is flush with the inside face of the panel, thus locating the small bush in the panel hole. Now place the remaining large insulating washer over the shank from the outside, so that it also lies flat with the face of the panel. The lock-nut can then be replaced on to the shank and screwed up tightly. The back plate is not at this stage fitted to the top plate, this operation being done at a later period of the assembly.

ASSEMBLY OF COMPONENTS ON TOP SIDE OF TOP PLATE

The Mains Transformer should be fitted first, its position being found by means of the Blue Print. It is secured through the screw holes 60, 61, 62 and 63. It will be seen that holes 61 and 62 are slotted. These slots are provided to allow for the extra length of the 25 cycle Mains Transformer, where this type is used.

Next turn the chassis up on end so that the transformer is resting on the bench, the weight of it keeping the chassis firm, and rendering it accessible

(cont. on page 18)

A Battery of our Hand Presses in operation.

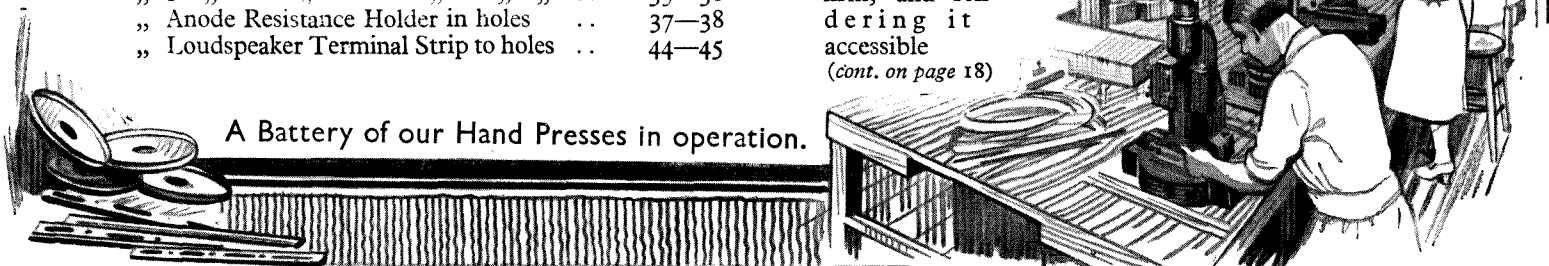

TELSEN ALL-MAINS S.G.3.—continued from page 17

from both sides. The valve-holders are shown in the Blue Print as V_1 , V_2 , V_3 and V_4 .

Therefore:—

Fit 5-pin valve-holder (solid type)	V_1 into holes	82—83
” 5 ” ” ” ” ”	V_2 ” ”	80—81
” 5 ” ” ” ” ”	V_3 ” ”	74—75
” 4 ” ” ” ” ”	V_4 ” ”	68—69
” 10—1 Coupling Unit in holes	76, 77, 78, 79
” L.F. Smoothing Choke in holes	56, 57, 58, 59
” Tapped Pentode Output Choke in holes	70, 71, 72, 73	
” Fuse-Holder in holes	64—65
” ” ” ” ” ”	66—67
” Screened Coil in holes	84—85
” ” ” ” ” ”	86—87

Great care should be taken here. The plinths screwed on to the coil bases should be removed and replaced in an inverted position under the screen bases and coils on the top plate, being secured to the latter with the six 1" 6 B.A. screws and nuts provided in the Constructor's Outfit. It should be carefully ascertained that the coil numbered terminals are correctly disposed as shown in the Blue Print, and that the small pressed out lips on the bases are located in the correct way. Before finally tightening up the coils to the top plate, the switch rod provided with these coils should be inserted so as to pass through the coil switch holes, at the same time placing the switch stop between the coils as shown in the Blue Print. Fix the wavechange knob on to the switch rod where it projects through the front panel and slide the rod backwards or forwards until the knob has the same spacing from the panel as the Separator and Volume Control knobs. Care should also be taken to see that the small spring clips on the coil bases make good earthing contact with the switch rod. The coil assemblies may now be finally tightened down, and the grub screw of the switch stop properly tightened against the flat face on the switch rod. Slide a coil switch-rod collar on to the switch rod so that it presses lightly against the screen base of Coil B7, and tighten up the grub screw, and replace the screens on the coil bases to avoid damage to the coil windings due to accidental knocks. These should be kept on as much as possible, being replaced after every wiring operation.

Fit Twin Gang Condenser to holes .. 90, 91, 92

The knobs should be removed and the gang condenser placed in position on the top plate so that the spindle projects through the centre hole provided in the front panel. Hold the condenser in position, and insert the 4 B.A. screws provided with it, through the holes 90, 91, 92 so that they enter the corresponding screwed holes in the condenser base. Adjust the condenser by sliding it backwards or forwards until the tuning scale is just clear of the back of the escutcheon plate. The condenser may now be screwed firmly into position. The cover on the condenser should be kept in position in order to prevent the moving vanes from being damaged by any accidental knocks.

This now completes the assembly of the components and the receiver is ready for wiring.

WIRING & COMPLETING THE CHASSIS ASSEMBLY

In the Constructor's Outfit will be found the necessary wire and

insulating sleeving which is to be used in wiring up this receiver. The majority of the wiring is carried out by the "tinned copper wire and sleeving method." For conveying the high voltages from the transformer, pull-back wire covered with sleeving is used, whilst twisted flex is utilised for the mains and L.T. heater leads.

An inspection of the Blue Print will show that two views of the receiver are given, one looking at the upper side of the top panel and the other at the underneath side. This gives all the necessary views of the chassis, thus enabling the constructor to wire up the receiver very easily. It should also be noticed that the front and back plates are indicated as being laid flat, whereas they are in practice, actually in a vertical position. This presentation of layout makes the wiring more easy to follow.

Each terminal point is numbered, while each hole through which a wire passes has a corresponding number with the letter H against it. It should be clearly understood that where a hole having a number with the letter H after it is shown, then the wire has to pass through this hole to the terminal point which is given above. Care should be taken when passing a wire and its covering sleeving through a hole, that they are not pulled too tight, so as to prevent the insulating sleeving being abraded by the edges of the hole, and thus cause the wire inside to touch the metal chassis and so cause a short circuit.

Commencing the wiring operations, the first wire starts at terminal No. 100. The wire then passes through hole 100H to terminal 1 on Coil A. Before securing to terminal A1, sleeving should be threaded over the tinned copper wire. This procedure is adopted throughout, and a complete list of wiring is given below:—

- Terminal 100 through hole 100H to A1.
- ” 102 ” ” 102H to B2.
- ” B8 ” ” 173H to 173 of grid leak condenser assembly.
- ” B8 to 115 of variable condenser.
- ” 175 through 108H to 108 of V_1 .
- ” 108 through 108H to 146 of 1 mfd. condenser.
- ” 129 through 129H, leaving a length of wire 4" long.
- ” 131 to 135 through 135H, leaving a length of wire $4\frac{1}{2}$ " long.

The constructor should now fit the back plate to the top plate in exactly the same manner as was adopted in fitting the front panel and plate assembly to the top plate.

Now proceed with the wiring:—

Take loose wire from 129H to 193 negative terminal of +L.S.—strip.

Take loose wire from 135H to 200 to 198 of 2 mfd. condenser.

Terminal A7 to A6 through 147H to 147 to 149 to 151 to 155 to 163 through 141H to 141 of variable condenser.

- ” 104 of V_1 through 104H through 8H to A8.
- ” A8 to 114 of variable condenser.
- ” 107 on V_1 through 107H to 148 to 156 to 177 of resistance holder.
- ” 178 of resistance holder to 103 to 149 of 1 mfd. condenser.
- ” 151 of 2 mfd. condenser to 176 of resistance holders.
- ” 158 of resistance holder to 150 through 117H to 117 of 10—1 Coupling Unit.
- ” 169 of H.F. choke to 171 through 171H to B5.
- ” B6 through 170H to 170 to 167 to 191 of 2 mfd. condenser.

A Corner of our
Self Sealing Condenser Winding Dept.

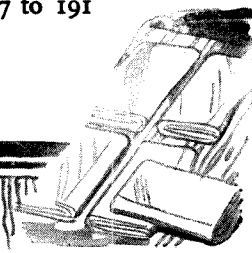
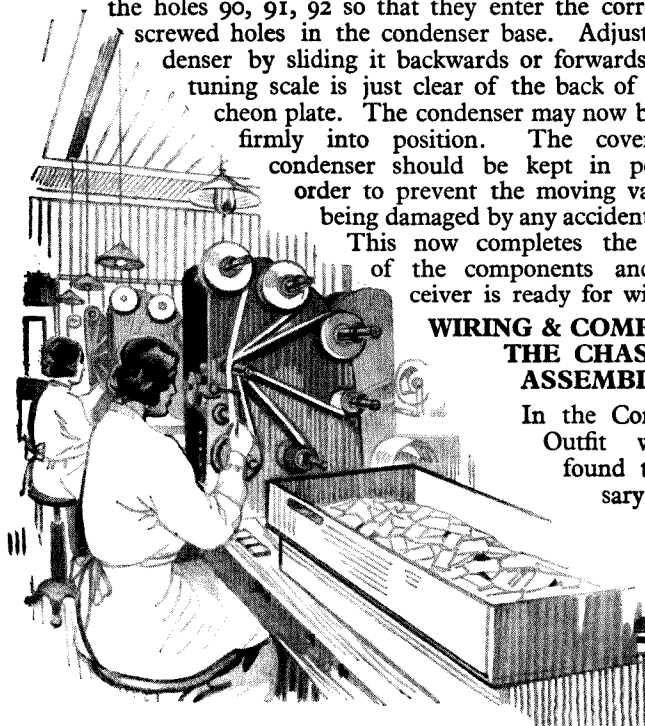

TELSEN ALL-MAINS S.G.3.—continued

- Terminal B7 through 170H to 154 to 164 of resistance holder.
- „ 171 of .0003 condenser through 111H to 111 of V₂.
- „ 112 of V₂ through 112H to 172 of grid condenser assembly.
- „ 118 of 10—1 Coupling Unit through 118H to 168 of H.F. choke.
- „ 152 of 1 mfd. condenser through 152H to 126 to 122 of V₃.
- „ 160 of resistance holder to 162 through 123H to 123 of V₃, leaving 3" of spare wire covered with sleeving. This is connected to the terminal on the side of the pentode valve at a later stage.
- „ 120 of 10—1 Coupling Unit through 120H through 125H to 125 of V₃.
- „ 116 of 10—1 Coupling Unit through 116H to 180 to 182 to 186 to 184 to 167 of resistance holder.
- „ 180 of 1 mfd. Self-Sealing Condenser through 119H to 119 of 10—1 Coupling Unit.
- „ 128 of output choke through 165H to 165 of resistance holder.
- „ 193 of +L.S.—strip to 195 to 197 to 199 to 201 of 2 mfd. condenser choke.
- „ 165 of resistance holder to 194 to 196 through 136H to 136 of smoothing choke.
- „ 134 of smoothing choke through 134H to 197 of 2 mfd. condenser.
- „ 196 of 2 mfd. condenser to 161 to 159 to 157 of resistance holder.
- „ 163 of 2 mfd. condenser to 195 of 2 mfd. condenser.
- „ 191 of 2 mfd. condenser to 155 of .1 mfd. condenser.
- „ 188 of hum adjuster to 190 to 166 of resistance holder.
- „ 192 of +L.S.— strip to 153 of 1 mfd. condenser.
- „ 109 of V₂ through 109H to 174 to 185 of gram. pick-up strip.
- „ 183 of A-E strip to 101 of separator condenser.
- „ 181 of resistance holder to 179 to 172 of grid leak assembly.

Attach 10 inches of wire to terminal B1 and place 9½" sleeving on it. Take this lead through the hole in the top of the screen cover and replace the latter.

This now completes that portion of the wiring done with tinned copper wire and sleeving.

The Mains Transformer is next fitted, the wiring terminals being T1, T2, T3, etc. The wiring is here carried out with pull back wire and black sleeving, the latter being threaded over the former in the same manner as with the tinned wire. These accessories are contained in the Constructor's Outfit.

Thus proceeding:—

- Terminal T5 through hole E through hole F to 130 of V₄.
- „ T6 „ „ E „ „ F to 132 on V₄.
- „ T7 „ „ D to terminal 201 of 2 mfd. condenser.
- „ T11 through hole D through F to 131 on V₄.
- „ T12 „ „ D „ F to 133 on V₄.

There are no more wiring points where the pull back wire is used, so the next wires to be fixed are those of the L.T. heaters. Here we use twisted flex of a maroon colour. First cut off 6" of twin flex from the roll of flex provided in the Constructor's Outfit. Untwist each end for a distance of 2", bare each single lead for a distance of half an inch and then twist the bare wire strands together, thus making the ends more solid. One inch

of black sleeving should then be slipped over each end and slid along so that the bare wire just protrudes. This sleeving is fitted for a double purpose; firstly, to give added insulation to the wire where it goes through the panel hole, and secondly, to prevent the frayed ends of the cotton covering from showing and so looking untidy. Take one wire from one pair of ends and pass through the hole 106H and fasten to terminal 106 on V₁. Now take the remaining wire from the same flex end and put through the hole 105H to terminal 105 on V₁. The opposite

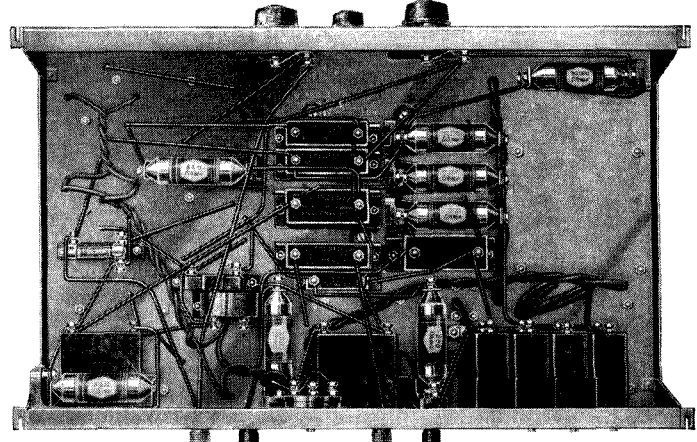

Underside of the Telsen All Mains S.G.3. Metal Baseboard—showing Components and Wiring

ends of the wires should now go through holes 113H and 110H to terminals 113 and 110 respectively on V₂. Next cut off a length of flex 10" long and proceed as before. Starting again at terminals 110 and 113 on V₂ take the wires through holes 110H and 113H and proceed to holes 124H and 121H and then to terminals 124 and 121. Now cut off another length of flex 6" in length, pass through holes 124H and 121H and join two ends to terminals 124 and 121 respectively. Take one lead of the other end of the flex to terminal 187 and the remaining end to 189. Cut off a further length of flex 20" long, the lead from one end being joined up to terminals 187 and 189 respectively. The flex now passes through hole C. The wires are here untwisted and brought up to the transformer terminals, one lead joining to terminal T9 and the other to terminal T10. Take 9½" of flex and join the two leads at one end to terminals 142 and 143 respectively. Then connect the other ends of this flex to terminals 106 and 105 on V₁. This now completes the wiring of the L.T. filament circuits.

The next items are the fuse-holders. Solder flex leads to terminals 138 and 140, pass the flex through hole G and take underneath to hole K. The flex should now be passed through hole K and the ends untwisted. The total length of this flex should be 16" long. Connect one of the untwisted leads to the terminal T1 of the Mains Transformer. The other lead should be cut off 7" from the end, thus leaving a short length through the panel. This is joined to terminal 144 of the Mains Switch. Connect one end of the 7" lead that has just been cut to terminal 145 of the switch, the other end being taken to T2, T3 and T4, according to the voltage of the Supply Mains. There should

(cont. on p. 62)

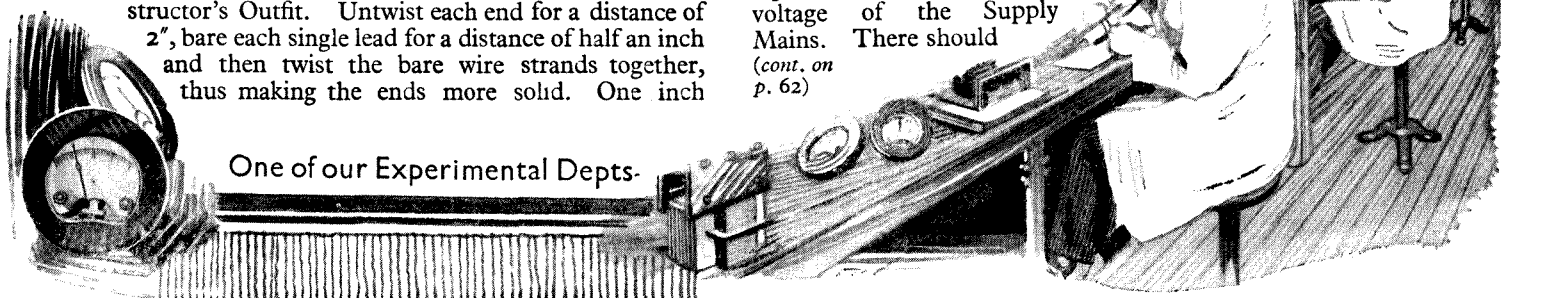

One of our Experimental Depts.

Telsen

BAND-PASS & SUPERHET COILS are specially designed for the needs of the future

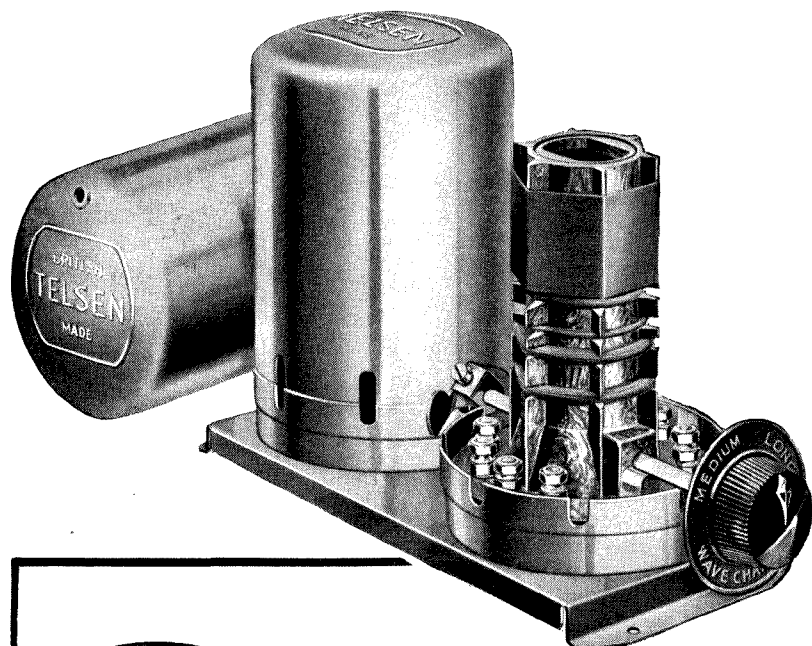

THE Telsen Band-Pass Coil Unit comprises two accurately matched Screened Band-Pass coils, wound on Black moulded Bakelite formers and mounted together on a single rigid plinth base. The coils are independent of each other and can be wired for any of the three types of Band-Pass Filter to give exceptional quality with Selectivity. Wave Change switching is incorporated in each coil base, the switches being ganged and controlled by a single knob. Complete with escutcheon plate and knob. No. W.290. Price **17/-**

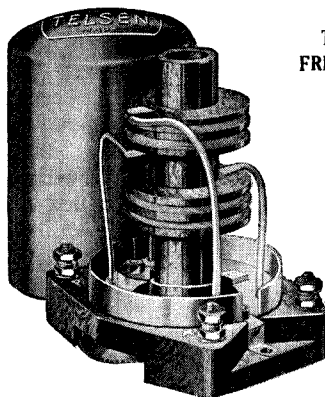

TELSEN INTERMEDIATE FREQUENCY TRANSFORMER

Consists of two tuned circuits comprising a Band-Pass Intermediate frequency filter tuned to 110 kc. by two pre-set balancing condensers fitted in the base of the coil. Small milled wheels projecting from the sides of the base enable these condensers to be adjusted for different values of stray capacities, and the filter coupling is also variable so that the optimum conditions for both quality and selectivity may be attained. Totally screened. No. W294. Price **12/6**

TELSEN OSCILLATOR COIL

Particularly suited to Superheterodyne circuits in conjunction with the Telsen Band-Pass Coils. Designed to operate at a frequency separation of 110 kilocycles from the Band-Pass tuning range, it will, with a standard 3 gang tuning condenser and suitable padding condensers, maintain a constant frequency separation over both wave ranges. The coil is complete with wave-band switching, escutcheon plate and knob. No. W293. Price **8/6**

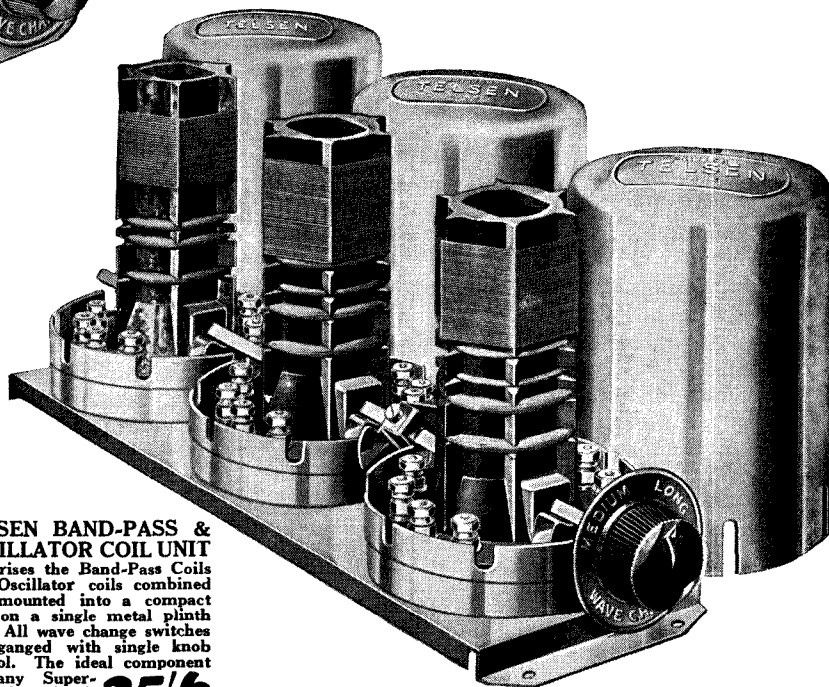
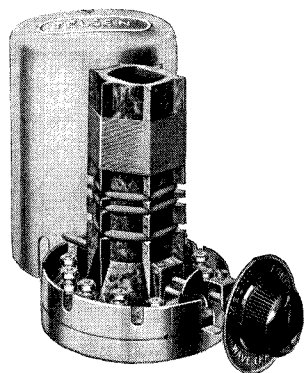

TELSEN BAND-PASS & OSCILLATOR COIL UNIT comprises the Band-Pass Coils and Oscillator coils combined and mounted into a compact unit on a single metal plinth base. All wave change switches are ganged with single knob control. The ideal component for any Superheterodyne circuit. No. W.292. Price **25/6**

TELSEN SUPERHET COILS TYPE NO. S.330

These Telsen Superheterodyne Coils are designed to cater for those constructors who wish to make a superheterodyne receiver which does not employ band pass tuning in the pre-detector high frequency stages. They possess the same exceptional features of high efficiency and low losses that have made the Telsen Screened Coils No. W.216 and the Telsen Band Pass Coils No. W.290 so justly famous.

Price **25/6**

TELSEN

RADIO COMPONENTS



An EASY PATH to GANGING CONDENSERS

AN ARTICLE OF OUTSTANDING IMPORTANCE TO ALL READERS—EXPLAINED IN A SIMPLE MANNER AND EASY TO UNDERSTAND.

TO many minds there appears to be something mysterious and highly technical in the explanation of the ganging of radio receivers. In reality it is very straightforward and easy to understand. We therefore propose to explain the function and working of this section of the radio art, together with a few remarks on the matching of coil inductances and condensers.

What is ganging, and why should it be necessary to gang receivers? The term "ganging" is applied to the mechanical linking of two or more variable condensers as a means of operating two or more tuned circuits by one control. The reason for this need is easily realised. As the reception of broadcasting became more and more popular, so the number of transmitting stations to satisfy this created demand increased. Unfortunately, a very limited wavelength or frequency band had been allocated for all the broadcast transmitters authorised to radiate, and this necessitated transmitters working very closely together in wavelength or, more correctly, in frequency. Thus the problem of selectivity became more and more acute, and to overcome this, receivers were designed with many tuned circuits. As each tuned circuit incorporated a variable condenser, this meant a multiplicity of main tuning controls. A receiver with three tuned circuits had three variable condensers, and the controls for these had to be set exactly for satisfactory elimination of interference from a station whose wavelength was close to the one it was wished to receive.

Owing to the difficulty thus experienced in tuning, the linking up mechanically of these variable condensers has now become an absolute necessity to cope with modern conditions; and the new range of Telsen Constructors' Receivers contained in this *Radiomag* illustrates fully modern practice in this direction.

We will now examine the conditions to be fulfilled in ganging up a receiver. Taking the simple circuit depicted in Fig. 1, the wavelength to which it is tuned is known to be:—

$$\lambda = 1885 \sqrt{LC} \dots \dots \dots (1)$$

where λ = wavelength in metres.
 L = inductance of coil in microhenries.
 C = capacity in microfarads.

Now, assuming the inductance L remains constant, it is obvious that as the condenser C is varied, the wavelength to which the circuit will tune varies as the square root of the capacity, or, put into symbolical form:—

$$\lambda \propto \sqrt{C} \dots \dots \dots (2)$$

Now let us look at the effects peculiar to a variable condenser of the square law variety. With this type, the capacity at any setting is proportional to the square of the angle of rotation from the zero or

minimum position. That is:— $C \propto \phi^2 \dots (3)$
 where C = capacity of condenser.
 ϕ angle of rotation of condenser.

Therefore from equation (3):— $\sqrt{C} \propto \phi \dots (4)$

and combining equations (2) and (4):— $\lambda \propto \phi \dots \dots (5)$

Briefly then, with a square law condenser the wavelength to which the circuit is tuned is proportional to the angle of rotation of the condenser. It follows that for a particular change in condenser dial setting a corresponding particular change in wavelength is produced. It should be noted that this implies that there are no stray capacities in the tuned circuit, a stray capacity being one which is introduced due to the capacity of the wiring of the circuit.



FIG. 1.

Now if we take two identical tuning coils and tune these with two identical square law condensers, these two condensers will have the same angular settings for a given wavelength. Thus the two condensers can be mounted on one spindle and both circuits controlled by one knob. This gives the essence of the theory of ganging receivers, the other refinements and explanations that follow giving the practical application.

This theory assumes we have no stray capacities in the circuit, but in practice we usually have, as the tuning circuit is part of the receiver whereby strays are introduced.

We will take a typical circuit to be ganged and consider it carefully from a ganging point of view. Fig. 2 shows the basic circuit of the Telsen "All Mains 3" Receiver, comprising two tuned coils and two tuning condensers, C_1 and C_2 . Here the loading of the aerial loose coupler coil L upsets the first inductance and the primary winding L_3 upsets the second grid inductance. Also the stray capacity

(cont. on page 22)

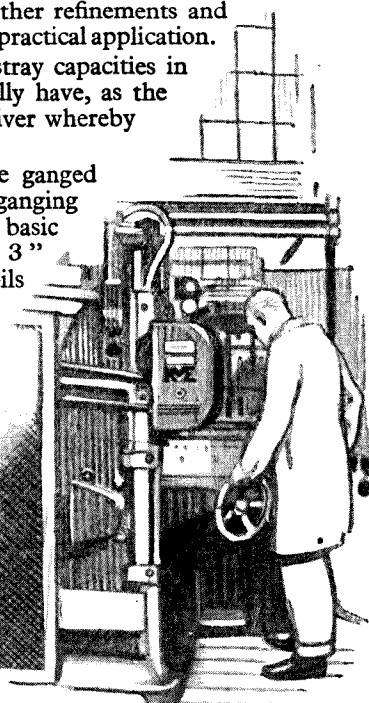

One of the Universal Die Sinking Machines in our Tool Room



AN EASY PATH TO GANGING CONDENSERS

continued from page 21

C_x of valve V_1 , represented by the grid to cathode capacity together with the capacity of the circuit wiring, affects capacity C_1 , whilst the grid to cathode capacity of valve V_2 , with its associated circuits represented by C_y affects C_2 .

Now, neglecting the effects of stray capacities which we will consider later, and assuming the effective values of the tuned inductances are L_1 and L_2 , we will examine what conditions have to be fulfilled in order that the circuits tune in unison with one another.

To tune to identical wavelengths, C_1 will have to be set at an angle ϕ_1 , and C_2 set to an angle ϕ_2 . It is very simply shown that if both sets of movable vanes are passed through a further angle θ to $(\phi_1 + \theta)$ and $(\phi_2 + \theta)$, the wavelength of each circuit is changed by the same amount even if the inductances are unequal. Therefore, if the circuits are ganged at any one wavelength, the ganging holds good over the whole of the wavelength band in spite of the inequality of the inductances, assuming there are no stray capacities.

Actually it is very easy to obtain coils matched to one another to within half of one per cent. accuracy so that it is quite possible for the condensers to be set up with their capacities equal for all settings of the common control knob.

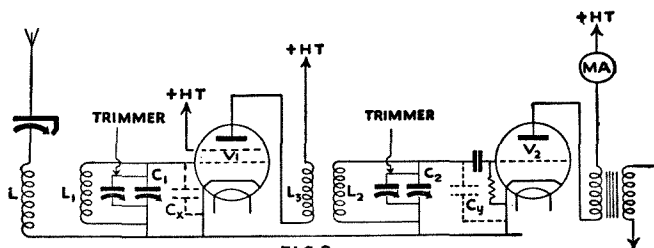

FIG. 2.

We will now see how the stray capacities C_x and C_y which affect the ganging may be accounted for. These are thrown permanently into the circuit across the tuning condensers C_1 and C_2 , and we have to provide special adjustments to deal with these. This is done by connecting across each variable condenser a small compensating or trimming condenser which may be adjusted and left permanently fixed. These trimmers are manipulated so that the extra total capacities in parallel with each of C_1 and C_2 are the same. That is to say, at any setting of the common spindle, C_1 plus the inserted value of its trimmer plus C_x , is equal to C_2 plus the inserted value of its trimmer plus C_y . The tuned circuits will now gang up faithfully over the whole wavelength scale.

In the particular circuit under discussion the Telsen Twin Ganged Condenser W.306 is used. The trimmer on C_2 takes the form of a small flat plate type of condenser with a mica dielectric, whilst that of C_1 consists of a small variable condenser controlled by a knob concentric with the main tuning control. Once set up, this small variable condenser need not be touched except for the most accurate tuning operations.

Now for putting the above theories into operation. We are going to gang up the above receiver. The screened coils used

are of the Telsen Twin Matched variety, W.287, and therefore accurately matched in inductance, so we have no worries in this direction. So, first of all, tune in a station at the bottom end of the medium wavelength scale. This station should not be too easily received, but just loud enough to hear. The aerial series condenser should be about half in—do not have it so that its self-contained switch is in the closed position—and as much reaction as possible should be used. The set should not be oscillating, but almost so. The small variable trimming condenser of C_1 should be placed about 60° in, retuning on the main control, should this be necessary. Next adjust the small trimmer of C_2 until the signals reach maximum strength, re-adjusting on the small variable trimming condenser if necessary. If the main tuning control is now rotated, stations will be received also at the top of the wavelength band, and both circuits will be found to be well in gang, as can be proved by rotating the small variable condenser when little, if any, adjustment will be found necessary. It is important to notice that the receiver should be ganged at the lower end of the wavelength scale, as here there is very little capacity of the main condensers C_1 and C_2 in circuit, the stray and trimmer capacities forming the greater part of the capacity tuning the inductances. Hence their effect is accentuated and enables a very delicate adjustment of the trimmers to be made.

If even more exact ganging is desired, a still weaker station should be tuned in nearer to the bottom end of the short wavelength band, and the above operations repeated.

A more accurate method of ganging is to include in the detector circuit a sensitive milliammeter. On tuning in a station, the milliammeter needle deflection is reduced by an amount proportional to the intensity of the incoming signal. Thus the procedure is the same as above, except that the milliammeter needle is watched for the point of maximum deflection instead of judging the maximum loudness of the receiver signals. This allows of a much finer adjustment of the trimmers and can always be used for sets employing leaky grid detection.

We will now consider the ganging up of a receiver employing three tuned circuits. An excellent example of this is the Telsen "Super Selective Four," described on pages 55-60 of this issue of the Radiomag. The basic circuit is given below in Fig. 3. This receiver incorporates the Telsen Triple Matched Screened Coils, W.288, and the Telsen Triple Ganged Con-

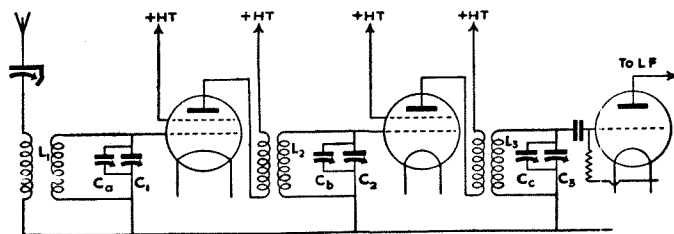
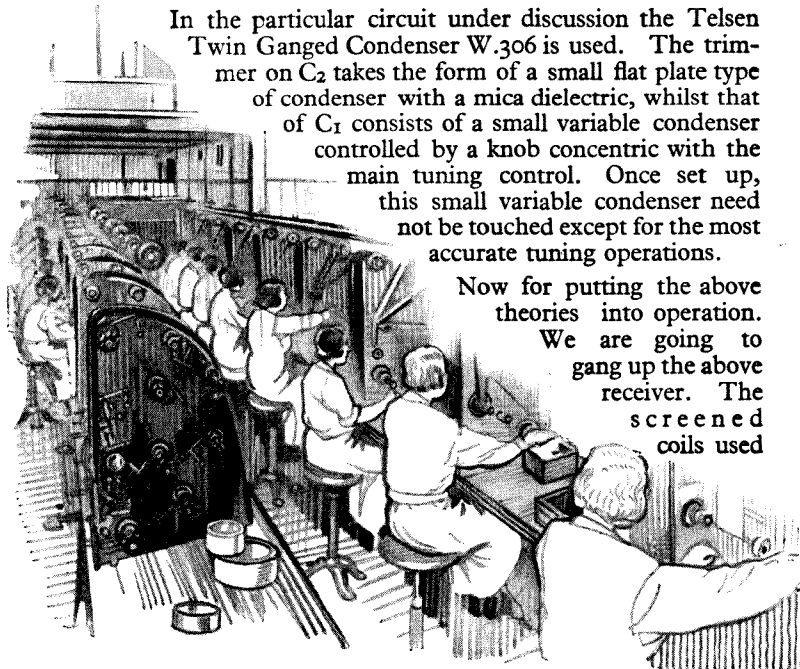

FIG. 3.

denser W.307. This latter component has trimmer condensers fitted in parallel with each of the main variable condensers C_1 , C_2 , and C_3 . These are denoted by C_a , C_b , and C_c .

First of all switch on the receiver and tune in a fairly weak station at the bottom end of the medium wavelength band. The aerial series condenser should be about half in and the reaction near to oscillation point. The trimmers C_a , C_b and C_c should now be adjusted carefully for maximum signal strength by means of the small star-shaped wheels. It is advisable to arrange matters so that one of the trimmers



Another View of our Self Sealing Condenser Winding Machines

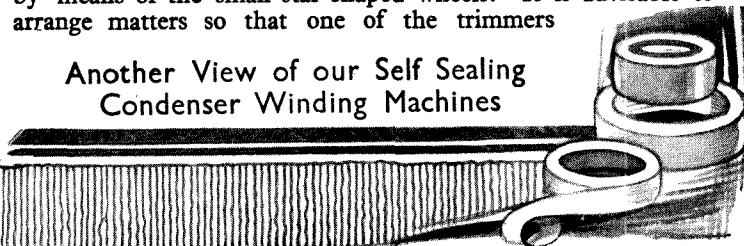

AN EASY PATH TO GANGING CONDENSERS

continued

is almost fully withdrawn, as even with the best of dielectrics there is, technically speaking, a small loss due to the dielectric. The Telsen W.307 condenser trimmers employ a mica dielectric, which has an exceptionally low loss, but ignoring this fact we will be correct in our procedure. When the set is ganged we will assume that all the trimmers are well in. Then it is a good plan to screw right out that trimmer that has been set with least capacity, and bring the others out until satisfactory ganging is again found. There is another good reason why the trimmer capacity should be kept as low as possible. That is, the range of wavelength tuning depends on the square root of the ratio borne by the total capacity in the circuit when the tuning condenser is at maximum, to the total capacity in the circuit when the condenser is at minimum. Hence to cover as wide a wavelength band as possible, it is essential to keep the trimmers at the lowest values compatible with good ganging.

A much weaker station at a lower wavelength than before should now be tuned in, and the above procedure repeated until the receiver is ganged up to a very high degree of precision. Then, on tuning in a station at the top end of the medium wavelength band, it will be found that the ganging still holds, and no further adjustment is required.

There are a few other essential points to bear well in mind when ganging a receiver, and these will now be rapidly reviewed.

It is very important to ascertain that the screens of the coils are fitting perfectly into the screening bases. If a receiver be ganged up with a screen not in position or even just displaced laterally, total reganging will be required when the screen is placed correctly in position. This is because the inductance of the coil depends on the disposition of masses of metal in its neighbourhood—and the screen is made of metal. Thus moving the screen alters the coil inductance and so the ganging of the receiver will be upset.

For the same reason it is advisable to use similar types of coils fitted with identical screens when constructing a radio receiver which incorporates ganged condensers. Further, it is very helpful to lay out the coils and ganged condensers in a symmetrical fashion.

A few words about the ganging of the long wavelength band would not be amiss at this stage. It sometimes happens that when a receiver gangs up satisfactorily on the medium wavelength band, the tuning is flat and indefinite on switching over to the long wavelength band. The first suspicion is of the matching of the long wavelength coils, which may have to be rematched. In any case it is worth while ascertaining if any improvement can be made here, as a little time spent in adjusting the long wavelength inductance will not be wasted.

But remember to regang on the medium wavelength band. These adjustments and the need for reganging will not be necessary with Telsen Screened Coils, as they are carefully matched for both the medium and long wavelength sections.

The query is also raised as to whether incidental stray capacities, due to the altered wiring, aerial load transference, and so forth, are changed on switching over to the long waveband. It is, therefore, important to keep all external wiring to the coils and condensers down to a minimum.

It is possible that variable condensers of the log law type may be used in a ganged receiver. Such a set is ganged by moving the condenser rotors relative to one another, and when used in such a way, small differences in inductances may be balanced out. First of all the receiver should be tuned to a weak station at the bottom of the medium wavelength band,

and adjusted for the maximum signal strength by use of the trimmer condensers. Next, tune in a station at about 500 metres and regang by altering the relative positions of the various condenser rotors. At this upper wavelength, the trimmers should not be touched in any way. The station previously received at the bottom end of the medium wavelength band should now be tuned in again and the receiver reganged by using only the trimmers. Then a return should be made to the 500 metre station and the reganging operation repeated by staggering the rotors. This procedure should be continually repeated until no further adjustment at either wavelength is necessary. The great point to bear in mind is, gang only with the trimmers at the bottom of the wavelength band, and gang only by staggering the rotors at the top end of the wavelength band.

Having now covered the chief points connected with the theory and practice of ganging radio receivers no difficulty should be experienced in setting up a receiver satisfactorily, providing the coils and variable condensers are matched up. All the Telsen ranges of matched coils and ganged condensers are adjusted to within exceedingly fine limits, so no trouble will be experienced in this direction when the Telsen range is used.

It is thought, however, that a few remarks on methods for matching coils and condensers will be welcomed. The wireless experimenter will then be able to carry out some important and advanced experiments using very little apparatus, and will have at hand means to match up his own components accurately. All that is needed is a little patience and practice, when very satisfactory results will be obtained.

We will first deal with the matching up of tuning coils. The coils to be matched should be of a similar type. They should be wound on equal sized formers made of the same material, the gauge of wire being equal and spaced to an equal extent. The relative positions of all windings should have been set with the greatest accuracy, even to the width and depth of the slots in which the long wavelength windings are wound. It will then only be necessary to make small adjustments to the windings. For example, the last one or two turns on the medium wave winding may have to be slid along the former away from the main windings to lower its inductance, or towards the main windings to increase the inductance. In the case of the long wave windings, turns must be removed to lower the inductance, or added to raise it. These remarks, of course, apply to home constructed coils, all the above details being automatically looked after in a manufactured commercial coil.

As these coils we propose to match are very similar, we can neglect the effect of the self capacity of the windings, for the difference in self capacity between the two coils will be of such a minute quantity that it can be ignored.

It must be remembered that the inductance of a coil is affected by the presence of surrounding metal.

The screening cans will therefore affect the inductance, so generally speaking, coils should be matched up when in their screened cans. It should be noted, however, that when coils are to be mounted in similar screens, their inductances will be equally affected so they may be matched unscreened.

We will give a method for matching inductances when the coils are screened.

(continued on page 24)

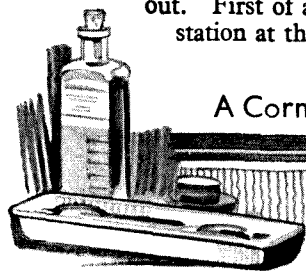

A Corner of the Surgery in our First Aid Department

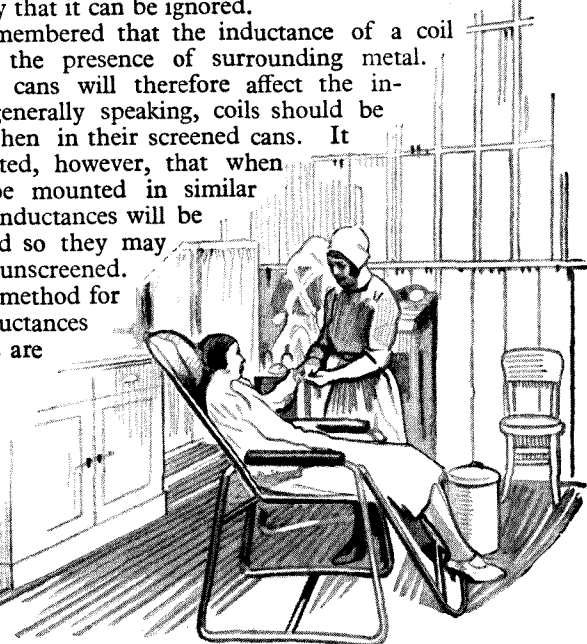

AN EASY PATH TO GANGING CONDENSERS

—continued from page 23

The matching can be done by the aid of any simple receiver that is fitted with reaction control. A millimeter of low current range is placed in the anode circuit of the detector valve, as shown in Fig. 4, which depicts the Telsen Nimrod II circuit converted for this measurement.

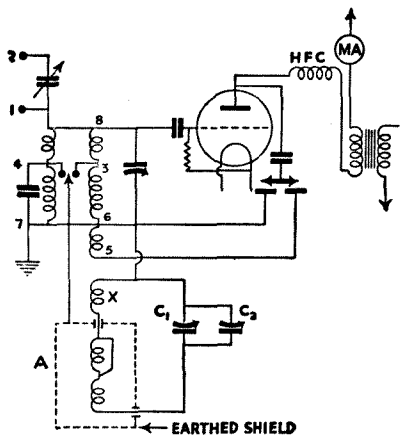

FIG. 4

The coil 1-4-7 does not perform any useful function in the matching and may be disconnected. The coil A to be tested is mounted in its screened shield and connected up as shown. X is a small coil of two or three turns, connected in series with A and so allows the grid coil of the receiver to couple up with the coil A. C_1 is a .0005 variable condenser with its movable vanes about half in mesh with the fixed vanes. C_2 is a variable condenser in

parallel with C_1 and has a maximum value of .0001. It is used as a vernier condenser and its inclusion permits of a greater accuracy in matching up. The receiver is now made to oscillate by increasing the reaction coupling. This is indicated by the millimeter needle in the detector plate circuit giving a slight deflection. The long wave section of coil A is now shorted out and the small coupling coil X brought up into inductive coupling with the grid coil of the receiver. The two circuits should now be tuned until they resonate with one another, this state being shown when the millimeter needle gives a further deflection. The coil X is now moved a way from the receiver grid coil so as to weaken the coupling to as great an extent as possible, i.e., the millimeter needle deflection is just observable. The reading of the vernier condenser should now be carefully noted. It is most important from now onwards that all the circuit arrangements are kept constant, only the vernier condenser being altered in any way. To gain this end, the positions of coil A and coil X should be carefully noted and the connecting wiring made to distribute itself so as to remain the same for all subsequent tests. It is a wise precaution to fasten the wiring into position

Coil B that is to be matched to Coil A should now be placed in circuit and, as stated above, must occupy the same position as previously taken by coil A. The vernier condenser reading is taken, the same procedure being followed for any other coils that require to be matched in this group.

Now, on inspecting the vernier condenser readings obtained, we can grade the coils in order of inductance, as it is plainly

clear that the coil with the highest inductance will need the lowest capacity to tune it, whilst the coil with the lowest inductance will need the highest capacity. The coil which needs

the highest vernier condenser reading is the standard to work to. The inductance of the other coils should be lowered by removing turns, or if varying by only a small amount, the end turns of the winding may be spread out. Thus, by adjusting the turns of the coils to give the same vernier condenser scale reading as the standard coil we have selected, we have matched all the coil inductances to one another very accurately indeed.

The switch connections across the long wavelength sections should now be removed and the same procedure adopted for ganging the long wavelength sections. The receiver will, of course, also be switched over to its long wavelength section and made to oscillate. The windings may be matched up by removing turns from the long, not the medium wavelength sections. Should it only be necessary to match up the coils without screens, the coupling coil X may be omitted, and the coil under test itself loosely coupled to the grid coil of the receiver.

Another method of matching coils is available which, in spite of, or probably because of, its extreme simplicity, gives surprisingly good results. More skill and patience, however, is required than with the above method. The connections are shown in Fig. 5. Here again a receiver using reaction is re-

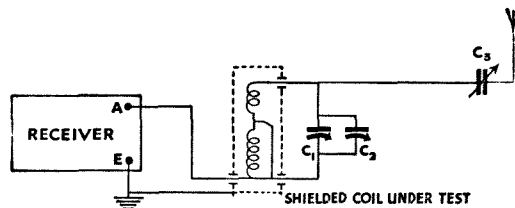

FIG. 5

quired. The screened coil is connected to the aerial terminal of the receiver and has shunted across it two condensers, C_1 and C_2 , of maximum values .0005 and .0001 respectively. In series with the aerial is a .0001 variable condenser (C_3) which is connected to the coil as depicted in the diagram. This condenser should be set with its vanes half enmeshed. The receiver itself has previously been tuned in to a strong transmission. The coil under test with its associated condensers forms an acceptor circuit, so C_1 and C_2 should be adjusted until the maximum reduction of signal strength is obtained. The reading of the vernier condenser C_2 should then be noted. The next coil is then put into the place of the coil just tested, great care being taken to preserve the same relative positions for the coil, condensers and wiring. The procedure of testing is exactly the same; just tune for the maximum reduction of signal strength leaving C_1 , C_3 and the receiver untouched. We then obtain different values of reading for the vernier condenser C_2 , and the inductances may be matched up exactly as in the first method given above.

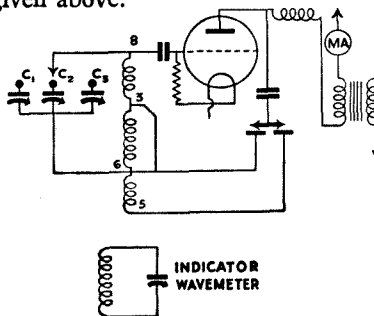
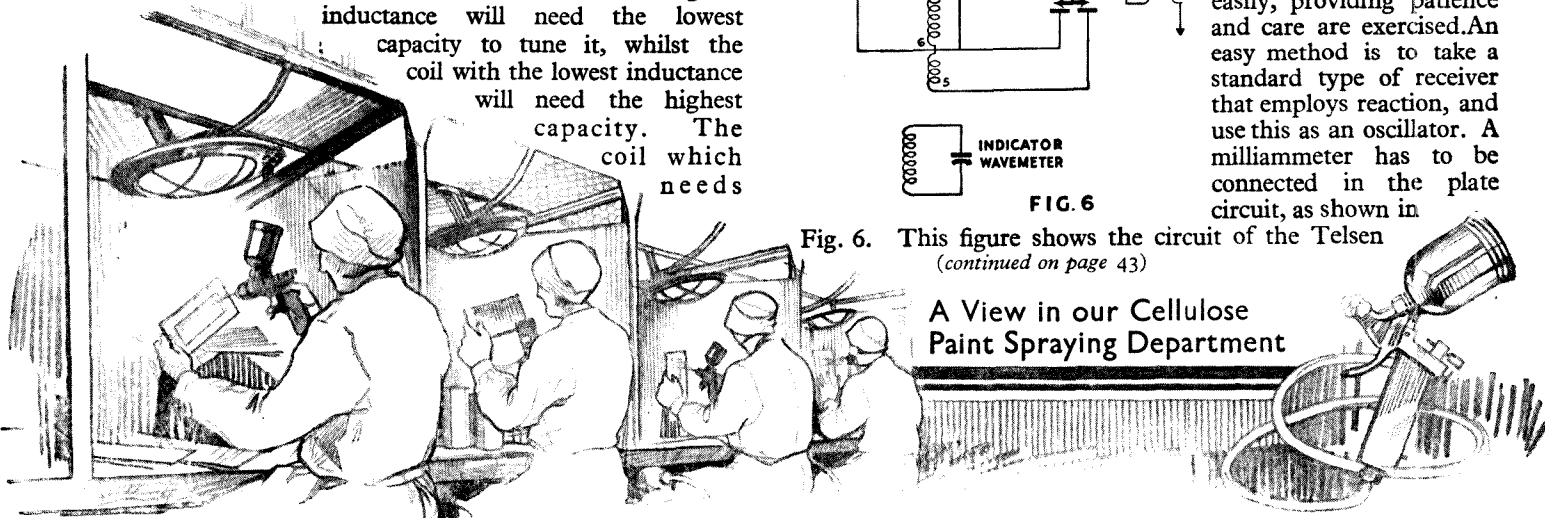

FIG. 6

Fig. 6. This figure shows the circuit of the Telsen (continued on page 43)

The only variable components now left to check up are the ganged condensers. This can be done very easily, providing patience and care are exercised. An easy method is to take a standard type of receiver that employs reaction, and use this as an oscillator. A millimeter has to be connected in the plate circuit, as shown in



A View in our Cellulose Paint Spraying Department

GANGED CONDENSERS

TELSEN GANGED CONDENSERS

The Telsen Ganged Condenser Units have been designed for use in modern receiver circuits in which accurate and simultaneous tuning of two or three circuits is obtained by the rotation of one dial. A pressed steel frame of great rigidity completely obviates any tendency to distortion, while the rotor and stator vanes are let into one-piece high pressure die castings, ensuring accurate spacing. All sections are very carefully matched by means of split end vanes, and trimmers are provided across each section to compensate for differences in stray capacities. In the twin gang condenser the front section carries a variable trimmer operated by a knob concentric with the main tuning control. Both models have an attractive stove aluminium finish and are complete with disc drive, dust covers, escutcheon plate, pilot light, knob and two alternative tuning scales.

TWIN GANG CONDENSER .. No. W.306

Price 16/6

TRIPLE GANG CONDENSER .. No. W.307

Price 22/6

TELSEN DRUM DRIVE AND CONDENSER ASSEMBLY

The Telsen Drum Drive and Condenser Assembly comprises a complete ganged condenser tuning unit. Two Telsen .0005 logarithmic variable condensers with right and left handed movements, and fitted with compensators, are mounted and ganged together through a rigidly constructed drum drive control. Mounted on the same spindle axis as the main tuning drive is a trimmer, giving a swinging movement of about 20° to the stator vanes of the right hand variable condenser, thereby enabling perfect matching of the condensers to be maintained throughout the tuning range. Two scales are supplied with the unit, one marked in wavelengths and one in graduations from 0—100. The scale is illuminated and has the additional advantage of being easily removable when it is desired to fit one of special calibration.

No. W.262

Price 17/6

TELSEN LOGARITHMIC VARIABLE CONDENSERS

The Telsen Variable Condensers are built to withstand years of service. Rigidity in construction, the effective clamping of both rotor and stator vanes, and freedom from backlash and end play have been the primary features aimed at in their design, and thereby accurate and consistent spacing is assured as long as the condenser is in service.

Capacity .0005 mfd. R.H. No. W.132	} Price 4/6 each
" .0005 mfd. L.H. No. 256 ..	
" .00025 mfd. No. W.130 ..	
" .00035 mfd. No. W.131 ..	
" .0005 mfd. R.H. with Compensator No. 261 ..	} Price 5/- each
" .0005 mfd. L.H. with Compensator No. 260 ..	

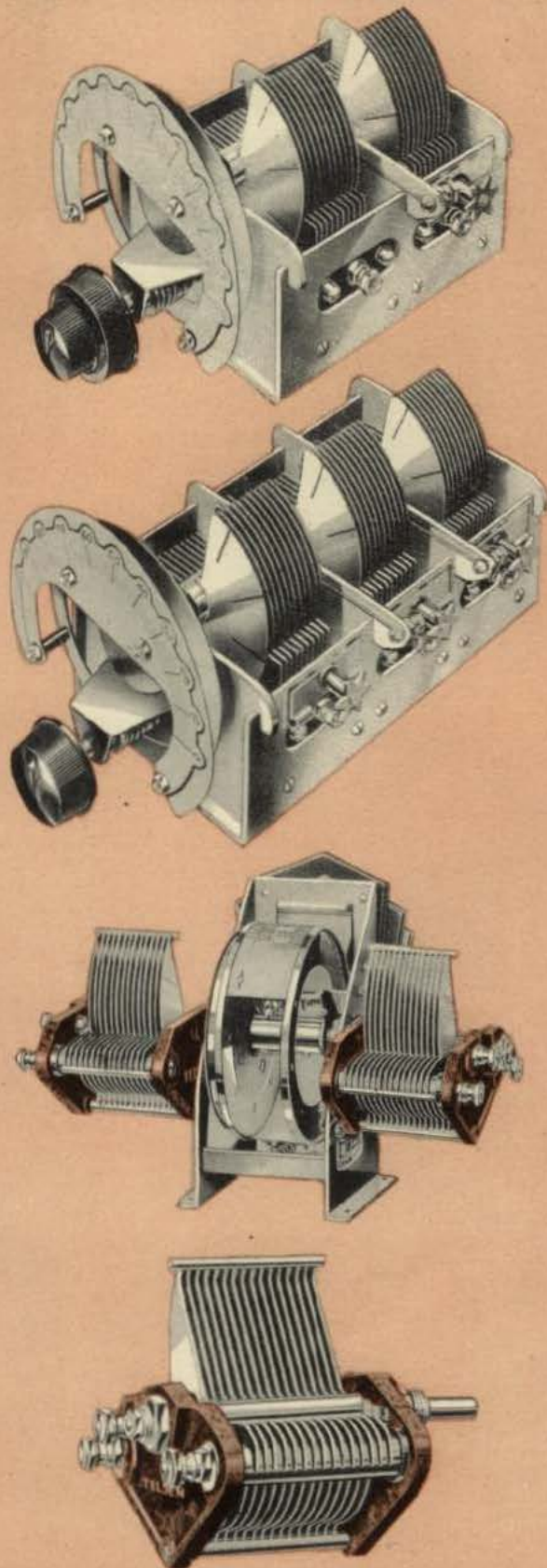

TELSEN
RADIO COMPONENTS

TUNING, DIFFERENTIAL & REACTION CONDENSERS

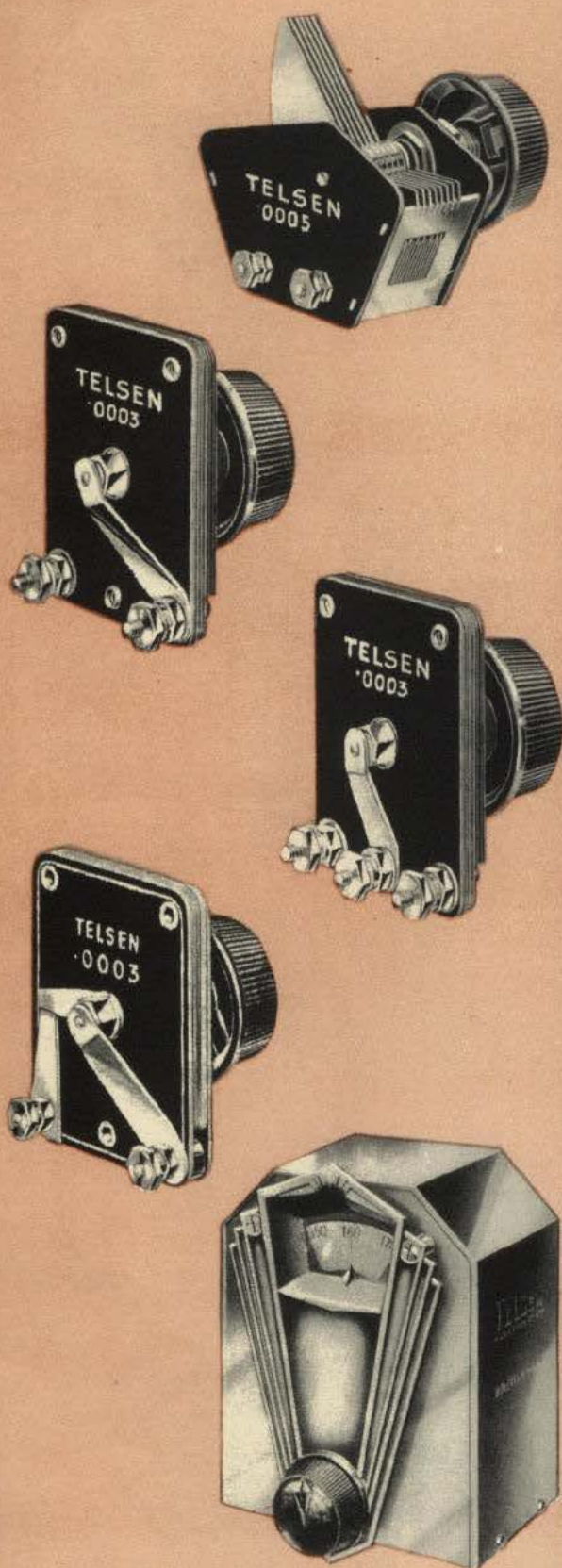

TELSEN BAKELITE DIELECTRIC TUNING CONDENSERS

Designed on lines of great rigidity, compactness and high efficiency, these condensers are confidently recommended for use in cases where space is limited. A high grade dielectric is employed, ensuring accuracy of tuning with minimum losses. Complete with knob.

Capacity .0005 mfd. No. W.193 .. } Price 2/6 each
 .. .0003 mfd. No. W.194 .. }

TELSEN REACTION CONDENSERS

These condensers are of an improved type, of great rigidity and precise construction. The rotor vanes are keyed to the spindle, and fitted with definite stops. The vanes are interleaved with finest quality solid dielectric. A strong nickel silver contact makes connection to the rotor, and a positive connection is made to the stator vanes. Supplied complete with knob.

REACTION CONDENSERS

Capacity	No.	Price each
.0003	W.188	2/-
.00015	W.189	
.0001	W.190	2/6
.00075	W.191	
.0005	W.192	

TELSEN DIFFERENTIAL CONDENSERS

These are similar in design and construction to the reaction condensers, and are supplied in four capacities.

Capacity	No.	Price each
.0003 mfd.	W.185	2/6 each
.00015 mfd.	W.186	
.0001 mfd.	W.187	
.00035 mfd.	W.319	

TELSEN AERIAL SERIES CONDENSER

An ideal component for selectivity and volume control. Among its outstanding features are an exceptionally low minimum capacity, and a switching device keyed to the control spindle whereby the condenser is short-circuited at maximum position to give increased volume. Complete with knob.

Capacity .0003 mfd., No. W.205

Price 2/3

THE TELEXOR

This totally enclosed unit, complete with oxydised silver escutcheon plate and knob, incorporates a special design of tuning condenser, covering the full circle and giving "log law" tuning in both directions. It embodies a new development in radio set construction by which wave range switching or the changing of coils is rendered unnecessary through the automatic switching device provided in the construction of the condenser. Thus, both medium and long wave ranges are covered by the operation of turning one knob, while at the same time the illuminated and clearly marked scale facilitates tuning.

No. W.180

Price 10/6

TELSEN

RADIO COMPONENTS

SLOW MOTION DIALS, DISC & DRUM DRIVES

TELSEN SMALL FRICTION DISC DRIVE

A low-priced Disc Drive for auxiliary controls. It is extremely robust and may be usefully employed for main tuning condensers where limitations of space have to be considered.

No. W.257

Price 2/6

TELSEN BAKELITE SLOW MOTION DIAL

Made in black or brown moulded bakelite, this elegant little dial has a gear ratio of 8-1, the disc being graduated from 0 to 100 in both directions. It can be fitted to any of the Telsen Tuning and Reaction Condensers, or other standard makes having a $\frac{1}{4}$ " spindle and is suitable for all panels up to $\frac{3}{8}$ " thickness. Mounting instructions are included with every dial.

Black .. No. W.141

Brown .. No. W.141A

Price 2/- each

TELSEN "313" DISC DRIVE

This is essentially an illuminated Disc Drive tuning control similar to W.184 and suitable for any standard tuning condenser with $\frac{1}{4}$ " spindle. Although primarily designed for the Telsen "Astrala Three" receiver, this component, with its exceptionally attractive escutcheon plate, is ideal for use in any receiver employing the usual panel controls indicated. These comprise "Separator," Volume control, and Wave-change and "On-Off" Switches, thus containing the main essentials of a complete control unit into a compact assembly. Escutcheon plate finished in Oxydised Silver.

No. W.313 Price 4/6

TELSEN "TELORNOR" DISC DRIVE

No. W.206 Price 4/6

TELSEN ILLUMINATED DISC DRIVE

Fitted with a handsome oxydised silver escutcheon of modern design, this drive incorporates an improved movement. The gear ratio of approx. 5-1 and the bold and well-proportioned figures make for delightfully easy tuning. The dial may be illuminated by means of an ordinary flash lamp bulb. A double-ended spanner to fit all Telsen "one hole fixing" nuts is supplied free with every Disc Drive.

No. W.184

Price 3/6

THE TELSEN DRUM DRIVE

A drive generally following standard practice, but embodying several detail refinements, among which may be instanced the cord drive which is arranged to reduce wear to a minimum and to prevent over-run, and the rocking stator trimmer which gives a variation of 20° and visual indication of setting. For use with Telsen screened coils an extra scale marked in wavelengths is supplied free of charge.

No. W.255

Price 8/6

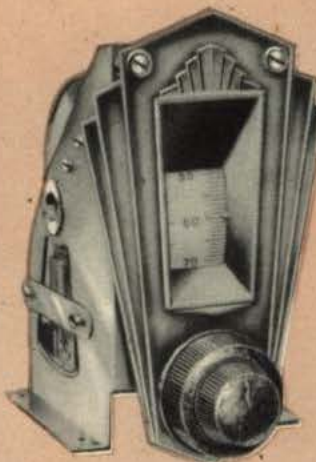
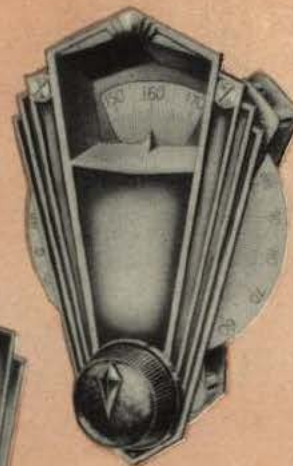

TELSEN
RADIO COMPONENTS

BAND PASS & SUPERHET COILS

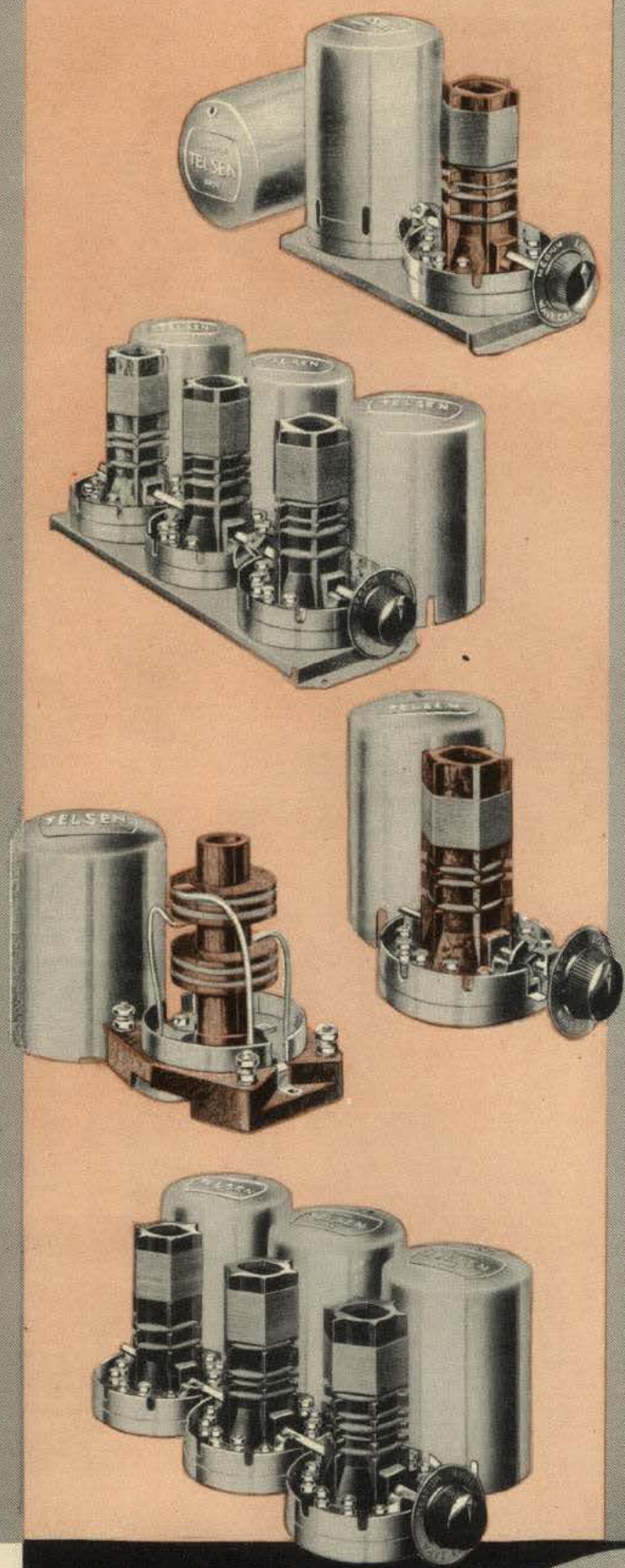

TELSEN BAND-PASS COIL UNIT

This unit comprises two accurately matched Screened Band Pass Coils wound on black moulded bakelite formers and mounted together on a single rigid plinth base. The coils are independent of each other and can be wired for any of the three types of band pass filter to give exceptional quality with selectivity. Wave-change switching is incorporated in each coil base, the switches being ganged and controlled by a single knob. Complete with escutcheon plate and knob.

No. W.290 Price 17/-

TELSEN BAND-PASS AND OSCILLATOR COIL UNIT

Comprises the Band Pass Coils and Oscillator Coils combined and mounted into a compact unit on a single metal plinth base. All wave change switches are ganged with single knob control. The ideal component for any superheterodyne circuit.

No. W.292 Price 25/6

TELSEN OSCILLATOR COIL

This coil is particularly suited to superheterodyne circuits in conjunction with the Telsens Band Pass Coils, for which it can be obtained separately, or in a combined unit (see W.292). It has been designed to operate at a frequency separation of 110 kilocycles from the band pass tuning range, and with a standard 3-gang tuning condenser and suitable padding condensers will maintain a constant frequency separation over both wave ranges. The windings are wound on a light oak moulded bakelite former, and the coil is complete with waveband switching, escutcheon plate and knob.

No. W.293 Price 8/6

TELSEN INTERMEDIATE FREQUENCY TRANSFORMER COIL

Consists of two tuned circuits comprising a band pass intermediate frequency filter tuned to 110 k.c. by two pre-set balancing condensers fitted in the base of the coil. Small milled wheels projecting from the sides of the base enable these condensers to be adjusted for different values of stray capacities, and the filter coupling is also variable so that optimum conditions for both quality and selectivity may be attained. Totally screened.

No. W.294 Price 12/6

TELSEN SUPERHETERODYNE COILS

These Telsens Superheterodyne Coils are designed to cater for those constructors who wish to make a Superheterodyne Receiver that does not employ band pass tuning in the pre-detector high frequency stages. They possess the same exceptional features of high efficiency and low losses that have made the Telsens Screened Coils No. W.216 and the Telsens Band Pass Coils No. W.290 so justly famous.

The mechanical construction and wavechange switch assembly are almost identical with that of the standard Telsens Screened Coils. These coils are designed to work in conjunction with a triple ganged variable condenser having specially shaped vanes for maintaining a constant frequency difference of 110 kilocycles between the frequency of the oscillator and that of the aerial and grid tuning coils.

Type No. S.330 Price 25/6

TELSEN
RADIO COMPONENTS

DUAL RANGE AERIAL & ANODE COILS

TELSEN DUAL RANGE AERIAL COIL

Incorporates a variable selectivity-device, making the coil suitable for widely varying reception conditions. This adjustment also acts as an excellent volume control, and is equally effective on long and short waves. The wave-band change is effected by means of a three-point switch and a reaction winding is included.

No. 76
Price 7/6

THE TELSEN H.F. COIL

May be used for H.F. amplification with screen grid valve, either as an H.F. transformer or alternatively as a tuned grid or tuned anode coil. It also makes a highly efficient aerial coil where the adjustable selectivity feature is not required.

No. 154
Price 5/6

TELSEN COMBINED DUAL RANGE SHORT WAVE COIL UNIT

With this unit tuned by a .00025 mfd. condenser, the short wave range of 20 to 80 metres can be covered by the operation of a dual range wavechange switch as in ordinary broadcast practice. It can also be used in sets covering all wave bands with a .0005 mfd. condenser, in which case the dual range feature is not employed. Stranded wire is used throughout, windings for aerial, tuning and reaction circuits being included.

No. W.174
Price 4/6

TELSEN SCREENED TUNING COILS

The result of much research and experiment, these coils embody the ultimate efficiency attainable in a perfectly shielded inductance of moderate dimensions. Provided with separate coupling coils for medium and long waves they are suitable for use as aerial coils or as anode coils following a screen grid valve, giving selectivity comparable only with a well designed band-pass filter. The coils are fitted with cam operated rotary switches with definite contacts and click mechanism, and are supplied complete with aluminium screening cans.

No. 216
Price 8/6
No. W.287 Twin matched Screened Coils
Price 17/-
No. W.288 Triple matched Screened Coils.
Price 25/6

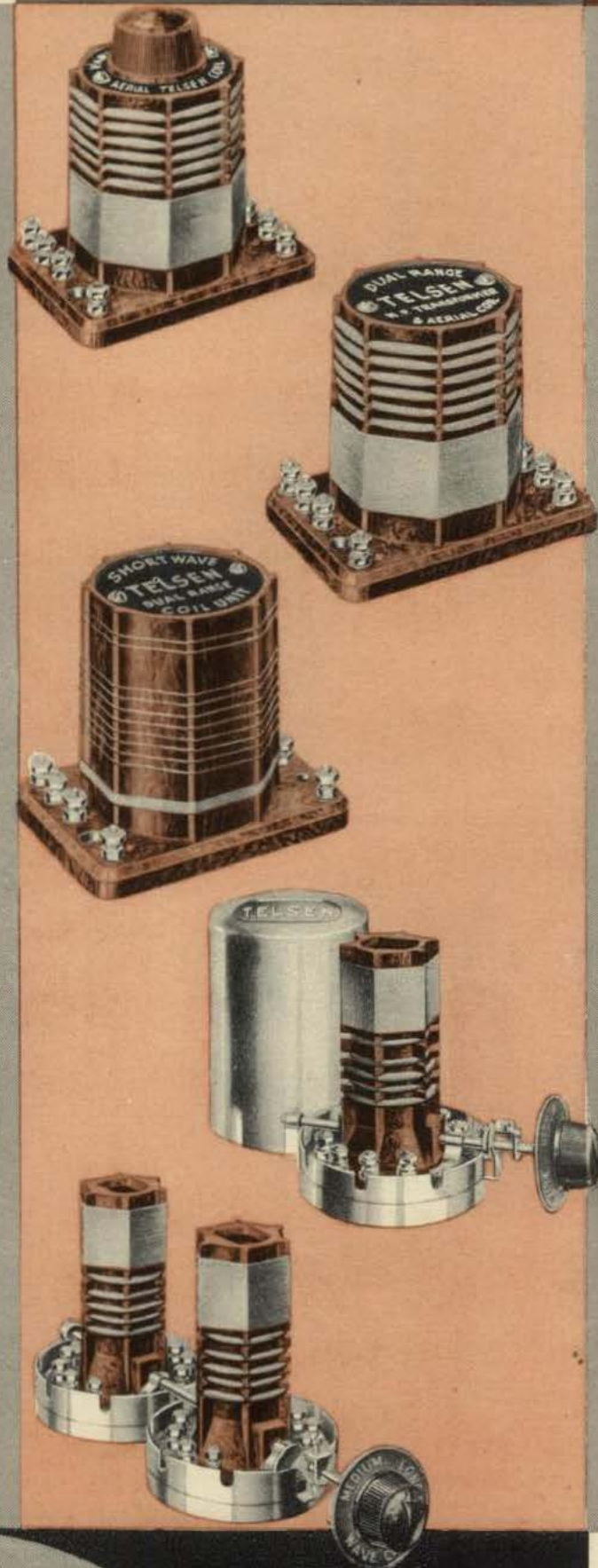

TELSEN
RADIO COMPONENTS

MAINS TRANSFORMERS

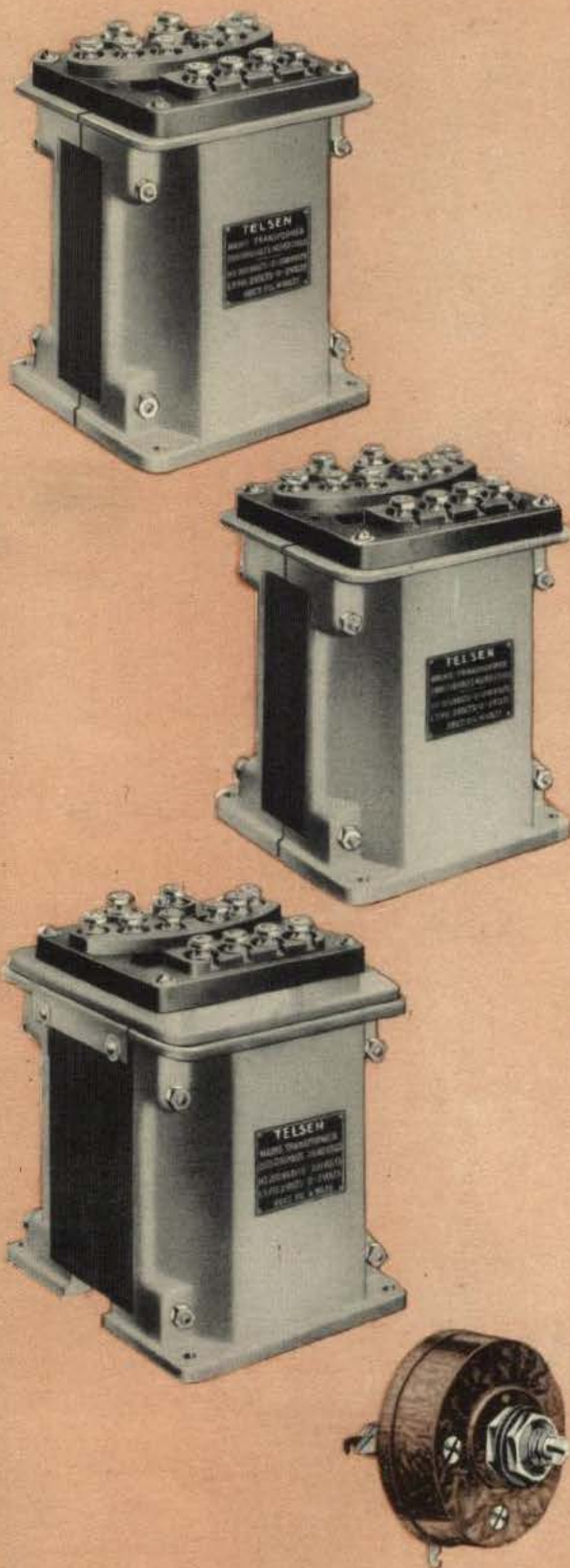

TELSEN MAINS TRANSFORMERS

These power transformers have been designed and constructed on thoroughly up-to-date and scientific lines. The utmost care and attention has been given to every detail in their construction, both electrically and mechanically, while their voltage regulation ensures that a steady and constant voltage is maintained under actual operating conditions. They are made in three models as stated, and have the same power output rating as follows:—

Model W.300
for 200/250 volts
A.C.40/100 cycles
Price .. 32/6

L.T. Filament—4 volts.
at 2½ amps with centre tap.
Rectifier Filament—4 volts
at 1 amp.

Model W.291
for 100/110 volts
A.C.40/100 cycles
Price .. 32/6

High Tension—For full wave
rectification. When using a Mazda UU30/250
valve and a Telsens W.302 L.F. choke with
smoothing blocks of 4 mfd. condensers, the
smoothed output is 200 volts at 32 mA.
D.C. load.

All three models have an attractive stove
aluminium finish, and the terminal panel on
top is protected by a moulded
bakelite cover. Suitable for
sets employing two A.C.
Valves, or for 3 valve sets
in which two are of the
A.C. Type, the third battery type taking .25
to .5 amps.

Model W.301
for 200/250 volts
A.C.25/40 cycles
Price .. 45/-

High Tension—For full wave
rectification. When using a Mazda UU30/250
valve and a Telsens W.302 L.F. choke with
smoothing blocks of 4 mfd. condensers, the
smoothed output is 200 volts at 32 mA.
D.C. load.

TELSEN HUM ADJUSTER

Comprises a variable centre tapped resistance designed for hum control in A.C. mains operated receivers and eliminators. Solidly constructed, it occupies very little space, and is extremely silent in operation, both electrically and mechanically. In attractively moulded bakelite case with single hole fixing.

No. W.299
Price 2/9

TELSEN
RADIO COMPONENTS

L.F. TRANSFORMERS

TELSEN "ACE" L.F. TRANSFORMERS

The Telsen "Ace" is eminently suitable for receivers where highest efficiency is required at a low cost and where space is limited. Its characteristic will bear comparison with that of any other transformer.

Ratio 3—1. No. W.66

Ratio 5—1. No. W.65

Price 5/6 each

TELSEN "RADIOGRAND" L.F. INTERVALVE TRANSFORMERS

Since their introduction, these Transformers have signified to designers and constructors alike the nearest approach to the ideal in intervalve transformer design. Evolved from the results of extensive research coupled with the soundest engineering principles, every transformer is subjected to rigorous tests to ensure faultless performance and enduring efficiency.

Medium Ratios: 3—1, No. W.59 ;

5—1, No. W.58.

Price 7/6 each

TELSEN "RADIOGRAND" HIGH RATIO 7—1 TRANSFORMER

This Transformer is designed to give extra high amplification on receivers employing only one stage of L.F. amplification. It is not recommended for use in receivers employing two L.F. stages as overloading is likely to occur.

No. W.60

Price 10/6

TELSEN "RADIOGRAND" LOW RATIO 1.75—1 TRANSFORMER

For use in receivers employing two stages of L.F. amplification, where exceptionally good quality is desired. When used following an L.F. stage employing choke or resistance coupling it will be found to give ample volume with remarkable reproduction.

No. W.61

Price 10/6

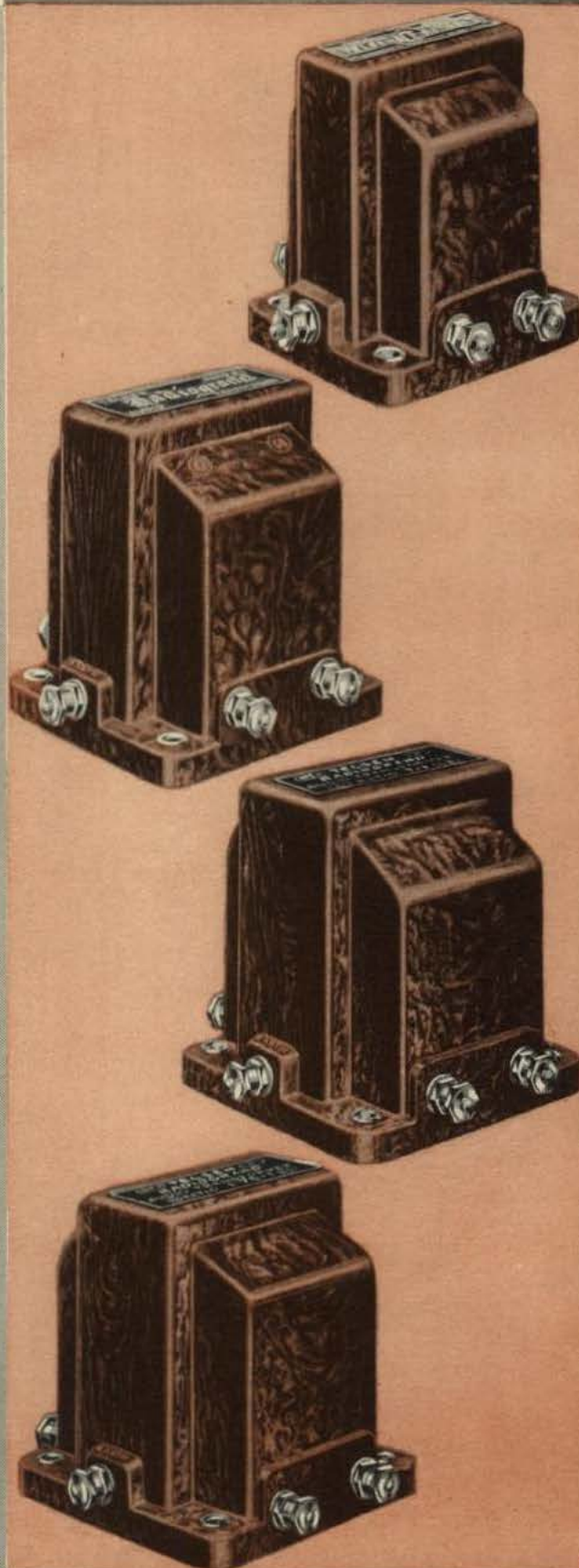

TELSEN
RADIO COMPONENTS

INTERVALVE COUPLING UNITS & L.F. CHOKES

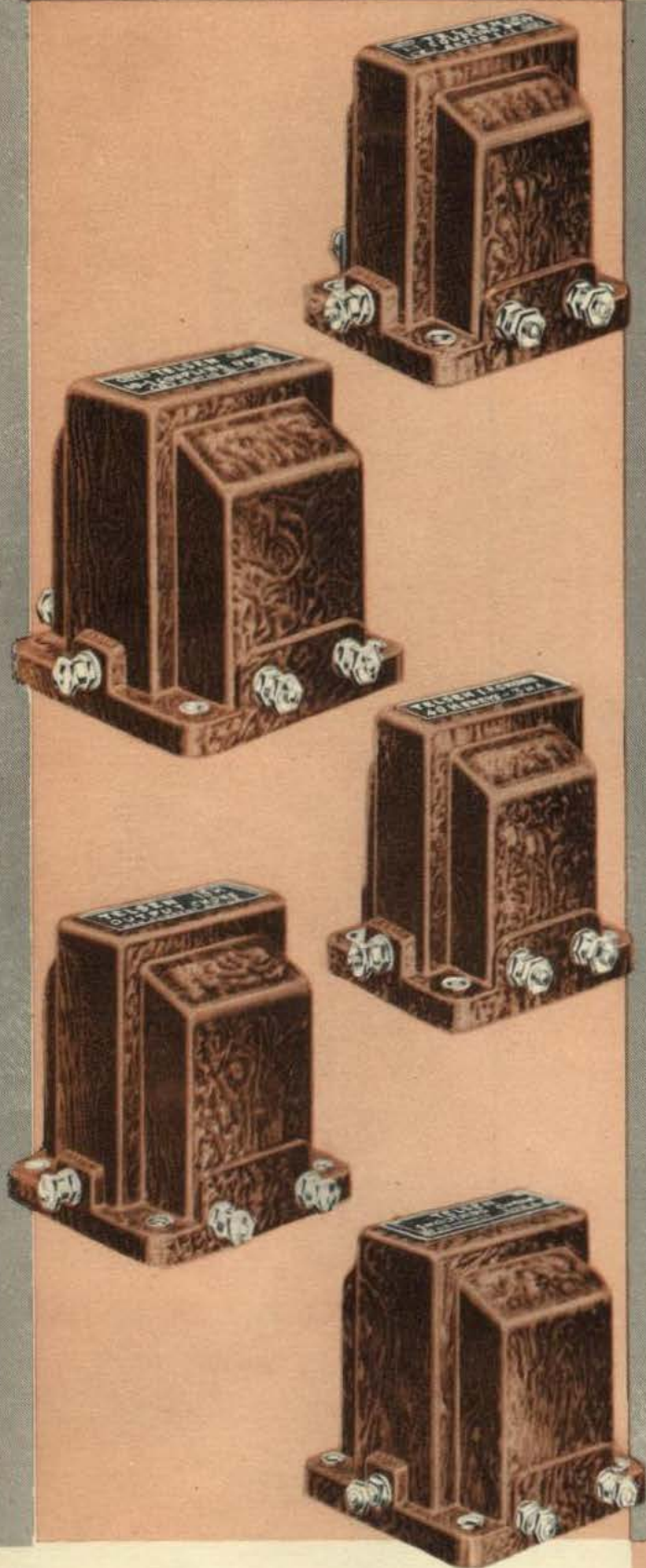

TELSEN 1-1 INTERVALVE COUPLING UNIT

This is a modern development of the one time deservedly popular R.C. units. It incorporates a low pass filter feed in its anode circuit, thus effectively preventing "motor boating," "threshold howl," and other forms of instability. With an H.L. type valve it will give an amplification of about 20, while consuming negligible H.T. current.

No. 214 Price 7/6

TELSEN 10-1 INTERVALVE COUPLING UNIT

A filter-fed Transformer using a high permeability nickel alloy core, and enabling a 10-1 voltage step-up to be attained while preserving an exceptionally good frequency characteristic which is compensated in the higher frequencies for use with a pentode valve.

No. W.215 Price 12/6

TELSEN "R.C." COUPLING UNIT

No. W.285 Price 4/-

TELSEN INTERVALVE L.F. COUPLING CHOKES

Rating	Normal Current	Max. Current	No.
40 H. at 3 mA	..	10 mA	.. W.68
100 H. at 2 mA	..	6 mA	.. W.69

These popular L.F. Chokes are primarily intended for use as coupling chokes in the anode circuits of modern radio receivers, but may be used in any circuit not carrying more than the stipulated maximum current.

Price 5/- each

TELSEN OUTPUT CHOKE

Designed for use as an output filter in conjunction with a condenser not less than 1 mfd., following any power or super power valve taking up to 40 mA anode current. Gives an ideal response curve under all conditions.

No. W.71 Price 7/-

TELSEN L.F. SMOOTHING CHOKE

The Telson Smoothing Choke has been designed to fulfil all the requirements of an efficient smoothing component in the rectified mains output circuit of a receiver. Its inductance is 28 henries at 25 mA the maximum permissible current not exceeding 50 mA D.C. Resistance 1,000 ohms.

No. W.302 Price 12/6

TELSON

RADIO CO

OUTPUT TRANSFORMERS & CHOKES

TELSEN OUTPUT TRANSFORMER, RATIO 1—1

This Transformer enables a high resistance type speaker to be connected to the output circuit of a receiver using a triode output valve without the necessity of passing direct current through the speaker windings. Saturation of the magnet system is thereby avoided, and the H.T. voltage is kept away from the speaker. Suitable for anode current up to 40 mA D.C.

No. W.62
Price 10/6

TELSEN MULTI RATIO OUTPUT TRANSFORMER

This is designed for use with moving coil loudspeakers having a low impedance speech coil winding. It has three ratios : 9—1, 15—1 and 22.5—1, which allows the correct matching of speakers of widely varying characteristics. Suitable for anode currents up to 40 mA.

No. W.63.
Price 10/6

TELSEN TAPPED PENTODE OUTPUT CHOKE

This Choke is designed primarily for pentodes taking an anode current of not more than 20 mA. By varying the connections, ratios of 1—1, 1.6—1 and 2.5—1 are attainable, thus providing for matching under widely varying conditions.

No. W.72
Price 7/6

TELSEN POWER PENTODE OUTPUT CHOKE

The use of this Power Choke prevents direct current passing through the loudspeaker when the latter is used in conjunction with power pentode output valves carrying up to 40 mA. It also enables correct matching and good quality to be obtained through the choice of three ratios, namely, 1—1, 1.3—1 and 1.7—1.

No. W.172
Price 10/6

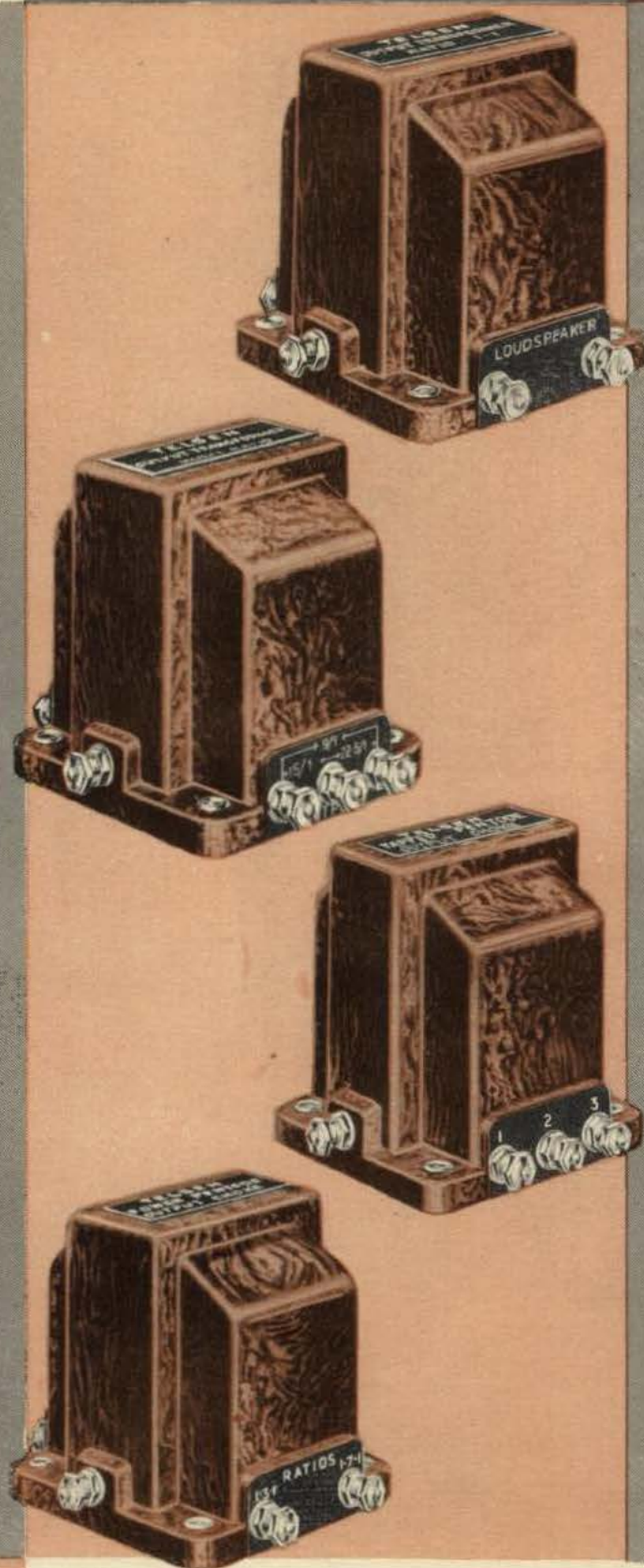

TELSEN
COMPONENTS

H. F. CHOKES, GRID LEAKS & HOLDERS

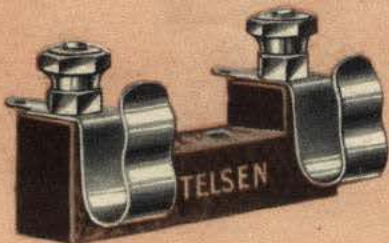
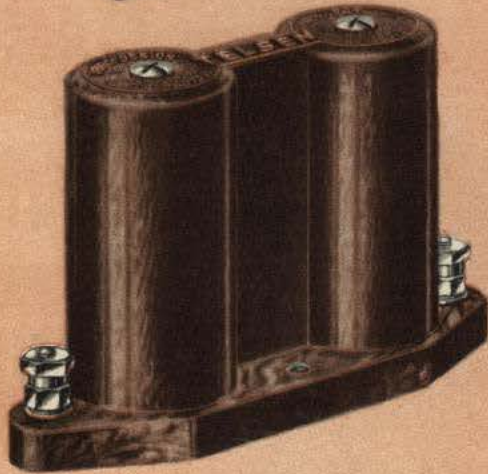

TELSEN STANDARD H.F. CHOKE

The Telsen Standard H.F. Choke is deservedly popular in view of its remarkable efficiency at a low cost. It is particularly suitable for reaction circuits, has a very low self-capacity for its high inductance and occupies a minimum of space.

No. W.75

Price 2/-

TELSEN BINOCULAR H.F. CHOKE

In high class circuits calling for exceptionally efficient H.F. chokes, the Telsen Binocular Choke can be relied upon in every respect. Its external field is negligible due to the binocular formation, it has a low self-capacity while its inductance is as high as 180,000 micro-henries.

No. W.74

Price 5/-

TELSEN SHORT WAVE H.F. CHOKE

This choke is specifically designed to cover the complete short wavelength band, usually considered to extend from 150 to 10 metres. "Blind Spots" have been eliminated, and its extremely low self capacity makes it a thoroughly reliable and efficient component for all Short Wave circuits. Enclosed in a neat bakelite moulding it occupies a minimum of space.

No. W.221

Price 3/6

TELSEN GRID LEAKS

These are absolutely silent and practically unbreakable and do not vary in resistance with application of different voltages. They are non-inductive and produce no capacity effects.

Cap. Megohms	No.	Cap. Megohms	No.
5 ..	W.254	1 ..	W.250
4 ..	W.253	1/2 ..	W.249
3 ..	W.252	1/4 ..	W.248
2 ..	W.251		

Price 1/- each

TELSEN GRID LEAK HOLDER

This will hold firmly any standard size or type of grid leak. The spring contacts are extended in one piece to form soldering tags, and the terminals and fixing holes are accessible without removing the grid leak.

No. W.148

Price 6d.

TELSEN
RADIO COMPONENTS

SELF SEALING & FIXED MICA CONDENSERS

TELSEN SELF-SEALING CONDENSERS

500 volt test			1,000 volt test		
Mfd.	No.	Price	Mfd.	No.	Price
.01	W.232	1/6	.01	W.239	2/6
.04	W.230	1/9	.04	W.237	2/9
.1	W.231	1/9	.1	W.238	2/9
.25	W.229	2/-	.25	W.236	3/-
.5	W.228	2/3	.5	W.235	3/3
1	W.227	2/3	1	W.234	3/6
2	W.226	3/-	2	W.233	5/-

These condensers are self-sealing, non-inductive and hermetically sealed. They are offered in two types, the capacities from .01 to 2 mfd. in bakelite cases, and blocks of 4, 6 and 8 mfd. in metal cases with soldering tags.

TELSEN SELF-SEALING BLOCK CONDENSERS

500 volt test			1,000 volt test		
Mfd.	No.	Price	Mfd.	No.	Price
4	W.175	5/6	4	W.178	9/6
6	W.176	8/-	6	W.179	14/6
8	W.177	10/6			

TELSEN MICA CONDENSERS

The new Telsen "Mica" Condensers represent an important advance in technique by which H.F. losses have been practically eliminated. The re-designed case is of more attractive appearance and can be mounted vertically or flat. Grid leaks, as before, may be mounted in series or shunt, clips being supplied free with capacities .0001, .0002 and .0003 mfd.

Cap.	No.	Price	Cap.	No.	Price
.0001 mfd.	W.240	1/-	.0005 mfd.	W.244	1/-
.0002	W.241	1/-	.001	W.245	1/-
.0003	W.242	1/-	.002	W.246	1/-
.0004	W.243	1/-	.006	W.247	1/3

The following mica condensers have also been added to the range for special purposes, e.g., band-pass filter circuits, etc., and are supplied in the Self-Sealing type bakelite cases.

Capacity	No.	Price
.01 mfd.	No. W.310	3/-
.02	No. W.311	3/6
.05	No. W.316	5/6

TELSEN PRE-SET CONDENSERS

The very low minimum capacity of the Telsen Pre-set Condensers gives a wide range of selectivity adjustment when used in the aerial circuit. They are substantially made, easily adjusted and provided with a locking ring. Their high insulation and low loss adapts them for a number of uses.

Max. Cap. Mfd.	Min. Cap. Mfd.	No.
.002	.00025	W.149
.001	.000052	W.150
.0003	.000016	W.151
.0001	.000005	W.152

Price 1/6 each

TELSEN TAG CONDENSERS

These may be mounted on either insulated or metal panels by utilising the two baseboard screw holes. The tags enable the condenser to be connected to any other component either directly or by soldering. H.F. losses are negligible.

Cap.	No.	Price	Cap.	No.	Price
.0001	W.207	6d.	.0005	W.211	6d.
.0002	W.208	6d.	.001	W.212	6d.
.0003	W.209	6d.	.002	W.213	6d.
.0004	W.210	6d.			

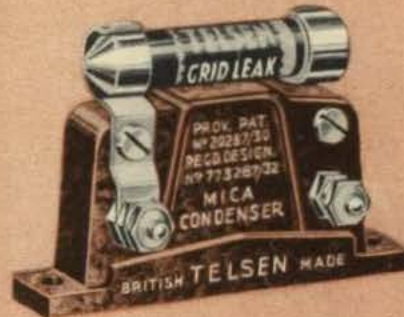
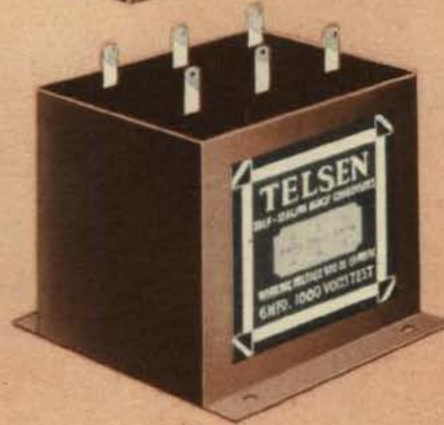
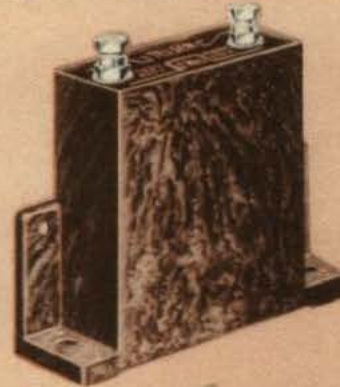

TELSEN

RADIO COMPONENTS

LOUD SPEAKER UNITS & CHASSIS

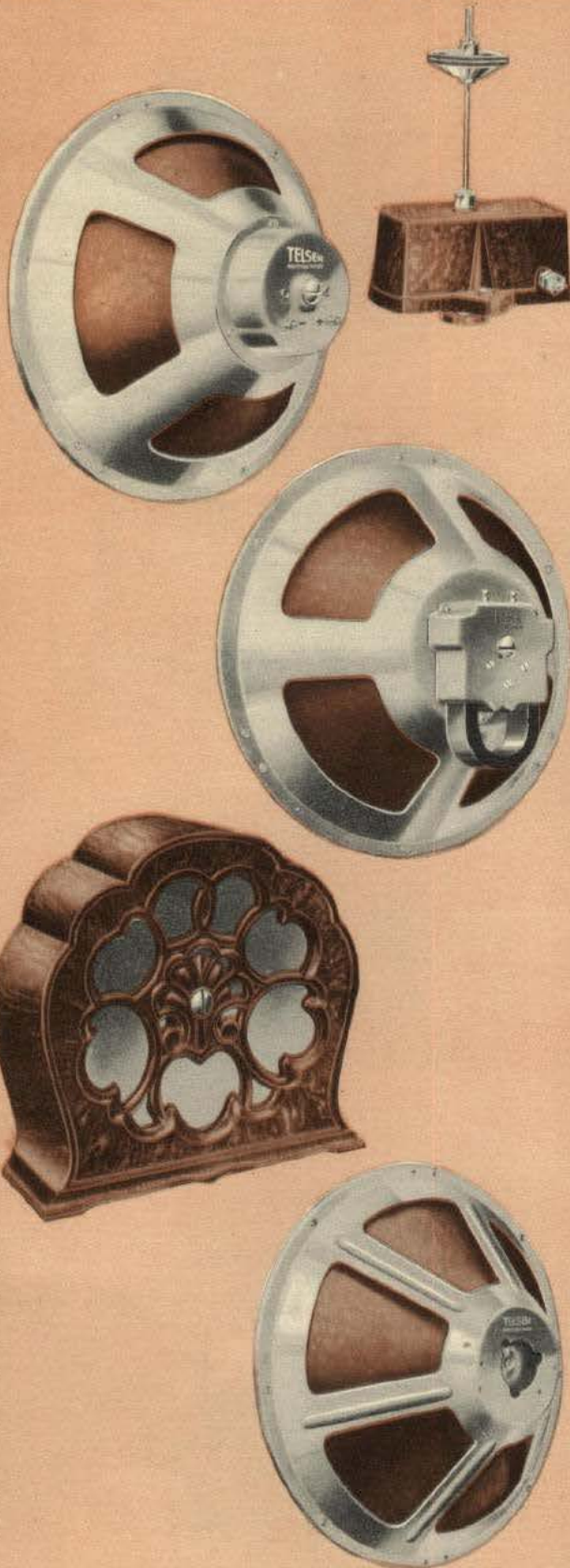

TELSEN LOUDSPEAKER UNIT

A reliable Loudspeaker Unit capable of giving a very pleasing performance at a low price. The magnets are of cobalt steel and the detachable rod which carries the cone is fitted with cone washers and clutch. The entire unit is enclosed in a beautifully moulded bakelite dust cover.

No. W.54
Price 5/6

TELSEN W.181 LOUDSPEAKER

An inexpensive combined Loudspeaker Cone Chassis and Unit, which gives a pleasing and natural balance of tone and will handle all the output necessary for ordinary reception. Fitted with a fully floating cone of damp-resisting material and mounted in a rigid pressed frame of 11" diameter.

No. W.181
Price 10/6

TELSEN W.182 LOUDSPEAKER

This complete Loudspeaker Chassis in two models, incorporates a powerful unit with a high degree of sensitivity and is capable of handling large power outputs. The tonal range is exceptionally fine, combining both depth and brilliance to a remarkable degree. The fully floating cone of special damp resisting material is mounted in a rigid pressed frame.

No. W.182 (Dia. 11") Price 17/6
No. W.183 (Dia. 14½") Price 22/6

THE TELSEN CABINET SPEAKER

A thoroughly reliable Loudspeaker, giving a very fine performance. The natural resonances have been adjusted so that a good tone balance is obtained. The artistic bakelite cabinet is finished in polished mottled walnut and will harmonise with any surroundings. Size : 11" high, 11½" wide, 3½" deep.

No. W.53
Price 25/-

TELSEN LOUDSPEAKER CHASSIS

The fully floating cone of specially prepared damp-resisting material is mounted on a flexible felt surround in a rigidly constructed, light pressed aluminium frame. The material and proportions of the cone give an exceptionally natural balance of tone free from objectionable resonances. With the Telsen Unit W.54, it forms an ideal, inexpensive combination which, for natural reproduction and all-round performance rivals the highest priced units.

Telsen "Major" Loudspeaker Chassis. Dia. 14½"
No. W.170
Price 10/6

Telsen "Popular" Loudspeaker Chassis. Dia. 11"
No. W.159
Price 5/6

TELSEN
RADIO COMPONENTS

TERMINAL BLOCKS, FUSE HOLDERS & SCREENS

TELSEN TERMINAL BLOCKS

Two insulated terminals are mounted upon a bakelite moulding as employed in the grid leak holder and power fuse mount.

They may conveniently be used for aerial and earth, loudspeaker, pickup or extra battery connections, or for independent anchorage points.

No. W.204

Price 6d.



TELSEN POWER FUSE-HOLDER

Made for mounting the Telsen Power Fuse. The end clips are securely held and are in one piece with the soldering tag projections. Ordinary wire connections can also be made under the clip screws.

No. W.203

Price 6d.

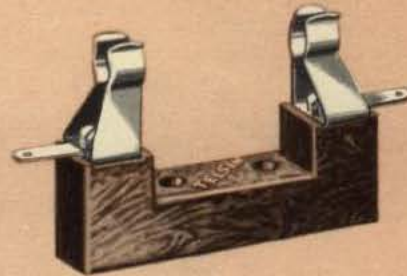

TELSEN POWER FUSE

These efficient little power fuses utilise a special fuse wire having a very small "timelag" when the fusing current has been attained. The wire is mounted in a glass tube hermetically sealed into caps of polished nickel.

Made in four values:—

Fusing Current	No.	Price
½ amp.	W.199	6d.
1 "	W.200	6d.
2 "	W.201	6d.
3 "	W.202	6d.



TELSEN SCREENS

These are beautifully finished, and a series of holes is provided for fixing in different positions the movable terminals supplied with it. Size 6" deep × 9½" wide. In model No. W.167 a hole is provided for mounting the screened grid valve in a horizontal position.

No. W.166

No. W.167

Price 2/-

Price 2/6

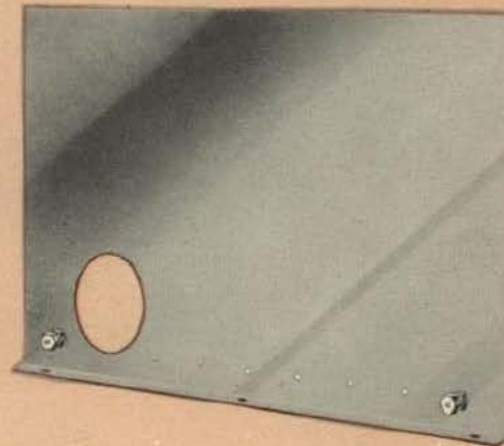

TELSEN FUSE-HOLDER

A neat and inexpensive device which should be incorporated in every receiver as a precaution against burnt out valves. The terminals are easily accessible and the standard type fuse bulb is held firmly, giving a perfect contact which cannot become loose.

No. W.146

Price 6d.



TELSEN 100 m/A. FUSE BULB

No. W.318

Price 6d.

TELSEN
RADIO COMPONENTS

PICK UPS, VOLUME CONTROLS & SWITCHES

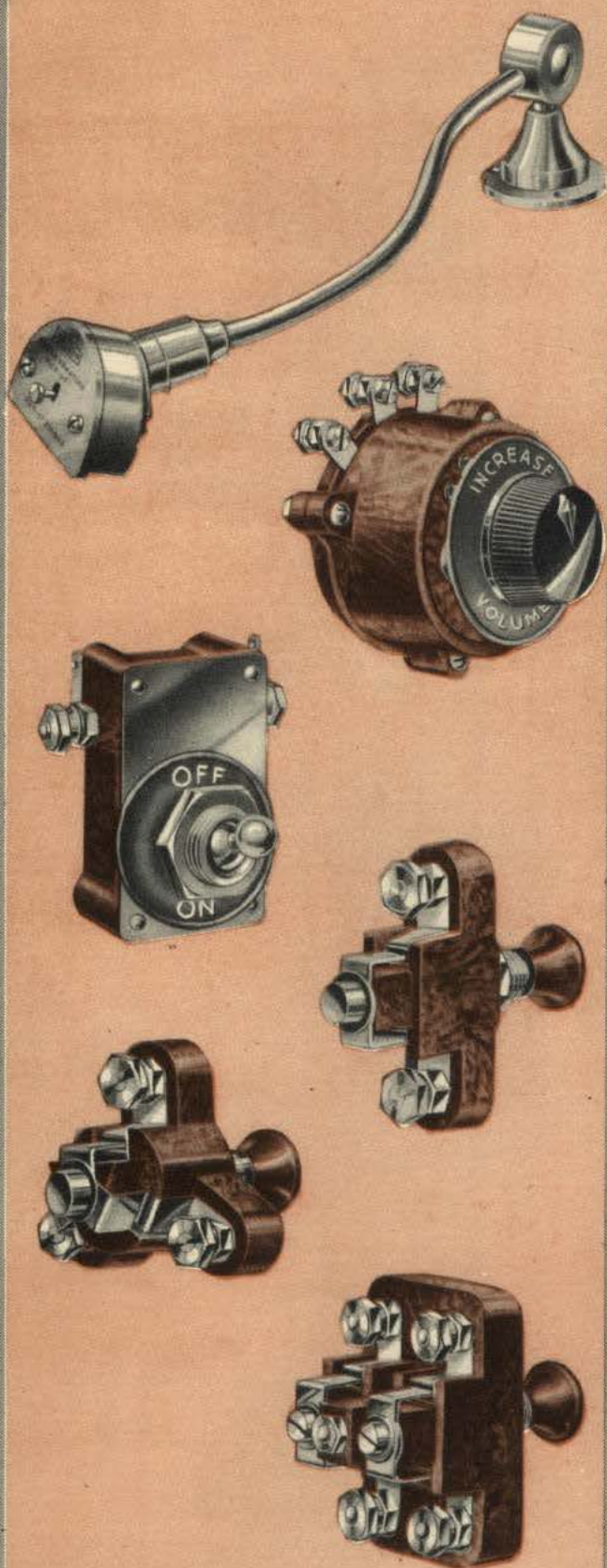

TELSEN NEEDLE ARMATURE PICK-UP

(Pat. No. 324943) As used by the B.B.C.

Very carefully designed in every detail, the Telsens Needle Armature Pick-up can be thoroughly relied upon to give true and faithful reproduction of Gramophone records, the frequency response ranging from as low as 25 cycles per second up to 7,500 cycles per second. The lightness of the Needle Armature allows for perfect freedom of movement in the record grooves, so that a natural response of both the high and low frequencies is obtained, while record wear is reduced to negligible proportions. A light tracking arm, nickel finished, ensures accurate tracking of the needle point in the record groove.

No. W.317 Price 32/6

TELSEN VOLUME CONTROLS

Telsens Volume controls are made primarily in two models, 10,000 ohms and 50,000 ohms. The resistance element is entirely wire-wound with a special alloy wire of high resistivity and great mechanical strength, ensuring constant value and noiseless operation. They are adaptable to a number of different uses in both H.F. and L.F. circuits, a notable feature in their construction being that, as the contact arm is insulated from the operating spindle, two or more may be ganged on the same spindle and controlled by one knob.

10,000 ohm	..	W.298	..	Price 3/9
50,000 "	..	W.295	..	" 3/9

TELSEN 50,000 OHM VOLUME CONTROL WITH MAINS SWITCH COMBINED

No. W.296 Price 5/6

TELSEN MAINS SWITCH

A miniature switch of very robust construction. Its rapid make and break action makes it particularly suitable as a master switch in Mains and Battery operated receivers, for switching Gramophone motors, and numerous other uses. Capable of handling up to 3 amperes at 250 volts with perfect safety. Enclosed in a neat moulded bakelite cover with one hole fixing.

No. W.297 Price 1/9

TELSEN PUSH-PULL SWITCHES

(Prov. Pat. No. 14125/31)

The Telsens Push-Pull Switches employ the "knife" type of self-cleaning contact, and a positive snap action. The nickel silver bridge piece is driven between the springy "fixed" contacts, and the wedge-shaped plunger squeezes the inner contacts outwards, closing the jaws in a firm grip. The series gap reduces self-capacity to a minimum, and the spindle is insulated from all contacts. They can be usefully applied for several different purposes, e.g., for the switching on and off of the high and low tension and grid bias batteries, for wave change switching where two or three contacts are employed, etc. The shape of the spindle guide prevents any possibility of the contacts becoming out of alignment.

Two-point, No. W.107	Three-point, No. W.108
Price 1/—	Price 1/3

TELSEN FOUR-POINT "TWO-POLE" PUSH-PULL SWITCH

Designed on the same lines as the 2 and 3-point Switches, this model is a two-pole switch highly suitable for use in wave changing on two coils or an H.F. transformer, or for switching pick-up leads or an additional loudspeaker.

No. W.153 Price 1/6

TELSEN
RADIO COMPONENTS

RESISTANCES & VALVE HOLDERS

TELSEN SPAGHETTI FLEXIBLE RESISTANCES

These resistances are made from the finest nickel-chrome wire, wound on a pure cotton core, stoved and impregnated so that moisture cannot attack the wire and cause corrosion. The bending of the resistance will not alter its value.

Made in the following values :—

No.	Resistance Ohms.	No.	Resistance Ohms.	Max. Price Curr. each
W.109	300	W.110	600	42 m/a. } 6d.
W.111	750	W.112	1,000	42 m/a. }
W.113	1,500	W.114	2,000	23 m/a. } 9d.
W.115	3,000	W.116	4,000	23 m/a. }
W.117	5,000			23 m/a. }
W.118	10,000	W.119	15,000	6 m/a. } 1/-
W.120	20,000	W.121	25,000	6 m/a. }
W.122	30,000			6 m/a. }
W.123	50,000	W.124	60,000	3 m/a. } 1/6
W.125	80,000	W.126	100,000	3 m/a. }

TELSEN CARTRIDGE RESISTANCE HOLDER

Resistance Holder .. No. W.286 .. Price 9d.

TELSEN CARTRIDGE RESISTANCES

These Resistances are of the 1 watt type, and maintain a constant value unaffected by change of temperature. They are enclosed within strong cartridge type cases with heavily nickelled end caps. Mounted in the Telsen Cartridge Resistance holder, which may be mounted vertically or horizontally, they present a very neat appearance. Made in the following values :—

Resistance	No.	Resistance	No.	Price
300 ohms ..	W.263	10,000 ohms ..	W.274	} Price 1/9 each
350 " ..	W.289	15,000 " ..	W.275	
400 " ..	W.264	20,000 " ..	W.276	
500 " ..	W.265	25,000 " ..	W.277	
600 " ..	W.266	30,000 " ..	W.278	
750 " ..	W.267	50,000 " ..	W.279	
1,000 " ..	W.268	60,000 " ..	W.280	
1,500 " ..	W.269	80,000 " ..	W.281	
2,000 " ..	W.270	100,000 " ..	W.282	
3,000 " ..	W.271	150,000 " ..	W.283	
4,000 " ..	W.272	200,000 " ..	W.284	
5,000 " ..	W.273			

TELSEN VALVE-HOLDERS

The latest models of Telsen Valve-holders have an extremely low self-capacity and are made in both solid and anti-microphonic types. These embody special contact sockets of one-piece design with neat soldering tags and end terminals.

Solid Type		Anti-microphonic type	
No.	Price	No.	Price
4-pin .. W.224 ..	9d.	4-pin .. W.222 ..	1/-
5-pin .. W.225 ..	1/-	5-pin .. W.223 ..	1/3

TELSEN UNIVERSAL VALVE-HOLDER

The Universal Valve-holder provides a method of supporting a screen grid valve in a horizontal position on a baseboard, and is ideal for use in conjunction with the Telsen screen W.167. Alternatively in confined spaces it enables any valve to be mounted parallel to the surface on which the holder is fixed.

No. W.198

Price 1/-

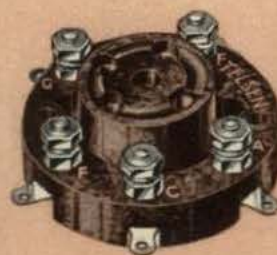
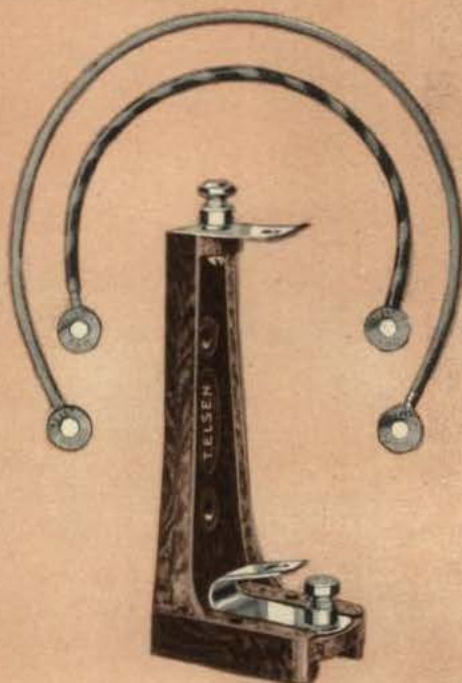

TELSEN

RADIO COMPONENTS

TONE CORRECTORS & CONSTRUCTORS' OUTFITS

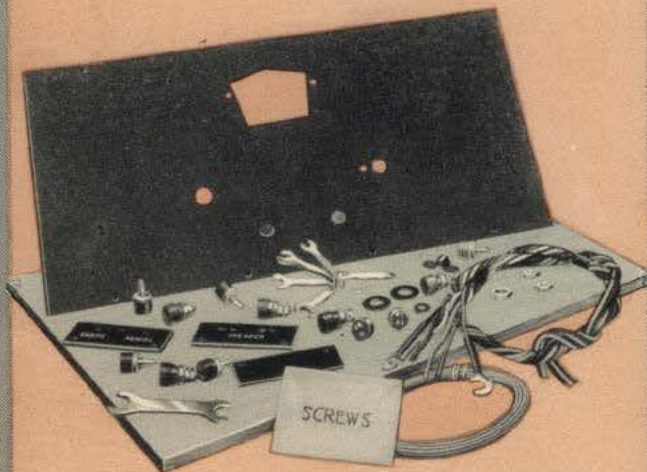
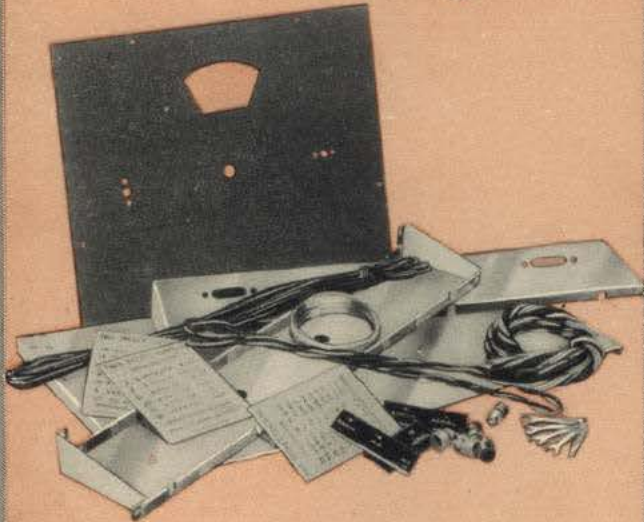
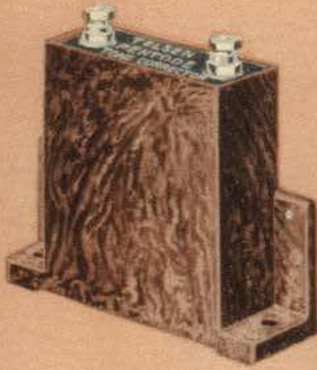

TELSEN PENTODE TONE CORRECTOR

This component has been designed to compensate for the accentuation of the high notes resulting from the use of a Pentode, and can be incorporated in the majority of circuits employing this valve in the output stage. In addition to acting as a tone corrector in this way, it gives protection to the Pentode valve by ensuring that the impedance of the output circuit does not rise to an excessive amount.

No. W.308 Price 3/6

TELSEN VARIABLE TONE CORRECTOR

Another extremely useful tone corrector that enables the experimenter to adjust the reproduction from his receiver to a balance of tone and quality suited to his own individual taste. By a turn of the knob the tone can be varied from an accentuation of the high notes to a predominance of the bass. Suitable for any output circuit.

No. W.314 Price 5/6

TELSEN CONSTRUCTOR'S OUTFITS

The Telsen Constructor's Outfits are prepared to simplify still further the construction of the Telsen "All Mains S.G.3," "Super Selective Four" and "Super Six" receivers (described in this issue), by grouping together the metal chassis, panel, baseboard and all the necessary sundries required for the construction of the receiver in question. Thus when the standard components for any of these receivers are obtained separately, the Constructor has only to purchase the corresponding outfit to enable him to complete the entire construction of the receiver selected.

TELSEN "ALL MAINS S.G.3" CONSTRUCTOR'S OUTFIT

No. W.303 Price 7/6

TELSEN "SUPER SELECTIVE FOUR" CONSTRUCTOR'S OUTFIT

No. W.304 Price 7/6

TELSEN "SUPER SIX" CONSTRUCTOR'S OUTFIT

No. W.305 Price 7/6

CONSTRUCTOR'S OUTFIT—TELORNOR

This outfit contains all the necessary requirements for the construction of all types of circuits where the "Telornor" can be embodied. Of these, the Telsen "Triple 3," the "Ajax 3," and the "Nimrod 2" will suffice as examples.

No. W.220 Price 3/6

CONSTRUCTOR'S OUTFIT — DRUM DRIVE AND CONDENSER ASSEMBLY

This is an invaluable accessory to the constructor building up any type of Circuit embodying the Telsen Drum Drive and Condenser assembly of which the Telsen "Jupiter 3" is an example.

No. W.219 Price 3/6

CONSTRUCTOR'S OUTFIT—TELSEN "ASTRALA 3"

This outfit contains all the necessary requirements for the construction of the circuits using the Telsen "313" Disc Drive—an example of which is the Telsen "Astrala 3."

No. W.326 Price 3/6

TELSEN
RADIO COMPONENTS

3

NEW COMPONENTS

ADDED TO THE TELSEN RANGE
SINCE GOING TO PRESS

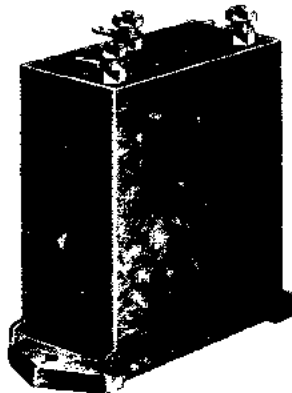

TELSEN "AMPLITOR"

(Pro. Pat. No. 2877/33).

The new Telsen "Amplitor" heralds a revolutionary advance in radio technique, for this brilliant new component effects two distinct and outstanding improvements in any type of set, firstly, giving amplification equal to an extra L.F. stage at no extra cost, and secondly, a tremendous improvement in quality of reproduction. The "Amplitor" is the only component of its kind in the world, and is covered by a special Telsen patent licence which will be found in each carton.

W.336. Price - - - **5/6**

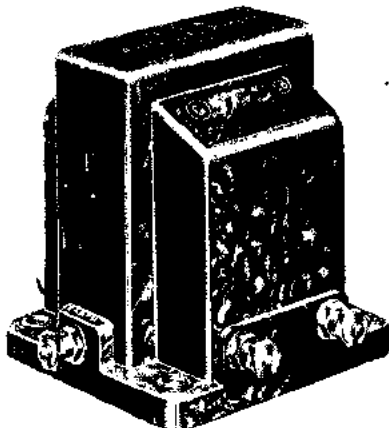

TELSEN "AUDIOFORMER"

The Telsen "Audioformer" solves the problem of tone compensation which has been created by to-day's demand for super-selectivity. Its fixed compensation restores all the high notes which have been lost by the cutting of the sidebands, yet it does so without any loss of amplification or reduction in bass response, and without necessitating either an extra L.F. stage or any additional components.

Absolutely self-contained, this single brilliant component is all you need to achieve that perfect reproduction which your critical ear demands.

Ratio 5—1.
W.327. Price - - - **11/6**

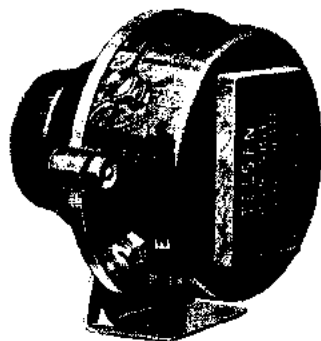

TELSEN VARIABLE TONE CONTROL

This Variable Tone Control supersedes the Telsen Variable Tone Corrector illustrated and described on page 40 of the two-colour Component Supplement. Its functions are identical, but the design has been improved since this issue went to press.

W.314. Price - - - **5/6**

PRICE REDUCTIONS

EFFECTED SINCE GOING TO PRESS

Cat. No.	Description.	Old Price.	New Price.	Cat. No.	Description.	Old Price	New Price
GRID LEAK							
W.248	1/2 meg. . . .	1/-	6d.				
W.249	1/2 " " " " . .	1/-	6d.	W.185	.0003	2/6	2/-
W.250	1 " " " " . .	1/-	6d.	W.186	.00015	2/6	2/-
W.251	2 " " " " . .	1/-	6d.	W.187	.0001	2/6	2/-
W.252	3 " " " " . .	1/-	6d.	W.319	.00035	2/6	2/-
W.253	4 " " " " . .	1/-	6d.	TUNING CONDENSER			
W.254	5 " " " " . .	1/-	6d.	W.193	.0005	2/6	2/-
FIXED MICA CONDENSER				W.194	.0003	2/6	2/-
W.240	.0001	1/-	6d.				
W.241	.0002	1/-	6d.				
W.242	.0003	1/-	6d.				
W.243	.0004	1/-	6d.	W.205	Aerial Series Condenser .0003	2/3	2/-
W.244	.0005	1/-	6d.	METAL SCREEN			
W.245	.001	1/-	6d.	W.166	Plain	2/-	1/3
TAG CONDENSER				W.167	with hole . .	2/6	1/3
W.207	.0001	6d.	4 1/2 d.	VOLUME CONTROL			
W.208	.0002	6d.	4 1/2 d.	W.298	10,000 ohms.	3/9	3/-
W.209	.0003	6d.	4 1/2 d.	W.295	50,000 ohms.	3/9	3/-
W.210	.0004	6d.	4 1/2 d.	W.296	with mains switch	5/6	4/9
W.211	.0005	6d.	4 1/2 d.	All Cartridge Resistances			
W.212	.001	6d.	4 1/2 d.	W.206	Telornor (This component is listed in <i>The Radiomag</i> at its reduced price)	1/9	1/-
VALVE HOLDER Solid Type							
W.224	4-pin	9d.	6d.				
W.225	5-pin	1/-	8d.				
Anti-Micro							
W.222	4-pin	1/-	8d.				
W.223	5-pin	1/3	10d.				
W.198	Universal Valve Holder	1/-	9d.				
REACTION CONDENSER							
W.188	.0003	2/-	1/9				
W.189	.00015	2/-	1/9				
W.190	.0001	2/-	1/9				
W.191	.00075	2/6	2/-				
W.192	.0005	2/6	2/-				

Cat. No.	Description	Old Price	New Price
	MACNAMARA "The Golden Voice" Model 312 - 12 gns.		10 gns.
	MACNAMARA "The Golden Voice" Model 315 - 15 gns.		11 gns.

NEW COMPONENTS

Additional Lines introduced since going to Press.

W.336	Amplitor						5/6
W.327	Audioformer						11/6

TELSEN BAND PASS AND SUPERHET COILS

—continued from page 9

inductive coupling is very suitable for good selectivity on the upper wavelength range.

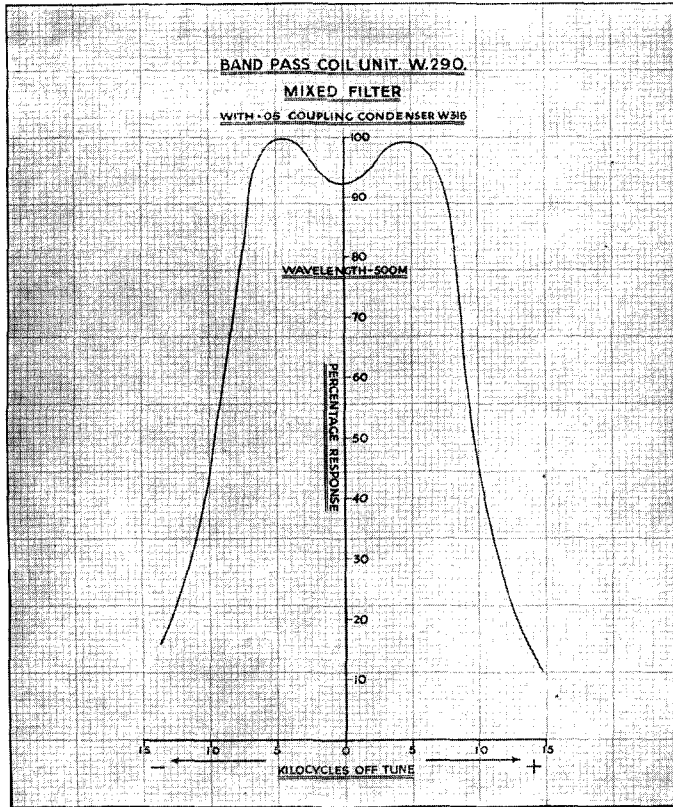

FIG. 8

The capacity coupled method depicted in Fig. 6 has characteristics such that the peak separation broadens as the wavelength is increased, the efficiency varying in the opposite direction. This is particularly useful when used before valves which are coupled by single tuned circuits, as the selectivity and efficiency of these two types of circuits vary in opposite directions, and hence by using suitable circuit values a constant level of selectivity and efficiency may be obtained throughout the whole wavelength range. The Telsen .01 and .02 mfd. Mica Condensers W.310 and W.311 respectively are particularly useful for this type of coupling, having a very low loss and more important still, being absolutely non-inductive.

The mixed filter shown in Fig. 7 is a combination of the inductive and capacity types of filters. It will have been noticed from the above remarks that the characteristics of these two types of filters are opposite in action and the mixed filter combines the best qualities of both.

The Telsen .05 mfd. Mica Condenser W.312 and the Telsen Cartridge Anode Resistance of 1,000 ohms W.268 are needed to accomplish this coupling, both being highly efficient in so far as they are non-

inductive. The necessary mutual inductance is obtained by means of the link circuits, these being connected to give a negative mutual inductance. This is necessary, as the link must be connected to give a positive reactance compared with that of the .05 mica condenser, and since capacitive and inductive reactances are normally opposite in sign, the mutual inductance is made of negative denomination.

Typical curves obtained with the Telsen Band Pass Coils are shown in Figs. 8 and 9 which explain the excellent selective results obtained in practice.

All Telsen Band Pass Coils are carefully matched to a standard inductance, and may be used in conjunction with the usual type of Telsen Screened Coils W.216 and W.287, so that great freedom in receiver design is possible.

We now pass to the new types of coils that, together with the Band Pass Coils, are of infinite value to the Superheterodyne Fan. The Telsen Combined Band Pass Oscillator Coil W.292 Unit is for use in superheterodyne receivers when the tuned circuits are to be ganged to one another and to the oscillator circuit, by ganged similar condensers. It is, of course, well

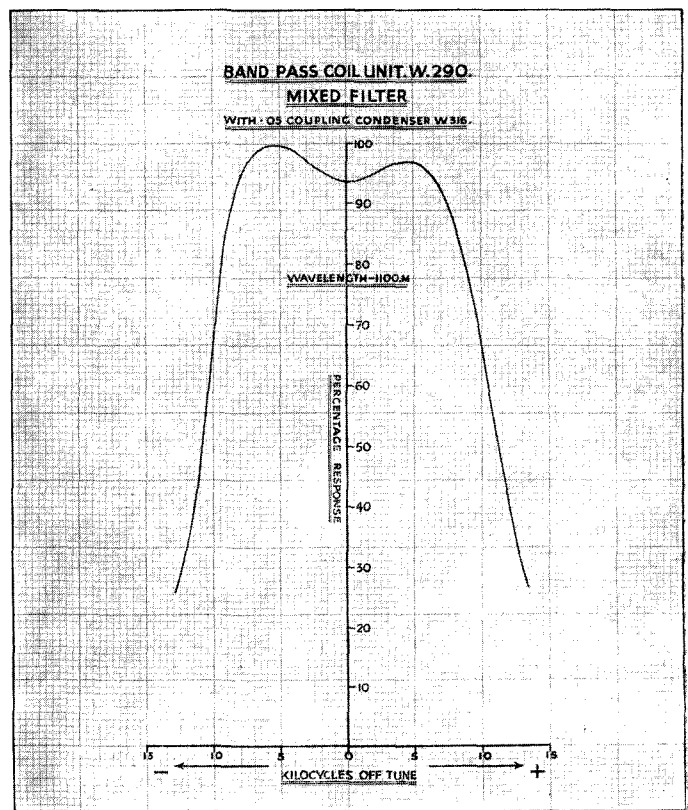
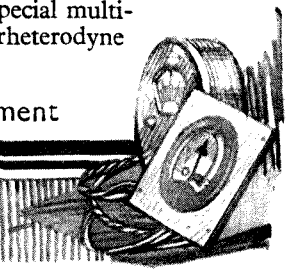
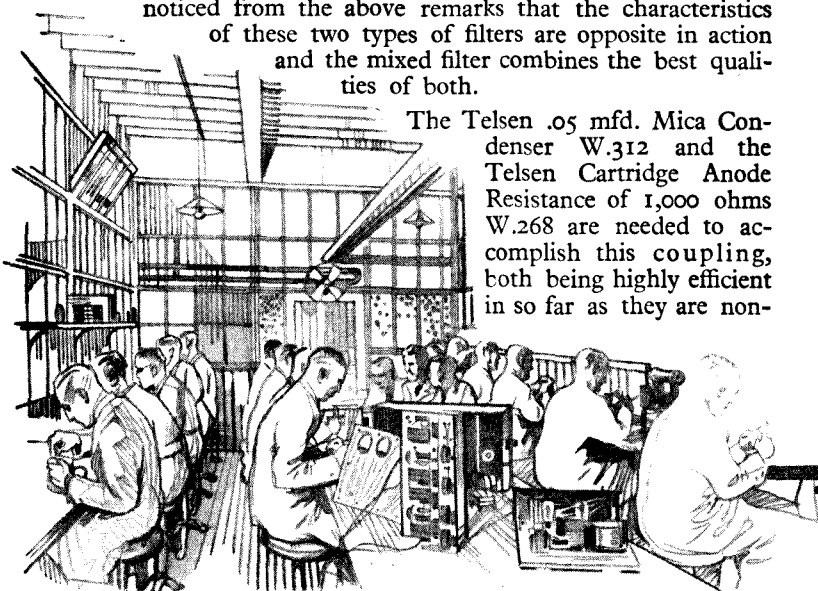

FIG. 9

known that in a superheterodyne receiver the frequency to which the oscillator is tuned must vary by a constant amount from the input circuit frequency, whatever be the dial setting of the ganged receiver. This could be achieved by using a multi gang condenser with the vanes of the oscillator condenser so shaped, as to tune the oscillator circuit at a constant frequency difference from the other circuits. This method has many drawbacks, the chief one being that the special multi-gang condenser can be used only for superheterodyne

(continued on page 42)

A View in our Technical Department



NEW TELSEN COMPONENTS—continued from page 41

work, and therefore cannot be incorporated in the "straight" type of circuit.

The Telsen Band Pass and Oscillator Coils have their inductances so proportioned that a ganged condenser of the orthodox type may be used. To ensure perfect ganging on both wavelength

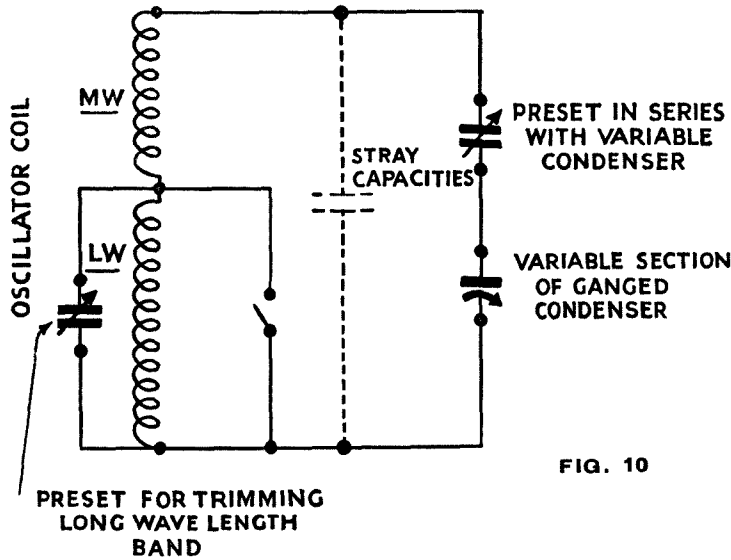

FIG. 10

ranges, small pre-set condensers are placed in circuit with the variable condenser of the oscillator, these enabling a constant frequency difference to be maintained throughout the tuning range. The circuit is shown in Fig. 10.

Coming to practical details, the Combined Band Pass and Oscillator Coils are mounted on a metal plinth, allowing a four-hole mounting for the unit, and ensuring perfect switch alignment. The inductance values of the coils when screened are as follows :—

Coil.	Wavelength Range.	Inductance.
Band Pass.	Medium	165 microhenrys.
Band Pass.	Long.	2,170 "
Oscillator.	Medium.	114 "
Oscillator.	Long.	680 "

The general details are the same as for the Band Pass Coil Unit, and need not be repeated here.

The Oscillator Coil W.293 has been introduced so that any constructor already possessing a set of Band Pass coils, and who wishes to construct a superheterodyne receiver, has only to purchase such a component in order to complete the range of coils required. These coils may then be ganged up together in the usual manner.

The Telsen Band Pass Intermediate Frequency Transformer W.294 incorporates all the features essential to this type of component. This tuning device is perhaps the most important component in a superheterodyne, as it governs to a great extent the selectivity, sensitivity, and quality. To obtain selectivity with good quality, band passing is an absolute necessity. Without the band pass effect, the coil H.F. resistances

would have to be of such a high value, (in order to avoid top note cut off) that the amplification would be cut down to a very low value. Band passing gives good selectivity combined with excellent quality. Even then, great care has to be exercised in designing the windings in order that excessive high note amplification shall not be given, and only by a careful compromise in the effects of the dynamic resistance and the inductance to capacity ratio, are the best results obtained.

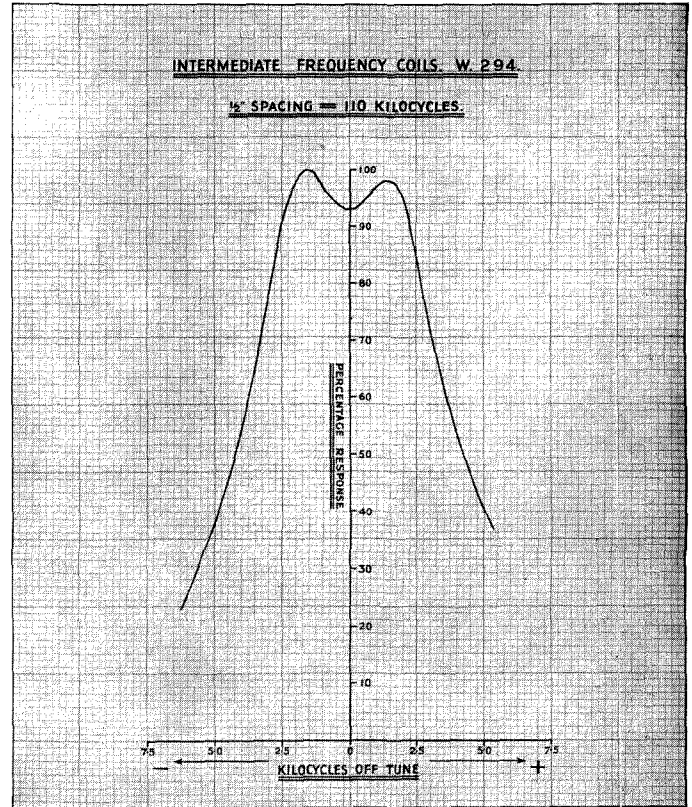
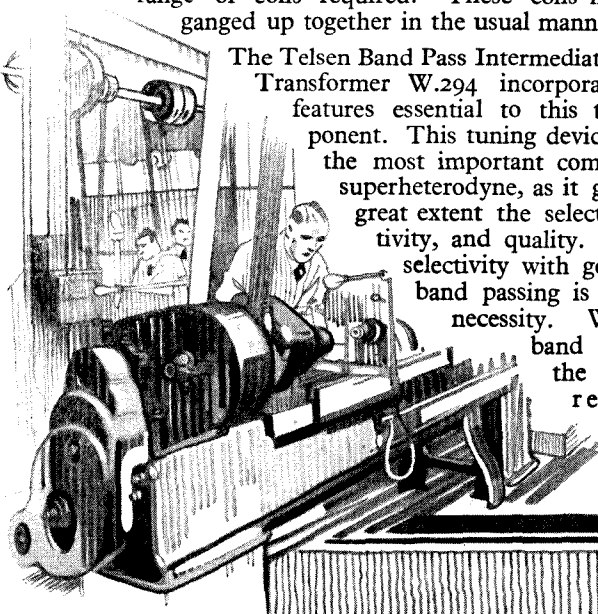

FIG. 11

All these matters have been most carefully considered in the design of the Telsen Band Pass Intermediate Frequency Transformers.

The section wound coils which may be varied in position relative to one another, are mounted on the same bakelite pillar. The magnetic coupling between them may thus be varied, and once the best position has been found the coils may be securely locked by a simple and easily operated device. Each coil is tuned by a pre-set condenser, the resonating frequency being 110 k.c. The condensers are adjusted in the Aston Factory to give this frequency. In practice it is found that the small stray capacities incidental to any receiver upset this tuning, so that the constructor may vary the condenser value by means of the small adjusting wheels projecting from the sides of the bakelite case. The band pass effect and hence the sensitivity, selectivity, and quality, may be completely controlled by the constructor. It is noteworthy that these condensers have a smooth and even action with a 270° movement. All adjustments are insulated from the earth connections, and the pre-set condensers have mica dielectrics. A well finished aluminium screen cover completes the assembly, and prevents reaction between different circuits. Fig. 11 depicts the band pass curve obtained with the transformer, the conditions under which it was taken being fully given.

The Telsen Needle Armature Pick-up W.315 has been



A Screw-cutting Lathe in our Tool Room

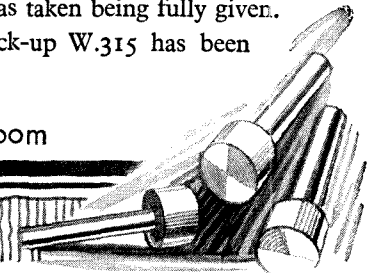

NEW TELSEN COMPONENTS—continued

developed to enable the most pleasing and faithful reproduction of modern gramophone recordings to be secured, together with satisfaction as regards low record wear.

The design is such that when the needle is in situation, it becomes the vibrating armature, the mass of which is so small as to have its natural resonant frequency well outside the audible limit, as far as gramophone reproduction is concerned. The needle, which is allowed ample movement, works in the gap between pole pieces attached to the limbs of a small "U" shaped magnet, the end being held by a screw in a small metal boss embedded in rubber, this latter having a damping effect. The Pick-up swivels on the gracefully curved arm, thus facilitating the easy changing of the needle by means of the projecting head of the fixing screw. The component is heavily nickelled, and being small, presents a neat and handsome appearance.

Owing to the lightness and efficient distribution of the different working masses, the needle point is allowed great freedom, so that it follows accurately and faithfully the grooves in the record, with a marked absence of objectionable resonance. This also ensures that the Pick-up responds in a uniform way to a very wide range of frequencies. The bearing pressure of the needle point laterally in the grooves is kept very low, so that the wear on the walls of the record is extremely small, whilst at the time the needle can easily follow the waveform of the sound impressions. It is well worth mentioning that the needle will follow without jumping, a record groove corresponding to 25 cycles per second.

Turning to the frequency response curve, this shows a marked rise in response below 200 cycles per second, whilst from 200 to 5,000 cycles per second it gives a gradual drop. From here onward a slight rise is shown until at 7,500 cycles per second a falling off occurs. It is, of course, realised that a straight line response curve is undesirable, especially below 200 cycles per second, as here the amplitude of swing has to be curtailed, due

to the pitch of groove standardised by the record manufacturers. A gradual rise in response after 5,000 is then necessary, in order to compensate for the loss on top notes usually found in low frequency amplifiers.

This type of characteristic curve ensures that in general, a delightful "body" to music, and in particular, a brilliance to orchestral work is imparted to the reproduction, the "attack" of the various instruments being rendered extremely well.

Pick-ups are usually designed to give very high outputs, but in doing this, certain desirable qualities are sacrificed. The Telsen Pick-up is primarily for high quality reproduction, so that the output voltage is accordingly lower than the average, being .1 to .2 volts. This is of little moment when used with modern amplifying equipment, with which the Pick-up will give ample volume.

In designing the tracking arm, great care has been taken to secure accurate tracking of the needle point in the record groove; and providing the arm is correctly placed relative to the turntable centre, the tracking error will not exceed $2\frac{1}{2}$ per cent. A template is supplied with each Pick-up for correctly positioning the Pick-up arm and turntable centre.

For controlling the volume, the Telsen Volume Control W.298 is recommended. This is similar to the Telsen Volume Control W.296 in its general design, except that its resistance is 10,000 ohms. Besides controlling the volume level, it reduces the effect of needle scratch, without impairing the response of the higher frequency notes.

It will have been by now realised that the Telsen Electric Co., Ltd., are keeping well to the fore in the adequate supply of new components for the wireless constructor, these new components giving him ample scope for extending his ambitions in the art of building more and more powerful and selective receivers, with the satisfying knowledge that complete faith may be placed in the design and manufacture of his Telsen Components.

NOTES ON GANGING CONDENSERS—continued from page 24

"Nimrod II" set up to carry out this test. The normal aerial loose coupling coil has, for the sake of clearness, been omitted, and also the normal tuning condenser has been completely removed from the circuit. In its place is the triple ganged condenser, which we will presume we wish to test, placed across the grid coil; the common rotor being connected to the low potential or earth side and one of the sections to be ganged, say C_1 , to the high potential or grid end. The trimmers of C_1 , C_2 and C_3 are all-loosened up to their fullest extent and the vanes set about 15° in mesh. The valve circuit is now made to oscillate by bringing up the reaction control. This will be observed by the milliammeter in the plate circuit giving a dip. An indicator for resonance is required and in this case may consist of a coil and a .0005 variable condenser in parallel coupled up very loosely to the grid coil of the oscillating set. The coil inductance should be about the same size as that in the set in order to get maximum sensitivity. This substitute wavemeter or indicator is tuned until a slight kick of the milliammeter needle shows resonance. The wavemeter is then placed farther away from the grid coil until on retuning it, the needle kick is only just perceptible. Now transfer the grid coil lead to the fixed plate lead of C_2 and adjust the end moving plates of that particular section of C_2 that is enmeshed with the fixed vanes until the same resonance point is obtained. Ganged condensers usually have the end of the moving vanes slotted in four or five places, and it is quite easy to bend these in to increase and outwards to decrease the capacity. After adjusting C_2 the condenser C_3 is similarly adjusted. Great care

must be taken to ensure that during these tests the rotor of the ganged condenser is not moved, and that the lead from the grid coil to the fixed vanes of the ganged condenser is as short as possible, in order to get the minimum amount of wire movement and so a minimum of change in the external capacity due to the wiring. It is a good plan to secure all wiring to prevent it moving. The grid lead should now be moved back to condenser C_1 , the rotor of which is rotated so that the vanes are about 30° enmeshed. The set is checked up to see that it is oscillating, and the resonance point of the circuit found by tuning the indicator wavemeter for a kick of the milliammeter needle. Now repeat the process for C_2 and C_3 and so match these up to the 30° section of C_1 . These tests should be repeated for various other positions of enmeshing of the vanes until the whole 180° of rotation of the ganged condenser have been covered. The condensers are then accurately matched up. The Telsen Twin and Triple Ganged Condensers W.306 and W.307 are most carefully matched up in our Aston factory and can be relied on with the utmost confidence; and it will form an interesting experiment for the experimenter to check up his skill in manipulating radio apparatus, by seeing how he finds the various sections of the Telsen W.307 ganged condenser agree with one another for all the positions of the moving vanes.

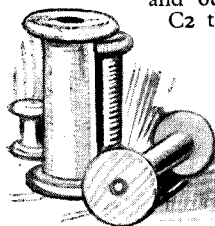

A Battery of our Winding Machines

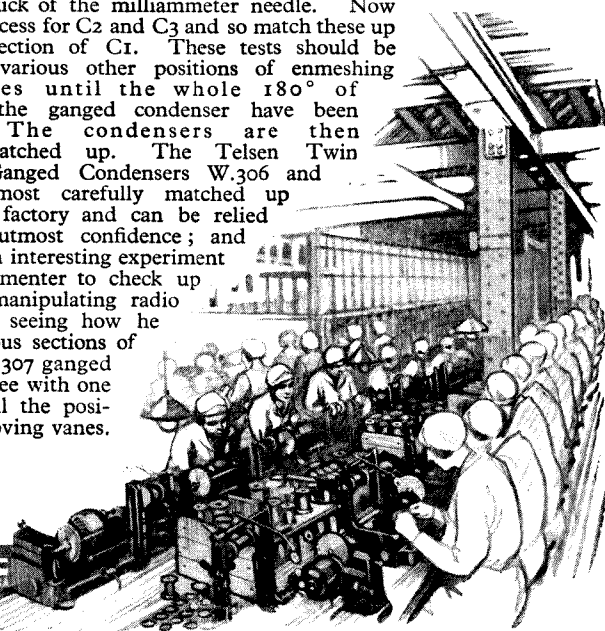

The TELSEN

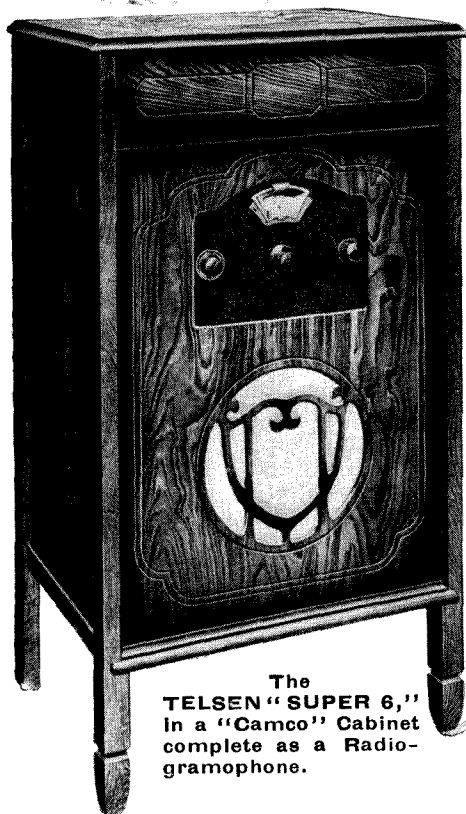

The TELSEN "SUPER 6," In a "Camco" Cabinet complete as a Radio-gramophone.



A POWERFUL AND RECEIVER EMPLOYING OF OUT

Pro. Pat.
DESIGNED BY

with that of straight receivers, and as quality became of paramount importance so was the "Superhet" further abandoned. But as the number of broadcasting stations increased, the ether became more congested, the call for selectivity became more urgent, and so the possibilities of the "Superhet" were again explored.

This exploration has shown that with present-day conditions and a carefully thought out circuit, quality comparable with that of the best straight receivers can be obtained. The result has been a wonderful revival in the use of this type of circuit and it is now within the reach of every pocket as well as being easy to construct.

To-day we need real selectivity and while the earlier types of the "Superhet" were very selective, they suffered from many types of interference, then not fully understood. These have now been fully investigated and satisfactory solutions found to all the intricate problems involved.

The leading feature of the Telsen "Super Six" is the special patented first detector circuit. This circuit has been evolved by the Research Department of the Telsen Electric Co., Ltd., and represents a valuable contribution to the technique of Superheterodyne design.

The outstanding advantage of this circuit is the greatly increased stability and enhanced sensitivity; indeed by its adoption it is possible to combine the stability of a

THE most outstanding development in the radio world of this last year has been the magnificent come-back staged by the Superheterodyne receiver.

This type of receiver is without doubt the most popular at the present time, and we can safely say without fear of contradiction that it has come to stay with us permanently.

It is everyone's desire to build and own a Superheterodyne set, and the Telsen Engineers have, after intense research and development work, evolved the Telsen "Super Six" receiver, which incorporates many novel and noteworthy features.

During the first few years of broadcasting, to possess a "Superhet" was to have the Rolls-Royce of the radio world. It was, however, neglected, and faded entirely into the background because of the enormous consumption demanded of the low and high tension batteries. Also the quality of reproduction was poor compared

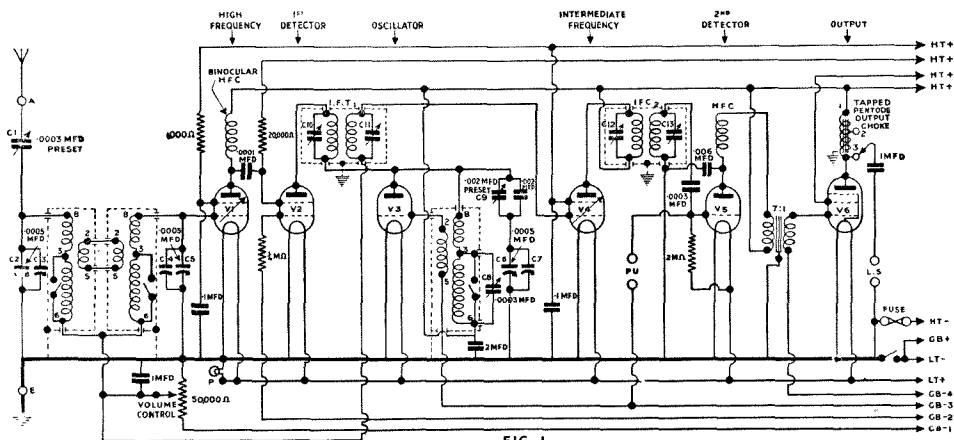
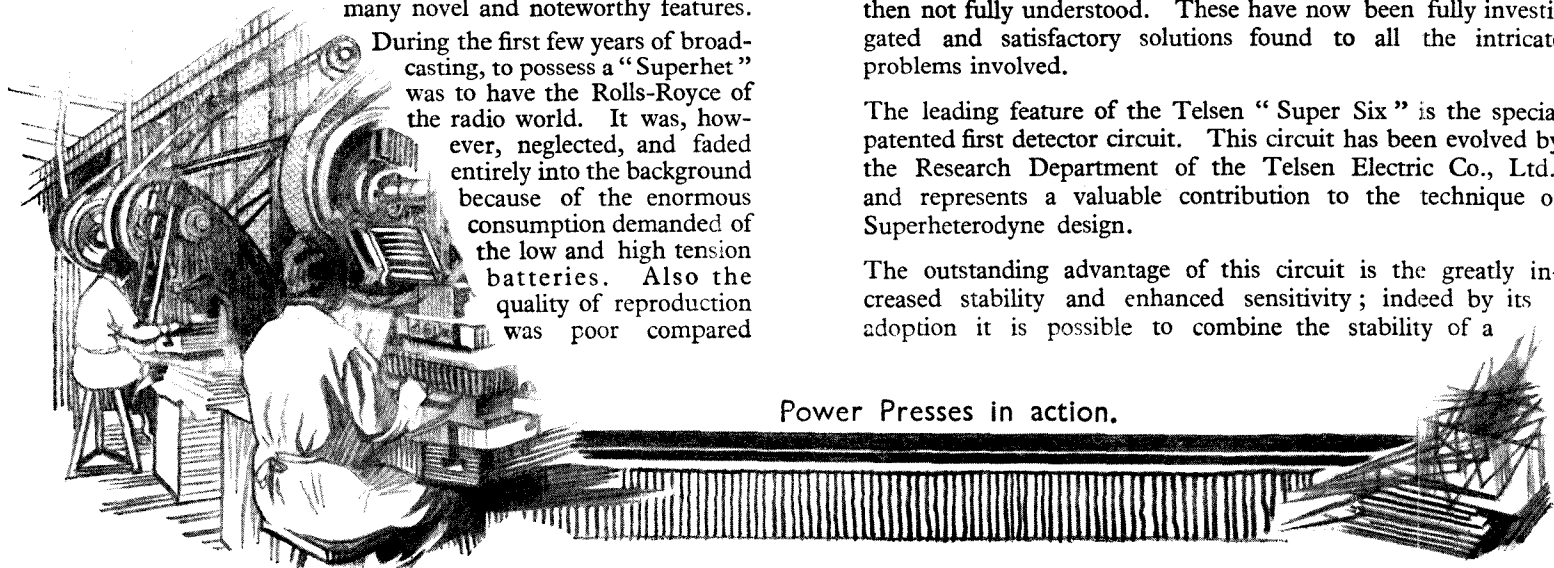
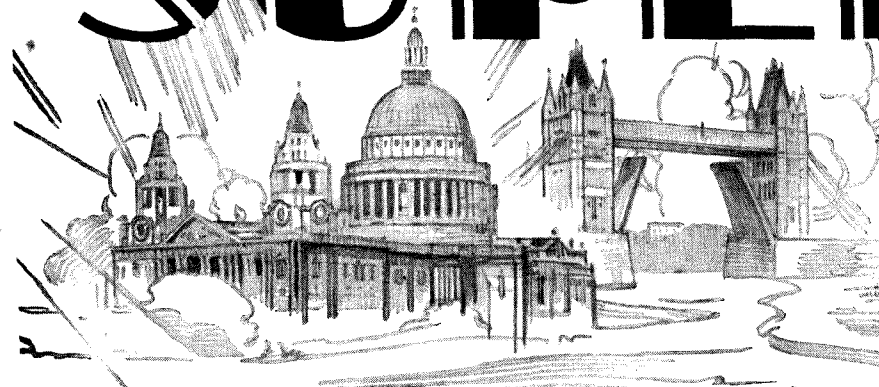

FIG. 1
THEORETICAL CIRCUIT OF THE TELSEN SUPER SIX



Power Presses in action.

SUPER 6



**SUPER SENSITIVE SUPERHET
A PATENTED CIRCUIT ARRANGEMENT
STANDING BRILLIANCE.**

No. 33257/32

THE TELSEN TECHNICAL STAFF.

factory-built receiver with the extreme sensitivity of the individually adjusted constructor's set.

The Telsen "Super Six" is built on a metal chassis. This ensures maximum shielding between critical circuits of this receiver together with a perfect mechanical rigidity. The front panel has a black crystalline finish, thus imparting to the receiver a smart and neat appearance. The top panel has mounted on it the Triple Ganged Condenser, Tuning Coils, Band Pass, Intermediate Transformers and Valves, which present a very clean appearance, for the layout is symmetrical and the majority of the wiring is carried out beneath it. Considering the receiver has six valves, it is remarkable to note the small amount of wiring necessary, this being very neatly disposed. In the Telsen "Super Six," the theoretical circuit of which is depicted in Fig. 1, we have two tuned circuits preceding the high frequency valve V1.

Incorporated in this receiver is a band pass filter employing a

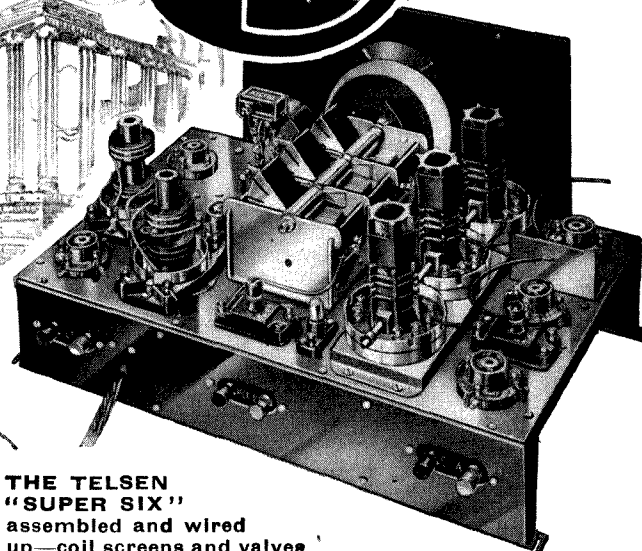

**THE TELSEN
"SUPER SIX"
assembled and wired
up—coil screens and valves
removed—showing
connections.**

system of inductive coupling. When choosing a band pass filter one would be inclined to select the mixed filter with its constant selectivity. This type of filter is, however, unsuitable, due to the fact that the common coupling condenser offers a high impedance to signals of the frequency of the intermediate stage. Signals of this frequency would therefore cause voltages to be applied across the grid of the high frequency valve V1, which are then amplified by the intermediate amplifiers. As a pure capacity filter produces the same effect, an inductive method has been developed to obviate this defect. Also included in the aerial circuit is a pre-set condenser C1, which can be adjusted to obtain the maximum efficiency from any type of aerial system, and to suit the conditions peculiar to the district in which the set is operated. The signals are then passed on to the first detector valve V2 by means of the Telsen special patented coupling which, together with the inductively coupled band pass input circuit, gives practically a straight line response for high frequency amplification. Following this valve we have a separate oscillator V3 which generates oscillations and feeds them into the plate circuit of V2, where they "beat" with the signal frequency oscillations to produce the intermediate frequency (110 k.c.). The signals are then fed through the intermediate transformer I.F.T.1, which is comprised of two tuned circuits band pass coupled to the grid of the intermediate frequency valve V4, a variable-mu valve being used in this stage. The signals are then applied to the primary of the second intermediate transformer I.F.T.2, which again is comprised of

(continued on page 46)

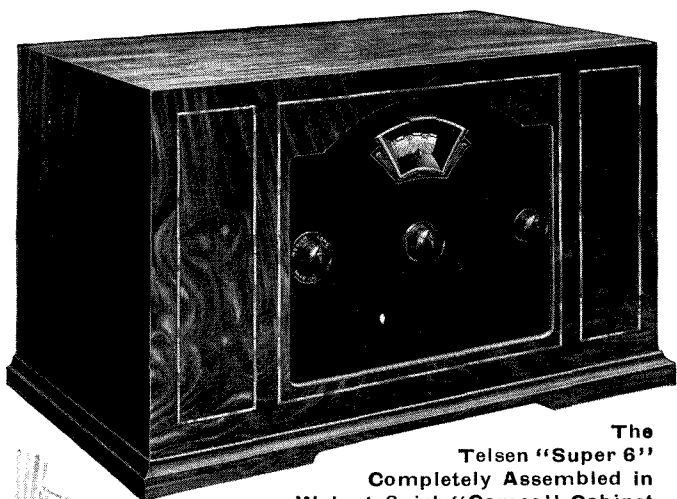

**The
Telsen "Super 6"
Completely Assembled in
Walnut finish "Camco" Cabinet**

A Power Press in operation.

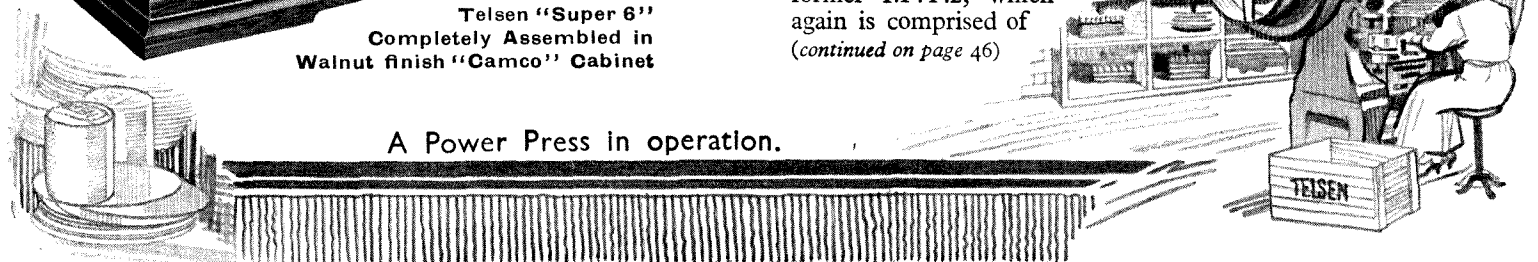

THE TELSEN "SUPER 6"—ONE KNOB TUNING

two tuned circuits band pass coupled to the second detector valve V5. The signals are rectified at this stage, then passed on through a 7-1 step up L.F. transformer to the output valve V6. A pentode valve giving one watt of undistorted power output is used here. The signals are then fed to the loudspeaker by means of a Telsen Tapped Pentode Choke and a condenser. In this way the quality of the output is balanced. With some loudspeakers, especially of the moving coil variety, it may be found that better results will be obtained by connecting the 1 mfd. condenser to a tapping on the pentode choke, instead of direct to the plate.

A most important control on the modern receiver is the volume control. The Telsen "Super Six" incorporates two variable-mu screened grid valves, one in the H.F. Stage V1 and the other as the intermediate frequency amplifier V4. This type of valve is the latest advance in the world of battery valves; it possesses the unique property that whilst its efficiency is lowered as the grid bias voltage is increased, it still retains the power to handle strong signals without distortion. It, therefore, can be seen that this is an ideal method, and can control signals from a roar to a whisper. On this volume control is also incorporated an on-off switch, which controls the filament current for the valves. So far we have a control for the tuning circuits, and one for the volume and on-off switching. There is

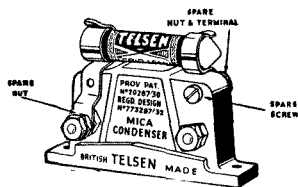

FIG. 2

another control which is for switching from the long to the medium wavelength ranges.

Therefore it can be seen that the Telsen "Super Six" is a highly efficient 6-valve receiver of superlative qualities with but three controls—Tuning, Wave-change and Volume.

All H.T., G.B. and L.T. current supplies are fed to the receiver by means of multi-way cords.

A 1/- Blue-print showing the complete assembly and wiring of the Telsen "Super Six" is given away free with this issue of the *Radiomag* which, with the help of this article, enables the set to be quickly constructed and adjusted for the most efficient working. A complete list of components required for building this receiver is given elsewhere, and a Constructor's Outfit containing the complete set of metal plates and panels, battery cords, tools and the usual small gear needed for the construction of this set will be found listed in the catalogue section. If the constructor desires, a complete kit of parts for this receiver (W.324) may be obtained, and this is also catalogued elsewhere in this issue of the *Radiomag*.

ASSEMBLY OF COMPONENTS ON UNDERNEATH SIDE OF TOP PLATE

The components should first be mounted on the underneath side of the top plate, and by consulting the Blue-print provided, the correct holes and positions in which to mount the components are immediately located. Nuts and screws to fasten the components to the chassis, together with a set of spanners, are contained in the Constructor's Outfit.

Fit Tapped Pentode output choke to holes 15—16—19—20.

„ Anode Cartridge Resistance Holder to holes 29—30.

„ „ „ „ „ „ 23—24.

„ Grid Leak Holder to holes 25—26.

„ Place ¼ meg. grid leak in holder.

„ .1 mfd. Condenser to holes 31—32.

„ .1 mfd. „ „ „ 11—12.

„ .1 mfd. „ „ „ 17—18.

Fit .0001 mfd. Mica Condenser to holes 27—28.

Fit .006 mfd. Mica Condenser to holes 3—4.

Assemble together the .0003 Mica Condenser and

2 meg. grid leak as shown in Fig. 2.

Fit this assembly to holes 5—6.

Fit .002 mfd. Condenser to holes

13—14.

Fit Binocular H.F. Choke to

holes 33—34.

Fit Standard H.F. Choke to

holes 1—2.

Fit 7-1 Radiogrand Trans-

former to holes 7—8—9—10

BACK PLATE ASSEMBLY

Fit 2 mfd. Condenser to

holes 43—44.

Fit 1 mfd. Condenser

to holes 39—40.

Fit Aerial-Earth terminal strip to holes 45—46.

Fit Loudspeaker terminal strip to holes 41—42.

„ Gram. Pick-up „ „ „ 35—36.

„ Terminals to holes provided in terminal strips.

Looking at the back plate from the outside, the red terminals should be placed in the right hand holes of the terminal strips, and the black terminals into the holes on the left hand side.

ASSEMBLY OF BACK PLATE TO THE TOP PLATE

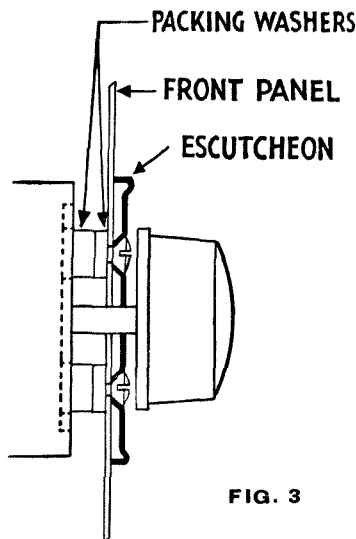

FIG. 3

The constructor should just make sure that all the 6 B.A. screws and square nuts are mounted along the front and sides of the top plate, and that these are only loosely assembled. Then slide the projecting top edge of the back plate underneath and against the front edge of the top plate, so that the slots in the top lip of the back plate engage between the square nuts and the top plate. Holding these in position, screw up the screws on to the nuts very tightly, and the operation is completed.

ASSEMBLY OF FRONT PANEL TO FRONT PLATE AND ESCUTCHEONS TO FRONT PLATE

The black crystalline finished front panel should now be assembled to the front plate. These are secured to one another with four 6 B.A. instrument headed screws, and square nuts contained in the Constructor's

Outfit. The escutcheon plates may now be fitted to the front panel. The wavelength escutcheon is for the extreme left hand hole and is fitted with two 6 B.A. screws and nuts. These accessories are to be found contained in an envelope in the carton in which the Telsen Combined Band Pass and Oscillator Coil Unit W.292 is packed. In the carton containing the Triple Gang Condenser W.307 will be found the escutcheon plate belonging to this component. This escutcheon is fastened to the front panel through the two screw holes provided for this purpose, the necessary screws and nuts being supplied with this escutcheon. The Combined Volume Control and Switch W.296 is

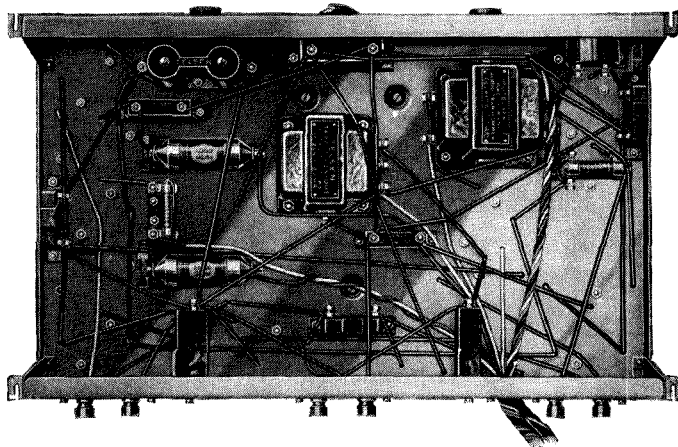

now mounted:—remove the screws and spacing washers and escutcheon plate from the Volume Control, and re-assemble as shown in Fig. 3.

ASSEMBLY OF COMPONENTS TO TOP SIDE OF TOP PLATE

The constructor should proceed as before, and in the following order.

The valve-holders are shown in the Blue-print thus, V1, V2, V3, etc.

Fit Antimicrophonic 4 pin valve holder V1 to holes 47—48.

„ „ „ „ V2 „ „ 51—52.

„ „ „ „ V3 „ „ 55—56.

„ „ „ „ V4 „ „ 69—70.

„ „ „ „ V5 „ „ 73—74.

Fit Antimicrophonic 4 pin valve holder V6 to holes

67—68.

Fit .0003 Pre-set Condenser to holes 49—50.

A small metal screen supplied in the Constructor's



A Corner of our Self Sealing Condenser Dept.

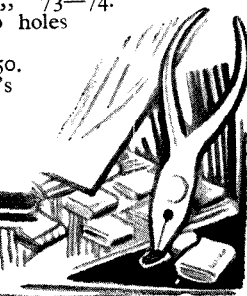

A STATION ON EVERY DEGREE OF THE DIAL

Outfit should be placed with the side containing the fixing holes under this pre-set condenser so that the holes line up, and with the side coming up between the pre-set and the valve-holder, as shown in the Blue-print.

- Fit .003 Pre-set Condenser to holes 53-54.
- „ .002 „ „ 63-64.
- „ Fuse-holder to holes 61-62.

The Superheterodyne Coils, namely the Band Pass and Oscillator Coils, are supplied ready mounted to a metal plinth. By removing the coil screens, the Constructor will see that the colour of the coil formers differ, the two Band Pass Coils being wound on black bakelite formers, and the Oscillator Coil wound on a light oak bakelite former. The complete coil assembly should be placed in position on the top plate of the chassis, in the position shown in the Blue-print, care being taken to see that the light oak coloured Oscillator Coil is so placed as to be at the rear of the chassis. The holes in the coil assembly should now line up with the holes 57-58-59-60, screws placed through these holes and the assembly tightened up with 6 B.A. nuts in the usual manner.

The intermediate Frequency Transformers may now be fitted. By the Blue-print the constructor will see that these Transformers are shown as I.F. Coil D and I.F. Coil E. The Constructor should now place an I.F. transformer on the top panel in the position shown in the Blue-print for Coil D, taking care to see that the terminal marked E is at the side nearest to the back of the set. This component may now be fastened down to the holes 65-66. The other I.F. Transformer E should be assembled in exactly the same manner and fastened through holes 71-72.

Fit the Triple Gang Condenser to holes 76-77-78.

Hold the condenser in position and insert the three 4 B.A. screws provided with it through the holes 76-77-78, so that they engage in the three screwed holes in the base of the condenser. Screw up but not too tightly, and slide the condenser lengthwise until the tuning scale rotates just clear of the back of the escutcheon. Then screw the condenser firmly into position.

WIRING

For the Constructor who does not wish to solder the connections, terminals are provided at each connection point, the thin tinned copper wire and sleeving method being strongly recommended for the wiring of this set; the necessary wire and sleeving is contained in the Constructor's Outfit.

It should be noticed that all terminal wiring points are numbered, whilst all holes through which the wires pass are shown with a number followed by the letter H.

It should be clearly understood that when a figure with H at its side is shown, it is to be taken that the wire concerned is to go through the holes thus marked.

Every connection in the receiver should be insulated, and sleeving is supplied in the Constructor's Outfit for this purpose.

The wire connection between the various points that go through chassis holes, should not be drawn too tight as the sleeving may be abraded on the edges of the hole.

In the Blue-print the coils are lettered A, B and C. The various terminals on these are indicated by the figures 1 to 8, and each particular coil connection has the coil letter in front of the terminal figure. Thus A8 refers to terminal 8 of coil A.

The complete list of wiring is now given, and the order shown here should be closely adhered to:—

- Terminal 137 of V1 through 137H through 143H to 143 through 143H through 149H to 149 through 149H to 133 to 130 of +L.S. — strip.
- „ 130 of —L.S.+ strip to 108 to 107 of Tapped Pentode Output Choke.
- „ 108 of .1 mfd. Condenser to 102 to 99 of Radiogrand Transformer.
- „ 102 on 1 mfd. Condenser to 120 on .1 mfd. condenser.
- Terminal 108 of .1 mfd. condenser through 169H to 169 through 169H through 176H to 176 through

176H through 173H to 173 through 173H to 93 through 181H to 181 on V5.

- Terminal 92 of .006 mfd. Condenser to 91 through 182 H to 182 on V5.
- „ 90 on Standard H.F. Choke to 97 on Radiogrand Transformer.
- „ 183 on V5 through 183H to 95 through 167H to 167 through 167H through 175H to 175 through 175H through 151H to 151 through 151H through 145H to 145 through 145H through 139 H to 139 on V1.
- „ 119 on Resistance Holder to 109 through 174H to 174 on V4.
- „ 172 on V4 through 172H through 163H to 163 of I.F. Transformer.

Terminal 161 on I.F. Transformer through 161H to 103 through B6H to B6.

- „ 103 on 1 mfd. Condenser through hole K to terminal 185 on Volume Control.
- „ 187 on Switch to 186 through K through 181H to 181 on V5.
- „ 180 on V5 through 180H to 94 to 127 terminal on Gram. Pick-up Terminal Strip.
- „ 126 on Gram. Pick-up terminal strip through C5H to C5.
- „ C6 through C6H to 132 through 146H to 146 on .0003 mfd. Pre-set Condenser.
- „ 144 on V2 through 144H to 125 to 115 on Resistance Holder.
- „ 133 on 2 mfd. Condenser through 152H to 152 on Fuse-holder.
- „ 133 on 2 mfd. Condenser to 134 on Aerial Earth Terminal Strip.

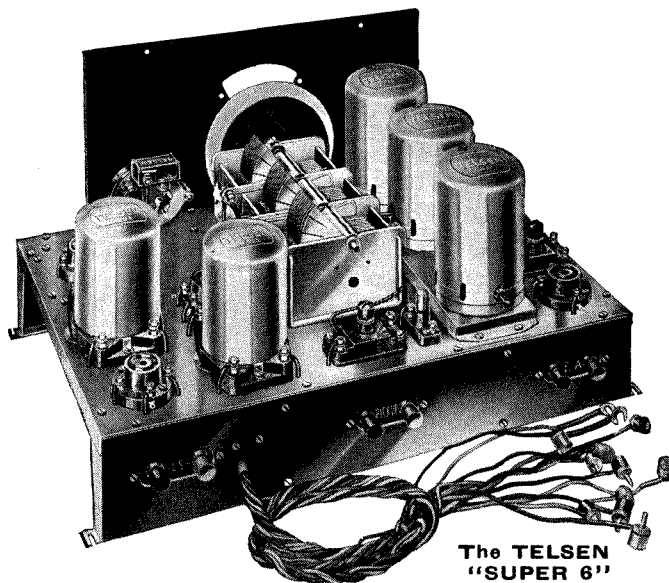

Note the neat arrangement of all Battery Leads.

Terminal 159 on .002 Pre-set Condenser through 159H to 111 through C8H to C8 through C8H through 150H to 150 of V3.

- „ 148 on V3 through 148H through C2H to C2.
- „ 138 on V1 through 138H to 121 to 118 on Resistance Holder.
- „ 124 on .0001 mfd. Condenser to 122 through 122H leaving a length of insulated wire 6½" long.
- „ 136 on V1 to A8 to 156 on Ganged Condenser.
- „ 155 on Ganged Condenser to B8 to 141 on .0003 Pre-set Condenser.
- „ A2 to B2.
- „ 147 on .0003 Pre-set Condenser to C3.
- „ A5 to B5.
- „ A6 to B6.
- „ 154 on Gang Condenser to 160 through 160H to 110 on .002 mfd. Condenser.
- „ 111 on .002 mfd. Condenser through 162H to 162 on I.F. Transformer.
- „ 164 on I.F. Transformer through 164H through hole H leaving an insulated length of wire 6½" long.
- „ 117 on ¼ meg. Grid Leak Holder through 142H to 142 on V2.
- „ 132 on 2 mfd. Condenser to 123 to 106 to 98 through 177H to 177 on I.F. Transformer.
- „ 171 on Ganged Condenser to 170 to 169 on V.6.
- „ 129 on 1 mfd. Condenser to 131 on +L.S.— Terminal Strip.
- „ 168 on V6 through 168H to 100 on Radiogrand Transformer.
- „ 104 on Tapped Pentode Output Choke through 165H to 165 on V.6.

(continued on page 48)

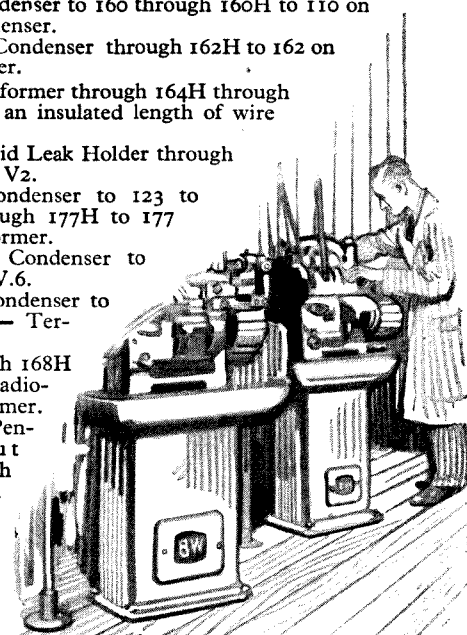

High Speed Automatic machines in action

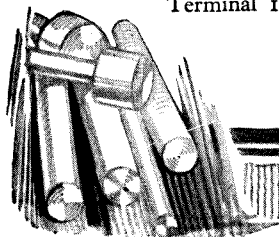

THE TELSEN "SUPER 6"—OUTSTANDING

Terminal 165 on V6 through 165H to 128 on 1mf. Condenser.
 ,, 96 on .0003 Mica Condenser through 179H to 179 on I.F. Transformer.
 ,, 178 on I.F. Transformer and leave a length of insulated wire 6½" long.
 ,, 157 on Pilot Lamp-holder to 139 on V1.
 ,, 158 on Pilot Lamp-holder to 171 on Gang Condenser.

The shielded wire should now be fitted. First bare each end for a distance of ¼" and twist the flex wire inside between the finger and thumb. Thread the shielding back for a distance of one inch, place the end through the hole 140H and join the inner wire to terminal 140 on the .0003 Pre-set Condenser.

Now take the other end of the shielded wire, and join it to 135 on the Aerial-Earth terminal strip.

At 1" from this terminal, join on to the shielding of the wire, 2" of tinned copper wire. The joint should be made by tightly wrapping round the shielded position the thin tinned copper wire for a distance of ¼". Thread some of the sleeving over the end of this tinned wire, and join the free end to terminal 134 on the Aerial-Earth Terminal strip.

Two Cords, a cord clip, wander plugs, and spade terminals are contained in the Constructor's Outfit, together with sleeving for the neat finishing of the cord ends. Of the two sets of Cords included, one has eight and the other has four leads. The leads in these cords are clearly coloured so that each can be easily traced.

The wander plugs are suitably engraved and the colour code adopted for these and the eight-way cord is as follows:—

Black	H.T. -	White	H.T. +1
Speckled	G.B. +	Maroon	H.T. +2
Yellow	G.B. -1	Blue	H.T. +3
Green	G.B. -2	Red	H.T. +

The Constructor should untwist the eight-way Battery Cord for a distance of 18" before connecting the leads to the various wander plugs, as this makes the connection neater and simpler, and also enables the leads to be retwisted or plaited into convenient groups; thus the H.T. leads can be plaited into one cord and the grid bias leads into another.

Suitable sleeving is included in the Constructor's Outfit to give a neat finish to the cord ends. To do this, slide the braiding back about ¼" and then cut off the rubber covered wire to the same length.

The braid can then be brought forward again, moistened, and screwed to a point between finger and thumb. It is then easy to thread on a small length of sleeving, which can be brought up to the terminal or wander plug when the connection has been made, so covering all loose ends of braiding.

The wander plugs can now be attached to the correctly coloured leads, finishing the cord appearance as above. Then thread the free end of the eight-way cord through the hole marked L in the back plate; the cord ends are then connected up as follows:—Black lead (H.T. -) through 153H to 153 on Fuse-holder.

Speckled lead (G.B. +) through K to 188 on Switch.
 Yellow lead (G.B. -1) through K to 184 on Volume Control.
 Green lead (G.B. -2) to 116 on ¼ meg. leak holder.
 White lead (H.T. +1) to 109 on .1 mfd. Condenser.

Maroon lead (H.T. +2) to 112 on Resistance-holder.

Blue lead (H.T. +3) through 166H to 166 on V6.

Red lead (H.T. +) to 106 on Tapped Pentode Output Choke.

The four-way cord should be now fitted in exactly the same manner as the eight-way cord. The leads of the four-way cord are as follows:—

Red	L.T. +	Grey	G.B. -3
Black	L.T. -	Yellow	G.B. -4

After fitting the Grid Bias wander plugs to the Grey and Yellow wires, the spade terminals should be fitted to the L.T. + and - wires (Red and Black). Two short lengths of 3 mm. sleeving, one coloured red and the other black, are provided with the spade terminals. The red sleeving should be slid over the red wire and the black sleeving over the black wire.

Bare about 1½" of the wire end, and then fold back the bare part on itself so as to form a thick wire end, thus making a very firm grip for the spade terminals, which should be placed round the end of the wire. The teeth on the spade terminal should then be pinched down one by one with a pair of pliers, so that they grip the wire very tightly. The finishing sleeving can then be slid back into position over the teeth of the terminals.

The loose leads can now be taken to the terminal points in the same manner as before, and in the following order:—

Red lead (L.T. +) to terminal 95 on .0003 mfd. Condenser.
 Black lead (L.T. -) through hole K to 188 on Switch.
 Grey lead (G.B. -3) to terminal 126 on Gram. terminal strip.
 Yellow lead (G.B. -4) to terminal 101 on Radiogrand Transformer.

The prespahn insulating strip contained in the Constructor's Outfit should now be fastened round the two cords at the point where the cord clip is to be secured. The Cord Clip should now be placed over this insulation and fastened down through holes 37-38.

SETTING UP AND ADJUSTING THE "SUPER SIX"

The set is now ready for setting up for the reception of broadcasting.

In Valve-holder V1 insert Mazda Valve S.215.V.M.
 ,, ,, ,, V2 ,, ,, ,, 215S.G.
 ,, ,, ,, V3 ,, ,, ,, H.L.2.
 ,, ,, ,, V4 ,, ,, ,, S.215.V.M.
 ,, ,, ,, V5 ,, ,, ,, H.L.2.
 ,, ,, ,, V6 ,, ,, ,, Pen. 220A.

Join the loose lead from 122H to the terminal on top of V1.

Join the loose lead from H to the terminal on top of V2.

Join the loose lead from terminal 178 to the terminal on top of V4.

The Pen.220A. valve should be of the 5-pin type. If it should have four pins only, the terminal on the side of the base should be joined by a length of insulated wire to the terminal 166 of valve-holder V6.

Now connect up the Loudspeaker, aerial and earth to their respective terminals located on the back plate.

Screw the fuse into the fuse-holder. This should be of the .15 ampere type and may be purchased from your local dealer, as may the 3 volt pilot lamp for illuminating the dial.

Now connect up the L.T., G.B. and H.T. batteries as follows:—

Connect spade of black lead to - terminal of accumulator.
 Connect spade of red lead to + terminal of accumulator.

See switch is in the "off" position.

Insert G.B. -1 plug into -16 volt tapping of G.B. battery.

,, G.B. -2 ,, ,,	-10½ ,, ,, ,, ,,
,, G.B. -3 ,, ,,	-11 ,, ,, ,, ,,
,, G.B. -4 ,, ,,	-9 ,, ,, ,, ,,
,, H.T. +1 ,, ,,	72-84 ,, ,, ,, H.T. ,,
,, H.T. +2 ,, ,,	90 ,, ,, ,, ,,
,, H.T. +3 ,, ,,	108 ,, ,, ,, ,,
,, H.T. + ,, ,,	120 ,, ,, ,, ,,
,, H.T. - ,, ,,	- tapping of H.T. battery.

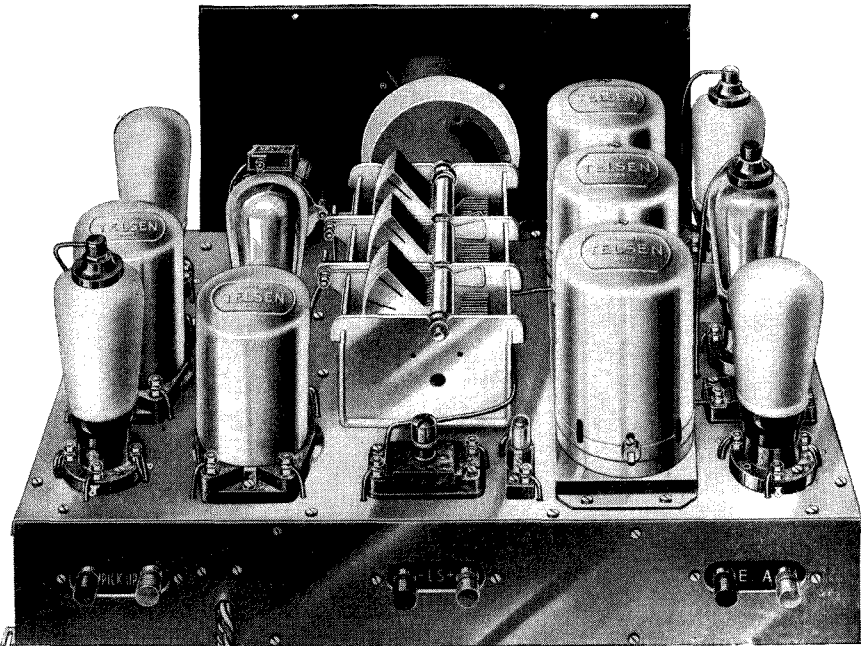

THE TELSEN "SUPER 6" ready for testing out.

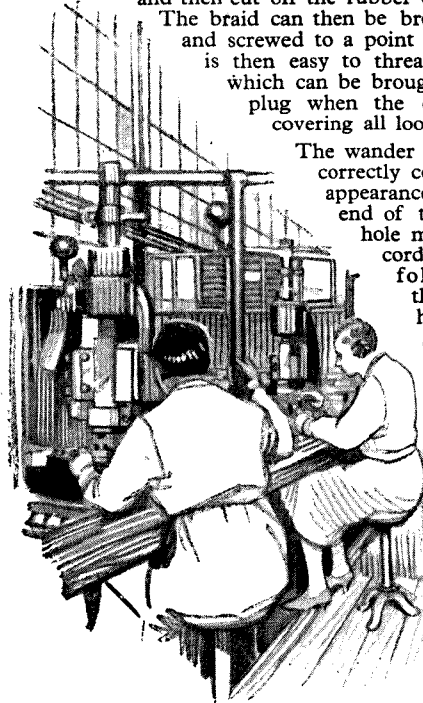

Some of our Hand Presses in action

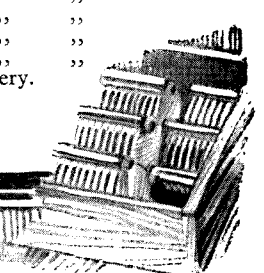

QUALITY WITH SUPER SELECTIVITY

The trimming condensers may be screwed down temporarily as follows:—
C4.—Screw in the "star wheel" until about one half of a complete turn from being fully screwed in.
C1 and C9.—Screw down until about three complete turns from the full in position.

Now switch on.

Should the receiver become unstable and oscillate before the Volume Control reaches its maximum position, this is due to the voltage of H.T. +2 being of too high a value; it should accordingly be tried in the lower H.T.appings until a progressive increase in volume with perfect stability is obtained as the Volume Control is turned.

After switching on the receiver, first rotate the wavechange switch to the medium wavelength position. At no time during ganging is it necessary to adjust the tuning condenser C3 and C7, which are mounted on the Ganged Tuning Condenser. They should therefore be set at minimum capacity by unscrewing the star wheels which operate them, to a position such that the plates of the trimmer are well separated. In adjusting the trimming condensers of the "Pre-set" type, namely C1, C8 and C9, use the insulated screwdriver provided for this purpose; this will avoid any disturbing effects due to the proximity of the hand.

The adjustments fall into three categories, and are best carried out in the following order:—

- 1.—The tuning of the I.F. circuits.
- 2.—The ganging.
- 3.—The balancing of the selectivity and quality.

The first two processes are carried out by tuning for maximum signal strength. The coils inside the I.F. Transformers should be set at nearly their maximum distance apart and a station tuned in as accurately as possible. The strength of this station should be adjusted to a conveniently low level by means of the Volume Control, so that differences of strength are easily perceptible.

The trimming Condensers C10, C11, C12 and C13 are varied by rotating the thumb wheels situated at the sides of the bottom of each coil. Adjustment of these trimmers must now be carried out. Starting from C10, rotate the "thumb wheel" backwards and forwards for the maximum response; repeat the same operation on C11, C12 and C13. If it is found that maximum signal strength occurs with any one of the thumb wheels rotated to the full extent of its travel, then all the other three thumb wheels should be rotated slightly in the opposite direction and the station retuned by the ganged condenser.

Tune in a station near the bottom of the scale, making sure that the signals are constant and are not from a station susceptible to serious fading. The station as in the last operation must be tuned in accurately, and kept at a low volume level by means of the Volume Control. Adjust the trimming condenser C4 for maximum response and finally the aerial trimming condenser C1. The set is now temporarily ganged at the bottom of medium band. The next step is to rotate the triple ganged tuning condenser and tune in to a station near the top end of the medium wavelength band. An adjustment is now made with the "padding" condenser C9; each time C9 is turned, the triple ganged condenser must be rotated in the opposite direction to receive this same station. Therefore when C9 is turned in a clockwise direction, the triple ganged condenser must be rotated in an anti-clockwise direction. This adjustment should be carried out slowly and if a decrease in the strength of the signals is observed when, say, C9 is rotated in a clockwise direction, C9 must therefore be rotated in the opposite direction, rocking the triple ganged condenser each time an adjustment is made to C9 until the position is found for maximum response. The top end of the medium wavelength band is now in gang and a final ganging must be made at the bottom end. To readjust, rotate the triple ganged condenser to a station as near as possible to the minimum position of the tuning dial and rotate the trimming condenser C4 for maximum response.

The last adjustment to be made on the medium wavelength band is the aerial trimming condenser C1. It has been found that this should be adjusted when the set is tuned to a station of about 400 metres. The medium wavelength band is now in gang. To gang up the long wavelength band, rotate the wave-change switch to the long wavelength position, and with the triple gang condenser tune in a station at about 1,400 metres—preferably a long distance station. Gang up by means of rotating the long wavelength trimming condenser C8. Like C9, the triple ganged condenser has to be "rocked" in an opposite direction for each movement of C8 in order to keep the station in tune.

The last operation is the adjustment of the coils on the I.F. Transformers and these should be adjusted to give a compromise between maximum selectivity and quality so as to suit individual tastes. This is achieved by varying the coupling between the coils.

Finally it may be found that an adjustment of the I.F. Transformer trimming Condenser C10, C11, C12 and C13 is necessary to give the maximum sensitivity.

GRAMOPHONE PICK-UP

The constructor is advised to turn to page 53, where under the heading of "Practical Hints and Tips" the necessary instructions for fitting this component will be found. It should be noted that arrangements have been made in the receiver for the necessary grid bias voltage, this being controlled by the battery lead marked G.B.—3. The Telsen Needle Armature Pick-up W.317 is strongly recommended for use with this receiver.

TONE CORRECTION

The tone may be varied by the Telsen Variable Tone Corrector W.314, which gives a choice in the degree of top note cut off, or by the Telsen Pentode Tone Corrector W.308, which gives a fixed alteration in the top note response.

THE TELSEN SUPER SIX

List of Components

Quantity	Description	Cat. No.	Price
5	Anti-Microphonic Valve-holders, 4-pin	W.222	5/-
1	" " " " " " 5-pin	W.223	1/3
1	2 meg. Grid Leak " " " "	W.251	1/-
1	1/4 " " " " " "	W.248	1/-
1	1,000 ohm Anode Cartridge Resistance	W.268	1/9
1	20,000 " " " " " "	W.276	1/9
2	Anode Cartridge Resistance Holders	W.286	1/6
1	Grid Leak Holder " " " "	W.148	6d.
1	50,000 ohm Volume Control with Mains Switch	W.296	5/6
2	.003 Pre-set Condenser " " " "	W.151	3/-
1	.002 " " " " " "	W.149	1/6
1	.0001 Fixed Mica Condenser " " " "	W.240	1/-
1	.0003 " " " " " "	W.242	1/-
1	.002 " " " " " "	W.246	1/-
1	.006 " " " " " "	W.247	1/3
2	.1 mfd. Self-Sealing Condensers	W.231	3/6
2	1 " " " " " "	W.227	4/6
1	2 " " " " " "	W.226	3/-
1	Triple Ganged Tuning Condenser	W.307	22/6
1	Band-Pass and Oscillator Coil Unit	W.292	25/6
2	Intermediate Frequency Transformer Coils	W.294	25/-
1	Binocular H. F. Choke " " " "	W. 74	5/-
1	Standard H.F. Choke " " " "	W. 75	2/-
1	7—1 "Radiogrand" Transformer	W. 60	10/6
1	Tapped Pentode Output Choke " " " "	W. 72	7/6
1	Fuse Holder " " " " " "	W.146	6d.
1	Super-Six Constructor's Outfit	W.305	7/6

The Telsen "Super Six" as detailed above is supplied as a complete kit at the inclusive price of £5 18s. 6d.

RECOMMENDED VALVES AND BATTERIES

Mazda S.215.V.M, 215.SG, H.L.2. S.215.V.M, H.L.2 and Pen. 220.A.

H.T. Battery: 2 of Ediswan 60 volt, 20 mA., Cat. No. 69724; or 1 of Ediswan 120 volt, 20 mA., Cat. No. 69728.

G.B. Battery: 1 of Ediswan 16 volt. G.B. Battery, Cat. No. 69805.

L.T. Battery: 1 of Ediswan 2 volt, 45 a.h. Type E.L.M.4.

RECOMMENDED MAINS UNIT—REGENTONE

D.C. Eliminator for H.T. only, Type D.C.1.

A.C. Eliminator for H.T. only, Type W.1.A.

D.C. Eliminator, with trickle charger, Type D.C. Combined 2.

A.C. Eliminator with trickle charger, Type A.C. Combined W.4.A.

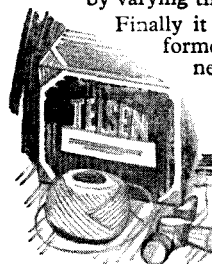

One of our Packing Departments.

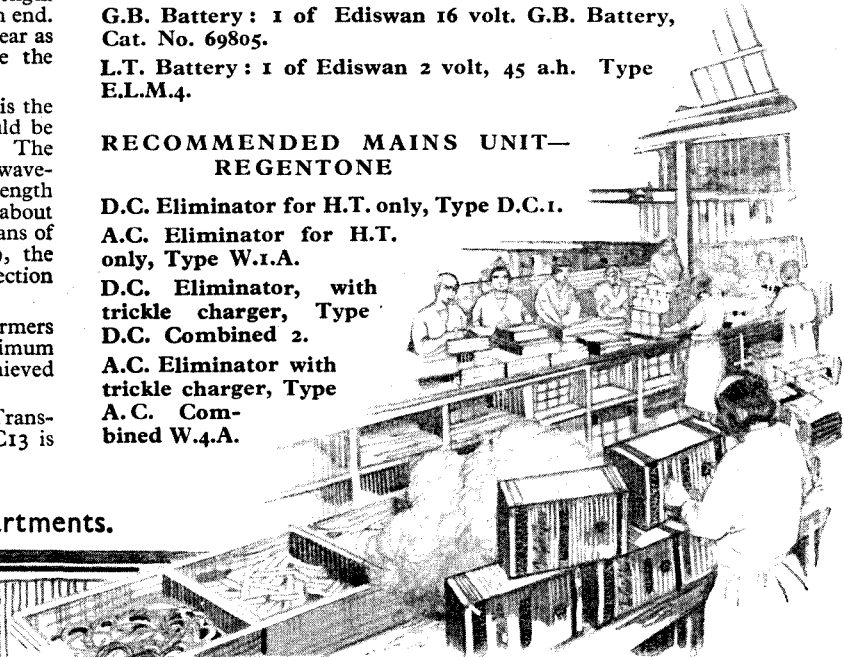



Purveyors of
Electric Lamps
By Appointment

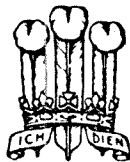

Manufacturers
and Purveyors
of Electric Lamps
By Appointment

EDISWAN

The name that means 'EXCELLENCE'

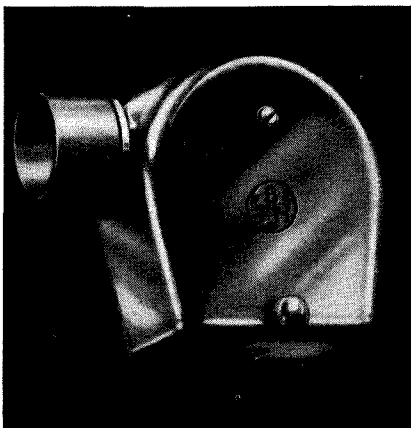

B.T.H. SENIOR PICK-UP complete with four adaptors to fit standard tone-arms. Price 27/6.

B.T.H. MINOR PICK-UP has been redesigned and improved and now includes a special volume control fitted in the base of the tone-arm pillar. This model is constructed in a one-piece moulding of B.T.H. "Fabrolite" and is recommended to those requiring a high / efficient but inexpensive pick-up. Price 25/-.

B.T.H. SENIOR PICK UP (1931 model). This has been completely redesigned and gives an even better response curve than hitherto. Free coupling of the head to the tone-arm reduces pressure on records and facilitates needle changing, and a ball-bearing universal joint on the tone-arm support ensures easy tracking. An independent and specially designed volume control of correct value is supplied with this connoisseurs' model. Price £2.2.0 complete with volume control.

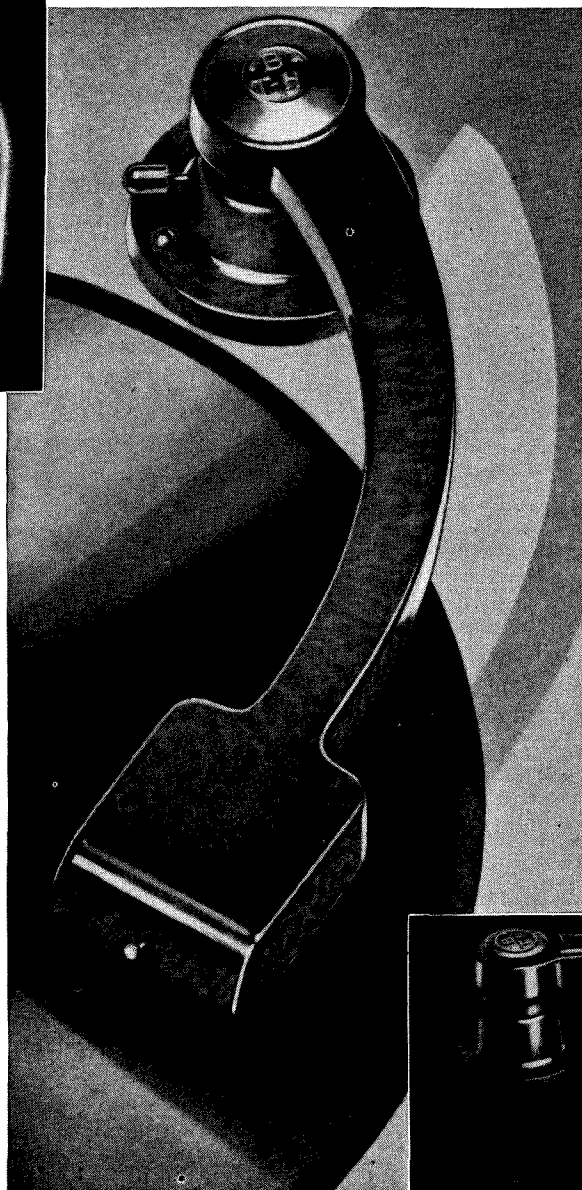

**THIS
PICK-UP
MINDS
ITS OWN
BUSINESS**

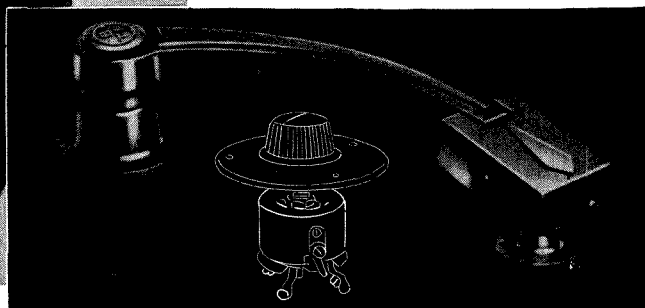

PICK-UP and Tone Arm

It's a pick-up that doesn't take liberties with the record—it plays all there is on the record—no less, no more. That is why leading radiogram manufacturers use it; why radio engineers choose and recommend it—for its even, accurate and sensitive response over a wide range of frequencies.

All good radio dealers stock B.T.H. pick-ups and will be pleased to demonstrate them.

THE EDISON SWAN ELECTRIC CO. LTD.



155 CHARING CROSS RD., LONDON, W.C.2

GOOD RADIO DEALERS RECOMMEND EDISWAN

FURTHER Practical HINTS and TIPS



AERIAL SUSPENSION

WHEN an aerial is attached to a tree or high pole which is apt to sway in stormy or windy weather, a considerable strain is likely to be placed upon the aerial suspension. A simple method of counteracting this is to pass the suspending wire or rope over a pulley attached to the tree, fastening to the lower end a balancing weight sufficient to maintain a reasonable tension in the aerial. This is illustrated, in the case of a pole:—

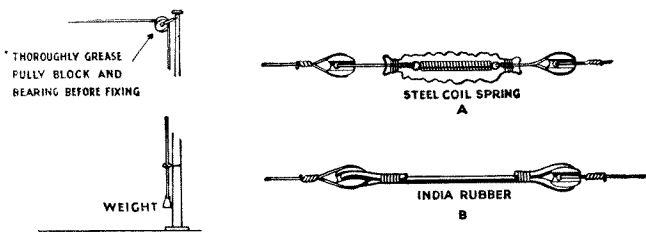

Another method serving the same purpose is to interpose in the guy line, or even between a pair of insulators, a coil spring of suitable tension. Alternatively, two insulators may be linked together by a length of thick india-rubber (sketch *b*). These last two methods have the disadvantage of deteriorating through exposure to weather conditions, but will last for some considerable time before renewal becomes necessary. Moreover, a little ingenuity could be exercised with the result that they would last very much longer. For example, the coil spring could be smeared inside and out with thick grease or vaseline to prevent rust, and then encased in weather-proofing canvas (sketch *a*). Sufficient "bagginess," concertina fashion, should of course be provided to allow for the tension of the spring when it is doing useful work in windy weather. Incidentally, the spring should be made of "spring" steel, and of a gauge heavy enough to withstand the pull of the aerial when taut, and a little extra. Unless the experimenter has had previous experience of making springs, however, he will find they are very much easier to buy than to make.

VARYING TRANSFORMER RATIO

Every wireless enthusiast and constructor is familiar with the time-honoured "junk" box, and invariably has recourse to it at some time or other either to resurrect an old component to serve a useful purpose (for which it may or may not have been intended), or to relegate to it some component for which no immediate use can be found. It quite often happens that among the latter is an otherwise perfectly good transformer, indefinitely shelved for no other

reason than that it has not the right ratio for a place in the "new set." It is here that a timely hint may not only give it a new lease of life, but save the constructor unnecessary expenditure.

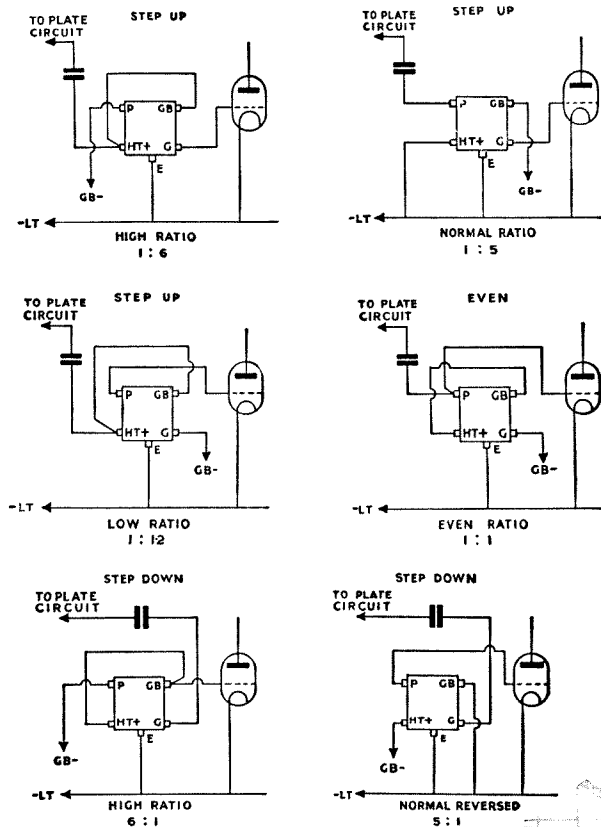

Supposing we have an interval transformer whose normal step-up ratio is 5—1, or more correctly speaking 1—5, it is possible by employing the parallel feed system to obtain altogether seven different ratios. It may be that when the transformer is used in the ordinary way, the normal step-up is too high, giving greater amplification than is required, even perhaps

(continued on page 52)

A Battery of our Hand Presses in Operation

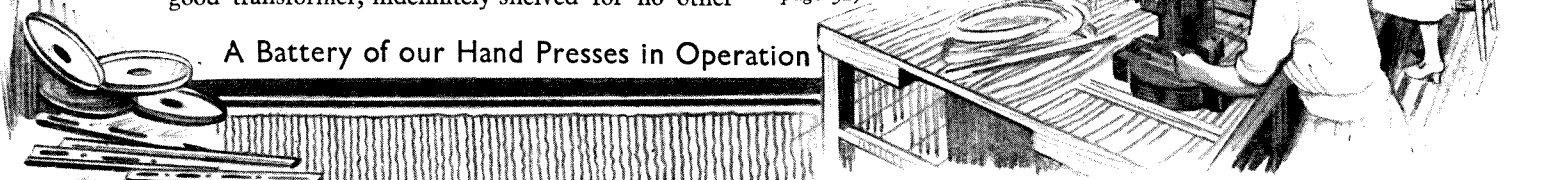

PRACTICAL HINTS AND TIPS — continued

resulting in a tendency to L.F. oscillation or distortion. By varying the coupling connections to the transformer, lower ratios of step-up or step-down can be obtained and the amplification accordingly reduced. A ratio higher than normal is also obtainable to give greater amplification.

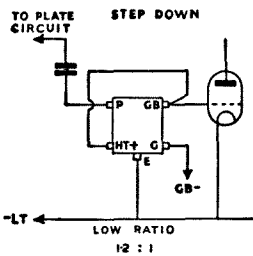

Taking the above transformer as an example, diagrams are given showing how the coupling connections may be varied to give these different ratios, and what the new ratios will be.

It should be borne in mind, however, that the methods outlined above are artificial means to an end, applicable

in the case of a parallel-fed transformer. Whereas in the majority of cases extremely satisfactory results are thus obtainable, the methods suggested cannot be advocated in circuit arrangements relying on impedance matching for the most favourable operating conditions.

CONNECTING AN EXTRA LOUDSPEAKER

When we wish to connect an extra loudspeaker to a receiver provided with sockets for this purpose, our natural impulse is to plug the two loudspeaker leads into the sockets and hope for the best when we switch on. Sometimes we may be lucky and get very good results indeed. But if we are optimistic enough to do this without any other considerations there are almost equal chances that we shall get poor results, and start wondering whether the blame lies in the set or the speaker. The set because we are led to believe that it has not energy enough to drive two speakers, and the speaker perhaps because it is not sensitive enough, or if overloaded because it cannot handle the energy imposed upon it. In either case we are probably doing one or the other a gross injustice.

Let us consider for a moment, therefore, other factors that have to be taken into account. To start with, it is obvious that a moving iron speaker is not interchangeable with one of the moving coil type. Primarily, our object should be to obtain suitable matching between the output valve and the loudspeaker we wish to use. To do this we shall either have to select a speaker that will be suitably matched or, if we already have one, to take steps to match it to the output of the receiver. This will depend on the type of output valve used. To obtain the maximum undistorted output from this valve, the impedance of the speaker circuit should be twice that of the valve; or more correctly, it should be as near as possible equivalent to the "optimum load" for the valve.

For our present purpose, however, it will be sufficient to summarise a few points to bear in mind, and to remember also, should we wish to determine correct matching impedance by calculation, that we already have in circuit the impedance of the speaker incorporated in the receiver.

In the case of a triode or ordinary power output valve being used an additional speaker of the high resistance moving iron type may be connected direct to the extra loudspeaker sockets. Provided the one in the set is of similar

type, good results may be expected, and beyond a slight reduction in volume, since the available energy is divided between each speaker, no ill effects should occur, unless they are introduced through other causes. We mention this because it sometimes happens, when connecting an additional speaker, that the use of long extension leads gives rise to instability in the low frequency circuits (see "Threshold Howl"). If the speaker in the receiver is a moving coil, and we wish to use a moving iron one externally, we may have a little difficulty owing to their being of different types.

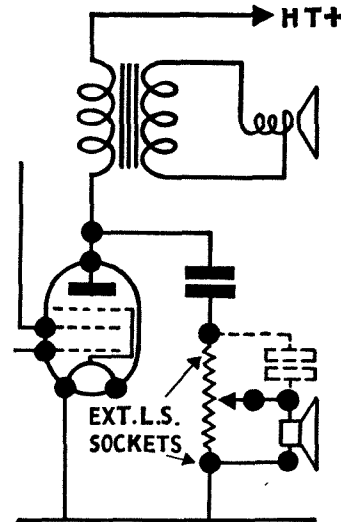

Although the reproduction of the moving coil may be slightly affected, the chief trouble will probably be due to the incapacity of the moving iron speaker to cope with the energy imposed upon it, especially if the output valve is a super power valve capable of handling large outputs. This means that the external speaker must have its available energy controlled, but it is obviously desirable that this should be made possible without seriously affecting the volume obtainable from the moving coil speaker. We can do this by connecting across the extra loudspeaker sockets a potentiometer of about

50,000 ohms, the loudspeaker being connected between the centre point or sliding contact of the potentiometer and the earth end as shown in the diagram.

Should there be too much loss of high notes by this arrangement, we can compensate for this by inserting an extra condenser of about .001 mfd. across the other half of the potentiometer, as shown dotted in the diagram.

In the case of a pentode output valve, which has a very much higher impedance, an output transformer or low frequency choke is invariably employed in the output circuit to ensure correct matching. We can assume that the built-in speaker will already have a matched output, but the extra loudspeaker circuit seldom incorporates an additional output transformer, which if needed, depends for its correct ratio on the impedance of the loudspeaker to be used, in conjunction with that of the built-in circuit. Generally speaking, when a high impedance speaker is connected externally to a receiver with pentode output, it is preferable, though not essential, to feed it through a small step-down transformer. Whereas an additional speaker of the moving coil type must always be fed through a fairly high ratio step-down transformer, whether used with power or pentode output. With the latter, the ratio may be anything from 10 : 1 to 80 : 1, while for a power valve a ratio of 25 : 1 is seldom exceeded.

THRESHOLD HOWL

This is the name given to an extremely aggravating type of reaction in the form of a low frequency oscillation. It is so called because it generally reveals itself as a low squeak or howl just as the set is brought to the "threshold" of oscillation by

A Corner of our
Self Sealing Condenser Winding Department

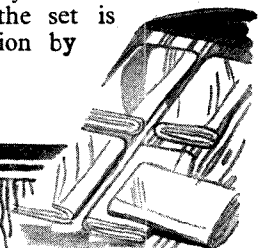
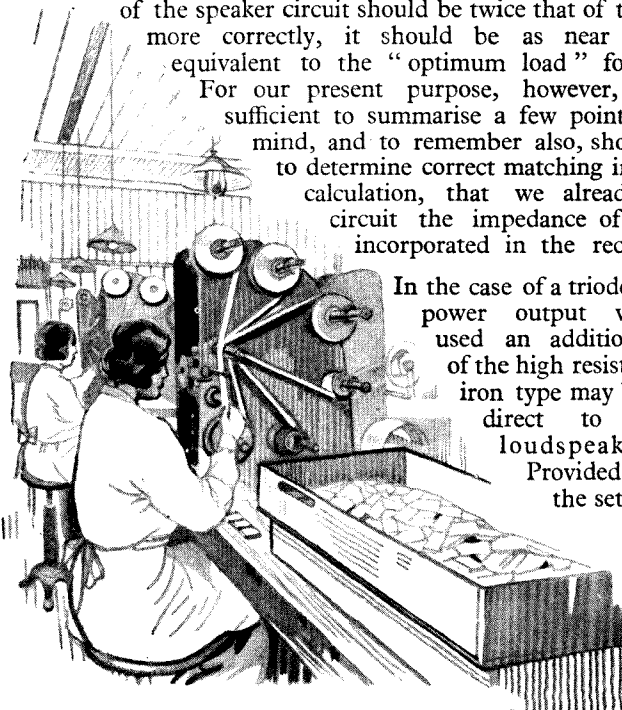

MORE PRACTICAL HINTS AND TIPS—continued

means of the reaction control. Unless very pronounced, reception of one or other of the local stations will not be seriously affected, since there is no need to employ reaction. Even so, in bad cases, certain low frequency notes may be harshly distorted owing to its presence in the circuit. But when it occurs in a receiver relying on the extensive use of the reaction control for the reception of more distant stations, it can be very disturbing, as its effect is to limit the use of the reaction control to a point appreciatively lower than that at which the maximum sensitivity of the set is developed. To cross the threshold where the howling begins is to blot out signals completely. Consequently, some of the stations that could normally be received by the use of reaction are quite impossible to get.

Usually, however, the fault is not a difficult one to overcome, being generally caused by high frequency currents reaching the low frequency stages and feeding back either into the aerial or some other portion of the tuning circuits. In some cases, as we have already hinted at in the previous article, it may be due to long extension leads to the loudspeaker. A cure for this is often effected simply by keeping the loudspeaker leads away from the aerial, and not allowing them to double back across the receiver in any way. A further precaution may be taken by inserting a high frequency choke in the negative lead (that is,

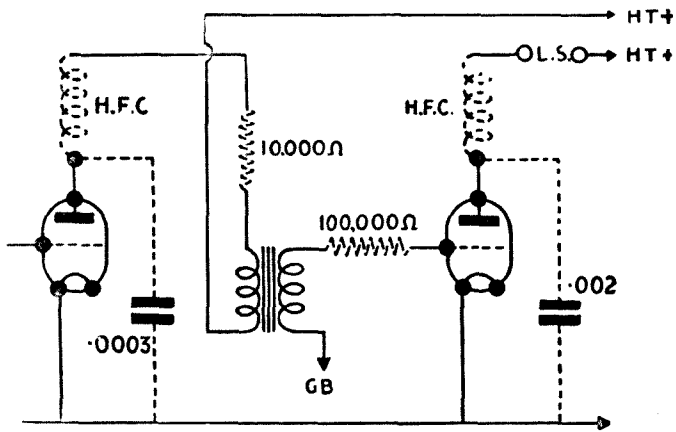

the one nearest to the plate of the output valve) to the loudspeaker, and connecting a by-pass condenser of about .002 mfd. between the plate side of the choke and negative filament. But volts are frequently too precious to permit of any drop, however small, in the anode potential of the output valve, so that it is wiser to bear in mind that "prevention is better than cure," and to take steps to eliminate the fault from where the low frequency stages begin, namely the detector valve.

A high frequency choke and its associated by-pass condenser in the plate circuit of the detector will effectively stop the trouble in the majority of cases, and is usually standard in most circuits, but where this fails to cure it completely we can try inserting a "stopping" resistance of about 100,000 ohms in the grid lead of the first L.F. valve. Yet another remedy is to insert a resistance in the anode circuit of the detector, which explains incidentally why threshold howling is seldom evident in circuits employing resistance capacity coupled stages.

In the circuit diagram above, the remedies discussed for the elimination of threshold howl are indicated by dotted lines.

CONNECTING A GRAMOPHONE PICK-UP

One of the first simple tests applied to a receiver which emits no sound on switching on is to touch the grid terminal of the detector valve with the finger or some metallic object to see if the set is "alive." When the receiver is working normally, the effect of this is to produce a loud hum or singing noise in the loudspeaker due to external pick-up. Even a short length of idle wire connected to the grid terminal, especially with mains sets, will bring in this noise. This is a fact that should be borne in mind when connecting a pick-up to a receiver, and is the reason why it is essential to keep the pick-up grid lead as short as possible. Of course, when the pick-up is in circuit, the effect is not so marked since the other side of the pick-up is connected either direct to earth or to earth through the grip bias battery, and with most battery sets unless the pick-up leads are exceptionally long, no appreciable interference is likely to be experienced. With mains sets, the problem becomes more acute. In practice, it is not always possible to have short leads to the pick-up terminals or sockets and it then becomes necessary to screen them. Actually, since one lead is already at earthy potential, we need only screen the grid lead from the pick-up, but a pair of leads is just as easy to screen as a single one and obviously makes a much neater job. Screened leads for this purpose are now in wide commercial use, either single or double, and are readily obtainable from most radio dealers. When the pick-up leads are screened and connected to the receiver, the screening itself must be connected to earth. It is well to remember, too, that when an electric gramophone motor is used, hum from the motor is frequently introduced into the pick-up, and to safeguard against this, a wire should be taken to earth from a convenient screw or nut on the metal part of the motor frame. If the tone arm is a metal one, this can also be earthed in the same way. These precautions, trivial though they may sound, will ensure freedom from hum when working on gramophone.

So far we have assumed that the pick-up is being connected direct to the receiver. If we wish to include a volume control and a radio-gramophone switch to dispense with having to disconnect the pick-up every time we want to receive radio, the same precautions hold good with regard to screening and earthing, but two other questions arise as to where we are to mount the additional components. The volume control we can deal with at once, the most convenient position being on the gramophone itself near the tone arm. But the switch is not so easy. From what has already been said, it is clear that a lead of any length between the grid of the valve and the switch is going to pick up any hum that is going. Even if we carefully screen this lead we are going to run into trouble as the tuning of the grid circuit will be upset when receiving radio, and in a ganged receiver this would be fatal. It is essential, therefore, to mount the switch as near to the grid terminal of the valve as possible and in the non-earthly lead.

Difficulties in the way of controlling the switch from the panel or other convenient position can generally be surmounted by fitting an extension spindle
(cont. on page 60)

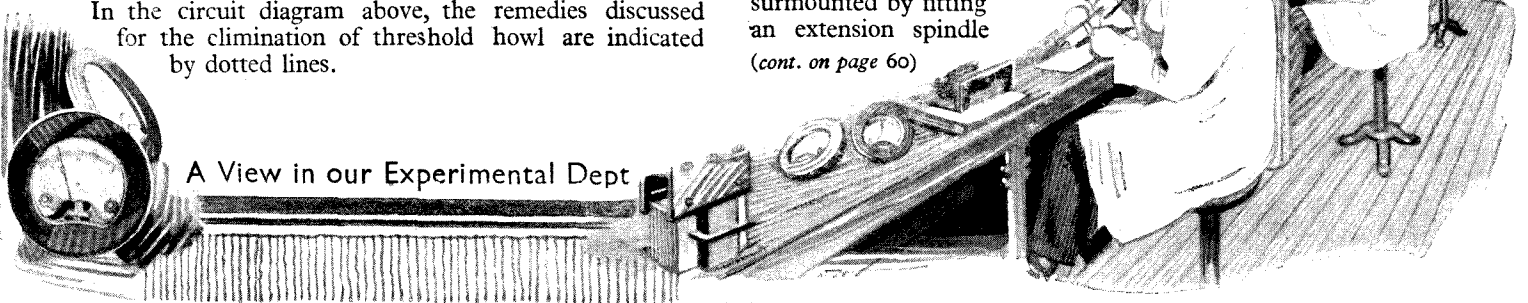

A View in our Experimental Dept

TELSEN SPECIFY REGENTONE TO MAINTAIN THE EFFICIENCY OF THEIR CIRCUITS

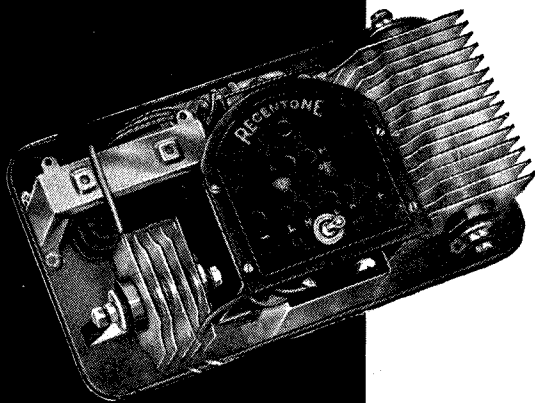
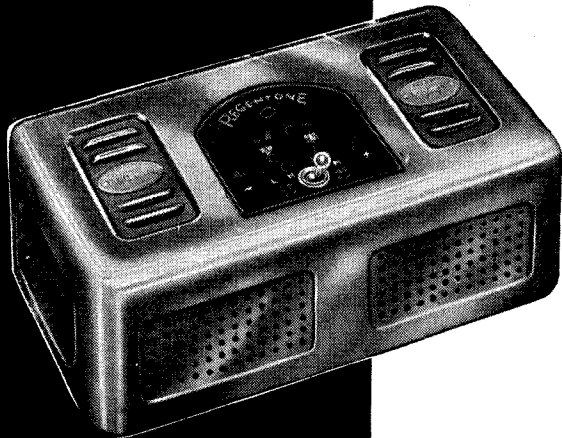

"We shall continue to specify Regentone for all Telsen circuits" say the Telsen engineers. They know that they can depend on Regentone—on Regentone's specialised experience—to maintain the reputation of Telsen sets.

And what a difference in a battery set made all electric with a Regentone Mains Unit! Gone is the fear of failing batteries! Gone is the expense of constant charging! And in its place *unfailing* power, giving you greater volume, clearer tone, more life-like radio—for as little as 1½d. a month.

It takes only two minutes to instal a Regentone. There is a Regentone for any set—to fit inside any portable—for as little as 39/6 or 7/6 down.

Change from batteries to mains—and change with Regentone, the experts' choice. Insist on Regentone! Regentone exclusive features have no equal.

Each Regentone Mains Unit incorporates these exclusive features:

Each model is housed in a solid drawn steel case, attractively designed, with a Florentine bronze finish. Each model is provided with tappings divided into three main groups: SCREEN GRID, DETECTOR and POWER. The screen grid and detector supply each have high, medium and low outputs. The power supply has one output only.

All mains units incorporate a LINE VOLTAGE REGULATOR, by means of which the voltage fluctuation can be compensated for in the main supply line.

The Line Voltage Regulator and voltage tappings are carried by a specially moulded distributing block; the sockets carrying voltage are sunk into the insulating medium.



REGENTONE — THE EXPERTS' CHOICE

REGENTONE LTD., Regentone House, 21 Bartlett's Buildings, Holborn Circus, London, E.C.4. Telephone: Central 8745 (5 lines).
Northern Distributors: W. E. Beardsall & Co., Victoria Bridge, Manchester. Irish Free State Distributors: Kelly & Shiel, Ltd., 47 Fleet Street, Dublin.

The TELSEN SUPER SELECTIVE

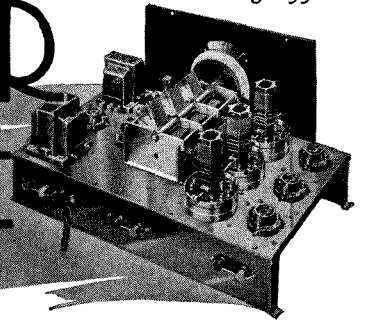
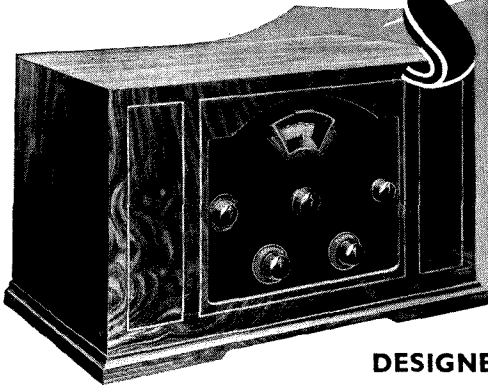

A VERY SELECTIVE
TWO H.F., DET., PENTODE
BATTERY RECEIVER.

4

DESIGNED BY THE TELSEN TECHNICAL STAFF.

THERE is undoubtedly a great demand for a highly sensitive battery receiver that is easily built and so simple to operate, that the veriest novice is able to tour the ether bringing into his home the most distant of foreign programmes.

To this end the Telsen "Super Selective Four" has been designed. It combines the stability and reproduction engendered by the handling of a commercially manufactured receiver, together with the quality of reaching out for distance transmitting stations so essential to the wireless constructor.

An examination of the set shows immediately that metal is employed throughout in all the chassis work. This ensures the maximum of screening between the various highly efficient circuits employed, and at the same time maintains perfect mechanical rigidity.

There are five controls mounted on this front panel. Of these, the main tuning control is normally the only one used, the others being auxiliaries and requiring occasional adjustment only. The other controls are the wavelength change switch which enables all the three tuning coils to be changed from the long to the medium wavelength band or vice versa, the aerial separator control, the volume control and the on-off switch for the low tension accumulator supply.

Concerning the type of circuit used, a theoretical diagram is shown in Fig. 1.

The circuit incorporates two stages of screened grid valve high frequency amplification, the aerial being loose coupled to the tuned grid circuit of the first valve, which in turn is coupled by a high frequency transformer to the tuned grid circuit of the second valve. A leaky grid detector valve followed by a pentode of the high efficiency type completes the main circuit. These two tuned stages give all the high frequency amplification that is desirable, and, with the addition of the tuned grid circuit of the detector valve, making three tuned circuits in all, enables a very high degree of selectivity to be attained.

As there are three tuned circuits, three variable tuning condensers are required which in the usual circumstances would call for three condenser control knobs on the front panel. However, by using the Telsen Triple Matched Coils W.288 and the Telsen Triple Gang Condenser W.307, the tuning is operated by the use of only one panel control.

The detector valve is followed by a Telsen 10—1 Coupling Unit, which is outstanding in its merits of high magnification, of giving remarkably good bass response, and having a compensated top note register to reduce hiss and heterodyne whistle especially when followed by an efficient pentode valve in the output stage.

A marked feature is the extensive decoupling employed with the various high frequency and low frequency circuits. Everyone is aware of the extensive part played by correct decoupling in radio receivers, and the Telsen "Super Selective Four" fully conforms with the most up-to-date practice in this direction.

A 1/- full size Blue Print showing the complete assembly and wiring of the Telsen "Super Selective Four" is given away free with this issue of the Radiomag which, with the help of this article, enables the set to be quickly constructed and adjusted for the most efficient

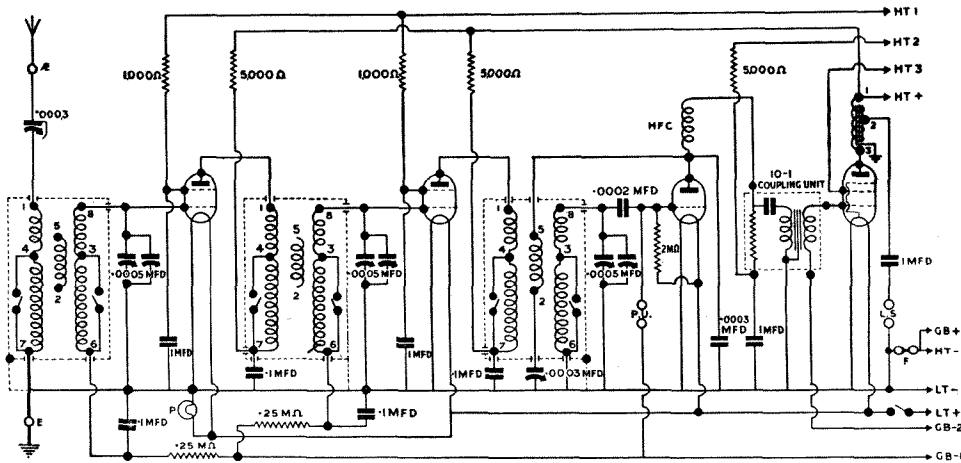

THEORETICAL CIRCUIT OF THE TELSEN 'SUPER SELECTIVE FOUR'

FIG. 1.

working. A complete list of the components required for building this receiver is given elsewhere, and a Constructor's Outfit containing the complete set of metal plates and panels, battery cords, tools, and the usual small gear needed for the construction of this set will be found listed in the catalogue section.

(continued on page 56)

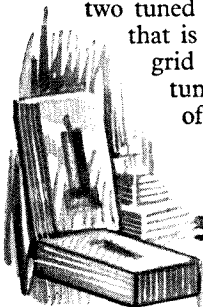

One of the Universal Die Sinking Machines in our Tool Room

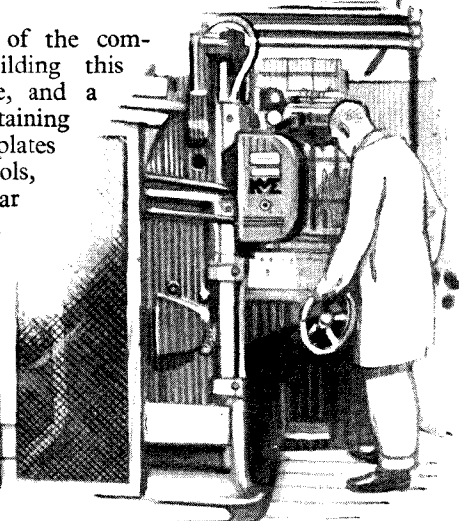

THE TELSEN SUPER SELECTIVE FOUR — continued

For those constructors who have no suitable spare Telsen components to hand, a complete set of Telsen parts is available in the "Super-Selective Four" Kit W.323. This Kit contains all and every component and accessory needed in the construction of the "Super-Selective Four" receiver, and as the components are specially matched to one another, the maximum degree of efficiency is assured.

ASSEMBLY OF COMPONENTS ON UNDERNEATH SIDE OF THE TOP PLATE

The underneath side of the top plate which measures 16½" × 9½" is the side with turned up lips of metal at two of its ends. A large number of components have to be assembled on this side, and by consulting the Blue Print, the correct holes and positions in which to mount the various components are at once located.

In order to preserve a neat appearance of the top plate, all screw heads should project on the upper side and all the nuts be screwed home on the underneath side of the plate.

- Fit anode cartridge resistance holder in holes 1—2
- " " " " " " " 3—4
- " " " " " " " 5—6
- " " " " " " " 7—8
- " " " " " " " 9—10

Insert two 1,000 ohm and three 5,000 ohm anode resistances in the correct holders as shown in the Blue Print.

- Fit standard H.F. choke in holes 11—12
- " .003 mica condenser in holes 13—14
- " .1 Self-Sealing condenser in holes .. 15—16
- " .1 Self-Sealing condenser in holes .. 17—18

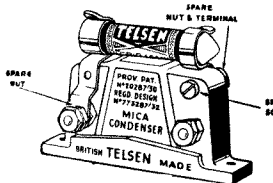

FIG. 2

Assemble together the .0002 mica condenser and two megohm grid leak as shown in Fig. 2 and fit this combination into holes 19—20.

- Fit .1 Self-Sealing condenser into holes 21—22
- " .1 Self-Sealing condenser into holes 23—24
- Fit grid leak holder into holes 25—26 and fix into it a ¼ megohm grid leak.
- " grid leak holder into holes 27—28 and fix into it a ¼ megohm grid leak.
- " 1 mfd. Self-Sealing condenser into holes .. 29—30
- " I " " " " " .. 31—32
- " I " " " " " .. 33—34
- " I " " " " " .. 35—36

Now assemble ¼" cheese-headed 6 B.A. and flat nuts into all the remaining holes spaced round the edge of the top plate. These should not be screwed up tightly but left loose, as they are, at a later stage, used for bolting all the chassis assembly together.

ASSEMBLY OF FRONT PANEL AND FRONT PLATE

The black crystalline finished front panel measuring 12" × 9" is now assembled to the front plate. These are secured to one another with four 6 B.A. flat head counter-sunk screws and flat nuts contained in the

Constructor's Outfit. The positions of these screws are depicted in Fig. 3 by A, B, C and D, which also shows the complete assembly of the front panel and front plate with the various controls. The various controls are now assembled to the front panel unit.

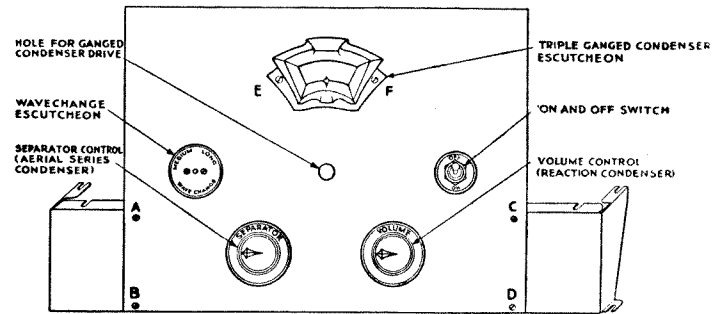

FIG. 3

Accordingly, fit the Aerial Series Condenser with Switch W.205. Looking at the front of the assembly, the hole in the lower left hand side is used for this. This component has to be insulated and care must be exercised in the assembly. Remove the knob, and take off all the loose assembly pieces on the condenser shank, namely the lock nut, spare lock nut, two large insulating washers and one insulating bush. Now place on the condenser shank the cupped washer contained in the Constructor's Outfit, then a large insulating washer, and then the two thick insulating bushes that are also contained in the Constructor's Outfit.

The cupped washer should be so fitted that the cupped portion (see Fig. 4) faces away from the bakelite condenser. Insert from the back through the lower left hand hole, the condenser being disposed as shown in the Blue Print. See that the washer lies flat against the back of the front plate, and the front edge of one thick bush therefore just projects at the front. Place the separator escutcheon on the projecting bush, then the second large insulating washer, and finally screw loosely to the shank the locking nut. Rotate the escutcheon plate into its correct position, and holding the whole assembly firmly, screw up the lock nut tightly. Now fix the knob on to the condenser spindle. The wavelength escutcheon denoting medium and long wavelengths is for the extreme left hand hole and is fitted with the two 6 B.A. screws and nuts provided, these accessories being contained in an envelope in the carton in which the Telsen Matched Screened Coils W.288 are packed.

The On-Off Switch W.297 is of the quick break action type and is fitted in the extreme right hand hole.

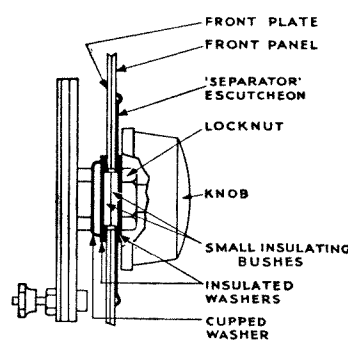

FIG. 4

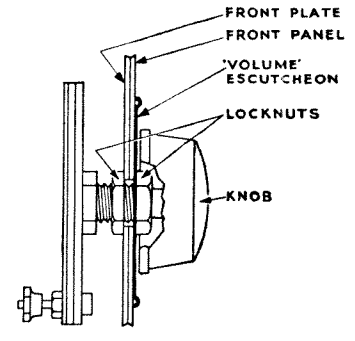
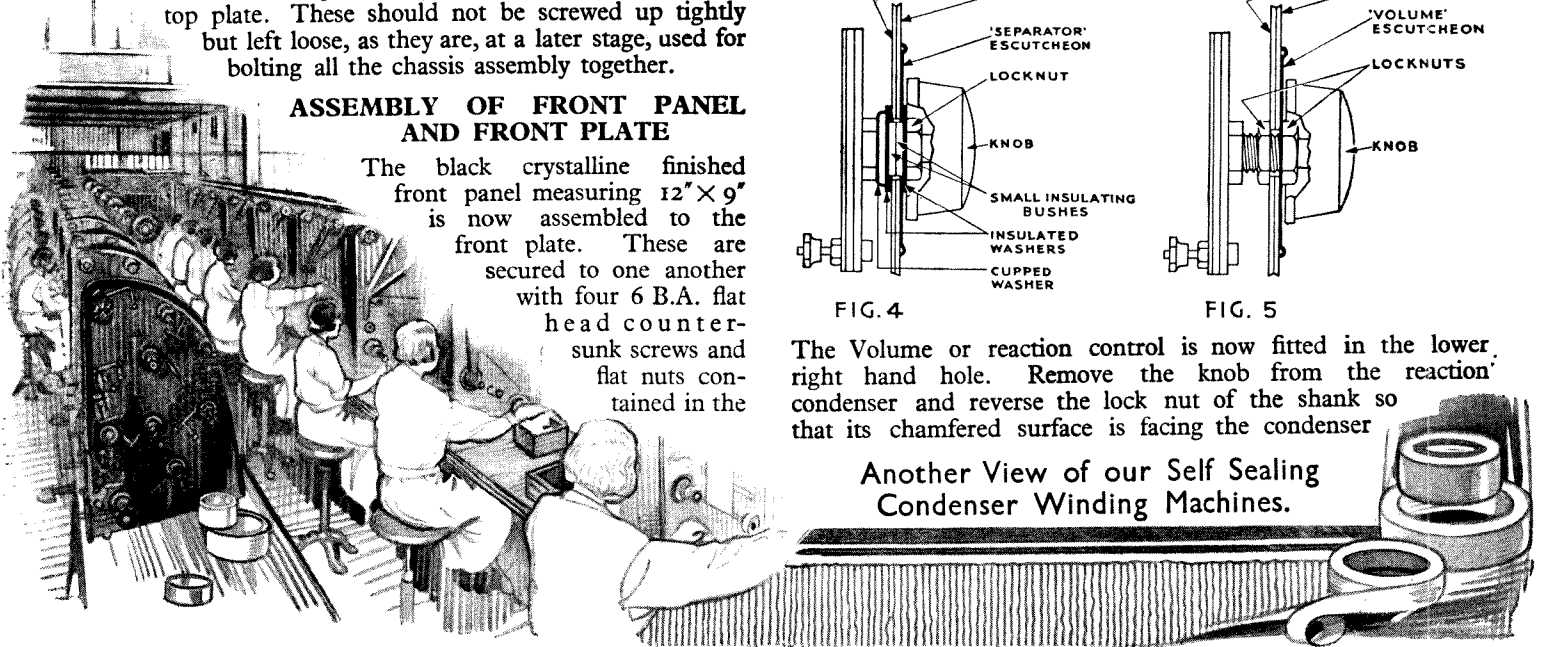

FIG. 5

The Volume or reaction control is now fitted in the lower right hand hole. Remove the knob from the reaction condenser and reverse the lock nut of the shank so that its chamfered surface is facing the condenser

Another View of our Self Sealing Condenser Winding Machines.



THE TELSEN SUPER SELECTIVE FOUR — *continued*

(see Fig. 5). Now insert the shank through the lower right hand hole with the condenser placed at the back as shown in the Blue Print. Place the volume escutcheon over the shank and then screw on the spare nut that is fitted to the condenser W.205 so that the shank thread just shows between the nut and the spindle. Now tighten up firmly the back nut against the panel after correctly positioning the escutcheon plate, and replace the knob.

The triple gang condenser escutcheon plate is now assembled to the front panel. It will be found in the carton containing the Triple Gang Condenser W.307, being mounted on a cardboard packing piece with two screws and nuts.

ASSEMBLY OF ABOVE UNIT TO THE TOP PLATE

This is a very simple matter. First ascertain that all the 6 B.A. screws and square nuts that are mounted along the front and sides of the top plate are only loosely assembled. Then slide the projecting top lip of the front plate underneath and against the front edge of the top plate, this particular edge being the one nearest to the grid leak holders, in which the $\frac{1}{4}$ megohm grid leaks are mounted. The top lip of the front plate has six slots which engage with the screws and square nuts along the top plate front edge. Holding these two metal pieces in position, screw up the six screws and nuts very tightly, and the operation is complete.

ASSEMBLY OF BACK PLATE

The Aerial Earth, +L.S.—, and Pick-up Terminal Strips contained in the Constructor's Outfit should first have the necessary terminals assembled on them. The three terminal strips are then assembled on the inside of the back plate with the cheese-headed screws and nuts provided, so that the outside appearance of the plate is as shown in Fig. 6.

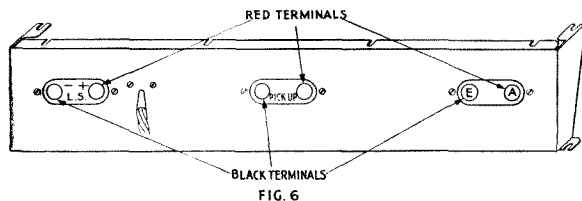

FIG. 6

The back plate is fitted to the top panel, the method of mounting being similar to that previously adopted in assembling the front panel and plate to the top plate.

ASSEMBLY OF COMPONENTS TO UPPER SIDE OF TOP PLATE

A complete list of the numbered holes and components is given below, this being arranged in the order in which the assembly is best carried out:—

- Fit Anti-microphonic 4-pin valve-holder in holes 37—38
- ” ” ” 4 ” ” ” ” ” 39—40
- ” ” ” 4 ” ” ” ” ” 41—42
- ” ” ” 5 ” ” ” ” ” 43—44
- Fit Tapped Pentode Output
- Choke in holes 45—46—47—48
- ” 10—1 Coupling Unit in holes .. 49—50—51—52
- ” Fuse Holder in holes 53—54
- ” Triple Matched Screened Coils and plinths in holes 55—56
- 57—58
- 59—60

The plinths screwed on to the coil bases should be taken off and placed in an inverted position under the screen bases on the top plate, being mounted with the 1" 6 B.A. screws and nuts provided in the Constructor's Outfit.

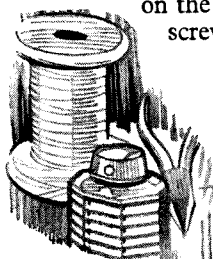

A Corner of our Aerial Coil Dept.

Before screwing down the coils too securely, the 8" switch rod provided with this range of coils should be inserted to pass through all the coil switch holes, placing the switch stop and the loose collar in the positions indicated in the Blue Print.

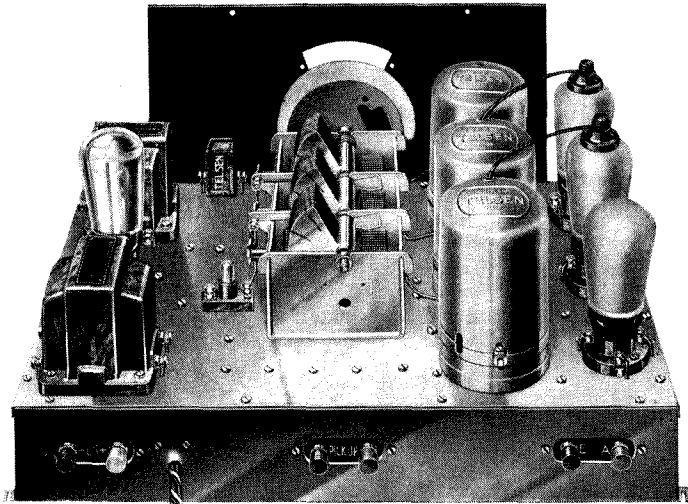

THE TELSEN "SUPER-SELECTIVE FOUR" assembled and ready for testing out.

Place the knob on to the switch rod where it projects through the front panel, and slide the rod backwards or forwards until the knob has the same spacing from the front panel as that of the Separator and Volume control knobs.

Turn the wavelength change knob until its arrow points to the long wavelength position when the flat portion of the switch rod will be found to be uppermost. As the switch rod is rotated into this position, the switch gear of the coils will be heard to click into position. Keeping this position, the switch stop should be located very close to the screen base and then screwed up tightly so that the screw bites into the flat of the switch rod.

Fit the Triple Gang Condenser into holes 61—62—63, these holes being indicated on the underneath side in the Blue Print.

Holding the ganged condensers in position, insert the three 4 B.A. screws provided with it through the holes 61, 62 and 63 so that they engage in the three screwed holes in the ganged condenser base. Screw these up to a slack tightness, and slide the ganged condenser lengthwise until the graduated tuning scale rotates just clear of the back of the escutcheon. Then screw the condenser firmly into position.

WIRING

For those who do not wish to solder connections, we strongly recommend the "thin wire and sleeving" method which incidentally is used here.

On looking at the Blue Print it will be noticed that two views of the receiver are given, one looking at the upper side of the receiver top panel and the other of the underneath side. Thus all necessary views of the chassis are given to enable easy wiring up to be carried out.

(continued on page 58)

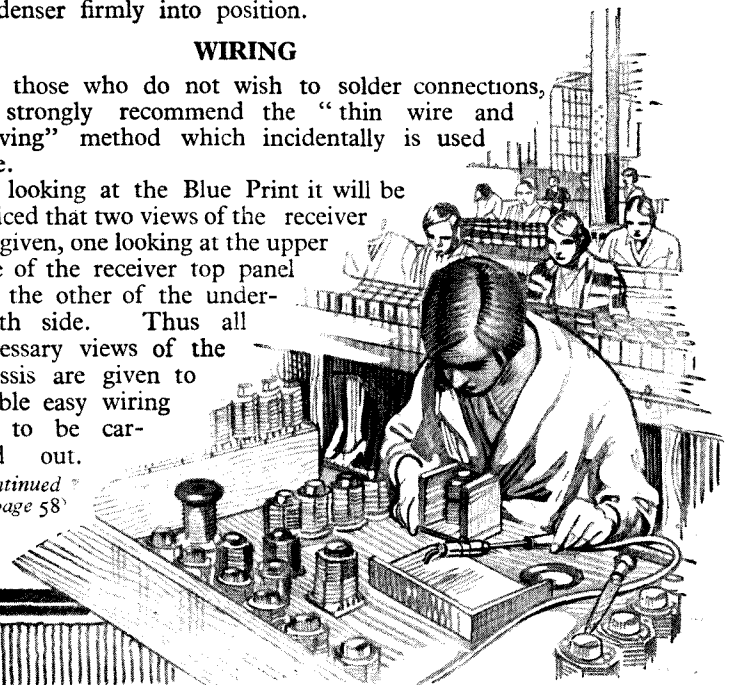

CONNECTING UP THE TELSER SUPER-SELECTIVE FOUR—continued from page 57

It will also be observed that all terminal wiring points are figured, whilst all holes through which wires pass are designated by a figure together with the letter H, these being of considerable assistance in laying out the wiring.

Every connection in the receiver should be insulated, and sleeving is supplied in the Constructor's Outfit for this purpose.

The wire connections between the various points that go through chassis holes, should not be drawn too tight as the sleeving may be abraded on the edges of the holes.

In the Blue Print the coils are lettered A, B, and C. The various terminals on these are indicated by the figures 1 to 8, and each particular coil connection has the coil letter in front of the terminal figure. Thus A8 refers to terminal 8 of coil A. The four valve-holders are also designated by the letters V₁, V₂, V₃, and V₄.

The complete list of wiring is now given, this being in the best order for wiring up the receiver.

Terminal 68 of V₃ through 68H to 69 (earth terminal of A-E strip).

- ” 68 of V₃ through 68H through 70H to 70 of V₂.
- ” 70 of V₂ through 70H to 71 through 72H to 72 of V₁.
- ” 73 of V₁ through 73H through 74H to 74 of V₂.
- ” 74 of V₂ through 74H to 75 through 76H to 76 of V₃.
- ” 73 of V₁ through 73H through 77H to 77 of on-off switch.
- ” 77 of on-off switch through 78H to 78 of V₄.
- ” 79 of V₁ through 79H to A8 to 80 of ganged condenser.
- ” 81 of V₂ through 81H through 82H to B8 to 83 of ganged condenser.
- ” 84 of V₃ through 84H to 85 to 86 of gram. pick-up strip.
- ” 87 of V₃ through 87H to 88 to 89 through 89H to C₅.
- ” 90 of grid leak condenser assembly through 91H to C8 to 92 of ganged condenser.
- ” 69 of A-E strip to 93 to 94 through 95H to C₆.
- ” C₇ through 95H to 96 to 97 of 1 mfd. condenser.
- ” B₆ through 98H to 98 to 99 of grid leak holder.
- ” B₇ through 100H to 100 to 101 of resistance holder.
- ” A₆ through 102H to 102 to 103 of .1 mfd. condenser.
- ” A₇ through 104H to 105 to 106 of reaction condenser.
- ” A₁ through 107H to 107 of aerial series condenser.
- ” 108 of V₁ through 108H to 109 to 110 of 1 mfd. condenser.
- ” 111 of V₂ through 111H to 112 to 113 of 1 mfd. condenser.

Terminal C₂ through 114H to 114 of reaction condenser.

Terminal 116 of aerial series condenser to 115 of A-E strip.

- Terminal 94 of 1 mfd. condenser to 117 to 118 to 105 to 119 to 120 through 121H to 121, the earth terminal of pentode choke.
- ” 122 of grid leak holder to 123 to 124 of gram. pick-up strip.
- ” 125 of ganged condenser through 125H to 119 through 126H to 126 of fuse holder to 67 of ganged condenser.
- ” 120 of 1 mfd. condenser through 127H to 127 of V₄.
- ” 127 of V₄ through 127H through 128H to 128 earth terminal of 10—1 coupling unit.
- ” 128 through 128H to 129 of +L.S.— strip.
- ” 130 of output choke through 130H through 131H to 131 of V₄.
- ” 132 of V₄ through 132H through 133H to 133 of 10—1 coupling unit.
- ” 134 of 1 mfd. condenser to 135 of +L.S.— strip.
- ” 136 of output choke through 136H to 137 of 1 mfd. condenser.
- ” 138 (+H.T. of 10—1 coupling unit) through 138H to 139 to 140 of 1 mfd. condenser.
- ” 141 (P of 10—1 coupling unit) through 141H to 142 of H.F. choke.
- ” 143 of output choke through 143H to 160 to 150 of resistance holder.
- ” 151 of resistance holder to 152 of resistance holder.
- To C₁ attach 9" of wire and place on it 8½" of sleeving. Thread this through the eyelet in the screen top and place the screen securely in position in the screen base.
- To B₁ attach 9" of wire and place on it 8½" of sleeving. Thread this through the eyelet in the screen top and place the screen securely in position in the screen base.
- Terminal 153 of pilot light to 125 of ganged condenser.
- ” 154 of pilot light to 77 of on-off switch.

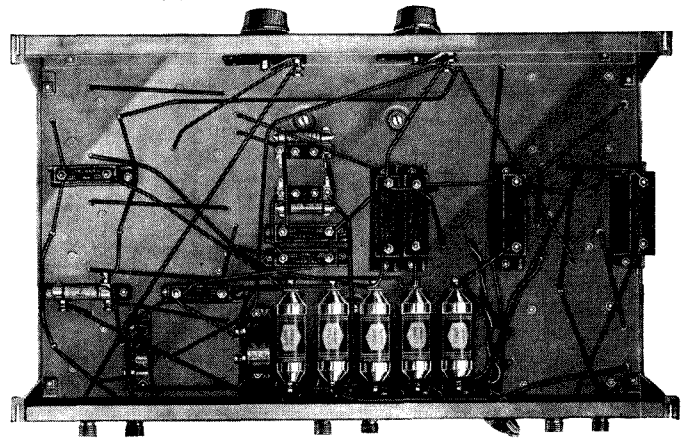

Underside of the baseboard showing the components and wiring for the Telsen Super-Selective Four.

The receiver is now completely wired except for the battery cords which now claim attention. Two cords, a cord clip, wander plugs and spade terminals are contained in the Constructor's Outfit together with sundry lengths of sleeving for the neat finishing of the cord ends. Two cords are included, one consisting of eight strikingly coloured leads, twisted together, and a two-way cord

A View in our Cellulose
Paint Spraying Department

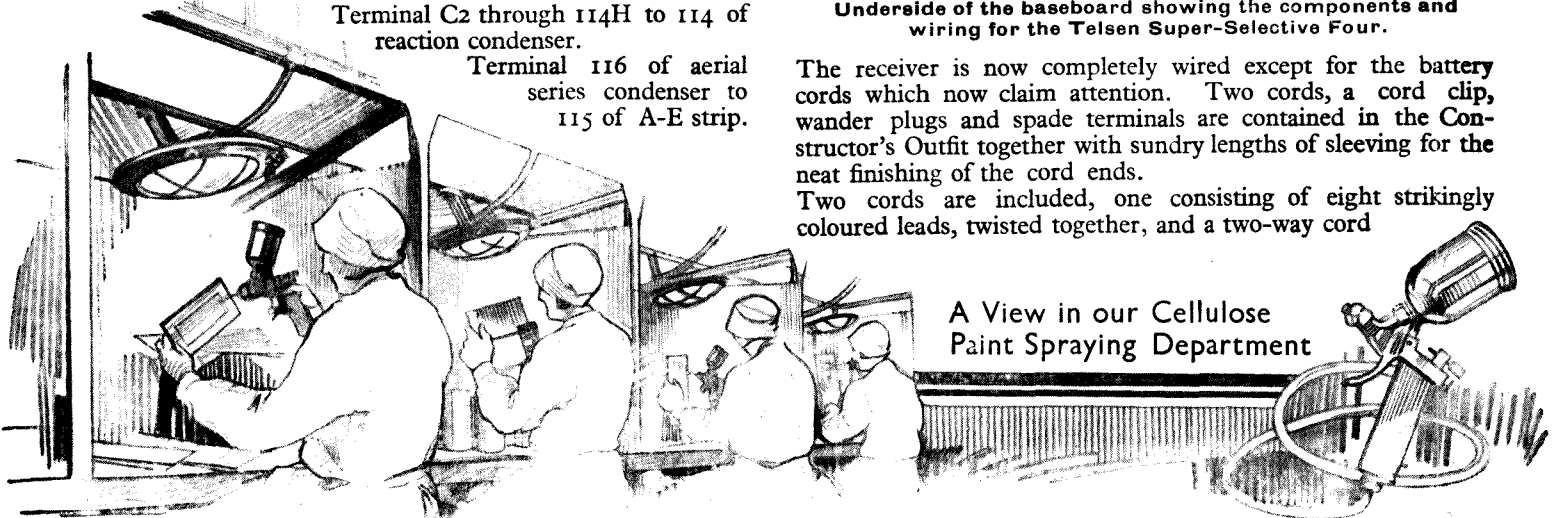

CONNECTING UP THE TELSEN SUPER-SELECTIVE FOUR—continued

with leads of red and black. The wander plugs are suitably engraved and the colour code adopted for these and the eight-way cord is as follows :—

Black	H.T.—
Speckled	G.B.+
Yellow	G.B.—1
Green	G.B.—2
White	H.T.+1
Maroon	H.T.+2
Blue	H.T.+3
Red	H.T.+

The constructor is advised to separate out the battery cord leads about 18" before connecting them to the various wander plugs, as this makes the connections neater and simpler, and also enables the leads to be retwisted or plaited into convenient groups; thus the five H.T. leads can be plaited into one cord, and the three G.B. leads into another cord.

Giving the cord a neat appearance at both ends presents no difficulty. Some suitable sleeving is included in the Constructor's Outfit for doing this. Thus, slide the braiding back about ¼" and cut off the rubber covered wire to the same length. The braid can then be brought forward again, moistened, and screwed to a point between finger and thumb. It is then easy to thread on a small length of sleeving, which can be brought up to the terminal or wander plug when the joint has been made, thus covering any loose ends of braiding.

Now attach the wander plugs to the correct coloured leads, finishing the cord appearance as above, and thread the free end through the aperture in the back plate as shown in Fig. 6. The cord ends are then connected up as follows :—

- Black lead (H.T.—1) through 156H to 156 of fuse holder.
- Speckled lead (G.B.+) through 156H to 156 of fuse holder.
- Yellow lead (G.B.—1) to 124 of gram. pick-up strip.
- Green lead (G.B.—2) through 157H to 157 (G.B. terminal of 10—1 coupling unit).
- White lead (H.T.+1) to 152 of resistance holder.
- Maroon lead (H.T.+2) to 158 of resistance holder.
- Blue lead (H.T.+3) through 159H to 159 terminal of V₄.
- Red lead (H.T.+) to 160 of resistance holder.

The above remarks also apply to the two-way cord which is now fitted. First attach the two spade terminals. For these leads, a short length of 3 mm. red and black sleeving is provided as the 1½ mm. sleeving used for the wiring is not large enough to slide over the spade connections when fitted. Bare about 1½" of the wire end and then fold back the bare part on itself so as to form a thicker wire end, and thus ensure a firmer grip for the spade terminal. This is now placed round the wire end and with a pair of pliers, the teeth pinched down one by one on to the wire so that they grip it tightly. Then the finishing sleeve is slid into position.

Thread this lead through the cord aperture in the back plate and finish the wiring as follows :—

- Red (+accumulator or +L.T.) through 155H to 155 of on-off switch.
- Black (—accumulator or —L.T.) to 129 of +L.S.— strip.

The cord insulator contained in the Constructor's Outfit is now neatly wrapped round both battery cords, and eased through the cord hole until one end just projects out of the back plate. The

cord clip that is also contained in the Outfit should now be placed round the insulation on the cord, and fastened firmly into position with two 6 B.A. cheese-head screws and hexagonal nuts.

CONNECTING UP AND ADJUSTING THE "SUPER SELECTIVE FOUR"

Place in each of valve-holders V₁ and V₂, a screened grid valve, connecting the long lead issuing from the screen of coil B to the top terminal of the valve in V₁ and that from the screen of coil C to the valve in V₂. Insert the detector valve in V₃ and the pentode valve in V₄. The pentode valve should be of the 5-pin type, but if it has four valve pins only, a small length of wire should be joined between terminals 159 of V₄ and the terminal on the side of the pentode valve. Next connect up the aerial and earth leads and attach the loudspeaker to the correct terminals.

If it is desired to illuminate the tuning dial, a 2.5 volt .2 ampere flashlamp bulb should be inserted in the holder mounted on the condenser cover. This component may be purchased from your local dealer. A Telsen fuse bulb W₃₁₈ is then placed in the fuseholder.

- Insert G.B.+ wander plug into + tapping of grid bias battery.
- " G.B.—1 " " " —1½ volt tapping of grid bias battery.
- " G.B.—2 " " " —7½ volt tapping of grid bias battery.
- " H.T.—1 " " " — tapping of H.T. battery.
- " H.T.+1 " " " +78 volts H.T.
- " H.T.+2 " " " +102 volts H.T.
- " H.T.+3 " " " +114 volts H.T.
- " H.T.+ " " " 120 volts H.T.

Connect spade of black lead to — terminal of accumulator.
" " " red " " + " " "

It should be noted that the value of voltage of G.B.—2 depends on the type of pentode valve used in the output stage. It is here advisable to consult the makers' valve instructions as to the value of grid bias to be used.

The Separator and Volume controls should now be turned fully clockwise and anti-clockwise respectively, the wavelength switch set to the medium range, finally switching on the L.T. current by means of the on-off switch. On rotating the tuning control knob, stations will be received, and the receiver should be similarly tested on the long wavelength range.

The set is now ready to be ganged up, and a full description of this operation is described on page 21 of this issue of the *Radiomag* in the article "An Easy Path to Ganging Condensers," which should now be consulted.

GRAMOPHONE PICK-UP

It should be noted that arrangements have been made in the receiver for the necessary grid bias voltage, this being controlled by the battery lead marked G.B.—1.

(continued on page 60)

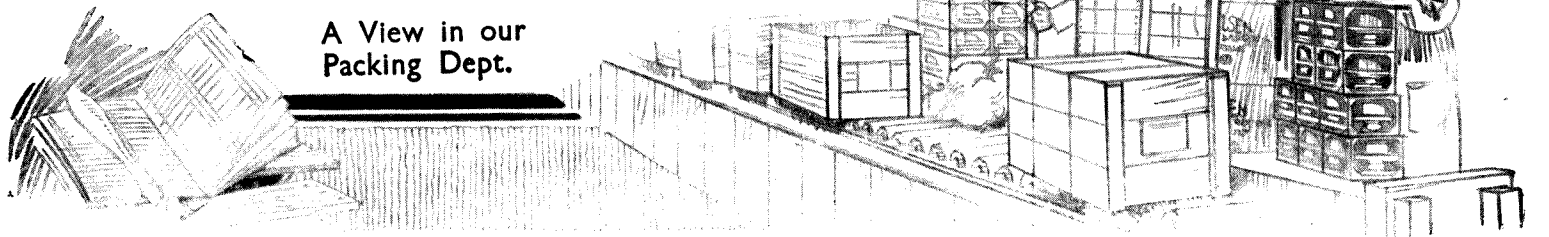

A View in our
Packing Dept.

THE TELSEN SUPER-SELECTIVE FOUR—cont. from page 59

CABINET

Several suitable cabinets are available for housing the Telsen "Super Selective Four," one being illustrated in the main heading to this article.

STONE CORRECTION

The tone of the Telsen "Super Selective Four" may be varied in one of two ways. Firstly, by use of the Telsen Variable Tone Corrector W.314 which, as the name indicates, allows the frequency response of the receiver to be altered, and secondly, the Telsen Pentode Tone Corrector W.308 that gives a fixed alteration of tone by cutting off some of the top note response.

RECOMMENDED VALVES AND BATTERIES

Mazda S.G.215A. S.G.215A. H.L.2. Pen. 220A or Pen. 220.
 H.T. Battery : 2 of Ediswan 60 volt 20 m/a. Cat. No. 69724.
 or: 1 Ediswan 120 volt 20 m/a. Cat. No. 69728.
 G.B. Battery : 1 Ediswan 9 volt. Cat. No. 69804.
 L.T. Battery : 1 Ediswan 2 volt 45 A.H. Type E.L.M.4.

RECOMMENDED MAINS UNIT

Regentone D.C. Eliminator, for H.T. only. Type D.C.1.
 Regentone A.C. Eliminator, for H.T. only. Type W.1.A.
 Regentone D.C. Eliminator, with Trickle Charger. Type D.C. Combined 2.
 Regentone A.C. Eliminator, with Trickle Charger. Type A.C. Combined W.4.A.

THE TELSEN SUPER SELECTIVE FOUR List of Components.

Quantity	Description	Cat. No.	Price
5	Anode Cartridge Resistance Holders ..	W.286	3/9
2	1,000 ohm Anode Cartridge Resistances	W.268	3/6
3	5,000 ohm Anode Cartridge Resistances	W.273	5/3
1	Standard H.F. Choke	W.75	2/-
1	.0003 mfd. Mica Condenser	W.242	1/-
4	.1 mfd. Self-Sealing Condensers, 500 v. type	W.231	7/-
1	.0002 mfd. Mica Condenser	W.241	1/-
1	2 megohm Grid Leak	W.251	1/-
2	$\frac{1}{2}$ megohm Grid Leaks	W.248	2/-
2	Grid Leak Holders	W.148	1/-
4	1 mfd. Self-Sealing Condensers, 500 v. type	W.227	9/-
1	.0003 mfd. Aerial Series Condenser with Switch	W.205	2/3
1	.0003 mfd. Bakelite Reaction Condenser	W.188	2/-
1	Mains Switch	W.297	1/9
3	4-pin Anti-microphonic Valve-holders	W.222	3/-
1	5-pin Anti-microphonic Valve-holder ..	W.223	1/3
1	Tapped Pentode Output Choke, 50/25 Henry, 20 m/a.	W.72	7/6
1	10-1 Coupling Unit	W.215	12/6
1	Fuse Holder	W.146	6d
1	Fuse Bulb	W.318	6d.
1	Set of Triple Matched Screened Coils ..	W.288	25/6
1	Triple Ganged Condenser	W.307	22/6
1	"Super Selective Four" Constructor's Outfit	W.305	7/6

The Telsen "Super-Selective Four" as detailed above, is supplied as a complete Kit, Catalogue No. W.323, at the inclusive price of £4 18 6

ERECTING EFFICIENT AERIAL AND EARTH

—continued from page 12.

Earth. The earth wire now claims our attention, and no less than the aerial, this should also receive very careful consideration. We must remember that the aerial and earth together form two plates of a condenser, and therefore the more we can have the earth directly under the aerial, the better. Probably the nearest approach to ideal earth conditions is to run a double thickness of wire or copper strip in the ground immediately underneath and along the entire length of the aerial, burying it about two or three feet deep. In an uncultivated garden, or one that has not yet been laid out for a new house, this proposition can be successfully carried out, and is worth considering; but while there are alternatives, no pressure for an earth of this description will be brought to bear in circumstances where the aerial is suspended over a bowling green or a bed of prize tulips! A direct water main connection by means of an earth clip has hitherto been considered the most efficient earth from a practical point of view, and often is the most convenient, but it is now generally acknowledged that a good copper tube or plate sunk well into moist ground near the earth lead-in will serve equally well. An American method is to sink a tube or rod about eight feet long into the ground, placing round the top end near the surface about five pounds of rock salt, pouring water over it until dissolved. In unusually dry ground it is also recommended that three or four of these should be sunk and joined in parallel. Inside the house it is advisable to have the earth lead also as short as possible. Too long a lead, or a bad connection will tend to reduce selectivity and volume. The same rubber-covered flex as used for the aerial inside the house should also be used for the earth lead. In conclusion we would add that the use of a gas main, or the casing of electric light or power cables is not recommended.

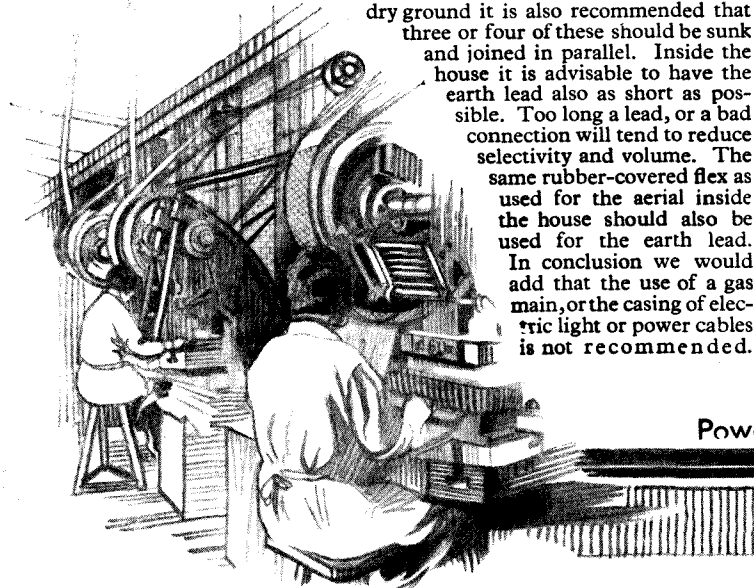

Power Presses in Action

HINTS AND TIPS

—continued from page 53

for the control knob. If a single pole switch is used, the moving contact, to which the extension spindle is connected, should be connected to the lead going to the pick-up. With a two-way switch, the moving contact has to be connected to the grid of the valve, so that to avoid any tendency to receive hum on radio the spindle may have to be insulated or made of ebonite rod.

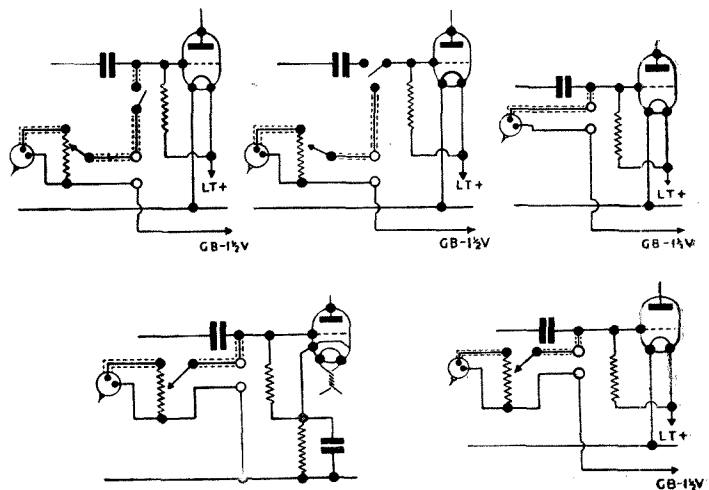

ALL SCREENS (SHOWN DOTTED) TO BE CONNECTED TO EARTH

In mains receivers where provision is made for connecting a pick-up, the necessary grid bias is incorporated in the circuit. For battery receivers, the earthy side of the pick-up should be connected to about 1½ volts negative bias. The theoretical circuit diagrams above indicate the connections for a gramophone pick-up, and the leads that should be screened if they are too long.

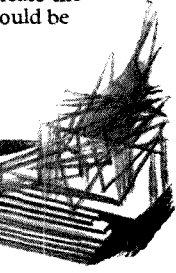

TOE CONTROL

in

Selective Receivers

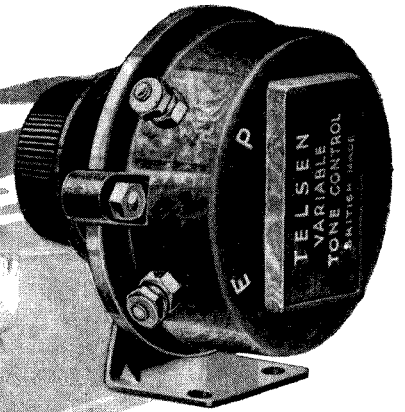

THE technique of radio reception has passed through several stages. In the early days of broadcasting the only thing that mattered was the reception of some sort of signals; whether one could hear the actual words spoken by the artists or not, was of secondary importance, although it must be admitted that even the proudest owner of a home constructed receiver would hesitate before describing his set's performance as good unless he could differentiate between, say, a military band and a soprano.

The first advances were made in the design of H.F. amplifiers, and this soon led to a great increase in the range of receivers. As a result, more stations were added to the experimenters' log, but the tone still left much to be desired. However, during 1927 the dawn of the quality era began, and a limited section of experimenters started specialising in quality receivers. At that time a set had to be designed to satisfy one of two requirements, range or quality, and it was not considered to be a practical proposition to build a receiver to give both.

The demand for high quality reproduction was largely fostered by the introduction of moving coil loudspeakers, and discerning amateurs began to insist on high quality components. Thus the straight line vogue was initiated, and designers vied with each other in the production of straight line components, i.e., components having an even frequency response throughout the whole of the musical range. In other words high and low notes must be given the same prominence as notes in the middle of the musical scale.

During 1929 the quality type of receiver began to be combined with the long range type and foreign stations now acquired a real entertainment value. To-day fresh developments are rapidly taking place in the quality field and a more critical attitude is being adopted towards the question of radio reproduction. Radio engineers are beginning to ask if straight line reproduction is really desirable in amplifiers under present-day conditions, and in the writer's opinion the answer to this question is in the negative. It is certainly necessary to have an amplifier capable of faithfully reproducing the entire frequency

range, but it is also essential to be able to control that range at will. The proportion of treble and bass required for natural reproduction depends on several factors; such as, the loudspeaker in use, the conditions of reception and individual preference. This is where a tone corrector system scores, for it enables the user to vary the response of his receiver as required. The Telsen Variable Tone Corrector W.314 has been designed to fulfil these requirements and no set can be considered up-to-date without this addition. Furthermore, it can be confidently predicted that the addition of this component will add a new zest to the pleasure the listener obtains from his set, whether he specialises in quality reproduction, distant station reception, or both. Parallel with the advances in receiver technique arose new problems in reception; for the ever-increasing popularity of broadcasting resulted in a very rapid growth of transmitting stations. Briefly, the problem that presented itself was that of finding room in the overcrowded ether for all the new stations, and the only solution was to set the wavelengths very close together. From the listener's point of view this procedure has two disadvantages, firstly extreme selectivity becomes essential and secondly high pitched heterodyne whistles are liable to spoil his reception. Fortunately for the radio constructor there is a remedy for both these evils. The problem of obtaining knife-edged selectivity is easily solved by the use of The Telsen Band Pass Coils W.290 described elsewhere in this issue, while the whistles can be completely removed by the use of the Telsen Variable Tone Corrector.

Although it has been stated that for perfect reproduction the very highest musical notes and overtones must be retained, this statement must be taken as applying, in general, to local station reception only. In the case of distant reception the results will generally be improved by cutting off some of the upper register, and thereby reducing interference. Thus by a simple manipulation of the knob on the Telsen Variable Tone Corrector the annoying high pitched whistles which accompany many transmissions can be removed without sacrificing quality. There is still another use for the Telsen Tone Correction device, which is applicable to both fixed and variable types, and that is for correction purposes in Pentode output valve circuits. It is well known that the use of a Pentode output valve tends to over-accentuate the reproduction of the high notes when used in conjunction with the average loudspeaker. In such cases the tone balance can be immediately restored by the addition of the Telsen Tone Corrector. Another advantage occurring from its use in this position is that it has the effect of levelling out the effective impedance of the loudspeaker at all frequencies.

(cont. on page 63)

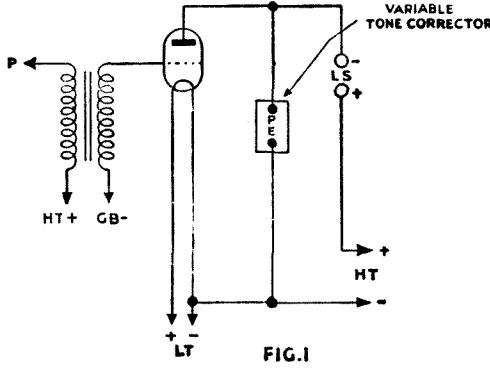

FIG. 1

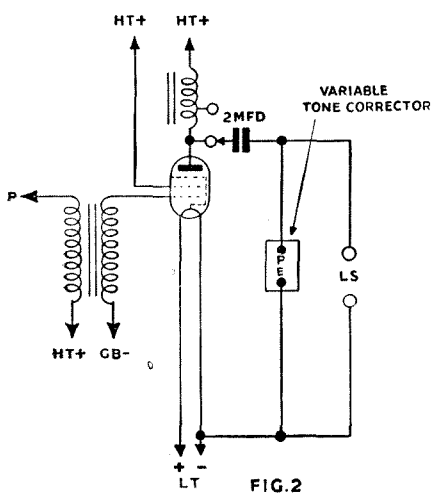

FIG. 2

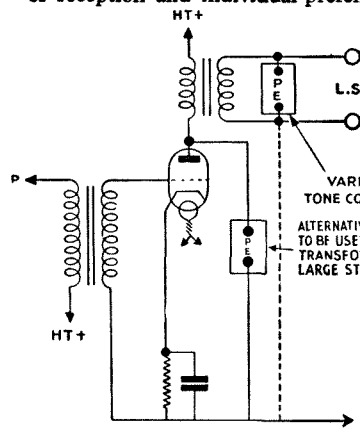
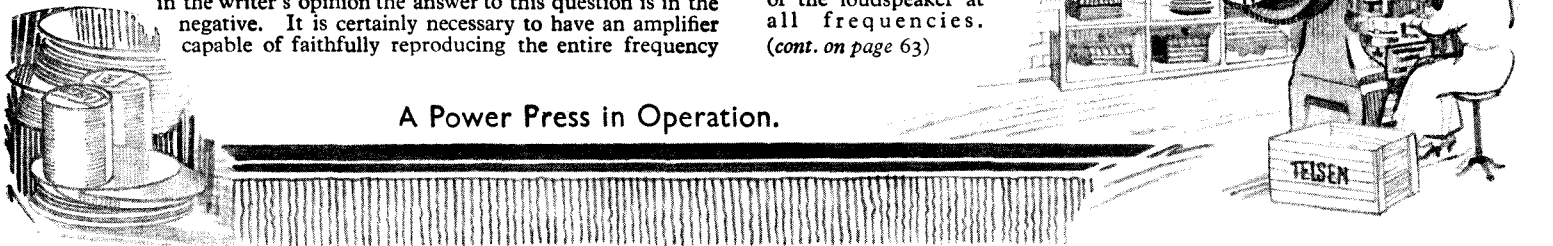

FIG. 3

A Power Press in Operation.



FURTHER NOTES ON BUILDING THE TELSEN ALL-MAINS S.G.3. RECEIVER—continued from page 19.

now be approximately three yards of maroon twin flex left over. This is used for connecting the receiver to the Mains Supply. Therefore pass one end of the flex through hole L in the back plate, and take it up through the hole J. Untwist it, and solder one lead to terminal 137 and the other to terminal 139 of the

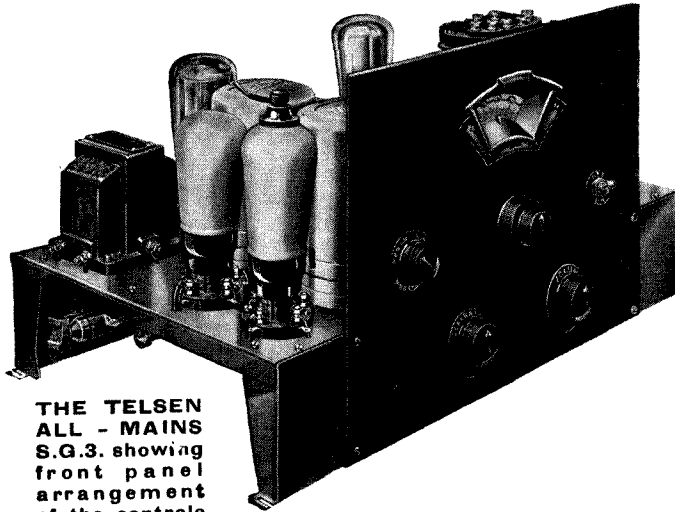

THE TELSEN ALL - MAINS S.G.3. showing front panel arrangement of the controls

fuse holders. Fit the universal mains plug to the free end of the flex, the plug being contained in the Outfit. A small clip is also to be found in the Outfit which should be placed over the flex and fastened into position through holes 21—22. The insulation material found in the Constructor's Outfit should be wrapped round the cord where it passes under the clip.

The Anode Cartridge Resistances are now clipped into the Resistance Holders. Each resistance has its value clearly shown on its side, and great care should be taken that the correct resistance is placed in the positions shown in the Blue Print. Now replace the bakelite cover on the Mains Transformer, taking the leads out through the cover holes in orderly fashion. The wiring is now completed so the leads should be tidied up and neatly disposed in the set. The constructor should now carefully check over the wiring and connections with the help of the Blue Print and the photograph, special care being taken to see that the mains lead is on the correct voltage tap of the power transformer.

SETTING UP AND ADJUSTING THE TELSEN "ALL MAINS S.G.3"

Having ascertained that everything is in order, and that no mistakes have been made in the wiring, the valves may be inserted in the valve-holders. First insert a Mazda valve type AC/S2 into the valve-holder V₁.

The wire which projects from the top of Coil B screen is connected to the terminal on top of the AC/S2 valve. Insert a Mazda AC2/HL valve into the sockets of valve-holder V₂, and a Mazda Pen. 425 into V₃. The loose wire of terminal 123 on V₃ should be connected to the terminal on the side of the valve base.

The Rectifier valve Mazda UU_{30/250} should now be placed in V₄. The two Telsen

1 ampere fuses W.200 are now placed in the two fuse-holder clips. Connect up the aerial, earth and loudspeaker to their terminals, see that the "on-off" switch is in the "off" position, connect the mains plug to a convenient supply point, and the receiver is ready to be switched on.

The separator knob should now be turned as far to the right as it will go without forcing, that is, with the arrow pointing towards the right-hand side of the set. The volume control should be turned fully to the left. The wavechange switch is also turned to the left. This sets the switches of the coils in the positions for receiving the medium-wave stations. Set the tuner to the wavelength of the nearest Regional Transmitter, and switch on. The valves take a few seconds to warm up, so the constructor should not be surprised if nothing is heard immediately. Provided that you live anywhere within a "reasonable service area" of a station included in the Regional scheme, signals should be heard. If this is not the case, rotate the knob of the tuning condenser one way or other, until a station is tuned in. It will inevitably be found that at one or two places on the dial, more than one station will be received at the same time, and the avoidance of this condition is the purpose of the separator knob. This should be turned slowly to the left until the interfering station has disappeared. The volume control knob should then be turned to the right until the wanted station is at the desired strength. This control should be used with discretion, as excessive reaction will cause distortion. Should a slight hum be noticeable after the valves have warmed up, it can be eradicated by turning the small screw of the "Hum Adjuster" located in the back of the chassis, first one way then the other until a point is reached where the hum is reduced to a minimum. The wavechange switch knob should now be rotated to the right so that it is set to the long wavelength range, and the set tested for reception on the National stations.

It will be noticed that the main tuning control has a small knob concentrically mounted on it; this is used for fine tuning of a station once it has been found by the main tuning control. It should be turned slightly one way or the other until the station comes through clear and sharp.

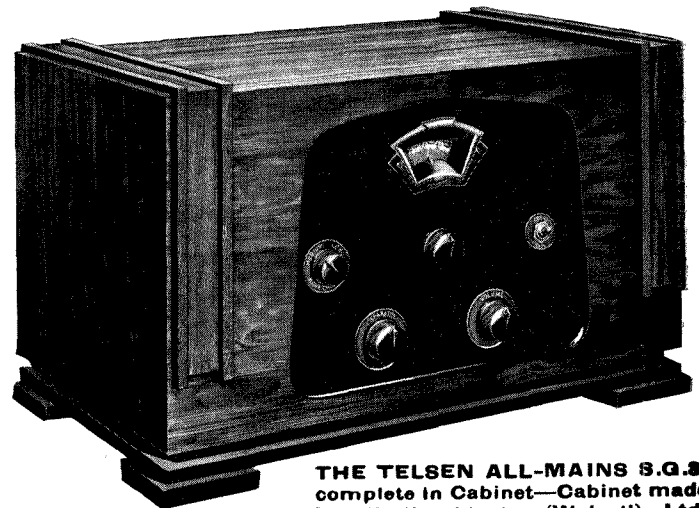

THE TELSEN ALL-MAINS S.G.3. complete in Cabinet—Cabinet made by Radiocabinets (Walsall) Ltd.

The receiver is now ready to be ganged so that its tuned circuits work in combination at maximum efficiency. A complete account for carrying out the necessary adjustments will be found on pages 21 to 24 of this issue of the *Radiomag*, in the article "An Easy Path to Ganging Condensers" Dial Lamp.—If it is desired to illuminate the ganged condenser scale, a lamp bulb should be

A Corner of our Kitchens

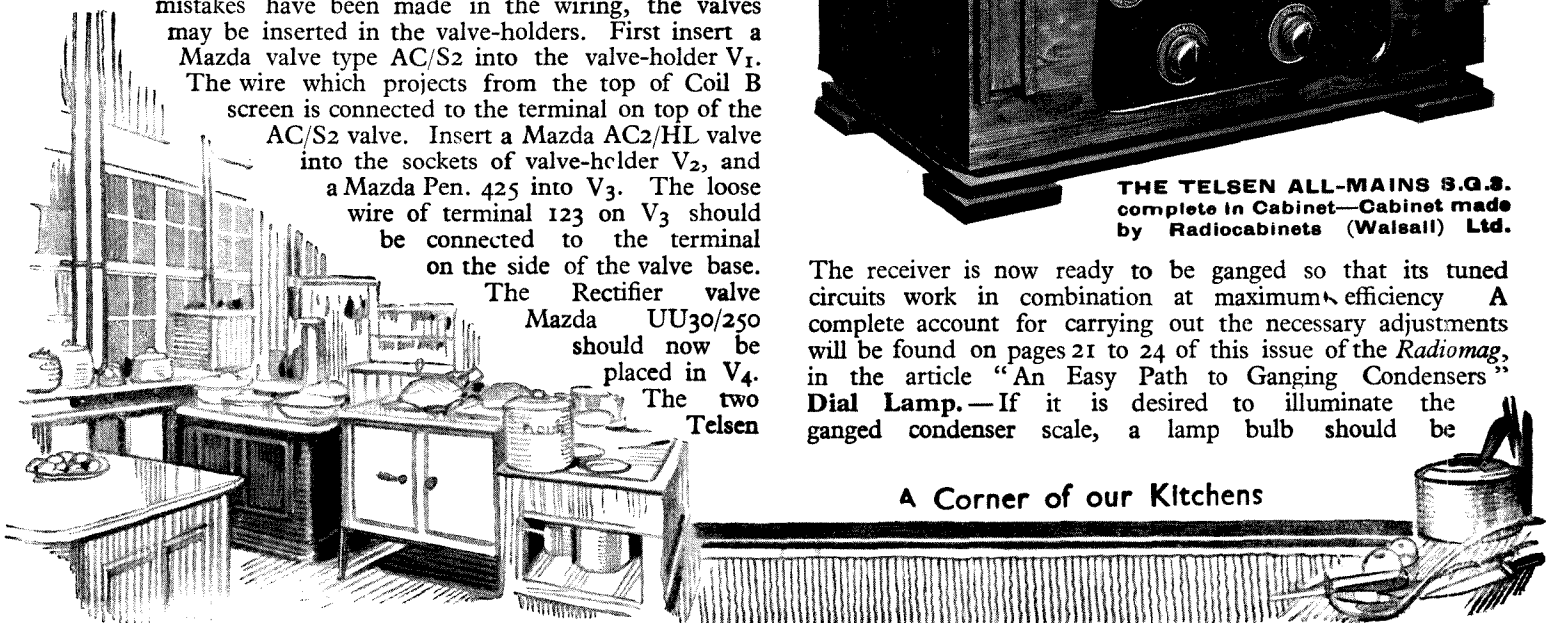

TELSEN ALL-MAINS S.G. 3—continued

fitted into the lamp holder that has already been wired up and is mounted on the cover of the ganged condenser. A suitable bulb is necessary, the 6.2 volt .3 ampere type being recommended.

Tone Correction.—Sometimes it is wished to vary the tone of a receiver so that individual tastes may be satisfied. The constructor is therefore advised to use either the Telsen Variable Tone Corrector W.314 or the Telsen Pentode Tone Corrector W.308. The first of these units gives, as the name indicates, a variable control of the tone and will meet every requirement in this direction, whilst the second component gives a fixed cut off of the top notes. Both these units are now available and if used, are connected across the loudspeaker terminals of the set.

Matching the Loudspeaker.—It is advisable to experiment with the three terminal connections on the Tapped Pentode Output Choke. Instructions for doing this are contained in the carton of this component and it is strongly advised that these tests be tried. In some cases it will be found that if the lead from the 1 mfd. condenser connected to the loudspeaker output is joined to terminal 3 of the Tapped Pentode Output Choke, an improvement in volume and tone will also result.

Cabinet.—Several suitable cabinets are available for housing the Telsen "All Mains S.G.3," and an example will be found illustrated in this issue of the *Radiomag*.

Gramophone Pick-up.—As mentioned previously in this article, the Telsen Needle Armature Pick-up W.317 has just been released to Telsen Constructors. The acquisition of this component will give a feeling of great satisfaction to the constructor, as when used with the Telsen "All Mains 3" the finest reproduction imaginable of gramophone records is at his disposal. General remarks for fitting are given in the article "Hints and Tips" on pages 51 to 53 of this *Radiomag* under the sub-heading "Connecting a Gramophone Pick-up." For controlling the volume of reproduction, a Telsen Volume Control W.298 is needed. This has a resistance of 10,000 ohms and has the effect of reducing needle scratch without impairing the H.F. response to any appreciable degree.

Valves.—The valves recommended for this receiver are of the Mazda type. The circuit has been designed round these valves and in order to obtain the most efficient results they should be used.

H.F. stage	Mazda	AC/S2.
Detector stage	"	AC2/HL.
Pentode stage	"	Pen. 425.
Rectifier stage	"	UU30/250.

TELSEN "ALL MAINS S.G. THREE" List of Components

Quantity	Description	Cat. No.	Price
8	Anode Cartridge Resistance Holders ..	W.286	6/-
1	60,000 ohm Cartridge Resistance ..	W.280	1/9
1	50,000 ohm Cartridge Resistance ..	W.279	1/9
1	10,000 ohm Cartridge Resistance ..	W.274	1/9
1	5,000 ohm Cartridge Resistance ..	W.273	1/9
1	1,000 ohm Cartridge Resistance ..	W.268	1/9
1	500 ohm Cartridge Resistance ..	W.265	1/9
2	350 ohm Cartridge Resistances ..	W.289	3/6
1	Standard H.F. Choke ..	W. 75	2/-
3	5-pin Solid Type Valve-Holders ..	W.225	3/-
1	4-pin Solid Type Valve-Holder ..	W.224	9d.
1 set	Twin Matched Screened Coils ..	W.287	17/-
1	Twin Gang Condenser ..	W.306	16/6
1	.0003 Aerial Series Condenser with Switch	W.205	2/3
1	.00015 Bakelite Reaction Condensers ..	W.189	2/-
1	Mains Switch	W.297	1/9
1	Hum Adjuster	W.299	2/9
1	2 megohm Grid Leak	W.251	1/-
1	10-1 Coupling Unit	W.215	12/6
1	Tapped Pentode Output Choke ..	W. 72	7/6
2	Power Fuse-Holders	W.203	1/-
1	28 henry Smoothing Choke	W.302	12/6
1	.0003 mfd. Mica Condenser	W.242	1/-
1	.0001 mfd. Mica Condenser	W.240	1/-
7	2 mfd. Self-Sealing Condensers, 500 v. test	W.226	21/-
4	1 mfd. Self-Sealing Condensers, 500 v. test	W.227	9/-
1	.1 mfd. Self-Sealing Condenser, 500 v. test	W.231	1/9
1	Mains Transformer	W.300 or W.291	32/6
2	1 amp. Fuses	W.200	1/-
1	Telsen "All Mains S.G.3" Constructor's Outfit	W.303	7/6

As an alternative Mains Transformer, W.301 may be substituted for W.300 or W.291 at an extra cost of 12/6.

Kit Sets

The Telsen "All-Mains S.G.3" as detailed above, is supplied as a complete Kit at the following inclusive prices:

Suitable for 200-250 volt, 50 cycles supply ..	W.320	£6/18/6
" 100-110 " 50 " ..	W.321	£6/18/6
" 200-250 " 25 " ..	W.322	£7/11/0

CHOICE AND CARE OF H.T. BATTERIES—contd. from page 13

A 16½ volt grid bias battery is required for the "Super Six" and an Ediswan battery No. 69805 is recommended. The "Super Selective Four" requires a 9 volt grid battery only, and here an Ediswan grid bias battery No. 69804 is strongly advised. A convenient source of low tension current for either of these receivers will be found in the Ediswan type "ELM4" accumulator No. 69208.

Having chosen the most suitable H.T. battery for a particular receiver, the user will obtain the fullest benefit from it by observing one or two simple precautions. The receiver and its associated batteries should not be placed in a damp or a warm place, as this will tend to reduce the "shelf life" of the H.T. battery.

An important factor in controlling the H.T. current consumption of a receiver is the adjustment of the grid bias voltages that are applied to the amplifying valves. In practice, the best plan is to apply as much grid bias as is compatible with good quality. The higher the value of H.T. voltage applied to a valve, the larger is the optimum value of the grid bias to give the best results with economical working.

Another way in which the user may effect an economy is by careful adjustment of the screening grid voltages applied to the screened grid valves. The screening grid voltage should be reduced to the lowest possible value, consistent with adequate results, and the same applies to the voltage applied to the priming grid of a pentode valve. H.T. current consumption is largely controlled by these voltages and values higher than those required to give good results, should not be used.

From the foregoing remarks, it will be apparent that the H.T. current consumption of a receiver is, to a large extent, under the control of the user. With this in mind, all Telsen battery operated receivers are designed so that every important operating voltage is independently adjustable, separate battery leads being provided for this purpose.

It may with advantage be mentioned that the Grid Bias battery should be renewed every time that a new high tension battery is purchased.

Although no current is taken from it, it may, as we have seen in the case of the H.T. battery, deteriorate through internal action. It will then give a reduced voltage output, and the valves will then be underbiased, with the evil results that we have noted.

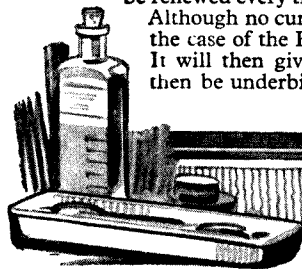

TONE CONTROL—contd. from p. 61

Hence the matching of the valve and speaker can be maintained at the optimum value. Finally the Tone Corrector acts as a safety device and obviates the possibility of damage to the pentode; both by preventing abnormal voltage rises, and by damping out any tendency to oscillation. Turning now to the practical applications of the Telsen Variable Tone Corrector, the theoretical diagrams show the correct positions for the insertion of this component in actual circuits.

Fig. 1 refers to the simplest case, and shows the power valve of a battery receiver in which the loudspeaker is directly connected in the plate circuit. In Fig. 2 is shown a pentode valve coupled by a tapped choke and 2 mfd. condenser to the loudspeaker, while Fig. 3 represents an indirectly heated power valve supplying the loudspeaker through an output transformer. It will be noticed that in each case the Telsen Variable Tone Corrector is connected across the loudspeaker, and this is the correct position for all normal circuits. The operation of the devices simply consists of adjusting the knob until the best tonal balance is obtained from the speaker, and then setting the volume control to give the required loudness.

A Corner of the Surgery in our First Aid Department.

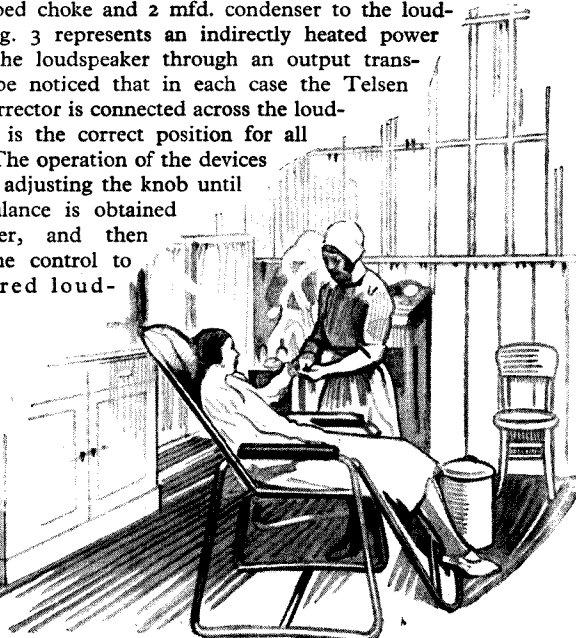

TELSEN RADIO COMPONENTS

A Complete List giving Catalogue Nos., Descriptions and Prices

* The items marked with an asterisk and printed in heavy type have been introduced since the last issue of *The Telsen Radiomag*.

Cat. No.	Description	Price	Cat. No.	Description	Price	Cat. No.	Description	Price	Cat. No.	Description	Price
CHOKES			DIFFERENTIAL CONDENSERS			DIALS			RESISTANCES (FIXED)—cont.		
W. 74	Binocular H.F. Choke ..	5/-	W.187	.0001 mfd. ..	2/6	W.141	Slow Motion, Black	2/-	W.109	Spaghetti type :-	
W. 75	Standard H.F. Choke ..	2/-	W.186	.00015 mfd. ..	2/6	W.141A	Walnut	2/-	W.110	300 ohms ..	-/6
*W.221	Short Wave H.F. Choke ..	3/6	W.185	.0003 mfd. ..	2/6	W.184	Illuminated Disc Drive ..	3/6	W.111	600 " ..	-/6
W. 68	40 hy. L.F. Choke	5/-	*W.319	.00035 mfd. ..	2/6	W.257	Small Disc Drive..	2/6	W.112	750 " ..	-/6
W. 69	100 " " "	5/-	PRE-SET CONDENSERS			W.206	Telornor ..	4/6	W.113	1,000 " ..	-/9
W. 71	Output Choke ..	7/-	W.152	.0001 mfd. ..	1/6	*W.313	"313" Disc Drive	4/6	W.114	1,500 " ..	-/9
W. 72	Tapped Pentode Output Choke ..	7/6	W.151	.0003 mfd. ..	1/6	DRUM DRIVES			W.115	2,000 " ..	-/9
W.172	Power Pentode Output Choke ..	10/6	W.150	.001 mfd. ..	1/6	W.255	Illuminated Drum Drive ..	8/6	W.116	3,000 " ..	-/9
*W.302	Smoothing Choke 28 hy. ..	12/6	W.149	.002 mfd. ..	1/6	W.262	Drum Drive and Condenser Assembly ..	17/6	W.117	4,000 " ..	-/9
COILS			FIXED CONDENSERS			FUSES			W.118	5,000 " ..	-/9
W. 76	Dual Range Aerial Coil ..	7/6	Mica :-			Battery type :-			W.119	10,000 " ..	1/-
W.154	H.F. Transformer Coil ..	5/6	W.240	.0001 mfd. ..	1/-	*W.318	100 m/a. Fuse Bulb ..	-/6	W.120	15,000 " ..	1/-
W.174	Dual Range S.W. Coil ..	4/6	W.241	.0002 mfd. ..	1/-	Mains type :-			W.121	20,000 " ..	1/-
W.216	Screened Coil ..	8/6	W.242	.0003 mfd. ..	1/-	W.199	.5 amp. ..	-/6	W.122	25,000 " ..	1/-
W.287	Twin Matched Screened Coils ..	17/-	W.243	.0004 mfd. ..	1/-	W.200	1 " " ..	-/6	W.123	30,000 " ..	1/6
W.288	Triple Matched Screened Coils ..	25/6	W.244	.0005 mfd. ..	1/-	W.201	2 " " ..	-/6	W.124	50,000 " ..	1/6
*W.290	Band Pass Coil Unit ..	17/-	W.245	.001 mfd. ..	1/-	W.202	3 " " ..	-/6	W.125	60,000 " ..	1/6
*W.292	Band Pass and Oscillator Coil Unit ..	25/6	W.246	.002 mfd. ..	1/-	FUSEHOLDERS			W.126	80,000 " ..	1/6
*W.293	Oscillator Coil ..	8/6	W.247	.006 mfd. ..	1/3	W.146	Battery Type ..	-/6	Variable Resistances :-		
*W.294	Intermediate Frequency Transformer Coil ..	12/6	*W.310	.01 mfd. ..	3/-	W.203	Power Type ..	-/6	W.299	Hum Adjuster	2/9
*W.309	Set of S.T.400 Coils ..	11/6	*W.311	.02 mfd. ..	3/6	GRID LEAKS			SCREENS		
*S.330	Superhet Coils, Type No. S.330	25/6	*W.316	.05 mfd. ..	5/6	W.248	1/4 meg. ..	1/-	W.166	Metal, plain ..	2/-
W.217	Coil Switch Coupling Assembly ..	-/6	W.207	.0001 mfd. Tag ..	-/6	W.249	1/2 " " ..	1/-	W.167	" with hole ..	2/6
W.218	Coil Switch Knob Assembly ..	1/-	W.208	.0002 mfd. ..	-/6	W.250	1 " " ..	1/-	SWITCHES		
TUNING CONDENSERS			SELF-SEALING CONDENSERS			W.251	2 " " ..	1/-	W.107	2-pt., Push-Pull ..	1/-
Air dielectric :-			W.232	.01 mfd., 500 v. ..	1/6	W.252	3 " " ..	1/-	W.108	3 " " " ..	1/3
W.130	.00025 mfd. ..	4/6	W.230	.04 mfd. " ..	1/9	W.253	4 " " ..	1/-	W.153	4 " " " ..	1/6
W.131	.00035 mfd. ..	4/6	W.231	.1 mfd. " ..	1/9	W.254	5 " " ..	1/-	*W.297	Mains Type ..	1/9
W.132	.0005 mfd., R.H.	4/6	W.229	.25 mfd. " ..	2/-	LOUDSPEAKERS			TERMINALS, etc.		
W.256	.0005 mfd., L.H.	4/6	W.228	.5 mfd. " ..	2/3	W. 53	Cabinet Speaker ..	25/-	W.204	Terminal Block ..	-/6
W.261	.0005 mfd., R.H. with Compensator	5/-	W.227	1.0 mfd. " ..	2/3	W. 54	Loudspeaker Unit	5/6	TOPE CORRECTORS		
W.260	.0005 mfd., L.H. with Compensator	5/-	W.226	2.0 mfd. " ..	3/-	W.159	Popular Chassis ..	5/6	*W.308	Pentode Tone Corrector ..	3/6
*W.306	Twin Ganged ..	16/6	W.239	.01 mfd., 1000 v. ..	2/6	W.170	Major Chassis ..	10/6	*W.314	Variable Tone Corrector ..	5/6
*W.307	Triple Ganged	22/6	W.237	.04 mfd. " ..	2/9	W.181	Complete Chassis Speaker ..	10/6	TRANSFORMERS		
TUNING CONDENSERS			W.238	.1 mfd. " ..	2/9	Interval :-			W. 61	1.75-1	
Bakelite dielectric :-			W.236	.25 mfd. " ..	3/-	W.182	Complete Chassis Speaker, 11" dia.	17/6	"Radiogrand" 10/6		
W.194	.0003 mfd. ..	2/6	W.235	.5 mfd. " ..	3/3	W.183	Complete Chassis Speaker, 14 1/2" dia.	22/6	W. 59	3-1 " " ..	7/6
W.193	.0005 mfd. ..	2/6	W.234	1.0 mfd. " ..	3/6	PICK-UPS			W. 58	5-1 " " ..	7/6
W.205	Aerial Series, .0003, with Switch ..	2/3	W.233	2.0 mfd. " ..	5/-	*W.317	Needle Armature Type ..	32/6	W. 60	7-1 " " ..	10/6
W.196	Aerial Coupling, .00004 ..	2/-	BLOCK CONDENSERS			CONSTRUCTOR KITS			W. 66	3-1 "Ace" ..	5/6
W.180	Telexor ..	10/6	W.175	4 mfd., 500 v. ..	5/6	*W.320	All Mains S.G.3, 200/250 v. 50 c. ...	138/6	W. 65	5-1 " " ..	5/6
REACTION CONDENSERS			W.176	6 " " ..	8/-	*W.322	All Mains S.G.3, 200/250 v. 25 c. ...	151/-	*W.327	5-1 " " "Audioformer"	11/6
W.189	.00015 mfd. ..	2/-	W.177	8 " " ..	10/6	*W.321	All Mains S.G.3, 100/110 v. 50 c. ...	138/6	Output :-		
W.188	.0003 mfd. ..	2/-	W.178	4 " " 1000 v. ..	9/6	*W.323	Super Selective Four ..	98/6	W. 62	1-1 "Radiogrand"	10/6
W.192	.0005 mfd. ..	2/6	W.179	6 " " " ..	14/6	*W.324	Super Six ..	118/6	W. 63	Multi-ratio "Radiogrand"	10/6
W.191	.00075 mfd. ..	2/6	CONSTRUCTORS' OUTFITS			*W.325	Strala Three ..	39/6	Mains :-		
			W.219	Drum Drive ..	3/6				*W.300	200/250 v.40/100 c.	32/6
			W.220	Telornor ..	3/6				*W.301	200/250 v.25/40 c.	45/-
			*W.303	All Mains S.G.3 ..	7/6				*W.291	100/110 v.40/100 c.	32/6
			*W.304	Super Selective Four ..	7/6				VALVE-HOLDERS		
			*W.305	Super Six ..	7/6				W.224	4-pin, Rigid type ..	-/9
			*W.326	Strala Three ..	3/6				W.225	5 " " " ..	1/-
			COUPLING UNITS						W.222	4 " " Anti-microphonic ..	1/-
			W.214	1-1 ..	7/6				W.223	5 " " Anti-microphonic ..	1/3
			W.215	10-1 ..	12/6				W.198	Universal ..	1/-
			W.285	R.C. ..	4/-				VOLUME CONTROLS		
						*W.263	300 ohms ..	1/9	*W.298	10,000 ohms ..	3/9
						*W.289	350 " ..	1/9	*W.295	50,000 " ..	3/9
						*W.264	400 " ..	1/9	*W.296	50,000 " with Mains Switch combined ..	5/6
						*W.265	500 " ..	1/9			
						*W.266	600 " ..	1/9			
						*W.267	750 " ..	1/9			
						*W.268	1,000 " ..	1/9			
						*W.269	1,500 " ..	1/9			
						*W.270	2,000 " ..	1/9			
						*W.271	3,000 " ..	1/9			
						*W.272	4,000 " ..	1/9			
						*W.273	5,000 " ..	1/9			
						*W.274	10,000 " ..	1/9			
						*W.275	15,000 " ..	1/9			
						*W.276	20,000 " ..	1/9			
						*W.277	25,000 " ..	1/9			
						*W.278	30,000 " ..	1/9			
						*W.279	50,000 " ..	1/9			
						*W.280	60,000 " ..	1/9			
						*W.281	80,000 " ..	1/9			
						*W.282	100,000 " ..	1/9			
						*W.283	150,000 " ..	1/9			
						*W.284	200,000 " ..	1/9			
						*W.286	Cartridge Resistance Holder ..	-/9			

FOR PERFECT "ALL ELECTRIC" RADIO

Telsen

MAINS TRANSFORMERS

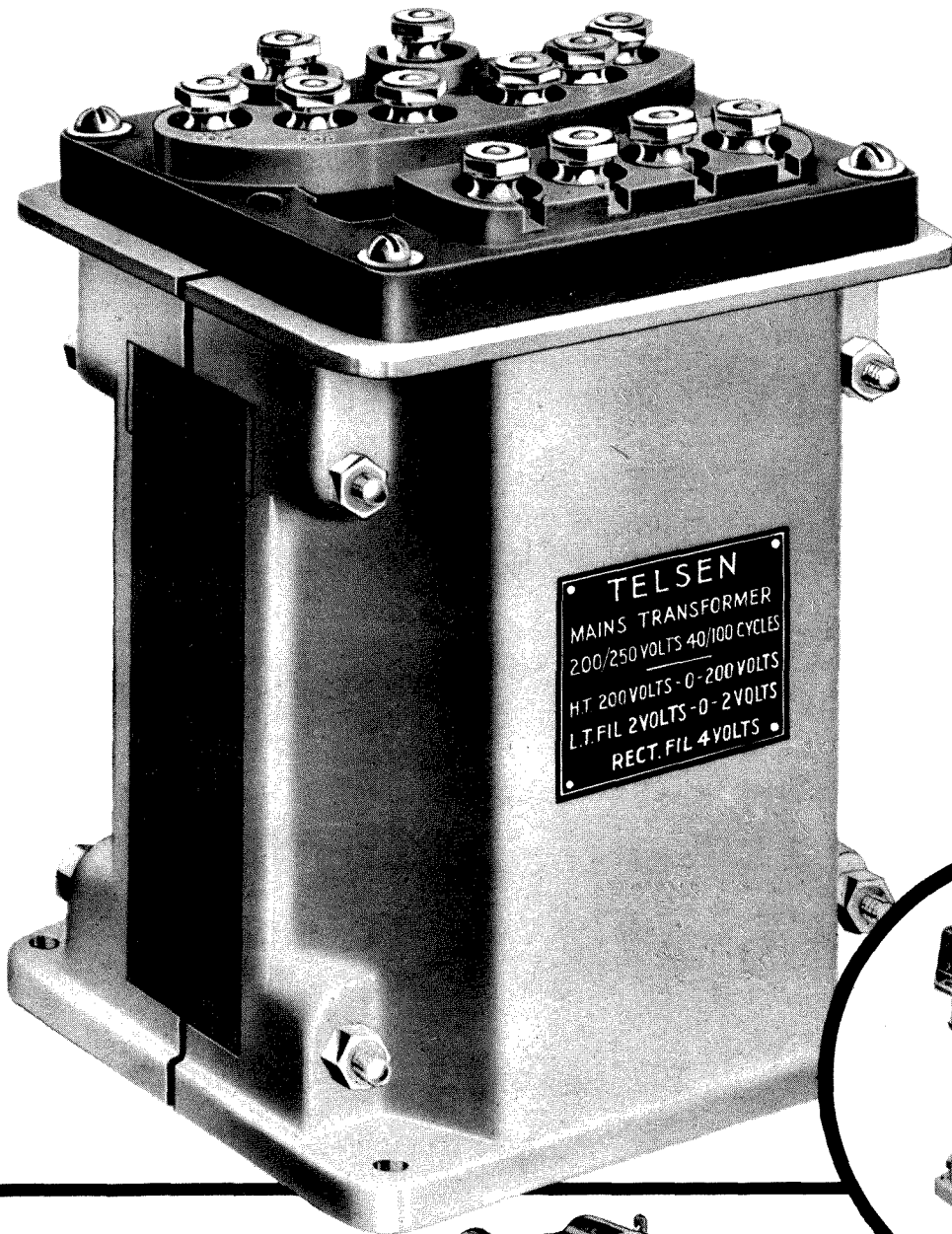

TELSEN
MAINS TRANSFORMER
200/250 VOLTS 40/100 CYCLES
HT 200 VOLTS - 0 - 200 VOLTS
L.T. FIL 2 VOLTS - 0 - 2 VOLTS
RECT. FIL 4 VOLTS

THESE power transformers have been designed and constructed on thoroughly up-to-date and scientific lines. The utmost care and attention has been given to every detail in their construction, both electrically and mechanically, while their voltage regulation ensures that a steady and constant voltage is maintained under actual operating conditions. They are made in three models, as under, and have the same power output rating, as follows :—

L.T. Filament—4 volts at 2½ amps. with centre tap.

Rectifier Filament—4 volts at 1 amp.

High Tension—For full wave rectification. When using a Mazda UU30/250 Rectifier valve and a Telsen W.302 L.F. Choke with smoothing blocks of 4 mfd. condensers, the smoothed output is 200 volts at 32 mA. D.C. load.

All-three models have an attractive stove aluminium finish, and the terminal panel on top is protected by a moulded bakelite cover. Suitable for sets employing two A.C. valves, or for 3 valve sets in which two are of the A.C. type, the third battery type taking .25 to .5 amps.

Model W.300 for 200/250 volts A.C. 40/100 cycles. PRICE **32/6**

Model W.301 for 200/250 volts A.C. 25/40 cycles. PRICE **45/-**

Model W.291 for 100/110 volts A.C. 40/100 cycles. PRICE **32/6**

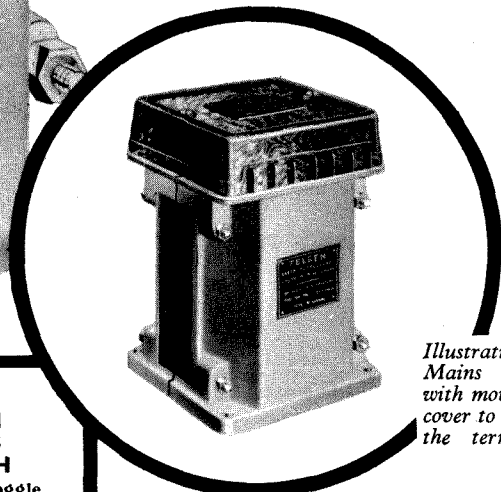
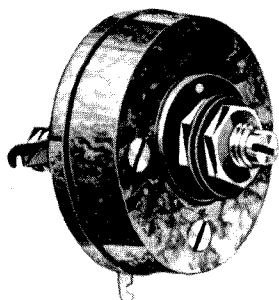

Illustration of Telsen Mains Transformer, with moulded bakelite cover to protect top of the terminal panel.



TELSEN HUM ADJUSTER

Comprises a variable centre tapped Resistance designed for Hum control in A.C. Mains operated receivers and Eliminators. Is silent in operation.

No. W. 299.

2/9

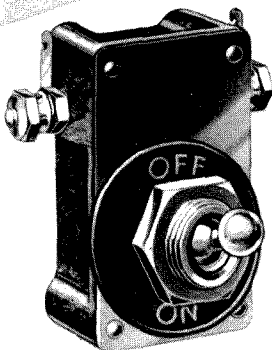

TELSEN MAINS SWITCH

A miniature toggle switch of very robust construction. Their rapid make and break action makes them particularly suitable as master switches in Mains and Battery operated receivers.

No. W. 297

1/9

TELSEN
RADIO COMPONENTS

PRICE

1¹/₄

THE TELSEN SUPER-SELECTIVE FOUR

ISSUED FREE WITH THE
TELSEN
 Radiomancy

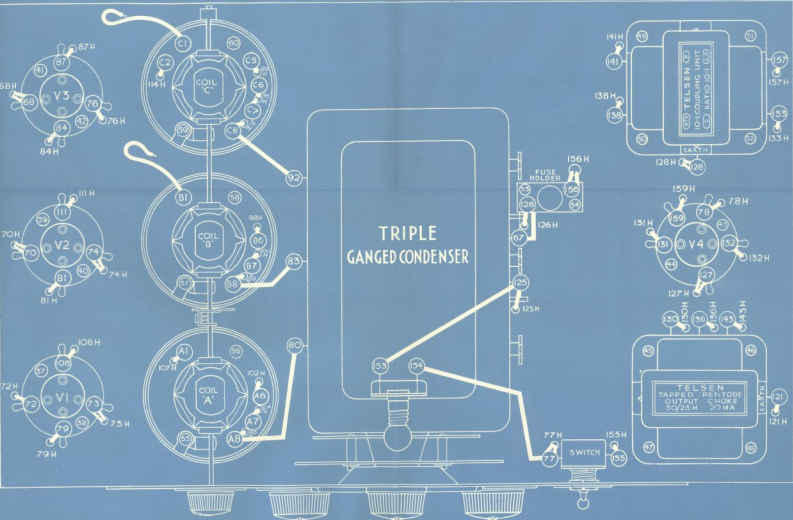
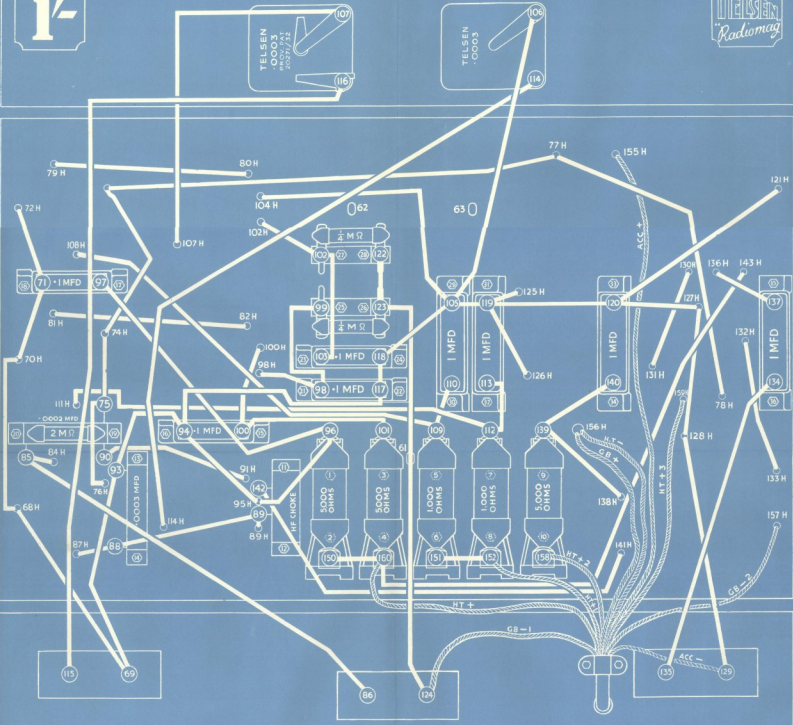

Everyone should hear the *NEW*

TELSEN "AIR-MARSHAL 3"

It leads the world in performance and value!

98 $\frac{1}{6}$

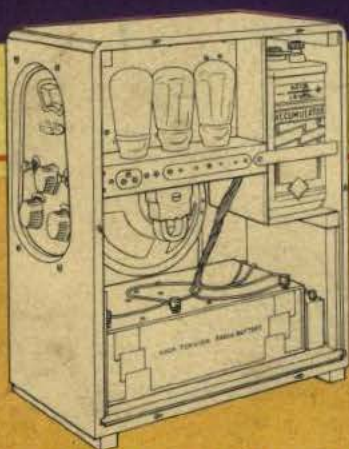

Illustration of Set with back removed, showing Standard Batteries and Accumulator in position.

SIX OUTSTANDING FEATURES

- 1 Entirely self-contained, with accommodation for all batteries.
- 2 Beautiful walnut or oak cabinet.
- 3 Powerful built-in loudspeaker.
- 4 Supplied with Mazda valves.
- 5 Brilliant circuit arrangement.
- 6 100% British Telsen Components.

Ask your dealer for a free demonstration in your own home to-night

TELSEN
RADIO RECEIVERS