

The **TELSEN** **RADIOMAG**

Vol. I.

No. I.



TELSEN SONGSTER 2+TELSEN CONQUEROR 3+TELSEN COMMODORE 3+TELSEN EMPIRE 4

BUILD BETTER

ON

TELSEN

RADIO COMPONENTS

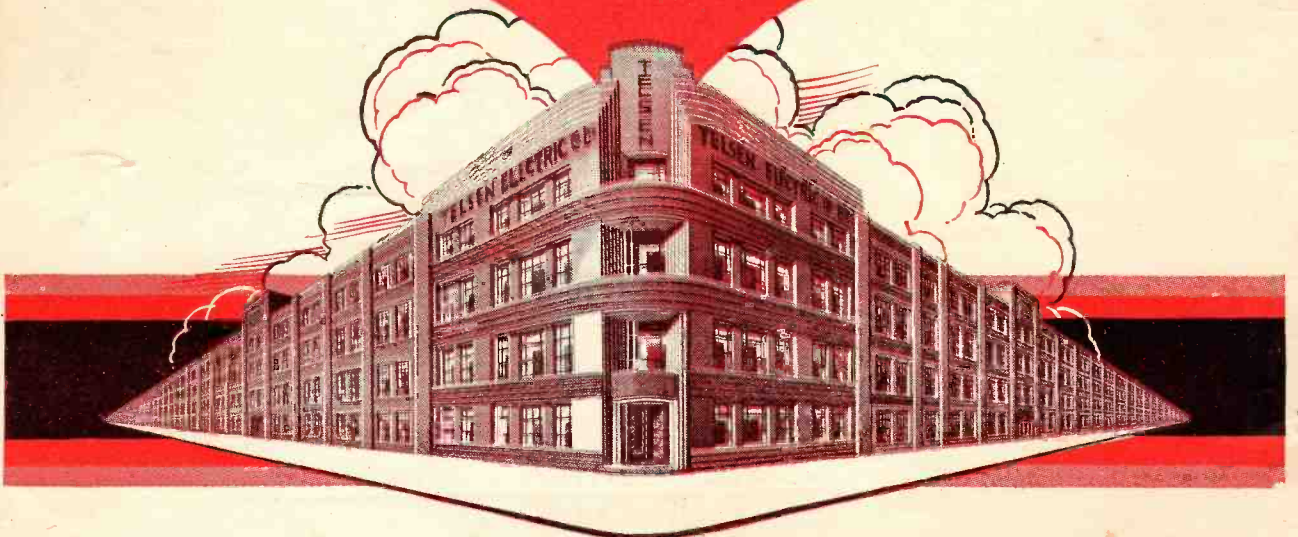

The TELSEN RADIOMAG

Incorporating the Telsen radio component catalogue and the Telsen circuits, together with building and operating instructions.

Vol. I (First Edition)

(Copyright).

BUILD BETTER!

“**BUILD BETTER**” has been the slogan of British craftsmen for centuries passed. Since the early days of the “guilds” skilled workmen have pooled their knowledge in efforts to improve and uphold their callings. “Build Better” has been the watchword of our industries with the result that British goods have won for themselves a high reputation in the minds of merchants and consumers throughout the world.

With the dawn of broadcasting, a new hobby came to life, a new form of entertainment destined to give untold pleasure. Throughout the remarkable developments of radio it has been the constant desire of every home constructor to “build better.” From the days of the humble crystal to the present multi-valve superhetrodyne receiver, the amateur has kept pace, and even anticipated the trend of design and construction. Throughout this hectic race the amateur has devoted every attention to new circuits employing fresh coupling arrangements, or perhaps the addition of another valve, and little time has been available for undivided attention to the performance and efficiency of the individual components.

As the years pass, sensational developments are becoming more rare, and although it can never be accepted that the zenith has been

reached, it must be admitted that startling changes in the near future are certainly not indicated.

The time has arrived for the home constructor to improve reception, not necessarily by a change in circuit, but by studied choice of each individual component. High powered broadcasting stations have erected their masts in many parts of Europe; their wavelengths are separated by only a few metres and the problem of reception becomes increasingly difficult.

The employment of components designed by prominent radio engineers and manufactured with meticulous care and precision definitely assists in overcoming these difficulties.

TELSEN components are produced under such conditions. The raw materials are subjected to the most severe tests and only those which survive are incorporated in the finished product. The actual manufacture is carried out under the strictest supervision and TELSEN components are tested under broadcast conditions before they leave the factory.

Thus the famous philosophy of Emerson can very well be applied:—

“THEY BUILD BETTER THAN THEY KNOW WHO BUILD ON TELSEN.”



Circuits designed for simple construction

THE Telsen recommended circuits described in this booklet are not issued as kits, but are intended for construction with standard Telsen components obtainable from any radio dealer. Readers who require a complete kit set are referred to the Telsen Victor 3, described on the back cover.

Nevertheless, the circuits offer not the slightest difficulty in construction, even to the veriest novice. No attempt has been made to lay down exact positions and sizes to a fraction of an inch, in order that constructors may use existing panels, baseboards, cabinets, etc. For the same reason full size blue prints have not been issued, so that some latitude may be given to the individual constructor. The most convenient standard sizes, however, have been indicated, likewise the best layout for easy runs of wiring. It is not recommended that smaller baseboards are used, otherwise the layout will be found too cramped for easy wiring.

In addition to the list of components given for each receiver, a panel, baseboard and terminal strip will be needed, together with the necessary fixing screws, a few yards of insulated connecting wire and the requisite number of terminals. The baseboard should be of wood $\frac{3}{8}$ or $\frac{1}{2}$ in. thick, which will usually be found included if a cabinet is purchased. The panel may be of plywood or ebonite, but not of metal as the reaction condenser spindle must be insulated from earth. The terminal strip should be of ebonite, about 2 in. wide, and may conveniently run the whole length of the baseboard.

The panel will need drilling for the controls, the hole sizes for all Telsen variable condensers being $\frac{3}{8}$ in. full, and for Telsen switches $\frac{5}{16}$ in. full. Exact positions are not laid down, but the constructor should adhere to the symmetrical arrangement shown in each illustration. Three or four small holes along the bottom edge of the panel will suffice for fixing to the baseboard. The terminal strip must be drilled for the desired number of terminals, and also for fixing to the baseboard.

A neat job may be made of the wiring with any of the covered connecting wires on the market, or bare tinned copper wire may be used in conjunction with a suitable size of insulated sleeving. Point to point wiring details have not been given, in conformity with the general policy of these recommended circuits. The diagram is, however, very simple to follow, in fact much simpler than the usual "practical" diagram for the constructor who wishes to follow the principles of the circuit—a practice strongly to be recommended. Soldering is unnecessary, the white dots at the junction of wires indicating that the terminals concerned are to be joined by the shortest route.

No technical knowledge is required for the construction or operation of the Telsen circuits, but if any reader, owing to inexperience, has misgivings regarding the wiring, he is recommended to try the Telsen Victor 3 Kit, with which a point to point wiring diagram is included. Practically all the components can be used later for building a more ambitious circuit. The general procedure in construction is as follows:—Mount the terminals on the terminal strip in the correct order, and attach to baseboard. Lay out *all* the components in the position roughly indicated in the blue print, using the photograph as a guide to a balanced layout. Mark through the fixing holes of the components and proceed to screw them down. Suitable sizes of screws are No. 4 by $\frac{1}{2}$, $\frac{5}{8}$, $\frac{3}{4}$ and $\frac{1}{4}$ in. long. Now complete the wiring as far as possible, before mounting the panel components and attaching the panel. The wiring should then be completed and the connections tightened up all round. The batteries should be connected by lengths of rubber-covered flex fitted with wander plugs for the dry batteries and spade tags for the accumulator. Special notes on the construction and operation of each individual circuit are given in the following pages, and further general instructions with full notes on the subject of choice and use of accessories will be found on pages 10, 23 and 31.





The TELSEN "CONQUEROR" ³

A straight three valve receiver employing a detector and two L.F. stages, the Telsen "Conqueror" three is already achieving an enormous and well deserved popularity.

As an up-to-date version of what is certainly the favourite circuit arrangement of the home constructor, it presents several points of interest. In the first place, the selectivity adjustment of the Telsen Aerial Coil enables exactly the right degree of selectivity to be obtained for the locality and conditions in which it is used. Regional programmes can be definitely separated at any distance over 5 miles, and this without complicating the essential simplicity of the circuit. The amount of foreign reception available naturally will depend to some extent on the distance from the "local," but under all ordinary conditions the principal foreign stations come in strongly.

Another point of interest is the .0003 mfd. Condenser connected across the terminals 4 and 7 of the Aerial Coil. This serves to cut out any trace of short wave interference on the long wave band.

The quality of reproduction will be found surprisingly good up to the full volume of the super power valve recommended. This is largely due to the employment of a stage of choke coupling followed by a transformer. Differential reaction is employed, giving a wide range of control and the whole of the circuit is simple and straightforward.

It is not desirable to vary the specification (other than in small details), except that if preferred, a Telsen air-spaced tuning condenser may be substituted for the Telsen bakelite tuning condenser, and a Telsen slow motion dial may be fitted to either.

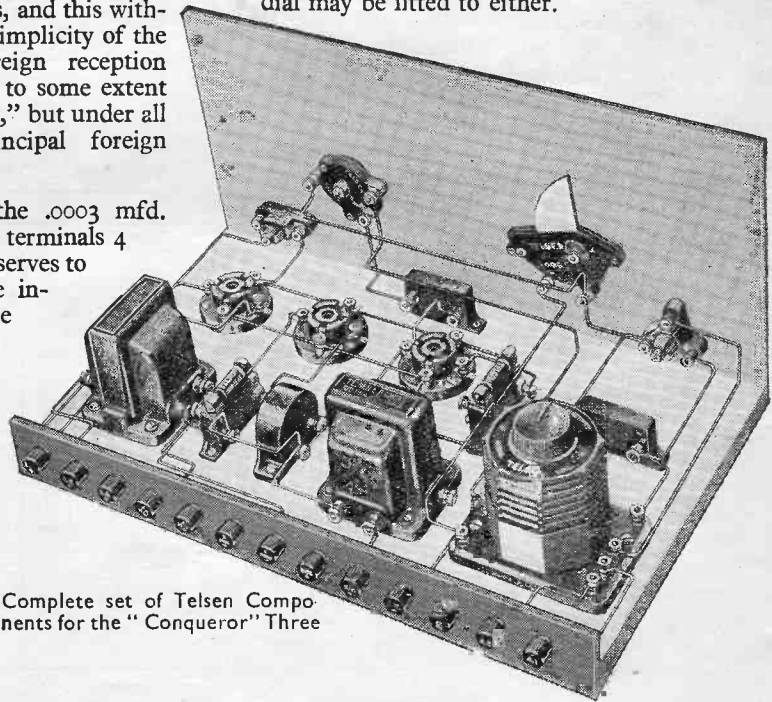

Complete set of Telsen Components for the "Conqueror" Three

3 1/3



The TELSEN "CONQUEROR" THREE (cont'd)

The "Ace" transformer may be substituted if desired by a Telsen 3-1 "Radiogrand," or better still by a Telsen 1.75-1, which will give a further slight but definite improvement in quality, appreciable to the critical listener.

If desired, terminals H.T.+2 and H.T.+3 may be run into one, enabling the set to be worked from an eliminator with only two positive sockets.

The general notes on construction on pages 2 and 10 and operation on page 23 should be followed, and owing to the simplicity of this set, there are no special precautions to be added.

There is no choice offered for the valves required to enable this receiver to give its proper performance. A smaller power valve would be more economical in H.T. consumption, but would be badly overloaded under all normal reception conditions, and the volume obtainable without distortion would be very much reduced. The same remarks apply, to a less degree perhaps, to the H.T. voltage available. 120v. is really desirable if the set is to give of its best. The proper bias for the P.220A with 120v. P.T. is 9 volts (on G.B.—2) but an increase to 10½v. will have the advantage of somewhat reduced H.T. consumption with little falling off in the volume which can be handled. As the H.T. battery runs down, however, bias must be reduced in order to maintain quality. At 110v. H.T., 9 volts bias is the most that can be allowed, and at 100v. it should be 7½v.

As regards the L.2., if this is connected to maximum H.T. volts, *i.e.*, if H.T.+2 and H.T.+3 have been run into one, G.B.—1 should be given a value of -3v. bias for all values of H.T. between 100v. and 120v. If, on the other hand, a separate H.T. Tapping below 100v. is used, 1½v. bias is the correct value.

VALVES RECOMMENDED.

- Detector V.1. MAZDA H.L.2.
- L.F. V.2. MAZDA L.2.
- Output V.3. MAZDA P.220.A.

**TELSER "CONQUEROR" THREE.
List of Components.**

Quantity	Description	Cat. No.	Price
3	Valve Holders	W.105	1 6
2	.0003 Mica Condensers, with Clips	W.93	1 0
1	.002 Mica Condenser	W.97	6
1	Grid Leak, 2 meg.	W.101	9
1	Grid Leak, 1 meg.	W.100	9
1	Aerial Coil with Selectivity adjustment	W.76	7 6
1	.0005 Bakelite Tuning Condenser	W.134	2 0
1	.0003 Differential Reaction Condenser	W.140	2 0
1	Three-point Switch	W.108	1 3
1	Two-point Switch	W.107	1 0
1	"Ace" Transformer, ratio 3-1	W.66	5 6
1	L.F. Choke, 100 henrys	W.69	5 0
1	Standard H.F. Choke	W.75	2 0
1	.001 Mica Condenser	W.96	6
			£1 11 3

Panel 14 x 7 in.
Baseboard 14 x 9 in.

The theoretical circuit of the Telsen "Conqueror" 3.

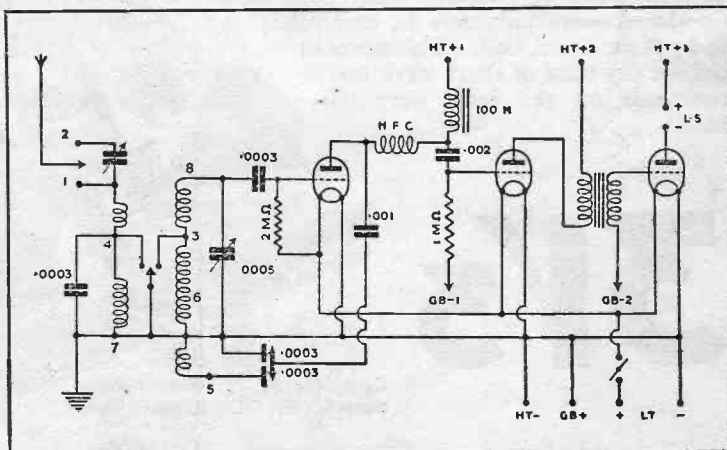

THE TELSEN 'CONQUEROR' 3

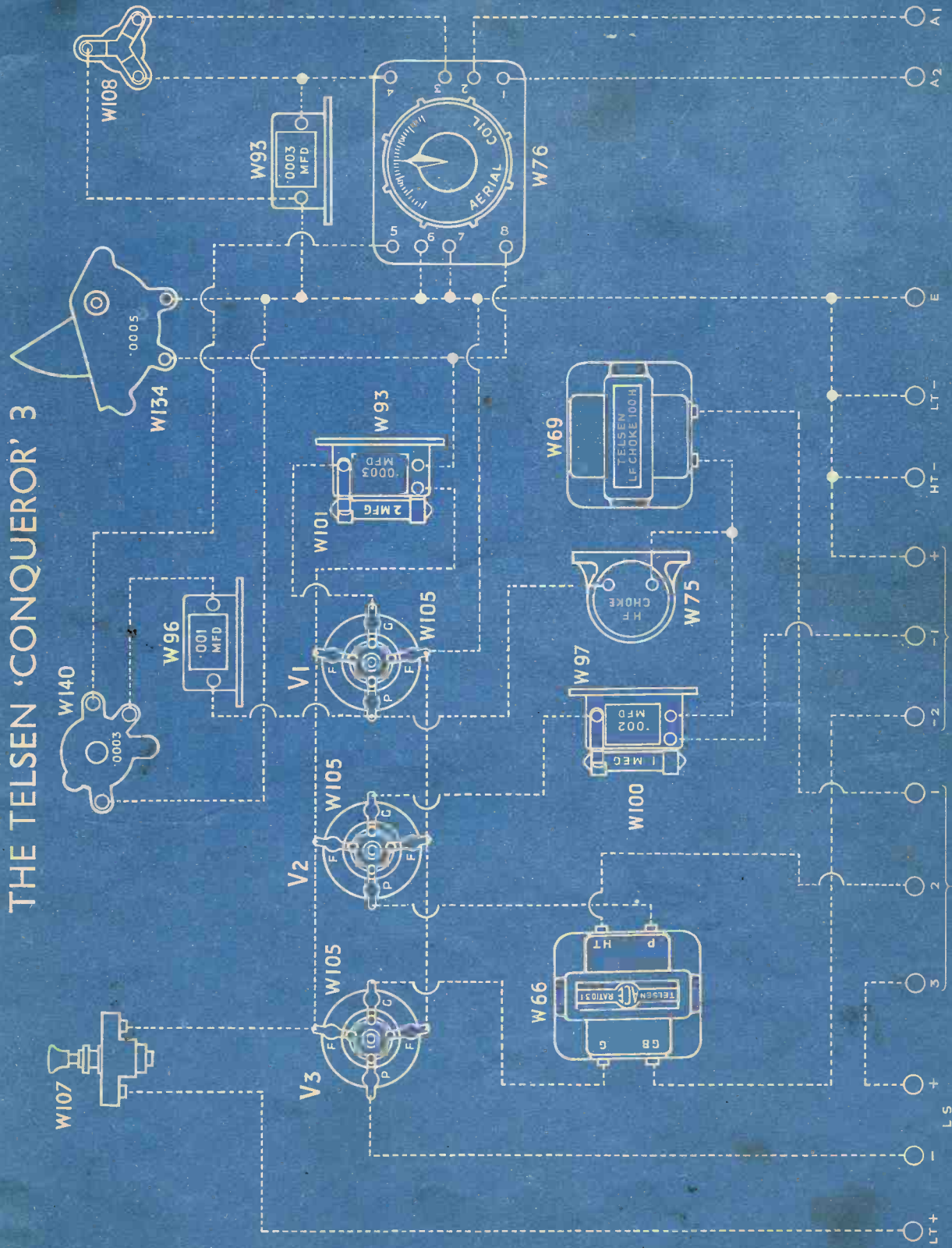

WIRING DIAGRAM

THE TELSEN 'COMMODORE' S.G.3

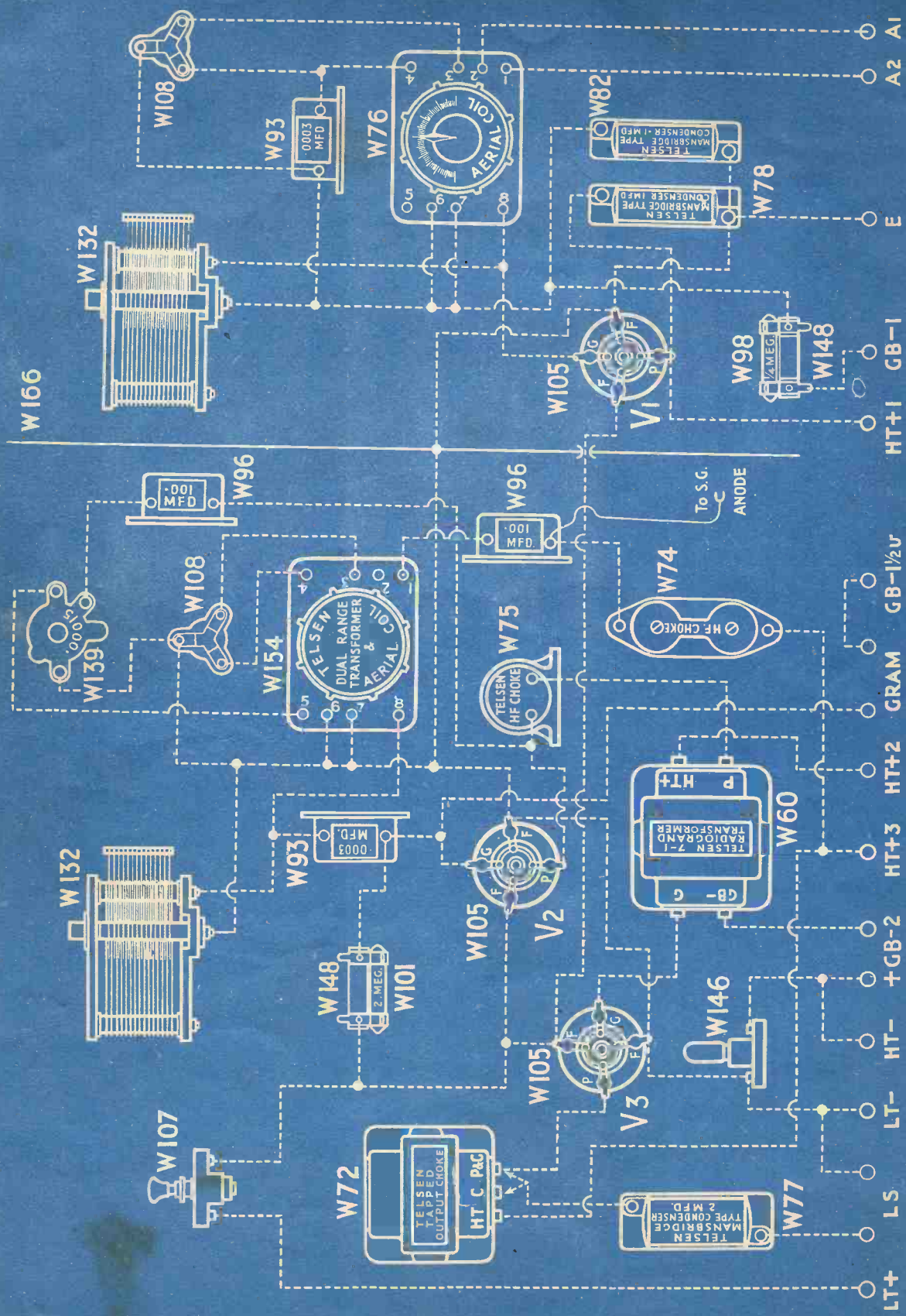

WIRING DIAGRAM

The TELSEN "COMMODORE" ³

THE Telsen "Commodore" Three is an admirable set for the constructor who requires a highly selective receiver for a reasonable outlay. The H.F. side of the circuit is identical in every way with the Telsen "Empire" Four, and the two tuned circuits, combined with the variable selectivity adjustment on the aerial coil, will give a high degree of selectivity under all conditions. A good range of Continental stations can be received with ample volume and clarity. The L.F. side incorporates a Telsen 7-1 Transformer and a Tapped Choke Output Filter, which enables either a Pentode or ordinary Super Power Valve to be used. Plenty of volume and splendid quality of reproduction is obtainable with either. It will be noted on the blue print that there are two alternative connections between the output choke and the 2 mfd. condenser. When using a Pentode, the centre connection "C" should be used, otherwise the connection marked "P. & C.I."

No special instructions regarding the building appear to be necessary. It will be found easier to wire the base-board with the panel and screen not in position, and to add these at a later stage when they become necessary in order to complete the wiring. Where connection is made to the screen

it is desirable to scrape the surface slightly to remove any trace of lacquer. It will be helpful to read the comments on the construction and operation of the Telsen "Empire" Screen Grid Four on page 25 as well as the general instructions in other parts of this booklet.

Two terminals are brought out for the gramophone pick-up connection. Strictly, only one is necessary as the other is connected directly to the $1\frac{1}{2}$ volt tapping on the grid bias battery, and this connection may be made by means of a wander plug direct instead of passing through the terminals shown. Further instructions on the connection of a gramophone pick-up are given on page 10.

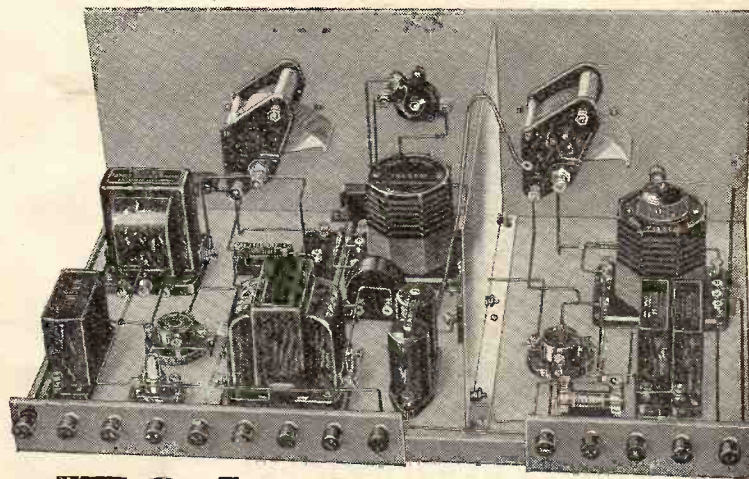

76'

Complete set of Telsen Components
for the "Commodore" Three



MAKE THE MOST OF YOUR FAVOURITE RECORDS

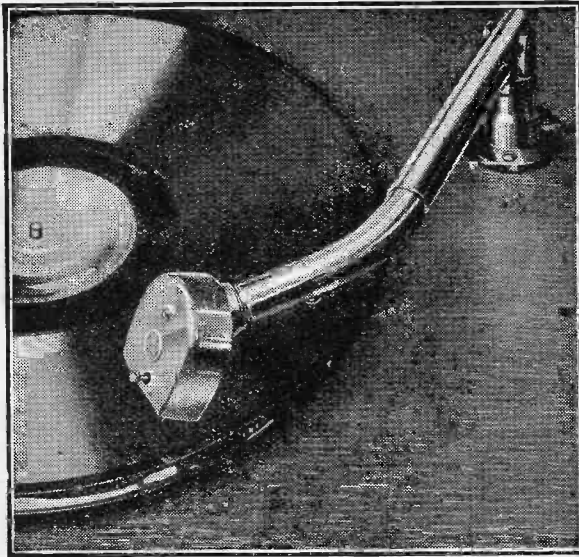

B.T.H. "Senior" Pick-up and Tone Arm, latest model with ball bearing spring balance tone arm. Nickel or gilt finish, Price 45/-.



B.T.H. "Minor" pick-up and Tone Arm, moulded as one unit in Fabrolite compound, walnut brown finish. Price 27/6.

You haven't heard your records at their best until you've played them with a B.T.H. Pick-up. All these subtle inflections which the acoustic sound box misses are faithfully reproduced. You will discover new beauty—a new brilliance of tone which rediscovers even your favourite records. Leading radiogram manufacturers pin their faith to B.T.H. Pick-ups—you too can achieve the finest possible reproduction

with a  **PICK-UP**
and Tone Arm

NOW FOR THE BEST POSSIBLE REPRODUCTION

B.T.H.



REPRODUCERS

Minor "D.C." Model.
Price £1 11 6

1931/2 Models.
Senior A.C. Model,
New Reduced Price
£7 15 0. Senior
D.C. Model, New
Reduced Price
£5 5 0.

Minor Permanent Magnet Model.
Price £2 10 0

1931/2 Senior Permanent Magnet,
New Reduced Price
£5 12 6.

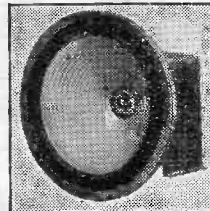
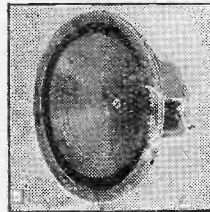
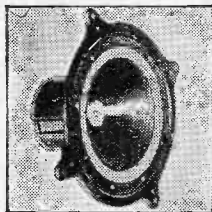

If you want the best possible reproduction you need an R.K.—the original moving coil speaker and still the standard of excellence against which other makes are judged.

There is an R.K. to suit every purpose and pocket—from the "Minor D.C." model at 31/6 to the "Senior A.C." model at £7 15s. od. Every R.K. is 100% British made.

EDISWAN RADIO



Advt. of:—

THE EDISON SWAN ELECTRIC CO., LTD.

The TELSEN "COMMODORE" THREE (cont'd)

Of the three output valves offered as alternatives, probably the best for all-round use is the Pen. 220 which, whilst giving excellent range and ample volume, has the advantage of keeping the H.T. consumption of the set below 10 mA. and thereby effecting considerable economy in battery expenditure. The Pen. 220A. is a power pentode which will handle a greater power than the P. 220, and is not easily overloaded.

The power valve P. 220A. is recommended to the set builder who, whilst requiring ample volume with high quality on the local transmissions and also on the main foreign stations, chooses a screen grid set for its selectivity rather than extreme range.

Both pentodes have an extra connection, which may take the form of a terminal on the side of the base, or a fifth pin. In the latter case a five pin valve holder should be substituted for V.3. The extra connection in either case must be connected by means of a flexible wire to an additional H.T. wander plug. This plug in the case of the Pen. 220 should be connected to 100-105 volts, and the correct value of grid bias is then -3 volts (on G.B.-2). When using the Pen. 220A. the value for the extra H.T. lead is 120, and bias $-7\frac{1}{2}$ volts.

120 volts H.T. is recommended for H.T.+3, and the screen voltage (H.T.+1) should be varied between 50 and 80 volts for best results.

The detector voltage (H.T.+2) is not critical, and may be between 60 and 80 volts. A bias of $-1\frac{1}{2}$ volts should be applied to the screen grid valve (G.B.-1).

VALVES RECOMMENDED.

- H.F. V.1 MAZDA S.G.215.
 Detector V.2 MAZDA L.2.
 Output V.3 MAZDA P.220A., Pen. 220 or Pen. 220A.

TELSER "COMMODORE" THREE LIST OF COMPONENTS

Quantity	Description	Cat. No.	Price
1	"Radiogram" 7-1 Transformer	W.60	12 6
1	Tapped Output Choke, 20 henrys	W.72	8 6
1	Binocular H.F. Choke	W.74	5 0
1	Standard H.F. Choke	W.75	2 0
1	Aerial Coil with Selectivity Adjustment	W.76	7 6
1	2 mfd. Mansbridge Type Condenser	W.77	3 0
1	1 mfd. Mansbridge Type Condenser	W.78	2 3
2	.0003 mfd. Mica Condensers	W.93	1 0
1	Grid Leak, 2 meg.	W.101	9
3	4-pin Valve Holders	W.105	1 6
1	Two-point Switch	W.107	1 0
2	Three-point Switches	W.108	2 6
2	.0005 mfd. Logarithmic Condensers	W.132	9 0
2	Slow-Motion Dials	W.141	5 0
1	Fuse Holder	W.146	6
2	Grid Leak Holders	W.148	1 0
1	H.F. Coil	W.154	5 6
1	Screen	W.166	2 0
1	.1 mfd. Mansbridge Type Condenser	W.82	1 9
2	.001 mfd. Mica Condensers	W.96	1 0
1	$\frac{1}{2}$ meg. Grid Leak	W.98	9
1	.00015 mfd. Differential Re-action Condenser	W.139	2 0
			£3 16 0

Panel size 18 x 7 in.
 Baseboard size 18 x 10 in.

The theoretical circuit of the Telsen "Commodore" 3.

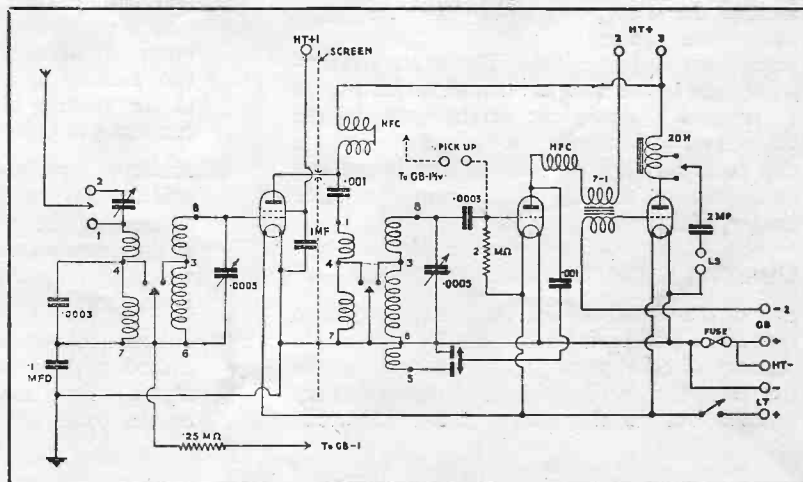

Hints and Tips on construction

THE following notes on construction should prove very useful to the amateur who is building one of the Telsen circuits.

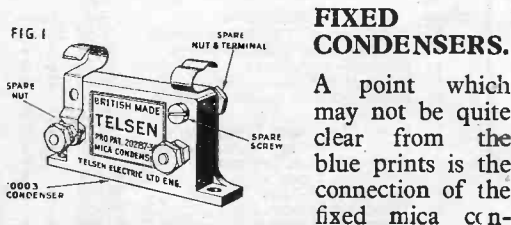

FIXED CONDENSERS. A point which may not be quite clear from the blue prints is the connection of the fixed mica condensers carrying grid leaks. The Telsen .003 Mica Condenser is sold with patent grid leak clips which may be mounted to give either series or parallel connection. In the Conqueror 3 and Songster 2, condensers are used with the series arrangement. It is important to note that one clip should be mounted facing the front of the condenser, using one of the spare nuts, and the other facing the back, using the spare screw, nut and terminal. The exact arrangement used in the Songster 2 is shown in Figure 1. Figure 2 shows the arrangement in the Conqueror 3. It does not actually matter which clip faces forward, so long as that is the one connected to the G terminal on the valve holder, and the other to F.

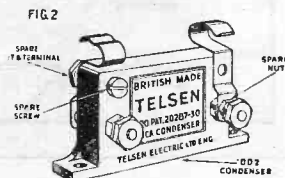

USING A GRAMOPHONE PICK-UP.

Any of the circuits in this book may be used to reproduce gramophone records by the simple connection of a gramophone pick-up. In the Empire 4 and the Commodore 3, terminals are brought out for this purpose, but additional

information on this point may be useful. Figure 3 shows the pick-up connected in its simplest form. G is the grid connection to a valve, usually the detector, and GB represents a wander plug which may be permanently plugged into the bias battery. In the case of the detector valve, 1½ volts is the correct amount of bias under all normal circumstances. In the

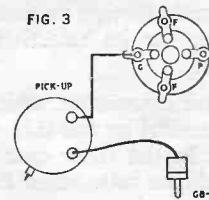

Empire 4 the grid of the first L.F. valve is used, because the full amplification of two L.F. stages, fed from a sensitive pick-up, will cause bad overloading of the output stage and therefore distortion, unless a volume control is used. The same applies to almost any circuit using two stages of L.F. as in the Conqueror 3. When using the first L.F. valve, which is already biased negatively, the other connection to the pick-up is made to the existing bias connection, which in the Empire 4 is GB—2.

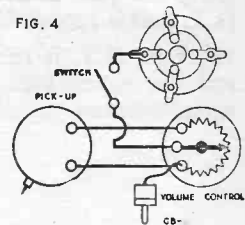

A simple 2-point switch may be inserted in the grid circuit to avoid the necessity of disconnecting the pick-up when it is not in use. If the detector valve is the one concerned, the wire from its grid to the switch or terminal must be as short as possible.

Figure 4 shows how a volume control is connected with a switch included as described above. Both may be conveniently mounted on the panel.



L.F. TRANSFORMERS



TELSEN "RADIOGRAND" L.F. TRANSFORMERS

Telsen "Radiogrand" Transformers have signified to expert designers and enthusiastic constructors all that is finest in British radio craftsmanship. Every "Radiogrand" Transformer is built on the soundest engineering principles and tested under broadcast conditions for immaculate performance and enduring efficiency.

Ratio 3-1. No. W.59. Ratio 5-1. No. W.58.

Price 8/6



TELSEN "ACE" L.F. TRANSFORMERS

Similar to the famous "Radiogrand" Transformer in its life-like reproduction and capacity for reliable service, the Telsen "Ace" is eminently suitable for receivers where highest efficiency is required at a low cost and where space is limited.

Ratio 3-1 No. W.66
Ratio 5-1 No. W.65

Price 5/6

TELSEN "RADIOGRAND" RATIO 7-1 TRANSFORMER

This transformer is designed to give extra high amplification on receivers employing only one stage of L.F. amplification. Following the detector in the popular screened grid three arrangement it will give sufficient power to load fully the output valve. It is not recommended for use in receivers employing two L.F. stages as overloading is likely to occur.

No. W.60.

Price 12/6

TELSEN "RADIOGRAND" INTERVAL TRANSFORMER, RATIO 1.75-1

For use in receivers employing two stages of L.F. amplification, where exceptionally good quality is desired. The somewhat lower step-up ratio is amply offset by the extra power available under modern receiving conditions. When used following an L.F. stage employing choke coupling it will be found to give ample volume with remarkable reproduction.

No. W.61.

Price 12/6



OUTPUT TRANSFORMERS

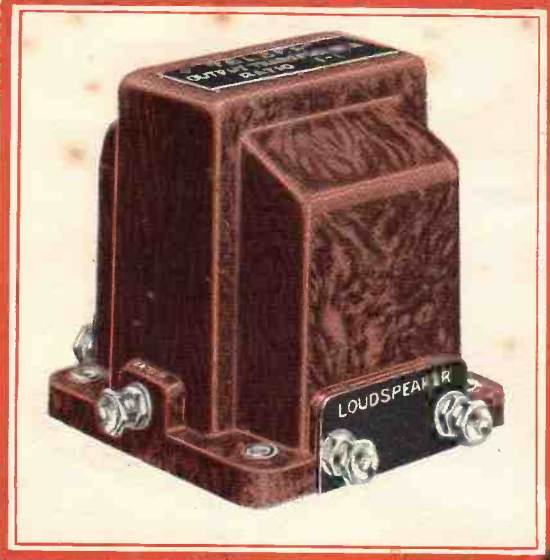

TELSER OUTPUT TRANSFORMER,
RATIO 1 - 1

This Transformer is intended for connecting the loudspeaker to the output stage of the receiver. Its object is to avoid saturation of the loudspeaker magnet system, by isolating the direct current from the speaker windings. This produces a remarkable improvement in the quality of reception. It also serves to keep H.T. voltage from the speaker and its leads, which is especially important when using a D.C. Eliminator. The primary terminals should be connected to the original loudspeaker terminals on the receiver, and the loudspeaker should then be connected across the secondary of the transformer, which may be mounted inside or outside the receiver.

No. W.62.

Price 12/6

TELSER MULTI RATIO OUTPUT TRANSFORMER

This is designed for use with Moving Coil Loudspeakers having low impedance speech coil windings. It has three ratios, 9-1, 15-1 and 22.5-1. The primary is connected in the anode circuit of the output valve and the speech coil of the loudspeaker is connected to two of the secondary terminals. The choice of three ratios enables the correct matching of speakers of widely varying characteristics.

No. W.63.
Price 12/6

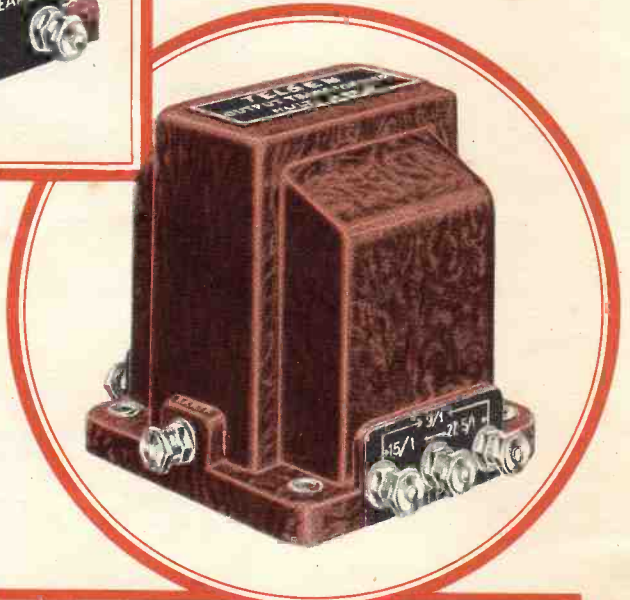

TELSER PENTODE OUTPUT TRANSFORMER

The purpose of the TELSER pentode output transformer is to prevent direct current passing through the loudspeaker, and also to match the speaker to the pentode valve, which is essential for good quality reproduction. It should be connected in the output circuit where the output valve is a pentode. By using this transformer the quality obtained with the pentode valve becomes quite equal to that expected from a normal super power valve.

No. W.64.

Price 12/6

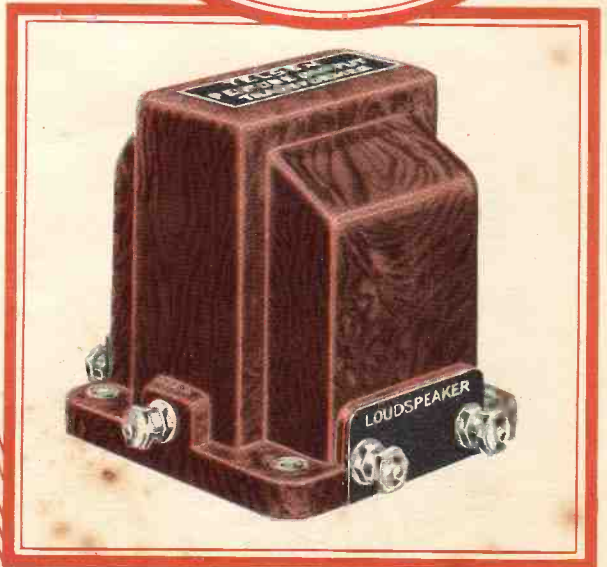

L.F. & OUTPUT CHOKES

TELSEN INTERVALVE L.F. COUPLING CHOKES

These popular L.F. Chokes are primarily intended for use as coupling chokes in the anode circuits of modern radio receivers, but may be used in any circuit not carrying more than the stipulated maximum current. The 100 H. type should be connected in the anode circuit of an H or HL type valve. The 40 H. type is designed for use with an L type valve. Either is highly suitable for power grid detection where the anode current does not exceed the specified limit.

Rating	Normal Current	Max. Current	No.
40 H. at ..	5 mA.	8 mA.	W.68
100 H. at ..	3 mA.	6 mA.	W.69

Price 5/-

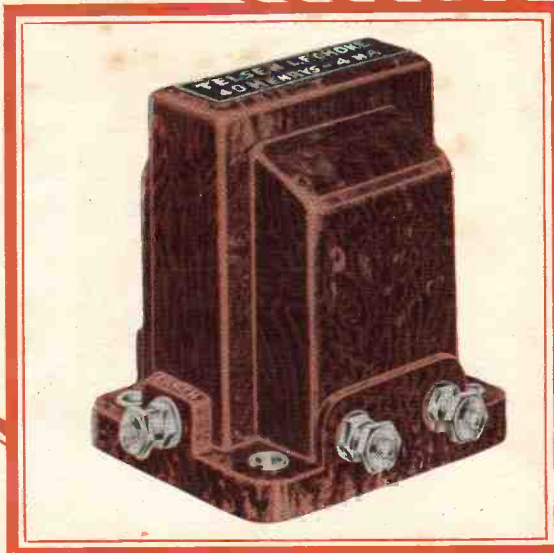

TELSEN HEAVY DUTY POWER GRID L.F. CHOKE

This choke is designed to fill the demand for an intervalve choke which will carry the heavy anode current of indirectly heated valves in Power Grid Detection circuits. It is also suitable for second-stage smoothing in circuits not carrying more than 12 mA.

40 henrys (at 12 mA.).

No. W.73.

Price 8/-

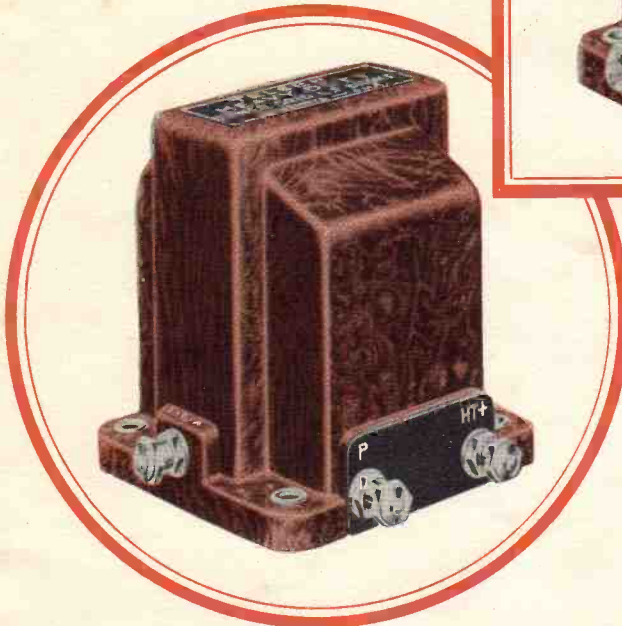

TELSEN OUTPUT CHOKES (Tapped and Plain)

Designed for use as Output Filter Chokes in conjunction with a condenser of not less than 2 mfd. these chokes are highly suitable with any power or super power valve taking up to 25 mA. The centre tapped choke may be used with pentodes, or where the loudspeaker impedance is appreciably lower than that of the valve, so that closer matching is obtainable. The plain choke is also suitable for smoothing currents up to 25 mA.

Telsen Output Choke (plain), 20 henrys (25mA)

No. W.71 Price 8/-

Telsen Output Choke (tapped), 20 henrys (25mA)

No. W.72 Price 8/6



H.F. CHOKES

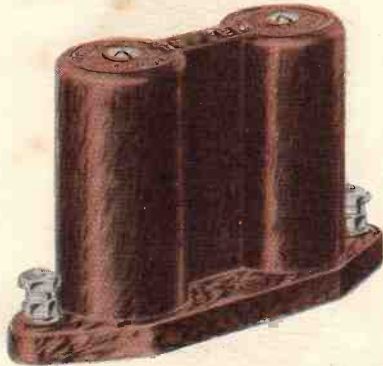

TELSEN BINOCULAR H.F. CHOKE

In H.F. amplification the performance of a choke is of supreme importance. The Telsen Binocular H.F. Choke is called for wherever the highest efficiency is required. Its high inductance (180,000 micro-henrys) and exceptionally low self-capacity (.000002 microfarad) ensure a very high impedance at all wavelengths, and its excellent efficiency curve proves that it is free from parasitic resonances. These qualities, together with the restricted field due to the binocular formation, make it the ideal choke for a high class circuit.

No. W.74.
Price 5/-

The curve below, published by courtesy of *Amateur Wireless*, represents the efficiency of the Telsen Binocular Choke over the broadcast band.

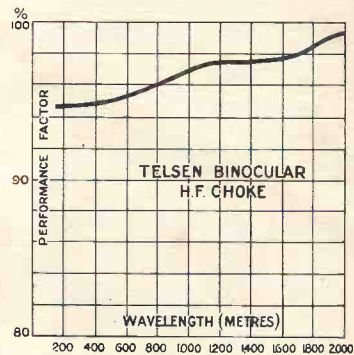

TELSEN STANDARD H.F. CHOKE

The Telsen Standard H.F. Choke, which utilises the minimum baseboard space, is designed to cover the whole broadcast band and has the very low self-capacity of .000008 microfarad. It is highly suitable for reaction circuits. The inductance is 150,000 micro-henrys and the resistance 400 ohms. It has proved very popular and has been incorporated by set designers in many of the leading circuits.

No. W.75.

Price 2/-



DUAL-RANGE TUNING COILS

TELSEN AERIAL COIL

This is the latest development in dual-range aerial coil design; it incorporates a variable series condenser which can be set to give any desired degree of selectivity, making the coil suitable for all districts whatever reception conditions may be. This adjustment also acts as an excellent volume control, and is equally effective on long and short waves. The waveband change is effected by means of a 3-point switch. A reaction winding is included. Full particulars with wiring diagram are included with every Telsen Aerial Coil.

No. W.76.

Price 7/6

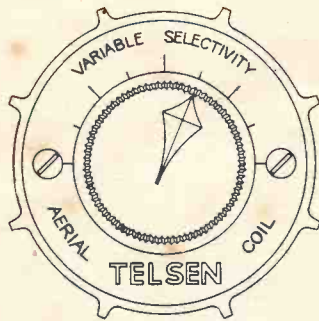

TELSEN H.F. TRANSFORMER AND AERIAL COIL

This coil is primarily designed for H.F. amplification in conjunction with screened grid valves. It is arranged so that it can be connected as an H.F. Transformer or alternatively as a tuned grid or tuned anode coil. It also makes a highly efficient aerial coil where the adjustable selectivity feature is not required. A reaction winding is incorporated. When used as an H.F. Transformer the wave change is effected by means of a 2-pole switch, such as the Telsen No. W.153; when connected otherwise use Telsen 3-point switch No. W.108. Full particulars with wiring diagram are included with every Telsen H.F. Transformer and Aerial Coil.

No. W.154.

Price 5/6

VARIABLE CONDENSERS

TELSEN BAKELITE DIELECTRIC CONDENSERS

These condensers are of a new and improved type and of exceptionally compact dimensions. The rotor vanes are keyed to the spindle and fitted with definite stops. The vanes are interleaved with finest quality bakelite. Fitted with pigtail connection to rotor. Supplied complete with knob.



Differential Condensers.		
Capacity	No.	Price
.0003	W.140	2/-
.00015	W.139	
.0001	W.138	

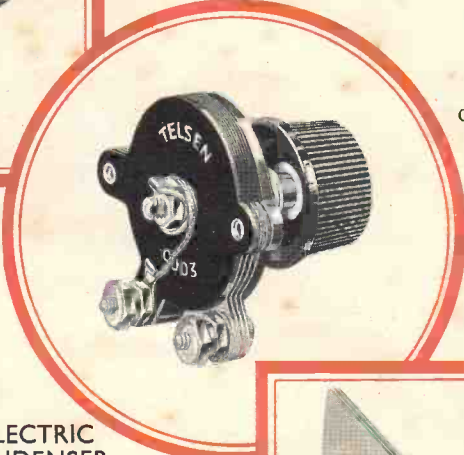

Reaction Condensers.		
Capacity	No.	Price
.0003	W.137	2/-
.00015	W.136	
.0001	W.135	2/6
.00075	W.158	
.0005	W.157	

TELSEN BAKELITE DIELECTRIC TUNING CONDENSER

Designed and constructed on the same principles as the Telsens Bakelite Dielectric Differential and Reaction Condensers. The connection to the rotor is made by means of a phosphor bronze pigtail so that no crackling due to rubbing contacts is possible. The connection to the stator vanes is absolutely positive. Supplied complete with knob.

Capacity .0005. No. W.134.
Capacity .0003. No. W.133.

Price 2/-

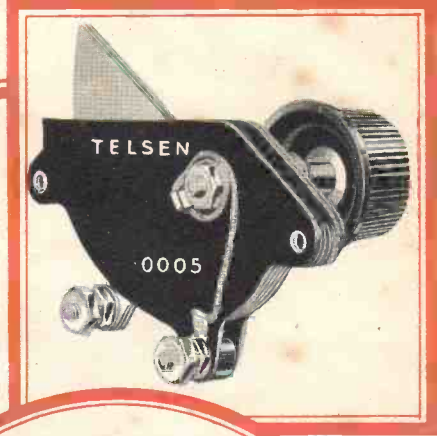

TELSEN LOGARITHMIC VARIABLE CONDENSERS

The Telsens Variable Condenser is built to stand years of service. The sturdy frame is braced by three solid pillars and the effective clamping of the vanes, each held at three points, makes distortion impossible. The rotor also is built into a rigid unit, the vanes being held at both ends. Generous bearings provide against backlash or end play and the spacing will remain accurate as long as the condenser is in service.

Capacity .0005. No. W.132.
Capacity .00025. No. W.130.
Capacity .00035. No. W.131.

Price 4/6

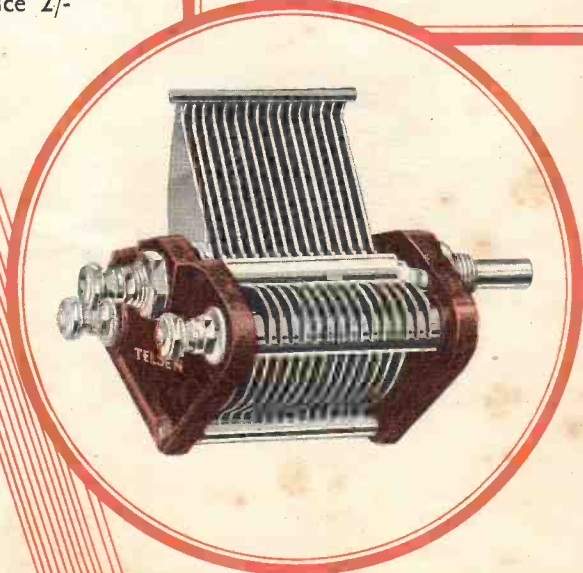

SWITCHES & DIALS

TELSEN PUSH-PULL SWITCHES

(Prov. Pat. No. 14125/31)

The Telsen Push-Pull Switches are designed on sound engineering principles. They employ the "knife" type of self-cleaning contact, as used in electrical power work, and a positive snap action. The nickel silver bridge piece is driven between the springy "fixed" contacts, and the wedge-shaped plunger squeezes the inner contacts outwards, closing the jaws in a firm grip. The series gap reduces self-capacity to a minimum, and the spindle is insulated from all contacts.

Two-point. No. W.107.
Price 1/-

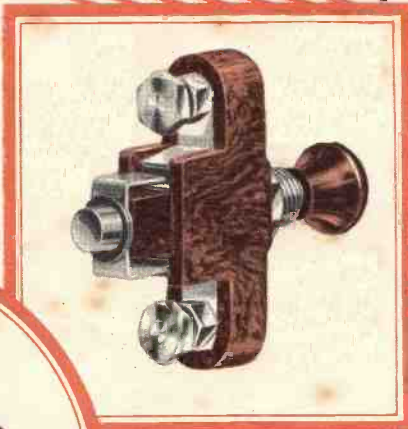

Three-point. No. W.108.
Price 1/3

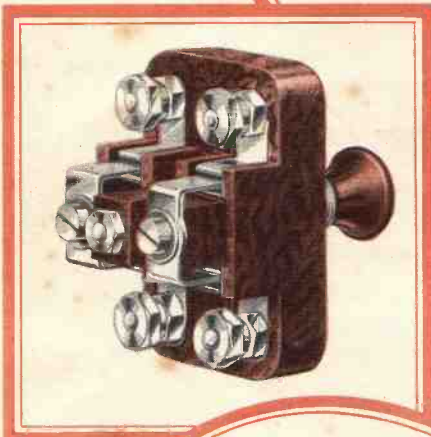

TELSEN FOUR-POINT "TWO-POLE" PUSH-PULL SWITCH

(Prov. Pat. No. 14125/31).

Designed on exactly the same principles as the Telsen two-point and three-point switches described above, this model is a two-pole switch highly suitable for use in wave changing on two coils or an H.F. Transformer.

No. W.153.
Price 1/6



TELSEN SLOW MOTION DIAL

Beautifully moulded in black or brown bakelite, the Telsen Slow Motion Dial has an exceptionally smooth action with a ratio of approximately 8-1. There is no toothed gearing, so that it is impossible to strip the dial. The figures are clearly marked and are arranged to provide for right or left hand rotation. Supplied complete with screws and nuts for fixing to the panel.

No. W.141.
Price 2/6

LOUDSPEAKER UNIT



TELSEN LOUDSPEAKER UNIT

The Telsen Loudspeaker Unit has earned unstinted praise from all quarters. It provides at a popular price a reliable unit which gives a very fine performance pleasing to the most sensitive ear. The natural resonances have been adjusted so that a good balance of tone results, and the unit gives, for all its compact dimensions, a surprising depth of tone without losing the crispness necessary for good reproduction. A detachable cone rod, chuck and washers are included, also brackets for mounting on any standard chassis.

No. W.54.
Price 5/6

This sketch shows the method of fixing the Telsen Loudspeaker Unit to the Chassis with the angle brackets and screws provided.

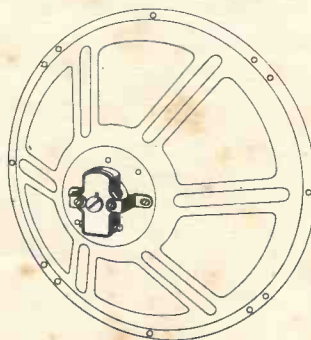

LOUDSPEAKER CHASSIS



TELSEN LOUDSPEAKER CHASSIS

The fully floating cone of specially prepared damp resisting material is mounted on a flexible felt surround in a rigidly constructed, light, pressed aluminium frame. The material and proportions of the cone have been selected to give an exceptionally natural balance of tone free from objectionable resonances. The cone is fitted with cone washers and chuck to take the loudspeaker rod, and the frame is pierced for easy attachment to most of the popular loudspeaker units. Combined with the Telsen Unit it forms an ideal inexpensive combination, which, for natural reproduction and all round performance, rivals the highest priced units.

Telsen "Major" Loudspeaker Chassis, diam. 14½ ins. No. W.170.
Price 10/6

Telsen "Popular" Loudspeaker Chassis, diam. 11 ins. No. W.159.
Price 5/6

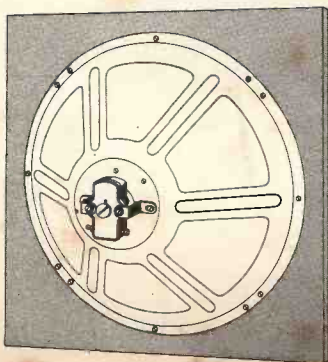

This shows the Telsen Chassis with Unit attached, screwed to a baffle board by means of wood fixing screws placed through the pierced holes provided in the outer rim of the Chassis.

CONDENSERS

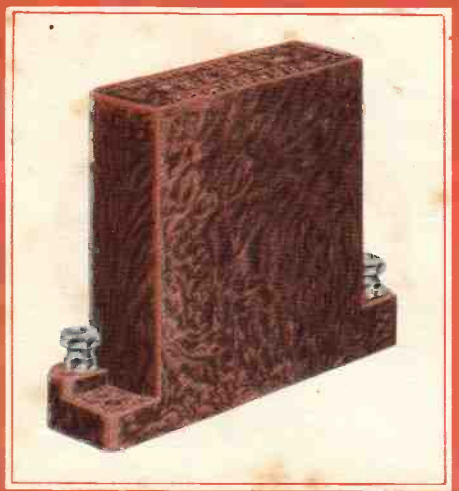

TELSEN MANSBRIDGE TYPE CONDENSERS

The following capacities are accurate within 5 per cent. of the stated values.

Cap. Mfd.	500 volt test		1,000 volt test	
	Cat. No.	Price	Cat. No.	Price
.01	W.83	.. 1/6	W.90	.. 2/6
.04	W.81	.. 1/9	W.88	.. 2/9
.1	W.82	.. 1/9	W.89	.. 2/9
.25	W.80	.. 2/-	W.87	.. 3/-
.5	W.79	.. 2/3	W.86	.. 3/3
1.0	W.78	.. 2/3	W.85	.. 3/6
2.0	W.77	.. 3/-	W.84	.. 5/-

TELSEN MANSBRIDGE TYPE CONDENSERS

These are made from the finest materials it is possible to obtain. Manufactured by the most advanced processes known, they are subjected to the most stringent tests. The test peak voltage is discharged by direct short circuit before the insulation tests are made and the highest standards of insulation are adopted. Telsens Mansbridge type self-sealing condensers are absolutely non-inductive. They are dehydrated in a high vacuum, impregnated and sealed, so that their high efficiency will endure indefinitely. For capacities and prices see table above. The illustrations show Telsens 1 mfd. and 2 mfd. Mansbridge Type Condensers.

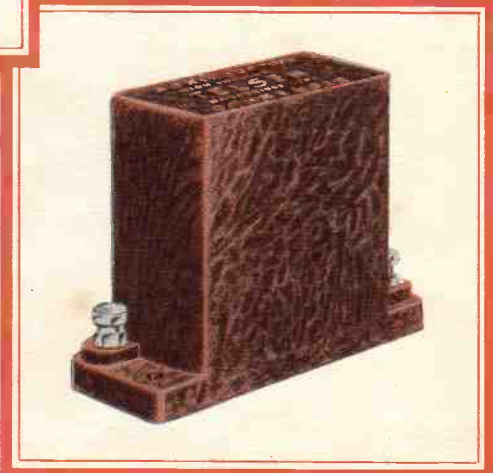

TELSEN FIXED MICA CONDENSERS

(Prov. Pat. No. 20287/30)

The Telsens Fixed Mica Condensers are made in capacities up to .002 mfd. Careful design and manufacture result in the H.F. losses being practically negligible. The .0003 Telsens fixed mica condenser is supplied complete with patent grid leak clips for series or parallel connection. All sizes may be mounted upright or flat.

Cap. Mfd.	No.	Cap. Mfd.	No.
.002	W.97	.. .0003	W.93
.001	W.96	.. .0002	W.92
.0005	W.95	.. .0001	W.91
.0004	W.94	..	

Price 6d.

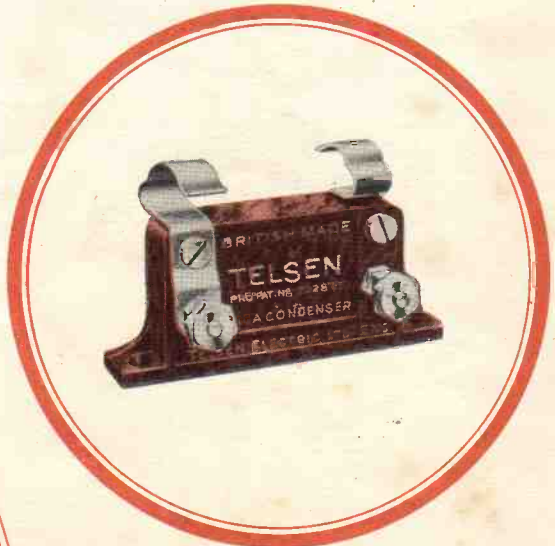

VALVE HOLDERS ETC

TELSEN VALVE HOLDERS

(Prov. Pat. No. 20286/30)

Telsen valve holders incorporate a new design embodying patent metal spring contacts, which provide the most efficient contact with split or non-split valve legs. The metal springs are extended in one piece to form soldering tags. Telsen valve holders have a very low capacity and are self-locating.

4-pin. No. W.105. 5-pin. No. W.106.

Price 6d.

Price 8d.

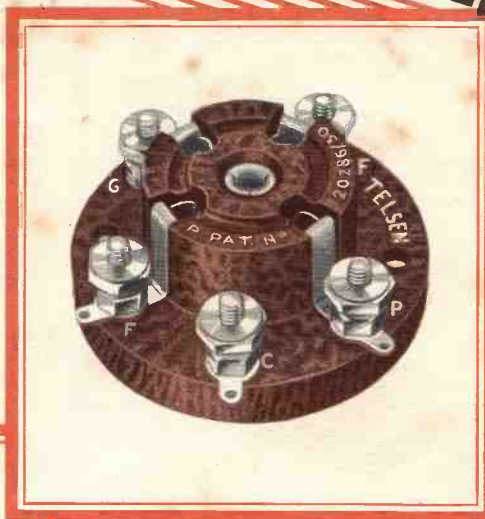

TELSEN GRID LEAKS

These are absolutely silent, and practically unbreakable. Telsen grid leaks do not vary in resistance with application of different voltages. They are non-inductive and produce no capacity effects.

Cap.		No.
Megohms.		
5	..	W.104
4	..	W.103
3	..	W.102
2	..	W.101
1	..	W.100
1/2	..	W. 99
1/4	..	W. 98

Price 9d.

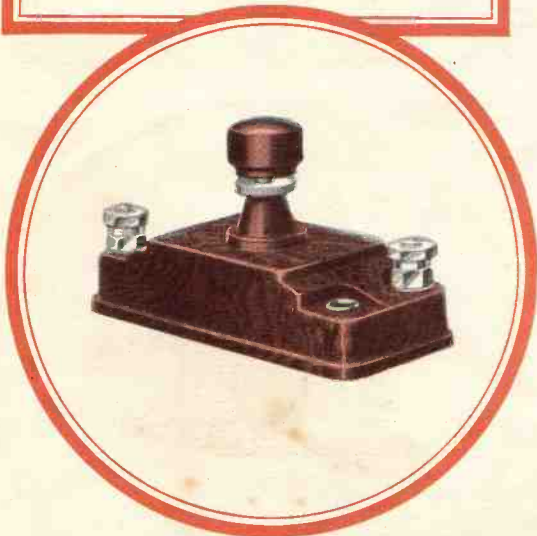

TELSEN PRE-SET CONDENSERS

The very low minimum capacity of the Telsen pre-set condensers gives a wide range of selectivity adjustment when used in the aerial circuit. They are substantially made, easily adjusted and provided with a locking ring. High insulation and low loss.

Max. Cap.	Min. Cap.	No.
Mfd.	Mfd.	
.002	.00025	W.149
.001	.000052	W.150
.0003	.000016	W.151
.0001	.000005	W.152

Price 1/6

SCREENS ETC.

TELSEN SCREENS

These are beautifully finished, and a series of holes is provided for fixing in different positions the movable terminals which are supplied. In model No. W.167 a hole is provided for mounting the screened grid valve in a horizontal position.

No. W.166.
Price 2/-

No. W.167.
Price 2/6

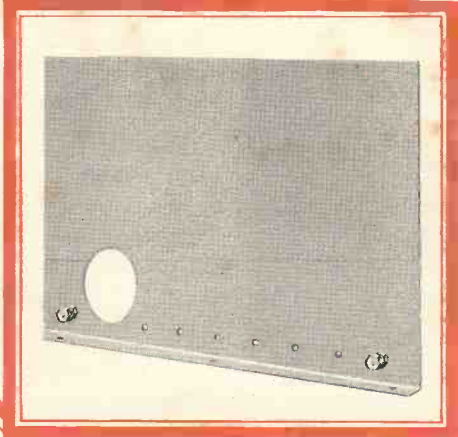

TELSEN FUSE HOLDER

A neat and inexpensive device which should be incorporated in every receiver as a precaution against burnt out valves. The terminals are easily accessible and the fuse bulb is held firmly, giving a perfect contact which cannot become loose.

No. W.146.
Price 6d.

Note.—The illustration shows the Telsen fuse holder in use with the standard type fuse.



TELSEN GRID LEAK HOLDER

This will hold firmly any standard size or type of grid leak. The spring contacts are extended in one piece to form soldering tags, and the terminals and fixing holes are accessible without removing the grid leak.

No. W.148.
Price 6d.



TELSEN SPAGHETTI FLEXIBLE RESISTANCES

These resistances are made from the finest nickel-chrome wire wound on a pure cotton core, stoved and impregnated so that moisture cannot attack the wire and cause corrosion. The bending of the resistance will not alter its value. The tags are firmly clamped to the element and are clearly marked with the value after stringent test.

Made in the following values:—

Resistance Ohms.	Maximum Current	Price
300	42 mA.	} 6d.
750	42 mA.	
1,500	23 mA.	} 9d.
3,000	23 mA.	
5,000	23 mA.	} 1/-
10,000	6 mA.	
20,000	6 mA.	} 1/6
30,000	6 mA.	
50,000	3 mA.	}
80,000	3 mA.	

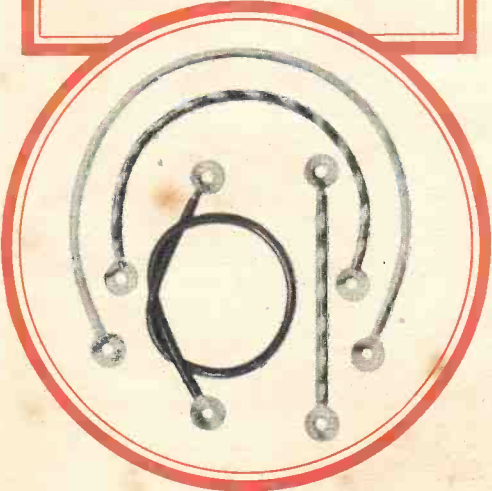

Making reception simple

WHEN the batteries and loud speaker have been connected, insert the valves according to the list recommended with each circuit and the set will be ready for reception.

First turn the reaction control to the left as far as possible, which is the position for minimum reaction; also turn to the extreme left the knob on top of the Aerial coil, which is the position for maximum input or minimum selectivity. Now pull out the switches on the front panel. The right-hand two-point switch makes the valves alive, and the three-point switches, when pulled out, set the coils for reception of the lower Broadcast band. On turning the tuning knob or dials slowly, reception of the local station should be heard if it is transmitting at the time. In the case of the Telsen "Commodore" S.G.3. and Telsen "Empire" S.G.4. where there are two tuning controls, it will be necessary to keep them in step, starting at the lower end. On receiving signals, adjust each dial separately to the position of maximum strength. If reception is now too loud the volume may be reduced by turning the knob on the Aerial coil slowly to the right. Adjust slightly the tuning if necessary.

This procedure is essential for cutting out interference from one station while receiving another. With the set tuned to the station you are wanting to receive, turn the selectivity control slowly to the right until the interfering station disappears, at the same time slightly adjusting the tuning if necessary. If volume is now insufficient it may be made good by the use of a little reaction. A setting will usually be found for the selectivity control which gives best all round results, and continual adjustment should not be necessary.

The reaction control should be used sparingly. On turning this control slowly to the right on any station, volume will be found to increase up to a point at which distortion sets in and finally the set goes into oscillation. *It must not be left in this condition.*

It cannot give you proper entertainment and if increased range is desired the only satisfactory solution is to build a more powerful set. Generally speaking, use as little reaction as possible to give the requisite volume.

To receive long waves, push in the three-point switch or switches and proceed as before.

* * *

AERIAL AND EARTH.

For general purposes an aerial about 60 feet long and as high as possible will give greatest range. When close to a powerful Broadcasting station—say within 10 miles, it may be helpful to cut the length down to half, though the selectivity control on the Telsen Aerial Coil will compensate for all but extreme cases. (The use of the selectivity adjustment is somewhat equivalent to reducing the size of the aerial). The aerial should be kept as far as possible from trees, chimneys, etc., and the down lead should be well clear of the wall. It must be well insulated wherever it is suspended or passes into the house.

The earth lead should be as short and direct as possible. A main water pipe makes the best earth of all, but if this is not convenient an earthing tube driven into soil (which is kept damp in dry weather) is the next best. The connection to the earth tube is usually a weak point and should be inspected occasionally.

The aerial will normally be attached to the terminal marked A1 on the blue print (in conformity with usual practice) but connected to terminal 2 on the coil. When in this position, the selectivity control is in operation. Maximum input (and minimum selectivity) is obtained with the coil knob turned to the left.

If the set is used some distance from a powerful station, or if the aerial is so short that no interference is obtained even when the control is all "in," the aerial may be connected to A2 (terminal 1 on the coil) which will give slightly greater range. This, of course, puts the selectivity control out of action. In extreme cases, as when an indoor aerial is used on a set of moderate power, not close to a Regional station, the aerial may be tried on terminal 8 of the aerial coil. This will give much increased power, but tuning would be too flat except under the conditions described. There is no harm in trying the different aerial connections. When using a D.C. Eliminator it is advisable to keep to A1 as first described.



MAKE CERTAIN OF GOOD RESULTS

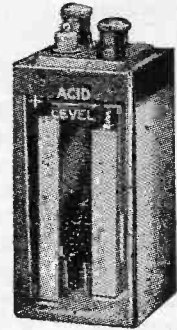
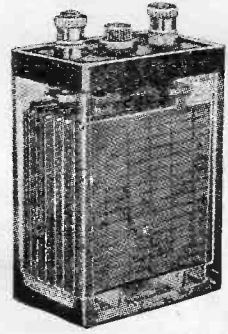
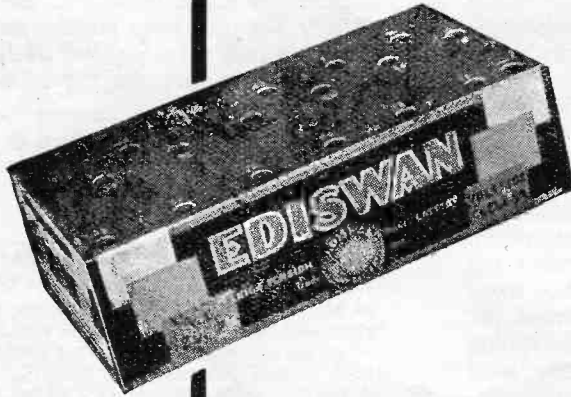

use these super quality batteries

There is an added liveliness about the set fitted with Ediswan Batteries. A sense of crispness—a new fullness of tone—a sharpness of tuning, which were not there with the old H.T. and L.T.

Made by an entirely new process at Ponder's End, Middlesex, Ediswan Radio Dry Batteries will give you longer useful service than other types are capable of—and they cost no more.

Ediswan Accumulators, too, give you definite advantages in their paste retaining grids of specially strong construction and the famous Ediswan dry charge process which abolishes the tiresome and prolonged first charge.

EDISWAN

RADIO DRY BATTERIES & ACCUMULATORS

PRICES

RADIO ACCUMULATORS

B.W.G. 2	24 AMPERE HOURS ..	8/9
B.W.G. 3	36 AMPERE HOURS ..	11/9
B.W.G. 4	48 AMPERE HOURS ..	13/9
MAJOR	70 AMPERE HOURS ..	11/-

PRICES

RADIO BATTERIES

60 VOLT 10 M/A	7/9
66 VOLT 10 M/A	8/6
120 VOLT 10 M/A	14/6
60 VOLT SUPER POWER 20 M/A ..	15/6
120 VOLT SUPER POWER 20 M/A ..	31/-



The TELSEN "EMPIRE" 4

THIS is the circuit for the constructor who requires long range and a big reserve of power with really high quality reproduction. This powerful circuit employs a stage of screen grid H.F. amplification and two stages of L.F. There are two tuned circuits employing the new TELSEN Dual Range Coils which are separately tuned to give the greatest efficiency and ease of control, at the same time relieving the constructor of any ganging troubles. Additional selectivity is provided by the selectivity adjustment on the Aerial Coil, which not only contributes to eliminating interference, but also enables the excessive power of the local stations to be kept fully under control. The screen grid valve is biased by the common Grid Bias battery, and the biasing lead is decoupled to eliminate any possibility of feed-back at this point. The screening grid is decoupled by a 1 mfd. condenser, and a separate H.T. lead is provided for it to give a wider control of stability.

Passing to the other side of the screen, the H.F. valve is coupled to the detector by the tuned grid method. Reaction is applied through a differential condenser fed from the detector plate. The L.F. side is interesting by reason that it employs a

stage of choke-coupled amplification followed by a Telsen 1.75-1 transformer. This arrangement, together with the choke output filter, combine to give complete L.F. stability without the necessity for decoupling, and exceptionally rich and natural reproduction. In spite of the splendid results obtained from this powerful circuit it presents no difficulty whatever in construction. The general procedure outlined on page 2 can be followed with confidence. After attaching the terminal strip, which may be in one piece, or in two sections as shown in the photograph, the baseboard components should be laid out in the positions indicated by the blue print, but following the photograph as an indication.

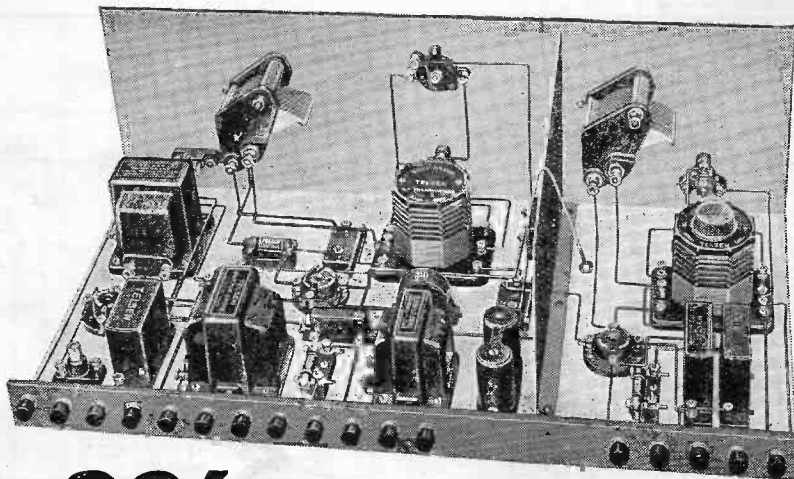

82⁹/₁₀₀

Complete set of Telsen Components for the "Empire" Screen-Grid Four.



THE TELSEN "EMPIRE" FOUR (cont'd)

Space should be left for the screen, but it should not be put on at this stage, as the wiring of the baseboard will be easier with both the panel and screening absent.

These may be added afterwards when the switches and variable condensers have been mounted. Where connections are made to the screen it is advisable to scrape the surface to remove any trace of lacquer. The slow motion dials present no difficulty, but it will be necessary to mount the tuning condensers with one edge vertical as shown in order to clear the dial fixing screws, and also in one case to give clearance from the screen. It is not advisable to vary the specification; the L.F. side will *not* be improved by attempting to get a higher ratio of amplification. The arrangement shown is sufficient to load fully the super power valve under all normal conditions, and even on distant stations.

The H.F. side will be found quite stable as arranged, provided suitable values are chosen for H.T.+1 and H.T.+2. If these are too high the set may be found slightly unstable at the top of the long wave scale, and the voltage tappings should be reduced until complete stability is obtained. This will be round about 60 volts in each case, H.T.+1 being more important than H.T.+2.

(cont'd on page 32)

TELSEN "EMPIRE" S.G. FOUR.
List of Components.

Quantity.	Description.	Cat. No.	Price
1	"Radiogrand" 1.75-1 Transformer	W.61	12 6
1	Output Choke, 20 henrys	W.71	8 0
1	L.F. Choke, 100 henrys	W.69	5 0
1	Binocular H.F. Choke	W.74	5 0
1	Standard H.F. Choke	W.75	2 0
1	Aerial Coil with Selectivity adjustment	W.76	7 6
1	1 mfd. Mansbridge Type Condenser	W.78	2 3
1	.1 mfd. Mansbridge Type Condenser	W.82	1 9
2	.0003 mfd. Mica Condensers	W.93	1 0
1	.002 Mica Condenser	W.97	6
2	.001 Mica Condensers	W.96	1 0
1	Grid Leak, 1 meg.	W.100	9
1	Grid Leak, 2 meg.	W.101	9
1	Grid Leak, ½ meg.	W.98	9
4	4-pin Valve Holders	W.105	2 0
1	Two-point Switch	W.107	1 0
2	Three-point Switches	W.108	2 6
2	.0005 Logarithmic Condensers	W.132	9 0
1	.00015 Differential Reaction Condenser	W.139	2 0
2	Slow-motion Dials	W.141	5 0
1	Fuse Holder	W.146	6
3	Grid Leak Holders	W.148	1 6
1	H.F. Coil	W.154	5 6
1	Screen	W.166	2 0
1	2 mfd. Mansbridge Type Condenser	W.77	3 0

£4 2 9

Panel size 21 x 7 in.
Baseboard size 21 x 10½ in.

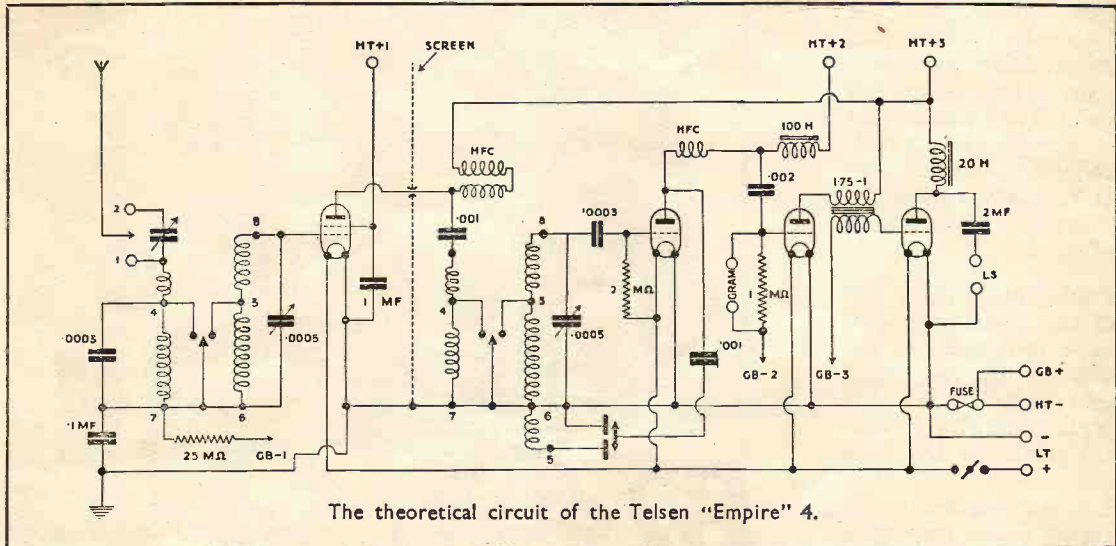

THE TELSEN 'EMPIRE' S.G.4

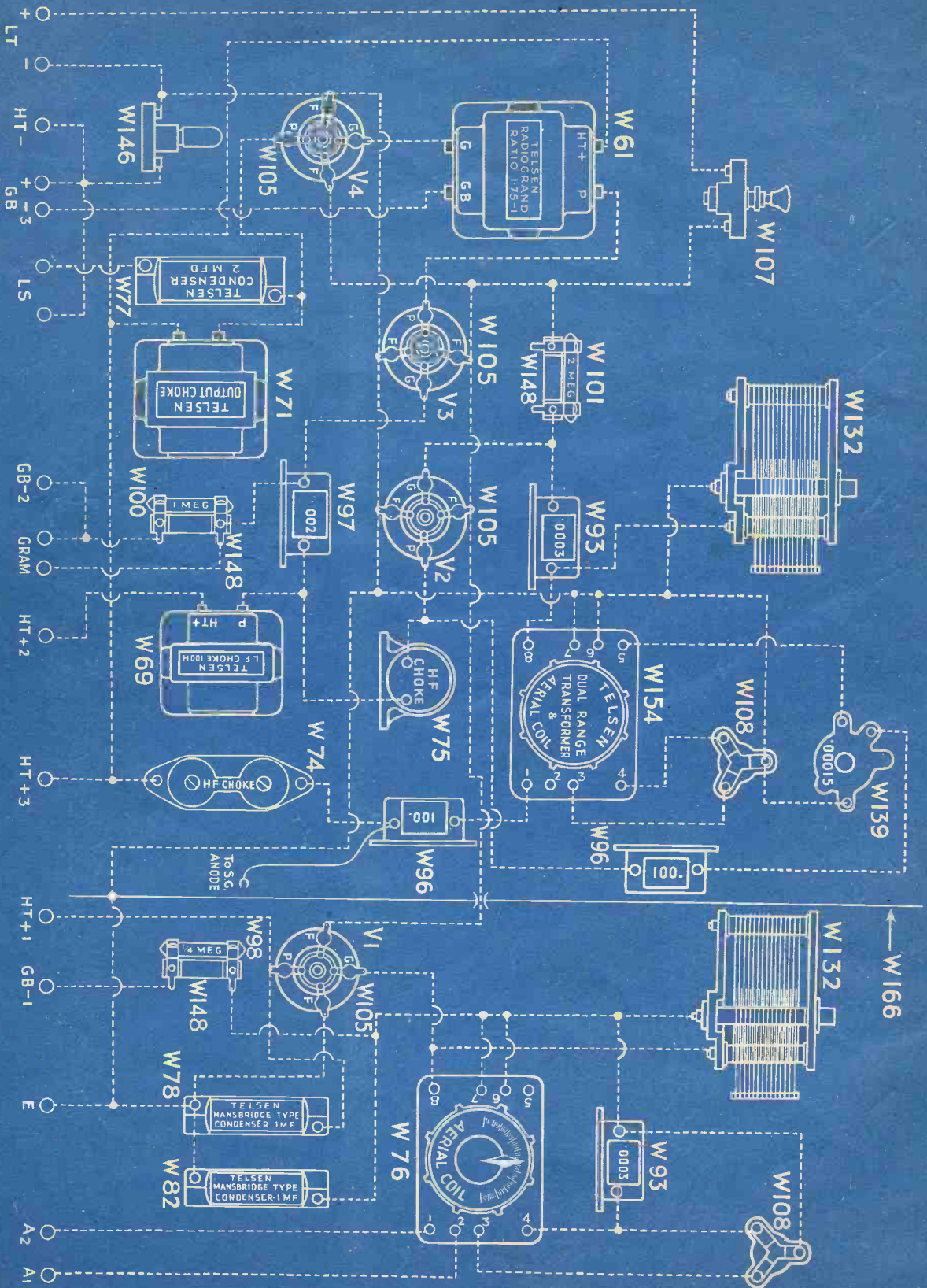

WIRING DIAGRAM

THE TELSEN 'SONGSTER' 2

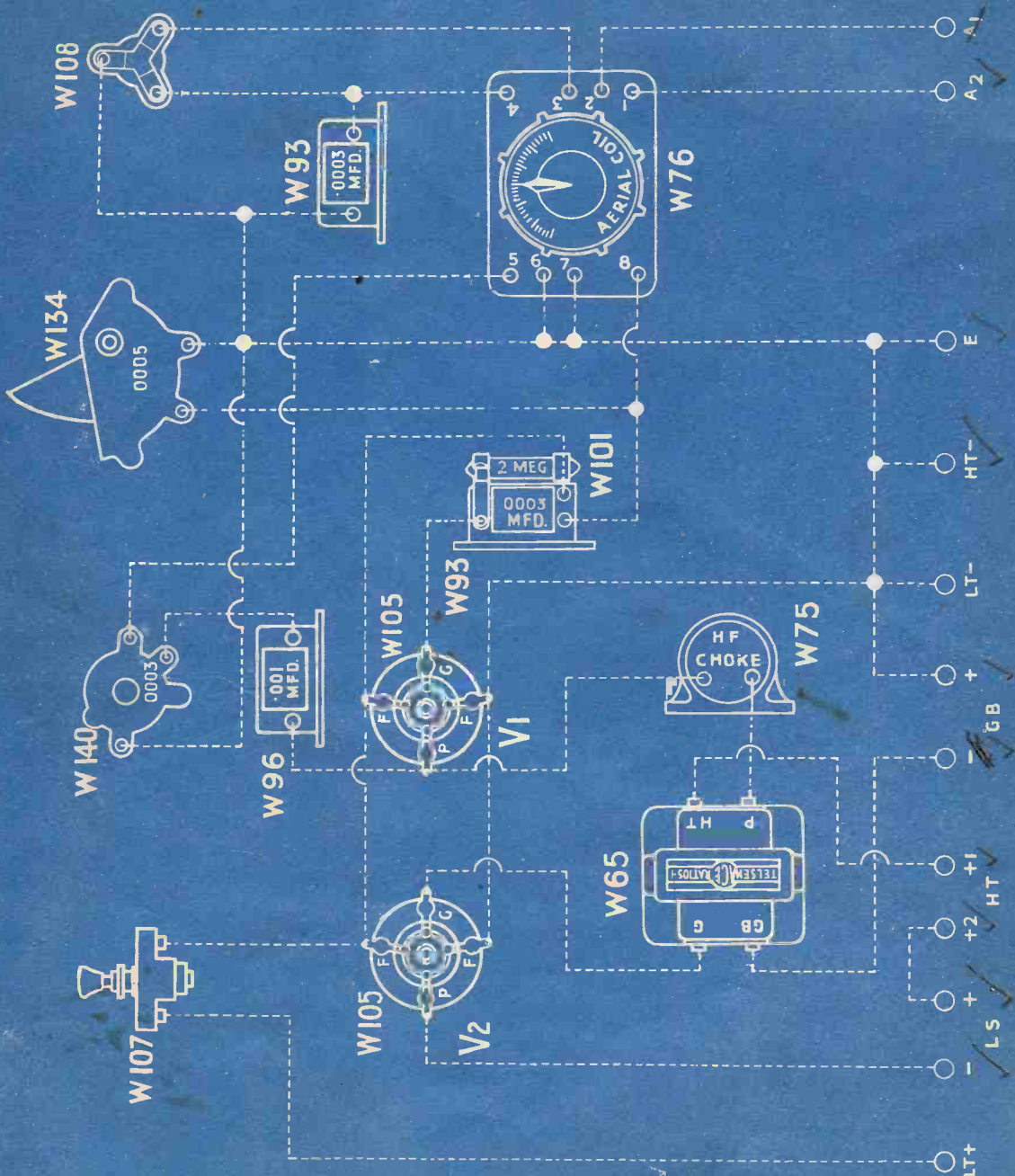

WIRING DIAGRAM

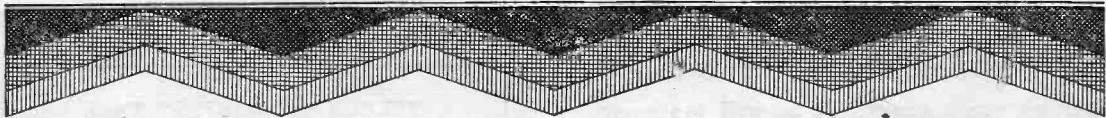

The TELSEN "SONGSTER" ²

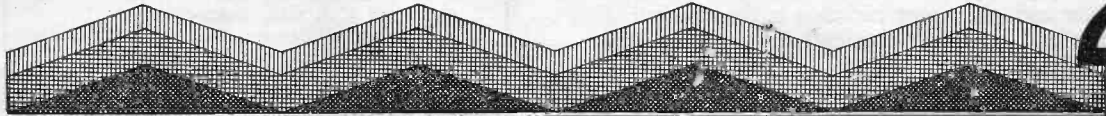

THIS is a simple but highly efficient two valve receiver which will appeal to many, not only for its low first cost and economy in upkeep, but for the satisfying loudspeaker reception which it will give. Owing to the incorporation of the TELSEN Selectivity Aerial Coil it will definitely separate Regional programmes at any distance over five miles.

This set, therefore, is all that is necessary for satisfactory reception of the local transmissions, which is the accepted sphere of the two valve receiver. Nevertheless, when operated not too close to the local station, foreign reception may certainly be expected with a good aerial.

The Telsen "Songster" Two is also perfectly suitable for reproducing gramophone records with the aid of a pick-up. Full instructions will be found on page 10. A volume control across the pick-up would be desirable. The quality of the reproduction, both on radio and gramophone, is very good and worthy of a good loudspeaker.

Construction and operation are simplicity itself and reference to the general instructions given in this booklet covers everything that need be said.

Very little alteration is possible without detracting from the essential simplicity of the arrangement. If desired, the bakelite tuning condenser may be replaced by an air-spaced logarithmic variable condenser and a slow motion dial may be fitted to either. A Telsen "Radiogrand" 5-1 Transformer, or better still, a Telsen super ratio 7-1 "Radiogrand"

may be fitted in place of the Telsen "Ace" and will, of course, give an audible difference in performance. These matters are open to the preference of the individual constructor.

A matter worthy of attention is the choice of output valves offered together with the conditions required to get the best out of the set with each.

The P.220 is suitable where local station reception at normal volume is the main requirement and where the nearest regional transmitter is within, say 25 miles. The

Pen 220 is a Pentode which will give considerably more power for the same input, and will therefore



24'6

Complete set
of Telsen Components
for the "Songster" Two.



THE TELSEN "SONGSTER" TWO (cont'd)

increase range somewhat, as well as power available on local stations, but in order to get the best quality it is desirable to use a high impedance loudspeaker, or a tapped choke output filter, as in the Telsen "Commodore" 3. The detector voltage (H.T.+1) is not critical, and any tapping between 60 and 80 volts will be near enough. Some variation in the strength of reaction can be obtained by altering the detector voltage.

At least 100 volts is necessary for H.T.+2 to get satisfactory volume without distortion, and 120 volts is better. The amount of grid bias applied is very important, and depends on the H.T. volts. With the P.220 and 120 volts on H.T.+2, $-4\frac{1}{2}$ volts bias is required. At 100 volts, this should be reduced to -3 , and it should be remembered that when a 120-volt battery has "run down" to some extent it will be necessary to reduce bias to 3 volts to maintain good quality.

The Pen 220 has a fifth connection, which may be in the form of a fifth pin or a terminal on the side of the base. In the former case, a five-pin valve holder should be substituted for V.2. In either case the extra contact must be

TELSEN "SONGSTER" TWO.

List of Components.

Quantity	Description	Cat. No.	Price
2	Valve Holders	W.105	1 0
2	.0003 mfd. Mica Condensers	W.93	1 0
1	Grid Leak 2 megohm	W.101	9
1	Aerial Coil with Selectivity adjustment	W.76	7 6
1	.0005 Bakelite Tuning Condenser	W.134	2 0
1	.0003 Differential Reaction Condenser..	W.140	2 0
1	3-point Push-Pull Switch	W.108	1 3
1	2-point Push-Pull Switch	W.107	1 0
1	"Ace" Transformer, ratio 5-1	W.65	5 6
1	H.F. Choke	W.75	2 0
1	.001 Mica Condenser..	W.96	6
			£1 4 6

Panel size 12 x 7 in.

Baseboard size 12 x 7 in.

connected by a piece of flex to an additional wander plug at 100-105 volts. The correct grid bias is then 3 volts. Never adjust the bias or H.T. plugs without switching off the set, and especially when using a pentode.

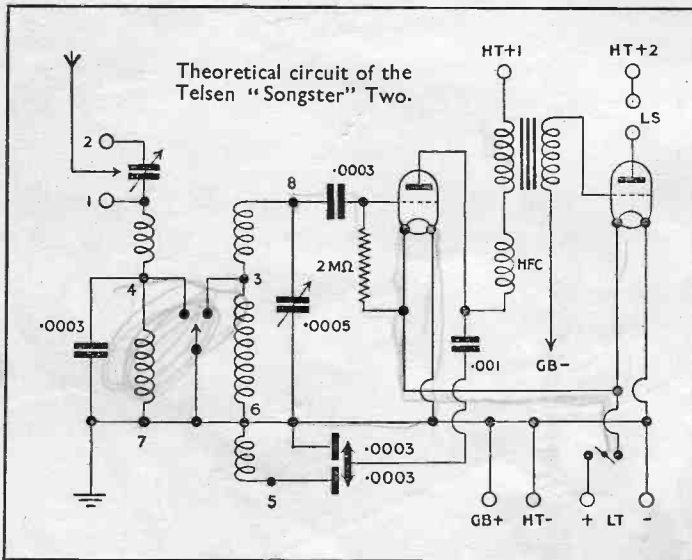

VALVES RECOMMENDED FOR THE TELSEN "SONGSTER" TWO.

- Detector .. V.1. MAZDA L.2.
- Output .. V.2. MAZDA P.220 or Pen.220.



Do you? consider your accessories?

THE accessories used with a radio receiver play an important part in its performance. A poor valve or a weak battery does not contribute to perfect reproduction.

The following notes on these essential accessories should prove interesting to the home constructor.

VALVES.

No set can be expected to do itself justice with valves that are old or unsuitable. Although they may not have deteriorated to a great extent, such big improvements have recently been made in the characteristics of valves that it is no exaggeration to state that the performance of a receiver fitted with valves eighteen months old would not be recognisable if fitted with a new set of 1932 valves. This applies particularly to the new Mazda range of 2-volt valves which are recommended exclusively for the Telsen circuits. Since the 1932 range of valves were first introduced, ample opportunity has been afforded to make extended tests, and Mazda have been selected because it was found that they give definitely better results.

The same remarks apply to the individual *types* of valve. There are often two or three choices of valve of one make for a given position in the receiver, and although some result may be obtained by any of the possible combinations, careful selection after extended tests is certain to give a more reliable result.

BATTERIES.

However good the receiver and however good the valves, they are both strangled if not supplied with proper battery power. To fit a set with inadequate batteries is a very false economy, and to let them continue in use after they have run down is to waste much of the time and trouble spent in building the receiver—this is an aspect not properly appreciated in many cases.

H. T. BATTERY.

The H.T. Battery is very important, and it is here that false economy is so often practised. An inferior battery may be slightly cheaper, but its useful life is so much shorter that actually it costs *more* for *worse* service. The same applies to using a good battery above its recommended discharge rate. The Ediswan standard capacity battery is rated to carry up to 10 milliamperes, and is very suitable for the Telsen Songster Two, which when properly biased will consume less than 10m.A. Long and satisfactory service may therefore be expected with this battery. The remaining Telsen circuits consume much more

than 10 m.A., and this cannot be avoided if good quality is to be maintained. (A possible exception is the Telsen Commodore Three when used with a Pen. 220 valve). It is safe to say that the principal cause of the poor standard of quality suffered by those who presumably have not heard better, is insufficient H.T. A power valve which will give adequate volume without overloading (which means distortion), cannot serve its purpose if there is a lack of high tension supply.

With these circuits therefore, the smaller type will not give its proper life, and the inferior "standard capacity" batteries which are usually useless over a current consumption of 7 to 8m.A., will only last a matter of weeks. It is, therefore, recommended that the Ediswan Heavy Duty type is used, which is rated to carry 20m.A. This will then be working within its capacity and will give months of service without excess voltage drop, loss of volume or distortion and crackling, which are signs of an overworked or run down H.T. Battery. 120 volts is much to be preferred to 100 volts, the difference in power and quality being well worth the extra few shillings.

GRID BIAS.

Maintenance of correct grid bias voltage is possibly more important than anything, and as it is not a question of expense there is no excuse for not giving the matter proper attention. A few volts error in grid bias tappings will cause horrible distortion, may run down the H.T. battery in half its proper life, and in extreme cases may shorten the life of the valves. The figures for correct grid bias under different conditions are given on a leaflet with each valve sold, and these recommendations should be carefully noted. Where alternate figures are given, as "9-10½" volts, it may be assumed that the higher figure is the best one for economy in H.T. current and the lower for best volume and purity. This applies mostly to the power valve. The first L.F. valve must also be biased to exactly the right amount, but the economy question hardly arises—try both values given and use which sounds best on a loud passage. For S.G. valves, 1½ volts bias is almost invariably correct.

The values of grid bias have been given in relation to each circuit and from these it will be seen that a 9-volt battery will suffice—provided that the H.T. battery is up to its work. If an H.T. battery not capable of supplying 20m.A. is used, grid bias must be increased a little, and the next size bias battery used. Though there is no current taken from a grid bias



battery it will deteriorate in time, and taking account of its low cost and the expensive results of deficient bias, it is worth while having the voltage of the bias battery tested whenever the H.T. Battery is replaced, and if there is any doubt, renewing it. Suitable 9-volt batteries are Ediswan 9 VG and 9 VFG (which only differ in shape) and for the higher bias voltages, Ediswan 15 VG.

ACCUMULATOR.

A choice of two volt types is permissible but the "mass-plate" type has the advantage that it will stand up to longer periods without charging—a certain amount of overcharging and other forms of abuse which it often receives. With regard to the upkeep, it should be taken at regular intervals of two or three weeks to a reliable charging station whether it is run down or not.

For the Telsen Songster Two, the accumulator recommended is the Ediswan "Little Loten," which is adequate, but for the remaining Telsen circuits, the Ediswan "Loten Minor" or type XG442 is advisable.

LOUDSPEAKER.

Some choose their loudspeakers by price, some by size, name, appearance, or even by the alleged number of poles! There is only one test when choosing a loudspeaker—*hear it*—at the same time as the others under selection, *i.e.*, one after the other without too much delay. The set supplying the test music should be free from distortion, and volume should be neither too loud nor too soft. Radio is better than a gramophone. Do not choose a speaker that is too deep toned—it will soon become tiring. This is really a form of distortion, and it can become more maddening than shrillness, which is the other extreme. Choose the speaker that sounds the most natural, especially on speech. For an inexpensive combination, it will be found very difficult to better the Telsen Loudspeaker Unit with the Telsen Major Cone Chassis. Insist on hearing one. It should be mounted in a cabinet or on a baffle to get true results.

THE TELSEN "EMPIRE FOUR"

(cont'd from p. 26)

The use of the reaction Condenser and selectivity controls is exactly as described in the general operating instructions on page 23. Adjustment of reaction will usually mean a slight adjustment in the right-hand tuning condenser, and adjustment of the selectivity control will probably necessitate a small correction of the aerial tuning condenser.

There is no object with this set in using a large aerial, 50 feet is ample for all conditions, and exceedingly good results can be obtained on a small or even an indoor aerial. In the latter case, it may be found advisable to use terminal A.2. for the aerial. This cuts out the selectivity control and would only be used when some distance from the local Regional station, where this extra selectivity would not be necessary. A fuse holder has been fitted as a refinement to prevent the possibility of damage to valves or batteries through a short circuit or wrong connection. This must be fitted with a proper radio fuse of the 60 or 100 milliampere type. A flash lamp bulb, though similar in appearance, is not suitable, as it will afford no protection to the valves. If at any time the set should appear completely dead, although everything else is in order, the fuse should be suspected and a spare one put in to determine whether that is the cause of the trouble. Terminals are provided for use with a Gramophone Pick-up, and further instructions on this point are given in the article on page 10.

For suitable battery voltages, see table below.

VALVES RECOMMENDED FOR THE TELSEN "EMPIRE" 4.

H.F.	V1. MAZDA S.G.215
Detector	V2. MAZDA H.L.2.
L.F.	V3. MAZDA L.2.
Output	V4. MAZDA P.220A.

BATTERY VOLTAGES.				
recommended for the Telsen circuits.				
Position.	Songster Two.	Conqueror Three.	Commodore Three.	Empire Four.
H.T. +1	60v.	60v.—80v.	50v.—80v.	50v.—80v.
H.T. +2	100v.—120v.	80v.—120v.	60v.—80v.	60v.—80v.
H.T. +3	—	100v.—120v.	120v.	120v.
G.B.—1	3v.—4½v.	1½v.—3v.	1½v.	1½v.
G.B.—2	—	7½v.—10½v.	See text.	3v.
G.B.—3	—	—	—	9v.—10½v.

N.B.—The Telsen Electric Co., Ltd., cannot undertake to test or service home-built Receivers, and will not be in any way responsible for Sets sent in for this purpose.



2 VOLT MAZDA MASTERPIECES

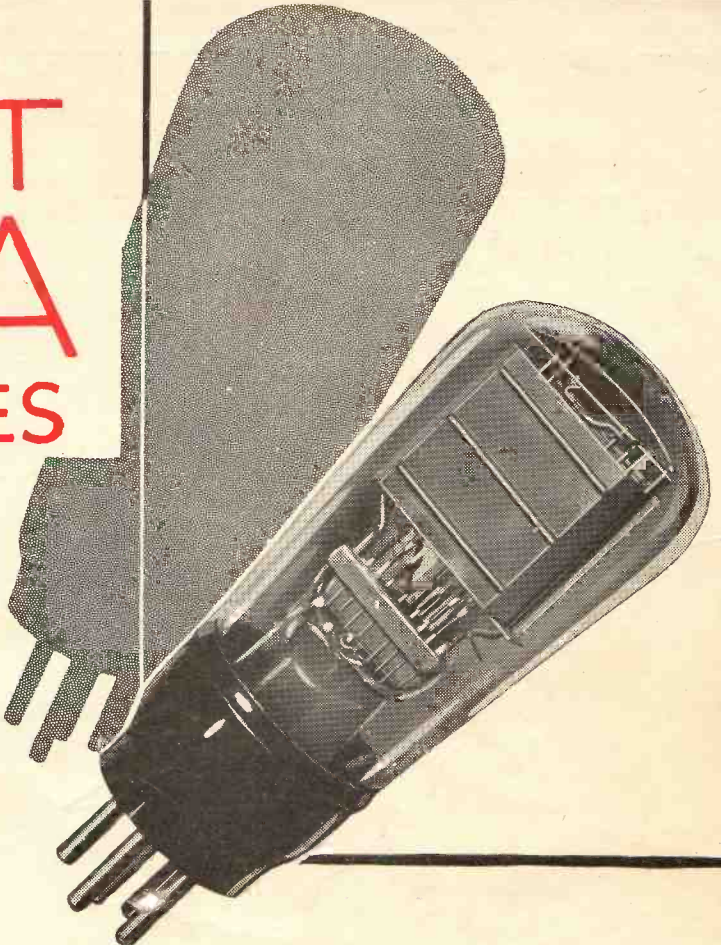

TYPE	PRICE
H.210 - - -	8/6
HL.210 - - -	8/6
†★ HL.2 - - -	8/6
L.210 - - -	8/6
†★ L.2 - - -	8/6
† P.220 - - -	10/6
† P.220A - - -	13/6
P.240 - - -	13/6
PEN.230 - - -	20/0
PEN.220 - - -	20/0
PEN.220A - - -	20/0
† S.G.215 - - -	20/0
★ S.G.215A - - -	20/0
★ S.G.215B - - -	20/0

★ Metallised

† Specified for the Telsen Circuits

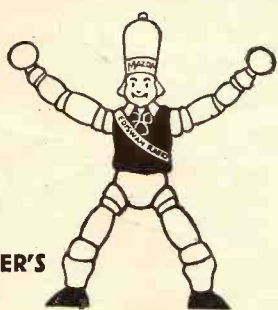

LOOK FOR
"EDDY" IN
YOUR DEALER'S
WINDOW

Since 2-volt valves were made, never has there been so amazing a range as this — so much evidence of brilliant engineering — so many valves with outstanding characteristics. Instance the Pen. 220; or pentode, which at once presents the solution to the output stage problem in portable sets, for it gives an astonishingly large output for a combined screen and anode current of under 5 mA. It is a valve H.T. dry battery users have longed for. It is typical of all Mazda 2-volt valves. Mazda 2-volt valves, both metallised and clear bulb types, are sold by all good radio dealers.

THE AMAZING

MAZDA PEN. 220

Characteristics:

Filament Voltage - - 2.0 volts Anode Current (Max) - 12 mA
 Filament Current - - 0.2 amps. Screen Voltage (Max) - 150 volts
 Anode Voltage (Max) - 150 volts Mutual Conductance - 2.5 mA/V
 At $E_a = 100$; $E_s = 100$; $E_g = 0$.

PRICE 20/ =

MAZDA THE BRITISH VALVES

The Edison Swan Electric Co. Ltd.



155 Charing Cross Road, London, W.C.2

BUILD THE

TELSEN

**VICTOR
3**

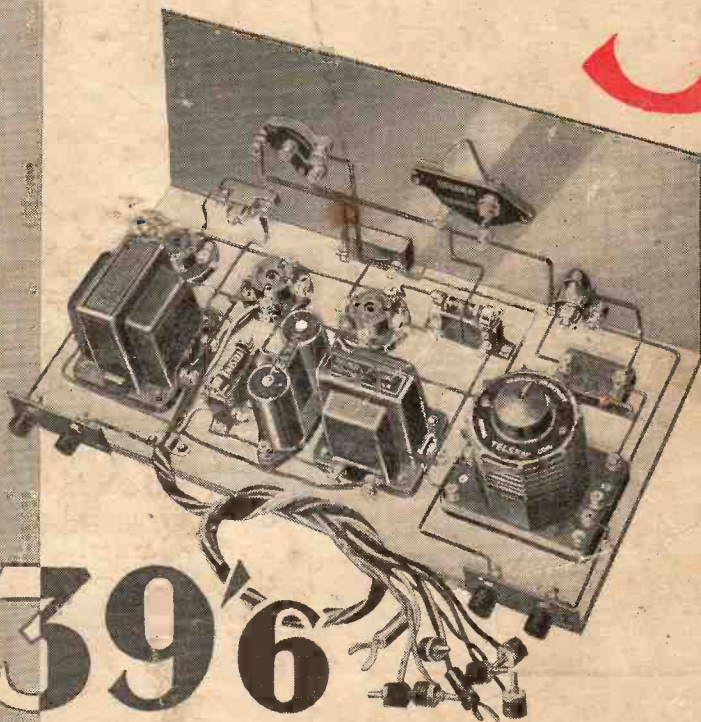

39'6

ALL BRITISH