

Electronic Engineering

OCTOBER 1952

ERIE* Fully Protected High Stability Resistors



ERIE* fully protected high stability resistors are fully type approved by the R.C.S.C., whose tests not only confirm that all their characteristics are well within the specified limits, but also reveal that, in particular, they have an average noise-level of 0.1 microvolts per D.C. volt applied and a maximum noise-level of only 0.2 microvolts as against the permitted maximum of 0.5 microvolts. FURTHERMORE, their overall stability is such that there is no need to order a closer tolerance than the application actually demands.

THE ONLY HIGH STABILITY RESISTOR IN THE WORLD in which the super-sensitive cracked carbon film is free from direct contact with paints, lacquers and other finishes which have a detrimental effect under extremes of temperature.

THE ONLY HIGH STABILITY RESISTOR IN THE WORLD which has an effective vitrified barrier which protects the film and gives complete freedom from soldering troubles, and from damage in transit, in handling and in assembly.

ERIE Resistor Limited, Carlisle Road, The Hyde, London, N.W.9
Tel.: COLindale 8011 Factories: London and Great Yarmouth: Toronto.
Canada: Erie, Pa., U.S.A.

★ Registered Trade Marks

TYPE	MAX. PEAK VOLTS D.C.	RATING AT 85°C.	RESISTANCE RANGE OHMS	R.C.S.C. STYLE	R.C.S.C. TYPE APP. CERT.	APPROVED RESISTANCE RANGE OHMS	DIMENSIONS MAX.	
							LENGTH	DIA.
100	500	$\frac{1}{2}$ watt	10-3 Meg.	RC3M	525/3	10-1 Meg.	1.300"	0.375"
108	325	$\frac{1}{4}$ watt	25-1 Meg.	RC3N	592/3	27-1 Meg.	0.800"	0.255"
109	250	$\frac{1}{8}$ watt	100-510,000 ohms	RC3L	626/2	100-510,000 ohms	0.540"	0.255"

STANDARD TOLERANCES: $\pm 1\%$, $\pm 2\%$, $\pm 3\%$, $\pm 4\%$, $\pm 5\%$ and $\pm 10\%$

TWO SHILLINGS

A new low-priced STABILIZED POWER SUPPLY UNIT

PRICE
 Stabilized Power Supply Unit (metered) £23.2.6
 Stabilized Power Supply Unit (without meters) £18.18.6
 Plated Bench Stands £1.1.0

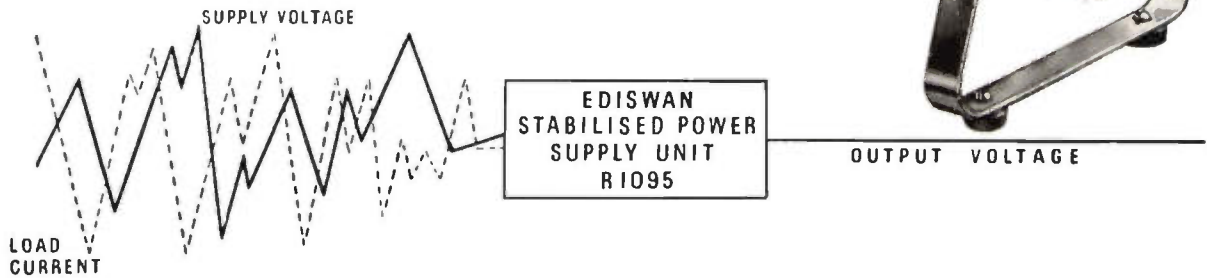
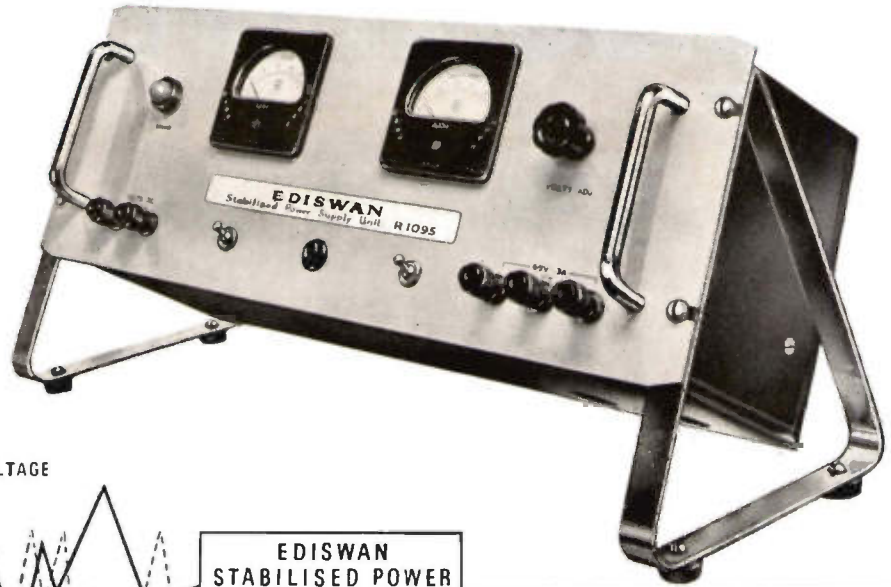

Designed and developed as a result of many years experience in the design and use of Stabilized Power Supplies for research and test purposes, the Ediswan Stabilized Power Supply Unit R.1095 is an entirely new, low-priced constant voltage source.

Operating on 200-250 volts, 40-100 cycles A.C. supply it provides an adjustable 120-250 volts D.C. highly stabilized supply at 0.50 mA and a 6.3v C.T. 3 amp. A.C. unstabilized output for heater supply.

The stability is such that with mains change of 10v,

output change is less than 0.1v. With load change of 0.50 mA, output change is less than 0.1v.

Output resistance less than 2 ohms. Ripple approximately 2 mV.

The unit can be supplied with or without meters. Provision is made for the addition of meters at a later date.

The unit is designed for standard 19" rack mounting or for bench use. Plated bench stands as illustrated are available if required.

Further details are available on request.

EDISWAN

THE EDISON SWAN ELECTRIC COMPANY, LTD.

Radio Division

155 CHARING CROSS ROAD, LONDON, W.C.2.

Member of the A.E.I. Group of Companies.

Telephone: Gerrard 8660.

Telegrams: Ediswan, Westcent, London.

SP70

CLASSIFIED ANNOUNCEMENTS

The charge for these advertisements at the LINE RATE (if under 1" or 12 lines) is : Three lines or under 7/6, each additional line 2/6. (The line averages seven words.) Box number 2/- extra, except in the case of advertisements in "Situations Wanted," when it is added free of charge. At the INCH RATE (if over 1" or 12 lines) the charge is 30/- per inch, single column. Prospectuses and Company's Financial Reports £14 0s. 0d. per column. A remittance must accompany the advertisement. Replies to box numbers should be addressed to : "Electronic Engineering," 28, Essex Street, Strand, London, W.C.2. Advertisements must be received before the 14th of the month for insertion in the following issue.

OFFICIAL APPOINTMENTS

ADMIRALTY: Electrical Engineers. The Civil Service Commissioners invite applications from men for Main Grade and Basic Grade Electrical Engineers for service in Admiralty. Candidates must have been born on or before 1st October, 1922, for Main Grade and on or before 1st October, 1927, for Basic Grade. They must have a University Honours Degree in Engineering or an equivalent qualification and a minimum of two years' practical training followed by practical experience in a responsible electrical engineering post of at least three years for Basic Grade and of eight years for Main Grade or such other experience as the Commissioners consider equivalent. Present London salary scales (somewhat lower in provinces). Basic Grade—Minimum £628 (at age 25) then according to age up to £875 at 34. Maximum £970. Main Grade—£870 by eight annual increments to £1,280. Exceptionally a starting salary above the minimum of the grade may be granted. Higher posts normally filled by promotion. The London salary scale of the next higher grade of Superintending Electrical Engineer is £1,331 x £50 — £1,536. Full particulars and application forms from the Civil Service Commission Scientific Branch, Trinidad House, Old Burlington Street, London, W.1, quoting S210/52. Completed forms to be returned by 16th October, 1952. W 2962

ASSISTANT (SCIENTIFIC) CLASS. The Civil Service Commissioners give notice that an Open Competition for permanent and pensionable appointment to the basic grade will be held during 1952. Interviews will be held throughout the year, but a closing date for the receipt of applications earlier than December, 1952, may eventually be announced either for the competition as a whole or in one or more subjects. Candidates must be at least 17½ and under 26 years of age on 1st January, 1952, with extension for regular service in H.M. Forces, but candidates over 26 with specialized experience may be admitted. All candidates must produce evidence of having reached a prescribed standard of education, particularly in a science subject and of thorough experience in the duties of the class gained by service in a Government Department or other civilian scientific establishment or in technical branches of the Forces, covering a minimum of two years in one of the following groups of scientific subjects: (i) Engineering and physical sciences. (ii) Chemistry, bio-chemistry and metallurgy. (iii) Biological sciences. (iv) General (including geology, meteorology, general work ranging over two or more groups (i) to (iii) and highly skilled work in laboratory crafts such as glass-blowing). Salary according to age up to 25: £236 at 18 to £363 (men) or £330 (women) at 25 to £500 (men) or £417 (women); somewhat less in the provinces. Opportunities for promotion. Further particulars and application forms from Civil Service Commission, Scientific Branch, Trinidad House, Old Burlington Street, London, W.1, quoting No. S59/52. Completed application forms should be returned as soon as possible. W 2965

B.B.C. requires Engineer in Studio Equipment Section of Planning and Installation Department in London. Appointment will be in salary grade £795-£1,065. Duties include specification, ordering and testing of equipment used for transmission of films for television and for making films from television; planning complete installations including such equipment; liaison with manufacturers and supervision of contracts. Requirements include considerable practical experience in the use of high-grade cinematographic equipment and thorough knowledge of principles of its design and of associated techniques relating to lenses, film stock, film processing, etc.; good knowledge of principles of television, and preferably some experience of application of films for television purposes. A Degree in Electrical Engineering or Physics, or equivalent qualification desirable.

Applications to Engineering Establishment Officer, B.B.C., London, W.1, giving details of qualifications and experience within 7 days. W 2945

B.B.C. requires a limited number of Technical Assistants, age 21 or over in Operations and Maintenance Department for service at Transmitter, Studio, and Television Centres throughout the United Kingdom. Knowledge of mathematics, electricity and magnetism to School Certificate Standard; experience in electrical or radio engineering an advantage. Salary £360 p.a. with annual increments to £470 p.a. maximum. Promotion prospects. Application forms from Engineering Establishment Officer, Broadcasting House, London, W.1 (enclosing addressed foolscap envelope). After completion, forms to be sent to B.B.C., c/o Ministry of Labour, 211 Marylebone Road, London, N.W.1, marking "T.A.11". W 2972

MINISTRY OF SUPPLY require experimental officer in Radio Department, Royal Aircraft Establishment, Farnborough, Hants, for experimental design of aircraft aeriels for modern high speed aircraft. Thorough knowledge of properties of aeriels, transmission line filters and matching units, with practical experience of measuring techniques and aerial development in V.H.F. wave band, essential. Knowledge of aircraft constructional materials and techniques, as far as these affect aerial design, is also required. Candidates should have Higher School Cert. (Science) or equivalent, but possession of higher qualifications in physics or engineering may be an advantage. Salary according to qualifications and experience within inclusive range: £597-£754 p.a. (Min. age 26.) Rates for women somewhat lower. Post unestablished. Application forms from Ministry of Labour and National Service, Technical and Scientific Register (K), Almack House, 26 King Street, London, S.W.1, quoting D.352/52A. Closing date 10th October, 1952. W 2948

MINISTRY OF SUPPLY require Experimental Officers in Research and Development Establishments. Most posts concern Guided Weapons, and require knowledge and experience of electronics. Minimum qualification H.S.C. (Science) or equivalent but higher qualifications in Physics or Electrical Engineering an advantage. Salaries according to age, experience, etc., within inclusive ranges: Experimental Officer (min. age 26), £597-£754. Assistant Experimental Officer, £264 (age 18)-£555. Somewhat lower for women. Posts unestablished. Application forms from M. L. and N. S., Technical and Scientific Register (K), Almack House, 26 King Street, London, S.W.1, quoting A233/52/A. Return within 14 days. W 2949

MINISTRY OF SUPPLY have vacancies at Research Establishment near Sevenoaks, Kent, in following fields: (1) Electronic circuit design, (2) Trials of experimental equipment, (3) Development of electro-mechanical devices, (4) Measurement of transient phenomena on electrical and explosive equipments, (5) Development work on electrical components, (6) Maintenance of laboratory electronic instruments. Candidates must possess Higher School Certificate (Science), or equivalent, higher qualifications in Physics or Electrical Engineering may be an advantage. Salary within inclusive ranges £597-£754 for Experimental Officer (minimum age 26) and £264 (age 18)-£555 for Assistant E.O. Rates for women somewhat lower. Posts unestablished. Application forms from Ministry of Labour and National Service, Technical and Scientific Register (K), Almack House, 26 King Street, London, S.W.1, quoting D.365/52-A. W 2962

RUNWELL HOSPITAL, Near Wickford, Essex. Applications are invited for the post of Senior Technician in the Department of Electroencephalography. Previous experience essential. Applications should be sent to the Physician Superintendent, T. Fitzroy Kelly, Secretary. W 2952

SITUATIONS VACANT

The engagement of persons answering these advertisements must be made through a Local Office of the Ministry of Labour or a Scheduled Employment Agency if the applicant is a man aged 18-64 inclusive or a woman aged 18-59 inclusive unless he or she, or the employment, is excepted from the provisions of the Notification of Vacancies Order, 1952.

A SENIOR COMMERCIAL APPOINTMENT is offered in the Equipment Division of Mullard Ltd., to an applicant having experience in the operational or systems planning aspects of radio communications and/or broadcast transmitters and systems. Candidates should have a University Degree or equivalent, an interest in the systematic organization and handling of various types of equipment and should be experienced in dealing with customers at all levels. Please forward personal details including salary required to the Personnel Officer, Mullard Ltd., Century House, Shaftesbury Avenue, W.C.2. Applications will be treated in confidence. W 2929

ADDITIONAL Senior and Junior Engineers are required by a small but progressive firm of electronic instrument manufacturers in Surrey for interesting development work on important projects. Applicants should possess a Degree in physics, and should have industrial experience and a practical mind. Both salary and prospects will be good for the right men. Apply Box No. W 2933.

ADMINISTRATIVE PERSONAL ASSISTANT to Research Director of Decca Radar Limited required. Scientists or engineers are invited to apply for this senior appointment where the successful applicant will be responsible for the administration of the Laboratory for recruitment, training and welfare of the personnel. Please write to Research Director, Radar Laboratory, 2, Tolworth Rise, Surbiton, Surrey. W 2973

AMBASSADOR RADIO and Television require Electronic Engineers for laboratory research and development work. Applicants must have had reasonable experience in electronic research and development. They should be Graduates in Physics, Telecommunications or Electrical Engineering, or hold the Higher National Certificate or City and Guilds Final in Radio subjects. Progressive positions are offered to men who can prove their ability. Commencing salary in accordance with qualifications and experience. Applications must be made in writing in the first instance, intimating availability for interview at Princess Works, Brighouse, Yorkshire. W 2879

AN ELECTRONIC ENGINEER is required to investigate Vibration Phenomena on Guided Missile projects. Applicants should be experienced in the use of, and capable of developing, Electronic Equipment for this purpose and should hold a H.N.C. or recognized equivalent, or have exceptional experience. Details should be sent to the Assistant Manager, (A) The Fairey Aviation Company Limited, Dept. E, Research and Armament Development Division, Heston Aerodrome, Hounslow, Middlesex. W 2931

AN ENGINEER required for Service Dept. Knowledge of electronic measuring instruments essential. Commencing salary according to age and experience. Write giving full details of qualifications and experience to Dawe Instruments Ltd., 130, Uxbridge Road, Hanwell, London, W.7. W 2966

AN EXCELLENT opportunity exists in a new section for a first rate engineer, thoroughly experienced in the development and design of high power radar modulators. This is a permanent position, carrying a substantial salary and superannuation facilities. The post calls particularly for a man with initiative and energy. Applications, quoting reference 921 D, from suitably qualified men will be welcomed by Central Personnel Services, English Electric Co. Ltd., 24-30 Gillingham Street, London, S.W.1. W 2953

SITUATIONS VACANT (Cont'd.)

The engagement of persons answering the advertisements must be made through a Local Office of the Ministry of Labour or a Scheduled Employment Agency if the applicant is a man aged 18-64 inclusive or a woman aged 18-59 inclusive unless he or she, or the employment, is excepted from the provisions of the Notification of Vacancies Order, 1952.

APPLICATIONS are invited for a post with a Company engaged in airborne geophysical surveying. Applicants should have a good knowledge of Radio and Electronics equipment, and be prepared to go abroad on flying operations. Previous flying experience an asset. Apply Box No. W 2944.

BELLING & LEE LTD., Cambridge Arterial Road, Enfield, Middlesex, require research assistants in connexion with work on electronic components, fuses, interference suppressors and television aeriels. Applicants must be graduates of the I.E.E. or possess equivalent qualifications together with similar laboratory experience. Salary will be commensurate with previous experience: five day week, contributory pension scheme. Applications must be detailed and concise, and will be treated as confidential. W 138

CHIEF ELECTRONIC ENGINEER (between 35-45) required with mechanical engineering background for a Company engaged on an expanding development programme in Industrial Electronic production equipment and automatic special purpose machines and test gear. A.M.I.E.E. or equivalent desirable though extensive practical experience will rank higher than purely academic qualifications. Write Box No. W 2961.

CHIEF INSPECTOR required. Applicants must have a sound basic knowledge of Radio Theory and be conversant with VHF and Radar. Applications should be made in writing giving full details of experience and qualifications to Personnel Manager, Murphy Radio Limited, Welwyn Garden City. W 2980

DECCA RADAR LTD. invites applications from microwave, electronic and mechanical engineers to join the Company in its extensive work in a wide field of microwave link and radar development. The Company offers excellent starting salaries and first rate opportunities for men to exploit their initiative and to rise rapidly to responsible posts. Graduates without industrial experience who are prepared to undertake intensive training are also invited to apply for junior posts. Apply in writing to Research Director, Radar Laboratory, 2, Tolworth Rise, Surbiton, Surrey. W 150

DECCA RADAR LTD. require draughtsmen and junior draughtsmen for Research Drawing Office, preferably experienced in any of the following fields: Radar, radio and electronic circuits, electro-mechanical devices, light mechanical engineering. Knowledge of workshop practice essential, applicants must possess Ordinary National Certificate or equivalent. Positions are permanent and progressive; salaries based on A.E.S.D. rates. Tracers (female) also required. Write giving full details to Chief Draughtsman, Decca Radar Limited, 2, Tolworth Rise, Surbiton, Surrey. W 151

DESIGNERS required for Factory Test Apparatus. Experience in Pulse Techniques essential. Apply Personnel Manager, E. K. Cole Ltd., Ekco Works, Malmesbury, Wilts. W 2885

DEVELOPMENT engineer or physicist is required for work concerned with transistor and cold cathode valve circuitry. Degree or H.N.C. in electrical engineering or physics with electronics or telecommunications is essential. Previous experience would be useful. Appointment is at Stanmore. Apply to the Staff Manager (Ref. GBLC/S/671) Research Laboratories of the General Electric Co. Ltd., Wembley, Middlesex, stating age, qualifications and experience. W 2937

DRAUGHTSMEN: one Senior, one Junior, required for North London Manufacturers of Electro-Mechanical Scientific Instruments and Electrical Equipment. Early move to Stevenage where housing available. Write Box No. W 2963.

DRAUGHTSMEN. A large engineering company and drawing office in Central London has several vacancies for men who have a wide experience in the light electro-mechanical field.

These are permanent and pensionable posts connected with both important defence projects and long term private development work. Applications are invited from men with sufficient experience and ability to justify from good salaries. Please write in confidence giving full details of past experience quoting reference L.19 to Box No. W 2977.

DRAUGHTSMEN required. Must have sound experience in Radio, Television or Electronic Design. North London Area. Knowledge of Government Department practice desirable. Special opportunities and pay in excess of accepted minima. C/o Newspaper. Write Box No. W 2887.

DRAUGHTSMEN. Senior and Junior Electro Mechanical and Circuit Draughtsmen required for work on electronic computing and training equipment, including Flight Simulators. Location near Waterloo station. Apply in writing to Mr. G. B. Ringham, Chief Engineer and Manager, Flight Simulator Division, Redifon Ltd., Broomhill Road, Wandsworth, S.W.18. W 2889

E. K. COLE LTD. (Malmesbury Division) invite applications from Electronic Engineers for permanent posts in Development Laboratories engaged on long-term projects involving the following techniques: 1. Pulse Generation and Transmission. 2. Servo Mechanism. 3. Centimetric and V.H.F. Systems. 4. Video and Feedback Amplifiers. 5. V.H.F. Transmission and Reception. 6. Electronics as applied to Atomic Physics. There are vacancies in the Senior Engineer, Engineers and Junior Grades. Candidates should have at least 3 years' industrial experience in the above types of work, together with educational qualifications equivalent to A.M.I.E.E. examination standard. Commencing salary and status will be commensurate with qualifications and experience. Excellent opportunities for advancement are offered with entry into a Pension Scheme after a period of service. Forms of application may be obtained from Personnel Manager, ECKO Works, Malmesbury, Wilts. W 2800

ELECTRICAL ASSISTANT required for an industrial metallurgical research laboratory in the S.E. London area, to help with problems connected with furnaces and control equipment. National Certificate in electrical engineering a minimum requirement, with some knowledge of electronics an advantage. Write giving full particulars to Box No. W 1568.

ELECTRICAL ENGINEERS are required for interesting and varied work in the Nelson Research Laboratories, English Electric Co. Ltd., Stafford. Applicants should have sound workshop and some drawing office experience and will be required to control the engineering of electronic, H.F. heating or vacuum equipment beyond the Laboratory stage and therefore, should have had experience in one or more of these fields. These posts offer ample scope for advancement to men with initiative and ability; salary according to qualifications and experience comparable with present-day levels. Please write, quoting reference 1016 and giving full details to, Central Personnel Services, English Electric Co. Ltd., 24-30 Gillingham Street, London, S.W.1. W 2950

ELECTRICAL ENGINEER or Physicist with Higher National Certificate or equivalent is required for the design of small quantities of special transformers for experimental apparatus. This appointment is at Stanmore. Apply to the Staff Manager (Ref. GBLC/S/638) Research Laboratories of The General Electric Co. Ltd., Wembley, Middlesex, stating age, qualifications and experience. W 2930

ELECTRONIC ENGINEER required with experience in microwave techniques and measurement. Salary according to qualifications and experience. Box No. W 1554.

ENGLISH ELECTRIC COMPANY LTD., Luton, invite applications for permanent posts in a department developing and engineering in a wide variety of specialized electronic circuits. Previous experience in such work would be an asset and, for one vacancy, some experience in optics or oscillography would be a recommendation. Salaries will be in accordance with qualifications and experience, up to £625 per annum. The laboratories are new and pleasantly situated. Please write, giving full details and quoting reference 1002, to Central Personnel Services, English Electric Co. Ltd., 24-30 Gillingham Street, London, S.W.1. W 2839

ENGLISH ELECTRIC CO. LTD., Luton, have a vacancy for an Electronics Engineer with drawing office experience for liaison between laboratory and drawing office. Higher National Certificate or equivalent an advantage, but not essential. Salary according to experience and qualifications in the range of £500 to £650 with good prospects. Please write, giving full details and quoting ref. 988A to Central Personnel Services, English Electric Co. Ltd., 24-30 Gillingham Street, London, S.W.1. W 2947

ENGINEER, I.E.E. or equivalent standard wanted for interesting electronic development. Good prospects for engineer with wide outlook. Applicants must be British and between 25 and 35. Write stating details of experience, etc., to Works Manager, Revo Electric Co. Ltd., Tipton, Staffs. W 1558

ENGINEERS required for interesting work on components for Telecommunications and Television Transmission Equipment. Should be capable of undertaking development work without supervision. Scope for men with enterprise and imagination with suitable experience. Degree or equivalent desirable but not essential. Apply Box No. W 2834.

ELECTRO-MECHANICAL ENGINEERS required with good academic qualifications, apprenticeship, theoretical background and knowledge of production methods for development work. Experience in electrical methods of computation, servo theory and instrument design desirable. Apply with full details of age, experience and salary required to the Personnel Manager, Sperry Gyroscope Co., Ltd., Great West Road, Brentford, Middx. W 2904

ENGINEERING REPRESENTATIVES with contacts in industry required to obtain specific problems for group of consultants. Write in first instance. Box No. W 1566.

EXPERIENCED Radio Testers and Inspectors required for production of communication and radio apparatus. Also Instrument makers, wireers and assemblers for Factory Test apparatus. Apply Personnel Manager, E. K. Cole Ltd., Ekco Works, Malmesbury, Wilts. W 146

EXPERIENCED ELECTRONIC ENGINEER required by the English Electric Company Limited, Luton, for investigation into the nature of mechanical vibrations in connexion with guided missiles project. Position of responsibility in a new department is available for a well qualified man. Adaptability and ability to develop electronic measuring techniques required. H.N.C. or equivalent and some experience of vibration work essential. Salary according to qualifications. Please write giving full details of qualifications and experience and quoting reference "850 C" to Central Personnel Services, English Electric Company Ltd., 24-30, Gillingham Street, London, S.W.1. W 2846

EXPERIENCED MEN (ex-Service Radar Mechanics preferred) are required for duties in the Electronics Division of Saunders-Roe Limited. Applicants should be capable of intelligent assembly and wiring of a wide variety of electronic apparatus from circuit diagrams. Write, giving details of experience, age, etc., to the Personnel Officer, Saunders-Roe Limited, East Cowes, Isle of Wight. W 2895

EXPERIENCED DRAUGHTSMEN required in the following fields: A. Carrier Telephony. B. Electronic Instruments. C. Radio Receivers and Transmitters (From 10kW). Write stating qualifications, experience and wages required to Mullard Equipment Ltd., Brathway Road, Wandsworth, S.W.18. W 2943

EXPERIMENTAL ELECTRICIAN, ENGINEER, B.Sc., preferably Physicist with electronic experience. Capable of carrying out on his own initiative and to a satisfactory conclusion, development work in connexion with electrical discharge phenomena applicable to manufacturing processes. Well-paid permanent position with first-class Company, Northwest London area, offered to suitable applicant. Write giving personal details, qualifications, age, experience and salary required to Box No. W 2940.

EXPERIENCED COMPONENT engineers are urgently required by a large Midland firm for work of National importance. Applicants

CLASSIFIED ANNOUNCEMENTS
continued on page 4



By Appointment to the Professional Engineer...

ATTENUATORS · FADERS · STUD SWITCHES AND TOGGLE SWITCHES
WIREWOUND POTENTIOMETERS · HIGH STABILITY CARBON RESISTORS
WIREWOUND RESISTORS · PLUGS AND SOCKETS · TERMINALS
KNOBS DIALS AND POINTERS

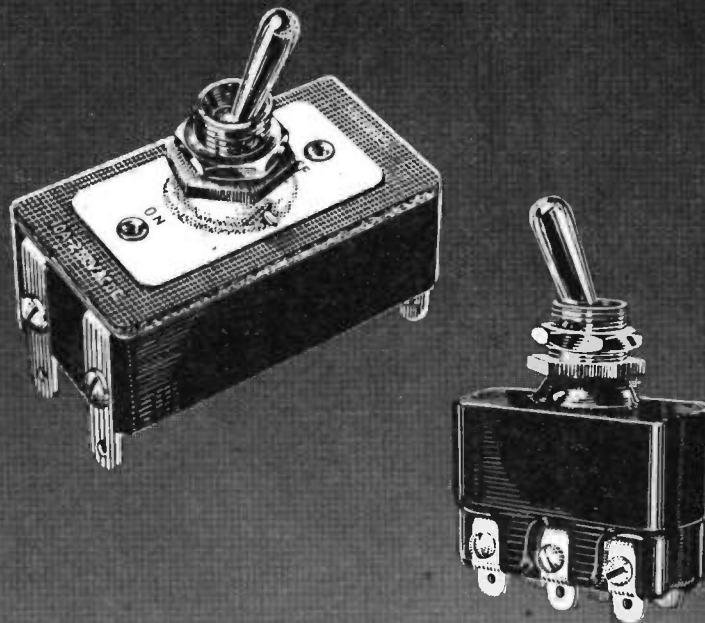

TOGGLE SWITCHES

10 Amps./250v. AC/DC Range
Double Pole ON/OFF Operation
Fully R.C.S.C. Approved

Type 501085
6 Amps./250 v. AC/DC
Double Pole Change-over Operation

PAINTON
Northampton England

SITUATIONS VACANT (Cont'd.)

The engagement of persons answering these advertisements must be made through a Local Office of the Ministry of Labour or a Scheduled Employment Agency if the applicant is a man aged 18-64 inclusive or a woman aged 18-59 inclusive unless he or she, or the employment, is excepted from the provisions of the Notification of Vacancies Order, 1952.

selected will be required to build up a new section specializing in selection and design of electrical and mechanical components for electronic equipment, together with associated light and medium heavy control gear, transformers and wiring. Applicants should have a full working knowledge of service specifications and type approval procedure, experience of component design and an understanding of ratings. Please write giving full details of experience and qualifications and quoting reference IHF to Box No. W 2951.

FERRANTI LTD., Moston, Manchester, have vacancies for: (1) Mechanical/Electrical Engineers of proved ability in the design and application of (a) Gyroscopic Instruments (b) Small Electric Servos and Analogue Computers. Candidates should be able to show proof of past achievement in these fields rather than high academic attainments. Salary in the range of £1,000-£1,250 p.a. (2) Mechanical/Electrical Engineers for development work on (a) and (b) above. Preference will be given to candidates who can show evidence of practical achievement. Salary in the range of £750-£850 p.a. The Company has a Staff Pensions Scheme. Application forms from Mr. R. J. Hebbert, Staff Manager, Ferranti Limited, Hollinwood, Lancs. Please quote reference H.N. W 2934

FERRANTI LTD., Edinburgh—invite applications from suitably qualified persons for the position of Research Engineer in their Small Transformer Department in Edinburgh. The duties involve investigations into new techniques and materials associated with transformers for use in electronic equipment with a view to their ultimate use in large-scale production. Candidates should preferably have a University Degree and experience in (1) Transformer design and development tendencies and/or (2) Electronic component research. Staff Pension Scheme and excellent conditions and equipment. Reply quoting Ref. T/RE and give full details of age, qualifications and experience to the Personnel Officer, Ferranti Ltd., Ferry Road, Edinburgh. W 2941

FERRANTI LTD., Moston, Manchester, have the following vacancies for work in connexion with the development of cathode ray tubes for television, oscillography and special purposes: (1) Senior Engineers and Scientists to take charge of research and development sections. Applicants should have a good Degree in physics, electrical engineering or glass technology, and have had experience in supervising development work. Salary according to qualifications and experience, in the range £750 to £1,250 per annum. Please quote reference GCT/1. (2) Engineers and Scientists for work in the following fields: Thermionic emission, vacuum techniques, electron optics, photoelectric phenomena, electronic circuits, glass technology and high-voltage techniques. Qualifications include a good Degree or equivalent. Previous experience would be an advantage, though not essential. Salary, according to qualifications and experience, in the range £450 to £1,000 per annum. Please quote reference GCT/2. (3) Mechanical or Production Engineers to undertake the development of machinery for mass-production of electronic devices. Qualifications etc. as in (2). Please quote reference GCT/3. (4) Technical Assistants for experimental work in the fields listed in (2) above. Qualifications are a degree or Higher National Certificate. Salary range £400 to £600 per annum according to age and qualifications. Please quote reference GCT/4. The Company has a Staff Pensions Scheme. Application forms from Mr. R. J. Hebbert, Staff Manager, Ferranti Limited, Hollinwood, Lancs. Please quote appropriate reference. W 2917

GRADUATE engineers or physicists are required for work at Wembley and Stanmore in connexion with (a) I.F. receivers (b) microwave and V.H.F. equipment (c) aerials (d) magnetrons. All vacancies are of an interesting experimental nature and men with a practical flair combined with good academic qualifications are needed. Apply to the Staff Manager (Ref. GBLC/679) Research Laboratories of The General Electric Co. Ltd., Wembley, Middlesex, stating age and record. W 2936

GUIDED WEAPONS DEVELOPMENT offers good opportunities for Senior and Junior Electronic, Electrical, Radio and Mechanical Engineers and Draughtsmen, Aerodynamicists, Technical Authors, and Computers (female); also for skilled and semi-skilled Fitters, Electronic Wiremen, Toolmakers and Machine Tool

Operators. Apply, quoting reference S.P. and giving particulars, qualifications and experience, to the Employment Manager, Vickers-Armstrongs Limited (Aircraft Section), Weybridge, Surrey. W 2914

INSTRUMENT ENGINEERS required for the development of control systems for aircraft. Candidates must be British born between the ages of 25 and 35, and be capable of carrying out development of electronic or electro-mechanical systems on their own initiative. Pension scheme in force. Salary range £550-£750. Apply, quoting Ref. A.A., to Box No. W 2954.

JUNIOR DEVELOPMENT ENGINEERS are required to assist in development of precision electronic laboratory instruments. Successful applicants will be engaged on interesting long-term projects concerned with the development of a wide range of equipment. The appointments are of a permanent nature, they carry considerable technical responsibility and offer scope for the exercise of individual initiative. Applicants should have had previous practical experience of development, preferably in the instrument field. Theoretical qualifications ranging from O.N.C. (or an equivalent standard) to a University Degree in Communications Engineering or Physics are acceptable. Salaries are in the range of £350-£650 p.a. and are dependant upon age, qualifications and experience. Applications should be made to Personnel Manager, Furzehill Laboratories Ltd., Boreham Wood, Herts. W 147

JUNIOR ELECTRONIC ENGINEER for test and development high grade instruments. Excellent opportunity for experience with prospects of advancement in small but enterprising firm. Surrey area. Box No. W 2969.

MAINS RADIO GRAMOPHONES LTD. have vacancies for development engineers for design work on domestic radio and television. The openings cover a wide field from basic technical research to construction of experimental receivers and models. The positions will be permanent, carrying Staff Status, Superannuation Scheme, etc., for suitable applicants. Application must be made by letter in the first instance, giving all relevant details, to: Mains Radio Gramophones Limited, 359, Manchester Road, Bradford. W 1569

MIDDLESEX HOSPITAL MEDICAL SCHOOL. Department of Physics Applied to Medicine. Laboratory Technician (Minimum age 26) required for maintenance and construction of prototype electronic equipment. Salary £410 p.a. rising to £475 plus £30 London weighting and family allowance, with superannuation. Apply immediately to Secretary, Barnato Joel Laboratory, Middlesex Hospital, W.1. W 1571

MURPHY RADIO LTD. have vacancies for designer draughtsmen in their Electronics Division. A varied programme ensures opportunity of widening experience with excellent prospects. Apply giving particulars of training and experience to Personnel Manager, Murphy Radio Ltd., Welwyn Garden City, Herts. W 2884

NELSON RESEARCH Laboratories, English Electric Co., Ltd., Stafford, have vacancies for two senior research scientists to study the influence of physical and metallurgical properties on the magnetic characteristics of ferromagnetic materials and the development of improved materials. Applicants must have a good Honours Degree and several years' post-graduate and industrial experience on the physics and metallurgy of magnetic materials. Previous experience of leading a group is desirable but not essential. Please write giving full details and quoting reference 310 C. to Central Personnel Services, English Electric Co., Ltd., 24-30, Gillingham Street, London, S.W.1. W 2958

PHYSICIST required for experimental work in Leeds upon development and test of gamma radiation detectors. Preferably a young graduate with some research experience, not necessarily in this field. Manipulative skill essential and experience of electronic equipment very desirable. Salary in range £400-£600 according to qualifications. Apply Box No. W 1572.

PHYSICISTS required by large electrical firm in South-West for vacuum tube development. Good salary according to qualifications and good opportunities for initiative. Five-day week. Pension scheme. Write, in confidence, giving full particulars of training and experience to Box N. 6728 A. K. Advg., 212a Shaftesbury Ave., W.C.2. W 2946

PHYSICAL CHEMIST required having experience and an interest in the electrical properties of materials. Salary according to qualifications and experience. Box No. W 1560.

PHYSICAL CHEMIST required having experience and an interest in the electrical properties of materials. Salary according to qualifications and experience. Box No. W 1553.

PHYSICISTS AND ELECTRONIC ENGINEERS. Interesting and varied work on industrial application of measurement techniques. Vacancies exist for experienced staff in Research Department of West London Engineers. Please forward full details of age, education, qualifications, experience and salary required to Box A. 208, Central News Ltd., 17, Moorgate, London, E.C.2. W 2970

PHILIPS BALHAM WORKS. 45 Niehtingale Lane, Balham, S.W.12, require young Electronic Engineer, minimum qualifications Higher National Certificate, for development of electro-medical and radiation instruments. Permanent appointment. Write stating age, training, experience and salary required. W 2938

REQUIRED, Laboratory Assistant for maintenance of electronic equipment in Aylesbury, Bucks. Experience in operation and maintenance of electronic equipment necessary. Skilled ex.R.A.F. tradesman would be considered. Salary £7 to £10 per week according to experience. Reply to Box No. W 1555.

RESEARCH ENGINEER required for Television Development Laboratory. Previous experience with reliable manufacturer essential. Write giving details of age, qualifications and salary required, to Personnel Manager, Vidor Limited, West Street, Erith, Kent. Applications treated confidentially. W 2966

ROYAL FREE HOSPITAL OF MEDICINE. Hunter Street, London, W.C.1. Electronics technician to work in Inter-departmental workshop on construction and repair of research apparatus. Salary £410 rising to £475 p.a. plus London weighting allowance and superannuation. Applications with full details and two testimonials to the Warden and Secretary as soon as possible. W 2968

SALES MANAGER'S Assistant required in Electronics Division of large Company, to take charge, without supervision, of sales correspondence, records and routine. Applicants should possess Degree in Electrical Engineering or Graduateship of the I.E.E. or Brit.I.R.E. and show successful sales record. Write giving full particulars of experience and salary expected to Box E.C.528 c/o 191 Gresham House, E.C.2. W 2956

SENIOR AND JUNIOR Electronic Engineers required for development of Guided Missiles and other work of national importance. Good academic qualifications, a thorough knowledge of low frequency electronic circuits including D.C. Amplifiers, and practical design experience of lightweight electronic equipment are desirable. The posts are pensionable, and offer good scope for a man to learn and develop new techniques and advance his position. Apply to the Personnel Manager, Sperry Gyroscopic Co., Ltd., Great West Road, Brentford, Middx., giving full details of age, qualifications and experience and salary required. W 2906

SENIOR Electro-Mechanical Engineer with good academic and professional qualifications, and experience of modern production methods required for development of airborne equipment, including gyroscopic devices and instrument servo-mechanisms. Applicants should have at least 5 years' experience in this class of work. Excellent prospects. Write fully stating age, experience and salary expected to Box E.C.527, c/o 191 Gresham House, E.C.2. W 2957

CLASSIFIED ANNOUNCEMENTS
continued on page 6

FAULTLESS FLUXING

GIVES PRECISION SOLDERING

* Enthoven Superspeed has a continuous stellate core of ACTIVATED Rosin which gives an exceptionally high wetting and spreading power, enabling the flux and solder to be drawn rapidly by the force of capillary attraction into restricted spaces, even in the vertical plane. The activating agent volatilizes at soldering temperature.

* The distinctive stellate core ensures a more rapid release of flux and therefore immediate wetting by the solder, at moderate soldering-bit temperatures that lessen the risk of alteration to the electrical and mechanical properties of components.

SAVES TIME, CUTS COSTS

Superspeed

"WHITE FLASH" activated rosin-cored solder for general electrical, electronic and telecommunication work, and all standard uses. A.I.D. and G.P.O. approved. Complies with M.O.S. Specification DTD 599.

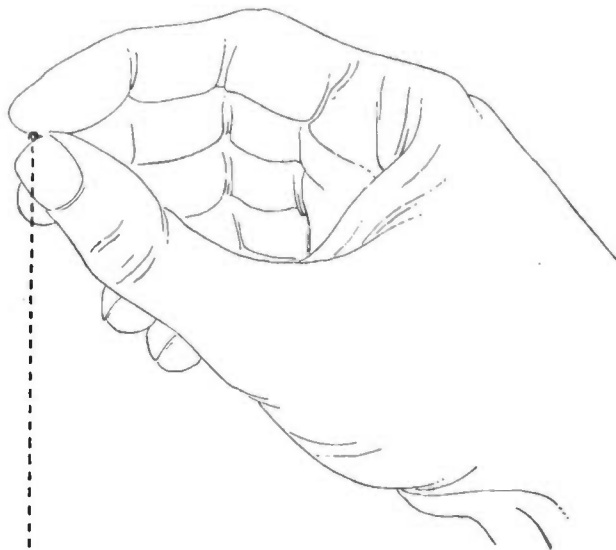

PRECISION SOLDERING DEMANDS

Superspeed

* The flux in Enthoven Superspeed is always released in exactly the correct proportion. Dry and H.R. joints due to underfluxing or overfluxing cannot occur. One application of Superspeed always does the job effectively.

* The residue from Superspeed flux is non-corrosive and non-hygroscopic. It solidifies immediately to a hard, transparent film of high dielectric strength and insulation resistance.

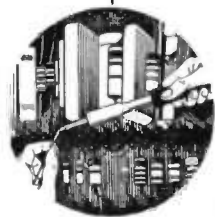
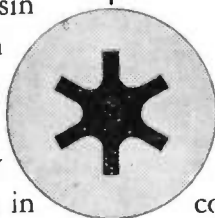

AN **ENTHOVEN** PRODUCT

Made by

H. J. ENTHOVEN & SONS, LTD.

89 Upper Thames Street, London, E.C.4. Tel: Mansion House 4533
who will gladly send you their comprehensive Superspeed booklet.
Technical advisers are available for free consultation.

SITUATIONS VACANT (Cont'd.)

The engagement of persons answering these advertisements must be made through a Local Office of the Ministry of Labour or a Scheduled Employment Agency if the applicant is a man aged 18-64 inclusive or a woman aged 18-59 inclusive unless he or she, or the employment, is exempted from the provisions of the Notification of Vacancies Order, 1952.

SENIOR ELECTRONIC ENGINEER required. Experience of Helicopter instrumentation and of analogue computers would be an advantage. Apply, stating experience, age, etc., to the Personnel Officer, Saunders-Roe Ltd., Southampton Airport, Eastleigh, Hants. W 2852

SENIOR TELEVISION DEVELOPMENT ENGINEER required for Research Laboratory by well-known manufacturer in South East London. Write, giving details of age, qualifications, previous experience and salary required to Personnel Manager. All applications will be treated confidentially. Box No. W 2967.

SYDNEY S. BIRD & Sons Ltd., require an Experienced Engineer for work in connexion with the development and production of Television Components. Experience in the R.F. field is particularly important. Write stating previous experience and salary required to The Managing Director, Cydon Works, Cambridge Arterial Road, Enfield, Middlesex. W 1559

TELEVISION and Radio Designers required by well-known U.S. concern. Excellent opportunity for qualified engineers who desire to emigrate. Initial interview in England after sending full particulars and qualifications to Box No. W 2955.

TECHNICAL ASSISTANT required for Cathode Ray Tube production. Applicants must have had previous experience in a technical capacity on valve development or production. Vacancy offers excellent prospects. Apply in first instance by letter only to: Personnel Department, LJB/S.3, E.M.I. Factories Ltd., Hayes, Middlesex. W 2939

TECHNICAL ASSISTANTS, experienced in dealing with electronic measurement and instrumentation, required for work on Aero Engines and their application. Candidates aged between 25 and 30, possessing Degree or Diploma and willing to deal with problems during flight preferred. Applications stating age, qualifications and details of experience should be addressed to the Divisional Personnel Manager, The Bristol Aeroplane Company Limited, Engine Division, Filton House, Bristol. W 2849

TEST ROOM ASSISTANT, experienced, electro-mechanical, used to prototypes. Write T. & R.P., 25, Bickerton Road, Upper Holloway, N.19. W 1564

TECHNICAL & RESEARCH PROCESSES LTD., require a Designer-Draughtsman with precision mechanical and electronic experience for interesting development projects. Write fully to, 25 Bickerton Road, Upper Holloway, N.19. W 1557

THE ENGLISH ELECTRIC Valve Co. Ltd., Chelmsford, Essex, has several attractive vacancies, Junior and Senior, for Physics and Engineering Graduates to undertake research and development work on vacuum tubes. Applications from graduates who have recently qualified as well as those with industrial and research experience will be considered. Please write, giving full details, and quoting ref. 419F, to Central Personnel Services, English Electric Co. Ltd., 24/30, Gillingham Street, London, S.W.1. W 2975

THE GENERAL ELECTRIC CO. LTD., Brown's Lane, Coventry, have vacancies for Developments Engineers, Senior Development Engineers, Mechanical and Electronic, for their Development Laboratories on work of National Importance. Fields include Microwave and Pulse Applications. Salary range £400-£1,250 per annum. Vacancies also exist for Specialist Engineers in Component design, valve applications, electro-mechanical devices and small mechanisms. The Company's Laboratories provide excellent working conditions with Social and Welfare facilities. Superannuation Scheme. Assistance with housing in special cases. Apply by letter stating age and experience to The Personnel Manager (Ref. CHC). W 2911

THE PLESSEY COMPANY intends to appoint a senior commercial executive to one of their largest divisions which is engaged in the mass production of electronic and electro-mechanical equipment. Applications are invited from men with experience in a post of similar responsibility preferably in an allied industry. Knowledge of production and technical appreciation are desirable qualifications, but experience of sales promotion at high level is essential. This is a senior post, and will be remunerated accordingly. Applications will be treated with the strictest confidence, and should be addressed to the Secretary and Executive Director, The Plessey Company Limited, Ilford, Essex. W 2976

THE PLESSEY COMPANY LIMITED has vacancies in its telecommunications engineering department for senior engineers and draughtsmen to work on long term private ventures and defence projects. Qualifications for senior engineers are a degree in physics or engineering and at least two years' experience in electronic, radio or radar development work. Six or more years' experience of advanced work in the above field will be accepted as an alternative to a degree. Qualifications for draughtsmen are at least two years' drawing office experience on electronic, radio or electro-mechanical devices. The positions are permanent and pensionable and very good salaries are available for experienced men. Applicants should be of British birth and nationality and will be required to work either at Ilford or at the Company's Laboratories near Witham, Essex. Apply in confidence to the Personnel Manager, The Plessey Company, Vicarage Lane, Ilford, quoting reference T.E.D. W 2971

TWO RESEARCH ENGINEERS are required for the initiation and control of electronic projects with ability to undertake responsibility of projects without supervision. An Engineering or Physics Degree plus experience is essential. Commencing salary will be within the range of £650-£850 per annum. Applications should be addressed to the Personnel Manager, Standard Telecommunication Laboratories Limited, Progress Way, Enfield Middx. W 2935

TRIAL ASSISTANTS required for Guided Missiles by prominent engineering organization in Northern Ireland. Applicants should have served a recognized apprenticeship or equivalent, and have good practical experience of one or more of the following: (a) Electronics, Radar or Television. (b) Light Electrical Equipment. (c) Precision mechanical or hydraulic apparatus. Ex-N.C.O.'s of technical branches of the Services considered. Applicants must be prepared to travel. Reply stating age and experience to T.T.I. Box No. W 2964.

VIDOR LTD., Erith, have vacancies for Senior and Junior Draughtsmen with good engineering background, with a flair for designing in mechanical and/or electrical field. Apply to Personnel Manager giving details of age, training and experience. W 2965

VIBRATION ENGINEER required for work on an important Defence Project. Experience of monitoring techniques essential together with some theoretical knowledge of mechanical vibrations and shock. H.N.C. or equivalent preferred but O.N.C. acceptable in special cases. Write stating salary required, age and details of qualifications and experience quoting reference 1000A, to Central Personnel Services, English Electric Co. Ltd., 24-30 Gillingham Street, London, S.W.1. W 2964

WAYNE KERR require several draughtsmen for design and development work on high priority electronic test equipment. The work is interesting and offers considerable scope for men with initiative and design ability. Attractive salaries in excess of the revised A.E.S.D. rates will be offered to suitable applicants. Write giving details of past experience to The Wayne Kerr Laboratories Ltd., Sycamore Grove, New Malden, Surrey. W 2960

Further "Situations Vacant" advertisements appear on pages 56 and 59 in displayed style.

SITUATIONS WANTED

B.S.C., with wide engineering and administrative experience in electronic and light electrical industry, desires change. Highest references. Please write to Box 1563.

FOR SALE

AMERICA'S famous magazine Audio Engineering, 1 year subscription 28s. 6d.; specimen copies 3s. each. Send for our free booklet quoting all others; Radio Electronics, Radio and Tele. News, etc. Willen Limited (Dept. 9), 101 Fleet Street, London, E.C.4. W 198

MAGSLIPS at 1/10th to 1/20 of list prices. Huge stocks. Please state requirements. K. Logan, Westalley, Hitchin, Herts. W 116

PURE BERYLLIUM FOIL, 0.005" thick and Beryllium Metal Discs for X-Ray Tube Windows: Elgar Trading Ltd., 240 High Street, London, N.W.10. W 141

WEBB'S 1948 Radio Map of the World, new multi-colour printing with up-to-date call signs and fresh information: on heavy art paper 4s. 6d., post 6d. On linen on rollers 11s. 6d., post 9d. W 102

MINIATURE STEEL BALLS and Ball Bearings, Swiss and German Precision Work. Quick delivery. Distributors: Insley (London) Limited, 119 Oxford Street, London, W.1. Tel.: Gerrard 8104 and 2730. W 143

ELECTRONIC COMPONENT SUPPLIES. We specialize in the supply of Electronic Components, Accessories, Test Equipment, etc., for Government Depts., Industrial Concerns, Research Establishments, Laboratories, Colleges, etc. Your enquiries and orders will receive our prompt attention. Holiday & Hemminger Ltd., 74/78 Hardman Street, Deansgate, Manchester, 3. Tel. Deansgate 4121. W 148

TOROIDAL COILS wound, and latest potted inductors to close limits. Bel Sound Products Co., Marlborough Yard, Archway, N.19. W 139

OSCILLOSCOPE Mullard B.100 £6. Power valves, Westinghouse 813, 500 watts £2. Rectifiers, R.C.A. 866, £2. Siemens Electronic Flash duty, 250v, 2000 0-2000v £3. T. S. Davis, Hensol, Pontytlun, Glam. W 1570

RESISTANCES WIREWOUND 15 ohm 3 watt 3d., 19 140 680 1 watt 2d., vitreous 45 100 2 watt 3d., 25 1000 1500 3 watt 4d., 50 200 3000 6 watt 5d., 1500 15 watt 10d., 2000 30 watt 1s. 3d., 2500 55 watt 1s. 6d., 800 30 watt tapped every 160 2s.; variable 30K+30K 1s. 3d.; slider 6 amp 4 ohm 8s., 2 1/2 amp 22 ohm 12s. 6d.; condensers, 200v wkg 1mf 3d., 2mf 4d.; rectifiers FW 12v 1A 5s. 6d., 2 1/2A 9s. 6d., 5A 17s 6d., 8A 23s., 24v 1 1/2 times 12v price., 36v twice 12v price, HW 300v 200mA 12s. 6d.; meters 250 microamp (temperature scale) 2" 12s. 6d., super heavy chokes, various low impedances £1, 3KN transformers, various types £5. earphones, single 300 ohms, 1s. 6d.; prices include U.K. carriage, C.W.O.—Parker, 68 Station Road, Petersfield, Hants. W 1565

SINE-COSINE Potentiometers, I pots, Mag slips, Selsyns, 24v Klaxon Motors 1/20 H.P., Mag-slip accessories, all in new condition. Servo-tronic Sales, 1 Hopton Parade, High Road, Streatham, London, S.W.16. See our display advertisement on page 60. W 2918

CLASSIFIED ANNOUNCEMENTS
continued on page 8

Bridge...



There is little fear of burning your bridges in this case—for these Tufnol housings, built to hold copper segments making electrical contacts, combine impressive strength with the highest electrical insulation. This particular installation is in use on large excavators engaged on outcrop workings of coal and iron ore; but Tufnol is serving in countless other ways throughout the Nation's industries in their drive to maintain and increase the export trade. For Tufnol holds a unique balance between the properties of metal and hardwood, with none of the defects of either. Among other virtues, it resists chemical action, possesses high compressive, shear, and tensile

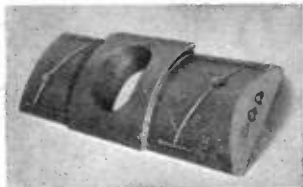

A Tufnol slipper pad for the universal coupling of a rolling mill drive.

strength, withstands moisture and corrosion, is light in weight, and can be quickly and accurately machined by the usual methods. Available in standard sheets, tubes, rods, bars, angles and channels, it can also be supplied in specially moulded shapes. Industry still has countless gaps which Tufnol, with its unlimited possibilities, will be able to fill.

ONLY AN ABRIDGED VERSION

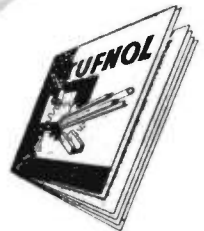

of Tufnol's remarkable properties is recorded here. The full story of Tufnol is revealed in literature which we shall be happy to send you. Let us know where your particular interests lie. If



you have a NEW use for Tufnol, our Technical Staff will be glad to co-operate on it with you. Why not write TODAY?

TUFNOL

REGISTERED TRADE MARK

An ELLISON Product

TUFNOL LTD • PERRY BARR • BIRMINGHAM • 22B

251

SINE-COSINE RESOLVERS (Magslip Transmitters 3", No. 5, AP 10861). These precision instruments can also be used in pairs on 110v A.C. (a) as Voltage Regulators, output 0 to 110v (infinitely variable), and (b) as Selsyn Motors (pull out torque 24 in. oz.). Brand new in tins 45s. ea., post free.—P. B. Crawshay, Tubes £3. Polarograph Heyrovsky £15. Motor generator, 30v 50 amp, £5. Transformer, heavy 166, Pixmore Way, Letchworth, Herts. W 149

CINTEL Standard Electronic Counting Unit for batch total of 25, with counting head and light guides. Complete with all valves, never used, new condition, cost £110 in 1949. Reasonable offer wanted. Box No. W 1556.

800 LBS. M.E.A. 130A Radiometal Laminations for sale at list price. Wilfeo Products, 230/254 Brand Street, Glasgow, S.W.1. W 2942

WANTED

BELGRAVE BUYERS, buy used Mercury, aircraft sparking plugs, Platinum and Silver contacts and waste materials containing precious metal. Forward samples, stating quantities, keenest prices. Non-ferrous scrap metals also purchased. Belgrave Buyers (E.E.), 5 Belgrave Gardens, London, N.W.8. MA1. 7513. W 1558

WANTED for binding. American "Electronics" February and March 1952. State price. Dawe Instruments Ltd., 130, Uxbridge Road, Hanwell, London, W.7. W 2959

WANTED, Electronic Engineering, Volumes 1-14, numbers 1-171. Please write, quoting price, to Librarian, Brown University Library, Providence 12, R.I., U.S.A. W 1567

EDUCATIONAL

CITY & GUILDS (Electrical, etc.) on "No Pass—No Fee" terms. Over 95 per cent successes. For full details of modern courses in all branches of Electrical Technology send for our 144-page handbook—Free and post free. B.I.E.T. (Dept 337C), 17 Stratford Place, London, W.1 W 142

FREE. Brochure giving details of courses in Electrical Engineering and Electronics, covering A.M. Brit., I.R.E., City and Guilds, etc. Train with the Postal Training College operated by an Industrial Organisation. Moderate fees. E.M.I. Institutes, Postal Division, Dept. EE29, 43, Grove Park Road, London, W.4. (Associate of H.M.V.). W 2808

SERVICE

METALWORK.—All types cabinets, chassis racks, etc., to your own specifications. Philpott's Metal Works Ltd., (G4B1), Chapman Street, Loughborough. W 2562

SOLDERING TAGS and Eyelets, Screws, Nuts and Washers for all purposes. Thos. Allnutt & Co., Lee Chapel Lane, Langdon Hills, Essex, Laindon 122. W 1562

THE ELECTRICAL INSTRUMENT REPAIRERS. All kinds of meters, Volt, Amp, Galvo, recording, Electric Clocks, Aircraft instruments repaired. We are also skilled Horologists. Government Ministry enquiries invited. Ask for estimate. Send your enquiries to: Mr. J. R. W. Ridgway, F.B.H.I., J. R. Ridgway & Co., 341 City Road, E.C.1. TERminus 0641. W 1528

FORMULAE TO FACT...

The PARTRIDGE-WILLIAMSON OUTPUT TRANSFORMER

Potted type (as illustrated) £7 5s. 3d.

De Luxe type £6 16s. 6d.



To convert formulae to actual performance implies the use of the very highest standards in the materials and workmanship employed. Since the inception in 1947, of the now world-famous Williamson Amplifier, Partridge "to-specification" components have been the insistent choice of the experts. This transformer is available in a varied range of impedances. Secondary windings are brought out to eight separate sections of equal impedance. Stock types comprise 0.95 ohm, 1.7 ohm, 3.6 ohm and 7.5 ohm sections.

Full technical data on request

PARTRIDGE TRANSFORMERS LTD
ROEBUCK ROAD - KINGSTON BY-PASS - TOLWORTH - SURREY
TELEPHONE - 22601-000 - 6132-0



Now available for early delivery

HIGH STABILITY RESISTORS

FULLY INSULATED

The Radio Resistor Co. Ltd. can now offer early deliveries of the above product of the Rosenthal factories.

These High Stability Resistors are produced in a range from 1 Ω to 1500 M Ω and from 1/20th to 20 watts, in tolerances as fine as ±0.5%. They are extremely stable in use. The temperature co-efficient is low and shelf drift small. Full data is offered to bona fide manufacturers on the

characteristics and performance of this remarkable range of units.

The Rosenthal Company have manufactured high stability resistors for some 22 years and their long experience in this field is unequalled.

THE RADIO RESISTOR CO. LTD.

50 ABBEY GARDENS, LONDON, N.W.8
Telephone: Maida Vale 5522

Rosenthal
RIG

Microwave Test Gear

Metropolitan-Vickers Electrical Company announce a complete range of precision microwave test gear for use in 3 in. x 1½ in. waveguide over a band of wavelengths from 10 cm. to 11 cm.

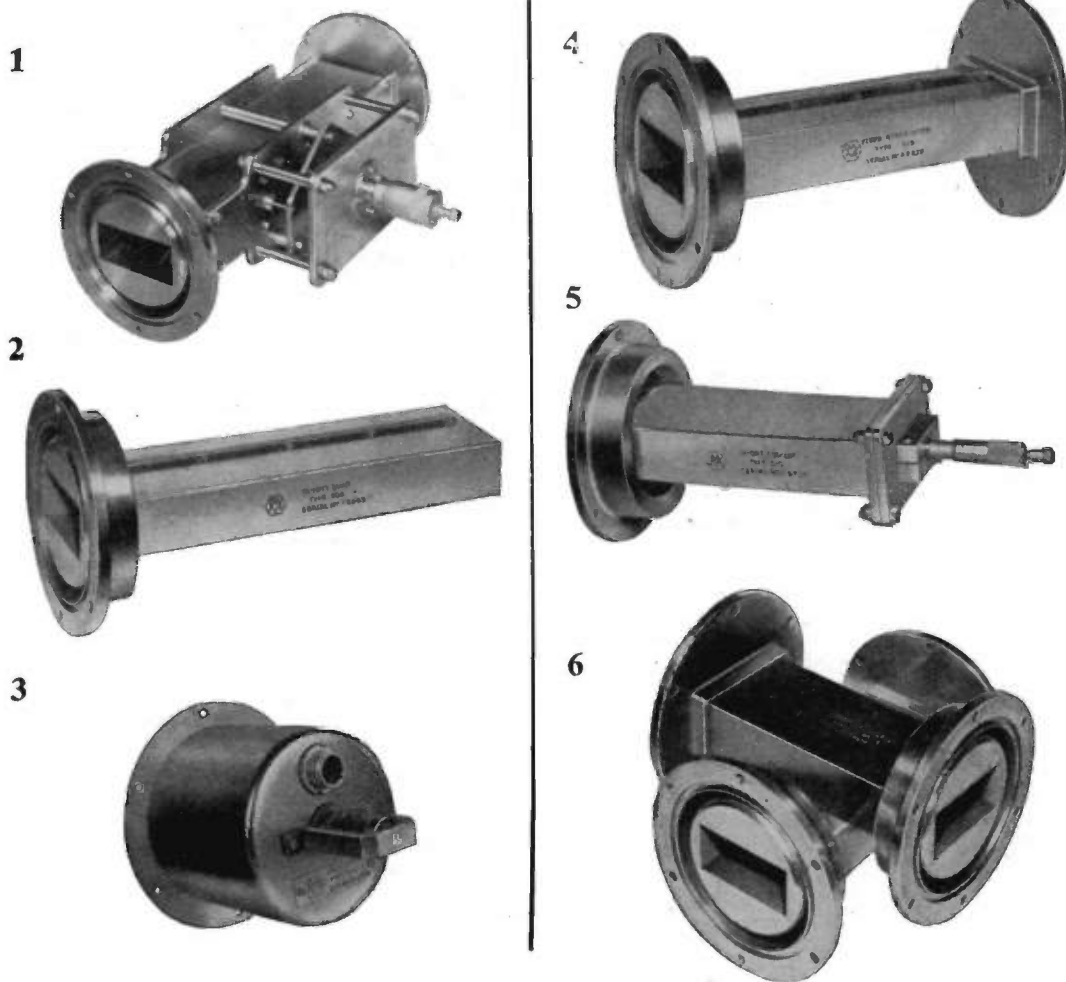

1 PRECISION ATTENUATOR Type 501

2 MATCHED LOAD Type 506

3 OSCILLATOR Type 508

4 FIXED ATTENUATOR Type 519

5 SHORT CIRCUIT Type 510

6 DIRECTIONAL COUPLER Type 504

Other Metrovick microwave equipment includes variable attenuator type 502, standing wave detector type 512, wave meter type 517, high power load type 515, S & X band spectrometer type 518.

Full technical details will be sent on request.

METROPOLITAN-VICKERS ELECTRICAL CO. LTD., TRAFFORD PARK, MANCHESTER 17
Member of the A.E.I. group of companies

METROVICK Test gear for the microwave laboratory

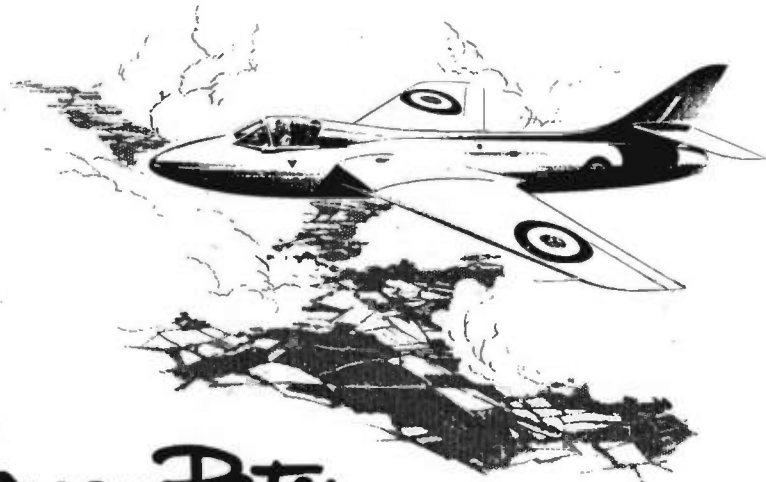
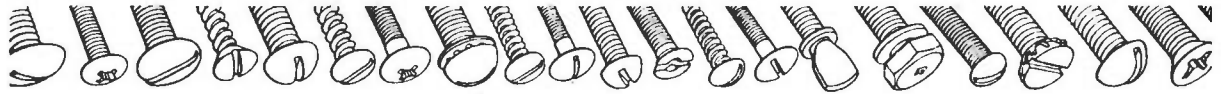

Fly away Peter

As easy as that? Of course not! The idea is born and developed, the plans are made and assembly is prepared. And this is where we come into the picture. We are there although you cannot see us. Bolts and Screws and Rivets are required and they must have a pedigree, just the same as the Hawker Hunter.

The plane is built, it flies. Another fine aircraft has been helped on its way with our products, our knowledge and our resources. This we ensure by laboratory testing all raw materials and observing the closest metallurgical and process controls through every stage of manufacture of every fastener.



We supply all industries requiring small fasteners of the highest quality to hold together the products they manufacture. Our specialists are always at your service to advise and assist you with your own particular problems.

LINREAD LTD. STERLING WORKS COX ST. BIRMINGHAM 3

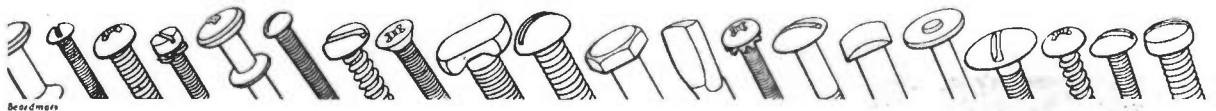

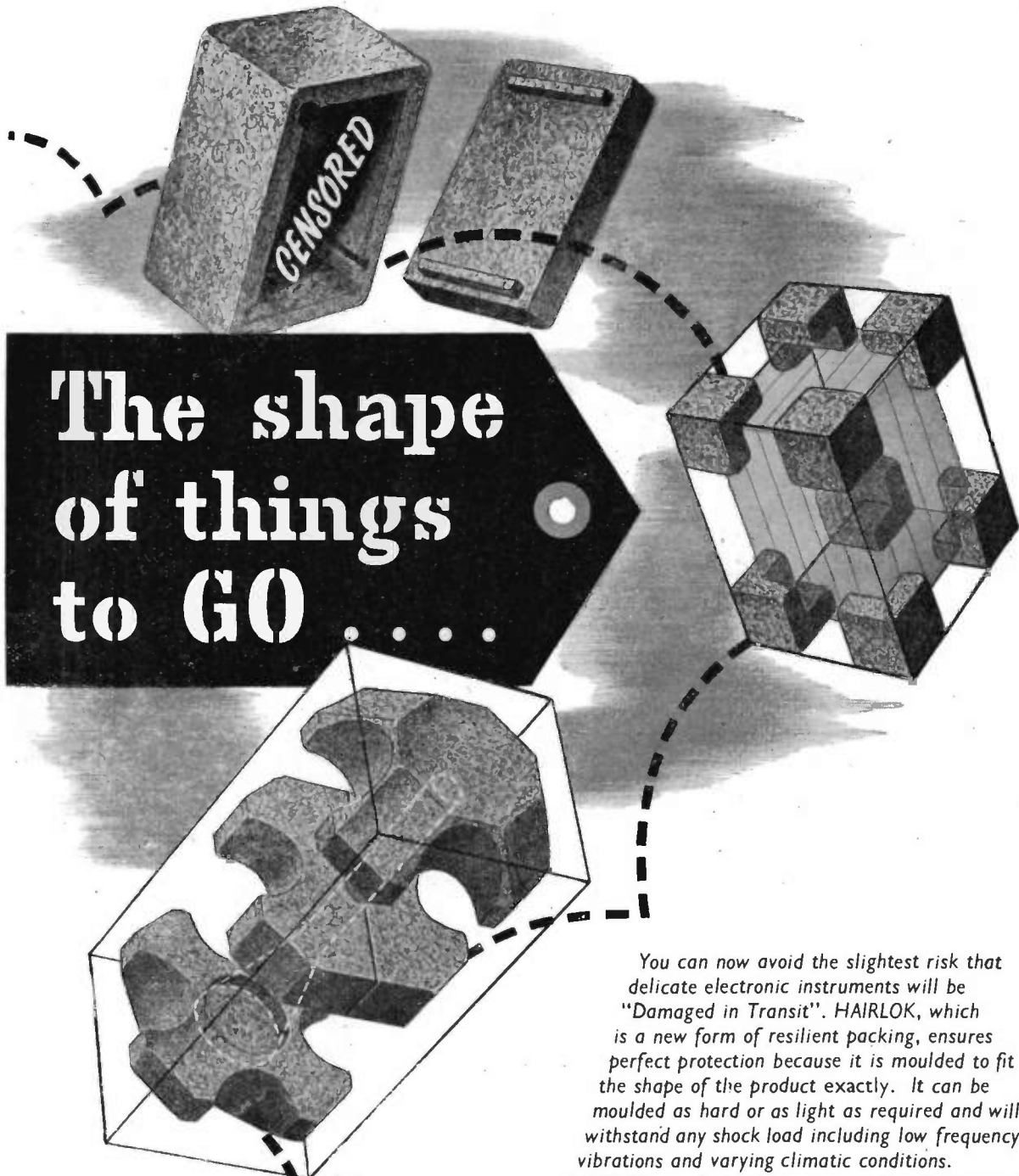

The shape of things to GO

You can now avoid the slightest risk that delicate electronic instruments will be "Damaged in Transit". HAIRLOK, which is a new form of resilient packing, ensures perfect protection because it is moulded to fit the shape of the product exactly. It can be moulded as hard or as light as required and will withstand any shock load including low frequency vibrations and varying climatic conditions. HAIRLOK complies with government specification and is non-staining to silver. To ensure that equipment is "Received in Perfect Condition" specify Hairlok packing. We shall be glad to send full details on request.

THE Hairlok COMPANY LIMITED
BEDFORD AND LONDON

PLASTIC MOULDINGS

**FOR THE
ELECTRONIC
AND
ALLIED INDUSTRIES**



- FULLY A.I.D. APPROVED FOR DEFENCE PROGRAMME REQUIREMENTS.
- AMPLE CAPACITY AVAILABLE FOR ALL COMPRESSION MOULDINGS, UP TO 250 TON PRESSES, AND SMALL PRECISION MOULDINGS IN THERMOPLASTICS.
- SPECIAL GRADE MOULDINGS IN MELAMINE AND NYLON-FILLED PHENOL.
- PROMPT ATTENTION TO ALL ENQUIRIES.
- GOOD, RELIABLE DELIVERY, AND FIRST-RATE QUALITY IN PRODUCTION.
- A REPRESENTATIVE WILL CALL, IF DESIRED.

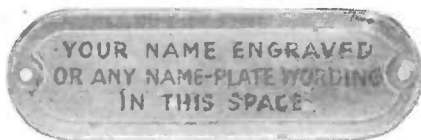

NAME PLATES FROM STANDARD TOOL

Attractive name plates to your own wording at extremely keen prices.

VISCOSE DEVELOPMENT COMPANY LIMITED
WOLDHAM ROAD, BRÓMLEY, KENT. RAVENSBORNE 2641



THE GREAT MASTERS

Sir Isaac Newton (1642-1727)

A great name in English science, that will always be remembered through the story of the falling apple, and how it led to the discovery of the law of gravity.

Sir Isaac, carrying on the work of Galileo and Kepler made vast advances in mathematics and astronomy. His theories were very ably expressed in a great work, the "Principia".

The name "Taylor Tunncliff" has become synonymous with all manner of high quality ceramics serving the electrical and electronic industries of our own age.



TAYLOR TUNNICLIFF & CO., LTD.

Masters of Porcelain Insulation

MAKERS OF FINE PORCELAIN FOR HIGH VOLTAGE INSULATION AND CERAMICS OF EVERY DESCRIPTION FOR RADIO · TELEVISION & THE ELECTRICAL INDUSTRIES

HEAD OFFICE: EASTWOOD · HANLEY · STAFFS · Stoke-on-Trent 5272/4

LONDON OFFICE: 125 HIGH HOLBORN · W.C.1 · Holborn 1951/2

MUIRHEAD MAGSLIP RESOLVER NO. 2

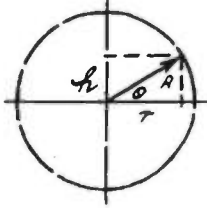

Given R, θ
find h, r
 $h = R \sin \theta$
 $r = R \cos \theta$

Change of Axes. $x' = x \cos \alpha + y \sin \alpha$
 $y' = y \cos \alpha - x \sin \alpha$

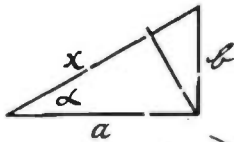
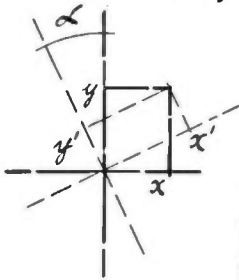

~~$x = \sqrt{a^2 + b^2}$~~

$x = a \cos \alpha + b \sin \alpha$

Given N, E
determine R, θ

$R = E \cos \theta + N \sin \theta$
 $E = E \sin \theta + N \cos \theta$

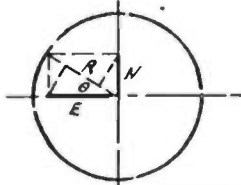

THE RESOLVER No. 2 is a special type of Magslip used for the solution of trigonometrical problems such as the conversion of polar to Cartesian coordinates.

Each stator phase is energized in accordance with an applied computing voltage. No power is taken from this source, energization being obtained by means of an amplifier and a second (feedback) stator winding. The rotor voltages are proportional to the exciting voltages and to the sine and cosine of the angle between the stator and rotor electrical axes. The error does not exceed 0.1%.

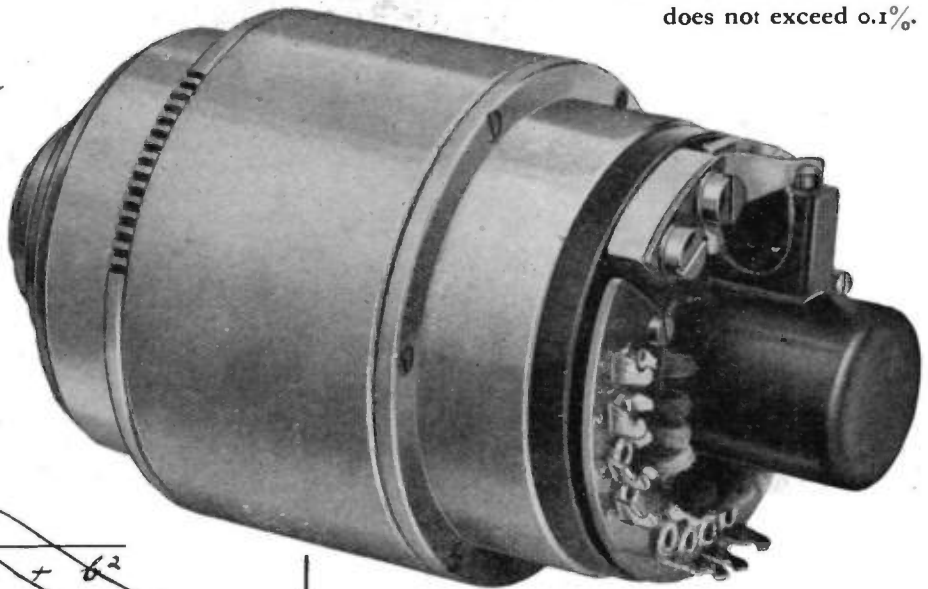

POST THIS COUPON

Please send me Bulletin B-690 fully describing
MUIRHEAD MAGSLIP RESOLVERS

NAME _____

MAILING ADDRESS _____

COMPANY _____

POSITION _____

79

MUIRHEAD & CO. LTD., BECKENHAM, KENT, ENGLAND

PRECISION ELECTRICAL INSTRUMENT MAKERS

Communication and Industrial Valves by *Standard*

The comprehensive range of high-quality valves manufactured by Standard includes types for almost every application, representative of which are :

- Broadcast, Communication and Television transmission
- Airborne and Mobile V.H.F. Equipment
- Microwave links
- Telephone and Telegraph Coaxial and line transmission
- D.C. Power Supply Rectification
- R.F. Heating
- Counting and Computing
- Motor Speed Control
- Welding Control
- Medical Diathermy
- Voltage Stabilisation
- X-Ray
- Vacuum Measurement
- Thermocouples

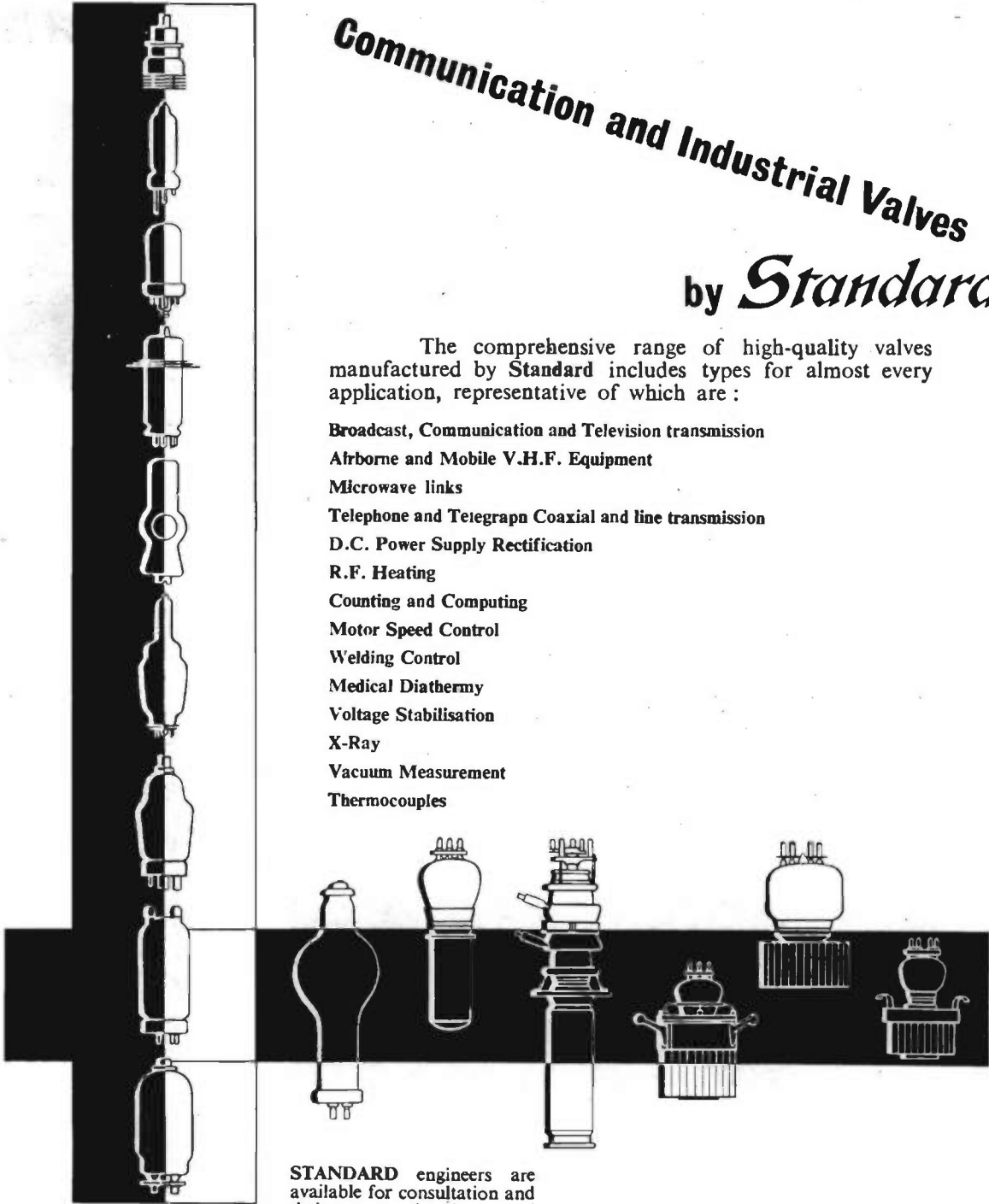

STANDARD engineers are available for consultation and their co-operation is assured to designers and technicians throughout industry wishing to take advantage of Standard's long experience in the field of valve engineering.

Please write to

Standard Telephones and Cables Limited

Registered Office: Connaught House, 63, Aldwych, London, W.C.2

RADIO DIVISION — OAKLEIGH ROAD, NEW SOUTHGATE, LONDON, N.11

ONLY the LAB unit has all these features...

- ★ Continuous storage
- ★ 700 resistors in a space 12" x 4" x 4"
- ★ Ohmic values separately carded
- ★ Finger-tip selection

Here's the most practical way of buying and storing resistors that anyone could wish for. Occupies only 48 sq. in. of shelf space. As easy to use as a card index. Rapid selection from 700 sorted and carded resistors. Continuous storage — empty cards merely replaced with full ones available from stock. The Lab Continuous Storage Unit is supplied FREE with initial purchase of

180 Type R Resistors (Order LSUC $\frac{1}{2}$)
 or 240 Type T „ (Order LSUC $\frac{1}{4}$)

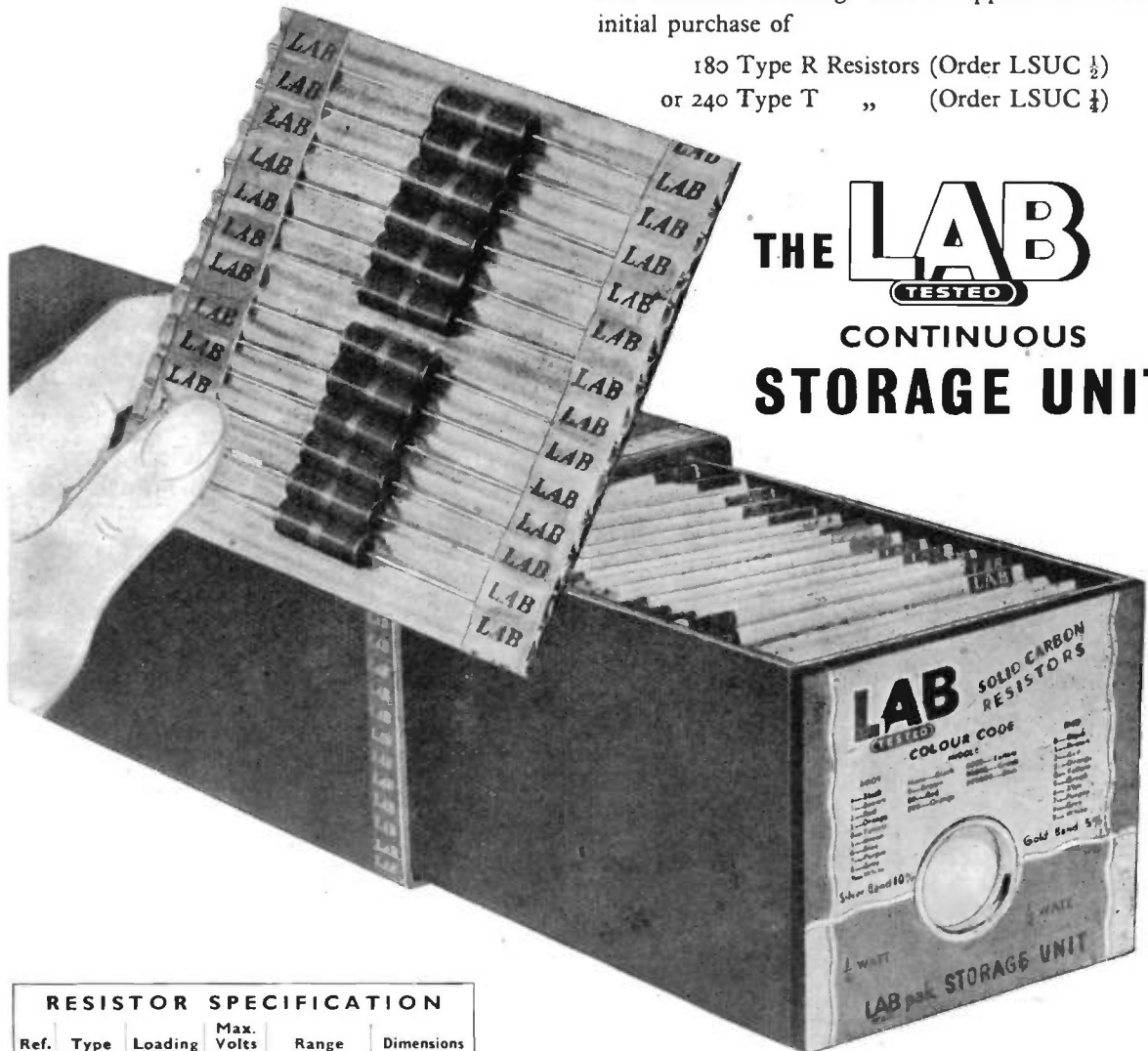

THE **LAB**
TESTED
 CONTINUOUS
STORAGE UNIT

RESISTOR SPECIFICATION					
Ref.	Type	Loading	Max. Volts	Range	Dimensions
T	$\frac{1}{4}$ -watt	$\frac{1}{2}$ -watt	250	10 ohms to	$\frac{3}{8}$ " x $\frac{3}{8}$ "
R	$\frac{1}{2}$ -watt	1-watt	500	10 megohms	$\frac{1}{2}$ " x $\frac{1}{2}$ "

Tolerance available $\pm 20\%$, $\pm 10\%$ $\pm 5\%$

The Lab Continuous Storage Units are available from your normal source of supply, but more detailed information can be obtained from

THE RADIO RESISTOR COMPANY LTD

50 ABBEY GARDENS, LONDON, N.W.8 • Telephone: Maida Vale 5522

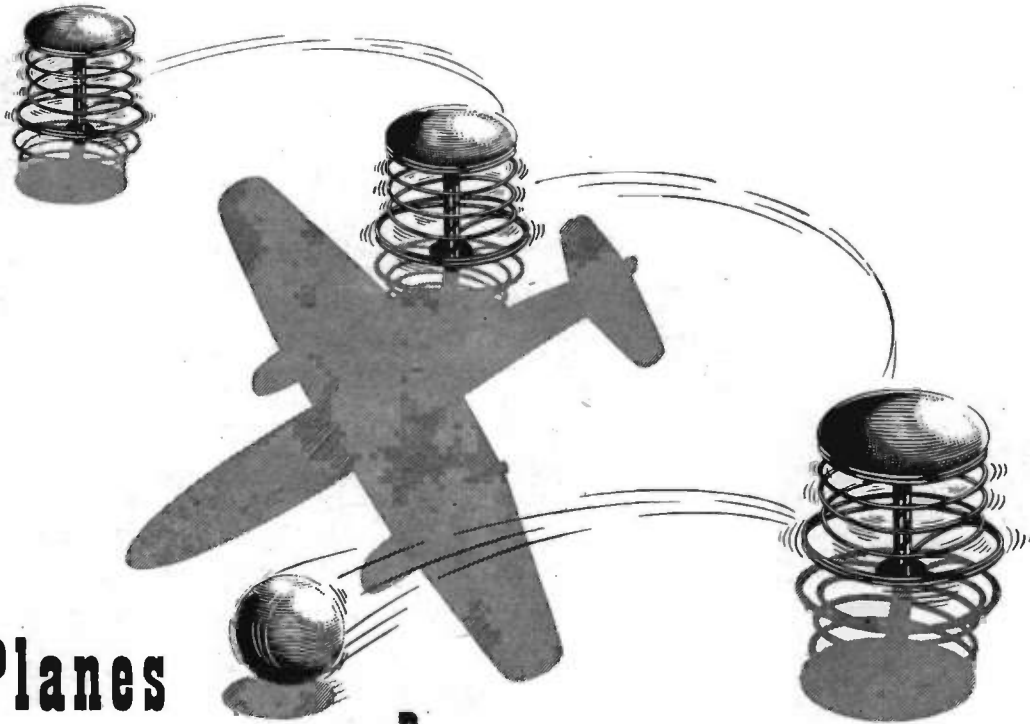

Planes and Pintables

Poles apart, yet with one essential feature in common; dependence on switches and selectors for certain operational functions. In this vital need for unfailing reliability in widely differing industries today, more and more designers place their confidence in N.S.F. switches.

Whether it is the basic control of circuits in aircraft or of electrical appliances on public supply mains, there is an N.S.F.-Cutler-Hammer Switch to perform the duty with complete dependability.

For the more complex job of circuit selection in radar and telecommunications or in electronic instruments, the N.S.F.-Oak Switch fulfils these functions perfectly.

For similar duties, where remote control is necessary, the combination of the N.S.F.-Ledex Rotary Solenoid and N.S.F.-Oak Switches will provide automatic circuit selection unequalled in flexibility and scope. The N.S.F.-Ledex Rotary Solenoid can also be used successfully in a wide variety of mechanical devices requiring a high torque, snap action, rotary movement applied through an angle of up to 95°.

Full details of all N.S.F. products are available upon request.



Switch to N.S.F. for better switching



N.S.F. LIMITED
KEIGHLEY · YORKS

Phone: Keighley 4221/5

Grams: ENESEF, Keighley

LONDON OFFICE: 9 Stratford Place, W.1. Phone: Mayfair 4234

Sole licensees of Oak Manufacturing Co., Chicago, and G. H. Leland Inc., Dayton, U.S.A.
Licensees of Igranic Electric Co. Ltd, for the above products of Cutler-Hammer Inc. Milwaukee, U.S.A.

Nickel-Iron Alloys for Magnetic Screens

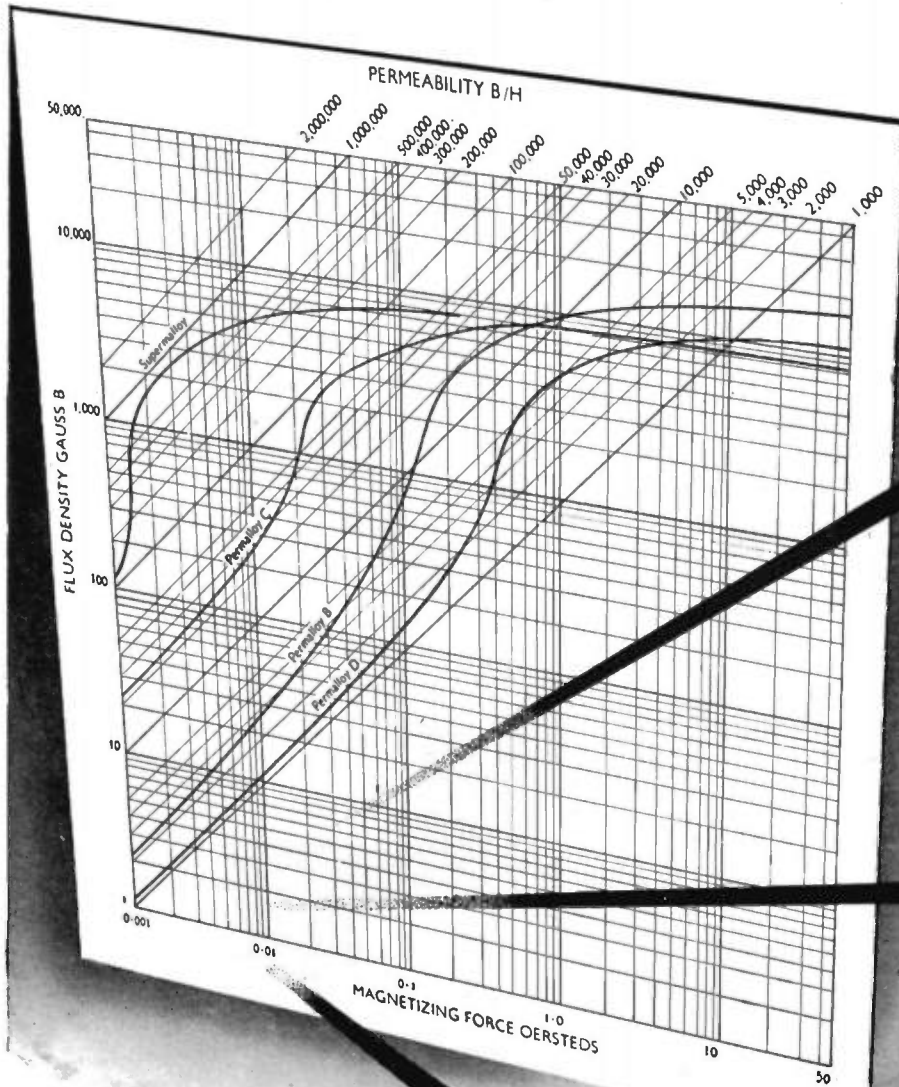

The high permeability, at low field strengths, of certain nickel-iron alloys makes them ideally suitable for electromagnetic screens in communication and instrument apparatus. The curves shown above indicate the relationship of flux density and permeability to magnetising force for various grades of these alloys. These curves are taken from our publication, "The Magnetic Properties of the Nickel-Iron Alloys". Write for a free copy.



THE MOND NICKEL COMPANY LTD · SUNDERLAND HOUSE · CURZON ST · LONDON · W1

MARCONI communication systems



serve mankind

The jungle is no longer the barrier which for so many centuries hampered the progress of communications. Guglielmo Marconi's invention of wireless overcame this obstacle just as it overcame the ocean and the

desert. The Company which he founded is still exploring, in the same exacting way, new ideas and techniques for bringing communications more fully into the service of mankind.



SURVEYED



PLANNED



INSTALLED

MARCONI'S WIRELESS TELEGRAPH COMPANY LTD • CHELMSFORD • ESSEX

OCTOBER 1952

19

ELECTRONIC ENGINEERING



In our fifty years of manufacture we have produced some 175,000,000 miles of winding wire of all types, more than 300 times the return distance to the moon. Not that we have any intention of taking our product to the moon, either by rocket or other means, for as there is neither air nor water there we should find no inhabitants to appreciate its fine qualities.

The largest manufacturers of fine enamelled wire in the world.



W I N D I N G W I R E S

CONNOLLYS (BLACKLEY) LTD. MANCHESTER 9 Tel: CHEetham Hill 1801
LONDON OFFICE: 14 Norfolk St.,
London, W.C.2 TEMple Bar 5506

BIRMINGHAM OFFICE: 19 Bent Avenue,
Quinton, Birmingham. 32 WOODgate 2212

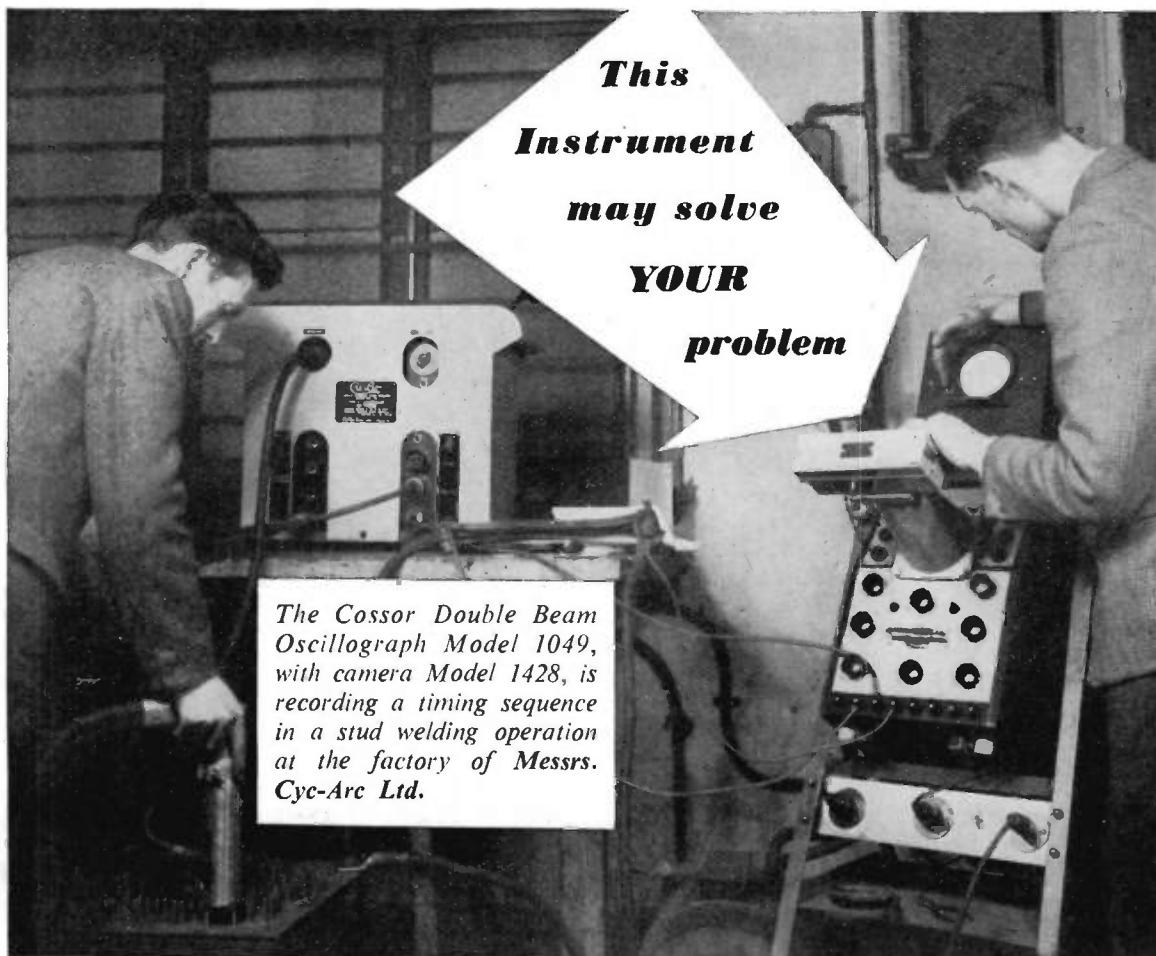

**This
Instrument
may solve
YOUR
problem**

The Cossor Double Beam Oscillograph Model 1049, with camera Model 1428, is recording a timing sequence in a stud welding operation at the factory of Messrs. Cyc-Arc Ltd.

In displaying simultaneously the mutual effect of two related and variable quantities the Cossor Double Beam Oscillograph is solving many of the fundamental problems with which the Research and Development scientist is constantly beset. In addition, workers in every branch of Industry are realising the infinite uses of this instrument in the detection and analysis of faults and the accurate monitoring of manufacturing processes.

The technical advisory staff of the Cossor Instrument Division is always at your service to help with your own particular problem.

In Models 1035 and 1049 the two traces are presented on a flat screen of 90 mm. diameter and the amplifiers and time base are so calibrated that measurement of the voltage input as well as the time interval between various significant portions of the oscillogram is made possible. Permanent records of these traces for subsequent analysis may conveniently be made by attachment of the Cossor Model 1428 Camera.

ELECTRONIC **COSSOR** INSTRUMENTS

Please address enquiries to:

A. C. COSSOR LTD., INSTRUMENT DIVISION (DEPT. 2), Highbury, London, N.5

Telephone: CANonbury 1234 (30 lines)

C.I.33

★ Use COSSOR VALVES and TUBES ★

EVERSHED F.H.P. MOTORS

TYPICAL A.C. SERVO MOTORS FOR ELECTRONIC CONTROL

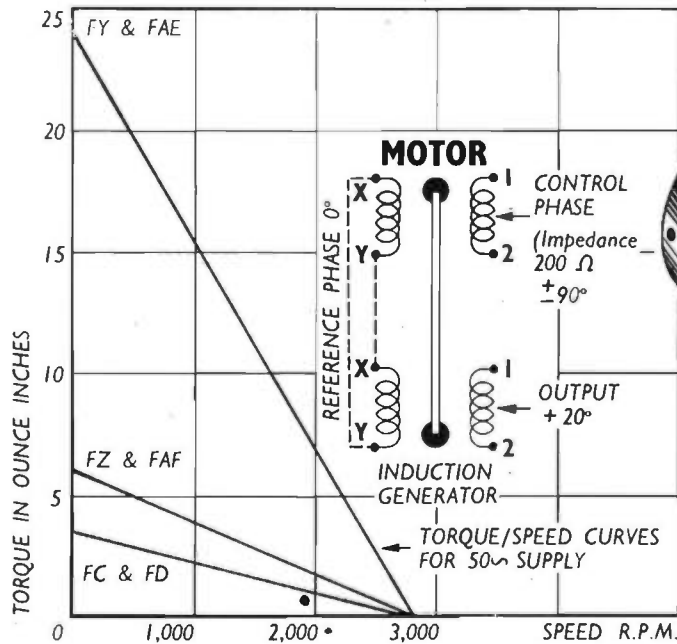

All motors are rated for a standstill temperature rise of 55°C. Motors may be supplied with a limited range of alternate armature and field windings. Please send for Publication EE 22.

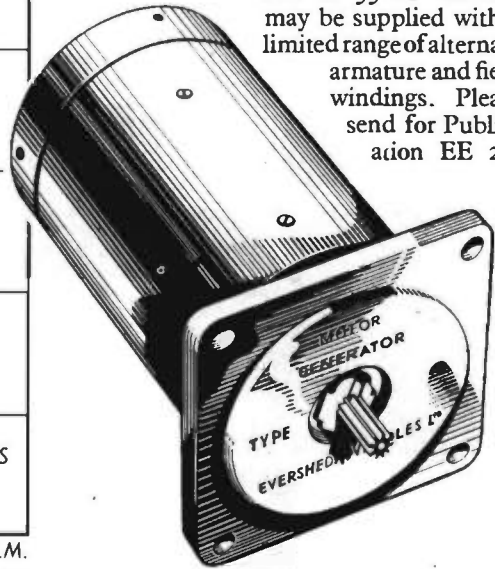

Frame Size	Moment of Inertia oz. ins. ²	Stall Torque oz. ins. ²	Reference Phase			Control Phase Watts	Output Watts	Generator		
			Supply		Watts			Reference Phase		Output per 1000 r.p.m. (10k load) volts
			V	C/S		Volts	C/S			
FC	0.16	4.0	50	50	8.6	11	2.3	—	—	—
FD	0.21	4.0	50	50	8.6	11	2.3	50	50	0.75
FZ	0.27	6.0	50	50	12	12	4.3	—	—	—
FAF	0.32	6.0	50	50	12	12	4.3	50	50	0.75
FY2/B	0.6	22.0	50	50	35	35	16	—	—	—
FAE	0.65	22.0	50	50	35	35	16	50	50	0.75



EVERSHED & VIGNOLES LIMITED

ACTON LANE WORKS - CHISWICK - LONDON - W.4.

Telephone : Chiswick 3670

Telegrams : Megger, Chisk, London.

Cables : Megger, London

6/85

This is Britain's famous power amplifying tube... for years the favorite tube of experimenters and research laboratories; acknowledged in every country of the world to be the finest tetrode ever made. It is currently used in the Leak, Williamson, Radio Craftsmen and other fine amplifiers.

The KT66 is a versatile power tetrode with a number of useful applications. It may be used in the output stage of an audio-frequency power amplifier, either tetrode-connected for maximum sensitivity and power output or triode-connected for high quality working. In transmitting circuits using frequencies up to 30 Mc/s it may also be used as an oscillator or as a radio frequency amplifier.

A high slope, indirectly heated beam tetrode, the KT66 is suitable for either single or push-pull audio operation and may be employed as a beam tetrode with aligned grids. This alignment of the grids reduces losses in the screen and makes for the highest possible power conversion efficiency. With this system of construction high orders of power output may be obtained with a low screen dissipation, and the anode is designed to dissipate 25 watts continuously with a reliable life performance.



THE FINEST AUDIO TUBE EVER MADE!
KT66

OPERATING CONDITIONS

Single Valve A.F. Amplifier	Tetrode connected		Triode connected		volts
	Anode and Screen Voltage	Bias Voltage	Anode and Screen Voltage	Bias Voltage	
Anode and Screen Voltage	250	-15	400	-38	volts
Bias Voltage	volts
Anode Current	85	63	mA
Screen Current	63	60	mA
Input Voltage	15	...	volts peak
Bias Resistance	38	19	ohms
Anode Load Resistance	160	2200	600	315	ohms
Distortion	4500	2750	%
Power Output	9	7	watts
	7.25	5.8	

Two Valves Push-Pull, A.F. Amplifier.
(Data per pair of valves unless otherwise stated.)

	Full load	450v. supply	250v. supply
Anode Voltage
Screen Voltage

DIMENSIONS



7-PIN "OCTAL"

Pin 1: Not connected
Pin 2: Heater
Pin 3: Anode
Pin 4: Screen Grid, g2
Pin 5: Control Grid, g1
Pin 6: Omitted
Pin 7: Heater
Pin 8: Cathode

View looking on underside of base.

(All dimensions are in mm. and are the maximum except where otherwise stated.)

RATINGS

	Tetrode connected	Triode connected	volts
Heater Voltage
Heater Current
Anode Voltage
Screen Voltage

THE FAMOUS **KT66** . . . IN USE ALL OVER AMERICA AND ACKNOWLEDGED TO BE THE FINEST BEAM GRID TETRODE EVER MADE IS AN **Osram** VALVE MADE IN ENGLAND

The photographic reproduction is taken from literature published in America by the British Industries Corporation and gives an entirely unsolicited tribute to this fine valve.

Power Output	...	5000	80	watts
	5000	volts
	5	ohms
	50	%
	50	watts.

BRITISH INDUSTRIES CORPORATION
164 Duane Street, New York 13, N. Y.

THE GENERAL ELECTRIC CO. LTD., MAGNET HOUSE, KINGSWAY, LONDON, W.C.2

Precious Metal Contacts

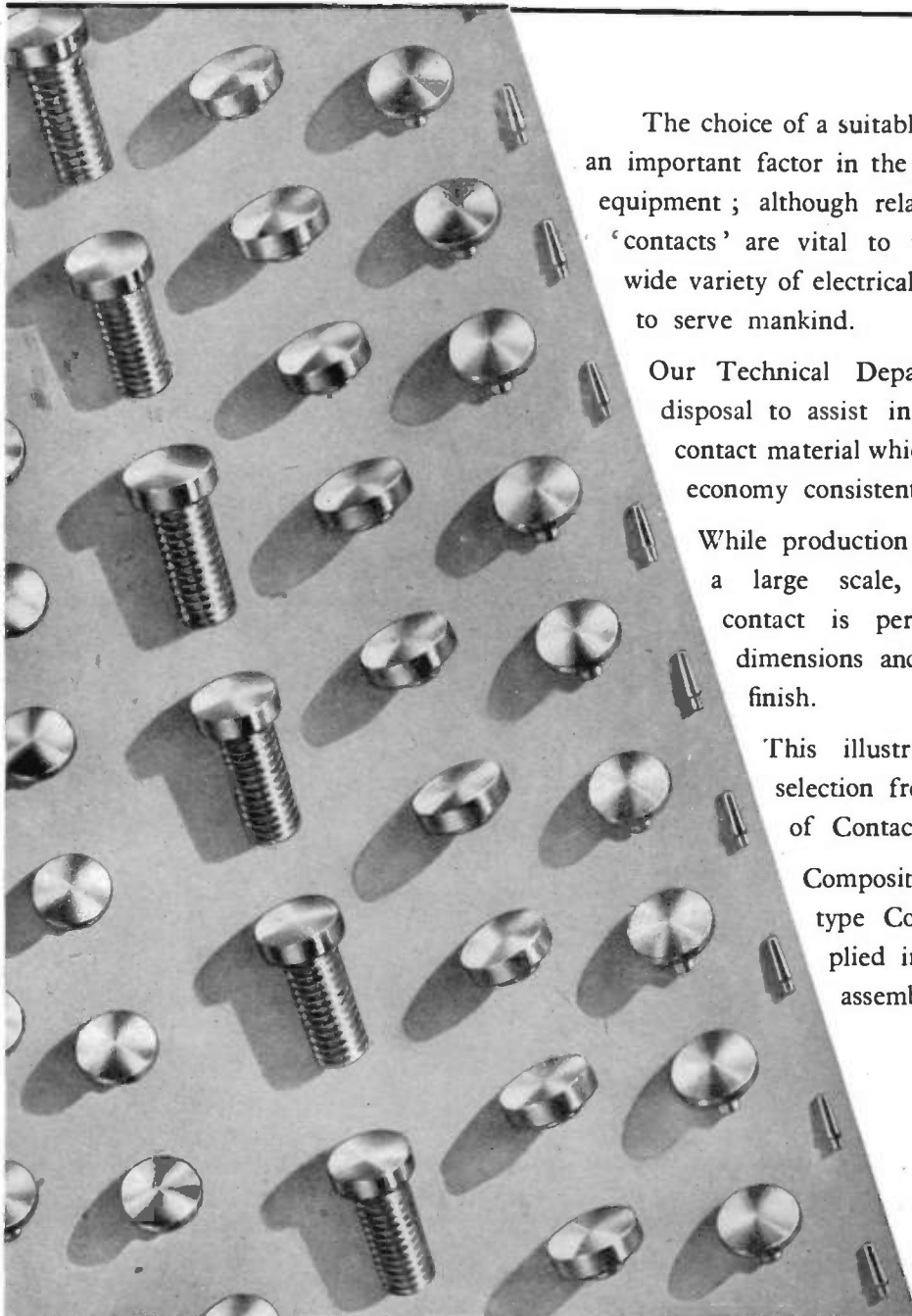

The choice of a suitable contact material is an important factor in the design of electrical equipment ; although relatively small in size 'contacts' are vital to the efficiency of a wide variety of electrical apparatus designed to serve mankind.

Our Technical Department is at your disposal to assist in the selection of a contact material which will offer greatest economy consistent with efficiency.

While production is carried out on a large scale, every 'BAKER' contact is perfectly accurate in dimensions and bears a superfine finish.

This illustration represents a selection from the many types of Contacts we manufacture.

Composite and Laminated type Contacts can be supplied in any form to suit assembly requirements.



Write for booklet showing full range of Contacts

BAKER PLATINUM LTD., 52 HIGH HOLBORN, LONDON, W.C.1
Chancery 8711



MONOSCOPE TUBES

THE Monoscope is basically a simple caption scanner apparatus capable of providing a video signal derived from a fixed pattern within the tube.

Almost any pattern comprising pure line, halftones or a combination of both can be supplied on receipt of specific requirements, and two standard types are available.

Type J.101 — Test Chart "A"

Type J.201/XI — Test Chart "C"

TYPICAL OPERATING DATA

Deflection	- - -	electromagnetic
Focus	- - - - -	electrostatic
V _h	- - - - -	6.3 V
V _g (cut-off)	- - - - -	-50 V
V _{a1}	- - - - -	1200 V
V _{a2} (focus)	- - - - -	800/850 V
V _{a3} (wall)	- - - - -	1200 V
V target	- - - - -	1160/1200 V
I target	- - - - -	5 μA

Resolution better than 500 lines

Video Signal 0.5 μA peak to peak (min)

CINEMA-TELEVISION LIMITED

A Company within the J. Arthur Rank Organisation

WORSLEY BRIDGE ROAD · LONDON · SE 2 6

Telephone: Hither Green 4600

SALES AND SERVICING AGENTS

F. C. Robinson & Partners Ltd.,
287 Deansgate, Manchester, 3

Hawnt & Co., Ltd.,
59 Moor St., Birmingham, 4

Atkins, Robertson & Whiteford Ltd.,
100 Torrisdale Street, Glasgow, S.2



The "Belling-Lee" page for Engineers

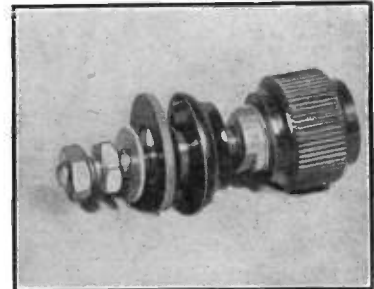
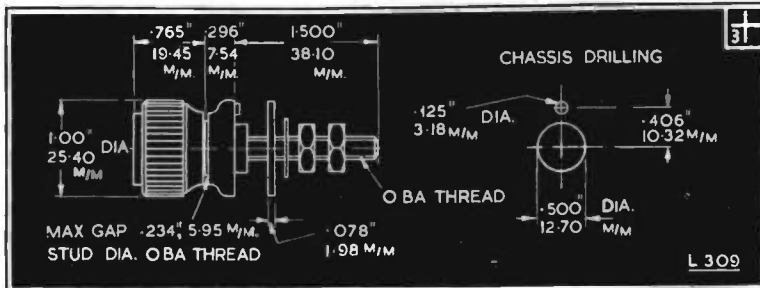

'F' TYPE TERMINAL L309

OTHER TYPES AND RATINGS
AVAILABLE

PLEASE WRITE FOR DETAILS

Because of the heavy duty it has to perform, this terminal is very robust and is particularly suited to the construction of medium power transformers, charging boards, transmitting equipment, etc. The current rating is 30 amps, peak working voltage 1,000, but in other respects it closely resembles the well-known "Belling-Lee" 'B' type terminal, which remains to-day virtually unchanged and in greater demand than ever.

Outstanding features include a non-removable head, non-rotating indications disc, self-bushing chassis attachment, and insulating washer.

A' DIA HOLE

HOLE RECD. IN PANEL 'F' DIA.

SUITABLE FOR 'E' PANEL THICKNESS.

LIST No	A		B		C		D		E		F	
	INS.	M.M.	INS.	M.M.	INS.	M.M.	INS.	M.M.	INS.	M.M.	INS.	M.M.
L 592	.067	1.70	.125	3.18	.187	4.76	.484	12.30	.093	2.38	.106 - .111	2.69 - 2.83
L 666	.046	1.19	.094	2.38	.156	3.97	.351	8.92	.062	1.59	.085 - .088	2.16 - 2.24
L 751	.067	1.70	.156	3.97	.187	4.76	.515	13.10	.125	3.18	.106 - .111	2.69 - 2.83
L 753	.109	2.78	.171	4.37	.250	6.35	.515	13.10	.125	3.18	.161 - .166	4.09 - 4.21

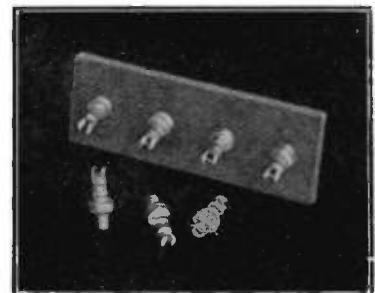

TURRET LUGS

These pillars present definite advantages over the normal type of pressed tag. They will be found very suitable as anchoring pillars for small transformers, special tag boards, coil assemblies, test points, etc., and in equipment where space is limited and where extra strength is required. They are turned from riveting quality brass, and if correctly mounted in a plain hole (they should not be countersunk), will not rotate.

Centre holes range from 0.046 in. dia., to 0.109 in. Rated up to 10 amps.

LIST NUMBERS

L 592 L 666
L 751 L 753

BELLING & LEE LTD
CAMBRIDGE ARTERIAL RD., ENFIELD, MIDD., ENGLAND

Laminations

ELECTRICAL
STEEL
LAMINATIONS

ALL SIZES
AND FOR ALL
FREQUENCIES

TELEPHONE
DIAPHRAGMS



*Richard Thomas
& Baldwins Ltd.*

INDUCTANCE

THIS IS A COIL, an ordinary coil such as we all know. It's simple enough, but to make good coils one must measure them. Measure their inductance, their Q , their self-capacitance and perhaps their resistance. All this can be done with Marconi instruments and done simply and accurately.

1000 c/s **Universal Bridge TF 868.**

0.1-20 Mc/s **R.F. Impedance Bridge TME 20B/1.**

0.05-170 Mc/s **Circuit Magnification Meters TF 329G
and TF 886A.**



MARCONI instruments

SIGNAL GENERATORS • OUTPUT METERS • BEAT FREQUENCY OSCILLATORS • WAVE ANALYSERS

MARCONI INSTRUMENTS LIMITED • ST. ALBANS • HERTS • Telephone: St. Albans 6161/7

Midland Office: 19 The Parade, Leamington Spa. Northern Office: 30 Albion Street, Hull.
Export Office: Marconi House, Strand, London, W.C.2.

FOR INCREASED ACCURACY
 SUPPRESS SIGNAL DISTORTION

The distortion of signals by noise can be the cause of serious error occurring in messages transmitted by automatic radio telegraph. The noise-suppressing action associated with frequency-shift operation, makes it possible to operate automatic radio telegraph systems satisfactorily under conditions where "on-off" keying would result in an excess of errors in received signals. Being dependent upon frequency change rather than variation in signal amplitude the effects of fading are considerably reduced — particularly when dual diversity working is employed — permitting a considerable increase in usable time.



▲ Type FSK.2. Keying Unit for frequency-shift keying is designed for conversion of any conventional communications transmitter for frequency-shift operation.

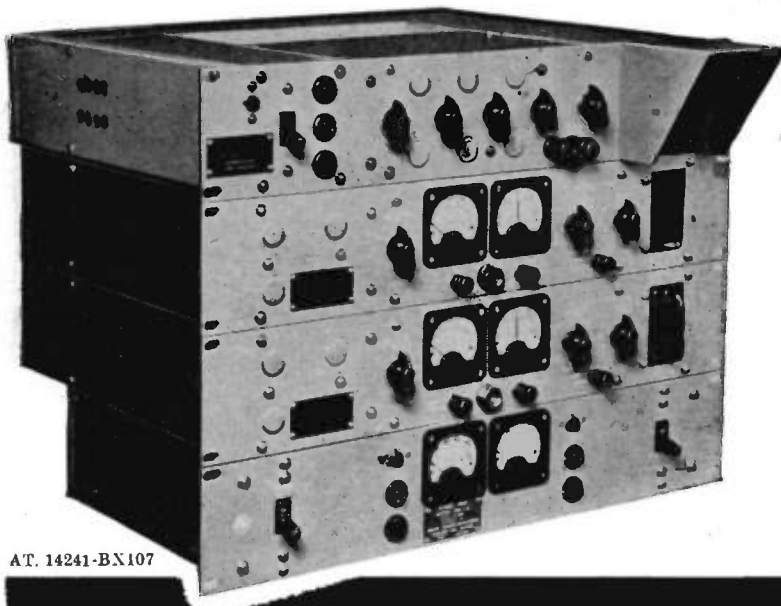

◀ Type FSU.7. Receiving Terminal is for dual diversity shift reception. It includes a cathode-ray monitor unit with which the balance of the two aerials and receivers in a dual diversity combination can be checked visually, and with which the correct tuning point of the two receivers can be set up while a transmission is in progress. Other models are available for single receiver reception.

Both these units can be fitted on site by station engineers, any modification of radio equipment required being only of a minor nature.

AT. 14241-BX107

AUTOMATIC TELEPHONE & ELECTRIC CO. LTD.

Radio and Transmission Division, Strowger House, Arundel Street, London, W.C.2.
 Telephone: TEMple Bar 9262. Cablegrams: Strowgerex, London.





POWER UNIT TYPE 698B

for

Klystron Valves

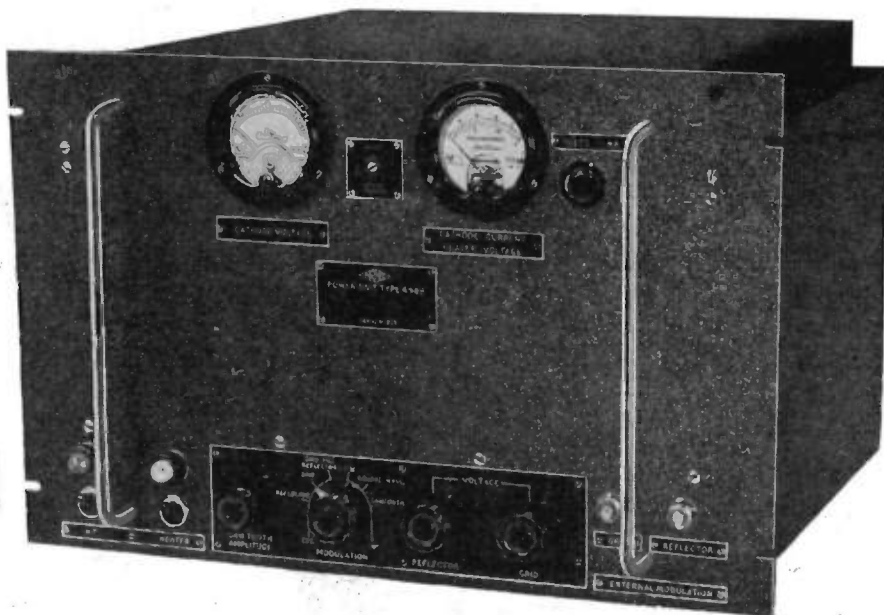

THE POWER UNIT, TYPE 698B, is designed to provide H.T. and L.T. supplies for high voltage Klystron valves. All the H.T. supplies are stabilised, the output voltage change being less than 0.5 per cent of the input voltage change. Internal oscillators provide square wave and sawtooth wave modulation, and switching enables either the internal modulation, or modulation from an external source, to be applied to the grid or reflector voltages. A switch position is also provided for operation under c.w. conditions.

STABILISED H.T. OUTPUTS

	Maximum	Minimum
Cathode Volts - - -	-2.4 kV	-1 kV
Grid Volts (relative to Cathode)		
Maximum - - -	-220V	-100V
Minimum - - -	0V	0V
Reflector Volts (relative to Cathode)		
Maximum - - -	-500V	-280V
Minimum - - -	0V	0V
Cathode Current (Maximum on load) - - -	18 mA	10 mA

Stabilisation Output change of less than ± 200 mV for input change of 210-250V.

Ripple Voltage Not greater than 20 mV R.M.S.

Regulation Output Impedance less than 500 ohms at 10 mA.

L.T. OUTPUTS

Rating 4.0 V D.C. at 1.4A.

Ripple Less than 150 mV R.M.S.

Full details of this or any other Airmec instrument will be forwarded gladly upon request.

AIRMEC LABORATORIES **LIMITED**

HIGH WYCOMBE - BUCKINGHAMSHIRE - ENGLAND
 Tel. : HIGH WYCOMBE 2060 Cables : AIRMEC HIGH WYCOMBE

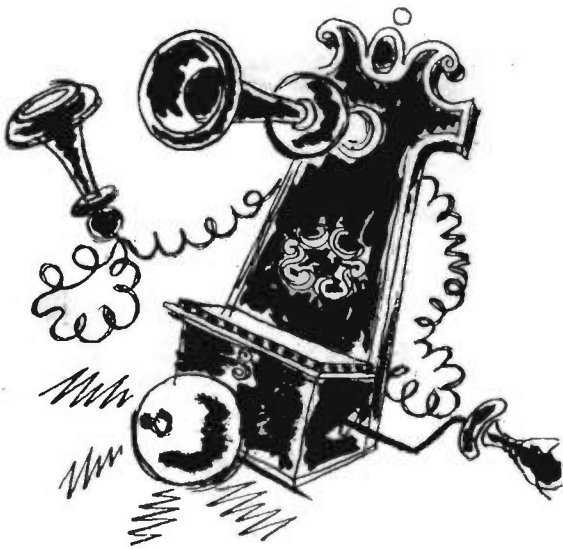

Ringing the Bell!

When the voice of Man first carried, faint and cackling beyond the human range, few saw the potentiality of a great industry of communication. The few had courage and conviction, and to them we owe our telephones. Parmeko, from their beginning, lent to these pioneers specialized aid; and Parmeko Transformers are designed by men devoted solely to that task; are produced on single-purpose plant, and are used by most of Britain's largest manufacturers.

PARMEKO of LEICESTER

Makers of Transformers for the Electronic and Electrical Industries

Electronic Engineering

Incorporating *ELECTRONICS, TELEVISION and SHORT WAVE WORLD*
Managing Editor, H. G. Foster, M.Sc., M.I.E.E.

Vol. XXIV

OCTOBER 1952

No. 296

Contents

Commentary	435
The Monitoring of High-Speed Waveforms	436
J. G. McQueen	
Automatically Indicating the Termination of a Television Programme	441
The Physical Realization of an Electronic Digital Computer	442
By A. D. Booth, D.Sc., Ph.D., F.Inst.P.	
Electronics in Industry	445
B.B.C. New Automatic Unattended Transmitter Technique (Part 1)	446
By F. A. Peachey, M.I.E.E.; R. Toombs, B.Sc., A.M.I.E.E., and C. Gunn-Russell, M.A.	
Atomic Exports	449
Canadian Television	449
The Wien Bridge and Some Applications	450
By C. F. Brockelsby, A.R.C.S., B.Sc., A.M.I.E.E.	
A Gain Stabilized Mixer	453
By M. Lorant	
The Clavoline	454
By G. H. Hillier	
A Study of the Characteristics of Glow-Discharge Voltage-Regulator Tubes (Part 2)	456
By F. A. Benson, M.Eng., Ph.D., A.M.I.E.E., M.I.R.E.	
A Timed RC Circuit	461
By John P. German, M.S.	
Changing the Phase of a Low Frequency Sinusoid	462
By P. Huggins, A.M.Brit.I.R.E.	
A Design for a Constant Volume Amplifier	464
By G. J. Pope	
An Electronic Square-Law Circuit for Use with a Graphic Recorder	466
By M. J. Tucker, B.Sc.	
Letters to the Editor	469
Electronic Equipment	470
Book Reviews	472
Publications Received	474
Notes from the Industry	475
Meetings this Month	476

Published Monthly on the last Friday of the preceding month at
28 Essex Street, Strand, London, W.C.2.

Phone: CENTRAL 6565. Grams: 'LECTRONING, ESTRAND, LONDON'

Subscription Rate:
(Home or Abroad) Post Paid 12 months 26s. or \$3.75 (U.S.)

Classified Advertisements, Page 1
Index to ADVERTISERS, 62

The Mullard range

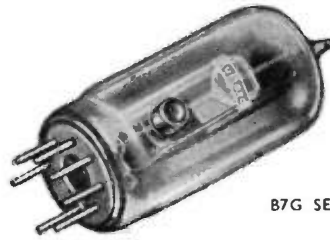

B7G SERIES



B8G SERIES

of all-glass
photocells for

industrial
applications

WIRED-IN SERIES

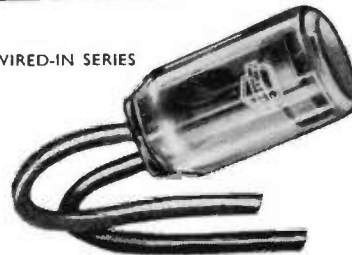

DEVELOPED on the all-glass technique, Mullard photocells have the outstanding advantages of rigid construction and freedom from microphony, maximum ratio of cathode area to bulb size, high sensitivity and stability and positive location with uniform orientation. They are available on either the B7G or B8G base, with alternative cathode surfaces: caesium-silver oxide (C type cells) with a high sensitivity to red and infra red radiations; and caesium-antimony (A type cells) with a high sensitivity to daylight and radiations of blue predominance.

For applications where savings in space are a prime consideration, as for example, in compact photo-electric equipments, a small wired-in photocell, suitable for end-on incidence of illumination, is also available.

Brief technical details of the Mullard range of photocells are given below. Those who require more comprehensive information, including principles of operation, characteristic curves, and circuit details, are invited to apply for the revised edition of the Mullard publication "Photocells for Industrial Applications".

PRINCIPAL CHARACTERISTICS OF MULLARD INDUSTRIAL PHOTOCELLS.

Type	Base	Max. Anode Supply Voltage (V)	Max. Cathode Current (μ A)	Max. Dark Current at Max. Anode Supply Voltage (μ A)	Sensitivity* (μ A/lumen)	Max. Gas Amplification Factor	Projected Cathode Area (sq. cm.)
20CG	B8G	90	5.0	0.1	150	10	6.7
20CV	B8G	150	20	0.05	25 ($V_a = 100V$)	Vacuum	6.7
58CG	Wire-in	90	1.5	0.1	100	9	1.1
58CV	Wire-in	100	3.0	0.05	20 ($V_a = 50V$)	Vacuum	1.1
90AG	B7G	90	2.5	0.1	150	7	4.0
90AV	B7G	100	5.0	0.05	45	Vacuum	4.0
90CG	B7G	90	2.0	0.1	125	10	3.1
90CV	B7G	100	10	0.05	20 ($V_a = 50V$)	Vacuum	3.1

*Sensitivity measured at max. anode supply voltage, with the whole cathode area illuminated by a lamp of colour temperature 2,700°K. and with a series resistor of 1M Ω .



MULLARD LTD., COMMUNICATIONS & INDUSTRIAL VALVE DEPT., CENTURY HOUSE, SHAFTESBURY AVENUE, LONDON, W.C.2
MVT 125

Electronic Engineering

Vol. XXIV.

OCTOBER 1952

No. 296.

Commentary

THE radio industry is facing a number of difficulties at the present moment with its pre-occupation with the rearmament programme and export markets, and doubt was expressed about the advisability of holding an Exhibition at Earl's Court again this year.

Sales of domestic receivers in the home market have been deliberately restricted since the Budget by an increase in purchase tax and by restrictions on hire purchase and the effect which this has created can be seen from figures recently published by the Radio and Television Retailers Association. According to the R.T.R.A. the hire purchase sales of radio receivers fell by 59 per cent from January to April this year, while the hire purchase sales of television receivers fell by 78 per cent.

These are startling figures, but they by no means indicate a decline in the radio and television industry which, on the contrary, is making an increasingly important contribution not only to the rearmament programme but to the economy of the country by a vigorous export drive.

On the rearmament side, security prevents comment, but the success of the British radio and television industry in the world's markets is readily apparent. From a very modest £2 million just before the war, the industry has increased the value of its exports to £22·3/4 million for 1951 and it is expected that this figure will rise to £25 million for 1952.

But judged on a basis of attendances figures, the nineteenth National Radio and Television Exhibition organized by the Radio Industry Council was most successful for no fewer than 290,000 visitors went to Earl's Court.

There were the added attractions, as far as the general public was concerned, of the large auditorium theatre in which the B.B.C. artists could be seen in the flesh, and the Fighting Services again co-operated by staging excellent displays. It is inevitable, however, that each succeeding Radio Show tends to become merely an exhibition to attract the buying public. Domestic receiver design is now so stabilized that this year's models will show only minor advances on last year's and until colour television and perhaps frequency modulation are here, the more scientifically minded visitor to Earl's Court finds less and less to appeal to him.

This is in no sense a criticism of the exhibition which is designed primarily to sell more domestic receivers, but it is a matter of regret to us that so little of the

other activities of the radio industry were on view.

It may well be, of course, that a more technical display of this kind would not combine with the present Radio Show.

* * *

The Flying Display and Static Exhibition of the Society of British Aircraft Constructors is held, in the words of the official programme "to promote the export trade of its member companies and to demonstrate the quality of British aeronautical products" and few people who attended Farnborough last month could doubt that this country has obtained an unchallenged leadership in the design and manufacture of high speed aircraft.

The development of the jet engine has added enormously to the speed of modern aircraft and no more convincing demonstration of this could be obtained than in the recent R.A.F. Fly Past over London to commemorate the Battle of Britain. This aerial procession was led as usual by the Hurricane—a type which played such a predominant part in the darks days of 1940 and had a top speed of 300 m.p.h. Yet the new Hunter which brought up the rear of the procession is easily capable of flying *more than twice* this speed. And this has all come about in less than fifteen years!

But it has not been a matter of adding jet engines to existing aircraft, for many fundamental problems in aerodynamics have had to be solved before the Canberra could cross the Atlantic there and back in eight hours and the Comet add something like one hundred and fifty miles an hour to the speed of the world's air liners. Basically new designs of aircraft have been called for and at Farnborough last month the first results of the British aircraft industry's approach to these problems were on display for the world to see and, we hope, to buy.

The contribution made by the radio industry is by no means insignificant and it is true to say that much of the research on supersonic flight would have been impossible without the aid of the electronic techniques developed very largely by the radio industry itself.

Here at Farnborough there was much to see and admire in the way of electronic apparatus, radio communication equipment and radar—an important side of the other activities of the radio industry to which we have earlier referred.

The Monitoring of High-Speed Waveforms

A Description of Techniques Incorporated in the Metropolitan-Vickers
Recurrent Waveform Monitor Type 500 †

By J. G. McQueen*

THE instrument to be described has been designed to observe recurrent waveforms having frequency components up to 300Mc/s. Negligible loading is introduced on the circuit producing the waveform, and amplitudes as low as 0.1V are displayed without distortion. Two concurrent waveforms may be viewed simultaneously.

The monitor can only be used when the waveform is repeated continuously, preferably at a rate higher than about 100 per second. During each recurrence a measurement is made of the instantaneous amplitude of a selected point in the waveform. Each measurement is utilized to form one Y co-ordinate of a graph of the waveform, each co-ordinate being made to persist for a considerable portion of the time interval between recurrences. The graph is traced out relatively slowly by causing the selected point to occur at a slightly different instant during each recurrence. The X co-ordinates of the graph are produced by a deflexion in synchronism with the position of the selected point within the waveform.

The essential difference between this and other techniques is that the waveform under observation is not used to deflect an electron beam in a cathode-ray tube, but is, instead, applied to a circuit capable of measuring its instantaneous amplitude at a predetermined point. As many of the advantages of the system result from this difference, the means by which instantaneous amplitude measurements are made will now be briefly described.

Fig. 1 is a simplified circuit of the probe unit to which the waveform to be displayed is applied. The valve V_1 is normally cut off, its grid leak, R_1 , being returned to a bias point. The waveform is applied to the grid of V_1 via the capacitive divider formed by the small series capacitor, C_1 , and C_2 in parallel with the grid capacitance of the valve. As V_1 is normally cut off its grid input impedance is not modified by transit time effects.

At the instant selected for waveform amplitude measurement a very narrow negative going pulse (about 1

millimicrosecond wide) is applied to the cathode of V_1 causing a short pulse of current to flow in the valve. The amount of current depends on the instantaneous level then existing at the grid. The short pulse of current discharges the anode capacitance by a small amount (of the order of 0.5V) following which the anode capacitance recharges slowly to H.T. through the high value resistor R_2 . The anode waveform of V_1 is thus a sharp drop whose amplitude depends on the instantaneous amplitude of the

input waveform, followed by an exponential rise having a time-constant of the order of 20 microseconds. Although the steep edge is lost in subsequent amplification a pulse output is nevertheless obtained whose amplitude is a function of the instantaneous amplitude of the input waveform as measured in V_1 . The means by which this pulse is converted into a suitable Y deflexion voltage will be described later.

The probe unit is normally placed very close to the circuit being monitored, and the terminal attached to the input plate of the series capacitor, C_1 , is allowed to touch the required point in the circuit. C_1 represents the whole of the loading on the monitored circuit and is normally adjusted to a value of less than 1pF. C_2 and the grid capacitance of V_1 form a bottom capacitance of about 10pF resulting in an attenuation of at least 10:1. Very much greater attenuation is obtained by reducing C_1 . The waveform amplitude required at the grid of V_1 depends on the amount of amplification following the probe unit, and this is limited by the effective noise level at the grid

of V_1 . This is found to be about 2 millivolts. Assuming a capacitive division of 10:1, 20 millivolts of noise (effectively) exist at the input terminal of the probe unit. If a larger setting of C_1 is tolerable a proportional decrease in the effective input noise level is obtained.

The following advantages are apparent from the above description:—

- (1) The high speed waveform is confined to the grid circuit of the probe input valve.
- (2) The probe unit may conveniently be placed very close to the circuit producing the waveform.

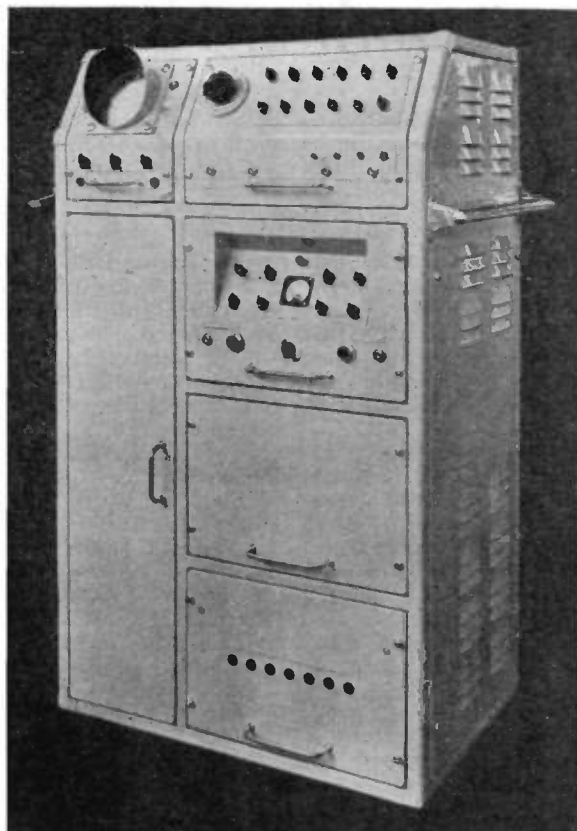

The complete instrument

(The probe units which plug into the front panel are not shown)

* Metropolitan-Vickers Electrical Co., Ltd.

† Patent applications have been made in respect of all techniques and circuits discussed in this article.

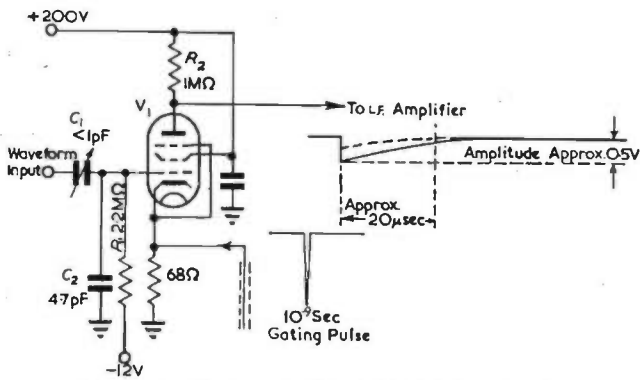

Fig. 1. Simplified schematic diagram of probe unit input stage

- (3) The input impedance of the probe unit is high.
- (4) Very low amplitude waveforms may be viewed.
- (5) Due to the very narrow gating pulse instantaneous amplitude measurements of frequencies up to 300Mc/s can be made with negligible error.
- (6) By the use of two probe units instantaneous amplitudes of concurrent waveforms may be measured.

The advantages listed above result primarily from the Y deflexion system, i.e., the production of a series of Y co-ordinates of the graph of a waveform rather than the utilization of the waveform itself as a deflecting potential. In addition to these there are several advantages associated more particularly with the X deflexion system.

- (1) The X plates are fed with a series of co-ordinates rather than with the fast time-base of a conventional high speed oscilloscope.
- (2) There is no necessity to produce a steep edged brightening waveform.
- (3) Most important is the fact that means exist for providing a stable graph of a waveform in cases where the waveform is jittering with respect to its pre-pulse.

The anti-jitter operation indicated in the last paragraph adds considerably to the complexity of the instrument and, while certain monitoring requirements justify this complexity, there are many cases in which it is not necessary. Therefore the instrument has been designed to operate either with or without an additional unit containing the anti-jitter circuits. The anti-jitter system will be described later.

Normal Operation

Fig.2. is a block diagram showing the operation of the monitor when viewing a waveform which is not jittering with respect to its pre-pulse. Block 1 indicates a pre-pulse which must occur at least 0.5 microsecond before the beginning of the waveform to be monitored (Block 3). The instrument has been designed to monitor a waveform occurring up to 24 microseconds after the pre-pulse. When running on internal pre-pulse generation the instrument provides an output trigger pulse about 1 microsecond after the pre-pulse, this delay enabling the front edge of the output trigger pulse to be monitored.

Block 4 represents

Fig. 2. Block diagram showing operation of high-speed monitor when waveform is not jittering with respect to pre-pulse

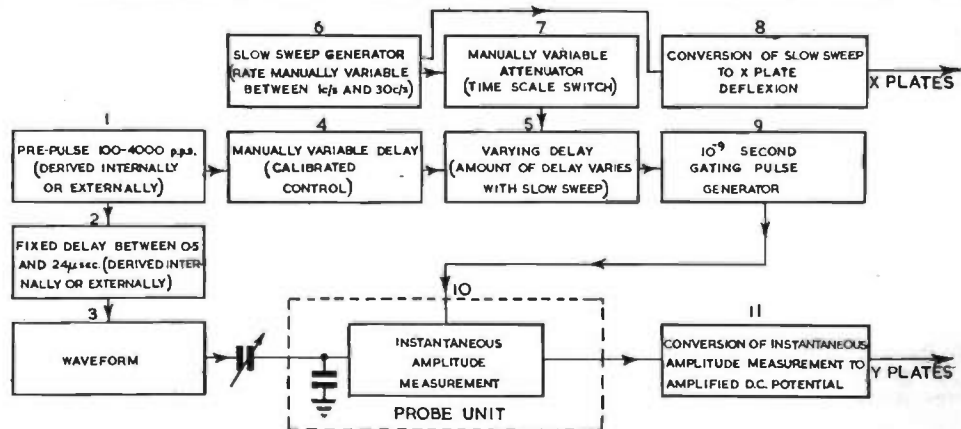

a manually variable delay which consists of a linear negative going sawtooth having a slope equal to 7 volts per microsecond. The sawtooth, which is triggered by the pre-pulse, is applied to the cathode of a diode whose bias is varied by an accurately calibrated control.

A further delay (Block 5) which varies at a relatively slow rate is introduced by applying to the anode of the same diode a slow sawtooth waveform generated in Block 6. At the instant that the diode conducts it passes a pulse to Block 9 which generates a negative going pulse of approximately 1 millimicrosecond width. This gating pulse is fed along a coaxial line to the probe unit (Block 10) in which, as previously described, a pulse is produced whose height is dependent on the amplitude of the monitored waveform at the instant of the gating pulse. Block 11 converts the output from the probe unit into a flat topped pedestal of upwards of 100 microseconds duration whose height is proportional to the measured instantaneous amplitude. A brightening pulse selects the top of each pedestal for display.

The position of each gating pulse within the monitored waveform is dependent on the free-running slow sawtooth generated in Block 6. The X co-ordinates of the graph of the waveform are therefore required to change in synchronism with the slow sawtooth, and, in Block 8, a suitable deflecting voltage is generated. The slow sawtooth is attenuated in Block 7 by an amount depending on the setting of the time scale switch; e.g. a 7 volt slow sawtooth waveform fed into Block 5 produces a microsecond movement of the gating pulse. A 0.35V slow sawtooth provides an effective time scale of 0.05 microsecond.

The manually variable delay (Block 4) controls the position of the time interval during which gating pulses occur, thereby providing horizontal movement of the displayed waveform. Calibration of this control in 0.01 microsecond divisions (fine adjustment) and 2 microseconds steps (coarse adjustment) enables the time scale of the display to be accurately measured. In addition the control is adjusted to provide a delay roughly equal to that between the prepulse and the waveform. An inherent delay of about 0.5 microsecond in Blocks 4 and 9 sets a limit to the earliest point following the prepulse which can be observed.

Anti-Jitter Operation

The difference between anti-jitter and normal operation is in the derivation of the X deflexion potential. In the operation just described the X deflexion is maintained in synchronism with the movement of the gating pulse relative to the pre-pulse. As long as the monitored waveform remains in fixed time relationship to the pre-pulse the X deflexion is therefore representative of the movement of

the gating pulse within the waveform. If, however, the waveform is produced erratically with respect to the pre-pulse it is necessary that each X co-ordinate of the final graph be produced by a direct measurement of the position of the gating pulse within the waveform.

Fig. 3. represents this operation. Block 2 indicates the irregular delay between the pre-pulse and the waveform. The variable delay represented by Block 4 remains substantially constant during the monitoring of a waveform. It is adjusted by an automatic means, to be described later, to cause the mean position of the gating pulses to be roughly in the centre of the portion of the waveform selected for viewing. As the waveform is jittering with respect to the pre-pulse the position of any particular gating pulse within the waveform cannot be previously determined. All that is now required of Blocks 4, 5, 6 and 7 is that a reasonable number of gating pulses be made to occur during the waveform. The position of the gating pulses during successive waveforms may well be entirely random.

The gating pulses produced in Block 9 are fed to the probe unit, Block 10, and the resulting series of instan-

a small fixed amount before application to the time measuring circuit.

Block 13 is a manually variable delay which serves to select the interval of time (relative to the locking pulse) which is to be displayed. Assume that the locking pulse occurs 1 microsecond after the front edge of the waveform. It is then required that a gating pulse which occurs 1 microsecond before the locking pulse (i.e. on the front edge of the waveform) should give rise to an X co-ordinate at the left-hand side of the display, and, assuming that the displayed time scale is to be 0.25 microsecond, a gating pulse occurring 0.75 microsecond before the locking pulse should produce an X co-ordinate at the right-hand side of the display. Now, as the gating pulse is delayed 2 microseconds before being applied to the time measuring circuit, Block 13 should be set to give 1 microsecond delay to make the measured time interval zero when an X co-ordinate at the left-hand side of the display is required. The time scale switch (Block 15) which is a variable attenuator is adjusted, in the present assumed case, to provide a full scale movement of the X co-ordinate when the measured time interval is changed by 0.25 microsecond. As

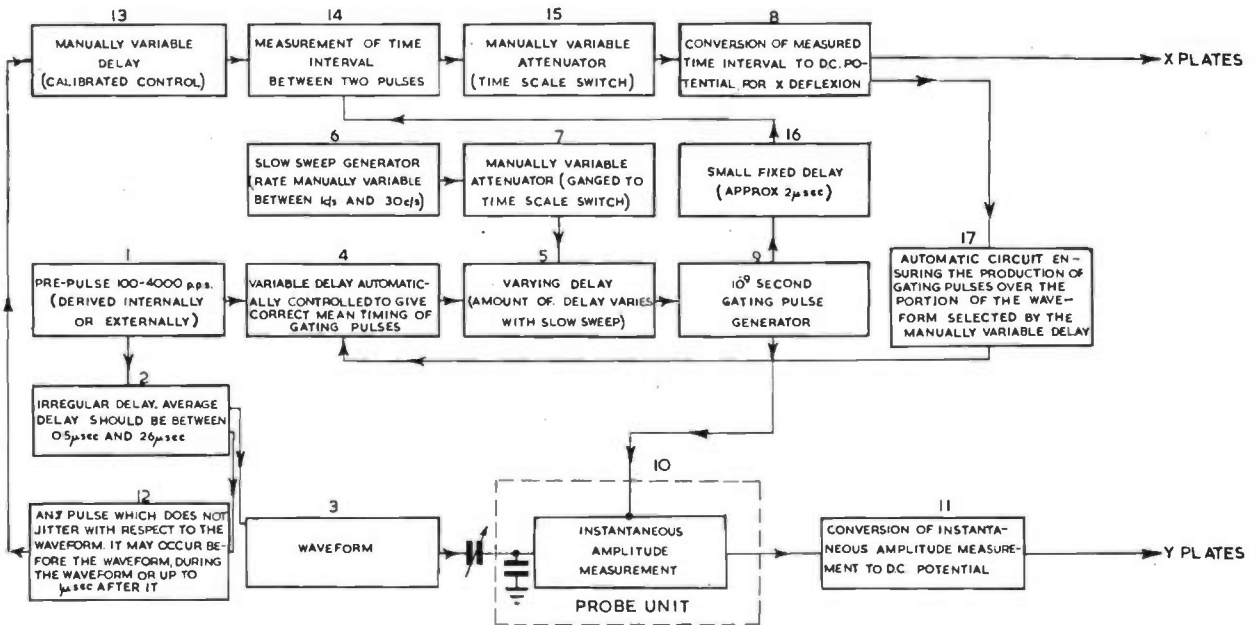

Fig. 3. Block diagram showing operation of high-speed monitor when waveform is jittering with respect to pre-pulse

taneous amplitude measurements are amplified and lengthened in Block 11 to produce Y co-ordinates.

Block 12 represents the generation of a locking pulse. This is a pulse which is produced externally to the instrument, the actual means by which it is generated depending on the circuit being monitored. The requirement is that the locking pulse should occur in fixed time relationship with the waveform under observation. It may well be the front edge of the waveform itself. It need not occur before the waveform; in fact provision is made for utilizing a locking pulse occurring up to 1 microsecond after the earliest point in the waveform being monitored.

Block 14 is a circuit which measures the time interval between the locking pulse and the gating pulse. The time interval measurements are converted in Block 8 into voltage pulses of similar duration to the Y co-ordinates, each voltage pulse forming an X co-ordinate of the display.

The gating pulses may occur either before or after the locking pulse. The time measuring circuit, however, requires that one pulse always occurs before the other. For this reason the gating pulse is delayed in Block 16 by

adjustment of the manually variable delay (Block 13) has the effect of moving the displayed waveform horizontally it is used as a measure of the time scale.

The movement of the gating pulse within the waveform during successive recurrences is partially controlled by Blocks 4, 5, 6 and 7, while random movement is provided by jitter of the waveform with respect to the pre-pulse. It is required that the average position of the gating pulses should be near the centre of the displayed waveform. It has been seen that when the gating pulse occurs at or before the beginning of the portion of waveform selected for display, an X co-ordinate at the left-hand side of the display is produced. Similarly, gating pulses occurring at the end of or after the waveform produce X co-ordinates at the right-hand side of the display. Block 17 is a circuit which integrates all the X co-ordinates and provides a slow automatic control of the delay between prepulse and gating pulses (Block 4). If, for example, there is an excess of X co-ordinates at the left-hand side of the display, the delay (Block 4) is slowly increased until balance is achieved. This circuit does not shift the displayed waveform. It

only ensures that points of the graph are plotted within the limits of the selected time scale.

Fig. 4 is an illustration of the efficacy of the anti-jitter system. The waveform is the front edge of the rectified output of a pulsed 3cm magnetron. Due to inherent jitter in the thyratron which is used in the generation of the magnetron driving voltage and further jitter in the build-up of magnetron oscillations, normal operation of the monitor provides the random distribution of co-ordinates shown in (a). Waveform (b) is the same as (a), but in this

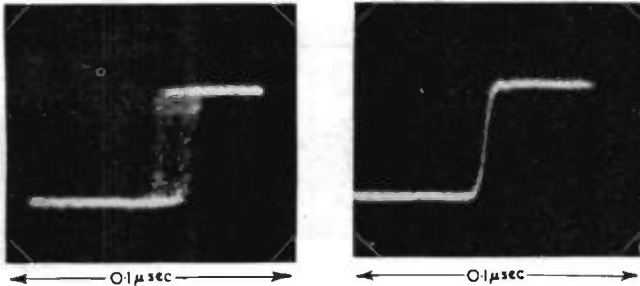

Fig. 4. Front edge of rectified magnetron oscillation (a) Normal operation of monitor (b) Anti-jitter operation of monitor

case anti-jitter operation is provided by using the waveform itself as a locking pulse.

The stabilizing of a time scale to a time instant occurring after its start is analogous in a conventional oscilloscope to triggering the time-base from the waveform itself and then delaying the waveform before application to the Y plates. The system described above has the advantage that the waveform is not delayed and is not subject to any distortion which such a delay might introduce.

Limiting Factors

The limitations imposed by various parts of the system will now be considered.

The monitored waveform must be recurrent and must be substantially the same shape each time it occurs. As only one element of a graph is produced each time the waveform occurs, 100 per second is considered about the lowest suitable recurrence rate. An afterglow tube is used to provide a constant display of the graph. The upper limit of recurrence depends on the ability to count down the prepulse and locking pulse (not the waveform). 4,000 per second is the highest rate at which the display circuits will work but very much higher recurrences may be handled by counting down. If the waveform is free running a pre-pulse within the specified limits must be derived, but, as already explained, jitter between it and the waveform is unimportant.

The limitation imposed by the timing and time measuring circuits is an extremely small pulse to pulse discrepancy in the positioning of the X co-ordinates (less than 0.3 millimicrosecond) resulting from valve noise.

The effective "speed" of the time scale is without limit. By causing each gating pulse to occur at exactly the same place while driving the X plates with the slow sweep, an infinite effective speed is obtained. The shortness of the time scale is no criterion of performance, as there is a limitation set by the frequency response of the monitor which makes a time scale shorter than about 50 millimicroseconds valueless.

The limitation in frequency response is due to two causes. Firstly, it is necessary to feed the waveform to the grid of a normally cut-off valve. The low-pass filter formed by the probe input lead and the grid of the valve has been found to have a cut-off frequency of about 380Mc/s with a substantially flat response up to 350Mc/s. It is thought that an improvement may be obtained by the use of a specially constructed probe input valve.

The second limitation to frequency response is due to the width of the gating pulse. It has already been explained that a pulse of current passes through the probe input valve, the amount of current depending on the amplitude of the waveform at the instant of the gating pulse. As the gating pulse is of finite width it is the mean amplitude of the waveform during the gating pulse which is measured.

The attenuation of a sine wave of frequency f which is measured by a series of gating pulses of width T can be derived as follows:—

In Fig. 5 a square gating pulse of width T is centred on point P of the waveform $V \sin \omega t$.

The mean amplitude of $V \sin \omega t$ during the period T is

$$\begin{aligned} & \frac{1}{T} \int_{t-T/2}^{t+T/2} V \sin \omega t \\ &= \frac{2V}{\omega T} \sin \omega T/2 \cdot \sin \omega t \\ &= V \cdot \frac{\sin \pi f T}{\pi f T} \cdot \sin \omega t \end{aligned}$$

The resulting waveform, therefore, has an amplitude

$$\frac{\sin \pi f T}{\pi f T} \times \text{input waveform}$$

Assuming $T = 1$ millimicrosecond and $f = 300\text{Mc/s}$, the ratio of output to input is

$$\begin{aligned} & \frac{\sin 0.3\pi}{0.3\pi} \\ &= 0.86, \text{ an attenuation of } 1.3\text{db.} \end{aligned}$$

Circuits

Most of the circuits used in the monitor follow standard practice, and will not be described in this article. The accurate timing of the gating pulse and the amplification of very low level pulses call for considerable care in the stabilizing of H.T. supplies and in the isolating of independent parts of the system. In particular it is found necessary to avoid any unintentional coupling between the slow sawtooth generator and the gating pulse generator or the Y deflexion system.

Two circuits are shown, for the reason that they do not follow standard practice, and were specifically designed for this instrument. They are (1) the complete circuit of the probe unit and the subsequent amplifying stages and (2) the derivation of the millimicrosecond gating pulse.

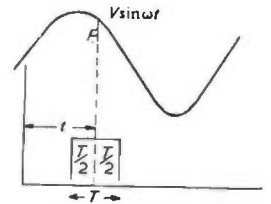

Fig. 5. Measurement of mean amplitude of sine wave during time interval T

Y. CO-ORDINATE DERIVATION

$V_1, 2, 3, 4$ in Fig. 6, are housed in the probe unit. The remaining circuits are in the main instrument.

The operation of V_1 has already been described. The negative going pulse at the anode of V_1 is amplified in the low frequency amplifier V_2 , and is fed to the main instrument. The circuit of V_3 and V_4 is an exact replica of that of V_1 and V_2 , with the exception of V_3 grid, which is returned (via C_3) to earth and has no waveform applied to it. The gating pulse is fed to V_1 and V_3 cathodes, so that the output from V_2 and V_4 are identical except for the modulation on V_3 anode output due to the waveform at V_1 grid. V_4 output is inverted in V_5 , and the two waveforms are then added so that on the slider of VR_1 only the modulation due to the monitored waveform appears.

The reason for this balancing circuit is to cancel out any noise or other unwanted waveform at the cathode of V_1 . Thus small variations in the amplitude of the gating pulse have no effect. (It should be noted that as the gating pulse is about 10V in amplitude a variation of 1 per cent

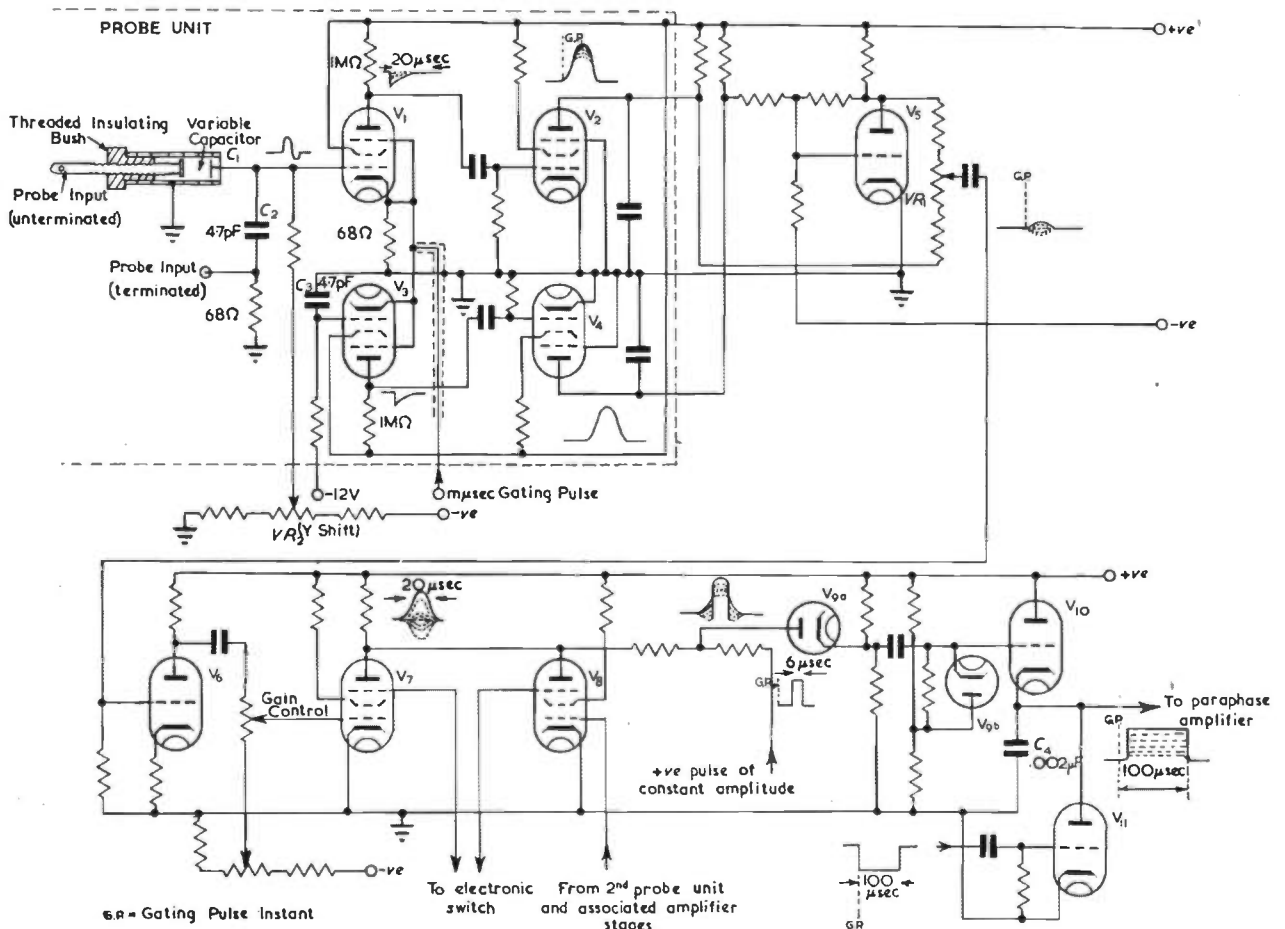

Fig. 6. Derivation of Y co-ordinate

produces the same change in V_1 current as a 0.1V waveform on V_1 grid, which is the normal working level.) Another unwanted waveform which might appear at the cathode of V_1 and which is effectively cancelled is that due to high frequency chassis currents which are normally troublesome when monitoring a waveform such as shown in Fig. 8. This waveform is only 0.5V in amplitude and occurs simultaneously with a 200kW thyatron pulse. In spite of this the interference is negligible.

The balanced output is amplified in V_6 and again in V_7 . V_7 and V_8 have a common anode load, and V_8 is preceded by the same stages as V_7 . By means of switching the suppressors of V_7 and V_8 electronically the outputs from two probe units can be fed into the common load during alternate slow sweeps of the X deflexion system.

It is required that the pulse lengthening circuit be provided with unidirectional pulses. Therefore, a constant amplitude pulse is added to the waveform at V_7 and V_8 anodes. D.C. restoration is carried out in V_9 and the resulting waveform is applied to the cathode-follower V_{10} , which charges C_1 to rather above the peak of the grid waveform. C_1 remains charged until V_{11} conducts after about 100 microseconds (or in the case of low repetition rates, after about 400 microseconds). V_{11} remains conducting until the next gating pulse occurs, when it again cuts off, allowing C_1 to charge to a new level.

The resulting pedestals are fed to a paraphase amplifier and to the Y plates of a cathode-ray tube.

Amplitude calibration is carried out by adjusting the voltage calibrated control VR_2 , which changes the grid potential of V_1 , thereby introducing vertical shift. It is, however, still necessary to know the attenuation due to

the input capacitive divider which is variable. This is measured by applying to the probe input a c.w. oscillation of known amplitude. A 3V and 30V peak-to-peak oscillation are available, and the resulting unlocked band of Y co-ordinates is compared with the calibrated shift, the ratio between the two being the attenuation for a given setting of the capacitive divider.

MILLIMICROSECOND PULSE GENERATOR

Fig. 7. is the circuit of the final stage of the millimicrosecond gating pulse generator. The basic requirement in the generator is the very rapid switching on of the valve V_2 . The current in the anode circuit is caused to change from zero to roughly 2A in a time of the order of 1 milli-

Fig. 7. Final stage of millimicrosecond pulse generator

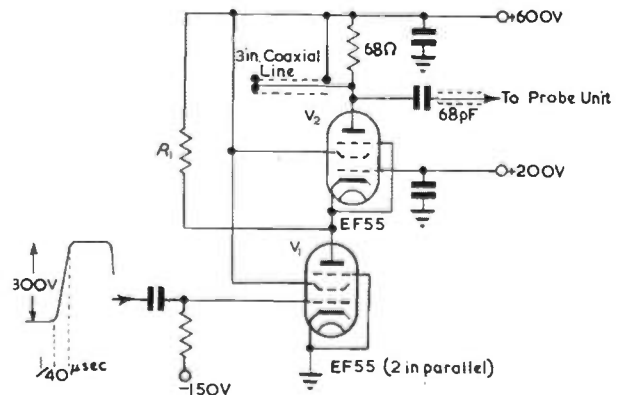

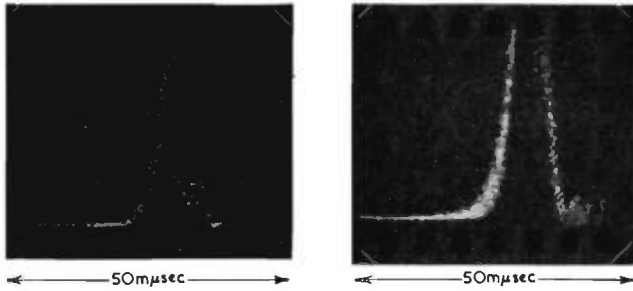

Fig. 8. T.R. cell "Spike" recorded on high-speed recurrent waveform monitor. (a) With "keep alive" voltage applied to cell. (b) "Keep alive" removed; same voltage scale as (a)

microsecond. The resulting negative edge travels along the piece of short-circuited line, and the returning inverted edge cancels the initial drop, the current in V_2 having by this time reached a constant value. A narrow pulse is thus formed at the anode of V_2 , and is fed to the probe unit where the tip only of the pulse is used to gate the input valves as already described.

V_2 is switched on by a negative waveform applied to its cathode. Although this method has the disadvantage that the switching waveform has to provide the whole of the current for V_2 , there are two overriding advantages:—

- (1) It is a simpler matter to provide a fast negative edge than a similar positive one.
- (2) A negative edge can be produced with a sharp

Fig. 9a. Grid and cathode waveforms of a $\frac{1}{2}\mu\text{sec}$ blocking oscillator pulse generator. The voltage scale of each wave form is the same. (b) The front edge of the above waveforms on a $0.1\mu\text{sec}$ time scale

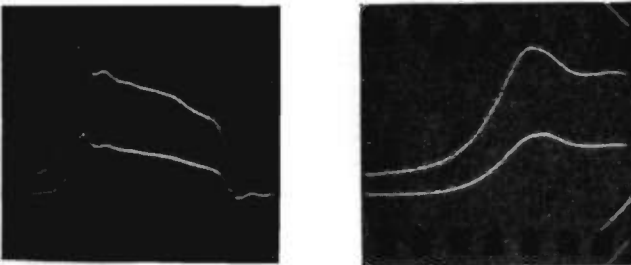

transition from maximum rate of change of voltage to constant voltage.

V_1 , shown as a single valve, though it is preferable to use two in parallel, is switched on fairly rapidly by a blocking oscillator pulse, the resulting current reaching a maximum of several amperes in about 5 millimicroseconds. By the time the current has reached its maximum it has discharged the anode capacitance of V_1 and the cathode capacitance of V_2 from 600V to about 200V at which point the bias on V_2 is overcome and the remaining negative going edge before V_1 bottoms switches on V_2 sufficiently rapidly for the present purpose.

Some Practical Applications

One application of the monitor has already been indicated in Fig. 4 in which the rectified build-up of oscillations in a magnetron is shown. An important waveform associated with the above is the break-through in a T.R. cell to which the magnetron output is applied. The break-through, shown in Fig. 8,

is an example of the low amplitude, steep edged waveforms, in the monitoring of which the instrument is used to its best advantage. It would be an extremely difficult matter to reproduce the waveforms of Fig. 8 by any other means.

Fig. 9. shows the waveforms associated with a blocking oscillator in which case use is made of the waveform mixing facility.

Fig. 10. shows a few cycles of build-up of a pulsed 150Mc/s oscillator. The two concurrent waveforms appear at the anode and grid respectively of the valve.

Many other applications will no doubt come to mind, and the usefulness of the technique in any particular case can be assessed in the light of the foregoing description.

Acknowledgment

The author is indebted to the Directors of Metropolitan-Vickers Electrical Co. Ltd. for their help and encouragement in carrying out this work and for their permission to publish this article.

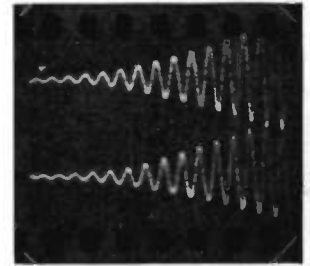

Fig. 10. Build up of oscillations in a pulsed 150Mc/s oscillator

Automatically Indicating the Termination of a Television Programme*

It is standard practice in television receivers in this country to apply the D.C. component of the picture signals to the cathode-ray tube and this allows dark and bright scenes to be reproduced as such on the receiver screen. When, however, the picture transmission ceases, the practice results in no raster being left visible on the television screen and with the cessation of the sound transmission in addition it sometimes happens that the continued functioning of the receiver passes unnoticed so that sets not switched off before the end of an evening's programme may become left on all night. This is wasteful, particularly of tube life of the receiver, and it is desirable to have some automatic indication that the receiver is still switched on although the programme has ended.

Indication by an automatic brightening of the raster appears to be a simple and appropriate form of indication and can be achieved in a very simple manner by greatly reducing the degree of the D.C. component applied to the cathode-ray tube. There is then, however, the disadvantage of insufficient dis-

crimination between dark and bright scenes, and in particular dark effects, employed frequently in studio technique, fail to be reproduced. Moreover, there is the tendency to show return lines on the screen when the average picture brightness is small.

A more satisfactory method is to employ a control of the cathode-ray tube that does not depend on the picture brightness but on some characteristic of the transmission which is constant so long as the transmission lasts and then ceases with the transmission. Thus the sound carrier may be employed and a control applied to the cathode-ray tube, depending on the D.C. present in the sound detector circuit. Alternatively a control may be developed proportional to synchronizing impulse amplitude. Here the control can conveniently be obtained from the anode circuit of the separator valve. In accordance with the usual practice at present adopted synchronizing impulses are applied in a positive sense to the control-grid of the separator valve with the result that the valve is not strongly conducting on the average during a transmission, but becomes strongly conducting when synchronizing impulses cease. The ending of the potential of the separator valve and this can be used to increase the intensity of the cathode-ray beam so that with the ending of the transmission a suitably bright raster is shown on the screen of the picture tube.

* Communication from E.M.I. Engineering Development Ltd.

The Physical Realization of an Electronic Digital Computer

By A. D. Booth*, D.Sc., Ph.D., F.Inst.P.

It is the purpose of this article to complete the description of an electronic computing machine, using magnetic drum storage, which was commenced in the previous articles^{1,2}.

The principal components and control elements which remain to be discussed are: (1) the multiple shift instructions, (2) the multiplier, (3) the function table, (4) the control. and these will be taken in the above order.

Multiple Shift Instructions

As explained in a previous article¹, numbers are represented, for machine purposes, in binary form and it is assumed that the "binary point" occurs immediately at the right of the most significant binary digit (i.e. that the numbers are numerically less than unity) thus a number will appear as:

0.1100,000 (3/4 in decimal notation)

In this machine, as in most others at present operating or under construction, negative numbers are represented by complements modulo 2. (That is by subtracting the positive number from 2). Thus:

$-3/4 = 2 - 3/4 = 1.0100,0000$

Now it will be seen that if several numbers are added together the sum will tend to increase. This means that, in a machine of the type under discussion where the numbers are of a limited number of binary places only, the result of a large number of additions will soon grow out of the range of the machine and digits will be lost from the most significant end. To avoid this, the register storing the number must be capable of shifting its contents to the right by any desired number of places. In a similar manner the operation of multiplication applied, as in this case, to numbers which are numerically less than unity, tends to decrease the size of the resulting numbers and consequently it is desirable to have an instruction which will shift the register contents to the left by any number of places.

A moment's consideration will show that the right shift " n " places instruction (R_n) is equivalent to division of the number held in the register by 2^n . Similarly the left shift " n " places instruction (L_n) multiplies by 2^n .

It is desirable that the sign of a number held in the register should not change as a result of a shift operation. This can be ensured by the following scheme:

In right shift n , (i.e. division by 2^n) the most significant digit, F_1 , of the original number remains unchanged and fills successive positions to its right after each shift. Thus:

Original	0.1101,0000 (13/16)	1.0011,0000 (-13/16)
1st shift	0.0110,1000 (13/32)	1.1001,1000 (-13/32)
2nd shift	0.0011,0100 (13/64)	1.1100,1100 (-13/64)
3rd shift	0.0001,1010 (13/128)	1.1110,0110 (-13/128)
etc.		

The Birkbeck College computing machines have shifting register units of the type shown in Figs. 9(b) and 10 of the previous article² and it will be seen that if no external connexion is made to F_1 and a series of shift pulses is sent to the gates G_n precisely the desired result is attained.

A left shift order is slightly more complex since no actual left shift gates are included in the register units.

This situation may be overcome, however, by observing that if the head and tail of an " r " stage register are connected together to form a ring and ($r-n$) right shift pulses are applied, the result of the operation is effectively an n stage left shift.

In practice, the machine under discussion has two registers usually called A and R and for various reasons it is convenient to arrange for the tail of A to be connected to the head of R during shift operations. This means that

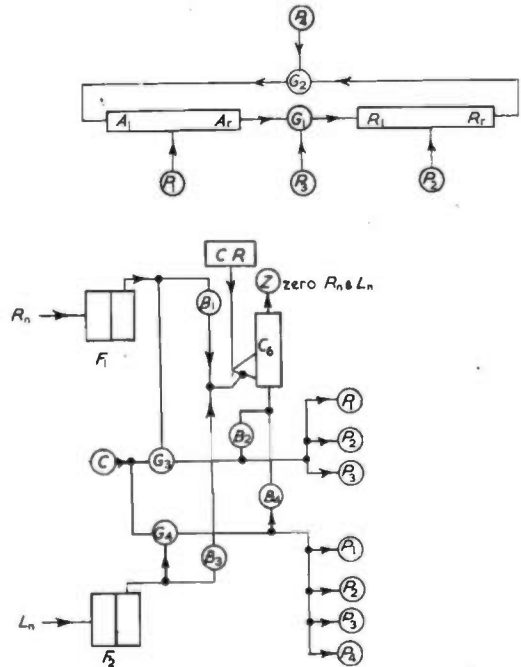

Fig. 1. Control for R_n and L_n

in fact, an n stage left shift is obtained by means of ($2r-n$) right shift pulses.

The details of the control circuits are given in Fig. 1, P_1 and P_2 are the shift pulsers for registers A and R respectively. P_3 connects A_r to R_1 and P_4 , R_r to A_1 . C_6 is a standard counter capable of being pre-set to any number indicated by the digits contained in part of the control register $C.R.$

It is worth mentioning at this point that this pre-setting of a counter is a simple substitute for a coincidence sensing device, thus if it is required to know when the contents of a certain binary counter of total capacity 2^p have reached q say, it is sufficient to preset the counter 2^p-q and to observe when carry occurs from the most significant stage. This trick could not, however, be applied to the main counter in the machine since in this case a continuous

* Birkbeck College Research Laboratory.

record of the drum position is required and considerable loss of time would result from the adoption of the above simple coincidence sensing scheme. C is a set of clock pulses and F_1 and F_2 are the control flip-flops for R_n and L_n respectively. B_1 - B_4 are diode buffers inserted in obvious places to prevent feedback from one operation to another. The operation of the circuit is as follows: when R_n is set up a d.c. step voltage is obtained from one anode of F_1 , this operates a gate, via B_1 , to pre-set C_6 to the number held in $C.R.$ (actually $64-n$ in the present machine). At the same time G_3 is set to emit subsequent clock pulses which pass, via B_2 to C_6 causing the latter to count, and to the pulsers P_1 - P_3 causing A and R to shift and A_r to be sent to R_1 .

When n pulses have passed G_3 , C_6 emits an operation complete pulse which restores F_1 to its zero state and thus terminates the operation.

The operation of L_n is exactly similar except that C_6 is now pre-set to n and P_4 is also pulsed, via G_4 , causing R_r to be sent to A_1 .

The Multiplier

The design of multipliers for digital computing

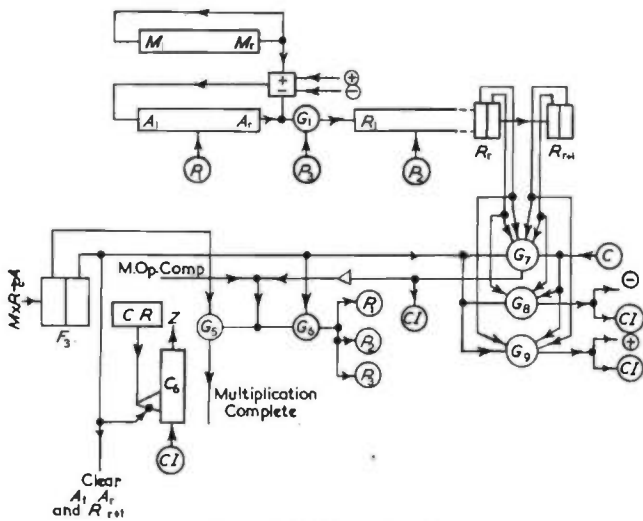

Fig. 2. Multiplier schematic

machines has been a subject of considerable controversy in the past. It is fairly easy to design a multiplier, either serial or parallel, which will deal with positive numbers; however, it is an irksome restriction in an all-purpose computing machine if numbers have to be tested for sign and converted to positive form prior to insertion into the multiplier and the result subsequently corrected for sign.

When numbers are represented in complement form an automatic multiplier, designed for positive operation only, would generate the following quantities if applied to non-positive quantities:—

- (1) $+a \times +b = ab$
- (2) $-a \times +b = 2b - ab$
- (3) $+a \times -b = 2a - ab$
- (4) $-a \times -b = 4 - 2a - 2b + ab$

so that in cases (2) and (3) corrections of $-2b$ and $-2a$ would have to be added to the result and in case (4) $2a + 2b - 4$. This can be done but results in fairly elaborate circuits and appears to be undesirable, especially in a serial machine of the type under discussion. As a result theoretical studies were undertaken with a view to finding a procedure which would need no prior knowledge of the signs of the numbers being multiplied and no corrections at the end. The mathematical details of this process have been given elsewhere³ and it is neces-

sary to mention now only the mechanical details. Referring to Fig. 2, the multiplier is held in the shifting register R and the multiplicand in M . The auxiliary counter C_6 is again used, this time to stop the multiplication process after the required number of operations. It should be noted that by presetting C_6 in a suitable manner any desired number of steps of multiplication can be carried out thus obviating wasted time when the multiplier is known to have less than n "live" digits. The process is as follows:—

- (1) If $R_r = 0$, $R_{r+1} = 0$, shift A and R one place to the right so that $A_r \rightarrow R_1$ and $R_r \rightarrow R_{r+1}$.
 - (2) If $R_r = 1$, $R_{r+1} = 1$, exactly as in (1).
 - (3) If $R_r = 1$, $R_{r+1} = 0$. Subtract M from A and then shift A and R as in (1).
 - (4) If $R_r = 0$, $R_{r+1} = 1$. Add M into A and then shift A and R as in (1).
- R_{r+1} is initially clear.

The shift is suppressed at the last operation.

When F_3 is sent into the excited state by the initiating pulse from the function table, A and R_{r+1} are cleared and the required priming number is set into C_6 from the control register $C.R.$ G_5 is closed so that the normal memory operation complete pulse, used to clear the add/subtract units, is inhibited, G_4 ... G_9 are opened. If $R_r = R_{r+1}$ (i.e., both zero or both unity) G_7 emits the next clock pulse from C , this goes to $C.I.$ and causes C_6 to count.

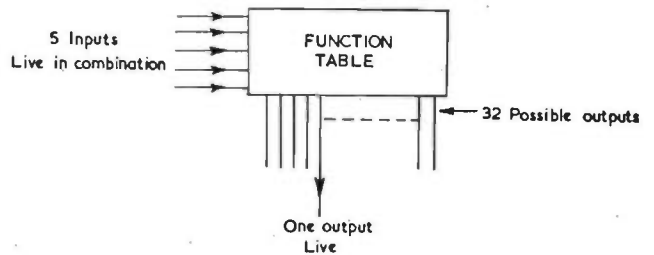

Fig. 3. Schematic of function table

After a delay $|>$ to enable C_6 , if necessary, to terminate the operation, the pulse passes via G_6 to P_1 , P_2 and P_3 causing the required shift of A and R . If the process is, however, complete C_6 will have restored F_3 to zero state closed G_6 and opened G_5 , thus allowing the pulse from G_7 and $|>$ to appear as an "operation complete" signal. If $R_r \neq R_{r+1}$ either G_8 or G_9 will emit the clock pulse, G_8 stimulates the subtract unit causing M to be subtracted from A , G_9 stimulates the add units causing M to be added into A . Both gates cause C_6 to add one to its original contents. If the current operation is not the final one, the addition or subtraction complete pulse passes, via G_6 , to the shift pulsers P_1 ... P_3 , if it is the final one, however, C_6 will have zeroed F_3 , closed G_6 and opened G_5 , and an operation complete pulse will appear via G_5 .

It will be seen that the circuit is very economical in components and also that it "shortcuts", that is, runs over any consecutive series of 0's or 1's in the multiplier without having to wait a full addition or subtraction time. A further property of the device is that a separate register M is not necessary, since M can be obtained directly from the store, this, however, slows up the operation very considerably in the case where a magnetic drum is used.

The Function Table

In this, as in most other computing machines, orders are represented in coded binary form, and since they are between 16 and 32 in number, any order can be represented by a 5 binary digit array. It is thus necessary to have means of obtaining a signal on a unique member

of 32 output channels in accord with the combination set up on the five input channels, this is shown, schematically in Fig. 3.

Three general methods of engineering a function table exist:—

- (1) By counting.
- (2) By series elements.
- (3) By parallel or matrix elements.

In the first method a counter causes a shifting register to move a single "1". If a five stage binary counter C_5 is used

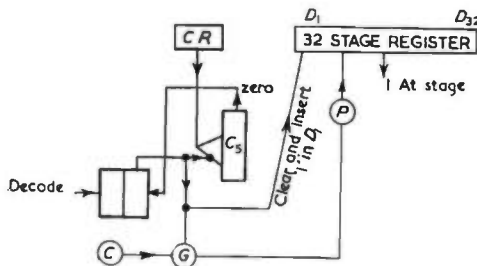

Fig. 4. Counting function table

together with a 32 stage register D as shown in Fig. 4 a "1" initially placed in D_1 will eventually reside in D_{32^n} where n is the number preset in C_5 . This scheme has the advantage of using only standard components, but has the disadvantages of complexity and inherent slowness. A variant not requiring either C_5 or D is obtained by having the instruction word so long that each operation can be given a particular digit to itself, this is so wasteful of memory space that it is usually considered impracticable.

The second method is most familiar in the form of a relay "tree" or pyramid as shown in Fig. 5. Here only one conducting path between the 32 output lines and the earth exists for each combination of on/off of the 5 relays $S_1 \dots S_5$. Although this circuit has been described in terms of relays it can be constructed from double triode valves, each anode corresponds either to an "on" or an "off" contact, the grids correspond to the coils and the cathodes to the centres. The scheme appears to be an excellent one and to have the sole disadvantage of

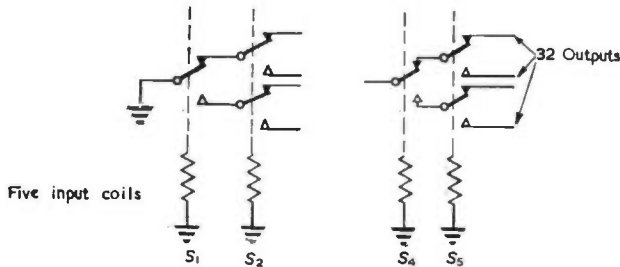

Fig. 5. Tree function table

requiring a large set of different voltage levels for correct grid biasing.

The third method uses a resistance or diode matrix as shown in Fig. 6. It will be seen that for resistive connexion the voltage in any output line is $1/3(\sum V_A)$ and that this can only reach $V_{A(MAX)}$ if all inputs to the line are at high potential. If diode connexion is used the output voltage is $V_{A(MIN)}$ unless all the inputs are high in which case it rises to $V_{A(MAX)}$. The diode matrix is thus clearly the most satisfactory but if germanium crystals are used a 5×32 table containing 160 elements is very expensive. It is hoped that the introduction of selenium rectifiers, of low capacitance, will in future improve matters.

Since a resistive matrix uses high value resistors the output step voltage has a very slow rise, to overcome this difficulty one of a set of gates $G_1 \dots G_n$ is set up by the table and then used to transmit a standard sharp pulse from a clock source C .

The Control

In Fig. 7 is shown the control schematic for a machine of the type under consideration, and it will now be explained how this operates to guide the machine in the execution of its various functions.

Firstly it will be assumed that a group of order digits is just appearing at the digit output of M (the store) and that the binary element $C.F.$ is set in the excited position. The gate G_i is open and the train of "n" clock pulses, coincident with the required word digits, are passed to the shift pulser of the control register $C.R.$ These pulses cause the contents of $C.R.$ to shift progressively to the right and, at each stage, one of the incident digits from M is absorbed. When the whole n digits have appeared these will be stored in $C.R.$ and the memory now emits an operation complete (Op. Comp.) pulse which restores

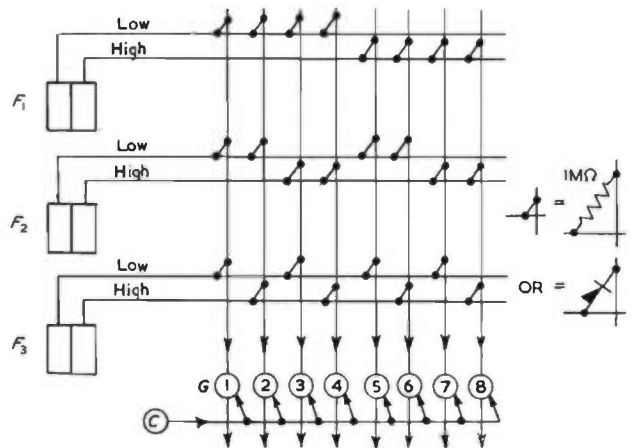

Fig. 6. 3×8 matrix decoder

$C.F.$ to its normal state. As $C.R.$ returns to zero a pulse is emitted, via line a , which gates the memory location digits of the number required in the following arithmetic operation to the memory location register $M.L.$ After a short delay τ to enable the decoder $D.C.$ to settle down on the contents of $C.R.$, a gating pulse is applied to $D.C.$ and one of its 32 outputs emits an operation pulse. At this stage several courses of action are possible: (1) Arithmetical orders not involving the memory (e.g., left and right shift). Here the operational output of $D.C.$ actuates the particular sequence line in the arithmetic unit $A.U.$ $A.U.$ performs its operation and emits an op. comp. pulse. This operation complete pulse advances the control counter ($C.C.$) one stage via line b and then, after a delay to allow $C.C.$ to settle down, causes $M.L.$ to absorb the position recorded by $C.C.$ —via lines c and d . At the same time $C.F.$ is sent into its excited state (via c) and M is instructed (via c') to emit the order located in the position shown by $M.L.$ When M has reached the appropriate position clock digits are emitted and again pass via G_i to repeat the cycle.

(2) Arithmetical orders involving transfer from M (e.g., +, -, \times , etc.). The gate pulse to $D.C.$ acts as before and $A.U.$ organizes itself to execute the required order. When it is ready it emits a "read" pulse via f to M . M when ready emits n clock pulses coincident with the digits of the given word, these pass to $A.U.$ which receives the incident digits and performs the required operation on them. When this is finished an Op. Comp.

pulse is emitted by M which, if appropriate (i.e., in + and in - but not in \times), is re-emitted by $A.U.$ to initiate the same cycle as in (1).

(3) Transfers from the arithmetic unit to the memory. Here, as in (2), $A.U.$ prepares itself for operation and then emits a "record" pulse to M via h . This causes M to emit clock pulses as before and these cause data to be shifted out of $A.U.$, via k , to M which now absorbs them in the given position. At the end of the cycle M emits its Op. Comp. pulse and the remainder of the cycle as in (1) and (2).

(4) Transfers of control. Two operations of this type exist in the single address type machine being described.

(a) Absolute transfers out of sequence.

(b) Conditional transfers out of sequence.

In the first $D.C.$ emits a pulse to $A.U.$ which is emitted directly, via m , this resets $C.C.$ to a completely new location previously contained in the order stored in $C.R.$, and after a delay, to allow $C.C.$ to settle down, sends the usual cycle pulse via c thus initiating the next cycle on the order located in the new contents of $C.C.$

In the case of conditional transfers (i.e., "if number in accumulator is positive proceed in sequence, if negative, however, transfer control to instruction located in memory position x "). The first condition causes a standard Op. Comp. pulse to be emitted, via b , while the second produces an output on m which operates as in absolute transfer.

(5) Input-output orders. If it is imagined that the input-output equipment is in $A.U.$ the operation is seen to be identical with that described in (1), (2) or (3).

Other Types of Control

Those differences which will result from the substitution of a different sort of memory or arithmetic unit are more or less trivial. If a parallel operation memory is used the only change will be that, instead of M emitting " n " clock pulses, it will emit only one which will simul-

taneously gate all the digit outputs to the appropriate receptors, this means that k , o and p will become n digit channels.

Similarly, if a two address code is adopted, in which each order contains the location of the next, the only effect will be to eliminate $C.C.$ and replace it by the multichannel connexion r , to connect b to c and d directly, and to perform conditional transfer on the channel t normally used for number locations. The latter opera-

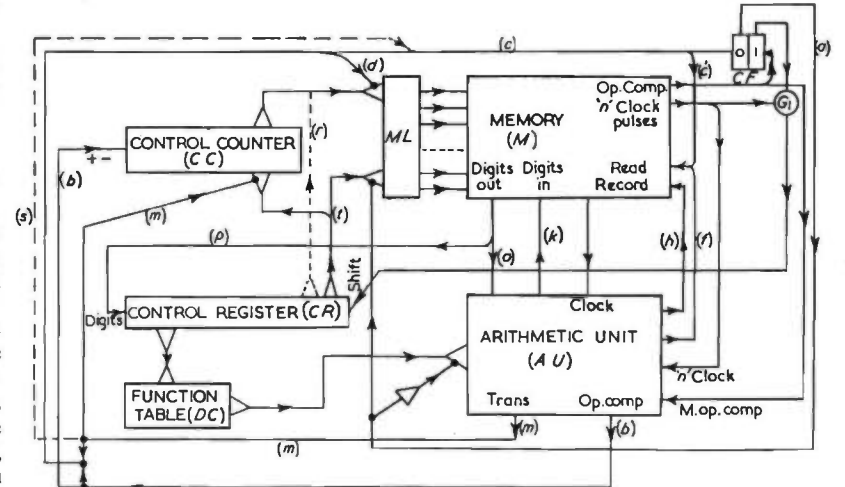

Fig. 7. Schematic of control

tion is performed by means of the connexion(s) which by-passes the gate channel d .

Conclusion

The final article in this series will deal with the input-output devices for computing machines which are at present under development in this laboratory.

REFERENCES

1. BOOTH, A. D. A Magnetic Digital Storage System. *Electronic Engg.* 21, 234 (1949).
2. BOOTH, A. D. An Electronic Digital Computer. *Electronic Engg.* 22, 492 (1950).
3. BOOTH, A. D. A Signed Binary Multiplication Technique. *Q. Journal Mechanics and Applied Maths.* 4, 236 (1951).

ELECTRONICS IN INDUSTRY

Supplement to Electronic Engineering

AS announced on page 133 of the March 1952 issue of ELECTRONIC ENGINEERING the second supplement on *Electronics in Industry* will appear in next month's issue of this journal.

Like the first supplement which was published in April last, it will be printed on tinted paper and will be bound in with the issue.

Among the articles on the further applications of electronics to industry and industrial research will be contributions by qualified authors on the following subjects:

Vibration Studies in Aircraft Design.

Electronics in the Rubber Industry.

Nucleonics as an Aid to Industry.

Electronics in the Textile Industry.

An order form is enclosed in this issue for regular readers who may require additional copies and for readers who are not regular subscribers and who wish to secure a personal copy.

The price of the November issue, complete with supplement, will remain at 2s., and all inquiries relating to copies should be addressed to: ELECTRONIC ENGINEERING (Circulation Dept.), 28 Essex Street, Strand, London, W.C.2.

BBC New Automatic Unattended Transmitter Technique

(Part 1)

By F. A. Peachey*, M.I.E.E.; R. Toombs*, B.Sc., A.M.I.E.E.; C. Gunn-Russell*, M.A.

SINCE the early days of the British Broadcasting Corporation, the general trend has been to extend the broadcasting service by increasing the power of the main medium and long wave transmitters. However, there are still localities where reception is poor, perhaps due to fading, or through interference after nightfall from stronger foreign signals in crowded frequency bands. The difficulty cannot be overcome by further increases in power on medium wavelengths, or by providing more high-power stations as there are insufficient wavelengths for the latter. Another method must be adopted and an obvious solution, though only a partial one until V.H.F. comes into general use, is to erect small-power, local stations for operation on shared wavelengths, in places where the main transmitters do not provide a satisfactory signal. Eight such stations have already been brought into service by the BBC, and four more are planned or in the course of construction. This represents an appreciable capital outlay, but more important are the manpower difficulties and the revenue charges, which are inevitably heavy at all manually operated stations. Some of these low-powered stations are already unattended, but are remotely controlled from premises which have to be staffed. This is an economic arrangement if the unattended station is not too remote from its "parent" station. If outside the limits of reasonable radio reception, these stations have, however, required a return programme channel for monitoring purposes, which is expensive. So far, the BBC has not accepted any arrangement as being sufficiently reliable without some programme monitoring check.

If a remote control system is used to operate a transmitter, the latter may be unattended, but is not necessarily fully automatic. Control and monitoring is effected by a parent station, sometimes using the Automatic Monitor described earlier¹.

Summarizing the situation, the BBC has already in service:

(1) FULLY STAFFED STATIONS

Such stations are fed by a programme signal line and a control line (one programme signal line per programme radiated and usually a control line common to the complete station).

(2) REMOTELY CONTROLLED UNATTENDED STATIONS

These are stations which are not staffed, but have a "return" programme signal line so that monitoring of the radiated signal from the transmitter may take place at the base supplying the programme signal. This is usually accomplished automatically by means of the "Automatic Monitor Minor". The latter provides an alarm if the programme signal radiated by the distant transmitter is outside reasonable limits of distortion. When this alarm is

observed, an engineer at the originating station can make use of the remote switching facilities to ascertain which part of the system is faulty. He can then, by further remote switching, take some action to clear the trouble.

The BBC now proposes to try in service as an adjunct to the remotely controlled type, stations which are largely self-sufficient and possibly one hundred miles from the parent station. In this system the transmitter consists of two or three units each checked by its own self-contained automatic monitor; details of this part of the system will be given in Part 2 of this article. It is also necessary to check the performance of the line connecting the parent station to the remote station. A method of providing such a check without the need for a return programme line is described in this part of the article.

The Line Monitor

This is done by producing pulses from the rectified programme signal at the parent station and passing these signals over a phantom circuit derived from the normal programme circuit to the remote station. At the remote station similar signals are derived from the programme at that point and compared with those arriving from the phantom circuit. Any lack of correlation between these signals which indicates a sufficiently serious fault, will close down the transmitter until normal conditions are restored. By this means, two important advantages should accrue. As monitoring is achieved in this way and no return programme signal line is needed, the reliability of monitoring is nearly doubled. Possibly of greater importance is the saving in running costs. The capital cost of the automatic apparatus required for this purpose will, of course, depend on the source and method of manufacture, but it should certainly be less than the rental charge for one year of the line it saves. This will mean a revenue saving per station, after the first year of operation, of £1000 to £2000 per annum.

Emphasis should be given to the fact that reliability has throughout been regarded as of foremost importance and it is considered that the circuit arrangements about to be described fulfil that requirement. This has been achieved not only by providing duplicate monitoring and input equipment, but also by dividing the transmitter into several identical and self-contained units which normally operate in parallel. Incidentally, the transmitter output combining problems which therefore arise, are to be described in another article, to be published shortly.

As an automatic system cannot pass absolute judgement on programme quality, but must, by necessity, be provided with a source of comparison, some extra channel other than the programme channel must be provided. Such

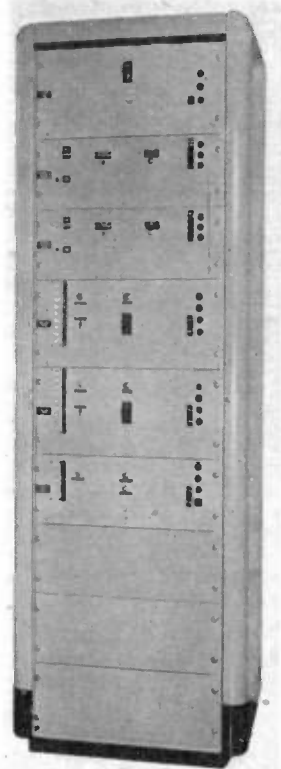

Automatic monitor unit for transmitters at unattended stations.

* Design Department, BBC Engineering Division.

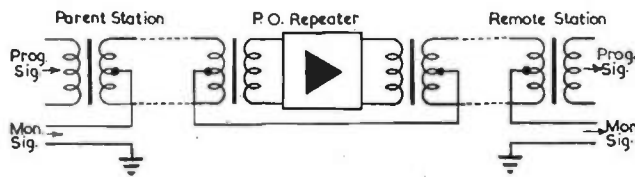

Fig. 1. Programme signal line and monitoring signal phantom circuit

a channel needs to convey only a small amount of information; in fact, it need not be wideband as long as the pulses derived from the programme signal are sufficiently slow and do not contain components that would interfere with the programme.

With a suitably designed message system, the phantom circuit derived from the programme line is adequate for conveying the monitoring signals². This is shown in Fig. 1.

Slow speed messages, describing the condition of the programme, are provided by a detector which is shown in Fig. 2. This, it will be seen, is a two valve amplifier

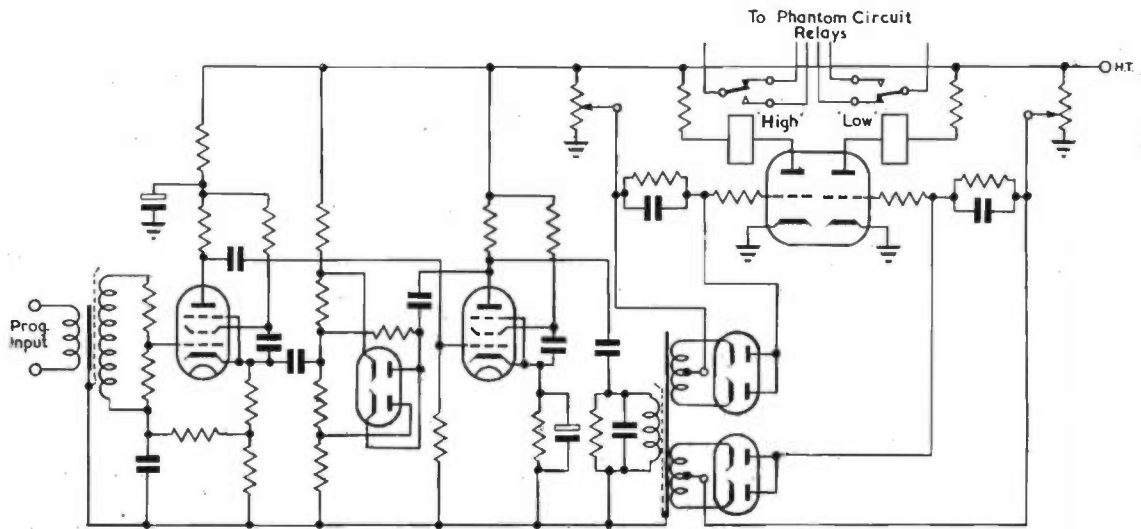

Fig. 2. Sending end detector (simplified diagram)
Receiving detector as above but one output receiver and relay circuit omitted.

having a non-linear amplitude characteristic provided by back biased diodes in the negative feedback path. Below a certain volume these diodes are inoperative and the amplifier provides full gain, while at higher volumes the diodes conduct, increase the amount of negative feedback and so decrease the gain. The output from the amplifier is rectified and passed to relays which describe the volume of the programme. This is done in terms of three volume ranges, *A*, *B* and *C*, as shown in Fig. 3.

The detectors cause the operation of further relays, external to the unit, which apply distinctive D.C. signals to the phantom. Three signals are used, distinguished by magnitude or polarity, corresponding to the three ranges of programme volume considered.

The phantom circuit is, of course, fitted with low-pass filter networks so that the maximum frequency component which results from this D.C. switching is unlikely to cause interference on the programme channel. It will be appreciated that this alone places a restriction on the speed at which information is sent.

At the distant end of the line, that is, at the transmitting station, a similar detector assesses the rectified value of the received programme, but indicates only two level ranges, *A'* and *C'*, as shown in Fig. 3.

Now it will be seen that while there is correlation between the sending and receiving detector operation, i.e. *A* corresponds with *A'* or *C* corresponds with *C'*, conditions of transmission may be regarded as satisfactory. If,

however, *A* corresponds with *C'* or *C* with *A'* it means that in the one case the programme has dropped in volume or in the other case that the programme has increased in volume. The former may occur if the line becomes broken and the latter, if some spurious source of signal, such as line noise, has arisen between the sending and receiving ends. The division between the level conditions is made at the value shown in Fig. 3 so that the monitor will be sensitive to the predetermined amount of noise at which action is deemed desirable.

The *B* volume range is provided so that the overall device shall not be too sensitive to small changes in transmission line equivalent. When the programme volume at the sending end is within this range, that at the distant end may be hovering between ranges *A'* and *C'*. In these circumstances monitoring should be temporarily suspended. This is effected by sending over the phantom a 'neutral' signal which prevents the distant monitor from taking executive action. This 'neutral' signal is also invoked to prevent the sending of false messages to the

phantom, if a failure occurs in the monitoring equipment at the sending end. To provide for this, the detectors at the sending end are duplicated and their relays are interconnected. As long as they give the same signal as each other, the 'neutral' signal is sent only during the period that the programme volume lies within the *B* range, but it is

Fig. 3. Showing volume of programme signal at which detectors operate
This is different for high and low frequencies as aural grading is introduced in the detector circuits.

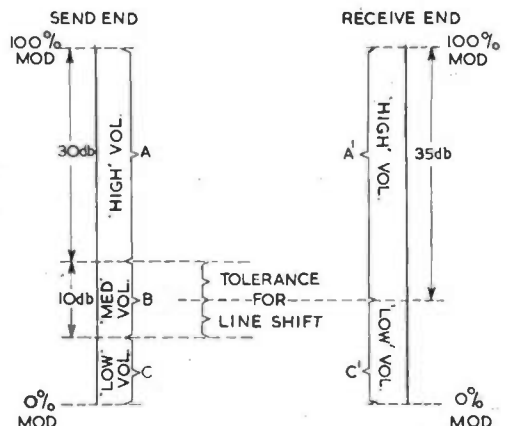

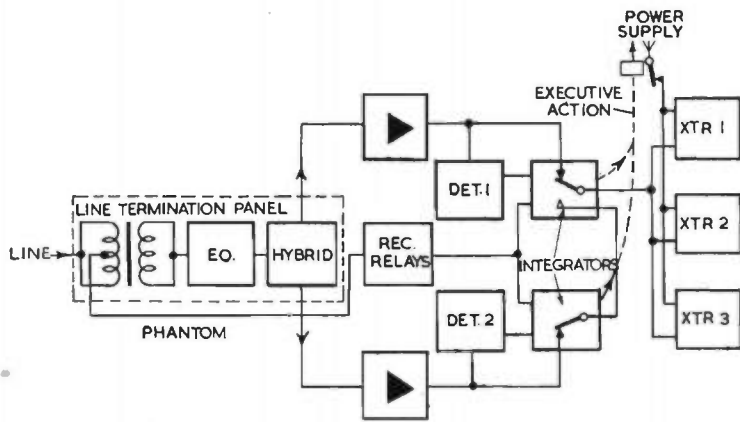

Fig. 4. Block schematic of equipment at receiving end

sent continuously if the indications from the two sending end detectors differ for an appreciable period. This latter condition produces an alarm at the sending end, indicating that the line monitoring has failed.

At the receiving end, the detectors are duplicated for a similar purpose but are used in a different way (see Fig. 4). The line, on entry into the transmitter building, is split into two independent chains and a separate detector is connected across each. The interconnexion of the detector relays and the associated integrator circuits is arranged so that if the signal from either detector differs from the sending end signal, the transmitter will be fed off the other branch from the line termination panel. This guards against incorrect action due to a fault on either detector, and also looks after a fault arising in the receiving line amplifier apparatus.

It will be appreciated that with this line monitoring system it is important that the relays at the two ends shall operate in the correct sequence. The criterion is that when the line with its associated equipment is not faulty, the receiving end shall never detect (except for a period, too brief to give operation) a condition of programme volume which is opposite to that signalled from the sending end. To satisfy this, the time-constants are so arranged that the sending end relays always "shadow" those at the receiving end if the programme is rapidly decreasing in volume. This is shown in Fig. 5. If the programme increases in volume, the "shadow" provided by the forward time-constants is sometimes cancelled by the time delay on the phantom circuit, but in such a case the period of error is too short to cause subsequent operation.

The time-constants are also such that the overall system may discern extraneous noise during intervals between words. It would, however, be quite wrong to close down a transmitter for a substantial period for just such a short

Fig. 5. Relay operating sequence

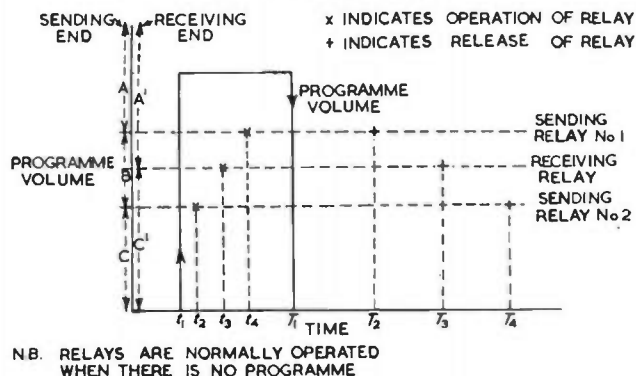

period of noise. To avoid this, further discrimination, approximating more closely to the action of an engineer or operator at the station, is introduced by a special integrator device shown in Fig. 6. This receives signals in accordance with the correlation or differences between the sending and receiving detectors.

Capacitor C receives a discharge if the signals correlate at low-level and a charge if they differ at either high- or low-level. The discharge time-constant of this capacitor circuit is very long indeed—several hours—and so it keeps a continuous and stored integration watch on the detector operation. If, due to a profusion of "differences" in a given period the voltage on this capacitor increases sufficiently, the gas discharge tube V_1 will strike and executive action be taken in closing down the transmitter. Correlation assessment is not made at high signal volume

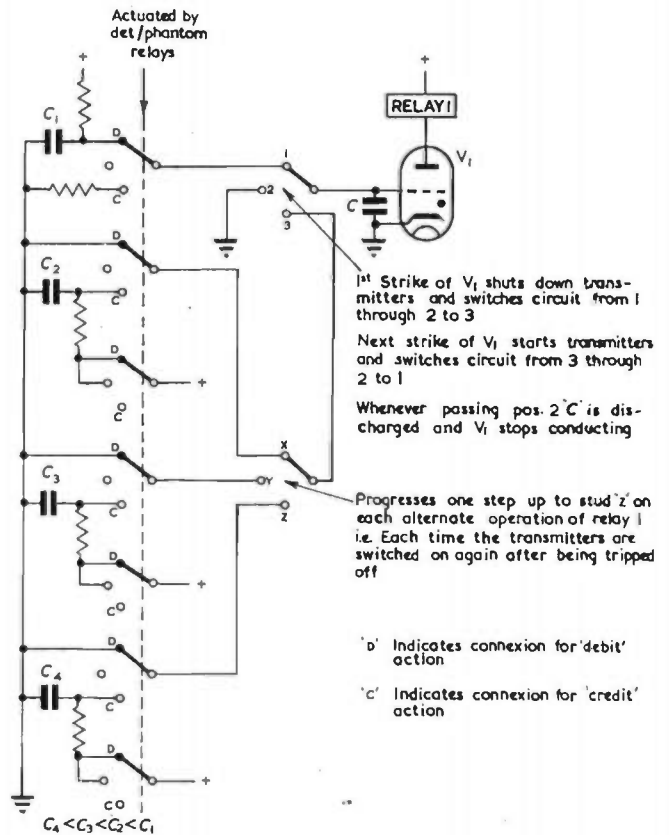

Fig. 6. Simplified circuit arrangement of "debit/credit" integrator

as this is away from the maximum sensitivity of the detectors, and under fault conditions might produce undue dilution of the ultimate assessment. On the other hand, difference at high volumes can be registered. This also fits in with circuit convenience. It will be seen that the effect approximates fairly closely to the action of an operator who would not take the drastic action of closing down a transmitter unless the background noise were not only loud but persistent.

After the transmitter has been closed down by such means, this integrator capacitor is cleared of previous information and is virtually reversed in action. Whereas previously it was charged by "difference" signals (or "debits") by means of C_1 , being switched to it, it is now charged from correlation signals (or "credits"), by C_2

being switched to it instead of the discharge leak. A 'debit' produces a complete short-circuit (for the period of the fault) on C, whereas a 'credit' is established by the discharge of a small capacitor on to a large capacitor, and for a given grade of fault it therefore takes very much longer for an overall credit charge to be established.

This in effect means that after the transmitter has been closed down due to line trouble, it can be restored, but the monitor has become more critical of fault condition. The circuits are so designed that a further switch-off due to a transmission fault in the same day, will produce even greater difficulty in restoration.

This obviates "fast and loose" operation on an intermittent line fault. In acting with increased caution after each shut down the equipment approaches the attitude of an engineer or operator. The stored information about any earlier switching operation is cancelled whenever the power supply to the equipment is broken. A time switch makes and interrupts the main supply at the beginning and end of the normal programme period so that the integration will be cleared at least daily.

Two such integrators are provided, so that if the first one becomes faulty, the second will automatically take over as a consequence of the first transferring the transmitters to the reserve local programme input equipment (see Fig. 4).

These several units and their associated relays are so interconnected that a normal fault on the monitoring apparatus either brings into use alternative apparatus or prevents the monitor from taking executive action.

A fault at the sending end while holding off the line monitoring also produces an alarm. The possible absence

of monitoring at the receiving end may be discerned by another means which will be described in the second part of this article.

In some instances the line routings are such that two or more such small-power stations will be fed in tandem. This presents no particular problem, as the monitor signal generated at the sending end, or parent station, can be passed through to successive stations by simple relay equipment.

In designing systems for automatic operation of unattended stations, the general complication, if it can be considered such, arises from the need to provide alternative apparatus which takes over automatically if the normal equipment becomes faulty. It is estimated that the visiting by a service team should not have to be more frequent than once a month, but this largely depends on the reliability of the lines connecting the parent station to its satellite. Much experience has been gained regarding line reliability and with the co-operation of the Engineering Department of the General Post Office, there is every reason to suppose, that apart from the few inevitable and spasmodic mishaps, the need to close down a station through line trouble should be relatively infrequent. The monitoring apparatus is, of course, designed to be more reliable than the apparatus it is monitoring.

(To be continued)

REFERENCES

1. WYNN, R. T. B. Chairman's Address before the Radio Section. *J.I.E.E.*, 97, Pt. III (1950).
RANTZEN, H. B. PEACHEY, F. A. and GUNN-RUSSELL, C. The Automatic Monitoring of Broadcast Programmes. *J.I.E.E.*, 98, Pt. III (1951); and also The Broad Principles in the Design of Automatic Monitors. *Electronic Engg.* 23, 19 (1951).
2. British Patent No. 15480/52.

Atomic Exports

The Ministry of Supply have announced that Britain is now the largest exporter in the world of radio-active materials for peaceful purposes.

The only other competitors in the world market for these materials at present are the United States and Canada.

Owing to the growing urgency of demands from far away countries, B.O.A.C. have converted a fleet of Argonauts to carry the materials in their wing tips and are now considering suggestions for similar modifications to Comet 2 aircraft. This method reduces the cost of transport by over sixty per cent by cutting out the cost of heavy lead containers.

During the year which ended in June the Supply Ministry's Atomic Research Establishment at Harwell sent more than 3,000 consignments of isotopes to no fewer than 37 different countries.

Radio-active isotopes are still used mainly for medical purposes and new discoveries are continually being made to increase their scope; but they are also daily gaining more significance in scientific research and industrial applications.

Altogether 9,578 consignments were sent from Harwell in the year, of which 3,053 went overseas by air.

Another indication of the growing international interest in the by-products of Britain's atomic energy programme has been the steady flow of scientists to the Isotope School at Harwell, where the technique of using isotopes is taught. To date, 133 experienced scientists, doctors and engineers have passed through the School. Of these, 102 have come from Great Britain and the others from India, Australia, South Africa, Belgium, Egypt, Greece, Holland, Israel, Italy, Norway, Spain, Sweden and Yugoslavia. Nearly two-thirds of the total have been chemists and bio-chemists and the remainder has been made up of electrical, electronic and other engineers, physicists and medical men.

When the School first opened in March 1951 it was housed in a converted hut, but it has now been moved to a permanent brick-building outside the security fence in which all modern facilities and instruments have been provided for the specialized work.

Canadian Television*

The Canadian Broadcasting Corporation's first television network was officially opened on September 6th.

Both Toronto and Montreal have been equipped with two studios (one large and one small) and their control rooms, a master control room, and film projector room.

In the large studios are three complete Image Orthicon camera chains and, in each control room, all the vision mixing, distribution amplification, power supply, inter-communication, producers' and engineers' control equipment. The smaller studios are similarly equipped, but with only two Marconi Image Orthicon camera chains.

The master control rooms have studio picture monitors, waveform monitors and master control switching equipment, while the film and projector equipment will allow the two stations to televise 16mm films, slides and film strips.

The projectors can be remotely controlled from any of the control positions.

The two outside broadcasting vans incorporate the latest techniques in design. They are streamlined, and contain all the equipment normally found in fitted studios. Each is a three-camera station with full video, audio and radio link equipment.

All portable equipment can be stowed quickly and neatly, and just as quickly set up into operation. Producer and technicians can sit comfortably in the van for control purposes.

Representing the British company at the opening ceremony was Commander B. G. H. Rowley, the Marconi representative in New York.

*Communication from Marconi's Wireless Telegraph Co., Ltd.

The Wien Bridge and Some Applications

By C. F. Brockelsby*, A.R.C.S., B.Sc., A.M.I.E.E

ALL modern alternating current bridge methods stem from the work of Max Wien, who published, in 1891, a description of apparatus and procedure which underlies the techniques now in use. Among the circuits described¹ is one for the comparison of two capacitors; this circuit, shown in Fig. 1, is that which today is usually known as the Wien bridge. It is seldom used for the measurement of capacitance; its importance now lies in the fact that balance occurs only at a particular frequency, determined by the values of the arms. The bridge is therefore useful for measuring frequency and, by appropriate circuit techniques, as a substitute for an inductance-capacitance tuned circuit in selective apparatus such as filters, tuned amplifiers and oscillators. In the following paragraphs, the operation of the bridge itself is developed and some examples of its application are explained.

The Wien Bridge

The balance condition can be written down in the usual way, by equating the ratios of the vector impedances of adjacent pairs of arms[†], which gives

$$R_3/R_1 = (R_1 + 1/j\omega C_1)(1/R_2 + j\omega C_2) \quad (1)$$

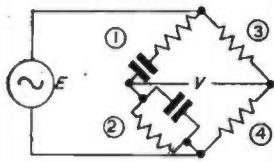

Fig. 1. The Wien bridge

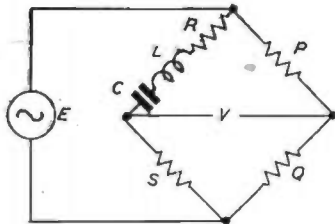

Fig. 2. Series resonance bridge

Separating the real and imaginary parts,

$$\left. \begin{aligned} \omega_0^2 C_1 C_2 R_1 R_2 &= 1 \\ R_1/R_2 + C_2/C_1 &= R_3/R_4 \end{aligned} \right\} \quad (2)$$

If $R_1 = R_2 = R$ and $C_1 = C_2 = C$, Equations (2) reduce to

$$\left. \begin{aligned} \omega_0 CR &= 1 \\ R_3/R_4 &= 2 \end{aligned} \right\} \quad (3)$$

The physical basis of the bridge balance is easy to see. The phase-angle of arm 1 rises from -90° at very low frequencies to zero at very high frequencies, while that of arm 2 falls from zero to -90° . At some frequency these phase-angles must, therefore, be equal; if the ratio R_3/R_1 is then made equal to the ratio of the impedances of arms 1 and 2, the bridge will balance. It is to be noticed that the balance frequency depends equally upon all four components of arms 1 and 2, being determined by the product $C_1 C_2 R_1 R_2$. There is no essential relation between the values of these components; for example, making $R_1 = R_2$ and $C_1 = C_2$ is simply a matter of convenience. If this equality is only approximately maintained in practice, the effect will be a slight alteration of the frequency, according to the product of the values, and a slight change in the required ratio of R_3 to R_4 . If these resistors are fixed in value, (this is necessary in some applications) deviations of the components of arms 1 and 2 from their ideal values will result in a slightly imperfect bridge balance.

* Late of Marconi Instruments, Ltd.

† The suffices refer to arm numbers in Fig. 1.

Frequency Response

The variation with frequency of the transmission through the bridge can be obtained as follows. Inspection of Fig. 1 permits us to write

$$V/E = R_4/(R_3 + R_1) - Z_2/(Z_1 + Z_2) \quad (4)$$

With $R_3 = 2R_1$ this becomes

$$V/E = (Z_1/Z_2 - 2)/3(1 + Z_1/Z_2) \quad (5)$$

With $R_1 = R_2 = R$ and $C_1 = C_2 = C$,

$$Z_1/Z_2 = 2 + j\omega CR + 1/j\omega CR \quad (6)$$

Putting in the angular frequency, ω_0 , at which the bridge balances, $\omega_0 = 1/CR$,

$$\begin{aligned} Z_1/Z_2 &= 2 + j(\omega/\omega_0 - \omega_0/\omega) \\ &= 2 + jy \text{ (say)} \end{aligned} \quad (7)$$

Hence

$$V/E = \frac{1}{3} \cdot \frac{jy}{3 + jy} \quad (8)$$

The magnitude of the ratio of the input to the output voltage is therefore given by

$$|E/V| = 3\sqrt{1 + 9/y^2} \quad (9)$$

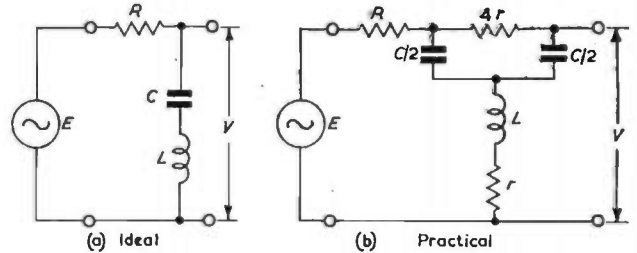

Fig. 3. Ideal and practical rejector circuits

The phase of V relative to E is ϕ , with $\cot \phi = y/3$.

Analogous Circuits

It is obvious that the transmission behaviour of the bridge bears a general resemblance to that of a tuned circuit: the series-resonance bridge of Fig. 2 is, in fact, an exact equivalent. The analysis of its frequency characteristic, on the lines of the above treatment of the Wien bridge, gives, for $R/S = P/Q = 2$.

$$V/E = \frac{1}{3} \cdot \frac{j2Qy}{3 + j2Qy} \quad (10)$$

where $Q = \omega_0 L/R$

The response is thus precisely the same as that of the Wien bridge if $Q = \frac{1}{2}$. In this sense, we may say that the "equivalent Q " of the Wien bridge is 0.5.

Equation (10) can be generalized by taking the resistance S as part of the series tuned circuit; this yields a new value Q' for the magnification of the coil: $Q' = \omega_0 L/(R + S)$. The frequency characteristic then becomes

$$V/E = \frac{1}{(n + 1)} \cdot \frac{jQ'y}{1 + jQ'y} \quad (11)$$

Where $n = R/S = P/Q$.

Equation (11) also describes the behaviour of a bridge containing a parallel-resonant circuit.

The simplest circuit having this frequency characteristic is shown in Fig. 3(a); it includes a perfect, loss-free tuned

circuit. This is, of course, unobtainable in practice, but the circuit of Fig. 3(b) is equivalent in performance. The frequency characteristic of these circuits is given by

$$E/V = \frac{jQy}{1 + jQy} \dots\dots\dots (12)$$

where $Q = \omega_0 L/R$. This characteristic is the same (apart from the insertion loss) as that of the Wien bridge if $Q = 1/3$, so that, in this more general sense, the "equivalent Q " of the bridge is $1/3$.

The frequency characteristic of the Wien bridge—and of the resonance bridge with the proper value of Q —is shown in Fig. 4, which also illustrates the effect of a slight departure from the ideal ratio R_3/R_4 , making the balance imperfect. The residual signal at the best obtainable balance is proportional to the error in the ratio arms, being given approximately by

$$V/V_\infty = (2/3)p \dots\dots\dots (13)$$

where $V_\infty =$ output voltage at frequencies far removed from balance.

$p =$ fractional error in resistance ratio.

Thus a ratio error of 0.1 per cent limits the suppression of the bridge to 62db; an error of 1 per cent, to 42db, and so on.

A polar plot of the transmission characteristic is informative; it shows both amplitude and phase characteristics.

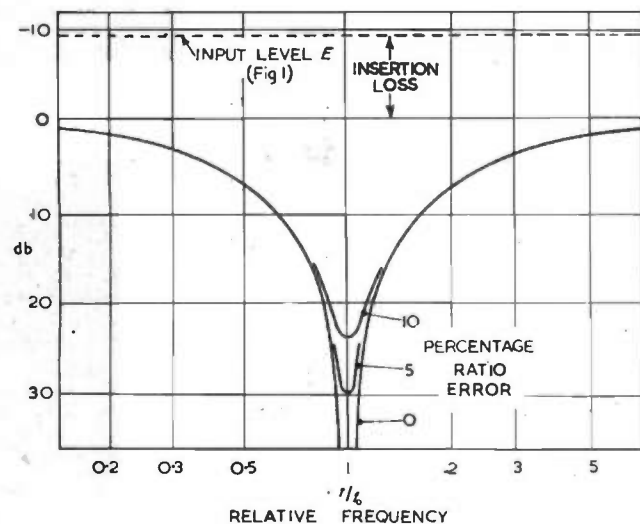

Fig. 4. Frequency characteristic of Wien bridge

What is required is to express V/E of Equation (8) in the form $r \exp j\theta$ and obtain a relation between r and θ from which the polar plot can be drawn.

Omitting the factor $1/3$, which represents only the insertion loss, from Equation (8),

$$r e^{j\theta} = r(\cos\theta + j \sin\theta) = V/E = jy/(3 + jy) \dots\dots\dots (14)$$

Equating the real and imaginary parts gives

$$\left. \begin{aligned} 3 \cos\theta - y \sin\theta &= 0 \\ y \cos\theta + 3 \sin\theta &= y/r \end{aligned} \right\} \dots\dots\dots (15)$$

Eliminating y : $r = \cos\theta \dots\dots\dots (16)$

The polar plot is therefore a circle; it is shown in Fig. 5, which also shows the effect of maladjustment of the ratio arms.

When the ratio arms are correctly adjusted, Fig. 5 shows that the output voltage, at frequencies very near balance, is in quadrature with the input voltage. When the ratio arms are changed slightly, however, the bridge output voltage, at the balance frequency, is exactly in phase—or out of phase—with the input voltage, the sign depending upon the direction in which the ratio arms are altered.

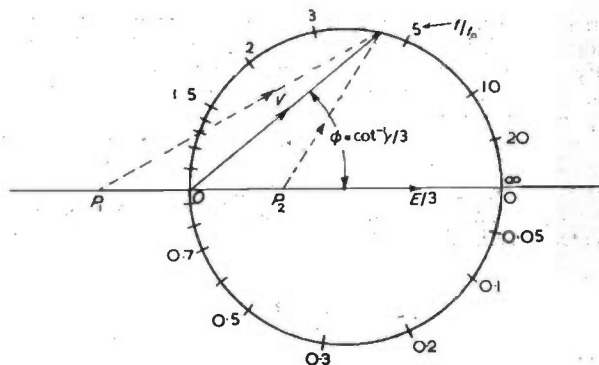

Fig. 5. Polar plot of V on $E/3$
Vector V rotates about O when $R_3 = 2R_4$; but about P when $R_3 \neq 2R_4$.
 P_1 is for $R_3 < 2R_4$; P_2 is for $R_3 > 2R_4$.

Unbalanced/Unbalanced Connexion

In common with all other four arm bridges, the input and output connexions of the Wien bridge must be balanced to earth on one side, or both sides, of the bridge. When the bridge is used simply for the determination of frequency, this is no great disadvantage as a screened and balanced transformer can be provided. It is, however, difficult to construct transformers with a very wide frequency range and small phase shift; they are therefore inconvenient in many applications and must usually be excluded from negative feedback circuits. Where a power supply is available, the transformer can be replaced by a phase-splitting valve with the circuit of Fig. 6. The frequency response of this circuit is the same as that of the original Wien bridge (shown in Figs. 4 and 5). The insertion-loss becomes very nearly zero because of the cathode-follower connexion. The valve will introduce stray capacitances which will normally have only a very small effect upon the balance frequency. The permissible amplitude of the signal is, of course, limited to that which the valve can handle.

The foregoing discussion brings out the essential features of the behaviour of the Wien bridge and some applications will now be described.

Distortion Measurement

The total harmonic content of an approximately sine-wave signal is commonly measured by suppressing the fundamental and measuring the residual, i.e., harmonic, voltage. The tuned-circuit bridge of Fig. 2 and the bridged-T circuit of Fig. 3(b) have both been used for this purpose in successive models of the Marconi Instruments Limited Distortion Factor Meter type TF 142. In these circuits, the minimum Q to obtain a substantially equal response to all harmonics is about 3*.

* This is the Q of the bridge as in equation (11). The Q of the coil itself will usually need to be considerably higher.

Fig. 6. Phase splitter and Wien bridge

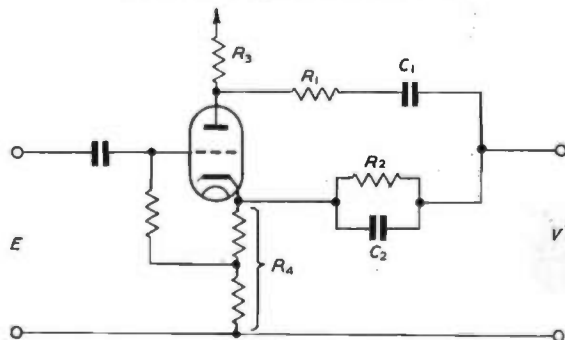

It is therefore not possible simply to substitute the Wien bridge, which has an effective Q of about 1/3. This difficulty can be overcome by including the bridge in the closed loop of a negative feedback amplifier, which flattens the response at frequencies away from balance. The block schematic circuit diagram of Fig. 7 shows the connexions; writing A for the voltage amplification of the amplifier and n for the ratio of output to input voltage of Fig. 6, the overall amplification m of Fig. 7 is given by the usual negative feedback equation:

$$\begin{aligned} 1/m &= 1 + 1/nA \\ &= 1 + \frac{3 + jy}{jAy} \end{aligned} \quad (17)$$

Hence

$$m = \frac{jAy}{3 + j(A + 1)y} \quad (18)$$

$$|m| = \frac{Ay}{\sqrt{\{9 + (A + 1)^2 y^2\}}} \quad (19)$$

At extreme frequencies, $y \rightarrow \infty$

$$m \rightarrow m_\infty = A/(A + 1) \quad (20)$$

The frequency characteristic is therefore given by

$$|m/m_\infty| = \frac{(A + 1)y}{\sqrt{\{9 + (A + 1)^2 y^2\}}} \quad (21)$$

Equation (21) shows that the frequency characteristic is flat when $(A + 1)y \gg 3$; the droop is less than 5 per cent when $(A + 1)y > 9.4$. At the second harmonic, $y = 2 - 1/2 = 1.5$; an amplification A of only 5.3 is therefore sufficient to secure a flat response within 5 per cent for all frequencies from the second harmonic upwards. A single-valve amplifier is clearly capable of providing this over a wide frequency range and also gives the correct phase for negative feedback.

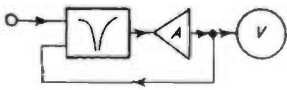

Fig. 7. Distortion meter

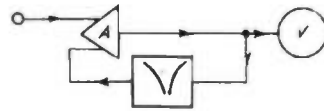

Fig. 8. Analyser

Wave Analysis

If the circuit of Fig. 7 be rearranged as in Fig. 8, putting the Wien bridge in the negative feedback path, its response curve is inverted by the feedback and a selective amplifier is obtained. It is quite practicable to build such amplifiers with a satisfactory performance for very many measurement purposes, including use as bridge detectors, but the application to wave analysis is limited by the difficulty of obtaining sufficiently rapid attenuation as the signal moves away from the tuned frequency.

(This difficulty can be overcome by using two selective amplifiers in cascade. This arrangement has other advantages; for example, a flat-top response curve can be obtained by staggered tuning).

In the Distortion Meter, discussed above, the fundamental is fully suppressed by the Wien bridge; only a little negative feedback is required to level off the response to all the harmonics. In the analyser, however, the minimum amplification is approximately unity (at frequencies far from balance) and the maximum amplification is simply that of the amplifier (at balance, when the feedback vanishes). The separation in amplitude provided by the selectivity of the system can, therefore, never exceed the gain of the amplifier. Thus, if it is desired to measure a component whose amplitude is only 0.1 per cent of that of the strongest component, the gain must be at least 60db. In practice, most measurements will be made with the wanted component only part of the way down the skirt of the curve of response to an unwanted component and the separation will therefore be less than the above.

The frequency characteristic of Fig. 8 is readily obtained by a method similar to that used for Fig. 7 and is given by

$$m_0/m = 1 + \frac{iAy}{3 + jy} \quad (22)$$

$$|m_0/m| = \left\{ \frac{9 + (A + 1)^2 y^2}{9 + y^2} \right\}^{1/2} \quad (23)$$

where m_0 = amplification at tuned frequency, $y = 0$.

For example, when the bridge is tuned to the second harmonic, the response to the fundamental ($y = 1.5$) has fallen by a factor

$$\left\{ \frac{9 + (A + 1)^2 \times 2.25}{11.25} \right\}^{1/2} \sim \frac{A + 1}{\sqrt{5}}$$

that is, 5 for $A = 10$, or 45 for $A = 100$. The fundamental-suppression at the second harmonic is therefore about 6db less than the amplifier gain.

The sharpness of tuning near the bridge balance can be found by letting y become small (say, less than unity) in Equation (22), which reduces to

$$m_0/m \sim 1 + j \frac{A + 1}{3} y \sim 1 + j(A/3)y \dots (24)$$

This is the equation for the response of a tuned circuit

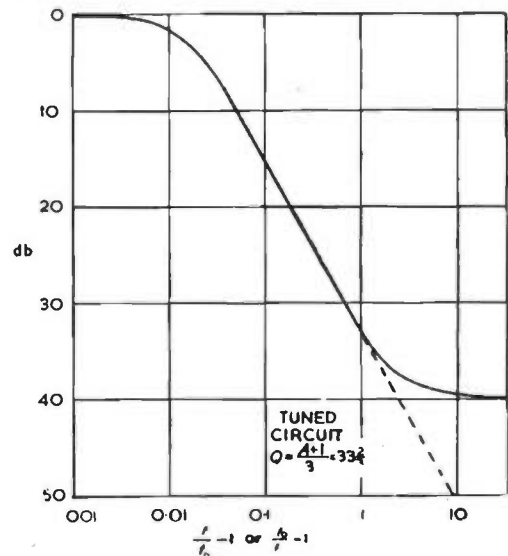

Fig. 9. Response of selective amplifier. $A = 100$

with $Q = A/3$. The effective Q of the selective amplifier is thus $A/3$; the negative feedback amplifier increases the effective Q of the bridge A times.

For very small mistuning Δf , $y \sim 2\Delta f/f$. Then

$$m_0/m \sim 1 + (2A/3) \Delta f/f \dots (25)$$

$$|m_0/m| \sim 1 + 2A^2/9 (\Delta f/f)^2 \dots (26)$$

which is sufficiently accurate for mistuning up to about 15 per cent. The response falls by 3db for a percentage mistuning of $(150/A)$ per cent.

The response curve for $A = 100$ is shown in Fig. 9, with the curve for a tuned circuit ($Q = 33\frac{1}{3}$) for comparison.

Oscillator

It was shown, in connexion with Fig. 5, that a departure from the exact balance value of the ratio arms produces, at the tuned frequency, an output voltage from the bridge which is at 0° or 180° to the input voltage. If the connexions are like those of Fig. 8, in-phase voltage produces negative feedback and the out-of-phase voltage produces positive feedback. If this is of sufficient magnitude, the loop amplification will reach unity and the system will

oscillate at substantially the balance frequency of the bridge. Output in the required phase is produced by increasing the value of R_3 in Fig. 6; the fractional increase required is $1/A$.

To make it possible to adjust the amplitude of oscillation smoothly down to a low value, at which the waveform will be good, it is desirable to put into the circuit an element which varies automatically with amplitude in such a way as to reduce the positive feedback when the amplitude increases. Perhaps the simplest arrangement is to include a metal-filament lamp as part of R_4 .

The oscillation frequency will be that for which the phase-shift of the complete loop is zero, so the phase-shift in the amplifier must be small if the frequency is to be substantially that of the bridge. It is easy to show, from Equation (22), that a phase shift ϕ in the amplifier results in a small frequency shift given approximately by $\Delta f/f = 1.5 \tan \phi/A$. For example, with $A = 30$, a phase shift of 11° produces a frequency shift of 1 per cent. The amplifier phase-shift can easily be made zero at any single frequency, but it is more difficult to maintain a high amplification

with very small phase-shift over a wide frequency range. At high frequencies, moreover, it is no longer permissible to neglect "stray" reactances within the bridge network. Wien bridge oscillators thus find their main utility at frequencies between a few cycles and a few tens of kilocycles per second.

Conclusion

The Wien bridge, especially when used in conjunction with a phase-splitting valve, is a versatile device capable of performing a number of useful functions in electronic circuits. The foregoing discussion, while not exhaustive, brings out the main features of the behaviour of the bridge and indicates the scope of three of its more important applications.

Acknowledgment

Acknowledgment is due to Messrs. Marconi Instruments Limited for permission to publish this paper.

REFERENCE

1. WIEN, M. *Ann. der Phys.* 44, 681 (1891).

A Gain Stabilized Mixer

By M. Lorant

A new type of feedback mixer that will retain gain calibration over a reasonably long period of time has been developed recently at the U.S. National Bureau of Standards. The device helps correct the serious defect of long time calibration instability common to many units used for the continuous recording of radio field intensity. The mixer is equally applicable to other types of frequency selective measuring equipment.

In the operation of the circuit, gain stabilization is brought about by using, as negative feedback, the difference frequency voltage from the output of a superheterodyne mixer. As an approximate explanation of its performance, the mixer tube may be considered similar to a voltage feedback i.f. amplifier. When a high degree of feedback is maintained, excellent gain stability is achieved. The conversion gain is also stabilized to the extent that the conversion transconductance is linearly proportional to the average value of amplifier transconductance.

When a high degree of feedback is employed the gain is essentially not a function of the valve transconductances, but is approximately proportional to the ratio of two constants determined by the switching or modulating function of the mixer valve. One constant relates to the average value of amplifier transconductance and the other refers to the conversion transconductance. Variations in the constants are chiefly due to tube ageing, but are also effected by changes in circuit impedances, oscillator and supply voltage instability, etc. However, there is little effect upon the gain with feedback provided both constants are similarly changed by approximately the same percentages. This appears to be the case with valves such as the 6SA7 and 6SB7-Y. With other valve types there may be appreciable differences in the percentage change of the constants, resulting in a change in the centre frequency voltage gain which had not been anticipated. This effect may be considered as a limiting factor for stability improvements with some mixer valves. Fortunately, the valves used during the course of the experimental work did not appear to suffer appreciably from this possible limitation.

In an experimental single-stage circuit (Fig. 1) a 6SB7-Y was employed as the mixer tube. With an anode supply of 100 volts or greater (300 volts normal) and 26db of feedback, the gain variation was less than 5 per cent of that which would be experienced without feedback. This particular single valve

mixer experiment indicated that a large change in conversion transconductance resulted in a relatively small change in voltage gain. It should be noted that in order to substantially improve the gain stability, a relatively high degree of feedback is required. For this reason a valve with a high conversion transconductance should be selected. In addition, the tuned anode circuit should have a high impedance and a high Q if a relatively narrow bandwidth is desired.

The gain stabilization principle may be extended to mixer couples (Fig. 2) or possibly to mixer triples as well. For example, if feedback is applied over two stages using practically obtainable coils of high Q, a relatively narrow bandwidth with improved flatness will result. The feedback voltage is derived from the capacitive voltage divider of a tuned anode circuit and is returned to the cathode of the first stage through a parallel resonant circuit. The cathode

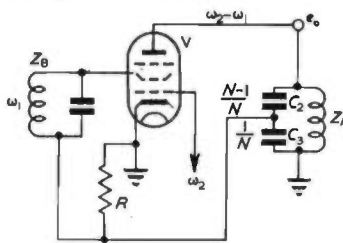

Fig. 1. Single valve feedback mixer

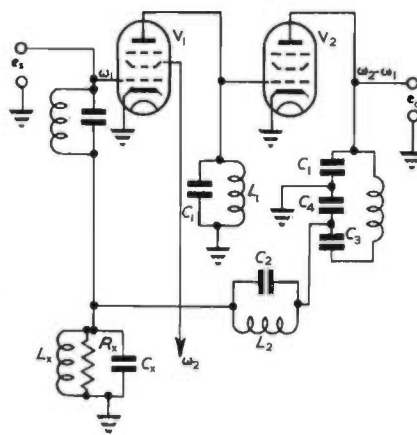

Fig. 2. An extension of the gain stabilization principle

ode return is used to obtain the correct phase relationships. The resulting improvement in gain stability for the mixer couple operating at 3.75Mc/s with 23db of feedback is greater than that obtained in the single valve circuit.

When the mixer valve is operated with a fairly large cathode resistor, degeneration of both signal and oscillator voltages will be appreciable. To avoid this difficulty, the phase of the feedback voltage is reversed by suitable means and the feedback applied to the signal grid of the mixer. This circuit is similar to the mixer couple previously described except the feedback voltage returns to a junction between a parallel tuned grid circuit and a grounded shunt circuit composed of resistance, inductance, and capacitance. The purpose of this shunt-connected R , L , and C is to furnish the correct terminating impedance for the feedback circuit as well as to provide a sufficiently low impedance at the signal frequency to by-pass the grid return. This arrangement has been used to maintain a constant feedback ratio over a frequency range of 1 to 20Mc/s.

Compared to a cascade, synchronous, single-tuned mixer-amplifier arrangement, the new mixer couple provides improved gain stability, increased gain-bandwidth product and a gain-frequency characteristic which more nearly approaches an ideally rectangular shape.

The Clavioline

By G. H. Hillier

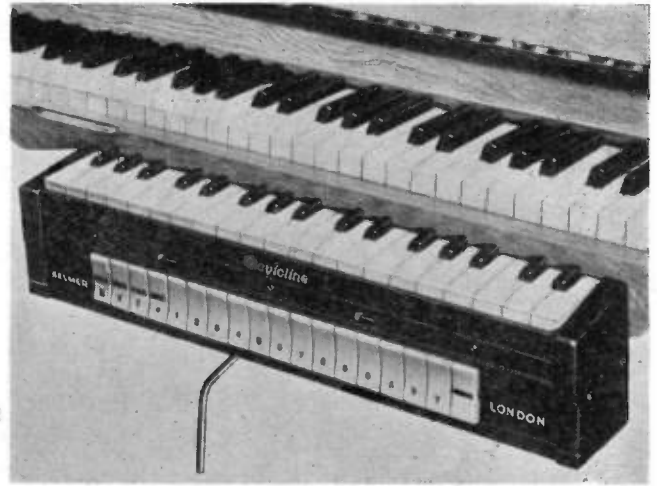

Fig. 1. The keyboard of the Clavioline attached to a piano

THE Clavioline¹ is a small electronic musical instrument manufactured in this country under licence from M. Constant Martin, a French inventor who has a considerable amount of work in the electronic musical instrument field to his credit.

The instrument is melodic, that is, it can sound only one note at one time. It is played from a small keyboard of three octaves, 20 in. in length, which is arranged so that it may be attached to a piano, and played therewith.

Many different tonal effects are obtained by manipulation of one or more of the 18 stop tablets which can be seen in Fig. 1 extending along the front of the keyboard, and the performer can soon learn to imitate a considerable number of different instruments. Three vibrato speeds, and two vibrato amplitudes contribute considerably to its effectiveness and, for use in the simulation of plucked strings, a separate tablet produces a percussion effect at the commencement of the tone. Control of expression is by means of a knee operated swell.

The complete tone generator, the vibrato oscillator and its buffer amplifier, together with a control valve, are in the keyboard unit, which also contains all the tone forming circuits. The amplifier, power supply and loudspeaker are carried in a separate case, into which the keyboard unit packs for transit. The whole equipment weighs approximately 46 lbs.

As the circuit diagrams show, the Clavioline is economically designed, and it is obvious that a considerable amount of thought has gone into it. Its simplicity and economy compared with the Hammond Solovox², for example, are marked, although one feature of the Solovox, octave coupling, is absent in the Clavioline.

The tone generator, Fig. 2, uses a 6SN7 as a multi-vibrator, the frequency of which is changed by altering the resistance in circuit between the grid of the right-hand

triode and earth, ($R_{39, 40, 41}$, etc.), and by changing the capacitance in circuit between the anode of the left-hand triode and the grid of that on the right, (C_{6-10}). The value of the tuning resistors is such that each increment of the complete series placed in circuit by the key contacts will lower the frequency of operation of the oscillator by one semi-tone. Thirty-six sets of key contacts and resistors are included in order to cover the compass of the keyboard. The values of the capacitors C_{6-10} have been so chosen that operation of the switch S_1 , either to the left or right of the centre position will transpose the pitch of the sound produced either down or up one octave. The control for this switch can be seen between the stop tablets and the keys in Fig. 1. The Clavioline therefore covers five octaves. The variable resistors VR_6 and VR_3 , enable the performer to put the Clavioline in tune with the piano or other instruments with which it is to be played. Other pre-set controls, not shown in the figures, are adjusted during manufacture and tuning. Most of the capacitors and resistors used are close tolerance, high stability types in order that frequency drift may be minimized, the tuning resistors, for instance, being specially made to $\frac{1}{2}$ per cent. As the power supply components are separate from the keyboard unit, there is no noticeable warming up drift after one minute's operation.

The oscillator is kept quiescent, when no key is pressed, by the application of 30V bias to the grid of the right-hand triode via the tuning resistors and VR_6 .

Operating in conjunction with the tone generating oscillator is a vibrato oscillator, V_3 , another 6SN7, and its buffer amplifier V_4 a 6L63 (Fig. 3). Normally inoperative, this oscillator is set in operation by S_3, S_1 , or S_5 , which respectively give vibrato speeds of 4.5, 5.5, or 6.5c/s, by selection of the resistor in the grid-anode, and grid-earth circuits. The output from this oscillator is passed to the cathode-follower buffer amplifier, V_1 , via C_{16}, R_{23} , and S_6 , and the output from this valve modulates the tone oscillator V_2 , with which it shares a common cathode resistor, R_{23} . S_6 shunts the buffer feed resistor R_{23} in order to provide a measure of control over the deviation produced by the vibrato oscillator. A small amount of amplitude modulation is produced, but the greater effect is that of a frequency shift vibrato, which is more acceptable and natural.

From the tone oscillator, the signal is passed to the grid of the control valve V_2 , a 6BA6. This valve is normally kept in a non-conducting state in a similar manner to the oscillator by the application of bias to the cathode via a high value resistor, R_8 ,

Fig. 2. The tone generator and control circuits

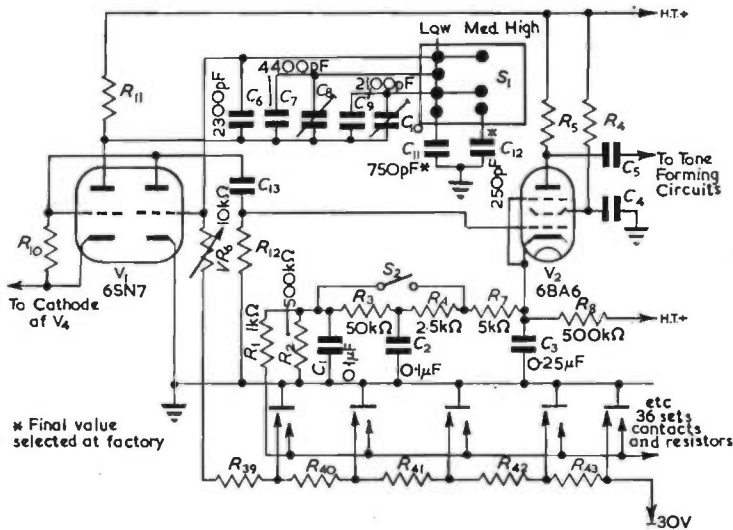

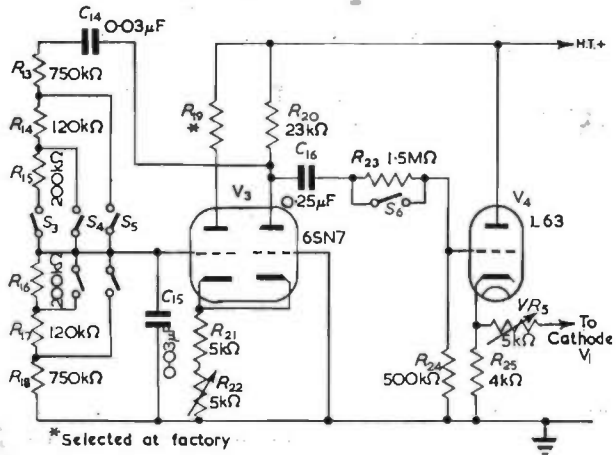

Fig. 3. The vibrato oscillator and buffer amplifier

from the H.T. supply. Associated with the cathode circuit of V_2 is a low-pass filter and delay network.

On pressing a key, two contacts are made, one shortly before the other. The first removes the bias from the oscillator by grounding the junction of two of the frequency determining resistors, and at the same time sets the amount of resistance in circuit in order to produce the correct note. The second contact removes the bias from V_2 , which, after a delay determined by the time-constant of the cathode circuit, passes the signal to the tone forming circuits, via C_3 , with the correct "attack". If two keys are inadvertently pressed, only the higher of the two notes will sound.

The switch S_2 (tablet "P") is included in order to reduce the time-constant of the circuit so that a definite transient appears at the commencement of each note. It helps to provide the plucked string effect when used in conjunction with the expression control. This control is a variable resistor, R_{32} , of special construction and grading, connected across the output from the control valve, and operated by the lever which can be seen in Fig. 1. The track is so graded that bowed and plucked string effects, for example, when "playing" the violin or guitar, may be obtained with a little practice.

The output from the control valve is trapezoidal in form, which as is well known, is composed of the fundamental,

Fig. 4. The tone forming circuits

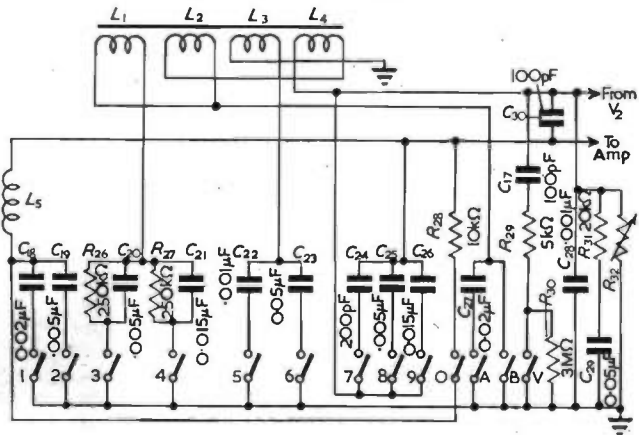

together with a long series of the natural harmonics thereof. Such a wave is easily modified to produce the characteristic tone colours of orchestral instruments. In the Clavioline this is effected by passing the wave through a set of resonant, high and low-pass filters (Fig. 4). These filters suppress harmonics of the fundamental which are not required, and also, by their resonant nature, exaggerate frequency

TABLE 1
Suggested combinations for some of the instrumental tone colours which can be reproduced on the Clavioline

INSTRUMENTS	NO.	LETTER	VIB.	AMP.	COUPLER
Violin	1	O or V	2	+	High
Viola	1	O or V	2	+	Medium
Tenor-Sax. .. .	4	—	3	—	Medium
Trumpet	—	—	2	—	Med.-High
Trombone .. .	3	—	2	—	Low
Horn	23	—	3	+	Low
Bassoon	37	—	—	—	Low
Cornet	6	—	1	—	Medium
Oboe	148	—	1	—	Medium
Flute	345	—	1	—	High
Piccolo	140	—	2	—	High
Hawaiian Guitar	146	P	2	+	Medium
Banjo	34	BP	—	—	Medium
Mandolin .. .	368	P	—	—	High
Musical Saw .. .	3	B	2	+	High

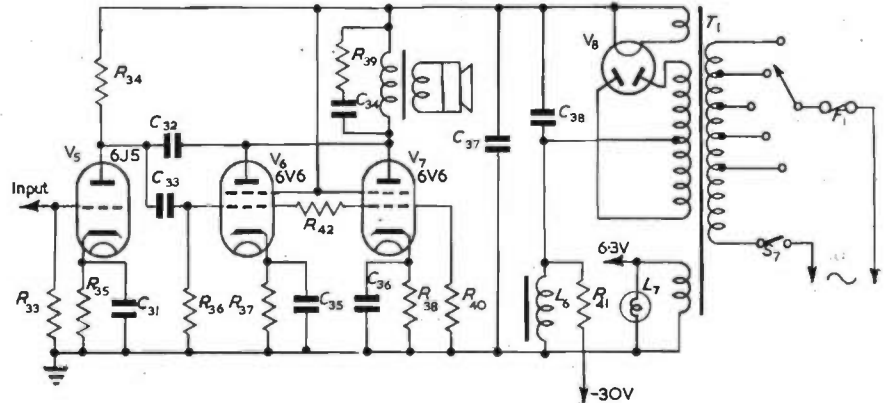

Fig. 5. The amplifier and power supply unit

bands in order to produce the characteristic formants required. Table 1 shows how these filters are selected by the stop tablets to give distinctive tone colours, and the writer, who has played the instrument, can say that the tones produced, in particular the strings and brass, are very realistic.

From the keyboard unit the signal is passed to the amplifier, Fig. 5, which is designed to introduce a controlled amount of harmonic distortion, which adds to the realism of the sound produced. In the same way, the 10 in. moving-coil loudspeaker has been specially produced to add its measure to the distortion produced in the amplifier. Most of the distortion added in the amplifier and loudspeaker is 2nd harmonic.

In production, a number of the components in the generator, tone forming circuits, and the amplifier are hand picked in the finishing or voicing process.

Acknowledgment

The writer is indebted to Messrs. Henri Selmer and Co. Ltd, of London for their co-operation and help in producing this article, and to M. Constant Martin for permission to publish the circuit diagrams.

REFERENCES

1. British Patent Specification No. 653340.
2. British Patent Specification No. 541911.
3. DOUGLAS, A. The Solovox. *Electronic Engg.* 22, 275 (1950).
3. British Patent Specifications Nos. 643846 and 657292.

A Study of the Characteristics of Glow-Discharge Voltage-Regulator Tubes

(Part 2)

By F. A. Benson*, M.Eng., Ph.D., A.M.I.E.E., M.I.R.E.

Vibration and Mounting

Current-voltage and striking characteristics have been obtained and measurements of initial drifts and life tests have been carried out with tubes mounted in a vertical position upside down and also with the axes of the tubes horizontal. All the results, including length of life, appear to be independent of the method of mounting.

Several tubes of each type have also been subjected to severe vibration tests. The tubes were mounted on a lever fixed at one end, the other end resting on a toothed wheel attached to a driving-motor shaft. They could, in this way be set in rapid vibration.

The tests indicate that vibration does not seriously affect stability. The changes in running voltages recorded were only of the order of 0.01 per cent. For best results, however, in applications where vibrations or sudden shocks are liable to occur, an anti-microphonic mounting should be used as specified by some manufacturers¹⁶.

Photoelectric Effects

Baker¹⁷ has observed certain photoelectric effects associated with several commercial neon glow lamps in America. He reports a case where moderate daylight reduced the striking voltage obtained for a tube kept in the dark by about 10 per cent.

It was, therefore, decided to examine all the glow-discharge tubes, at present under consideration, for such effects. The tubes were placed in the dark and then in moderate daylight. The striking voltages and running voltages were recorded for the two conditions.

No differences in the characteristics were observed with the tubes in the dark or in moderate daylight except for one tube of each of the types VR105 and VR150. In these two particular cases placing the tubes in the dark increased the striking voltages by about 12 per cent over those in normal daylight as already mentioned previously.

It appears, however, that, apart from these two types of tube, even where glow-discharge tubes are used under conditions where constancy of the striking voltage is important, it is unnecessary to keep the level of illumination within certain limits or to coat the envelopes with paint or other material to render them opaque. This also applies to the CV71 tubes for which an opaque coating is specified.

Operation with Reversed Polarity

For two reasons it was felt that a knowledge of the properties of tubes operating with the cathode potential positive with respect to the anode would be of interest. First, the author has experienced several cases where tubes have been accidentally used with reversed connexions. Secondly, glow-discharge tubes have been successfully applied to the stabilization of A.C. voltages in addition to D.C. ones. The striking and running voltage characteristics with reversed polarity have been determined for most tubes.

STRIKING VOLTAGE

Table 5 shows the results obtained. It is difficult to draw any definite conclusions about striking voltage with reversed connexions. Even for tubes of the same type, in some cases the voltage is reduced, in others it is increased by reversing the polarity. For example, of the particular CV1070 tubes tested, the striking voltage was mainly lower with reversed connexions than when operating normally, only 3 out of 36 tubes striking at a higher voltage. The maximum decrease in striking voltage was 13V. For the 85A1 tubes, on the other hand, the majority struck at a higher value when reversed. The maximum increase was 28.5V, but a decrease of 7.5V was observed.

To explain the difference between the striking voltages in the two cases it is necessary to draw attention to the theory of striking for non-uniform fields.

TABLE 5—CHARACTERISTICS OF TUBES WITH REVERSED POLARITY

TUBE TYPE	STRIKING VOLTAGE VARIATIONS FROM TUBE TO TUBE (V)	RUNNING VOLTAGE FROM TUBE TO TUBE (V)	VARIATION FOR A SINGLE TUBE (MAX.) V.
CV1070 ..	103.5-119.5	85.0-112.0	16
85A1 ..	106.5-142	93.5-135.0	28
CV45 ..	†	†	†
S130 ..	†	†	†
CV71 ..	130-160	132-187*	46*
KD60 ..	72-75.5	49-60.5	2.5
CV188 ..	100-115	78.0-95.5	14
G50/1G ..	58-75	48.0-51.5	2.5
G180/2M ..	172-197‡	147-205‡	58‡
G120/1B ..	80-110	51.5-73	16
VR105 ..	122-132	103-157	54
VR150 ..	162-180	146-197†	27†
CV284 ..	80-117	64.5-86	16.5
NT2¶	—	—	—

KEY FOR TABLE 5

* 0.4 to 4mA only.

† 5-15mA only.

‡ Only one tube of each type tested as at a current of about 70mA tubes arc over.

§ One anode used only.

|| In normal daylight.

¶ Electrodes are the same shape. The characteristics for normal and reversed connexions are almost the same.

THEORY OF STRIKING FOR NON-UNIFORM FIELDS

In the case of non-uniform fields Townsend's theory gives the following condition for striking¹⁸:

$$\int_0^d \alpha_n \left[- \int_0^s (\alpha_n - \alpha_0) du \right] ds = 1 \dots (5)$$

where the integration variables u and s , and distance between electrodes d are measured with the cathode as origin. α_n is often called the electron-ionization coefficient, and is the number of ions produced by collision by an electron per centimetre of path. If the polarity is reversed

* The University of Sheffield

so that the anode is now the origin, the condition becomes:

$$\int_0^d \alpha_p \left[- \int_0^s (\alpha_p - \alpha_n) du \right] ds = 1 \dots \dots (6)$$

where α_p is the positive-ion-ionization coefficient which is analogous to α_n .

Now α_n and α_p are not the same in general and so (5) and (6) are not satisfied at one value of applied voltage. Thus, the striking voltages for normal and reversed connexions are different.

Thomson's theory, based on the fact that positive ions liberate secondary electrons from the cathode leads to the same conclusions¹⁸.

In this case:

$$\int_0^d \alpha_n ds = \frac{1 + \beta}{\beta} \dots \dots \dots (7)$$

or

$$e^{-\alpha_n d} = \frac{1 + \beta}{\beta} = 1 + 1/\beta \dots \dots \dots (8)$$

where β is the number of secondary electrons liberated from the cathode per ion pair produced in the gas.

Now β is a function of the field strength at the cathode, hence value of α_n (and therefore of applied voltage) is different for normal and reversed connexions. It is to be expected that the field strength at the cathode will generally be greater when the cathode is the smaller electrode, i.e., with reversed connexions. Thus β will be the larger for this case and the applied voltage for striking smaller. That this is not always true may possibly be due to the fact that not nearly so much care is taken with the preparation of the anodes of the tubes as with the cathode surfaces.

RUNNING VOLTAGE

The results obtained are given in Table 5. It is seen that the regulation of all tubes is greatly increased by reversed polarity. The discharge becomes "abnormal" and the small "cathode" area becomes entirely covered by glow at quite a small current. The "abnormal" discharge gives the observed voltage rise with current over the working range.

Reversed-polarity running is generally accompanied by large random drifts, steps are still evident and hysteresis effects are very pronounced. In fact, if characteristics are taken several times, quite different values of running voltage are obtained at a given value of current, e.g. for the 85A1 type values of 8V are not uncommon.

NORMAL OPERATION AFTER RUNNING WITH REVERSED POLARITY

The striking voltages and running characteristics of the tubes were recorded with normal connexions after operation with reversed polarity to determine if the latter causes any permanent damage. Excluding the few tubes which arced (see Table 5), all others tested had the same striking voltage and running characteristics before and after operation with reversed connexions.

EFFECT OF REVERSED POLARITY ON TUBE LIFE

Some tubes of Type CV1070 were run for a considerable time with reversed connexions. It was found that the running voltage increases very rapidly, in some cases more than 30 per cent during the first 200 hours of life.

Effects of Tube Age

Twelve tubes of the CV1070 type were tested on arrival from the manufacturer. Their age at that time was unknown. They were then stored and tested at intervals over a period of 3000 hours. The striking voltages of the tubes were unchanged during this time. The running voltages were in all cases, however, increased, considerably during

the first 1000 hours and then remained nearly constant. The maximum increase in running voltage at a given value of current was 1.6V, the average value 1V and the minimum value 0.6V.

The increase of voltage observed is considered to be caused by contaminations of the cathode by gases from the glass walls which will take place to some extent whether current passes or not unless special precautions are taken as in the 85A1 tube. For these high-stability tubes, where any gases if produced are removed immediately by the molybdenum coating, the running voltage is almost constant with time during long resting periods. No results have been obtained for the other tube types, but it is reasonable to assume that they behave in a manner similar to the CV1070 samples.

Current Overloads

Peschel¹⁹ has reported that accidental current overloads will frequently make glow-discharge voltage-regulator tubes entirely useless as regulators although they may appear to be functioning quite normally. His statements are misleading, however, as they give no details of the magnitudes or durations of the overloads in question.

The effects of overloads on the characteristics of tubes of the CV1070 and S130 types have been examined in some detail. Several CV1070 tubes were run with overloads ranging from 10 per cent to 700 per cent for periods between 15 seconds and 1 hour.

One important point arising from these tests is that, because of the large cathode area, the increase of voltage with current in all tubes is fairly small over a current range extending well beyond the maximum value.

It appears that overloads of 200 per cent can be applied for a period up to 1 hour without permanent damage to a CV1070 tube. The effect of larger overloads is to increase the running voltage for a given value of current, probably due to sputtering of the cathode by the discharge, but it is interesting to note that the regulation over the current range does not increase very greatly.

Changes in the characteristics of the S130 tubes become evident after overloads of 100 per cent applied for a few seconds only and the running characteristics move bodily by a few volts.

A slight overload (up to about 25 per cent) appears to do no damage to a tube of any type except that it reduces the useful life appreciably as discussed later.

Exposure to Magnetic and Electric Fields

All tubes are affected by exposure to stray magnetic and electric fields. In general, however, the effects of stray fields are not serious, but it is advisable not to place tubes near transformers or permanent magnets. Variations in running voltage of more than 20 per cent may be obtained by locating a tube close to a permanent magnet with a field strength of 1500 oersteds. Fortunately tubes do not appear to be permanently affected by strong fields. Several tubes of the CV188 type operated in the gap of a 1500-oersted magnet for a short time gave their normal characteristics again when removed from the field.

Long-Term Tests

Variations in the characteristics of tubes of the CV1070, 85A1, S130 and KD60 types have been observed during the first several thousand hours of continuous operation. Each tube was run at an approximately-constant current and was exposed to small ambient-temperature changes. Mention has already been made of the observed increase in temperature coefficient of running voltage and the increase of initial drift with life. Attention has also been called to the effects of reversed polarity on life. It remains only to discuss the striking- and running-voltage variations with time and the effect of overloads on life.

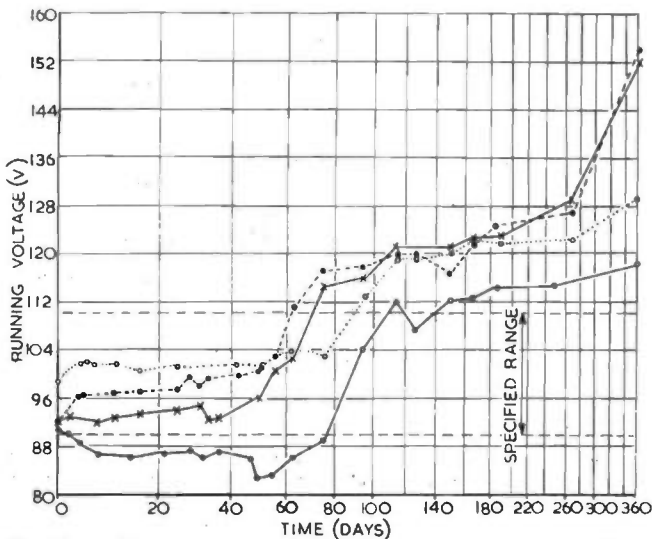

Fig. 15. Typical characteristics showing the variations of running voltage with time for tubes type S130 run continuously at approximately-constant tube currents of 5mA.

RUNNING VOLTAGE VARIATIONS The CV1070 Tubes

Twenty-four tubes were run continuously at an approximately constant current of 5mA for about 10 000 hours. Some typical characteristics for the tubes are shown in Fig. 15. Other typical characteristics are given in Fig. 16 illustrating the voltage variations during the first 1 680 hours plotted to a larger scale than on Fig. 15.

It appears that for this type of tube the running-voltage/life characteristics can be divided into three parts:—

(1) An initial "ageing" period during which the voltage may change fairly rapidly. The duration of this period is, in general, about 100 hours, but may extend to 300 hours. Voltage variations of up to ± 10 per cent are observed. It seems worth while ageing tubes before putting them into service to take them out of this period.

(2) An intermediate period lasting up to about 1300 hours from the start during which only small voltage variations of a random nature are observed. The maximum variation during this period is less than ± 2 per cent, but the change is generally considerably less than this figure.

(3) A final period where again large variations occur

Fig. 16. Typical characteristics showing the variations of running voltages with time for tubes type CV1070, run continuously at approximately-constant tube currents of 5mA.

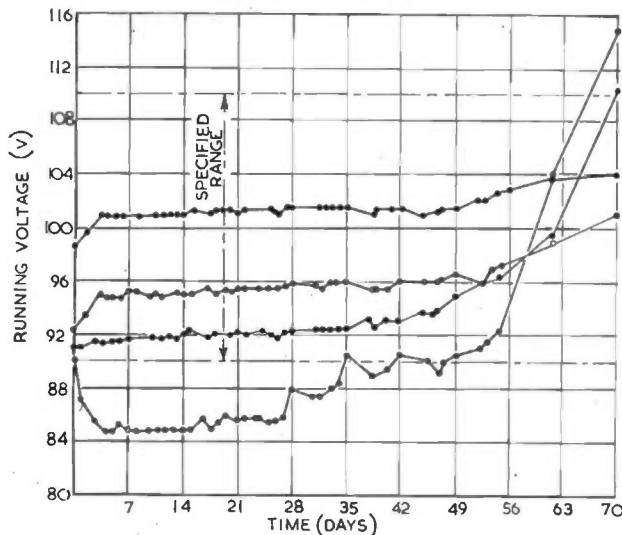

and the voltage gradually increases even after it passes out of the specified range. It can be seen from Fig. 15 that after about 9 000 hours operation the running voltage may have increased by about 70 per cent. Apart from the fact that the glass envelopes darken with time the tubes appear to be running quite normally even after the voltage reaches its upper specified limit. Thus, it is advisable to replace tubes in any equipment before they have a chance of running into this final period of life.

All the tubes tested ended their useful life, i.e. reached period (3) at about 1300 hours within about 200 hours of each other. It does seem rather remarkable that tube life

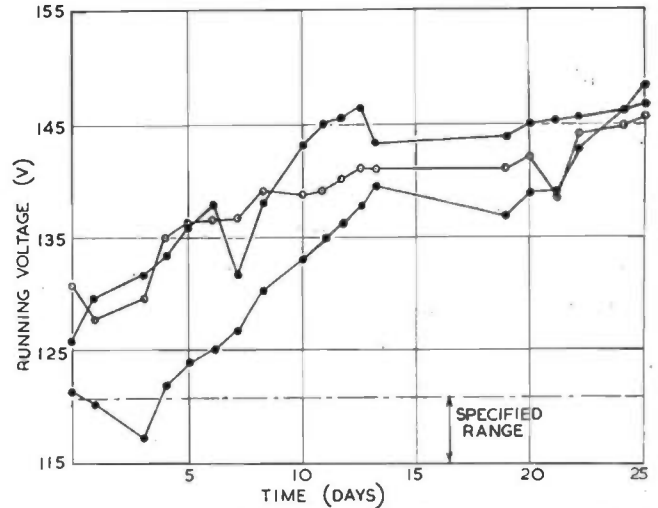
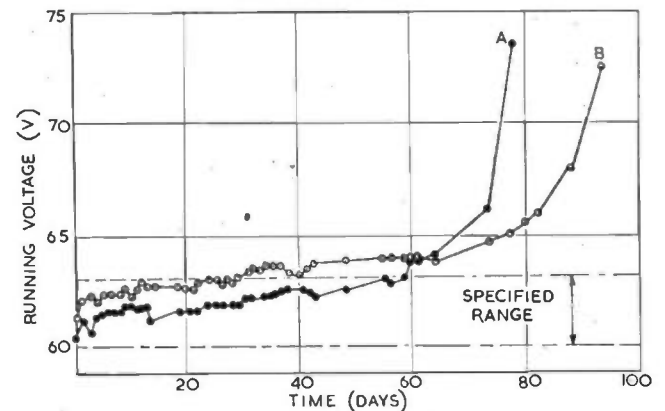

Fig. 17. Typical characteristics showing the variations of running voltages with time for tubes type S130, run continuously at approximately-constant tube currents of 50mA.

Fig. 18. Typical characteristics showing the variations of running voltages with time for tubes type KD60, run continuously at approximately-constant tube currents of 1mA.



can be predicted fairly accurately for a given operating current.

During the lives of the tubes the slopes of the current-voltage curves of Fig. 1 generally change considerably, the characteristics do not usually move parallel to themselves as might be anticipated.

The S130 Tubes

Twelve tubes were run continuously at an approximately constant current of 50mA. Some typical characteristics for the tubes are shown in Fig. 17. Large running-voltage variations are observed throughout the life of the tubes; there is no period corresponding to (2) as with the CV1070. Tubes which are within the specified range at the start soon pass out of it; voltage increases of up to 10 per cent during the first 150 hours seem usual and thereafter changes of 0.1V/hr are common. It will also be observed from Fig. 17 that large voltage drops occur quite frequently.

The KD60 Tubes

Two tubes only were available for life test so no generalizations can be made. However, the few results obtained are thought to be of some interest and are, therefore, included. The tubes were run at approximately-constant currents of 1mA. The characteristics obtained are shown in Fig. 18. An initial ageing period is evident during the first 50/100 hours. Thereafter the running voltage gradually rises until it passes out of the specified range. The time taken for this appears to vary considerably from tube to tube. After about 1500 hours operation the running voltage increases very rapidly with time.

At points A and B (Fig. 18) respectively the two tubes tested developed an oscillating glow. Records obtained by the manufacturer do show, however, that tubes of this type are capable of running satisfactorily for 5 000 to 8 000 hours depending on the current.

The 85A1 Tubes

Twenty-two tubes were run continuously at an approximately constant current of 5mA for about 10 000 hours. In contrast with the other types of tube these show little change of running voltage with time. There is an initial ageing period which lasts from about 50 to 200 hours. The

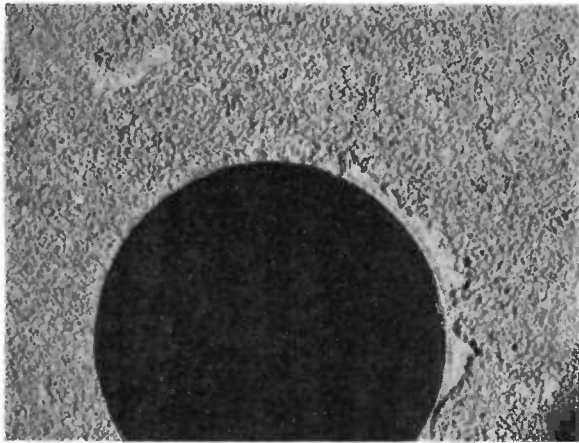

Fig. 19. Photo-micrograph of a portion of the cathode surface of a new CV1070 glow-discharge tube.

maximum change of running voltage during this period was 0.5 per cent and the average change 0.3 per cent. After that, during the 10 000 hour tests the maximum change in running voltage was 0.6 per cent and the mean change 0.4 per cent. The variations are of a random nature. Even after 10 000 hours there is no evidence that the useful life of the tube is being approached.

STRIKING-VOLTAGE VARIATIONS

The striking voltages of the tubes were recorded at various stages throughout the long-term tests. The striking voltage increases with life, very considerably in many cases.

For the CV1070 tubes the striking voltage increases by from 8 to 90 per cent in the first 7 500 hours. At this stage the majority of the striking voltages were well outside the upper specified limit.

For the S130 tubes increases in striking voltage from 5-16 per cent are observed during the first 1000 hours of operation.

For the two KD60 tubes tested the striking voltage increase amounted to about 5 per cent in the first 1500 hours. There seems to be some evidence that the magnitude of the change of striking voltage with time for this type of tube is a function of the tube current, the lower the current the smaller the variation.

In the case of the 85A1 tubes the maximum increase in striking voltage is less than 5 per cent during the first 10 000 hours operation and after this time all the voltages are still well inside the specified limits. Many tubes of this type showed no change of striking voltage with time.

CURRENT OVERLOADS

A few CV1070 tubes were run continuously at an approximately constant current of 10mA (i.e. at 25 per cent overload). There is an initial ageing period in the running-voltage/life characteristics as before lasting from about 50 to 100 hours, during which the voltages change quite rapidly. These changes may be either increases or decreases. In contrast with the life characteristics obtained for currents of 5mA, however, there is no period where the voltage remains nearly constant. Instead the running voltage increases gradually, after the ageing period, in a random manner at a rate of about 5mV/hr for approximately 1000 hours and, thereafter, at a much faster rate.

No results have been obtained for other types of tube.

DISCUSSION OF RESULTS

During the life of a tube of the CV1070 or S130 type

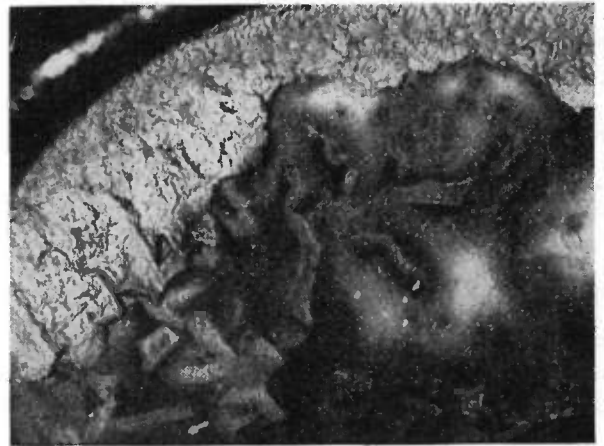

Fig. 20. Photo-micrograph of a portion of the cathode surface of a CV1070 glow-discharge tube after 2,000 hr. continuous operation at a current of 5mA.

a visible deposit forms on the glass envelope. This is caused by sputtering of the cathode by the glow-discharge and is greatly accelerated by current overloads. Figs. 19 and 20 show photo-micrographs of portions of the cathode surfaces of a new CV1070 tube, and a tube of the same design after 2 000 hours continuous operation at a current of 5mA, respectively. The new tube shows a uniform cathode surface suggesting an oxide coating on a metal base. This coating has been completely removed in 2 000 hours by sputtering and explains the cause of the observed running-voltage variations for tubes of this type.

The deposit, during its formation on the glass envelope, will trap some of the gas in the tube and, therefore, will alter its pressure. However, the cathode drop in a discharge tube is substantially independent of the gas pressure. Liberation of gases from the glass walls by the glow-discharge may also be responsible for some variation of running voltage. These gases may contaminate the cathode or the original gas filling and increase the working voltage. It has been shown by Langmuir²⁰, and others^{8,9}, for example, that a discharge in neon liberates gases, in particular oxygen, from the glass walls. In the 85A1 tubes, which when run continuously for as long as 10 000 hours show quite small variations of running voltage, the molybdenum layer on the tube walls shields the glass from the discharge and prevents liberation of gases. It also acts as a getter. It is not sufficient, however, to introduce the

molybdenum anywhere in the tube, it must be on the glass walls. Further, sputtering of the molybdenum cathode in an 85A1 tube does not appear to be troublesome.

Conclusions

It has been demonstrated that glow-discharge tube characteristics show considerable variations, not only from tube to tube of the same design, but also with the passage of time and with changes in ambient temperature. Many of these variations appear to have been largely unrecognized in the past. Tubes of the high-stability types show substantial improvements over the earlier designs. However, for use in high-stability power-supply or other precision circuits, it appears that glow-discharge tubes are not suitable unless they are specially chosen, and used under carefully-controlled conditions. A careful revision of tube specifications is necessary, particularly since in many cases they are somewhat misleading.

Acknowledgments

The work recorded in this paper has been carried out in the Department of Electrical Engineering at the University of Sheffield. The author wishes to thank Mr. O. I. Butler, M.Sc., M.I.E.E., for facilities afforded in the Laboratories of this Department and for the encouragement given during the preparation of the paper. The assistance of Philip's Electrical Ltd., Standard Telephones and Cables Ltd. and Ferranti Ltd., in supplying some of the tubes for examination is also gratefully acknowledged.

APPENDIX

TABLE A.—VARIATIONS IN STRIKING VOLTAGES OF TYPE CV1070 TUBES

(NOTE.—The tubes were not all obtained at the same time but in batches over a period of two years.)

SAMPLE	VOLTAGE	SAMPLE	VOLTAGE	SAMPLE	VOLTAGE
1	131.5	13	117.0	25	117.0
2	119.0	14	122.0	26	114.5
3	118.5	15	122.5	27	117.5
4	111.0	16	126.0	28	114.0
5	134.0	17	125.0	29	118.0
6	119.5	18	113.0	30	119.0
7	125.0	19	116.0	31	114.0
8	116.0	20	127.0	32	120.0
9	130.0	21	120.0	33	119.0
10	122.0	22	124.0	34	122.0
11	128.5	23	115.5	35	117.0
12	129.0	24	116.5	36	115.5

TABLE B.—VARIATIONS IN STRIKING VOLTAGES OF TYPE 85A1 TUBES

(NOTE.—The tubes were not all obtained at the same time but in batches over a period of two years.)

SAMPLE	VOLTAGE	SAMPLE	VOLTAGE	SAMPLE	VOLTAGE
1	112.5	13	113.5	25	113.5
2	115.5	14	113.0	26	114.0
3	113.5	15	112.5	27	113.5
4	112.5	16	113.5	28	114.0
5	112.5	17	116.0	29	116.5
6	111.5	18	115.0	30	111.0
7	112.5	19	113.5	31	110.5
8	114.0	20	114.5	32	111.5
9	114.5	21	112.5	33	112.5
10	112.5	22	115.5	34	113.0
11	113.5	23	112.0	—	—
12	112.0	24	111.5	—	—

TABLE C.—VARIATIONS IN STRIKING VOLTAGES OF TYPE S130. TUBES

SAMPLE	VOLTAGE	SAMPLE	VOLTAGE	SAMPLE	VOLTAGE
1	143.0	8	141.5	15	150.5
2	166.0	9	161.0	16	160.0
3	167.0	10	167.5	17	169.0
4	157.0	11	155.0	18	153.0
5	157.0	12	167.5	19	150.0
6	149.5	13	175.0	—	—
7	172.0	14	144.5	—	—

TABLE D.—VARIATIONS IN STRIKING VOLTAGES OF TYPE CV71 TUBES

(NOTE.—Independent of whether glass bulb is rendered opaque as required by specification, or not.)

SAMPLE	VOLTAGE
1	141-151
2	145-170
3	140-160
4	145-162
5	140-155
6	149-157

TABLE E.—VARIATIONS IN STRIKING VOLTAGES OF TYPE KD60 TUBES

SAMPLE	VOLTAGE
1	74.0
2	77.0
3	75.5
4	75.0
5	78.5
6	80.0

TABLE F.—VARIATIONS IN STRIKING VOLTAGES OF TYPE CV188. TUBES

SAMPLE	VOLTAGE
1	106.5
2	118.0
3	117.0
4	109.5
5	112.5
6	110.5

TABLE G.—VARIATIONS IN STRIKING VOLTAGES OF TYPE CV45 TUBES

SAMPLE	VOLTAGE	
	a	b
1	125.0	145
2	115.0	154
3	120.0	158
4	121.0	153
5	118.0	153
6	124.5	156

(a) Ignition electrode connected to 220V D.C. positive through a 54k Ω resistor
(b) Ignition electrode not connected.

TABLE H.—VARIATIONS IN STRIKING VOLTAGES OF TYPE VR150 TUBES

SAMPLE	VOLTAGE
1	160
2	154
3	157
4	131-147*
5	172
6	150

* 131 volts in ordinary daylight, 147 volts in the dark.

TABLE I.—VARIATIONS IN STRIKING VOLTAGE OF TYPE NT2 TUBES

SAMPLE	VOLTAGE
1	72.0
2	62.0
3	61.0
4	65.5
5	67.0
6	62.0

REFERENCES

- MULLARD ELECTRONIC PRODUCTS LTD. Use of 85A1 Stabilizer in Stabilized D.C. Power Supplies. Application Report No. 13/1949.
- BAKER, A. K. Photoelectric Effects on Neon Tubes. *Electronics*, 12, 52, (Sept. 1939).
- REICH, H. J. Theory and Application of Electron Tubes. Section 11-6 (1944).
- PESCHEL, S. S. Tester for V.R. Tubes. *Electronics* 22, 148 (April 1949).
- LANGMUIR, I. The Alleged Production of Absorbed Films on Tungsten by Active Nitrogen. *Phys. Rev.* 37, 1006 (1931).

A Timed RC Circuit

By John P. German,* M.S.

OCCASIONALLY a unique circuit employing electronic components can be devised to produce a toy which appeals to both children and adults. The blinking-light toy (Fig. 1) makes use of the principle of a capacitor charging and discharging through a resistor to provide a reliable timing device for turning neon lights on and off in a definite pattern. Each neon bulb will fire in order, and continue in that direction until the capacitors of the circuit are unbalanced. After the steady-state operating condition of the circuit has been reached it is possible to change the direction of rotation by placing one's hand across any neon bulb or unbalancing the circuit by any convenient method.

Since the drain on the battery is in the order of a few microamperes the life of the battery should be several months.

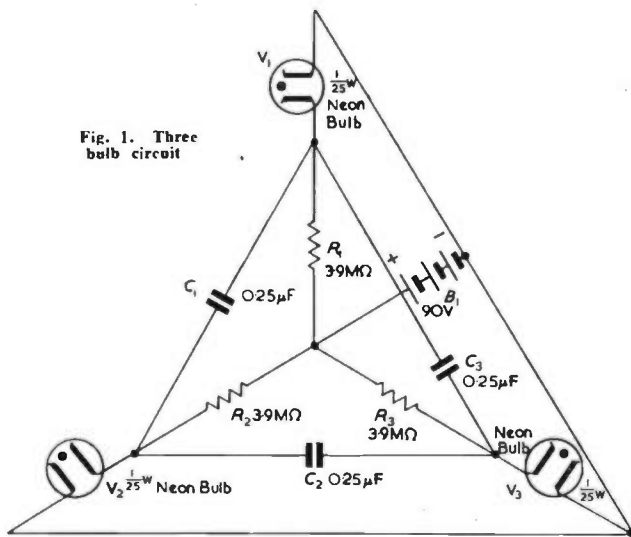

Fig. 1. Three bulb circuit

The neon bulbs will burn at a rate determined by the values of the capacitors and resistors used in the circuit. The rate at which the neon bulbs burn will be slower for large values of capacitance and resistance and faster if the size of the capacitance and resistance is decreased. If an uneven rate of firing is desired, the component values can be made unequal, but if the values become too different, some pattern instability may be experienced. The values given in Fig. 1 will provide a rate of fire which is reasonably slow.

The value of the resistors used will primarily determine the current drain on the battery. If the resistors are increased to too high a value—say, above 10 megohms—the current through each neon bulb will become so small that the glow will not be very bright. In addition to the dull glow at very low currents, the system may become unstable and a steady-state operation may seldom be reached. On the other hand, if the resistors are reduced too low—below one megohm—the battery current will increase to an appreciable value and the rate of firing will be so fast that the value of the capacitors will have to be increased to compensate for the loss of resistance.

The battery may be connected into the circuit with either polarity. The voltage must be reasonably high in order to provide sufficient potential to fire the neon bulbs. A 90-volt battery seems to work well.

* The University of Texas.

An exact mathematical solution of the circuit is somewhat complex, so a more general discussion is all that will be attempted here. As soon as the battery is connected, the full 90 volts appears across each of the three neon bulbs. The bulb with the lowest breakdown potential will fire first. For purposes of discussion, say V_1 of Fig. 1. Electrons flow from the battery through V_1 and R_1 back to the plus terminal of the battery. At the same time there is a flow of electrons from the negative side of the battery through V_1 , C_3 and R_3 back to the battery, and a flow of electrons from the battery through V_1 , C_1 and R_2 back to the battery. This additional flow of electrons charges capacitors C_1 and C_3 at an exponential rate in such a polarity that the negative side of the capacitors C_1 and C_3 is toward V_1 . Capacitor C_2 will have no charge built up on it as long as C_1 and C_3 each charge an equal amount. In an actual case there will be a slight charge on C_2 due to the unbalance of C_3R_3 and C_1R_2 . As soon as the charge on either C_3 or C_1 reaches such a value that the potential across V_1 drops below its firing potential, then V_1 will stop glowing. At this instant, the full potential of the battery and the accumulated charge on C_1 and C_3 will appear across the two remaining neon bulbs V_2 and V_3 , respectively. The next bulb to fire will be determined by the

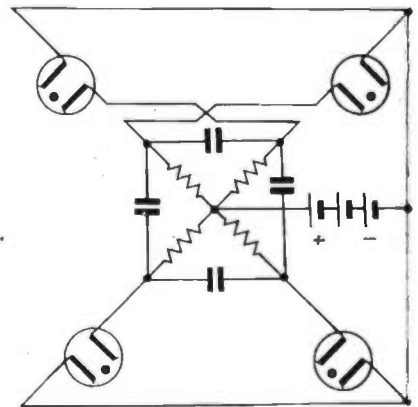

Fig. 2. Four bulb circuit

breakdown potential of the two remaining bulbs and by the potential across each. In this discussion say that the next neon bulb to fire is V_3 . At this point the process begins to repeat itself, but the initial conditions are different since the two adjacent capacitors C_2 and C_3 do not have zero charge. Because of this initial unbalanced charge, V_2 will fire after V_3 goes out and the process will repeat itself, turning the bulbs on in a clockwise order. If the capacitors are suddenly unbalanced, the system may reach a steady-state operation in such a fashion that the bulbs fire counterclockwise.

Fig. 1 may be expanded to provide a timing circuit for more than three neon bulbs. As an example, Fig. 2 shows the circuit for four neon bulbs. Since it is possible to obtain several operating modes as the number of bulbs is increased, it may be necessary to relocate some of the neon bulbs in the circuit in order to produce a clockwise or counterclockwise operation. In the four-bulb model it will probably be necessary to relocate two of the bulbs as shown in Fig. 2 in order to prevent the bulbs from firing diagonally across the square. As the number of bulbs is increased, the effective time-constant of the circuit is reduced, and the bulbs fire at a faster rate, so that it may be necessary to increase the size of the capacitors. In addition, it takes a longer time for a steady-state operating condition to be reached. When an eight-bulb unit was built by the author, it was found that if the lead to one side of the battery was disconnected and shorted to the other terminal, the capacitors could be discharged in a few seconds and, when re-connected, the circuit would reach a steady-state operating condition in a very short time.

Changing the Phase of a Low Frequency Sinusoid

By P. Huggins*, A.M.Brit., I.R.E.

THERE are numerous electronic applications in which it is desirable to vary the phase-angle of a low frequency sinusoidal voltage by means of a manual control. For instance: phase shift control is usually required for delaying the firing point on thyratrons by varying the grid-cathode phase relationship with respect to the anode-cathode sinusoidal voltage¹. In most instances the application is at mains frequency; although this is not always the case².

Manual Control

When analysed, most circuits used for this purpose are fundamentally of the basic type shown in Fig. 1. A number of authors have described the action of this circuit^{3,4} so no more than a cursory description follows. T is a matching transformer, having a low resistance high impedance centre-tapped secondary. It is so connected, that primary and secondary voltages are in phase. This transformer feeds a series circuit consisting of reactance X and potentiometer R . The input E.M.F. is fed into T_1 primary. The output is taken from between the transformer centre-tap and the potentiometer slider. The

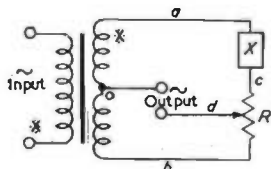

Fig. 1. Basic phase shift circuit

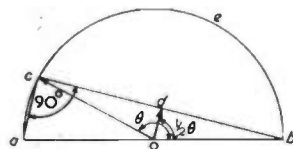

Fig. 2. Vector diagram for Fig. 1

manner of the phase shift can be understood best from the vector diagram (Fig. 2). When the slider is at c , the output voltage will have a magnitude oc and phase lag θ° . When the slider is at mid point d , the output voltage will be of magnitude od and the phase lag is $\frac{1}{2}\theta^\circ$. When the slider is at b the output E.M.F. will be that of one half the secondary winding and the phase displacement will be zero. Thus the total phase shift for the full traverse of the potentiometer slider is θ° .

The relationship between the design parameters is very readily obtained from the geometry of the circle diagram. These can most readily be summarized as

$$\theta = 2 \cot^{-1} Q$$

where θ is available phase shift in degrees, and Q is the

ratio $\frac{\text{Reactance}}{\text{Resistance}}$ of the series circuit.

CASE OF $\theta = 120^\circ$

However, although the above equation is an expression for the general case, applications involving a 120° (variable) phase shift are common, because this figure is the "available firing angle" for most thyratrons (Fig. 3). In this particular case some simplifications can be obtained from the symmetry of the particular circle diagram (Fig. 4).

* *Slaky Electric Welding Machines Ltd.*

As will be seen from this diagram, since $\angle cob$ is 120° , the internal angles of triangle aoc are all 60° , and so the triangle is equilateral. Hence the voltage across the reactance is equal to the voltage across one half of the transformer secondary. This makes the experimental determination of optimum $X:R$ ratio for 120° phase shift relatively simple.

The other design parameter of interest is the minimum voltage to which the output drops (od). By the properties of similar triangles $od = \frac{1}{2} ao$. Hence the magnitude of the output voltage will vary between the limits of the E.M.F. across half of the secondary winding and 50 per cent of this figure, being a minimum when the slider is in the mid position. This is true whatever the value of θ .

Limitations of the Standard Circuit

Two inherent disadvantages of the circuit are: the magnitude of the output E.M.F. varies as the potentiometer is adjusted; the rate of change of phase-angle for incremental changes of the slider, is non-linear.

The first of these can be overcome by connecting R purely as a variable resistance, instead of a potentiometer

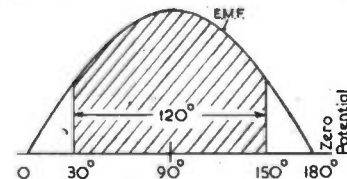

Fig. 3. Shaded area indicates optimum firing conditions for most thyratrons and ignitrons

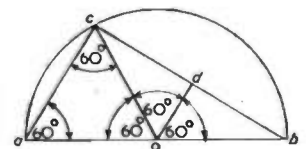

Fig. 4. Vector diagram where $\theta = 120^\circ$

(i.e. disconnecting point b). The phase-angle swept will be θ° as before, but the locus of the variable vector will follow the arc ceb and thus have a constant magnitude. The penalty for stabilizing the magnitude of the output voltage is that when $R \approx 0$, the full secondary voltage appears across the reactance. Also the load on the transformer T is not a constant one.

The solution to the second disadvantage is to divide R into two equal resistances, making one a potentiometer (cosine law) and one a fixed resistor. It is necessary to have a two position range switch (D.P.D.T.) to interchange the relative positions of the resistor and potentiometer for each range.

The practical limit to the phase shift available is probably about 168° with this type of circuit. ($Q = 0.1$).

Over 180° Phase Shift

By having one phase shift network within another phase shift network (Fig. 5) it is possible to obtain double the phase shift available from one circuit. This can be seen from the series of circle diagrams shown in Fig. 6. The assumptions are: that T_2 is 1:1 ratio, and that the loading of the inner circuit is negligible ($k = 10$ say). The fact that the potentiometers are ganged will mean that the output voltage varies from rs to $r'o$ (Fig. 6), a total phase displace-

ment of 2θ . Thus the output voltage is halved and the phase shift doubled. By making T_2 a 2:1 step-up, the output voltage level can be maintained. Greater shifts (integral multiples of θ) are possible by extending the scheme⁵.

Automatic Control

Of more importance, with the increasing application of variations of the fundamental circuit (Fig. 1), is the possibility of having an independent "automatic" control as well as, or in lieu of, the manual potentiometer.

Replacing R by metrosils, thermistors, or a.c. amplifiers has fascinating possibilities. Alternatively, it is possible to make the reactance the variable in the circuit. For instance, by making R a potentiometer, and X a saturable reactor, it is possible to have both a manual (R) and an automatic (L) control, and this system is used in various motor control schemes⁶.

However, the latter method is only suitable where the automatic control is in the nature of a vernier control, or perhaps a compensation. For instance, if $R = 10X_L$

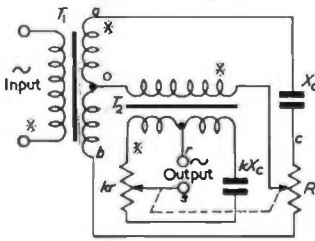

Fig. 5. Multiple circuit to obtain phase shift in excess of 180°

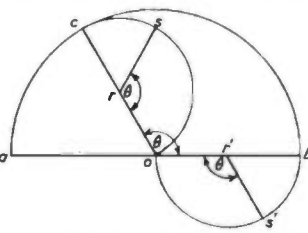

Fig. 6. Vector diagram showing overall phase shift of circuit (Fig. 5) is $2\theta > 180^\circ$

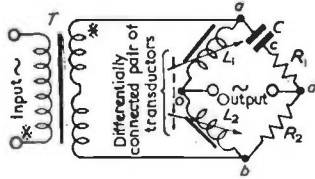

Fig. 7. A method of phase shift control where the variations can be governed by D.C. or electro-magnetic amplifiers

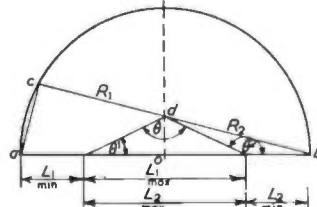

Fig. 8. Vector diagram for Fig. 7

where X_L is a saturated transductor, and R is the series resistance (including that of the reactor winding), the available phase shift will be in the order of 160° (actual figure depending upon reactor resistance). If now the saturating source be completely removed from the transductor and its reactance consequently increased say five times, the change in inductance will only produce about a 40° change in phase. Hence the automatic control is only about one quarter as effective as the manual one.

To increase the effectiveness of the automatic control the author has devised the following scheme:

C and $(R_1 + R_2)$ represent the usual series circuit (Fig. 7). One side of the output is taken from the junction of R_1 and R_2 . The other side, however, is not taken from a centre tap on T , but from the junction of two identical saturable reactors (having high impedance low resistance a.c. windings). These saturable reactors are differentially connected, so that as the automatic control voltage is varied, one transductor increases in inductance as the other one decreases. Thus when the inductance of one transductor is a minimum, that of the other is at a maximum, and vice versa.

The circle diagram for the circuit is shown in Fig. 8. Providing the amount of current drawn is small, the output voltage will have a phase displacement varying from θ_1 to θ_2 . The total phase shift will, therefore, be θ .

Optimum values of the circuit parameters are most readily obtained by geometric construction. The smaller the Q of the series circuit, the greater value of θ .

The d.c. control of the transducers will be largely governed by individual requirements.

Combined Automatic and Manual Control

This can be tackled in two ways. The most flexible method is to have adequate electronic circuits preceding the two transductor primaries; and push-pull or see-saw types of d.c. amplifier stage can readily be adapted. Alternatively the output of two independent phase shift circuits (one for automatic and one for manual) can be fed into a common transformer (Fig. 9). The output is taken from T_2 secondary.

The individual phase shift ranges of the manual automatic circuits are derived as already outlined.

The combined output voltage at T_2 secondary will be of the form $E_o \angle \phi$ where:

$$|E_o| = T \sqrt{E_1^2 + E_2^2 + 2E_1E_2 \cos(\theta_1 \sim \theta_2)}$$

$$\text{and } \phi = \tan^{-1} \left[\frac{E_1 \sin \theta_1 + E_2 \sin \theta_2}{E_1 \cos \theta_1 + E_2 \cos \theta_2} \right]$$

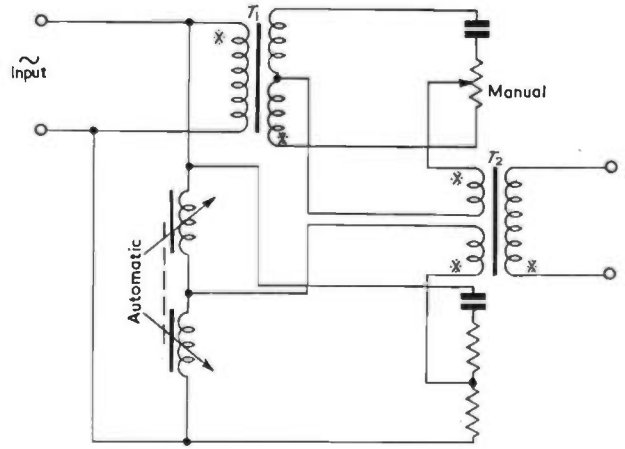

Fig. 9. Dual control circuit, suitable where a "manual" and an "automatic" adjustment of phase shift is required

T being the turns ratio (considering one primary), E_1 and E_2 being voltages of the individual outputs of the manual and automatic circuits (i.e. the input e.m.f.'s. to T_2 primaries).

Providing the following circuit limitations are acceptable, the $E_o \angle \phi$ calculations can be simplified:

- (1) That the turns ratio of the manual section of the transformer be unity.
- (2) That the manual circuit be connected so that its output e.m.f. (i.e. the input to T_2 primary) be always half T_2 primary e.m.f.
- (3) That the turns ratio of the automatic section of T_2 windings be such that the virtual mean input e.m.f. to T_2 be equal to half T_1 secondary e.m.f. (this is reasonably possible, as in many cases there is not a very large swing in output voltage from the automatic circuit employed (cf Fig. 8).

Under the above conditions $E_2 \approx E_1 = \frac{1}{2} E_s$ (where E_s is the secondary voltage across T_1) and $T = 1$.

Hence

$$|E_o| \approx \sqrt{E_1^2 + E_1^2 + 2E_1^2 \cos(\theta_1 \sim \theta_2)}$$

$$= \sqrt{2E_1^2} \times \sqrt{1 + \cos(\theta_1 \sim \theta_2)}$$

$$\therefore |E_o| \approx 0.707E_s \sqrt{1 + \cos(\theta_1 \sim \theta_2)}$$

which shows that the output voltage will vary between the

limits of E_s (when $(\theta_1 \sim \theta_2) = 0^\circ$) and $0.707E_s$ (when $(\theta_1 \sim \theta_2) = 90^\circ$). And the expression for the resultant phase displacement will reduce to:

$$\phi = \tan^{-1} \left[\frac{\sin \theta_1 + \sin \theta_2}{\cos \theta_1 + \cos \theta_2} \right]$$

Conclusion

The phase shift circuits discussed in the above text are off-shoots of the basic form outlined in Fig. 1. The circle diagram technique is valid for complex circuits as for the basic circuit, but it must be borne in mind that if the circle diagram assumes certain properties or approximations, the designer must endeavour to meet these conditions. For instance, it has always been assumed that the voltages

in the two halves of the centre-tapped transformer windings are in phase. This will only be so if the secondary resistance is small compared with its inductive reactance. Again, the series reactance has always been considered to be a pure one, and this assumption, too, must be scrutinized: particularly in the case of a saturable reactor. And, of course, the current drawn at the output terminals is considered to be comparatively small.

REFERENCES

1. JAMES H. BURNETT. Thyatron Grid Circuit Design. *Electronics* 108 (March, 1951).
2. G. BUILDER. A Stabilized Frequency Divider. *Proc. I.R.E.* 177 (1941).
3. O. S. PUCKLE. Time Bases. Appendix VII (Chapman & Hall, Ltd.).
4. W. WILSON. Electronics in Heavy Industry. *J. Brit. I.R.E.* 293 (1949).
5. C. E. SPITZER. Thyatron Control Circuits for Over 180° Phase Shift. *Electronics* (Dec., 1950).
6. W. WILSON. Electronics in Heavy Industry. *J. Brit. I.R.E.* 297-298 (1949).

A Design for a Constant Volume Amplifier

By G. J. Pope*

WHEN modulating a carrier wave, the highest efficiency and greatest signal-to-noise ratio are obtained at large modulation depths. The wide amplitude range of speech signals makes some form of compression desirable so that a reasonable modulation depth may be set without risk of overmodulation. The so-called constant volume amplifier is used extensively on overseas telephone circuits for this purpose.

Obviously, such a device is useful on any circuit requiring amplitude range limitation. The present circuit is designed to operate within some 10msec after the arrival of a strong signal and return to its previous state in 2-3 seconds.

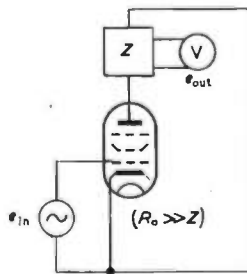

Fig. 1. Basic circuit of pentode and anode load

Principle of Operation

Fig. 1 shows, in skeleton form, an amplifier consisting of a pentode (a constant current generator) with anode load, the gain being given approximately by the equation:

$$e_{out}/e_{in} = g_m Z$$

where g_m = slope of valve in mA/V
 Z = anode load in $k\Omega$.

Changes of input voltage may be compensated by inverse changes of Z . The design to be described arranges for Z to be varied such that it is approximately inversely proportional to input amplitude changes within practical limits.

Any variable impedance would, of course, be suitable for the anode load, but it is believed that the use of a property of the cathode-follower is new in this particular application. The circuit to be described is simple to set up and reliable in operation, with results comparable to those of the more conventional circuits using metal rectifier bridge networks.

The Cathode-Follower as a Variable Impedance

As is well known, the impedance presented by the cathode-anode circuit of a cathode-follower is given by:

$$Z = \frac{R}{1 + \mu}$$

and since

$$\mu = g_m R \text{ where } g_m = \text{slope in mA/V}$$

and R = anode resistance of the valve

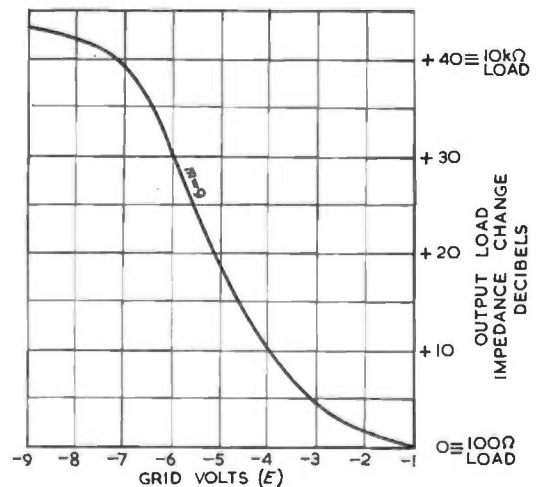

Fig. 2. The change of Z for variations of grid potential

then

$$Z = 1/g_m \text{ when } \mu \gg 1$$

Inspection of the curves of a triode-connected CV138 (EF91) shows that the product of its anode resistance and slope for various negative grid voltages is large compared with unity between values of zero and -7 volts. At voltages exceeding -7 on the grid, the g_m has become so small that this is no longer true.

The graph Fig. 2 shows the change of Z for variations of grid potential. Between grid voltages of -3 and -7 , it will be seen that there is an approximately logarithmic relationship between the grid potential and the output impedance (measured in decibels). With the valve in question, a 37db change is obtained, the lowest impedance being some 140 ohms.

* G.P.O. Research Laboratories.

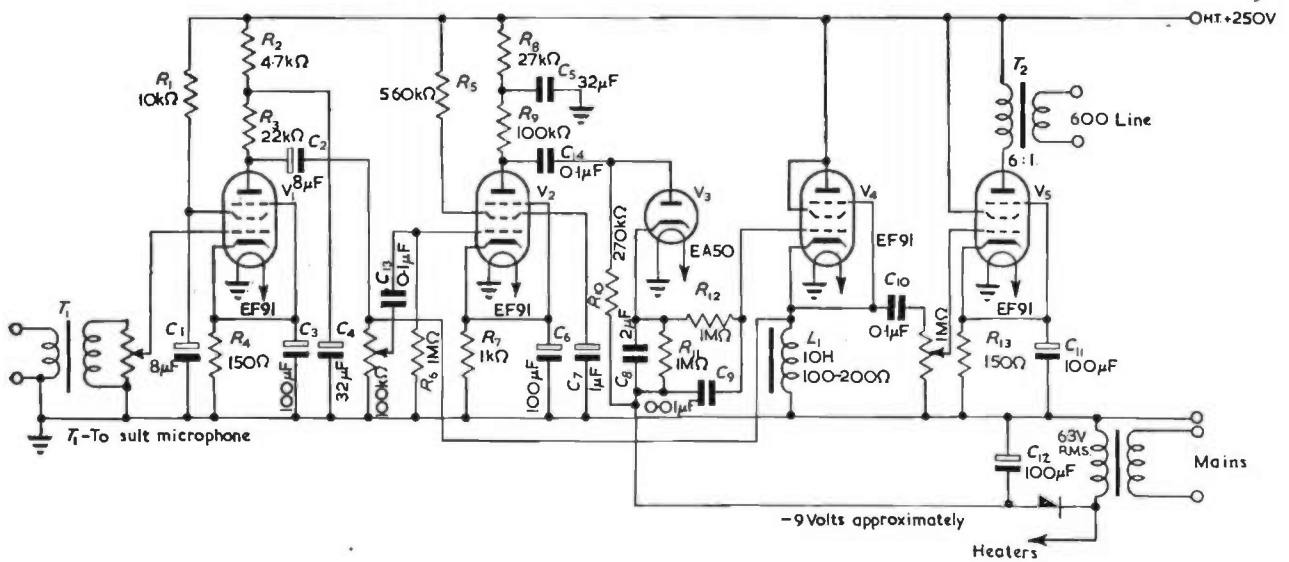

Fig. 3. The complete circuit

A 10 henry A.F. choke has been provided in the cathode circuit to prevent changes of grid voltage due to normal auto-bias action from affecting the cathode-follower characteristics. The highest cathode-follower impedance is some 20kΩ with maximum negative bias applied. The cathode and amplifier anode circuits which are, of course, in shunt, reduce this value to approximately 10kΩ at 1kc/s (see graph Fig. 2). At very low frequencies, the choke begins to shunt the cathode circuit, but the response for speech is adequate.

Fig. 3 shows an arrangement where the anode load of V_1 consists of a 22kΩ resistor shunted by the cathode-anode impedance of the cathode-follower V_4 biased towards cut-off. The anode of V_1 feeds a voltage amplifier V_2 whose output is rectified by V_3 to produce a positive going voltage to offset the standing bias on V_4 .

It will be noticed that the feed for V_2 is taken from the output load and not from the input grid circuit of V_1 . Using this method, incremental changes are more smoothly compensated, and the device has a better characteristic over a greater range. If the bias feed were taken from V_1 grid circuit, it would be necessary for the variable element to have an exactly reciprocal characteristic to any input change, that is for an input increase of 20db, the output load would have to decrease by 20db. As this condition is not fulfilled over any part of the range of the present cathode-follower element, either over or under compensation would result.

With no input signal, V_4 is non-conducting and presents an impedance of approximately 20kΩ to shunt R_2 , the anode load resistor of V_1 . As the input signal increases, V_2 develops a voltage which offsets the bias on the grid of V_4 , so that the effective anode load of V_1 is reduced, with a resultant drop in gain of the device.

The resistor R_{12} and capacitor C_9 decouple the grid of V_4 to audio-frequencies without seriously affecting the operate time.

Sudden increases in input level are rapidly checked because C_8 charges quickly via the forward resistance of V_3 , while decreases of output level are unchecked until C_8 has partially discharged via R_{11} . This means that the gain of V_1 (with the attendant background noise) does not increase appreciably during pauses in speech.

Performance

Fig. 4 shows the compression characteristic obtained and corresponding harmonic distortion figures are shown in

Table 1. The distortion at low compression levels may seem excessive at a first consideration, but in practice is not noticeable, probably due to the fact that such a level may be tolerated on speech signals. Or again, the varying levels of speech continually carry the working point of

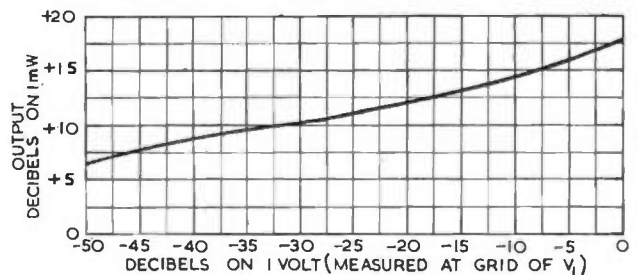

Fig. 4. The compression characteristic

the amplifier into the less distorting part of its characteristic, that is from zero to -20db in the table.

INPUT RELATIVE TO 1V (DECIBELS)	PERCENTAGE DISTORTION
0	5
-10	6.5
-20	9.5
-30	10
-40	10
-50	6

Operation

The amplifier may well take the place of the usual pre-amplifier, the main modulator being fed by a 600 ohm line from the output transformer T_2 . The input potentiometer VR_1 is set so that V_1 is not overloaded by the strongest input signals. It will, of course, have little other effect on the working conditions as any change of input signal to V_1 will be largely compensated. VR_2 may be adjusted to give a similar response to Fig. 4, by applying varying level tones.

VR_3 performs the function of normal volume control. The cathode-follower bias supply should be between 8 and 9 volts negative. It is, therefore, important that the heater supply be reasonably constant, as this supplies the bias in the circuit described.

An Electronic Square-Law Circuit for Use with a Graphic Recorder

By M. J. Tucker*, B.Sc.

The circuit described uses the curvature of valve characteristics to produce an output voltage proportional to the square of the input voltage. It has been designed for graphic recording of the mean-square of a complex audio-frequency signal, but can be used to give the square of the voltage at any instant. A simple extension enables it to be used for multiplication. Fluctuations in the output zero after warming-up can be kept within 1 per cent (peak-to-peak) of the maximum output from a sinusoidal input by using simple power-supply stabilization.

A THERMOCOUPLE meter is a simple and satisfactory method of measuring the mean-square of an electrical signal, though its slow and not easily controllable speed of response might be a disadvantage in some applications. A thermocouple will not, however, give sufficient power to drive a pen recorder directly, so that either photographic recording or a rather elaborate D.C. amplifier would have to be used if a continuous record were required. Recording dynamometer meters which measure mean-square cur-

Principle of Operation

Fig. 1 shows the basic circuit and Fig. 2 the principle on which it operates. The input voltage is fed in push-pull to the grids of two valves whose anode currents are added. If the characteristic curves were straight lines, an input voltage would cause no change in the combined anode currents because the increase in one valve would be exactly balanced by the decrease in the other. In practice the characteristics are curved, and the increase

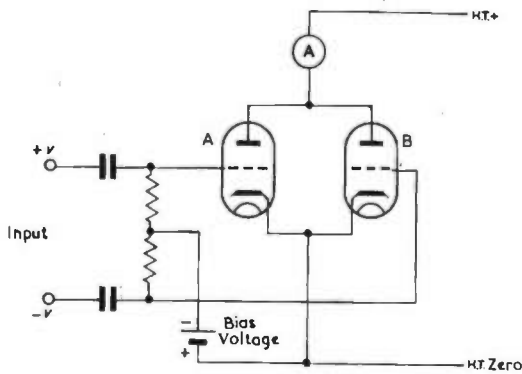

Fig. 1. Basic circuit

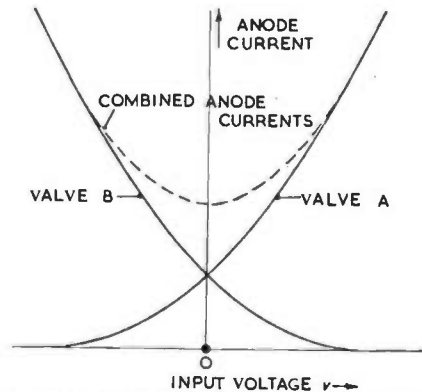

Fig. 2. This shows how the circuit of Fig. 1 combines two non-linear characteristics to give a square-law characteristic

rent are available, but these have a considerable inductance which limits their use to low frequencies and they require inconveniently large driving powers (of the order of 10 to 15 mean watts). Electronic square-law circuits thus have marked advantages where it is necessary to take a continuous record of the output.

The squaring may be achieved electronically by using the curvature of valve characteristics^{1,2} or the curvature of the characteristics of diode or metal rectifiers^{3,4}. One recent circuit uses a series of diodes as automatic switches to produce an approximation to a square-law response curve by means of straight-line segments.⁵ Another circuit⁶ uses a temperature controlled diode in which the filament current is the sum of the A.C. input and a D.C. current which is controlled by a feedback circuit to keep the anode current of the diode constant, and is therefore a measure of the power of the input signal. Also, any multiplying circuit may be used as a square-law circuit by putting the same signal into both inputs, but such circuits are usually comparatively complicated.

The circuit described here is based on a principle similar to that described by Ross and Shuffrey¹, but it has been designed to avoid the use of special power supplies, to allow graphic recording of the output, and to give the maximum possible ratio of working range to instability of the output zero. Its performance has been examined in detail, and its theory is discussed in the Appendix.

in one valve will be greater than the decrease in the other so that the combined current increases. The combined characteristic is of the type shown in Fig. 2 and approximates to a parabola, or square-law curve, with a steady current added.

The steady current is balanced against that through a similar pair of valves working under identical conditions but with no signal applied to their grids, and this arrangement gives comparatively good stability against changes in supply voltage and ambient temperature.

Connecting a resistor in place of the milliammeter in the triode circuit of Fig. 1 has the effect of straightening the combined characteristic and reducing the range over which the square-law is obeyed, and in the practical circuit pentodes are used to overcome this effect. Resistors in series with the cathodes or screens also tend to straighten out the characteristics, but are necessary if special voltage supplies are to be avoided. They are kept as small as possible by using common resistors for all four valves, with which arrangement their effective value is further reduced by the shunting effect of the balancing valves. The improvement in working range that could be obtained by supplying the screen and cathode voltages from a low-resistance potential divider is probably not worth the extra H.T. drain and the necessity of using high-power resistors. These effects are further discussed in the Appendix.

Circuit Details

The practical circuit is shown in Fig. 3. The input

* National Institute of Oceanography

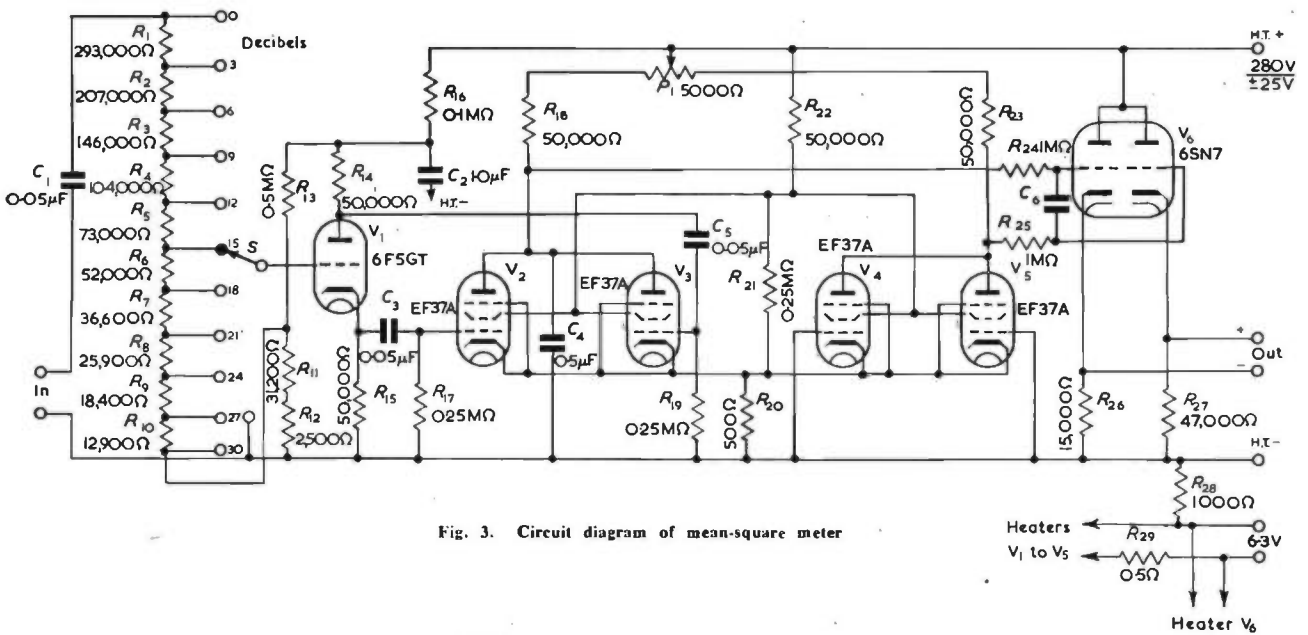

Fig. 3. Circuit diagram of mean-square meter

potential-divider sensitivity-control has $\sqrt{2:1}$ (3db) steps representing a 2:1 change in output, and feeds a cathode-follower phase-splitter which supplies the push-pull signal for the square-law valves (V_2 and V_3). V_4 and V_5 are the balancing valves. The signals from the two anode loads are taken through a suitable smoothing circuit to the two grids of a balanced cathode-follower output stage.

Because squares are always positive, the output voltage is always in the same sense: on application of a signal the current through the right-hand triode of V_6 increases and that through the left-hand triode decreases. The right-hand triode is therefore run with a low quiescent current and the circuit is arranged so that the currents through the two triodes are approximately equal at mid-scale output.

If the circuit is to be used to give the instantaneous square of the input voltage, the smoothing components (C_1 , C_6 , R_{24} and R_{25}) must be removed. It will also be necessary to balance V_2 and V_3 for the linearly amplified component (direct signal break-through) by inserting a pre-set potentiometer with its ends connected to the screen grids of V_2 and V_3 and its tapping point to the junction of R_{21} and R_{22} . This potentiometer should have the lowest possible resistance: 5000 ohms is probably sufficient.

H.T. VOLTAGE

The H.T. voltage should be within about 25 volts of the specified value, otherwise the calibration curve may become slightly non-linear near the origin. The important factor appears to be the current through the square-law valves, and if an H.T. voltage outside the above limits has to be used R_{31} should be altered to bring the anode current of each valve to approximately 1.4mA. It will also be necessary to alter R_{26} to a value such that in the quiescent state it carries between 7 and 10mA and to make R_{27} approximately three times this resistance. Change in H.T. voltage has a comparatively small effect on the slope of the calibration curve.

Performance

A calibration curve using a sinusoidal input is shown in Fig. 4. The curve is linear within 1 per cent up to just under 50 volts output.

When measuring complex waveforms, the ratio of peak amplitude to R.M.S. amplitude will usually be higher than that for a sinusoidal waveform, and a smaller output range must be used. Using an output meter with a range of 15 volts full-scale the circuit can handle a peak amplitude of

2.5 times the R.M.S. amplitude without appreciable distortion, and this is probably an adequate margin for most purposes. It is therefore recommended that a resistor be placed in series with the recorder such that the full-scale deflexion is about 15 volts, which should include the voltage drop in the internal resistance of the circuit (about 700 ohms). The maximum output current is 5mA.

Two circuits have been built and tested. In the first, zero drift was negligible after a warming-up period of half an hour, but in the second circuit the zero drifted at the rate of between one and two volts per hour for about 2 hours after switching on. When the valves are new the zero drift is worse, and it is advisable to leave the instrument switched on for 24 hours before using it for the first time. Apart from any slow drift that may be present, the output contains fluctuations due to fluctuations in power supplies: variations in the heater voltage appear to have more effect than variations in H.T. To obtain the best balance against power supply changes some selection is necessary for V_2 , V_3 , V_4 and V_5 . By selection of the best combination out of 5 aged valves that were available, the author was able to obtain a balance such that a 5 per

Fig. 4. Calibration of the square-law circuit using a 50c/s sinusoidal input

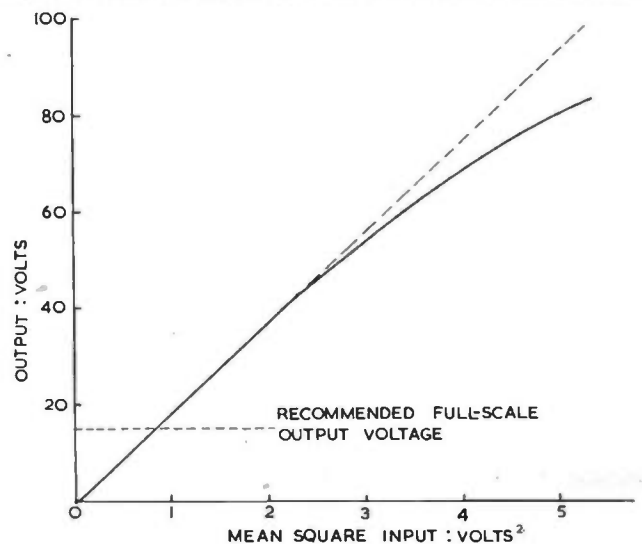

cent change in mains voltage produced less than a 0.4 volt change in the output zero (using a conventional simple power unit). The stability was improved by supplying the power unit through a stabilizing transformer, but these are very dependent on mains frequency and during the winter months when this is liable to fluctuate rapidly, they are not as effective as could be desired. However, even during the winter months the output zero usually kept within a range of 0.5 volts over a period of several hours after warming up, and this is probably adequate for most purposes. During the summer the fluctuations in output zero were considerably less and kept within a range of 0.1 volts.

For the first 100 hours or so of use the instrument settled down to a different zero each time it was switched on, the range initially being 1 volt. This effect slowly disappeared as the instrument aged.

Multiplication

To use the circuit for multiplication it is necessary to feed the grids of V_4 and V_5 from another phase-splitter similar to V_1 . The sum of the two signals would be fed to V_1 and the difference to the other phase-splitter, the outputs then being given by:

$$(x + y)^2 - (x - y)^2 = 4xy$$

If mean products are required, a capacitor similar to C_4 should be connected between earth and the common anodes of V_4 and V_5 . If instantaneous products are required, the smoothing circuits should be removed and fine balancing potentiometers inserted between the screens of V_2 and V_3 and of V_4 and V_5 in the manner described above under the heading "Circuit Details".

Conclusion

The instrument described is suitable for recording the mean-square value of an alternating voltage. The ratio of working range to output zero instability is not as good as could be desired, but is better than that of most similar instruments and is probably adequate for many purposes. The circuit is comparatively simple and requires no special power supplies!

APPENDIX

THEORETICAL DISCUSSION

The most important factor in the performance of thermionic square-law circuits is usually the ratio of the range of square-law operation to the instability of the output zero. The push-pull method of operation increases this ratio by increasing the operating range.

It is convenient to represent the valve characteristic over the working range by the series:

$$i = a_0 + a_1v + a_2v^2 + a_3v^3 + \dots \quad (1)$$

where i is the anode current,

v is the grid voltage.

For the sake of simplicity v will be taken as the change from the steady bias voltage, which means that the coefficients a_0, a_1, a_2, \dots are functions of the bias.

a_0 represents the steady anode current, a_1v represents the linear amplification (which has no D.C. component if the grid is fed through an RC coupling) and a_2v^2 is the square-law term. The a_3v^3 and higher terms represent distortion in the present application.

In the circuit of Fig. 1 valve A is fed with $+v$, and valve B with $-v$, so that the anode currents are given by:

$$i_A = a_0 + a_1v + a_2v^2 + a_3v^3 + a_4v^4 + \dots$$

$$i_B = a_0 - a_1v + a_2v^2 - a_3v^3 + a_4v^4 + \dots$$

and the combined anode current by:

$$i_A + i_B = 2(a_0 + a_2v^2 + a_4v^4 + \dots) \quad (2)$$

so that half the unwanted terms have disappeared.

It is usually possible to find a bias point on a valve characteristic such that either a_3 or a_4 is zero. In a single valve circuit it is probably best to choose a bias which gives a good compromise between a_3 or a_4 , in which case both

have an appreciable value. In the push-pull circuit, however, a_3 has no importance and the bias can be chosen such that $a_4 = 0$. The linearity of the curve of $i_A + i_B$ against v^2 is therefore improved, and hence the working range is extended. The absence of the a_1v term, which represents linear amplification, also means that the circuit will give instantaneous squares.

It should, perhaps, be pointed out that in some applications the odd power terms are not important. They produce no D.C. component in the output when the input has a symmetrical periodic waveform (i.e. waveforms with no even harmonics) or a statistically symmetrical non-periodic waveform such as thermal noise. It is also apparent that in circuits where the odd power terms are not eliminated, calibration with a sinusoidal input is not permissible if non-symmetrical input waveforms are likely to be used. All the even power terms produce a D.C. component in the output from a sinusoidal input; calibration with such an input is therefore a good measure of the performance of push-pull circuits.

It has been assumed so far that there are no resistors in series with the anodes or cathodes of triodes, or the screen grids or cathodes of pentodes. Resistors in series with the individual leads straighten out the characteristics and reduce the square-law coefficient a_2 compared with a_0 and a_1 , which is an undesirable effect. Calculation of the effect of resistors in common leads is lengthy, but it can be seen that they produce a kind of negative feedback on the combined current and straighten out the arms of the combined characteristic curve, tending to make it into a V shape instead of the parabola desired. The effect of a resistor in the anode of a pentode is very small, unless it causes the anode voltage at some point of the characteristic to drop so low that the anode does not collect effectively all the electrons passing the suppressor grid.

To find the optimum bias point Ross and Shuffrey plotted the characteristic of a single valve on log-log paper and chose the centre of the range over which the curve is a straight line with a slope of 2. This method ignores the fact that the odd power terms are of no importance in the push-pull circuit, and in the author's experience it is quickest to find the best point by trial and error. If two curves similar to those in Fig. 2 are drawn for different biases, it is immediately obvious in which direction the bias should be adjusted and the correct value, which is not very critical, is quickly found.

Ross and Shuffrey improved the shape of the valve characteristic by applying the signal voltage to the suppressor grid of a pentode as well as to the control grid, the voltage applied to the suppressor grid being considerably greater than that applied to the control grid. In the author's experience the improvement in the shape of the characteristic is too little to compensate for the loss in sensitivity and the increase in complication involved.

The theory of diode and metal-rectifier square-law circuits may be treated in the same way. Draper and Tucker have described a circuit suitable for either of these elements³, and in their theoretical discussion they have represented the characteristics by equations of the forms:

$$r = Ke^{-qv} \text{ for a metal rectifier if } v \text{ is small}$$

$$Ki = e^{qv} \text{ for a thermionic diode.}$$

Both these equations can be expanded into a power series of the type of Equation (1).

REFERENCES

1. ROSS, H. MCG. SCHUFFREY, A. L. An Electronic Square-Law Circuit. *J. Sci. Instrum.* 25, 200 (1948).
2. RAGAZZINI, J. R. BOYMEI, B. R. A Square-Law Vacuum-Tube Voltmeter. *Rev. Sci. Instrum.* 11, 312 (1940).
3. DRAPER, J. H. P. TUCKER, D. G. A Square-Law Circuit. *J. Sci. Instrum.* 24, 20 (1947).
4. WALKER, D. C. RICHARDS, D. L. HORTON, G. P. Design of Square-Law Rectifier Circuits for Measuring Instruments. *P.O. Elect. Engrs.* 43, Pt. 2, 74 (1950).
5. CHANGE, B. WILLIAMS, F. C., YANG, C. C., HIGGINS, J. A Quarter-square Multiplier using a Segmented Parabolic Characteristic. *Rev. Sci. Instrum.* 22, 683 (1951).
6. CAMPBELL, R. D. The Diotron—An Aid to R.M.S. Instrumentation. *Electronics* 27, 93 (1950).

Letters to the Editor

(We do not hold ourselves responsible for the opinions of our correspondents)

Advanced Theory of Waveguides

DEAR SIR,—In a review of "Advanced Theory of Waveguides", which appeared in your issue for May 1952, one of us (J.B.) stated that the equivalent circuit for the H-plane step, as given in section 5.1, was incorrect because of the neglect of the phase of the transmitted wave. We have recently discussed this point in detail and would like this opportunity of bringing our conclusions to the notice of your readers.

The method used for the analysis is based on the variational principle developed by Schwinger, but there are some minor differences. In such of Schwinger's work as has been seen by us, a suitable form for the equivalent circuit is selected and variational expressions are derived for the values of the circuit elements. This cannot be done for the H-plane step as it does not possess the required symmetry, and a slightly different procedure is used. A variational expression is obtained for the input impedance of the junction at some arbitrary reference plane, taken for convenience in section 5.1 as the plane of the step. From this an equivalent circuit can be deduced which will correctly describe the reflexion properties of the junction. To complete the specification of the equivalent circuit it is necessary to consider the phase of the transmitted wave. This can be most conveniently carried out by terminating the output guide in an arbitrary impedance: the input impedance then becomes a function of the position of this load and the equivalent circuit can be completely defined. An example of this procedure appears in section 5.3 dealing with the E-plane T-junction.

If the analysis of the H-plane step is completed in this way it is found to the degree of approximation used that the circuit in Fig. 5.2 is correct. The shift of the reference plane mentioned in the review does not appear until the approximation is carried a stage further, when it is found that a small quadrature component appears in the expression for the junction field. It is interesting to note that, owing to the slightly altered form of the equations for the E-plane step, the latter fails to exhibit this phenomenon, and the junction field is rigorously co-phased.

Yours faithfully,

L. LEWIN,
J. BROWN*

* Imperial College of Science and Technology, London, S.W.7.

Recording of Noise in Vehicles

DEAR SIR,—In the article on "Electronics in Automobile Engineering Research" in your April issue it is stated, in connexion with the recording of noise in vehicles, that "the recording and reproduction of intense low frequencies often causes considerable modulation

noise although the same recording and reproducing heads and tape are quite satisfactory when used for speech or music. The Association is in close touch with the manufacturers concerning these problems."

The apparatus concerned, consisting of a commercially available tape deck with amplifier constructed generally in accordance with the instructions supplied by the manufacturers of the deck, was brought to us by two representatives of the M.I.R.A. Frequencies from 30 to 70c/s were fed into this apparatus and the distortion complained of made apparent. The same frequencies were then fed into our standard recording gear and reproduced, using the same samples of tape, without any sign of the trouble. The resulting waveforms were considered satisfactory by the M.I.R.A. for their purpose. The tapes used included both our own product and those of other manufacturers.

From these tests it was concluded that magnetic recording is capable of giving the desired response with our equipment which is, in fact, quite normal equipment; but it is also apparent that other commercially available equipment can give the low frequency distortion complained of.

Yours faithfully,

P. T. HOBSON,

Research Manager,
Magnetic Tapes Division,
Minnesota Mining and Manufacturing Co., Ltd.

The author replies:

DEAR SIR,—With reference to Mr. Hobson's letter concerning distortion in the magnetic tape recording of very low audio frequencies, I would point out that the article was written before we had contacted Mr. Hobson concerning this matter. So far as Mr. Hobson is concerned his letter is a correct statement. Although, to be frank, we do not know enough about the low frequency modulated noise referred to in the article to argue the matter in your columns, nevertheless, I would repeat that both recorder design and tape characteristics appear to be involved.

Yours faithfully,

J. R. BRISTOW,

Research Manager,
The Motor Industry Research Association.

A High Quality Power Amplifier

DEAR SIR,—I have read E. J. Miller's article "A Stable, High Quality, Power Amplifier" appearing in the August issue of ELECTRONIC ENGINEERING with great interest; it appears to me that it represents a straightforward, down to earth approach to a problem which has

puzzled a good many amateurs and high-fidelity enthusiasts.

I would greatly appreciate your comments on the following two questions:—

1. Curve C in Fig. 3 shows the power output for 5 per cent total harmonic production. According to the data I have available on the 6V6 tube, the total harmonic distortion with 285 volts plate supply and a power output of 14 Watts is 3.5 per cent. In view of the 20db feedback in the pass-band, I would have expected a much lower distortion than the values given in the data sheets for the 6V6, which are of course for a straight amplifier without feedback. I am wondering whether there is a decimal point missing in this figure, 0.5 per cent being a value which I would consider as more probable.

2. Would you be kind enough to give me the characteristics of the EF37, or indicate what American tube is equivalent to it (I assume that it will be a 6J7 or 6SJ7).

Have you any data on the output impedance of the amplifier? This is in my opinion of great importance for good damping of the loudspeaker.

Yours faithfully,

WALTER RICHTER.

Milwaukee,
Wisconsin, U.S.A.

The author replies:

DEAR SIR,—Thank you for your letter and for the interest that you have taken in the amplifier.

Unfortunately Curve C in Fig. 3 showing 5 per cent total harmonic production, is correct. I have figures of power output for lower values of harmonic distortion, but I did not feel justified in publishing them. As you know, in this type of amplifier the onset of distortion with increasing input signal is rapid and thus the power output for 0.1 per cent, 1 per cent and 5 per cent total harmonic production is not so very different. Measuring low values of distortion, even where excellent signal generators and filters are available is always difficult and the results are often impossible to reproduce.

Exactly why valve manufacturers achieve much higher output for a given distortion is not apparent. Possibly the cause is that valves are tested under ideal conditions, e.g., purely resistive loads, fixed bias and perfect matching.

The EF37 is a near equivalent to the American type 6J7, however it has a somewhat higher mutual conductance. Use of the EF37, or the low hum version EF37A, has been standardized because, in my experience, this valve has the best, and by far the most consistent, microphone performance from sample to sample. In this particular application perhaps this is unnecessary, but in a pre-amplifier, to be published later, this feature is essential. I regret that I have no experience of American valves in this respect.

The source (or output) impedance of the amplifier has been measured and found to be 1.6 ohms for an amplifier having a 15 ohm termination. This should provide adequate damping.

Yours faithfully,

E. J. MILLER.

ELECTRONIC EQUIPMENT

A description, compiled from information supplied by the manufacturers, of new components, accessories and test instruments.

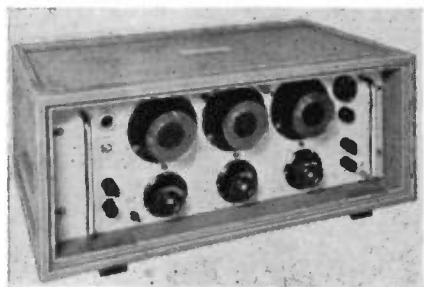

S.T.C. Industrial Counter
(Illustrated above)

THE Standard industrial counter type 74505A is an electronic counter capable of handling pulses at rates up to 5 000 per second. It has been designed for use in situations where mechanical and electro-magnetic types are too sluggish to count accurately or even to count at all, and can be used for batch selection, as a pulse divider and as a frequency-divider.

It owes its speed of response to the use of Nomotron decade counter tube. The tube is a cold-cathode gaseous-discharge device having ten possible states of equilibrium, i.e., the discharge can take place between the anode and any one of ten cathodes arranged in a circle. The glow of the discharge is visible through the end of the tube. Transfer electrodes are situated between adjacent cathodes, and these enable the discharge to be transferred from one cathode to the next in one direction only. If the tube is fed with a continuous train of pulses, the discharge can be made to rotate continuously, ten pulses being required for one complete revolution.

Three of the G10/240E tubes are used in the industrial counter—one for counting units, the second for tens, and the third for hundreds, so that any number between 0 and 999 can be indicated by the discharge positions in the three tubes.

The incoming pulses are first shaped and amplified, and then fed to the first (units) counter tube. At the end of each revolution on the units counter tube, i.e., at every tenth pulse, the discharge in the second (tens) counter tube is made to step round one position. At the end of each revolution on the tens counter tube, i.e., at every hundredth pulse, the discharge in the third (hundreds) counter tube is made to step round one position. Three switches are provided, one for each counter tube, for batch selection purposes. Each has a dial graduated from 0 to 9, and the principle of operation is as follows.

Suppose it is desired to count batches of 125; then the hundreds switch is set to "1", the tens switch to "2", and the units switch to "5". When the 125th pulse arrives, a pulse of 150 volts is generated across the output terminals, and the discharges return to the "0" position on each tube. The process is then repeated,

starting with the 126th pulse. The output pulse can be applied to a device for separating one batch from the next. For normal counting, the switches are all set to "0", and a key is provided for manual resetting to the "0" position.

A minimum input pulse voltage of 25 volts is needed, and the output pulse voltage is 150 volts. The counter's power requirements are: 100-110V, 120-130V, 140-150V, or 200-250V, 40-60c/s single-phase A.C.

**Standard Telephones and Cables, Ltd.,
Connaught House,
Aldwych, London, W.C.2.**

Model DI Portable Recorder
(Illustrated below)

A NEW portable recorder has been produced by Electrical and Electronic Development, Ltd., in which the record and replay amplifiers, power pack oscillator and tape desk are housed in a case with a removable cover. The recorder is supplied with a desk type moving coil microphone and stand, microphone and main leads, a reel of recording tape and a spare reel.

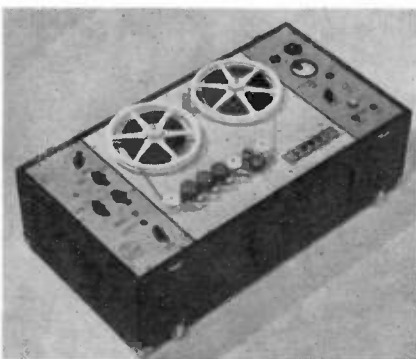

On the left hand panel there are two inputs selected by a switch and a balanced feed microphone input of $15/30\Omega$, the second being a high impedance jack socket input requiring an input of 0.6V to modulate fully the tape. Separate record and replay volume controls are provided, as well as a selector switch for record, rewind and replay. There is also a compensation switch for $7\frac{1}{2}$ in. and $3\frac{1}{2}$ in. per second.

On the right hand panel is placed a record level meter which works in a peak level valve voltmeter circuit, and a mains input socket with voltage tap board adjacent. A control is supplied for adjusting the bias to suit various tapes and, positioned over the internal $5\frac{1}{2}$ in. speaker is a jack socket for an external speaker with a tap board giving impedances of 3, 7 and 15 ohms as required. Adjacent to this is a speaker muting switch which enables the operator to monitor with phones in place of the speaker if required.

The output of the amplifier is 3 watts

with a low distortion factor. The frequency response is level with 2db from 70 to 10 000 cycles at $7\frac{1}{2}$ in. per second. The frequency response of the whole equipment is ± 2 db from 70 to 10 000 cycles, and can be extended when feeding a high quality amplifier from the monitor phones jack socket.

The tape desk incorporates brakes, fast forward and fast rewind, twin speed and erase, record and monitor heads.

The recorder measures $26\frac{1}{2}$ in. by $15\frac{1}{2}$ in. by $10\frac{1}{2}$ in., and weighs 52lb.

**Electrical and Electronic Development, Ltd.,
Bickford Road, Witton,
Birmingham, 6.**

Standing Wave Meter Model 2.
(Illustrated below)

THE standing wave meter model 2 is constructed on a selected waveguide held in a metal frame which carries the drive mechanism and scale. The vertical tuned line is held in place by a screwed ring and spring which enables the penetration of the probe into the waveguide to be varied from zero to 2mm. An engraved scale on the screwed ring indicates the probe penetration to within 0.1mm.

The travelling carriage rides upon the surface of the waveguide, accuracy of alignment and fitting rendering choke recesses unnecessary; a spring-loaded roller on the underside of the frame retains the carriage upon the waveguide.

Traverse is controlled by a multi-strand steel cord which is driven by a screwed drum. The drum moves across the frame as it is turned, thus keeping the cord on the centre line of the waveguide during the full travel of the carriage. One full turn of the control knob moves the carriage approximately 18mm. The carriage travel is 63.5mm approximately and is measured by a metric vernier scale to 0.01mm. The scale is of rustless steel and is standard at 20°C.

Tuning of the crystal detector, which uses a silicon crystal rectifier, is controlled by a knob at the top of the tuned line which has a piston movement of 22mm and tunes to 3.2cm wavelength near the centre of travel. At 3.4cm

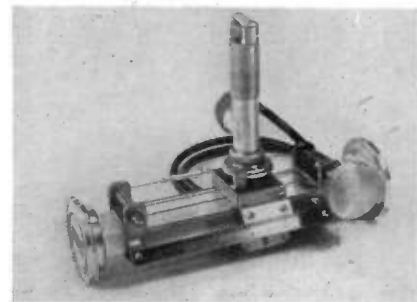

tuning points are available near each limit of the piston movement. D.C. output from the crystal is taken via a screened cable to the indicating instrument. A 0-50 microammeter is recommended for this purpose.

The standing wave ratios are readable to better than ± 0.1 db. The instrument weighs 28oz.

**Microwave Instruments, Ltd.,
West Chirton Industrial Estate,
North Shields,
Northumberland.**

New S.T.C. Magnetic Material

Added to the range of magnetic alloys manufactured by Standard Telephones and Cables, Ltd. This is Permalloy F, a nickel-iron alloy in which a rectangular hysteresis loop and a low value of coercive force are obtained by the method of domain orientation. It is, therefore, suitable as a core material for all types of saturable reactor. Permalloy F is produced in the form of toroidal cores wound from thin tape, and these cores are supplied in the fully heat-treated condition ready for winding. In common with all magnetic materials which have high permeability, Permalloy F is somewhat strain-sensitive and needs to be handled with care during winding and other processing if its high magnetic properties are to be retained fully. For some designs it may be advisable to place the core in a box before winding; this will serve both to avoid straining the core during winding and to prevent the penetration of coil-impregnating compounds into the core.

The magnetization characteristics are such that a flux density of nearly 14 000 gauss may be obtained in magnetizing fields of less than 0.1 oersted. From a maximum flux density of 13 500 gauss, the remanence is greater than 13 000 gauss, while the coercive force is less than 0.05 oersted, thus resulting in a hysteresis loss of only 210 ergs.

The specific gravity of the alloy is 8.4, and the electrical resistivity is 26 microhms per centimetre cube.

The core sizes which are proposed range from 2.25in. to 1.00in. outer diameter, 1.50in. to 0.50in. inner diameter, with a height of from 0.5in. to 0.25in., and a tape thickness of 0.004in. or 0.002in.

**Standard Telephones and Cables, Ltd.,
Connaught House,
Aldwych, London, W.C.2.**

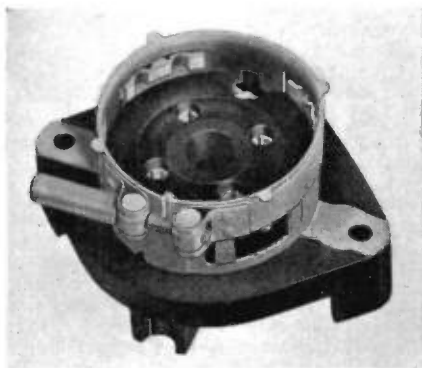

Arcoelectric Toggle Switch

(Shown below)

A THREE position toggle switch with a true Q.M.B. action has been designed by Arcoelectric (Switches), Ltd., in which each position is obtained with a positive snap.

The switch is provided with six terminals for connexion and will switch three separate single pole circuits. Alternatively it can be used to control two circuits, and either the end or central position can be the "off" position.

The contacts are of the self-cleaning low resistance type. The switch, Catalogue No. M.40, is rated 5A 250 volts A.C./D.C. Fixing is by means of two inserts tapped 6 B.A. at $1\frac{1}{4}$ in. centres.

Applications for this switch include switching electric motors to give two speed and "off", and controlling electric elements to give two heats and "off".

**Arcoelectric (Switches), Ltd.,
Central Avenue,
West Molesey, Surrey.**



Ediswan Clix Valveholders

(Illustrated bottom left)

TWO new valveholders, type B4A and B4D, have been added to the Ediswan Clix range of components. These valveholders have silver-plated hardened beryllium copper contacts conforming to R.C.S.C. Specification 251.

The quartz-phenolic body has low moisture absorption, high surface and volume resistivity, low permittivity and low power losses. The silver-plated beryllium copper sockets are designed to provide good contact pressure and resistance, while the specified limit figures for insertion and withdrawal forces are attained with a wide margin.

**The Ediswan Swan Electric Co., Ltd.,
155 Charing Cross Road,
London, W.C.2.**

Cossor Camera Drive Unit

(Illustrated top right)

DESIGNED for use with the Cossor camera models 1428 and 1432 when film drive becomes essential, this unit embodies a capacitor motor of ample power, which is worm coupled to a gear box having a range of nine speeds.

The model camera drive unit is arranged for film speeds in inches per second as follows: 0.05; 0.1; 0.25; 0.5; 1.0; 2.5; 5; 10 and 25. Gear selection is

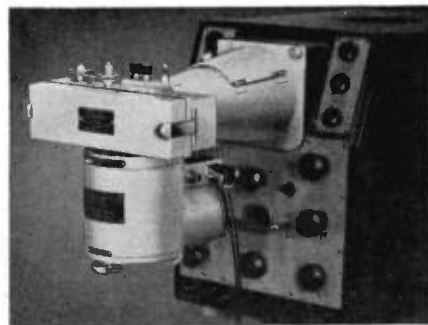

effected by rotation of an engraved knurled knob and, by the positive action of the drive engagement lever, the starting and stopping of the film is, for practical purposes, instantaneous.

Switching of the motor is by push-pull type control mounted to the gear box. The drive unit may be operated from single-phase a.c. supplies of 110V, 200V, 225V and 250V through an auto-transformer which, with the motor capacitor, is housed separately and forms part of the mains lead to the unit.

For short records development may be carried out in a dish by "see-sawing" as with a standard roll-film, but where several feet have to be handled, it is almost essential to adopt some form of frame or drum processing technique.

**A. C. Cossor, Ltd.,
Instrument Dept., Cossor House,
Highbury Grove, London, N.5.**

Morgan Megistor

THIS high value glass enclosed resistor was described on p. 345 of the July, 1952, issue of ELECTRONIC ENGINEERING. The following details are supplementary to the information given previously.

Change of resistance with applied voltage is small and reversible, and varies in magnitude with the resistance value. The voltage coefficient is expressed as an average percentage change per volt over the range 1 to 100 volts.

The limits are:—

Resistance	Voltage Coefficient
10^7 to 10^{10} ohms	Less than -0.1% per volt
10^{11} "	" " -0.15% " "
10^{12} "	" " -0.2% " "
10^{13} "	" " -0.25% " "

The nominal resistance value is measured at 25°C. The change of resistance value with ambient temperature is small and reversible, and varies in magnitude with resistance value. The temperature coefficient is expressed as an average percentage change per °C over the range 0 to 60°C.

The limits are:—

Resistance	Temperature Coefficient
10^7 to 10^9 ohms	Less than $+0.2\%$ per °C.
10^9 to 10^{11} "	" " $+0.3\%$ " "
10^{11} to 10^{13} "	" " $+0.4\%$ " "

All Megistors are individually tested and it is claimed that the performance of all Megistors complies 100 per cent with the above specification and that in most cases the changes observed are considerably less than the limits shown.

**The Morgan Crucible Co., Ltd.,
Battersea Church Road,
London, S.W.11.**

Thermionic Valve Circuits

By Emrys Williams. 314 pp., 212 figs. 3rd edition. Sir Isaac Pitman and Sons, Ltd. 1952. Price 21s.

THE present volume is the third edition of Professor Williams book which was first published in 1942. It is based on lectures given to third year degree students, and provides a comprehensive survey of valve circuit theory.

In the first chapter the author deals with A.C. theory, circuit theorems, distortion, amplitude and frequency modulation, whilst in the second he deals with the construction and characteristics of thermionic valves of the conventional type.

The next two chapters are concerned with amplifiers. The various types of A.F. and R.F. coupling are discussed together with the analysis required to determine the maximum gain and power output in each case. Composite characteristics in push-pull circuits are also treated. Chapter IV contains much additional material on negative feedback and wideband amplifiers compared with the earlier editions.

Chapter V is devoted to regeneration and oscillation. The basic circuits of the common types of tuned circuit and relaxation oscillators are analysed. The extension of oscillators to the flip-flop and time-base circuits is included, together with an interesting original theorem relating to single frequency oscillators.

In Chapter VI detectors and rectifiers are described including phase sensitive rectifiers, and the use of a diode for the purposes such as A.G.C.

The author next deals with frequency changing and modulators commencing with the analysis of the equation of a modulated wave and following with frequency changer and modulator circuits. The principles of heterodyne and super-heterodyne working conclude Chapter VII.

The last chapter is additional matter included in the book for the first time, and forms a very useful introduction to pulses and pulsed circuits. Pulse modulation, the formation and shaping of pulses, differentiation and integration, and electronic switching are all explained together with representative circuits. A short bibliography relating to this chapter is included.

The mathematical knowledge required of the reader does not extend beyond that necessary for simple differential equations, and the author develops very clearly the proofs of all the important results.

In the paragraph on distortion the author does not adhere to B.S.I. definitions, and ρ is used for the anode slope resistance in place of the more common symbol r_a .

It is inevitable in a book of this size that much must be omitted or drastically condensed. Thus only brief reference is made to band-pass circuits, to smoothing circuits, and to power rectifiers. In Chapter IV (Amplifiers) the reader learns that the anode efficiency in Class A cannot exceed a theoretical maximum of 50 per cent, but the practical limits are not given. This chapter covers a very wide range of subject matter and would probably have been improved, from the student's point of view, if it had been divided into two.

BOOK REVIEWS

The book contains numerous diagrams, although some of them are disconcertingly small. Additional circuits in the chapter on oscillators would have avoided the necessity of detailing modifications in the text. Errors are commendably few.

It is evident that the publishers have endeavoured to keep the cost of production to a low figure, but the textual matter certainly seems to deserve better quality paper.

In conclusion, the criticisms made are of relatively minor details. Professor Williams has succeeded in presenting very clearly the theory of valve circuits, and the book can be confidently recommended to the serious student seeking an introduction to this subject.

J. E. F. VOSS

Reports on Progress in Physics Vol. (XV)

Edited by A. C. Strickland. 338 pp. The Physical Society. 1952. Price £2 10s. 0d.

THE bulk of the contents of this book, which contains reports on nine physical subjects, lie outside the scope of this Journal. There are, however, three papers of considerable electronic interest—the review of ferrites by A. Fairweather, F. F. Roberts and A. J. E. Welch (pp. 142-172); of galvanomagnetic effects in conductors by D. K. E. MacDonald and K. Sargison (pp. 249-274) and of travelling wave tubes by R. Kompfner (pp. 275-327).

A historical method of approach has been adopted in all three reports, and in the second this necessitates some reference to later passages for the elucidation of the opening paragraphs. One does not expect reports of this nature to cover every detail of theoretical and experimental progress in each subject, and the present authors have confined themselves to a lucid account of the development of the field, and have presented only the basic theory. A comprehensive list of references is included for the student who wishes to make a more complete study of the subject.

In the paper on ferrites the authors describe the crystal structure and magnetic properties of various ferrites and their preparation, and include a subsection on the frequency characteristics of these properties. This topic is relevant to the use of ferrites in high frequency transformers of low loss. Dielectric and semi-conducting properties are also discussed and the outline of Neels' theory of ferromagnetism is given.

In the second report the authors refer to the pioneering work of Kapitza as the basis of experimental knowledge in the field of galvanomagnetic effects. His method of short-circuiting a high-powered generator enabled him to produce magnetic fields of the order of

3×10^5 gauss and so to make reasonably accurate measurements both on the Hall effect and the much smaller magneto-resistive effect. The fundamental difference between the origins of these effects is stressed by the authors. Whereas the Hall E.M.F. may be shown to be a direct result of the Lorentz force on the electrons, and should therefore be present to a certain extent in all conductors, the magneto-resistive effect is dependent on the dispersion of electrons from their forward motion through the conductor, which is in turn a function of the distribution of relaxation times among the electrons. Thus the latter effect is smallest when the relaxation times are most nearly equal.

The effects of temperature, crystal structure, and size are also discussed and a theoretical analysis of magneto-resistance given.

In the last of the nine reports the development of travelling wave tubes is traced by Kompfner from the early Klystron. The conventional triode, and to a lesser extent the Klystron, suffer from the defect that increasing power is drawn from the input as the time of transit of the electrons through the R.F. field becomes comparable with the period of oscillation. This restriction disappears if the R.F. field can be made to travel with the electron beam, and the author describes early experiments in which a helix is used to slow down the rate of propagation of the R.F. field to a convenient level. The development and performance of this type of tube is described, and such characteristics as attenuation in the helix, bandwidth, beam velocity, stability, gain and noise are discussed.

Various other structures which have been used to propagate slow waves are compared, and the report ends with a review of the important field opened by recent attempts to amplify microwaves by electron-electron interaction.

A misprint occurs on page 277 where a factor of 2 is missing from an equation in the text, and again at the foot of page 309 where two words should be interchanged. The word "Inference" on the eighth line of page 324 should read "Interference".

A cumulative subject index for volumes I to XV is included at the end of the book.

E. M. DEELEY

Radio and Television Receiver Troubleshooting and Repair

By Alfred A. Ghirardi and J. Richard Johnson. 822 pp. Rinehart Books Inc., New York. 1952. Price \$6.75.

THIS is yet another of the type of book which is intended to help engineers to service radio and television receivers quickly and properly. Like most American books of this sort it contains an enormous amount of informa-

tion, but is padded out to such an extent that reading often becomes dull and boring. For instance, more than a page is devoted to the description and illustration of a "direct drive tuner" (a pointer on a knob) and a selection of knobs. It is stated that a likely fault is that the knob may become loose. Having shown that it is fixed by means of a set screw, it is suggested that the screw should be tightened to remedy the fault. Again, under the heading "10-10 Dead Receiver" it states "In a dead receiver, both the picture and sound sections are inoperative. This means that the trouble cannot be in a section which affects only one or the other, but must be somewhere in a section upon which both sound and picture sections depend."

Some illustrations are badly headed. For instance, on page 248 there is a diagram entitled "Fig. 7-19 Schematic Diagram of 2 filament type tubes with their filaments connected in series, showing how plate current as well as filament current pass through the filament circuit. Filament current is not shown in the diagram." A little care here would have made it so much clearer to the reader who, presumably, is reading the book to learn just this sort of thing; to leave out, and state it is left out, one of the things the diagram is intended, and stated, to illustrate, is very unfortunate.

As already stated the book contains an enormous amount of information, and this is presented in an orderly manner and very well illustrated throughout.

Chapter 1 describes typical components of a radio or television receiver, and the faults which may develop in them. It is very useful and complete and is most suitable material for the start of the book.

Chapters 2 and 3 cover points, the importance of which are not always appreciated. They include a systematic approach to repair work generally and perhaps most neglected of all the time saving which can be effected by means of a few questions put to the person actually making the complaint about the receiver. Suitable questions are given which can be time-savers.

Chapters 4 and 5 show the basic methods of static and dynamic testing, i.e., those tests which do not need a signal such as to A.C. and D.C. supplies, components and wiring checks, etc., and the method of signal tracing, or following a signal through a receiver until the faulty section is found. In practice both methods are used. Suitable test equipment is illustrated and described, and typical receiver circuits are shown. The points at which the various tests are applied are discussed and explained. The capacitor in the probe of a valve voltmeter is called an "isolating conductor capacitor" on page 132. Even a valve holder is shown from both sides to illustrate the relation of the pin numbers, top and bottom, to those on the circuit diagram.

Chapters 6-9 continue with more detailed general problems and those which mainly occur in certain types of sets such as A.C./D.C., battery, or communication receivers. The chapters also contain a number of charts which indicate where faults which cause certain symptoms are likely to be. In common with

all the chapters in the book these are followed by a summary of the chapter and a list of "review questions". These summaries should be quite unnecessary and their contents would be much better in the chapters themselves. If it is thought that the questions are useful, then it would be best if some reference were made to the page upon which the answers could be found. The answers to the "odd" questions are given at the back of the book. The "evens" are left out.

Chapter 10 is a short one on troubleshooting television receivers. It is difficult to see how the subject could be covered in 52 pages, but the authors make a brave attempt. This chapter, and Chapter 14 which covers alignment of television receivers, are the only ones devoted solely to this subject, but of course much of the basic writing is equally applicable to television servicing. After a brief mention of methods of taking receiver performance data in Chapter 11, come Chapters 12 and 13 which cover the alignment of A.M. and F.M. receivers.

Chapters 15 to 18 discuss the replacement of resistors, inductors, transformers and capacitors, and are quite thorough. How to choose a correct replacement can be quite a difficult matter if the faulty part is badly damaged or not the original, and these chapters show how to avoid "replacements" which will have short life. The remaining chapters deal with mechanical repairs such as drives, loudspeaker cones, record players and recording equipment.

As the book sets out to cover the entire subject, it is a pity that space could not be found for some details of minor cabinet repairs, retouching and repolishing etc., as it has become more and more important that receivers should be returned to clients looking satisfactory, and behaving accordingly.

A few errors were noticed, such as an electrolytic across the smoothing choke in Fig. 6-14 and a change of modulation depth of the bars on a C.R.T. which is intended to show line non-linearity. There is non-linearity, too, but the mark-to-space ratio change across the screen is much more noticeable.

The book is a good example of its type and should be of more help to the "troubleshooter" than the service engineer.

C. H. BANTHORPE

Television Principles and Practice

By F. J. Camm. 215 pp., 144 figs. George Newnes Ltd. 1952. Price 25s.

ON the jacket of this book it states that "this handbook is a necessity for . . . the technician, the student and the amateur." In this preface Mr. Camm says that he has dealt with the subject in "as non-technical a manner as possible". Taking Mr. Camm's statement as being the correct object of the book he can claim to have done the job competently.

It is a good and up-to-date review of present methods and trends in television, and will be of use to the layman or the amateur turning to television for the first time. It cannot, however, be considered as a book suitable for the serious student or technician.

CHAPMAN & HALL

Just Out

DESIGN FOR A BRAIN

by

W. Ross Ashby

M.A., M.D., D.P.M.

Director of Research,
Barnwood House, Gloucester

254 Pages. 70 Figures. 36s. net.

ELECTRICAL MEASURING INSTRUMENTS

PART I

General Principles and Electrical Indicating Instruments

by

C. V. Drysdale & A. C. Jolley

Second Edition, revised by

G. F. Tagg

B.SC., PH.D., M.I.E.E., F.INST.P.

608 Pages 351 Figures 75s. net.

37 ESSEX STREET, LONDON, W.C.2

The First published design
for B.B.C. F.M. Reception

A HOME BUILT FREQUENCY MODULATED RECEIVER

By K. R. Sturley, Ph.D., M.I.E.E.

Price 4/6 (postage 3d.)

Contains full details and wiring diagrams for the construction of a frequency-modulated receiver for reception of the B.B.C.'s high-fidelity F.M. transmitter at Wrotham (Kent). Included in the booklet is a design for a suitable aerial system and a simple modulated test oscillator for alignment of the I.F. stages.

Obtainable from

Electronic Engineering

28 ESSEX STREET, STRAND,
LONDON, W.C.2.

BOOK REVIEWS (Continued)

Automatic and Manual Control

xi + 584 pp. Butterworth Scientific Publications, May, 1952. Price 50s.

A REVIEW of this book, which is a record of the very interesting and informative conference held at Cranfield in 1951, very rightly should contain a tribute to Professor Tustin for his pioneer spirit and his considerable labours, first in initiating the conference and, secondly, in compiling the book.

Being a contemporary of Professor Tustin in his student days, it is no surprise to the present reviewer to see the progressive spirit manifest in this work.

The conference itself was a signal success, bringing together as it did the leading personalities in this field from most of the civilized world, and the book is a faithful record of the papers presented and, also, the public discussion thereon.

A short account appears also of the demonstrations which were given after the sessions of lectures covering practical servo technique already developed and the hints for the future.

The speakers have something worthwhile to say; for example, Professor Gordon S. Brown, dealing with the educational problems involved in the new technique, is forthright in declaring the necessity of producing a new type of engineer as he says on page 6 "The solution is not to condense the old specialities and crowd them into a new curriculum, but to provide a new synthesis that will produce not a jack of all trades, but a master of a new trade, a specialist in the concepts and techniques of feedback system synthesis". Other speakers draw upon their recent and past experience and give of their suggestive thinking on both the theoretical and practical sides of machine and human servos and also on process control subjects. The range in size and power of mechanisms drawn upon as examples in the consideration of stability problems is from the smallest electrical and electronic devices up to ship stabilizers and to power supply systems involving many megawatts.

As indicated by Sir Ben Lockspeiser in his presidential address, one of the important events which has resulted from the study and development of control systems "is the emergence in recent years of a philosophy of automatic control, based on the recognition of a common pattern and a common basis of principle in a great variety of engineering devices."

The book is divided into nine sections, varying in length from two to 146 pages (580 pages in all). The largest section is on "General Theory" and comprises eight papers, dealing with stability, frequency response, feedback and design problems.

Other important sections deal with "Process Control," "Non-linear Prob-

lems," and "Systems working on Intermittent Data and Step by Step Servos", the first two each contain eight and the last five papers. The papers in these sections cover specialized theory and practice in their particular subjects, including stability, the effect of time, measurement, and transmission lags, on-off control, the effects of friction, backlash and resilience.

Smaller sections, each containing two papers, deal with "Educational Problems" and "The Human Operator" and a section of three papers covers "Particular Devices and Applications including Analogues."

The smallest section "Analysis of the Behaviour of Economic Systems" suggests a similarity between economic and servo systems, and the final section describes the demonstrations already mentioned.

A short bibliography or list of references occurs after each paper and is followed by the discussion relating to that paper.

The discussions contain valuable material particularly in the sections dealing with the design and stability of servos and, also, in the process control section.

A short but useful index is included with author and subject sections.

J. BELL.

Technological Applications of Statistics

By L. H. C. Tippett. 189 pp. Williams and Norgate, Limited, London. February, 1952. Price 18s.

THIS is an excellent book. The author has already written an introduction to statistics which is established as one of the best of its kind. He has now written a second book which deserves equal praise, although its aim is more limited. In the preface he says that it is a write-up of lectures given by invitation in America at the Massachusetts Institute of Technology. They were very good lectures. The author has the gift of enlightenment and restrained enthusiasm which one hopes from an expert combined with a simplicity of manner which is deceptive, and he makes skilful use of carefully chosen examples.

The first part, "The Routine Control of Quality", is an analysis of a number of controls already in use in industry to show how to apply standard methods, why these methods are chosen and the reasons for the particular manner of their use. The second part is entitled "Investigation and Experimentation" and the reader who forgives the second "-ation" will find there the uses of variance and correlation analysis together with the considerations which arise when an experiment is being planned.

G. J. KYNCH

PUBLICATIONS RECEIVED

B.E.A.M.A. GLOSSARY OF TECHNICAL TERMS AS USED IN INDUSTRIAL HIGH FREQUENCY HEATING has been compiled to clarify the meaning of new terms which have been loosely applied in this technique. British Standard definitions have been used or referred to except where the term used in the I.H.F. field has a different meaning. The glossary is obtainable from the British Electrical and Allied Manufacturers' Association, 36 and 38 Kingsway, London, W.C.2., price 2s.

CALIBRATION OF COMMERCIAL RADIO FIELD-STRENGTH METERS AT THE N.B.S. by F. M. Greene describes briefly the standards and methods used in the calibration of certain types of radio field-strength meters in the frequency range 10kc/s to 300Mc/s. It is available from the National Bureau of Standards, U.S. Dept. of Commerce, Washington 25, D.C., U.S.A., price 10 cents, postage extra.

BIBLIOGRAPHY ON GEIGER-MUELLER PHOTON COUNTERS by E. J. Walker includes references to most of the article on G.M. photon counters which have appeared in English and German, and a selection of those published in French, Russian and Italian. Where possible, the author's abstract, together with Mr. Walker's comments, are given. National Bureau of Standards Report 1050. U.S. Dept. of Commerce, Washington 25, D.C., U.S.A.

LABGEAR INSTRUMENT CATALOGUE gives full technical details and specifications of this Company's latest developments in the nuclear physics field. Labgear (Cambridge) Ltd., Willow Place, Cambridge.

INDUSTRIAL LUBRICANTS AND ENGINEERING SPECIALITIES is a booklet containing notes to explain the Regosine System of Industrial Oils and how it may be employed to obtain correct lubrication of all ordinary engines and machines. It covers general industrial lubrication, grease lubrication, listate lithium grease, cutting oils, heat treatment oils, drawing lubricants and process oils, lubricants, etc. The Regosine Oil Co. Ltd., Minerva Works, Woodlesford, Near Leeds.

TIN AND ITS USES No. 26 contains an illustrated account of "Contact" plating with tin, whereby the tinning of the bores of fine tubes can be coated while the more accessible exteriors are being electro-tinned by ordinary electrolysis. It also includes articles on tinplate development, bronze specifications, and tin mining in Malaya. The booklet is issued by the Tin Research Institute, Fraser Road, Greenford, Middx.

ULTRASONIC SOLDERING EQUIPMENT describes the principles and methods of use of Mullard ultrasonic soldering equipment. This equipment makes possible the tinning of aluminium and other light metals without the use of flux. Suitable applications of the technique are dealt with in the booklet, and the use of the ultrasonic soldering iron for filling blow holes and other faults in light alloy castings is mentioned. The booklet is available from the Equipment Division of Mullard Ltd., Century House, Shaftesbury Avenue, London, W.C.2.

ELECTROTHERMAL VALVE RETAINER LEAFLET AND SHOWCARD have recently been issued by Electrothermal Engineering Ltd., 270, Neville Road, London E.7. Physical samples of the Electrothermal range of valve retainers are affixed to the showcard as an aid to draughtsmen to enable them to choose suitable retainers for various applications. The leaflet describes the standard retainers available, and mentions the fact that special constructions to suit design requirements can be supplied. Any manufacturers requiring a showcard and leaflet should send details of their requirements to Electrothermal Engineering Ltd.

WINSTON ELECTRONIC EQUIPMENT is a catalogue devoted to this firm's converter equipment. It contains details of the properties of image converter tubes and some typical applications. It then describes the Winston image converter units and infra-red, ultra-violet, stroboscopic, slit-scanning equipments etc. Winston Electronics Ltd., 1, Park Road, Hampton Hill, Hampton, Middx.

This Order Form should be used for EXTRA copies of the November issue, containing the supplement "Electronics in Industry."

Details appear in the October issue, page 445

Please supply me with copies of the November 1952 issue of ELECTRONIC ENGINEERING, with "Electronics in Industry" supplement, at 2/- each (postage 4d. extra).

*Remittance of.....herewith.

*Please charge my account.

* Please delete whichever is inapplicable.

Name.....

Address.....

Hand this form to your Newsagent, or send direct to :

ELECTRONIC ENGINEERING
28, Essex Street, Strand, London, W.C.2.

Notes from the Industry

Radio Gramophone Development Co. Ltd., last year became a wholly-owned subsidiary of Automatic Telephone and Electric Co. Ltd. This company are continuing operations at the existing Bridgnorth factory under the name of A. T. and E. (Bridgnorth), Ltd., while those assets of the Radio Gramophone Development Co. Ltd., comprising the manufacture and sale of domestic radio receivers, etc., previously carried on at Bridgnorth have been assigned to a new company called Radio Gramophone Development Co. Ltd., with head office situated at 3-4 Hampton Court Parade, East Molesey, Surrey.

The South East London Technical College Evening Classes will be given on ten post-graduate subjects this session. These are: high voltage engineering; electrical engineering economics; communication engineering economics; vector analysis and fundamentals of electromagnetic theory; communication networks; advance laboratory work; fundamental theory of electric machines as the basis for design; electric circuit theory; applications of photography in engineering and industry, and elements of electric lighting practice. Most of these courses begin in October, and lectures are held on one evening per week.

In addition, four special short courses will be held on the following subjects: physical properties of modern materials; electric strain gauges and their application; power factor improvement and capacitor design, and principles of logic for engineers. These courses will also occupy one evening per week.

Full details of these and other courses in electronics and allied subjects are available in the prospectus available from the Principal, Department of Electrical Engineering and Applied Physics, South East London Technical College, Lewisham Way, London, S.E.4.

Brit. I.R.E. Premiums and Examination Awards for 1951. The senior award of the Brit. I.R.E., the Clerk Maxwell Premium, will be made to H. Paul Williams, Ph.D., for his paper on "Subterranean Communication by Electric Waves," published in the Institution's Journal, March, 1951. Dr. Williams was formerly with A. C. Cossor, Ltd., and is now with Fairey Aviation Company. This premium is for the most outstanding paper published in the Institution's journal during the year 1951. The award will be made at the Annual General Meeting on October 8th.

Other 1951 awards which will be presented at the same time, and which have just been announced by the General Council of the Institution are as follows:

R. E. Spencer, B.A. (E.M.I. Engineering Development, Ltd.), will receive the

Heinrich Hertz Premium for his paper on "The Detection of Pulse Signals near the Noise Threshold" which appeared in the October, 1951, issue of the journal.

The Louis Sterling Premium will be presented to Emlyn Jones, B.Sc. (Mullard Research Laboratory), for his paper on "Scanning and E.H.T. Circuits for Wide-Angle Picture Tubes." This paper, first read at the 1951 Radio Convention, was published in the Journal of January, 1952.

R. G. Kitchenn, B.Sc. (Eng.) is awarded the Leslie McMichael Premium. His paper was on "An 8-channel Transmitter for an Experimental Carrier Wire-Broadcasting System." (August, 1951). Mr. Kitchenn was formerly with the Local Lines & Wire-Broadcasting Branch of the Engineer-in-Chief's Office, G.P.O.

The first award to be made of the Brabazon Premium is to G. E. Roberts (The Decca Navigator Co., Ltd.) for his Convention paper on "The Design and Development of the Decca Flight Log" (February, 1952). This premium is for the most outstanding contribution to the Institution's proceedings on radio or electronic aids to aircraft safety.

E. G. Rowe, M.Sc. (Brimar Valve Division, Standard Telephones & Cables, Ltd.), will be presented with the Marconi Premium, his paper being "The Technique of Trustworthy Valves" (November, 1951).

The Dr. Norman Partridge Memorial Award and the Students' Premium for 1951, have been withheld.

In addition, the following examination prizes will be awarded:—

G. R. Beswick (Birmetals, Ltd., Quinton, Birmingham), will receive the President's prize awarded to the most successful candidate in the Graduateship Examination in 1951. He will also receive the Electronic Measurements prize awarded to the most outstanding candidate who passed Part IV of the Graduateship Examination in 1951, in Electronic Measurements.

C. J. White (BBC, Daventry, and formerly R.A.F.), will be awarded the Mountbatten Medal as the most successful candidate who passed the Graduateship Examination in 1951, whilst serving in H.M. Forces.

The Council regrets that it has been necessary to withhold the S. R. Walker prize, and the Audio Frequency Engineering prize, as no candidate reached the required standard.

Supply Ministry Electronics Chief to Visit U.S., Canada. Mr. N. C. Robertson, Director-General Electronics Production, Ministry of Supply, left England by air on Tuesday, September 9th, for a four-weeks' visit to the United States and Canada. He is to exchange information on electronic manufacturing techniques and discuss standardization of equipment between Britain, Canada and the U.S.A.

During his journey he will visit Government establishments and industrial plants engaged on electronics production for the United States and Canadian forces.

Radio Export Record. The total value of exports of radio equipment of all kinds in July was £2,303,500, an increase of £721,000 as compared with the previous month.

Most striking feature was a total value of £878,800 for exports of capital goods, such as broadcasting and communications equipment, navigational aids and electronic equipment for industry. This does not include indirect exports of equipment such as that installed in ships and aircraft.

Exports of receivers jumped by £130,000 to £442,500 and components, not counting sound reproducing equipment, exceeded half a million pounds in value.

Ministry of Supply School of Electronics, Malvern. T. E. Goldup, M.I.E.E., a director of Mullard, Ltd., has been appointed Chairman of the Board of Governors of the Ministry of Supply School of Electronics, Malvern, in succession to Professor Willis Jackson, D.Sc., D.Phil., M.I.E.E., Professor of Electrical Engineering, City and Guilds College, London.

In addition to being a governor of the Ministry of Supply School of Electronics since 1949, Mr. Goldup is a governor of the Wandsworth Technical College, and a member of the Advisory Committee of the Norwood Technical College. He is also a member of the Radio Research Board of the Department of Scientific and Industrial Research.

Engineers Guild Ltd. Mr. Henry Nimmo, M.I.C.E., M.I.Mech.E., M.I.E.E., who has been chairman of the General Council during the past two years, has been elected president of the Engineers' Guild in succession to Mr. Robert Chalmers, O.B.E., B.Sc., M.I.C.E., M.I.Mech.E., whose term of office expires on September 30.

Mr. Nimmo is also chairman of the Southern Electricity Board and a part-time member of the British Electricity Authority.

Lanark School of Engineering is this year holding a series of six lectures on the American practice in colour television. The lectures deal with: the position of colour in the electromagnetic spectrum; fundamentals of colour television process; scanning methods; colour reproducers, and the various proposed systems, such as C.B.S. R.C.A., G.E.C., Vericolour, etc. The lectures take place at 7.30 p.m. on Wednesday evenings.

Courses are also available to cover electrical engineering practice, radio and radio servicing, telecommunications and television. Full details of these courses are available from the Principal, School of Engineering, Crawford Street, Burnbank, Hamilton, Lanarkshire.

Meetings this Month

THE BRITISH INSTITUTION OF RADIO ENGINEERS

Date: October 8. Time: 6.30 p.m.
Held at: London School of Hygiene and Tropical Medicine, Keppel Street, London, W.C.1.
Presidential Address.
By: W. E. Miller, M.A.(Cantab.).

Scottish Section
Date: October 2. Time: 7 p.m.
Held at: Department of Natural Philosophy, The University, Edinburgh.
Lecture: Recent Developments in Television—Methods of Picture Generation.
By: H. McGhee.

BRITISH KINEMATOGRAPH SOCIETY

Date: October 1. Time: 7.15 p.m.
Held at: G.B. Theatre, Film House, Wardour Street, London, W.1.
Lecture: The Viewing of Moving Pictures (Film and Television).
By: W. D. Wright, A.R.C.S., D.Sc.
Joint meeting with the Television Society

BRITISH SOUND RECORDING ASSOCIATION

Date: October 24. Time: 7 p.m.
Held at: Royal Society of Arts, John Adam Street, London, W.C.2.
Lecture: 78, 45 and 33½ Records.
By: B. E. G. Mittel.

Portsmouth Centre
Date: October 16. Time: 7 p.m.
Held at: Council Chambers, Portsmouth.
Presidential Address.
By: H. Davies, M.Eng., M.I.E.E.
Annual exhibition and open evening (exhibition open from 5 p.m. to 10 p.m.).

THE INSTITUTION OF ELECTRICAL ENGINEERS

All London meetings, unless otherwise stated, will be held at the Institution, commencing at 5.30 p.m.

Date: October 9.
Inaugural Address.
By: Colonel B. H. Leeson, O.B.E., T.D.
Date: October 20.
Informal discussion: The Institution and Current Affairs.
Opened by: The President.

Radio Section
Date: October 15.
Chairman's Address.
By: E. C. S. Megaw, M.B.E., D.Sc.
Date: October 27.
Discussion: The Impact of Television on Sound Broadcasting.
Opened by: G. Parr, B.Sc.

Measurements Section
Date: October 21.
Chairman's Address.
By: L. Hartshorn, D.Sc.

Cambridge Radio Group
Date: October 14. Time: 6 p.m.
Held at: The Cambridgeshire Technical College.
Chairman's Address.
By: K. N. Hawke, B.Sc.

Merseyside and North Wales Centre
Date: October 6. Time: 6.30 p.m.
Held at: Liverpool Royal Institution, Colquitt Street, Liverpool.
Chairman's Address.
By: W. A. Hatch, M.B.E.

North-Eastern Centre
Date: October 13. Time: 6.15 p.m.
Held at: Neville Hall, Westgate Road, Newcastle-on-Tyne.
Chairman's Address.
By: H. Leyburn, B.Sc.(Eng.).

North-Eastern Radio and Measurements Group
Date: October 20. Time: 6.15 p.m.
Held at: King's College, Newcastle-on-Tyne.
Chairman's Address.
By: D. R. Parsons.

North Midland Centre
Date: October 10. Time: 6.30 p.m.
Held at: British Electricity Authority offices, Yorkshire Division, 1 Whitehall Road, Leeds, 1.
Chairman's Address.
By: H. S. Moody, B.Sc.

North-Western Centre
Date: October 7. Time: 6.30 p.m.
Held at: The Engineers' Club, 17 Albert Square, Manchester, 2.
Chairman's Address.
By: J. Prince.

North-Western Measurements Group
Date: October 28. Time: 6.15 p.m.
Held at: The Engineers' Club, Albert Square, Manchester 2.
Lecture: Telemetering for System Operation.
By: R. H. Dunn, B.Sc., and C. H. Chambers.

North-Western Radio Group
Date: October 22. Time: 6.30 p.m.
Held at: The Engineers' Club, Albert Square, Manchester 2.
Discussion: What Practical Benefits can Communication Engineers Expect from the Modern Information Theory?
Opened by: E. C. Cherry, M.Sc.(Eng.).

Northern Ireland Centre
Date: October 14. Time: 6.45 p.m.
Held at: The Presbyterian Hostel, Howard Street, Belfast.
Chairman's Address.
By: H. Weston.

North Scottish Sub-Centre
Date: October 8. Time: 8 p.m.
Held at: The Caledonian Hotel, Aberdeen.
Chairman's Address.
By: L. B. Perkins, B.Sc.

South East Scotland Sub-Centre
Date: October 9. Time: 7 p.m.
Held at: The Royal Hotel, Dundee.
Chairman's Address.
By: L. B. Perkins, B.Sc.

South West Scotland Sub-Centre
Date: October 7. Time: 7 p.m.
Held at: The Institution of Engineers and Shipbuilders, 39 Elmbank Crescent, Glasgow.
Chairman's Address.
By: J. S. Hastie, B.Sc.(Eng.).

South Midland Centre
Date: October 6. Time: 6 p.m.
Held at: The Grand Hotel, Birmingham.
Chairman's Address.
By: K. R. Sturley, Ph.D., B.Sc.
Annual General Meeting and Conversation.
Date: October 21. Time: 7.15 p.m.
Held at: The Winter Gardens Restaurant, Malvern.
Lecture: The Magnetic Fluid Clutch.
By: E. J. R. Hardy, B.Sc.(Eng.).

South Midland Radio Group
Date: October 27. Time: 6 p.m.
Held at: The James Watt Memorial Institute, Great Charles Street, Birmingham.
Informal Lecture: Why Quantum Theory Matters to Engineers.
By: D. A. Bell, M.A., B.Sc.

Southern Centre
Date: October 1. Time: 6.30 p.m.
Held at: British Electricity House, 111 High Street, Portsmouth.
Chairman's Address.
By: C. J. Turnbull, R.N.

South-Western Sub-Centre
Date: October 8. Time: 6.30 p.m.
Held at: The Dorset Technical College, Weymouth.
Lecture: Illumination.
By: S. S. Beggs.

Western Centre
Date: October 10. Time: 7.30 p.m.
Held at: The R.A.E. College, Farnborough.
Lecture: Introduction to the Theory of Information.
By: J. E. Flood, Ph.D., and L. R. F. Harris.

West Wales (Swansea) Sub-Centre
Date: October 16. Time: 6 p.m.
Held at: The Central Public Library, Swansea.
Chairman's Address.
By: D. L. J. Powell, B.Sc.

West Midlands (Birmingham) Sub-Centre
Date: October 13. Time: 6 p.m.
Held at: The South Western Electricity Board Offices, Colston Avenue, Bristol.
Chairman's Address.
By: A. C. Warren, B.Sc.

West Midlands (Birmingham) Sub-Centre
Date: October 16. Time: 6 p.m.
Held at: The Central Public Library, Swansea.
Chairman's Address.
By: D. L. J. Powell, B.Sc.

Irish Branch

Date: October 16. Time: 6 p.m.
Held at: Trinity College, Dublin.
Chairman's Address.
By: P. J. Dowling, B.E., B.Sc.

District Meetings
(Other than those held in the area of a Local Centre)

Maidstone
Date: October 6. Time: 7.30 p.m.
Held at: "The Wig and Gown," Maidstone.
Lecture: The Development and Design of Electrical Control Gear for Machine Tools.
By: A. R. H. Thorne.

Norwich
Date: October 20. Time: 7.30 p.m.
Held at: The Royal Hotel, Norwich.
Lecture: Technical Colleges and Education for the Electrical Industry.
By: H. L. Haslegrave, M.S., Ph.D., M.Sc.(Eng.).

Oxford
Date: October 8. Time: 7.30 p.m.
Held at: The Southern Electricity Board, 37 George Street, Oxford.
Lecture: Short-Circuit Testing Technique.
By: J. G. P. Anderson, B.Sc.

THE INSTITUTION OF POST OFFICE ELECTRICAL ENGINEERS

Date: October 7. Time: 5 p.m.
Held at: The Institution of Electrical Engineers, Savoy Place, Victoria Embankment, London, W.C.2.
Chairman's Address: Engineering and the Postal Service.

Informal Meeting
Date: October 29. Time: 5 p.m.
Held at: The Conference Room, 4th Floor, Waterloo Bridge House, S.E.1.
Vice-Chairman's Address: Some Aspects of Local Line Utilization.

THE PHYSICAL SOCIETY

Date: October 3. Time: 5 p.m.
Rutherford Lecture: The Atomic Nucleus and its Constituents.
By: Professor R. E. Peierls.

Date: October 29. Time: 5 p.m.
Lecture: The Stationary Waves in the Space Lattice of Crystals and their Experimental Proof.
By: Professor M. von Laue.

Acoustics Group
Date: October 13. Time: 5 p.m.
Held at: The Science Museum, London, S.W.7.
Lecture: The American Acoustical Scene.
By: A. T. Pickles.

Colour Group
Date: October 15. Time: 3.30 p.m.
Held at: The Institute of Ophthalmology, Judd Street, London, W.C.1.
Lecture: Colour Vision in the Central Peripheral Parts of the Retina.
By: Dr. E. N. Willmer and R. A. Weale.

Low Temperature Group
Date: October 16. Time: 5.30 p.m.
Held at: The Science Museum, London, S.W.7.
Lecture: Compressor Design and Characteristics.
By: Dr. A. J. Barnard.

PRESENTATION OF TECHNICAL INFORMATION DISCUSSION GROUP

Date: October 21. Time: 6 p.m.
Held at: University College, Gower Street, London, W.C.1.
Lecture: Colour Correction by Photographic Means.
By: F. Smith.

THE RADAR ASSOCIATION

Date: October 7. Time: 7.30 p.m.
Held at: The Bedford Corner Hotel, Bedford Square, London, W.1.
Radar Film Show.

SOCIETY OF RELAY ENGINEERS

Date: October 7. Time: 2.30 p.m.
Held at: 21 Bloomsbury Street, London, W.C.1.
Lecture: Television Wire Broadcasting—P.O. Testing of Licensed Systems.
By: C. F. W. Hawkins and G. H. Barlow.

THE TELEVISION SOCIETY

Main Society
Date: October 1. Time: 7 p.m.
Held at: The G.B. Theatre, Film House, Wardour Street, London, W.1.
Lecture: The Viewing of Moving Pictures.
By: W. D. Wright, A.R.C.S., D.Sc.

Date: October 24. Time: 7 p.m.
Held at: The C.E.A., 164 Shaftesbury Avenue, London, W.C.2.
Lecture: The Birth of a High Definition Television System.
By: S. J. Preston, M.A., A.M.I.E.E.

ELLIOTT BROTHERS (LONDON) LTD . . . established 1800,
 pioneers in Electrical Instrumentation, emphasise their lead with a
 range of microwave instruments which are the first of their type
 in this country

ELLIOTT

MICROWAVE INSTRUMENTS

for the 3.2 cm. and 8-9 mm. wavebands



ROTARY ATTENUATOR

8-9 mm. WAVEBAND

The Rotary Attenuator is designed to provide a variable attenuation which has the same law over a wide frequency band, the bandwidth being limited by the waveguide characteristics. Transmission phase is not disturbed by change of attenuator setting. The voltage standing wave ratio is 0.95 or better. The instrument is supplied with a calibration chart.

The attenuator consists of three sections of circular waveguide with rectangular to circular taper sections at either end. Each circular section contains a nichrome-coated glass vane which absorbs all the power in a wave polarised with its electric vector parallel with the plane of the vane. The two outer vanes are fixed and have their planes parallel with the broad faces of the waveguide, while the centre vane is rotatable and is attached to a scale which indicates its angle of rotation. A rotary attenuator for the 3.2 cm. waveband is also available.



MATCHED LOADS

3.2 cm. WAVEBAND

Designed for low power applications, this load consists of a pair of nichrome-coated glass vanes mounted in a length of selected waveguide. The voltage standing wave ratio set up by the absorbing vanes is not greater than 0.995 over a 12 per cent band centred on a wavelength of 3.2 cms. Provided that the load is coupled to a waveguide correct to nominal size within ± 0.0005 in., the voltage standing wave ratio set up by the flange coupling is not greater than 0.997. The position of the load element in the waveguide is adjustable through a distance of about a wavelength.

8-9 mm. WAVEBAND

This load is designed for lower power applications. The voltage standing wave ratio is not greater than 0.995 over a 10 per cent band in the waveband 8-9 mm. Provided the load is coupled to a waveguide, within ± 0.0002 in. of nominal size (i.e., the standard tolerances for electroformed waveguide) the voltage standing wave ratio set up by the flange coupling is not greater than 0.997. The position of the load element in the waveguide is adjustable through a distance of about a wavelength.

MICROWAVE PHASE AND IMPEDANCE PLOTTERS

To speed up the measurement of waveguide impedance, instruments have been developed for the direct measurement of transmission or reflexion coefficient of a waveguide component. For rapid assessment of component performance the transmission or reflexion coefficient is displayed on a cathode-ray tube in polar co-ordinates as the frequency is swept over a band, a Smith Chart being superimposed for reflexion measurements. More accurate

measurement is possible when not sweeping in frequency and, since the r.f. signal is heterodyned down to 200 c/s, comparison with low frequency standards is possible. This enables microwave attenuators to be calibrated against a standard decade resistance box.

For aerial work the phase and amplitude across the near field are plotted automatically on chart recorders.

For further information, write for leaflets MW.2 and MW.3

ELLIOTT BROTHERS (LONDON) LTD., CENTURY WORKS, LEWISHAM, LONDON, S.E.13. TIDeway 3232

Presenting . . .

The



Miniature H Type Switch

A MINIATURIZED version of the well-known A.B. 'H' Type Switch.

The same utter reliability that has made its big brother famous is engineered into this switch and its complete flexibility of application makes it a "must" in equipment where space is at a premium.

Early deliveries can be given and we cordially invite your enquiries



Metal Products Ltd

16, BERKELEY STREET, LONDON, W.1.

*Phone : Grosvenor 5206/7

FINE GAUGE—LONG LENGTHS

Nickel Chrome RESISTANCE WIRES

Although the spider may have pioneered the production of a fine gauge strand of continuous length we have added refinements of our own. Our speciality is Resistance Wire manufactured in long lengths to reduce your operational changes. Our normal range covers gauges down to 50 s.w.g. to customers' specifications, but even finer gauges, equally consistent in uniformity and accuracy, are available on application.

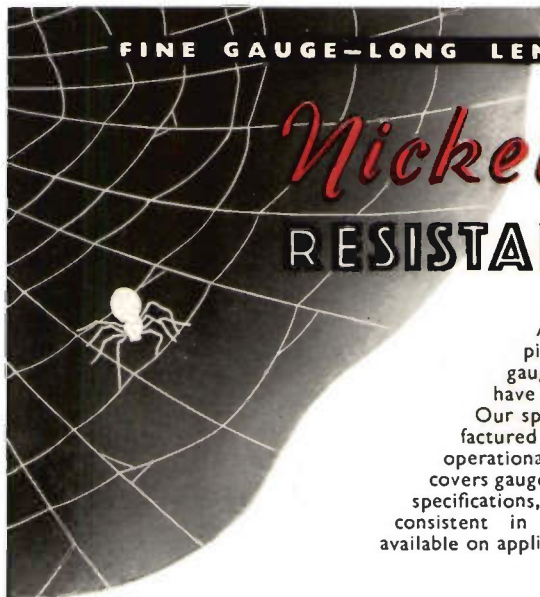

LONDON AGENT : Cotsil, Ltd.,
80 Mortimer St., London, W.1.
Telephone : Langham 1071/2.

Cromaloy V

FOR CONSISTENCY

A. C. SCOTT & CO. LTD., CROMALOY HOUSE, CITY RD., MANCHESTER

dim AS 13

"DECALS"

Invaluable in the laboratory and for small scale production. Available in book form each book containing approx. 500 assorted words, or the equivalent in letters and numerals. All characters are in white, 1/8 in. high.

In order to give a comprehensive coverage of modern electronic equipment, individual pages have been devoted to various specialised subjects as follows

1. Audio engineering and communications equipment.
2. Television equipment and oscilloscopes.
3. Radar and navigational equipment.
4. Other electronic equipment, not already covered.
5. Units of quantity and some general terms.
6. Letters and numerals.

Individual pages obtainable separately.

Some outstanding advantages

Very cheap, can be applied to equipment at any location without instruments or machinery. Can be removed when the function of a control is changed. Long lasting. Approved for use on service equipment.

PRICE PER BOOK **4/9** (postage 3d.)

ALEXANDER EQUIPMENT LIMITED

Child's Place, Earl's Court, London, S.W.5

FRObisher 6762

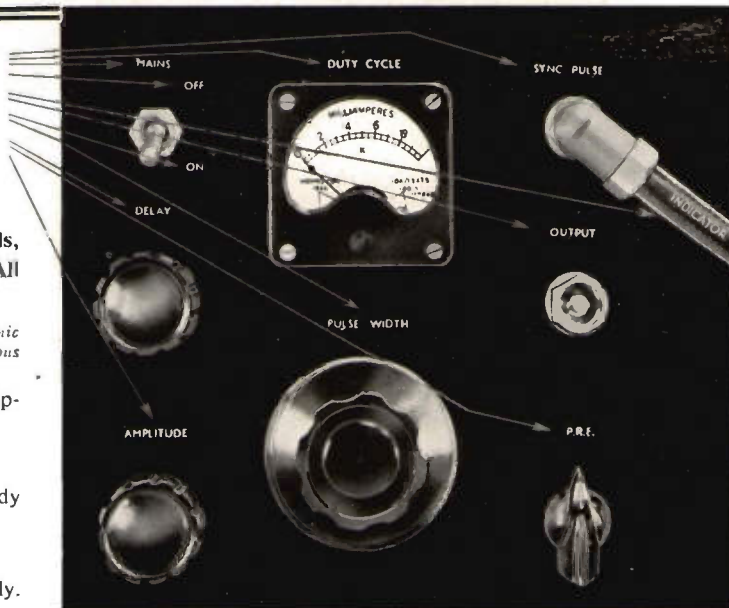

Standard

push button
ATTENUATOR



for true **V.H.F.** measurements

This outstanding "Standard" V.H.F. Attenuator now in its second year of production remains the first and only accurate instrument of its kind and continues to meet a heavy demand from leading organisations and authorities the world over.

Four models now available

Characteristic Impedance	75 ohms	50 ohms
0-9 db in 1db steps	Type 74600-A	Type 74600-E
0-90 db in 10 db steps	Type 74600-B	Type 74600-F

All types will handle inputs up to 0.25 watts.

Accuracy of D.C. adjustment

0-9 db Models: The insertion loss error will not exceed ± 0.05 db for any setting.
0-90 db Models: The insertion loss error for the 90 db setting will not exceed $+ 0.3$ db. For other settings this limit falls linearly to a value of $+0.06$ db at the 10 db setting.

High frequency performance

0-9 db Models: At 50 Mc/s the insertion loss error for the 9 db setting will not exceed ± 0.15 db. For other settings this limit falls linearly to a value of ± 0.05 db for the 1 db setting.
0-90 db Models: At 50 Mc/s the insertion loss error will not exceed ± 0.1 db per step.
N.B. All insertion loss errors are relative to zero db setting.

Ready for Building into your own equipment.

Calibration charts for frequencies up to 100 Mc/s for the 0-9 db models or 65 Mc/s for the 0-90 db models can be supplied on request.



Standard Telephones and Cables Limited

Registered Office: Connaught House, Aldwych, London, W.C.2

TRANSMISSION DIVISION, NORTH WOOLWICH, LONDON, E16

A VOLTMETER PLUS



these

**outstanding
features**

- ★ Measures 1mV to 100V.
- ★ Frequency range
10 c/s to 0.5 Mc/s
- ★ Logarithmic voltage
scale.
- ★ Linear dB scale.
- ★ Constant reading
accuracy.
- ★ 2 Megohm input
impedance.
- ★ Null indication down
to 100 microvolts.
- ★ No set zero required.
- ★ Rugged construction.
- ★ Amplifier can be used
separately.
- ★ PROMPT DELIVERY.

Developed — as is the rest of the Furzehill range of instruments — by engineers, for engineers, this 378 B/2 has proved its value over and over.

Write for full particulars.

FURZEHILL LABORATORIES LTD.

BOREHAM WOOD — HERTS — ELSTREE 3940

THE LABORATORY MODEL 50 WATT AMPLIFIER

(Suitable for vibration analysis, ultrasonics, etc.)

The latest form of this amplifier has a power output exceeding 50 watts over all the frequency range 10 c.p.s., to 35,000 c.p.s., and reduced power above and below these frequencies.

The standard output is 3.75 and 15 ohms impedance with heavy tertiary feedback which can be changed to voice coil for the 15 ohm balanced output if required. Other impedances within reasonable limits can be supplied to order.

Special versions of this model can be supplied for frequencies up to and exceeding 120 KC's with slightly restricted low frequency end.

The standard finish is in a well ventilated steel case, or rack mounted to special order on 10½ in. panel.

Measurements 22 in. x 18½ in. x 16 in.

Weight 61½ lbs.

Manufactured by :

VORTEXION LIMITED

257-263, THE BROADWAY, WIMBLEDON, LONDON, S.W., 19

Phones : LIBERTY 2814 & 6242-3.

Grams : "VORTEXION, WIMBLE, LONDON."

3 industrial valves from a large range

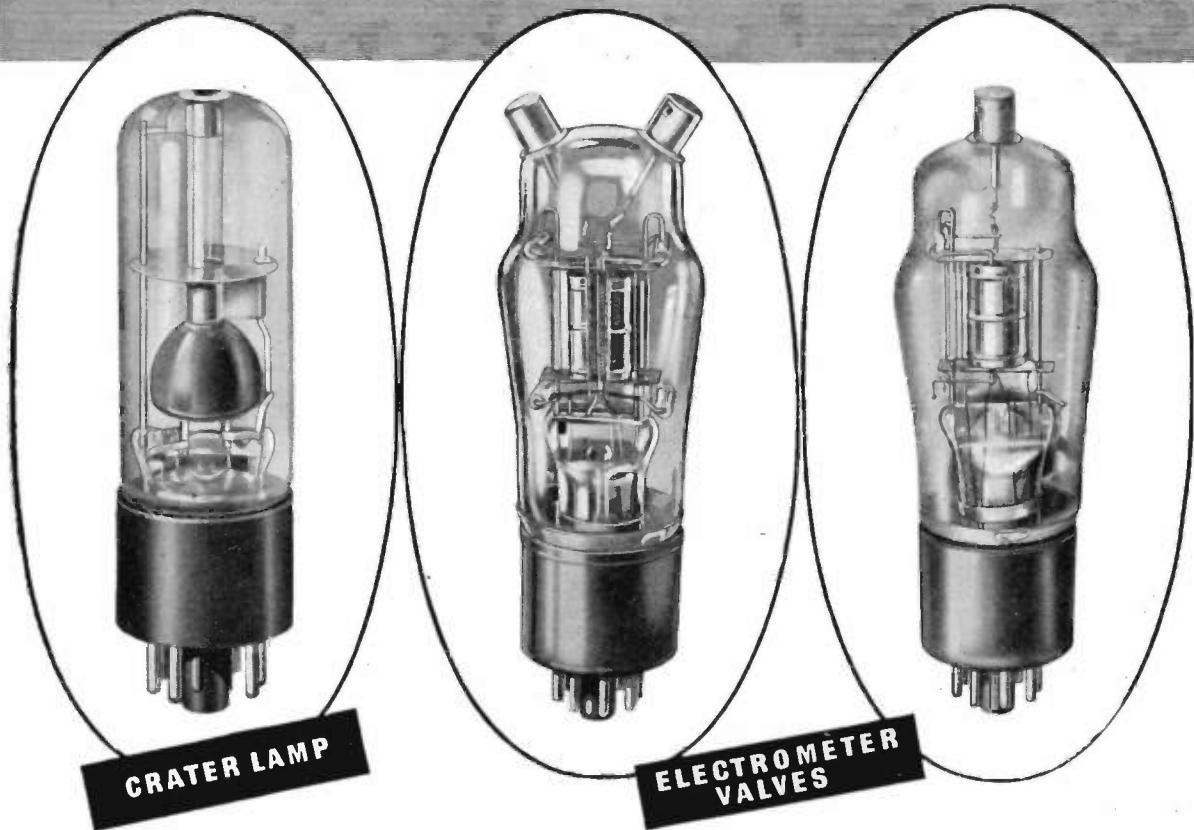

The Electronics Department of Ferranti Ltd. manufactures an extensive range of indirectly heated single and double tetrode electrometer valves with control grid currents ranging from 30×10^{-14} amps to better than 3×10^{-14} amps.

Illustrated here (centre and right)

are two examples of Electrometer valves and (left) a Crater lamp, which gives a light output proportionate to the anode current. Ferranti specialize in the manufacture of industrial valves to suit a wide diversity of needs.

Let us send you more details.

Ferranti Ltd.

ELECTRONICS DEPARTMENT MOSTON MANCHESTER 10



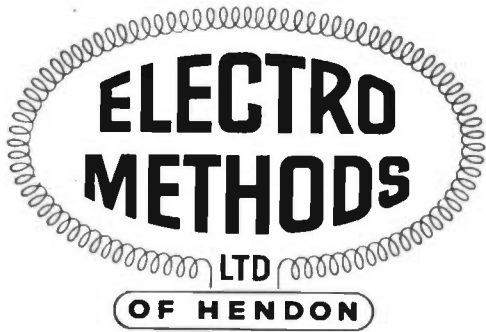

**—the first name for
precision
RELAYS**

GENERAL-PURPOSE : TIME-DELAY
MERCURY : HEAVY-DUTY

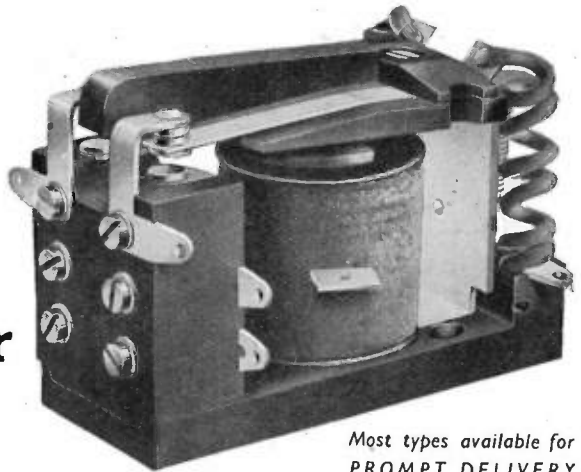

*Most types available for
PROMPT DELIVERY*

Complete technical data of our extensive range of standard relays will be forwarded on request. The unrivalled experience of our technicians is at all times at your disposal.

If you have a relay problem it will pay you to consult us.

.....
ELECTRO METHODS LTD., Division RI,
THE VALE, LONDON, N.W.11. : Telephone GLAdstone 6611

SPECIALISTS IN THE MANUFACTURE OF RELAYS, THERMOSTATS, MAGNETIC AMPLIFIER

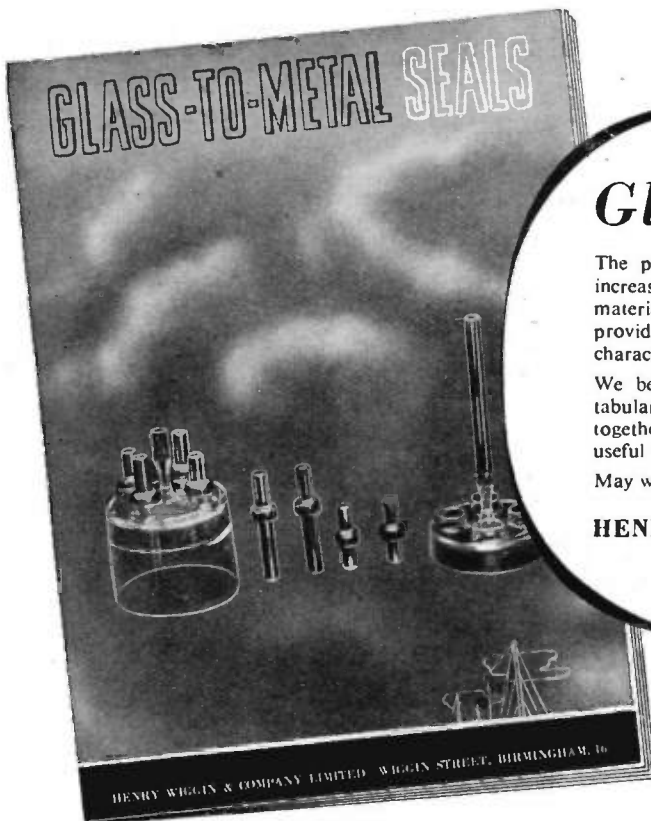

Glass-to-metal Seals

The present abnormal conditions of supply have placed increased emphasis on the correct choice of constructional materials. As an example, the Nilo range of nickel-iron alloys provides a range of compositions each having distinctive characteristics and developed to meet a specific requirement.

We believe that our revised publication, which includes tabular data on the properties of the various grades of alloy, together with examples of their industrial use, will prove a useful guide to the selection of the correct grade of material.

May we send you a copy?

HENRY WIGGIN & COMPANY LIMITED

Wiggin Street, Birmingham 16

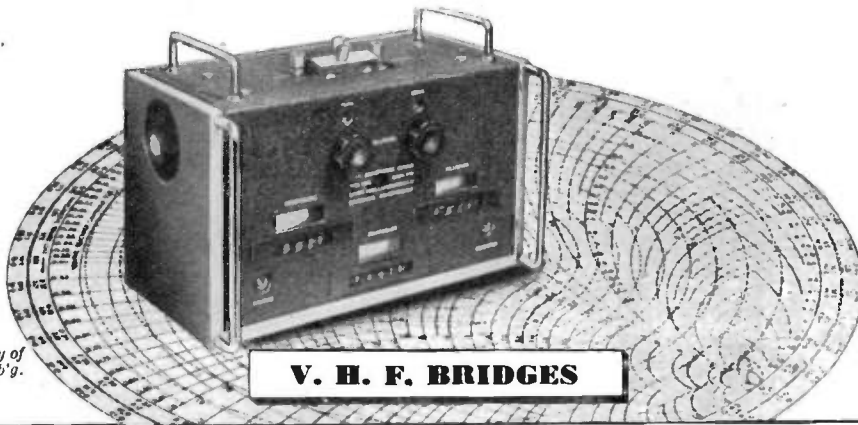
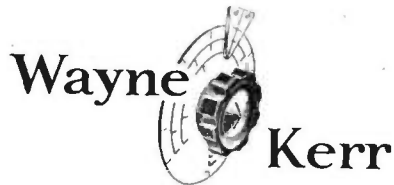

Diagram by courtesy of
McGraw Hill Pub'g.
Co. Inc.

V. H. F. BRIDGES

for balanced and unbalanced measurement at frequencies between 1 Mc/s and 250 Mc/s.



THE WAYNE KERR LABORATORIES LIMITED, NEW MALDEN, SURREY. PHONE: MALDEN 2202

Ceramic stand-off Insulators

by
U.I.C.

UNITED INSULATOR CO. LTD. OAKCROFT RD. TOLWORTH · SURBITON · SURREY
TELEPHONE: ELMBRIDGE 5241
CABLES: CALANEL, SURBITON

TUBES & SECTIONS

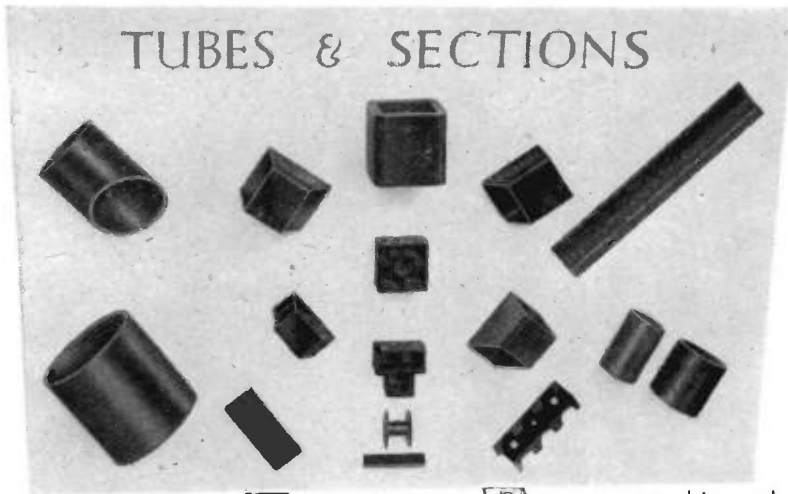

**Here's
the
answer . . .**

to your manufacturing problem: you require Components to resist moisture and corrosion, to be light and strong, resilient and sound proof

Our laminated tubes & sections combine these characteristics with high dielectric properties and low price.

• Our technical service will gladly co-operate and advise.



Resinoid & Mica Products Ltd.

COLONIAL WORKS
MARY ST · BALSALL HEATH
BIRMINGHAM 12
Tel.: CALTHORPE 1303

28 QUEEN ANNE'S GATE
WESTMINSTER
LONDON S.W.1
Tel.: WHITEHALL 8892

WESTERN HOUSE
MIDLAND ROAD
BRISTOL 2
Tel.: BRISTOL 22906

L 3520 D

G.E.C. SELENIUM RECTIFIERS

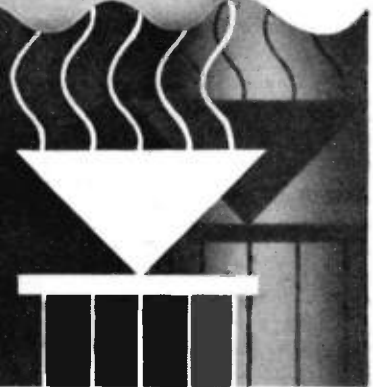
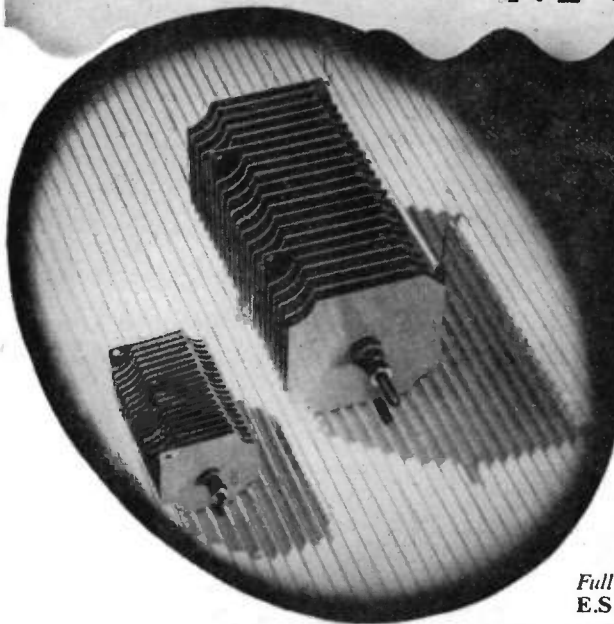

G.E.C. Selenium Rectifiers are ideal for all applications where a D.C. power supply is to be provided from an A.C. source. They are designed and rated for long life and reliable operation, have high operating efficiency and are economical in first cost. A comprehensive range is available for output currents from a few mill-amps. to thousands of amps.

Full particulars available on application to:
E.S.V. Dept., Magnet House, Kingsway, London, W.C.2.,
or the address below:

SALFORD ELECTRICAL INSTRUMENTS LTD · SALFORD 3 · LANCS

A SUBSIDIARY OF THE GENERAL ELECTRIC CO. LTD. OF ENGLAND

FOR HIGH FIDELITY RECORDINGS



Careful design and rigid control in manufacture, provide the critical listener with a reliable hard-wearing tape that will help to get the very best results from any tape recorder.



MAGNETIC DATA

Coercivity 240-260 Oersteds
 Total Remanent Flux . . . 0.4/0.5 lines $\frac{1}{4}$ in. width
 Uniformity throughout a reel ± 0.5 d.b.

FREQUENCY RANGE

50 c/s to 10 Kc/s at a playing speed of $7\frac{1}{2}$ in./sec.

Medium coercivity gives a high signal output with an extended high-frequency response, whilst still retaining an easy erasure. Signal/noise ratio is high; transfer and distortion are negligible.

PLAYING TIMES (per track)

REELS	1 $\frac{1}{2}$ " / SEC	3 $\frac{1}{4}$ " / SEC	7 $\frac{1}{2}$ " / SEC	15" / SEC
1200 Ft.	120 Min.	60 Min.	30 Min.	15 Min.
600 Ft.	60 Min.	30 Min.	15 Min.	7 $\frac{1}{2}$ Min.
300 Ft.	30 Min.	15 Min.	7 $\frac{1}{2}$ Min.	3 $\frac{1}{2}$ Min.

If you want advice on tape-recording problems, our entire technical knowledge is at your disposal. Write to :— MINNESOTA MINING & MANUFACTURING CO. LTD., 167 Strand, London, W.C.2. Telephone: TEMple Bar 6363

2,400 ft. professional reels (10 $\frac{1}{2}$ " diameter double sided spools) now available

Write to :— MINNESOTA MINING & MANUFACTURING CO. LTD., 167 Strand, London, W.C.2. Telephone: TEMple Bar 6363



Manufacturers of Ammeters, Voltmeters, Ohmmeters, Wattmeters and frequency meters for switchboard or portable use.

MULTI-RANGE TEST SET SERIES 100

The universal testing set for Service Engineers. Sensitivity—10,000 ohms per volt. Strong metal case with carrying handle, complete with leads having detachable bulldog clips and test prods. Size 9 x 5 $\frac{1}{2}$ x 4 ins.

MEASURING INSTRUMENTS (PULLIN) LTD.
 ElectrIn Works, Winchester St., London, W.3
 Tel.: ACOrn 4651/3 & 4995.



RANGES

AC/DC VOLTS: 10, 25, 100, 250, 500, 1,000.

DC. MILLIAMPS 2.5, 10, 25, 100, 500.

AC/DC MICROAMPS: 100 Microamps 10v range.

RESISTANCE RANGES: 0/1 Meg (13,500 ohms mid-scale) 0/10,000 ohms (135 ohms mid-scale).



PERMANENT MAGNETS

A COMPLETE SERVICE —
ADVISORY AND SUPPLY —
FOR SPECIALISED INDUSTRIES

The most efficient method of using the high energy Permanent Magnet materials in the manufacture of Loud Speakers is shown in this illustration.



DARWINS LTD

TINSLEY · SHEFFIELD · 9

D27/A.



ACCLAIMED THE WORLD OVER



Throughout the Years the name of Garrard has reigned supreme in the production of Turntable Units of unsurpassed quality. Dealers can unhesitatingly recommend instruments fitted with Garrard Three-speed Self Changing Units.

STRAIN makes its mark...



The equipment comprises three Units. The Oscillators and Power Supply Unit, the Bridge and Amplifier Unit, and that shown, the Recording Unit.

KELVIN HUGHES

Four pen dynamic Strain Recorders

Employing four pick-off devices and recording their output simultaneously, the Kelvin Hughes Strain Recorder gives valuable information on the behaviour of a structure or a machine under conditions of dynamic loading. Resistance wire strain gauges, capacitance-change and inductance-change devices such as accelerometer pick-up systems may be used independently in each channel. Sensitivity is such that full-scale deflection for a 200 pF capacity pick-up is given for a change of approximately 1 pF, while with a 2000 ohms resistance gauge, full-scale deflection is obtained for about 0.006% change of resistance. Single channel instruments are also available.



KELVIN HUGHES PRECISION INSTRUMENTS

Why not write for further details?

KELVIN & HUGHES (INDUSTRIAL) LIMITED, 2, CAXTON STREET, LONDON, S.W.1

It's all plain
sailing at
G·G·L

Modern machinery and methods keep capstan and automatic productions and sheet metal pressings flowing to you on time, at a price you will like.

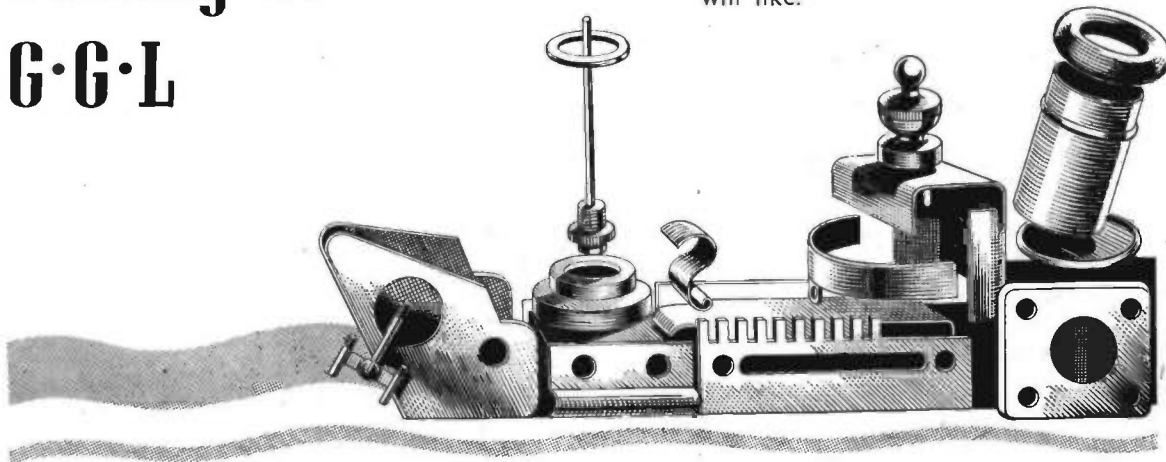

GRIFFITHS, GILBART, LLOYD & CO., LTD.,

EMPIRE WORKS

PARK ROAD

BIRMINGHAM 18

Tel.: NORthern 2132/4.



FERROXCUBE

FERROMAGNETIC FERRITE

FOR TELEVISION

THE improvement in television components, with their smaller size and greater efficiency, is largely due to Ferroxcube, the new Mullard magnetic core material.

The uses of Mullard Ferroxcube in the production of TV components fall into these three main groups:

LINE OUTPUT TRANSFORMER CORES

Since the advent of wide-angle television tubes, with the accompanying demand for increased E.H.T. supplies, the need for line output transformers of the highest possible efficiency has been greater than ever. Mullard Ferroxcube, with its low iron losses, completely fulfils this need — also facilitating the assembly of small, compact transformer units by means of solid, non-laminated U-shape cores.

DEFLECTION COIL YOKES

Mullard Ferroxcube cores in ring form are ideal for producing the magnetic circuit around deflection coils. Used in this way, Mullard Ferroxcube makes possible the construction of efficient deflector coils with a high Q factor. In order to simplify assembly problems, these ring cores are supplied either in the form of a complete circle, as two semi-circles, or as castellated yokes.

LINEARITY AND PICTURE WIDTH CONTROLS

Mullard Ferroxcube can very conveniently be extruded into rods and tubes. In this form it is ideal for use in linearity and picture width controls, providing a smooth control in a compact assembly.

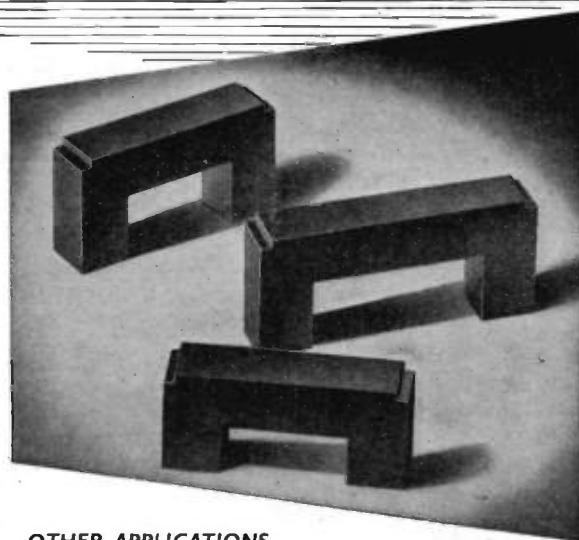

OTHER APPLICATIONS

In addition to its uses in television receivers, Mullard Ferroxcube is also being widely employed in line communications, radar, and other specialised electronic equipments. The purposes for which it is already being most successfully applied in such equipments include filter networks, wide band transformers, magnetic amplifiers, and pulse transformers.

PLEASE WRITE FOR FULL DETAILS



Mullard FERROXCUBE

FERROMAGNETIC FERRITE

MULLARD LIMITED · CENTURY HOUSE · SHAFESBURY AVENUE · LONDON · W.C.1
(MF376)

ALL-POWER

REGULATED POWER SUPPLIES

Semi-standard designs are available covering output voltages from 0.1 to 2,000 volts and output currents from 1mA to 10 amps.

Special Units can be made to any Specification, and although the demand for our products is continually increasing we can still offer reasonably prompt delivery.



ALL-POWER TRANSFORMERS LTD.

CHERTSEY ROAD, BYFLEET, SURREY.

TEL: BYFLEET 3224.

ALWAYS "FIT"



CASTORS

THE WORLD'S BEST

Loads up to **30 TONS** per castor. Wheel diameters from 2" to 44". All types of wheels and head fittings can be selected from our range of over

7,000 TYPES & SIZES

ASK FOR BROCHURE

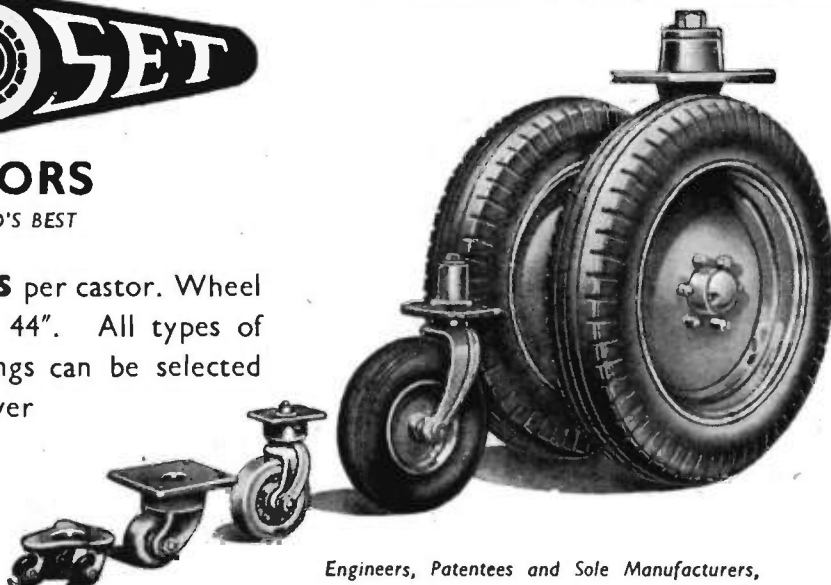

Engineers, Patentees and Sole Manufacturers,

AUTOSET (PRODUCTION) LTD., Dept. O, Stour St., B'ham 18

EST. OVER 30 YEARS.

EDG 1143/4

Please mention "Electronic Engineering"

AT2

26 Standard Models

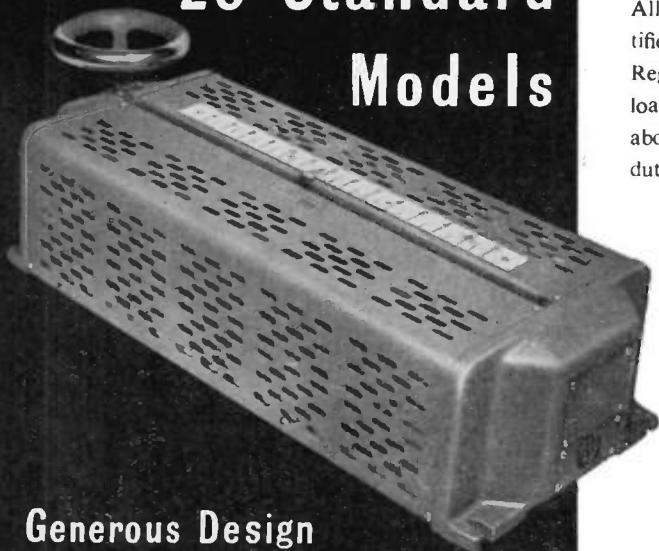

Generous Design
Robust Construction
Rugged Self-lubricating Brushes

All types of A.C. apparatus—motors, furnaces, rectifiers, transformers—can be controlled by a single Regavolt whose output can be set, regardless of the load current, precisely at any voltage from 0 to 30% above the supply. Its rugged design for heavy industrial duty ensures reliability under severe working conditions.

Special designs can be made for incorporation in your own apparatus in addition to the wide range of single, 3 phase, hand and motor driven models listed in our catalogue No. 3121.



REGAVOLT REGULATING TRANSFORMER

THE BRITISH ELECTRIC RESISTANCE CO. LTD.

Specialists in the control of current and voltage for more than 25 years.

Queensway, Ponders End, Middlesex

Telephone: HOWard 1492

Telegrams: Vitrohm, Enfield

BR. 3121

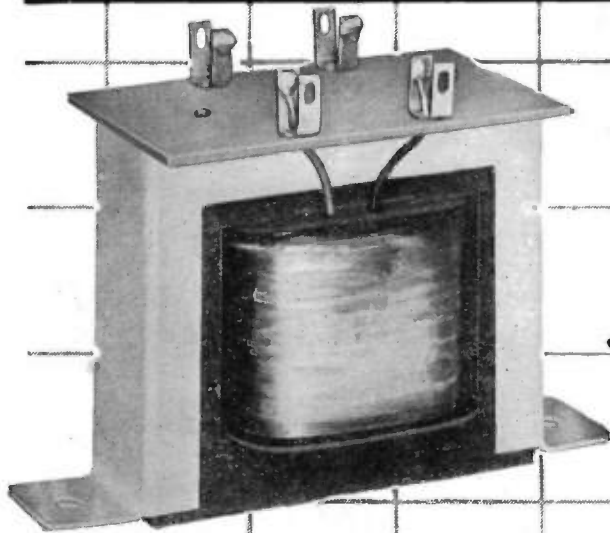

Are you using a transformer this size?



when this size might do the job



Miniaturization can simplify your production problems. Maybe it can widen your market too, by enabling selling costs to be reduced. If you are interested in Input, Output or Interval Transformers, or L.F. Chokes, between the sizes indicated, write for a copy of our comprehensive Brochure—Free and Post Free. Small or large quantities supplied at competitive prices.

Manufacturers of Miniaturized Electronic Instruments

JOHN BELL & CROYDEN

117 HIGH STREET, OXFORD

Telephone: Oxford 48362 & 47072

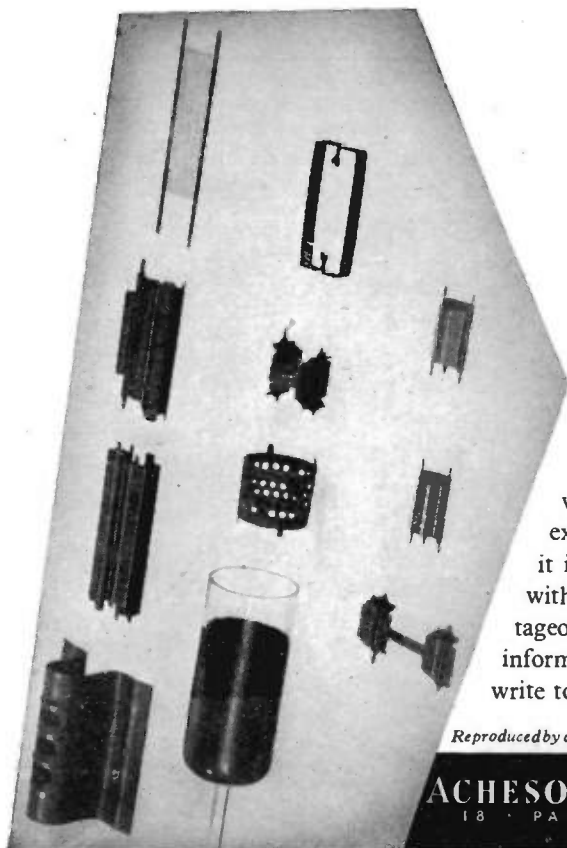

Secondary emission – and temperature – REDUCED

The film formed by 'dag' colloidal graphite is inert to electron bombardment and minimises secondary emission. These properties have led to the extensive use of 'dag' colloidal graphite for the treatment of valve grids and envelopes. The smooth graphite functions excellently as a 'black body'; therefore the substrate on which it is deposited is kept at a lower temperature than is the case with an untreated surface. The treatment is particularly advantageous when used on anodes. For full information on these and other applications write to Dept. D.18.

Reproduced by courtesy of The Edison Swan Electric Company Limited

ACHESON COLLOIDS LIMITED
18 · PALL MALL · LONDON · S.W.1



TAS/AC 6

**EVEN A miniature
DIFFUSION PUMP CAN OFTEN MULTIPLY
THE CAPACITY OF YOUR ROTARY PUMP !**



SPECIFICATION
MODEL 102(1) OIL
DIFFUSION PUMP
ULT. VACUUM:
 5×10^{-6} mm.Hg.
SPEED (baffled)
 7-8 litres/sec.
SPEED (unbaffled)
 9-10 litres/sec.
FLUID CHARGE 10ml.

The addition of an EDWARDS 1 in. oil or mercury inexpensive diffusion pump will provide a vacuum better than 10^{-6} mm. Hg and the unlimited scope of a high vacuum system . . . an invaluable aid where industrial research and pilot experiments are being conducted on a small scale.

Let us know what vacuum equipment you have available and we will gladly advise you on the best combinations and techniques.

for better vacuum service . . .

W. EDWARDS

& CO. (LONDON) LTD., LONDON, S.E.26

Phone: Sydenham 7026 (8 lines) Grams: Edcohivac, Souphone London

Goodmans Industries Ltd

*apologise for the delay in the past but
are pleased to announce that supplies of the*

AXIOM 150

MARK II

12 inch 15 watt P.M. LOUDSPEAKER

are available for immediate delivery

The very much improved acoustic properties of this the latest in the famous of Axiom High Fidelity Loudspeakers command the admiration of all those who require quality and value in a speaker.

This high fidelity reproducer gives extremely smooth response in the middle and upper registers, ensuring minimum "scratch" from recordings. On most inputs this shows to advantage no matter what the origin.

In addition the Axiom 150 Mk. II has a wide frequency range and the very low bass resonance ensures faithful reproduction down to the lowest frequency encountered in orchestral reproduction. This new AXIOM is a marked advance on past models and is suitable for use with all good quality amplifiers.

You are invited to write for details of the Axiom 150 Mk. II and the special reflex cabinets designed with speaker aperture at optimum listening height.



SPECIFICATION

Frequency Coverage	...	30/15,000 c.p.s.
Overall Diameter	...	12 1/4" (31.3 cms)
Overall Depth	...	6 3/8" (17.6 cms)
Fundamental Resonance	...	35 c.p.s. (nominal)
Voice Coil Diameter	...	1 1/2" (4.4 cms)
Voice Coil Impedance	...	15 ohms at 400 c.p.s.
Max. Power Capacity	...	15 watts peak A.C.
Flux Density	...	14,000 gauss
Total Flux	...	158,000 maxwells
Nett Weight	...	12 lbs. 13 ozs.



GOODMANS

GOODMANS INDUSTRIES LTD., AXIOM WORKS, WEMBLEY, MIDD. WEMBLEY 1200

The De Luxe Home Built TELEVISOR and RADIOGRAM

By W. I. FLACK, M.I.R.E., Fellow of the Television Society

Price 6/6

This booklet gives all the details necessary for the building of a comprehensive home entertainer incorporating a Televisor and a three wave-band radio-gramophone.

The design of the De Luxe Televisor is based on the well known "Electronic Engineering" Home-Built Televisor and this booklet enables the earlier version to be modified to the De Luxe model which uses all the latest circuit techniques and refinements.

Order your copy through your Bookseller or direct from:—

Electronic Engineering

28 ESSEX STREET, STRAND, LONDON, W.C.2.

AN ULTRASONIC SOLDERING IRON

*Can be used for soldering
aluminium, and other metals
that form refractory oxides*

THE problem of soldering metals that form refractory oxides has now been overcome.

A new soldering iron, developed by Mullard Ltd., destroys oxide film by ultrasonic stimulation and provides a "clean" metallic surface.

This means that perfect soldering of aluminium, and other metals, can now be achieved without scraping or brushing molten metals. Standard soft solders can be used. And no flux is needed.

A small electronic amplifier supplies the ultrasonic power. Two controls, a mains and a trigger switch, ensure simplicity of operation. Unskilled workers can use the apparatus without discomfort, since the ultrasonic

frequency used is inaudible to the human ear. Full information about the Mullard Ultrasonic Soldering Iron—the only commercial model in the world—is available on request.



The soldering iron has a nickel silver bit driven by a magnetostriction transducer. The transducer is arranged to run at its natural resonant frequency by a feed-back system. A conventional low voltage winding heats the soldering bit.



The Mullard Ultrasonic Soldering Iron and Amplifier. The unit operates from A.C. mains and is robustly made to suit workshop conditions.

Mullard

CONDUCTIVITY EQUIPMENT · POTENTIOMETRIC
TITRATION APPARATUS · ELECTRONIC POLARO-
GRAPHS · TEMPERATURE CONTROLLERS · UNIVERSAL
MEASURING BRIDGES · VALVE VOLTMETERS
P.M. SIGNAL GENERATORS · OSCILLOSCOPE

NORTHERN AGENT: F. C. Robinson & Partners, Ltd., 287, Deansgate, Manchester, 3
SCOTTISH AGENT: Land, Speight & Co. Ltd., 73, Robertson Street, Glasgow. C.2.

Mullard Ltd., Equipment Division, Century House, Shaftesbury Avenue,
London, W.C.2. Telephone: GERrard 7777



FORTIPHONE HEARING AID

Actual size

*uses MUREX
Sintered Permanent
MAGNETS*

Maximum magnetic energy in a limited area is required to ensure the efficient operation of this Hearing Aid receiver, and a Murex Alcomax III Sintered Permanent Magnet is used to provide these conditions. Efficiency and stability are distinguishing features of Murex Sintered Magnets.

MUREX LIMITED • (Powder Metallurgy Division)

RAINHAM · ESSEX Telephone: RAINHAM ESSEX 3322

London Sales Office: Central House, Upper Woburn Place, W.C.1. EUSton 8265

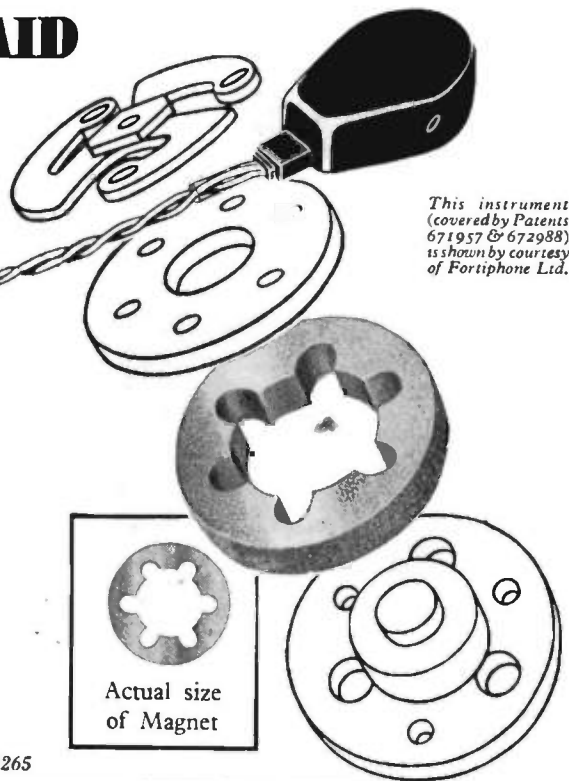

This instrument (covered by Patents 671957 & 672988) is shown by courtesy of Fortiphone Ltd.

Extra High Gain, Extra Wide Band —

Four Nagard Amplifiers recently developed are available either as separate units or for use with Nagard Oscilloscopes.

Extra high gain makes these instruments of especial interest to physiological, chemical and stress research workers, the exceptional band width being of great assistance in measurements of vibration, supersonic and high frequencies. High-speed rise time is provided for pulse display.

D.C. AMPLIFIERS

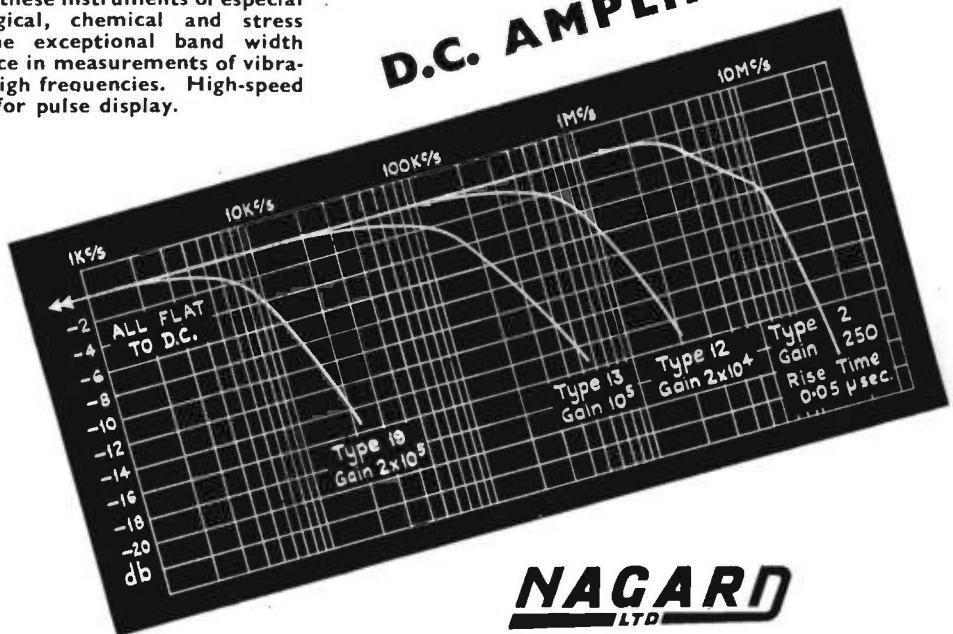

A special low capacity probe attachment is available for use with amplifier Model 103/2, input capacity of the probe being less than 3 μ F.

NAGARD
LTD

See what you measure!

18, Avenue Road, Belmont, Surrey.

VIGilant 0345

Redifon . . .

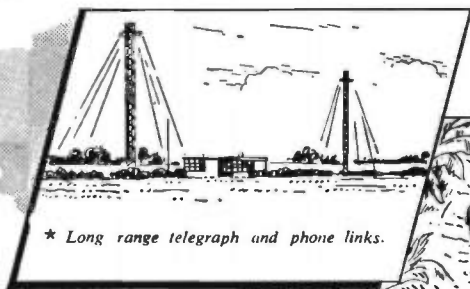

* Long range telegraph and phone links.



* Colonial Services.
Fixed and mobile stations.

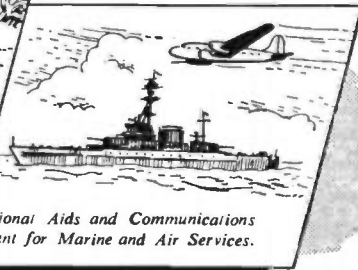

* Navigational Aids and Communications
Equipment for Marine and Air Services.

spans the world

REDIFON LIMITED, Broomhill Road, London, S.W.18.

Designers & Manufacturers of Radio Communications & Industrial Electronic Equipment. Phone: VANdyke 7281.

Delco Power for AIRCRAFT

As a contribution to the rearmament programme GENERAL MOTORS LIMITED have made arrangements for DELCO motors for the Aircraft Industry and other special purposes to be manufactured at the FRIGIDAIRE DIVISION.

The Delco range of British-made motors, generators, rotary transformers etc. for aircraft is designed to provide power for a wide variety of ancillary equipment including electronic control gear and radio.

Design approval is held from the Ministry of Supply Director of Instrument Research and Development, for D.C. Aircraft Electric Motors.

Available motors include totally enclosed, fan ventilated flame-proof and immersed types built to meet users' requirements and the relevant M.O.S. specifications. All motors achieve maximum output with minimum weight and many variations of standard designs are regularly manufactured to meet individual demands.

All enquiries for

DELCO

Reg'd Trade Mark

AIRCRAFT MOTORS

To FRIGIDAIRE DIVISION OF GENERAL MOTORS LIMITED
STAG LANE · KINGSBURY · LONDON N.W.9 · Colindale 6541

some typical applications . . .

- ★ SERVO DEVICES
- ★ FUEL PUMPS
- ★ GUN TURRET MECHANISM
- ★ BLOWERS
- ★ SCANNER DRIVES
- ★ DE-ICING EQUIPMENT
- ★ FOLLOWER DEVICES
- ★ HYDRAULIC PUMP DRIVES
- ★ VENTILATING FANS
- ★ CAMERA DRIVES
- ★ FLAP OPERATORS
- ★ RADIATOR SHUTTERS
- ★ BOMB SIGHT



2½" dia. Frame Size Motor
Two Pole—D.C.



3" dia. Frame Size Motor
Two Pole—D.C.

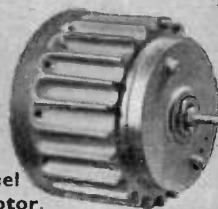

Immersed Fuel
Boost Pump Motor.

TELCONNECTORS

co-axial plugs and sockets

These connectors enable identical cables to be joined together, or flexible cables to be joined to their lead-sheathed counterparts. They are fully waterproofed and suitable for use up to 3,000 Mc/s. The flange may be fitted to either half for passing cables through panels.

Illustrated is the 53/29M Plug and 53S/29M socket, for use with PT29M cable; also the 53C panel-mounting socket for terminating cable runs and the 53S protective cap for excluding dust and moisture.



All types are readily available in various sizes and combinations.

Write for Publication T/1.



TELCON RF

THE TELEGRAPH CONSTRUCTION & MAINTENANCE CO. LTD
Head Office: 22 Old Broad Street, London, E.C.2.
Tel: LONDON Wall 7104
All enquiries to: Telcon Works, Greenwich, S.E.10.
Tel: GREENWICH 3291



cables

Three "Electronic Engineering" Monographs

RESISTANCE STRAIN GAUGES

By J. Yarnell, B.Sc., A.Inst.P.

Price 12/6

This book deals in a practical manner with the construction and application of resistance gauges and with the most commonly used circuits and apparatus. The strain-gauge rosette, which is finding ever wider application, is treated comprehensively, and is introduced by a short exposition of the theory of stress and strain in a surface.

ELECTROPHYSIOLOGICAL TECHNIQUE

By C. J. Dickinson, B.A., B.Sc.

(Magdalen College, Oxford)

Price 12/6

The author describes the use of electronic methods as applied to research in Neurophysiology. Chapters are devoted to amplifying, recording and stimulating techniques used in physiology and medicine (e.g. electrocardiography, electroencephalography, etc).

VOLTAGE STABILIZERS

By F. A. Benson, M.Eng.,

A.M.I.E.E., M.I.R.E., University of Sheffield.

Price 12/6

This monograph describes the various devices employing saturated elements, glow-discharge tube circuits and thermionic valve arrangements for voltage stabilization. A comprehensive bibliography is included.

Order your copy through your bookseller or direct from:—

Electronic Engineering

28 ESSEX STREET, STRAND, LONDON, W.C.2



FOR
PRECISION PRESSINGS!

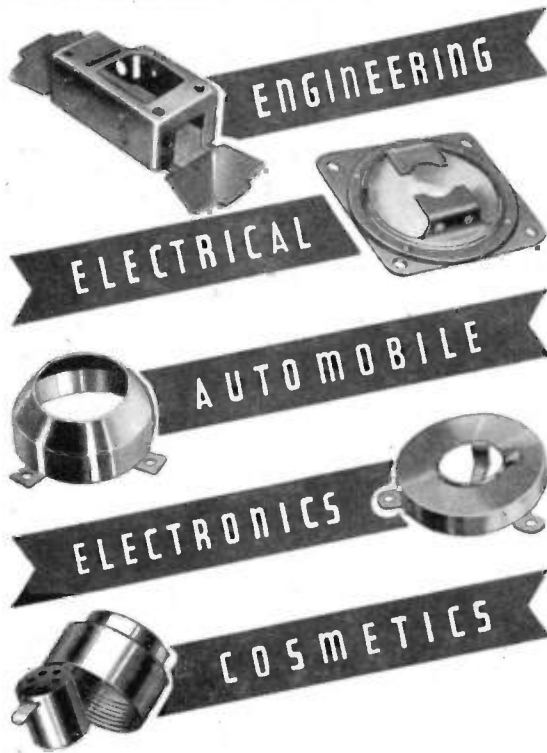

IN ALL METALS FOR ALL INDUSTRIES

WRIGHT, BINDLEY & GELL LIMITED
 TELEPHONE GREET TELEGRAMS
 VICTORIA 2295/6/7 (4 lines) BIRMINGHAM, II BINDLEY, BHAM. II



Progress in Electronics

IN the modern laboratories of the Mullard Organisation many new applications of electronics are being developed to meet the ever-changing needs of industry, communications, and medicine.

Bringing the benefits of this research to the community is another Mullard function. In great factories in Lancashire and Surrey, millions of valves, electron tubes, and components are produced for Britain's electronics industry.

Behind the name Mullard, therefore, is a store of experience in electronics that may well prove of immense importance to your own organisation.

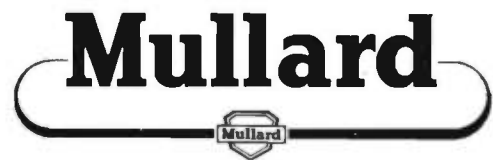

Mullard Ltd., Century House, Shaftesbury Avenue, London, W.C.2.

(3685)

ABOVE ALL OTHERS

POTTED AND COMPOUND FILLED TRANSFORMERS AND CHOKES

made by Woden are the answer when the call is for transformers to operate under exacting industrial conditions, coupled with adverse climatic conditions.



Every transformer leaving our factory is subjected to a rigid inspection, and is fully impregnated with moisture proof filling compound by the latest vacuum and pressure process. The fact that "WODEN" are the choice of many leading radio and television manufacturers is proof enough of the quality of our products.

Please send for latest Catalogue.



MOXLEY ROAD, BILSTON, STAFFS.

TELEPHONE : BILSTON 41959

REDUCE YOUR PRESS TOOL COSTS

THE HUNTON UNIVERSAL BOLSTER OUTFIT FOR SHEET METAL PIERCING AND BLANKING ON FLY PRESSES

Bolster Frame with 2 adjustable gauges and insertable steel Holders for Dies $\frac{1}{2}$ in. to $3\frac{1}{2}$ in. bore diameter.

Two Punch Holders with detachable positive-action Strippers take the complete range of Punches $\frac{1}{2}$ in. to $3\frac{1}{2}$ in. diameter

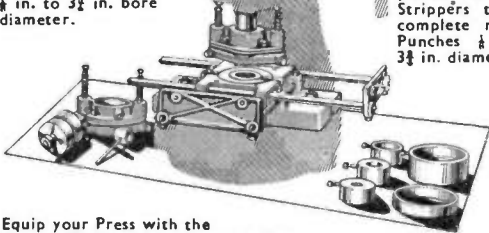

Equip your Press with the Hunton Outfit and use inexpensive standardised Punches and Dies $\frac{1}{2}$ in. to $3\frac{1}{2}$ in. diameter obtainable from stock—in $\frac{1}{2}$ in. sizes—when you need them. Standardised Tools also available at short notice for Square, Oblong and other shapes, Louvre Forming (up to 8 in. long), Corner Notching, Corner Radiusing, Angle Iron Notching and Piercing, etc.

Get the Outfit now—Buy Punches, Dies and tools as you need them

Descriptive brochure and prices on request.

HUNTON LIMITED

Phoenix Works, 114-116, Euston Road, London, N.W.1
Telephone : Euston 1477 Telegrams : Untonexh, London



MIRACLE OF PROGRESS!

Ragosine Molybdenised lubricants have about as much in common with ordinary lubricants as the giant ocean liner of today has with the small sailing-ship from which it developed!

RAGOSINE MOLYBDENISED LUBRICANTS

give for the first time in commercial form the amazing advantages of Molybdenum Disulphide for all difficult lubrication purposes.

A NEW range of lubricants for use :-

Where remote conditions do not allow conventional lubricants to be applied.

Where bearing pressures are beyond the capacity of conventional lubricants.

Wherever danger of scoring, galling, scuffing or seizing exists.

For difficult metal forming operations.

For application to cutting edges and dies to reduce wear.



RAGOSINE

Molybdenised Lubricants

Full details of complete range, prices and packing from



RAGOSINE OIL CO. LTD.

IBEX HOUSE, MINORIES, LONDON, E.C.3.

MINERVA WORKS, WOODLESFORD, Nr. LEEDS, YORKS.

ENGLISH ELECTRIC COMPANY LIMITED

GUIDED MISSILES AND RESEARCH DEVELOPMENT

ENGLISH ELECTRIC, Luton, have vacancies on their Guided Missile Project for both Senior and Junior Engineers on exceptionally interesting work, both in research into new techniques and development of existing ones. Good prospects and permanent posts for able men of the following categories:—

- (1) **ELECTRONICS, RADAR or TELEVISION ENGINEERS**, with H.N.C. or Degree in Electrical Engineering, either with or without Industrial or Research experience.
- (2) **ELECTRICAL ENGINEERS**, with H.N.C. or Degree interested in Servo-mechanisms, computing devices or instrumentation. Previous experience desirable but not essential.
- (3) **PHYSICISTS** interested in Electronics, Radar, Television, Computing Devices or Optics, either with or without industrial experience.

Please write, quoting reference S.A.23A, with appropriate number, and giving full details to

**CENTRAL PERSONNEL SERVICES,
ENGLISH ELECTRIC CO., LTD.,
24-30, GILLINGHAM ST., LONDON, S.W.1**



RACK MOUNTING CABINET FOR 19" PANEL

CABINET to accommodate one 19 x 10½ in. x 14G. Steel Rack Panel with 17 x 12 x 2½ in. Chassis and Angle Brackets in 18G. Steel; Panel secured by four chromium plated screws. Louvred on back, having radiused front corners..... **£5 12 6**

With recessed Lid in top..... **£6 7 6**

Two carrying Handles, extra..... **9 0**

FINISHES : Black, Grey or Brown Wrinkle Enamel.

CARRIAGE : Extra.

ILLUSTRATED LISTS AND
TRADE TERMS ON APPLICATION.

**REOSOUND ENGINEERING & ELECTRICAL
COMPANY, "REOSOUND WORKS,"
COLESHILL ROAD, SUTTON COLDFIELD**
Tel.: SUT. 4685. Grams.: Reosound Sutton Coldfield

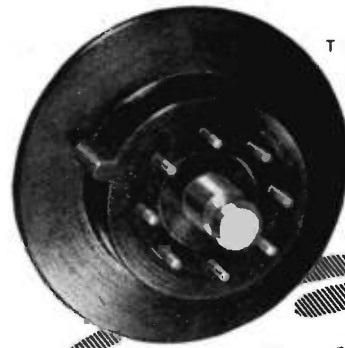

THERMOPLASTIC
& THERMOSETTING

Precision Mouldings



**TOOL MAKERS - MOULDERS - ASSEMBLERS
AND LAMINATED TUBE MAKERS**

Elco Plastics Ltd.

& TUBE LAMINATION LTD

DESBOROUGH PARK ROAD,
HIGH WYCOMBE, BUCKS.
Telephone: High Wycombe 1921/2



*Pioneers and specialists
in Small Valves*

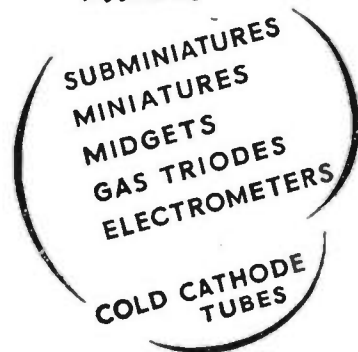

HIVAC LTD

**GREENHILL CRESCENT, HARROW-ON-THE-HILL,
MIDDLESEX.**

Telephone: HARrow 2655

D
**DONOVAN ACCESSORIES—
 FOR THE ELECTRONIC
 APPARATUS MANUFACTURER!**



TYPE J.96 TERMINAL BLOCKS. Made in 15, 30 and 60 amp. sizes.



Type C.30 PUSH-BUTTON UNIT arranged for mounting on customers' own cover plate.

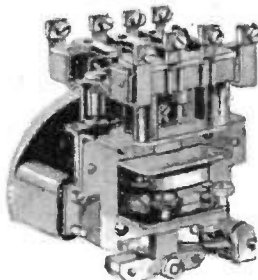

Type A.11 A.C. POWER RELAY - 4-pole with N.O. or N.C. contacts.

THE DONOVAN ELECTRICAL CO. LTD.
 Safuse Works · Stechford · Birmingham 9

**ELECTRONIC EQUIPMENT
 VALVE
 COOLING**



Secomak
INC.

Blower Units are also made in larger sizes, having outputs up to 140 c.f.m. and static water lift up to 32".

Send us particulars of your requirements.

"Secomak" Model 129 Blower Unit, designed specifically for Valve Cooling. Output : 33 c.f.m. free air. Static Water Lift: 0.63". Single phase, permanent capacitor, totally enclosed motor rated at 25 volt/amps for continuous running. Overall dimensions: 6½" × 5¼" × 4½".

SERVICE ELECTRIC CO., LTD.

SECOMAK WKS. HONEYPOT LANE, STAMMORE, MIDDX. Tel: EDGware 5566 7-8 9



Dept. E.E.

18 TOTTENHAM COURT ROAD, LONDON, W.1.

Tel.: MUSEum 2453/4539

Business Hours: Monday-Friday 9—5.30 Saturday 9—1

RELAYS

D.C. COIL RESISTANCE

3,000 TYPES: 1.9Ω to 80,000Ω
 600 TYPES: 0.4Ω to 9,200Ω.

ALSO LARGE STOCKS OF DOUBLE & TRIPLEWOUND AND SLAGGED COILS.

CONTACTS

3,000 TYPES: up to 8 sets.
 600 TYPES: up to 4 sets.
 3,000 TYPES: Make (M), Break (B), in Twin-silver, Twin-platinum, Dome-silver (2 amp.), Tungsten (5 amp.), and Flat-silver (8 amp.). Change-Over (C), in all but Tungsten: Make-Before-Break (K), in Twin-silver and Twin-platinum.

600 TYPES: (M), (B) and (C), in Twin-silver and Twin-platinum.

SPECIAL
 High resistance slugged coils (up to 10,000 OHMS with 1" slug) now available.

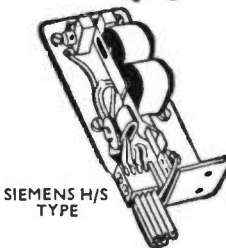
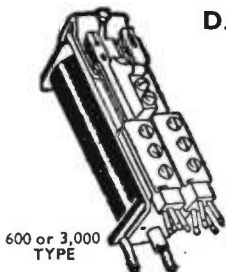

...In almost every type of machine...

There's just no limit to the scope of "Castle" Service to engineering Repetition Work in all metals Machining and Light Assemblies. And every item in millions carries the hallmark of precision.

Write for brochure



THE CASTLE ENGINEERING COMPANY (NOTTINGHAM) LIMITED

HASLAM STREET · CASTLE BOULEVARD · NOTTINGHAM

L6135B



STOCKISTS OF
BX
POLYSTYRENE

A first-class rigid insulating material, supplied in sheets and rods in a range of thicknesses and diameters ex stock.

Information and guidance on manipulation, machining and cementing available on request.

MILTOID LTD.

34/36 Royal College Street, London, N.W.1.
Phone: EUSon 6467. Grams: Celudol, Norwest, London

now available!

THE BPL UNIVERSAL TEST SET
20,000 Ohms/Volt

- * Leather carrying handle
- * Mirror Scale
- * 20,000 ohms per volt for D.C. and A.C.
- * Two ohms ranges operated from large internal battery.



- * Captive head terminal connectors for all ranges.
- * Easy to read 2 colour dial
- * Rotary switch selects ranges clearly marked.
- * Solid bakelite moulded case

LIST PRICE
£11 10 0 including test leads. Subject to Trade Discount.
LONDON STOCKIST:
M.R. SUPPLIES LTD., 68 New Oxford Street, W.C1.

We also supply
B.P.L. Super Rangers and D.C. Test sets. Also Moving Coil and Moving Iron Panel Mounting Meters. A comprehensive range of Measuring Bridges and Electronic Testing instruments.

BRITISH PHYSICAL LABORATORIES
HOUSEBOAT WORKS · RADLETT · HERTS
Telephone: RADLETT 5674-5-6

FIXED CONDENSERS OF ALL TYPES

Both Paper & Mica

Large stocks available for immediate delivery. Your specific enquiries, giving full details, will receive immediate attention. Our prices show substantial savings.

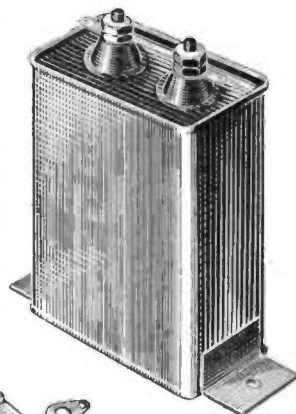

CLAUDE LYONS LTD.

Electrical & Radio Laboratory Apparatus
180 Tottenham Court Rd., London, W.1. Tel. MUSeum 3025

PRECISION IN CERAMICS BY BRAY

Quantity production of small automatically made pieces in Steatite, Porcelain, and Rutile materials for electric cooking and heating equipment, and telecommunication apparatus.

BRAY

GEO. BRAY & CO. LTD., Leicester Place, Leeds 2.
Tel.: 20981/8. Grams: "Bray, Leeds 2"

BRADMATIC LTD.

MAGNETIC TAPE RECORDING EQUIPMENT

Bradmaster Model 5 Tape Desk

- Built to professional standards.
- Two speeds— $3\frac{1}{2}$ and $7\frac{1}{2}$ inches per second.
- Easily adjusted for single or twin track recordings.
- Fast wind and rewind—full reel rewound in $1\frac{1}{2}$ minutes.
- Heavy alloy flywheel. Freedom from "wow" and "flutter."
- Double servo brakes on each hub.
- Push Button control.
- Three heavy duty motors.
- Three shielded Bradmatic heads.
- Size : $13\frac{1}{2}$ in. x $15\frac{1}{2}$ in. x $6\frac{1}{2}$ in. deep.

Price £41 (fitted with 5 R.P. heads)
or with 6 R.P. heads £42

PORTABLE RECORDERS

In rexine covered case, fitted with model 5 Tape Desk (6RP heads) and C.J.R. Type D.I amplifier with monitoring. Provision for external loudspeaker. Complete with microphone and leads.

PRICE : £119 15 0

High Fidelity Sound Heads :—

Type SRP (record/play), ££3 5 0.

Type SE (erase) £3 5 0.

Type 6RP (super fidelity), £3 15 0.

Oscillator Coils, Screening Cans, E.M.I., Scotch Boy and G.E.C. tape, amplifiers and microphones.

Trade supplied. Send for lists.

BRADMATIC LIMITED

STATION ROAD • ASTON • BIRMINGHAM 6
Phone : EAST 0574. Grams : Bradmatic, Birmingham.

WAYMOUTH GAUGES & INSTRUMENTS LTD.

a subsidiary company of

SMITHS AIRCRAFT INSTRUMENTS LTD.

invite applications for vacancies in their Engineering Department at Godalming.

PROJECT ENGINEER to direct the work of a team engaged on projects covering specialised instruments and electronic equipment. Applicants should possess a University Degree or Higher National Certificate in Electrical Engineering or similar qualifications and have had experience in this type of work. Ref. E1.

ASSISTANT ENGINEER for theoretical and experimental work on magnetic amplifiers. Qualifications such as degree in Physics or Electrical Engineering or Higher National Certificate are required. Previous experience in this field of work would be an advantage. Ref. E2.

ASSISTANT ENGINEER for theoretical and experimental work on problems of aircraft fuel contents gauging. Qualifications similar to post above are required. Ref. E3.

TECHNICAL ASSISTANT to assist in development work on magnetic amplifiers and electrical instruments. For this previous experience is not essential but preferred qualifications would be an Engineering degree or Higher National Certificate in Electrical Engineering. Ref. E4.

DRAUGHTSMEN, senior and junior, for work on aircraft instruments, magnetic amplifiers and electronic equipment. Minimum qualifications Ordinary National Certificate in Mechanical or Electrical Engineering. A knowledge of Inter Service requirements and current design practice is required for the senior post. Ref. E6.

INSTALLATION ENGINEER to assist in installation aspects of fuel contents gauges and generally work with other engineers on calibration and field work on similar equipment. Applicants should have a knowledge of aircraft installations and accessories and preferably some previous experience in this type of work. Ref. E7.

Applications should be made in writing, quoting the reference of the vacancy, and giving details of qualifications and experience to the Chief Development Engineer, Waymouth Gauges & Instruments Ltd., Station Road, Godalming, Surrey.

"SANOID" FIRST AID

For over fifty years we have studied and supplied the specialised First Aid requirements of Industry. We believe our efforts have been of advantage to those we are privileged to serve, as on many occasions we have been able to meet the particular needs of various industries and conditions.

May we help you? Our wide experience is at your service, and we should be pleased to send you our current catalogue and price list.

A PRODUCT OF

Cuxson Gerrard & Co. Ltd.
OLDBURY BIRMINGHAM

FIRST AID SPECIALISTS

ESTABLISHED 1878

ELECTRONIC INSTRUMENTS IN INDUSTRY

COSSOR Oscilloscopes, Cameras, Sweep Generators.

DAWE Stroboscopes, Vibration Meter, Sound Level Meter, A.F. Analyser, Moisture Meters.

ADVANCE Signal Generators, Audio Generators, Constant Voltage Transformers.

AVO Multirange Meters, Electronic Test Meters.

If You Require Further Information Consult :—

A. C. FARNELL, LTD.

Tel. 32958-9

15 PARK PLACE,
LEEDS, 1

Tel. 32958-9



RELAYS AND KEY SWITCHES



LARGEST EX-GOVT. STOCK IN GT. BRITAIN

Types 600-3000 Relays — Siemens High Speed
Also A.C. 250 volts 50 cycles

Uniselect Switches, Telephone Switchboards, Telephone Components, Plugs, Jacks, Handsets — Government Contractors.

JACK DAVIS (RELAYS) LTD. (Dept. E.E.)

36 PERCY STREET, LONDON, W.1

Phones : MUSeum 7960, LANgham 4821

WE TALK YOUR LANGUAGE when it comes to TRANSFORMERS

- ★ designed for standard & special applications.
- ★ built for reliability.
- ★ engineered for trouble-free operation.



TRANSFORMERS BY

Amos of Exeter

AMOS OF EXETER, RTS WORKS, COWICA STREET, EXETER.

HIGH PURITY
GERMANIUM DIOXIDE

(GeO₂)

Manufactured by

ELGAR LABORATORIES

(ELGAR TRADING LTD.)

240 High St., Harlesden,
London, N.W.10, England.

Cables : ELGATRAD, LONDON

**CROYDON PRECISION
INSTRUMENT CO.**

STRAIN MEASURING EQUIPMENT
PRECISION D.C. POTENTIOMETERS
RESISTANCE STANDARDS
VOLT RATIO BOXES
RESISTANCE BOXES, ETC.

Early deliveries — Full details from :—

116 Windmill Road, Croydon, Surrey

Telephone : THOrnton Heath 4025

POWER Transformers



10VA to 100kVA Open,
Enclosed, Oil Cooled,
D.W. and Auto

For Industrial Engineering,
Furnaces, Electronics, Phase
Conversion, etc.

THE TRANSFORMER & ELECTRICAL CO. LTD.

Eastern Works, Walthamstow, London, E.17

Phone : KEYstone 5031/2

SINE-COSINE POTENTIOMETERS—10,000 ohms centre
tapped, rectangular card type, direct drive to card, 60 : 1
reduction drive to sine and cosine outputs. Oil immersed for
long life. A precision instrument of the highest accuracy at a
fraction of current price. New, in makers cartons £3.10.0 each.

**WE ALSO HAVE LARGE STOCKS OF MAGSLIPS, SELSYNS, IPOTS,
BALL AND PLATE INTEGRATORS, SERVO MOTORS AND OTHER
TYPES OF EQUIPMENT FOR COMPUTATION REMOTE INDICATION,
REMOTE POWER CONTROL AND SERVO CONTROL PURPOSES.**

Write for copies of our current brochure and price lists.

24v Klaxon Motors, 1/20 h.p. 2,500 r.p.m., shunt wound,
continuous rating new, 35/- each.

Electrolytic Capacitors, 32uF 450v. wkg., rectangular metal
can 3/6 each. £4.15.0 per case of 30 capacitors.

Potentiometers, 5 ohm, 10 watt 4/- each.

Wire wound Resistors, 10,000 ohm 5 watt, 1/6 each.

SERVOTRONIC SALES

INCORPORATING HOPTON RADIO
1, HOPTON PARADE, HIGH ROAD, STREATHAM,
LONDON, S.W.16 STReatham 6165.

"SPEARETTE"

**MINIATURE VALVE
EXTRACTING TOOLS**

For B7G - B8A - B9A - B8B,
and B8G Based Valves.

**SPEAR ENGINEERING CO. LTD.,
WARLINGHAM, SURREY.**

Telephone : Upper Warlingham 2774.



**BRASS, COPPER, BRONZE,
ALUMINIUM, LIGHT ALLOYS**
IN ROD, BAR, SHEET TUBE, STRIP, WIRE

3000 STANDARD STOCK SIZES

H. ROLLET & CO., LTD.

6, CHESHAM PLACE, LONDON, S.W.1.

SLOane 3463

WORKS :

36, ROSEBERY AVENUE, LONDON, E.C.1.

"No Quantity too Small"

also at

Liverpool - Manchester - Birmingham - Leeds

FREE

**A VALUABLE
BOOK**

which details the wide
range of Engineering and
Commercial Courses of
modern training offered

by E.M.I. Institutes—the only Postal College which is part of a world-
wide Industrial Organisation. Engineering Courses include training for :

City and Guilds Grouped Certificates in Telecommunications; A.M.Brit.I.R.E. Exami-
nation, Radio Amateur's Licence, Radio & Television Servicing Certificates,
General Radio and Television Courses, Radar, Sound Recording, etc. Also Courses
in all other branches of Engineering.

EMI Institutes

associated with
**MARCONIPHONE
COLUMBIA HMV**

COURSES FROM **£1** PER MONTH

POST NOW

Please send, without obligation the FREE book
E.M.I. Institutes, Dept. 11

43 Grove Park Rd., Chiswick, London, W.4

Name

Address

IC.108



RELIANCE

RELIANCE MNFG. CO. (SOUTHWARK), LTD.,

SUTHERLAND ROAD, HIGHAM HILL, WALTHAMSTOW, E.17.

Telephone : Larkwood 3245

Wire-wound and Composition
types. Single, Ganged, Tandem
Units. Characteristics : linear,
log., semi-log., non-inductive,
etc. Full details on request.

**THE LATEST in
AIR DIELECTRIC TRIMMERS**

Encased in acetate container for extra protection

Width: 16.5 m/m. Length: 22 m/m. Height: 1.5 to 8pF—7.5 m/m. 1.5 to 20pF—10 m/m. 2 to 26pF—11 m/m. 2 to 32pF—12 m/m. Law: Straight line capacity. Power Factor: Less than .001. Insulation: Over 2000 megohms. Voltage: 500 D.

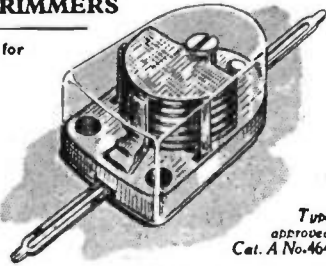

Type approved
Cat. A No. 464

OXLEY DEVELOPMENTS CO. LTD.
ULVERSTON, NORTH LANCs. TEL: ULVERSTON 3306

**'Radiospares'
Quality Parts**

**The
Service Engineer's
First Choice**

L. WILKINSON WHOLESALE AND EXPORT
19, LANSDOWNE ROAD, CROYDON
Phone: CRO 0839 Telegrams: "WILCO" CROYDON

Voltage Regulators. Input 230 volt A.C. 21 amps., output 57.5 Vt. to 228 volts in 16 Steps. With current limiting Reactor. Made by English Electric. £15.
Variac Transformers. Type 80 CO. Input 200/240 v. Output 220 v. 7.5 amps. £7 10s. each.
Wheatstone Bridge. Accuracy 0.01 per cent. Five decades of "Thousands" "Hundreds" "Tens" "Units" "Tenths". Made by H. W. Sullivan, Ltd.
RACKS for 19 in. panels. Heavy channel type. 6 ft. 6 in. Standard. P.O. drilling. £6.
Operators' desks for above Racks, 19 in. by 12 in. 15s. each.
Klaxon Geared Motors. No. 1K5SB3-W7. 230V. A.C. Split Phase Induction Type, with a torque of 15lbs. ins. R.P.M. 175 £10 each.
Signal and Noise Generator. For television frequencies 20/88 Mc/s. in 4 Bands. Crystal controlled. Leaflet available on request. Price £14 10s.
RELAYS. P.O. Type 3000. Built to your requirements. Prompt delivery given.



HIFI LTD., 150, HIGH STREET, LYE, STOURBRIDGE, WORCS. Telephone: LYE 261

ELECTRONICS IN INDUSTRY

The first part of a survey of the advance of electronics into industry was presented in a supplement to 'ELECTRONIC ENGINEERING' last April.

The survey will be continued in a second supplement to be published in the NOVEMBER issue and will include articles on the application of Electronics to:—

- WELDING CONTROL · INDUSTRIAL PROCESS CONTROL**
- NUCLEONICS IN INDUSTRY · VIBRATION**
- MANUFACTURE OF TEXTILES**
- NON-DESTRUCTIVE HIGH VOLTAGE TESTING**

Make sure of your copy of this important issue by placing an order either with your newsagent or direct with:—

Electronic Engineering

28, ESSEX STREET, STRAND, W.C.2

26/- per annum

Single copies 2/-

INDEX TO ADVERTISERS

A.B. Metal Products Ltd.	34	English Electric Co., Ltd., The	56	Oxley Developments Ltd.	61
Acheson Colloids Ltd.	48	Enthoven & Sons Ltd., H. J.	5		
Airmec Laboratories Ltd.	30	Erie Resistor Ltd.	Cover i	Painton & Co., Ltd.	3
Alexander Equipment Ltd.	35	Evershed & Vignoles Ltd.	22	Parmeko Ltd.	31
All-Power Transformers Ltd.	46			Partridge Transformers Ltd.	8
Amos of Exeter	59	Farnell Ltd., A. C.	59	Radio Resistors Co., Ltd.	8 and 16
Automatic Telephone & Electric Co., Ltd.	29	Ferranti Ltd.	39	Radiospares Ltd.	61
Autoset (Production) Ltd.	47	Frigidaire Division of General Motors Ltd.	52	Ragosine Oil Co., Ltd.	55
		Furzehill Laboratories Ltd.	37	Redifon Ltd.	52
				Reliance Mfg. (Southwark) Ltd.	60
Baker Platinum Ltd.	24			Reosound Engineering & Electrical Co., Ltd.	56
Bell & Croyden, John	48	Garrard Engineering & Manufacturing Co., Ltd., The	44	Resinoid & Mica Products Ltd.	42
Belling & Lee Ltd.	26	General Electric Co., Ltd., The	23	Rollet & Co., Ltd.	60
Bradmatic Ltd.	59	Goodmans Industries Ltd.	49		
Bray & Co., Ltd., George	58	Graham Gear Co., Ltd.	62	Salford Electrical Instruments Ltd.	42
British Electric Resistance Co., Ltd.	47	Griffiths, Gilbert, Lloyd & Co., Ltd.	45	Scott & Co., Ltd., A. C.	35
British Physical Laboratories Ltd.	58			Service Electric Co., Ltd.	57
		Hairlok Co., Ltd., The	11	Servotronic Sales	60
Castle Engineering Co. (Nottingham) Ltd.	57	Hifi Ltd.	61	Spear Engineering Co., Ltd.	60
Chapman & Hall Ltd.	473	Hivac Ltd.	56	Standard Telephones & Cables, Ltd.	15 and 36
Cinema-Television Ltd.	25	Hunton Ltd.	55		
Connolly's (Blackley) Ltd.	20			Taylor, Tunnicliff (Refractories) Ltd.	13
Cossor Ltd., A.C.	21	Kelvin & Hughes Ltd.	45	Telegraph Condenser Co., Ltd., The	Cover iii
Croydon Precision Instrument Co.	60			Telegraph Construction & Maintenance Co., Ltd., The	53
Cuxton, Gerrard & Co., Ltd.	59	Linread Ltd.	10	Thomas (Richard) & Baldwins Ltd.	27
		Lyons Ltd., Claude	58	Transformer & Electrical Co., Ltd., The	60
Darwins Ltd.	44			Tufnol Ltd.	7
Davis Supplies Ltd., Alec.	57	Marconi Instruments Ltd.	28	United Insulator Ltd.	41
Davis (Relays) Ltd., Jack	59	Marconi's Wireless Telegraph Co., Ltd.	19		
Donovan Electrical Co., Ltd.	57	Measuring Instruments (Pullin) Ltd.	43	Viscose Development Co., Ltd.	12
		Metropolitan-Vickers Electrical Co., Ltd.	9	Vortexion Ltd.	38
Edison Swan Electric Co., Ltd., The	Cover ii and Cover iv	Miltoid Ltd.	58		
Edwards & Co. (London) Ltd., W.	49	Minnesota Mining & Manufacturing Co., Ltd.	43	Waymouth Gauges & Instruments, Ltd.	59
Elco Plastics Ltd.	56	Mond Nickel Co., Ltd.	18	Wayne-Kerr Laboratories Ltd.	41
Electro-Alloys Ltd.	62	Muirhead & Co., Ltd.	14	Wiggin & Co., Ltd., Henry	40
Electro-Methods Ltd.	40	Mullard Ltd.	32, 46, 50 and	Wilkinson, Ltd.	61
Electronic Engineering Monographs	50, 53, 61 and	Murex Ltd.	54	Woden Transformer Co., Ltd.	55
Elgar Trading Ltd.	60			Wright, Bindley & Gell Ltd.	54
Elliott Brothers (London) Ltd.	33	Nagard Ltd.	51		
E.M.I. Institutes Ltd.	60	N.S.F. Ltd.	17		



Graham Gear Co Ltd

SPURS
SPIRALS
BEVELS
8-100 D.P.

**STATION ROAD
BROOKMANS PARK, HERTS.
Tel:- HATFIELD 3130**

**TUNGSTEN WELDING
ELECTRODES FOR INERT
GAS ARC WELDING**



**EA
LIMITED**

Molybdenum
Tubes and other
Molybdenum Components.
Tungsten Rods and three-piece Lead Wires for tungsten to glass seals.
X-ray Targets with or without cast-on copper body.
Rotating Anodes.
Tungsten Contact Rivets and Screws.

ELECTRO-ALLOYS Ltd.
12, BRUNEL RD., LONDON, W.3.
Makers of TUNGSTEN and MOLYBDENUM Products

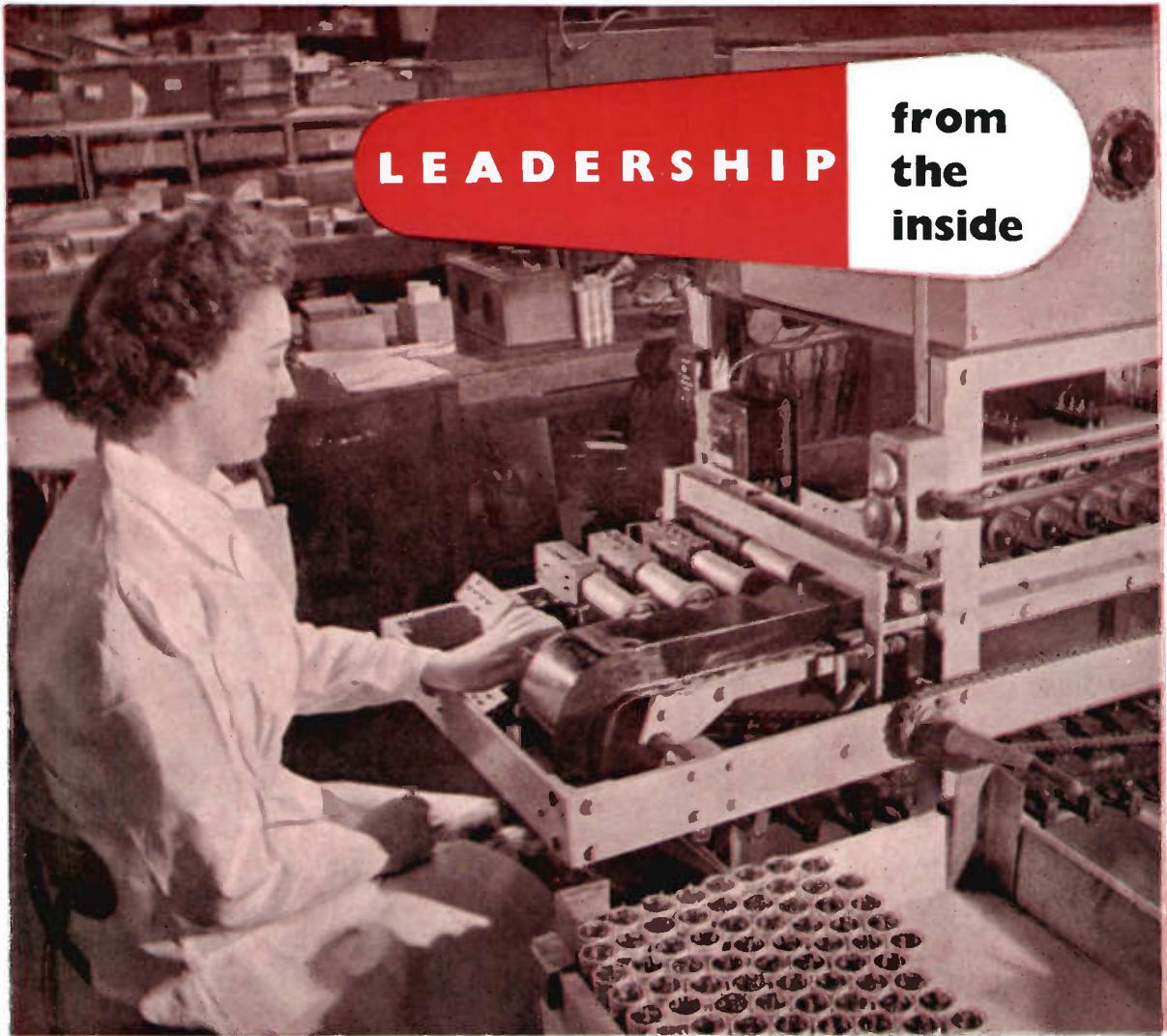

LEADERSHIP from the inside



*Quest and Test — symbols of
Condenser Perfection*

There are many men and women at T.C.C. who are employed solely to keep production down! They are, of course, the keen-eyed testers whose job it is to ensure that no condenser which does not meet every required standard ever leaves the works.

To aid them in their unrelaxing vigilance, batteries of truly "mechanical brains" — designed and built in the works — perform miracles of selection and rejection. These machines — exclusive to T.C.C. — progressively subject the condensers to capacity, insulation and over-voltage tests, some of them marking each condenser according to its performance.

This is part of the never-ending pursuit of perfection which is the background of leadership — and has been for 45 years.

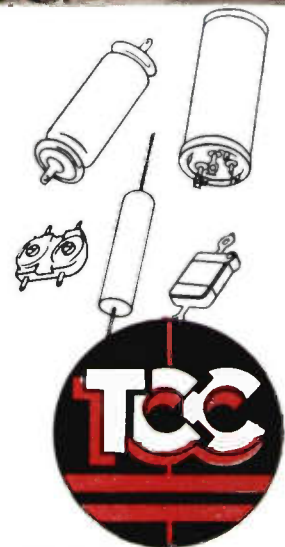

SPECIALISTS IN CONDENSERS SINCE 1906

THE TELEGRAPH CONDENSER CO. LTD · RADIO DIVISION · LONDON · W.3 Tel: ACORN 0061 (9 lines)

22 Edm. Swan

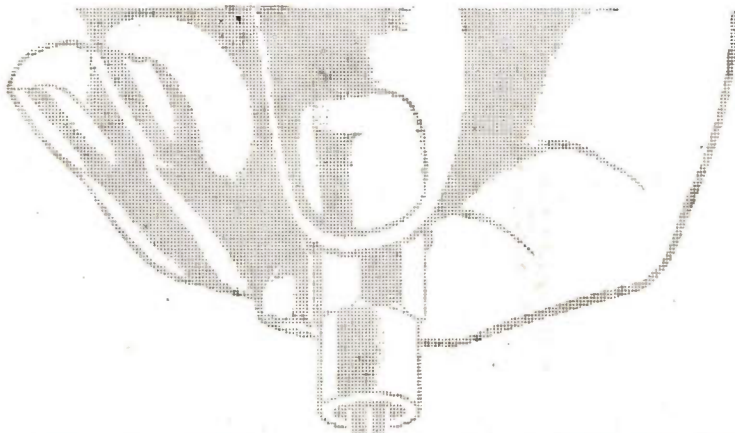

EDISWAN

C L I X

By adding the Clix range of radio, television and electronic components to its existing list of products The Edison Swan Electric Co., Ltd. is able to offer an improved components service to the radio industry. Future enquiries and orders for these products, and others in the Ediswan range, will be welcomed.

**United
for better
Radio, Television
& Electronic
component
service**

THE EDISON SWAN ELECTRIC COMPANY LIMITED

155 Charing Cross Road, London, W.C.2, and branches

Member of the A.E.I. Group of Companies

ER9