

# Electronic Engineering

MAY 1952

PAINTON

*By Appointment to the Professional Engineer...*

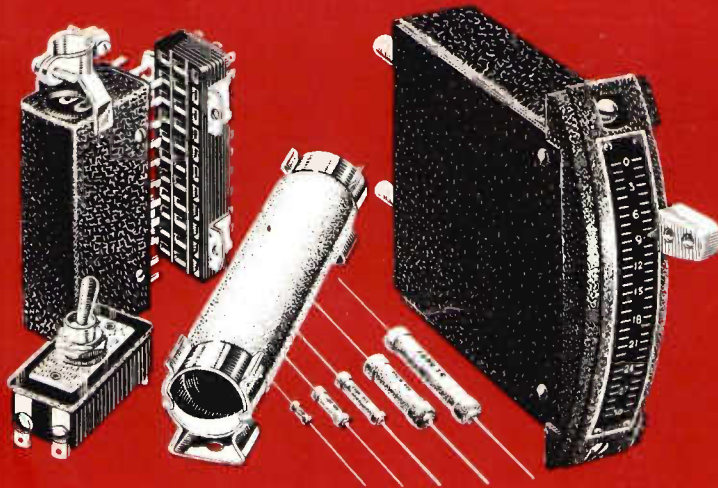

ATTENUATORS · FADERS · SWITCHES · WIREWOUND POTENTIOMETERS · PLUGS  
AND SOCKETS · WIREWOUND RESISTORS · HIGH STABILITY CARBON RESISTORS  
KNOBS DIALS AND POINTERS · TERMINALS

PAINTON

*Northampton England*

TWO SHILLINGS

# The core of the Motor is the Electrical Stamping



 **SANKEYS...**  
**ARE THE LARGEST**  
**MANUFACTURERS**  
**OF ELECTRICAL**  
**STAMPINGS IN**  
**EUROPE**



**SANKEYS**  
**"STALLOY" &**  
**"LOHYS"**  
Electrical Sheets  
are Rolled at  
The **MANOR WORKS**

**JOSEPH SANKEY & SONS LTD.**

ESTABLISHED 1854

**BANKFIELD WORKS, BILSTON STAFFS, ENG.**

TELEGRAMS: SANKEY - BILSTON

LONDON OFFICES: ULSTER CHAMBERS, 106 REGENT STREET W 1



## CLASSIFIED ANNOUNCEMENTS

The charge for these advertisements at the **LINE RATE** (if under 1" or 12 lines) is: Three lines or under 7/6, each additional line 2/6. (The line averages seven words.) Box number 2/- extra, except in the case of advertisements in "Situations Wanted," when it is added free of charge. At the **INCH RATE** (if over 1" or 12 lines) the charge is 30/- per inch, single column. Prospectuses and Company's Financial Reports £14. 0s. 0d. per column. A remittance must accompany the advertisement. Replies to box numbers should be addressed to: "Electronic Engineering," 28, Essex Street, Strand, London, W.C.2. Advertisements must be received before the 14th of the month for insertion in the following issue.

### OFFICIAL APPOINTMENTS

**ADMIRALTY:** Principal Scientific Officer (Physicists). The Civil Service Commissioners invite applications for two permanent posts in the Royal Naval Scientific Service at the Underwater Countermeasures and Weapons Establishment, near Portsmouth, one of the posts will be ultimately at Greenock. Candidates must have been born on or before 31st December, 1920. They must possess either a first or second class Honours Degree in Physics or Engineering or be corporate members of the Institutions of Civil or Mechanical or Electrical Engineers, or produce evidence of outstanding ability to carry out the duties required. Candidates must be Physicists and must have specialised knowledge of eddy current phenomena, audio and low frequency techniques and be able to take charge of projects involving research and development. Considerable experience is also expected in electronic amplifiers magnetic and electromagnetic apparatus, according to the requirements of the post in question. Successful candidates will be required to lead a group of scientists engaged on the development of electromagnetic devices. Inclusive salary scale (men): £1,033-£1,377; (women) £907-£1,218. Exceptionally a starting salary above the minimum may be granted according to qualifications and experience. The posts are superannuable under the Federated Superannuation Systems for Universities. Further particulars and application forms from Civil Service Commission, Scientific Branch, Trinidad House, Old Burlington Street, London, W.1, quoting No. S4132/52. Completed application forms must be returned by 9th May, 1952. W 2584

**APPLICATIONS** are invited by the Ministry of Supply for the following posts in the Experimental Officer Class at R.A.F. Signals Experimental Establishments in Bedfordshire and near London. Senior Experimental Officer (Ref. D17/52A) for the development of calibration procedure for radio test equipment and preparation of calibration publications. Duties will also include the calibration of substandards (against N.P.L. approved standards); specialist advice to Radio Equipment Calibration Centres and training of personnel for supervisory duties in these centres; liaison with the Radio Measurements Division in the Experimental Establishments of the Ministry of Supply. Experimental Officer (Ref. D18/52A) and Assistant Experimental Officers (2) (Ref. D19/52A) for the calibration of transfer standards (a) involving frequency and pulse measurements, and maintenance of the frequency standard (b) involving bridge and miscellaneous measurements, and (c) involving output and attenuation measurements. Experimental Officer (Ref. D6/52A) for the reconstruction of a radar landing aid and organisation of associated experimental investigation and to advise R.A.F. and contractors on associated problems. A knowledge of pulse systems and associated techniques is desirable and experience in current electronic practice and laboratory techniques is essential. Candidates should have a Higher National Certificate or equivalent qualification in applied physics, radio or electrical engineering. Experience in the duties outlined above is desirable. Salary will be assessed according to age, qualifications and experience within the following inclusive ranges:- S.E.O. (Minimum age 35) £803-£1,033. E.O. (Minimum age 26) £597-£754. A.E.O. (Minimum age 18) £264-£555. Rates for women somewhat lower. Posts are unestablished. Application forms obtainable from Ministry of Labour and National Service, Technical and Scientific Register (K), Almack House, 26 King Street, S.W.1, quoting appropriate reference. Closing date 10th June, 1952. W 2600

**ASSISTANT (Scientific) Class:** The Civil Service Commissioners give notice that an Open Competition for pensionable appointment to the basic grade will be held during 1952. Interviews will be held throughout the year, but a closing date for the receipt of applications earlier than December, 1952, may eventually be announced either for the competition as a whole or in one or more subjects. Candidates must be at least 17½ and under 26 years of age on 1st January, 1952, with extension for regular

service in H.M. Forces, but candidates over 26 with specialised experience may be admitted. All candidates must produce evidence of having reached a prescribed standard of education, particularly in a science subject and of thorough experience in the duties of the class gained by service in a Government Department or other civilian scientific establishment or in technical branches of the Forces, covering a minimum of two years in one of the following groups of scientific subjects:- (i) Engineering and physical sciences. (ii) Chemistry, bio-chemistry and metallurgy. (iii) Biological Sciences. (iv) General (including geology, meteorology, general work ranging over two or more groups (i) to (iii) and highly skilled work in laboratory crafts such as glass-blowing). Salary according to age up to 25: £236 at 18 to £363 (men) or £330 (women) at 25 to £500 (men) or £418 (women), somewhat less in the provinces. Opportunities for promotion. Further particulars and application forms from Civil Service Commission, Scientific Branch, Trinidad House, Old Burlington Street, London, W.1, quoting No. S 59/52. Completed application forms should be returned as soon as possible. W 2603

**B.B.C.** requires Engineer in the Transmitting Equipment Section (Power). Qualifications: Engineering Degree or equivalent technical qualifications; practical training and experience with manufacturers; broad knowledge of technical aspects of practical application of wide variety of electrical plant including switchgear, transformers, rectifiers, AC/DC motors and generators, contractor and control gear, batteries, cables, etc.; ability to supervise layout and diagram work. Knowledge of products of leading electrical manufacturers and of Diesel engine equipment, familiarity with estimating procedure, examination and summarising of tenders, writing specifications for power plant and equipment would be useful. Starting salary £795 or according to qualifications with increments to £1,065 p.a. maximum. Applications to Engineering Establishment Officer, Broadcasting House, W.1, within 7 days. W 2578

**B.B.C.** requires Technical Assistants aged 21 or over in Operations and Maintenance Department for service at Transmitter, Studio, Recording and Television Centres throughout the United Kingdom. Knowledge of mathematics, electricity and magnetism to School Certificate standard; experience in electrical or radio engineering an advantage. Salary £360 p.a. with annual increments to £470 p.a. maximum. Promotion prospects. A few vacancies exist for women in Recording Department in London. Application forms from Engineering Establishment Officer, Broadcasting House, London, W.1 (enclosing addressed foolscap envelope). After completion, forms to be sent to B.B.C., c/o Ministry of Labour, 211 Marylebone Road, London, N.W.1, marking envelope T.A.11. W 2588

**CROWN AGENTS** for the Colonies. Wireless Station Superintendent (temporary) required by the Gold Coast Government Posts and Telegraphs Department for two tours of 18 to 24 months in the first instance. Commencing salary (including Overseas Pay and Temporary Allowance) according to qualifications and experience in the scale £834 rising to £920 a year, with gratuity of £25 for each completed period of three months service. Outfit allowance £60. Free passages. Candidates must possess a Higher National Certificate in Electrical Engineering or equivalent, and have had practical experience in two or more of the following fields:- V.H.F. link systems; H.F. communication network; Frequency shift keying and teleprinter maintenance; V.H.F. and H.F. Direction finding systems; Aeronautical navigation aids (ground); Manufacture of light engineering equipment. Apply at once by letter, stating age, full names in block letters and full particulars of qualifications and experience, and mentioning this paper to the Crown Agents for the Colonies, 4 Millbank, London, S.W.1, quoting on letter M.29100.B. The Crown Agents cannot undertake to acknowledge all applications and will communicate only with applicants selected for further consideration. W 2586

**DEPARTMENT** of Scientific and Industrial Research:- Applications are invited for an unestablished Experimental Officer post at the Food Investigation, Torry Research Station, Aberdeen, to assist in physical research, both fundamental and applied, related to the processes of curing, drying, and freezing of biological material. Candidates should possess a theoretical knowledge of physics up to graduate level, experience of general physical laboratory techniques, and a capacity for design and invention. The salary range at present for men is £597-£754. Candidates should be at least 26 and preferably under 31 on 31st December, 1952, but older candidates are not excluded. Forms obtainable from Ministry of Labour and National Service, Technical and Scientific Register (K), Almack House, 26 King Street, London, S.W.1, quoting A116/52/A. Closing date 10th May, 1952. W 2495

**ENGINEER** required by Ministry of Supply for an Establishment near Sevenoaks, Kent. Qualifications: British, of British parentage; engineering apprenticeship; corporate membership of one of the Institutions of Civil, Mechanical or Electrical Engineers or exempting qualifications, and experience appropriate to the duties. Experience in the design of radio receivers and transmitters and/or in the handling of high speed transients an advantage. Duties: Design and development work in a wide field of electronic instruments. Salary: Within the range £1,256-£1,454 p.a. Not established, periodical competitions for established posts. Application forms from Ministry of Labour and National Service, Technical and Scientific Register (K) (D115/52A), Almack House, 26 King Street, London, S.W.1. Closing date 13th May 1952. W 2581

**MINISTRY OF SUPPLY** invite applications from Engineers for employment at a Research Establishment in Bucks. There is one post carrying a salary within the range £927-£1,218 per annum requiring a wide experience in radio communications and/or electronic engineering and specialist experience in at least one of the following: (1) Aerial design and propagation characteristics of frequencies above 30 Mc/s. (2) Pulse transmitters and receivers. (3) Pulse circuit techniques and display systems. (4) Radio navigation and approach aids. (5) Servo systems and turning gear. Duties: To control team engaged on the installation, design and siting of ground radar and other systems employing pulse techniques; act as consultant to the R.A.F. on technical problems arising from the operational application of such equipments and initiate such technical investigations as may be necessary. Ref. D.119/52A. There are five posts with a salary within the range £623 (at age 26)-£927 p.a. requiring experience in one of the following: (1) Pulse type approach aids, including aerial systems. (2) Telecommunication and navigational aid systems. (3) Radio telegraph and radio telephone terminal officers and associated radio receiving and transmitting stations. (4) Transportable ground radio installations. (5) Mobile radio and radar equipment, including vehicles; and a sound knowledge embracing modern theory and practice of at least one of the above mentioned systems or equipments. Familiarity with R.A.F. signalling procedure an advantage. Duties: Will include technical investigations, airfield siting, design and installation. Ref. D.120/52A. Candidates must be British of British parentage and have served a recognised engineering apprenticeship, and be corporate members of one of the Institutions of Civil, Mechanical or Electrical Engineers or have exempting qualifications. The posts are not established, but there are periodical competitions for established pensionable posts. Application forms from Ministry of Labour and National Service, Technical and Scientific Register (K), Almack House, 26 King Street, London, S.W.1, Quoting Ref. No. Closing date 13th May, 1952. W 2582

**VACANCIES** in Government Service. Skilled Craftsmen required for maintenance of Radio, Teleprinter and Electronic apparatus; also Assembler-Testers with experience of Telecommunications equipment by Government Establishments situated in (a) Middlesex and Kent (b) Gloucestershire. Basic pay (a) £6 14s. 6d.

**OFFICIAL APPOINTMENTS (Cont'd.)**

(b) £6 12s. 0d. plus merit pay up to £2 10s. 0d. according to skill and experience. Paid annual and sick leave according to normal Civil Service Industrial Regulations. Opportunities of securing permanent and pensionable posts. Apply Box No. W 1453.

**SITUATIONS VACANT**

*The engagement of persons answering these advertisements must be made through a Local Office of the Ministry of Labour or a Scheduled Employment Agency if the applicant is a man aged 18-64 inclusive or a woman aged 18-59 inclusive unless he or she, or the employment, is exempted from the provisions of the Notification of Vacancies Order, 1952.*

**A LARGE BRITISH** firm in the light electrical engineering industry requires the following specialists for its electronic laboratory located in the North part of London:- An experienced Physicist having extensive knowledge of semi conducting materials and of the modern theory of material structure. Applicants should have a practical approach to problems and be able to investigate and check on the practicability of developmen's and ideas. Two electronic engineers thoroughly familiar with pulse circuit experimental techniques. The posts are permanent with contributory pension scheme and usual staff standards. Salaries will be considered individually and applicants should write to Box No. 528, Dorland Advertising, Ltd., 18/20 Regent Street, S.W.1, giving full details of qualifications, experience, age, and approximately salary range required. W 2585

**A LEADING COMPANY** in the Radio and Electronic Industry setting up a new laboratory in the West London Area has vacancies for Electronic Engineers, Draughtsmen, and Model Makers of all grades. Applicants for these vacancies should give full details of qualifications and experience and should state salary required. Apply Box No. W 2556.

**APPLICATIONS** are invited for the positions of Service and Commissioning Engineers in the Industrial Electronics Department of the English Electric Company Ltd., at Stafford. Essential requirements: H.N.C. (electrical or mechanical) and practical experience in a manufacturing industry. Successful applicants will be given electronic training, and on completion will be required to make production tests and to travel all over the country on commissioning and servicing duties. Please write, giving full details, and quoting Ref. 979, to Central Personnel Services, English Electric Company, Limited, 24/30 Gillingham Street, London, S.W.1 W 2590

**ASSISTANT ENGINEER**, age 21-30, required by firm of Telecommunication Engineers to develop projects to meet customers requirements in the Telegraph field. Applicants should possess initiative and have a basic knowledge of telegraph practice. A Degree or H.N.C. an advantage but not a necessity. Salary according to age, qualifications and experience up to £500 per annum, together with participation in a non-contributory pension and benefit plan. Apply in writing, giving full particulars of education and experience, to Box No. W 1468.

**ASSISTANT FOREMAN** required for Workshop engaged in the assembly of miscellaneous electronic equipment. Essential requirements:- Several years experience of Electrical Instrument production, preferably in the Telecommunications, Radio or Radar fields: good theoretical knowledge of electronics and preferably previous supervisory experience. Good prospects and conditions, and Superannuation Scheme. London area. Write, giving age, full details of experience and salary required to Box No. W 2594.

**A WELL-KNOWN** Midland Company requires an H.F. Heater Applications Engineer for test work on samplers and the design of applicators. Men with metallurgical knowledge and at least H.N.C. should apply, giving full details of qualifications and experience, quoting Reference HPH to Box No. W 2566.

**A VACANCY** exists for a Projects Engineer in the Broadcasting Division of Marconi's Wireless Telegraph Co., Ltd., Chelmsford. Applicants should possess a University Degree or equivalent qualifications and should preferably have had experience in Television Engineering. The appointment is of a responsible nature and offers interesting work in the rapidly expanding Television field. There are excellent prospects of promotion for a man with drive and initiative. A good salary is offered com-

mensurate with qualifications and experience. Please apply giving full details and quoting Reference No. 466c to Central Personnel Services, English Electric Co., Ltd., 24/30 Gillingham Street, London, S.W.1. W 2591

**BELLING & LEE LTD.**, Cambridge Arterial Road, Enfield, Middlesex, require research assistants in connexion with work on electronic components, fuses, interference suppressors and television aeriels. Applicants must be graduates of the I.E.E. or possess equivalent qualifications together with similar laboratory experience. Salary will be commensurate with previous experience: five day week, contributory pension scheme. Applications must be detailed and concise, and will be treated as confidential. W 138

**BOLTON PAUL** Aircraft Limited have a vacancy in their Electronics Division for an experienced Development Engineer for work in connexion with analogue computers and applications to instrumentation and testing techniques. Some knowledge of servo-mechanism design in the electronic field will be an advantage. Applicant's should preferably possess an Honours Degree in Physics or Engineering. Write stating qualifications, age and experience to the Personnel Manager, Bolton Paul Aircraft Ltd., Wolverhampton. W 1461

**CHECKER** required by large established Company situated in East London area. Applicants should have extensive experience of the Line Telecommunication field. Good staff conditions and superannuation scheme in operation. Please write stating experience and salary required to Box No. W 2592.

**DECCA RADAR LIMITED** invites applications from Microwave, Electronic and Mechanical Engineers to join the company in its extensive work in a wide field of microwave link development. The Company offers good starting salaries and first rate opportunities for men to exploit their initiative and to rise rapidly to responsible posts. Graduates without industrial experience, who are prepared to undertake intensive training are also invited to apply. Write full details to Mr. S. R. Tanner, Decca Radar Limited, 2 Tolworth Rise, Surbiton, Surrey. W 2701

**DEVELOPMENT ENGINEER** required by small firm West Middx., making widely diverse range single and small quantities special instruments. Applicant should have wide knowledge circuitry preferably including pulse and high speed oscilloscope techniques. Some qualification desirable, experience essential. Salary range £10-£15 week, dependent experience. Write full particulars, Box No. W 1467.

**D. NAPIER & SON, LTD.**, Luton Airport, Beds., require Electronics Engineer of Degree or H.N.C. Standard for development work on experimental vibration analysis and the associated electronic measuring and 50D/39/24/R/1999 recording equipment in connexion with guided missiles projects. Applicants should apply to the Local Employment Exchange, stating age, qualification and salary required. W 2606

**D. NAPIER & SON LTD.**, The Airport, Luton, require: Electronic Engineer with good academic qualifications and practical experience, required for development work on vibration pick ups and associated equipment. Apply in first instance giving age, qualifications and salary required to local Employment Exchange. W 2573

**DRAUGHTSMEN**, Senior and Junior required. Experience in Electronics and Light Electrical Engineering an advantage. Apply by letter, stating age, nationality and experience to E.M.I. Engineering Development Ltd., Penleigh Works, Wells, Somerset. W 1414

**DRAUGHTSMEN** are invited to make an appointment with E.M.I. Research Laboratories to discuss the several vacancies which are available in their Drawing Office at Hayes. Vacancies exist for both Mechanical and Electro Mechanical Designs Draughtsmen on a variety of equipment offering maximum interest and good prospects. Confidential interview arranged without obligation, and arrangements for Saturday morning interview if necessary. Consideration given to holiday arrangements. Long term employment prospects and excellent pension scheme. Apply giving fullest details of experience, qualifications, etc., in the first instance to Personnel Department (ILT/R), E.M.I. Limited, Blyth Road, Hayes, Middlesex. W 2601

**DRAUGHTSMAN/CHECKER** required for Small Drawing Office, must have good knowledge of electronic equipment and small mechanical components. Technical Standard to at least O.N.C. or equivalent. Good prospects

and salary. Write, with full particulars quoting Ref. AGH to Box No. W 2597.

**E. K. COLE LIMITED** (Malmesbury Division), invite applications from Electronic Engineers for permanent posts in Development Laboratories engaged on long-term projects involving the following techniques: 1. Pulse Generations and Transmission. 2. Servo Mechanisms. 3. Centimetric and V.H.F. Systems. 4. Video and Feedback Amplifiers. 5. V.H.F. Transmission and Reception. 6. Electronics as applied to Atomic Physics. There are vacancies in the Senior Engineer, Engineer and Junior Grades. Candidates should have at least 3 years' industrial experience in the above types of work, together with educational qualifications equivalent to A.M.I.E.E. examination standard. Commencing salary and status will be commensurate with qualifications and experience. Excellent opportunities for advancement are offered with entry into Pension Scheme after a period of service. Forms of application may be obtained from Personnel Manager, Ekco Works, Malmesbury, Wilts. W 2321

**ELECTRICAL** test room assistants required urgently by well-known Scientific Instrument Company situated in North London. Technical education to O.N.C. standard an advantage. Box No. W 2560.

**ELECTRICAL ENGINEERS**, Age 25-30 with Degree or Higher National Certificate and practical experience in Servos, Electronics or Telecommunications, required for development work on low power servo systems. Apply with full particulars to Manager, Engineering Department and Labour, Vickers-Armstrongs, Ltd., Crayford, Kent. W 2563

**ELECTRONIC ENGINEERS** required for development work in the Gloucestershire area. Good academic qualifications and apprenticeship. Experience in one or more of the following desirable:- Control systems, D.C. Amplifiers, Computing Devices, Video Circuits, Microwave Techniques. Apply with full details of qualifications, age and salary required to Box No. A.C. 71443, Samson Clarks, 57/61 Mortimer Street, London, W.1. W 2604

**ELECTRONIC ENGINEERS** required for design work on aircraft electronic systems. Apply Employment Manager, Vickers-Armstrongs Ltd. (Aircraft Section), Weybridge, Surrey. W 2505

**ELECTRO-MECHANICAL** Engineers required with good academic qualifications, apprenticeship, theoretical background and knowledge of production methods for development work. Experience in electrical methods of computation, servo-theory and instrument design desirable. Apply with full details of age, experience and salary required to the Personnel Manager, Sperry Gyroscope Co., Ltd., Great West Road, Brentford, Middlesex. W 2528

**ERIE RESISTOR LTD.**, require Technical Sales Representative to call on manufacturers and wholesalers in London and the South. Applicants must have recent similar experience, and be fully conversant with modern radio and television technology from manufacturing angle. Remuneration by salary, car allowance and expenses. Written applications only, stating age, experience, and salary required, to Sales Manager, Carlisle Road, The Hyde, London, N.W.9. W 1454

**ESTIMATING ENGINEERS** are invited to apply for employment with a large Electro-mechanical Engineering Company situated in the London area. Applicants should have a specialised knowledge of radio components. The post offers excellent prospects of advancement with good staff conditions and a superannuation scheme in operation. Please write in confidence stating details of experience and salary required to Box No. W 2587.

**ESTIMATING ENGINEERS** required by large progressive Engineering Company situated in the West Country. Applicants should have extensive knowledge of automatic work, multi and single spindles, Capstan work and small machined assemblies. The vacancy is of a permanent and progressive nature, pension scheme in operation. Applicants please write in confidence stating qualifications and salary required to Box No. W 2700.

**EXPERIENCED ENGINEER** required by Company in North-West England for design and development of television aeriels and associated components. Write giving age, experience and salary required to Box No. W 1463.

**CLASSIFIED ANNOUNCEMENTS**  
continued on page 4



# Electrodeposited Rhodium

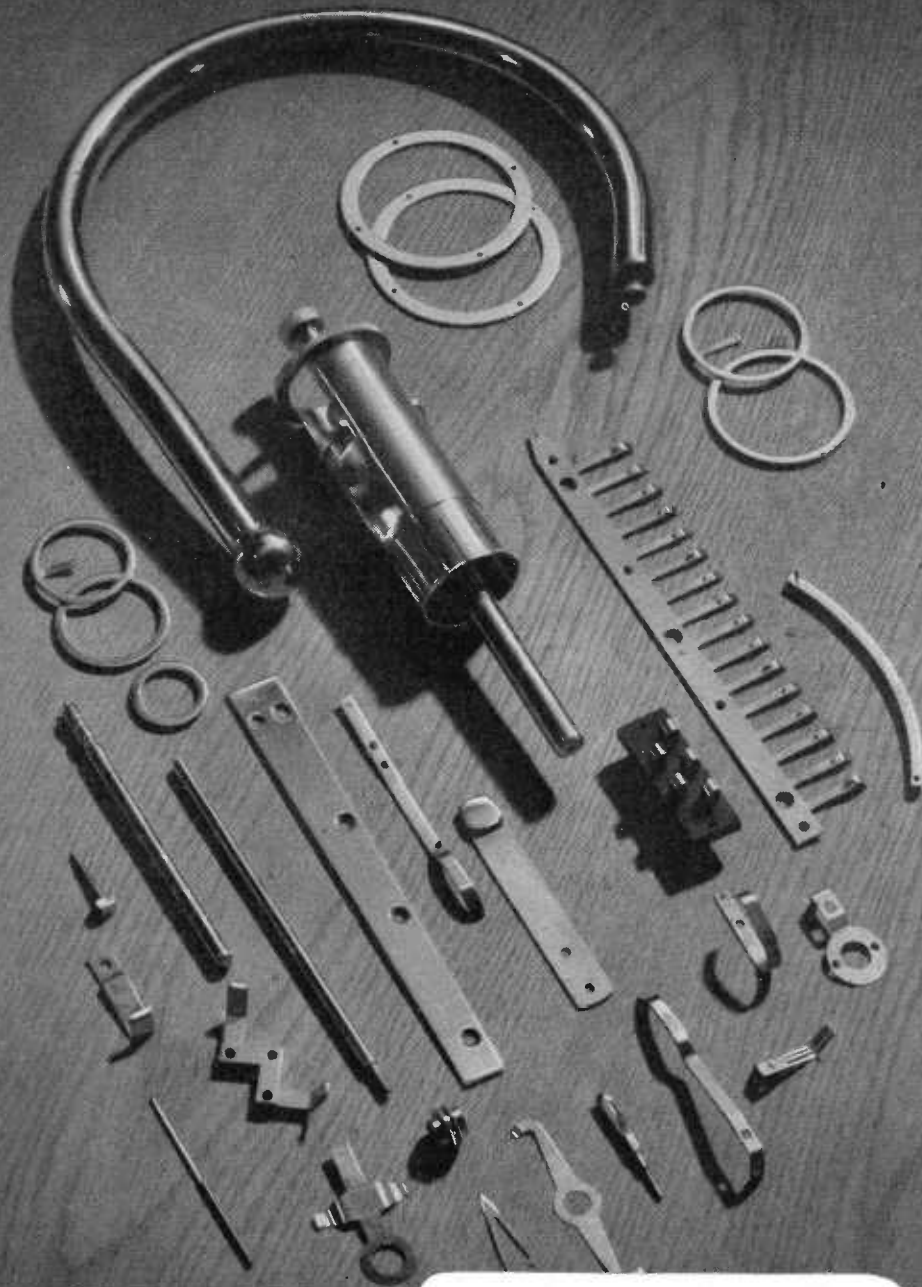

- Technical advice
- Comprehensive facilities —

*One of the Specialised Services of*

**Johnson**   
**Matthey**

JOHNSON, MATTHEY & CO., LIMITED HATTON GARDEN LONDON, E.C.1  
Telephone: HOlborn 9,277 BIRMINGHAM: Vittoria Street, Birmingham 1  
GD 221

**SITUATIONS VACANT (Cont'd.)**

*The engagement of persons answering these advertisements must be made through a Local Office of the Ministry of Labour or a Scheduled Employment Agency if the applicant is a man aged 18-64 inclusive or a woman aged 18-59 inclusive unless he or she, or the employment, is exempted from the provisions of the Notification of Vacancies Order, 1952.*

**FERGUSON RADIO** Corporation Ltd., Great Cambridge Road, Enfield, Middx, have vacancies for Senior and Junior Development Engineers in the radio and television fields. Previous experience of circuit development work essential. Write giving full details of qualification and experience to Chief Engineer, c/o Employment Manager. W 2608

**FERRANTI LTD.** have vacancies for Electronic Engineers in connexion with new developments in the Valve Dept. at Moston, Manchester. Applicants should have an Honours Degree in Physics or Electrical Engineering with vacuum physics or electronics as a subject. Experience in valve production techniques an advantage but not essential. Salary from £500 per annum according to qualifications and experience. Permanent staff appointments with superannuation. Forms of application from Mr. R. J. Hebbert, Staff Manager, Ferranti Ltd., Hollinwood, Lancs. Please quote Ref. Mil. W 2559

**FERRANTI LIMITED** have immediate vacancies for men with Electrical Engineering qualifications to undertake the advanced testing of naval anti-aircraft fire control equipment involving Electronics and servo mechanisms either in firms workshops or on board H.M. ships in home ports. Salary in accordance with age and experience between £356 and £650 per annum. Normal expenses plus a generous allowance are paid when working out. Previous experience of this type of work though desirable, is not essential. Forms of application from Mr. R. J. Hebbert, Staff Manager, Ferranti Ltd., Hollinwood, Lancs. Please quote reference H.G.N. W 2537

**FERRANTI LTD.** Moston Works, Manchester, have staff vacancies for circuit development work associated with a long-term telecontrol subject. Vacancies exist in the Senior Engineer, Engineer and Technical Assistant grades. Salaries: according to age and experience, for engineers and senior engineers, within the range £500 to £1,200 p.a., and for technical assistants between £400 and £600 p.a. Applicants should have a Degree in Physics or Engineering, Higher National Certificate, or its equivalent. The Company has a staff pension scheme. Application forms may be obtained from Mr. R. J. Hebbert, Staff Manager, Ferranti Ltd., Hollinwood, Lancs. Please quote reference N.H.S. W 2545

**GENERAL ELECTRIC Co., Ltd.**, Research Laboratories, Wembley, Middlesex, require an experienced Engineer or Physicist to lead a small research team and to advise project groups working on radar and radiocommunication problems. The work will be concerned with fundamental aspects in these fields and with centimetric measuring techniques, circuitry, aerials and propagation. Work will be at new laboratories at Stanmore. Apply to the Staff Manager (Ref. GBLC/699) giving age and details of experience and qualifications. W 2575

**H.F. HEATING ENGINEERS** are required by the English Electric Company for their Industrial Electronics Department. These vacancies are for junior and senior Engineers with good experience of valve type H.F. Heaters. These are permanent and progressive appointments offering excellent opportunities for qualified engineers or those with sound practical experience of this class of work. Interviews can be arranged for Saturday mornings. Write, giving full details and quoting Ref. 357D to Central Personnel Services, English Electric Company, Limited, 24/30 Gillingham Street, London, S.W.1. W 2570

**IMPERIAL COLLEGE** of Science and Technology. (City and Guilds College) Lecturer required in Electrical Engineering Department from 1st September, 1952, commencing salary between £600 and £800 in the Lecturer scale (according to experience and qualifications), with F.S.S.U. and Family Allowances. Industrial experience desirable, with special interests in vacuum electronic research. Applications, accompanied by full statements of qualifications and with references, should be sent to the Head of the Electrical Engineering Department, City and Guilds College, Exhibition Road, London, S.W.7, not later than 1st June 1952. W 2589

**INSTALLATIONS SUPERVISOR** required. Applicants are invited with experience of maintenance and test of small electronic and electro-mechanical devices. Additional mechanical knowledge an advantage. Qualifications—H.N.C. standard. Write stating age, experience and salary required: The Personnel Manager, Sperry Gyroscope Company, Ltd., Great West Road, Brentford, Middlesex. W 2576

**INSTRUMENT** assemblers and improvers required with some electrical knowledge for Scientific Instrument Company situated in North London. Box No. W 2561.

**LABORATORY ENGINEER** experienced in design and testing of electro-magnetic devices required by North London Instrument manufacturers. Details of experience and salary required to Box No. W 2593.

**LARGE** and well known group of companies is requiring the following for one of its progressive subsidiaries in the London area: Senior Electrical Design Draughtsmen preferably with some knowledge of radio or high frequency apparatus and able to direct junior staff. The above appointments are of a permanent nature and will carry adequate salaries to men of right experience and ability. The company's activities are expanding and these appointments offer an opportunity for steady progress. Applied High Frequency, Ltd., 52a Goldhawk Road, London, W.12. W 2580

**McMICHAEL RADIO LTD.**, require qualified Draughtsman with experience in the Mechanical Design of Radio and Electronic Instruments for the Government Services. Salary will be commensurate with ability. Write stating age, training, experience and salary required to The Chief Engineer, Equipment Division, McMichael Radio Ltd., Slough, Bucks. W 2453

**McMICHAEL RADIO LTD.**, require Senior Project Engineers in their Equipment Division Development Laboratory at Slough. Training and experience in the field of Applied Electronics (including Communications) and experience of working with Government Departments are the chief qualifications required. Salary will be commensurate with ability. Write stating age and full details of training, qualifications and experience to The Chief Engineer, Equipment Division, McMichael Radio Ltd., Slough, Bucks. W 2454

**MEN** with experience of Telephone Exchange Circuits for Research and Development work on the application of Electronics to Exchange working. Good salary and prospects offered. Apply Box No. W 1456.

**MURPHY RADIO LTD.**, offer the following vacancies in an expanding programme covering the field of domestic equipment and many branches of Electronic Development: (1) Senior Development Engineers having Degrees in Engineering or Physics with post graduate experience of equipment design who would be capable of leading a development team. (2) Development Engineers with similar academic qualifications having less or no industrial experience. (3) A Specialist Engineer with good academic qualifications having a sound knowledge of components and raw materials used in the Radio industry. This vacancy is only suitable for an applicant who is experienced in Electrical measurements and life testing of components. These posts are permanent and pensionable and offer good opportunities for advancement. Applications giving full details of experience and qualifications should be forwarded to the Personnel Manager, Murphy Radio, Ltd., Welwyn-Garden-City. W 2439

**MURPHY RADIO LIMITED** have vacancies for Designer Draughtsmen in their Electronic Division. A varied programme ensures opportunity of widening experience with excellent prospects. Apply giving particulars of training and experience to: Personnel Manager, Murphy Radio Ltd., Welwyn Garden City. W 2607

**NEW ZEALAND.** Applications are invited from suitably qualified persons for the under-mentioned vacancies in the Civil Aviation Branch, Air Department, New Zealand. Radio Engineers—Professional Engineers competent in one or more of the following: design and/or installation of radio communications, navigational aids, radar and electronic equipment. Applicants must hold either an Engineering Degree specialising in telecommunications, electronics and/or Graduate membership of the Institute of Electrical Engineers or its equivalent. Salary will be up to £950 N.Z. per annum for Corporate Membership of Institution of Electrical Engineers or equivalent and up to £770 N.Z. per annum for non corporate members. Radio Technicians for base radio

workshops, installation and general maintenance duties on radio/radar communications and navigational equipment. Applicants must hold a certificate of Radio Technology or equivalent, and experience in either pulse or continuous wave techniques is desired. Salary up to £770 N.Z. per annum as merited. Further details together with the necessary application forms can be obtained from—The High Commissioner for New Zealand, 415 Strand, London, W.C.2. mentioning this paper and quoting Reference No. 3/47/28. Completed applications should be lodged not later than 30 June 1952. W 2550

**ONE OR TWO** experienced Radar or Electronic Engineers, also Engineers experienced in Servo-mechanisms are wanted for a Guided Weapons project by English Electric Laboratory, Luton. Progressive posts with a starting salary of £600 to £1,000 per annum according to experience. Write giving full details quoting Ref. 456H, to Central Personnel Services, English Electric Company Limited, 24/30 Gillingham Street, London, S.W.1. W 2574

**PHYSICISTS. RADIO ENGINEERS.** Electronic Engineers. Positions for Senior and Junior Staff are available for Research and Development work on T.V., Electronics and Vacuum Physics. This Company is one of the Pioneers in the development of Television and is still in the forefront of Research and Development in this field. Our organisation is built up primarily to undertake research and development work, and we have a large Scientific and Technical Staff engaged on an increasing Government and Commercial programme. Excellent opportunities exist for progressive work on new and interesting developments. Requirements for Senior posts. A British University Degree, or its equivalent, in Physics, Electrical Engineering, or Communications Engineering. At least 5 years post graduate work on Research or development. Successful applicants will be placed in charge of Research or Development projects being carried out by the Company. Requirements for certain Junior posts. A British University Degree or its equivalent, in Physics, Electrical Engineering or communications Engineering. Practical experience not essential but an advantage. Requirements for other Junior posts. Ordinary National Certificate or equivalent, in Physics, Electrical Engineering or Communications Engineering. 3 to 5 years experience on Research, Development or Design of Radio, Electronic or T.V. equipment. Successful applicants for Junior posts will join groups working on Research or Development projects being carried out by the Company. Salary and facilities offered by the Company. Senior Engineers in range of £650-£1,000 p.a. Junior Engineers in range of £380-£650 p.a. depending on age, qualifications and experience. Pension scheme, 5-day week. Canteen facilities. Write, giving all particulars of experience, qualifications, age etc., to Personnel Department, Cinema-Television Limited, Worsley Bridge Road, Lower Sydenham, London, S.E.26. W 2579

**PRODUCTION MANAGER** required for radio and light electrical manufacturing. Must have had experience in modern production methods, time study, estimating, and laying out production lines. Apply in writing to Managing Director, R.M. Electric, Ltd., Team Valley, Gateshead, stating age, experience, and salary required. W 1452

**RADAR ENGINEER** preferably with experience of R.C.M. on centimetre wavelengths, required for laboratory within 30 miles of London. Progressive post. Starting salary £600-£1,000 per annum according to experience. House available to married man. Reply quoting reference DEF to Box No. W 2548.

**RADAR ENGINEERS.** Senior and Junior required with B.Sc.(Eng.) or Chartered Electrical Engineer Diploma, or equivalent. Applicants should have had at least three years experience in works and laboratory with experience on Pulse work preferably centimetric transmitters. Duties will involve acting as liaison between Development, Research Departments and the works. They will also be required to prepare Works Test specifications and advise on Test equipment. Write stating fullest particulars and salary required to Box No. W 2572.

**ROCKET MOTOR** design and development. Electronic and Electrical Engineers required for work on testing and instrumentation in this and rapidly expanding field, on a project connected

**CLASSIFIED ANNOUNCEMENTS**  
continued on page 6

# EKCO SCINTILLATION COUNTER TYPE N502

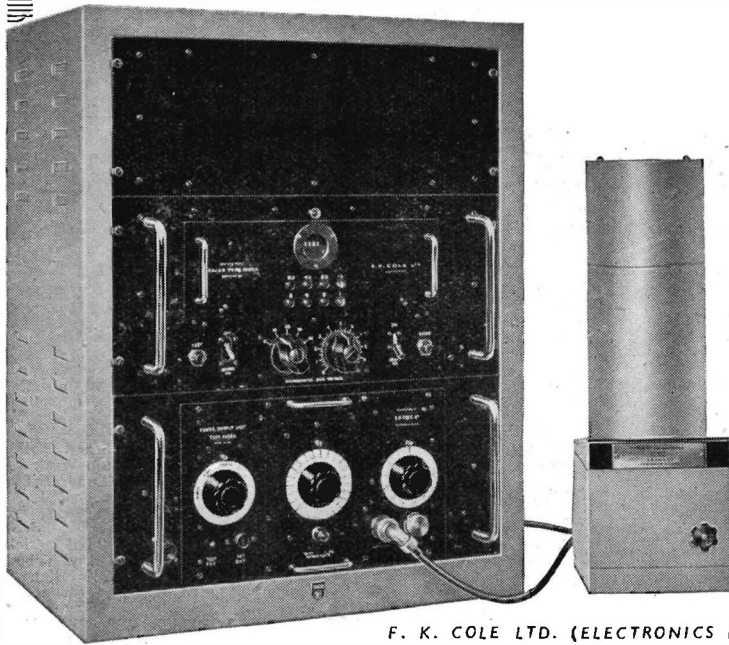

For the first time in this country EKCO make available a self-contained Scintillation Counter for the accurate measurement of Alpha and Beta particles and Gamma rays. A high-gain, low dark-current photo-multiplier tube, in a lead castle giving adequate shielding, is combined with a wide band fed-back linear amplifier thereby providing a self-contained unit suitable for use with an Ekco Scaler 1009A, a Ratemeter 1037A or other suitable counting equipment. In general, counting may be accomplished at higher rates and with much greater efficiency than with the conventional G.M. counter.

Full details of this and other Ekco equipment for the Radiochemical Laboratory will be sent on request

## EKCO ELECTRONICS

F. K. COLE LTD. (ELECTRONICS DIVISION) 5 VIGO STREET, LONDON, W.1

## Self-Tapping SCREWS

We manufacture these hardened self-tapping screws which are available on short delivery in all finishes. They can be supplied with Phillips recessed heads as well as with slotted heads, in two types, namely the fully pointed type A, and the blunt pointed type Z.

LINREAD LTD · COX ST · BIRMINGHAM 3



## SITUATIONS VACANT (Cont'd.)

The engagement of persons answering these advertisements must be made through a Local Office of the Ministry of Labour or a Scheduled Employment Agency if the applicant is a man aged 18-64 inclusive or a woman aged 18-59 inclusive unless he or she, or the employment, is exempted from the provisions of the Notification of Vacancies Order, 1952.

with the Guided Missile programme. Location near large industrial town in Midlands. Applications to Staff Officer, Box No. W 2577.

**SENIOR CIRCUIT ENGINEERS** are required by the English Electric Co., Ltd. Experience of designing time bases, stabilised power packs and cathode ray monitoring circuits is essential; a Degree and an interest in production development is desirable. Good salaries will be paid to those appointed to these responsible positions. Applicants should write, stating preference for London or Midlands area, giving full details and quoting reference 921A to Central Personnel Services, English Electric Co., Ltd., 24/30 Gillingham Street, London, S.W.1. W 2596

**SENIOR DRAUGHTSMEN** required for work on light current electrical and electronic equipment. Must be familiar with R.C.S. 1,000 specifications and production requirements. Technical standard to at least O.N.C. or equivalent. Write quoting Ref. ADD to Box No. W 2602.

**SENIOR AND JUNIOR Electronic Development Engineers** required. H.N.C. and Degree standard. Experience in U.H.F. and centimetric work an advantage. Apply by letter, stating experience, nationality and salary required, to E.M.I. Engineering Development Ltd., Penleigh Works, Wells, Somerset. W 1415

**SENIOR AND JUNIOR Electronic Engineers** required for development of Guided Missiles and other work of national importance. Good academic qualifications, a thorough knowledge of low frequency electronic circuits including D.C. Amplifiers, and practical design experience of lightweight electronic equipment are desirable. The posts are pensionable and offer good scope for a man to learn and develop new techniques and advance his position. Apply to the Personnel Manager, Sperry Gyroscope Co., Ltd., Great West Road, Brentford, Middx., giving full details of age, qualifications and experience and salary required. W 2605

**SERVICE ENGINEER** required having good knowledge of reciprocating aircraft engines and reasonable knowledge of electronic practice. Preference will be given to applicants with experience of electronic engine performance analysis. Successful applicant will be required to travel in U.K. and Continent. Salary commensurate with qualifications and experience, but not less than £450 p.a. Superannuation scheme. Apply with full details of age, experience and salary required to the Personnel Manager, Sperry Gyroscope Co., Ltd., Great West Road, Brentford, Middlesex. W 2489

**S. SMITH & SONS (ENGLAND) LTD.**, Bishops Cleeve, Cheltenham, require the following staff: Senior Engineer—to lead a section in the design and development of small servo systems including the application of gyroscopic and magnetic amplifier technique. This is a permanent post and carries superannuation benefits and housing assistance will be given to successful applicant. Commencing salary £900 to £1,200 dependent on age, qualifications and experience. Ref. 4/EN/G. Senior Mechanical Engineer—to control design and development of a wide range of Aircraft Instruments and allied equipment. Applicants should have a sound technical education with previous design experience in pressure sensitive elements and intricate mechanisms. Salary £900 to £1,200 depending upon age and experience. Ref. 5/EN/JM. Development Engineer—for development of high grade test equipment in connexion with manufacture of automatic pilots and aircraft instruments. Work involves application of electronic techniques over a frequency range from zero to approximately 100 k.c. c.p.s. together with light electrical and mechanical engineering. Preference will be given to applicants with experience of applied measurements in one or more of the above engineering fields but the foremost qualification is a sound appreciation

of fundamental engineering principles. Salary according to qualifications and experience. Ref. 1/EN. Development Engineers—senior and junior engineers experienced in the design of electronic test equipment including valve volt-meters, C.R.O., oscillators, etc. Applicants will be responsible for the development of research models to the production stage and must have a good fundamental knowledge of electrical theory and practical experience of design. Salary dependent on qualifications and experience. Ref. 2/EN. Development Engineers—for work on auto control and servo systems. Applicants with experience in low frequency electronic techniques, including the use of magnetic amplifiers. Preference given to those with previous experience in designing equipment for aviation requirements. Salary according to qualifications and experience. Ref. 3/EN. Write quoting Reference Numbers and giving qualifications and experience to the Personnel Manager. W 2568

**THE BRISTOL Aeroplane Company Limited.** invite applications for the following vacancies:—(a) Electronics Engineer, A.M. Brit. Radio Engineers, City and Guilds final tele-communications or equivalent, with a wide experience covering transmitters, receivers, aeri-als, test equipment, etc. (b) Electronics Instrument Maintenance Engineer, City and Guilds tele-communications or equivalent, with a wide experience of the maintenance of Electronic instruments. An ex-R.A.F. long service N.C.O. in the radio branch will also be considered. (c) Electronics Instrument Draughtsmen, City and Guilds tele-communications Grade 2, Ordinary National Certificate Electronics Engineering or equivalent, with experience in the design of Electronic Instruments and Apparatus. Application giving age, experience and qualifications should be addressed to the Ministry of Labour, 20 Nelson Street, Bristol, 1, and marked for the attention of the Personnel Manager. The Bristol Aeroplane Company Limited, Aircraft Division, Filton House, Bristol. W 2609

**THE GENERAL ELECTRIC CO., LTD.**, Browns Lane, Coventry, have vacancies for Development Engineers, Senior Development Engineers, Mechanical and Electronic, for their Development Laboratories on work of National Importance. Fields include Microwave and Pulse Applications. Salary range £400-£1,250 per annum. Vacancies also exist for Specialist Engineers in component design, valve applications, electro-mechanical devices and small mechanisms. The Company's Laboratories provide excellent working conditions with Social and Welfare facilities. Superannuation Scheme. Assistance with housing in special cases. Apply by letter stating age and experience to The Personnel Manager (Ref. CHC). W 2491

**THE RESEARCH Laboratories of Ericsson** Telephones Ltd., have vacancies for a number of Physicists and Electrical Engineers for work in the field of Electronic Computing and Switching and in new audio developments. Starting salaries for suitable qualified applicants in the junior grades are up to £670 p.a. Apply to Personnel Officer, Beeston, Nottingham. W 1455

## SITUATIONS WANTED

**ENGINEER** (28) G.I.Mech.E., Grad. I.P.E., N.C. & H.N.C. Mech Engrg., N.C. Elec. Engrg., 12 years experience works laboratory, D.O. (3½ years chief draughtsman), Mech. design and development, radar, electro-mech. and laboratory apparatus. At present development engineer process machinery, seeks progressive post in London. Please state nature and location of situation available. Box No. W 1466.

**LABORATORY TECHNICIAN** layout and complete construction electronic equipment from theoretical diagram without supervision skilled Engineer and Draughtsman. Box No. W 1448.

**TECHNICAL SALES Management.** Man, age 34. Four years experience sales management market research, etc. Electronics Engineer of proven ability. Top grade speciality selling. Requires position with future. Electronics, Radio, Television or Telecommunications. Box No. W 1465.

## FOR SALE

**AMERICA'S** famous magazine Audio Engineering, 1 year subscription 28s. 6d.; specimen

copies 3s. each. Send for our free booklet quoting all others; Radio Electronics, Radio and Tele. News, etc. Willen Limited (Dept. 9), 101 Fleet Street, London, E.C.4. W 108

**CONSTANT VOLTAGE TRANSFORMER.** Oil immersed. Output to 1 per cent. Tapped 200/250 volts, 750 watts. Sine wave output. £25. Telephone Frobisher 6762. W 1464

**ELECTRONIC HEATER** or Brazing Machine, by Electric Furnace Co., type T.10/4MW., Power input 15 KVA, Average Operating Frequency 500 k.c., Maximum output current 140 amps Radio frequency, suitable 380/440 Volts. 50 cycles, 3 phase, Spare Oscillator Valve, original cost £1,400 will accept offer. A. and B. Utilities, 42 St. Mary's Street, Southampton. W 1442

**FOR SALE** a first-class twin turntable dual speed disc recording equipment complete with amplifiers, spares and all accessories. New. Particulars from Crown Agents for the Colonies, 4 Millbank, London, S.W.1. (Reference O/PROD. 1465.) W 2599

**MAGSLIPS** at 1/10th to 1/20 of list prices. Huge stocks. Please state requirements. K. Logan, Westalloy, Hitchin, Herts. W 116

**MAGSLIP MOTORS** 3" mark 4. OS409A. 50v. 50CPS 3-phase, 3 terminals, overall length 5½", overall width 3¼". 5/16" spindle extends 11/16", 2,750 R.P.M. yellow end moulding. Brand new in sealed tin 30s. each, also other types. C.W.O. Spencer-Cooke, Lymans Road, Arlesey, Beds. W 1458

**MINIATURE STEEL BALLS** and Ball Bearings, Swiss and German Precision Work. Quick delivery. Distributors: Insley (London) Limited, 119 Oxford Street, London, W.1. Tel.: Gerrard 8104 and 2730. W 143

**PURE BERYLLIUM FOIL**, 0.005" thick and Beryllium Metal Discs for X-Ray Tube Windows; Elgar Trading Ltd., 240 High Street, London, N.W.10. W 141

**SOCKET SET SCREWS**, 4BA, 2BA, 3/16 dia. in stock. Your enquiries invited. C. A. Sale & Co., Ltd., 9 Park Hill, Clapham, S.W.4. Mac. 3526. W 1462

**TOROIDAL COILS** wound, and latest potted inductors to close limits. Bel Sound Products Co., Marlborough Yard, Archway, N.19. W 139

**WEBB'S** 1948 Radio Map of the World, new multi-colour printing with up-to-date call signs and fresh information; on heavy art paper, 4s. 6d., post 6d. On linen on rollers, 11s. 6d., post 9d. W 102

## EDUCATIONAL

**FREE!** Brochure giving details of courses in Electrical Engineering and Electronics, covering A.M.Brit.J.R.E., City and Guilds, etc. Train with the Postal Training College operated by an Industrial Organisation, Moderate fees. E.M.I. Institutes, Postal Division, Dept. E.E.29, 43 Grove Park Road, London, W.4. Chiswick 4417 (Associate of H.M.V.). W 2338

**CITY & GUILDS** (Electrical, etc.) on "No Pass—No Fee" terms. Over 95 per cent successes. For full details of modern courses in all branches of Electrical Technology send for our 144-page handbook—Free and post free. B.I.E.T. (Dept 337C), 17 Stratford Place, London, W.1. W 142

## SERVICE

**CAPACITY** available for manufacture of complete Instruments, Assemblies and Components. Capstans to ½" dia. Accurate Sheet Metal Work. Sherwood Products, 5 Rosemont Road, N.W.3. Ham. 6655. W 1470

**YOUR COPIES BOUND**, handsome volumes imit. Blue Leather, Gold Lettering. 10s. 6d. each, post free. C.W.O. Jerome Alcock, Cheadle, Stoke-on-Trent. W 1384

## WANTED

**WANTED.** Approximately 1 dozen magnetron or similar type permanent magnets any size suitable. Box No. W 1469.



**.. THAT  
CAN'T  
BE  
WORN**

When we are asked to state occasions where Tufnol's endurance has proved superior in action to more conventional materials, we bow our heads in modest confusion—since engineering and industry can show innumerable examples. This ball-race housing has

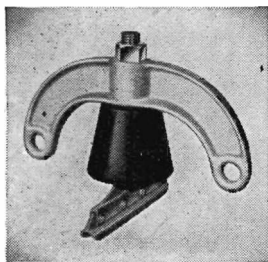

*A Bell Insulator supporting overhead conductors on a Coke Oven Plant. Hot and dusty conditions have no ill-effects on Tufnol.*

several advantages due to Tufnol's unique qualities alone: though extremely light in weight it stands up to impact, shock and grinding wear: and above all it's slight natural resilience means that it works 'sympathetically' with metals and substantially reduces wear

on the bearings. Tufnol, in fact, displays a balance of the virtues of both hardwood and metal—with few of their defects. Besides impressive shear, tensile and compressive strengths, good electrical

insulating qualities, and resistance to corrosion and moisture—add the fact that it machines easily and quickly and can be lubricated with water! Small wonder that Tufnol is gaining loyal allegiance from engineers everywhere.

**NEW KINGDOMS TO CONQUER . . .**

*Supplied in standard sheets, tubes, rods, bars, angles and channels, or to order in specially moulded blanks or finished parts, Tufnol's field of application is so vast that engineers are only just beginning to realise its possibilities. Literature is available dealing with its conquests up to the present date. Our technical staff will co-operate enthusiastically on any NEW use for Tufnol you may find.*

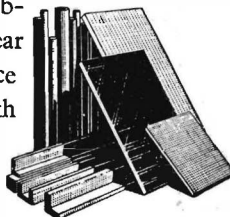

**TUFNOL**  
REGISTERED TRADE MARK  
An ELLISON Product

**TUFNOL LTD • PERRY BARR • BIRMINGHAM • 22 B**

256

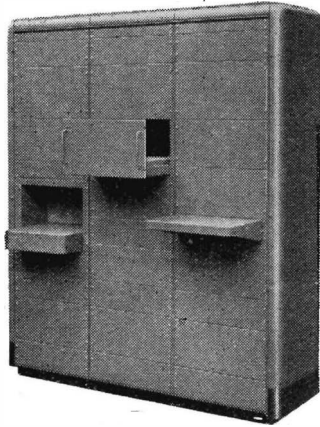

Imhof's enclosed racks and instrument cases are standard articles, giving you quick delivery, low prices based on quantity production, with no design worries or tool charges. They are available in any quantity.

Standard enclosed racks are made in 4 ft. and 6 ft. high units, 19 in. deep and taking standard 19 in. rack panels. Semi-standard units are made 24 in. deep and/or taking 22½ in. panels. Accessories available include panels, chassis, chassis runners (plain or telescopic), mobile bases, gram unit, desk unit, handles, etc. Enclosed racks can be supplied in any non-standard size desired at approximately 40 to 50 per cent increase in cost, according to quantity.

Twenty-two different sizes and types of standard cases are made, designed to meet the main needs of electronic instrument housing. Chassis, brackets, handles, etc., are available, and the standard rack accessories are interchangeable with the 'R' series cases.

We also design and make special cases for any purpose and are equipped to manufacture, in bulk, cases, racks, etc., to customers' specifications.

# RACKS AND CASES

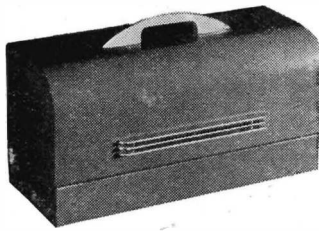

Please write for our 1952 Catalogue, giving full information on our standard range of cases, racks, etc., and latest Price List.

**IMHOF'S**

**ALFRED IMHOF LIMITED**

**112-116 NEW OXFORD STREET, LONDON, W.C.1. MUSEUM 7878**

## Three "Electronic Engineering" Monographs

### RESISTANCE STRAIN GAUGES

By J. Yarnell, B.Sc., A.Inst.P.  
Price 12/6

This book deals in a practical manner with the construction and application of resistance gauges and with the most commonly used circuits and apparatus. The strain-gauge rosette, which is finding ever wider application, is treated comprehensively, and is introduced by a short exposition of the theory of stress and strain in a surface.

### ELECTROPHYSIOLOGICAL TECHNIQUE

By C. J. Dickinson, B.A., B.Sc.  
(Magdalen College, Oxford)  
Price 12/6

The author describes the use of electronic methods as applied to research in Neurophysiology. Chapters are devoted to amplifying, recording and stimulating techniques used in physiology and medicine (e.g. electrocardiography, electroencephalography, etc.

### VOLTAGE STABILIZERS

By F. A. Benson, M.Eng.,  
A.M.I.E.E., M.I.R.E., University of Sheffield.  
Price 12/6

This monograph describes the various devices employing saturated elements, glow-discharge tube circuits and thermionic valve arrangements for voltage stabilization. A comprehensive bibliography is included.

Order your copy through your bookseller or direct from:—

**Electronic Engineering**

**28 ESSEX STREET, STRAND, LONDON, W.C.2**



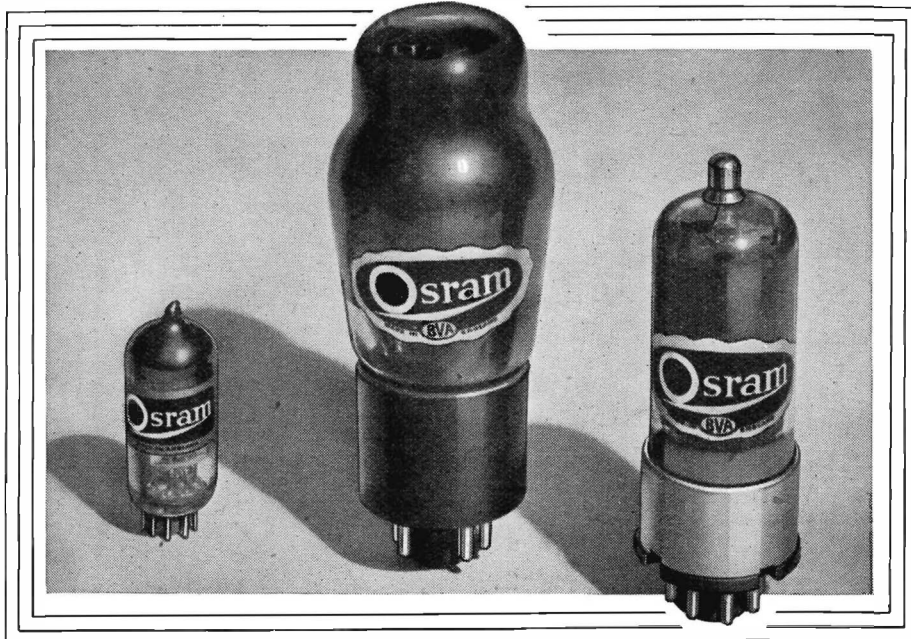

**D77.** Double-diode. Vision detector and sync separator.

**KT61.** High sensitivity output tetrode. Frame T.B. output and sound output.

**DH63.** Double-diode-triode. Sound detector and A.F. amplifier.

# Osram VALVES

*are recommended for  
the 'VIEW MASTER' television receiver*

Only by using the valves specified can you be sure of the best results from your "View Master."

The designers have found that the valves illustrated are the best for the job.

Use Osram valves for their proved consistency of performance.

**Also specified :** *G.E.C. 9-inch cathode ray tube 6504A, or alternatively, the 12-inch tube 6705A may be used without circuit alteration.*

---

THE GENERAL ELECTRIC CO. LTD., MAGNET HOUSE, KINGSWAY, W.C.2



**when ship speaks to ship**

Only by trouble-free radio communication can ships be kept safely on their courses, in constant touch with each other, receiving and passing on weather information and warnings.

No wonder then, that so many insist on G.E.C. Quartz Crystal Units in their radio equipment—they know from experience that only the best is good enough for this critical component.

●  
*Write for list QC 5012 (R)*

**SALFORD ELECTRICAL INSTRUMENTS LTD · SALFORD 3 · LANCs**  
A SUBSIDIARY OF THE GENERAL ELECTRIC CO. LTD. OF ENGLAND

---

# 'ENGLISH ELECTRIC'

## electronic insulation tester



### Designed for industrial electrical testing

It provides for the first time **10-kV D.C.** in a truly portable equipment having the following outstanding features :

**Non-lethal output adjustable from 500 to 10,000-volts.**

**Measurement up to 250,000 megohms.**

**High accuracy on comparative tests.**

**Rejection of surface leakage current.**

**Aural indication of ionisation.**

Price **£55** · Size : 15" × 10" × 6" · Weight : 23 lbs.

---

The **ENGLISH ELECTRIC** Company Limited

QUEENS HOUSE, KINGSWAY, LONDON, W.C.2

Industrial Electronics Dept. Stafford

Works : STAFFORD · PRESTON · RUGBY · BRADFORD · LIVERPOOL

EIN. I.



# new

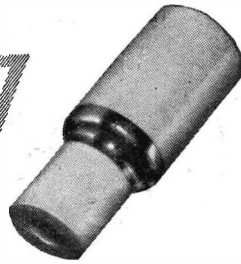

## **METALLISED CERAMICS FOR HERMETIC SEALS**

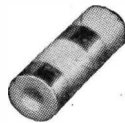

*Steatite & Porcelain Products present an outstanding advance in the technique of metallising ceramics ; they can now offer ceramic bushes for hermetically sealed components free from all shortcomings common to earlier types of metallising*

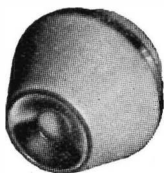

There are five important advantages of the new process:

- 1** The new metallising is robust and highly resistant to solution in any soft solder alloys.
- 2** Any method of soldering may be used, without precautions of controlled temperature and soldering time; no special skill in soldering is necessary for consistent results.
- 3** The new metallised ceramics may be repeatedly mounted and demounted: they may be removed from faulty or broken-down components and used again.
- 4** High melting-point soft-solders (such as silver-lead) may be used in assembly of these new

metallised ceramics. Thus, all risk is eliminated of failure of the hermetic sealing during component assembly into equipment.

- 5** No gas or oil leakage can occur—the bond between the new metallising and the ceramic is stronger than the ceramic itself.

### **SEND FOR FULL DETAILS**

The new metallising is applied to all the hermetic seals of the standard range (shown in catalogue No. 25, available on request). Special types, including multi-seals, can readily be produced to customer's requirements. Please write to us for further details. We shall be glad to answer any queries on the new metallised ceramics.

**STEATITE & PORCELAIN PRODUCTS LTD**

STOURPORT-ON-SEVERN WORCESTERSHIRE TEL : STOURPORT 111 GRAMS : STEATAIN STOURPORT



SP79

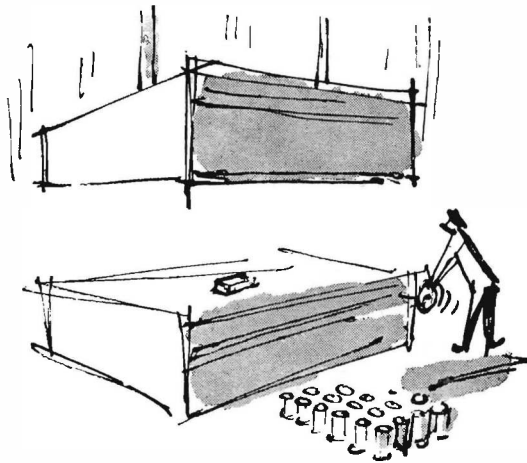

**for can making presses**

**or plane shaking stresses**

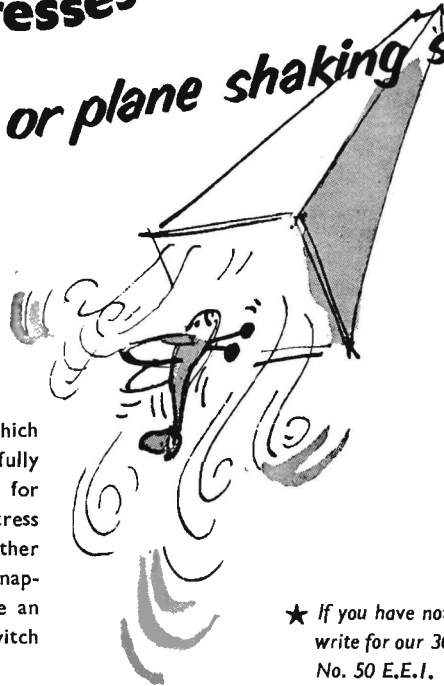

There's no limit to the applications in which BURGESS Micro-Switches have been successfully employed. Thickness control of steel sheets for can-making . . . and for actuating the stress recorders in airplane test rigs are just two further examples showing the adaptability of these snap-action precision-built switches. When you have an automatic switching problem, our Micro-Switch Division will be most happy to assist you.

★ If you have not already done so write for our 30 page Catalogue No. 50 E.E.I.

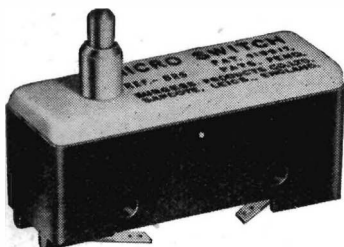

*Industries Automatic Choice*

BURGESS PRODUCTS CO. LTD. Micro-Switch Division, Dukes Way, Team Valley, Gateshead II. Tel.: Low Fell 75322/3



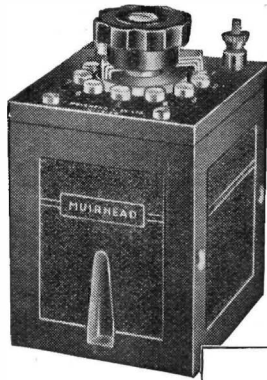

# UNIVERSAL UNITS

RESISTANCE • CAPACITANCE • INDUCTANCE

**I**N education and in industry, these units find a host of applications. There is a physical reality about them which appeals to the elementary student and which is necessarily missing from the more expensive boxes where switches are hidden mysteries and connexions must be taken on trust. This unit form of construction is economical and very convenient, and the moulded containers are sensibly engineered, so that fixing to a panel or to each other is quite simple.

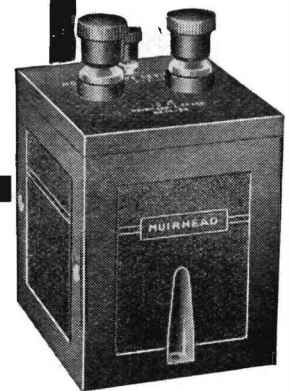

WRITE FOR DESCRIPTIVE LITERATURE

**MUIRHEAD & Co., LTD.**

PRECISION ELECTRICAL INSTRUMENT MAKERS

BECKENHAM • KENT • ENGLAND

Telephone: BECKenham 0041 Telegrams & Cables: MUIRHEADS ELMERS-END

PRECISION

**MUIRHEAD**

ELECTRICAL INSTRUMENTS

54K



**DECCA RADAR LTD offer**

**RESEARCH ENGINEERS**

**DESIGNERS**

**DEVELOPMENT ENGINEERS**

**SERVICE ENGINEERS**

**a career with a future**

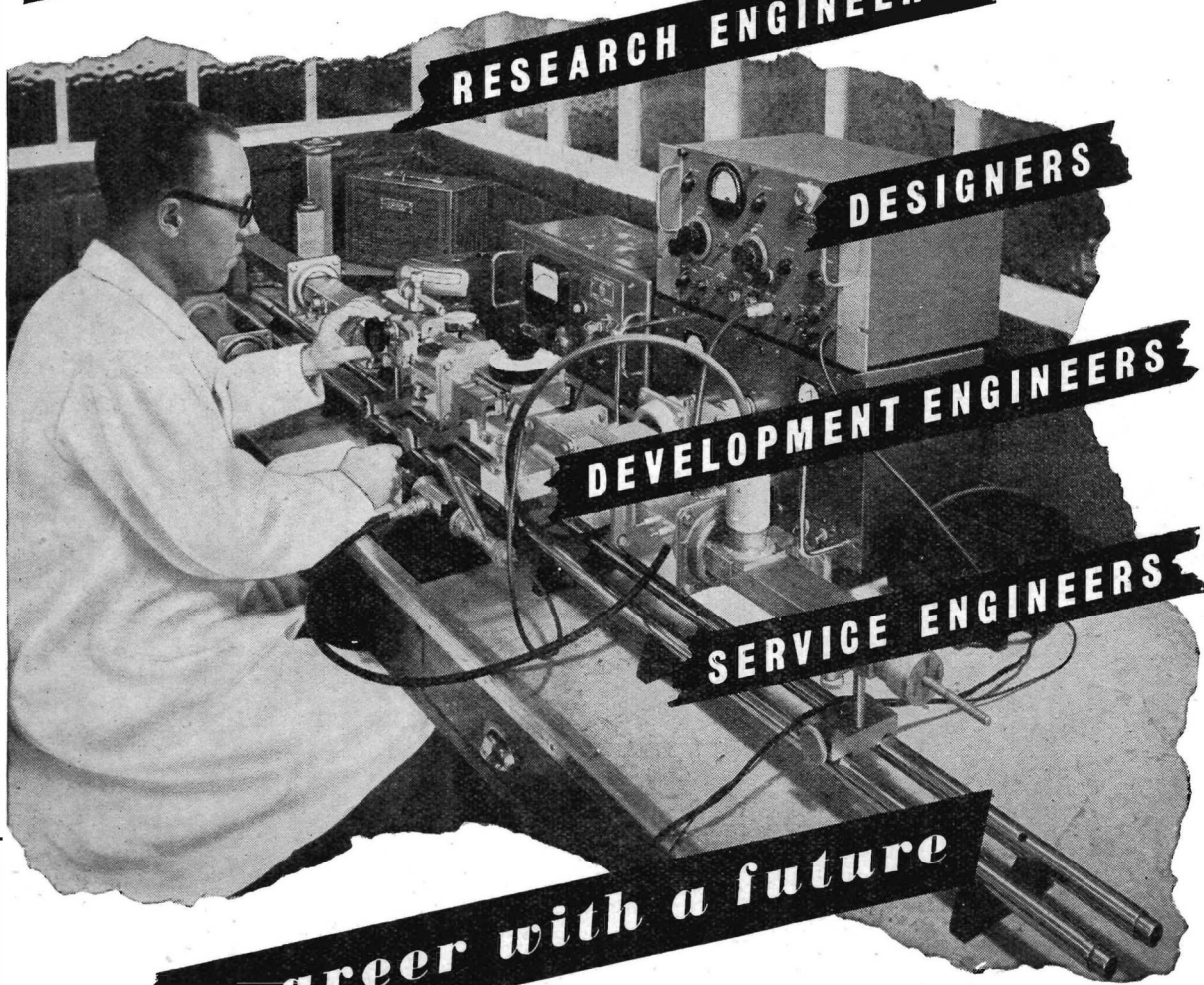

In the past two years, we have established ourselves at the forefront of British radar research and design. The quality of our Marine Radar is now world famous, and we are engaged in a large scale programme of equipping Merchant and Naval vessels.

We have well-equipped Laboratories and an outstanding team imbued with a strong spirit of enterprise and enthusiasm. We have before us a far-reaching programme of research and development in the field of centimetric radar and we can offer to men of outstanding merit, a chance to join a progressive Company where interesting and vital work is to be found and excellent opportunities exist. Men of ability who are prepared to work hard to achieve success are invited to write to us in confidence, giving details of experience, qualifications, age and salary required. Letters should be addressed to the Managing Director. (See below)

*Applicants not excepted from the provisions of the Notification of Vacancies Order, 1952, should apply through a local office of the Ministry of Labour or a scheduled employment agency.*

**DECCA RADAR LIMITED, 1-3, BRIXTON ROAD, LONDON, S.W.9. RELIANCE 4421**

# Microwave Test Gear

Metropolitan-Vickers Electrical Company announce that a complete range of precision microwave test gear is available for use in 3 in.  $\times$  1½ in. waveguide over a band of wavelengths from 10 to 11 cms.

## **PRECISION ATTENUATOR** *Type 501*

A highly stable metallised glass vane forms the attenuating element in this instrument, which is capable of an accuracy of .02 db.

## **VARIABLE ATTENUATOR** *Type 502*

This is a level-setting attenuator, employing a resistance card element.

## **FIXED ATTENUATORS** *Type 519, 520*

These are intended as "padding" attenuators, and have values of 10 db and 20 db respectively.

## **OSCILLATOR** *Type 508*

A low-voltage, "plug-in" reflex klystron type CVZ116 is used in oscillator type 508. A power output of 100 milliwatts is available from about 9.7 cms. to 11.2 cms. wavelength.

## **SHORT CIRCUIT** *Type 510*

This instrument provides a very low loss wave guide short circuit which is accurately variable in position.

## **STANDING WAVE DETECTOR** *Type 512*

This standing wave detector is a precision instrument, embodying several new features of mechanical and electrical design.

## **WAVE METER** *Type 517*

The wavelength range from 10.2 cms. to 11 cms. is covered by this extremely accurate cavity wavemeter.

## **MATCHED LOAD** *Type 506*

This is a convenient laboratory load, which has a VSWR of .98 from 10.4 cms. to 11 cms. wavelength.

## **HIGH POWER LOAD** *Type 515*

Peak powers of 2 megawatts and mean powers of 3 kilowatts can be absorbed in this water load. Thermometers are fitted to enable calorimetric measurements to be made.

## **DIRECTIONAL COUPLERS** *Type 504 and 505*

The through attenuation of these couplers is 20 db and 40 db respectively. They are designed for high directivity over a wide band.

## **S AND X BAND SPECTROMETER** *Type 518*

This is a superheterodyne spectrometer, with interchangeable S-band and X-band units. It incorporates a calibrated attenuator.



**METROPOLITAN-VICKERS ELECTRICAL CO. LTD., TRAFFORD PARK, MANCHESTER 17**

*Member of the A.E.I. group of companies*

**METROVICK**

*Test gear for the microwave laboratory*

R/E 202



# PHASE MEASURING EQUIPMENT TYPE RX103

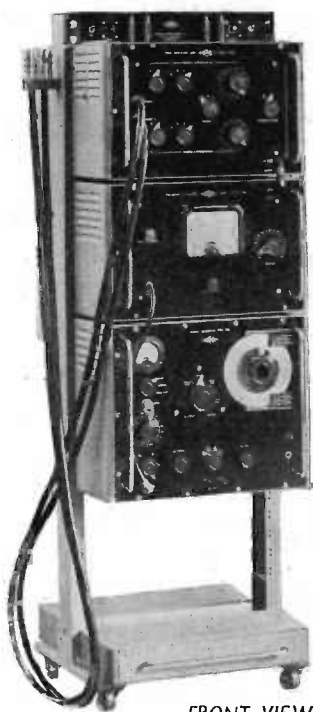

FRONT VIEW



REAR VIEW

This equipment has been developed and manufactured by Airmec Laboratories from a General Post Office Research Branch design. It was primarily intended for the measurement of the loop phase-shift and gain of feedback repeaters over the frequency range 50 kc/s-20 Mc/s, but it is equally suitable for the measurement of these quantities in amplifiers, filters, equalisers and other four terminal networks.

*Full details of this or any other Airmec instrument will be forwarded gladly upon request*

**AIRMEC** LABORATORIES **LIMITED**  
HIGH WYCOMBE • BUCKINGHAMSHIRE • ENGLAND  
TEL. : HIGH WYCOMBE 2060 CABLES : AIRMEC HIGH WYCOMBE

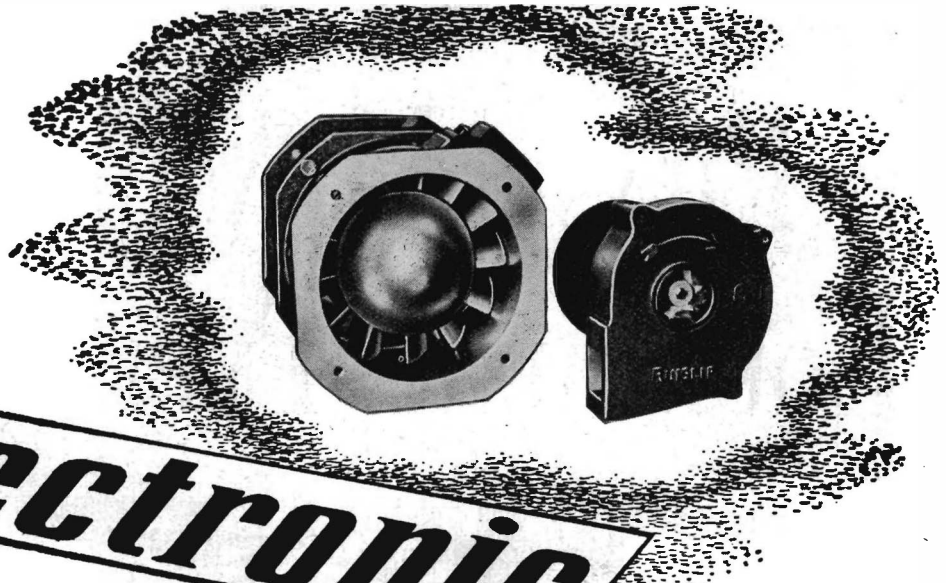

# *electronic* COOLING

The wide range of blowers for force-cooling of valves and maintenance of desired temperature levels in electronic and general electrical apparatus is typical of the progress maintained by **ADI**. The illustration shows the smallest of the blowers (4" Axial Flow type and 2½" Centrifugal type), but our range covers duties from 5 c.f.m. up to many thousands of c.f.m. at pressures up to 45 or more inches w.g. These blowers are used in MARINE & AERODROME RADAR INSTALLATIONS, AIRCRAFT AUTOMATIC PILOTS, COMMUNICATION AND BROADCASTING STATIONS, R.F. HEATING EQUIPMENT, Etc. Let us know your application—we shall be pleased to put forward our proposals.



Complete  
Air Treatment  
Plant

**AIR CONTROL INSTALLATIONS LTD.**

Manchester

**RUISLIP, MIDDX.**

Glasgow

Telephone: Ruislip 4066 (8 lines)

Telegrams: Controlair, Ruislip





# Electronic LEAK DETECTOR

*Convenient*  
*Accurate*  
*Sensitive*

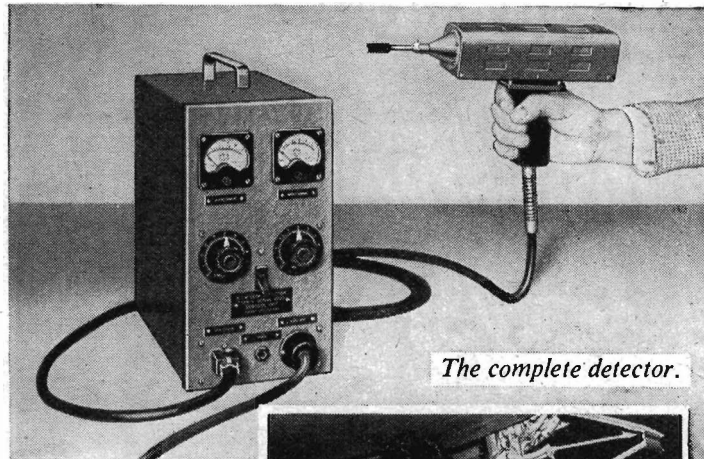

Leaks in containers or pipes imperceptible by other means can be easily and accurately located by the BTH Type H Electronic Leak Detector. This instrument, developed in the BTH Research Laboratories to detect the vapours of halogen compounds in air, is sensitive enough to react to Arcton ( $CCL_2$ ,  $F_2$ ) escaping from a container at the rate of 1/50 oz. per year. The detector is easily portable—eminently suited to use in the laboratory, on the assembly line, or for service testing in the field. Applications include testing of refrigeration and air-conditioning plant which already contains a halogen-bearing compound, and leak-testing of tanks, pipes, joints, welds, pneumatic systems, etc., by introducing a suitable "tracer" gas into the system under test.

The detector emits, by means of a small built-in sounder, a series of clicks; a change of frequency denotes the presence of a leak. For work in noisy surroundings headphones are available.

*Illustrations show use of the detector in examining for leaks (A) Aircraft pneumatic system (B) Pressure vessels (C) Gas-filled cable junction box.*

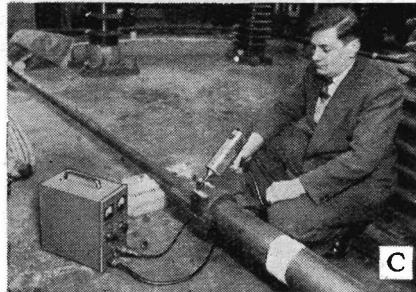
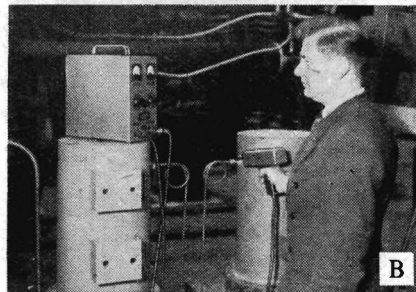
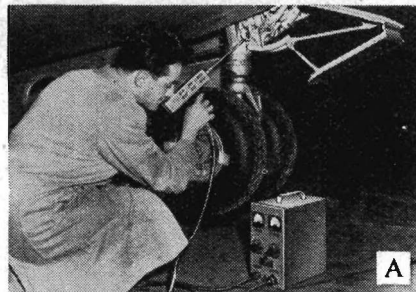

THE  
**BRITISH THOMSON-HOUSTON**

COMPANY LIMITED, RUGBY, ENGLAND

Member of the AEI group of companies

A 4292

*Ceramic  
Switches  
by*

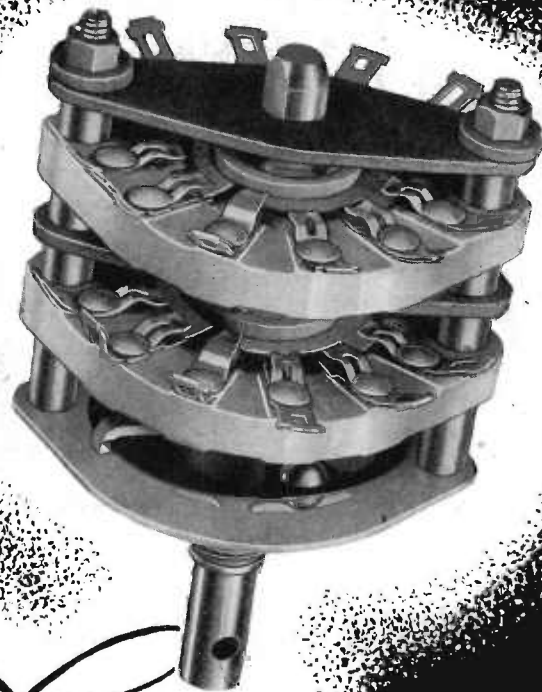

A. B. Metal Products are proud to announce that their famous H Type range of Switches is now available with "CERAMIC" insulation.

Stators and Rotors are manufactured in best quality electrical Porcelain, giving the highest degree of insulation, together with first-class Radio frequency Characteristics.

Early deliveries can be quoted, and we invite your enquiries.

*Write for illustrated brochure :—*

# **A. B. Metal Products Ltd**

16, BERKELEY STREET, LONDON, W.1.

'Phone : Grosvenor 5206/7

---

*It Seems..*

*It may be*

*It looks..*

*It might..*

*It could be —*

**be SURE!**

***MARCONI instruments* will give you  
the right answer . . . . . that's their job**

SIGNAL GENERATORS · BRIDGES · VALVE VOLTMETERS · Q METERS · FREQUENCY STANDARDS  
OUTPUT METERS · WAVE METERS · WAVE ANALYSERS · BEAT FREQUENCY OSCILLATORS

MARCONI INSTRUMENTS LIMITED · ST. ALBANS HERTS · PHONE: ST. ALBANS 6161/7

---

Is **VF** \*

*spoiling your output?*

Whenever the successful operation of apparatus or plant depends on an absolutely constant mains voltage, then "V.F."\* (Voltage Fluctuation) can have disastrous effects. Every variation results in loss of efficiency, and output suffers accordingly. That is why BERCO and B.P.T. voltage and current regulating equipment plays an important part in well planned organisations all over the world.

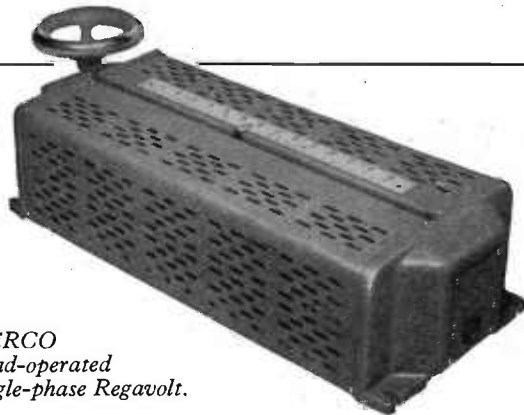

*BERCO  
hand-operated  
single-phase Regavolt.*

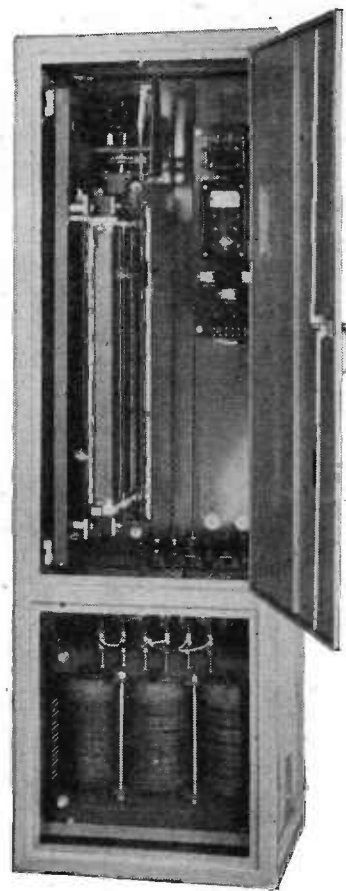

*Typical BERCO/BPT three phase  
Automatic Stabiliser 30 kVA.*

For constant voltage use a model from the wide range of Automatic Stabilizers made by British Power Transformer Co. Ltd., for single and three phase supplies.

For variable voltage select a "Regavolt" from the wide range of models made by The British Electric Resistance Co. Ltd. Interesting information and full performance details given in booklet No. C1011.

**THE BRITISH ELECTRIC RESISTANCE CO. LTD.**  
**BRITISH POWER TRANSFORMER CO. LTD.**  
Queensway · Ponders End · Middlesex

Telephone : HOWard 1492

Telegrams : "Vitrohm Enfield"

B.R./BP/1011T



# 10 advantages of **SELENIUM SenterCel RECTIFIERS** miniature selenium rectifiers

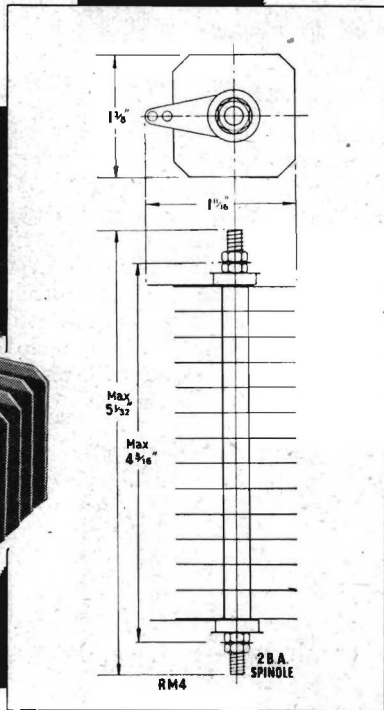
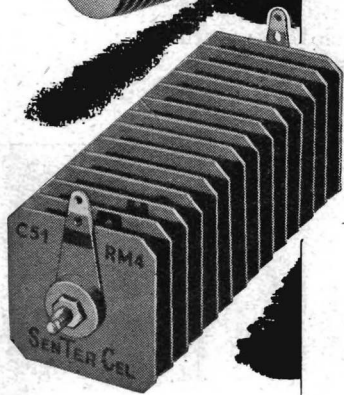
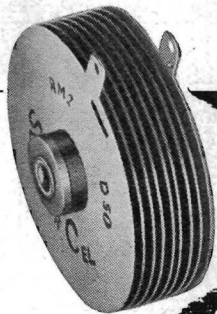
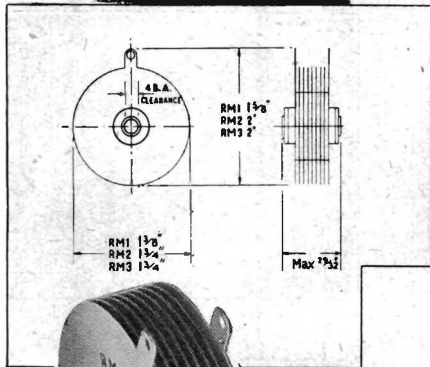

Compare these outstanding features with those of the rectifiers which at present you are using:—

- Less wiring
- Unlimited instantaneous overload such as the charging current of de-formed electrolytic capacitors, or even a short circuit.
- Far lower heat dissipation.
- No "warming-up" period.
- No valve-holder.
- Practically indestructible in normal service.
- No limit to size of electrolytic capacitor.
- Saves weight.
- Saves space.
- Low in cost.

## Study these RATINGS

TYPE	RM1	RM2	RM3	RM4
Maximum ambient temperature	35°C 55°C	35°C 55°C	35°C 55°C	35°C 40°C 55°C
Maximum output current (mean)	60mA 30mA	100mA 60mA	120mA 90mA	275mA 250mA 125mA
Maximum input voltage (r.m.s.)	125V	125V	125V	250V
Maximum peak inverse voltage	350V	350V	350V	700V
Max. instantaneous peak current	Unlimited	Unlimited	Unlimited	Unlimited
Weight	1 oz.	1.4 oz.	2 oz.	4.5 oz.



**Standard Telephones and Cables Limited**

(Registered Office: Connaught House, Aldwych, W.C.2)

**RECTIFIER DIVISION:** Warwick Road, Boreham Wood, Hertfordshire.

Telephone: Elstree 2401 Telegrams: Sentercel, Borehamwood

# The "Belling-Lee" page for Engineers

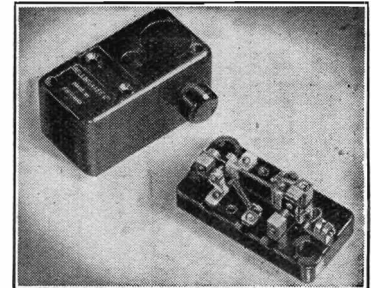
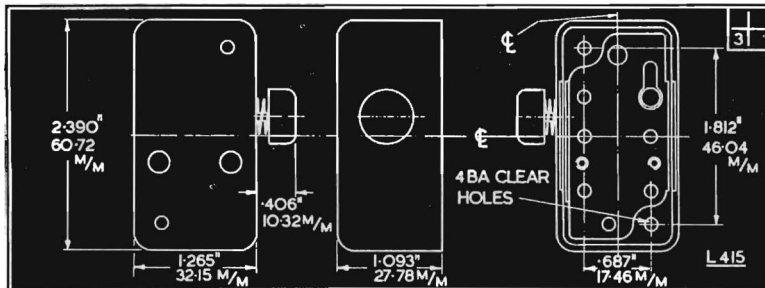

## THERMAL DELAY SWITCHES

### LIST NUMBERS

L.413	L.423
L.415	L.424
L.417	L.395

Thermal delay switches for use with motor drives, electrical tools, etc.; also for application to non-critical process timing. The type illustrated above (List Number L.415) shows a manual resetting switch.

Where an automatic self-resetting type is required, these are available under List Number L.413 (illustrated below).

Apart from the resetting mechanisms, the general arrangement and electrical characteristics of the two types are similar. Each is fitted with Standard instrument contacts which will break a maximum current of 4 amps. at 250 volts A.C., or 2 amps. at 50 volts D.C.

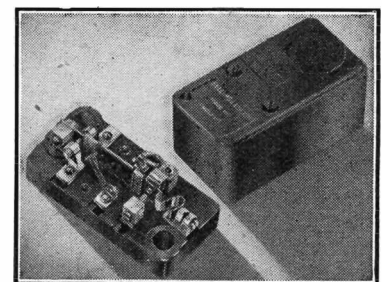
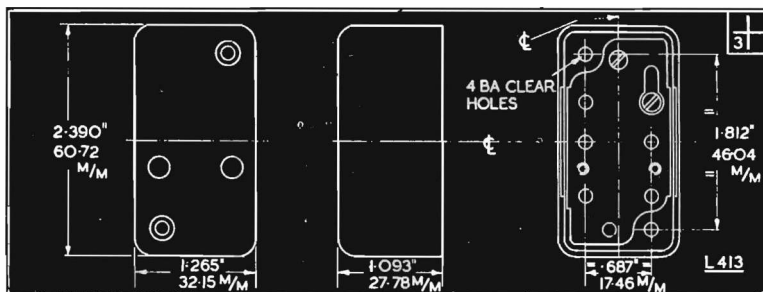

### FURTHER DETAILS ON APPLICATION

They can also be supplied to special orders, to break up to 20 amps. at 250 volts A.C. or 5 amps. at 100 volts D.C.

The maximum continuous rating is 10 amps.; normal heater loading for continuous operation, 3-4 watts at any voltage up to 50 volts A.C. or D.C.

For intermittent operation, a heater loading up to 25 watts is permissible. The heater may be in series with main contacts, or independent, being insulated for 250 volts A.C. working potential to bi-metal.

Please write for illustrated pamphlet Ref. P.377

**BELLING & LEE LTD**  
CAMBRIDGE ARTERIAL RD., ENFIELD, MIDDX., ENGLAND

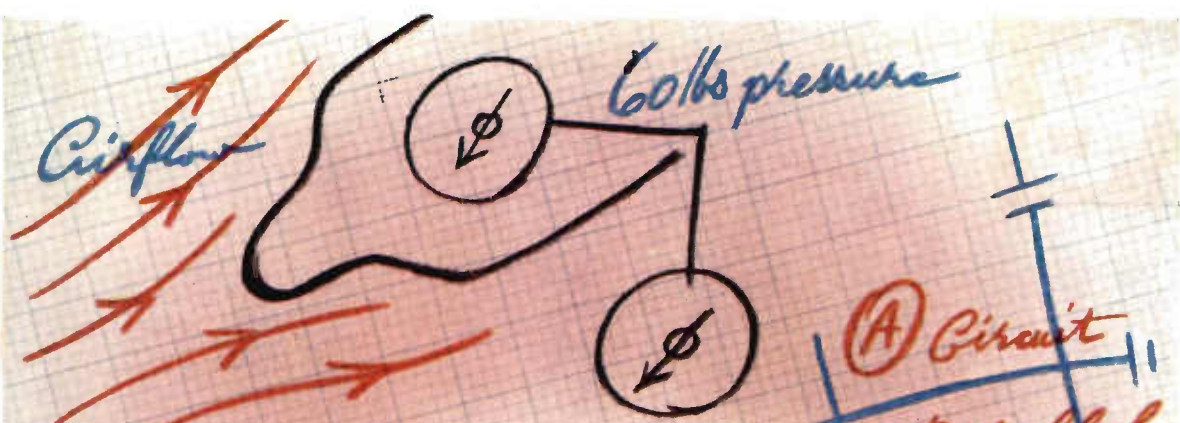

## MAKING DOODLES WORK

Pass the rough outline of something new and how it must perform to Plessey, who will develop, test, and produce a prototype—your idea brought to life with shrewd refinements. And it will be easy to manufacture, in quantity, cheaply. That is Plessey design and development in simple terms. It can also be expressed in figures—more than 10,000 workers, over twenty acres of design offices, laboratories and production equipment. Or, if you remind us that capacity needs to be mental as well as physical, take this example :

the Electronic Revolution Counter at the Royal Aircraft Establishment, which measures the speed of jet engines with an accuracy of one in a thousand, was developed in collaboration with RAE and produced throughout by Plessey.

Now you have some idea of the unique combination of technical brain and mechanised brawn at your command. Executives in industry or Government service may like us to explain how . . .

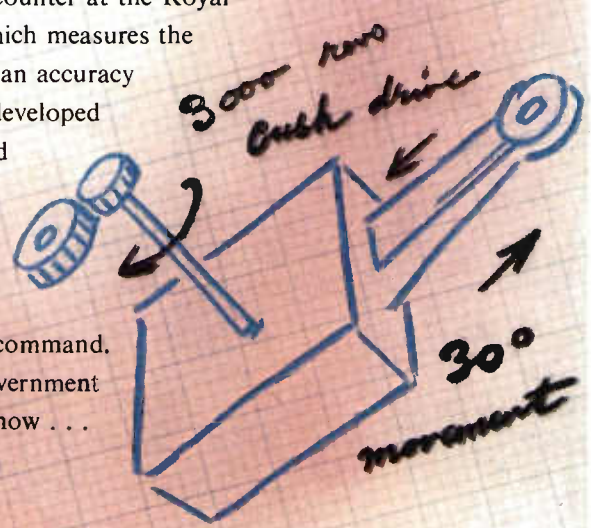
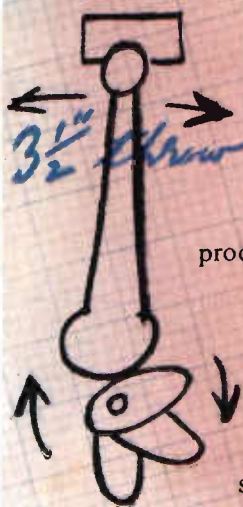

**Plessey** PUTS IDEAS INTO PRODUCTION

THE PLESSEY COMPANY LIMITED · ILFORD · ESSEX



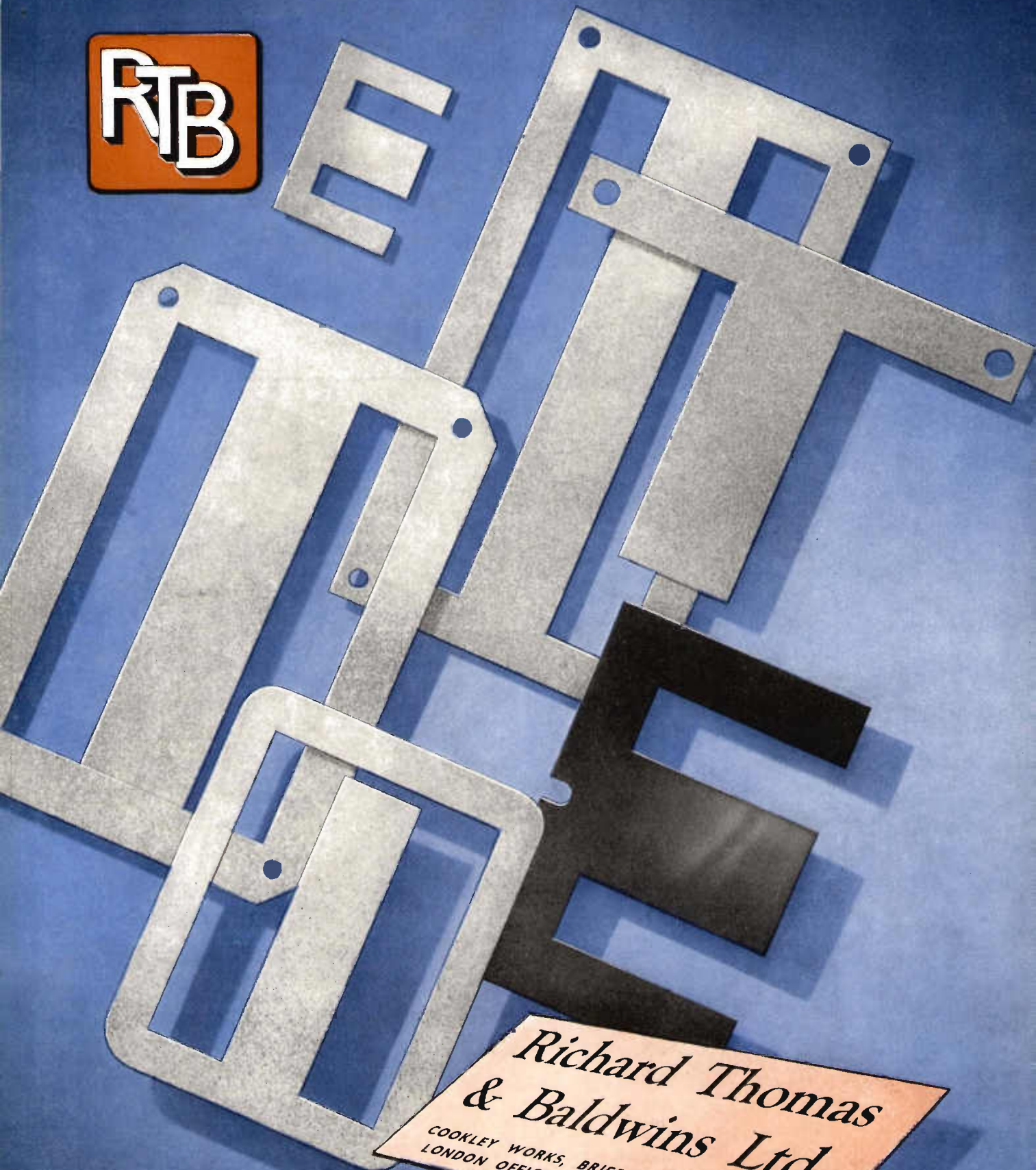

*Richard Thomas  
& Baldwins Ltd.*  
COOKLEY WORKS, BRIERLEY HILL, STAFFS.  
LONDON OFFICE: 47 PARK STREET, W.1



**RESOLVE YOUR PROBLEM  
into FIGURES with the aid of  
the NAGARD TYPE 103  
OSCILLOSCOPE**

*A wide range calibrated instrument for the faithful display of electrical potentials against time, and the measurement of all essential data.*

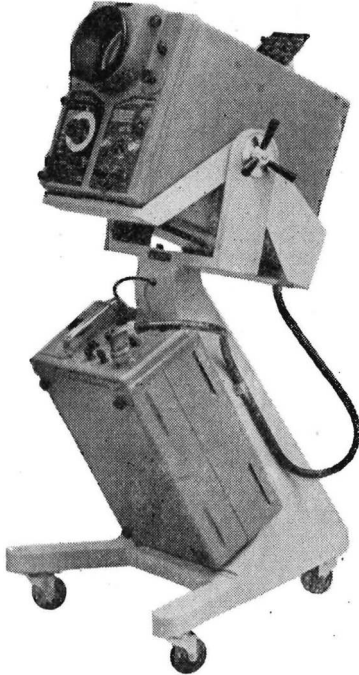

**For TRANSIENT DISPLAY**

**Two new Models L & M 103 now available incorporate:—**

- 6 in. C.R.T. with **POST DEFLECTION ACCELERATION**, flat screen, fine focus and good sensitivity.
- **TRIGGERED SWEEPS** at **CALIBRATED SPEEDS**.  
MODEL L up to 55 mm./ $\mu$  sec.  
MODEL M up to 100 mm./ $\mu$  sec.
- **CONTINUOUS VARIATION** of **SWEEP SPEED** gives resolution of all wave forms with good detail down to 0.1  $\mu$  sec. pulse durations.
- **Y AMPLIFIER**—D.C. to 10 Mc/s displays rise times of 0.05  $\mu$  sec
- **CORRECTED CATHODE FOLLOWER PROBE** capable of faithful transmission, via the amplifier, of rise times of 0.05  $\mu$  sec., and voltages up to 100.
- **OTHER MODELS** with **HIGH GAIN D.C. AMPLIFIERS** are available.
- **CAMERA ATTACHMENT.**

**NAGARD**  
LTD

18, AVENUE ROAD, BELMONT, SURREY.

Phone : VIGILANT 0345

# Electronic Engineering

Incorporating *ELECTRONICS, TELEVISION and SHORT WAVE WORLD*  
Managing Editor, H. G. Foster, M.Sc., M.I.E.E.

Vol. XXIV

MAY 1952

No. 291

## Contents

Commentary	213
<b>Millimicrosecond Pulse Techniques (Part 1)</b>	214
By N. F. Moody, A.M.I.E.E., G. J. R. Maclusky, B.Sc., and M. O. Deighton, B.Sc.	
<b>A Simple Valve Comparator</b>	220
By B. C. Foster	
<b>A Versatile Phase-Angle Meter</b>	224
By G. N. Patchett, Ph.D., B.Sc., A.M.I.E.E., M.I.R.E., A.M.Brit.I.R.E.	
<b>Remote Control of B.B.C. High-Power Transmitter</b>	229
<b>Some Recently Developed Cold Cathode Glow Discharge Tubes and Associated Circuits (Part 2)</b>	230
By G. H. Hough, Ph.D., and D. S. Ridler	
<b>A New Television Studio</b>	235
<b>The Activities and Equipment of an Industrial Electronics Laboratory (Part 5)</b>	236
By G. H. Hickling, B.Sc., A.M.I.E.E.	
<b>The Required Figure of Merit of Frame Deflector Coils</b>	238
By E. T. Emms, B.Sc., A.R.C.S.	
<b>Calibration Bars for Single Sweep Time-Bases</b>	239
By M. Gregson	
<b>The Prediction of Audio-Frequency Response (No.3)</b>	241
By N. H. Crowhurst, A.M.I.E.E.	
<b>Some Features of American Electrocardiograph Design</b>	243
By E. E. Suckling, M.Sc., A.M.I.E.E.	
<b>Letters to the Editor</b>	245
<b>The 36th Physical Society Exhibition</b>	246
<b>Book Reviews</b>	252
<b>Notes from the Industry</b>	255
<b>Meetings this Month</b>	256
<b>Publications Received</b>	256

Published Monthly on the last Friday of the preceding month at  
28 Essex Street, Strand, London, W.C.2.

Phone: CENTRAL 6565. Grams: 'ELECTRONING, ESTRAND, LONDON'

Subscription Rate:  
(Home or Abroad) Post Paid 12 months 26s. or \$3.75 (U.S.)

Classified Advertisements, Page 1  
Index to ADVERTISERS, 56

## Radar Display Tubes with High Resolution

The most important requirements of a radar display tube are that it shall be capable of a resolution at least equal to that of the radar system employed; that it shall present a picture of high brilliance and contrast; and that it shall operate reliably under the continuous and arduous conditions of service encountered in navigational radar applications.

The Mullard range of radar display tubes, developed with the advantage of the vast experience gained in the production of television picture tubes, has been specially designed to meet these requirements.

Characterised by very high definition, high brilliance and contrast, low deflection defocusing, low astigmatism, and long after-glow, these tubes are now being extensively used in a wide variety of navigational radar equipments. Brief descriptive details of these tubes are given below; more comprehensive information will gladly be supplied on request.

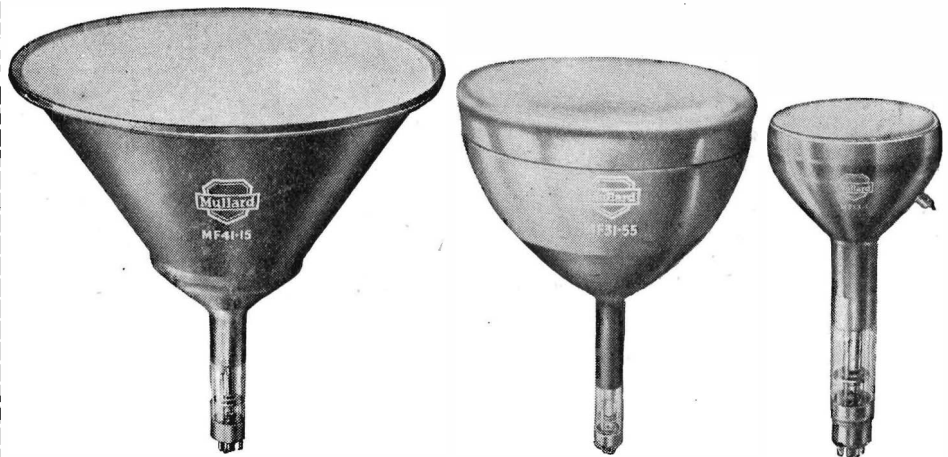

	MF41-15	MF31-55	MF13-1
<b>DESCRIPTION</b>	A 16" flat-faced, wide angle, radar display tube with a metallized fluoride screen. Ideal for use in harbour radar systems.	A 12" flat-faced radar display tube with a metallized fluoride screen. This tube is on the Government list of Preferred Types (CV429).	A 5" compact, flat-faced, radar display tube with a metallized fluoride screen. Designed for small marine and airborne radar displays where high performance coupled with saving in space is required. This tube is the equivalent of the 5FP7A.
<b>HEATER</b>			
$V_h$	6.3	6.3	6.3
$I_h$	0.3	0.3	0.3
<b>LIMITING VALUES</b> (absolute ratings)			
$V_{g2}$ max.	16	15	11
$V_{g2}$ min.	6	7	5.5
$V_{g1}$ max.	450	†600	450
$V_{g1}$ min.	200	250	200
$-V_g$ max.	200	200	200
<b>DIMENSIONS</b>			
Max. bulb diameter	406	307	127.5
Max. overall length	515	520	289
Useful screen diameter	360	260	108
<b>BASE</b>	B12A	B12A	Octal.

† Beam current not to exceed 50  $\mu$ A



MULLARD LTD., COMMUNICATIONS AND INDUSTRIAL VALVE DEPT., CENTURY HOUSE, SHAFTESBURY AVE., LONDON, W.C.2

MVT 114

# Electronic Engineering

Vol. XXIV.

MAY 1952

No. 291.

## Commentary

THE present charter of the B.B.C. was extended last January for a period of six months and little time now remains before Parliament must make a decision regarding the future of the B.B.C. It is unlikely that a further extension will be granted and the most controversial issue will undoubtedly be whether the monopoly of the B.B.C. is to be continued or whether sponsored programmes are to be permitted.

Most of the opposition members and not a few of the government's supporters are in favour of the continuance of the charter along the present lines but strong words are being heard in support of at least some alternative in the way of competitive or sponsored broadcasting. It is agreed that technical progress and improvements in programmes are being retarded by lack of sufficient capital, particularly with regard to television, and unless the B.B.C. has some other source of income licence fees will have to be increased.

As was to be expected, the supporters of the B.B.C.'s continued monopoly have not failed to call attention to all the evils of the poorer quality American sponsored programmes. They have received the active sympathy of the national press who claim that while newspapers may carry advertisements and yet maintain a reputation for accuracy and impartiality such a state of affairs could not apply to the B.B.C.

Both sides have tended to overstate their case and neither will admit a compromise. It is true that the B.B.C. has earned for itself an enviable record and has, on balance given the listener accurate and unbiased news and a wealth of entertainment unequalled by any other broadcasting service. Yet even its most ardent supporters cannot claim that the system is incapable of improvement, and the case against sponsoring is weakened by the fact that unless licence fees are increased—and increased considerably—other sources of income must be sought.

\* \* \*

The exhibitions of the Physical Society and the Radio and Electronic Component Manufacturers Federation were both held last month.

The former, the 36th in the series of annual exhibitions of scientific instruments and apparatus, was held at Imperial College and a review of selected exhibits is contained elsewhere in this issue. Some hundred and forty exhibitors, ranging from Government Research Establishments and Universities to the instrument making industry and valve manufacturers, showed what progress has been made in the last year. But as each year comes round it

becomes increasingly difficult to distinguish between what may be classified as new scientific instruments and apparatus and the logical development of standard instruments.

As it is, the exhibition tends each year to become more and more a commercial or trade exhibition of the instrument industry with the research aspect taking a second place.

In the less academic atmosphere of Grosvenor House the Ninth Exhibition of the R.E.C.M.F. emphasized the growing importance of this country as a manufacturer and exporter of radio and electronic components.

Before the war imports of components exceeded our exports but the position is now reversed and Great Britain has become the world's largest exporter. From the comparatively small figure of £500,000 in 1939 the value of exports rose steadily to nearly £7½ million in 1951. The comparative figures for the various sections of the radio and electronic industry supplied by the Radio Industry Council are given below and demonstrate the remarkable growth in the short period of the post war years.

	(Annual rates in £ million)									
	1938	1945	1946	1947	1948	1949	1950	1951	1952†	
Components, etc.	0.4	0.45	1.4	2.5	3.5	4.0	5.3	7.4	9.7	
Transmitters, etc.	*	*	1.1	1.5	2.7	3.2	6.5	5.7	6.4	
Domestic radio	1.5	1.6	3.5	4.7	3.7	3.4	3.4	5.3	5.7	
Valves	0.3	0.2	1.8	1.5	2.0	1.9	2.7	3.7	4.0	
	<u>2.2</u>	<u>2.25</u>	<u>7.8</u>	<u>10.2</u>	<u>11.9</u>	<u>12.5</u>	<u>17.8</u>	<u>22.1</u>	<u>25.8</u>	

(† based on first two months; \* no figures available.)

Principal markets for British components in 1951:

Brazil	— £830,000	South Africa	- £450,000
India	— £725,000	Sweden	— £360,000
U.S.A./Canada	£710,000	Belgium	— £300,000
Netherlands	— £530,000	Argentina	— £280,000
Australia	— £520,000	New Zealand	- £265,000

The most notable increase during the year was to the dollar area which in the space of two years has moved from the bottom of the list to third in the table. In 1949 the dollar area absorbed less than 1 per cent of our exports, whereas in 1951 it took nearly 10 per cent. Of the total dollar exports, amounting to £710,000, the United States share was £373,000. Brazil remained the principal customer for the second year in succession and with the Argentine again in the market, South America absorbed components to the value of over £1.2 million.

# Millimicrosecond Pulse Techniques

(Part 1)

## An Introduction to Techniques and the Development of Basic Circuits †

By N. F. Moody,\* A.M.I.E.E.; G. J. R. Maclusky,\*\* B.Sc.; M. O. Deighton,\*\* B.Sc.

*This series of papers is a review of work carried out during the last three years on the development of circuit techniques for ultra-short pulses and their application to problems of measurement in the laboratory.*

*The present paper discusses the properties and application of the various circuit elements, with particular reference to secondary emission pentodes, and leads to the development of several novel circuits.*

*Three further parts will be published which exemplify and extend the techniques by describing apparatus designed for measurements in physical and nuclear research.*

RECENT advances in electronics have shown a growing interest in pulses of duration less than  $0.1\mu\text{sec}$ . While the high speed transmission of intelligence, as in multi-channel communication systems and digital computers comes to mind, in the laboratory the study of short term phenomena by fast pulse techniques is already yielding important new data.

Particularly is this true in nuclear research where the advent of the scintillation counter<sup>1</sup> requires for its full exploitation all familiar pulse manipulations to be applied in the range  $10^{-7}$  to  $10^{-10}\text{sec}$ .

This, the first of a series of articles, is devoted mainly to techniques leading to simple circuits which may be applied to laboratory instrumentation such as will be described in the later articles.

Since these developments are recent, and the subject of continuing work, these articles may be considered in the nature of a laboratory report: the reader's indulgence is, therefore, asked for the incompleteness which is often evident.

### Wide-band Performance of Valves

The Fourier spectrum of a narrow pulse extends over a wide frequency range and it is therefore essential for a valve which handles such pulses to perform over a correspondingly large bandwidth.

The suitability of a given type for this kind of application can be estimated approximately from the value of its wide-band factor of merit  $F$ , which may be defined as the frequency at which the valve gives unit gain when driving its stray capacitances alone. In Table 1 are shown specimen values of this factor for various R.F. pentodes together with those for a typical secondary-emission type, the Phillips EFP60. (The figures in the last line refer to dynode operation of this valve, discussed in a later section). The advantage of using the secondary-emission process to obtain a high transductance is apparent, particularly when one realizes that conventional pentodes of comparable performance require a very special grid-cathode assembly, and are therefore generally expensive.

Only recently, however, has it been found possible to manufacture dynode surfaces with an operating life of 1,000 hours, and the exploitation of the secondary-emitting pentode necessarily had to await this development.

\* Ministry of Supply, England.

\*\* National Research Council, Canada.

† Part 1 of this paper is based on an unpublished lecture given at an AIEE-IRE conference, New York, October, 1950, which has been extended and revised to include developments since that date.

### A 50Mc/s Wideband Amplifier

At the present time, distributed amplification remains practically unchallenged as a means of obtaining voltage amplification with a bandwidth of 100-200Mc/s.<sup>2,3</sup> Such amplifiers, however, are not without serious drawbacks, being very uneconomical of valves and so also of power

Table 1. Relative Valve Performance for Wideband Application.

Valve Type	Total Capacitance (Ctot)	Mutual Conductance (gm)	Wideband Figure of merit (F)
6AH6	13.6pF	9 mA/V	105Mc/s
CV138	11.0pF	7.5mA/V	108Mc/s
6AK5	6.8pF	5 mA/V	117Mc/s
404A†	10.0pF	12.5mA/V	200Mc/s
418A†	*18.7pF	25 mA/V	212Mc/s
EFP60	17.7pF	25 mA/V	225Mc/s
EFP60 (dynode)	22.7pF	20 mA/V	140Mc/s

\* No external shield.

† Recently developed valves by Bell Telephone Laboratories using special techniques to allow small grid/cathode spacing.

consumption. Furthermore, smaller bandwidths in the range 20-100Mc/s are sufficient for many purposes and can be achieved using ordinary circuit techniques, now that high-slope valves of secondary-emission type have become available.

The EFP60, in particular, has been the subject of experiments and, although not primarily intended for V.H.F. application (the grid input admittance at 100Mc/s is believed to be  $2,000\mu\text{mhos}$ ), it has nevertheless given useful results in the range up to 100Mc/s.

Using this valve as a simple high-slope pentode, an experimental four-stage amplifier has been constructed, which exhibits a bandwidth of nearly 50Mc/s and an overall gain of 500 (i.e. 4.7 per stage). Single sections of low-pass filter type are used to couple successive stages, instead of ordinary resistance coupling. This improves the shape of the frequency response curve, giving a sharper cut-off at the upper limit. If  $\theta$  denotes the normalized frequency  $\omega CR$ , then the high frequency response of four such stages has the form  $1/(1 + \theta^2)^2$ , instead of  $1/(1 + \theta)^2$  which obtains for resistance coupling. The amplifier terminates in a fifth stage having a gain of unity and designed to feed a 75 ohm cable. This has no appreciable effect on the measured overall response curve, which agrees closely with theoretical predictions (see Fig. 1).

Since the pass-band of an amplifier such as this extends

into the V.H.F. region besides including most standard radio-frequencies, the problem of ensuring adequate decoupling throughout the band is acute. Fig. 2(a) shows the functional arrangement of the R.F. circuits. The two capacitors  $C/2$  represents stray capacitances which, together with the small coil  $L$ , constitute the coupling filter section shown in Fig. 2(b). Radio-frequency currents are decoupled to earth via small button-type capacitors  $C_0$ , which would cause a rising response at lower frequencies, owing to their increased reactance. (High permittivity ceramic capacitors have proved satisfactory for this purpose, but care must be taken to ensure that piezo-electric effects causing mechanical resonance of the ceramic do not occur within the band.<sup>4</sup>) It will be observed, however, that they are here shunted by an inductive circuit consisting of  $L_0$  and  $R$  in series. If the value of  $L_0$  is suitably chosen, the whole forms a constant impedance network equal to a pure resistance at all frequencies (Fig. 2(c)). By this means it was found possible to extend the response down to 10kc/s.

Additional decoupling is used in all R.F. circuits as a precautionary measure. With external circuit feedback reduced in this way and, of course, proper shielding between input and output of each stage, no trouble was experienced from self-oscillation, and the use of "stopper" resistors with their attendant stray capacitances proved unnecessary.

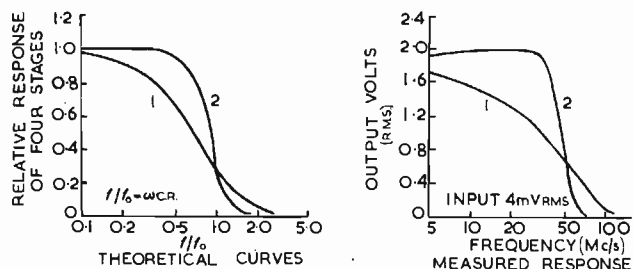

Fig. 1. Theoretical and experimental response curves of four stages using, (1) resistance and (2) filter coupling

Some remarks on the D.C. supply networks of this amplifier are included, being relevant to the operation of secondary-emission valves generally. Firstly, due to the inherent instability of these devices, the correct operating conditions cannot always be established merely by applying the prescribed potentials to the electrodes. Some form of negative feedback circuit is essential in each stage, both to stabilize the anode current and thus the mutual conductance, and also to provide the initial dynode activation which is sometimes necessary. One such arrangement recommended by Phillips<sup>5</sup> involves feedback from dynode to cathode; for our application, however, it was considered essential to ground the cathode, since the design of by-pass networks of sufficiently low impedance throughout the proposed frequency band presents great difficulties. Accordingly feedback to the grid from a point in the anode circuit is employed, as shown in Fig. 3, and the resulting steady anode current is substantially dependent only on the value of the resistor  $R_3$ , the ratio of  $R_1$  to  $R_2$ , the bias voltage  $-E$  and the H.T. supply, here 350 volts.

Fig. 3 shows also the method of supplying the dynode. This electrode is actually a source of current and requires moreover to be maintained at a potential close to +150 volts, if appreciable negative input admittance is to be avoided. In practice a region of some 50V centred around 150V is characterized by a relatively low admittance, negative at the lower extremity and positive at the upper value. When the dynode is used as an output electrode with a load low compared to the dynode impedance, the whole of this region is available for sensibly linear signal swing. The

dynode potential may then be chosen according to the signal polarity. In the circuit used, the greater part of this potential is developed by the dynode current itself flowing through a VR105 voltage regulator tube, the balance of voltage being dropped across the decoupling resistor  $R_4$  and load. The effective impedance of the dynode supply is thus kept as low as 3,000 ohms without the necessity of drawing a large current from the main H.T. line.

Both anode and dynode supply-circuits are intended to handle D.C. and low frequencies only, and hence must be carefully isolated from R.F. sections of the amplifier.

### The Dynode as an Active Electrode

Due to the mode of action of the secondary-emitting pentode, most of the varying current which enters at the anode leaves again via the dynode instead of the cathode. This fact opens up interesting possibilities for the design of special circuits not applicable to normal pentodes.

If, for example, equal load resistors are inserted in anode and dynode circuits, then roughly equal and opposite amplified voltages will appear at those electrodes in res-

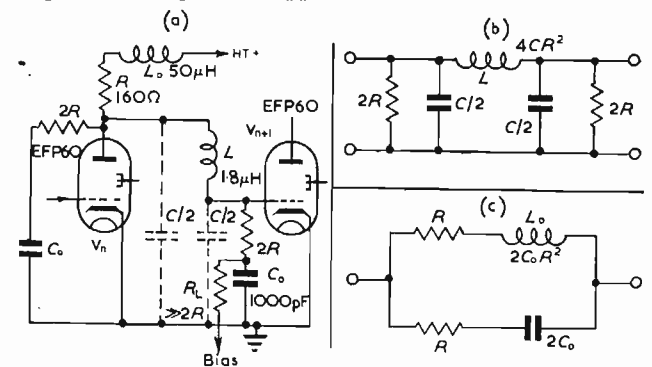

Fig. 2. (a) Circuit of 50Mc/s amplifier, (b) Equivalent high-frequency coupling, (c) Equivalent low-frequency anode load

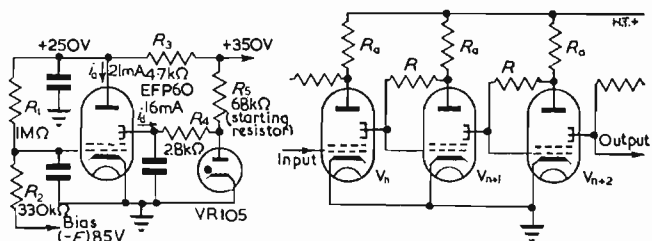

Fig. 3. D.C. supply network for EFP60

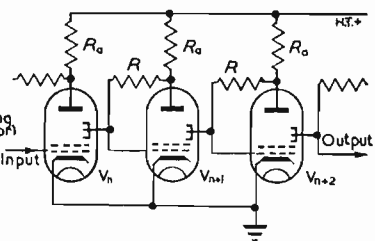

Fig. 4. Dynode coup'ed amplifier with negative feedback

ponse to any input signal. The phase similarity between grid and dynode allows regeneration if these electrodes are coupled, and the extremely low negative resistance then resulting (in the order 50 ohms), permits the design of switched oscillators of small build-up time and a variety of novel trigger circuits. Two fast trigger circuits will be described later.

One application of the dynode properties is of particular importance to nuclear physicists and others, who deal with a wide range of pulse sizes and often wish to count pulses of medium height in the presence of others many times larger. This is the development of multi-stage pulse amplifiers which are free from overload paralysis.

Conventional amplifiers generally respond to extremely large pulses by drawing heavy grid current in one or more of their later stages, resulting frequently in paralysis of long and uncertain duration. The use of secondary-emission pentodes, however, allows coupling to be arranged from dynodes to following grids rather than from anodes. This eliminates the normal phase-inversion between adjacent stages, thus permitting the design of ampli-



fiers wherein every grid handles negative pulses. Such a circuit, to a first approximation, reacts to an input pulse of excessive size simply by cutting off a certain number of its stages for the duration of the pulse only.

Against the system envisaged above is the fact that an inferior gain-bandwidth product will result, due to the greater capacitance of the dynode and lower mutual conductance (see Table I). This objection, however, is not

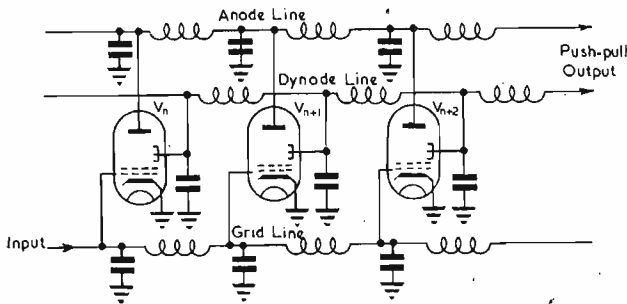

Fig. 5. Distributed push-pull amplifier

very serious, since a practical system will employ dynode-coupling only in its later stages, whose combined gain can be as little as 50 and still afford substantial protection from overload paralysis.

Consistent with this, a bandwidth of 60Mc/s could be achieved with a stage gain of about two, and the balance of overall gain required in the system could be derived from earlier anode-coupled stages.

One possibility is to form a dynode-coupled wideband amplifier embodying negative feedback from each succeeding anode, as shown in Fig. 4. Further consideration, however, shows that the valve transit-time delay of about 2mμsec. (which is internal to the feedback loop) affects the response considerably, giving in some instances a large spurious peak at the high-frequency end.

The circuit of Fig. 4 is consequently restricted to two principal applications. Firstly, where the bandwidth is low (say 30Mc/s) but the stage gain high, the transit time  $\tau$  can be neglected and the gain per stage is given by the simple formula:

$$m = \frac{g'_m(R + R_a)}{g_m R_a + 1}$$

(where  $g_m$  = anode mutual conductance and  $g'_m$  = dynode mutual conductance).

For typical values of  $R$ ,  $R_a$ , the expression approximates to:

$$m \approx g'_m/g_m \cdot \frac{R + R_a}{R_a}$$

A considerable measure of gain stability is thus achieved, since the ratio  $g'_m/g_m$  is less variable than either quantity individually. The second field of application for the circuit is at high frequencies, where the degree of feedback can be adjusted to compensate partially for the decline in response inherent in the non-reflexed circuit. This state of affairs obtains, it can be shown, when:

$$g_m R_a = 1 / [(\tau/T)^2 + 2(\tau/T)]$$

Here  $\tau$  is the transit-time delay,  $T$  the time-constant  $C(R + R_a)$  of the dynode-grid circuit. The stray anode capacitance has been neglected, since this formula generally requires a low resistance for  $R_a$ .

An amplifier designed on this basis will have little better gain stability due to the addition of feedback. The frequency response, however, will be improved; in a typical amplifier of 5 stages, each having gain 2.2, the feedback actually raised the upper limit of frequency from about 60 to 100 Mc/s.

Another interesting design, not yet complete, involves a series of EFP60's connected as a distributed amplifier, with

three separate delay lines coupling together the grids, anodes and dynodes, respectively (see Fig. 5). With proper matching, the dynode and anode lines should deliver at their terminations push-pull output voltages sufficient to deflect the spot of a high-speed cathode-ray tube or operate a compensated fast discriminator of the types to be described. (It may be realized that the three types of amplifier so far described are in fact intended to be cascaded; the first type for the low level signals, the second type for intermediate levels, and the third—whose grid line impedance is too low to allow blocking—as an output stage for supplying the preferred push-pull output signal for subsequent manipulation.)

In view of the foregoing, manufacturers who are contemplating new or modified designs of secondary-emission valve would do well to bear in mind the significance of the dynode capacitance in future applications such as these.

### The Use of Non-thermionic Devices

It is of interest to mention some applications in the millimicrosecond field of devices other than thermionic tubes. One such is the germanium crystal diode, which is likely to be of increasing importance now that more reliable types are becoming available. This has been used as the sensitive element in a fast-pulse discriminator capable of operating with pulses only 6mμsec in duration.

An essential feature of any counting system that handles a range of pulse sizes is the discriminator, a device which generates a standard output in response to every input pulse exceeding a certain known height, but is insensitive to those that are less. The present unit will accept pulses from a 50Mc/s amplifier, this being beyond the capabilities of standard discriminators. Fig. 6 shows the essentials of the circuit.  $V_1$  and  $V_2$  are 6AK5's connected as a "long-tail pair", with cathodes effectively joined. Differences between the signals at the two grids thus have considerably more effect on the anode currents than do equal signals applied to both. Further, the anode time-constants of about 0.05μsec each, permit response only to relatively long pulses. The grids are fed from a bridge-type circuit, two arms of which consist of a back-biased crystal diode balanced against an equivalent resistance-capacitance combination,  $RC$ . Any sufficiently small negative input pulse, applied across the bridge, does not upset the balance except

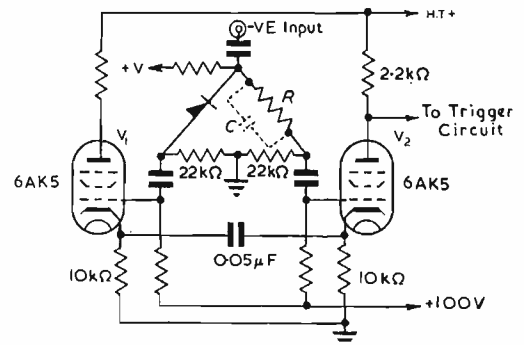

Fig. 6. Basic circuit of fast-pulse discriminator

for fast transient surges which are integrated at the anode and there is no appreciable output. If, however, an applied negative pulse exceeds in height the measured bias  $V$  (variable from 0 to 25 volts), then the diode conducts heavily for an instant, thus unbalancing the bridge. The stray capacitance of  $V_1$  grid discharges and then recovers with its own time-constant of 0.2μsec, resulting in a lengthened negative pulse at this grid which has no counter-part at  $V_2$ . Since the anode response can follow this wave there results an amplified negative pulse at  $V_2$  anode sufficient to trigger a "flip-flop" circuit, which in turn can actuate a scaler. The output pulse duration of

3μsec sets the resolution of the unit, which nevertheless performs nearly equally with pulses ranging in duration from 6mμsec up to 1μsec and more.

Another item, now coming into universal favour for generation of the very short pulses necessary for testing millimicrosecond equipment, is the mercury-contact sealed high pressure relay (e.g. Western Electric type 276B). These possess a very short switching-time, in the order of 1mμsec from open circuit to closed circuit. Hence they can be used in conjunction with appropriate lengths of concentric cable, or a capacitor, to generate pulses of accurately controlled height and duration. (See Fig. 7 for circuit and Fig. 10(a) for typical pulse generated). Experience with

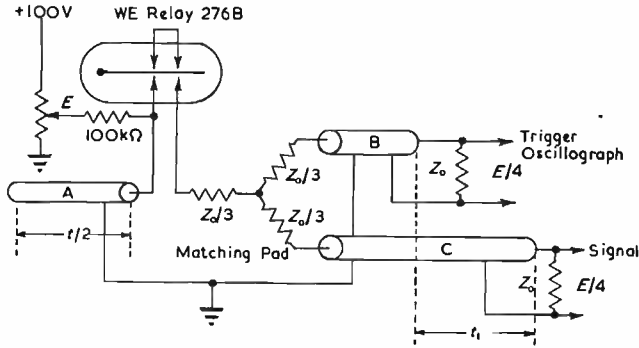

Fig. 7. Pulse generator based on W.E. relay

All inductive loops must be minimized. The 276B relay is modified by bringing leads out at the top. All cables are of equal  $Z_0$ . Pulse forming cable A is open-circuited and gives a pulse of length  $t$ , twice its delay time. The signal waveform may be delayed on the trigger pulse by  $t_1$ , the difference in electrical lengths between cables B and C. Relay coil (not shown) excited by rectified 50c/s A.C.

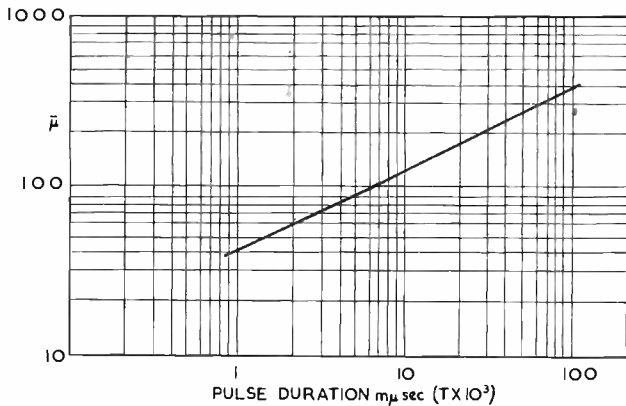

Fig. 8. Apparent pulse permeability for short pulses

$$\bar{\mu} = 6.2 \sqrt{\frac{\rho T \mu_0}{t_m}}$$

COMPUTED FOR CORE OF FOLLOWING PROPERTIES  
 $\mu_0 = 800$   
 $\rho = 50 \mu \Omega / \text{cm. cube}$   
 Lamination thickness .001"

FOR  $\rho$ ,  $\mu \Omega / \text{cm. cube}$   
 $t_m$ , Core thickness in mils  
 $T$ , Pulse length in  $\mu S$

the devices has shown that operation is usually reliable provided a working voltage of 10V is not exceeded. While they are still useful above this level, effects often occur which are attributed to the onset of gaseous discharges in the contact gap just prior to closure. These may give rise to a defective pulse-shape or to the generation of double pulses of an erratic nature.

The well-known properties of pulse transformers promise to be of the greatest value in the millimicrosecond region. For instance, operations such as impedance matching, with or without phase reversal, are ideally suited to transformers but are uneconomically performed by valves.

Experimental designs were attempted on the assumption that care in construction would allow pulse shape to be predicted according to the equivalent circuits applying for the microsecond range and this is found to be true.

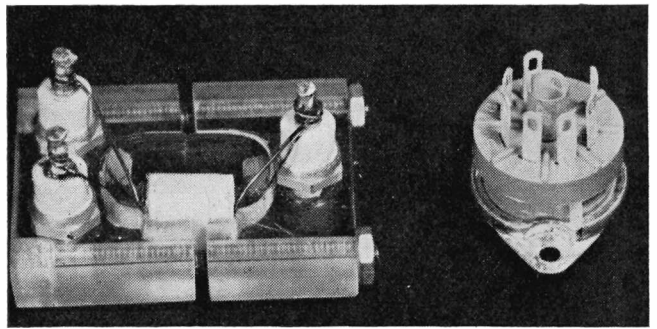

Fig. 9. 75Ω to 200Ω pulse transformer (Miniature valve holder indicates size.)

Cores may use thin (1/1,000in.) magnetic tape and the authors have shown that in this region pulse or apparent, permeability  $\bar{\mu}$  may be calculated from the simple formula:

$$\bar{\mu} = \frac{\sqrt{\rho T \mu_0}}{\mu_0 t_m}$$

which assumes that the flux penetration is fractional. In this equation  $\mu_0$  is the permeability for complete flux penetration,  $\rho$  is the core resistivity,  $t_m$  the lamina thickness,  $T$  the pulse duration.

The dependence of  $\bar{\mu}$  on  $\sqrt{T}$  indicates that cores which are satisfactory at 0.1μsec will still yield 1/3 the permeability at 10mμsec and a typical 1/1,000in. tape shows a calculated figure of  $\bar{\mu} = 120$ . (See also Fig. 8). Various ferroxcube cores perform successfully but the authors have found them to be inferior to thin mumetal clockspring torroids.

Since such transformers usually couple resistive loads, the latter may be used as the terminating impedance of a  $\pi$  filter section, whose inductance is the leakage inductance of the transformer, with the winding and terminal capacitances as the mid-shunt elements. Smooth windings are necessary to avoid internal reflexions, and direct interwinding capacitances should be avoided. Fig. 9 shows a photograph of an auto-transformer used to match 75 ohm and 200 ohm lines. It is wound on 1/1,000in. tape of  $\mu_0 = 800$  and is designed to pass a pulse of 300mμsec with only 2.5 per cent droop and with a rise time of 1mμsec set by the equivalent low-pass filter section.

The transformer has been tested with a 50mμsec pulse and Fig. 10 shows waveforms. Curve (a) is the test pulse, and curve (b) its distortion due to transmission through

Fig. 10. Pulse transformer waveforms

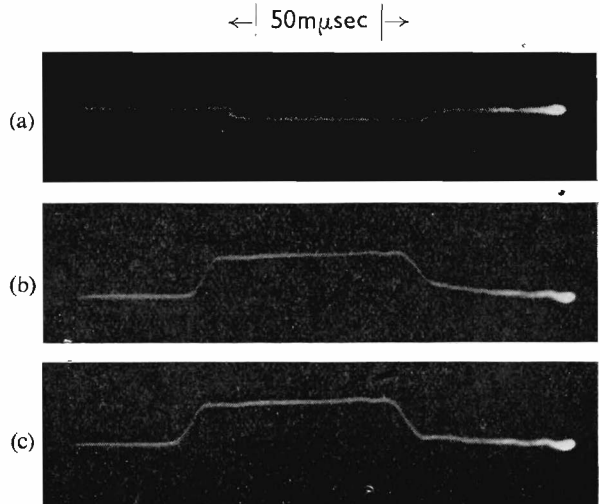

the oscilloscope amplifiers of 200Mc/s cut-off frequency. Insertion of the transformer, whose output is fed to the amplifiers, gives curve (c) and negligible distortion has been added.

### EFP 60 Trigger Circuits and Discriminators

The unusually high transductance between grid and dynode of the EFP60, some 17mA/V at 17mA dynode current, and the similarity of the input and dynode signal polarities, at once suggests that a high-speed trigger circuit may be based upon the valve. Moreover, the geometry<sup>5</sup> is such that when suitable operating voltages are applied, a heavy grid drive will yield a plate current which may rise above an ampere before space charge limitation ensues.

A simple single-stroke trigger circuit designed to produce heavy surge currents is shown in Fig. 11. It belongs to the blocking oscillator family, since regeneration causes a large fraction of the dynode current to be returned to the control grid, but the absence of a coupling transformer with its attendant time delay allows much faster waveforms which rise in about 10 millimicroseconds.<sup>6</sup> The waveforms are shown in Fig. 12 (left-hand scales), where the dynode curve commences with the positive reflexing edge and is followed by a period during which the coupling capacitor charges while the cathode and grid currents decrease. As will be seen later, resetting occurs when these currents fall to certain critical values, whereupon the dynode falls sharply and so cuts off the cathode current. Thereafter the dynode potential recovers with the time-

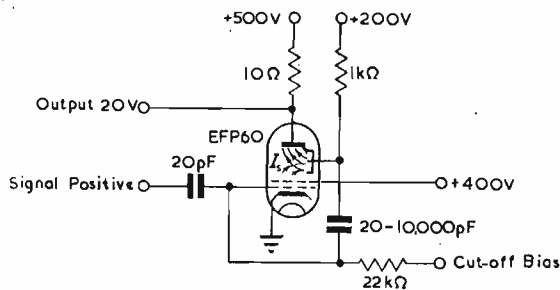

Fig. 11. Heavy duty trigger circuit

constant of the associated network in a conventional manner.

In millimicrosecond work it is often inconvenient to supply the grid drive of some 6 volts needed to fire this simple circuit, and Fig. 13 shows a circuit allowing triggering sensitivity to be increased some hundred-fold. The increased sensitivity is achieved by operating the secondary emission valve  $V_1$  in class-A condition, at its usual plate current of 20mA,<sup>†</sup> the regenerative dynode-grid loop (shown by heavy lines) being interrupted by a biased crystal  $X_3$ .

In order to set the desired quiescent conditions in  $V_1$ , the resistor  $R_1$  is made to produce a voltage drop of 144V by negative feedback applied to the control grid via  $R_2, R_3$  and the cathode follower  $V_2$ . The grid of  $V_1$  tends to -150V due to  $R_4$ , but is restrained at the cathode potential of  $V_2$  by  $X_1$ . The prime purpose of  $V_2$  is to provide a low impedance grid reference potential to aid in rapid recovery of quiescent conditions after firing. Bias for the diode  $X_3$ , which sets the triggering sensitivity, is obtained from point D in the cathode circuit of  $V_2$  and so is substantially independent of the exact control grid voltage demanded by  $V_1$ . Since the dynode transductance is 17.5mA/V, working into an a.c. load of some 500 ohms, the potential loop gain starts at 8.5 but the ratio of crystal

<sup>†</sup> Since this current causes the maker's voltage ratings to be exceeded the figure may be reduced to 10mA. This does not materially influence the performance which is, however, quoted for the higher current value at which more precise measurements have been taken.

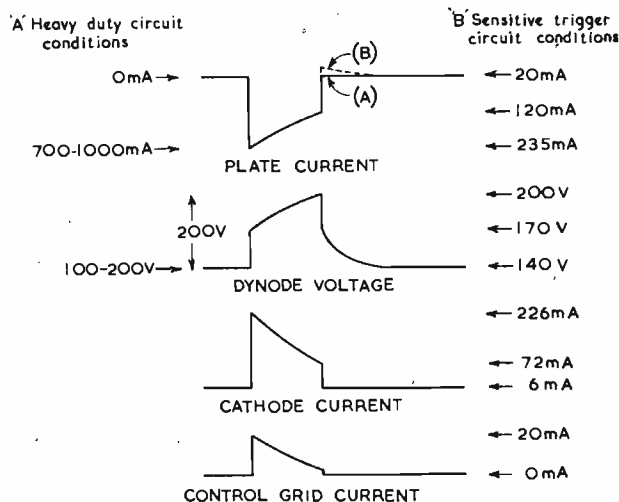

Fig. 12. Waveforms of secondary emission trigger circuits

capacitance to grid capacitance gives sufficient attenuation (about 16:1) to ensure stability in the quiescent state.

In order to describe the operation of the device as a simple trigger circuit it will be assumed that the bias  $V$  on  $X_2$  is set to zero, so that a positive signal at A may be considered as if it were directly applied to the grid; and, furthermore, the dotted connections to B will be ignored.

Assuming crystal  $X_3$  to be biased off by 1 volt, then, from the dynode gain quoted, a positive signal applied directly to the control grid and of amplitude slightly in excess of 0.1V will cause loop closure and reflexing will ensue. A stable triggering sensitivity several times better than this figure is readily achieved by further reduction of the loop bias.

The mechanism determining the relaxation period is complex, but for the reduced voltages used in the sensitive trigger circuit the following hypothesis explains the observed behaviour. Reference will be made to Fig. 12 which shows general waveform shapes and to Fig. 14 which illustrates the voltage and current changes during the semi-stable state. A dynode-grid coupling capacitor of 800pF was used for these measurements, giving 1.7μsec as the relaxation time.

On receipt of the triggering pulse the dynode rises, closes the loop, and generates a saturation current (space-charge limited) in the dynode-anode region. This dynode current of some 80mA results in a voltage rise of about 30V at

Fig. 13. An experimental high-speed discriminator  
(Crystal diodes: Sylvania, U.S.A.)

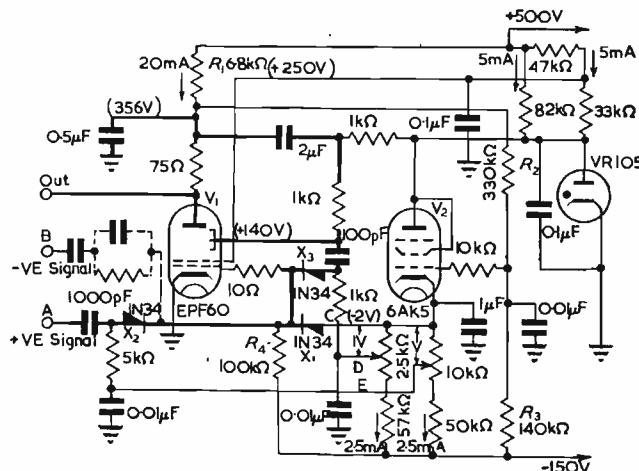

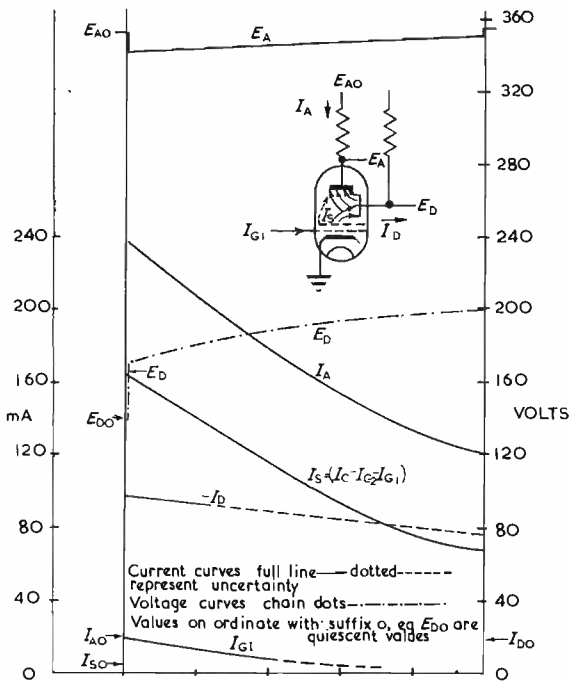
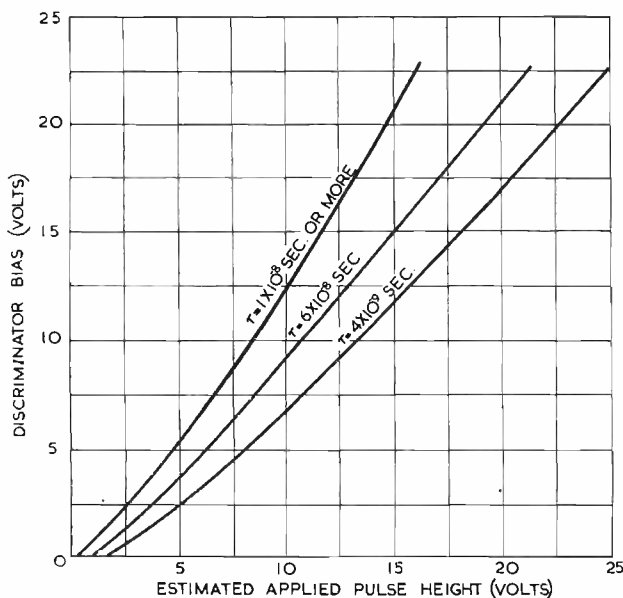

Fig. 14. Current and voltage relations for secondary emission trigger circuit

the electrode and also at the control grid, thereby causing grid current in the latter. At this time the primary current generated by the triode section is some 215mA and so is far in excess of the value needed to maintain the saturated dynode current. During the semi-stable state both grid and cathode currents diminish substantially, but until the primary current has fallen to about 50mA the dynode current changes only by some 10 per cent. The loop gain is therefore less than unity and the relaxation is maintained.

Recovery ensues when the primary current is insufficient to maintain dynode saturation, whereupon grid 1 reassumes control, the loop gain rises, and retriggering occurs. Since the retrip action takes place before grid current has ceased,

Fig. 15. Approximate characteristics of fast trigger discrimination using EFP60  
 $\tau$  = input pulse duration



the crystal  $X_3$  is conductive as the reflexing begins, but completion of the action presumably depends on its self-capacitance in the presence of the high loop gain then existing.

The anode current does not display the same constancy as that of the dynode, but its variation by a factor of two is much less than the primary current change. It is assumed that the anode collects a proportion of the primary stream directly, but this ratio is dependent both on the dynode-anode voltages and primary current at any instant.

### Use of the Sensitive Trigger Circuit as a Pulse Height Discriminator

Referring again to Fig. 13, when bias  $V$  is applied to the crystal  $X_2$  the device acts as a discriminator for high speed pulses, since only signals which exceed this bias can reach the grid of  $V_1$ . Discriminator bias of 0-25V is tapped from a potentiometer in the cathode of  $V_2$  and thereby the control grid potential of  $V_1$  is again the zero reference level.

Performance figures are shown by Fig. 15, the test being carried out with pulses of rise time about  $1\mu\text{sec}$ . Part of the origin displacement and curvature arises from the finite triggering time of the discriminator ( $5-10\mu\text{sec}$ ) though the test gear itself is probably not above suspicion. The capacitance of  $X_2$  will produce a current proportional to input wavefront rate, so causing an error, though this component (and possible reverse D.C. in  $X_2$ ) is minimized by the 1.5mA bleed in  $R_4$  which clamps the control grid of  $V_1$  via the low impedance of  $X_1$ .

Further reduction of capacitive break-through is possible if the signal exists in the preferred push-pull form, for then the negative waveform may be applied to terminals B and so inject a compensating current through the network shown dotted, which is arranged to match the non-conducting characteristic of  $X_2$ .

← 50μsec →

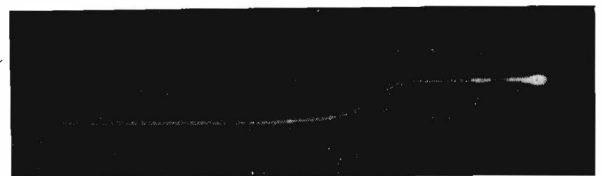

Fig. 16. Output wavefront of EFP60 trigger circuit

The remaining performance figures may be summarized as follows:

Discriminator range, 0.05-25V.

Stable triggering sensitivity, better than 0.1V for  $10\mu\text{sec}$  pulses.

Triggering delay, 3 to  $10\mu\text{sec}$  dependent on pulse shape and drive conditions.

Output pulse, 200 to 300mA (16V across  $75\Omega$ ).

Pulse duration, 0.1μsec-100μsec readily attainable (0.3μsec for values in Fig. 13).

The output pulse wavefront for the circuit of Fig. 13 is shown in Fig. 16 and is seen to be of the order  $10\mu\text{sec}$ .

### REFERENCES

- JORDAN, W. H., and BELL, P. R. : Scintillation Counters. *Nucleonics*. October (1949).
- GRINZTON, HEWLETT, JASBERG and NOE : Distributed Amplification. *Proc. I.R.E.* August (1949).
- KELLY, G. G. : A High Speed Synchroscope. *R.S.J.* January (1950).
- DEIGHTON, M. : Note on a Resonance Effect in "Hi-K" Ceramic Disc Condensers. *National Research Council, Report ELI-2* (Canada).
- Manufacturer's published EFP60 characteristics.
- VAN OVERBEEK, A. J. W. M. : Voltage controlled secondary emission multipliers. *Wireless Eng.*, 8, 114 (1951).

(To be continued)

# A Simple Valve Comparator

By B. C. Foster \*

THE majority of valve testers fall into two classes: (a) those giving a meter indication of the mutual conductance, (b) rather elaborate equipment giving a display of the  $I_a/V_a$  characteristics on a cathode-ray tube.<sup>1</sup>

The comparator to be described has been designed to give more adequate information than (a) without the expense normally associated with (b).

The circuit, though relatively simple and involving only eight valves, gives a C.R.T. presentation of the anode current,  $I_a$ , against anode voltage,  $V_a$ , characteristics of two valves simultaneously, at a series of grid voltages. Valves are tested by direct comparison of their characteristics with those of a known specimen of the same type. Alternately different valves can be compared in order to select the most suitable for a particular application. The traces

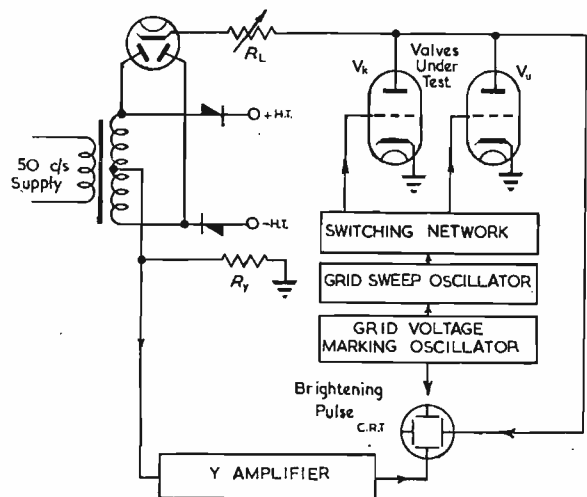

Fig. 1. The basic circuit arrangement

given by the two valves, are distinguished by making the  $V_a$  sweep amplitude lower on the known valve.

## Basic Circuit

The basic circuit is shown in Fig. 1. The anode voltage sweep is effected by the unsmoothed 100c/s output of a full wave rectifier circuit. The anodes of valves under test are coupled to the X plate of the C.R.T. to show anode voltage horizontally. The anode current returns to earth through a resistor  $R_Y$ . The voltage developed across  $R_Y$  is amplified and coupled to the Y plate to show anode current vertically. A variable resistor  $R_L$  can be introduced in the anode circuit, in order to limit the maximum anode current, when testing triodes.

The two valve characteristics are traced during alternate positive going anode sweeps. The valves under test  $V_k$ ,  $V_u$  are held beyond cut-off, except when the particular valve is presenting its characteristic. During the latter periods the control grid is carried over the grid base by the saw-tooth output of a 5kc/s oscillator. A second oscillator at 5 to 10 times this frequency, locked to it, serves to mark a series of grid voltages by brightening the trace. The manual brightness control is adjusted so that the spot is only visible on the characteristic curves presented.

\* Physical Chemistry Lab., Oxford.

The formation of the curves when testing a pentode is shown in Fig. 2, where the complete path of the spot has been drawn to explain the action.  $R_L$  (Fig. 1) is out of circuit, as is normal when neither valve under test is a triode. The grid sweep frequency has been reduced for clarity in Fig. 2. Both oscillators operate free from mains lock; the spots move along thereby giving the impression of continuous  $I_a/V_a$  curves.

The formation of the characteristic curves when testing a triode is shown in Fig. 3. In this case the anode load resistor  $R_L$  must be in circuit. When the anode current increases owing to the grid sweep waveform the anode voltage is reduced. Thus the spot travels over a series of

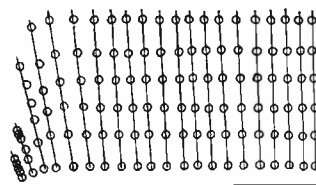

Fig. 2. The formation of the pentode characteristics. The spot is normally only visible at points corresponding to a series of grid voltages.

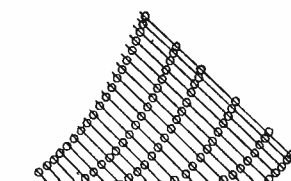

Fig. 3. The formation of the triode characteristics. The spot, which is normally only visible at the points marked, travels down successive diagonal lines, from left to right.

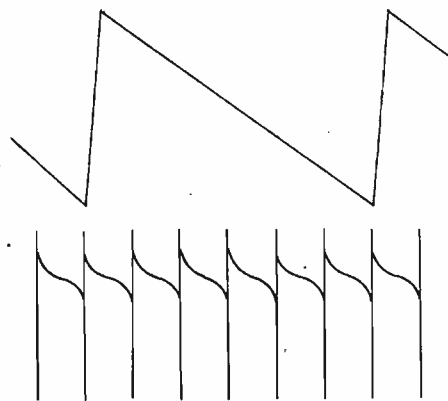

Fig. 4. The timing of the grid sweep (upper) and grid voltage marking waveforms.

approximate load lines as the anode voltage increases. The load lines are not normally visible.

The H.T. supply is obtained from the single winding by half wave rectification. This makes it necessary to present different maximum amplitudes of anode voltage sweep for the two valves, thus serving to distinguish them. The trace is entirely blacked out when the H.T. reservoir capacitors are being recharged.

## Design Considerations

It was decided to use the unsmoothed output of a full-wave rectifier circuit for sweeping the anode voltage  $V_a$ .

The advantages are:

- (1) Simplicity.
- (2)  $V_a$  can sweep up to any desired voltage.



(3)  $V_a$  sweep frequency is 100c/s; in each 50c/s period 4 spot journeys are available for presenting information.

(4) A single winding can supply  $V_a$  sweep and H.T.

The disadvantages are:

(1)  $V_a$  sweep is not linear.

(2)  $V_k, V_u$  grids must be carried through several voltages at say 5kc/s, to generate a family of characteristics, the latter formed by a number of spots.

(3)  $V_k, V_u$  must convey a sawtooth or stepped waveform, having components up to approximately 50kc/s.

(4) The complex  $I_a$  waveform must pass through the transformer, assuming it is not desired to select  $I_a$  from the cathode current.

The anode current waveform is most accurately developed across  $R_y$  when,

(1) using a small value resistor for  $R_y$ ,

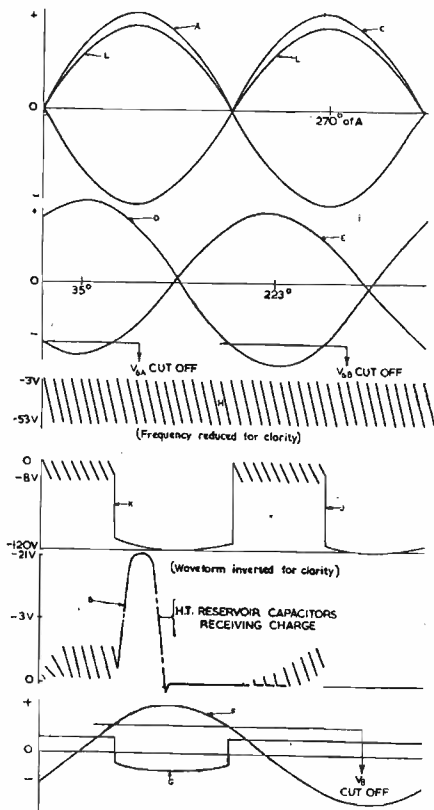

Fig. 5 (a). The waveforms of the switching network

(2) connecting a capacitor and resistor in series across the H.T. winding, in order that the higher frequency components can pass to earth via both halves of the winding.

The grid sweep oscillator can generate an output of

(1) stepped waveform, thus enabling the C.R.T. to be brightened by velocity modulation,

(2) sawtooth waveform; with a second oscillator to mark a series of grid voltages by brightening the trace at fixed time intervals during the grid sweep.

The second method was selected, using two Miller transistor oscillators, one at 5kc/s and one variable between 25 to 50kc/s for marking purposes. According to the detail of information required 5 to 10 grid voltages can be indicated. The timing of the grid sweep and marking voltage (at 30kc/s) is shown in Fig. 4. The two oscillators are synchronized by coupling the  $g_s$  circuits.

The negative pulse on  $g_s$  of the marker oscillator is differentiated for brightening purposes.

### The Switching Network

The sequence of operations covering the 50c/s period are:

(1) Known valve  $V_k$  presents characteristics,  $V_a$  rising 0 to 350 volt.

(2) H.T. reservoir capacitors are recharged.

(3)  $V_a$  returns to earth potential.

(4) Unknown valve  $V_u$  presents characteristics,  $V_a$  rising 0 to 470 volt.

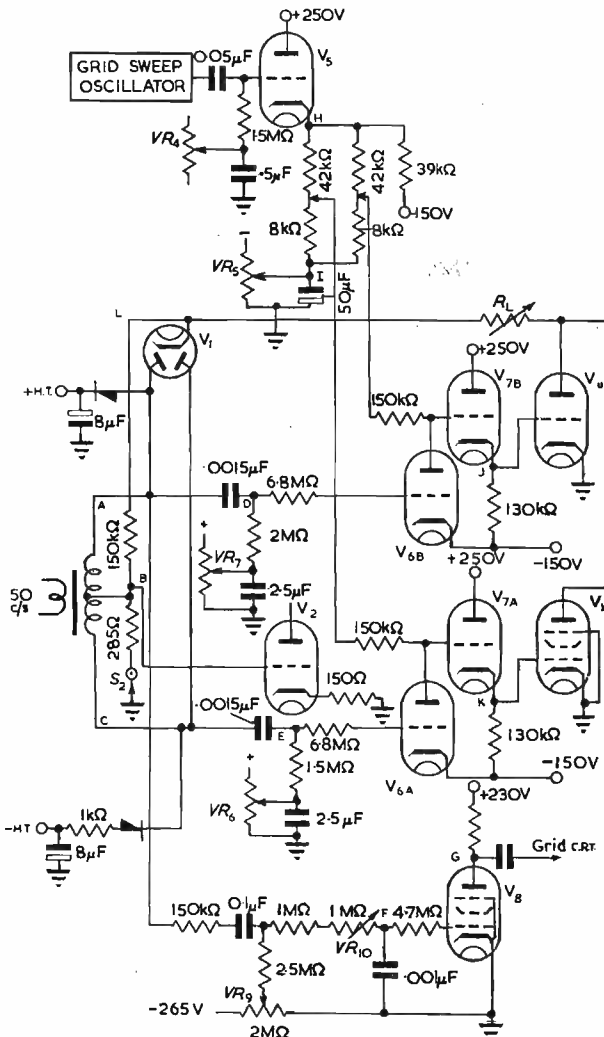

Fig. 5 (b). A simplified circuit of the switching network (the letters refer to waveforms in Fig. 5a).

(5) X axis for zero  $I_a$  marked as  $V_a$  returns to earth potential.

In addition during (2) and (3) above the trace is blacked out. The switching inherent in the rectifier action effects operation (2) above.

Figs. 5(a) and 5(b) give the waveforms and a simplified circuit of the switching network respectively. The output of the grid sweep oscillator is A.C. coupled to cathode-follower  $V_5$ , having variable bias ( $VR_4$ ).  $V_5$  load consists of two parallel potentiometer networks (from H to I), for feeding  $V_{7A}, V_{7B}$ .

Consider  $V_{6A}, V_{6B}$  to be removed.  $V_{7A}$  and  $V_{7B}$  carry the grid sweep waveform to the valves under test ( $V_k, V_u$ ),



- $VR_8$  Anode Load  $V_k, V_u$  or Triode O/L Protection.
- $VR_{11}$  G2 Voltage, 125 to 250V (approx.).
- $VR_{12}$  G2 Voltage, 0 to 125V (approx.).
- $S_1$  A.C. input On/Off.
- $S_2$  Anode Current Sensitivity.
- $S_3$  Grid Sweep Amplitude.
- $S_4$  Anode Load  $V_k, V_u, 22k\Omega$  In/Out.

**Initial Adjustment**

The adjustment of the pre-set controls can be divided into two processes.

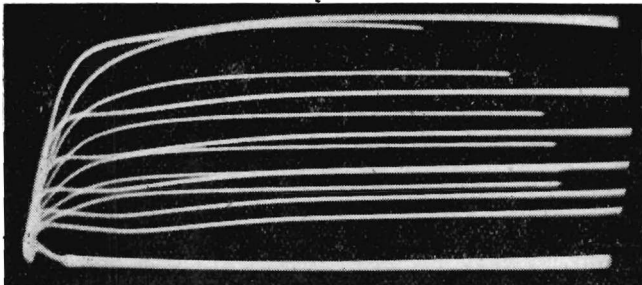

Fig. 7. 6V6,  $g_2$ -250V (higher  $V_a$  sweep) EL32,  $g_2$ -250V

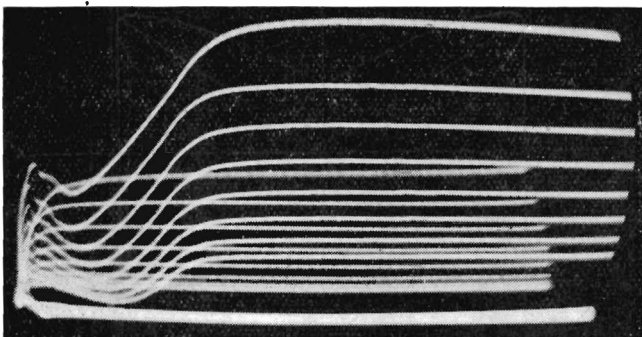

Fig. 8. 6J7,  $g_2$ -240V,  $g_3$ +100V (showing kink) 6K7,  $g_2$ -100V,  $g_3$ -0V

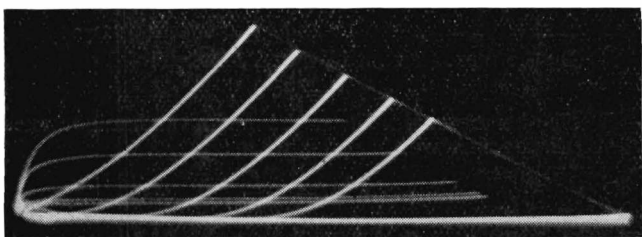

Fig. 9. HL1K (triode) IT4  $g_2$ -67.5V

(1) The setting up of the grid sweep voltage; this is effected with  $V_{cA}, V_{cB}$  and  $V_8$  removed. An r.f. pentode, say 6J7, is necessary to form  $V_k$  or  $V_u$ . Adjust  $VR_2, VR_3$  for the grid sweep oscillator  $V_a$  to deliver a 5kc/s 50V D.A.P. signal, measured at  $V_5$  cathode. Close  $S_1$ , turn  $VR_3$  out of circuit and insert the 6J7 in  $V_k$  position, with  $g_2$  100V and  $g_3$  earthed. Connect the 6J7 control grid to earth and rotate  $S_2$  for the single  $I_a/V_a$  characteristic on the C.R.T. face to be a convenient size, note the Y amplitude excluding H.T. charge pulse. With  $S_3$  at zero sweep position and 6J7, i.e.  $V_k$  control grid connected normally, adjust  $VR_5$  for the same presentation as above. Turn  $S_3$  towards the maximum grid sweep position, keeping  $VR_1$  at 7 to 10

curve position, while rotating  $VR_4$  for the most positive grid voltage indicated to be as above. Finally, check the Y amplitude is the same with 6J7 in  $V_u$  position, leaving  $VR_{12}$  untouched.

(2) The timing of the switching network; this requires V6A, V6B to be replaced. Let two pentodes form  $V_k, V_u$  and  $S_3$  be at zero sweep position. Adjust  $VR_6, VR_7$  for  $V_k, V_u$  to be switched "on", when  $V_a$  is at earth potential. Finally replace  $V_8$  and adjust  $VR_9, VR_{10}$  for the blackout pulse to extend over H.T. charge period and immediate X return stroke.

Note  $S_4$  must be open (it is spring loaded) and/or  $VR_8$  partly in circuit when testing triodes.

**Performance**

Different valves have been compared, in order to convey more information, by the photographs taken of the C.R.T. face. In Fig. 7 the 6V6 shows a tendency to follow the tetrode characteristic. The negative resistance in Fig. 8 has been produced by raising the 6J7  $g_2$  and  $g_3$  potentials.

Two directly heated valves are under test Fig. 9, the filaments receiving the normal A.C. L.T. supply. Anode load resistance is limiting  $I_a$ , in order to protect the triode; and in this case  $V_a$  is sweeping beyond the makers' maximum figure.

The vertical movement of the zero  $I_a$  line, when removing  $V_k, V_u$ , resulting from the A.C. coupling to the Y plate, is smaller than would be the case if the H.T. charge pulse were not present. The H.T. charge pulse is produced by the much heavier +H.T. than -H.T. loads. For the effective zero  $I_a$  line of  $V_k, V_u$  to be coincident the H.T. rectifiers must have high (or equal) backward resistance.

With steep slope valves (EF50, 6AK5) under test distortion of the more positive grid curves may be produced by instability. However, a small capacitor (22pF) from grid to cathode on the valve holder should eliminate this trouble.

**Acknowledgment**

In conclusion, the author thanks Professor Sir Cyril Hinshelwood, F.R.S., for permission to publish this article.

**REFERENCE**

<sup>1</sup> BROWN, C. W., HILL, F. L., A Universal Visual Valve Tester, *Electronic Eng.*, 21, 425 (1949).

**The Home Built Televisor for Channels 2, 3 and 5**

Details of the modifications necessary for operating the Electronic Engineering Home Built Televisor on Channels 2 (Holme Moss), 3 (Kirk o' Shotts), and 5 (Wenvoe), are now available.

Since the transmissions on Channels 2, 3 and 5 are similar to that of Channel 2 (Sutton Coldfield), i.e., single-sideband, the Televisors for these Channels are based on "A Home Built Televisor for Sutton Coldfield Reception" (price 4s. 9d. post free), the only differences being in the tuned circuits and the alignment procedure. Full details of these modifications are contained in a four-page leaflet that is now available, price 6d. post free, from:—

**Electronic Engineering**

Circulation Department  
28 ESSEX STREET, STRAND, LONDON, W.C.2

# A Versatile Phase-Angle Meter

By G. N. Patchett, Ph.D., B.Sc., A.M.I.E.E., M.I.R.E., A.M.Brit.I.R.E.

THERE are a large number of cases where the measurement of the phase-angle between two electrical quantities is required, ranging from the measurement of the power factor at power frequencies, to the measurement of the phase distortion of audio-frequency amplifiers. At power frequencies, a common requirement is the measurement of the phase-angle between a current and a voltage. This may be measured by means of a wattmeter, ammeter and voltmeter, but the accuracy is not high, particularly around unity power factor, as errors in the three instruments may be cumulative. A 1 per cent error (allowable error of a B.S.S. 1st grade instrument) may result in a power factor of 0.97 instead of unity, an angle error of 14°. At lower power factors the error is reduced, and at 0.7 power factor, a 1 per cent error in each instrument may result in a power factor of 0.679, an error of only about 1½°. It is common practice to use a power factor meter, of which there are a number of types. The accuracy

at 10° of 12', at 90° of 2° 20' and at 160° of over 20°. Obviously, angles above 90° must be avoided, if possible. This difficulty may be overcome in many cases by reversing one of the two voltages being measured.

On leaving power frequencies and entering the audio frequency field, power factor meters are no longer available nor are wattmeters in the accepted sense. Even if they were, the power consumption would normally be excessive. The three voltmeter method may still be used, except that it is usually necessary to use valve voltmeters, to prevent upsetting the conditions of the circuit by the loading introduced by normal voltmeters. It is therefore necessary to turn to some electronic measuring device. A cathode-ray tube may be used by connecting one voltage to the X deflecting plates and the other voltage to the Y deflecting plates, when, in general, an ellipse is formed, as shown in Fig. 1. The size and shape of the ellipse depends on the magnitude of the two voltages and the "fatness" of the ellipse by the phase angle ( $\phi$ ) between the two voltages.

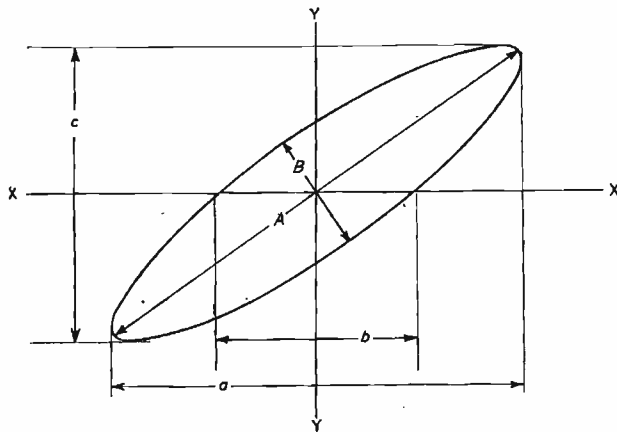

Fig. 1. Determination of the phase-angle from an ellipse on a cathode-ray tube

as given by B.S.S. 89 is, "over the range of power factor 0.5 to unity, at any current not less than one-fifth of the rated current for a polyphase power factor meter or one-third of the rated current for a single-phase meter and at rated voltage the limit of error is 2° of phase and the extent for a 10 per cent variation in voltage is not to exceed 0.5° of phase." This error is fairly small, but it only applies over a limited range of current and power factor, and a very restricted range of voltage. No figures are quoted for other currents or voltages. It must also be remembered that a single-phase power factor meter is only correct at one frequency.

On three-phase balanced load, a wattmeter with a change-over switch, or, the two wattmeter method may be used (also on unbalanced load) and the power factor calculated from the ratio of the wattmeter readings. When it is required to measure the phase-angle between two voltages a power factor meter cannot be used (as far as the author is aware no commercial phase-angle meter is available for this purpose, operating on the principle of a power factor meter), and the three voltmeter method is often used. Care is necessary or large errors may result due to small errors in the meters being cumulative. For simplicity, assuming that the two voltages concerned are equal in magnitude, a 1 per cent error in each instrument may result in an error

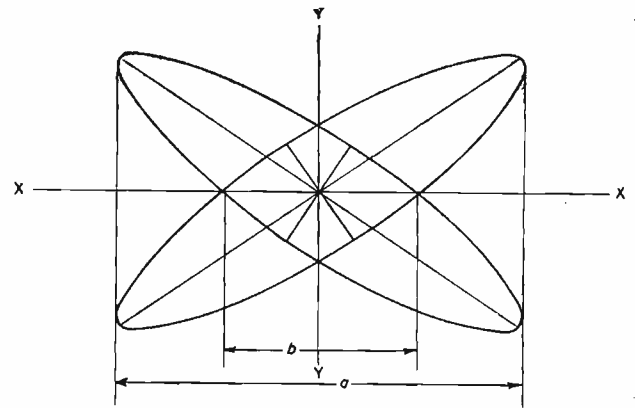

Fig. 2. Use of a double beam tube to produce a double ellipse for phase-angle measurement

The phase-angle may be determined in two ways:—

- (1) By the measurement of  $a$  and  $b$ , when:

$$\sin \phi = b/a$$

- (2) By the measurement of the major and minor axes  $A$  and  $B$ , together with  $a$  and  $c$ , when:

$$\sin \phi = \frac{A.B}{a.c.}$$

These lengths are rather difficult to measure due to parallax and due to the fact that the screen is not flat. The length  $b$  is difficult to determine as the position of the X axis has to be estimated. This difficulty may be partly overcome by using a double beam tube when two ellipses may be obtained as shown in Fig. 2, where the position and length of  $b$  is now more clearly defined.<sup>1</sup> Some of the difficulties of measurement may be overcome by photographing the trace, but this results in a delay in the results and tends to become expensive. Benson and Carter<sup>2</sup> have recently published an article dealing with the errors of this method of measurement, due to finite spot size and due to harmonics. The errors may be quite large, particularly when the angle approaches 90°. For example, using the first method, when  $a = 4$ cm, the error due to spot size at 10° is 2°, at 50° is 4° and at 70° about 9°. The errors using the second method are larger. The errors due to

harmonics are complex but in general become large as the phase-angle approaches  $90^\circ$ . Although, on paper, it sounds simple to apply the two voltages to the X and Y deflecting plates, in practice, one usually finds that the voltages are of totally wrong magnitude to give a suitable size of trace, and it is necessary to resort to attenuators or, more commonly, amplifiers, and one of the following conditions must be fulfilled:

- (a) The phase shift is negligible.
- (b) The phase shift is equal in both X and Y circuits.
- (c) The phase shift of each circuit is known.

It is often difficult to fulfill one of these conditions. The method further suffers from the fact that it is not direct reading and no indication is given of leading or lagging phase. In some cases the latter may be known, but in others it must be determined, for example, by making a phase shift in a known direction and noting the effect on the ellipse.

### Requirements

The author had need for a phase measuring instrument for general laboratory use and it was considered that it should fulfill the following requirements:

- (1) Should be direct reading in degrees.
- (2) Should give positive indication of lagging and leading phase.
- (3) Should cover the range  $90^\circ$  lagging to  $90^\circ$  leading and possibly the whole  $360^\circ$ .
- (4) Should operate over the frequency range 20-20,000c/s.
- (5) Should operate on an input voltage from 1 volt to 500 volts.
- (6) Should have a reasonably high input impedance, say greater than 50,000 ohms.
- (7) Should not be easily damaged by overload.
- (8) Should be instantaneous in action.
- (9) Accuracy should be as high as possible, say  $\pm 2$  per cent.

A number of electronic phase meters have been described from time to time,<sup>3-8</sup> but none fulfill all the above requirements.

### Principle Employed

The principle of the apparatus to be described is simple. One voltage, termed the reference voltage, is used to produce a circular trace on the screen of a cathode-ray tube and the other voltage, called the unknown voltage, is converted to a pulse and fed to the grid of the cathode-ray tube so as to extinguish the spot over a small portion of the circle. The phase of the unknown voltage will determine the position of the "break" in the circle and the phase-angle can be read off from its position on the screen. A block diagram of the apparatus is shown in Fig. 3. The reference voltage is fed through a variable gain amplifier, to a phase splitter circuit, giving two voltages in quadrature with each other. These voltages are amplified and fed to the X and Y deflecting plates of the cathode-ray tube, so as to produce a circular trace. The unknown voltage is normally fed through switch *S* (in position 2), to a limiting circuit which converts the sine wave into a square wave. This wave is then amplified and differentiated by a circuit of suitable time-constant, giving the positive and negative pulses as shown in Fig. 3. As only one pulse is required the waveform is passed through a limiter circuit which removes one pulse, and it is then fed to the grid of the cathode-ray tube, as a negative pulse. The limiter or squaring circuit is arranged so that it can be connected to the reference voltage (by means of switch *S*) in order to determine the point on the circle corresponding to zero phase-angle.

### The Circuit

A complete circuit of the apparatus is shown in Fig. 4. The reference voltage is fed, through the attenuator consisting of resistors  $R_1$ ,  $R_2$ ,  $R_3$  and  $R_4$ , to amplifier valve  $V_1$ . This is arranged with normal anode and bias resistors  $R_7$  and  $R_8$ , together with the negative feedback resistor  $R_9$ , which is used to vary the gain of the amplifier between the steps of the attenuator. The output from valve  $V_1$  is fed to the phase splitting circuit, consisting of resistor  $R_{10}$  with capacitors  $C_2$ - $C_6$  and resistor  $R_{10}'$  with capacitors  $C_2'$ - $C_6'$ . The resistance of  $R_{10}$  is made equal to that of  $R_{10}'$  and the capacitance of  $C_2$  is made equal to that of  $C_2'$  etc. Thus, whatever the frequency the voltage across  $C_2$ - $C_6$  will always be  $90^\circ$  out of phase with the voltage across  $R_{10}'$ . The capacitors are selected by switches  $S_1$  and  $S_2$  (ganged) so that the reactance of the capacitor in use is approximately equal to the resistance of  $R_{10}'$ , resulting in a voltage across  $C_2$ - $C_6$  approximately equal to that across  $R_{10}'$ . To allow for these voltages not being equal and also for the difference in the sensitivity of the two pairs of deflecting plates,  $R_{10}'$  is made a potentiometer so that the X deflexion may be varied to produce a circle on the cathode-ray tube. Each step on the switches  $S_1$  and  $S_2$  covers approximately a three to one range of frequency. The voltages from across  $C_2$ - $C_6$  and across a portion of  $R_{10}'$  are fed through the conventional amplifier valves  $V_2$  and  $V_3$  to the X and Y deflecting plates respectively. Negative feedback is used to improve the linearity which is important as will be shown later.

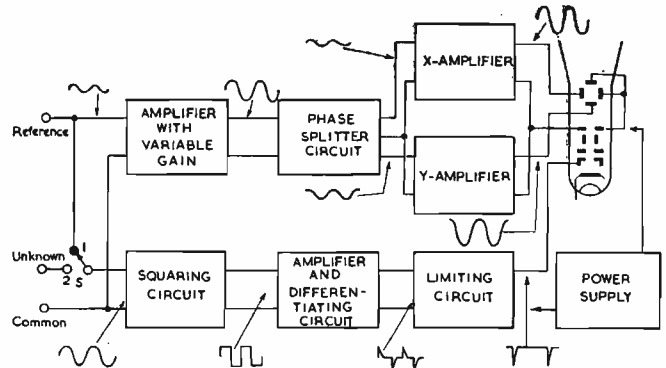

Fig. 3. The phase-angle meter

The unknown voltage is fed to the two step attenuator, consisting of resistors  $R_{21}$  and  $R_{22}$ , frequency compensated by capacitor  $C_{11}$ . The limiter or squaring circuit consists of two stages with an amplifier valve  $V_5$  between the two stages. Limiting is obtained by pairs of biased diodes (valves  $V_4$  and  $V_6$ ) as shown in Fig. 4, the bias being obtained from the drop across resistor  $R_{37}$ . The first stage of the limiter does not operate on small voltages, but prevents valve  $V_5$  from being overloaded on large inputs. The square or rectangular wave is now fed to the amplifier valve  $V_7$  and to the differentiating circuit consisting of capacitors  $C_{16}$  to  $C_{20}$  and resistor  $R_{31}$ . Suitable values of capacitor are selected for the frequency in use, by means of switch  $S_3$ , which is ganged (together with switches  $S_1$  and  $S_2$ ). The negative pulse is now removed (together with the lower part of the positive pulse) by the valve  $V_8$ , which is biased beyond cut-off by the voltage drop across resistor  $R_{35}$ . The sharp negative pulse now appearing at the anode of  $V_8$  is fed to the grid of the cathode-ray tube.

The power supplies for the cathode-ray tube and the amplifiers are conventional and need little comment. Potentiometers  $R_{41}$  and  $R_{44}$  form the brilliance and focus controls respectively, and potentiometers  $R_{45}$  and  $R_{47}$  form the X and Y shift controls. The smoothing of the h.t. supply is rather important and an unusually large smoothing capacitor has been used, mainly because it was available. In place of this a two stage LC filter could be used, with smaller capacitors. The squaring circuit can be



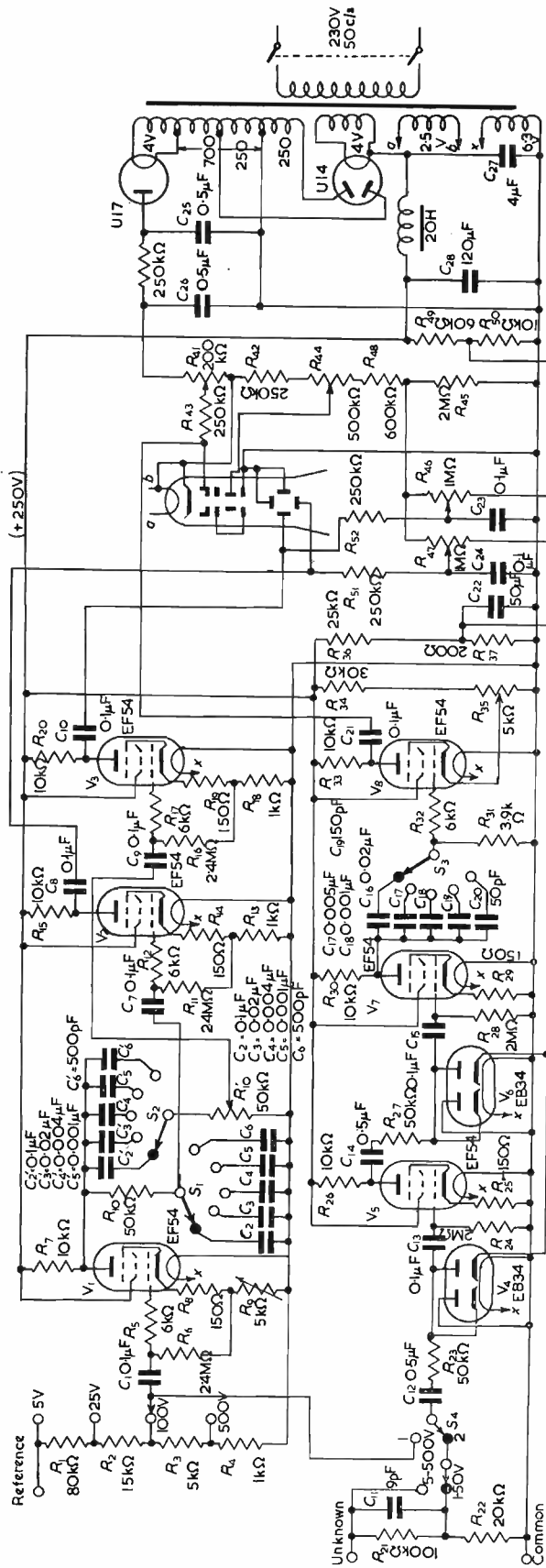

Fig. 4. Circuit of phase-angle meter

selected to the unknown voltage by switch  $S_4$  (position 2) or to the reference voltage (position 1). Over the screen of the cathode-ray tube is fitted a perspex scale marked in degrees, with a number of concentric circles. This scale is arranged by supporting it on four small rollers, so that it can be rotated by means of a knob attached to one of the rollers.

**Operation**

In use, one voltage (for convenience, if one of the voltages is approximately constant in magnitude, this should be used as the reference voltage) is connected to the reference voltage terminals, and the attenuator and frequency selector switch set to suitable ranges. The figure on the screen of the cathode-ray tube is now adjusted to a suitable size by means of  $R_9$ , and to form a circle by  $R_{10}$ . The circle is now adjusted by the X and Y shift controls,  $R_{16}$  and  $R_{17}$ , so that it is concentric with one of the circles marked on the screen. Switch  $S_4$  is now placed in position 1, so connecting the reference voltage to the limiter and producing a "break" in the circle. The scale is now turned until the zero mark is opposite the leading edge of the "break", i.e., the sharp side of the pulse. The phase angle meter is now set up and needs no further adjustment unless the magnitude or frequency of the reference voltage is changed. If the magnitude is changed, only  $R_9$  need be adjusted, but if the frequency is changed  $R_{10}$  must be adjusted and the zero reset, as the position of the zero depends on the frequency. To determine the phase of an unknown voltage, switch  $S_4$  is placed in position 2 and the position of the leading edge of the "break" noted on the scale. The instrument is direct reading and (once the direction of rotation of the spot has been determined) positive indication of lagging and leading phase angle is given over a range of  $\pm 180^\circ$ . The direction of spot rotation will, of course, be determined on the completion of the instrument and leading and lagging quadrants can then be marked on the scale. A photograph of a typical C.R.T. display is shown in Fig. 5.

It is essential that the reference voltage be reasonably sinusoidal or a poor circle will be obtained, resulting in errors which will be considered later, but it is not essential that the voltage fed to the squaring circuit be sinusoidal. Any voltage having a rapid rate of rise of voltage will produce a "break" in the circle independent of the limiting circuit, e.g., a pulse or square wave. A "break" will only be obtained if the rate of rise is positive, as the limiter circuit removes the pulse formed by the negative rate of rise of voltage. The author has used the apparatus to determine the angle of firing of a thyatron, using the drop across the load to feed the phase-angle meter. A "break" is obtained where the sudden rate of rise of voltage occurs on the firing of the thyatron.

In the apparatus built by the author a second channel identical to the circuit of valves  $V_4, V_5, V_6, V_7$  and  $V_8$ , was built so that the apparatus could be used in a number of alternative ways:

- (a) Channel 1 could be left on the reference voltage (switch  $S_4$  in position 1) to give a continuous check on the zero.
- (b) The phase-angle between three sinusoidal quantities could be measured simultaneously, e.g., in a three-phase circuit.
- (c) The phase-angle between certain non-sinusoidal quantities, e.g., pulses could be measured directly. In this case a sinusoidal voltage of the same frequency as the pulse is required to produce the circle. The pulse voltages are connected to channels 1 and 2 and produce two "breaks" in the circle, one being used as the reference.

The device may also be used as a frequency comparator, by feeding one frequency into the reference terminals and the other frequency into one of the channels. A number of "breaks" will now appear (usually rotating) and the

number of "breaks" being determined by the frequency ratio of the two voltages, e.g. five "breaks" will be produced by a frequency ratio of 5/1. The device may also be used as a synchroscope.

### Performance

It is seen that the phase-angle meter fulfils the first five requirements set out earlier. Its input impedance is reasonably high, being between 50,000 and 100,000 ohms, and fulfils requirement number six. Should a higher input impedance be required a cathode-follower may be used, before either the reference terminals or channel 1 and 2 terminals. This was not used as the voltage range would then have to be restricted. The cathode-follower unit could easily be made as an attachment external to the apparatus but using the same power supply. In connexion with requirement seven, little damage can be done by applying either A.C. or D.C. voltages up to 500 volts when the apparatus is on the low ranges. The instrument is instantaneous in action (requirement 8) and may be used

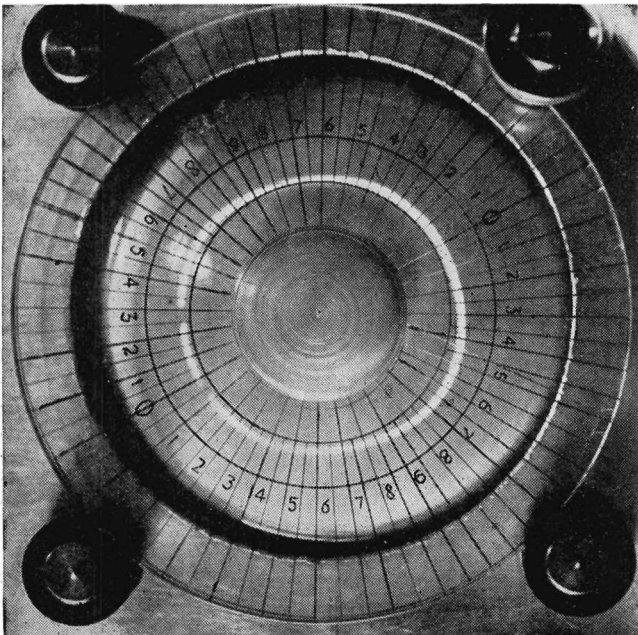

Fig. 5. A typical C.R.T. display

fully employed, for example, to see the changes in phase which occur when a synchronous machine is suddenly loaded or pulled out of step and for the detection of hunting in such machines. It may also be used to determine the phase of harmonic voltages, a number of "breaks" occurring equal to the order of the harmonic.

On considering accuracy (requirement 9) this was found to be rather difficult to check due to the lack of other accurate methods of phase-angle measurement, particularly at the higher audio frequencies. The error due to spot size using the same conditions as Benson and Carter<sup>2</sup> (i.e. a possible error of  $\pm 0.5\text{mm}$ ) and allowing an error of this amount in setting the zero and reading the angle from the "break" in the circle, the error comes to about  $2^\circ$  when using a 5cm diameter circle. This is constant, independent of the angle being measured, and compares favourably with the ellipse method, particularly at large angles, when the ellipse method becomes useless. The error is probably less than this as the reading is taken at right-angles to a line and not at an acute angle as in the case of many measurements on an ellipse. This error may be reduced by using a larger diameter circle, but it then becomes increasingly difficult to avoid distortion in the

amplifiers feeding the X and Y deflecting plates.

At 50c/s the performance was checked by means of a phase shifting transformer, some results being given in Tables 1 and 2. In Table 1, two sets of results are given as taken by two operators. In each case the "break" was adjusted to a scale mark and the phase shifting transformer read. It will be noted that the maximum error is  $2^\circ$  and the maximum error between the two operators is  $1^\circ$ . In Table 2 the phase shifting transformer was turned to some point without noting its reading. The readings of the phase-angle meter and, afterwards, that of the phase shifting transformer were noted. Again the maximum error is  $2^\circ$ . The maximum error due to change of voltage (of the reference and the unknown) within the limits of the instrument is about  $1^\circ$ . At the higher frequencies a

TABLE 1.—MEASUREMENT OF PHASE-ANGLE AT 50c/s.

PHASE-ANGLE AS READ ON PHASE-ANGLE METER	READING OF PHASE-SHIFTING TRANSFORMER	
	OPERATOR A	OPERATOR B
(degrees)	(degrees)	(degrees)
0	0	0
20	19½	19
40	39½	40
60	59½	60½
80	78½	79
100 } lag	98	98
120	118	118
140	138½	139½
160	159	160
180	179	180
20	19½	20
40	39	39
60	59	60
80	80	81
100 } lead	100	101
120	120	120
140	139½	139½
160	159	159½
180	179	180

TABLE 2.—MEASUREMENT OF PHASE-ANGLE AT 50c/s.

READING OF PHASE-ANGLE-METER	READING OF PHASE-SHIFTING TRANSFORMER
(degrees)	(degrees)
23	23
50	51
85 } lag	83
121	119
142	142
28	28
51	50
73 } lead	73
108	109
143	141
173	174

TABLE 3.—MEASUREMENT OF PHASE-ANGLE AT 10,000c/s.

CALCULATED PHASE-ANGLE	MEASURED PHASE-ANGLE	
(degrees)	(degrees)	
90	91 lag	92 lead
45	48 lag	45 lead
28		27 lead
39½		39 lead
56		58 lead
72		70 lead

number of checks were made by using an RC circuit of known values so that the phase-angle could be calculated, the impedance of R and C being low compared with the input impedance of the phase-angle meter. Table 3 shows a number of results taken at 10,000c/s where the error is seen to be  $2^\circ$ , except in one case. Variations of input voltages over a range of 5 to 1 by changing range did not cause the reading to be more than  $2^\circ$  from the calculated value. Due to the limited power available at this frequency the instrument could not be checked at the higher voltages. In all these tests a source of reasonably good waveform was used.

It should be noted that any phase shift produced in valves  $V_1$ ,  $V_2$  and  $V_3$  is not important so long as it remains constant, as these are in use to obtain both the zero and the reading. Similarly phase shift in the limiter

is not important so long as it does not change with magnitude, as this is used for both zero and the readings. It is important that there is negligible phase shift in the attenuators  $R_{21}$  and  $R_{22}$  and in  $R_1, R_2, R_3$  and  $R_4$  and it is this which limits the input impedance of the instrument.

The question of accuracy is largely tied up with the distortion of the waveform being measured. In common with other methods, errors will result if the waveform is not sinusoidal, and it is also necessary to state what is meant by the phase-angle of two non-sinusoidal quantities. It is usually taken as the phase-angle between the fundamentals of the two voltages. The accuracy of a power factor meter will depend on the waveform (and also the frequency), the amount depending on the type. The errors produced by harmonics using the ellipse on the cathode-ray tube have been considered<sup>2</sup> and it can be shown that these errors may not be negligible, even when the percentage harmonic is quite low, using either method a 2 per cent harmonic may cause an error of  $5^\circ$  when the angle being measured is  $60^\circ$ . The question of errors due to harmonics with the present apparatus is rather involved due to the fact that the error will depend on the order of the harmonic, its magnitude, its phase relative to the fundamental, the phase-angle being measured and whether the harmonic occurs in both waveforms and in what manner. The calculation is rather laborious as it is necessary to determine the change in magnitude and phase of the harmonic as it passes through the phase splitting circuit. Some results are given in the appendix where it is seen that, compared with the results given by Benson and Carter,<sup>2</sup> the errors are smaller than those of the ellipse method. In many articles on phase measuring devices no mention is made of errors due to harmonics, but this is important, as, in many cases, there is some distortion present in the voltages being measured, particularly at audio frequencies. The present apparatus has the advantage of being its own monitor of waveform since a small amount of distortion soon shows up on the shape of the figure obtained on the screen, this actually being a good method of detecting distortion.

It is seen that the apparatus fulfills the requirements set out earlier and has many uses. It is possible that the frequency range could be extended if required, but care would have to be taken in the attenuators.

#### Acknowledgment

The author wishes to thank Principal H. Richardson, M.Sc., F.Inst.P., for permission to publish this article.

#### APPENDIX

##### ERRORS DUE TO HARMONICS

There are a number of cases which will be considered: (a) Harmonics produced by the X and Y amplifier valves  $V_2$  and  $V_3$ .

Taking a typical example of 5 per cent 3rd harmonic voltage firstly, in one amplifier only (with two phase relationships to the fundamental) and, secondly equal harmonics in the two amplifiers. The results obtained are shown in Fig. 6. The phase-angle that has been plotted is relative to the X axis and not to the actual reference input voltage, as the phase relationship depends on frequency. The magnitude of the result is the same, only the position at which the maximum error occurs being altered. The effect can be shown in another way. Any harmonic in the Y amplifier will have the effect of shifting the spot on the circle to the limits shown by the dotted circles (Fig. 7), under worst conditions, by an amount  $X$ . This will cause the maximum error  $\delta\phi$  when  $\phi = 0$ , as is born out by Fig. 6 condition B. In this worst condition the error is given by  $\tan \delta\phi = x/R = P$ , where  $P$  is the ratio of harmonic to fundamental (arithmetic sum if more than one harmonic). With 5 per cent harmonic  $\tan \delta\phi = 0.05$  and  $\delta\phi = 2.87^\circ$  checking with Fig. 6 result B. With harmonics in the X amplifier the maximum error is the same, but it occurs when  $\phi = 90^\circ$ .

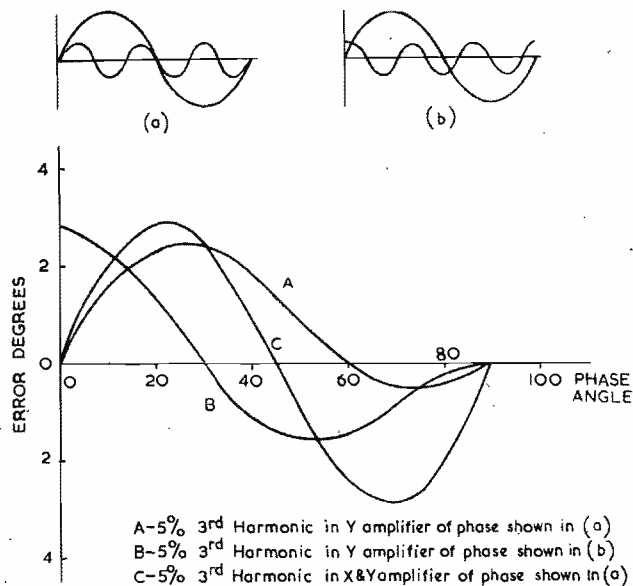

Fig. 6. Effect of distortion of waveform on accuracy of phase-angle meter

With harmonics in both amplifiers (equal percentages) the limits of the centre of the circle are shown in Fig. 8 when the maximum possible error (which will only occur very rarely) is when  $\phi = 45^\circ$  and  $\tan \delta\phi = \sqrt{2}x/R = \sqrt{2}P$  so that the error is approximately  $4^\circ$ . It is obvious from this that the distortion in these amplifiers should be kept to a minimum.

(b) Harmonics in the reference voltage.

This is involved due to the change in magnitude and phase that occurs in the phase splitting circuit. The error can be calculated in a specific case but the calculation is rather laborious. The effect of the phase splitter is to reduce the harmonic in the X circuit, since the voltage across  $C_2-C_6$  will be more nearly sinusoidal, and to increase the harmonic slightly in the Y circuit, since the voltage across  $R_{10}'$  will have a greater percentage of harmonic due to the reduction in the reactance of  $C_2' C_6'$ . Taking the case when the fundamental voltage across  $R_{10}'$  is half the total (the actual value depending on frequency) the maximum possible increase in harmonic is by a factor of two and this will only occur at the higher harmonics, which are likely to be small. In general, since the harmonic is

Fig. 7. Effect of distortion of waveform

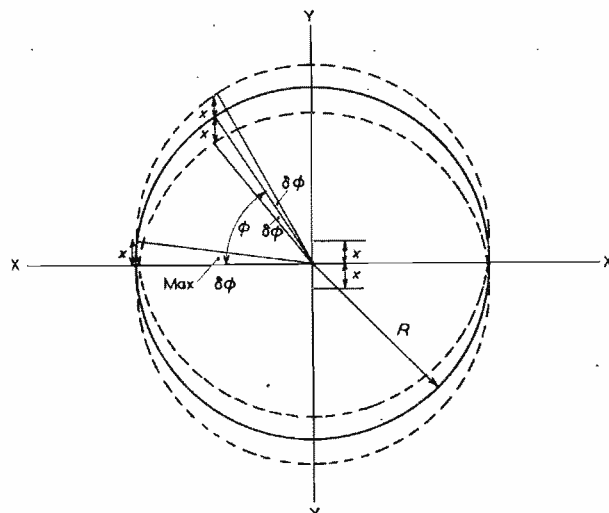

reduced in the X circuit and increased slightly in the Y circuit, it is unlikely that the error will exceed that given by the condition of equal harmonics in X and Y amplifiers, i.e., 5 per cent gives approximately  $4^\circ$  error. This error will only occur very occasionally in practice, as, for this error to occur, the angle  $\phi$  being measured must be a particular value and the harmonics must both be of maximum value in the X and Y circuits at that particular angle.

(c) Harmonics in the unknown voltage.

The effect of a harmonic is to alter the phase at which the voltage is zero and hence the phase of the resultant square wave. The maximum possible error for a 5 per cent

TABLE 4.—ERRORS DUE TO 5 PER CENT HARMONIC BY ELLIPSE METHOD

		ANGLE (DEGREES)			
		10	40	60	80
Error (degrees)	Harmonic in X axis only	3	3	3	3
	Harmonic in Y axis only	3½	6	12	—

(which appears to be the better), are given in Table 4. It is seen that the present apparatus compares favourably with the ellipse method as regard errors due to harmonics, particularly when the phase-angle is large.

#### REFERENCES

1. PATCHETT, G. N. : Some Unusual Applications of the Double Beam Cathode-Ray Oscillograph. *Electronic Eng.*, 16, 467 (1944).
2. BENSON, F. A. AND CARTER, A. O. : Phase Angle Measurements. *Electronic Eng.*, 22, 238 (1950).
3. RAGAZZINI, J. R. AND ZADEH, L. A. : Wide Band Audio Phase Meter. *Rev. Sci. Instr.*, 21, 145 (1950).
4. O'NEILL, L. H. AND WEST, J. L. : Direct Reading Phasemeter. *Rev. Sci. Instr.*, 21, 271 (1950).
5. LIVINGTON, E. A. : Dielectric Loss Measuring Equipment for Field and Works Testing. *Proc. I.E.E.*, 96, Pt. II, 73 (1949).
6. FLORMAN, E. F. AND TAIT, A. : An Electronic Phasemeter. *Proc. I.R.E.*, 37, 207 (1949).
7. KRETZMER, E. R. : Measuring Phase at Audio and Ultrasonic Frequencies. *Electronics*, 22, 114 (Oct., 1949).
8. RAWCLIFFE, G. H. AND BROWNSEY, C. M. : A Rectifier Meter for the Indication and Measurement of Phase Angles. *J.I.E.E.*, 95, Pt. II, 227 (1948).

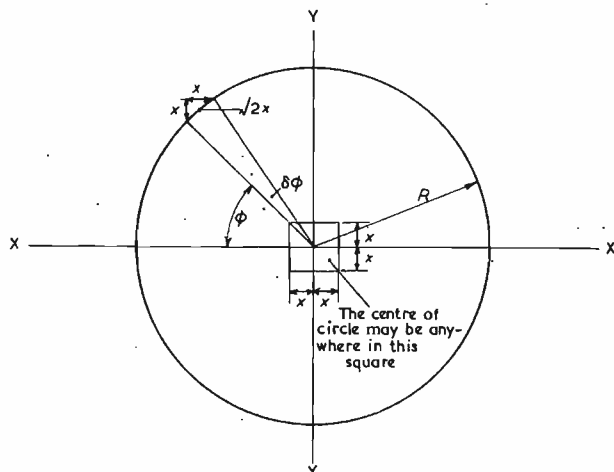

Fig. 8. Effect of distortion of waveform

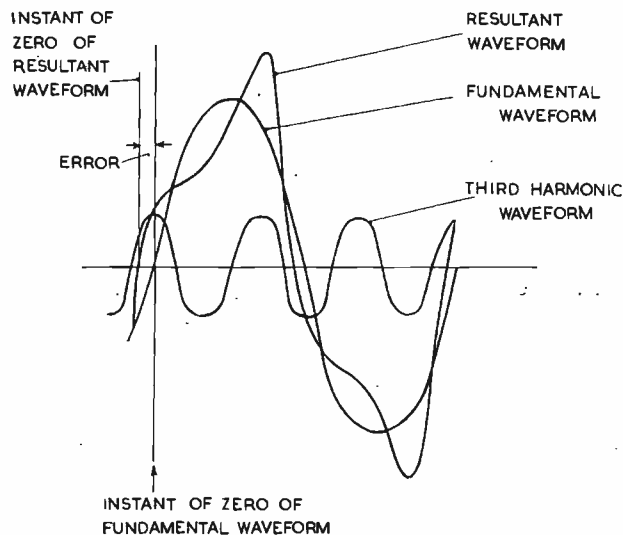

Fig. 9. Effect of harmonics on the accuracy of the phase-angle meter

third harmonic is about  $3^\circ$ . This occurs when the maximum of the harmonic wave is at the zero of the fundamental as shown in Fig. 9, where the effect is shown for an exaggerated percentage of harmonic.

These errors may, of course, be cumulative, but the possibility of maximum errors for both (b) and (c) being cumulative is very rare, since the occurrence of the maximum error in each case will be rare in itself.

Comparing with the results of Benson and Carter with harmonics in one circuit only, the errors for a 5 per cent harmonic, using the first method of phase measurement

## Remote Control of BBC High-Power Transmitter

The new high-power (150 kilowatt) Third Programme transmitter at Daventry, which came into service in April last year on 464 metres, has been working unattended since January 13. This is a notable achievement, since it is the first high-power transmitter to be operated by remote control.

The remote control system being used has been jointly developed by B.B.C. engineers and by Marconi's Wireless Telegraph Co., Ltd., the manufacturers of the transmitter. The transmitter is built as two identical units, the outputs of which are combined in a specially designed circuit so arranged that no transference of power takes place between the two sections.

The operation of applying the various power supplies to the transmitter is carried out automatically in the correct order and at the appropriate time intervals, by the operation of a single "start" button at the remote control point. The operation of this "start" button, situated in the main building, brings on the air blowers for cooling the valves, followed by the valve filaments, and other supplies in their correct sequence until, with the application of the main H.T., both halves of the transmitter are working.

This sequence of events is initiated and controlled by a series of relays, a system of interlocks being incorporated to ensure that, not only are the supplies and services applied in the correct order, but any fault or failure of supply will arrest the progress of the operation.

When all the operations have been completed and the transmitter is on the air, indicator lamps at the remote points are illuminated. If these lamps fail to light within approximately two minutes of the operation of the "start" button the engineer at the remote point knows that some fault has developed which needs investigation.

Two specially designed automatic monitors developed by the Designs Department of the B.B.C. are arranged so that one continuously monitors each half of the transmitter. A third automatic monitor checks the transmission from the aerial. In order to prevent the service being interrupted through a failure of the monitor itself, an arrangement is incorporated which enables it, upon suspecting a programme fault, to ensure that its own circuits are functioning correctly before shutting down the transmitter.

Since the monitor operates by comparing the programme as received with the programme as radiated it is essential that a momentary shut down of the transmitter due, say, to the operation of the lightning protection gear, shall not be regarded as a programme fault. The automatic protection of the transmitter itself incorporates a number of devices which, on the occurrence of a fault, will remove the main H.T., wait a few seconds and then restore it. If the fault persists the main H.T. is again removed and restored. After the third attempt the transmitter automatically closes down and gives an alarm.

# Some Recently Developed Cold Cathode Glow Discharge Tubes and Associated Circuits

(Part 2)

By G. H. Hough,\* Ph.D., and D. S. Ridler†

## Basic Trigger Tube Circuits

It may have been noticed that while present types of commercial tube use a trigger electrode to initiate a discharge, no corresponding electrode exists for extinguishing the discharge once established. For this reason it is a feature of trigger tube circuits that tubes are used in pairs in which a primary purpose of one tube is to extinguish the other. Either tube on triggering produces a pulse which depresses the voltage across the main gap of the other tube and causes it to extinguish. In consequence only one tube conducts at a time, and such pairs have been called flip-flops by analogy to the hard valve circuit. One advantage of the arrangement is that potentials of like polarity are available to indicate the two conditions of the flip-flop.

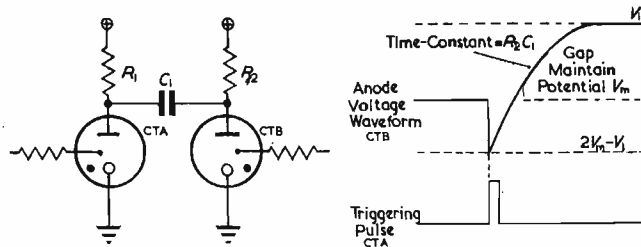

Fig. 9. Basic flip-flop using capacitor between anodes

There appear to be two fundamental circuits for coupling tubes together to achieve mutual extinguishing. The first is shown in Fig. 9, in which the anode of tube CTA is coupled to the anode of tube CTB by a capacitor  $C_1$ . If tube CTB is conducting, a breakdown in the main gap of CTA will depress the voltage across the main gap of CTB and cause it to extinguish according to the waveform shown. The second is shown in Fig. 10, in which the two anodes are both directly connected to a common resistor. Each cathode is associated with a parallel CR circuit such that if tube CTB is conducting a breakdown in the main gap of CTA will cause the potential across the main gap of CTB to reduce while  $C_1$  is charging and  $C_2$  is discharging.

Of these two circuits, the second is generally favoured, since the positive potential rising from earth is easily combined with other controlling potentials into a form suitable for operating further tubes or pairs of tubes. One difficulty which sometimes arises is that the common anode load reduces the available supply voltage to the tube, so that the two extinguishing systems do not work easily together with tubes having a restricted anode voltage range. For this reason the common anode load in Fig.

10 is sometimes replaced by the anode network of Fig. 9, which allows application of the full supply volts while giving a positive output. This hybrid circuit has an additional advantage in allowing some independence of anode and cathode time-constants which is useful in certain classes of high speed operation.

These basic arrangements can be extended beyond single tubes to form binary and decimal counting trains. A decimal counter using gas tubes was designed in 1942 by Bray and Brown, based on the pair in Fig. 10, and it is representative of modern design trends using individual tubes. This latter counter will now be described as a background to more recent work.

Fig. 11 shows a number of cold-cathode trigger tubes

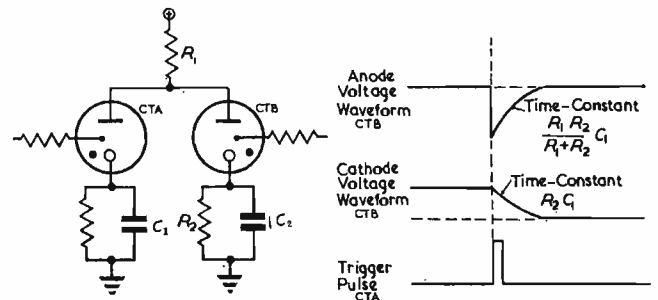

Fig. 10. Basic flip-flop using common anode load

CTA . . . CTN arranged as an  $N$ -stage counter. Assume that any one tube, say CTA, is conducting and that current is flowing from the positive supply through the common anode load resistor  $R_1$ , the main gap of CTA, resistors  $R_2$  and  $R_3$  to earth. Capacitor  $C_1$  will have charged to the potential across  $R_2$  and  $R_3$ , which also determine the anode voltage applied to the other tubes. In addition,  $C_2$  will have charged to the part of the cathode output potential across  $R_3$  to raise the potential of the trigger electrode of CTB to near breakdown. If, now, a positive pulse is applied to lead CL of insufficient amplitude to break down a trigger-cathode gap except when added to the priming potential across  $R_3$ , only tube CTB will trigger and conduct. Current will flow through the common load  $R_1$  and depress the anode voltage. As initially  $C_1$  is charged and  $C_2$  not, the potential drop across CTA is reduced below its maintaining potential, and with proper choice of constants CTA can be extinguished.  $C_2$  will charge with a time-constant of

$$\frac{R_1 \cdot (R_4 + R_5) \cdot C_3}{R_1 + R_4 + R_5}$$

while  $C_1$  discharges through  $R_2$  and  $R_3$  in series. Capacitor  $C_4$  charges through  $R_6$  and prepares or primes tube CTC, so that it is triggered by a further pulse to extend

\* Formerly Standard Telephones & Cables, Ltd., and now De Havilland Propellers, Ltd.

† Standard Telecommunication Laboratories, Ltd.



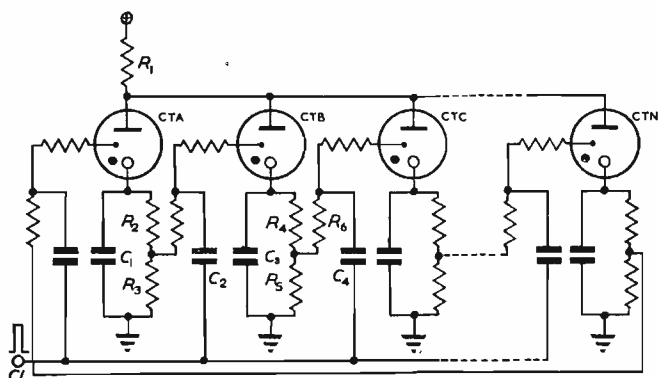

Fig. 11. An n-stage counter circuit

bias to CTD and so on. The ring is completed by tube CTN priming the first tube CTA.

In view of later developments it is of interest to note here that double-trigger gas tubes have been used to make so-called reversible counters. The potential from each tube primes both the preceding and the following tube, each priming direction being associated with a pulse lead, so that the position of the discharging tube is moved forward by a pulse on one lead, and backward by a pulse on the other.

An alternative to this pulse-and-bias method is the use of a simple rectifier gate circuit between stages, which gives an advantage in speed of operation at the expense of some slight increase in complexity. It should be realized, that all these depend ultimately for their operation upon a potential from a conducting tube which, when combined with a pulse, causes a following tube to fire.

The present practical upper limit to the frequency of counting, using a high speed tube such as the G1/370K in a special circuit, is in the region of 20,000c/s. Higher frequencies can be obtained but only at the expense of voltage margin.

A typical binary counter using a series of three coupled pairs of tubes is shown in Fig. 12. The basic circuit has been modified by the addition of capacitors  $C_1$ ,  $C_2$  and  $C_3$ , which are small compared with the anode coupling capacitors and resistors  $R_1$ ,  $R_2$  and  $R_3$ , which are small compared with the anode load resistors. These components are necessary to ensure that each stage passes one pulse to a following pair of tubes on each alternate changeover, thereby giving rise to the binary counting action.

Assume that initially tubes CTB, CTD and CTF are conducting and that counting pulses are applied to the trigger electrodes of the first pair of tubes, CTA and CTB, through capacitor  $C_4$ . A first counting pulse will trigger the non-conducting tube CTA, causing tube CTB to extinguish. The next pulse triggers tube CTB, causing tube CTA to extinguish, and so on. On each alternate changeover, tube CTB is triggered. Initially, while capacitor  $C_1$  charges, only resistor  $R_1$  limits the current in the main gap of CTB and, in consequence, a pulse occurs across resistor  $R_1$ . This pulse is applied to the trigger electrodes of the second pair, which in turn applies a further pulse to the third pair whenever tube CTD fires. Any number of tubes may be successively connected in this manner. The time-constants associated with the developed pulse are made deliberately short compared with the gap extinguishing time-constants in order that there may be no interference with the extinguishing process.

Several methods exist for generating a pulse on the changeover of a binary pair. The previous method was selected for description because it is economical on components and because it is not perhaps so well known as some of the others. The method works particularly well

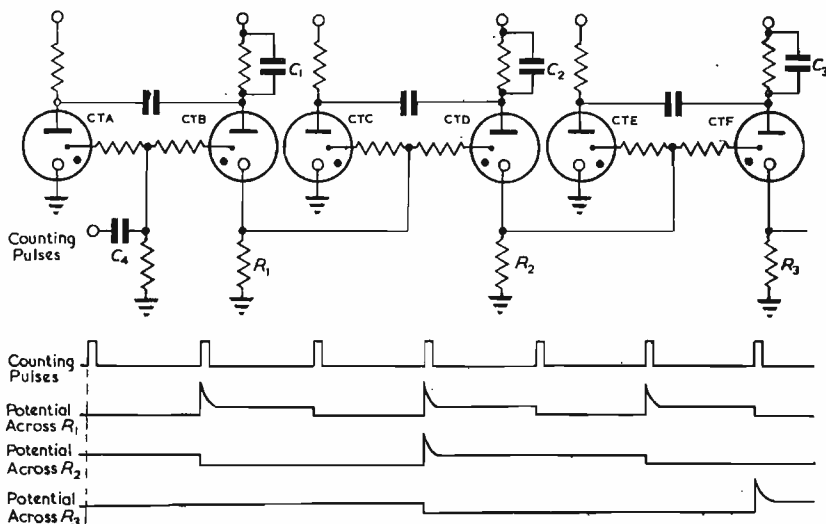

Fig. 12. Circuit illustrating the binary counter

with coated cathode types, which have gap characteristics more suited to the initial high current conditions required during the charge of capacitors  $C_1$ ,  $C_2$  and  $C_3$ , than the pure nickel cathode types.

A further important basic circuit which is finding increasing use with the present-day tendency towards computing is the pattern movement or shifting register. In the case of a counter, only one tube normally conducts and an applied pulse triggers the next tube which extinguishes the previous one. In a pattern movement a complete pattern or combination of tubes may be conducting at any one instant and an applied pulse causes the whole pattern of conducting tubes to move forward (or, if required, backward) one step. Whereas the energy necessary to extinguish unwanted tubes could come from a conducting tube in the simple counter, this is by no means convenient in the pattern movement, since there are a variable number of tubes to be extinguished. Normally, in a pattern movement using trigger tubes, the pulse itself is applied in parallel to the cathodes of all tubes causing them to extinguish.

Fig. 13 shows one circuit arrangement for coupling tubes together. Tubes CTL and CTM are two of a chain of trigger tubes forming a pattern movement. A positive pulse to move the pattern of discharges one step to the right is applied in common to all cathodes across resistor  $R_1$ , extinguishing all conducting tubes by reducing the

Fig. 13. Circuit illustrating shifting register

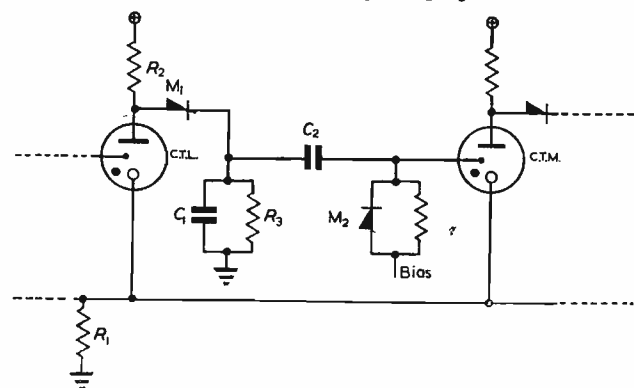

voltage across them. If tube CTL had been conducting prior to the pulse, the capacitor  $C_1$  charges through rectifier  $M_1$  in the forward direction and resistor  $R_2$  which is small compared with  $R_3$ . The positive charging waveform passes through capacitor  $C_2$  to trigger tube CTM when the cathode potential is restored after the pulse. If tube CTL had not been conducting, no change takes place at the anode and in consequence no pulse is formed and the discharge not "passed forward." The time-constant  $C_1 R_3$  is such that, if tube CTL subsequently triggers  $C_1$  discharges in the interpulse period, rectifier  $M_2$  catching the trigger of tube CTM at the bias potential.

### Multi-cathode Tube Counters

There exists one essential difference between counters using a number of individual gas trigger tubes and counters having all electrodes within a single gas-filled envelope. Nearly all individual tube counters rely for their operation upon a potential, derived from the circuit of a conducting tube, which determines or "primes" the next tube to be fired. On the other hand, the conducting gap in a multi-electrode tube directly influences a following gap by lowering its breakdown potential. This is achieved by physically positioning the following gap with respect to the conducting

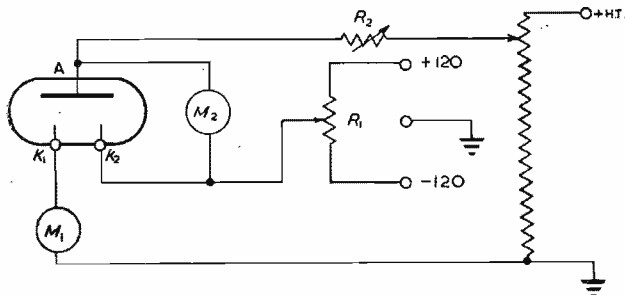

Fig. 24. The circuit used in the measurement of ionization coupling

gap so that its breakdown potential is influenced by the discharge. This form of priming, due to coupling between gaps, has been termed ionization priming.<sup>8</sup>

In any two gap electrode system comprising an anode and two cathodes, the percentage of ionization coupling from one gap to the other depends on the current in the priming discharge, the gas pressure, the distance between anode and cathode and the separation of the cathodes.

A simple circuit which was used to measure the dependence of  $\phi$  on priming current is shown in Fig. 14.  $AK_1$  was the priming gap, the current through which was varied by means of  $R_2$  and measured by  $M_1$ . The primed gap  $AK_2$  had its cathode returned to a variable potential which was measured with respect to the anode by  $M_2$ . Initially  $K_2$  was biased a few volts positive with respect to earth and the current through  $AK_1$  set at the required value. The potential of  $K_2$  was then adjusted negative with respect to the anode and the point of breakdown was measured as indicated by a change of current through the meter  $M_1$ .

The design of the tube used in these measurements is illustrated in Fig. 15. It had a number of cathodes which were associated with a common anode. A plane geometry was used and the cathodes were clamped between glow control plates from which they were insulated by suitably designed micas. The glow control plates<sup>9</sup> are shown connected to a positive potential of 60 volts which assists in the controlling action by introducing field distortion.

In multi-cathode tubes of this type a discreet area of cathode glow is essential, and the function of the glow control plates was to restrict the discharge to the selected area of the cathode. The small gaps produced by the associated micas prevented an extension of the cathode area by sputtered particles and, in addition, ensured an adequate insulation of the cathodes from the glow control electrodes.

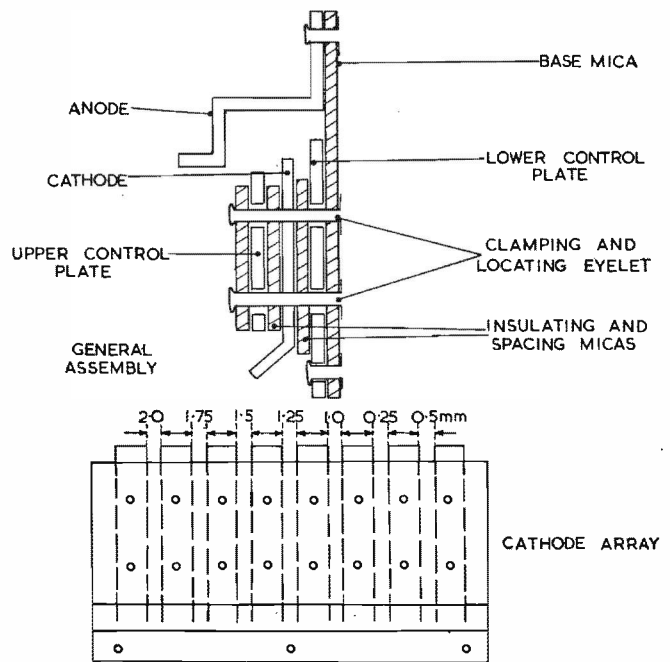
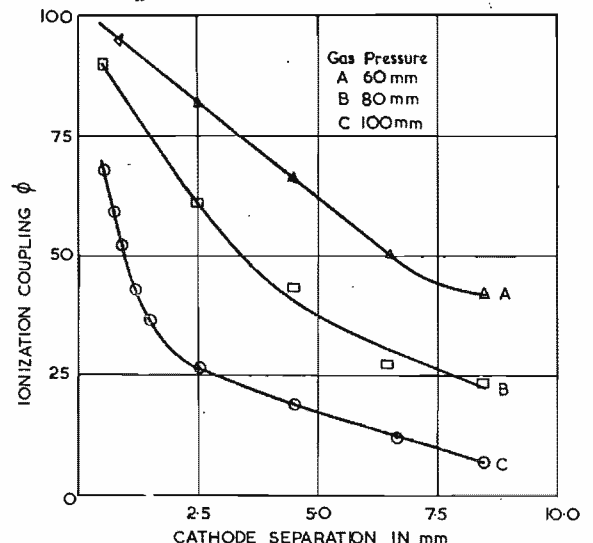

Fig. 15. The electrode structure used in measuring ionization coupling

A number of such tubes were made in order to cover the various ranges of geometry to be investigated, and by using each cathode as a priming cathode it was thus possible to obtain measurements on the variation of ionization coupling with cathode spacing. Using a constant priming current of 1.5mA the variation of  $\phi$  with cathode spacing was obtained at different pressures, and the results are shown in Fig. 16.

Fig. 17 shows the variation of  $\phi$  with current for various cathode-cathode spacings. As previously described, the glow area of the priming cathode was defined by glow control or shield electrodes, and the limit of normal glow discharge was 1.6mA. In the measurements made with small separations, the field due to the primed gap stabilized the position of the glow on the priming cathode and consistent results were obtained. In the case of the large separations between cathodes, there was an instability of the glow position at low currents, which resulted in a corresponding

Fig. 16. Ionization coupling curves  
Effect of cathode separation and gas pressure



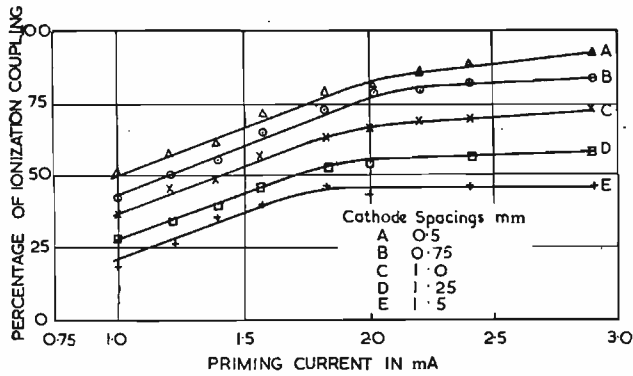

Fig. 17. Ionization coupling curves  
Effect of priming current and gas pressure

scatter of the experimental points plotted. The relative position of the curves were determined by the reliable values of  $\phi$  obtained for currents at the limit of normal glow.

These curves are sufficient to indicate that it is possible, by correct electrode design, to use a priming discharge to control the breakdown potential of an adjacent gap to any value between its normal breakdown and maintaining potential. When a 100 per cent coupling is used the primed gap is physically within the dark space of the priming discharge and the space charge of the existing discharge is merely extended when the primed gap starts to conduct. In this case there is no time lag in the priming and no formative delay of the discharge in the primed gap, and it is this form of priming which is most widely employed in the G1/370K trigger tube described and the multi-cathode tube, the G10/240E, which will be described later.

Potential priming of the type used in individual tube counting trains can be easily arranged to prime in one direction only. To produce a corresponding directional feature in ionization priming it is necessary to introduce some asymmetry into the design of the priming gap. This can be achieved by a suitably designed cathode, termed a directional cathode, which will be described in more detail later.

### Some Electrode Combinations

The use of ionization priming in combination with directional and non-directional cathodes gives rise to a number of possible electrode combinations within one envelope. Each has a set of properties and limitations that suit it for a particular field of application, and it is therefore proposed to discuss some of the possibilities.

The first arrangement of the multi-electrode counter is similar to that shown in Fig. 18. In this case there is a row of equally spaced cathodes protruding through a closely fitted aperture plate and equally spaced from the anode. Fig. 19 shows a typical circuit arrangement for such a tube used as a counter. The anode A is connected through the secondary of a pulse transformer  $T_1$  to a positive potential which is greater than the

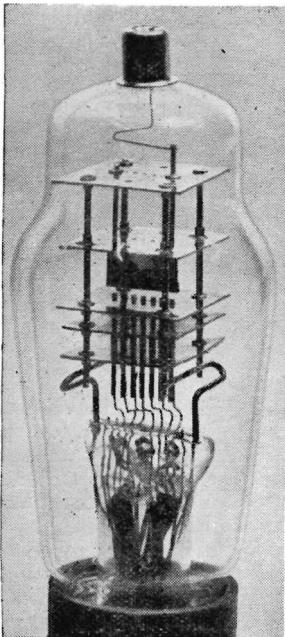

Fig. 18. A multi-cathode counter tube

maintaining potential of the gaps but less than their normal, or primed, breakdown potential. Cathodes  $K_2, K_3, K_4$  and  $K_5$  are earthed through series limiting resistors  $R_2, R_3, R_4$  and  $R_5$  and  $K_1$  is connected through  $R_1$  to negative bias which raises the  $AK_1$  voltage above the normal gap breakdown voltage. This gap then fires and remains as a permanent priming discharge whenever the tube is in use. The resistor  $R_1$  limits the current through the gap to some small convenient value, similar in magnitude to that taken by the other gaps when they have been fired.

Because of the reduction in ionization coupling with horizontal separation, and the time taken for any discharge to build up, it is possible to supply a positive pulse of a particular amplitude and width to the anode, which breaks down the  $AK_2$  gap only. The  $AK_2$  gap then takes over the priming function and primes the  $AK_3$  gap to the same level to which it was itself originally primed by  $AK_1$ . The application of a further similar pulse to the anode will then initiate an additional discharge in  $AK_3$  and so on until all the gaps are fired. The voltage developed across the resistor in the last cathode can then be taken to indicate a count of 4 in this case, and to trigger some device which in turn applies a suitable negative pulse to the anode to extinguish all gaps and reset the tube to a condition where it is ready to start a second cycle.

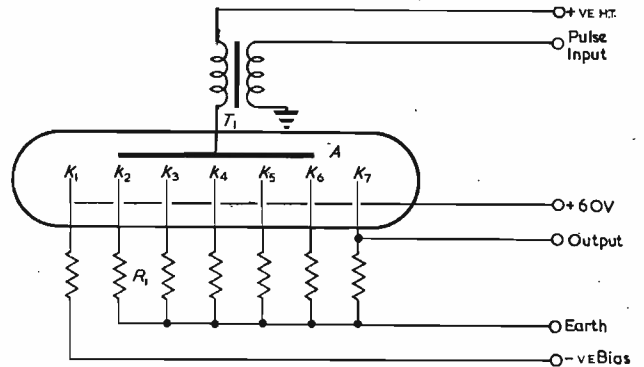

Fig. 19. Circuit for a high-speed multi-cathode counter  
Counting pulses are applied to the anode

This is essentially a high-speed device, which has been used at pulse repetition frequencies up to 200kc/s. It requires pulses that are of the order of a microsecond wide and of about 60 volts amplitude.

The limitations to the speed and circuit tolerances are, in general, associated with the registering and extinguishing circuit. Another limitation is that the position of the count is indicated by a number of cathode glows, as opposed to the single discharging gap obtained in the low-speed counter of Fig. 11.

The next arrangements use one or a number of auxiliary cathodes.<sup>10</sup> The principle of such a transfer cathode is illustrated with waveforms in Fig. 20, which shows a simple tube in which  $K_1$  and  $K_3$  are main cathodes and  $K_2$  is the transfer cathode. The geometry and gas pressure are such that a discharge in any one gap has a major effect only on the breakdown potential of an adjacent gap. For this reason, if current initially flows through gap  $AK_1$ , the third gap will not break down. The second gap is biased so that the potential across  $AK_2$  is less than its maintaining potential and does not break down until a negative-going pulse is applied to provide the additional potential to cause breakdown. Since the anode tends to follow the pulse and capacitor  $C_2$  holds cathode  $K_1$  positive, the potential across  $AK_1$  is reduced causing it to extinguish. The discharge has now transferred to cathode  $K_2$  on the leading edge of the pulse and gaps  $AK_1$  and  $AK_3$  will, therefore, be primed for the duration of the pulse. On the trailing edge, the anode potential rises until  $AK_3$  breaks down. It should be

noted that the potential across the first gap also increases but does not reach a value high enough to cause breakdown, since capacitor  $C_2$  will not have discharged through  $R_2$ . Furthermore, the anode potential is held down by the discharge on  $K_3$  by capacitor  $C_3$  charging. The discharge from  $K_2$  is extinguished because the potential across the gap is reduced below its maintaining level at the end of the pulse. In this way a pulse on the transfer cathode  $K_2$  has resulted in a transfer of discharge from cathode  $K_1$  to  $K_3$ . Since the circuit is symmetrical, a second pulse will transfer the discharge back to  $K_1$  and so on.

One important difference between the output waveform derivable from a transfer cathode type of counting tube and a scale-of- $n$  counter using individual tubes is that in the first case the output waveform starts to rise exponentially at the end of a counting pulse and in the second case from the beginning. In circuit practice a functional potential is often formed by a combination of cathode output and a coincident pulse in time and as wide as the counting pulse. In the transfer cathode counter this coincidence can only occur at the point where the cathode waveform starts to decay whereas in the second case some overlap is also possible at the beginning of the pulse which gives rise to an undesired sneak potential.

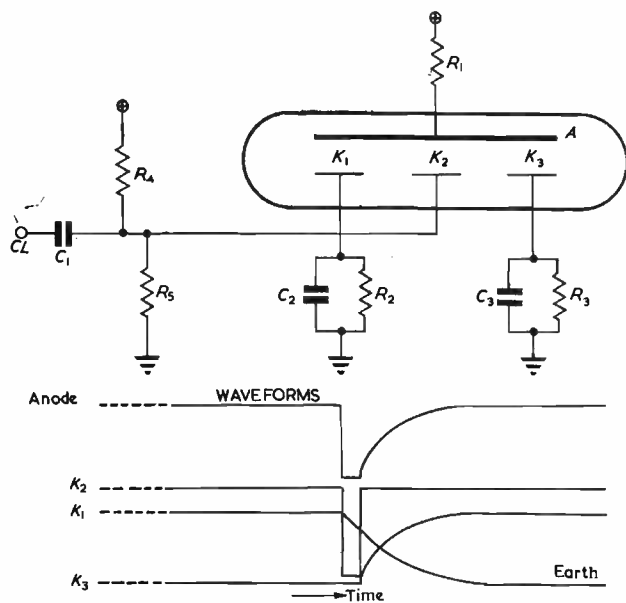

Fig. 20. A simple circuit illustrating the principle of the transfer cathode

Fig. 21 shows in a schematic form six combinations in which transfer electrodes are used, together with the pulse waveforms required for their operation. Scale-of-5 counters are shown, but it will be understood that any number of points could be included within practical tube design limits.

Fig. 21(a) shows a combination using one non-directional main cathode and two non-directional transfer cathodes for each stage of count. If current is initially flowing through the common load  $R_1$  gap  $AK_1$  and resistor  $R_2$  to earth, it is apparent that gap  $AK_2$  is primed so that a negative pulse on the counting lead  $CL_1$  will transfer the discharge to that gap in the manner previously explained. A second pulse on lead  $CL_2$  immediately following will bring the discharge to  $K_3$  and so to  $K_4$  on its trailing edge. The discharge has thus transferred from the first main gap  $AK_1$  to the second main gap  $AK_4$ . Since alternate transfer cathodes  $K_2, K_3, K_8$  and  $K_{11}$  are commoned together, as are  $K_5, K_6, K_9$  and  $K_{12}$ , a second pulse on  $CL_1$  and  $CL_2$  can only move the discharge forward to  $K_7$  and so on for further pulses. It is thus the order in which pulses appear on leads  $CL_1$  and  $CL_2$  that gives a sense of direction; a

pulse occurring on lead  $CL_2$  before lead  $CL_1$  would, therefore, move the discharge towards cathodes having a suffix of a lower order.

The parallel capacitance-resistance networks may be alternately commoned if individual outputs are not required, in which case the capacitors charge and discharge on alternate counting pulses. Furthermore, it will be appreciated that the natural waveforms produced by these latter networks could be replaced by suitable potentials applied from an external pulse source and a counter of this type has been described in this journal.<sup>11</sup>

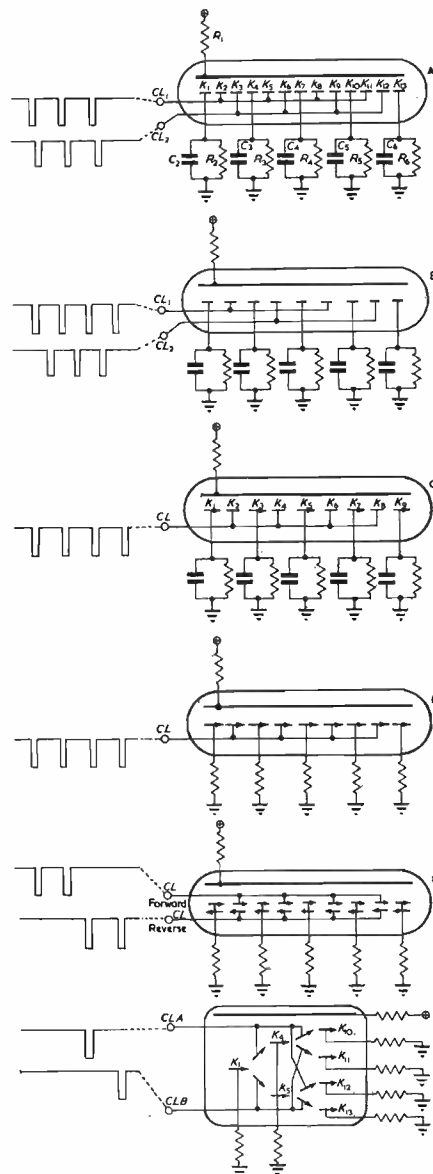

Fig. 21. Some electrode combinations possible in multi-cathode tubes when directional and non-directional electrodes are used

A simplification of this split-input pulse system is shown in Fig. 21(b) in which there is only one transfer cathode between each two main cathodes. The transfer cathodes are alternately commoned and the input pulses are fed alternately to each input. Again it is the relation of these pulse trains that provides the sense of direction.

These counters are complicated by the twin input pulse systems, and result in rather involved tube structures and external circuits. The next two types illustrate the simplification that results from the use of directional cathodes.<sup>12</sup>

Fig. 21(c) shows a tube with directional main cathodes interspaced by non-directional transfer cathodes. A discharge on  $K_1$  can be transferred to  $K_2$  and so to  $K_3$  by a first pulse on  $CL$ . A second pulse on the common transfer cathodes can only move the discharge via  $K_4$  to  $K_5$  due to the directional property of  $K_3$ . As in the simple case of transfer, it is the charge on the cathode capacitor of  $K_3$  that prevents the discharge retreating from  $K_4$  to  $K_3$  on the trailing edge of the pulse.

A related tube is shown in Fig. 21(d) in which both transfer and main cathodes are directional. The capacitors are now no longer necessary to prevent a retreat to previous cathodes, and the tube becomes independent of external time-constant circuits. Such a tube is inherently faster than the previous type, which is necessarily slowed down by the nature of the exponential cathode waveform. The speed becomes dependent upon the rate at which the discharge becomes directionally effective on each cathode and also the rate at which the previous gap can recover.

This electrode configuration can also be used with a positive driving pulse. All that is necessary for transfer is a relative movement of potential level between cathodes and this may be achieved equally well by lowering the level of a non-conducting cathode or raising the level of a conducting cathode. Thus, if positive pulses with a suitably adjusted level are applied to the transfer set of directional cathodes in Fig. 21(d), the discharge moves to the right

and will only rest on main cathodes while the counting pulse is actually on. This property is not normally present in all-directional configurations and makes the arrangement of interest for this reason.

Although these two latter types can be operated in only one direction, Fig. 21(e) shows that the use of a main cathode that is directional with respect to a forward and reverse set of transfer cathodes<sup>13</sup> retains the flexibility of the previous types without the complicated input systems. The direction of the discharge movement is dependent upon the pulse supply being connected to the forward or reverse transfer cathodes.

A further possible combination is shown in Fig. 21(f) in which the discharge may travel from a home cathode to two main cathodes each giving access to two further cathodes. In the simple tube shown, the discharge may be stepped to any one of the four final cathodes  $K_{10}$  to  $K_{13}$  by two pulses applied in sequence to the leads  $CLA$  and  $CLB$ . It will be seen that this arrangement may act as a selector using binary code.

#### REFERENCES

- <sup>8</sup> British Patent 639727.
- <sup>9</sup> British Patent Application, 12098/48.
- <sup>10</sup> British Patent Application, 15815/48; U.S. Patent 2473407.
- <sup>11</sup> BACON AND POLLARD, The Dekatron, *Electronic Engg.*, XXII, 173, (1950).
- <sup>12</sup> British Patent Application, 25487/48.
- <sup>13</sup> British Patent Application, 7432/50.

(To be continued)

## A New Television Studio

Included in the recent developments at the B.B.C.'s television studios at Lime Grove is the fitting out of a new studio. This is Studio H and is the latest to be brought into service. It was commissioned on February 4, 1952, and used for the Children's programme. The floor area is 2,800 sq. ft.

This studio is equipped with vision apparatus manufactured by Electric & Musical Industries Limited and it is interesting to recall that this equipment was used for televising the Olympic Games in 1948. The equipment was in constant use for other outside broadcasts until about four months ago. There are three studio cameras employing C.P.S. Emitron pick-up tubes, two of which are mounted on Vinten "Pathfinder" dollies and the third on a De Brie rolling tripod.

A telecine channel is provided for the insertion of film sequences in productions as required.

The sound installation is composed of B.B.C. type "A" studio equipment and can accommodate six studio microphones, four gramophone outputs and a film sound channel for the telecine sound output. Two microphone booms are used on the studio floor.

The layout of the vision control rooms for Studio H differs from usual B.B.C. practice in that the vision mixing control desks and picture monitors have been so disposed as to give the production teams a frontal view through the window into the studio instead of the usual side view. In the vision control room a desk immediately in front of the studio window accommodates the producer, his secretary and the vision mixer, while a second desk on a raised dais behind the first one is provided with monitoring equipment required by the senior engineer. (The raising of the engineer's position gives him a clear view of the studio free from any obstructions by his colleagues at the lower desk.) Both desks incorporate built-in picture monitors so arranged that they can be speedily removed for servicing. Above each position are small spotlights so focused as to throw a good general illumination on scripts and other documents on the desk, while leaving all other sections relatively dark. To remove any possibility of eye-strain due to glare from the studio affecting eyes previously

attuned to watching the picture monitors the double-glazed windows between the control rooms and the studio are fitted with tinted glass. A window which can be opened or closed by a power-operated control divides the vision and sound control rooms.

The vision mixing arrangements in this studio are interesting and were planned to simplify the operational side while still giving all the facilities required. This has involved modifications to the original E.M.I. equipment by B.B.C. engineers. The vision mixing equipment which forms part of the control gear associated with the studio cameras is installed in an apparatus room at studio floor level, but is remotely controlled from a panel in the vision control room above. The output of each camera is controlled by a push button so that "cuts" from one camera to another can be made simply by pressing the appropriate button. When it is desired to fade from one camera to another instead of cutting, one fader per camera has been provided for this purpose. A further facility has been incorporated which enables the outputs of two cameras to be superimposed and for the degree of superimposition to be pre-set independently of the remaining camera, which may be supplying the transmitted picture. The superimposition is adjusted and checked on a pre-view monitor screen and this picture is brought into the transmission chain when required by operating a "superimposition key." This automatically releases the camera formerly on transmission.

The original acoustic treatment in Studio H was very absorbent, all the walls and ceiling being covered with rock wool. In order to improve the sound quality, the rock wool was removed from the main piers on both sides and part of the ceiling. These areas were recovered with hard-board, and measurements taken before and after this treatment indicated that an increase of some 30 per cent in reverberation time had been made. This has produced an appreciable acoustic "livening" of the studio.

A new ventilation plant has been installed for Studio H and includes air washing, heating and de-humidifying sections. No provision has been made for refrigeration of the air, but experience shows that the washing process reduces the temperature by 7 per cent to 8 per cent.



# The Activities and Equipment of an Industrial Electronics Laboratory

By G. H. Hickling,\* B.Sc., A.M.I.E.E.

(Part 5)

## Design of Equipment

### Selection of Equipment

It has already been stressed that equipment should be universally applicable and also that careful discrimination should be exercised in its purchase or design to ensure a high standard of reliability—commensurate with that of the industrial plant on which testing operations will be carried out. It must be remarked here that much commercially available apparatus fails to comply with one or other of these two requirements. Many manufacturers specialize in a few single-purpose instruments—test equipment for the radio industry, pH meters, stroboscopes, moisture detectors and so on—while relatively little really satisfactory general purpose test equipment is available, of the types described.

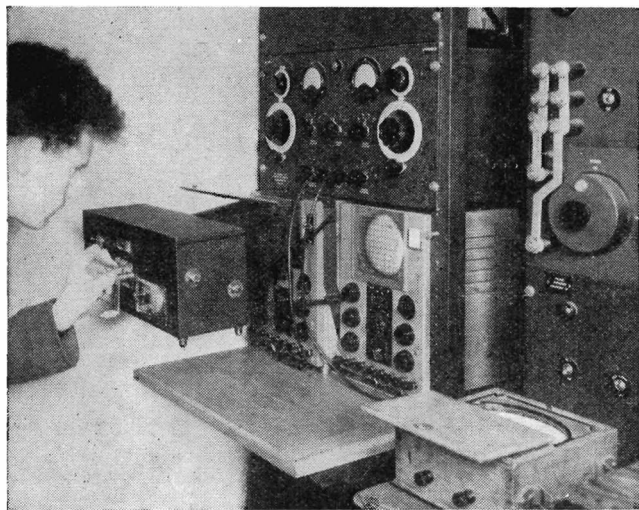

Fig. 35. Typical rack assembly

in the previous parts of this article and most needed in the average industrial laboratory.

The writer has recently made a survey of electronic equipment obtainable from the leading British manufacturers and this, while extremely useful in itself, has only served to confirm the foregoing conclusion. Incidentally, it is well worth while, in any laboratory, compiling a card index of available apparatus and components and of their sources of supply. The advertisement pages of this journal afford one excellent source of information for such a scheme.

This situation, and the need also to meet various special requirements, necessitates the construction in the laboratory of much of the equipment needed; consequently a few notes at this stage on the more practical aspects of its design and construction may not be inappropriate.

\* C. A. Parsons & Co., Ltd.

### Construction and Standardization

Two essentially different types of equipment have to be considered. For normal laboratory and factory use, robust mains operated equipment of the standard Post Office 19in. rack mounted type is strongly recommended (see e.g. Figs. 35, 37 to 39 and other previous illustrations). Such equipment—to which the following notes mainly apply—can be rapidly assembled in either fixed or mobile racks with considerable economy in space; yet it is equally suitable for use on the bench. For "field" work, on the other hand, it is most useful to have available a number of small portable instruments (Fig. 36). Vibration and noise meters and analysers, light-meters, etc., fall into this category, while the miniature portable oscilloscopes (mains or battery operated) which are now available make a further useful addition to this class of equipment.

Standardization in all laboratory equipment has many advantages; and while the remarks which follow have a

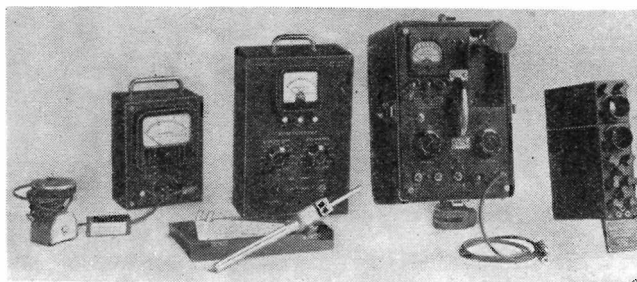

Fig. 36. Some portable vibration and noise measuring apparatus

bearing primarily on laboratory-made equipment, it is nevertheless desirable that in the more important aspects all the instruments used in the laboratory, whether "home-made" or purchased from commercial sources, should conform to the same standards. In this respect a special plea is made to manufacturers that the number of types of plug and socket connectors, etc., should be reduced to the necessary minimum, thereby making it possible to achieve inter-changeability of cable connectors for all equipment. Those types which (it is to be hoped) may ultimately be accepted as British standards should combine the features of simplicity and absolute reliability.

The basic standard unit suggested for all laboratory electronic equipment is the 19in. rack-mounted instrument, of which various illustrations have been given, with preferred panel heights of 3½in., 7in. and 10½in. These are sufficient for all normal requirements and there is no advantage in introducing intermediate sizes. Aluminium panels ¼in. thick are very satisfactory; a good "professional" finish can be obtained by applying crackle black stoved enamel, all lettering, etc., being subsequently engraved through the paint and left unfilled. Robust

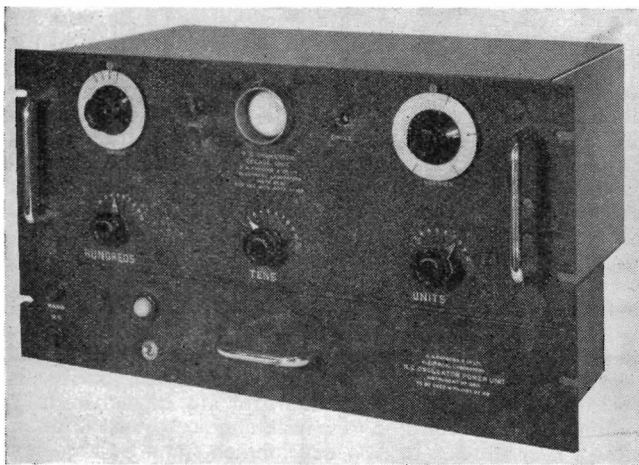

Fig. 37. Decade RC laboratory oscillator

standard sized cadmium-plated chassis can be purchased ready made from specialist manufacturers, as also can complete instrument racks and rack cabinets, dust covers, etc. Many other constructional parts may also usefully be standardized—particularly such items as “frame bars” (enabling chassis to be placed any way up without damage), tag strips for mounting small components, valve cans and so forth, most of which can also be bought ready made.

Standard laboratory instruments of the type described, if they are to be used permanently on the laboratory bench, may be mounted in suitable metal cabinets as illustrated in Fig. 1.

Equipments made for factory or industrial applications, as distinct from laboratory use, will still, preferably, be variants on this type of construction; the basic P.O. standard sizes should be retained. The supervisory equipment shown in Fig. 7 of Part 1, for example, uses the same basic standard chassis construction; but various forms of protective casing are used to meet individual requirements.

A multi-channel laboratory amplifier of standard construction is shown in Fig. 38. In order, however, to meet a demand for smaller individual amplifier units than can conveniently be constructed within the standard 19in. frame size, a so-called “sub-unit” construction has been evolved, of which one form is illustrated in Fig. 39. Incorporated, again, in an industrial equipment, this arrangement greatly facilitates servicing: the individual units are, in this instance, inserted from the back of the main unit, and each plugs into a common power pack built into the front of

Fig. 38. 5-Channel general purpose amplifier with demodulator stages

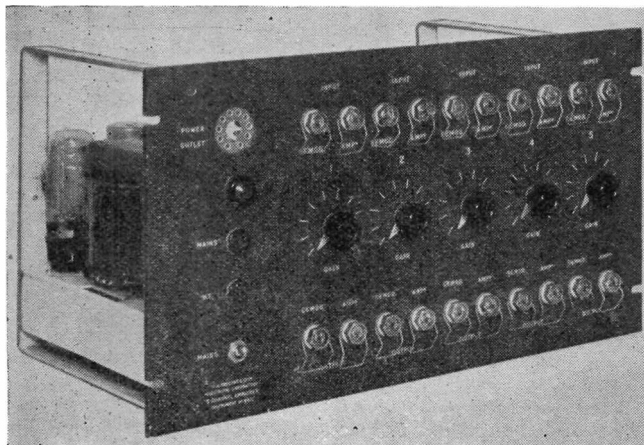

the chassis. Any faulty unit is thus immediately replaceable by a spare. A variation on this construction was illustrated by the pyrometer amplifier in Fig. 16.

The principle of standardization should not stop at purely constructional features. Equipment should be designed electrically, as already suggested, so that the various electrical units—detectors, pre-amplifiers, amplifiers and indicator units may be assembled together as “bricks” to build up any desired recording system. Thus it was recommended in Part 3 that amplifier units should normally be matched to the impedance of an indicating meter or recorder, with an output level limited to about 20 volts, cathode-ray oscillographs or other special indicating devices each being provided with their own calibrated driver amplifiers (preferably direct coupled) designed to accept this input signal. In this context, incidentally, it may be remarked that while there is an almost overwhelming choice of portable cathode-ray oscilloscopes, there is a definite need for a good general purpose standard rack-mounted oscillograph unit, to form a logical component in rack-mounted test assemblies.

### Development Routine

The development of electronic instruments in considerable numbers and variety has been found necessary in the laboratory with which the writer is associated, these includ-

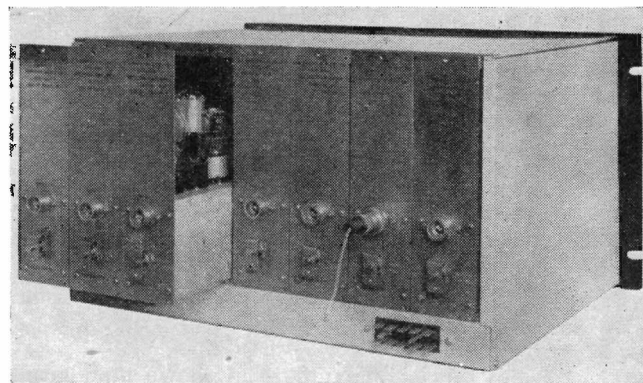

Fig. 39. Industrial multi-channel amplifier unit

ing of necessity many standard laboratory instruments. After a number of years spent in this work a fairly definite pattern has evolved in the design and development of these items, and it seems worth while therefore to give a brief indication of the routine which is followed.

Standardization has actually been carried a stage further, in this laboratory, than is suggested by the foregoing remarks. Commercially available components have been carefully investigated and a collection of data sheets has been prepared, giving all details required by the circuit designer and draughtsman. This greatly reduces the work of developing new designs and at the same time ensures the use of only the most reliable component parts. The circuit design for a new instrument is first prepared by one of a small design staff—also responsible for the general supervision of the laboratory development work. If it involves any novel features necessitating an experimental try-out, a prototype circuit is then assembled in the laboratory and the necessary tests and circuit modifications carried out until satisfactory performance is obtained. For this purpose standard “experimental chassis”, ready drilled for fitting components, are kept available. The circuit diagram is subsequently completed, with a detailed specification of every component to be used (including types of indicating meters, connectors, etc.) and passed to a draughtsman for layout design. Little or no other information need normally be given owing to the standardized construction adopted. A final circuit diagram—again specifying every item—is

drawn first, and returned for checking, after which the necessary working drawings are made.

From this point onwards, the ordering of any material not available from the department's own stores, and the piloting of the unit through the various workshops concerned, is handled entirely by a small "planning department"—fully experienced in ironing out all of the "snags" which inevitably arise in any production process. Finally, when the finished instrument is returned to the laboratory, it undergoes thorough tests and, where necessary, circuit adjustments, until it conforms to a previously prepared "acceptance specification". Each new instrument is given a type number and every detail of its performance is recorded and filed under this reference to facilitate future servicing.

### Conclusion

To conclude on a note appropriate to the general theme of these articles, it has been the writer's endeavour to show how it is possible to plan the equipment of a typical industrial electronics laboratory in advance, so as to provide for the great diversity of tasks which it may be called upon to perform, with maximum economy, while at the same time increasing its usefulness and efficiency as a unit. The aim should be always to avoid waiting until a particular instrument is needed and then having to improvise.

Reliability should be the keynote of all electronic equipment for use in industry; any saving in this direction is false economy. Every instrument should, on the other hand,

be selected for its general applicability. The endeavour should be to build up a complete set of equipment on the "unit" principle to cover every type of measurement likely to arise. Standardized construction as well as standardization of circuits is a material help in this direction, both in the production of new equipment and in its practical application. Electronics in this country has so far lagged somewhat behind the needs of industry in this direction; but herein lies an outstanding opportunity for enlightened and planned production. Instrument manufacturers, furthermore, could render a most valuable service to industry generally by co-ordinating the design of standard laboratory instruments so that users purchasing any British electronic measuring equipment could rely on its being completely interchangeable with that of any other manufacturer—and so that they could, moreover, quickly obtain the most suitable equipment, of reliable design, for any type of test.

Finally, the electronic research engineer must himself always keep abreast of new developments and be prepared to adopt new techniques, for in no other field of applied science does progress so rapidly outdate methods and equipment—perhaps only recently introduced.

### Acknowledgments

The author wishes to express his indebtedness to the Directors of Messrs. C. A. Parsons & Co. Ltd. for permission to publish this series of articles and to various colleagues for assistance, particularly in the preparation of the illustrations.

## The Required Figure of Merit of Frame Deflector Coils

By E. T. Emms,\* B.Sc., A.R.C.S.

IN a previous article<sup>1</sup> the author has shown how, given a set of frame deflector coils, the complete time-base may be designed. In many cases the problem which faces the designer is somewhat different. He is told that the frame time-base must be such that it works from an H.T. line of say 180 volts with a specified output pentode (say the ECL80) and be capable of scanning a C.R.T. (say the MW22-14) the latter being operated at a specified E.H.T. voltage (say 9kW). The designer then has to decide how "good" his deflector coils must be from the point of view of deflexion sensitivity, if such a problem is to be solved. Having decided the degree of "electrical goodness" required he must then design and construct suitable deflector coils bearing in mind that such coils must be "electronically good", i.e., they must cause minimum deflexion defocusing, be of such a length that corner cutting is not obtained, etc. The object of this article is to suggest how the designer may estimate the required degree of "electrical goodness" of his frame deflector coils in order that they may be used in conjunction with a given output pentode operated from a given H.T. line, to scan a given C.R.T. operated at a given E.H.T. voltage. To put the problem into practical units it is convenient to express the "electrical goodness" by a figure of merit which may be defined by:

$$F = D / \sqrt{r_y}$$

where  $D$  is the sensitivity (i.e. the deflexion obtained when unit current passes through the coils) and  $r_y$  is the resistance of the coils. The author prefers to express  $D$  in cm/amp and  $r_y$  in ohms. Other designers prefer to express  $D$  in metres/amp or cm/mA, etc., but it is felt that since the

use of cm/amp for  $D$  results in a figure for  $F$  lying between 5 and 50 (with normal coils) that its use is to be preferred. Other authorities use a figure of merit which is related to the reciprocal of  $F$  as defined above. It is felt that this is to be deprecated since it is considered preferable that a "good" coil should give a high figure of merit.

Thus in what follows we shall express  $D$  in cm/amp and  $r_y$  in ohms. The design procedure is best illustrated by examples using the theoretical results obtained in Reference 1.

### Example I: A Design in the Minimum Mean Anode Current Condition

It is desired to predict the value of  $D / \sqrt{r_y}$  of the deflector coils which is required in order that an MW22/14 may be scanned at 9kV using an ECL80 as output pentode operated from the 180V H.T. line.

Consultation of the published data on the ECL80 reveals that with  $V_a = 50$  volts,  $V_{g2} = 170$  volts (i.e., allowing 10 volts for cathode bias) the available peak anode current is 26mA. The permissible voltage swing below the H.T. line is then  $180 - 50 - 10 = 120$  volts. Let us assume that it is desired to operate the circuit in the Minimum Mean Anode Current Condition, Equation (28) of Reference 1 gives:

$$I_a(T) = I_{a \min} + 1.077 \left\{ 1 + L_y/L_s \right\} I_{pp}/k_n$$

We know from experience that  $k$  may be about 0.98,  $L_y/L_s$  will be about 0.1 so that we have:

$$n = 1.21 I_{pp} / \left\{ I_a(T) - I_{a \min} \right\}$$

From the published data on ECL80  $I_a(T) = 26$ mA, while

\* Late Mullard Research Laboratories, now at Air Trainers, Ltd.

we may choose  $I_{a \text{ min}} = 3\text{mA}$ , experience showing that reasonable linearity may be expected with this minimum current. Thus:

$$n = 52.6 I_{pp} \dots \dots \dots (1)$$

Equation (34) of Reference 1 gives as the swing below the H.T. Line:

$$V_1(T) = R_p I_a(T) + \frac{nr_2 I_{pp}}{k} \left\{ 0.789 - \frac{0.289k^2}{1 + L_y/L_s} \right\}$$

which with  $I_a(T) = 26\text{mA}$ ,  $k = 0.98$ ,  $L_y/L_s = 0.1$  reduces to:

$$V_1(T) = 26 \times 10^{-3} R_p + 0.548 nr_2 I_{pp}$$

Using Equation (1) to eliminate  $n$  we get:

$$V_1(T) = 26 \times 10^{-3} R_p + 28.9 r_2 I_{pp}^2$$

Now  $r_2$  is the sum of the deflector coil resistance and the transformer secondary resistance. The latter is kept as small as possible in the interests of an efficient circuit and, in fact, it rarely exceeds 40 per cent of the deflector coil resistance. Thus putting  $r_2 = 1.4 r_y$  as representing the worst case we have:

$$V_1(T) = 26 R_p \times 10^{-3} + 40.5 r_y I_{pp}^2$$

The full deflexion required on the MW22-14 is 16cm, so that  $I_{pp} = 16/D$ , where  $D$  is the sensitivity in cm/amp. Thus:

$$V_1(T) = 26 R_p \times 10^{-3} + 10,350 r_y/D^2$$

The available voltage swing below the H.T. line we have seen to be 120 volts so that:

$$120,000 = 26 R_p + 10.35 r_y/D^2 \times 10^6$$

whence:

$$D/\sqrt{r_y} = 10^3/\sqrt{(11,580 - 2.51 R_p)} \dots \dots \dots (2)$$

This equation enables the value  $D/\sqrt{r_y}$  required to be calculated if the transformer primary resistance is given.

$R_p$ (k $\Omega$ )	0	0.5	1.0	1.5	2.0	2.5	3.0	3.5
$D/\sqrt{r_y}$	9.3	9.5	10.5	11.2	12.4	13.5	15.7	18.3

For example we may say that using an ECL80 operated from an H.T. line of 180 volts, an MW22-14 may be scanned at 9kV with a transformer whose secondary resistance does not exceed 40 per cent of the deflector coil resistance.

(a) Using deflector coils having  $D/\sqrt{r_y} = 10.5$  (measured on an MW22-14 at 9kV) if the transformer primary resistance does not exceed 1,000 ohms.

(b) Using deflector coils having  $D/\sqrt{r_y} = 15.7$  (measured on an MW22-14 at 9kV) if the transformer primary resistance does not exceed 3,000 ohms.

It is clear that the second design should lead to a cheaper output transformer, but the figure of merit of the deflector coils is higher and possibly difficult to attain.

### Example II: A Design in the Zero Initial Slope Condition

It is desired to predict the value of  $D/\sqrt{r_y}$  of the deflector coils which is required in order that an MW41-1 may be scanned at 14kV using an ECL80 as output pentode operated from a 180V H.T. line.

Consultation of the published data on the ECL80 reveals that with  $V_a = 50$  volts,  $V_{g2} = 170$  volts (i.e., allowing 10 volts for cathode bias) the available peak anode current is 26mA. The permissible voltage swing below the H.T. line is then  $180 - 50 - 10 = 120$  volts. Let us assume that it is desired to operate the circuit in the Zero Initial Slope Condition, then Equation (13) of Reference 1 gives:

$$I_a(T) = I_a(O) + (1 + L_y/L_s) I_{pp}/k_n$$

We know from experience that  $k$  may be about 0.98,  $L_y/L_s$  will be about 0.1 so that we have:

$$n = 1.13 I_{pp} / \{ I_a(T) - I_a(O) \}$$

From the published data on the ECL80  $I_a(T) = 26\text{mA}$  while we may choose  $I_a(O) = 3\text{mA}$ , experience showing that reasonable linearity may be expected with this minimum current. Thus:

$$n = 49.2 I_{pp} \dots \dots \dots (3)$$

Equation (17) of Reference 1 gives as the voltage swing below the H.T. line:

$$V_1(T) = R_p I_a(T) + \frac{nr_2 I_{pp}}{k} \left\{ 1 - \frac{k^2}{2(1 + L_y/L_s)} \right\}$$

which with  $k = 0.98$ ,  $L_y/L_s = 0.1$ ,  $I_a(T) = 26\text{mA}$  becomes:

$$V_1(T) = 26 R_p \times 10^{-3} + 0.574 nr_2 I_{pp}$$

Putting  $r_2 = 1.4 r_y$  as before, and taking  $V_1(T)$  as 120 volts we get on eliminating  $n$ :

$$120,000 = 26 R_p + 39.4 r_y I_{pp} \times 10^3$$

Full frame deflexion on the MW41-1 is 28cm so  $I_{pp} = 28/D$ , giving:

$$120,000 = 26 R_p + 30.9 r_y/D^2 \times 10^6$$

whence:

$$D/\sqrt{r_y} = 10^3/\sqrt{(3,890 - 0.842 R_p)} \dots \dots \dots (4)$$

This equation enables the value of  $D/\sqrt{r_y}$  required to be calculated if the transformer primary resistance is given.

$R_p$ (k $\Omega$ )	0	0.5	1.0	1.5	2.0	2.5	3.0	3.5
$D/\sqrt{r_y}$	16.0	17.2	18.1	19.5	21.3	27.7	27.0	32.5

For example we may say that using an ECL80 operated from an H.T. line of 180 volts, an MW41-1 may be scanned at 14kV with a transformer whose secondary resistance does not exceed 40 per cent of the deflector coil resistance (a) using deflector coils having  $D/\sqrt{r_y} = 18.1$  (measured on an MW41-1 at 14kV) if the transformer primary resistance does not exceed 1,000 ohms.

(b) Using deflector coils having  $D/\sqrt{r_y} = 27.0$  (measured on an MW41-1 at 14kV) if the transformer primary resistance does not exceed 3,000 ohms.

It is clear that the second design should lead to a cheaper output transformer, but the figure of merit of the deflector coils is appropriately higher and probably very difficult to attain.

### REFERENCE

<sup>1</sup> EMMS, E. T. The Theory and Design of Television Frame Output Stages. *Electronic Engineering*, 24-96 (1952)

# Calibration Bars for Single Sweep Time-Bases

By M. Gregson

A COMMON use of the cathode-ray tube is the measuring of time intervals between a succession of events. A single sweep horizontal time-base is employed, the first event initiating the sweep, the later events usually being depicted by vertical displacement of the trace. The following describes a method of calibration at intervals of the order of 1/100th second, i.e., for slow speed time-bases.

The method fulfils these requirements:

- (1) The entire field of view must be covered, hence the calibration consists of vertical bars.
- (2) The bars must be bright enough to photograph clearly. This is particularly necessary when a succession of traces, one below the other, are included in the same photographic record, and each trace is

oscillating (see Fig. 1). Bars from so-called square waves may have insufficient actinic intensity to avoid confusion with the traces themselves.

- (3) The speed of sweep must be adjustable, and the linearity of no consequence; clearly the calibration system must be a function of the trace.
- (4) The calibration error must be within the visual error.

This calibration method differs from all others in that it is applied, not to the signal deflector plates, but to the time-base itself.

The discharge producing the trace sweep is applied to the grid of  $V_1$  (Fig. 2). When the time-base is functioning normally  $V_2$  is cut off for the entire sweep duration; the voltage at the point X decreases as the discharge proceeds,  $V_3$  conducts, and the stage acts simply as a cathode-

follower (ignoring for the moment the small capacitor  $C_2$ ).  $V_5$  and  $V_6$  constitute a cathode-coupled amplifier to give the necessary D.C. plate connexions. At the beginning of every discharge, whether for normal trace sweep or for calibration purposes, a large negative voltage is applied to the anode of  $V_4$ , which is then cut off for the sweep duration; the purpose of this diode is to bring the electron spot back to its initial position after the sweep, and to assist in holding it there.

When the calibration bars are required the grid of  $V_2$  is put into A.C. contact with the oscillator through the small capacitor  $C_3$ . From the oscillator short pulses are derived at the required time intervals (say 1/100sec). These pulses must be negative and of quite large amplitude, say 100 volts. Their period is determined by  $C_3R_3$ .  $V_2$  is, on this occasion, initially conducting, more or less to saturation; owing to the increased P.D. across  $R_2$  the electron spot on the tube is displaced, preferably off the face of the tube (see later). The oscillator is synchronized to give the first negative pulse with the commencement of the time-base discharge. When this occurs,  $V_2$  is cut off for a brief instant, and the voltage at X reverts to that normally obtaining at the commencement of discharge; hence the electron spot flashes to its initial sweep position. Then  $V_2$  conducts once more and the voltage at X rises.  $V_3$  cuts off,  $V_4$  is already cut off. The voltage at point Y, therefore, stays fixed at the discharge initial voltage, and is steadied by  $C_2$ . The electron spot on the tube stays fixed, too, at zero position.

The next negative pulse takes the voltage at X to the value which it normally possesses 1/100sec after the start of the time-base. Point Y also assumes this voltage,  $V_2$  conducts once more, the voltage at Y stays fixed for another 1/100sec, and so the process is repeated time after time. Note that the corresponding points on normal and calibration sweeps are obtained only under identical conditions, i.e., when  $V_2$  is not conducting. The calibration sweep now

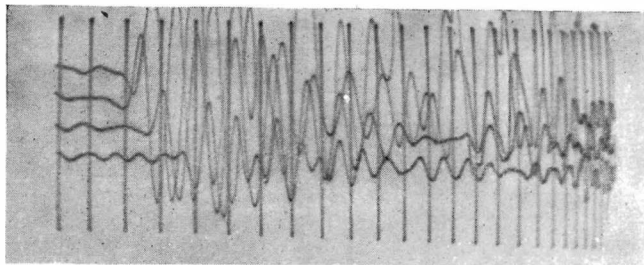

Fig. 1. The timing lines superimposed on a geophysical record

consists of a series of bright dots, each of 1/100sec duration, each following the previous one 1/100sec later along the normal trace sweep. An R.F. oscillation is applied to the signal plates, and the dots are transformed into vertical bars. The electron beam for the entire sweep is concentrated into these bars.

$C_2$  must be small enough to discharge completely during each short pulse. It must be large enough to slow down the "drift" of the grid of  $V_3$  so that this drift, over each period of 1/100sec is not observable as a broadening of the bars. Using a 6-in. C.R.T., the author finds a  $0.005\mu\text{F}$  capacitor satisfactory, and the effective discharge time appears to be of the order of 1/10,000sec; there may be a preference for replacing  $C_2$  by a much smaller capacitor between grid and anode.

Care must be taken that at no point on the normal trace sweep does  $V_5$  or  $V_1$  run into grid current.  $V_2$  must pass sufficient current to ensure that point A (Fig. 3) does not drop below point B. The oscillation producing the vertical bars need not, of course, be R.F., but R.F. is far distant from the other frequencies involved, and should the field interfere with the time-base the effect is easily removed (e.g.,

a 50pF capacitor across the C.R.T. time-base plates).

That part of the circuit shown to the left of  $V_1$  is schematic, the time-base being triggered by closing the key K. It is convenient to have the electron spot deflected off the screen prior to all time-base triggerings, not only prior to the calibration sweep. This is achieved by making  $V_2$  normally conduct; switch S is in position "1", so that when K is closed the grid of  $V_2$  is driven negative and  $V_2$  immediately cuts off. The time-constant  $C_4R_3$  needs to be sufficiently long to hold the grid below earth potential for the trace duration. The anode of  $V_4$  is similarly treated.

If the calibration pulses are derived from a two-valve multivibrator, the cathode of one valve may be taken to a point corresponding to Z. Thus this valve is cut off until K is closed, whence synchronization is obtained together with the necessary magnitude of pulses from the anode (the intervening positive pulses have no effect). A trace brightener may also be derived from Z, since even when the electron spot is not visible, being deflected to one side, it tends to cast a glow over the screen, unless of very low intensity.

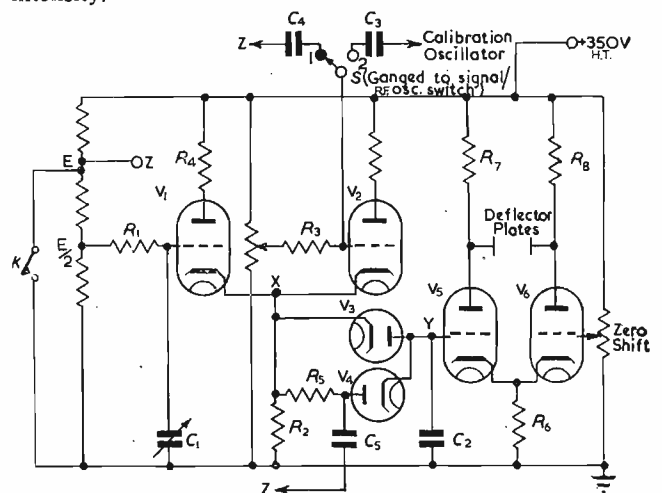
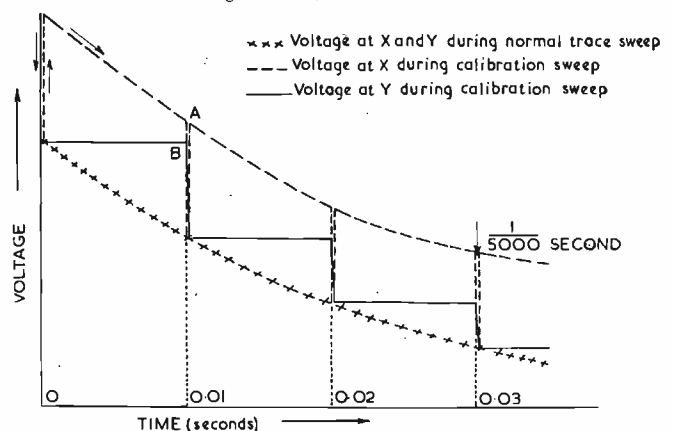

Fig. 2. The circuit diagram  
Fig. 3. Associated waveforms



In the author's circuit the time-constant  $C_1R_1$  is variable between 1/10sec and 1/2sec,  $R_2 = 10\text{k}\Omega$ ,  $R_4 = 33\text{k}\Omega$ ,  $R_7 = R_8 = 220\text{k}\Omega$ ,  $R_6 = 39\text{k}\Omega$ ,  $C_2 = 0.005\mu\text{F}$ . Time-constant  $C_3R_3$  is of the order of 1/5000sec,  $C_4R_3 = C_5R_3$  of the order of 1sec. For  $V_1 + V_2$  and  $V_5 + V_6$  6SN7 type valves may be used, and  $V_3 + V_4$  may be any small low-resistance double diode.

The author evolved the circuit for the calibration of seismic prospecting records. While being particularly applicable in this field these calibration bars may be found useful with any oscillating traces, or for other types of display.



# The Prediction of Audio-Frequency Response

## No. 3—Single Complex Impedance in Resistive Network

By N. H. Crowhurst, A.M.I.E.E.

THIS data sheet will assist in computing the response where the network can be reduced to one of the forms shown in Figs. 1 or 2. Although the treatment is theoretically applicable to networks of the type shown at Fig. 1, practical applications generally conform to that shown at Fig. 2.

The most noteworthy application for these charts is the prediction of response for circuits including an iron cored component. Referred to a given winding, eddy current loss may be regarded as a constant resistance shunt, so this loss can be represented as part of the shunt resistance  $R_2$  in the configuration of Fig. 2(a). The variable part of the losses, due to hysteresis, can be calculated, for fixed input potential, by means of charts given in an earlier data sheet, then the charts given in this data sheet are used to give direct reference of response in amplitude and phase, at this chosen level. By repeating the process at different levels, the effect of change in level on response may be shown with greater facility by use of these charts.

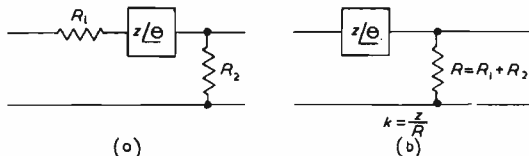

Fig. 1. Networks with series complex impedance

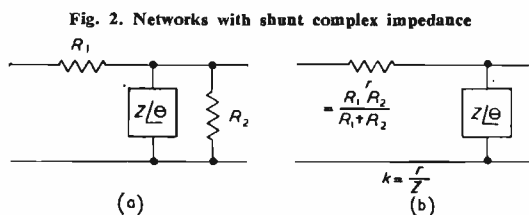

Fig. 2. Networks with shunt complex impedance

### Formulae

Using the notation shown at Fig. 1(b) and 2(b), i.e.,  $k = z/R$  or  $r/Z$ , and  $\theta$  is the phase angle of the impedance  $z$  or  $Z$ , the attenuation ratio, due to the introduction of the impedance  $z$  as compared with short circuit, in the arrangement of Fig. 1, writing  $z \cdot \cos \theta = r$  and  $z \cdot \sin \theta = x$ , is

$$A = 1 + \frac{r + jx}{R} = 1 + k \cdot \cos \theta + jk \cdot \sin \theta \quad \dots (1)$$

whence the amplitude loss is given by

$$\begin{aligned} \text{db} &= 20 \log_{10} (1 + k \cdot \cos \theta + jk \cdot \sin \theta) \\ &= 10 \log_{10} (1 + 2k \cdot \cos \theta + k^2) \quad \dots (2) \end{aligned}$$

and the transfer phase-angle by

$$\phi = -\tan^{-1} \frac{k \cdot \sin \theta}{1 + k \cdot \cos \theta} \quad \dots (3)$$

or due to the introduction of  $Z$  as compared with open circuit, in the arrangement of Fig. 2, writing  $Z \cdot \cos \theta = R$ , and  $Z \cdot \sin \theta = X$ , the attenuation ratio is

$$\begin{aligned} A &= 1 + \frac{r}{R + jX} = 1 + \frac{rR}{R^2 + X^2} - \frac{jXr}{R^2 + X^2} \\ &= 1 + k \cdot \cos \theta - jk \cdot \sin \theta \quad \dots (4) \end{aligned}$$

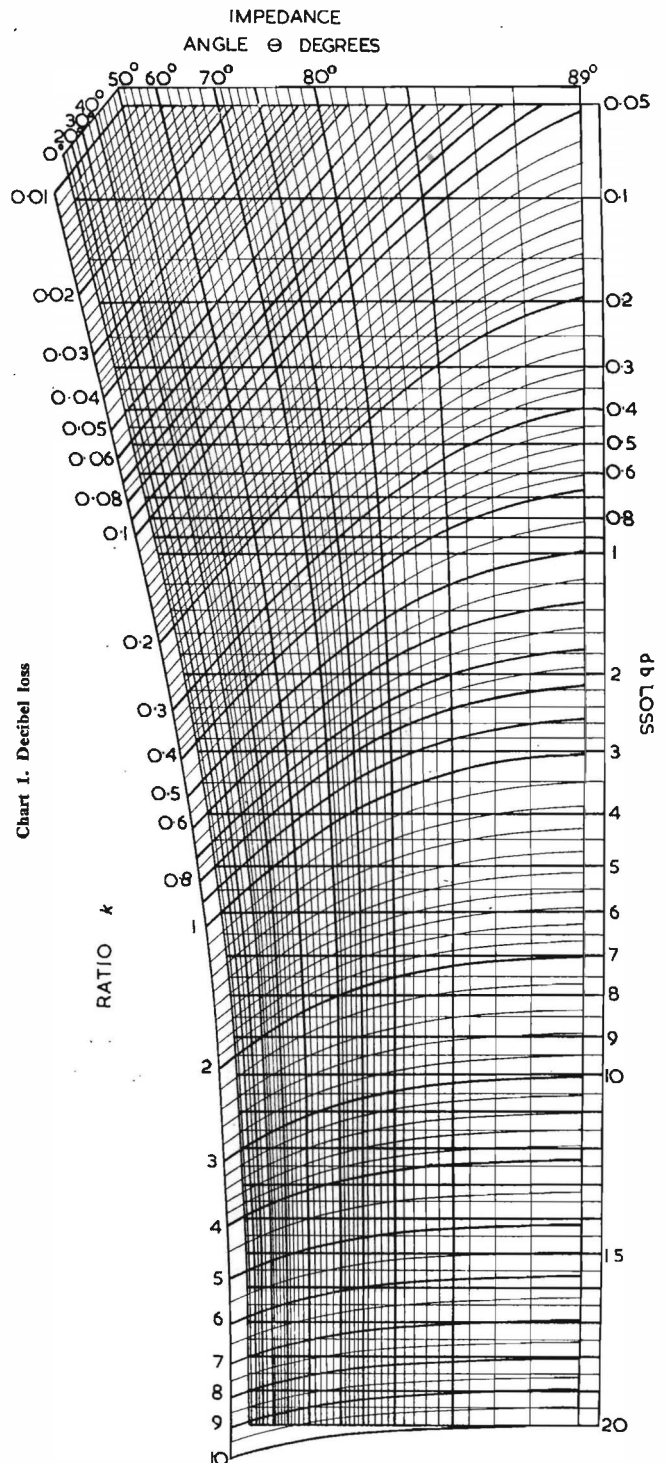

Chart 1. Decibel loss

whence the amplitude loss is given by

$$\begin{aligned} \text{db} &= 20 \log_{10} (1 + k \cdot \cos \theta - jk \cdot \sin \theta) \\ &= 10 \log_{10} (1 + 2k \cdot \cos \theta + k^2) \dots \dots \dots (5) \end{aligned}$$

which is identical in value with (2), and the transfer phase-angle is given by

$$\phi = \tan^{-1} \frac{k \cdot \sin \theta}{1 + k \cdot \cos \theta} \dots \dots \dots (6)$$

In the foregoing expressions for  $A$ , the ratio given is  $\frac{\text{input}}{\text{output}}$ , since it gives the more convenient form for writing. The loss, expressed in db will be numerically the same either way, but the sign will be negative if the ratio is taken as  $\frac{\text{output}}{\text{input}}$ . The expression required for transfer

presenting db loss or transfer phase angle against these variables, one as the "x" quantity with curves for successive constant values of the other. Using this method, every curve drawn has a different configuration, so that plotting is arduous, and the final result more liable to inaccuracies than the method employed in the production of these charts.

For Chart 1, presenting the amplitude loss in db, the quantity presented in the "y" direction is db loss, plotted to a scale of  $\log D$ , where  $D = 2k \cdot \cos \theta + k^2$ , and the scale is calibrated in terms of db loss =  $10 \log_{10} (1 + D)$ . In the "x" direction the quantity plotted is  $\log m$ , where

$$m = \frac{k}{\cos \theta}$$

quantity, it being merely used as a reference to obtain the other scales.

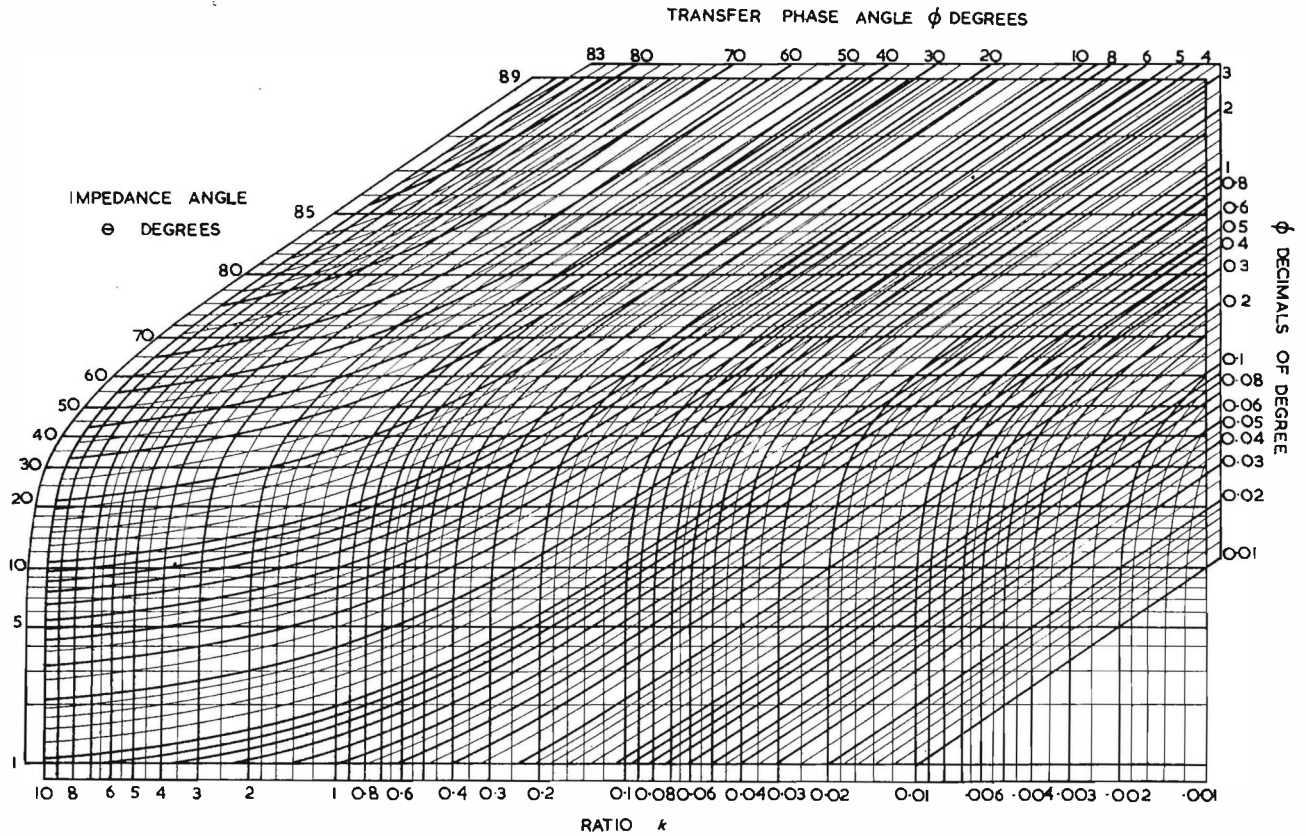

Chart 2. Transfer phase-angle

phase-angle is the angle of the output potential vector referred to the input potential vector as zero. This angle will be equal but opposite in sign to the angle of input potential referred to output potential. Hence the reversal of sign in deriving expressions (3) and (6) from (1) and (4) respectively. The fact that there is a negative sign in expression (3) indicates that an inductive impedance for  $z$  will produce a phase lead, while a capacitive impedance will produce a phase lag. For the more usual circuit of Fig. 2, expression (6) shows that if  $Z$  is an inductive impedance, the network produces a phase lag, which is the general application, or if  $Z$  is a capacitive impedance there will be a phase lead.

**Design of Charts**

Each of the resultant quantities, db loss and transfer phase-angle, is a function of the independent variables  $k$  and  $\theta$ . A family of curves could therefore be plotted,

Expressions involving  $\theta$  and  $k$  can now be separated from Equations (2) or (5)

$$D = (m^2 + 2m) \cos^2 \theta \dots \dots \dots (7)$$

$$\text{and } D = k^2(1 + 2/m) \dots \dots \dots (8)$$

Curves representing these expressions to the scales chosen, for constant values of  $\theta$  and  $k$  respectively, can be drawn and used as templates for the rulings presenting values of  $\theta$  and  $k$ , different rulings being obtained by sliding the template along the  $D$  or "y" axis. The chart is made a more convenient shape by the use of oblique axes.

For Chart 2, presenting the transfer phase-angle  $\phi$ , the quantity shown vertically is  $\theta$ , plotted to a scale of  $\log \tan \theta$ , and calibrated in  $\theta$  degrees. The quantity plotted

horizontally, to a log scale, is  $q = \frac{1}{k \cdot \cos \theta}$ . The expressions

involving  $\phi$  and  $k$  can now be separated from Equation (6)

$$\tan \theta = (1 + q) \tan \phi \dots \dots \dots (9)$$

$$\text{and } q^2 = \frac{1 + \tan^2 \theta}{k^2} \dots \dots \dots (10)$$

Curves representing these expressions to the scales chosen, for constant values of  $\phi$  and  $k$  respectively, can be drawn and used as templates for the rulings representing values of  $\phi$  and  $k$ , different rulings being obtained by sliding the template for  $\phi$  rulings along the  $\tan \theta$  or "y" axis, and that for  $k$  rulings along the  $q$  or "x" axis. Rectangular axes were used in this case.

#### Use of Charts

The finished charts form simple reference graphs relating three quantities in each case, so there is no ambiguity as to use. An example will serve as illustration.

An iron-cored transformer, step-up ratio 2.5:1, operates from a source impedance of 20k $\Omega$ , and has a secondary load resistance of 0.5M $\Omega$ . Eddy current loss is equivalent

to a resistance of 0.1M $\Omega$  in shunt with the primary. At spot frequencies of 50, 100 and 200c/s, the hysteresis effect may be represented, for an input level of 10 volts, by impedances of: 10k $\Omega$ , 58°; 16.5k $\Omega$ , 60°; and 30k $\Omega$ , 62° respectively.

The value of  $r$ , in Fig. 2(b), is calculated by finding the equivalent resistance of the source impedance, the referred secondary load, and the eddy current loss, in parallel. The referred secondary load will be 0.5M $\Omega \div 2.5^2$ , or 80k $\Omega$ . The effective parallel resistance of 20k $\Omega$ , 80k $\Omega$  and 0.1M $\Omega$  is 13.8k $\Omega$ . Thus values of  $k$  for 50, 100 and 200c/s at this level are, respectively, 1.38, 0.835, and 0.46.

Applying these values to the charts and tabulating the results:

Frequency	k	$\theta$	db loss	$\phi$
50	1.38	58°	5.8	33°
100	0.835	60°	3.9	27°
200	0.46	62°	2.08	18°

## Some Features of American Electro-cardiograph Design

By E. E. Suckling\* M.Sc., A.M.I.E.E.

**S**PECIFICATIONS issued by the American Medical Association for electrocardiographs, include the following requirements.

(a) The instrument shall have a frequency response which is substantially flat up to 40c/s at which point the amplitude drop off must not be more than 20 per cent.

(b) The tracing obtained when a sustained step of voltage is applied to the input, shall not return to the base line at a rate greater than 10 per cent per second.

(c) The sensitivity of the balanced input to in-phase signals is to be not more than 1 per cent of that to out of phase signals.

The direct writing instrument is easily capable of complying with these requirements and is, because of its convenience, rapidly displacing electrocardiographs which depend on photography for obtaining permanent records. Some manufacturers are still producing mirror and string galvanometer instruments but it is estimated that several thousand direct writing instruments are now made and sold annually in the U.S.A. Direct writers in a few cases depend on ink but the heated stylus burning a line on chemically prepared paper is more popular.

The following description analyses the main features of the products of five of the major manufacturers. All are general utility portable mains operated instruments and are claimed to give good records without special precautions concerning interference.

#### Design Requirements

The electrocardiograph designer is faced with the following problems:

(1) The amplifier, usually mains powered, must operate the pen writer or recorder to give a centimetre deflexion from a signal of 1 millivolt.

(2) The instrument, although having a response to sine waves which may be several seconds in period must be insensitive to power line variations.

(3) The instrument must give little loss in response at 40c/s but must nevertheless not show power frequency interference (i.e. 60c/s in U.S.A.) when its input is directly connected to a patient who may be sitting or lying in a quite substantial a.c. field.

High standards of safety in design and the very utmost in simplicity of operation are of course mandatory.

#### Circuits Used

All five instruments use a push-pull system with three stages of voltage amplification. Pentode power valves drive the pen motor either as cathode-followers or as pentode power amplifiers. The first stage is capacitance coupled to the later stages which are in all cases direct coupled.

The following table analyses the circuit arrangements used.

Model	Input Valves	1st Stage Gain	Output	Output Stage	Type of Recorder
1	2 6SJ7's	250	6V6	Cathode-follower	Ink writer
2	6SL7	40	50L6	Pentode amplifier	Ink writer, loudspeaker type movement
3	2 1620's	70	6V6	Cathode-follower	Hot wire stylus, D'Arsonval movement
4	12AX7	70	6AQ5	Cathode-follower	Hot wire stylus, D'Arsonval movement
5	12AX7	60	6AQ5	Cathode-follower	Hot wire stylus, D'Arsonval movement

#### Base Line Drift

With very low frequency push-pull amplifiers very considerable drift is caused by variations in the input valve heater voltage. Unless the first stage valves are balanced with accuracy for the unusual criterion of equal mutual conductance changes for similar increments of heater voltage, quite small power line variations are liable to cause a substantial drift differential. The following table shows the measures taken to cope with this problem.

#### Model

1. No stabilization (tubes presumably selected)

\* State University Medical Center, New York City.

2. Voltage regulating transformer
3. No stabilization. Rectified D.C. used (tubes presumably selected)
4. Electronically regulated supply used to operate R.F. oscillator at 500kc/s; R.F. used for heaters.
5. As 4 with oscillator working at 2Mc/s.

The use of R.F. or D.C. on the first valve heaters assists in reducing instrument hum. In instrument number 5 a power line swing from 117 volts down to 105 volts or up to 130 volts causes the stylus to drift about half a centimetre.

#### INTERFERENCE

The problem of power line interference picked up from the patient has in none of the five instruments been met by the use of sharp filters. Amplifier frequency response is kept low at frequencies above 100c/s to reduce cross modulation interference from diathermy and such sources and some instruments have an optional control to reduce response at 60c/s under bad conditions. In all cases strong reliance is placed on the fact that a patient in an alternating electric field will have a similar potential induced throughout his body and as a consequence equal and in phase A.C. potentials are offered to the two input grids of the amplifier from an interfering source. If the amplifier is well balanced, no deflexion of the indicator results. In practice potentials as high as 200 millivolts induced in the patient are not uncommon. As the electrocardiogram itself supplies a potential of only about 1 millivolt between the two grids, a "rejection ratio" for in phase as compared with out of phase first grid signals of at least 1,000 times is needed. A simple push-pull amplifier will give a rejection ratio of perhaps 50 times and as a consequence special arrangements must be made to increase this ratio. The five designs cope with this problem as follows:

Designs 1 and 2. Feedback connexions from later to earlier cathodes and grids with pre-set adjustments.

Designs 3, 4 and 5 cathodes of each pair of valves led through a high value of common cathode resistor to a negative supply of about 100 volts.

In unit number 3, the negative voltage is obtained by placing the earth tap on the power supply at a suitable point. In units 4 and 5 the stabilized R.F. supply generated to provide heater power for the first valve provides a voltage which is rectified to give the negative potential needed.

The preference by three manufacturers for the system using a high common cathode resistor in each stage to increase the rejection ratio appears to be well founded by the following analysis based on the components used in instrument number 5.

For the 12AX7 using the voltages shown in Fig. 1 the amplification factor is approximately 80 and the plate resistance approximately 140,000 ohms. Consequently the mid-band gain for a signal appearing between A and B is

$$80 \times \frac{\frac{1}{0.5 \cdot 10^6} + \frac{1}{2 \cdot 10^6}}{140,000 + \frac{1}{\frac{1}{0.5 \cdot 10^6} + \frac{1}{2 \cdot 10^6}}} = 60 \text{ times}$$

Equal in phase signals appearing simultaneously between grid A and ground and grid B and ground will be attenuated because of the high cathode resistor i.e. mid-band gain for in phase signals.

$$= \frac{-\mu \cdot Z_0}{r_p + (\mu + 1)R_K + Z_0} = .3.$$

Thus an interfering signal of 200 millivolts becomes 60 millivolts at C and D and is negligible at the output of the amplifier. However, as pointed out by Parnum,<sup>1</sup> this is not the whole picture. The valves of the first stage are not identical and similar potentials occurring at C and D are not amplified similarly. If the two tubes have differences in mutual conductance of 10 per cent, C may receive 60 millivolts from the original 200 millivolt interfering signal, while D only receives 54 millivolts. There is now an effective signal of 6 millivolts appearing between the grids of the second stage which will not be balanced out by perfect symmetry in the later stages of the amplifier and which will be amplified in the normal way. However, the first stage has now increased the wanted electrocardiogram signal from 1 millivolt to 60 millivolts, so that this 6 millivolts of interference is only 10 per cent of the wanted signal which is usually tolerable in electrocardiography. If interference conditions or tube balance are better, it will of course, be much lower. If the rejection ratio is defined as the ratio of in phase signal to out of phase signal for similar outputs on the recorder, it can be seen that if one millivolt between the two grids gives a one centimetre stylus deflexion, then 10 x 200 i.e. 2,000 millivolts will be needed as a common signal to the two inputs for a similar output, a rejection ratio of 2,000 times. The first grid is biased to 0.8 volts negative and will not, of course, handle a 2 volt signal but this ratio is sustained at lower input levels.

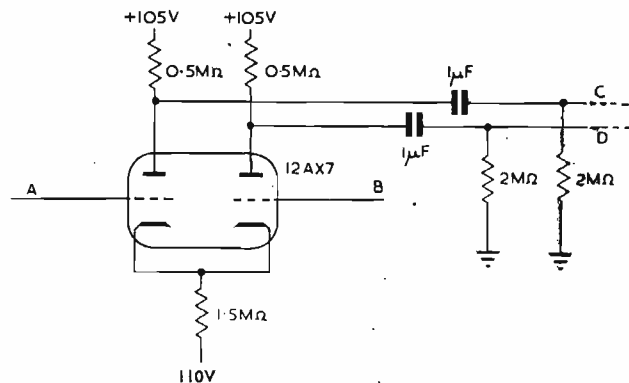

Fig. 1. Use of high value common cathode resistor

It is thus seen that an entirely adequate performance is achieved with this circuit arrangement when first valve gains differ even by 10 per cent and that consequently accurate choice of resistors or selection of closely matched tubes is unnecessary. Practically the whole of the interference rejection is done in the first stage. The in phase signal passes through the amplifier at a fairly low level and only sufficient common mode degeneration is needed in later stages, to prevent its being built up to a level to again compete with the wanted signal.

#### General Features

Separate leads to an earth point are not needed with most instruments under normal conditions. Neon indicators are used to show that the mains plug has been plugged in the way round which places the chassis nearest to ground potential. A good safety code appears to be followed.

In instruments 4 and 5 the D'Arsonval type of pen motor has a restoring torque of about 400 gram centimetres. In instrument number five the power supply chassis measures 7½in. by 3in. and the amplifier chassis 5½in. by 2½in. Most complete instruments weigh about 30 pounds.

#### REFERENCE

<sup>1</sup> PARNUM, D. H. Transmission factors of differential amplifiers. *Wireless Engr.* 27, 125 (1950).

# Letters to the Editor

(We do not hold ourselves responsible for the opinions of our correspondents)

## Informational Intensity of Graphical Computers

DEAR SIR.—Mr. Rey's statement in the February issue on page 69 that graphical (analogue) computers differ only in degree, not kind, from digital computers is correct and welcome. I hope, without any robust confidence, that it will thin the numerous ranks of those who believe that an informational device can produce a continuous, and therefore infinite, output of information about its input.

Mr. Rey is, however, mistaken in identifying the graphical representation of numbers  $O$  through  $N-1$  with the digital system of radix  $N$ . It would be so only if the lengths representing the numbers were arbitrarily assigned to the  $N$  numbers. In fact, a system of radix  $r$  needs, amongst other things, not only a stock in trade of  $r$  distinguishable symbols, but also an agreed ordering of these  $r$  symbols. The graphical (analogue) system uses only an arbitrary symbol such as a chalk mark, least distinguishable change of length, and a "zero" or "blank" that has to be shared amongst the indistinguishable marks. In other words, a non-unique and therefore non-Boolean complement. If you score by chalking up marks on a wall, and wish to subtract one, you can rub any one mark out, and the gap remaining belongs no more to one mark than another. In fact the system is invulnerable to rearrangement, segmentation, and so on. If it were not so, graphical methods of computation would be impossible.

One of the possible electrical representations of such a system is a set of identical circuit-breakers in parallel, numbers being represented by the total current flowing through the system. Clearly so long as  $n$ , say, circuit-breakers are closed, the system will represent the number  $n$ , whichever the  $n$  closed ones may be. This is certainly not characteristic of the system of radix  $n$ , there being a considerable difference between 123, 213, for instance.

It will be noted that circuit-breakers are not covered by Boolean Algebra, which is characteristic, and unusual, in having unique complements to its elements. For instance, the "off" position of one switch must be distinguishable in effects from the "off" position of another. Few computing or informational systems are Boolean, and it is open to grave doubt whether any good has been served by pulling Boolean Algebra by the tail into discussions of computation, just because it has occasionally been used legitimately. The governing discipline is the more general one of Lattice Algebra. At the moment this is rather too abstract to be useful to any other than those who already can use it, and not very useful to them.

Once the Boolean blinkers are removed, and the possibility of non-integral radices recognized, we see that the difference between graphical and digital representation is one of intensity. The graphical representation is far less intense than the digital, as is shown by the fact that we

can erase much of a graphical construction and still reconstruct it from the context. Pictorial displays of information, e.g., photographic records are at an even lower intensity.

These notions can be expressed precisely in a way consistent with the special "radix" interpretation, and opening the way to a rational dynamics of informational transformations:—epistemo dynamics, I presume.

The intensity is of two kinds: informational pressure, which is the average information per unit extension, of space or time of course; and informational temperature, which is the average information per symbol. Analogue systems work at low temperature and, in order to avoid excessive size, rather high pressures, near the limits of their resolution. Digital computers work at fairly high temperatures, low spatial pressures, and to compensate, high and sometimes very high temporal pressures.

Human beings can apprehend information only at low temperatures and fairly low spatial and temporal pressures. "Step up" and "step-down" transformers are therefore essential elements, and very much neglected ones, in an informational system than can accept data from and pass it on to the outside world.

The informational temperature of a strictly digital system of radix  $r$  is proportional to  $\log r$ . If it is not digital, e.g., if non-significant zeros to the left are omitted, its temperature is lower. Graphical (analogue) representation of up to  $N$  integers has temperature  $(\log N)/N$ . This tallies with the fundamental relation of integral radix systems, to wit:

$$(\text{number of digits}) \times (\text{logarithm of radix}) \cong (\text{logarithm of number represented})$$

One can say, therefore, that the radix of analogue computers is the  $N$ -th root of  $N$ ; i.e.,  $N^{1/N}$ .

Mechanical complexity, power consumption in sorting and classifying, etc., all involve the parameter  $(r-1)/\log r$ , which is the average number of alternatives or degrees of freedom that have to be provided for every unit of information handled. It measures the "parallelism" of the system. It is monotonic, having its minimum at zero  $r$ . Thus there is no "best" radix in which to work from complexity point of view. The expression  $r/\log r$  too often used for this end gives ludicrous results because it assumes that a choice of  $r$  objects implies  $r$ , not  $r-1$ , alternatives.

The fact that an analogue representation of numbers up to  $N$  is quite a different thing from the representation of radix  $N$  can be tested quite simply by putting  $N$  equal to ten, and comparing the results with a tolerably well known system that uses the marks 0,1,2,...,9, in that order but not necessarily in that order.

Yours faithfully,

R. A. FAIRTHORNE.

Farnborough, Hants.

## The author replies:

DEAR SIR.—Mr. Fairthorne confuses representation by aggregate and by analogue, respectively. Taking his example,  $N$  similarly fed relays have their outputs joined; the number  $n$  is then represented analogue fashion by the total current, as this has  $N+1$  possible states but only one (digital) place; however,  $n$  is also represented by the configuration of all the relays (or the contributory currents) each of which contributes nothing or a unit. The latter form of representation is an aggregate of unities; it can be regarded as a degenerate digital system wherein each place carries the same digital weight, unity in the example. Aggregates and analogues are thus opposite extremes (also see table). There is a waste of  $2^N - N - 1$  possible states in using  $N$  relays for aggregate rather than binary system representation, a prodigious price for "invulnerability to re-arrangement," etc. The transformation (mechanical aggregate) to (electrical analogue) is neither "up" nor "down," but it is easy; the same is true if the aggregate is replaced by a digital, preferably by the binary system. This explains why, since prehistoric times, aggregates have been abandoned for doing sums more complicated than are required of a circus horse.

Thus one is unwise to ignore the binary system along with the elements of logic (Boolean Algebra) in dealing with "on-off" devices and signals. Their combination in the arithmetic and control of computers is a natural process; if I have failed to bring this out, I refer the correspondent to the literature cited at the end of each part of my article.

Mr. Fairthorne introduces many quaint terms, either without definition or for quantities already answering to other names. It does no good to ignore the work that has gone before! Mr. Fairthorne's conclusions are wrong because, *int. al.*, his term "symbol" is contrary to its meaningful definition in Information Theory; this incidentally, hallows the radix "two."

Yours faithfully,

T. J. REY.

## REFERENCE

<sup>1</sup> CHERRY, E. C.: A History of the Theory of Information. *Proc. I.E.E.*, 98, III, 383 (1951).

TABLE

Form of Representation	Radix	Digital Places	Example
Aggregate of unities .. .. .	1	$N$	111 (Chalk marks)
Digital System (non-degenerate)	$r$ ( $r > 1$ )	$> \log_2 N$ $< 1 + \log_2 N$	0011 (binary) 03 (decimal)
Analogue .. .. .	$N$	1	--- (line segment)



# The 36th Physical Society Exhibition

A review of some of the more interesting exhibits shown at the Physical Society's Exhibition, held at Imperial College, South Kensington, from April 3rd to 8th.

## Power Supply Type 698B

(Shown centre)

**T**HIS power unit is designed to provide H.T. and L.T. voltages for klystron oscillators under test conditions.

All the H.T. supplies are stabilized, the output voltage change being less than  $\pm 0.5$  per cent of the input voltage change, and the ripple voltage being less than 20 millivolts R.M.S. The output impedance of the H.T. supplies is not greater than 500 ohms with a current drain of 10 milliamps.

A D.C. heater supply of 4 volts at 1.4 amps is provided, the ripple voltage being less than 100 millivolts R.M.S. A fine control of this voltage is included to enable it to be adjusted to the correct value, metering facilities being provided.

Internal oscillators provide square-wave modulation of 70 volts peak-to-peak at frequencies between 2,000 and 4,000c/s, and sawtooth modulation over the range 150-600c/s at amplitudes up to 50 volts peak-to-peak. Switching enables either the internal modulation, or modulation from an external source to be applied to the grid and reflector voltages. A switch position is also provided for operation under C.W. conditions.

Two meters are included in the unit for checking the cathode voltage and cathode current. A meter switch enables the cathode current meter to be used for setting up the heater supply to the correct voltage.

The unit operates from 210-250 volt 50c/s mains supplies and is designed for mounting on a standard 19in. rack.

Airmec Laboratories, Ltd.,  
High Wycombe, Bucks.

## The Aviscope

**T**HE Aviscope has been designed to analyse fully living cellular structures and semi-transparent sections, which is an advantage over the electron microscope, the use of which is limited to examining dry or inanimate structures and shadow castings. Also, due to the relatively short duration of the scanning spot no distortion of the specimen structure is encountered.

Seven units comprise the complete microscope as follows: a flying spot scanning generator which consists of an electro-magnetically focused and deflected cathode-ray tube, with a short persistence screen, having fine focus; an optical system which reduces the scanning field to the same dimensions as to the object being scanned, comprising two high power microscopes, fully corrected, built specifically for the instrument; a precision slide stage with micrometric adjustment, permitting a wide variety of stable movements in either axis, diagonally, and rotationally; a sensitive and stable photo-multiplier tube of a low noise level; a wide-band electronic amplifier of high

stability and low noise whose output modulates the spot intensity which is fully corrected throughout its range; a 9in. screen directly viewed tube of the magnetically focused and deflected type acting as a monitor for any number of remote viewing units; and a synchronization unit comprising: a master oscillator, a line sync-pulse generator, a line blanking pulse generator, a frame sync-pulse generator, a frame blanking pulse generator, a sync-pulse mixer, a blanking pulse mixer, and a co-ordinating circuit et. al.

In addition to maintaining the relative spot positions on the screens of the two tubes the output from the instrument consists of a complete B.B.C. type television waveform (405 lines, 25 frames, interlaced 2-1).

One of the principal advantages of this electronic amplification system lies in contrast control over any particular range being examined; contrast may thus be increased at will. Magnification, which is variable incrementally, is controlled by means of a rotating optical turret and the

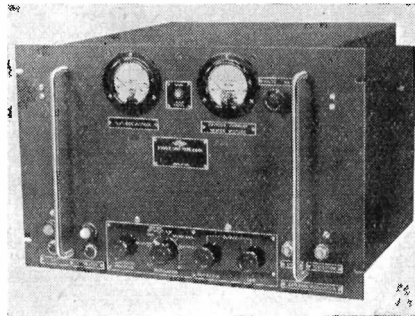

limits of magnification depend upon the lens per field.

The resultant image can be viewed on a large screen by a number of people, and any number of other remote viewing units may be connected with a corresponding increase in the viewing audience.

Avimo, Ltd.,  
Taunton, Somerset.

## The Characteristics of a Constant Impedance Low Pass Filter

**T**HE application of "Cintel" equipment to the examination of filter characteristics was an interesting demonstration on the stand of Cinema Television, Ltd. The instruments used were a square wave and pulse generator, sweeping oscillator and phase correction units.

The filter, having a constant impedance of 100 ohms, comprises two bridged-T type sections with equalizer giving a pass band extending from D.C. to 2.9Mc/s, the attenuation being 6db down at the cut-off frequency. Three phase correc-

tion networks are included in the filter giving accurate correction of the phase distortion.

The characteristics, which are visually demonstrated, are: amplitude frequency characteristic, constant impedance characteristic and transient characteristic.

The object of the amplitude/frequency characteristic test is to show the variation in the transmission characteristic both inside and outside the pass band. The method used is to feed a sinusoidal waveform of fixed amplitude and varying frequency into the filter and observe the output on an oscilloscope. The varying frequency is obtained from a sweeping oscillator which, by means of a synchronously driven rotating capacitor, provides a sweep frequency range extending from 50kc/s to 5Mc/s and is continuously repetitive. The envelope of the waveform displayed on the cathode-ray tube is the transmission characteristic of the filter.

The constant impedance characteristic test is designed to show the relatively small deviations from constant impedance both inside and outside the pass band. The filter forms the "unknown" arm of a Wheatstone bridge, balanced for the nominal impedance of the filter. The "generator" terminals of the bridge are supplied from the sweeping oscillator and the "detector" terminals are connected to an oscilloscope via a differential amplifier. The amplitude of the displayed signal is a measure of the deviation from nominal impedance.

An alternative interpretation of the waveform (more convenient for a quantitative analysis) is to regard the bridge and differential amplifier as a "directional coupler" responding only to signals which have been reflected by the impedance mismatch in the filter. The magnitude of the reflexion can be expressed in db's relative to the original signal.

In the transient characteristic tests either a square-wave or pulse waveform is applied to the filter and the output viewed on an oscilloscope. In the absence of phase distortion, the output transients would be perfectly symmetrical; the tests show that a close approach to this condition can be obtained in practice by the use of phase correction.

The demonstration comprises three parts designed to show firstly the severe distortion existing when no phase correction is used, secondly how this distortion can be experimentally corrected by the use of adjustable phase correction units, and thirdly how the same correction is obtained when the adjustable units are replaced by fixed networks made up in accordance with the data obtained in test.

Cinema-Television, Ltd.,  
Worsley Bridge Road,  
London, S.E.26.

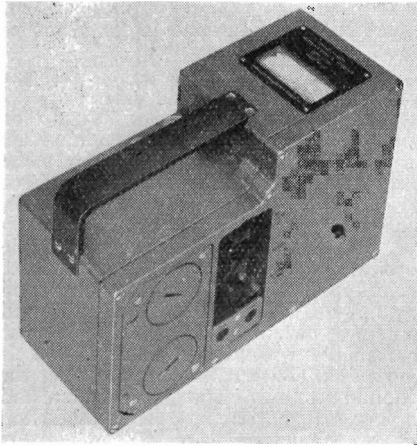

### Portable Dose Rate Meter

(Illustrated above)

THIS instrument, designed for the measurement of gamma radiation, is a self-contained ionization chamber type radiation monitor. It can also be used for the qualitative detection of beta radiation. Measuring 9in. by 6in. by 4in. and weighing 8lb, it may be carried in its canvas case with shoulder strap almost as easily as a box camera. When contained in its carrying case, the controls are accessible through a flap and the indicating scale may be read through a window.

The instrument is hermetically sealed and desiccated in a die-cast aluminium case. Indication of dosage is given by a directly calibrated meter with a range of 0 - 3 Rontgens per hour; the scale is interconnected with the main control switch to give indication of the switch position.

The chamber has a free volume of approximately 310cc and is moulded in air-wall equivalent material. The circuit of the meter comprises an ME1401 electrometer tube with a backed-off meter which reads changes in anode current. Adjustment of the grid bias provides zero-

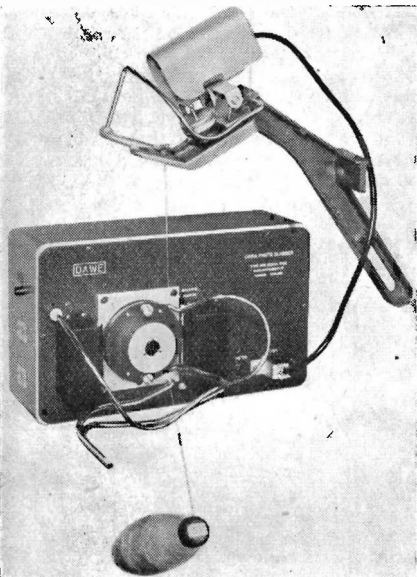

setting control and variable degeneration provides calibration control.

The design of the instrument provides easy access to the batteries which are contained within a separate waterproof compartment. One 9 volt and one 30 volt miniature battery is used, and these have several months life in normal use. The cells are of the standard 1.5V U2 type, the filament cell having a life of approximately 120 hours, and the scale lamp cell of approximately 8 hours.

E. K. Cole, Ltd.,  
Ekco Works,  
Southend-on-Sea, Essex.

### "Lindra" Photo Slubber

(Illustrated bottom left)

THE "Lindra" Photo Slubber is an equipment designed by Dawe Instruments, Ltd., in collaboration with the Linen Industry Research Association for detecting and cutting yarn of excessive thickness known as slubs. The Photo Slubber enables the slubs to be located while the yarn is being wound from the spinning bobbins to the cone or other package.

In operation, a beam of light from a projector lamp passes through two apertures to a balanced photocell system using a differential amplifier. A standard yarn or wire of equivalent light transmission is fitted across one aperture while the test yarn passes through the other aperture at the normal winding speed of several hundred yards per minute. If the test yarn exceeds a pre-determined thickness the amplifier output operates a thyatron which has an electro-magnetic cutter in the anode circuit. The yarn is cut before the slub reaches the cutter so that the slub can be removed by the operator.

The equipment is so designed that the winding operation cannot be performed without the yarn passing through the cutting head. Great care has been taken over the design of the guides to facilitate the threading up. The equipment is suitable for continuous 24 hour a day operation. To simplify the design a central power unit is employed operating an individual optical unit for each winding head. Air at a pressure slightly above atmospheric is fed to the optical head, thereby preventing risk of faulty operation due to accumulation of textile fibres and dust in the slit.

An interchangeable slot unit for the lamp housing enables any reasonable yarn size to be employed; standard sizes are 0.03in. for 25 lea upwards, and 0.05in. for 11 to 25 lea. The winding speed is such that with the yarn running at 600 yards per minute the fault is indicated and the yarn cut before the slub reaches the cutter. The main setting control consists of a vernier adjustment on the optical slot. No electrical adjustments are accessible to the operator other than the re-set button. The slubber has a power supply of 200 to 250 volts 50c/s.

Dawe Instruments, Ltd.,  
130 Uxbridge Road,  
Hanwell, London, W.7.

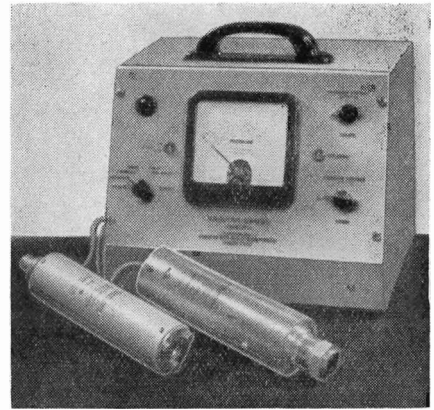

### Combined Philips-Pirani Vacuum Gauge

(Illustrated above)

THIS combined instrument provides a compact wide range gauge suitable for high vacuum systems in which roughing and fine side conditions have to be measured, such as in vacuum coating plants. The range covered is 1.0 to  $10^{-5}$ mm of mercury, and the instrument is fitted with complete leak-testing facilities.

Basically the design comprises an Edwards Pirani type gauge and a cold cathode ionization gauge (Philips Patent) in the same cabinet having the power supply facilities and calibrated meter in common. Transfer is quickly made from one gauge to the other by means of a switch, and current flows continuously through each gauge head—thus obviating any warming-up waiting time. Both types have a single gauge head. The Philips gauge reads over the pressure range of  $5 \times 10^{-3}$  to  $10^{-6}$ , and the Pirani over 1.0 to  $10^{-3}$ mm of mercury.

W. Edwards and Co. (London), Ltd.,  
Worsley Bridge Road,  
London, S.E.26.

### Portable Valve Voltmeter CT54

(Illustrated below)

THE portable Valve Voltmeter CT54 has been developed for the Services from the "Micovac" Electronic Test Meter to serve under rigorous conditions on active service.

The instrument is sealed and complies with the climatic and endurance tests laid down in the Inter-Services Specification K114. An important feature is that it

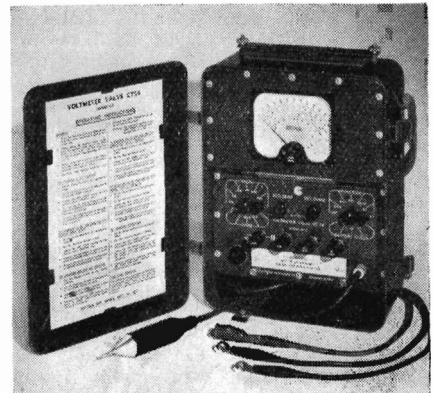

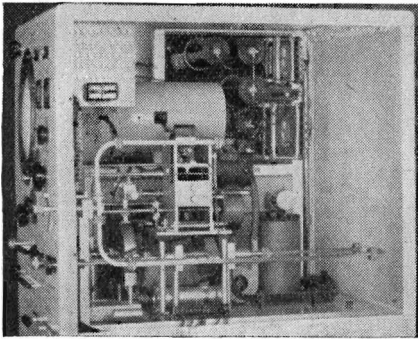

may be operated from dry batteries or from the mains.

The performance specification of the CT54 may be summarized briefly as follows. On A.C. voltages can be measured up to 480V in six ranges (lowest range 0.2-4V). The input impedance is constant on all ranges and at audio and low radio frequencies is equivalent to 7pF in parallel with a load of 2 megohms. The probe enables R.F. measurements to be made up to frequencies of around 200Mc/s. On D.C. the same voltage specification applies, that is 0 to 480V in six ranges, and voltages of either polarity may be measured. There is an additional 2,400V D.C. range and a special E.H.T. multiplier is provided for this.

**Electronic Instruments, Ltd.,  
17 Paradise Road,  
Richmond, Surrey.**

#### Measurement of R.F. Attenuation

(Illustrated above)

THE apparatus demonstrated the measurement of attenuation whereby the R.F. signal is heterodyned to a low audio frequency (220c/s) and frequency stability is ensured by deriving the L.O. signal and the test signal from the same oscillator, the desired frequency change being effected by a continuously running, mechanically driven phase changer. At this frequency a resistance attenuator can be used as the comparison standard.

The accuracy of measurement of attenuation attainable by this method has not been fully investigated yet, nor will the equipment be capable of any very high accuracy, but it should be possible to measure to approximately 0.1db over a 40db range with the equipment exhibited and the method should be capable of development to yield higher accuracies. This technique was first developed for use in the waveband around 3.2cm, and one of its advantages over the standard method is that it can be used in the shorter wavelength range around 8½mm without loss of accuracy.

A pulse signal generator for testing broad-band networks was also shown which produced short pulses of high frequency energy of rectangular envelope shape. Pulse lengths of 0.1 to 0.5µsec are available which may have a frequency up to 60Mc/s. The oscillations are produced by suddenly cutting off the current in a parallel tuned circuit. The resultant ringing oscillations are maintained by feedback from an auxiliary valve until the end of the pulse, when they are suddenly damped. This method allows the pulse to be viewed continuously on a fast scan

cathode-ray tube, which is built into the equipment, the amplitude of pulse being sufficient for direct application to the Y. plate. A demonstration was given of the application of the apparatus to the examination of the transient response of a broad-band amplifier.

**Elliott Brothers (London), Ltd.,  
Century Works, Lewisham,  
London, S.E.13.**

#### "EEL" Flame Photometer

(Illustrated below)

IT is well known that if a metallic salt, such as sodium chloride, is introduced into a non-luminous flame this then burns with a colour characteristic of the metal in question. A Flame Photometer is an instrument which utilizes this phenomenon to measure the relative concentrations of the alkali metals in solutions. In general, the solution under test is atomized and is introduced into a non-luminous flame burning under carefully controlled conditions. This flame then becomes coloured and the

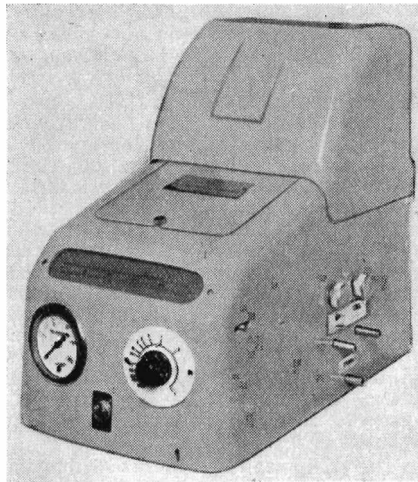

intensity of the light emitted is measured by means of a photocell. The various regions of the spectrum appropriate to the different elements are isolated by passing the light through an optical filter or a monochromator of either the prism or diffraction grating type. The intensity of the light emitted with the sample is then compared with that emitted with a prepared solution of known concentration.

An internal standard technique has also been described which, it is claimed, reduces the effect of interfering ions. Interference is, however, only reduced, not obviated, and allowances must still be made. Thus the more complex instrument required for this method offers no advantages over the more simple single cell flame photometer if the latter be designed to give a steady reading not unduly affected by the presence of ions other than that being determined.

The "EEL" flame photometer is a single cell instrument employing optical filters and requiring the minimum of adjustment between readings. Stability of reading is achieved by an internal gas pressure stabilizer and the use of an external air pressure regulator. A broad,

flat flame and suitable optical system minimize variations due to flame movement.

The gas used may be either coal gas or any of the oil derived gases, such as propane, butane, "Calor" gas or "Bottogas" together with compressed air. The resulting low temperature flame very greatly reduces interference effects.

The light emitted by the flame is collected by a reflector and focused by a lens through the interchangeable optical filters on to an "EEL" barrier layer photocell. The current generated by this cell is taken through a calibrated potentiometer to a Tinsley taut suspension galvanometer unit. A glass window is interposed between the lens and filter for cooling purposes. This glass window and holder may be removed, as may the top of the chimney, to facilitate cleaning the optical components.

**Evans Electro Selenium, Ltd.,  
Harlow, Essex.**

#### The Testvac and Ceramic Valves

(Testvac shown below)

THE Testvac is a portable and safe source of high voltage, high-frequency output which may be employed for vacuum testing and many other applications.

The circuit is similar to the Tesla circuit and includes a spark gap of adjustable length fitted with tungsten tipped electrodes. The output frequency, 4 megacycles per second, is high for instruments of this type and for this reason provides efficient and less disruptive penetration through the walls of a vacuum system. In vacuum testing the exploring electrode is held close to the glass wall of the system (or in a metal system at some point with a glass indicator tube), and visual indications are thereby provided which make it possible for the approximate pressure to be estimated.

The instrument can often be used in the detection of small leaks in a glass vacuum system. On the application of the exploring head to the leakage point, a bright thread of light will appear to penetrate through the glass from the electrode and travel along the crack in the glass tubing. Another useful application is the removal of electrical leaks in vacuum tubes due to getter deposit or evaporated metal which may settle across mica or glass insulator supports. These leakage films may be removed or very much reduced by applying the discharge to the electric lead wires outside the tube, so giving rise to a track

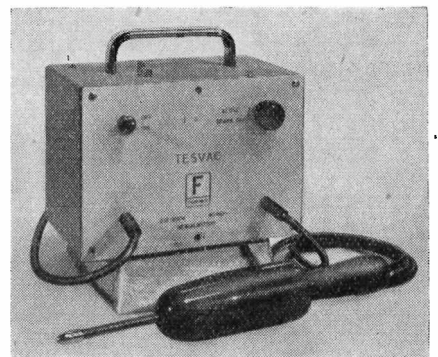

discharge along the leakage path inside the tube.

Some examples of special valves developed for use as oscillators at 1,000Mc/s were also shown. These valves have ceramic envelopes which allow them to be operated at higher temperatures than would be possible with conventional glass envelopes. The dimensions of the valves are, therefore, small in relation to the power available from them.

**Ferranti, Ltd.,  
Hollinwood, Lancs.**

#### U.H.F. Measuring Equipment

A RANGE of components and test equipment for the frequency band 1,600 to 2,400Mc/s was shown by the G.E.C. Research Laboratories. It included a signal generator, a test receiver, a microwattmeter, a wavemeter, a standing wave line of "slab" configuration, and a circuit response indicator.

The signal generator uses a disk seal triode in a coaxial line circuit, and non-contact bridges are driven from micrometer heads. A level monitor of the directional coupler type and a direct reading piston attenuator are provided. The test receiver is intended for use with the generator for measurements of insertion loss, impedance, etc. An oscillator similar to that in the signal generator is used, and this, together with the mixer and i.f. amplifier, is mounted in a single unit. The bandwidth is of the order of 6Mc/s and the noise factor is 12db.

The microwattmeter is a direct reading power bridge of the substitution type with a maximum input of 120 microwatts. Its function is primarily to standardize the output of the signal generator. Its accuracy at maximum input is approximately  $\pm 0.5$ db.

The wavemeter uses a cylindrical wave grid mode tuned by a non-contact plunger driven from a micrometer, and has an accuracy of  $\pm 200$ kc/s, read-

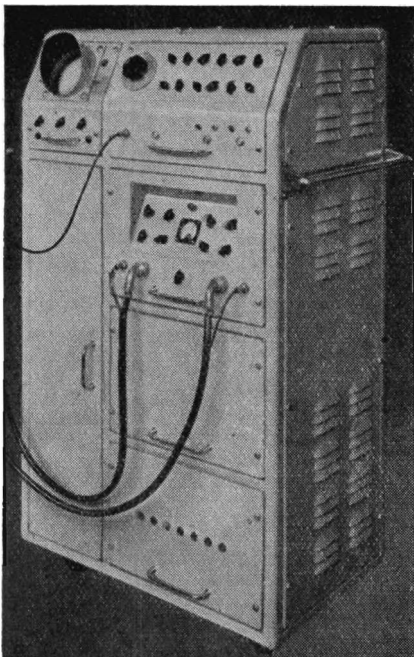

ability of  $\pm 60$ kc/s, and a Q factor of the order 2,000.

In the circuit response indicator, an oscillator is provided with a mechanical scanning arrangement, giving a 100Mc/s scan that may be centred in the range 1,700-2,300Mc/s, and a C.R.T. displays the insertion loss characteristics.

**The General Electric Co., Ltd.,  
Research Laboratories,  
Wembley, Middx.**

#### High Speed Recurrent Waveform Monitor

(Illustrated bottom left)

THIS equipment will display on a cathode-ray tube a recurrent waveform having frequency components as high as 300Mc/s and, if necessary, of less than 1/10volt amplitude.

The method used is to measure, during one cycle, the instantaneous amplitude of a point in the waveform. On successive recurrences the instantaneous amplitudes of other points in the waveform are measured, and it is arranged that after some 200 cycles the whole of the waveform has been sampled. The whole process is then repeated. When a measurement of instantaneous amplitude has been made it is amplified in a relatively low-frequency amplifier and is applied as a steady voltage of some 100 microseconds duration to the Y-plates of a cathode-ray tube. At the same time a steady X-deflexion, indicative of the time interval between the beginning of the waveform and the instant of amplitude measurement, is applied to the tube. Thus, after any one recurrence of the waveform, one element of a graph of the waveform is applied to the tube.

The measurements of instantaneous amplitude are carried out in a single small valve which is placed very close to the circuit being monitored. The low-frequency output from the probe unit, which houses this small valve, is fed to the main unit by means of cables. As the small valve conducts for only about 1 millimicrosecond during each recurrence, it offers no loading to the waveform other than a fixed capacitance to earth which is shunted, externally, by 2 megohms. The waveform is fed into the probe unit via a variable series capacitor, normally of less than 1 or 2pF. This series capacitor represents the whole loading on the circuit being monitored.

The advantages of the system are: the waveform being monitored suffers no distortion due to cathode-ray tube plate capacitance or the ringing of monitoring leads; waveforms of low amplitude may, in effect, be amplified without difficulty; as the frequency response of the system is flat up to 300Mc/s, and waveforms of 1V amplitude loaded by 5pF, or 2½V waveforms loaded by 2pF produce a full-scale cathode-ray tube display; the display may be "locked" to the waveform being monitored, thereby eliminating jitter even if the waveform is jittering with respect to its prepulse; two concurrent waveforms may be viewed simultaneously by a system of electronic switching, and the provision of a very fast time scale, such as 50 millimicroseconds, may be achieved without any loss of brightness.

The equipment shown had a means of measuring the amplitude of the waveform being monitored, and a built-in calibrator

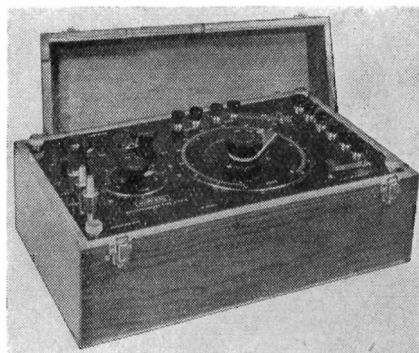

to enable time scale measurements to be made.

**Metropolitan-Vickers Electrical Co., Ltd.,  
Trafford Park,  
Manchester, 17.**

#### D.C. Potentiometer Type D-72-A

(Illustrated above)

THE Muirhead D.C. potentiometer type D-72-A is an improved type general purpose potentiometer designed particularly for measuring small potentials outside the scope of voltmeters.

The design of the potentiometer follows conventional practice. The current circuit comprises a series of equal resistors, assembled between the studs of a rotary switch constituting the main dial, in series with a slide-wire. Course and fine controls are included for the purpose of adjusting the current when standardizing the instrument against a known voltage derived from a standard cell. The potential circuit is connected between the arm of the switch on the main dial and the slide-wire brush, included in which are the galvanometer and test terminals. With this simple arrangement it is not possible to balance to an absolute zero voltage because of the inevitable small potential which occurs across the resistance formed by the junction of the main dial and the slide-wire. This disadvantage is eliminated by incorporating a network of resistors in association with the slide-wire which, by introducing an opposing voltage, enables a small reverse potential to be measured in addition to providing a true zero position. A special standard-cell balancing-circuit, comprising a separate potential divider in parallel with the main potentiometer and tapped at a point corresponding to the standard cell voltage, enables the accuracy of the instrument to be checked at any time without the necessity of altering the positions of the dials. Three voltage ranges are provided by means of suitable shunt and series resistors whereby the voltage across the complete potentiometer is reduced by the required amount while the total resistance, and consequently the current, are kept constant.

The following three voltage ranges may be selected:  $\times 1 - 0.01$ V to  $+1.92$ V,  $\times 0.1 - 0.001$ V to  $+0.192$ V, and  $\times 0.01 - 0.0001$ V to  $+0.0192$ V. All the resistors have an accuracy better than 0.1 per cent.

**Muirhead and Co., Ltd.,  
Elmers End,  
Beckenham, Kent.**



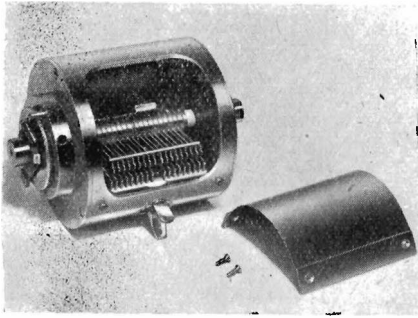

**Precision Variable Capacitors**  
(Illustrated above)

THE Mullard precision variable capacitor, a prototype of which was shown at last year's Physical Society's Exhibition, is now in production, and is made to meet the requirements of the telecommunication design engineer in respect of matching accuracy, long-term stability and cyclic thermal behaviour.

The capacitor is fully screened, and the rotor shaft is extended through both end-plates so that other similar capacitors can be ganged in-line. Three versions are available at present, which are interchangeable in respect of external dimensions and all have a nominally straight-line-frequency law. Type F0 is a double spaced single unit having a capacitance swing of 20-340pF, Type F2 is a 2-gang capacitor with a capacitance swing of 20-340pF per section, and Type G is a single unit with common rotor and split stator, with a capacitance swing in section A of 11-112pF and in section B of 16-226pF. Other types within the limits of existing design parameters can be supplied. In all three types the diameter of the case is 3.0in. and the length 2.672in.

**Mullard, Ltd.,**  
Century House,  
Shaftesbury Avenue,  
London, W.C.2.

**Television Standard Signal Generator**  
**GM 2657**

(Illustrated below)

THE Philips Generator GM2657 has crystal controlled sound and vision channels, and features: 13 video modulation patterns; variable synchroniz-

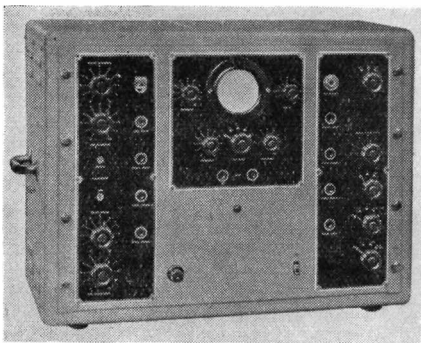

ing pulses; variable blanking times; provision for external sound and video modulation, and a built-in monitoring oscilloscope.

The output signal of the generator is in accordance with the F.C.C. vision standards, providing both vertical and horizontal blanking pulses, vertical and horizontal synchronizing pulses and exact equalizing pulses.

It is possible to lead an internal pattern or an external picture to the synchronization signal. The following patterns out of these signals can be switched in, with a few switches: horizontal, vertical and crossed bars; horizontal, vertical and crossed lines; spots, and gamma control. The signals for the bars can be mixed with those for the lines and spots.

A sound transmitter is also incorporated in the instrument. This oscillator can be modulated by internal modulation, 6,000c/s, and by external modulation. Sound modulation can be either A.M. or F.M. The oscillator can be switched off, independent of the-pattern generator.

For control purposes an oscilloscope is built-in, which can check all the signals.

**Philips Electrical, Ltd.,**  
Century House, Shaftesbury Avenue,  
London, W.C.2.

**Nyquist Diagram Plotter**  
(Shown centre)

THE Plessey Nyquist Diagram Plotter has been designed primarily to enable a permanent record of the frequency

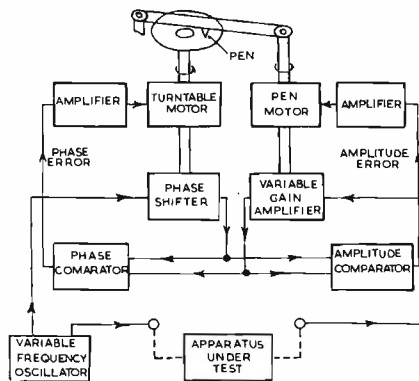

response to be obtained quickly and accurately, but without the use of much technical knowledge on the part of the operator.

The principle of operation of the plotter may be seen by reference to the block diagram shown centre. An oscillator provides a variable frequency signal to drive the apparatus under test, the rate at which the frequency is varied being automatically adjusted to suit the prevailing conditions. A second output from the oscillator feeds a phase-shifter which is mechanically coupled to the turntable on which a polar chart is carried. The output from the apparatus under test returns into the plotter, and passes through a variable-gain amplifier whose gain-control is mechanically coupled to a pen which moves radially over the chart. For a given oscillator frequency the phase-shifter output is of constant amplitude but variable phase, whereas the variable gain amplifier output is of variable amplitude but constant phase. By suitable adjustment of both gain and phase, the

variable-gain amplifier output may be made to match exactly the phase-shifter output. These adjustments are automatically carried out by two motors, which are fed with signals proportional to the amplitude difference, and phase difference, respectively; in making the adjustments the motors also position the pen at the correct point on the chart.

At regular frequency intervals the frequency-sweep stops, and by means of a third motor the pen automatically writes a small arrow-head mark by which those points on the chart, corresponding to a known series of frequencies, can afterwards be identified.

The maximum oscillator sweep covers the range from 0.16c/s to 1,600c/s (1 to 10,000 radians/sec angular frequency), and any decade or decades within this range may be selected by switches. The higher frequencies will probably not be encountered in servo systems as such, but they may be useful for investigating the stability of servo amplifiers which contain their own feedback loops. It is also possible that the wide frequency coverage may extend the usefulness of the plotter beyond the field of servomechanisms; the instrument can, of course, be applied to any device having an electrical input and output.

The plotter has an oscillator output of 15V maximum, with a source impedance of 500 ohms. The input impedance is 250kΩ, and the amplitude range approximately 30/1. The two units measure 22in. by 12in. by 12in.

**The Plessey Co., Ltd.,**  
Ilford, Essex.

**Precision Frequency Measuring**  
**Equipment**

THE G.E.C. Direct-reading Precision Frequency Measuring Equipment permits rapid frequency measurements to be made by even an unskilled operator. The range of the equipment is from 10c/s to 10Mc/s and the accuracy of observation is better than 1c/s plus the error of the source of standard frequency.

The general principle of operation is to heterodyne the unknown signal with a selected series of standard frequencies chosen from a standard decade series, descending order of magnitude, until a residual frequency of less than 1kc/s remains. This is then measured on a frequency meter stage which has a discrimination better than 1c/s.

By an ingenious design, the digits defining the unknown frequency are automatically selected in the source of a measurement and the appropriate figures are illuminated at the end of the measurement.

The fixed error of the equipment at any frequency does not exceed 1c/s plus a percentage error equal to that of the standard frequency. Smaller errors are obtained when the frequency under measurement is a multiple of 100c/s or 1kc/s. It has an input impedance of approximately 75 ohms, earthed on one side. The sensitivity is such that an input of 20mV over most of the range is sufficient. It has a power supply of 200-250V 50c/s, input approximately 80VA, and a selectivity whereby two signals of equal amplitude and differing by as little as 1kc/s can be resolved.

**Salford Electrical Instruments, Ltd.,**  
Salford 3, Lancs.

### S.T.C. New Equipment

(Illustrated below)

RECALLING the Netherlands-Denmark Coaxial Cable system inaugurated in September, 1951, were a 74505-A Repeater Testing Equipment and a 74510 Transmission Test Trolley. The former is used for testing and maintenance of H.F. amplifiers, equalizers and pilot regulators at repeater stations of coaxial carrier telephone systems operating with up to 16 supergroups representing 960 telephone channels per coaxial tube. It includes; a variable-frequency oscillator having a frequency range 50kc/s to 5.2Mc/s and an accuracy of  $\pm 0.05$  per cent after calibration; a fixed-frequency oscillator, and full facilities for making insertion loss and gain measurements. The 74510 Transmission Test Trolley (illustrated below) finds a more general application for making comprehensive transmission tests and measurements in the frequency range 200c/s to 200kc/s on all multi-channel open-wire and cable carrier telephone systems and certain V.H.F. radio systems.

Another exhibit of topical interest was associated with the micro-wave radio relay system designed, manufactured and installed by Standard Telephones and Cables Limited between the television transmitter at Kirk o'Shotts and Manchester, and brought into public service on March 14 this year. This is the 74801-A S.H.F. Power Measuring Set designed for measuring the small amounts of power flowing in waveguides. The technique employed depends on the fact that a thermistor bead is so small that the heating effect of microwave frequencies is identical with that of direct current, and 40-60 cycles alternating current which may thus be used as a comparative basis for measurement.

The 74706-A valve routiner provides a means of testing type G10/240E unidirectional, 10-point Nomotrons under any adverse conditions likely to be met within the specification limits. It per-

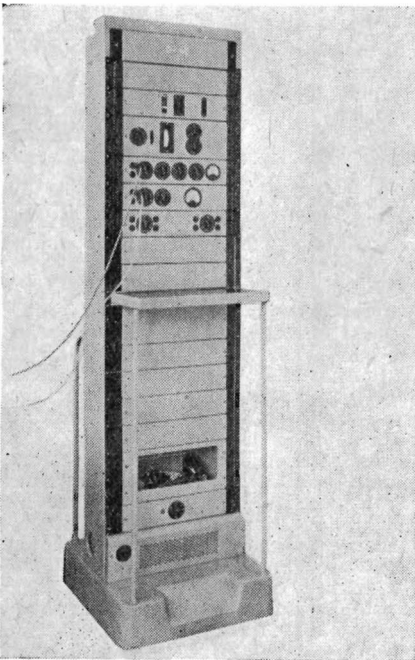

forms 25 different tests on each of the 10 cathodes in 1.5 minutes and, if a fault be found, automatically stops the test and lights an alarm lamp. If the tube is satisfactory, a green lamp lights at the conclusion of the 250 tests.

The 25 different tests are made from a combination of the following variables: H.T. variation; variation in resistance of anode load, cathode loads, transfer bias bleeder resistors and control plate bias bleeder resistors; and variation in amplitude and width of pulses fed to the transfer electrodes.

The method of testing consists of applying a sequence of ten 5kc/s pulses to the transfer electrodes of the tube and detecting that the discharge leaves the cathode under test and returns to it again via all the other cathodes. The detection is carried out by a cathode volts test and includes a check that the cathode volts exceed the stipulated minimum value.

Such a test is made 25 times, each test using one of the combination of variables. At the 25th test, eleven pulses are fed to the tube, so that the discharge comes to rest on the next cathode, which then undergoes twenty-five identical tests.

The 25-position selector is stepped at a rate of about 3 steps per second, so that the total testing time is just under 84 seconds. This selector only moves on to its next position provided the results of the previous test are satisfactory. A series of 10 lamps indicates which test is being carried out at any time, and also at which test the tube has failed.

Standard Telephones and Cables, Ltd.,  
Connaught House,  
Aldwych, London, W.C.2.

### New Telcon Materials

TELCONAL is an alloy of copper manganese and aluminium, which has a low temperature coefficient of resistance and is an adequate substitute for the generally employed nickel copper (Constantan) type of alloy. From tables of characteristics of Constantan and Telconal it is easy to observe their close similarity. Telconal is ductile and can be drawn to fine gauges. It does, however, require treatment for stabilization, and some care has to be taken to ensure satisfactory soldered joints.

Aluminium clad iron is a low carbon iron faced on both sides with aluminium, and in consequence the superficial characteristics of aluminium are combined with the strength of the iron core. This material, which was used extensively in Germany during the last war, is employed in the electrodes of valves and in instrument manufacture generally. In the former case it replaces nickel.

A high vanadium cobalt-iron alloy is also being developed, the retentivity being about 9,000 gauss and the coercivity approximately 300 oersteds. This alloy is malleable and can be stamped and pressed in either the hot or cold condition.

The Telegraph Construction and  
Maintenance Co., Ltd.,  
Telcon Works, Greenwich,  
London, S.E.10.

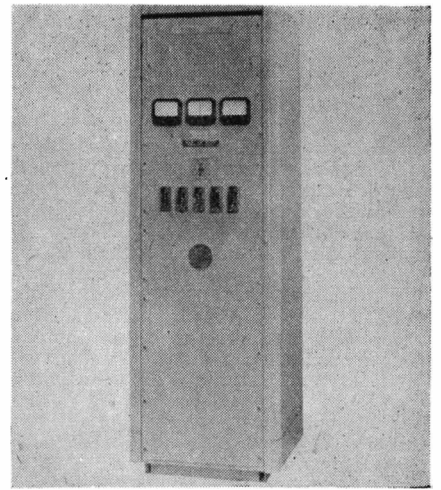

Transbooster Regulated Voltage  
Power Unit

(Illustrated above)

MANY applications arise in which a D.C. power supply has to be provided from A.C. mains with somewhat narrow limits of permissible voltage variation. As typical examples may be mentioned telephone exchange equipment, telephone repeaters and radio transmitters. In some cases, too, the voltage limitations may be still further restricted by the fact that a stand-by battery is required to be floated in order to maintain operation in event of failure of the A.C. power mains.

In general such equipment will be required to run practically unattended, and to be fully automatic in its operation.

The Westinghouse Transbooster equipment, a typical example of which was exhibited at the Physical Society's Exhibition, is designed to meet these requirements in that it is a completely static piece of apparatus to provide a D.C. power output from A.C. supply mains, capable of being built in a wide range of sizes, to cover a wide range of output voltages. The method of regulation of output is by means of transducers, but in such a manner that the usual disadvantages of transducers, i.e., of large size, high cost and low power factor, have been reduced.

The example exhibited is intended for use on 400 volt, three-phase, 50c/s supplies, and is designed for a full rated output of 60 amperes at 50 volts. Regulation at constant voltage is maintained from full-load down to one-tenth full load. Accuracy of the control is within the limits of  $\pm 1$  per cent of the set point, and the set point can be pre-adjusted to any desired value within wide limits in order to suit desired voltage conditions for the floating battery, etc.

The above figure for accuracy of output voltage is maintained over the full range of one-tenth load to full-load and over a variation of input voltage of from -10 per cent to +6 per cent of the nominal value. The output voltage is also independent of the normal variations in supply frequency, and of the variations in ambient temperature.

Other forms of controllers providing different characteristics for special purposes can be readily applied.

Westinghouse Brake and Signal Co., Ltd.,  
82 York Way, King's Cross,  
London, N.1.



## Advanced Theory of Waveguides

By L. Lewin. 192 pp., 54 diagrams. Iliffe and Sons Ltd. November, 1951. Price 30s.

**W**AVEGUIDE discontinuities are most conveniently represented in terms of reactances coupled to the transmission line corresponding to propagation in a straight length of the guide, and the object of the book under review is to present a detailed survey of the mathematical methods used to calculate the values of these equivalent reactances. The problems considered include irises, steps, flares, T-junctions, radiation from open-ended guides and corrugated guides. An introductory chapter gives a summary of the relevant results of electromagnetic theory.

The methods of solution available for this type of problem may be outlined by considering a capacitive iris. The tangential electric field in the plane of the iris is represented by some function, as yet unknown, and the fields in the remainder of the waveguide structure are calculated in terms of this function. This ensures the continuity of the tangential electric field in the plane of the iris, and the condition that the tangential magnetic field be also continuous in this plane is then imposed. There results an integral equation for the unknown function representing the tangential electric field, the solution of which enables the complete field distribution within the waveguide to be calculated. It is then a simple matter to determine the equivalent reactance.

In other waveguide problems the same method is used and it is normally a fairly straightforward matter to derive the appropriate integral equation. The difficulties are encountered in solving the equation, an exact solution being rarely possible. The bulk of this book is therefore devoted to the methods which may be used in particular cases to derive an approximate solution. The first, illustrated by the chapter on irises, consists of making approximations in the integral equation and solving the simpler equation which results. The usual form of approximation is equivalent to assuming that the reactive part of the field within the waveguide is the same as it would be under static conditions. It is then sometimes possible to solve the equivalent static problem by another method, such as the use of a conformal transformation, and an example of this is given in the section dealing with waveguide steps. Once the equivalent reactance of the discontinuity has been obtained from the quasi-static solution, correction terms can be added to allow for the approximations made to the original integral equation.

The second method of tackling the problem is to use the variational technique developed by Schwinger. The integral equation is not solved, but is used to give an expression for the equivalent reactance, which is stationary for variations of the tangential electric field distribution about its true value. Substitution of a function which is not the exact solution will still lead to a fairly accurate value for the reactance because of the stationary property. This method is used by the author in a number of the problems with which he deals.

The chief difficulty with an approximate solution is to determine the limits of error within which the final solution will

# BOOK REVIEWS

lie: this aspect of the problem does not receive in this volume the attention which it merits. The author gives a few numerical values to illustrate the magnitude of his approximations but too often little or nothing is said as to the final accuracy. No mention is made of the part the variational method can play in this: it is sometimes possible, as for example with an iris, to apply the method in two different ways such that one gives a lower limit to the correct answer and the other an upper limit. A comparison of the two solutions then gives the magnitude of the possible error.

In view of the now accepted use of the M.K.S. system of units it is regrettable that the author uses the C.G.S. practical system. However, since the most important results are those involving normalized reactances it is easy to change them to the M.K.S. system. There is an omission in the section on the H-plane step, where the phase of the transmitted wave is not considered, with the result that the equivalent circuit in Fig. 5.2 is incorrect, unless an appropriate reference plane in the waveguide is specified. In this particular case the error is negligible in practice, but it shows the need for care in the specification of equivalent circuits.

It will be clear that this is a book for the applied mathematician who will find much of interest in the techniques used. The chapter on tuned posts and tuned irises contains material which is particularly valuable in view of the lack of any other detailed treatment of these topics. The author makes it clear in his preface that the engineer, who is primarily interested in results, will find the bulk of these elsewhere. The book concludes with an extensive bibliography of the literature on waveguides.

J. BROWN.

## Sound Insulation and Room Acoustics

By P. V. Brüel, translated by J. M. Borup. 275 pp., 264 figs. Chapman and Hall Ltd. November 1951. Price 35s.

**W**ITHOUT forgetting the magnificent pioneer work of Lord Rayleigh, W. A. Sabine and others it is nevertheless true to say that the study of sound was made possible largely by the thermionic valve. It is not surprising therefore that the application of the results of recent studies in room acoustics and sound insulation has been almost entirely confined to broadcasting and film studios where physicists and electrical engineers are to be found, and largely ignored in the field of domestic architecture. Very recently an increasing number of architects have been turning their attention to the acoustical requirements of the buildings they design, but even now flats are being erected with such poor insulation between floors that normal quiet behaviour causes distress to those below. The appearance of this English version of an excellent Danish work on the subject is

therefore very welcome. Its stated object is to give civil engineers and architects some idea of the laws of acoustics, but it also gives enough practical data to enable them to be applied without difficulty to actual designs.

The book opens with chapters devoted to fundamental ideas and physiological acoustics. In this section the reader is introduced to units and methods of measurement, and to detailed information on a range of measuring instruments of Danish manufacture. There is also a description of the ear and the way it responds to sounds of different frequency and power. The next section, on fields of sound, might well be skipped at the first reading by all but the most determined architect, though the matter on true impedance and the natural oscillations in rectangular rooms is very clearly written and is necessary for the proper understanding of later chapters.

Fields of sound lead naturally to a consideration of sound absorbers, beginning with porous absorbers and continuing with resonant types, giving many practical examples. There appears to be a slight confusion in the calculations for the maximum absorption of a Helmholtz resonator. In the case of the circular-hole type it is suggested that the driving pressure of the sound wave is doubled because the hole is surrounded by a hard surface, but in the treatment of the slit resonator this step is omitted. In actual fact, the pressure should be doubled in all cases, not for the reason given, but because the "open circuit," i.e., totally reflected, pressure is required for calculation of the volume flow. A very useful table of absorption coefficients of building materials, and information on absorption by the air itself concludes the chapter.

Chapter V is devoted to sound insulation and noise reduction, the theory of transmission through holes, slits and various types of walls being followed by practical constructional details. The importance of sound transmitted by narrow slits is stressed, and recommendations are made also for protection against impact noises, for the damping of ventilation ducts and for the reduction of noises originating in plumbing systems.

The final chapter of some 90 pages describes how the principles outlined in the rest of the book may be applied to the interior acoustics of buildings for all purposes. The survey covers conference chambers, music rooms, cinemas, concert halls and broadcasting studios for speech, music and drama. Though the results in the case of conference and lecture rooms may be assessed by means of intelligibility measurement, aesthetic judgments assume the primary importance in the case of concert halls and broadcasting studios. The author therefore rightly disposes of all attempts to construct ideal reverberation criteria on the basis of known psychological factors, but brings together a welcome amount of

subjective data on preferred reverberation time and on the shape of the characteristic. Not everyone will agree however with his advocacy of concert hall shapes designed to reflect as much as possible of the sound directly on to the audience, for although it is true that the hearing at the far end may be improved in some cases, the subjective effect is found to be one of deadness and hardness of tone, and an intimacy which is more desirable in a cinema.

The book has a few unimportant misprints in the mathematical sections but is fairly free from errors. The most serious perhaps is on page 119 in the expression for specific flow resistance which should read

$$R_{st} = \frac{981h.A.t}{V}$$

The only general criticism of the book concerns the translation. The unusual choice of words was found to be often distracting and sometimes misleading, making some of the arguments more difficult to follow than they need have been. It is no reflexion on the competence of the translator to say that, as in all such cases, revision by one speaking English as his mother-tongue would have effected a great improvement.

A feature which might well be copied by others is the close attention to dimensions and to units where applicable, every quantity, symbol and equation being labelled with the correct dimensional representations. - All footnotes and references are collected at the end, where there is also an adequate bibliography. The presentation of the whole book with its numerous illustrations, clear printing and strong binding deserves the highest praise. It could be very profitably read, not only by those to whom it is primarily addressed, but by broadcasting and recording engineers, and all others who come into contact with acoustic problems.

C. L. S. GILFORD

### Radar and Electronic Navigation

By G. J. Sonnenberg. 272 pp., 196 figs. George Newnes Ltd. August 1951. Price 31s. 6d.

**M**ORE strictly this book should have been entitled "Radar and Electronic Aids for Navigation at Sea" since very little mention is made of aids for air navigation, i.e., of the more specialized sets which are used both by civil and military aircraft and landing grounds. However, it would appear that the author has been more concerned with the navigation of ships, since he deals with this subject extremely thoroughly.

Five main aids are discussed, namely Decca, Loran, Consol, Echo Sounding and Radar, a chapter being devoted to each system. These are preceded by an introduction which, in the reviewer's opinion, could well have been omitted and replaced by a few well chosen references. It is recognized that the reader must have a certain amount of background knowledge to understand the intricacies of such a subject, but to attempt to supply this knowledge in a matter of 30-40 pages is compressing the

subject matter to the point of being misleading by over-simplification.

The procedure adopted by the author to deal with the subject matter of each chapter is the same in each case—the principles of the system are explained very simply and then practical equipment by various manufacturers is described and commented upon. This is followed by complete operational details of the system explaining the sort of difficulties one meets in practice, and advice is given on the method of use in order to obtain the optimum results. It is the author's practical knowledge of the equipment which makes this book really worthwhile and of great assistance to those who have to operate and maintain navigational aids under the normal stress of sea conditions.

Under the heading of Radar come some of its satellites: Ramark, Radar beacons, etc., the treatment of which gives an example of the author's thoroughness in tackling a subject. It is also shown in this chapter by a number of examples that, although Radar is undoubtedly an invaluable help to navigators it has a considerable number of drawbacks, and that a wide range of improvements will have to be incorporated before it would be possible for ships to navigate by Radar alone with perfect safety in every situation.

A minor weakness of this work is the looseness of some of the terms used and the inconsistency of the units, especially those of length. An example of the loose terminology is observed on page 157 where the author states the frequency of the *supersonic* vibrations of an equipment to be 15kc/s. This is followed in the very next line with the statement that most people can *hear* this pitch.

It is perhaps disappointing to see no reference to many of the wartime aircraft navigation aids, a notable omission being the equipment known as Gee. This equipment was developed before Loran, and it is probable that the latter benefited considerably from the work and experience of the British Scientists.

However, these criticisms do not prevent the reviewer recommending the book as both readable and instructive.

J. W. R. GRIFFITHS

### Microphones

By the Staff of the Engineering Training Department of the B.B.C. 114 pp., 78 figs. Iliffe and Sons Ltd. February 1952. Price 15s.

**T**HE contents of this book was originally a textbook used in training B.B.C. engineers, and has now been made available by the B.B.C. for general publication. It contains six chapters and five appendices, and is illustrated by clear diagrams and half tones.

The requirements for microphones in a broadcasting studio are set out in an introductory chapter, and this is followed by chapters covering the laws relating to sound waves and their behaviour. The design and characteristics of various types of microphones are then described, and full details are given of the ribbon, moving-coil, crystal and capacitor instruments used by the B.B.C. in recent years.

CHAPMAN & HALL

## THE MAGNETRON

by

R. A. Latham, M.A., PH.D.  
(Imperial College, London)

A. H. King, M.A.  
(Clifton College, Bristol)

L. Rushforth, B.Sc., M.I.E.E.  
(B.T.H. Co. Ltd. Research Laboratory.)  
152 pages 82 figures 18s. net

The book is exclusively concerned with the high power, multi-resonator magnetron, in whose development and manufacture the authors took part.

## PRINCIPLES OF RADIO

by

Keith Henney

(Fellow, Inst. of Radio Engineers - U.S.A.)  
and

Glen A. Richardson

(Asst. Professor of Electrical Engineering,  
Iowa State College.)

Sixth Edition  
655 pages 406 figures 44s. net

37 ESSEX STREET, LONDON, W.C.2

The latest  
"Electronic Engineering"  
monograph

## RESISTANCE STRAIN GAUGES

By J. Yarnell, B.Sc., A.Inst.P.

Price 12/6

This book deals in a practical manner with the construction and application of resistance gauges and with the most commonly used circuits and apparatus. The strain-gauge rosette, which is finding ever wider application, is treated comprehensively, and is introduced by a short exposition of the theory of stress and strain in a surface.

Order your copy through  
your bookseller or direct from

Electronic Engineering

28 ESSEX STREET, STRAND,  
LONDON, W.C.2.

## BOOK REVIEWS (Continued)

### Proceedings of a Conference on Centimetric Aerials for Marine Navigational Radar

150 pps. 93 figs. 26 plates. Her Majesty's Stationery Office. January 1952. Price 15s.

ONE of the most widespread applications of microwaves in peacetime has been in equipping merchant ships with navigational radar. Wartime experience has been exploited to the full, but significant improvements have been made since then. Not the least of these have been in the design of aerials, and a conference, arranged by the Ministry of Transport in June 1950, provided an opportunity for discussing the newer developments. The papers read at this conference and a résumé of the discussion have now been published in the volume under review.

The most important property of a marine radar aerial is that the side-lobes shall be sufficiently small to avoid spurious signals. Targets as different in size as the Queen Mary and a navigation buoy have to be detected, and it is clear that an echo from the former picked up by a side-lobe may be as large as the main echo from the latter. The Ministry of Transport has specified that the aerial side-lobes should be at least 26db below the level of the main beam and this has been achieved in practice. It is desirable however to have even smaller side-lobes and much of this report is devoted to this aspect of aerial design.

Most of the basic design of marine radar aerials has been carried out at the Admiralty Signal and Radar Establishment, and the first paper, by D. G. Kiely, gives a summary of this work. His general conclusion is that the most suitable aerial for present-day use is the parabolic cylinder, which has a reasonably good side-lobe performance and is mechanically strong. The practical details of the construction of such an aerial are described by A. Harrison and G. Duckworth, and it is made clear that a satisfactory design can only be arrived at after much detailed experimental work. A later paper by J. A. Taylor and R. F. Hansford on a much larger aerial designed for the radar installation at the Port of Liverpool, further substantiates this and provides an insight into the amount of mechanical design involved. It is interesting to note from the discussion on these papers that there is by no means complete agreement on the best design. For example opposing opinions are expressed on the desirability of using an asymmetric feed for a parabolic cylinder, and there is no explanation of the experimental observation that a deformation of the contour from the usual parabolic shape improves the side-lobe performance.

A number of the papers contain information of general interest to aerial designers. K. Milne has provided a set of tables and figures showing the effect of phase errors in the aperture distribution on the side-lobes in the radiation pattern which should prove to be of considerable value. Circular polarization is now being used fairly widely for the suppression of

rain echoes and J. A. Ramsey's review of the methods of obtaining circular polarization brings together much useful and previously scattered information. Diffraction by obstacles such as masts makes it necessary to site a ship-borne radar very carefully, and an investigation of this is reported by E. J. W. Underhill. Other papers discuss the non-homogeneous lens as a possible aerial of the future; the increase in side-lobes caused by placing the aerial feed in the path of the emerging beam, and the use in aerial construction of a new plastic material, duresstos.

The difficulty of making accurate measurements on aerials is frequently referred to and three papers deal specifically with this problem. W. A. Johnson outlines the possible methods for determining the power gain, and the importance of the site in this connexion is emphasized in the discussion. Two papers deal with automatic recording instruments: one by C. M. Burrell for phase distributions, and the other by M. C. Crowley-Milling and C. W. Miller for polar diagrams. Not only do such instruments result in an enormous saving in time but they also provide more accurate results by eliminating human errors and reducing oscillator and receiver drifts.

The bulk of the material in this volume refers specifically to the marine radar band around 9,500Mc/s and provides a useful survey of present-day microwave aerial techniques.

J. BROWN

### Electrical Instruments and Measurements

By W. Alexander. 352 pp. 112 figures. Cleaver Hume Press Ltd. 1951. Price 12s. 6d.

THE publishers are to be congratulated on the production of a book of this size, on good paper and well illustrated, for the price of 12s. 6d.

The author in his Preface quotes the importance of the subject to students, technicians, contractors and all engaged in the electrical trades. City and Guilds, National Certificates and similar examinations are mentioned, so it can be taken that the book is intended to blend the theory of instruments with their practical use. On examination it is found that the book is almost entirely descriptive, and largely based on earlier text-books.

It commences with some useful theory and principles of electromagnetic fields and their application to moving-coil and moving-iron instruments in particular. Apart from this, the theory, and especially as applied in practical design, is sketchy and while the descriptive matter will be of use to contractors, etc., little fundamental information is given for the serious student of measuring instruments. The importance of torque, the torque/weight ratio, the relation with ampere-turns and typical consumption figures for various types and sizes are most essential in commercial design, and in the understanding of instruments by a student of any branch of electrical engineering.

The moving-coil and electrostatic types are capable of approximate design to first principles, and well-known formula exist but unfortunately are not included. Some principles given are not entirely correct: it is stated that the electrostatic voltmeter consumes a small amount of power. On D.C. no current passes, and on A.C. there is a small capacitance current proportional to frequency, but being almost a pure capacitor the current is entirely reactive and has no power component, other than the negligible insulation loss.

In several respects the book is not up to date, the most obvious case being in the induction ammeter and voltmeter. Only the shaded-pole type is illustrated, but this has been obsolete in the U.K. for over a quarter of a century; it never attained first grade accuracy and was replaced by Ockenden's and Lipman's designs, both of which give first-grade accuracy and are in wide use. The induction wattmeter is apparently confused with the induction watt-hour meter: in the latter the reading is only correct for a moderate voltage range; half the voltage will not result in half the speed, but if it is to be used with a spring control as a wattmeter this limitation completely upsets it. Further lack of familiarity with modern instrument practice is shown by the reference to the copper shunt for rectifier instruments. This was a useful device about twenty odd years ago but present-day copper-oxide rectifiers are so improved that the copper shunt is unnecessary.

An authority often quoted in the book is B.S.89:1937. This is somewhat out of date and is under revision, and in general performance figures are an average to suit most makers. For particular instruments much higher performance is attained, as is well known by instrument engineers. Resistance testers are mentioned in a few lines, but no information is given as to circuits, ranges, relation between deflexion and scale, etc., which would be of use to the undertaking of the subject.

Terminology and symbols are generally correct, but a few errors are present. "Capacitor" is used generally, but "condenser" appears in some places; "mc/s" is meant for "Mc/s"; the correct "kVAhr" is wrongly shown as "kVAhr," and "mfds" is an abomination that should not be found in any reputable text-book. The term "thermal rectifier" for a thermo-couple is at least novel. Diagrams would be easier to follow if standard symbols were used throughout, instead of the semi-isometric views which are normally used for non-technical readers. There is a brief reference to valve voltmeters, in the subject of electronics.

The chapters on measurements are generally better, but the two final chapters are largely reproduced from a maker's booklets.

To summarize, the book is likely to be useful to junior students, contractors, and those with a similar standard of knowledge of electricity, who require some descriptive information on some of the common types of instruments and measurements, but who have no interest in the theory or in practical instrument designs.

E. H. W. BANNER

# NOTES FROM THE INDUSTRY

**The D.S.I.R. Headquarters Technical Information Service** has been merged with the Technical Information and Documents Unit. The new unit retains the name TIDU. Its address is Cunard Building, 15 Regent Street, S.W.1. (Telephone: Whitehall 9788).

The unit holds the German industrial documents which were brought back to this country after the war. It is receiving unpublished reports from British and American sources and it issues summaries of them. Many of these reports contain information which is not published in the normal way. TIDU maintains a technical inquiry service and is the British centre for an international questions and answers scheme. This scheme is organized to provide information about industrial techniques from the U.S.A., Canada, France, Germany, Ireland, Sweden and the United Kingdom.

**British Standard 1799, "Power Rating of Valve-driven High Frequency Induction Heating Equipment,"** (B.S.1799:1952) specifies the method of expressing the power rating of valve-driven high frequency induction heating equipment operating from single or polyphase mains supplies. The appendices explain the significance of output voltage and current in relation to power ratings and give examples of methods of output power measurement.

Until now no uniform practice has been observed in the power rating of high-frequency induction heating equipment, some manufacturers preferring to state the power taken from the supply mains while others give a figure for the output determined under arbitrary conditions. Users of this equipment need information on both input and output power and may, in addition, require some guidance on the voltage and current available at the output terminals. This standard has been prepared, therefore, to enable uniformity of practice to be achieved in the power rating of this type of high frequency heating equipment, and to give guidance and information on the subject. Copies of this standard may be obtained from the British Standards Institution, Sales Branch, 24 Victoria Street, London, S.W.1, price 2s. 6d. post free.

**Ekco/Victor Agreement.**—Under an agreement concluded with the Victor Animatograph Corporation of Davenport, Iowa, U.S.A., E. K. Cole, Ltd. are to market in Great Britain and certain overseas territories the Victor 16 mm. film projector manufactured in this country.

Mr. J. C. Rogerson has been appointed manager of the new department which will be known as the British Victor Division, with headquarters at 5 Vigo Street, W.1, the London offices of E. K. Cole, Ltd.

**British Radio Exports.**—In spite of the demands of the Defence Programme, British radio exports in February again showed an increase, the total value being £2,136,000, which, with the January figures, brings the annual rate to more than £25 million compared with £22 million in 1951.

All four sections of the industry show a substantial increase in January and February compared with the first two months of 1951, the comparative figures based on Customs and Excise returns, being:—

	1952 Jan./Feb.	1951 Jan./Feb.
	£	£
Components	1,615,000	1,013,000
Transmitters, communications, navigational aids, etc.	1,064,000	687,000
Receivers	956,000	634,000
Valves	658,000	470,000
<b>Total</b>	<b>4,293,000</b>	<b>2,804,000</b>

These figures take no account of indirect exports of equipment installed in ships and aircraft or components used in electrical apparatus other than radio and electronic equipment. Half the output of components, it is estimated, is being exported.

**British Sound Recording Association Private Exhibition** of sound recording, reproducing and audio frequency equipment will be held at the Waldorf Hotel, Aldwych, London, W.C.2, on Saturday, 17 May and Sunday, 18 May from 10.30 a.m. to 6 p.m. on both days. The official opening, by John Snagge, O.B.E., will take place at 2.30 p.m. on the 17th. Admission is free to members. Non-members may gain admission by catalogue available at the door, priced 1s. 6d., or by post 1s. 8d. from the Hon. Secretary, at "Wayford," Napoleon Avenue, Farnborough, Hants.

A number of firms will demonstrate high quality recording and reproducing equipment using disk, tape and wire. Some of the latest types of loudspeakers will also be demonstrated on both days.

**The Seventh Annual Exhibition of Electronic Devices.** The North Branch of the Institution of Electronics will be holding its seventh annual exhibition of electronic devices at the College of Technology, Manchester, from 15-18 July, 1952. The exhibition will be open from 12 noon till 9 p.m. on the 15th, 10 a.m. till 9 p.m. on the 16th and 17th, and 10 a.m. till 5 p.m. on the 18th, and admission will be by ticket obtainable from the Secretary, 17 Blackwater Street, Rochdale, Lancs.

In addition to the usual commercial section of the exhibition there will also be a scientific and industrial research

section, incorporating exhibits from the research associations and the universities. A series of lectures given by exhibitors relating to their products is in the course of preparation, and films on electronic subjects will be shown.

**Thomas Gray Memorial Trust.** The Council of the Royal Society of Arts has awarded the prize of £50, offered last year under the Thomas Gray Memorial Trust, to Mr. J. Home Dickson, for his "instrument which makes it possible to navigate a ship in fog by means of a direct comparison of a large scale chart and a Radar Plan Position Indicator." The competition was open to any person of British nationality, who might bring to the Council's notice an invention, publication, diagram or other device, which in the opinion of the judges was considered to be an advancement in the science or practice of navigation, proposed or invented by himself in the period 1 January 1946 to 31 December 1951.

**A Course of Television Lectures** on the application of modern techniques in B.B.C. practice and large screen projection will be held at Norwood Technical College on six consecutive Monday evenings commencing on May 5. The lectures begin at 7 p.m. The subjects to be covered include: large screen television for cinema requirements; studio layout and lighting; the design and operation of camera pick-up tubes; modulator and r.f. sections of transmitters; television transmitter aerial systems and pulse generators and channel equipment for use with camera pick-up tubes. The fee for the course is 17s. 6d., and for individual lectures 4s. each. Full details are available from the Secretary, Norwood Technical College, West Norwood, London, S.E.27.

**Mullard Educational Service.** An educational service has been instituted by Mullard, Ltd., to provide teachers and instructors in electronic subjects with information concerning recent developments and applications in this field. The details of this service are described in a pamphlet available from the Mullard Technical Publications Dept., Century House, Shaftesbury Avenue, London, W.C.2, entitled "The Mullard Educational Service." Included in the services listed in this pamphlet are: technical publications; assistance to individual instructors; filmstrips; wall charts, and class instruction and work sheets.

The technical publications provide useful background information, and are issued free of charge. They include technical descriptions of new valves, electron tubes, etc., and bulletins describing new developments in circuitry and application notes on new products. Individual assistance on technical problems is also available to instructors.

# Meetings this Month

## THE BRITISH INSTITUTION OF RADIO ENGINEERS

Date: May 7. Time: 6.30 p.m.  
Held at: the London School of Hygiene and Tropical Medicine, Keppel Street, Gower Street, London, W.C.1.  
Lecture: An Aerial Analogue Computer.  
By: W. Saraga, Ph.D., D. T. Hadley and F. Moss, B.Sc.

### Merseyside Section

Date: May 1. Time: 7 p.m.  
Held at: Electricity Service Centre, Whitechapel, Liverpool.  
Annual General Meeting followed by technical films.

### North Eastern Section

Date: May 14. Time: 6 p.m.  
Held at: Neville Hall, Westgate Road, Newcastle-upon-Tyne.  
Annual General Meeting followed by technical films.

## THE BRITISH SOUND RECORDING ASSOCIATION

Date: May 16. Time: 7 p.m.  
Held at: the Royal Society of Arts, John Adam Street, London, W.C.2.  
Open Evening.  
Date: May 17 and 18.  
Held at: the Waldorf Hotel, Aldwych, London, W.C.2.  
Convention and Exhibition.

## THE INSTITUTE OF NAVIGATION

Date: May 16. Time: 5 p.m.  
Held at: the Royal Geographical Society, 1 Kensington Gore, London, S.W.7.  
Lecture: Radar Chart-Matching Devices.  
By: J. Home Dixon.

## THE INSTITUTE OF PHYSICS

### Midland Branch

Date: May 1. Time: 5.15 p.m.  
Held at: the University, Edgbaston, Birmingham, 15.  
Lecture: Thomas Young.  
By: F. Oldham, F.Inst.P.

## THE INSTITUTION OF ELECTRICAL ENGINEERS

All London meetings, unless otherwise stated, will be held at the Institution, commencing at 5.30 p.m.

### Measurements Section

Date: May 6.  
Lecture: The Electricity Division of the National Physical Laboratory.  
By: R. S. J. Spilsbury, B.Sc.(Eng.).

### Radio Section

Date: May 14.  
Lecture: A Phototelegraphy Transmitter-Receiver Utilizing Sub-Carrier Frequency Modulation.  
By: R. O. Carter, M.Sc.(Eng.) and L. K. Wheeler, B.Sc.(Eng.).

### Utilization Section

Date: May 8.  
Lecture: The Use of Electricity in a Modern Iron and Steel Works.  
By: W. F. Cartwright.

### Education Discussion Circle

Date: May 20.  
Discussion: The Teaching of Engineering Economics.  
Opened by: Professor R. O. Kapp, B.Sc.(Eng.).

### North Midland Centre

Date: May 6. Time: 6.30 p.m.  
Held at: 1 Whitehall Road, Leeds 1.  
Lecture: The Maoris of New Zealand.  
By: Professor A. Durward, M.D.

### North Western Centre

Date: May 6. Time: 6.15 p.m.  
Held at: the Engineer's Club, Albert Square, Manchester.

Lecture: The Design of High-Speed Salient-Pole A.C. Generators for Water-Power Plants.  
By: E. M. Johnson, M.Sc.Tech. and C. P. Holder, B.A.

### North Lancashire Sub-Centre

Date: May 6. Time: 7 p.m.  
Held at: the Allen Technical Institute, Kendal.  
Lecture: A Review of Research in Electricity Supply.  
By: C. W. Marshall, B.Sc.

Date: May 7. Time: 7 p.m.  
Held at: the Harris Institute, Corporation Street, Preston.  
Lecture: as above.

### Northern Ireland Centre

Date: May 13. Time: 6.45 p.m.  
Held at: the Presbyterian Hostel, Howard Street, Belfast.  
Lecture: Modern Telegraph Practice.  
By: Major E. H. Wilkinson, M.C.

### South Midland Centre

Date: May 5. Time: 6 p.m.  
Held at: the James Watt Memorial Institute, Birmingham.  
Lecture: Railway Electrification in Great Britain.  
By: C. M. Cock.

### South Midland Radio Group

Date: May 24.  
Summer Visit to the Meteorological Station at Dunstable.

### Southern Centre

Date: May 7. Time: 6.30 p.m.  
Held at: the Royal Beach Hotel, Portsmouth.  
Lecture: Technical Colleges and Education for the Electrical Industry.  
By: H. L. Haslegrave, M.A., Ph.D., M.Sc.(Eng.).

## THE INSTITUTION OF POST OFFICE ELECTRICAL ENGINEERS

Date: May 5. Time: 5 p.m.  
Held at: the I.E.E., Savoy Place, London, W.C.2.  
Lecture: A General Introduction to Communication Theory.  
By: J. E. Flood, Ph.D., L. R. F. Harris, B.A. and A. D. V. Ridlington, M.A.

## PRESENTATION OF TECHNICAL INFORMATION DISCUSSION GROUP

Date: May 6. Time: 6 p.m.  
Held at: University College, Gower Street, London, W.C.1.  
Lecture: Modern Duplicating Methods.  
By: Mr. Parslow.

## THE SOCIETY OF INSTRUMENT TECHNOLOGY

Date: May 27. Time: 7 p.m.  
Held at: the Royal Society of Tropical Medicine and Hygiene, Manson House, Portland Place, London, W.1.  
Lecture: Recent Advances in the Industrial Use of the Microscope.  
By: E. W. Taylor

## THE TELEVISION SOCIETY

Date: May 1. Time: 6.30 p.m.  
Held at: the Lecture Theatre, the Institution of Electrical Engineers, Savoy Place, W.C.2.  
Lecture: London Town.  
By: Richard Dimbleby.

Date: May 8. Time: 7 p.m.  
Held at: the C.E.A., 164 Shaftesbury Avenue, London, W.C.2.  
Lecture: Image Orthicon Camera Tubes.  
By: Baldwin Banks, B.Sc. and K. Frank, Ph.D.

Date: May 23. Time: 7 p.m.  
Held at: the C.E.A., 164 Shaftesbury Avenue, London, W.C.2.  
Lecture: the H.M.V. 21-inch Tube Receiver.  
By: J. J. Billin.

## PUBLICATIONS RECEIVED

**FINE WIRE DATA** is a booklet containing a set of tables referring to textile covered winding wires including bunched enamelled copper conductors manufactured by Fine Wires Ltd., of Grove Road, Castle Boulevard, Nottingham.

**ELECTRONIC MUSICAL INSTRUMENTS** is an excellent bibliography on this subject compiled by the Information and Service Division of the Tottenham Public Libraries and Museum, London, N.17. It is probably the most comprehensive single bibliography available on this subject at the present time.

**TELEPHONE LINE PROTECTORS** is an eight-page leaflet published by the Edison Swan Electric Co. Ltd., 155 Charing Cross Road, London, W.C.2. It describes a form of electrode gas discharge tube which this company, in collaboration with the G.P.O., produced recently as a protective device for telephone systems.

**WIGGIN NICKEL ALLOYS No. 16** contains a description of the new Rover light-weight gas turbine in which Nimonic alloys are employed, and articles on wire cloth manufacture, chemical valves and the mag-nickel fuse. The cover commemorates the discovery of nickel two hundred years ago. Henry Wiggin and Co. Ltd., Wiggin Street, Birmingham, 16.

**THE BEETLE BULLETIN No. 1** is a most attractively produced booklet which is to be published twice yearly by the B.I.P. Group to keep industry informed of the developments in aminoplastics and in the plant, tools and processes used in their application. The bulletin contains illustrated articles on varied aspects of aminoplastics, and copies may be obtained from British Industrial Plastics Ltd., 1 Argyll Street, London, W.1.

**SILVER—ENGINEERING PROPERTIES AND USES** describes in some detail the uses of silver in modern engineering, and covers its applications to electronics. This interesting booklet is data sheet No. 2010, published by Johnson, Matthey and Co., Ltd., 73-83 Hatton Garden, London, E.C.1.

**MORGANITE RESERVOIR OIL RETAINING BEARINGS** is a technical brochure SD40 issued by the Morgan Crucible Co., Ltd., to describe their "Reservoir" bearings, which are manufactured by powder metallurgy methods from selected bronze or iron powders, and tool-made to precision limits. Their porous structure enables them to hold up to 30 per cent. of oil by volume. The Morgan Crucible Co., Ltd., Battersea Church Road, London, S.W.11.

**LONDEX DATA** is a new publication (No. 144) which contains information on the Londex range of products in a condensed and factual form for the benefit of engineers. It covers relays, timers, fluid and gas control, and special apparatus, such as electro-magnetic counters, photo-electric equipment, winker beacons, navigation and obstruction lights, etc. Londex Ltd., Anerley Works, 207 Anerley Road, London, S.E.20.

**36th ANNUAL REVIEW OF THE SILVER MARKET 1951** is issued by Handy and Harman, of 82 Fulton Street, New York 38, U.S.A., and states that the demand for the industrial uses of silver continues to grow. The use of silver brazing alloys in industry has increased production in assembling parts with strong, leak-tight, ductile joints, and the low flowing temperature and fast brazing action have caused manufacturing companies to turn to the alloys as a means of producing brazed parts in volume, states the report.

**B.I. CALLENDER'S MASS-IMPREGNATED NON-DRAINING CABLES CATALOGUE** is most attractively presented. The contents include an introduction to this type of cable, a short account of its advantages, its construction and terminations, conductor sizes and current ratings, and typical dimensions and weights. Copies are available on request from British Insulated Calender's Cables Ltd., Norfolk House, Norfolk Street, London, W.C.2.

**RESISTANCE WELDING AT WORK** is a leaflet produced by Sciaky Bros., Inc., of 4915 West 67th Street, Chicago 38, Illinois, U.S.A. It features spot and seam welding in aircraft construction, and the equipment made by Sciaky for this work.



By adding the Clix range of radio, television and electronic components to its existing list of products, The Edison Swan Electric Co., Ltd. is able to offer an improved components service to the Radio Industry. Future enquiries and orders for these products, and others in the Ediswan range, will be welcomed.

**United  
for better Radio,  
Television and  
Electronic  
component  
service**

THE EDISON SWAN ELECTRIC COMPANY LIMITED  
155 Charing Cross Road, London, W.C.2, and branches  
*Member of the A.E.I. Group of Companies*





# MARCONI

## broadcasting equipment

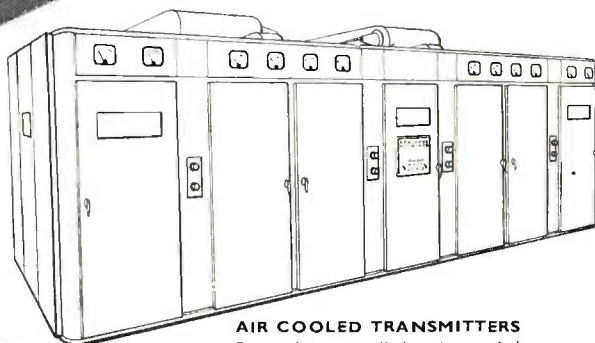
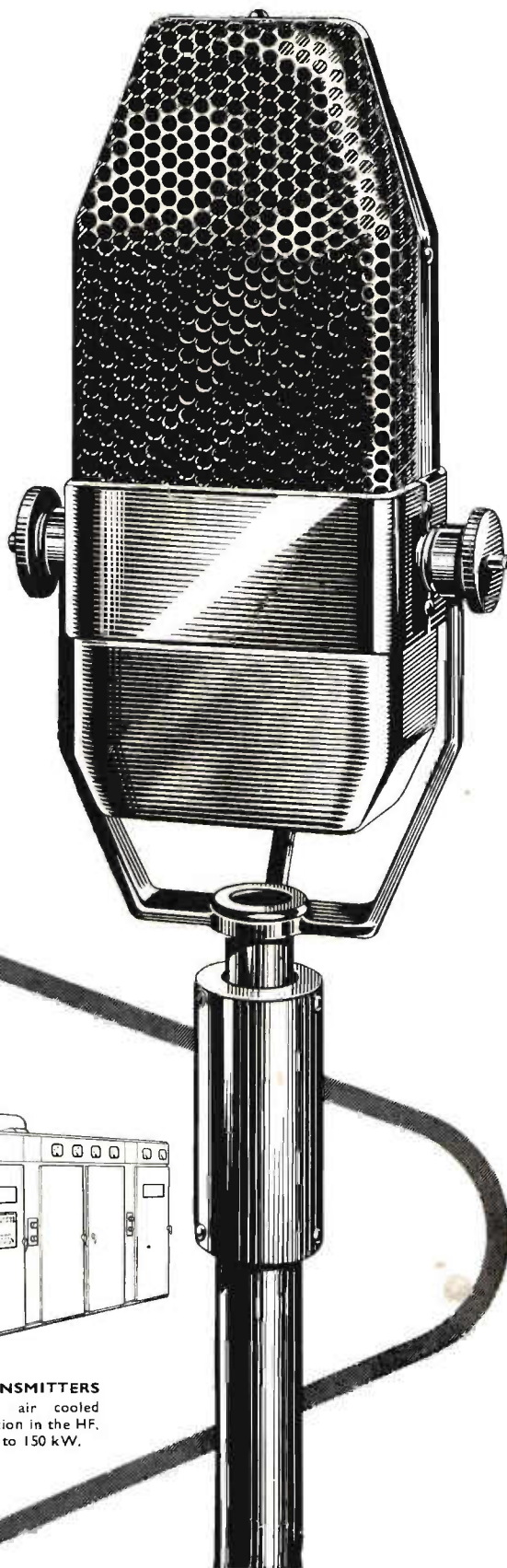

**AIR COOLED TRANSMITTERS**  
Remotely controlled, air cooled  
transmitters for operation in the HF,  
MF and LF bands up to 150 kW.

MARCONI'S WIRELESS TELEGRAPH COMPANY LTD · CHELMSFORD · ESSEX

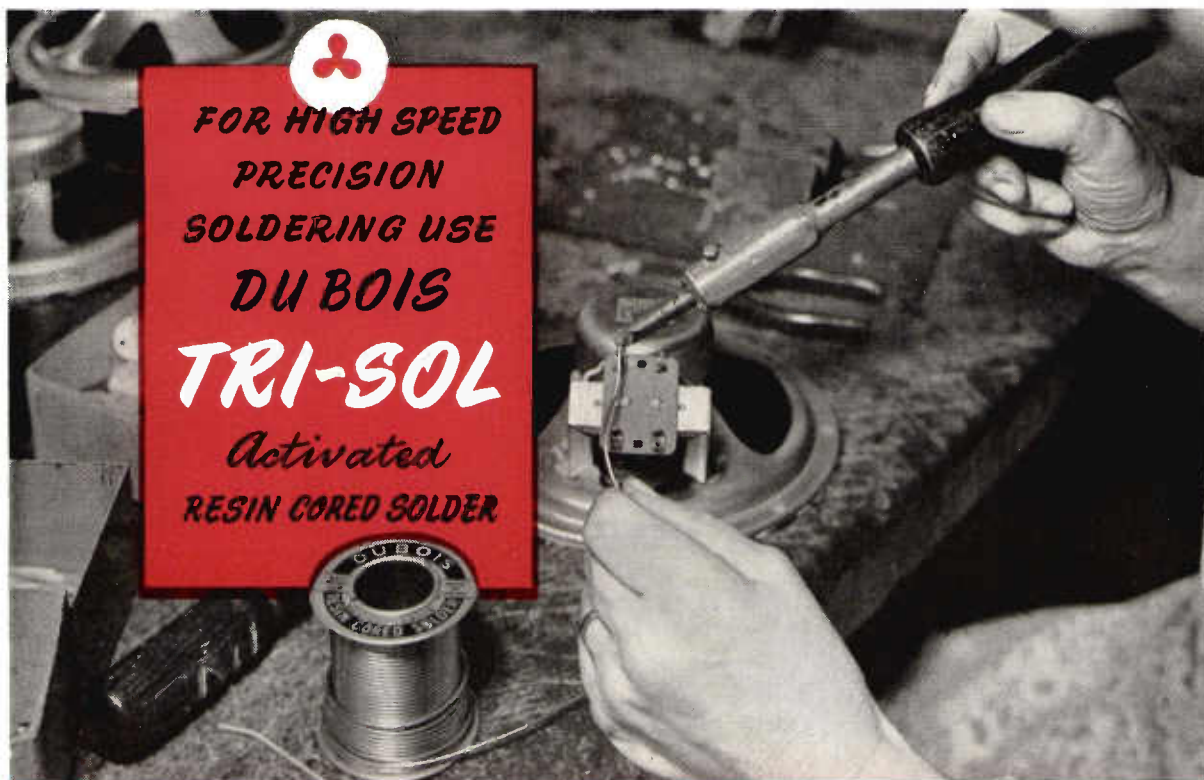

  
**FOR HIGH SPEED  
 PRECISION  
 SOLDERING USE  
 DU BOIS  
 TRI-SOL  
 Activated  
 RESIN CORED SOLDER**

*Photograph by courtesy of Raymond Electric Ltd.*

*Write for free sample and descriptive literature*

**THE DU BOIS CO., LTD., 15 BRITANNIA ST., KING'S CROSS, LONDON, W.C.1**

**TERminus 6624**

# NICKEL CHROME

*Finest*

**RESISTANCE  
 WIRES**

Manufactured to customers' specifications in gauges down to 50 s.w.g. and finer if required. Cromaloy™ V Resistance Wires are produced in long lengths to speed output by minimising time-wasting operational changes.



**LONG LENGTHS  
 DOWN TO 50 S.W.G.**

*Cromaloy V*

**FOR CONSISTENCY**

**A. C. SCOTT & CO LTD., CROMALOY HOUSE, CITY ROAD, MANCHESTER**

**LONDON AGENT: COTSIL LTD., 80 MORTIMER ST., LONDON, W.1. TEL: LANGHAM 1071/2**

dm AS. 12.



# RELIABILITY in your equipment

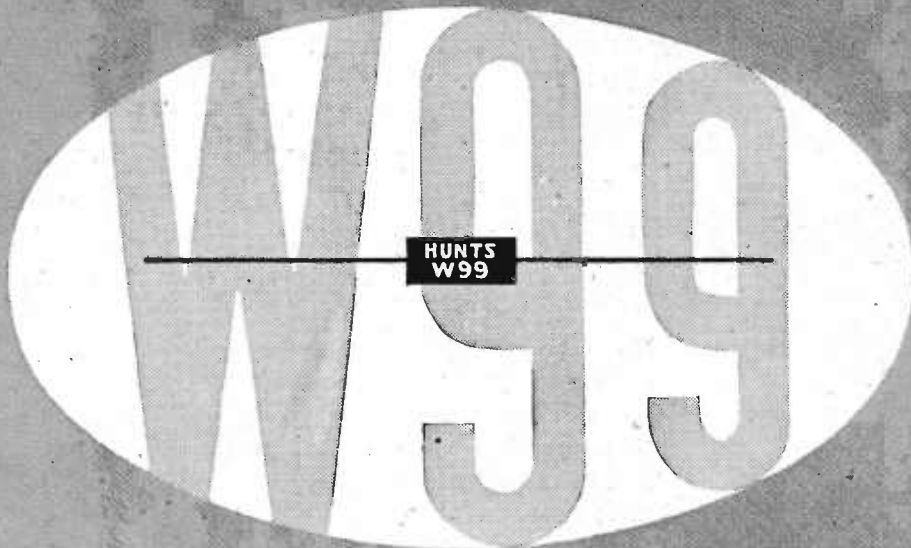

## extends to its smallest component

### THE MIGHTY MIDGET

Minimum size — Maximum reliability — Self healing  
Rugged construction — MOLDSEAL moisture proof case.  
I.R. = 20,000 M $\Omega$ . Minimum all values at working volts. at 20°C.  
Temp. range = -40°C to +71°C, (also types for higher temperatures).

#### STANDARD RANGE

Wkg. Voltage	Cap. Range $\mu$ F	★ Size
150 D.C.	0.004 to 0.01	A
	0.02 to 0.04	B
350 D.C.	0.001 to 0.003	A
	0.004 to 0.01	B
600 D.C.	2.5pF to 0.001	A
	0.002 to 0.004	B
300 A.C.	0.00005 to 0.001	A
	0.002 to 0.004	B

★ A. 3/16" x 7/16"      B. 1/4" x 9/16"

Registered Trade Mark

# HUNTS CAPACITORS

A. H. Hunt (Capacitors) Ltd. Wandsworth, London, S.W.18 BATTERSEA 3131

# Communication and Industrial Valves by *Standard*

The comprehensive range of high-quality valves manufactured by Standard includes types for almost every application, representative of which are :

- Broadcast, Communication and Television transmission
- Airborne and Mobile V.H.F. Equipment
- Microwave links
- Telephone and Telegraph Coaxial and line transmission
- D.C. Power Supply Rectification
- R.F. Heating
- Counting and Computing
- Motor Speed Control
- Welding Control
- Medical Diathermy
- Voltage Stabilisation
- X-Ray
- Vacuum Measurement
- Thermocouples

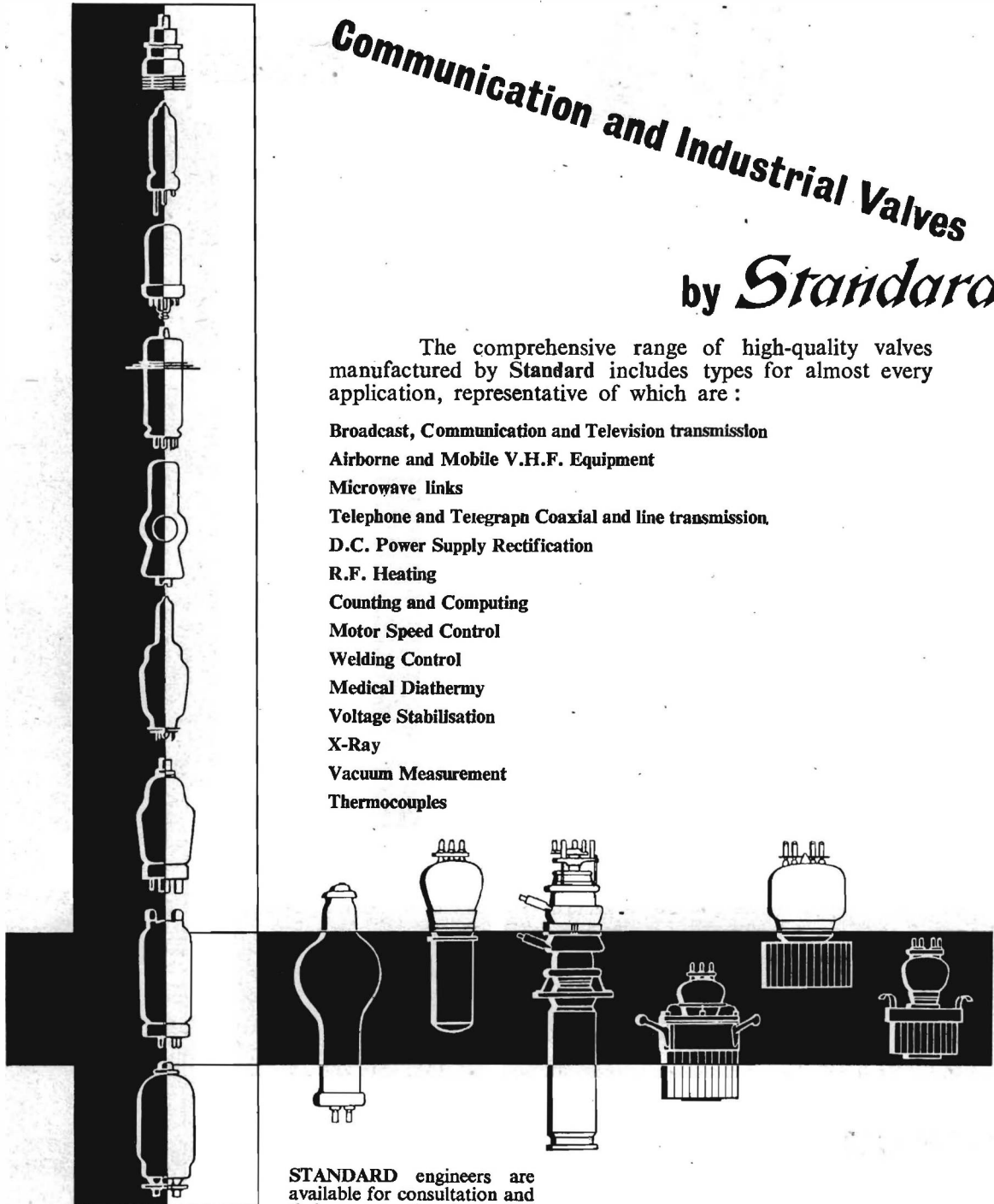

STANDARD engineers are available for consultation and their co-operation is assured to designers and technicians throughout industry wishing to take advantage of Standard's long experience in the field of valve engineering.

Please write to

**Standard Telephones and Cables Limited**

Registered Office: Connaught House, 63 Aldwych, London, W.C.2

RADIO DIVISION — OAKLEIGH ROAD, NEW SOUTHGATE, LONDON, N.11

UNIVERSAL  
AVOMETER

Model 8  
**20,000 ohms  
per volt plus**  
**AUTOMATIC Overload  
Protection**



Produced in response to a demand for a high sensitivity version of the world-famous Universal AvoMeter, this model incorporates the traditional design features of its predecessors, so highly valued for simplicity of operation and compact portability.

It has a sensitivity of 20,000 ohms per volt on all D.C. voltage ranges and 1,000 ohms per volt on A.C. ranges from 100V. upwards. A decibel scale is provided for audio frequency tests. In addition, a press button has been incorporated which reverses the direction of current through the moving coil, and thus obviates the inconvenience of changing over test leads when the current direction reverses. It also simplifies the testing of potentials, both positive and negative, about a common reference point. A wide range of resistance measurements can be made using internal batteries, separate zero adjustment being provided for each range.

It is of importance to note that this model incorporates the "AVO" automatic cut-out for protection against inadvertent overloads.

Size 8½" x 7¼" x 4½"  
Weight 6½ lbs. (including leads)

**£23 : 10s.**

The following accessories are available to widen still further the ranges of the instrument:—A Resistance Range Extension Unit to extend the limits of measurement from 0.025 ohms to 200MΩ, a 10kV. D.C. multiplier and a number of A.C. current transformers.

D.C. VOLTAGE	D.C. CURRENT	A.C. VOLTAGE	A.C. CURRENT	RESISTANCE
2.5V.	50μA.	2.5V	100mA.	First indication 0.5 Ω
10V.	250μA.	10V.	1A.	Maximum indication 20M Ω
25V.	1mA.	25V.	2.5A.	0—2,000 Ω using internal batteries
100V.	10mA.	100V.	10A.	0—200,000 Ω using internal batteries
250V.	100mA.	250V.	—	0—20M Ω using external batteries
1,000V.	1A.	1,000V.	—	0—200M Ω
2,500V.	10A.	2,500V.	—	

**THE AUTOMATIC COIL WINDER & ELECTRICAL EQUIPMENT CO. LTD.**  
WINDER HOUSE • DOUGLAS STREET • LONDON S.W.1 Telephone VICTORIA 3404-9



A8/1



**professional**

# T.V. SERVICING



## COSSOR 'TELE-CHECK' Model 1320

An Alignment Wobbulator for setting up the correct response curves of a T.V. receiver's tuned circuits. In addition the instrument incorporates a generator which produces a pattern of either horizontal or vertical bars on the receiver screen so that linearity of its time-bases can be checked.

A feature of the instrument is that the frequency modulation of the carrier injected into the receiver is carried out electronically, the X-sweep voltage of the oscillograph being used to control this modulation. The response curves of R.F. and I.F. tuned circuits are displayed on the oscillograph producing the sweep voltage, the 7 megacycles bandwidth of the F.M. sweep occupying the entire length of the trace. The carrier of the 'Tele-Check' can be set to any frequency between 7 and 70 megacycles.

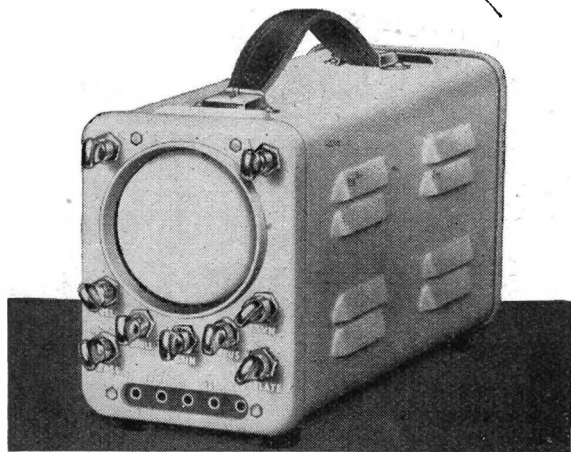

## COSSOR Model 1039 PORTABLE OSCILLOGRAPH

Although a miniature instrument and weighing only 9½ lbs. the oscillograph is fitted with a tube of 2¾" diameter and provides screen of adequate size for most displays. Its single-stage Amplifier covers a frequency range of 25 cycles to 3.5 megacycles (30% down) at a gain of 10 or from 25 cycles to 150 kilocycles (30% down) at a gain of 60. The switching provides the following facilities: D.C. to Y plate; A.C. to Y plate high gain at low bandwidth; low gain at high bandwidth.

The free-running Hard Valve time-base provides symmetric deflection to the X plates with repetition frequencies of 10 c.p.s. to better than 50 kilocycles and can be fed from the X terminal on the front panel to control the modulation of the Cossor 'Tele-Check'.

ELECTRONIC **COSSOR** INSTRUMENTS

Write for descriptive leaflets to your usual wholesaler, or direct to

A. C. COSSOR LTD., INSTRUMENT DIVISION, DEPT. NO. 2, Highbury, London, N.5



**Use COSSOR Valves and Tubes**



# FOR HIGH- FREQUENCY INSULATION -

*specify*  
**'FREQUELEX'**

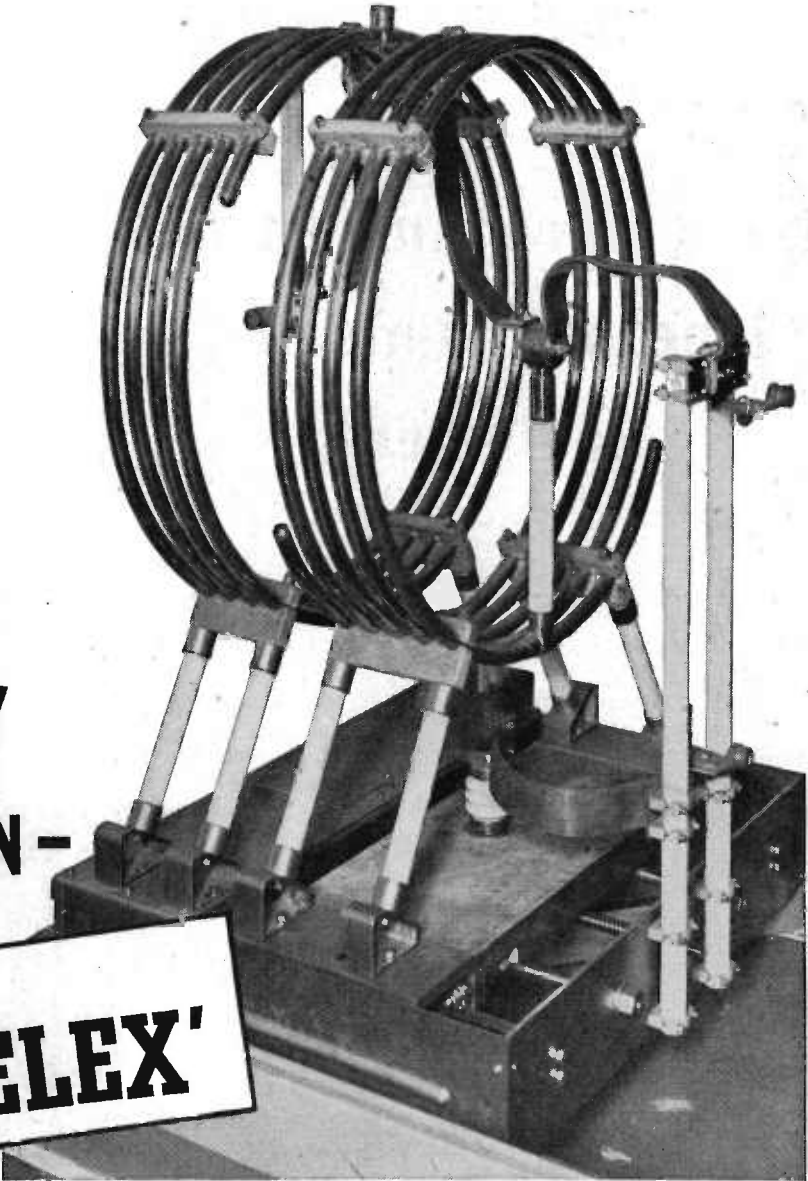

*Photograph by permission of the Standard Telephone & Cables Ltd.*

The Coupling Coil shown is supported by our "FREQUELEX" Ceramic Rods, and forms part of a 200 KW. Radio Transmitter.

This is only one of many applications where Rods made to close limits are required.

We specialise in the manufacture of Ceramic Rods and Tubes of various sections in several classes of materials over wide dimensional ranges.

*The principal materials are :*

1. Porcelain for general insulation.
2. Frequelex for High Frequency insulation.
3. Permallex and Templex for Capacitors :

The degree of accuracy depends on the size of the Rod or Tube, but the standard degree of accuracy is outlined in the Inter - Service Component Manufacturers' Council — Panel R Specification embodied in our Catalogue of Radio Frequency Ceramics, copy of which will be sent on request.

Large Rods up to 44" long and  $1\frac{1}{4}$ " square are used as supports for Tuning Coils, etc.

*We shall be pleased to have your enquiries for all sizes of Tubes and Rods. Prompt deliveries can be given for most sizes.*



## **Bullers** LOW LOSS CERAMICS

BULLERS LIMITED, 6 Laurence Pountney Hill, E.C.4. Phone: MANsion House 9971 (3 lines). Grams: 'Bullers, Cannon, London'

BL3

**ATE/TMC**

# Open Wire and Cable Line Transmission Equipment

The illustration shows the compact frequency generating equipment which serves twelve 12-channel carrier telephone systems. The master oscillator is controlled from a highly accurate 60 kc/s crystal: all generating equipment is in duplicate, and failure of the set in use causes the stand-by set to take over the load automatically. A monitor panel is provided for output checking.

## **AUTOMATIC TELEPHONE & ELECTRIC CO. LTD.**

*Radio and Transmission Division: STROWGER HOUSE, ARUNDEL STREET, LONDON, W.C.2*  
*Telephone: TEMple Bar 9262      Cablegrams: Strowgerex, London*



*Manufacturers:*

AUTOMATIC TELEPHONE & ELECTRIC CO. LTD. - - - Liverpool and London  
TELEPHONE MANUFACTURING CO. LTD. - - - St. Mary Cray, Kent

AT. 8441-B105

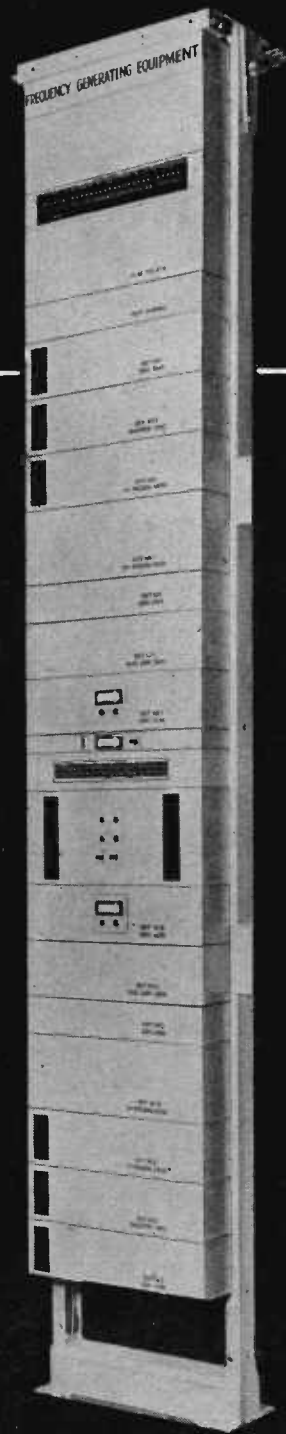

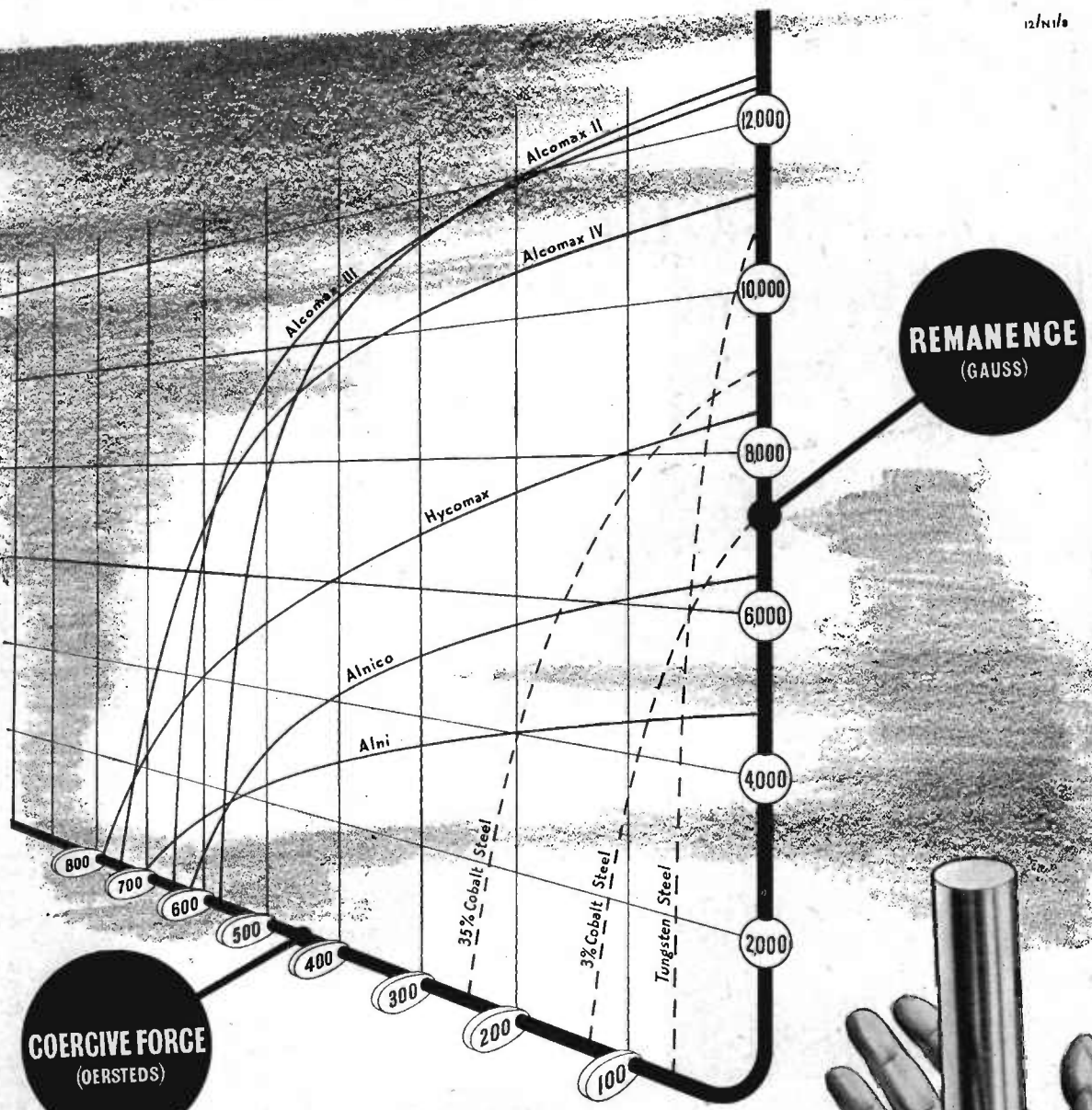

**Same energy —  
1/20 the weight**

A range of permanent magnet alloys, in which the principal elements are nickel, aluminium and iron, has resulted from continuous development over a period of years. These alloys have a very high coercive force which, in combination with their low specific gravity, enables a magnet of the same energy to be made one-twentieth the weight of a tungsten steel magnet.

The diagram shown above is based on curves taken from our publication, "The Magnetic Properties of the Nickel-Iron Alloys" which will be sent free on request.

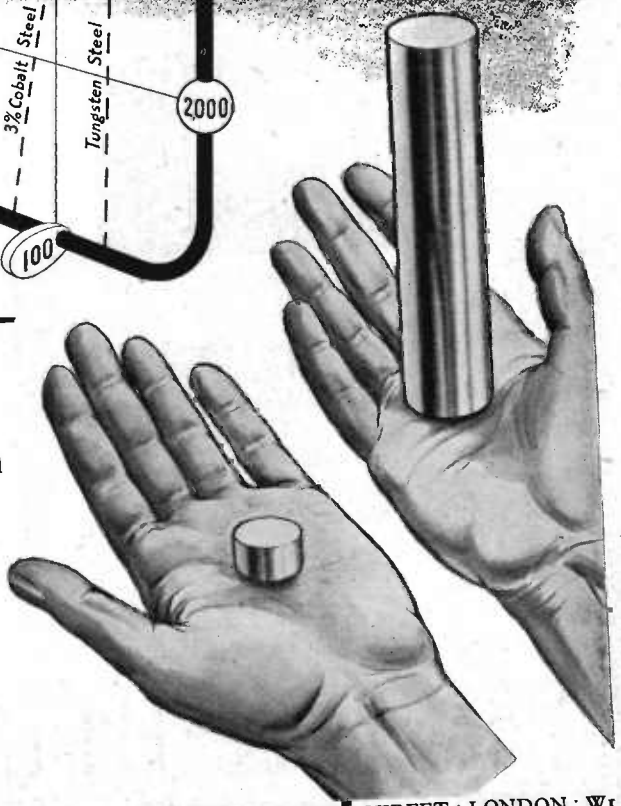

THE MOND NICKEL COMPANY LIMITED · SUNDERLAND HOUSE · CURZON STREET · LONDON · W1

# EDDYSTONE

## FINE COMMUNICATION RECEIVERS

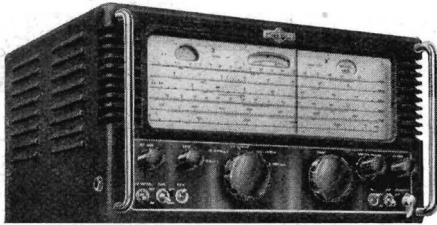

### MODEL "680X"

- Fifteen Valves
- Two R.F Stages
- Two I F Stages
- Separate Oscillator
- Variable Selectivity
- Crystal Filter
- "S" Meter
- Push-pull Output
- Polychromatic Finish

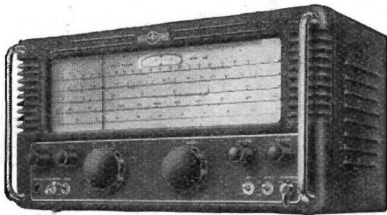

### MODEL "750"

- Double Superheterodyne
- Eleven Valves
- High Sensitivity
- Variable Selectivity
- Free from Images
- Separate Gain Controls
- Large Dial with Linear Scales
- Mechanical Bandsread
- Robust Construction

For full information, please apply to your local EDDYSTONE  
Registered Dealer or write to the Manufacturers :-

**STRATTON & Co. Ltd.**  
EDDYSTONE WORKS, BIRMINGHAM, 31

# WEBB'S *Radio*

## SPECIALISTS in HIGH FIDELITY Reproduction

WE ALL AGREE that improved technique has given better and better reproduction, and we can also agree that modern specialised equipment is superior to the normal commercial radio-gram.

BUT final choice from the many EXCELLENT amplifiers, speakers and pick-ups may not be so easy.

YOU ARE INVITED to hear and compare ANY COMBINATION of mains amplifier, speaker and pick-up—we shall be interested to have your opinion. Please remember—a visit to our demonstration room entails no obligation whatever.

### WEBB'S DEMONSTRATE AND STOCK :-

#### AMPLIFIERS

	£	s.	d.
ACOUSTICAL "QUAD" ... ..	35	0	0
LEAK "POINT ONE" ... ..	37	16	0
SOUND SALES "A-Z" ... ..	32	10	0
ROGERS "BABY" ... ..	18	0	0

#### PICK-UPS

LEAK "DYNAMIC" ... ..	12	0	8
CONNOISSEUR ... ..	6	9	0
DECCA "X/M/S" ... ..	7	0	0

#### LOUDSPEAKERS

VITAVOX "KLIPSCHORN" ... ..	145	0	0
WHARFEDALE "CORNER" ... ..	64	17	0
SOUND SALES "PHASE" INVERTER... ..	14	10	0
CHAPMAN "COLUMN" ... ..	47	5	0

AND L.S. UNITS BY GOODMAN'S, VITAVOX, WHARFEDALE, ETC.

#### FEEDER UNITS

LEAK "SUPERHET" ... ..	37	2	4
SOUND SALES "DX PLUS I" ... ..	21	19	6
ROGERS "TRF" ... ..	17	12	0
ACOUSTICAL ... ..	26	0	0

**WEBB'S** *Radio*

14 SOHO ST., OXFORD ST., LONDON, W.1.

Phone: GERrard 2089. Shop Hours: 9 a.m.—5.30 p.m. Sats. 9 a.m.—1 p.m.



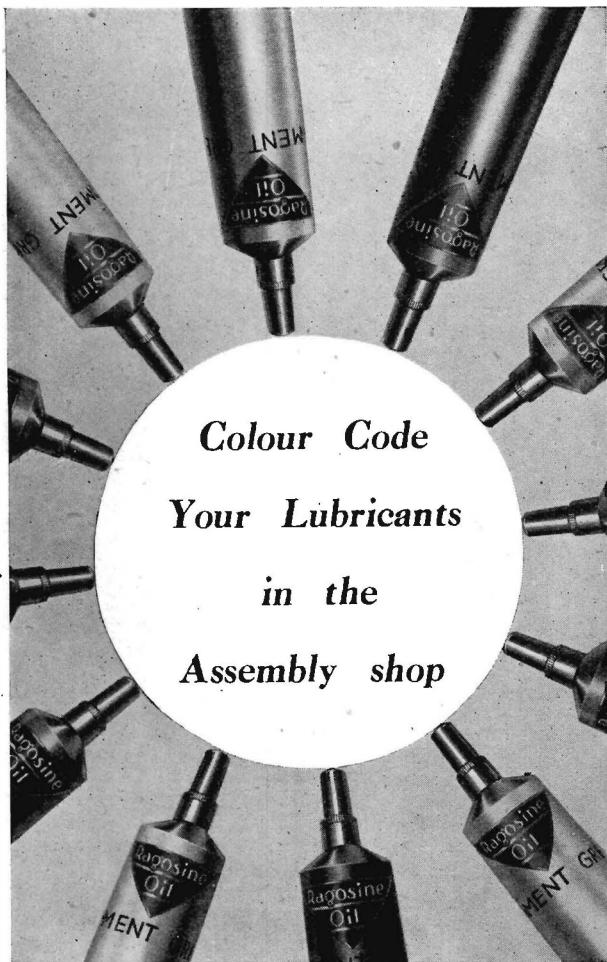

Colour Code  
Your Lubricants  
in the  
Assembly shop

We can now supply our Instrument lubricants in tubes of different colours – oil tubes with hypodermic needles – for recognition on the bench and freedom from contamination.

We should be pleased to survey your requirements and make our recommendations.

# RAGOSINE

Instrument Lubricants in Tubes.

Write to:

**RAGOSINE OIL CO., LTD.**



MINERVA WORKS,

WOODLESFORD, nr. LEEDS

Telephone: Rothwell 2164

London Office: IBEX HOUSE, MINORIES, LONDON, E.C.3

n.d.h

MAY 1952

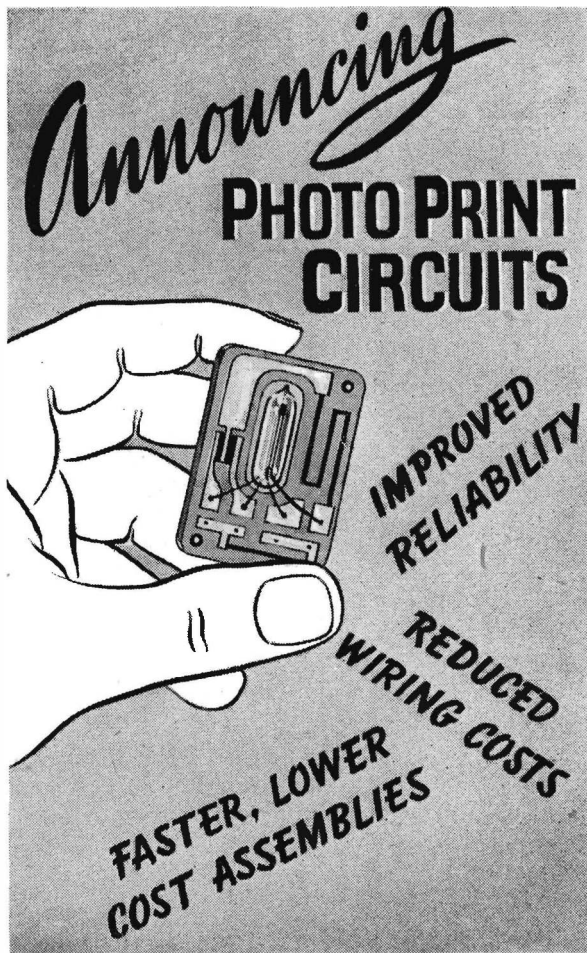

Wiring, Inductors, Switch Contacts, Flat Commutators, etc., produced in silver, copper, or silver-copper plated and silver plated. Resistors, Potentiometers etc., produced in cracked carbon form, rated at  $\frac{1}{4}$  watt per square cm. at values from 500  $\Omega$  to 50 K  $\Omega$  per square.

*We shall be pleased to answer YOUR problems in mass production of small electronic assemblies.*

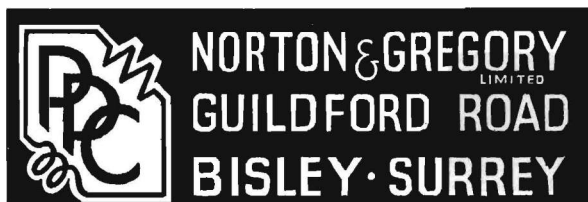



# PHILIPS *Present*

## STRAIN MEASURING BRIDGE GM.4571

Measuring Bridge for static strains · Battery-operated · Portable

### ★ FEATURES ★

- Bridge frequency 400 c/s. • Accuracy error  $\pm 1\%$ .
- Minimum readable strain .0005%.
- Reading range  $-1.6\%$  to  $+1.6\%$
- Suitable for use with any strain gauge of resistance greater than 100 ohms.

## STRAIN GAUGE GM.4472

For measuring strains and stresses in materials

### ★ FEATURES ★

- Wire wound on paper base. • Negligible weight.
- Extremely small. • 600 ohms or 120 ohms respectively.
- Gauge factor approximately 2. This is always indicated to an accuracy of  $\pm 3\%$ .



The Philips Strain Measuring Bridge, Type GM.4571, for static strains.

Philips Strain Gauge, Type GM.4472.

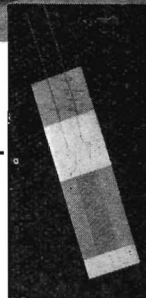

## PHILIPS ELECTRICAL LTD.

MANUFACTURERS OF: INDUSTRIAL X-RAY EQUIPMENT · LAMPS AND LIGHTING EQUIPMENT · SOUND AMPLIFYING EQUIPMENT  
MAGNETIC FILTERS · BATTERY CHARGERS AND RECTIFIERS · CAPACITORS AND MOTRONIC EQUIPMENT · HIGH FREQUENCY GENERATORS  
PHILIPS ELECTRICAL LIMITED, CENTURY HOUSE, SHAFTESBURY AVENUE, LONDON, W.C.2. (P1743B)

## QUARTZ CRYSTAL COATING PLANT

### Model 12QE High Production Unit

This new equipment possesses several outstanding design features . . .

- A high deposition rate and ease of control which permits the final adjustment of crystals already base coated, or the complete coating and final adjustment in one cycle.
- Frequency readings can be taken at any time during the coating.
- A unique turret head designed to accommodate a number of crystals which are rotated into calibrating position by an externally controlled drive.

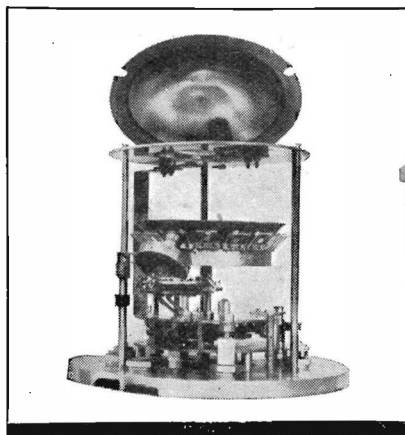

(above)  
Photograph of turret head of Model 12QE with cover removed from work chamber.

(right)  
Model 12E—the basic unit of the 12QE—in the form suitable for the production of coated optics, front-surface mirrors, rectifiers, photo-cells, plastic forms, shadow-casting.



for better vacuum service . . .

## W. EDWARDS

& CO. (LONDON) LTD., LONDON, S.E.26

Phone: Sydenham 7026 (8 lines) Grams: Edcohive, Souphone, London

# Bare & Insulated Resistance Wires

**EUREKA** (Regd) and **VACROM** (Regd)  
CUPRO-NICKEL NICKEL-CHROME



for  
**INSULATED WIRES**

'Eureka' (Regd.) and 'Vacrom' (Regd.) Resistance Wires can be supplied BARE or with STANDARD COVERINGS of cotton, silk, rayon, enamel and glass.

These wires have been used for many years for winding resistances for instruments, control apparatus, etc.

'Eureka' with its low temperature coefficient is always in demand for precision work, while Nickel-Chromes are used where a high resistance is required in a limited space.

Full details gladly supplied upon request



or  
**BARE WIRES**

**THE LONDON ELECTRIC WIRE COMPANY  
AND SMITHS, LIMITED**  
LEYTON, LONDON, E. 10.

**VACTITE WIRE COMPANY LTD.**  
75 ST. SIMON STREET,  
SALFORD 3, LANCs.

**AMMETERS  
VOLTMETERS  
OHMMETERS  
WATTMETERS  
FREQUENCY METERS**

For switchboard or  
portable use, also  
multi-range test sets.



**MEASURING INSTRUMENTS (PULLIN) LTD.**  
Electrin Works, Winchester St., Acton, London, W.3

## DYNAMOMETER TEST SET

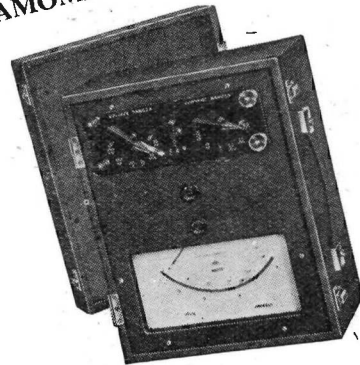

The Pullin Dynamometer Type PD.440 Test Set has 5 pressure ranges up to 500 volts A.C./D.C., 7 current ranges from 25 mA to 25A and 30 ranges true watts. Excellent damping and rapid change-over under load. Accuracy unaffected by variations in frequency from 25 to 400 cycles.

# BALDWIN

DUNLOP

## STATIGUN

FOR THE MEASUREMENT OF  
ELECTROSTATIC CHARGES

A self-contained battery operated instrument for the direct indication of voltage gradient: reads on three ranges with full scale values of 2 kilovolts per foot to 200 kilovolts per foot.

In use it is pointed at the charged surface and if necessary adjusted for range.

It will indicate if the charge is positive or negative.

OF PARTICULAR APPLICATION TO ALL PROCESSES IN WHICH ELECTROSTATIC CHARGES ARE DEVELOPED AND MAY BE A NUISANCE OR SOURCE OF DANGER.

It will also measure charge and resistance to earth with extra accessories.

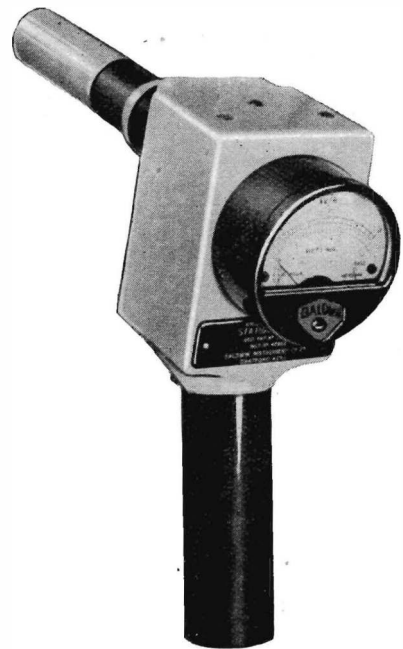

Weight 3 lb.

Write for Leaflet E.E. 123

**BALDWIN INSTRUMENT CO. LTD., DARTFORD, KENT**

Telephone: Dartford 2989 & 2980

## TOROIDAL POTENTIOMETERS 10-1000 WATTS

Ceramic Insulation only—and approved for Tropical conditions. Complete Ceramic Rings for strength. Approved by all Government Departments. Reasonable Delivery.

Also precision Toroidal-wound Potentiometers (including 360° of winding with up to eight tapping points) and Helical wound Potentiometers of 3600° of winding. All are available with sealed spindles and glass or ceramic terminal seats.

Specialists in ALL TYPES OF TOROIDAL WINDINGS

**P. X. FOX LIMITED**  
HORSFORTH · YORKSHIRE · ENGLAND  
Telephone: Horsforth 2831  
Telegrams: Toroidal, Leeds

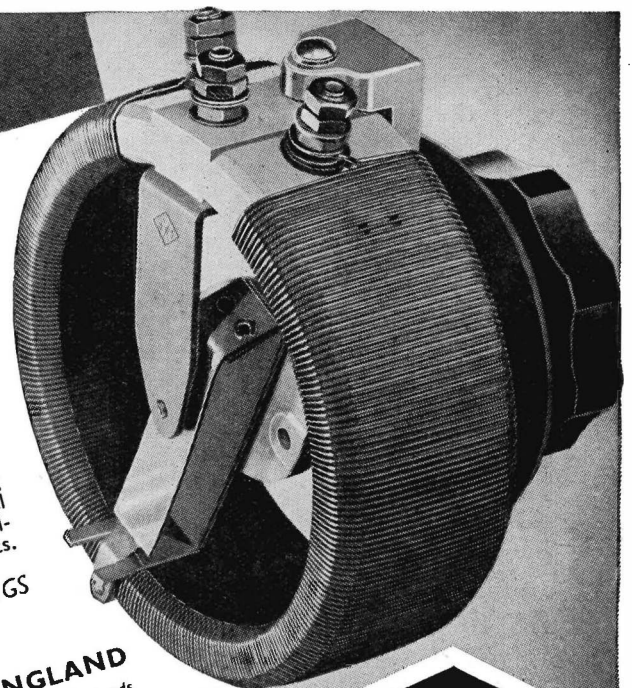

**P·X·F**

n.d.h.

Time Control of **PRODUCT FINISHING, PLASTIC MOULDING, HIGH FREQUENCY HEATING, COOKING EQUIPMENT, LAUNDRY WASHERS, DEGREASING PLANTS, and INSTRUMENT STERILIZATION.**

## VENNER PROCESS TIMERS

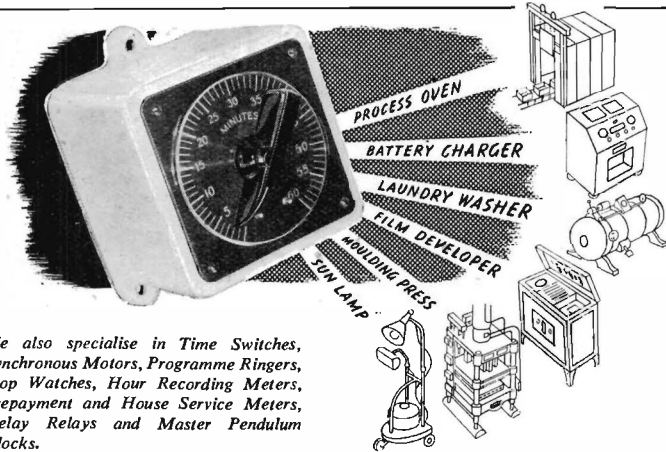

We also specialise in Time Switches, Synchronous Motors, Programme Ringers, Stop Watches, Hour Recording Meters, Prepayment and House Service Meters, Delay Relays and Master Pendulum Clocks.

WRITE FOR LEAFLET T.S.20/E.E.

Venner Process Timers are designed to switch electrical apparatus ON or OFF at pre-set periods. They may also be arranged to give visible and/or audible warning of the expiration of the time period. These instruments are available in spring or motor driven types, for surface or panel mounting, and can be supplied in a variety of time ranges.

*There is a VENNER time switch for every purpose!*

# VENNER Limited

Telephone ; MALden 2442 (6 lines)

KINGSTON BY-PASS · NEW MALDEN · SURREY

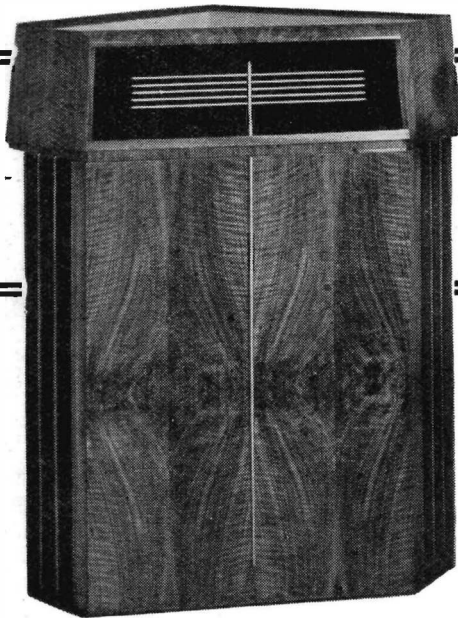

Let's forget the Loudspeaker and get on with the music

*W*HO wants to listen to a loudspeaker anyhow when there's Beethoven on the record? You can take the Klipschorn Reproducer for granted, almost ignore its presence in fact, and enjoy the music for a change. No need to sit open-mouthed, simulating admiration for the booms, tizzes, shrieks and tinkles customarily inseparable from "high fidelity" reproduction but never heard in the concert hall: this instrument sounds as close to the original as is possible today and will continue to set the standard for a long while so far as we can see. If you can afford £145 for a loudspeaker it's quite a good investment: you can spend a lot more money over a period of years and still not be satisfied.

## THE VITAVOX Klipschorn Reproducer

VITAVOX LIMITED · WESTMORLAND ROAD · LONDON · N.W.9.  
Tel. : COLindale 8671. Grams : Vitavox, Hyde, London.

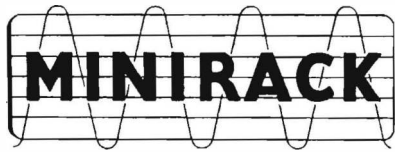

# OSCILLOGRAPHS

High quality Cathode-Ray  
Oscillograph recording instruments

- ★ Single and Multi-channel.
- ★ Trolley and Table Mounted.
- ★ Specialised F.M. and D.C. Amplifiers.
- ★ Pick-ups for pressure, force, vibration, acceleration and other quantities.



ME54 Five-channel Recorder

**S O U T H E R N I N S T R U M E N T S L I M I T E D**  
HAWLEY, CAMBERLEY, SURREY. Telephone: Camberley 1883/4. Telegraphic Address: "Minrak, Camberley, England."

## Looks like another job for Mumetal...

Fortunately there is always Mumetal to get designers out of tight corners — and corners are getting pretty tight these days! Mumetal is the Telcon nickel-iron alloy with exceptionally high permeability and extremely low loss and coercivity.

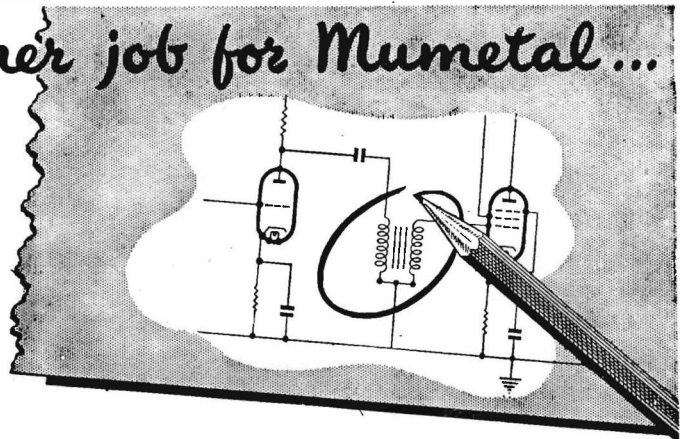

**SHIELDING.** Shields and screening boxes made from Mumetal sheet are many times more effective than any other shielding material of similar thickness. An infallible remedy for low frequency induction troubles in compact (amplifier) assemblies.

**MINIATURE COMPONENTS.** Really diminutive yet efficient transformers and inductors are now possible, thanks to cores made of Mumetal or in special circumstances its companions, Radiometal and Rhometal.

**ARMATURES.** Low coercivity and rapid magnetic response make Mumetal ideal for the armatures of relays, solenoids, moving-iron meters, gramophone pick-ups, etc.

**FORMS.** Mumetal is available in sheet, strip, rod or wire; we also produce standard shields to fit all C.R. tubes and transformers. It is ductile, can be stamped cleanly, drawn or rolled; non-scaling, does not rust.

Manufacturers are invited to write for Technical advice and details of design data.



Founded 1864

## TELCON METALS

THE TELEGRAPH CONSTRUCTION & MAINTENANCE CO. LTD.

Head Office: 22 Old Broad Street, London, E.C.2. Tel: LONDOn Wall 7104. Enquiries to: Telcon Works, Greenwich, S.E.10. Tel: GREEnwich 3291



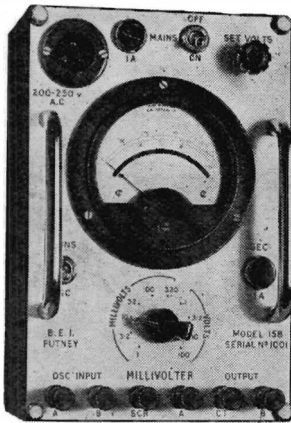

Descriptive Leaflet  
on request

## PEAK-TO-PEAK MILLIVOLTER

A versatile and accurately metered voltage source with a continuously variable output from 0.1 mV to 100 V, providing the Peak-to-Peak readings required in oscillograph and amplifier calibration work.

The low impedance output is balanced or unbalanced at will and the instrument includes a patented circuit which responds to the Peak-to-Peak value of a signal regardless of waveform within wide limits.

The output is either at mains frequency or if an output frequency between 30 c/s and 15 kc/s is required, an oscillator input may be applied.

OTHER PRODUCTS INCLUDE SQUARE WAVE GENERATORS ●  
R.C. OSCILLATORS ● MEGOHM METERS ● STABILIZED  
POWER SUPPLY UNITS ● INDUSTRIAL TIMERS AND CONTROL  
EQUIPMENT

FULL DETAILS ON REQUEST

# ALLIED ELECTRONICS LTD.

28 UPPER RICHMOND ROAD, PUTNEY, LONDON, S.W.15

Telegrams : Altron Put London

Telephone : Vandyke 1856

SULLIVAN-GRIFFITHS  
PORTABLE UNIVERSAL AC-DC BRIDGE TESTER  
FOR DIRECT READING MEASUREMENTS OF  
RESISTANCE, INDUCTANCE, CAPACITANCE AND CONDUCTANCE

RANGES  
RESISTANCE  
A.C. & D.C.  
0.3 ohms to  
3 megohms  
CONDUCTANCE  
0.3 micromhos  
to 3 mhos  
ACCURACY  
1 per cent

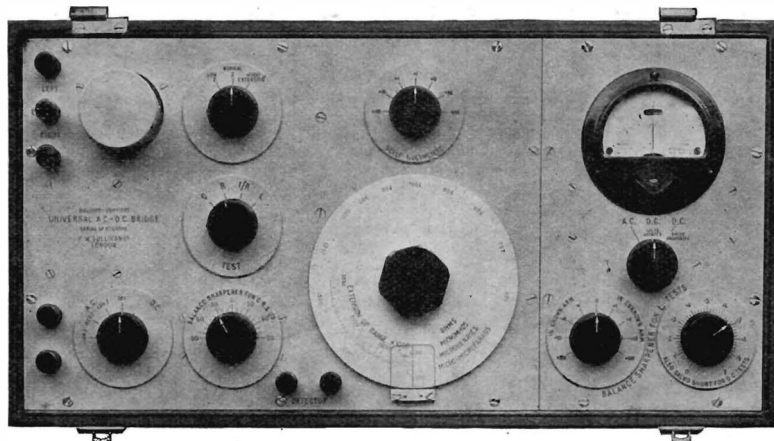

RANGES  
CAPACITANCE  
30  $\mu$ F to 30  $\mu$ F  
INDUCTANCE  
30  $\mu$ H to 30 H  
ACCURACY  
1 per cent

H. W. SULLIVAN  
LIMITED

LONDON, S.E. 15

Telephone ; New Cross 3225 (P.B.X.)

List No. AC900—Universa lAC-DC Bridge Tester (with self-contained source).

List No. AC901—Simple model for AC measurement capacitance, resistance and conductance only (also with self-contained source).

# An infinite capacity . . .

Third of a series telling the story of  
*Goodmans Loudspeakers*

"An infinite capacity for taking pains" aptly summarises the closely controlled techniques employed in the production of Goodmans speakers. Here, in the cone moulding department, the cones, on which the speaker performance ultimately depends, receive their final precision "moulding" and inspection. Moulding is just one method of treatment employed. The cones are given a special pressure treatment. They may then be resin treated, accurately trimmed to size and inspected.

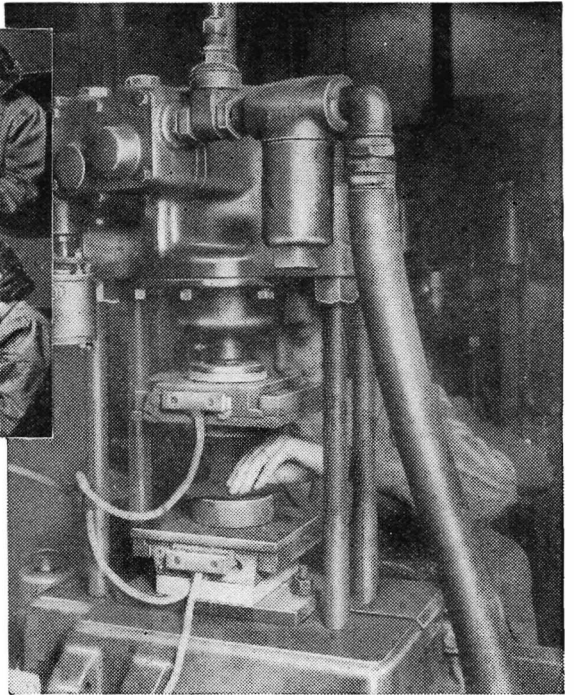

(Above) Operating a moulding press (Inset above) The fundamental resonance of the cone is determined by clamping the diaphragm at its periphery and driving it by another loudspeaker. This loudspeaker is fed from a variable frequency oscillator and air-coupled to the diaphragm under test. At the fundamental resonance, a noticeable increase in amplitude of the driver diaphragm is observed. (Inset below) A final visual check for consistency.

**AXIOM 150**  
Mk. 11  
12 in.  
**HIGH FIDELITY**  
Loud-speaker

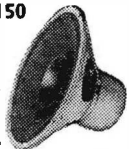

This is the latest model in the Goodmans High Fidelity range. Bass resonance 35 c.p.s. Write for details.

Each of the processes has a profound effect on the acoustic properties of the finished speaker; and all available scientific resources are employed to ensure a rigorous control.



## GOODMANS

GOODMANS INDUSTRIES LIMITED, AXIOM WORKS, WEMBLEY, MIDDX. Telephone: WEMbley 1200

# Vortexion

## TYPE C.P.20A AMPLIFIER

For AC Mains and 12 volt working giving 15 watts output, has switch change-over from AC to DC and "Standby" positions. Consumes only 5½ amperes from 12 volt battery. Fitted with mu-metal shielded microphone transformer for 15 ohm microphone, provision for crystal or moving iron pick-up with tone control for bass and top. Outputs for 7.5 and 15 ohms. Complete in steel case with valves.

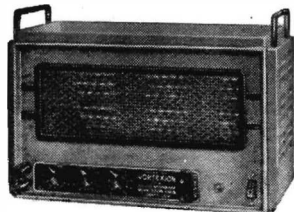
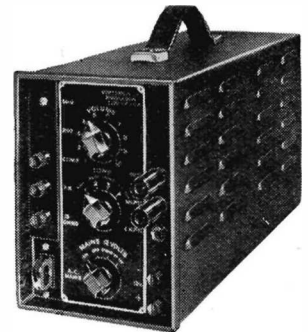

OTHER MODELS IN OUR RANGE OF AMPLIFIERS are "SUPER-FIFTY WATT," "THIRTY WATT" and "10-15 WATT RECORD REPRODUCER."

These are fitted in well ventilated steel cases with recessed controls as illustrated.

EXPORT ENQUIRIES INVITED

## VORTEXION LIMITED

257-261 THE BROADWAY, WIMBLEDON, LONDON, S.W.19

Telephone: LIB 2814 and 6242-3

Telegrams: "Vortexion Wimble, London."

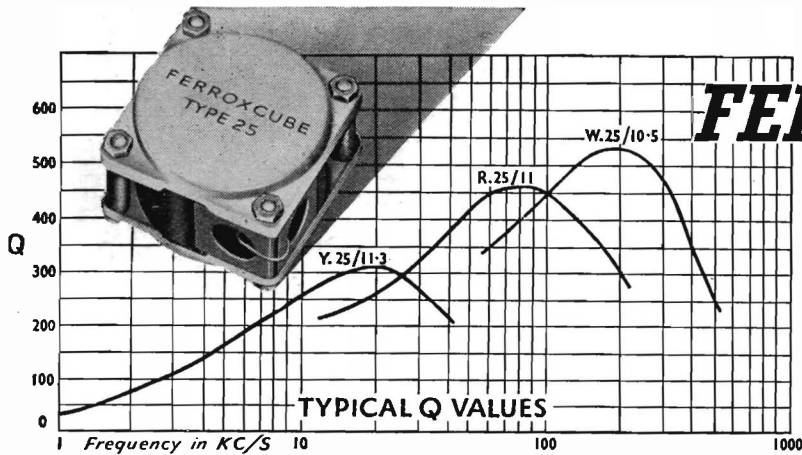

# FERROXCUBE

FERROMAGNETIC FERRITE

For Line

## Communications :

IN THE design of Mullard pot core assemblies types 25 and 36 full advantage is taken of the characteristics of Ferroxcube to produce inductances of remarkably high "Q" factors. This, combined with ease of winding, makes these cores very suitable for use in filter networks and wherever high quality inductances are required.

Fine adjustment of inductance is obtained by control of the air gap rather than by variation of the turns.

The good screening properties of the Ferroxcube and the convenient shape of the assemblies, which allows stacking or individual mounting, are other features which distinguish these Mullard cores.

### OUTSTANDING FEATURES

- ★ Low hysteresis coefficient
- ★ High values of inductance
- ★ Low self capacitance
- ★ Controllable air gap facilitating inductance adjustment
- ★ Self screening
- ★ Controlled temperature coefficient
- ★ Operation over a wide frequency range
- ★ Ease of winding and tapping
- ★ Easily mounted

PLEASE WRITE FOR FULL DETAILS



# Mullard FERROXCUBE

FERROMAGNETIC FERRITE

MULLARD LIMITED · CENTURY HOUSE · SHAFTESBURY AVENUE · LONDON · W.C.2

(MP372)

## Murex

# ZIRCONIUM

as applied to

## THERMIONIC

## VALVE

## MANUFACTURE

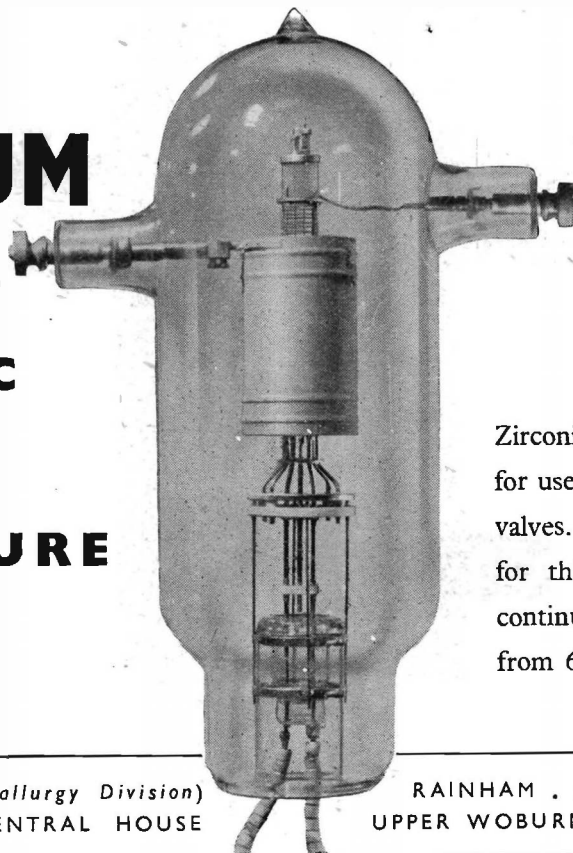

Zirconium sheet is now available for use as a getter in thermionic valves. It is particularly suitable for this purpose since it has continuous gettering properties from 600°C.

MUREX LTD. (Powder Metallurgy Division)  
LONDON SALES OFFICE: CENTRAL HOUSE

RAINHAM . ESSEX . Rainham, Essex 240  
UPPER WOBURN PL. W.C.1 . Euston 8265

## HIGH SENSITIVE BUZZERS

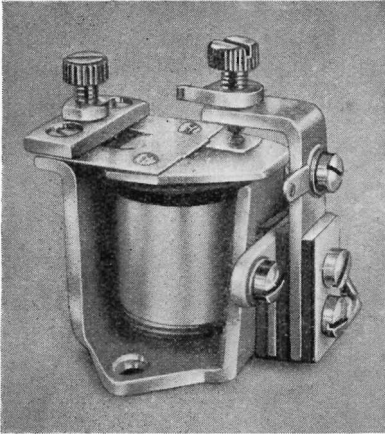

Wound from 4.5 to 60 volts

Solid Construction

Quality Materials

Fine-Silver Contacts

Easily Adjustable

Compact in Size

FOR TELECOMMUNICATION WORK  
STANDARD FINISH OR TROPICALISED

Enquiries Invited for :

CHOKES, POLARISED BELLS, INDUCTION COILS.

### AUTOPHONE LTD.

539/547 WANDSWORTH ROAD,  
LONDON, S.W.8. *MACaulay 2381/2.*

*They're worth waiting for...*

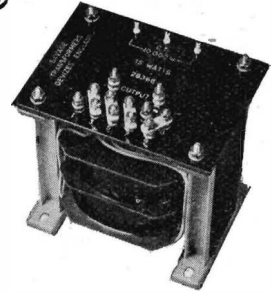

A lot more people than ever before have been ordering a lot more Savage Transformers than ever before. This and the shortages of raw materials are extending deliveries more than somewhat. As one of our Welsh Customers said however, "Savage Transformers are worth waiting for".



SAVAGE TRANSFORMERS LTD.  
Nurseed Road, Devizes, Wilts. Telephone : Devizes 536.

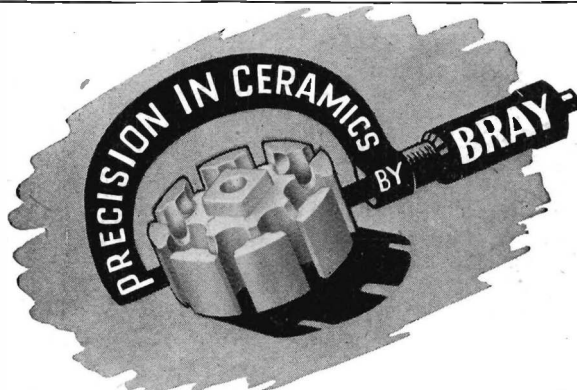

Quantity production of small automatically made pieces in Steatite, Porcelain, and Rutile materials for electric cooking and heating equipment, and telecommunication apparatus.

# BRAY



GEO. BRAY & CO. LTD., Leicester Place, Leeds 2.  
Tel.: 20981/8. Grams: "Bray, Leeds 2"

## Electrolytic Iron Powder

'SINTREX' BRAND

Its exceptional purity makes it especially suitable for electrical and magnetic applications. Supplied in a wide range of mesh gradings.



## GEORGE COHEN SONS & CO. LTD

BROADWAY CHAMBERS  
TELEPHONE



LONDON - - - W.6  
RIVERSIDE 4141

EE/517/1P20

# Copper, Brass, Bronze, Aluminium, Light Alloys

3,000 Standard Stock Sizes of  
ROD, BAR, STRIP, SHEET,  
TUBE, CHANNEL, ANGLE,  
TEE, WIRE

... No Quantity too Small

## H. ROLLET & Co. Ltd.

6 Chesham Place, LONDON, S.W.1

Telephone: SLOane 3463

Works: 36 Rosebery Avenue, London, E.C.1

BRANCHES:  
LIVERPOOL

KIRKBY TRADING ESTATE, EAST LANCASHIRE ROAD,  
Simonswood 3271.

MANCHESTER  
55 MARKET STREET. Blackfriars 2854

# WILLIAM H. SMALL LTD.

Phone: Victoria 0223. 2003  
Grams: Small, Victoria 0223. 2003  
Birmingham

WRIGHT STREET  
SMALL HEATH  
BIRMINGHAM.10



**WASHERS** in all materials  
**PRESSED NUTS** Brass & Steel  
**PRESSINGS** in all Metals,  
Bakelite & Fibre.

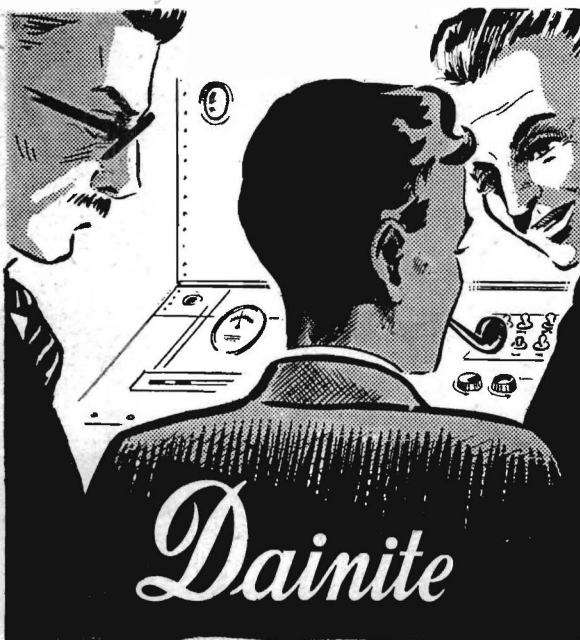

TECHNICAL SERVICE IN

## MOULDED RUBBERS

Your problems in Moulded Rubbers will not be problems to our experienced technical staff. We welcome the opportunity to help and advise you.

THE HARBORO' RUBBER CO., LTD.,  
Market Harborough (Tel.: 2274-5)

## SOLONS FOR ESSENTIAL JOBS!



Use SOLONS for the jobs that matter —this modern precision tool makes soldering speedier, simpler and more reliable. 5 models: 65 watt with oval tapered and round pencil bit; 125 watt with oval tapered and round pencil bit; 240 watt with oval tapered bit; each with 6 feet 3-core Henley flexible. Voltage ranges from 100 to 250. Write for folder Y.10

W. T. HENLEY'S TELEGRAPH  
WORKS CO. LTD.  
51-53 Hatton Garden,  
London, E.C.1.

**HENLEY**  
**SOLON**  
ELECTRIC  
FOR INDUSTRIAL USE



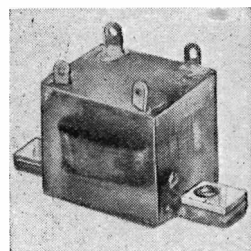
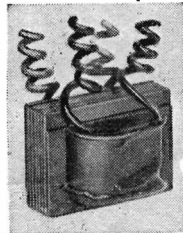
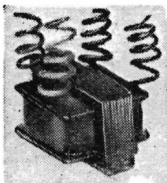

A wide range of  
**BELCLERE**  
 MINIATURE  
 TRANSFORMERS  
 now available

For input, output  
 and intervalve  
 coupling . . .

These very small, high efficiency transformers are now made in a wide range of models and ratios; actual sizes being approximately as shown here. They are available in tubular shrouded form for chassis mounting, encapsulated in synthetic resin or unenclosed without terminal panel or clamp. Enquiries for small or large quantities invited.

**JOHN BELL & CROYDEN**  
 117 HIGH STREET, OXFORD Phone: 48362

## SENSITIVE PANEL MOUNTING METERS

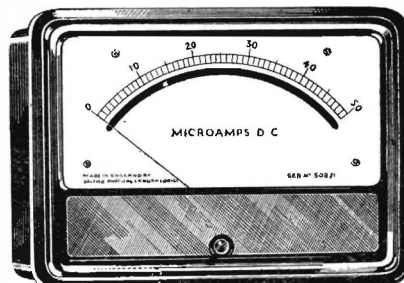

SIZE	2½"	3½"	5"
RANGE	25μA to 50A	10μA to 50A	10μA to 50A

(Prices on application)

S.50 types microammeters are stocked by M.R. Supplies Ltd. at New Oxford Street, W.C.1

All sizes available with MIRROR SCALE  
 1st Grade Accuracy.

**BRITISH PHYSICAL LABORATORIES**  
 HOUSEBOAT WORKS, RADLETT · HERTS  
 Telephone: RADLETT 5674-5-6

*Only with* **CO-AX**  
*P.F.* **CABLES**  
 AIR-SPACED ARTICULATED  
**4mm/ft**  
 Patents.  
 Regd. Trade Mark.

**THE LOWEST EVER  
 CAPACITANCE OR  
 ATTENUATION**

**IMMEDIATE  
 DELIVERIES**

SPECIALISTS IN AIR-SPACED  
 ARTICULATED CABLES SINCE 1929

**TRANSRADIO LTD.**  
 CONTRACTORS TO H.M. GOVERNMENT  
 138A CROMWELL ROAD, LONDON SW7  
 ENGLAND

LOW WATTEN TYPES.	IMPED. OHMS	ATTEN. db/100ft. at 100 Mc/s.	LOADING db/100ft. at 100 Mc/s.	Q.D.*
A 1	74	1.7	0.4	0.36
A 2	74	1.3	0.24	0.44
A 34	73	0.6	1.5	0.88
LOW CAPAC. TYPES.	CAPAC. p.p.f.	IMPED. OHMS	ATTEN. db/100ft. at 100 Mc/s.	Q.D.*
C 1	7.3	150	2.5	0.36
PC 1	10.2	132	3.1	0.36
C 11	6.3	173	3.2	0.36
C 2	6.3	171	2.15	0.44
C 22	5.5	184	2.8	0.44
C 3	5.4	197	1.9	0.64
C 33	4.8	220	2.4	0.64
C 44	4.1	252	2.1	1.03

HIGH POWER FLEXIBLE

PROTOCELL CABLE

VERY LOW CAPACITANCE

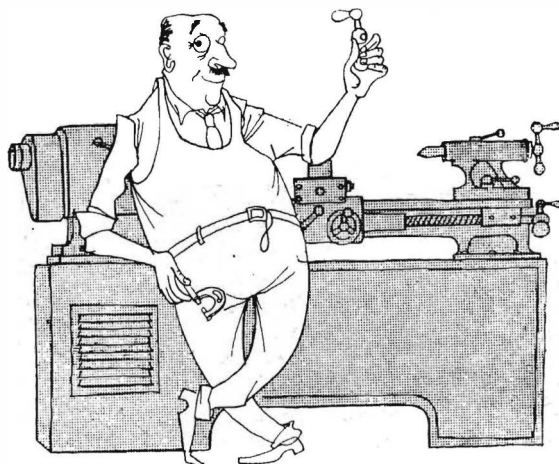

**YOU SEE THEM EVERYWHERE**

CASTLE REPETITION WORK contributes efficiency to every conceivable activity in industry. Moreover, we help many engineering firms to equip their own workshops, too. May we send you our Brochure?



**THE  
 CASTLE ENGINEERING  
 COMPANY (NOTTINGHAM) LIMITED**

HASLAM STREET · CASTLE BOULEVARD · NOTTINGHAM

L6136B

## DESIGN ENGINEERS!

Seamless one-piece  
METAL BELLOWS



- Combining the properties of:
1. A compression spring capable of repeated flexing.
  2. A container which can be hermetically sealed.
  3. A packless gland.

HYDRAULICALLY FORMED  
BY A PROCESS UNIQUE  
IN THIS COUNTRY

FOR Automatic coolant regulation. Movement for pressure change. Packless gland to seal spindle in high vacua. Reservoir to accept liquid expansion. Dashpot or delay device. Barometric measurement or control. Pressurised couplings where vibration or movement is present. Dust seal to prevent ingress of dirt. Pressure reducing valves. Hydraulic transmission. Distance thermostatic control. Low torque flexible coupling. Pressure sealed rocking movement. Pressurised rotating shaft seals. Aircraft pressurised cabin control. Refrigeration expansion valves. Thermostatic Steam Traps. Pressure amplifiers. Differential pressure measurements. Thermostatic operation of louvre or damper.

Write for List No. M.800-1

## Drayton METAL BELLOWS

Drayton Regulator and Instrument Co. Ltd., West Drayton, Middlesex

## DONOVAN ACCESSORIES for the ELECTRONIC APPARATUS MANUFACTURER

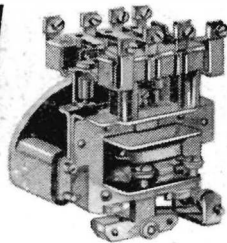

Type A.11 A.C. POWER RELAY—4-pole with N.O. or N.C. contacts.

### TYPE J.96 TERMINAL BLOCKS

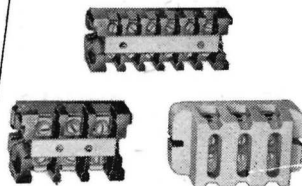

Made in 15, 30 and 60 amp. sizes.

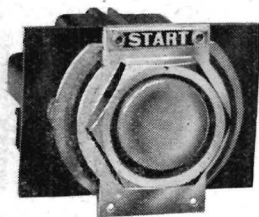

Type C.30 PUSH BUTTON UNIT arranged for mounting on customers' own cover plate.

**THE DONOVAN ELECTRICAL CO. LTD.**  
Safuse Works · Stechford · Birmingham, 9.

## "Cyldon" Precision Variable CAPACITORS

Miniature Trimmers, to High Voltage Transmitter Capacitors

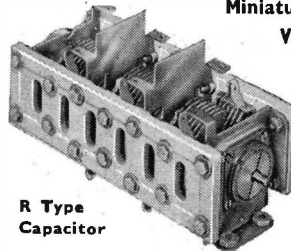

R Type Capacitor

For precision, stability, and long life, "Cyldon" superiority is recognised by all designers and users of electronic equipment.

A Tuning Condenser for use in V.H.F. Circuits. Well known in Service and Commercial Equipment. Stability, accuracy of matching and tracking, excellent power factor and efficient screening are "built" into this range, while the electro-plate finish of metallic components, meeting the requirements of RCS 1000, in no way detracts from the fundamental perfection achieved by carefully controlled production and assembly.

In the standard form the separate rotor assemblies are mounted on to a common spindle, giving efficient insulation of one section from another. Stator terminals only are provided to give the normally desirable series capacity characteristic, but these conditions, as well as the provision of R.H. or L.H. control, can be varied to suit designer's requirements. Air dielectric trimmers, giving a change of capacity of 6.5pF, can be fitted across the stator sections.

● Full details of the complete "Cyldon" range, and list of Overseas Agents available from the Manufacturers:

**SYDNEY S. BIRD & SONS, LTD.**

Contractors to Ministry of Supply, Post Office, and other H.M. Government Depts.

CAMBRIDGE ARTERIAL ROAD · ENFIELD · MIDDX. Enfield 2071-2

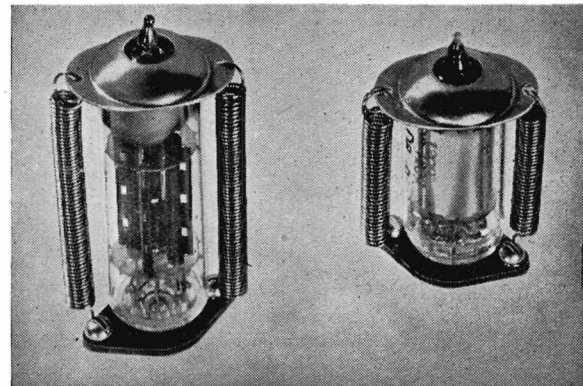

## VALVE RETAINERS

For B7G and B9A based valves. Also approved retainers for valves of all types and sizes.

**PLEASE REQUEST LEAFLET GIVING FULL INFORMATION**

**Electrothermal Engineering Ltd.**

270, NEVILLE ROAD, LONDON, E. 7.

## SOMETHING TO THINK ABOUT

Glass Tubing and Rod with Precision Outside Diameter, Phoenix, Pyrex, Hysil, Kodial, Quartz etc., or your own tubing.

WE WELCOME YOUR ENQUIRIES

**JENCONS (Scientific) LIMITED,**  
ROSEBANK WORKS, ACTON, W.3.  
ACORN 4628

## L. WILKINSON

Wholesale and Export

**19, LANSOWNE ROAD, CROYDON**

Phone: CRO 0839

Telegrams: "WILCO" CROYDON

Wheatstone Bridge. Accuracy 0.01%. Five decades of "Thousands" "Hundreds" "Tens" "Units" "Tenths" with rotary switch ratio arm adjustments, complete station with Galvanometer, Lamp Stand and Scale, Testing Keys, etc. Made by H. W. Sullivan Ltd.

RELAYS P.O. TYPE 3000  
SIEMENS HIGH SPEED  
RELAYS TELEGRAPH 4121C  
UNISELECTOR SWITCHES  
KEY SWITCHES  
PHONE PLUGS AND JACKS  
SELENIUM RECTIFIERS  
SLYDLOK FUSES

RESISTORS, WIREWOUND,  
POTENTIOMETERS, W.W.  
PYE SOCKETS 10H/3911 ETC.  
CONDENSERS  
SLOW MOTION DRIVES  
SANTON AND ARROW  
SWITCHES  
KLAXON MOTORS

LARGE STOCKS HELD AT COMPETITIVE PRICES

## "SPEARETTE"

PIN ALIGNING TOOLS.

VALVE EXTRACTING TOOLS.

WIRING JIGS.

RETAINING CLIPS.

SCREEN CAN EXTRACTING TOOLS

**SPEAR ENGINEERING CO. LTD.,**  
TITAN WORKS, WARLINGHAM, SURREY.

Telephone: Upper Warlingham 2774.

## TECHNICAL BOOKS

**H. K. LEWIS & Co. Ltd.,** invite inspection of their stock of books on all branches of Radio and Electrical Engineering. Catalogue on request.

**LENDING LIBRARY:** Technical and Scientific. Annual Subscription from TWENTY-FIVE SHILLINGS

Prospectus Post Free on Request.

**THE LIBRARY CATALOGUE** revised to December 1949, containing a classified Index of Authors and Subjects. To subscribers, 17s. 6d. net. To non-subscribers 35s. net. Postage 1s.

**LONDON: H. K. LEWIS & Co. Ltd., 136 Gower St., W.C.1**  
Telephone: EUSton 4282 (7 lines)

## a perfect reception

The MURAD 1 in. High Speed capstan lathe has had a first class reception from many leading manufacturers—amongst whom number such firms as E.M.I., Belling & Co., Ferguson Radio, Pilot Radio, Ultra Electric, E. K. Cole and Reyrolles. The outstanding accuracy and high speed of operation make this lathe ideal for the rapid and economic production of repetition screw parts.

# MURAD

CAPSTAN LATHE

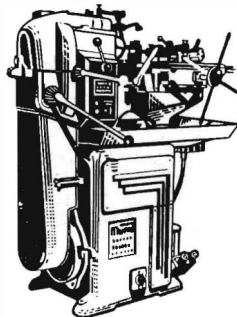

**MURAD DEVELOPMENTS LTD., STOCKLAKE, AYLESBURY, BUCKS.**

Phone: AYLESBURY 790 (4 lines) Cables: MURADITE AYLESBURY

## AMPLIFIERS

The How and Why of Good Amplification

by

**G. A. Briggs\* & H. H. Garner**

\* Author of LOUDSPEAKERS, SOUND REPRODUCTION and PIANOS, PIANISTS AND SONICS.

**15s. 6d. (16s. post free)**

18 Chapters, 216 pages, 174 illustrations (including more than 40 original oscillograms)

Fine art paper. Bound Full Rexine.

**Date of Publication:**

**28th April, 1952**

A few copies will be available at 21s. 0d. (21s. 9d. post free). Bound in red leather, embossed gold leaf, to match the Library Edition of Sound Reproduction.

The approach to the subject has followed the same lines as the previous books by G. A. Briggs, augmented by the wide technical experience of H. H. Garner.

published by

# Wharfedale

WIRELESS WORKS

Bradford Road, Idle, Bradford, Yorkshire.

\*Phone: Idle 461

\*Grams: Wharfedel, Idle, Bradford.

**THE LATEST in  
AIR DIELECTRIC TRIMMERS**

Encased in acetate container for extra protection

Width: 16.5 m/m. Length: 22 m/m. Height: 1.5 to 8pF—7.5 m/m. 1.5 to 20pF—10 m/m. 2 to 26pF—11 m/m. 2 to 32pF—12 m/m. Law: Straight line capacity. Power Factor: Less than .001. Insulation: over 2000 megohms. Voltage: 500 D.

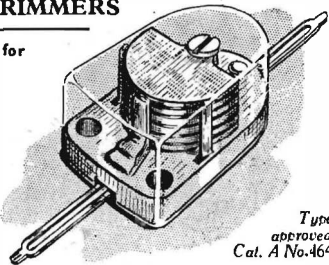

Type approved  
Cat. A No. 464

**OXLEY DEVELOPMENTS CO. LTD.**  
ULVERSTON, NORTH LANCs. TEL: ULVERSTON 3306

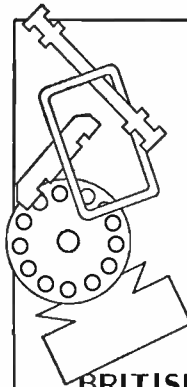

**MICA**

DISCS  
DIAPHRAGMS  
ELEMENT STRIPS  
CONDENSER PLATES  
SPECIAL SHAPES  
RAW MICA  
WASHERS  
etc

BRITISH MICA CO. LTD.—BEDFORD.



**RELAYS  
AND  
KEY SWITCHES**

LARGEST EX-GOVT. STOCK IN GT. BRITAIN

Types 600-3000 Relays — Siemens High Speed  
Also A.C. 250 volts 50 cycles

Uniselector Switches, Telephone Switchboards, Telephone Components,  
Plugs, Jacks, Handsets — Government Contractors.

**JACK DAVIS (RELAYS) LTD.** (Dept. E.E.)  
36 PERCY STREET, LONDON, W.1  
Phones: MUSeum 7960, LANGham 4821

WE SPECIALISE IN AUTOMATIC CONTROL,  
REMOTE INDICATING AND COMPUTING DEVICES

**OVER 20 MAGSLIP TYPES IN STOCK**

TRANSMITTERS — RECEIVERS  
FOLLOW THROUGH TRANSMITTERS  
SINE/COSINE RESOLVERS  
COINCIDENCE TRANSMITTERS  
HUNTERS — 3-PHASE MOTORS  
MOVING COIL HUNTERS

**SERVOTRONIC SALES**

INCORPORATING HOPTON RADIO  
1, HOPTON PARADE, HIGH ROAD, STREATHAM,  
LONDON, S.W.16

Telephone: Streatham 6165

SUPPLIERS TO UNIVERSITIES and RESEARCH LABORATORIES  
THROUGHOUT THE WORLD

**Third Edition  
Thermionic Valve  
Circuits**

By Emrys Williams, Ph.D., B.Eng., M.I.E.E., M.Brit.I.R.E. This well-known book has been comprehensively revised for the new edition, and includes a great deal of new material.

Illustrated—21s. net.

“A very good survey of all the main types of valve circuits, presented in such a way that the student may be in a position to understand, or even foresee, further developments.”—*Nature*

“Not only helps the student in grasping the theory, but provides the engineer with useful design data.”—*Electrical Review*.

**PITMAN**, Parker Street, Kingsway, London, W.C.2.



HIFI LTD., 150, HIGH STREET, LYE,  
STOURBRIDGE, WORCS. Telephone: LYE 261



**THE SERVICE ENGINEER'S  
FIRST CHOICE**

**WE TALK YOUR LANGUAGE  
when it comes to TRANSFORMERS**

- ★ designed for standard & special applications.
- ★ built for reliability.
- ★ engineered for trouble-free operation.



TRANSFORMERS BY **Amos of Exeter** A.I.D. APPROVED  
AMOS OF EXETER, RTS WORKS, COMICK STREET, EXETER.

## INDEX TO ADVERTISERS

A. B. Metal Products Ltd. . . . .	20	Electro-Alloys Ltd. . . . .	56	Nagard Ltd. . . . .	27
Air Control Installations Ltd. . . . .	18	Electronic Engineering Monographs	8 & 253	Norton & Gregory Ltd. . . . .	41
Airmec Laboratories Ltd. . . . .	17	Electrohermal Engineering Ltd. . . . .	53	Oxley Developments Ltd. . . . .	55
Allied Electronics Ltd. . . . .	47	English Electric Co., Ltd., The . . . . .	11	Painton & Co., Ltd. . . . .	Cover i
Amos of Exeter . . . . .	55	Fox Ltd., P.X. . . . .	44	Philips Electrical Ltd. . . . .	42
Automatic Coil Winder & Equipment Co., Ltd., The . . . . .	35	General Electric Co., Ltd., The . . . . .	9	Pieman & Sons, Ltd., Sir Isaac . . . . .	55
Automatic Telephone & Electric Co., Ltd. . . . .	38	Goodmans Industries Ltd. . . . .	48	Plessey Co., Ltd., The . . . . .	25
Autophone Ltd. . . . .	50	Harboro' Rubber Co., Ltd., The . . . . .	51	Radiospares Ltd. . . . .	55
Baldwin Instrument Co., Ltd. . . . .	44	Henley's Telegraph Works Co., Ltd., W. T. . . . .	51	Ragosine Oil Co., Ltd. . . . .	41
Bell & Croyden, John . . . . .	52	Hifi Ltd. . . . .	55	Rollet & Co., Ltd. . . . .	51
Belling & Lee Ltd. . . . .	24	Hunt Ltd., A. H. . . . .	33	Salford Electrical Instruments Ltd. . . . .	10
Bird & Sons Ltd., Sydney, S. . . . .	53	Imhof Ltd., Alfred . . . . .	8	Sankey & Son, Ltd., Joseph . . . . .	Cover ii
Bray & Co., Ltd., George . . . . .	50	Jencons (Scientific) Ltd. . . . .	54	Savage Transformers Ltd. . . . .	50
British Electric Resistance Co., Ltd. . . . .	22	Johnson Matthey & Co., Ltd. . . . .	3	Scott & Co., Ltd., A. C. . . . .	32
British Mica Co., Ltd. . . . .	55	Lewis & Co., Ltd., H. K. . . . .	54	Servotronic Sales . . . . .	55
British Physical Laboratories Ltd. . . . .	52	Linread Ltd. . . . .	5	Small Ltd., William H. . . . .	51
British Thomson-Houston Co., Ltd. . . . .	19	London Electric Wire Co. & Smiths Ltd. . . . .	43	Southern Instruments Ltd. . . . .	46
Bullers Ltd. . . . .	37	Lyons Ltd., Claude . . . . .	30	Spear Engineering Co., Ltd. . . . .	54
Burgess Products Co., Ltd. . . . .	13	Marconi Instruments Ltd. . . . .	21	Standard Telephones & Cables Ltd. . . . .	23 & 34
Castle Engineering Co. (Nottingham), Ltd. The . . . . .	52	Marconi's Wireless Telegraph Co., Ltd. . . . .	31	Steatite & Porcelain Products Ltd. . . . .	12
Chapman & Hall Ltd. . . . .	253	Measuring Instruments (Pullin) Ltd. . . . .	43	Sullivan Ltd., H. W. . . . .	47
Cohen, Sons & Co., Ltd., George . . . . .	50	Metropolitan-Vickers Electrical Co., Ltd. . . . .	16	Telegraph Condenser Co., Ltd., The . . . . .	Cover iii
Cole Ltd., E. K. . . . .	5	Mica & Micanite Supplies Ltd. . . . .	56	Telegraph Construction & Maintenance Co., Ltd., The . . . . .	46
Cossor Ltd., A. C. . . . .	36	Mond Nickel Co., Ltd. . . . .	39	Thomas (Richard) & Baldwins Ltd. . . . .	26
Davis (Relays) Ltd., Jack . . . . .	55	Muirhead & Co., Ltd. . . . .	14	Transradio Ltd. . . . .	52
Decca-Radar Ltd. . . . .	15	Mullard Electronic Products Ltd. . . . .	28 & 49	Tufnol Ltd. . . . .	7
Donovan Electrical Co., Ltd. . . . .	53	Mulicore Solders Ltd. . . . .	Cover iv	Venner Ltd. . . . .	45
Drayton Regulator & Instrument Co., Ltd. . . . .	53	Murad Developments Ltd. . . . .	54	Vitavox Ltd. . . . .	45
Du Bois Co., Ltd., The . . . . .	32	Murex Ltd. . . . .	49	Vortexion Ltd. . . . .	48
Eddystone Radio . . . . .	40			Webb's Radio . . . . .	40
Edison Swan Electric Co., Ltd., The . . . . .	29			Wharfedale Wireless Works Ltd. . . . .	54
Edwards & Co. (London) Ltd., W. . . . .	42			Wilkinson, L. . . . .	54

# LAMALAC

INSULATION

**SYNTHETIC RESIN LAMINATED MATERIALS**

Sheet, Rod and Tube in all dimensions, Bobbins & Coil Formers to any specification

**MICA AND MICANITE SHEET AND MANUFACTURED PARTS**

**MICA & MICANITE SUPPLIES LTD.**

BARNBURY SQUARE, LONDON, N.1.

Telephone: NORTH 3032/5    Telegrams: MICASULIM-LONDON

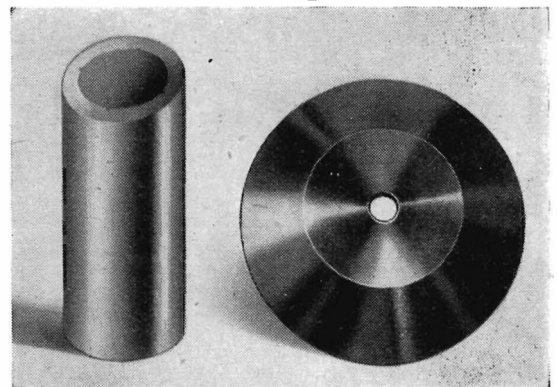

**X-RAY TARGETS WITH OR WITHOUT CAST-ON COPPER BODY. ROTATING ANODES.**

MOLYBDENUM TUBES AND OTHER MOLYBDENUM COMPONENTS.  
TUNGSTEN RODS AND THREE-PIECE LEAD WIRES FOR TUNGSTEN TO GLASS SEALS  
TUNGSTEN WELDING ELECTRODES FOR INERT GAS ARC WELDING  
TUNGSTEN CONTACT RIVETS AND SCREWS



**ELECTRO-ALLOYS Ltd.**  
12, BRUNEL RD., LONDON, W.3.

*Makers of TUNGSTEN and MOLYBDENUM Products*





**LEADERSHIP**

**from  
the  
inside**



*Quest and Test—symbols of  
Condenser Perfection*

**M**odern design of winding unit — machine and bench — gives high speed and accuracy and saves space, with unobstructed lighting for each operator.

This is but one of many "T.C.C. Firsts" designed to make production in millions possible. Many of the techniques and processes in modern condenser manufacture were originated within the T.C.C. organisation, and this quality of leadership is today acknowledged in every industry where condensers are used.

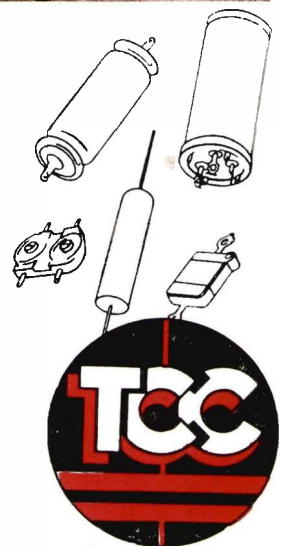

**SPECIALISTS IN CONDENSERS SINCE 1906**

THE TELEGRAPH CONDENSER CO. LTD • RADIO DIVISION • LONDON • W.3 • Tel: ACORN 0061 (9 lines)



# Why 50 overseas countries prefer British-made ERSIN MULTICORE SOLDER



*African Lamps Ltd.,  
Johannesburg, S.A.*

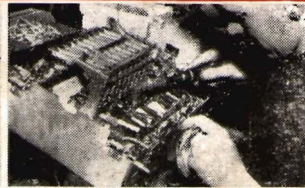

*Luxor Radio Factory,  
Motala, Sweden.*

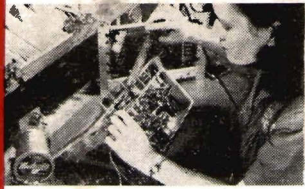

*Amalgamated Wireless Ltd.,  
Sydney, Australia.*



*Tandberg Radiofabrik,  
Oslo, Norway.*



*Canadian Admiral Corp.,  
Malton, Ontario.*



*Philips Radio Factory,  
Calcutta, India.*

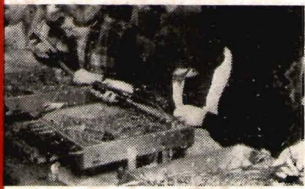

*DuMont Factory,  
Newark, U.S.A.*



*Philips Argentina S.A.,  
Saavedra, Buenos Aires.*

*We will be pleased to send to manufacturers, without charge, new technical literature and bulk prices. Service engineers and radio enthusiasts can obtain Size 1 cartons, at prices given below, from most radio and electrical shops.*

## SIZE 1 CARTONS 5/- RETAIL

Catalogue Ref. No.	Alloy Tin Lead	S.W.G.	Approximate length per carton
C 16014	60/40	14	13 feet
C 16018	60/40	18	37 feet
C 14013	40/60	13	13 feet
C 14016	40/60	16	26 feet

## MULTICORE SOLDERS LTD.

MULTICORE WORKS, MAYLANDS AVENUE, HEMEL HEMPSTEAD, HERTS • BOXMOOR 3636 (3 lines)

Despite freight charges and import duties, more and more radio, television and electronic component manufacturers overseas prefer to buy ERSIN MULTICORE, the British-made cored solder. Even in the U.S.A., where solders produced in that country can be obtained at a lower price, leading manufacturers continue to import ERSIN MULTICORE, because of the substantial economies which its use effects in material and labour costs.

The world-wide popularity of ERSIN MULTICORE is based on its proved reliability, its rapid and efficient fluxing action and its complete freedom from "dry" or H.R. joints.

Manufacturers know they can depend on ERSIN MULTICORE because the same unvarying and consistently high quality has been maintained for more than 13 years. Ersin, the flux contained in the cores, is a high grade rosin which has been specially activated, not only to prevent oxidation during soldering, but also to remove oxides from metal surfaces. With correct soldering technique every joint made with ERSIN MULTICORE is a perfect electrical connection which remains sound and free from corrosion during the life of the equipment.

