

Electronic Engineering

INCORPORATING ELECTRONICS, TELEVISION AND SHORT WAVE WORLD

PRINCIPAL CONTENTS

Toroidal Windings

Temperature Indicating Compounds (Colour Plate)

F.M. Transmitters for Police and Similar Services

A New Moving Coil Pick-up

A Television Signal Generator—Part 2

2¹/- JULY, 1946



PAPER *Capacitors*

THE STANDARD OF TECHNICAL EXCELLENCE QUALITY AND RELIABILITY

The Dubilier low inductance Tubular Paper Capacitors, with extended foil elements, cover the wide field of general commercial requirements; their construction providing inexpensively the highest degree of excellence.

The Metal-Cased Tubular Paper Capacitors, specifically designed and developed for stringent tropical conditions, satisfy the most exacting requirements. Neoprene sealed and impregnated for use at high operational temperatures they effectively meet exceptional demands.

The Metallised Paper Capacitors are extremely compact and efficient, setting a new standard in their own class.

Where miniature capacitors are necessary and where minimum size and weight are imperative together with electrical performance, and mechanical strength, the "Minicaps" are the most satisfactory selection.

The Metal-Cased "Minicaps" are Neoprene sealed and capable of withstanding the most severe conditions of tropical temperatures and humidity and fully justify inclusion in all designs.

MAKERS OF THE
WORLD'S FINEST CAPACITORS

DUBILIER

CONDENSER CO. (1925) LTD.

D4



THE COUNTERSIGN OF DEPENDABILITY IN ANY ELECTRONIC EQUIPMENT

NEW ELEMENTS IN THIS EIMAC TRIODE ADD MANY EXTRA HOURS PERFORMANCE

NEW NON-EMITTING GRID!

NEW LOW-TEMPERATURE PLATE!

NEW FILAMENT STRUCTURE!

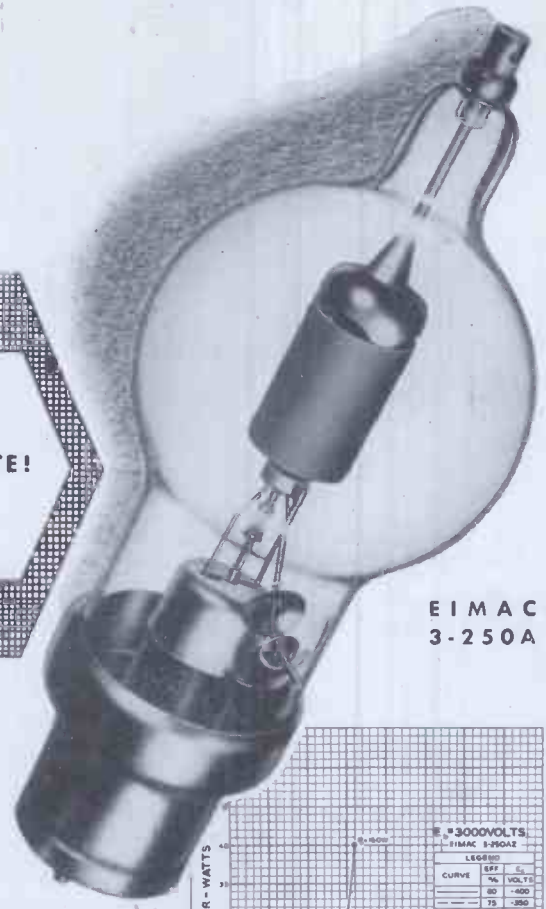

**EIMAC
3-250A**

Physically the new Eimac 3-250A triode is interchangeable with the old Eimac 250T. The new elements result in better performance and even longer life in a valve that has long been famous for its long life and stamina. This new valve is available in both low mu (3-250A2) and high mu (3-250A4) valve versions.

Its outstanding performance characteristics are exemplified by its low driving power requirements. . . . For example, in Class C telegraphy, with 3000 plate volts on a single valve, the Eimac 3-250A2 (low mu) will deliver 750 watts output with only 29 watts (approx.) of driving power. (See chart.)

You can depend upon Eimac year in and year out for leadership in vacuum valve developments. * That's one reason why Eimac valves are today, and have been for years, first choice of leading electronic engineers throughout the world.

*Ask your dealer to give you a copy of "Eimac Electronic Products" just off the press. Or write direct.

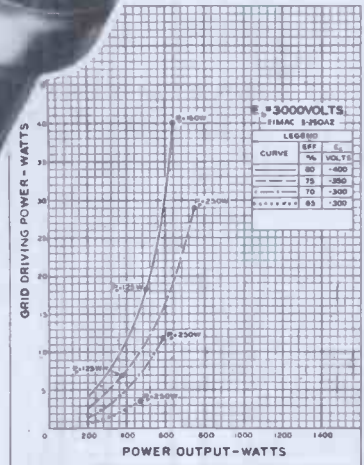

Follow the leaders to



EITEL-McCULLOUGH, INC., Dept. M 1211 San Mateo Ave., San Bruno, California.

Export Agents: Fraxar and Hansen, 301 Clay St., San Francisco 11, California, U.S.A.

ELECTRICAL CHARACTERISTICS		
Filament: Thoriated tungsten	3-250A2	3-250A4
Voltage	5.0 volts	5.0 volts
Current	10.5 amperes	10.5 amperes
Amplification Factor (Average)	14	37
Direct Interelectrode Capacitances (Average)		
Grid-Plate	3.1 uuf	2.9 uuf
Grid-Filament	3.7 uuf	5.0 uuf
Plate-Filament	0.7 uuf	0.7 uuf

Authorised Distributors: BERRY'S (SHORT-WAVE) LTD., 25, HIGH HOLBORN, LONDON, W.C.1.

TELEVISION AERIAL 'QUIZ' (No. 2)

Answers to some of the questions we are continually receiving by letter and telephone



Q.5. Does a Megger test at the receiver end of the feeder whilst it is connected at the dipole tell the whole story?

A. No; it should be remembered that the normal voltage induced in the aerial system is something less than 1 volt, whilst the Megger applies a P.D. of 500 V. or more and is therefore considered unsuitable.

Q.6. When may a Megger be used?

A. When the feeder is disconnected from the dipole, it can be used to check the insulation resistance of the feeder, but this will not indicate a variation of its characteristic impedance. This latter fault is only likely when the feeder has suffered some mechanical damage (e.g., kinks, sharp bends and bad cleating, etc.).

Q.7. How should the dipole be tested?

A. Only a visual examination is necessary in most cases and, of course, it means dismantling the aerial system.

Q.8. Is there any advantage in covering the terminals of a dipole?

A. Yes. Although water, ice or snow by themselves will not affect the picture, corrosion at this point would cause trouble through ultimate fracture of the leads. A sample Belling-Lee dipole ★ assembled to a short length of 336 feeder has been submitted to an accelerated life test (full K.110 tropical test, 1 dry cycle at 71° C. and 21 wet cycles at 61° C.). Very slight corrosion occurred on the zinc plated and passivated ferrous parts, the deposit mainly being zinc oxide with probably slight trace of zinc carbonate.

Upon removal of the flange and rubber teat encasing the connections, these (the connections) were found to be in excellent condition and practically unaffected by the test.

... TO BE CONTINUED

★ VIEWROD

PRICES

L.502/L.	Dipole, reflector and cross-arm, chimney lashings (less mast)	£5 5 0
L.502/C.	As 502/L, but no lashings	£3 12 6
L.501/L.	Dipole, long stand-off arm and chimney lashings ...	£2 16 6
L.501/T.	Dipole, long stand-off arm and wall fixing bracket	£2 3 6

BELLING & LEE LTD
CAMBRIDGE ARTERIAL ROAD, ENFIELD, MIDDX

GA



A standard of Zero Loss Angle

VARIABLE AIR CONDENSER TYPE D-14-A

BRIEF SPECIFICATION:
CAPACITANCE
50 μ F min. 1,250 μ F max.
LOSS ANGLE
Approximately 1 micro-radian in a dry atmosphere; 7 micro-radians in 75% relative humidity, for the frequency range 50 c/s to 10,000 c/s.
DRIVE
Worm reduction gear, 50:1 ratio.
SCALE READING
To 1 part in 5,000 direct reading; to 1 part in 20,000 by interpolation.
BACKLASH
Not exceeding 1 part in 20,000.
DIMENSIONS: 12.7" x 10" x 13.8".

This three-terminal double-screened condenser is provided with a guard circuit which ensures that the dielectric of the plate-to-plate capacitance is composed entirely of air. This, together with the special surface treatment of the plates reduces the plate-to-plate power loss to a quantity which can be disregarded even when measuring the smallest power factors.

Write for Bulletin B-537-A giving further particulars.

MUIRHEAD

MUIRHEAD & CO., LTD. ELMERS END, BECKENHAM, KENT.
Telephone: Beckenham 0041-0042
FOR OVER 60 YEARS DESIGNERS & MAKERS OF PRECISION INSTRUMENTS.

C.R.C. 45

MINIATURE or MIDGET

HIVAC LIMITED, Greenhill Crescent, Harrow on the Hill, Middx. Phone: HARROW 0895

JUST TO REMIND YOU—
"HYPERLOY"
 TRANSFORMERS & CHOKES

- WEIGH ONLY TWO OUNCES
- MEET THE MOST RIGID TROPICAL SPECIFICATION
- CAN EASILY BE MOUNTED IN ANY POSITION
- VARIED WINDINGS MEET MANY DIVERSE APPLICATIONS
- FULFIL THE MOST EXACTING REQUIREMENTS OF MODERN ELECTRONIC AND COMMUNICATIONS EQUIPMENT.

1023

WRIGHT & WEAIRE LTD
 HIGH ROAD • TOTTENHAM • LONDON • N17 Tel.: TOTtenham 3847/9
 VIBRATORS • TRANSFORMERS • SWITCHES • COILS

U.I.C.

Silvered Mica & Ceramic
CAPACITORS

A wide range of types for all purposes

UNITS INSULATOR CO. LTD.
 Oakcroft Rd., Tolworth, Surbiton, Surrey
 'Phone: Elmbridge 5241 'Grams Calanel, Surbiton

Unsurpassed In Ceramics

Plastics for many Purposes-
make good jobs **BETTER!**
Make the **BEST** with **TENAPLAS**

We make:—
RADIO SLEEVINGS
'TENAPLAX' TUBING FOR CONVEYING LIQUID FOOD EDIBLE OILS, ETC.
INSULATED WIRES & CABLES
SOLID SECTIONS & STRIPS
'TENATHERM' SELF-HEATING CABLE AND 'TENAPLAX' CO-AXIAL CABLE ETC.

TENAPLAS LTD

Write for details to
TENAPLAS LTD.
WORKS: UPPER BASILDON, NEAR PANGBOURNE, BERKS
Telephone No. Upper Basildon 228 & 269.

Constant Voltage



TRANSFORMERS
LINE VOLTAGE VARIATIONS OF $\pm 15\%$ REDUCED TO $\pm 1\%$
TYPICAL SPECIFICATION
Input Voltage ... 190-260 v. 50 c.p.s.
Output Voltage ... 230 v. $\pm 1\%$
Max. load ... 150 watts.
(Input power factor over 90 %
Prices on application. Write for details

ADVANCE COMPONENTS LTD.
BACK RD., SHERNHALL ST., WALTHAMSTOW, E17. PHONE LARKSWOOD 43665

OF course you don't have to take us too literally, but we assure our innumerable friends that we are pressing on with the production of all the well-known "Avo" Testing Instruments with a view to speeding up delivery dates as time goes on.

Meanwhile we have not neglected to use the advances perfected during the war years, and the several new instruments scheduled for early production will measure up to the traditional "Avo" standards of accuracy and reliability.

**Getting
Down
to
it!**

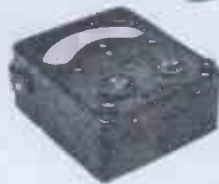

The 50-range Model 7 Universal AvoMeter is the leader of the world-famed range of "Avo" Electrical Measuring Instruments which are appreciated for their compact portability, dependability, and a steadfast accuracy which is often used as a standard by which other instruments are judged. Fully descriptive pamphlet available on application.

Frequency compensated

A.C. VOLTAGE STABILISATION

- ★ $\pm 1\%$ change in mains frequency reduced to $\pm 0.05\%$ in output voltage.
- ★ $\pm 1\%$ change in supply voltage will not change output by more than $\pm 0.04\%$.
- ★ Output voltage held within the extreme limits of $\pm 0.14\%$ for simultaneous variations of $\pm 6\%$ in voltage and $\pm 2\%$ in frequency.
- ★ Visually perfect waveform.
- ★ Made in sizes of 12, 24, 60, 120, 240 and 480 VA. Input 190/260 volts, 50 c/s. Output voltage any desired value.



“STABILISTOR” Type “B”

Please write for E.E.2 to :—
WESTINGHOUSE BRAKE & SIGNAL CO., LTD.,
82, York Way, King's Cross, London, N.I.

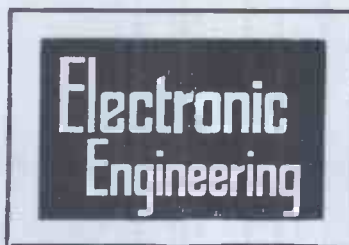

JULY, 1946

Volume XVIII.

No. 221.

CONTENTS

	PAGE
Editorial—Fair Play	197
The Technique of Toroidal Winding By F. E. Planer, Ph.D., M.Sc.	198
Advances in C.R. Tube Design	203
A Television Signal Generator—Part 2 By R. G. Hibberd, B.Sc., A.M.I.E.E.	204
Temperature Indicating Compounds By G. A. Williams	208
F.M. Transmitters for Police and Similar Services By E. P. Fairbairn, B.Sc.	213
Microphones—Part III (continued) By S. W. Amos, B.Sc., and F. C. Brooker, A.M.I.E.E.	221
A New Moving-Coil Pickup	224
Book Reviews	227
Notes from the Industry	228
Correspondence	228
New Development in Transformers	229
Abstracts of Electronic Literature	230
A New Component Testing Bridge	xii

S.E.M. 1/2 h.p. MOTOR

A STANDARD 1/2 h.p. single phase, capacitor motor that is ideal for all normal purposes has been designed and manufactured by S.E.M. engineers.

The motor, which is equipped with capacitor starting, is suitable for use on all the normal supply voltages. It is equipped with a simple and substantial centrifugal switch; has a high starting torque, and can be equipped with sleeve bearings in place of the standard ball-bearings, where specially quiet running is required. It is enclosed ventilated, speed 1425 r.p.m.

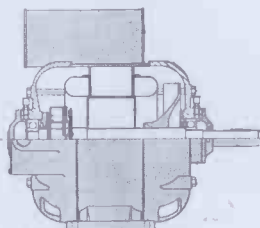

S.E.M. standard 1/2 h.p. single phase capacitor motor

In common with all S.E.M. machines, this motor is manufactured to the highest standards of mechanical detail and has passed rigid inspection tests.

SMALL ELECTRIC MOTORS LTD.

have specialized for over 30 years in making electrical machinery and switchgear up to 10 kW capacity. They are experts in the design and manufacture of ventilating fans and blowers, motors, generators, aircraft and motor generators, high-frequency alternators, switchgear, starters, and regulators.

A SUBSIDIARY OF BROADCAST RELAY SERVICE LTD.
BECKENHAM · KENT

CONDITIONS OF SALE.—This periodical is sold subject to the following conditions, namely, that it shall not, without the written consent of the publishers first given, be lent, re-sold, hired out or otherwise disposed of by way of Trade except at the full retail price of 2/- and that it shall not be lent, re-sold, hired out or otherwise disposed of in a mutilated condition or in any unauthorised cover by way of Trade, or affixed to or as part of any publication or advertising, literary or pictorial matter whatsoever.

MULLARD

VALVES



FOR DOMESTIC RECEIVERS

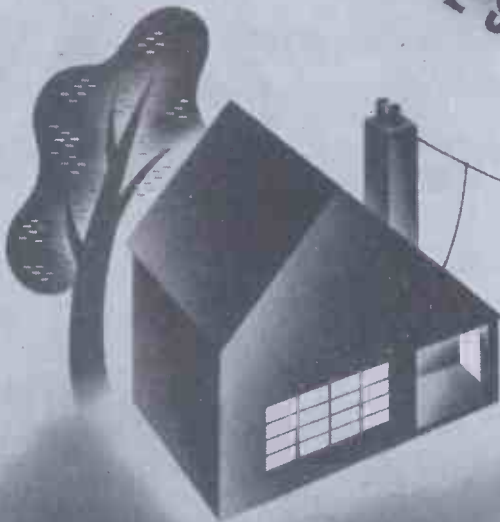

**Recommended Types for A.C./D.C.
Mains Operated Receiver.**

- CCH 35 Frequency changer.
- EF 39 Intermediate Frequency Amplifier.
- EBC 33 Detector L.F. Amplifier.
- CL 33 Output Pentode.
- CY 31 Rectifier.

*Other recommended types are available for A.C.,
battery and portable receivers.*

MULLARD *THE DOMINANT NAME IN ELECTRONICS*

PROPRIETORS

HULTON PRESS, LTD.

Electronic Engineering

MANAGING EDITOR:

G. PARR.

EDITORIAL, ADVERTISING AND PUBLISHING OFFICES, 43-44, SHOE LANE, LONDON, E.C.4

TELEPHONE
CENTRAL 7400

Monthly (published last day of preceding month) 2/- net. Subscription Rates :
Post Paid to any part of the World—
6 months, 13/-; 12 months, 26/-.
Registered for Transmission by
Canadian Magazine Post.

TELEGRAMS
HULTONPRES, LUD
LONDON.

Fair Play

TECHNICAL journals, fortunately, have nothing to do with politics. They are, however, concerned with accuracy and also with fair play, which is reputedly one of the attributes of the commercial life of this country.

Lately there have occurred two instances of irresponsible statements made in Parliament by people who should have learned a guiding principle in science—if you are not absolutely certain of your facts, don't say anything.

The first was a suggestion that the research organisation of Messrs. Cable & Wireless was behind the times or otherwise inefficient. This put the Company to a lot of trouble and expense to demonstrate to the Press that they did in fact have an efficient research organisation and that their work was of vital importance throughout the war.

Secondly, a disparaging statement was made in May last about the manufacturers of deaf-aids, who, it was suggested, were engaged in a "ramp" to exploit the public. This has led to the issue of a statement by Messrs. Allen & Hanbury, who are members of the Hearing Aid Manufacturers' Association:—

"The Hearing Aid Manufacturers' Association is justifiably annoyed at the Minister of Health's all-embracing use of the term 'exploitation' of the deaf, as if all

manufacturers of hearing aids pursued the commercial practices which call for censure in the case of one or two firms.

"All reputable manufacturers and distributors in this field conform to an ethical code which has the approval of the National Institute for the Deaf, who issue a list of approved firms for the guidance of the deaf public.

"The Duke of Montrose is the President of this excellent body which co-operated with the Hearing Aid Manufacturers' Association in 1943 to produce a specification for a Standard Hearing Aid.

"This would have sold at ten guineas, assuming the release of sufficient controlled materials to manufacture 10,000 appliances.

Index to Vol. XVII

A full cross-referenced Index for Volume XVII of *Electronic Engineering* is now available, price 6d. post free.

Applications should be addressed to the Circulation Department, Hulton Press, 43, Shoe Lane, E.C.4, and be accompanied by a P.O. or stamps to the value of 6d.

IMPORTANT

Subscribers who have their copies of the Journal sent direct from the Circulation Department need not apply separately for the Index, which will be sent in due course.

"Had it not been for war-time shortages, this scheme would have been put into effect and the hearing aid manufacturers would have done a considerable public service. Their plan was held in abeyance due to lack of Government support, and they are now subjected to undeserved criticism.

"It remains to be seen whether the Ministry can relieve the plight of thousands of deaf people in this country by producing even more effective hearing aids in greater quantity and at a lower price."

Whatever the rights or wrongs of any argument, a statement or innuendo made in the House of Commons is always invested with a weight which is out of all proportion to the standing of the individual who utters it. Several million people read it the following day, and by the time the unfortunate victim has seen it and prepared his counter-statement public interest has moved on, and the reply loses its effectiveness.

It is for this reason that publicity has been given to the cases quoted, and technical men, at any rate, will appreciate that there are two sides to the argument. In most cases they are better trained to cool judgment than some of the Ministers who represent them, and will have no difficulty in holding the balance between statements of fact and those which savour of mud-slinging.

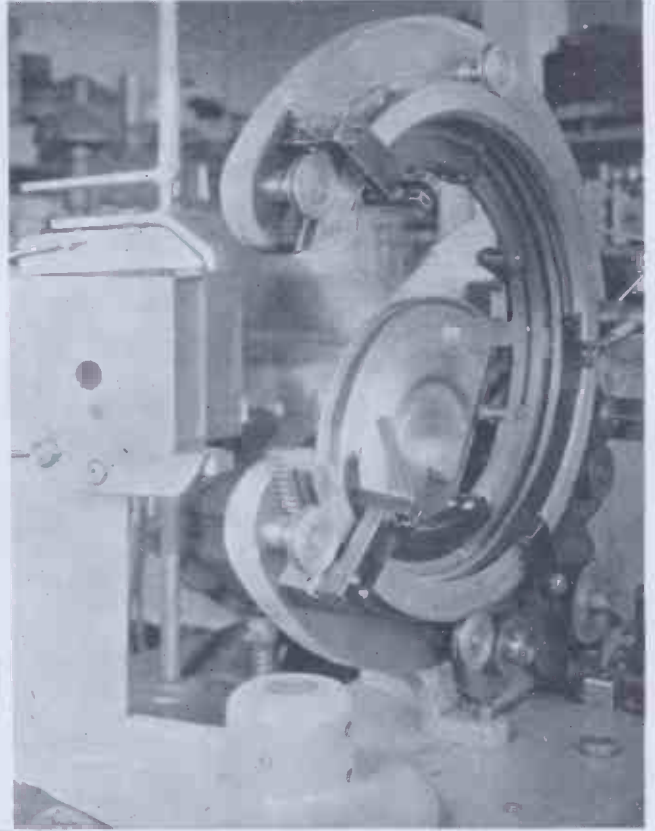
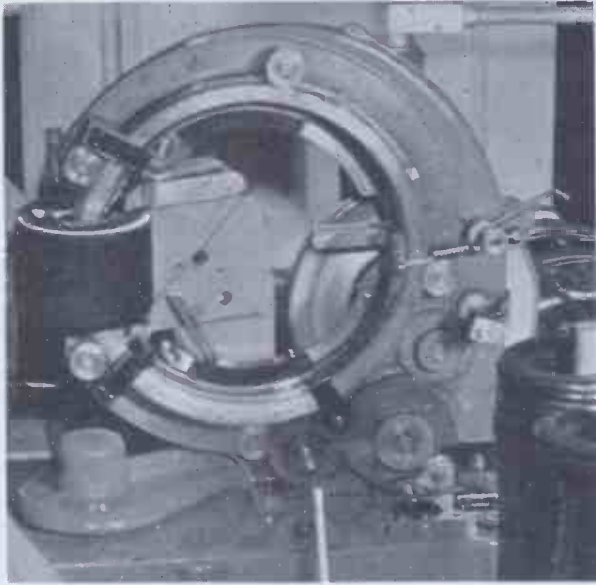

Representative Toroidal Winding Machines

Fig. 12 (below). Toroidal coil winding machine with automatic traverse. Winding speed 200 r.p.m.

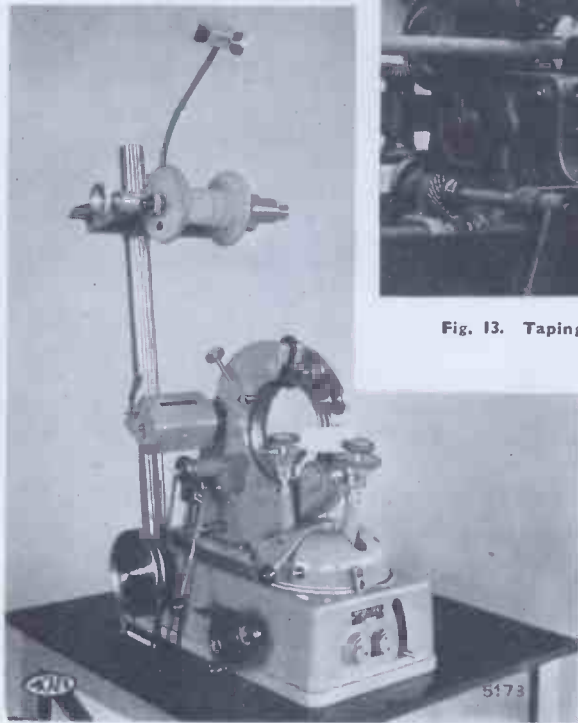

Fig. 13. Taping machine.

Fig. 9 (top left) and Fig. 10 (above). Machines for the winding of "Variac" transformers.

By courtesy of General Radio Company.

Fig. 11 (below). Toroidal winding machine.



By courtesy of Micafil Ltd., Zuerich-Altstetten.

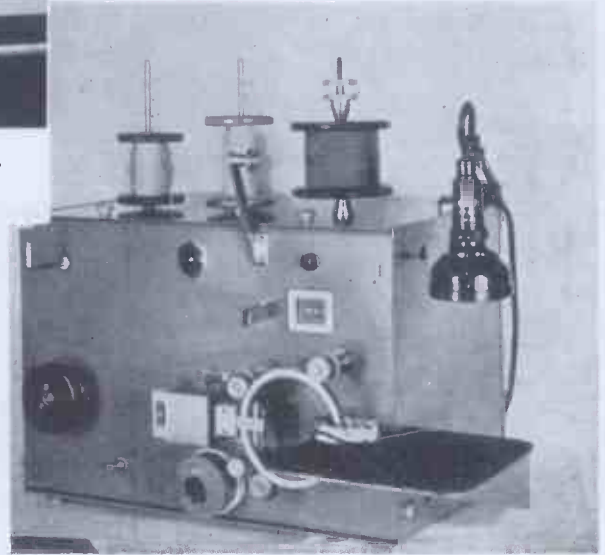

The Technique of Toroidal Winding

By F. E. Planer, Ph.D., M.Sc.

THE field of application of toroidal coils and transformers in Communications equipment is rapidly growing, and uses of toroidal windings in electrical circuits now extend over frequencies from zero to v.h.f.

While these notes will be concerned mainly with the technique of winding and the principles underlying toroidal winding machinery, a few comments regarding some of the uses and characteristics of toroidal windings may be of interest here.

Applications of Toroidal Windings

One of the most important characteristics of toroidal coils for use with alternating currents is their high permeability. The fact that the magnetic circuit is completely closed and does not in general contain any air gaps, allows an "effective permeability" to be attained which closely approaches the "toroidal" or specific permeability of the core material. The effective permeability is defined as the ratio of the inductance of a coil with its core in position to that without the core.

The high permeability of the toroidal core leads to a reduction in the number of turns required for a given inductance and hence to a decrease in copper losses and an increase in the Q-value of the coil. These properties make toroidal coils particularly suitable for applications in oscillatory circuits and frequency selective networks. Fig. 1 shows a simple iron-dust-cored toroidal choke, as used, for instance, in audio-frequency filter networks. The Q-values of this coil lie between 150 and 200.

Another feature of toroidal dust cores is that owing to their simple geometrical form higher moulding pressures may be employed than are used, for instance, with iron-clad types of cores. Consequently, a high iron content can be attained, resulting in a further increase in permeability, and values as high as 150 are achieved in commercial dust cores.

Another outstanding characteristic of this type of core is its very small stray inductive field. A toroidal power transformer is thus particularly suitable for use in compact assemblies where a danger of hum pick-up may exist. When used, for instance, in

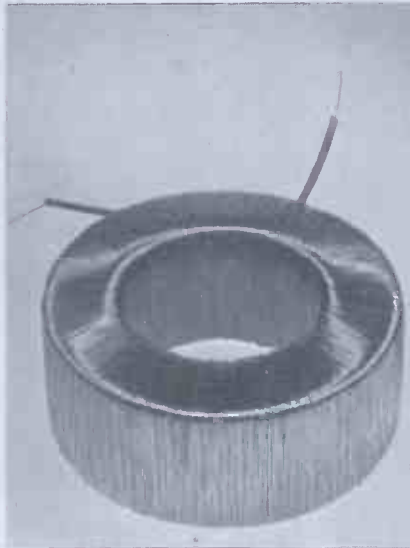
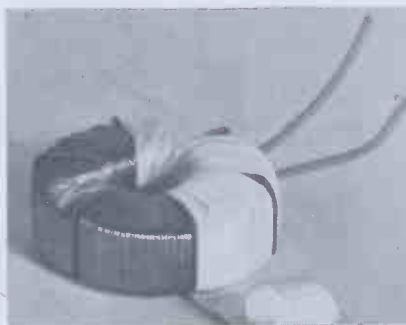

Fig. 1. Toroidal Inductance.

audio-frequency amplifiers it becomes permissible to locate intervalve transformers, etc., close to it without appreciable mains frequency currents being induced in the speech transformers.¹ The cores of transformers of this type consist of strips of magnetic material wound in the manner of a clock spring, or alternatively built up of stacks of thin, annular laminations.

A spiral core of thin nickel iron alloy is used in the input transformer shown in Fig. 2. This coil is designed for operation at carrier telephony frequencies, and comprises sectionalised windings spaced away from the core, in order to reduce its self

Fig. 2.



capacitance and the electrostatic coupling between windings.

The completely closed magnetic circuit and low leakage inductance of toroidal coils afford the possibility of mounting them in closely fitting metal cases without adversely affecting losses and Q-values. Also, the mutual inductance between adjacent coils when no screening is provided will be low for the same reason. This makes toroidal coils, which are already relatively small, particularly suitable for use in filter networks comprising several inductances, such as carrier telephony filter networks, scratch filters, etc.

An illustration of one of the toroidal transformers used in a new R.F. admittance bridge which operates between frequencies of 100 kc/s. and 100 Mc/s. is shown in Fig. 3. The inner winding of this transformer is surrounded by an electrostatic copper screen having an annular gap around its inside face.

Owing to the convenient physical distribution of conductors on toroidal cores, this type of winding arrangement lends itself to the construction of variable components. A well known example is the "Variac," a variable-ratio auto-transformer for use at mains supply frequencies.² Another example is the application of toroidal windings to rheostats, and Fig. 4a is a reproduction of a variable resistor in which a single layer winding has been applied to a ceramic core. Fig. 4b shows a toroidal winding suitable for continuous rotation of the contact arm. The linear accuracy of winding is better than 0.1 per cent.

Toroidal Winders

The winding of toroidal coils is still to a large extent done by hand. It is apparent that manual winding is a very time-consuming process, resulting, moreover, in excessive wear of the insulation due to bending, twisting and abrasion of the wire. In the few instances where automatic winders are employed, these are either imported or more generally developed and constructed by coil manufacturers for their own use. Consequently, literature on toroidal winding machinery and technique is very scarce.



Fig. 3 (above). Screened Toroidal transformer.
By courtesy of Scientific Acoustics Ltd.

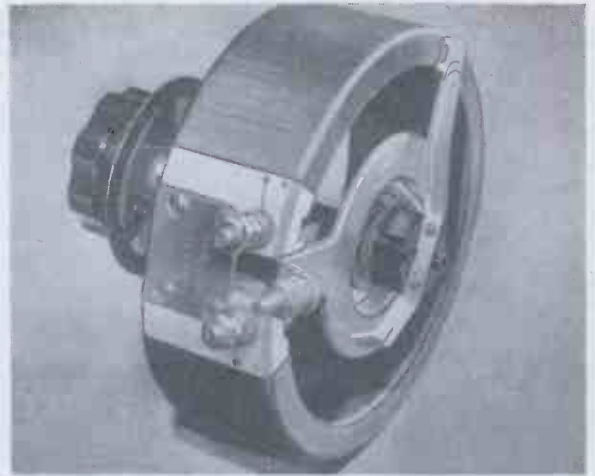

Fig. 4a (right). Toroidally wound rheostat.
By courtesy of The British Electrical Resistor Co., Ltd.

The principle of toroidal winding machines differs fundamentally from that of the ordinary bobbin winder, in that the wire reserve is stored on a magazine ring surrounding the toroidal core and interlinked with it. Fig. 5 shows schematically the arrangement of the magazine M and core C. P is a small pulley, pin or bridge mounted on a second ring parallel to the magazine ring and of similar diameter.

Removable segments in both rings allow the core to be placed in position. The segments are then replaced, and in order to load the magazine a mechanical connexion is generally made between both rings. With the pulley, or take-off ring motor-driven, sufficient wire is wound on to the magazine ring from an external bobbin to complete one winding.

The connexion between the two rings is then removed and the take-off ring driven in the reverse direction. With the beginning of the wire attached to the core, wire is thus being transferred over the pulley on to the core from the magazine ring with the latter idling.

One of the difficulties with this type of machine, particularly when winding at high speeds and with fine gauges of wire, is the non-uniformity of the tension on the wire and the periodic acceleration imparted to the magazine ring during the winding process.

It has been shown by the writer that with a uniformly driven take-off ring having an angular velocity of unity, the velocity of the magazine ring $d\psi/d\theta$, varies as $1 + \sin\gamma$, where γ is the angle which the stretched piece of wire PT makes with the radius OP, Fig. 6. This relation, the proof of which is given in the appendix, may be regarded as the fundamental expression governing the winding process. It is particularly convenient in permitting polar velocity diagrams to

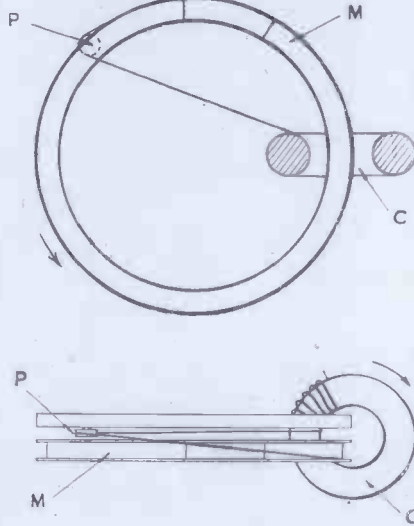

Fig. 5 (above).

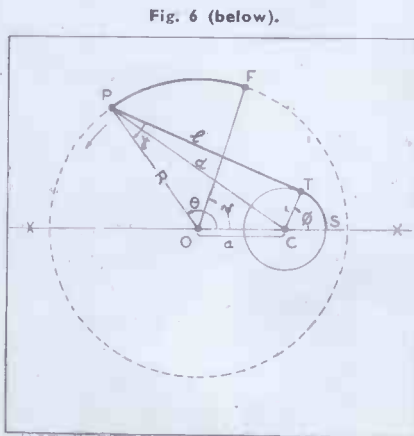

Fig. 6 (below).

be constructed graphically for any given winding arrangement as a function of the instantaneous angular position of the pulley; for the velocity of the magazine relative to that of the pulley ring, $\sin \gamma$, for any angular position of the pulley is numerically equal to the length of the intercept of a perpendicular drawn from the origin to the stretched wire or its extension, assuming the velocity diagram of the pulley to coincide with its path.

Fig. 7 is a reproduction of the polar diagram constructed in this manner for a ratio of core diameter to the diameter of the pulley path of 1:9.³ Curve a represents the path of the pulley as well as its angular velocity, b and c show the positive and negative velocities respectively of the magazine ring with respect to the pulley, and C shows the absolute velocity of the magazine ring.

From these diagrams it will be seen that not only does the velocity of the magazine ring vary appreciably over the cycle, but the change in velocity is confined to a relatively narrow region, so that owing to the high acceleration considerable strain is imposed upon the wire. These conditions determine the limiting factors in the design of toroidal winding machinery as regards winding speeds and gauges of wire.

A second derivation with respect to

$$\text{time of } \frac{d\psi}{d\theta} \text{ gives the acceleration of}$$

the magazine ring, and from this the critical angles, the minimum and maximum velocities and accelerations may be determined for any given geometrical configuration. It may be shown in this way that the maximum

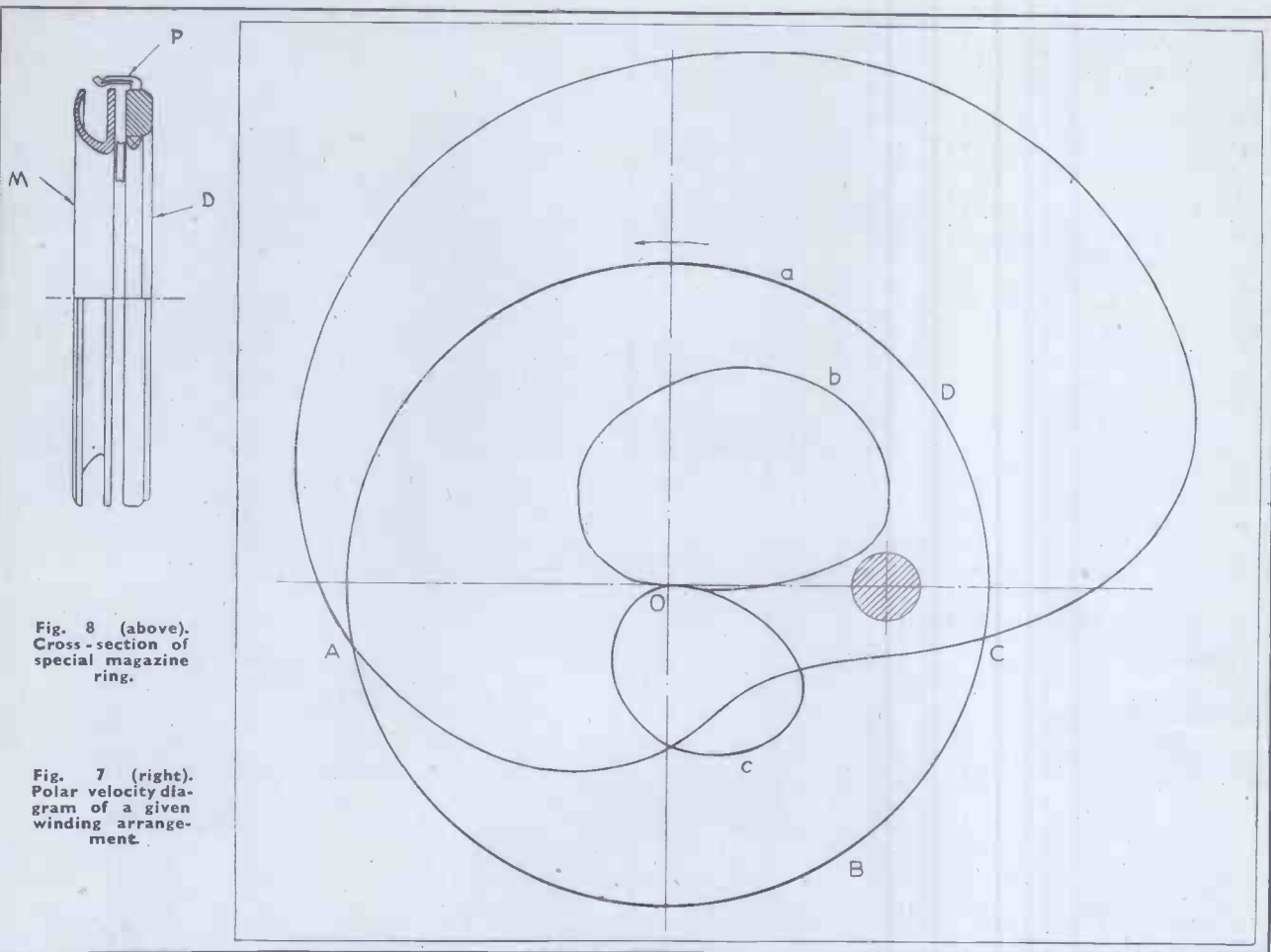

Fig. 8 (above). Cross-section of special magazine ring.

Fig. 7 (right). Polar velocity diagram of a given winding arrangement.

and minimum velocities are $\frac{a+r}{R} + 1$

and $\frac{a-r}{R} + 1$ respectively. The

maximum acceleration and deceleration occur at the two angular positions for which $\gamma = 0$, i.e., $\theta_1 = -\sin^{-1} \frac{a}{R}$

and $\theta_2 = \sin^{-1} \frac{r}{a}$, respectively, the respective values being:

$$\frac{d^2\psi}{d\theta^2} = \pm \frac{1}{4R \sqrt{a^2 - r^2}} - 1$$

It becomes apparent, therefore, that for given diameters the maximum acceleration, and hence the tension on the wire, increases with increasing eccentricity. One of the requirements in toroidal winders, however, is the provision for winding to the smallest

possible inner diameter of the coil. This means that the cross-section of the two rings has to be kept a minimum. In order to store sufficient wire in the magazine, and to prevent repeated loading in the production of a single coil, a large diameter of the rings become desirable. This requirement conflicts with the necessity for small acceleration, and a compromise must therefore be made. The need for economy in space has led to the design of specialised ring cross-sections, a typical example of which is illustrated in Fig. 8. This shows the magazine ring M which revolves on rollers bearing on its inside surface, and the take-off ring D, which is driven by a gear wheel engaging with teeth on its inside edge. The figure also indicates a pin P which serves to lift the wire out of the magazine during the winding process. When loading the magazine the pin may be swung back and the two rings locked.

Figs. 9 and 10 show machines employing these principles as used for

the winding of Variac transformers. Here the relatively wide inner diameter of the coil allows the use of a rectangular section magazine ring. The take-off ring is gear driven, and the rings are supported by rollers mounted around their outer rims. A special feature of these machines is the automatic gear-driven traverse. The bracket mounting the core is advanced such that the winding is applied in a single layer on the outside of the transformer and in a two- or three-layer banked winding on its inside.

For the winding of transmission coils at high speeds it has been found advantageous to provide a cyclic braking action on the magazine ring while this is decelerating. This tends to equalise the tension on the wire resulting in a more uniform winding and preventing loose turns. Fig. 11 is a reproduction of a machine incorporating a cam-operated automatic brake, adjusted in accordance with the polar diagram to operate during the

decelerating period.⁴ Another type of machine employs a number of cams designed on the basis of polar diagrams for use with different types of cores, in conjunction with a selecting mechanism for the desired cam contour and a mechanically operated brake.

In a recently developed type of machine, acceleration of the magazine ring and heavy tension on the wire has been overcome by the incorporation of a sliding pulley. In this machine the pulley is arranged to move against the tension of a spring along the circumference of the take-off ring as the tension of the wire increases, and to return to its normal position when the tension is released. This arrangement is capable of winding at speeds of over 300 r.p.m.

It is of interest here to mention the machines used for taping toroidal and field coils which operate on similar principles and to which the same theoretical considerations may be applied. Such machines are somewhat simpler than toroidal winding machines, as they do not in general incorporate a separate magazine ring. The tape is stored on the take-off ring itself, which comprises a slot or roller on its inner face over which the tape is guided to the coil. The tape reserve is arranged to slip in its container and forms thus in itself the "magazine ring" of the mathematical analysis above. A machine of this type developed by Dr. V. Planer is shown in Fig. 13, and Figs. 14 and 15 show two other types of taping machines.

Winding Practice

A few notes on modern winding methods used in the production of transmission coils may be of interest here. As was mentioned earlier, certain coils are sectionalised, and if necessary the winding is spaced away from the core, in order to reduce the self capacitance. Fig. 16 shows a new moulded coil former consisting of two halves developed for this type of winding. The former does not occupy a great deal of winding space and is rigid and self-aligning. The separators are wedge shaped and possess slots allowing the wire to pass from section to section. The two halves are identical, but the provision of lips ensures correct alignment of the separators. The use of formers of this type greatly contributes to standardisation and ease of winding, allowing the use of standard clamps and traverse arrangements on winding machines.

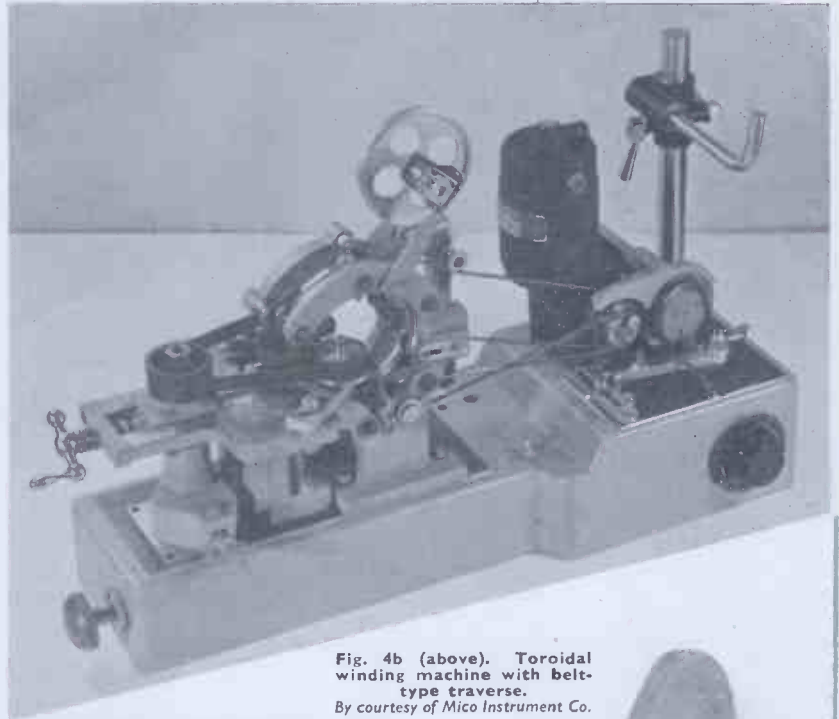

Fig. 4b (above). Toroidal winding machine with belt-type traverse.
By courtesy of Mico Instrument Co.

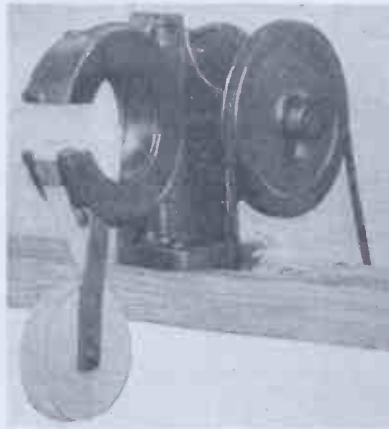

Fig. 15. Another type of Toroidal taping machine.
By courtesy of P. E. Chapman Electrical Works.

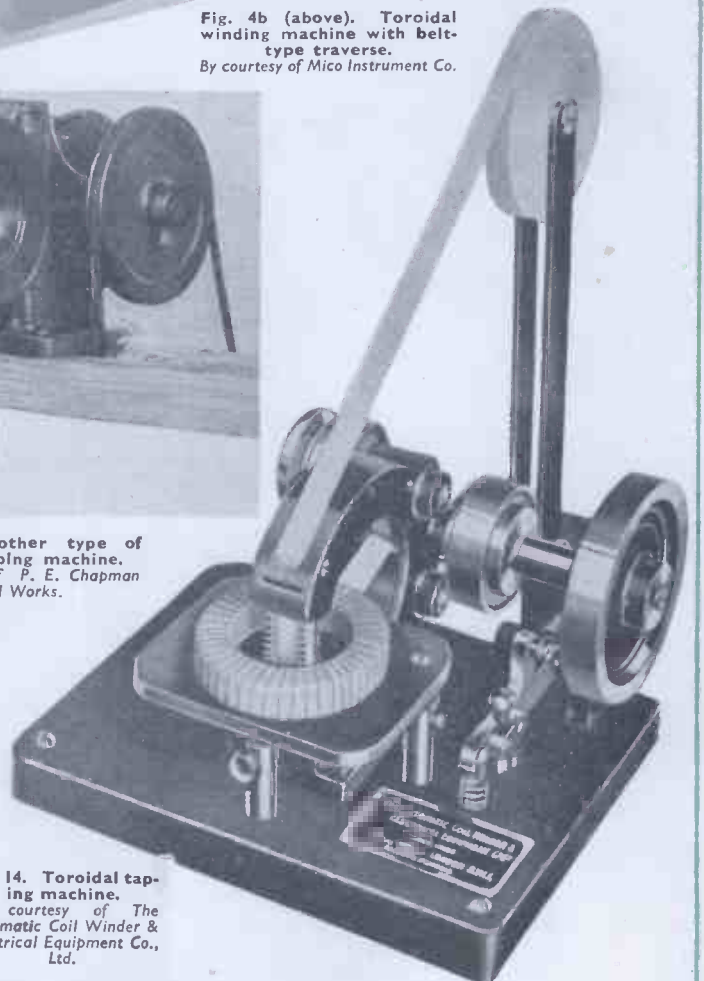

Fig. 14. Toroidal taping machine.
By courtesy of The Automatic Coil Winder & Electrical Equipment Co., Ltd.

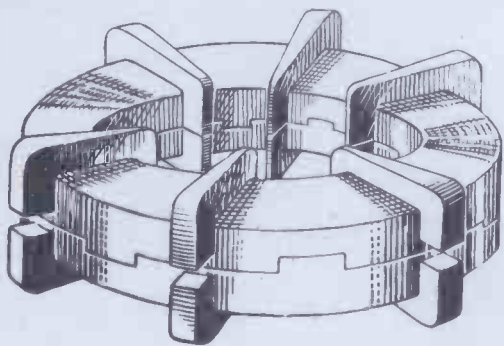

Fig. 16. Moulded Toroidal coil former.

As an alternative, or an addition to the sectionalised winding, the wire may be applied in a banked winding if very low self capacitance is desired. This type of winding requires the application of a specialised technique, and is naturally more time-consuming than ordinary layer-winding.

In many instances it is necessary to keep the capacity between windings a minimum, and for this purpose electrostatic screens may be interposed between different windings. This is done either by wrapping thin foil over the coil, or by the use of a pre-formed screen consisting of two halves.

Cotton or silk tape is applied on either side of the screen, and care must be taken to provide a well insulated annular gap between the two halves of the screen. Experiments are also in progress with special formers of a type similar to that in Fig. 16, having metallised interiors and possessing separate lead-out wires.

REFERENCES

- ¹ *Wireless World*, Oct. 4, 1935.
- ² *The Design of Variacs*, *Trans., A.I.E.E.*
- ³ *Wire and Wire Products*, July, 1945, p. 491.
- ⁴ *Journal of Scientific Instruments*, Dec., 1943, p. 185.

APPENDIX

With reference to Fig. 8, since the total length of wire remains unchanged:

$$l + \phi r + R(\theta - \psi) = k,$$

giving the displacement of the magazine ring:

$$\psi = \frac{1}{R}(r\phi + l) + \theta + k'$$

where $k' = k/R$ Eliminating ϕ and l and differentiating with respect to θ , the velocity of the magazine ring becomes:

$$\frac{d\psi}{d\theta} = 1 + \frac{rR + a(\sin\theta\sqrt{a^2 + R^2} - 2aR\cos\theta - r^2 - r\cos\theta)}{a^2 + R^2 - 2aR\cos\theta}$$

By adopting the angle $OPT = \gamma$ as a parameter, the above expression may be simplified to:

$$\frac{d\psi}{d\theta} = 1 + \sin\gamma$$

The acceleration of the magazine ring in terms of the primary constants is given by:

$$\frac{d^2\psi}{d\theta^2} = \frac{2aR\sin\theta\text{arccos}\theta - rR - a\sin\theta\sqrt{a^2 + R^2} - 2aR\cos\theta - r^2}{(a^2 + R^2 - 2aR\cos\theta)^2} + \frac{a^2R\sin^2\theta}{\sqrt{a^2 + R^2} - 2aR\cos\theta - r^2} + \frac{a\text{rsin}\theta + a\cos\theta\sqrt{a^2 + R^2} - 2aR\cos\theta - r^2}{a^2 + R^2 - 2aR\cos\theta}$$

Advances in Cathode-Ray Tube Design

At the recent Radar Convention mention was made of several improvements in cathode-ray tube design and construction, mainly as a result of the requirements of radar. Some notes on these are given below.

Magnetic Tube with Low Deflection Drive

Pre-war development had left the characteristics of the magnetic deflection cathode-ray tube such that the tube was very short and required considerable power to deflect it. This was not onerous for television purposes with a scan taking 100 μ sec. but aircraft applications demanded traces initially several times faster. To meet these difficulties the VCR530 tube was designed having much higher sensitivity and was extremely successful. This tube uses a deflection coil twice as long as the normal television coil and additional sensitivity is obtained by the large throw from the centre of the coil to the screen. For a time-base speed of 60 km/sec. it is only necessary to use a VT60A at 80 mA. This would probably have had to be replaced by at least four tubes of similar rating if the normal television type cathode-ray tube design had been adopted.

Search for a Very Compact Construction

Space is very restricted in aircraft and a search was made for methods of saving space which would not entail a loss of performance. Three such lines of attack showed promise: (a) the all-glass base, (b) the post-deflection accelerator system and (c) the use of a magnifying lens.

By the use of the all-glass base a cathode-ray tube can be materially shortened without shortening the gun/deflector system and thus losing performance. The valve base known as the B9G, originally introduced for the VR91 type valve, is used. This base has the drawback of a relatively poor breakdown performance and, to offset this, the second feature, the post-deflection accelerator, was introduced. The latter enables the total cathode/screen voltage to be supplied below and above the deflection plate voltage (which is itself generally around earth potential), so that breakdown is much less likely.

The use of a magnifying lens is a most important advance in achieving compactness and in improving performance. Special non-spherical lenses were developed which enabled a wide exit angle of light from the cathode-ray tube to be attained.

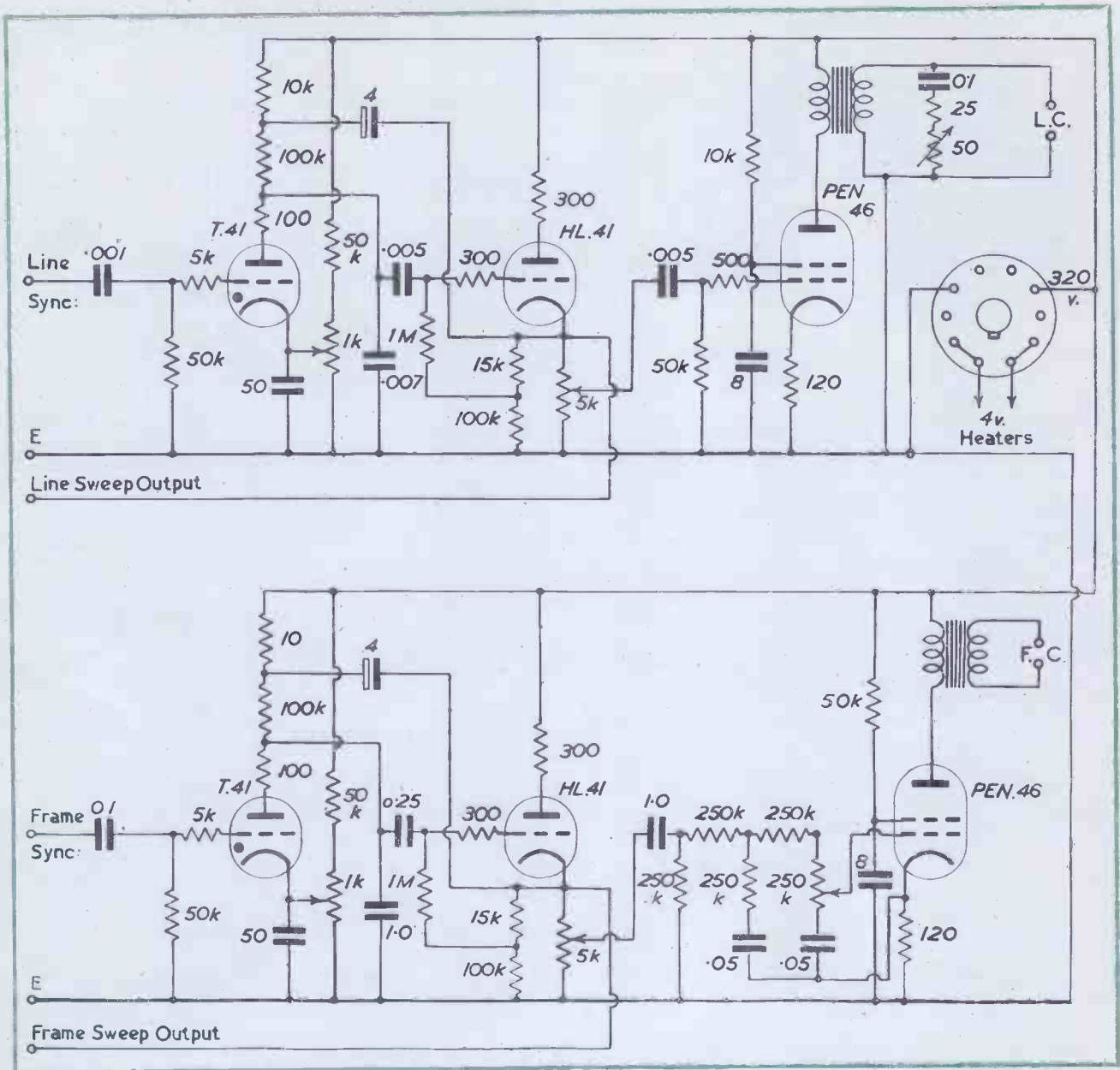

Monoscope Circuit

HERE are three separate circuits in the Monoscope unit:

- (1) Monoscope electrode supplies.
- (2) Monoscope scanning circuits.
- (3) Video head amplifier.

The complete circuit diagram is shown in Fig. 4.

Monoscope Electrode Supplies

The Monoscope is supplied from a 1,500-volt H.T. supply with positive earthed. The second anode and the

pattern electrode are at earth potential, the focusing anode (A₁) at approximately 400 volts to cathode, and the grid at approximately -20 volts to cathode. The collector is connected to the video amplifier H.T. supply, which is 200 volts positive to earth. One side of the heater supply is connected to cathode.

Monoscope Scanning Circuits

The frame and line scanning generators each consists of a T41 thyatron feeding into a cathode-

follower triode (HL41). In each, the thyatron circuit has fixed 100,000-ohm charging resistors, the charging capacity in each circuit being adjusted to give the required saw-tooth frequency. Synchronising impulses are fed onto the grid of the thyatron through a 5,000-ohm series resistor to limit grid current, and a 100-ohm resistor is included in the anode circuit to limit the anode current during the flyback period. The output frequency is adjusted by variation of the cathode potential.

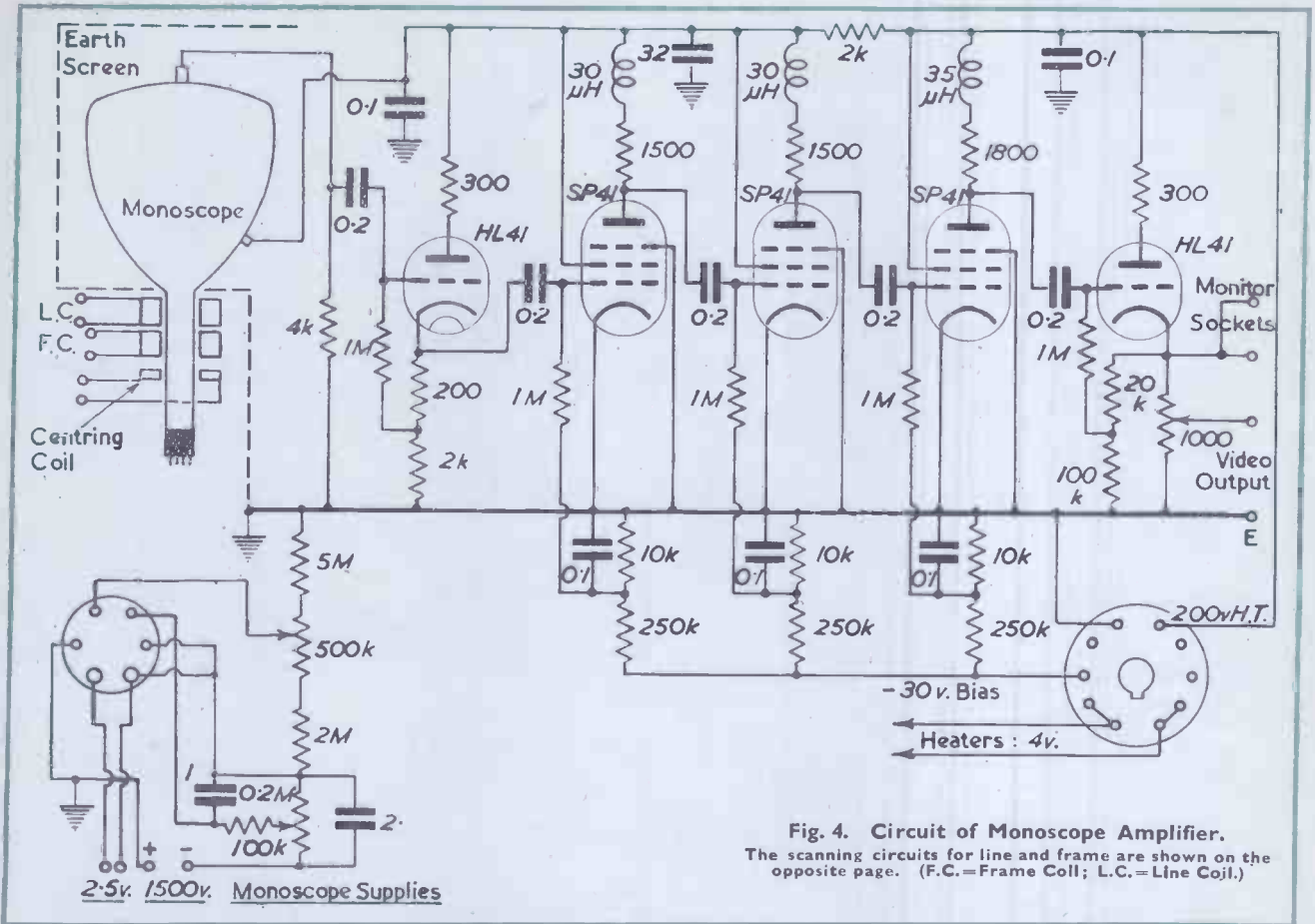

Fig. 4. Circuit of Monoscope Amplifier. The scanning circuits for line and frame are shown on the opposite page. (F.C.—Frame Coil; L.C.—Line Coil.)

A Television Signal Generator

By R. G. HIBBERD, B.Sc., A.M.I.E.E.

Part 2.—Monoscope and Video Circuits

The output from the thyatron is coupled to the cathode-follower stage, which has 300-ohm stopper resistors connected to the grid and anode pins of the valve to prevent parasitic oscillation. In order to compensate for the slight non-linearity that is normally present in the thyatron output, the decoupling condenser in the thyatron anode supply is returned to the cathode of the cathode-follower valve. This cathode-follower valve has a 5,000-ohm potentiometer as the cathode load. The potentiometer feeds the scanning amplifier and serves as an amplitude control, which is quite independent of the frequency control.

The two scanning amplifiers use Pen 46 valves, and the outputs are matched through step-down transformers to a low-impedance scanning

coil system. The line output transformer is provided with variable damping across the secondary to damp out the over-shoot, and the frame amplifier is fed through a two-stage compensation circuit to compensate for the loss of linearity in the output transformer.

Outputs are also taken from the cathodes of the cathode-follower scanning amplifiers, which are exactly similar to the monoscope scanning amplifiers. By this arrangement, the monitor scanning is a direct check of the monoscope scanning. This is of particular importance as regards the interlace, since if the monitor scan is correctly interlaced, then the monoscope scan must also be correctly interlaced.

During the initial tests it was found

necessary to provide a predeflection coil system to centre the monoscope scan on the pattern electrode. This system consists of two pairs of hank-wound coils displaced in quadrature and situated adjacent to the scanning coil system. The current through each pair of coils is adjustable to give magnetic shift controls.

Video Head Amplifier

The video amplifier contains five stages: a cathode-follower input stage, followed by three amplifier stages, and then a cathode-follower output stage. The cathode-follower input stage is used to reduce the capacity across the 4,000-ohm monoscope load resistance. By this arrangement the capacity is reduced to the order of 12 pF. The first two amplifier stages have anode loads of 1,500 ohms

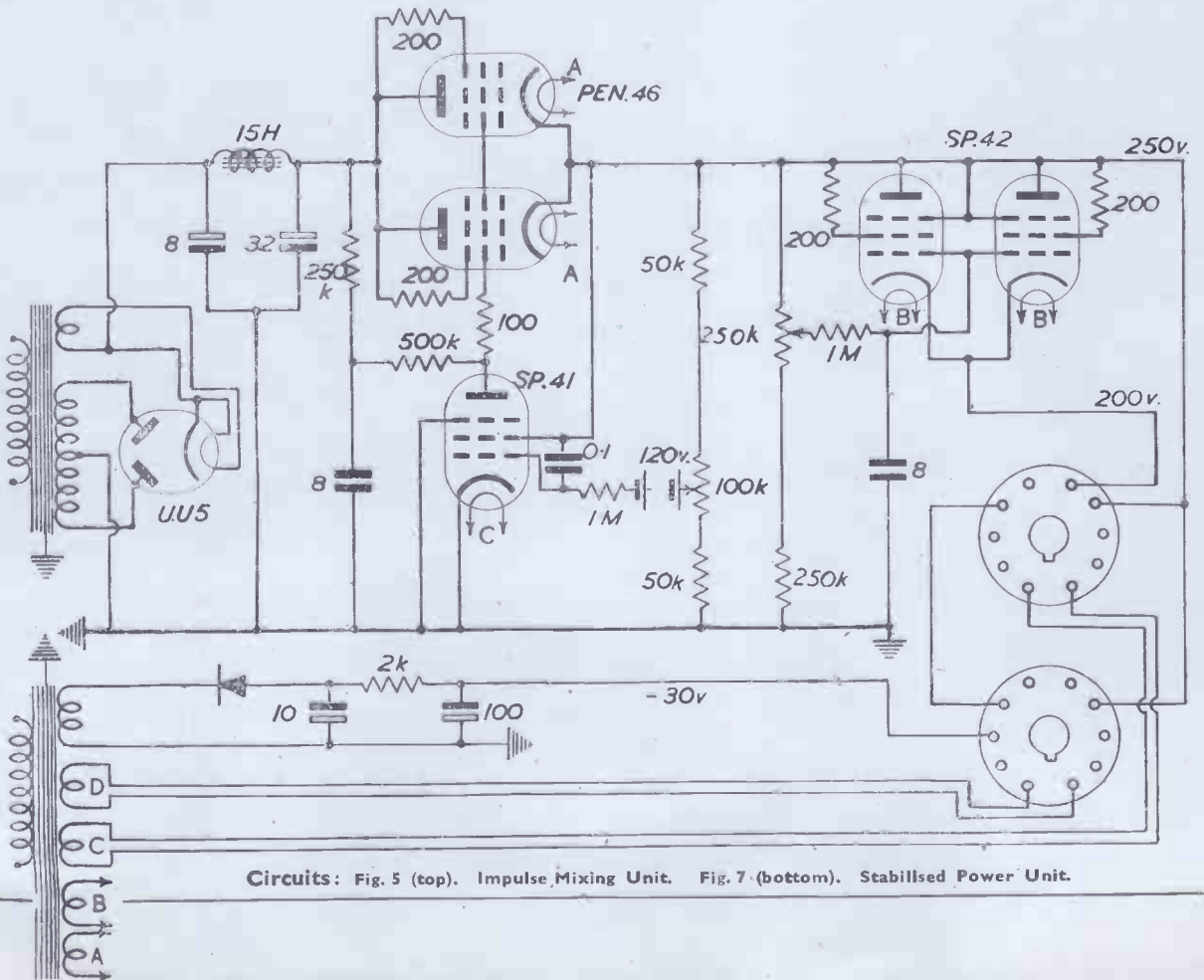
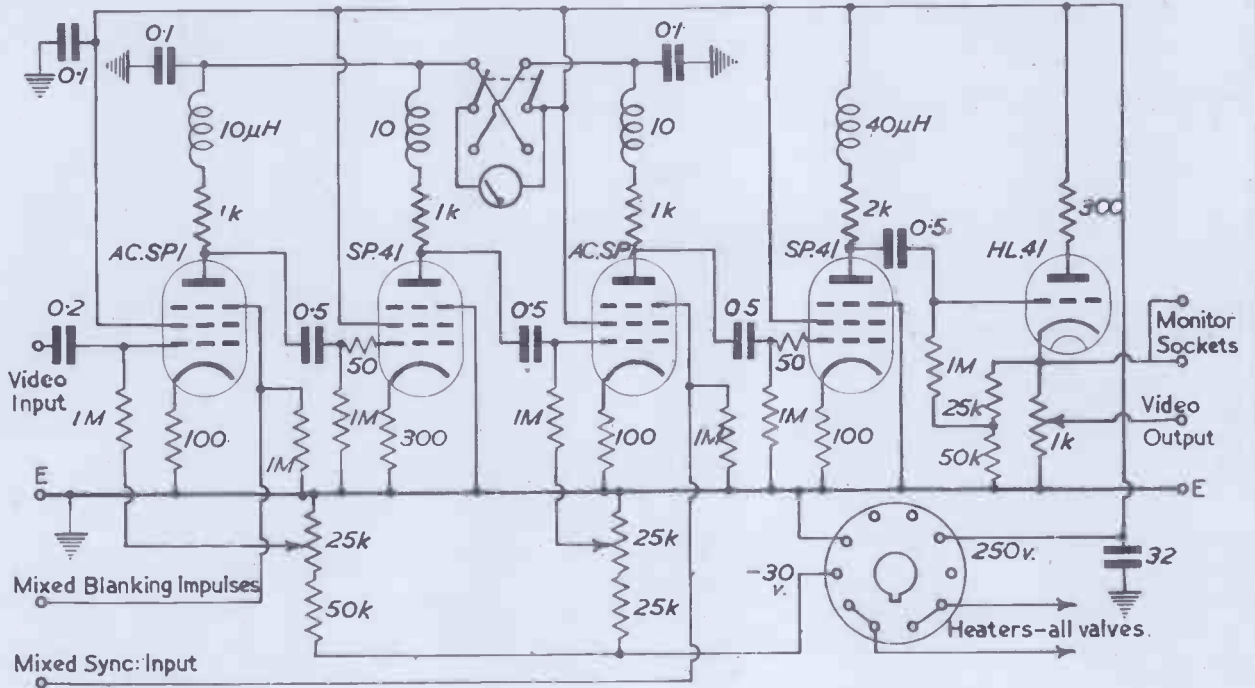

Circuits: Fig. 5 (top). Impulse Mixing Unit. Fig. 7 (bottom). Stabilised Power Unit.

with 30 μ H series compensating inductances. The third amplifier stage, since it is feeding the output cathode-follower valve, with its reduced input capacity, has a slightly greater anode load of 1,800 ohms with 35 μ H in series. Negative grid bias for each amplifier stage is obtained from a negative supply, the valve cathodes being earthed. The H.T. supply to the first two amplifier stages is decoupled through 2,000 ohms and 32 μ F, the latter being shunted by a 0.1 μ F paper condenser to by-pass the higher frequencies. A potentiometer in the cathode circuit of the final cathode-follower valve forms the output control and connexions are also made direct from the cathode of this valve to two output sockets for monitoring purposes. Intervalve couplings throughout the amplifier are 0.2 μ F and 1 megohm. Mazda SP.41 valves are used in the amplifier stages and HL.41 valves in the cathode-follower stages. Since there are an odd number of amplifier stages up to this point, the signal output is positive for white. The maximum output for peak white is between one and two volts.

Owing to mains voltage fluctuations being fed through the H.T. supply to the early amplifier stages, and producing excessive variations in the output, it was found necessary to use an electronically stabilised H.T. supply. This will be described later.

Impulse Mixing Unit

In this unit the blanking and synchronising impulses are, in turn, mixed into the video signal, and the resulting complete waveform is then amplified to the level required to modulate the final R.F. amplifier. The circuit diagram of this unit is shown in Fig. 5. Suppressor grid mixing is used, Mazda AC/SP1 valves being used on account of their short suppressor characteristic. The positive video signal from the head amplifier is fed to the control grid of the first AC/SP1 valve, and negative blanking impulses from the impulse generator are fed to the suppressor grid. These impulses extend beyond cut-off, and blank out the signals produced during the line and frame fly-back periods. In addition, these pulses provide a reference "black" level, which is adjusted by means of a variable bias on the control grid. Since the video signal consists of a stationary pattern, no special precautions are necessary to maintain

this black level, and the D.C. component may be restored at any point by the addition of suitable D.C. potential to the waveform.

The blanked signal is then fed through an SP41 phase reversing stage to another AC/SP1 valve. Here negative synchronising impulses are fed to the suppressor grid, the ratio of vision signal to synchronising pulse in the output being adjustable by varying the bias on the control grid. The complete signal is now fed to the final video amplifier, which raises the level to about 20 volts peak to peak. A cathode-follower output stage is again used. Each of the stages in this unit uses series inductance compensation and also cathode degeneration to minimise non-linearity due to valve characteristic curvature. The output signal is adjusted to have approximately equal vision signals and synchronising impulses, since the latter are subsequently limited in the modulation process. The overall frequency characteristic of the video circuits

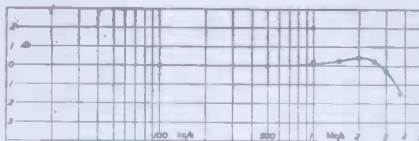

Fig. 16.

from the head amplifier input to the modulation output is approximately flat up to 3 Mc/s. and is shown in Fig. 6.

Stabilised Supply Unit

This unit supplies the various voltages to the video amplifier and mixing circuits. As stated above, it was found necessary to stabilise the H.T. supply. The circuit arrangement is shown in Fig. 7. A conventional rectifier circuit supplies 400 volts to the first stabilising circuit, which uses two Pen 46 valves in parallel as series control valves with an SP41 feedback amplifier. The D.C. reference potential is a 120 volt battery, but a neon tube may be used with some loss of stabilisation. The output voltage from the Pen 46 valves is approximately 250 volts, and feeds the mixing circuits. The supply to the video amplifier is further stabilised through two SP42 valves in parallel, giving an output voltage of about 200 volts. This arrangement gives satisfactory results with very severe mains voltage fluctuations.

TELEVISION COMMENTARY

The B.B.C. was happy in its choice of date for the reopening of the television service. Apart from the difficulty of exactly synchronising the commentary, the Victory Parade seen by television was a completely satisfying experience, not only because of the interest and clarity of the pictures—both close-ups of the Very Important People seen through the telephoto lens and long shots of the impressive passing columns—but because it was an experience shared with the chief actors. This, television's unique function, even the best film cannot offer.

Generalising on the programmes of the first ten days, it looks as if television's future successes will be in actuality programmes—the Wightman Cup tennis tournament at Wimbledon was the second outside broadcast—and in drama. "The Importance of Being Earnest" and "They Flew Through Sand," by the excellence of their choice, production and acting, overcame the limitations of the medium. "The Dark Lady of the Sonnets" and "The Silence of the Sea," on the other hand, although they would appear to be simpler and to make less demand upon the producer's resources, emphasised all the difficulties. Variety, depth of stage setting, movement and a certain speed are essential to television at present. The trick of camera panning from one speaker to another in monologues and dialogues is very monotonous and destroys illusion. Only a superlative actor could succeed here.

Transatlantic Quiz, even if radio-genic, is not pictorial and there seems no good reason for transplanting it into television.

It is obviously unfair to be hypercritical in these early days of revival, but there does appear to be a rather too frequent lack of slickness in cues and camera changes. It is good to see old and new faces among the announcers, who are all, at present, suffering from an infectious nodding on every second word which is very irritating to watch. We hope for an early cure and no spread of the infection. Geraldo's band was a very good piece of showmanship, and "Late Joys," a music-hall entertainment of the 1890s, demonstrated how vision can add to sound in this type of programme.

J. B.

Temperature Indicating Compounds

By G. A. WILLIAMS*

New methods of determining surface temperatures by Colour-changing Pigments and Chemical Compounds

THE temperature-indicating devices described herein have been extensively employed during the war in many and diverse industries and are now being rapidly recognised as a most useful addition to the standard temperature measuring instruments. They have many unique applications and in many instances provide a ready and accurate means of controlling temperatures in processes which at present are usually left to the individual operator's judgment. There are also other circumstances where because of position, movement, or impracticability, it is not possible to use pyrometers or thermocouples.

Many of the practical applications described have reference to electronic engineering, and it is thought, therefore, that an account of these methods will be of interest.

The temperature-indicating devices in question are of two types:—

(1) Paints containing a pigment which is formulated to change colour at a definite temperature ("Thermindex" Colours).

(2) Chemical Compounds which melt sharply at a predetermined temperature (Tempil Compounds).

The materials in Class (1) are marketed as ready mixed paints in two grades, standard and oil-resistant, and are suitable for application by brush or spray to practically any type of surface. The standard grade is for general purposes application and the oil-resistant grade, having especially good adhesive properties, can be applied for recording temperatures under oily conditions. Sixteen separate paints are supplied, giving a total of 48 indications in the range 80°-800° C. Some undergo a single-colour change, but the majority show successive changes as the temperature increases and are particularly useful for checking minimum and maximum temperatures. The following examples will illustrate the range of some of the individual colours:—

Under workshop conditions these colours should not be expected to give the exact measurement of the temperature but rather to permit a quick indication of the temperature at a given point, or the distribution of heat over a certain area.

Extract from Table of available Thermindex Colours

Ref.	Initial Colour	Transition Temperature		Colour Change
		Deg. C.	Deg. F.	
E102	Pink	115 310	240 590	Blue violet Grey
E94	Bright violet blue	155 300 340	310 570 645	Bright green Light brown Buff
E106	Reddish orange	205	400	Brick red Brown Almost black Medium grey Dirty white
		230	445	
		245	475	
		295	565	
E93	Grey blue	275	525	Buff Creamy white
		290	555	

If the paint is applied to a small object and the object heated until a colour change occurs regardless of the time taken in the process of heating, the accuracy of the indication will be in the region of $\pm 15^{\circ}$ C. When closer limits are desired, the makers provide a chart showing the time-temperature relationship similar to the examples given graphically in Fig. 2.

The compounds in Class (2) are supplied in three forms.

- (a) Crayons, "Tempilstiks";
- (b) Emulsions, "Tempilaq";
- (c) Pellets, "Tempils"

All three indicate in the same manner, *i.e.*, they melt sharply as soon as a predetermined temperature is attained or exceeded and are supplied as separate units, each indicating a specific temperature. Tempilstiks are available in 13° and 25° intervals from 125°-350° F. (52° to 177° C.) and in 50° intervals from 350°-1,700° F. (177°-926° C.). Tempilaqs cover a similar range and Tempil Pellets a higher range, *i.e.*, up to 1,800° F. (982° C.) in 25° and 50° intervals.

Tempilstiks can be applied to a surface as an ordinary chalk mark and at the stated melting point the mark liquefies sharply and remains a liquid smear so long as the temperature remains above that melting point. When the surface is highly polished, or a flame is likely to impinge directly on it, the Tempilstik can be drawn lightly across it until a liquid streak is left, thus showing that the melting point of that particular crayon has been reached.

Tempilaqs are applied by brush and dry almost instantly into a light coloured matt smear. As soon as the temperature of the surface is raised to the melting point of the Tempilaq in use, the smear liquefies and becomes transparent. In most cases the smear remains dark and shiny after the temperature has fallen and thus provides a permanent record of the minimum temperature attained at that point.

Tempil Pellets can be placed upon or against a surface and will melt sharply when the stated melting point is reached. Two sizes are available, standard and a miniature size measuring $\frac{1}{8}$ in. by $\frac{1}{8}$ in.

Temperature-indicating devices of the types just described are ideally suited to many industrial processes involving the controlled application of heat and it may prove useful to deal with some of these in detail under the following headings:

- (1) **Welding:** preheat and post-heat temperatures.
- (2) **Glass Industry:** Annealing and bulb temperature.
- (3) **Protection of Equipment:** Overheating, Cabinet Temperatures.
- (4) **Plastics.**
- (5) **Research and Development.**
- (6) **Ceramics.**

I. Welding Preheating

The intensive development of welding during the war period has shown the necessity for taking proper precautions against the most insidious of welding effects—cracking. To-day, welded parts are used under conditions of exceptional stress and the danger exists that even a minute crack will grow and result in the sudden failure of the section. Probably the most general precautionary measure employed against this danger is to control the rate of cooling in the welding operation. This is usually effected by preheating of the part to be welded to a predetermined temperature, so that the rate of cooling at the joint is considerably retarded.

It is essential that this preheating is controlled within definite limits dependent upon the composition and mass of the metal involved. "Thermindex" Paints or Tempilstiks are used to great advantage to control these preheat and post-heat temperatures.

(Continued on page 211.)

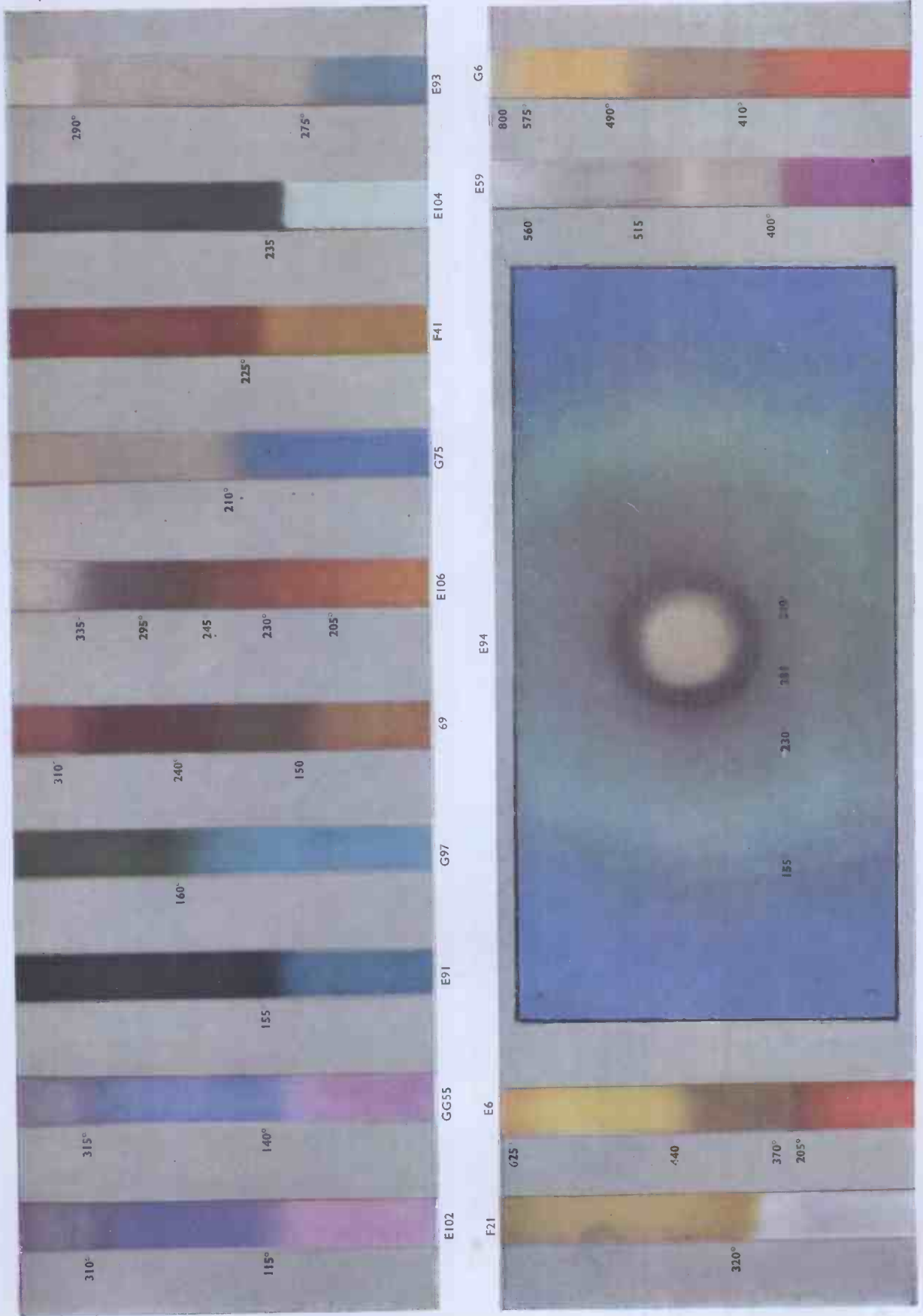

(Above calibrations are in degrees Centigrade.)

Fig. 2. Illustrations of metal strips showing actual "Thermindex" colour changes.

**Exploring
Temperature
Distribution
with
Heat Indicating
Paint**

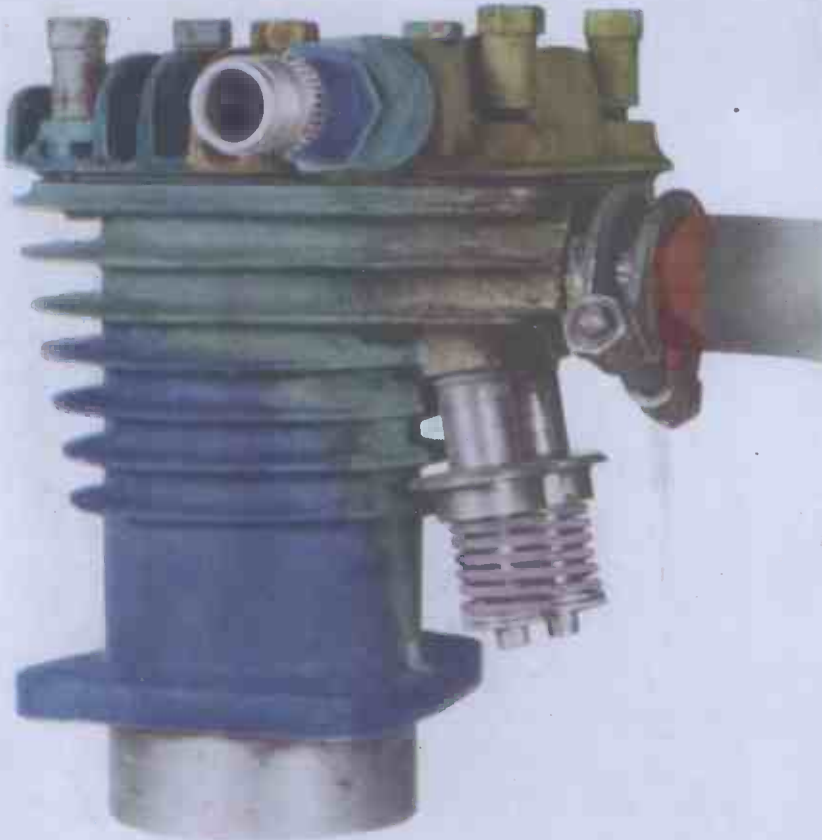

Fig. 3. (above). Air-cooled cylinder showing temperature rise around valves.



Fig. 4 (right). Plan view of cylinder showing temperature distribution over the head.

(Continued from page 208)

**2. Glass Industry
Annealing**

In general, it may be stated that Tempilaq Paint is used for actual control of annealing machines and ovens, as the various machines all have different annealing times. If "Thermindex" paints are used they should be calibrated for each machine.

The most common glass used in lamp manufacture is of potash-lead composition and the annealing range is from 410° C.-460° C. Above these temperatures the glass is plastic and easily deformed, consequently controls are necessary to ensure that the minimum temperature is reached, but the maximum temperature is not exceeded.

In order to carry out this control two Tempilaq Paints are used 800° F. (427° C.) and 850° F. (454° C.) and the temperature is controlled so that the 800° F. Tempilaq liquefies, whereas that for 850° F. does not.

Bulb Temperatures

"Thermindex" paints are used for obtaining approximate temperature bands during the operation of exhausting the air from the bulb and introducing an inert gas in its place. This operation must always be carried out under heat and the temperature must be controlled. Two bands of the appropriate "Thermindex" colours (dependent upon the type of bulb) placed near the base, one colour to be regarded as the minimum and the other as the maximum, will readily show the operator that he is keeping within the desired limits.

Exhausting and Gasfilling

During the exhausting and gasfilling operation, "Thermindex" paints

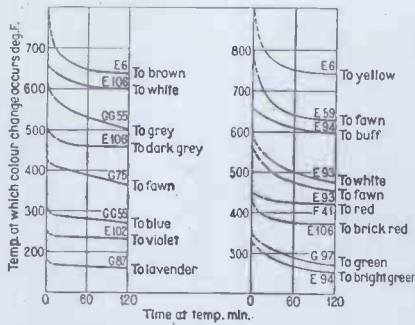

Fig. 1. Relationship between temperature of colour change and heating time.

are used as probes, that is, to determine roughly the temperature which the lamp attains. These temperatures are not critical and a tolerance of plus or minus 50° C. is permissible, consequently it is not necessary to calibrate the "Thermindex" paints accurately.

3. Protection of Equipment from Overheating

"Thermindex" paints, Tempilstiks or Tempilaq, are all equally useful devices for giving a visual indication that machine parts are remaining hot or have already overheated. Bearings, spindles, motors, etc., in fact, any equipment subject to overheating can be marked with the appropriate indicator at a point where it can readily be observed, so that ample warning is given if the temperature approaches a dangerously high level.

These indicators will be equally effective to check any tendency for hot presses, callender rolls, etc., to run below the desired temperature or to ascertain that large surface areas are uniformly heated to the required degree.

Cabinet Temperatures.

It would seem worth while considering the use of "Thermindex" paints, or the Tempil Indicators to investigate or check the working temperatures of valves, etc., in large amplifiers where, owing to limited air circulation, there is some danger of reducing the working life of the equipment.

4. Plastics

Plastic mouldings must sometimes be subjected to a prolonged process of heat-treatment and it is difficult to devise a satisfactory system for checking that such operations have been properly carried out. "Thermindex" paints can be exceptionally useful here, as a spot of the appropriate colour applied to each article will, by a change of colour, give clearly visible and permanent evidence that treatment has been effected.

Extruding or injection moulding machines which are not fitted with up-to-date recording instruments can be readily checked at critical points with a multi-change "Thermindex" colour, or by periodically checking with Tempilstiks with melting points appropriate to the proper working temperatures. Tempilstiks can be used also to ascertain the temperatures of moulds which need preheating prior to use.

5. Research and Development

While it is invariably necessary to know the exact temperatures by point to point measurements in research work, these indicators have been found extremely useful as an additional check upon pyrometers, etc.

Fig. 5 (left). When 235° C. is reached, the original white colour of "Thermindex" Colour EI04 changes to dark grey.
Fig. 6 (right). The clear light-coloured mark drawn with Tempilstik 300° F. melts and practically disappears when 300° F. is attained.



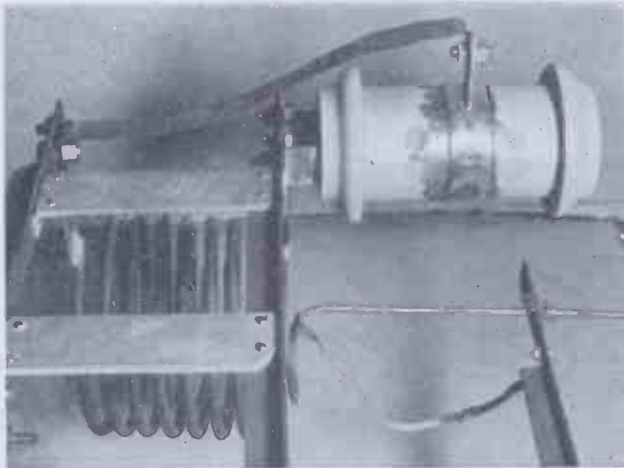

By courtesy of United Insulator Co.

Fig. 7 (right).
Fig. 8 (above)
Heat test on
capacitors.

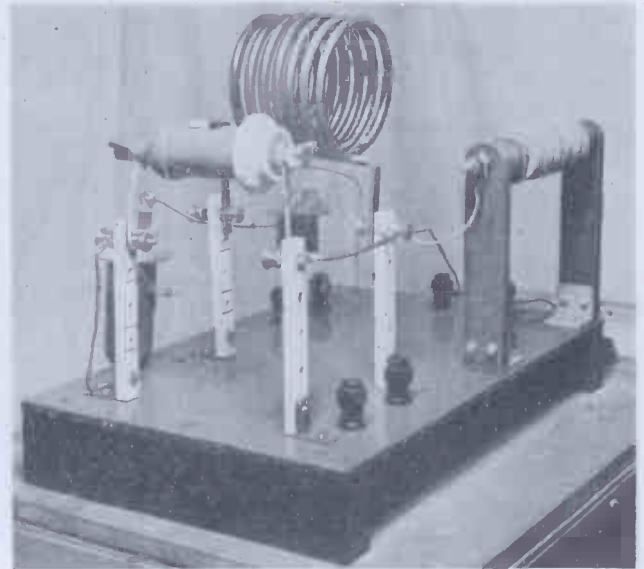

There are also many hundreds of cases where, because of position, movement, or because the object under test cannot be seen, these indicators have enabled many laboratories to ascertain temperatures hitherto unobtainable. Two examples are shown in Figs. 3 and 4. These show some of the results of tests carried out in connexion with the design of a stationary air-cooled engine. The outside of the cylinder-head was treated with "Thermindex" Standard Series Colour B80, which shows temperatures reached of 180° C. (green) and 185° C. (khaki), whereas Colour E94 applied to the sparking plug does not show a temperature much above 155° C. (bright green). Fig. 4 shows the internal application of the oil-resistant series of "Thermindex" to the combustion chamber. Colours O/F41 and O/E93 being used here clearly show the concentration of heat around the valves 225° C. (brick red) and 290° C. (creamy white).

6. Ceramics

In the firing of enamels and gold, on glass and pottery-ware it is by no means certain that the temperatures indicated by the thermocouple will be a true indication of that existing throughout the whole kiln. Enamels, etc., are fired on glass between 566° and 621° C., and on pottery between 680° and 900° C. Spots or stripes of the appropriate "Thermindex" Colours, E6, G6 and E59, applied to two or three of the work pieces and placed at the top, middle and bottom of the kiln, will provide quite an accurate picture of the overall distribution of heat.

Shell and pot capacitors must be so designed that the temperature rise for a given R.F. load is maintained within the limits. The shell and pot

capacitors of the type shown should not exceed 175° F. (79° C.) and 238° F. (115° C.) respectively, and our illustrations show a convenient method used to test these in the laboratories of the United Insulator Company by the use of Tempil pellets and "Thermindex" paints. Fig. 7 shows a pot capacitor under R.F. load upon which two Tempil pellets were placed—one for the minimum temperature 125° F. (52° C.) and another for the maximum, 175° F. (79° C.). It will be observed that the right-hand pellet has melted, whereas that for 175° F. has not, thus indicating that the minimum temperature was reached, but the maximum not exceeded.

The other illustration (Fig. 8) shows a shell capacitor under load to which has been applied two spots of "Thermindex" Colour E102 on the left-hand side, which will change colour at 239° F. (115° C.) and on the right-hand side two spots of "Thermindex" Colour G87 which will change at 175° F. (80° C.). Although not discernible in the photograph after test it was observed that Colour G87 had changed to lavender, whereas E102 had not, thus indicating that the temperature was maintained within the desired limits.

"Thermindex" temperature-indicating paints are manufactured by Synthetic & Industrial Finishes, Ltd., Watford, Herts, and the Tempil Products Corporation, Inc., of New York. Both are distributed solely by J. M. Steel & Co., Ltd., of Kern House, 36-38 Kingsway, W.C.2, who will be pleased to give further information and advice.

The Metallurgy of Zirconium

Prior to an investigation of the use of zirconium sand as a raw material for making zirconium metal and alloys, the Bureau of Mines, Washington, has released a publication combining the most useful information on the metallurgy of corrosion-resistant zirconium metal and describing its extraction, production, alloys and compounds, and various uses.

The Bureau's current report, compiled from numerous patents and publications, and containing a bibliography of more than 200 reference works, is intended as an aid to the industry in the commercial development of zirconium, according to Dr. R. R. Sayers, Director of the Bureau.

Zirconium metal, easily drawn into wires and rolled into thin sheets, is used widely in electronic tubes, as well as in electrical condensers, X-ray filters, lamp filaments, spot welding electrodes, flares, photo-flash bulbs and ammunition primers. Many valuable alloys are formed by mixing zirconium with other metals. Zirconium-copper alloys harden upon ageing and are good conductors of electricity, and zirconium-magnesium alloys have good mechanical properties and excellent corrosion resistance. Alloys of zirconium with iron and silicon have improved hot-working properties, better surface characteristics, and greater impact strength.

F. NEURATH.

Frequency Modulated Transmitters for Police and Similar Services

By E. P. FAIRBAIRN, B.Sc.*

IT seems likely that frequency modulation will have two broad fields of use; the broadcasting field in which the highest quality is the prime requirement, and the field of communications in which other of its characteristics are attractive. Little practical experience has been obtained in this country in the first field chiefly because of war conditions, but in the second field a system has been in use in one area for some years so that a good deal of experience has been gained. Since little information has been published on transmitters in the second category, it is hoped that the following article may be of general interest.

For such purposes as police systems the problem set is to establish reliable both-way communication between a headquarters station and a fleet of cars operating over a comparatively small area, much of which may be heavily built up and have dense motor traffic as well as other sources of severe interference. To be practical each system must cover its own area adequately but cause no interference in other areas; in addition the frequencies used must be in a band which is not already used for other services having higher priorities. These considerations practically rule out medium and high frequencies and it was the U.S.A. which first showed that frequencies of the order of 40 Mc/s. had the required properties. Britain was not far behind and, indeed, led the way in the use of frequencies of 80 Mc/s. and above. This choice was dictated by the requirements of other services, but has, on the whole, proved to be a good compromise. The first system (amplitude modulated) in Britain in this frequency band was installed in 1940, and since then most of the principal towns have been equipped with at least a skeleton service. The need for close frequency control on transmitters and for preset and remotely controlled receivers necessitates the

*G.E.C. Ltd. Coventry.

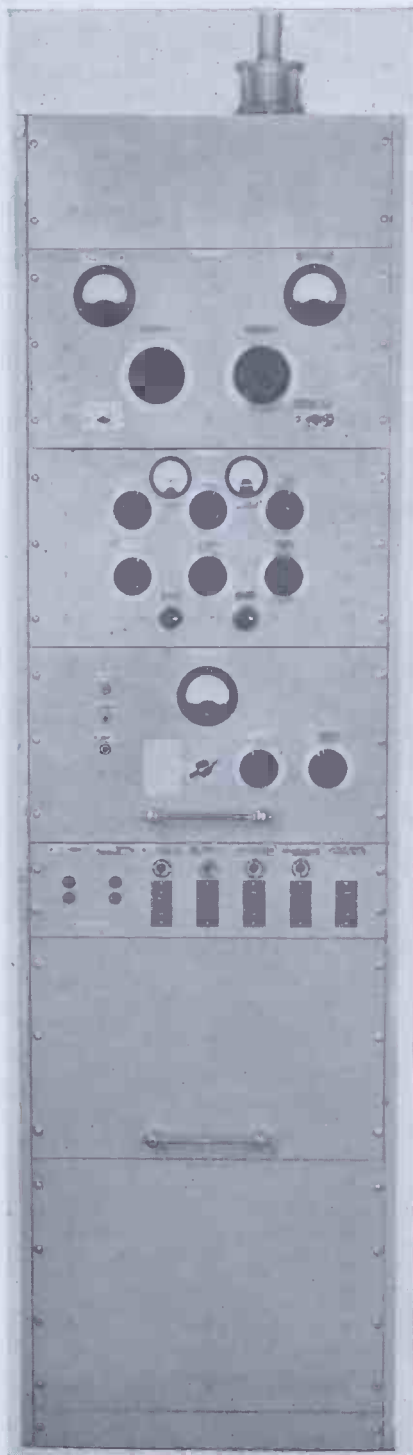

Transmitter for either A.M. or F.M. use.
Fig. 6 (left).
Exterior view.



Fig. 7 (right).
Interior view.

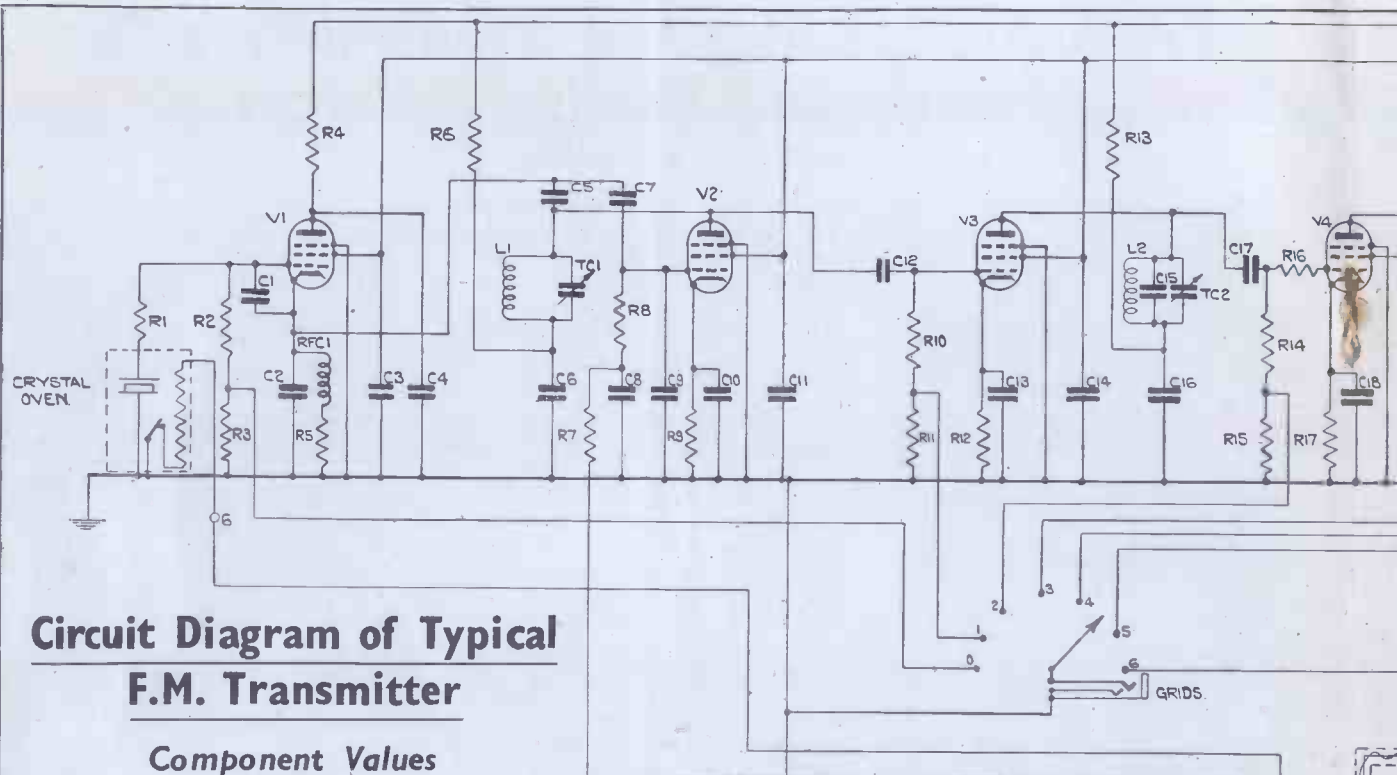

Circuit Diagram of Typical F.M. Transmitter

Component Values

R ₁	47Ω ± 20%
R ₂	47,000Ω ± 10%
R ₃	1,000Ω ± 10%
R ₄	4,700Ω ± 10%
R ₅	330Ω ± 10%
R ₆	22,000Ω ± 20%
R ₇	100,000Ω ± 10%
R ₈	See Note
R ₉	1,500Ω ± 10%
R ₁₀	47,000Ω ± 10%
R ₁₁	1,000Ω ± 10%
R ₁₂	330Ω ± 10%
R ₁₃	4,700Ω ± 20%
R ₁₄	47,000Ω ± 10%
R ₁₅	1,000Ω ± 10%
R ₁₆	4,700Ω ± 20%
R ₁₇	330Ω ± 10%
R ₁₈	4,700Ω ± 20%
R ₁₉	47,000Ω ± 10%
R ₂₀	1,000Ω ± 10%
R ₂₁	330Ω ± 10%
R ₂₂	4,700Ω ± 20%
R ₂₃	33,000Ω ± 10%
R ₂₄	100Ω ± 10%
R ₂₅	1,000Ω ± 10%
R ₂₆	33,000Ω ± 10%
R ₂₇	100Ω ± 10%
R ₂₈	1,000Ω ± 10%

R ₂₉	33,000Ω ± 10%
R ₃₀	56,000Ω ± 10%
R ₃₁	21Ω ± 1%
R ₃₂	47,000Ω ± 10%
R ₃₃	5,000Ω ± 10%
R ₃₄	330Ω ± 10%
R ₃₅	4,700Ω ± 20%
R ₃₆	11Ω ± 1%
R ₃₇	2Ω ± 1%
R ₃₈	100Ω ± 10%
R ₃₉	22,000Ω ± 10%
R ₄₀	100,000Ω ± 10%
R ₄₁	33,000Ω ± 10%
R ₄₂	56,000Ω ± 10%

NOTE :
 For "A" range R₈ is 2,200Ω ± 5% and C₁ is 15pF.
 For "B" and "C" ranges R₈ is 3,000Ω ± 5% and C₁ is 20pF.

TC1	4/20pF
TC2	4/20pF
TC3	4/20pF
TC4	4/20pF
TC5	4/20pF
TC6	4/20pF
TC7	2.8/8.9pF
TC8	2.8/8.9pF
NC	2pF ± 2pFmax.

use of crystal control for both of these units, and since there is an upper frequency limit to which crystals can be ground, frequency multiplication is necessary in both cases. Since transmission at these frequencies is quasi-optical the use of high radiated powers is unnecessary.

It is also undesirable, because of the risk of interference in other areas. A properly chosen site for the headquarters station, having as great an effective height for the aerial as possible and in an electrically quiet neighbourhood, is of much greater importance. For normal cases ra-

diated powers of 5-10 watts for mobile transmitters and 100 watts for headquarters transmitters are adequate; where the headquarters site is not very good or traffic is very dense, causing high interference levels from noise on mobile receivers, a radiated power of 500 watts from the head-

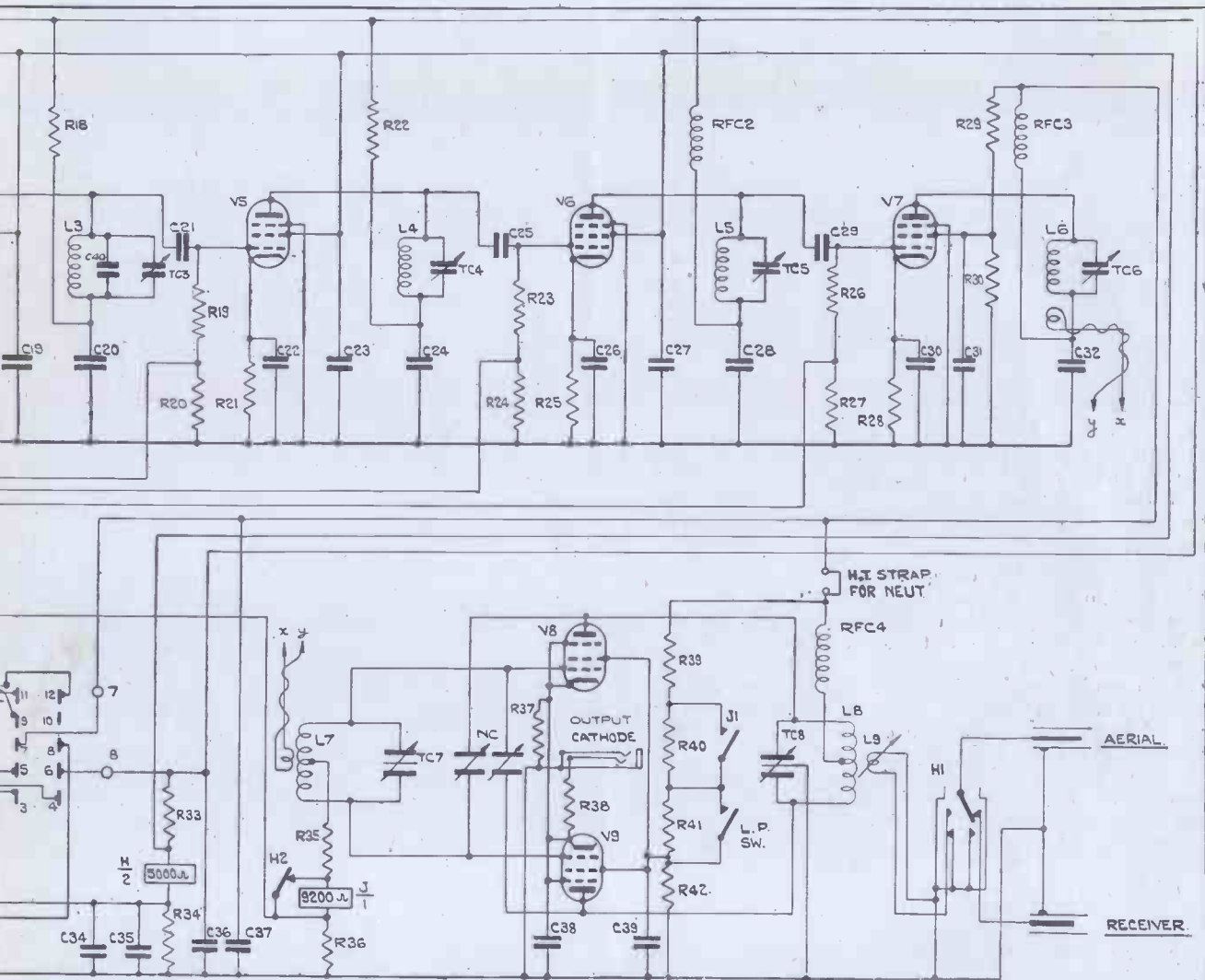

C ₁	47pF	± 10%	C ₁₅	15pF	± 10%	C ₂₈	.002μF	± 25%
C ₂	.0002μF	± 10%	C ₁₆	.01μF	± 25%	C ₂₉	15pF	± 10%
C ₃	.01μF	± 25%	C ₁₇	4.7pF	± 0.5pF	C ₃₀	.0002μF	± 10%
C ₄	.01μF	± 25%	C ₁₈	.01μF	± 25%	C ₃₁	.0002μF	± 10%
C ₅	.01μF	± 25%	C ₁₉	.01μF	± 25%	C ₃₂	100pF	± 10%
C ₆	10pF	± 10%	C ₂₀	.01μF	± 25%	C ₃₃	.0005μF	± 15%
C ₇	.01μF	± 25%	C ₂₁	4.7pF	± 0.5pF	C ₃₄	2μF	± 25%
C ₈	4.7pF	± 0.5pF	C ₂₂	.01μF	± 25%	C ₃₅	2μF	± 25%
C ₉	.005μF	± 25%	C ₂₃	.01μF	± 25%	C ₃₆	2μF	± 25%
C ₁₀	See Note		C ₂₄	.01μF	± 25%	C ₃₇	2μF	± 25%
C ₁₁	.01μF	± 25%	C ₂₅	15pF	± 10%	C ₃₈	.0005μF	± 15%
C ₁₂	.01μF	± 25%	C ₂₆	.0005μF	± 15%	C ₃₉	.0005μF	± 15%
C ₁₃	47pF	± 10%	C ₂₇	.0005μF	± 15%	C ₄₀	15pF	± 10%
C ₁₄	.01μF	± 25%						

List of Valves

V ₁	KTW 61
V ₂	KTW 61
V ₃	KTW 61
V ₄	KTW 61
V ₅	KTW 61
V ₆	TT II
V ₇	TT II
V ₈	TT II
V ₉	TT II

quarters transmitter may be worth while, but these cases are rare. Receiver sensitivities below 5 microvolts from a 75 ohms source are required and for A.M. efficient noise suppressors are essential.

Soon after Major Armstrong had introduced frequency modulation for

high-quality broadcasting in the U.S.A., extended tests were made in this country by the Research Laboratories of the G.E.C. on the system, primarily with a view to its use in the communications field. These tests showed that its chief advantages were the very good noise suppression

and nearly perfect A.G.C. action of the receiver, together with the low level of modulation and the high efficiency of the output stage of the transmitter. In A.M. transmitters high-level modulation is largely used; it is simple and a good modulation characteristic can be obtained

up to the large depths of modulation desirable in this class of service. The modulator is therefore responsible for an appreciable fraction of the weight, bulk and power consumption of the transmitter. Little saving results from the use of grid modulation or linear amplifiers, since for the same aerial power larger output valves are necessary because of the lower efficiency of such stages. The net result may well be a reduction in size of the modulation transformer but increased overall cost.

In F.M. transmitters the use of output stages not amplitude modulated enables more power to be obtained from the same valves and it also enables a range of transmitters to be designed in which each acts as a driver to the next larger, e.g., a 10-watt transmitter may drive a 100-watt and it in turn may drive a 500-watt output stage.

The tests referred to above were also used to determine the best deviation for these applications. Briefly, a large deviation improves the signal-noise ratio for all signals above a certain minimum field strength but a small deviation allows a weaker signal to be received at the cost of a certain reduction in signal-noise ratio in the strong signal area. The receiver band width and discriminator characteristic must, of course, be correspondingly adjusted in each case, as it is obvious that if a wide band receiver is used a reduction in the transmitter deviation will reduce the signal-noise ratio, without giving any corresponding gain in reception of weak signals. Since the greatest possible service area is desired and the signal-noise ratio is so good as to be a secondary consideration, this points to the use of a small deviation, but at the high carrier frequencies used another factor becomes important.

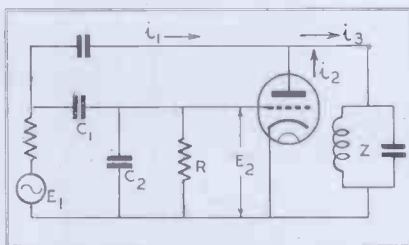

Fig. 2.

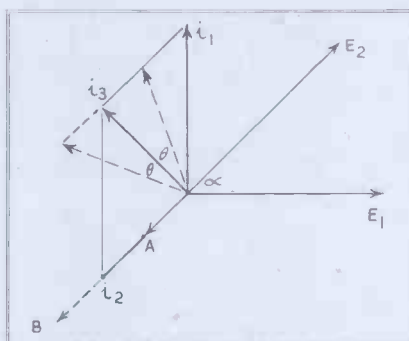

Fig. 3.

The receiver must accommodate not only the maximum deviation but also any frequency drifts which may occur. A good deal of the noise reduction is due to the discriminator, which, when accurately tuned to the carrier frequency, acts as a balanced bridge to any amplitude modulation which passes the limiters. If the carrier frequency drifts more than a certain percentage of the deviation from this ideal value, the noise becomes noticeable. A commonly used standard specification for crystals calls for tolerances on cutting error and thermal drift which would allow a possible maximum frequency difference between transmitter and receiver of ± 40 kc/s. at 100 Mc/s., and

to meet the condition just laid down a very wide deviation would be necessary. By designing a simple type of thermostatically controlled crystal oven which also incorporates an adjustable crystal air-gap, these tolerances were so reduced that a deviation of ± 12.5 kc/s. could be used. In practice this has proved a good compromise between the conflicting requirements of good signal-noise ratio and minimum usable signal for this particular application. Improvements in crystal control may allow the use of smaller deviations, or the same deviation at higher frequencies in the future; on the other hand, applications may call for greater deviations even with improved crystal control.

A point to note is that, since all mobile receivers work with the one headquarters transmitter, small variations in receiver crystals may be taken up by adjustment of the I.F. and discriminator transformers, and this was actually done in the first system installed because the crystal ovens were in an early stage of development and not easily obtainable. No trouble has been experienced, since temperature variations are much less than those which the crystal specification lays down. All transmitter crystals were of the temperature-controlled type since in this case no corresponding adjustment is possible if all transmitters are to be receivable on any receiver.

The frequencies necessary to transmit speech with very good intelligibility, but some loss in naturalness are from 300 to 3,000 c/s., and in systems of the type being described it is not advisable to exceed this band. An extension on the high-frequency side introduces noise of a particularly annoying type; an extension on the

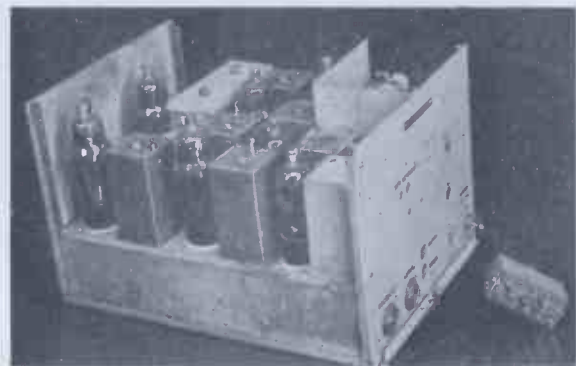
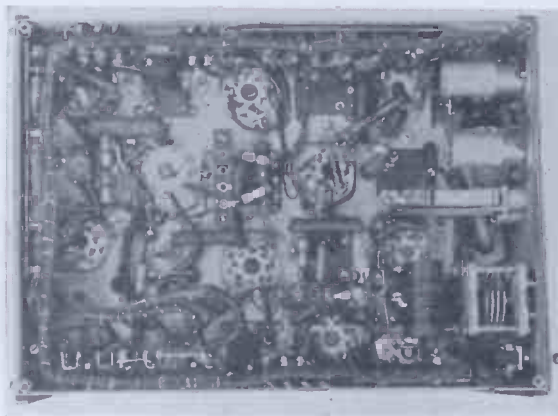

Fig. 4
(left).
Top view,
and
Fig. 5
(right).
Bottom view
of
transmitter.



low-frequency side can lead to pick-up of drumming noises in the case of cars. During the installation this was well illustrated. The quality of the transmission received from a certain car was unsatisfactory and after all the usual red herrings had been chased it was traced to the carbon microphone. This was a standard Post Office microphone inset, but owing to availability of production it was of a slightly different pattern to those previously used. A response curve showed a peak in the region of 40 c/s. while the car had a resonance at about the same frequency, which was not normally unduly noticeable to its occupants. The same microphone in other cars had caused no trouble, but the original type was, of course, used on all installations.

Two methods of frequency modulation are practicable; one uses a reactor valve to modulate a master oscillator whose mean frequency is indirectly controlled by a crystal, and the other uses a crystal-controlled oscillator whose phase is modulated in some way. Both methods normally employ frequency multiplication to obtain the output frequency; any such multiplication also multiplies the deviation by the same factor.

The reactor method gives frequency modulation directly and can produce wide deviations at the fundamental frequency with little distortion. The use of a master oscillator, only indirectly crystal controlled, tends to make it subject to microphony. It is probably most suited to high quality broadcast transmitters where the very large multiplications necessary to produce deviations of the order of ± 75 kc/s. from very low audio-frequencies lead to considerable complications in the case of phase modulators.

The direct crystal control of the phase modulator makes it practically immune from microphony and therefore particularly suitable for mobile transmitters. Modulation is normally effected by taking a portion of the oscillator output, amplitude modulating it and recombining it in quadrature with the original. The phase deviation thus produced must not exceed about ± 0.5 radian if appreciable distortion is to be avoided; the required deviation must be obtained by multiplication. If the lowest audio-frequency to be transmitted without attenuation is 300 c/s. and the final deviation required is ± 12.5 kc/s. the required multiplication is just under 84 times. In practice a multiplication

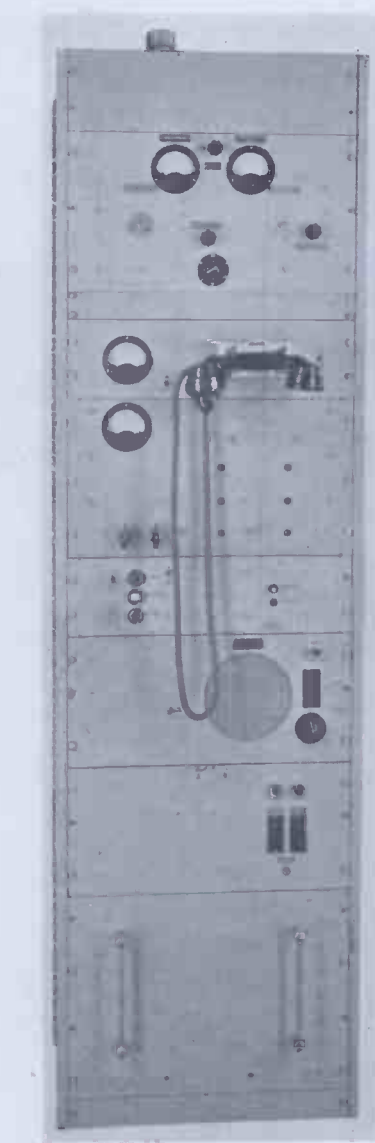

Fig. 8. A 500-watt F.M. transmitter and receiver.

of 72 times is used for convenience and is satisfactory since full modulation only occurs on the peaks of speech and peak clipping causes little distortion. The crystal oscillator frequencies required are thus of the order of 1 Mc/s. and such crystals, although not exactly popular with the manufacturers, can be obtained.

To produce frequency modulation from a phase modulator a simple network is necessary to make the audio-voltage applied to the modulator inversely proportional to the frequency. If this is provided the two methods of modulation are to all intents and purposes identical.

A Post Office type of carbon microphone inset is normally used. It is robust, cheap, and very closely controlled in manufacture, and various holders such as hand-sets with or without press switches, desk-sets, etc., are readily available. If the direct current feed is kept low the speech quality is remarkably good, better, in fact, than is given by many small moving-coil microphones. The only serious defect is that in very noisy situations, distortion can be severe due to the cross-modulation effect common to all carbon microphones. The transmitters have, therefore, been designed so that an extra amplifier valve can be fitted and the necessary changes made to use low-level microphones of any usual type.

A schematic diagram of a 10-watt transmitter is shown in Fig. 1 and a list of valves is given in Table 1.

TABLE I

Valve	Type	Function
V ₁	KTW61	Crystal oscillator
V ₂	KTW61	Phase modulator
V ₃	KTW61	Frequency tripler
V ₄	KTW61	Frequency doubler
V ₅	KTW61	Frequency tripler
V ₆	TT11	Frequency doubler
V ₇	TT11	Frequency doubler
V ₈	TT11	Push-pull output

The KTW61 is a well-known Osram valve; the TT11 is an Osram aligned grid R.F. tetrode with a plate dissipation of 7.5 watts.

The crystal oscillator is of a standard type, except that the following stage is fed from its cathode to provide a low impedance source for the modulator. Fig. 2 shows a schematic diagram of the phase modulator and Fig. 3 a vector diagram explaining its action.

The current i_1 leads the voltage E_1 by 90° . By a proper choice of C_1 , C_2 and R the voltage E_2 can be made to lead E_1 by the angle α . The current i_2 is 180° out of phase with E_1 and when combined with i_1 produces the current i_3 which develops a voltage across the tuned circuit Z . Components are so chosen that in the absence of modulation i_2 and i_3 are in quadrature. When audio-frequency voltages are impressed on the grid the anode current i_2 is caused to swing from A to B causing the phase of the current i_3 to vary in its turn through an angle $\pm\theta$ which is made approximately 30° for full modulation. As is usual in phase modulation systems, some amplitude modulation is also produced, but this is removed by the subsequent stages.



The interior of a police patrol car, showing the microphone on the dashboard and the loudspeaker below. The control panel is under the glove box.

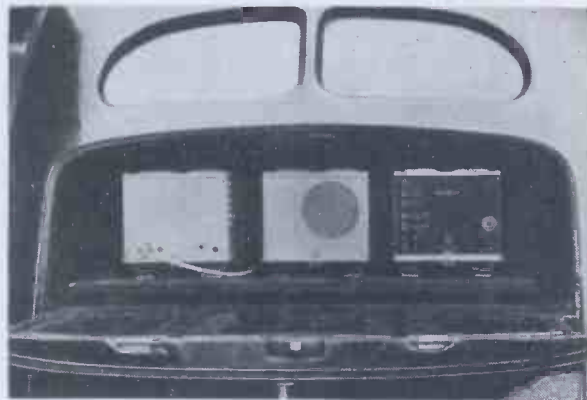

G.E.C. equipment in the boot of a patrol car. Left to right: receiver, power unit and transmitter.

By courtesy of the G.E.C. Ltd.

Returning to the main diagram, Fig. 1, the resistance-condenser network R, C , is the usual arrangement for producing frequency modulation from a phase modulator. Valves V_3 to V_7 are multipliers of the type in which the anode circuit is tuned to the required harmonic of the grid circuit. All these valves and the push-pull output stage are operated in Class C. An adjustable link couples the output tank circuit to the aerial cable socket via a special relay spring set designed to have a similar characteristic impedance to the cable used. The aerial cable socket is normally connected through this spring set to another socket to which the receiver aerial cable is connected. When H.T. is applied to the transmitter relay H operates to connect the aerial to the transmitter. It also removes a short-circuit from relay J which operates to provide full screen voltage to the output valves. The main function of relay J is to reduce the screen voltage to a safe value in case of loss of drive to the output stage. Possible alternatives would be to use either an external bias supply or cathode bias. The first method has obvious disadvantages, the second has two defects; it entails an appreciable loss of H.T. voltage and if the bias is sufficient to afford protection it becomes too great when the stage is driven.

Two H.T. supplies are required, one at 250 volts for all the earlier stages and a second at 300 volts for the last doubler and the output stage. This is done for economy and because such a transmitter is invariably used with a receiver, the power supply for which is used also for the earlier transmitter stages. The saving in cost and weight is considerable, par-

ticularly in battery-operated mobile installations which are normally worked in simplex, *i.e.*, the transmitter and receiver are never on at the same time.

Figs. 4 and 5 show top and bottom view of the transmitter with covers removed and give a good idea of the type of construction and accessibility. The receiver and common power supply with its two rotary converters and relays for remote switching use the same size chassis and identical base, side and top plates. The base plate fits on a standard tray which is provided with shock-proof mountings, and from which it can be released by slackening a single screw. The base plate fits on a standard tray which is provided with shock-proof mountings, and from which it can be released by slackening a single screw. The receiver also is of identical construction.

As a number of amplitude modulated 100 watt headquarters transmitters are in service the first frequency-modulated transmitter of this type took the form of a conversion, the modulator and its power supply in the A.M. transmitter being replaced by the F.M. modulator-driver and its much smaller power supply. During the transition period the amplitude modulator can be left connected and the transmitter used for either A.M. or F.M. by inserting the microphone jack in the appropriate plug. Figs. 6 and 7 show front and rear views of this transmitter. The panels, reading from the bottom, are: R.F. power supply; modulator-driver power supply; control; modulator-driver; driver and output. The modulator-driver circuit is essentially similar to that of the low power transmitter already des-

cribed, except that less multiplication is used, since a multiplication of 16 times is already provided by the driver panel of the A.M. transmitter.

As an example of the saving effected by the use of F.M. in transmitter design, and the flexibility of this system, Fig. 8 shows in the same cabinet an assembly of panels which provides both a 500 watt transmitter and a receiver. The panels, again starting from the bottom, are: 500 watt amplifier power supply; 10 watt transmitter and power supply; receiver and power supply; control; 100 watt amplifier and power supply; hand set; and 500 watt amplifier.

Both the receiver and the 10 watt transmitter are standard mobile units fed from A.C. power packs. The 10 watt transmitter acts as a driver to the 100 watt amplifier, which in its turn drives the 500 watt output stage. A 100 watt transmitter would therefore consist merely of the 10 watt transmitter driving the 100 watt amplifier, with either a control panel or a separate small controller. Alternatively, on the assembly shown, arrangements could be made to connect the aerial to either the 10, 100 or 500 watt stage at will, while there would be no difficulty in adding another stage to produce, say, 5 kW output.

It can be seen that, from the point of view of transmitter design, F.M. would be attractive even if it had no other advantages, such as its noise reducing properties. It is probable that the F.M. and A.M. systems will exist side by side, each being used under those conditions where its characteristics give it the advantage.

The author wishes to thank the General Electric Company for permission to publish this article.



MORGANITE RESISTORS

A
MORGAN
product

A STUDY IN FLEXIBLE COUPLINGS

The "Flexilant" Pinion

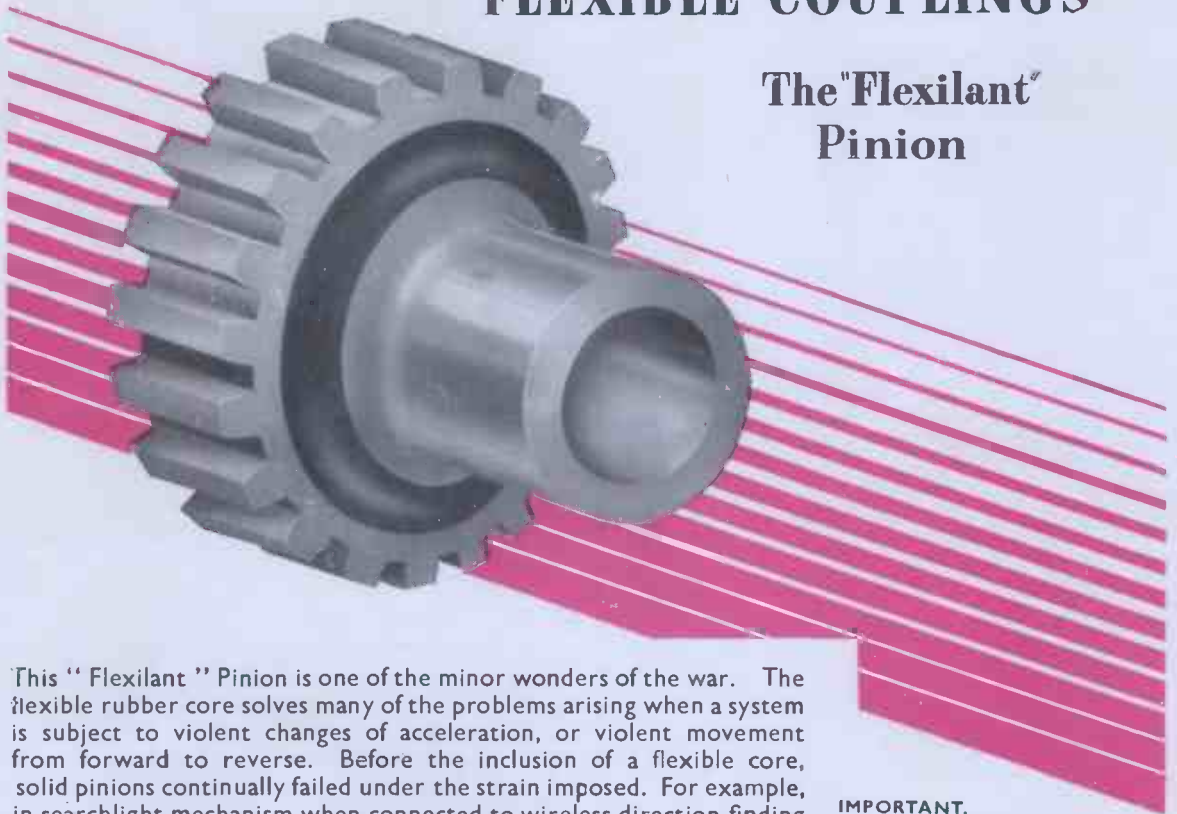

This "Flexilant" Pinion is one of the minor wonders of the war. The flexible rubber core solves many of the problems arising when a system is subject to violent changes of acceleration, or violent movement from forward to reverse. Before the inclusion of a flexible core, solid pinions continually failed under the strain imposed. For example, in searchlight mechanism when connected to wireless direction-finding equipment.

This "Flexilant" Pinion has a rubber element $1\frac{1}{8}$ " OD x $\frac{1}{8}$ " ID x $\frac{5}{8}$ " long. It is given a torque-test of 25 ft. lbs. applied 4 times in alternate directions. The displacement on the first and last application of this torque is between 10 to 15 degrees. The maximum permissible eccentricity between bore of boss and pinion teeth is .0075". This principle of using a rubber core can be applied to any sized wheel under suitable conditions.

IMPORTANT.

The "Short Review of FLEXILANT Products" Second Edition, gives a quick glance over the field of rubber-bonded-to-metal applications with typical examples. May we send you a copy?

You may wonder whether a bonded product would solve your problem. We would know - if you asked us.

RUBBER BONDERS LTD.

ENGINEERS IN RUBBER BONDED TO METAL

FLEXILANT WORKS • DUNSTABLE • BEDS.

TELEPHONE: DUNSTABLE 803-4-5



Microphones

Part III (continued)

By S. W. AMOS, B.Sc.,* and F. C. BROOKER, A.M.I.E.E.*



MODERN Types (S.T. & C.).— Fig. 7a shows a view of a Standard Telephones & Cables model 4017-A microphone, partially withdrawn from its case to show the magnet system. Another view of the same model, showing the diaphragm, was given in Part II of this series. Its diaphragm is dome shaped and corrugated, and is clamped firmly around its edge. Maximum use is made of the available winding space (a) by using flat, rectangular sectioned, aluminium, wire, and (b) by dispensing with a former; the turns being held together (and, at the same time, insulated) by phenol varnish. In the design of this microphone very great use has been made of the science of electro-acoustics, and behind the diaphragm one finds a veritable network of acoustic elements. Were it not for these elements the response would show irregular peaks at the higher frequencies and a falling off at the lower frequencies. Of particular interest is the equalising tube which couples a part of the air pressure appearing at the front to the back of the diaphragm. The phasing of this back pressure is such as to aid the total response at low frequencies. This does not entitle it to the description of "velocity" operation as the sound pressure reaching the back is merely a sample of the sound pressure on the front of the diaphragm . . . it cannot be claimed that the diaphragm is "open on both sides." Fig. 7b shows how these slits, cavities and tubes are arranged, and 7c gives the equivalent electrical network. This circuit is essentially a bandpass filter, the physical size and disposition of the elements having been arranged so as to produce the flattest possible fre-

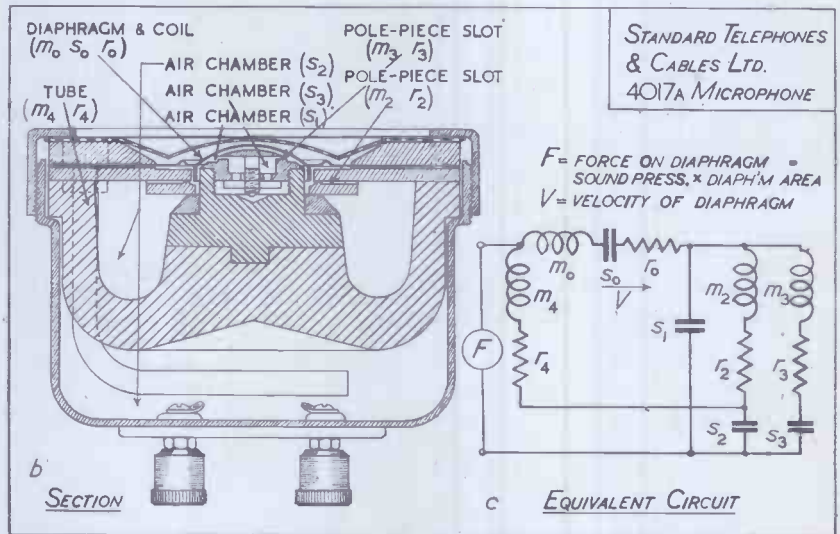

Fig. 7a (left). Microphone, type 4017-A, partially withdrawn from case. By courtesy of Standard Telephones & Cables, Ltd.

Fig. 7b and c. Cross-sectional view and equivalent circuit of a modern moving-coil microphone.

quency characteristic over a band of approx. 35 to 10,000 c/s. Because the dimensions are smaller than those of the Reisz or Magnetophone, diffraction effects are correspondingly less. The frequency response is thus less dependent upon the direction from which the sound emanates, but it is generally desirable to have the performers grouped within a cone of about 60° width in front of the microphone. A further step in the direction of attaining an "omni-directional" response (*i.e.*, equal response from all directions) was made by the Standard Telephones & Cables Co. in their model 4021-A. The casing of the microphone (Figs. 8a and 8b) is made absolutely spherical, and is only 2¼ in. across, thus minimising the diffraction effect at high frequencies. An "acoustic screen," placed in front of the diaphragm opening, serves the double purpose of attenuating the high frequencies arriving from the front (*i.e.*, cuts down the pressure-doubling effect) and reflects sounds arriving from the sides or behind. The pressure response is adjusted by a similar acoustic network to that described earlier, and gives a flat band-pass characteristic. It has been possible to simplify the cavity and slit arrangements because the general reduction in size of the diaphragm assembly has put its

resonant frequency up to a higher figure. It will be noticed that the opening of the bass-compensating tube is at the rear of the microphone casing. This is quite in order, as the wavelengths for which this tube is effective are so long, in comparison with the microphone dimensions, that the pressure is substantially the same all over the microphone.

The output of these two microphones is - 80 db. for the ordinary model (4017-A) and - 87 db. for the omni-directional (4021-A) type, both expressed with respect to the usual zero level of 1 volt (open circuit) per dyne per sq. cm. The output impedances are 30 ohms and 20 ohms respectively and it is usual to provide a line transformer to step up the impedance to about 300 ohm.

Condenser Microphones

As the name implies, this microphone is in reality a condenser. One plate is fixed and the other (the diaphragm) movable by virtue of the sound waves which impinge upon it. Thus the operation depends upon variations of capacitance, and when the microphone is connected up as shown in Fig. 9, will produce a varying P.D. across the resistance *R*.

The wanted A.C. component is then

* Engineering Training Department, B.B.C.

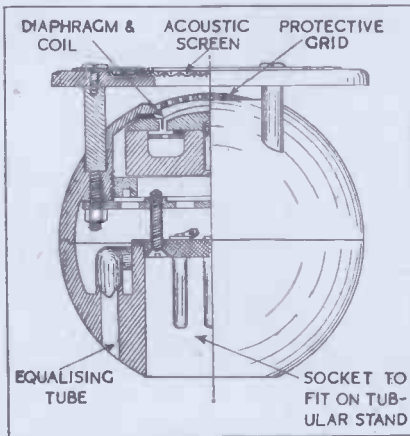

Fig. 8b. Part-sectional view of microphone, No. 4021-A.

By courtesy of Standard Telephones & Cables, Ltd.

taken off by the usual blocking condenser to avoid applying the polarising voltage to the amplifier which follows it. The construction of the microphone is fairly simple, consisting of a flat, stretched, duralumin diaphragm fixed about 0.002 in. from a rigid metal plate (Fig. 10). To make the voltage output proportional to sound pressure it is necessary that the displacement of the diaphragm should be independent of frequency. Stiffness control is therefore used, the resonant frequency of this stretched diaphragm being in the region of 8,000 c/s. The space between the diaphragm and back plate has to be kept small in order to preserve high sensitivity. In the earlier models the back plate was made flat and no escape for the air was provided, which, while providing a certain amount of resistive damping (as explained earlier), also added stiffness to the moving element. This latter feature is undesirable as the stiffness of the trapped air increases with frequency, so producing a displacement which falls off with an increase of frequency, for a given sound pressure.

This effect was overcome by providing slots in the back plate, as

Fig. 9. Circuit for condenser microphone.

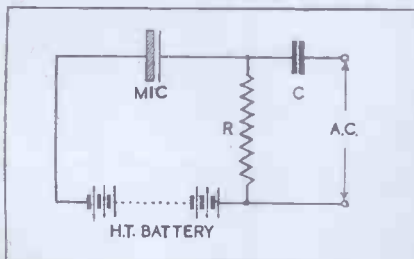

shown in the sectional diagram. The vent hole shown is to allow for long-term changes of pressure. The capacitance of the microphone is usually of the order of 200 $\mu\mu\text{F}$ and, due to this high impedance, any added capacitance would result in a loss in sensitivity.

The loss in sensitivity due to an external capacitance, C_s , being connected in shunt with the microphone, C_m , is given by the expression:

$$\text{loss (in db.)} = 20 \log_{10} \left(1 + \frac{C_s}{C_m} \right)$$

which shows that even leads of 200 $\mu\mu\text{F}$ capacitance would result in a loss of 6 db. Hence, to avoid the use of long leads, it is usual to mount the first stage of the amplifier in the microphone housing itself. The type first used by the B.B.C. utilised a streamlined "bomb" casing to house both microphone and amplifier, in order to minimise diffraction effects. American and German practice was to incorporate the amplifier in the top of a tubular stand, the increased diameter of the tube being only of the order of 3 in. diam. (A

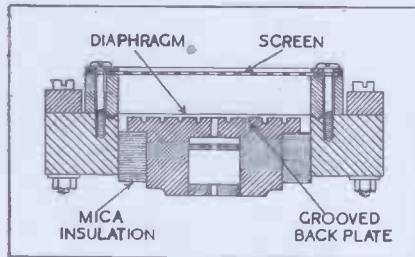

Fig. 10. Cross-section of condenser microphone.

photograph of one of these types was given in Part I of this article.) In a later version used by the B.B.C. the amplifier was arranged in two parts, the only components at the microphone end of the line being the essential ones of valve, grid leak and coupling condenser. This enabled a very much reduced size of casing to be used and, as this was made of perforated metal, diffraction effects were correspondingly small. The output of such a microphone (by itself) is between -60 and -65 db. below 1 volt, but it must be remembered that this is at high impedance. The "head" amplifier does not materially increase this voltage, its main function being to couple the high-impedance microphone (approx. 1 megohm) to the low-impedance line (300 ohm generally).

Piezo-Electric Microphones

The principle of operation of this

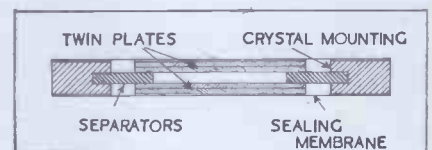

Fig. 8a. Microphone, type 4021-A.

By courtesy of Standard Telephones & Cables, Ltd.

type of microphone is that slices of certain crystals, notably quartz, tourmaline, and Rochelle salts, will produce an e.m.f. between their faces when the crystals are subjected to mechanical pressure or deformation. For microphones, Rochelle salt crystals are used because of their superior sensitivity. The crystals are usually made up in the form of twin elements (known as "bimorphs"), which are really two crystals placed back to back and in such a way that the voltages aid each other when the crystal is bent or twisted, according to the purpose for which it is intended. These bimorph elements are very small, about 0.5 in. sq. and as thin as 0.03 in., so that diffraction and directional effects are negligible. The Brush Development Company have evolved a unit which they call a "sound cell," and which consists

Fig. 11a. Section of "Brush" sound cell.



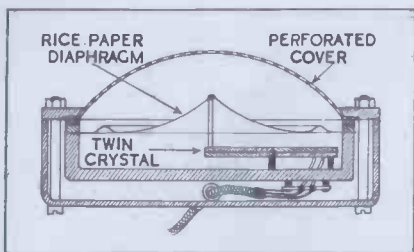
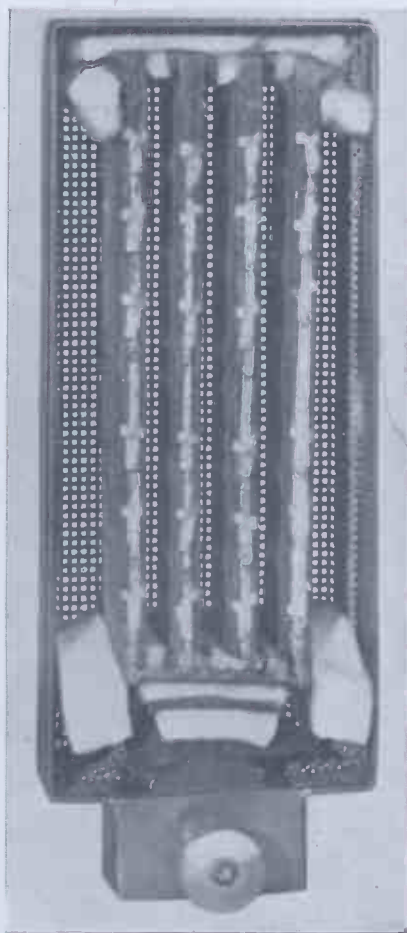

Fig. 13. Section of diaphragm-actuated crystal microphone.

of two bimorphs mounted in such a way as to leave an enclosed air space between (Figs. 11a and 11b). This arrangement gives a fair amount of freedom from pickup due to mechanical shock; for if the whole cell is moved so that the plates move in the same direction, the voltages are of opposing polarity and so cancel each other. One sound cell can be made to give a practically level response up to 15,000 c/s. and a sensitivity of - 90 db. for 1 dyne/sq. cm. input. If required, the

Fig. 11b. "Brush" single-cell microphone.



sensitivity can be improved by using several sound cells (as many as 24 have been used) in one microphone, the outputs being connected in series or parallel. The photograph (Fig. 12) shows how these are mounted, and the output of this model is about - 65 db.

The crystal, with its plates, behaves as a condenser and its impedance is therefore high, but not so high as the condenser microphone. All that has been said about condenser microphones with respect to matching and the use of head amplifiers refers also to crystal microphones to some degree. For multi-cell types connected in parallel, the consequent lowering of impedance allows one to dispense with the head amplifier for reasonably short lengths of cable lead. The crystal microphones described above are known as "direct-actuated" types, as the sound wave is allowed to impinge upon the crystal itself and thus deform it. There is another type, also a Brush product, which is diaphragm-operated, and is illustrated in Fig. 13. Only one crystal element is used, the diaphragm being an acoustic transformer which increases the coupling between air and crystal and so increases the sensitivity. A "twister" type of crystal is used, clamped at three corners and actuated by the diaphragm at the remaining corner. The use of a diaphragm inevitably introduces other effects, which have already been dealt with.

Directional Properties of Pressure Microphones

It has been seen that all pressure-operated microphones exhibit directional characteristics to some degree, dependent upon their physical size. It was shown, in Part II, that for a microphone of, say, 3 in. diam., there was negligible frequency distortion for sound waves arriving from a source within a cone of about 60° normal to the diaphragm, but that as the sound source moved progressively away from this cone, the response to frequencies above 1,000 c/s. fell off rapidly. While this was previously illustrated by a series of response curves drawn for different angles of incidence, a "polar diagram" gives a clearer picture of the state of affairs. Fig. 14 gives such a diagram, which is a cross-section of the field around a microphone, with contours ranging from 500 to 10,000 c/s. For frequen-

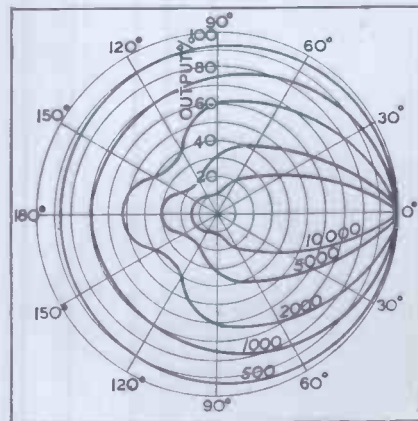

Fig. 12. "Brush" multi-cell microphone.

cies below 500 c/s., the contours are practically circular (N.B., they are really spheres, the polar diagram showing only a cross-section of the field) but at higher frequencies the microphone becomes progressively more "one-sided."

The practical implication of the foregoing is in the matter of attaining a correct artistic balance of the performers. By "balance" is meant the ratio of direct to indirect (i.e., reverberant) sound pick-up, and this ratio will depend upon the placement of the microphone with respect to the sound source. A microphone of the highly directional type will, for a performer situated a given distance away, give a larger ratio of direct/indirect sound than a microphone of the "omni-directional" type similarly placed. That is because the indirect sound is picked up from all round the microphone, but the direct pick-up is confined to a fairly narrow cone. In the next article, it will be shown how the directional properties, or otherwise, of differential pressure microphones are exploited in various forms of balance technique.

Fig. 14. Polar diagram for typical pressure-operated microphone.



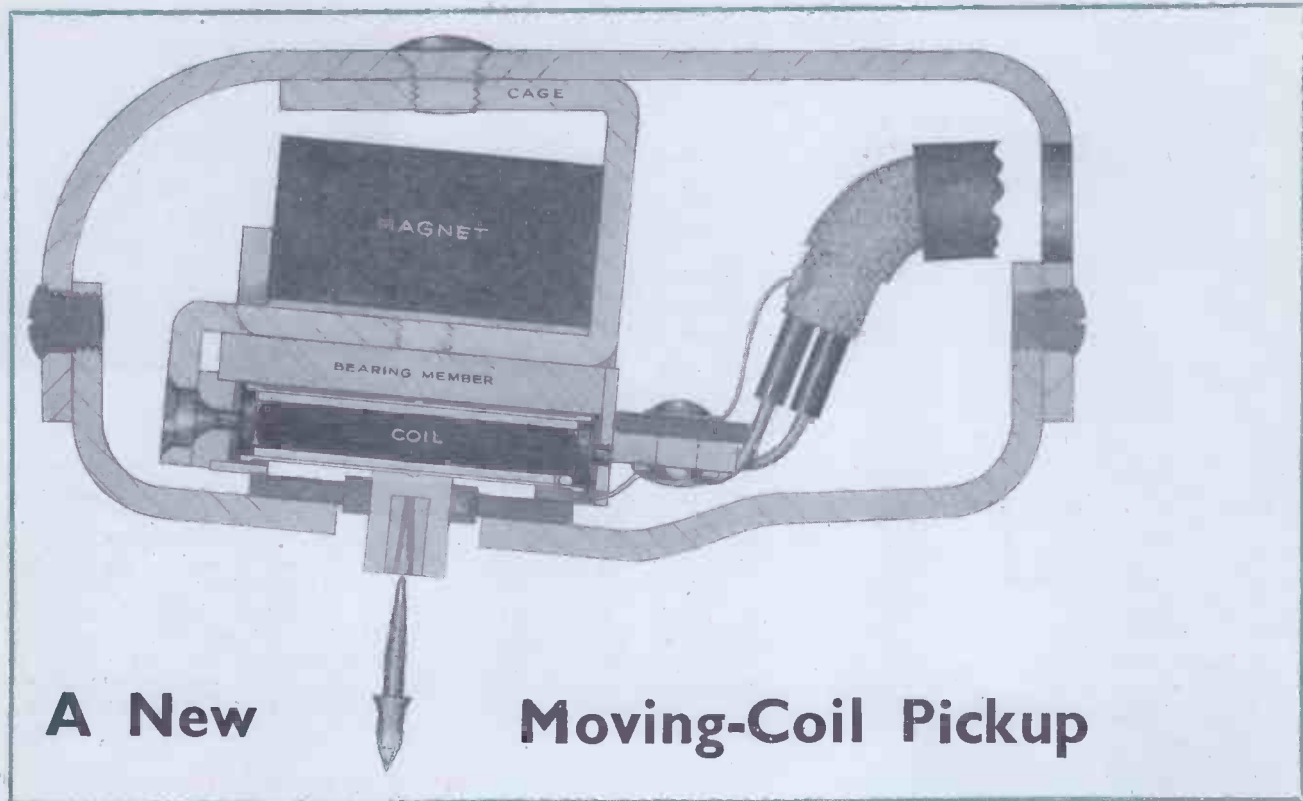

THE advantages of using the principle of the moving coil in pickups for gramophone reproduction have been recognised for many years, and the chief among these is its freedom from harmonic distortion. In order to lighten the weight on the record the coil can be made small and compact, and record wear is reduced by as light damping as possible.

In most light-weight pickups the reduction in pressure on the record is helped by eliminating the needle holder and locking screw and arranging for the needle to be self-supporting and as close to the coil as possible. This led to the use of sapphire needles which were fixed as an integral part of the pickup movement. The advantage of the sapphire reproducing point in long playing life and sharpness was, however, offset by the necessity for dismantling the pickup when a new needle had to be fitted, and the need for care in handling the pickup.

Further, even if a replaceable sapphire mounting were used, the sapphire would have to be inserted in the same position after removal, to prevent the facets formed by normal wear from cutting into the record.

It is claimed that all these design points have been successfully met in the new "Lexington" pickup, made by the Cooper Manufacturing Co., 134 Wardour Street, London, W.1.

It is of the moving coil type with provision for using both sapphire and steel needles, has a flat response curve from 30 c/s. to 12 kc/s., and has a weight on the record of only $\frac{1}{2}$ oz.

Construction

The construction of the moving coil system is shown in the accompanying photographs, which bear out the manufacturer's claim that it is "made like a watch."

The moving coil is wound on a thin perspex strip and is inserted in a perspex tube with walls .005 in. thick (Fig. 2). The centre of the tube is slightly thickened for reasons which will be seen later. Each end of the tube is closed with a small disk carrying the pivot, and the tube is then inserted into a brass carrier with jewels at each end in which the pivots rest.

The needle holder is in the form of a small perspex block cemented to the centre of the coil tube. This block has an insert with a tapered

hole into which the shank of the needle fits and is securely held. It will be seen that this method of construction ensures a purely rotational movement of the coil, the only restriction being the light rubber damping which is fitted later.

If the pickup is dropped heavily on the record, there is sufficient "give" in the tube to enable it to take the shock until the thickened centre portion touches the inside of the brass carrier, which then takes the force of the impact, protecting the coil from damage.

The brass carrier, with its coil, is assembled between pole pieces on a stiff holding jig, and the permanent magnet is slipped across the whole unit (Fig. 3). When the head is resting normally on the record the trailing angle of the needle is 5° .

An ingenious feature of the pickup is the taper holding device for the needles. The sapphire is mounted at the end of a thin aluminium shaft, the other end of which is taper turned to correspond with the hole, and which also has a small collar left on it near the needle end. This collar has a flat ground on it which serves to locate the needle in a given position relative to the holder (Fig. 4).

The data of the sapphire needle is as follows :

- Duralumin holder.
- Sapphire angle: 40°.
- Tip radius: 0.0015 in.
- Weight: 20 mgm.
- Playing time: 400-500 records.

Chromium tipped steel needles with the same tip radius to play 20 records are also available, and are interchangeable with the sapphires.

The method of changing the needles is shown in the photograph of Fig. 5. The pickup head rests over a small box, in the cover of which is a hole to take the needle shank, the side of the hole having a flat to correspond with that on the shank.

It is thus only possible to insert the needle one way into the holder, and if withdrawn, it can only be inserted the same way. The needle is then inserted into the pickup by pressing the head down on to the protruding shaft. To remove the needles, the pickup head is moved over to a second hole below which is a pair of gripping jaws. These are squeezed on the needle shank and pushed down, extracting the needle, which is then free to drop into a small tray below the hole. The only precaution which must be taken in removing or inserting needles is to avoid moving the pickup head sideways, or "worrying" the needle out.

Pickup Arm

The pickup arm is pivoted in two planes on ball bearings held in the pedestal (Fig. 6). The lower bearing projects slightly below the pickup baseplate and requires a 1 in. clearance hole in the motor baseboard to accommodate it. The head is offset by 15° to give good tracking.

The weight of the pickup head is taken partly by a cantilever spring which thrusts against the centre of the arm on a ball contact. This spring may be adjusted to compensate for the slight extra drag due to attraction of the pickup head by a steel turntable.

Performance

The pickup has been designed to give a flat response from 30 c/s. to 12 kc/s., any compensation for record-

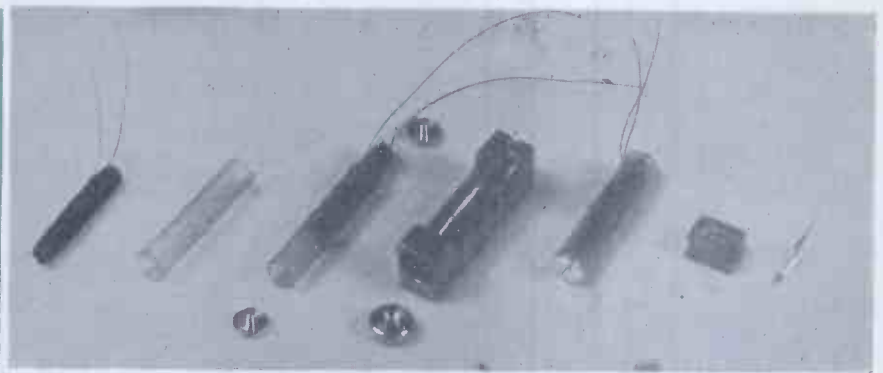

Fig. 2. Assembly of moving coil unit, showing (left to right): Coil, tube, coil partly inserted, coil carrier and completed coil needle holder and needle.

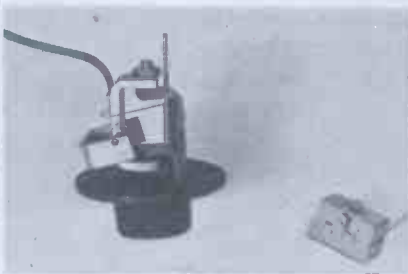

Fig. 6 (above). Pivoting of pickup arm.

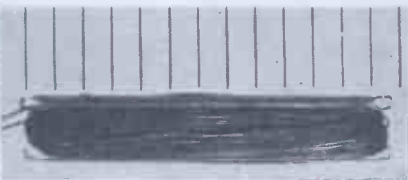
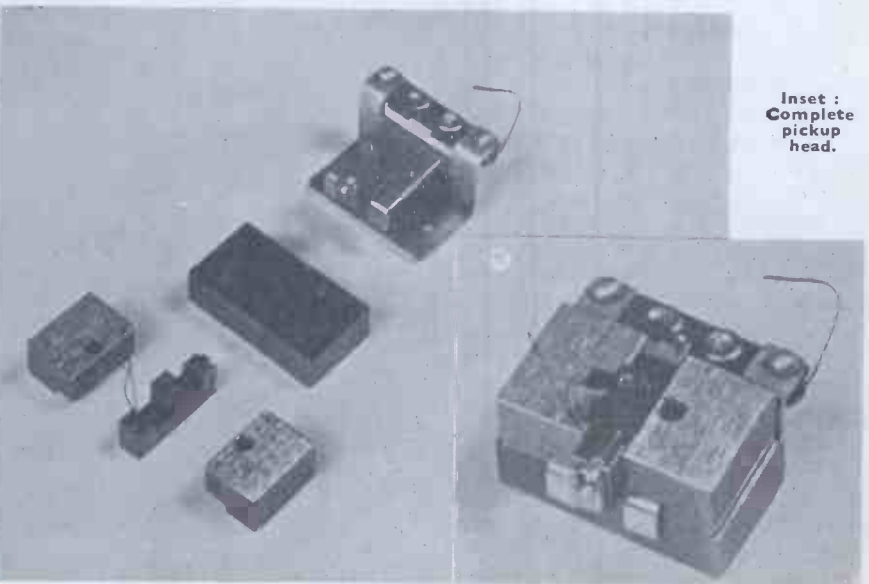

Fig. 3 (below). Assembly of coil unit in pickup head, showing magnet and pole pieces.



Fig. 5. Needle extractor and drawer showing needle. The roller arm in front acts as a pickup rest when turned up.

Fig. 4 (left). Magnified view of coil (scale in mm.).



Inset: Complete pickup head.

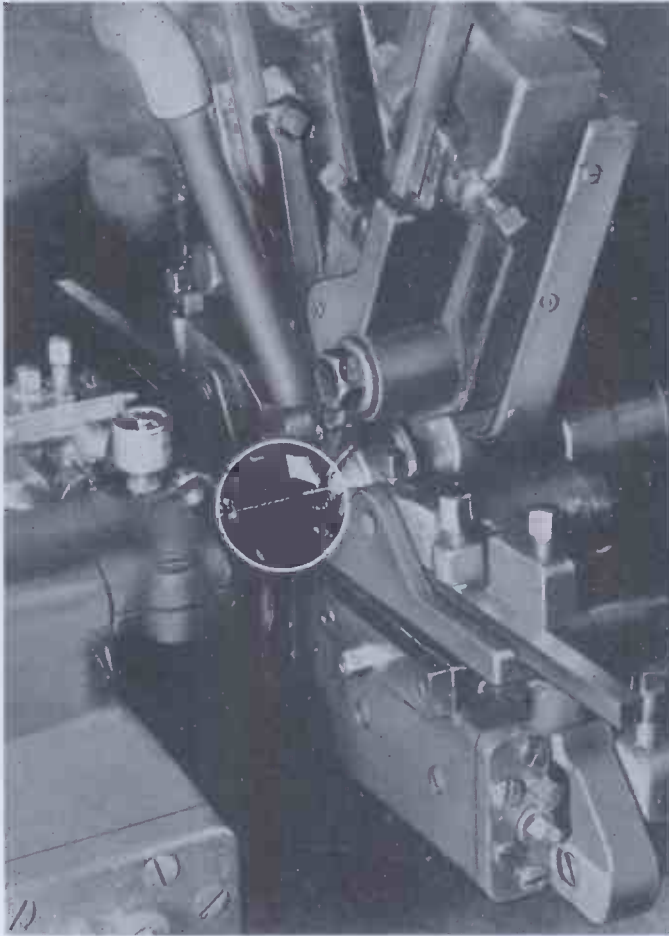

Fig. 7. Automatic machine for turning needle shafts and drilling for insertion of sapphire tip. Drill in position.

ing characteristic being made in the amplifier. Resonances have been carefully considered, and it has been found that a lift of 10 db. at 10 kc/s. is preferable to compensate for the falling-off of the average speaker. 15 db. at 30 c/s. is also desirable to compensate for the recording characteristic.

The impedance of the coil is 10 ohms at 400 c/s., and the output is 1.0 millivolt. A matching transformer is provided, which increases this output to 50 mV. The transformer has a flat characteristic from 30 c/s. to 20 kc/s. (within ± 1 db.), and can be supplied with mu-metal screening box if required.

The manufacturers also supply a preamplifier with a flat response from 10 c/s. to 20 kc/s. or with slight bass lift (*see on*).

The pickup is available complete with transformer, baseplate, and needle extractor, finished in black crystalline enamel at the very reasonable price of £5.

Preamplifier

A pickup of this type having a relatively low output and having a flat frequency response in the bass usually requires some form of correcting preamplifier when used with amplifiers normally fed by a moving-iron or crystal pickup. A compact form of preamplifier is shown in Fig. 8. This gives a gain of 15, and a bass response rising 6 db. per octave, thus correcting for the recording characteristic and providing an output of approximately 1 volt. Its size is 7 in. \times 4½ in. \times 3 in., and a double triode valve is used rather than a pentode to provide the necessary gain with correction.

Further particulars can be obtained from the Cooper Manufacturing Co. at the address quoted.

(Photographs by R. M. Weston.)



Fig. 8. Enlarged view of needle, showing collar and sapphire tip. (Scale marking in mm.)

Fig. 9 (below). Preamplifier for pickup.

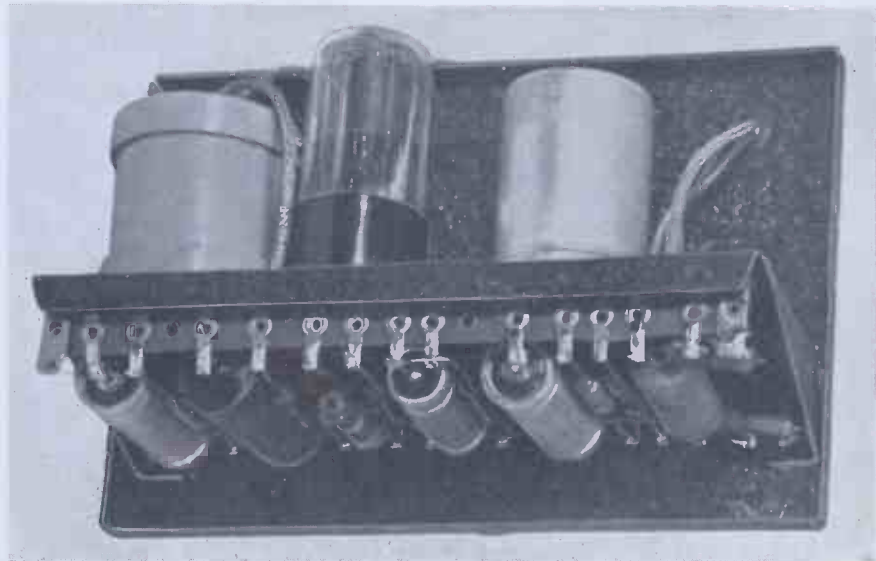

BOOK REVIEWS

Modern Practical Radio and Television

C. A. Quarrington, edited by W. H. Date, 3 volumes. (The Caxton Publishing Co., £3 10s. 0d. net.)

This three-volume treatise covers the whole field of radio and television and aims at an intermediate standard between the advanced works and semi-technical or popular accounts.

The first volume covers the ground-work—magnetism, electricity and radio theory, the second some further details of receiver circuits and television, and the last volume testing and servicing.

The illustrations, which number over 500, are a feature of the work.

In reviewing a comprehensive work of this kind it is difficult to assess its value as a whole, but valuable it undoubtedly is. There are a large number of beginners to radio who will find what they want in its covers. It will be useful to servicemen—in fact, the volume dealing with servicing is in some respects the best of the three.

On the other hand, Vol. I is perhaps the least satisfactory, owing to the enormous field compressed into it. Reactance and impedance is covered in three pages, and the single volume contains radio theory, superhets, coil design, and frequency modulation.

There are some slips, mainly due to the need for compression, which has also led to some "unclearness" in parts. For example, Fleming did not discover the Edison effect, although he was the first to apply it to radio detection. The definition of an alternating current as one which rises and falls above and below zero is not so good as saying that it reverses its direction of flow.

The moving coil pickup can hardly be described as having a relatively large output, even with a transformer attached.

The second volume includes not only circuit diagrams of five typical receivers, but also a complete television receiver, which should make the book particularly useful at the present time.

One can only admire Mr. Quarrington's zeal in compiling a work of this kind, and hope that his efforts and those of the publishers will be adequately rewarded.

G. P.

Plastics for Electrical and Radio Engineers

W. J. Tucker and R. S. Roberts (The Technical Press, Ltd.), 148 pages. 12s. net.

According to the preface, this book is concerned only with those plastics which are used as insulators and is apparently written specially for electrical and radio engineers.

Chapter I deals with the chemistry of plastics. There are a number of misprints and obscurities here and the authors would be advised to have this chapter vetted by a competent plastics chemist.

Chapter II deals with the materials, available and includes summaries of the methods by which the plastic materials are manufactured. Patently the authors have had little if any practical experience with the manufacture of the materials they describe and many errors have, in consequence, got into the text. In this connexion the authors might have been well advised to submit the appropriate portions of their text to various plastic manufacturers for criticism before publishing. They would surely find the manufacturers most helpful in pointing out errors or suggesting improvements.

Chapter III deals with terms and definitions and here the authors are on firmer ground, since they have drawn largely upon, and adequately summarised, the appropriate British Standards Specifications.

There does, however, appear to be some confusion in the matter of "inflammability." On page 80 they discuss the meaning to be applied to the term, but in the next paragraph the surprising statement occurs "Phenolic and urea formaldehyde plastics cannot be ignited at all. It therefore

follows that they will not support combustion in any circumstances."

Statements of similar purport occur on page 16. One feels that the authors should give more attention to this question of inflammability and make quite clear to the reader the difference between non-inflammability as determined by a standardised arbitrary test and, for example, the disposal of phenolic and urea moulding powder scrap by burning it in the Lancashire boilers of moulding firms.

Chapter IV deals with choice of materials, and here again the authors appear to be right on their subject, since the chapter is most informative.

Chapter V, dealing with moulding and manufacturing processes, is again not so good. The section on transfer moulding is, for such an important and industrial process, rather sketchy, and Fig. 10 should be redrawn, with attention in particular to the relative sizes of the "pot" and mould cavity.

When referring, on page 110, to proprietary adhesives, it would be desirable to indicate in the text where the reader can obtain the adhesives mentioned. The bald statement, for instance, that "Phenolic sheets and mouldings can be cemented together with Ardux cement" is not very helpful to the uninitiated.

Chapter VI deals with designing for moulding, and in the limited amount of space devoted to the subject the presentation is informative.

Chapter VII deals with plastics used as protective coatings as applied to electrical and radio apparatus, and here again the information offered has the indication of being based on practical experience, so can be studied with profit.

Chapter VIII, on enamels, insulated sleeveings and cables, is well conceived and informative: here the authors appear to have adopted the worldly wise expedient of calling in the help of an active manufacturer.

There is no index to the book, a defect which should be remedied.

The general conclusion is that the book is a little raw in places and is not to be recommended as a guide to plastics chemistry and manufacture. On the electrical side, which appears to be the authors' special forte, the information is much more reliable and authoritative. One feels that if a second edition is called for the authors could, by getting certain sections of their manuscript vetted by specialists, produce a really useful textbook.

C. A. REDFARN

**Books reviewed in this
Journal can be obtained
from**

**H. K. LEWIS & Co. Ltd.
136 Gower Street, W.C.1**

*If not in stock, they will be obtained
from the Publishers when available*

NOTES FROM THE INDUSTRY

Scientific Research and Income Tax

A booklet of explanatory notes has been issued by the Board of Inland Revenue which explain the main features of the law in operation as from April 6, 1946, with regard to income tax allowances for expenditure by traders on scientific research. Part IV of the Finance Act, 1944, authorises a new system of allowances for capital expenditure on scientific research undertaken by a trader in connexion with his trade, which provides, in general, for the expenditure to be allowed for income tax purposes over a period of five years. Also authorised is the deduction, in computing profits for income tax purposes, of certain payments made by traders to approved research associations, universities, colleges, research institutes and similar institutions for the purpose of research related to the trade, even though the payments are of a capital nature.

Marconi Instruments, Ltd., New Branch

Marconi Instruments, Ltd., have now established an office in western England at 10 Portview Road, Avonmouth, Bristol. Telephone: Avonmouth 438.

Standard Telephones and Cables, Ltd.

Industrial Supplies Division is the title of a new organisation set up by Standard Telephones and Cables, Ltd., for the exploitation and distribution of merchandise in the industrial field. It will handle the many products allied to or derived from the company's work in telecommunications, and operating as a self-contained unit, will have the facilities necessary for the type of service involved. The Division absorbs Stanelco Products, but the name "Stanelco" will continue to be used for the lines now well known under this trade mark.

Kingsbury Components, Ltd.

Change of Company Name

Kingsbury Components, Ltd., is the new name of the company previously known as Irving and Kingsbury, Ltd. Their products include single and double pole laminated toggle switches, volume controls, push-bar switches, bakelite moulding tools, die-casting moulds, press tools, etc., and their offices and works are situated at Oxford Avenue, Trading Estate, Slough, Bucks.

Birthday Honours

The following names, familiar in the industry, are included in the Birthday Honours List:—

Knights Bachelor.

Dr. C. C. Paterson, Director of Research Laboratories, the General Electric Co., Ltd., Wembley.

H. L. Saunders, Comptroller General, Patent Office.

C.B.E.

Dr. W. B. Lewis, F.R.S., T.R.E., Malvern, Worcs.

C. E. Horton, Chief Scientist, Admiralty Signal Establishment.

T. Fraser, Director, Metropolitan-Vickers Electrical Co., Ltd.

Prof. P. I. Dee, T.R.E., Malvern, Worcs.

Dr. F. E. Planer

Dr. F. E. Planer, formerly of the Western Electric Company, Ltd., has recently formed a company (The Addison Electric Company, Ltd., 163 Holland Park Avenue, London, W.11) to provide consultant services in electronics, telecommunications, etc., and to undertake the design and development of instruments, radio components and prototypes.

CORRESPONDENCE

Note to Employers

DEAR SIR,—It would be of great assistance to us if space could be found for all or part of the following news story:

An employer requiring an ex-Serviceman to fill a post, which required reasonable general ability without particular qualifications, advertised in a well-known daily paper. He got 3,000 replies. While it speaks volumes for the advertising powers of that newspaper, it did little to help the employer, whose office organisation was temporarily disrupted, or the 2,999 luckless applicants who had wasted paper, stamp and time.

The Officers' Association (the British Legion) Employment Bureau suggests a solution to the employer in the selection of his staff.

On its books, the Bureau has the details of several hundreds of ex-officers who are requiring employment. They are not by any means all £1,000 a year men. They are of all calibres, and can fit into jobs ranging from those of great responsibility to those where trustworthiness and integrity are all that is required.

At the Bureau all these officers are interviewed by experienced inter-

viewers and their qualifications and capabilities recorded and put into one of 150 categories.

When an employer sends a vacancy to the Bureau, the placings department endeavours to match the job with suitable men from one or more of those 150 categories, and normally a "short" list of half a dozen applicants is selected.

All communications from interested employers should be addressed to The Officers' Association (British Legion) Employment Bureau, 66 Denison House, 296 Vauxhall Bridge Road, London, S.W.1.

PRESS AND PUBLICITY DEPARTMENT,
BRITISH LEGION.

Television Waveform

DEAR SIR,—I note from the description of the "Television Waveform" published in the current issue of ELECTRONIC ENGINEERING, that the B.B.C. are now radiating a black-level interval *after* the line sync signal and before the beginning of picture modulation of duration $13/200$ or $6\frac{1}{2}$ per cent. of a line period. The latter is, of course, $\frac{1}{10,125}$ sec. (assuming the supply mains

are precisely 50 c/s.) and this multiplied by $13/200$ gives 6.4197 m.sec. There may presumably be some good reason for the choice of this figure even though the smallest distortion on the trailing edge of the sync signal could disturb some if not all of the decimal places. It is to be noted that no tolerances are mentioned.

Being interested in accuracy, even to small fractions of a microsecond, I have made some careful measurements of the transmitted waveform, and, according to my own oscilloscope, the period in question differs widely from the expected figure and appears to average 5.9259 m.sec. By a curious coincidence, this figure is equivalent to $12/200$, or 6 per cent., as compared with the fraction $13/200$ quoted above, of a line period. Except for the published information one might almost deduce that the B.B.C. were deliberately aiming at this round figure of 6 per cent.

It would be interesting to know if other readers' measurements agree with mine.—Yours faithfully,

N.2.

THORNTON HOWARD.

New Development in Transformers



THE "Astronic" BNN Series of Audio Transformers, manufactured by Associated Electronic Engineers, Ltd., of Stanmore, Middlesex, incorporate the latest developments in the technique of audio transformer design together with several unique features. The series employs single, dual or tri-alloy shields, giving a varying degree of noise suppression up to -90 db. relative to an open unshielded transformer of conventional design.

The multi-section coil structure is semi-toroidally wound and electrically balanced. Where tapings are employed, all taps are also electrically-balanced and winding accuracy is maintained to very close limits.

Particular care has been taken to provide an unusually generous core-section, enabling the instruments to be operated at a signal level much higher than would normally be expected.

The high-fidelity series are linear to within ± 1 db. over the range 30-15,000 c/s., and are available in types suitable for the following applications:—

- (i) Line to Grid.
- (ii) Microphone or Low Impedance Pick-up to Grid.
- (iii) Anode to Line.
- (iv) Anode to Grid.

This type of construction also lends itself to many other special applications not listed above.

Typical examples of performance are:—

Type BNNN (Tri-alloy shielding).
Primary impedance 3.75 or 15.0.
Ratio 1 : 100 or 4 : 200.
Fidelity : ± 1 db. from 30-17,000 c/s.
Noise Suppression : - 86 db.

Type BNN (Dual Alloy shielding).
Primary impedance : 600 ohms.
Ratio 1 : 20.
Fidelity : ± 1.2 db. from 25-16,000 c/s.
Noise Suppression : - 67 db.

For lower fidelity applications (*i.e.*, ± 1 db. 50-10,000 c/s.) a conventional shell-type core assembly is used with approximately 20 db. less noise-suppression.

Many types of electronic equipment call for an easy change in input impedance, and where this is so, this series is mounted on an international octal base enabling a ready change in ratio to be made. A hermetically-sealed type is available with fixed mounting base.

The illustration gives an excellent impression of the compact construction of this series.

This company also supplies power transformers, coil winding bobbins, sectional steel transformer clamps and a wide range of electronic equipment in the audio range.

MEETINGS

The Whitefield & District Radio Society

The above society is now holding regular weekly meetings every Monday evening at 7.30 p.m. at the Stand Grammar School, Higher Lane, Whitefield.

All radio amateurs, experimenters, and all persons interested in radio theory and practice in the Manchester and district area, are invited to obtain particulars from the Hon. Secretary, Mr. E. Fearn, 4 Partington Street, Newton Heath, Manchester 10.

Cambridge Summer School

in X-Ray Crystallography, 1946

The School will be held in the Department of Mineralogy and Petrology, and in the Cavendish Laboratory, Cambridge, from September 2 to September 13 inclusive.

Details may be obtained from G. F. Hickson, M.A., Secretary of the Board of Extra-Mural Studies, Stuart House, Cambridge.

The Institute of Physics

X-Ray Analysis Group

The 1946 Conference (X-Ray Analysis During the War Years) will be held at the Royal Institution, 19 Albemarle Street, W.1, on July 9, 10 and 11, and is open to all. Further particulars may be obtained on application to the Secretary, Institute of Physics, 19 Albemarle Street, W.1.



**PLEASE NOTE
OUR
NEW OFFICE
ADDRESS**

**WAVERLY WORKS
75 ST. SIMON STREET
SALFORD 3 LANCs**

**TEL: MANCHESTER, BLACKFRIARS 9831
TELEGRAMS: VACTITIC SALFORD**

**HEAD OFFICE :
24 Queen Annes Gate, Westminster, London, S.W. 1**

ABSTRACTS OF ELECTRONIC LITERATURE

CIRCUITS

Four-Channel Electronic Switch (N. A. Moerman)

An electronic switch permits display of four or more transients at once on a conventional cathode-ray oscilloscope screen. A crystal-controlled ring counter triggers the gate amplifiers which switch and mix signals supplied to a wide-band amplifier in the equipment.

—*Electronics*, April, 1946, p. 150.

Radiosonde Telemetering System (V. D. Hauck, J. R. Crosby and A. B. Dember)

Technical details of modern meteorological radiosonde transmitters, which use ceramic temperature-responsive resistors, an electric hygrometer employing a lithium chloride film on polystyrene and a new dry-pack perchloric acid battery. Both radar and radio d-f methods of radiosonde tracking for winds-alot observations are described.

—*Electronics*, May, 1946, p. 120.

Two-Terminal Oscillator (M. G. Crosby)

Negative transconductance provided by a two-stage amplifier gives the phase reversal necessary for circuit oscillation. Only two points in the circuit are needed for connexion of a simple tuned circuit to provide several oscillator arrangements.

—*Electronics*, May, 1946, p. 137.

Pulse Response of Thyatron Grid-Control Circuits (G. H. Gleason and C. Beckman)

Precise grid control is required for a thyatron functioning as an accurate controlling device. Frequently the desired precision of firing is obtained by applying peaked voltage pulses to the thyatron grid. Satisfactory operation required an external grid-cathode capacitance and a current limiting grid resistance. This paper presents, in the form of curves, an analysis of the influence of grid-circuit components upon the grid response for several commonly used grid signal pulses. Advantages of peaked wave-form grid control are discussed, and an example is worked out to illustrate the use of curves in evaluating grid response to a typical signal pulse.

—*Proc. I.R.E.*, February, 1946, p. 71P.*

Ultrasonic Generator (F. W. Smith and P. K. Stumpf)

The basic element of the piezo-type ultrasonic generator consists of an X-cut quartz plate vibrating in the longitudinal or thickness mode, acoustically loaded by immersion in a liquid medium and excited at mechanical resonance to achieve appreciable ultrasonic output. Design of the crystal holder to avoid damping is discussed, in addition to powder output, coupling circuits and R.F. generator circuit. One typical application of the ultrasonic generator to problems of enzymology is described.

—*Electronics*, April, 1946, p. 116.*

INDUSTRY

Fine Wires in the Electron-Tube Industry (G. A. Espersen)

This article discusses primarily the application of fine wires in the electron-tube industry. Some fundamental basic properties which confront the wire manufacturer are briefly discussed. Design formulas, including a nomograph, are given for electron-tube filaments. The use of platings of gold, platinum and zirconium on metals of the refractory group have assisted in the reduction of grid emission. A unique method of utilizing zirconium, both to accelerate the vacuum exhaust process and to serve as a continuous "getter," is described. A novel method of securing a uniform rate of evaporation of thin films of metals is discussed.

—*Proc. I.R.E.*, March, 1946, p. 116W.

Electronic Control of Cloth Guiders on Tentering Machines

A description is given of the finger-type cloth guider . . . and the development leading from this to electronic control. In the latter, a light source is arranged immediately above and in line with the cloth edge, light passing through glazed apertures and reflected by mirrors onto two photo-electric cells. When running correctly, the section of the light beam outside the cloth edge is continually striking its associated photo-electric cell, the other section being blacked-out. The cells are connected in a back-to-back circuit to an amplifier, a relay being included in the plate circuit of each amplifier valve to operate the clutch coils of the guider motor.

—*Text Rec.*, April, 1946, p. 36.*

Silk J., April, 1946, p. 37.

Electronic Heating in the Furniture Industry (E. S. Winlund)

Fundamentals of generating and applying high-frequency power to set bonding-glues employed in producing plywood, joining core-lumber for veneered furniture, and assembling joints of furniture, and discussion of economic aspects of wood-working industry applications.

—*Electronics*, May, 1946, p. 109.

A B-H Curve Tracer for Magnetic Recording Wire

(T. H. Long and G. D. McMullen)
Equipment is described which is able to show on the screen of an oscilloscope the cyclic hysteresis loop of a sample of magnetic-recording wire a little over 1 in. long and 0.004 in. diameter. Requirements of equipment for magnetic measurement and theoretical considerations are discussed and results shown which were obtained in the investigation. A discussion is included of operation of the equipment and of possible modifications.

—*Trans. A.I.E.E.*, Mar., 1946, p. 146.*

MEASUREMENT

Gate Circuits for Chronographs (L. B. Tooley)

Two thyratrons provide a simple switching system that permits amplification in a succeeding amplifier when the first pulse is received, blocks the amplifier when the second pulse is received. Readily substituted for more complicated gate circuits.

—*Electronics*, May, 1946, p. 145.

Spectral Intensity Measurements with Photo-Tubes and the Oscillograph

(G. H. Dieke, H. Y. Lohe and H. M. Crosswhite)

If a knowledge of short period changes in intensity of spectrum lines is required, the method of measurement must be capable of giving results within the required time. The authors point out that the only instrument with suitable response to make measurements of a short duration compared with the length of one cycle and with cycles ranging from 1/60th sec. to a microsecond or less, is the cathode-ray oscillograph; also that multiplier photo-tubes are particularly suitable for use with the oscillograph because of their high sensitivity. The experimental procedure in the use of such equipment for the study of discharge tubes, sparks and d.c. arcs is described.

—*Jour. Opt. Soc. Am.*, April, 1946, p. 185.*

Electrical Measurement of Strain (C. S. Redshaw)

In a paper presented to the R.Ae.S., the author traces the development of electrical strain gauges. Variable capacitance, inductance and resistance types are mentioned, also Piezo-electric and acoustic types. A variable inductance instrument is described as developed by Rotol, Ltd., using a frequency of 11,000 c/s. such that 1 in. effective length, strain of the order of 4×10^{-5} can be measured to within ± 5 per cent. and strains of 10^{-4} to within ± 2 per cent. Calibration methods and advantages of wire resistance gauges are discussed, including the merits of Nichrome wires.

—*Flight*, 4/4/46, p. 349.*

Aeroplane, 5/4/46, p. 411.

High Resistance D.C. Voltmeter (D. L. Waidelich)

A d.c. valve-voltmeter has been designed for measuring voltages of sources having an internal resistance as high as 1,000 megohms. The maximum error on any scale is less than 8 per cent., and for the upper 60 per cent. of scale, less than 5 per cent. At 100 megohms internal resistance, errors are 5 and 2 per cent., respectively. A description of the instrument and analysis of its circuit are given. Its disadvantages are that it measures positive direct voltages only, is not suitable for use on low voltages, has a residual current indication and indicates a reading with the input open-circuited.

—*Electronics*, March, 1946, p. 158.*

* Abstracts supplied by the courtesy of Metropolitan Vickers Electrical Co. Ltd., Trafford Park, Manchester

Coil winding MACHINES

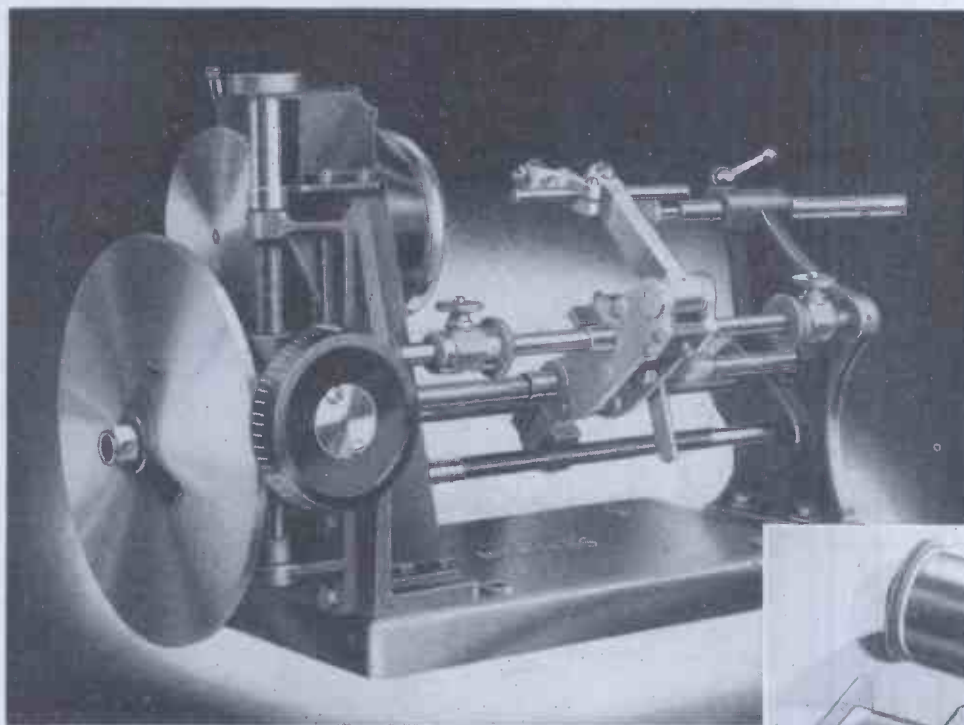

A typical selection of coils wound on the Neville's Pretoria Coil Winding Machine.

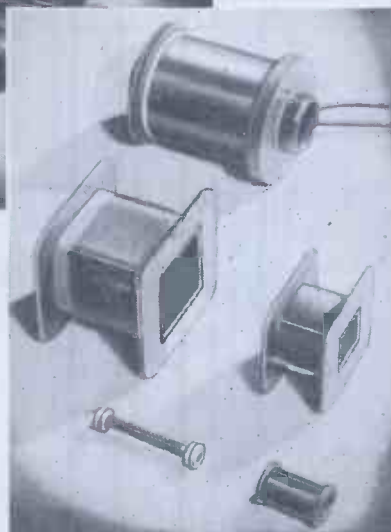

THE NEVILLE'S PRETORIA MODEL

For winding solenoid, transformer, choke and field coils.

A bench-mounting universal automatic coil winder embodying many refinements hitherto only obtainable on expensive machines. A special foot-operated clutch gives smooth control of the winding spindle and it is possible to wind up to four coils simultaneously.

CAPACITY : Coils from 3/16" to 6" in length. Gauges of wire 22—48 S.W.G.

DIMENSIONS : The machine is 23½" long, 10" wide and 12" high.

DRIVE : 1/4 H.P., 1425 R.P.M. Electric Motor.

SPINDLE SPEEDS : 400, 530, 800, 1250, 3000, R.P.M.

Write to department EG for full particulars. An experienced staff are available to give individual attention to any coil winding problems. Your enquiries are invited.

NEVILLE'S (LIVERPOOL) LTD

THE SIMMONDS TOWER · GREAT WEST ROAD · LONDON
A COMPANY OF THE SIMMONDS GROUP



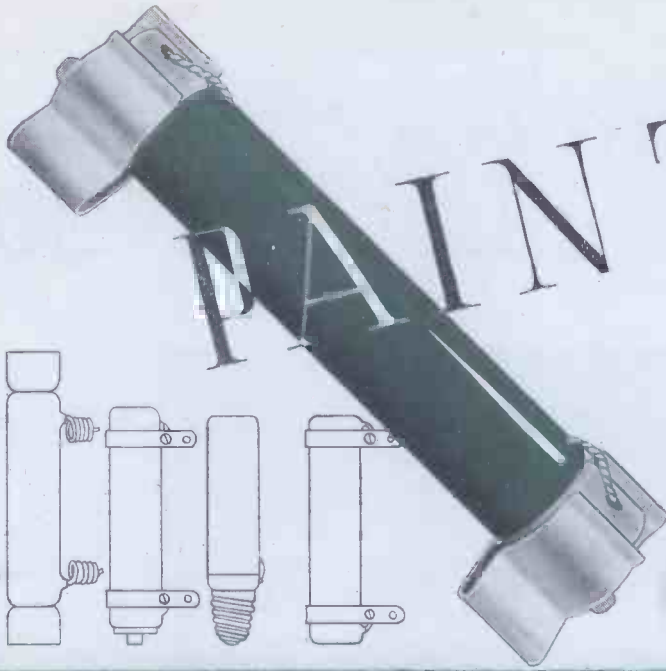

PAINTON VITREOUS RESISTORS

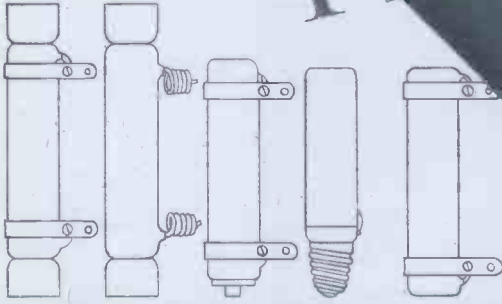

Painton Vitreous Resistors are available in values from 1 ohm to 100,000 ohms; from 10 watts to 150 watts rating, and are made in a wide variety of fittings. The Resistors consist of a fully vitrified porcelain tube, which carries a winding of high-grade resistance alloy wire. The ends are electrically welded to the copper terminal leads. This winding is held firmly in position by a coating of extremely durable vitreous enamel, rendering the unit absolutely impervious to the effects of moisture, and ensuring absolute stability of value under all conditions of service. Type approval of these Resistors has been given for use under the most severe tropical conditions.

PAINTON & CO. LTD
KINGSTHORPE NORTHAMPTON

Insulate with

PERMALI

Laminated, Impregnated, Densified

Outstanding for **STRENGTH**

Conforms to DCD WT1000

designers

Write for Data Booklet 20B, giving electrical and Physical Properties and Mechanical Characteristics of this extremely useful material, to the NEW INSULATION CO. LTD., Gloucester (Eng). Telephone: 4941.

**MULTI-RANGE
TEST SET**
Series 100

by
PULLIN

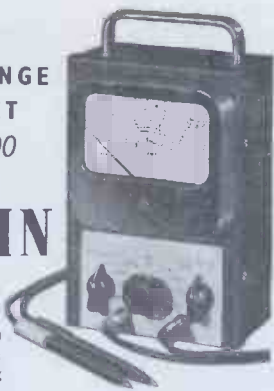

This low current consumption meter (sensitivity 10,000 Ohms per volt) is housed in a strong metal box, complete with test leads and prod. Ranges:—Milliamps (D.C. only)—2.5, 10, 25, 100 and 500. Volts (D.C. and A.C.)—10, 25, 100, 250, 500 and 1000. Ohms scale reading 100 Ohms to 1 Megohm with 13,500 Ohms at centre point. Price £8.0.0



MEASURING INSTRUMENTS (PULLIN) LTD

All enquiries to Dept. E, Phoenix Works,
Great West Road, Brentford, Middlesex. Ealing, 0011

Standard Cases
for
DELIVERY NOW



Superbly finished model of highest grade heavy gauge sheet steel, strongly welded and complete with internal metal chassis finished in light grey, brown, yellow, red or black.

- Type 1053A 15½" w. × 8" d. × 9" h. £4 15s. 0d.
- Type 1053B 17½" w. × 9" d. × 10½" h. £6 15s. 0d.
- Type 1053C 24" w. × 12" d. × 15" h. £8 17s. 6d.

IMHOF'S

142-116 NEW OXFORD ST., LONDON, W.C.1.

Dept. 2

"Cyldon"
Transmitting Capacitors

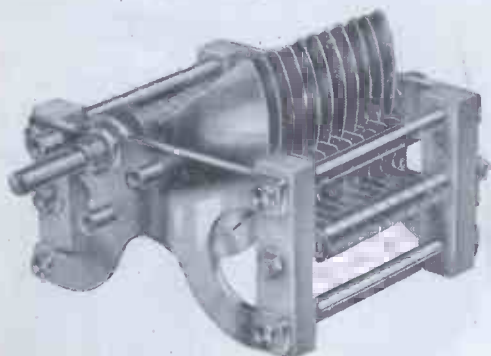

TYPE T.R. SQUARE LAW

Max. Capacity	List Price	Max. Capacity	List Price
100 pF	19s.6d.	300 pF	27s.6d.
150 "	20s.0d.	350 "	30s.0d.
200 "	22s.6d.	400 "	32s.6d.
250 "	25s.0d.	500 "	35s.0d.

SYDNEY S. BIRD & SONS LTD.
Cambridge Arterial Road, Enfield, Middlesex

ERG'S HAVE THE URGE TO GO ABROAD

**SPEAKING
EXPORTLY—**

ERG Resistors have an exceptional electrical specification and performance, with mechanical strength.

High Grade Vitreous Enamels used on our Tropical Resistors give long life, and definitely assist in the trouble-free manufacture and performance of Radio Receivers, Television and Test Equipment.

Processed up to the highest Service Standards at a competitive price.

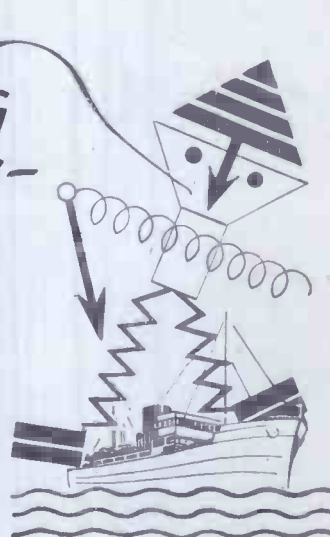

**ERG
RESISTORS LTD**

1021a, FINCHLEY ROAD
LONDON, N.W.11

Phone: Speedwell 6967

A New Component Testing Bridge



THE Type B.101 Component Testing Bridge, manufactured by the Wayne Kerr Laboratories, employs a new circuit technique which enables a wide range of measurements to be made with considerable accuracy.

Among the unique features which are claimed for this instrument are:

The direct measurement of power factor, leakage, and "Q" on a calibrated scale.

Components may be measured either when earthed or insulated from earth, and long leads do not affect the accuracy.

The general accuracy for absolute measurements is better than 2 per cent. on the *C*, *R*, and *L* ranges.

With external standards, using the substitution method, the accuracy is better than 0.1 per cent.

Percentage accuracy of scale reading is maintained by the use of two scales—one calibrated from 0 to 5, and the other from 0 to 1.5. It is thus never necessary to make measurements at the end of the main scale.

The bridge is self-contained and operates from 200/250 V 50 c/s., the indicator being a magic eye preceded by a pentode high gain amplifier.

Ranges

Capacitance: 0-500 μ F in 8 ranges.

Resistance: 0-500 M in 8 ranges.

Inductance: 0.1-5,000 H in 8 ranges.

By the use of a D.C. external source, the inductance can be measured with D.C. current passing through the coil.

Leakage

The test voltage for electrolytic condensers is selected by means of a switch, and the leakage is read on the dial in mA at the null point, as shown by the magic eye.

Power Factor

Power factor is measurable on the high-capacitance ranges from 0.5 μ F upwards.

Q

The Q figure is read direct on a logarithmic scale from 0 to 30, and applies to all ranges without multiplication.

Dimensions

Overall size: 14 in. wide by 10½ in. high by 9½ in. deep.

Finish: Crackle grey, semi-matt panel with chromium fittings.

Weight: Approximately 20 lb.

Power consumption: 20 watts.

Price: £19 19s.

Full particulars can be obtained from the Wayne Kerr Laboratories, Sycamore Grove, New Malden, Surrey. Telephone No.: Malden 0600.

Correction

We regret that an error occurred in the information given about this company in Notes from the Industry last month. It was stated that Mr. R. H. Foxwell would be in charge of the electrical design group and Mr. Raymond Calvert the mechanical design group. This was incorrect as, in point of fact, Mr. Foxwell will lead the electrical and Mr. Calvert the electrical group.

ANALOGY ON THE GOOSE STEP



There are various kinds of goose step - here we show the delicate tread of dear old mother goose herself; there is also the gentle Prussian variety which did so well for a time until old Joe objected.

The only thing these two goose steps have in common is that each step is identical, in fact just like the Transformers we delight in producing, whether the quantity is one or ten thousand, they are all identically the same - giving exactly the same ????? - not the slightest variation to cause trouble at a later stage.

To us it is a stirring sight to see our beloved Transformers goose stepping along the production lines - and if you saw them for yourself you would no longer wonder how it is that we produce the best Transformers so swiftly and so economically . . .

PARMEKO of LEICESTER.
Makers of Transformers.

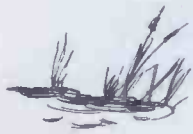

FLOATING ROTOR

DOUBLE CONTACT

Only in the famous

OAK SWITCH

NSF

Other British N.S.F. Products include PAPER CAPACITORS, SILVERED MICA CAPACITORS, WIRE WOUND RESISTORS AND VOLUME CONTROLS—Write for full details.

Manufactured by

BRITISH N.S.F. CO. LTD.

KEIGHLEY, YORKSHIRE

London Office: 25 Manchester Sq., W.1. Tel.: WELbeck 794116

Sole Licensees of OAK Manufacturing Co. Chicago

GA



Radio Towers

The design and erection of tall steel radio masts and towers is a specialised branch of structural engineering, allowance having to be made for considerable head loads caused by aerials suspended between two or more high structures.

These towers often include rigid platforms or systems of flexible booms for supporting complicated systems of vertical aerials or antennae wires. B.I. Callender's have had outstanding experience in this work and have erected some of the tallest towers in existence both in this country and overseas.

The example illustrated is one of the three 600-foot tall self-supporting towers erected for the General Post Office in Central Wales during 1942. B.I. Callender's can undertake all work including the design and erection of any type of radio tower or mast. Further information is available on request

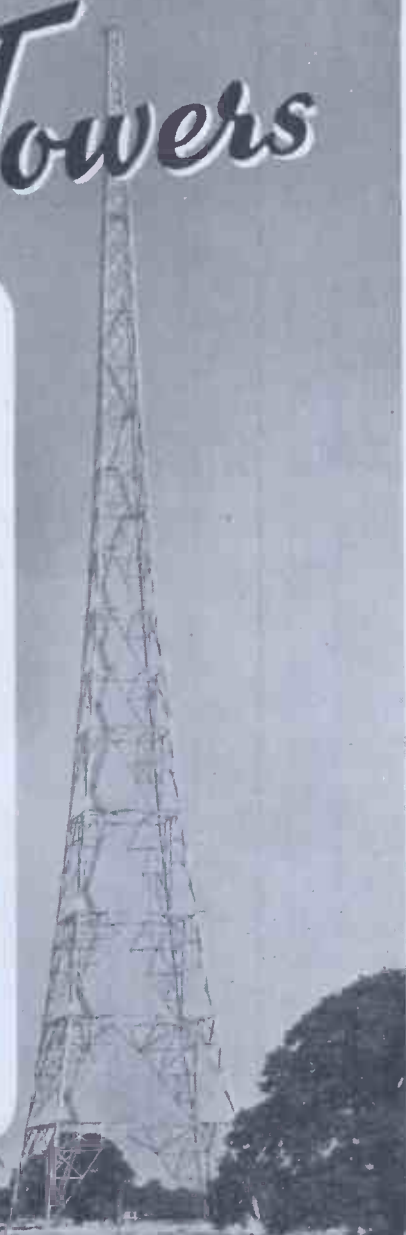

BRITISH INSULATED CALLENDER'S CABLES LIMITED
NORFOLK HOUSE, NORFOLK STREET, LONDON W.C.2

**"UNO"
STENCILS**

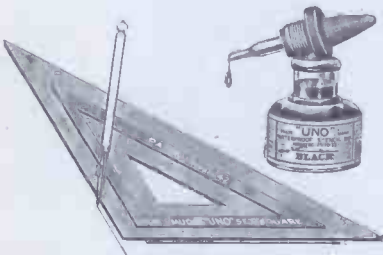

6 Stencils of
Electrical Symbols
6/- each

A. WEST & PARTNERS, LTD 36, BROADWAY
WESTMINSTER, S.W.1

STROBOSCOPES

for all applications

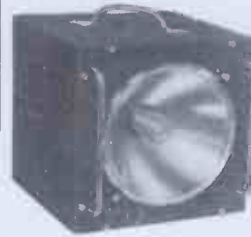

HIGH POWER UNIT
for Photography



SEPARATE LAMP UNIT
for difficult locations

STANDARD MODEL
for general use

**Dawe
Instruments Ltd**

HARLEQUIN AVENUE,
GREAT WEST ROAD,
BRENTFORD,
MIDDLESEX



Tel.: EALING 1850



BEAT FREQUENCY OSCILLATORS

**LELAND
INSTRUMENTS LTD**

—for priority requirements only,
at present. Write for particulars
stating frequency range required.
21, JOHN STREET, BEDFORD ROW, LONDON W.C1
TELEPHONE: CHANCERY 8765

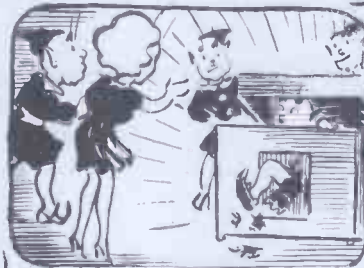

**THE "FLUXITE
QUINS" AT WORK**

Said EH to OO, "Well
that's queer.
Set's switched off yet it
grows, can you hear?"
Came a shout, "It's
all right, fixing wires
with FLUXITE,
But you want room to
move 'round in
here!"

For all **SOLDERING** work—you need **FLUXITE**—the paste
flux—with which even dirty metals are soldered and "tinned."
For the jointing of lead—without solder; and the "running"
of white metal bearings—without "tinning" the bearings.

It is suitable for **ALL METALS**—excepting **ALUMINIUM**—
and can be used with safety on **ELECTRICAL** and other
sensitive apparatus.

With Fluxite joints can be "wiped" success-
fully, that are impossible by any other method

Used for over 30 years in Government Works, and
by leading Engineers and Manufacturers, OF **ALL
IRONMONGERS**—IN TINS—8d., 1/4 and 2/8.
Ask to see the **FLUXITE POCKET BLOW-
LAMP**, price 2/6d.



The "Flux-
ite Gun"
puts Fluxite
where you
want it by
a simple
pressure.
Price 1/6, or
filled 2/6.

ALL MECHANICS WILL HAVE

FLUXITE

IT SIMPLIFIES ALL SOLDERING

Write for Leaflets on **CASE HARDENING STEEL** and **TEMPERING
TOOLS** with **FLUXITE** also on "WIPED JOINTS." Price 1d. each.

FLUXITE LTD. (Dept. T.V.) Bermondsey St., London, S.E.1

HIGH EFFICIENCY TRANSFORMERS

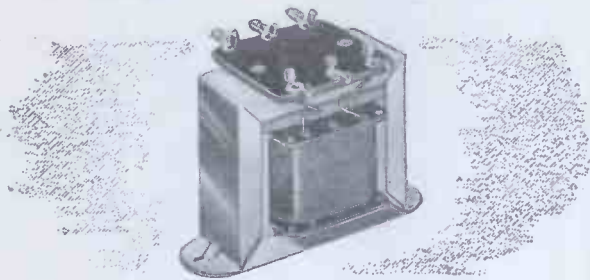

Peak Performance marks the New BULGIN Range

Bulgin Transformers are the radio engineer's first choice for uniform frequency response over the entire musical range. Midget or heavy duty, for inter-valve, microphone and pick-up coupling, for input and output use, you will find a Bulgin transformer for every need. Nickel alloy cores are specially laminated and have high permeability characteristics. Every model fitted with colour coded leads or metal tags for clear identification.

Most Bulgin high efficiency transformers are made to international standards and can be fitted swiftly to any set. The Bulgin range gives individual quality at attractive prices. You will appreciate the difference.

Mono-Metallic Welding is one more Bulgin Secret

One of the outstanding secret processes evolved by the Bulgin Laboratory is Mono-Metallic Welding, preventing deterioration by moisture. Bulgin welding, tested under battle conditions, stands every climatic condition and gives constant performance.

BULGIN

TRANSFORMERS for INPUT, OUTPUT, and COUPLING USES

A. F. BULGIN & CO. LTD., BYE PASS RD., BARKING, ESSEX

Telephone: RIPpleway 3474 (5 lines)

PHOTO-ELECTRIC CELLS

Se/Te on gold-alloy, supersensitive to light, gas-filled, permanent, operate relay direct or with Valve Amplifier, perfect reproduction of Speech and Music from sound track of films; large tube 3 1/2 in. from glass top to valve pin base, 1 in. diam., 38/-; same type 2 1/2 in. long, 35/-; small tube, 2 in. from top to terminal base, 3/4 in. diam., 30/-; miniature cell, glass top to cap base, 1 in. overall, 1/2 in. diam., thin flex leads, 28/-; all cells operate on 40-100 volts. Connections diagrams free.

PRECISION OPTICAL SYSTEM producing fine line of light from any car headlight bulb, for scanning film sound track direct into Photo-cell, metal tube 2 in. long, 1/2 in. diam., 1/2 in. focus, 52/-. Instructions free. Goods by return.

GEFA INSTRUMENTS, 38a, York St., TWICKENHAM, Middx. POPesgrove 6597

Varley

THERMAL DELAY SWITCHES

PROTECT YOUR RADIO EQUIPMENT

4 VOLT · 5 VOLT or 6.3 VOLT HEATERS

OLIVER PELL CONTROL LTD
CAMBRIDGE ROW · WOOLWICH · S · E · 18
TELEPHONE: WOOLWICH · 1422

More than enough for 4 TIMES the population of the British Isles



During the war years we made a total of **200,000,000 Felt Strips** for ANTI-GAS EYE SHIELDS

If your Peacetime productions need **FELT** Let STERLING quote you

Any SHAPE—Any SIZE—Any QUANTITY

STERLING

TEXTILE INDUSTRIES LTD.
STERLING WORKS, ALEXANDRA RD., PONDERS END, Middx.

Phone: HOWARD 2214-B, 1759

Grams: STERTEX, ENFIELD

CLASSIFIED ANNOUNCEMENTS

The charge for miscellaneous advertisements on this page is 12 words or less, 4/- and 4d. for every additional word. Box numbers count as four words, plus 1/- extra for replies. Remittance should accompany advertisement. Cheques and P.O.'s payable to Hulton Press, Ltd., 43 Shoe Lane, E.C.4. Replies to box numbers should be addressed as above, marked "Elec. Engg." Press date: 15th of month for following issue.

FOR SALE

IN STOCK. Rectifiers, Accumulator Chargers, Rotary Converters, P.A. Amplifiers, Mikes, Mains Transformers, Speakers of most types, Test Meters, etc. Special Transformers quoted for.—University Radio, Ltd., 22, Lisle Street, London, W.C.2. GER. 4447.

PHILIPS Resistance-capacity Bridge: 10 pF to 10 μ F, 1/10 ohm to 10 megohm. As new. £10 or offers. Chambers, Milverton, Bradford Road, Combe Down, Bath.

LOUDSPEAKERS

LOUDSPEAKERS—We carry on. Sinclair Speakers, 12, Pembroke Street, N.1.

LOUDSPEAKER repairs, British, American, any make, moderate prices.—Sinclair Speakers, 12, Pembroke Street, N.1.

MISCELLANEOUS

WE WILL BUY at your price used radios, amplifiers, converters, test meters, motors, pick-ups, speakers, etc., radio and electrical accessories. Write, phone or call, University Radio, Ltd., 22, Lisle Street, London, W.C.2. GER. 4447.

WEBB'S Radio Map of the World enables you to locate any station heard. Size 40 in. by 30 in. 2-colour heavy Art Paper, 4/6, post 6d. Limited supply on Linen, 10/6, post 6d.—Webb's Radio, 14, Soho Street, London, W.1. 'Phone: GERrard 2089.

MORSE Practice Equipment for Class-room or Individual Tuition. Keys, Audio Oscillators for both battery or main operation. Webb's Radio, 14, Soho Street, London, W.1. 'Phone: GERrard 2089.

MECHANICAL ENGINEERS to the Electronic Industry. Precision and Optical Instruments of all types designed and constructed in collaboration with Electronic Engineers. Tecnapot, Ltd., Mile Lane, Coventry.

WE HAVE THE Largest Stock of English and American radio books in the country, including many new out of print. Write or call for complete list. The Modern Book Co. (Dept. E.E.), 19/23, Praed Street, London, W.C.2 (PAD. 4185).

WE ARE NOW able to undertake the adjustment of resistors and capacitors over a wide range to within 0.1 per cent. Customers' own apparatus, including audio oscillators and wavemeters, carefully calibrated to any required degree of accuracy. We can supply special precision radio and mechanical components from the small gear or coil to the complete apparatus for the solution of unusual problems. Facilities also available for instrument finishing, including: engraving panels and dials, black crackle enamelling, and silver, nickel or chrome plating instrument parts. Lydiat Ash Laboratories, nr. Bromsgrove, Worcs.

SEND S.A.E. for new radio components price list. Speedy and efficient service. M.O.S., 24, New Road, London, E.1.

COMPONENTS FOR PROTOTYPES.—Commercial buyers for large industrial organisations, requiring components for prototypes (especially when they are in a hurry—which is mostly always) are gradually finding that the quickest way to get what they want is to 'phone Pad. 6116, or call at 177, Edgware Road (not far from Marble Arch) and take the goods away with them. No matter what is required, if we haven't got it in stock we always do our utmost to get it quickly, and we usually know where—and how.

OUR OWN FACTORY.—We have just acquired additional space on the premises and now have our own factory—primarily engaged on communications apparatus, transmitters and U.H.F. receivers. Mind you, it is only a little factory, but it is surprising sometimes what initiative and determined effort can do. WHEN you have a minute to spare—call in and see us—you will be quite interested.

Tele-Radio (1943), Ltd., 177, Edgware Road, London, W.2 (PAD. 6116).

POLAROSCOPES for glass strain determination, open stage, double eyepiece, sensitive tint, fields 2 in. to 10 $\frac{1}{2}$ in. diameter. Details on request.

POLAROID FILM for research; squares 4 in., 24/-; 6 in., 52/- H. S. B. Meakin, Ltd., 36, Victoria Street, S.W.1. ABBey 6713.

G6MB, G8RN AND G2CIN will be glad to meet you at 25, High Holborn, and to show you quite a number of new components that you have been waiting for—such as: A Slow-motion Dial for individual calibration complete with five blank and one engraved scales, escutcheon glass and knob for 15/6; A Chassis Cutter at 10/6 that will save you endless time in cutting your valve holes. Two new Short Wave Kits, one for A.C. operation from 9-345 metres and the other from 11-250 metres for all-dry battery operation. A Tank Coil and Condenser Unit incorporating interchangeable swinging link coil and neutralising condenser with coils for 56, 28, 14 and 7 Mc/s. We know what you've wanted—we've wanted it, too—that's why we're making it. If you can't come along, send a 3d. stamp for our 20-page illustrated catalogue to Berry's (Short Wave), Ltd., 25, High Holborn, London, W.C.1, nearly opposite to Chancery Lane (Telephone: HOLborn 6231).

METAL WORK of all descriptions constructed to specification. Cabinets, Chassis and complete Rack Assemblies. Modern attractive finishes. Designs to fit individual requirements. Machinings and turnings to close tolerances. Name plates and labels engraved, small or large quantities in various colours on any material. Speedy service. Sea Rescue Equipment, Ltd., Chiltern Works, Clarendon Road, Watford, Herts.

INSTRUMENTS.—Complete assemblies in attractive metal cabinets to designer's specification. First-grade workmanship and full technical facilities available. High grades of accuracy attained in the construction of prototypes and instruments. Sea Rescue Equipment, Ltd., Chiltern Works, Clarendon Road, Watford, Herts.

CHASSIS, RACKS, Cabinets, Panels, Aluminium Sheet 16 and 18 gauge. S.A.E. Lists. Amateur Radio Service, G6HP, Canning Street, Burnley.

PHOTOGRAPHY BY BEHR will show your product at its best. Ask for illustrated list. 44, Temple Fortune Lane, London, N.W.11. SPEedwell 4298.

SITUATIONS VACANT

A.M.I.E., City and Guilds, etc., on "NO PASS—NO FEE" terms. Over 95 per cent. successes. For full details of modern courses in all branches of Electrical Technology send for our 112-page handbook—FREE and post free. B.I.E.T. (Dept. 337B), 17, Stratford Place, London, W.1.

FOREMAN FOR COIL ROOM. West Riding area, used to mass production of all types of coils and transformers for domestic radios. Write, giving full particulars, age, experience and salary required, to Box No. 848, "Elec. Engg."

REQUIRED an experienced technician for development work on micro-wave relay and co-axial cable links. Degree in physics or engineering, with four or more years experience in industrial or Service Research Establishments on similar work. Salary comparable with Scientific Civil Service scale. Applications considered for early commencement or for later in the year. Cinema-Television Ltd., Worsley Bridge Road, Lower Sydenham, S.E.26.

DRAUGHTSMAN REQUIRED for design office of company specialising in the production of radio and electronic laboratory equipment. One able to work with the minimum of supervision preferred. Applications by letter only to the Wayne-Kerr Laboratories Limited, Sycamore Grove, New Malden, Surrey.

EXPERIENCED DRAUGHTSMAN required for development laboratory, accustomed to work on radio or electronic equipment. Apply in writing, stating age, qualifications and experience, to Personnel Manager, The Edison Swan Electric Co., Ltd., Ponders End, Enfield, Middlesex.

LEADING FIRM of Scientific Instrument Manufacturers establishing a new research establishment in Hertfordshire, only 12 miles from London, have vacancies for—

- (1) Senior Engineers and Physicists to take charge of major divisions. Experience in electrical engineering, mechanical design, servomechanisms, electronics or the design of scientific instruments essential. Salary, £1,000-£1,200, according to qualifications.
- (2) Research Engineers and Physicists, age 28-35, who have had experience in any of the above-mentioned subjects, to take charge of small research groups. Salary, £700-£900, according to qualifications and experience.
- (3) Junior Research Engineers and Physicists with scientific or technical qualifications but not necessarily experience in the subjects mentioned. Age 20-30. Salary, £250-£500, according to qualifications.

All the above will be permanent posts, giving opportunity of advancement to higher grades. A super-annuation scheme to which the firm contributes is available for those successful candidates who wish to join. Successful candidates who are insured under the Federated Superannuation Scheme for Universities will be able to continue their insurance under this scheme if they desire to do so. Box No. 849, "Elec. Engg."

RESEARCH ASSISTANT required for progressive and well-known S.E. London firm for work connected with high vacuum equipment covering electronic, instrument, light engineering and physical investigations. Technical training at least up to Higher National Certificate or Intermediate in Engineering or Physics essential and previous research or development experience in similar work highly desirable. Excellent opportunities for first-class workers. Applicants should give chronological details of experience, etc., with salary expectations. Applications from ex-Service technical personnel invited if experience and qualifications suitable. Box No. 853, "Elec. Engg."

RESPONSIBLE MAN required (B.Sc. Physics or H.N.C.), aged over 25 years, to run small mechanical and electrical testing section (five assistants) in laboratory of radio firm in South-West London area. Write, with full details of previous experience, qualifications and salary required, to Box No. 831, L.P.E., 110, St. Martin's Lane, W.C.2.

SITUATIONS WANTED

ENGINEER with wide experience radio industry seeks responsible position. Nine years in charge of large staff engaged on measurements and industrial applications. Many business, technical contacts. £500-£1,000. Available. Box No. 851, "Elec. Engg."

P.O. RADIO MECH., R.N., age 21 $\frac{1}{2}$, seeks clerical or practical career in radio or electronics; studying for C. and G. Final in Radio Communication. Release July. Box No. 850, "Elec. Engg."

EX-NAVAL RADAR OFFICER seeks progressive technical or executive post. Six years' experience radar and wireless. Associate Brit.I.R.E., C. and G. Finals Radio Communication, Technical Electricity. Box No. 847, "Elec. Engg."

CHARTERED MECHANICAL ENGINEER. Wide experience design of precision and electro mechanical equipment, also mechanical design of electronic equipment. Offers services as consultant or designer on a part-time basis. Box No. 852, "Elec. Engg."

PHYSICIST, Hons., B.Sc., long experience of design and manufacture electronic instruments, especially applications of C.R.O. to mechanical measurements, desires responsible development or research post with progressive firm. Box 854, "Elec. Engg."

WANTED

WE OFFER cash for good modern Communication and all-wave Receivers.—A.C.S. Radio, 44, Widmore Road, Bromley.

WANTED, VOIGT L.S. Units, horns, reflector speakers—any condition. Lowther Manufacturing Company, Bromley, Kent.

For the
AMATEUR TRANSMITTER
and the **DISCRIMINATING**
EXPERIMENTER

and all
components
carry

Webb's

UNCONDITIONAL GUARANTEE
OF SATISFACTION

AERIAL EQUIPMENT

Pyrex 3 1/2" strain insulator	...	1s.	0d.
" 6" shackle or egg insulator	...	6s.	9d.
Raymart Ceramic "T" insulator for centre of dipole, etc.	...	1s.	3d.
Enamelled wire, 14 s.w.g. per 100 foot coil	...	1s.	2d.
Belling Lee, 80 ohm transmission line, per yard	...	4s.	6d.
Coaxial cable with outer insulation, overall diameter 7/16", impedance 80 ohms, per yard	...	1s.	9d.
Ceramic feeder spacers :- 2"	6d.
4"	8d.
6"	...	1s.	0d.
Lead-through Insulator, cone type, Eddystone 1018	...	2s.	6d.

TOOLS

CHASSIS PUNCHES, double-ended, hardened steel for punching valve holes in up to 16-gauge metal. Available in five sizes :-
Diameter of hole 1 1/2", 1 3/4" ... 10s. 6d.
Diameter of hole 1", 1 1/4", 1 1/2" ... 9s. 6d.

SOLDERING IRONS

Solon 968, round pencil bit 230/250v.—65 watts	...	15s.	0d.
Solon 964 oval tapered bit 230/250v.—65 watts	...	13s.	4d.

COUNTER BORES—for cleaning chassis for perfect earth connections, per set of three, 2, 4 and 6 BA ... 5s. 9d.

ELECTRIC DRILLS, Wolf "Quartermaster" AC/DC operation 230/250 volts. Takes up to 1/8" drill, speed 1,800 R.P.M. ... £7 10s. 0d.
(Supplies very limited)

SOLDER Multi-core available in 16 s.w.g., per lb. reel ... 5s. 3d.

CRYSTAL CONTROL

(No permits now necessary for supply)
Q.C.C. mounted crystals to cover new 7 Mc/s and 14 Mc/s bands, also 58 and 28 Mc/s. A large selection of frequencies available from stock ... £1 12s. 6d.

TRANSMITTING VALVES

Standard Telephones 5B/250A—(807) Beam power amplifier	...	£1 10s. 5d.
Standard Telephones 2V/400A—(866-866A) Mercury rectifier	...	£1 7s. 6d.
Standard Telephones 4274A - Full-wave vacuum rectifier, 5V, 2 amps, 1,000v. 200 ma.	...	£1 0s. 0d.
Standard Telephones 4074A (RK34) double triode	...	£1 10s. 0d.

Leaflet showing full range of Amateur transmitting valves made by Standard Telephones available on request.

VALVE HOLDERS

Transmitting type for 813-5C/100A	...	12s. 6d.
803	...	12s. 6d.
Acorn Ceramic (U.S.A.)	...	2s. 0d.
Button Ceramic	...	1s. 6d.
Large Loctal (for EF50)	...	3s. 6d.
Retainers for EF50	...	1s. 6d.

Full range of all normal British and U.S.A. holders in stock.

TECHNICAL BOOKS

We carry a varied selection of informative and approved text-books, such as :-
Foundations of Wireless (Scroggle) ... 7s. 6d.
Short Wave Radio (Reyner) ... 10s. 6d.
Radio Laboratory Handbook (Scroggle) ... 12s. 6d.
First Course In Wireless (Decibel) ... 2s. 6d.
Radio Valve Manual (Bernards) ... 3s. 6d.
Wireless World Valve Data ... 2s. 0d.
Thermionic Valve Circuits (Williams) ... 12s. 6d.
Radio Reference Handbook (Babani) ... 10s. 6d.
Thermionic Valves In Modern Radio Receivers (Witts) ... 8s. 6d.

Webb's

RADIO

14 SOHO ST., LONDON, W.1. Phone: Gerrard 2089

Write, phone or call—
Our shop hours are 9 a.m. to 5 p.m.
(Saturdays 9 a.m. to 1 p.m.)

DESIGN for INDUSTRIAL FREEZE

If, like us, you were makers of small power tools, the world would seem full of twiddlers — people twiddling screwdrivers and spanners and drills and sich. Twiddling them by

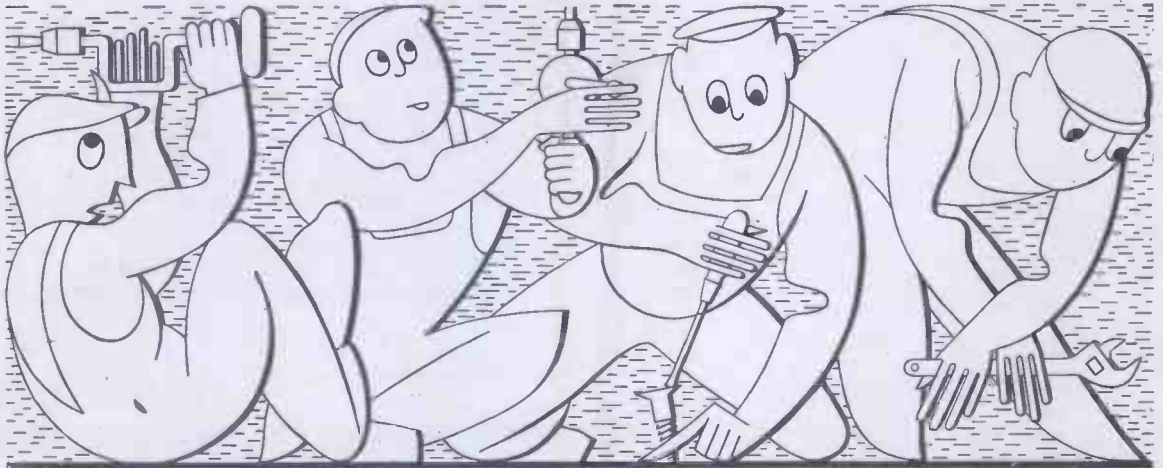

hand! And looking mighty awkward doing it. We don't tell them so, of course, in case they think we're trying to sell them Desoutter Power Tools. But you might.

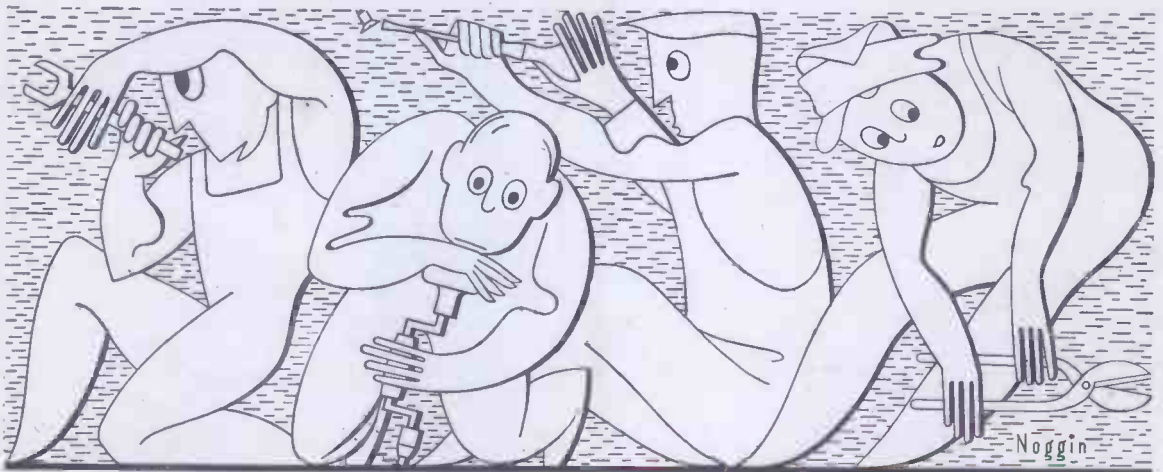

Specialists in Lightweight, Pneumatic and Electric Portable Tools

DESOUTTER

Desoutter Bros. Ltd. (Dept. U), The Hyde, Hendon, London, N.W.9.

Telephone: Colindale 6346-7-8-9.

Telegrams: Desprnuco. Hyde, London

C.R.C. 159