

# Electronic Engineering

INCORPORATING ELECTRONICS, TELEVISION AND SHORT WAVE WORLD

## PRINCIPAL CONTENTS

Scanning Systems for Colour Television  
Miniature Radio Components  
Negative Feed-back in Hearing Aid Amplifiers  
Condensers in Series-Heater Circuits  
Gasfilled Tubes as Pulse Generators

**2/- APR., 1945**

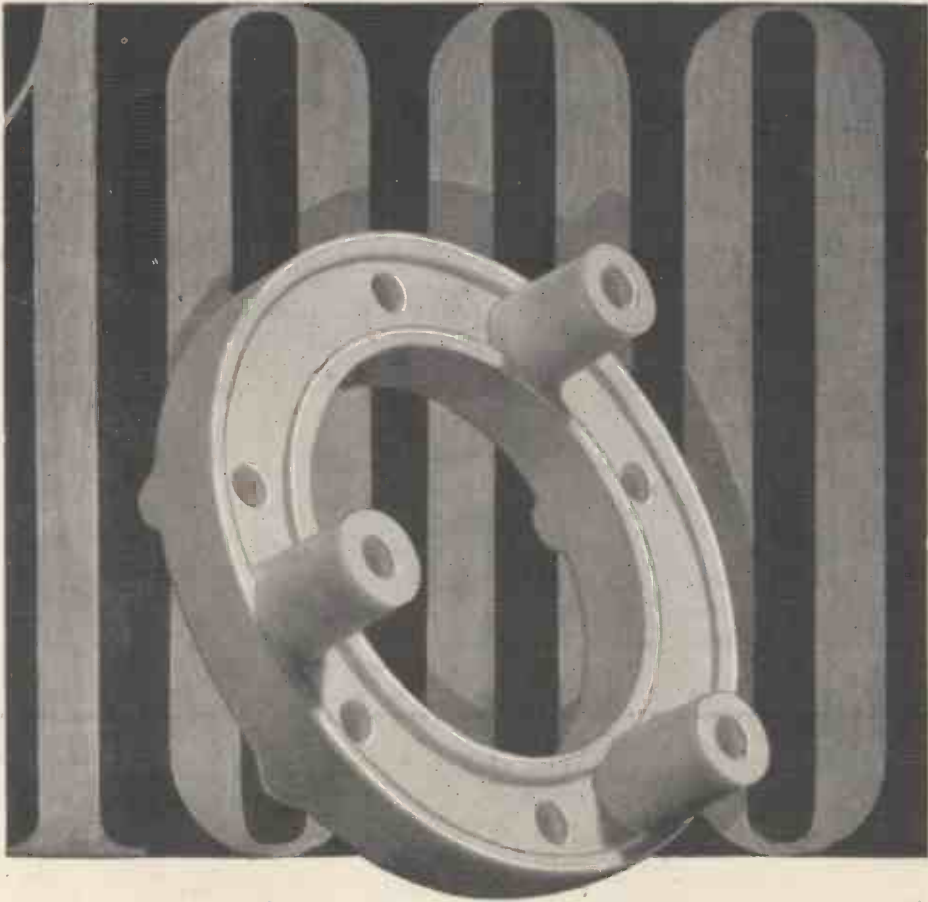

## ONE IN A THOUSAND

Ten years ago we introduced the first British-made low-loss ceramic. To-day the range of FREQUENTITE components covers more than a thousand pieces of every shape and size.

With such a store of manufacturing experience we are able to offer advice backed by practical knowledge on your insulation problem. Please consult us before you finalize your design.



## STEATITE & PORCELAIN PRODUCTS LIMITED

Head Office: Stourport-on-Severn, Worcs. Telephone: Stourport 111. Telegrams: Steatoin, Stourport.

S.P.17

# *Angles on* **BRIMAR PRESTIGE**

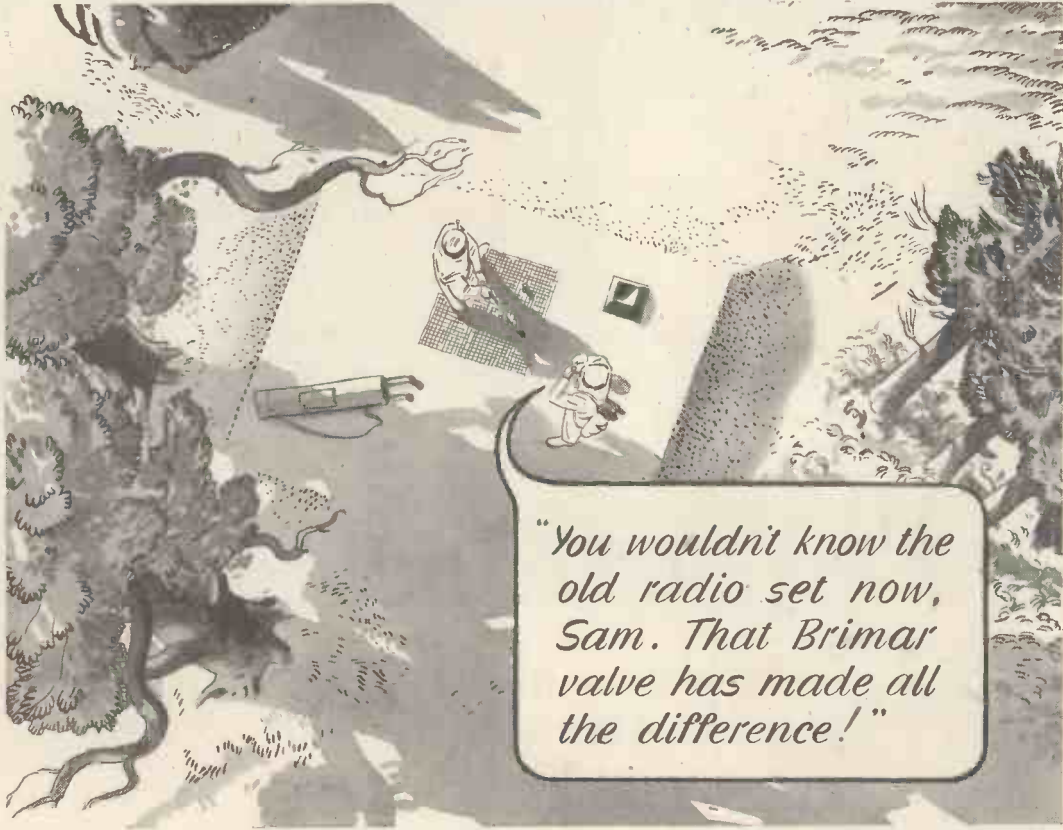

*"You wouldn't know the old radio set now, Sam. That Brimar valve has made all the difference!"*



*Engineers know that Brimar Valves operate within very close limits with unfailing reliability. That's why they often make "all the difference" to radio performance. Although still in short supply, you may be fortunate to get the Brimar Valve you need.*

# **BRIMAR**

(BVA)

# **VALVES**

**STANDARD TELEPHONES AND CABLES LIMITED, FOOTSCRAY, SIDCUP.**



## COLLINS ENGINEERING AND EIMAC VALVES *achieve outstanding results*

This Collins type 231D-11 (Navy TDH) radio transmitter is an outstanding demonstration of the value of capable engineering coupled with the intelligent choice and use of vacuum valves.

It is the latest of a series of Collins Autotune, quick shift transmitters which were originally introduced in 1939, and which use Eimac valves in the important sockets. In the 231D-11, two Eimac 750TL valves in parallel make up the power amplifier, while a pair of Eimac 450TL valves in class "B" are used as modulators for voice and MCW emission.

Mr. F. M. Davis, General Manager of the Collins Engineering Division, says: "Eimac valves have been found to be reliable, rugged and capable of withstanding the severe overloads encountered during equipment tests, without damage." Statements like this, coming from such men as Mr. Davis, offer proof that Eimac valves are first choice of leading engineers throughout the world.

Output CW—5 KW; Output 'Phone—3 KW 100% modulated with a pair of Eimac 450TL valves in class "B" audio; continuous coverage from 2 MC to 18.1 MC with 11 preset channels in that range and complete manual coverage throughout whole range. Capable of completely unattended remote control operation and of A1, A2 and A3 type emission. Audio characteristics: plus or minus three DB from 150 to 3,500 cycles. Total harmonic distortion less than 10%. The transmitter can be terminated into a 50 to 1,200 pure resistive load at zero degrees phase angle. 70 to 850 ohm load at plus or minus 45 degrees and 100 to 600 ohms at plus or minus 60 degrees

Write for your copy of Electronic Telesis—a 64 page booklet fully illustrated—covering the fundamentals of Electronics and many of its important applications. In layman's language

Follow the leaders to



# Eimac VALVES

EITEL-McCULLOUGH, Inc., 956 San Mateo Ave., San Bruno, Calif.

Plants located at: San Bruno, California and Salt Lake City, Utah

Export Agents: Frazar & Hansen, 301 Clay Street, San Francisco 11, California, U. S. A





*Going one better*

**IN COMMUNICATIONS**



To-day, wherever Bullers Low Loss Ceramics are used, reception is clearer and better than ever before.

**Made in Three Principal Materials:**

Years of research in Bullers Laboratories have developed these materials to such a high level of efficiency that Dielectric Loss is virtually eliminated. Bullers Ceramics are now playing a vital part in maintaining communications under all conditions.

**FREQUELEX.** An insulating Material of Low Dielectric Loss. For Coil Formers, Aerial Insulators, Valve Holders, etc.

**PERMALEX.** A High Permittivity Material. For the construction of Condensers of the smallest possible dimensions.

**TEMPLEX.** A Condenser material of medium permittivity. For the construction of Condensers having a constant capacity at all temperatures.

**BULLERS LIMITED**

THE HALL, OATLANDS DRIVE, WEYBRIDGE, SURREY

Telephone : Walton-on-Thames 2451  
Manchester Office\* : 196 Deansgate, Manchester

**Bullers**

**LOW LOSS CERAMICS**



# ELECTRONIC DEVICES

*for  
Science &  
Industry*

*G.E.C.*

CATHODE RAY  
TUBES ETC

Osram

Valves

Osram

PHOTO CELLS



The G.E.C. is foremost in the design, production and supply of radio valves and electronic devices as being essential links in the national effort to secure a speedy victory.

Thermionic Valves, Cathode Ray Tubes and associated Electronic Devices will inevitably become increasingly necessary in post-war application to scientific development in all spheres of electrical engineering and industry.

Here are just a few examples :—

- Navigational Aids
- Oscilloscopes for Industrial and Scientific Research
- Valve Control Devices and Electronic Switches.
- Public Address Equipment and Alarm Systems.
- High Frequency Heating.
- Instruments of all kinds.

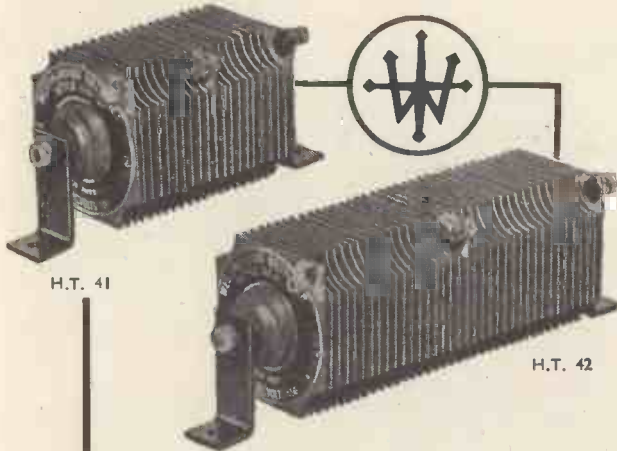

**H.T. UNITS IN "WESTALITE"**

Two new H.T. units in "Westalite" selenium-compound are now available for priority orders. Both types are suitable for a maximum output of 100mA and may be used either half-wave or voltage doubler. Maximum output volts H.T.41 200 and H.T.42 475 and 100mA.



**METAL RECTIFIERS**

WESTINGHOUSE BRAKE & SIGNAL CO., LTD.,  
Pew Hill House, Chippenham, Wilts.

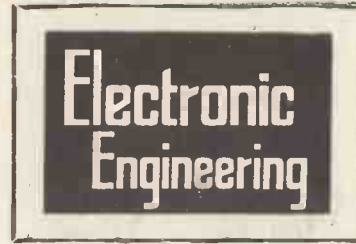

APRIL, 1945

Volume XVII.

No. 206.

**CONTENTS**

	PAGE
Editorial—Television Again ... ..	447
Components for Post-War Radio ... ..	448
Negative Feed-back in Hearing Aid Amplifiers ... ..	450
Condensers in Series-Heater Circuits ...	454
Scanning Systems for Colour Television ...	456
Aerial-Coupling Circuits—Part 3 ... ..	461
The Principles and Design of Valve Oscillators—Part 3 ... ..	465
Notes from the Industry ... ..	469
Low Frequency Amplification—Part 6 ...	470
The Mervyn Reactance Alignment Comparator ... ..	473
Gasfilled Tubes as Pulse Generators ...	474
A New R.F. Crack Detector ... ..	476
Book Reviews ... ..	478
April Meetings ... ..	480
Abstracts of Electronic Literature ... ..	482

  
**TELCON**  
**CABLES**  
*for*  
**HIGH**  
**FREQUENCY**  
**TRANSMISSION**  
**and RECEPTION**

●

Full particulars of all Telcon Products from:

**THE TELEGRAPH CONSTRUCTION & MAINTENANCE CO. LTD.**

Head Office: 22, Old Broad Street, London, E.C.2

Telephone: London Wall 3141

**CONDITIONS OF SALE**—This periodical is sold subject to the following conditions, namely, that it shall not without the written consent of the publishers first given, be lent, re-sold, hired out or otherwise disposed of by way of Trade except at the full retail price of 2/- and that it shall not be lent, re-sold, hired out or otherwise disposed of in a mutilated condition or in any unauthorised cover by way of Trade, or affixed to or as part of any publication or advertising, literary or pictorial matter whatsoever.

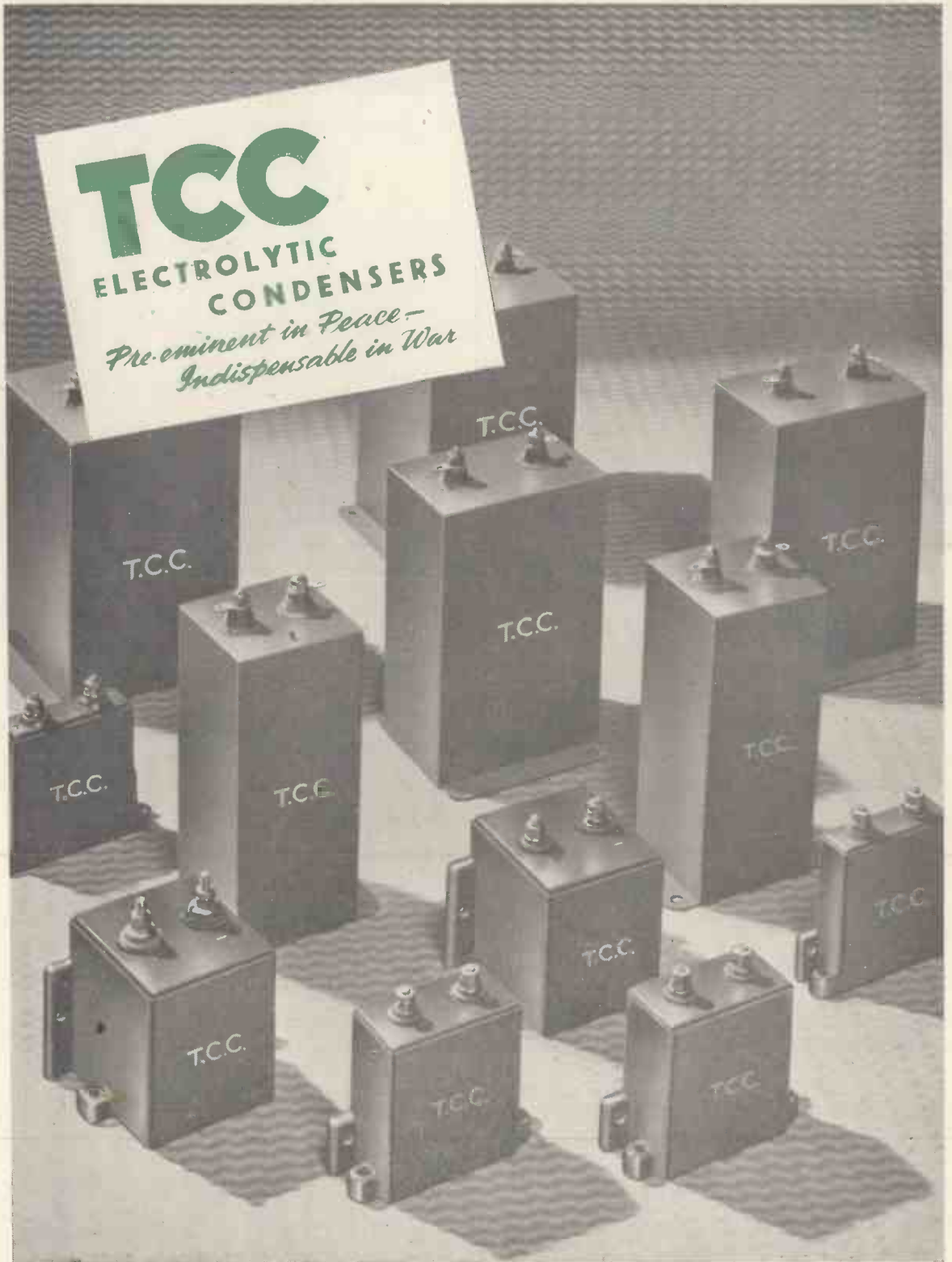

ADVERTISEMENT OF THE TELEGRAPH CONDENSER CO., LTD.



PROPRIETORS :

HULTON PRESS, LTD

# Electronic Engineering

EDITOR

G. PARR.

EDITORIAL, ADVERTISING AND PUBLISHING OFFICES, 43-44, SHOE LANE, LONDON, E.C.4

TELEPHONE:  
CENTRAL 7400

Monthly (published last day of preceding month) 2/- net. Subscription Rates :  
Post Paid to any part of the World—  
6 months, 13/- ; 12 months, 26/-.  
Registered for Transmission by  
Canadian Magazine Post.

TELEGRAMS :  
HULTONPRES, LUD  
LONDON.

## Television Again

THE recommendations of the Television Committee, which have recently been published,\* will not come as a surprise, to the members of the radio industry, who have already expressed their views through their Council. The 20,000 owners of receivers (or whatever the number is) will be pleased that they have not disposed of them at scrap prices.

The view has often been expressed that the best use was not made of the pre-war standard, and the resumption of the service will give an opportunity of showing whether this standard was quite so poor as the advocates of "1,000 lines or nothing" have suggested. Nevertheless, the Committee have expressed the opinion that television should eventually have a definition of 1,000 lines with possible colour and stereoscopy.

The question of definition affects the attitude of the cinema industry, who state in their evidence that the public will not be attracted to pictures of the present standard apart from their novelty, and their adoption of television in the theatres will be deferred until a better definition is available.

The brief summaries of the Report which appeared in the Press omitted

\* Report of the Television Committee, H.M. Stationery Office, 6d.

several items of interest to the radio industry. For example, the statement that "war research has produced little information and no discovery of a fundamental character bearing directly on television" explodes any vague rumours that several revolutionary inventions are only waiting for the ban to be lifted.

The importance of interference suppression is emphasised, and it is

recommended that the Postmaster-General should be given the necessary powers to enforce it.

As regards the provinces, it is expected that the service in Birmingham will be available within a year after the reopening of the London service, with a cable link between the stations, and other provincial centres will follow as rapidly as possible. Stations in the neighbourhood of Huddersfield, Falkirk, and Bristol had already been proposed before the war. These provincial centres will be supplied with programmes from the London studio, but presumably they will have their own mobile pickup units for televising local events. This is not mentioned in the Report, but it seems an obvious way of popularising television and making it a more intimate entertainment than the cinema can be.

From the list of witnesses and organisations represented there is one name missing—that of the Ordinary Viewer. It would be interesting to know whether any attempt was made to obtain the opinion of the man in the street.

And also—but it is heresy to ask the question—did all the members of the Committee possess television receivers?

### ELECTRONIC ENGINEERING MONOGRAPHS

The demand for the first two Monographs in this series :

#### FREQUENCY MODULATION

by

K. R. Sturley, Ph.D., M.I.E.E.

and

#### PLASTICS IN THE RADIO INDUSTRY

by

E. G. Couzens, B.Sc., and

W. G. Wearmouth, Ph.D.

has required several reprintings, with a consequent delay in the issue of further titles.

These are now in preparation ; in the meantime, readers are urged to order copies of the above while stocks are still available.

They may be obtained from the Circulation Department, Hulton Press, 43, Shoe Lane, London, E.C.4, price 2s. 8d. post free, or through any technical bookseller.

# The Size of Things to Come

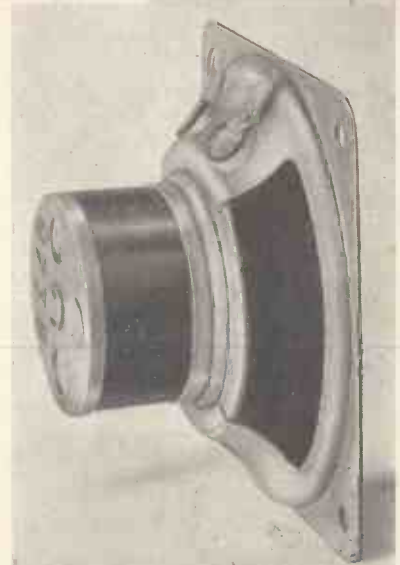
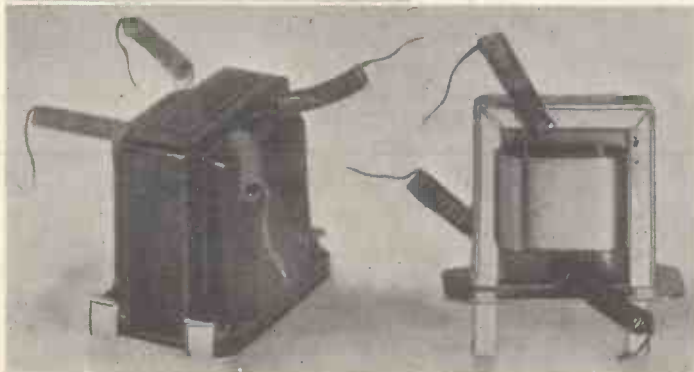
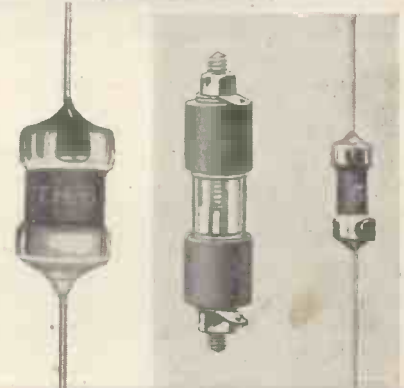
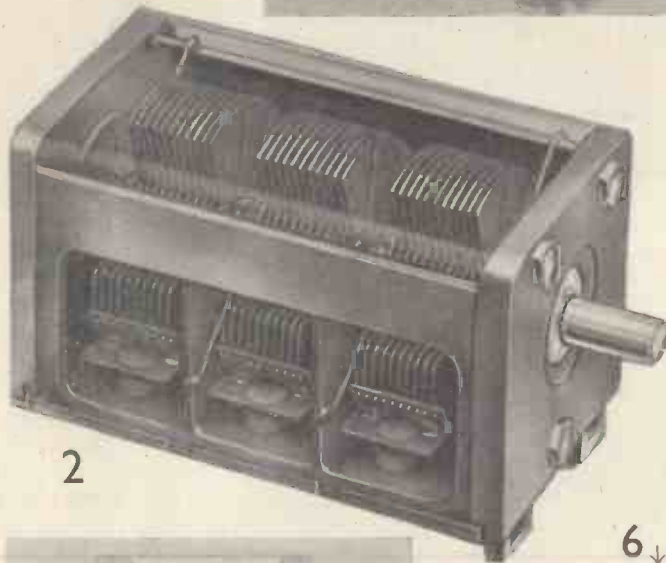
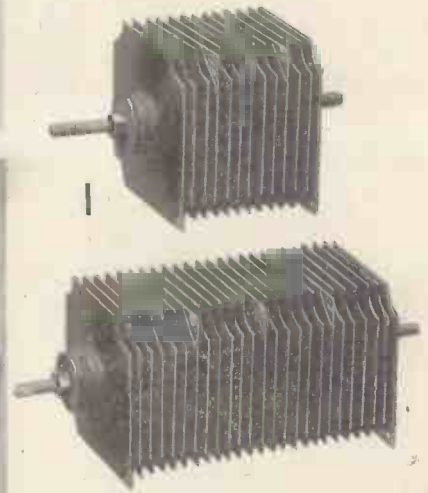

Photos 5, 8 and 9 by courtesy of the "Wireless World."

# Components for Post-War Radio

A description\* of some of the new components shown at the recent R.C.M.F. Exhibition. A further selection will be described later

THE second exhibition of radio components and accessories sponsored by the Radio Component Manufacturers' Association and held in London on February 20-22 was even more popular than the first, judging from the crowds which filled the hall throughout the period.

Apart from the designers of Service equipment, the exhibition gave an opportunity to many engineers to see the trend of post-war component design and the influence of Service requirements on the construction of familiar items such as variable condensers, transformers and resistors.

The tendency to provide small compact radio equipment has led to the development of miniature components in nearly all classes and the needs of overseas Service equipment has introduced tropical finish almost as a standard. Some specimens of miniature components are shown on the opposite page.

Many of the newer developments are still reserved for Service requirements and are confidential, but those illustrated together with many others will be available for post-war designers as soon as restrictions on manufacture and output are lifted. Detailed particulars can be obtained from the firms listed in the adjoining column, who will be pleased to supply literature on request from *bona fide* designers.

The numbers against each item refer to the illustrations on the opposite page.

## 1. Westectors and Westalites

The new miniature Westector, shown full size in the illustration, is only  $\frac{1}{2}$  in. long and weighs 1.06 gm. The original Westector is shown on the left of the new model.

Also shown are the new Type TH.1A, wax sealed, used largely for ring bridge modulators, and Type TH.6 with metal-capped ends similar to the miniature Westector.

The improved Westalite rectifiers now operate at double the previous voltage rating and the bulk and weight are approximately halved. The new type is shown above the older type for comparison.

*Westinghouse Brake & Signal Co., Pew Hill House, Chippenham, Wilts.*

\* Passed by Censor.

## 2. Variable Condensers

Mullard's variable condenser Type C7A is a 3-gang with a capacity of 300 pF per section.  $\pm 1$  pF or 1 per cent. The finish is tropical (K.110 Specn.) and the dimensions are  $3\frac{1}{2}$  in. overall length by 1.60 in. wide.

The miniature tubular paper condensers shown are sealed in a moulded polythene case, and the range available is from 0.001 to 0.1  $\mu$ F, 500 V D.C. working for the smaller sizes to 200 V D.C. for the larger. Capacity tolerance in each case is  $\pm 25$  per cent.

*Mullard Wireless Service Co., Century House, Shaftesbury Avenue, W.C.2.*

## 3. A.B. Rotary Wavechange Switch

Brit. Pat. 297/44. Totally enclosed and hermetically sealed for tropical use. Overall dimensions only  $\frac{3}{4}$  in. diameter by  $1\frac{3}{16}$  in. long behind panel. Ranges: Single pole up to 12 positions; 2-pole up to 6; 3-pole up to 4; 4-pole up to 3 positions.

*A.B. Metal Products, Gt. South-West Road, Feltham, Middlesex.*

## 4. Erie Resistors

This company claim to have produced the world's smallest resistor. The Type 5B  $1/10$ th watt moulded resistor is only  $\frac{3}{8}$  in. long by  $\frac{1}{4}$  in. diameter. The tentative range manufactured is from 10 ohms to 10 megohms. Type 16 resistor is a moulded insulated carbon resistor with axial leads, made in values from 220 ohms to 4.7 megohms.

*Erie Resistor Co., Carlisle Road, The Hyde, N.W.9.*

## 5. Microphone

This is a moving coil instrument with a 50-ohm voice coil and a flux density of over 4,000 gauss. The diaphragm is of bakelised paper and it has a rising frequency response specially engineered to give the greatest degree of articulation under very noisy conditions. This microphone is practically waterproof, will stand any conditions in this country, and tropical tests show that it has better weather resistance qualities than any other type at present in use.

*—Goodmans Industries, Ltd., Lancelot Road, Wembley, Middlesex.*

## 6. Metal-Cased Ceramic Capacitors

The ceramic capacitors produced by the Telegraph Condenser Co. are assembled in metal tubes, which give complete screening and render them capable of withstanding tropical conditions.

The external silvered coating of the capacitor is connected to the metal case, giving the maximum screening electrically as well as mechanically. The smallest sizes are  $\frac{3}{4}$  in. long by  $3/16$  in. diameter (10–100  $\mu$ F).

*Telegraph Condenser Co., Wales Farm Road, W.3.*

## 7. Midget Potentiometer

This potentiometer, made by the Morganite Co., is fully watertight and will operate from  $-40^{\circ}$  C. to  $70^{\circ}$  C. saturated humidity. The rating is  $1/10$ th watt uniform loading, and the range of resistance values is from 1,000 ohms to 3.3 megohms. Dimensions:  $23/32$  in. diameter by  $\frac{3}{8}$  in. back of panel. Insulation: 750 V D.C. working between case and circuit. Rotation:  $265^{\circ} \pm 5^{\circ}$ .

*Morganite Crucible Co., Battersea Works, S.W.11.*

## 8. Miniature Transformer

The very small inter-valve coupling transformers made by Messrs. A. F. Bulgin and Co., Ltd., are intended for hearing aid, ultra-small portable and "walkie-talkie" type equipment. They have good response curves over the range of 100–7,000 c/s. Both double-wound and auto models are available with bakelite cases or in skeleton form.

*—A. F. Bulgin and Co., Ltd., By-Pass Road, Barking, Essex.*

## 9. Miniature Loudspeaker

This speaker has been designed for use in midget sets and for inter-office communication equipment. It combines small size with very light weight ( $3\frac{1}{2}$  oz.), and has high sensitivity and an excellent overall response. The reproduction of speech is particularly crisp and clean. To improve the lower register and compensate for small cone and baffle size, frequency doubling has been introduced below 200 c/s.

*Celestion Limited, Kingston-on-Thames, Surrey.*



# Negative Feed-back in Hearing Aid Amplifiers

By F. E. PLANER, Ph.D., M.Sc., and  
E. A. MARLAND, B.Sc.



Fig. 1a.

**I**NCREASING interest has been shown in the last few years by Welfare and Health Centres, as well as research and industrial organisations, in the problems concerned with electrical aids for the hard of hearing. This trend may be attributed to several causes, the most important of which probably is the fact that modern audiometric examination methods have revealed an astonishingly high incidence of impaired hearing. According to the *British Medical Journal* some six and a half million people in this country alone suffered from defective hearing before the war<sup>1</sup> and it must be assumed that the number will be materially increased by the war.

Another factor responsible for the rapid development of the electrical hearing aid has been the comparatively recent progress in the field of electronic communications, both as regards circuit technique and the

design of new types of electrical components.

In order to extend the benefit of these improvements to the majority of sufferers, and it has been estimated that about 90 per cent. of all cases can be substantially assisted by the use of hearing aids, production of such instruments would have to be increased considerably. At the same time it would be essential to effect a reduction in the cost both of the new instrument and its maintenance. With pre-war prices ranging from twenty-five to thirty-five guineas high quality hearing aids have been available only to a few.

## Requirements of Hearing Aids

It is now generally appreciated that the highest quality and maximum amplification is obtainable only from valve amplifiers, and the following considerations will be confined to this type of hearing aid. High-slope valves are now made of such size that

they can be accommodated, together with their associated components, in a pocket-sized amplifier. Sufficient gain is obtainable from such an instrument to enable the use of a small high fidelity crystal microphone. Apart from the important considerations of high quality, large amplification, and small size, an ideal hearing aid should meet a number of other requirements, such as low battery drain, simplicity of controls and low cost. A further requirement concerns the frequency response characteristic and its adjustment, about which more will be said later on. Some of these requirements are, of course, conflicting and the design of an amplifier of this type will inevitably be a compromise.

## The Application of Negative Feed-back

The relatively high amplification obtainable with the new midget valves may under certain conditions allow a sacrifice in gain to be made for the improvement of quality resulting from the application of negative feed-back. Since its discovery by H. S. Black in 1934<sup>2</sup> negative feed-back has found innumerable applications. In high quality amplifier systems where size and weight are of little consequence it is now almost invariably used. Its effects upon amplifier performance are well known, including improved frequency response, reduction of distortion and noise introduced by the amplifying system, as well as increased stability with regard to variations in the supply voltages and circuit elements.

In a few of the more recent designs of hearing aid amplifiers incorporating high gain valves, use has been made of the enhanced quality obtainable with negative feed-back. As an example, a circuit recently described in the American literature<sup>3</sup> provides voltage feed-back between the anode and grid of the output stage. Fig. 2 is a reproduction of the circuit and it

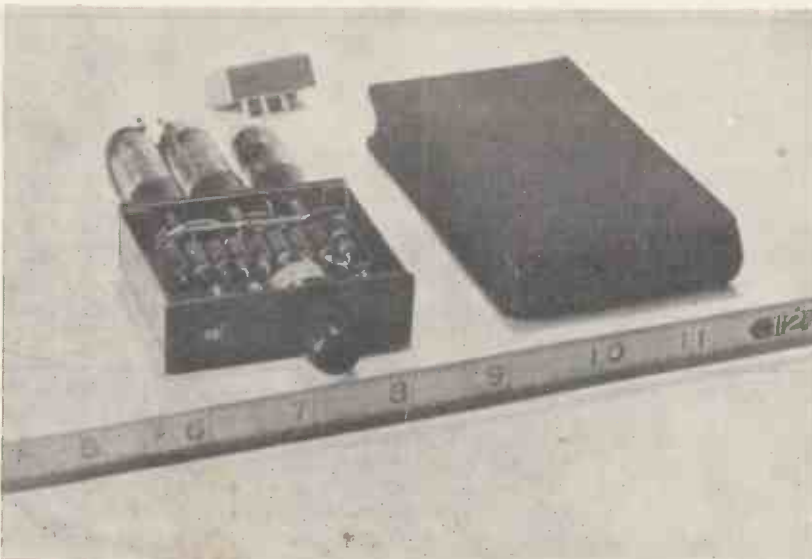

Fig. 1b. View of amplifier removed from case. (See (1a) above.)



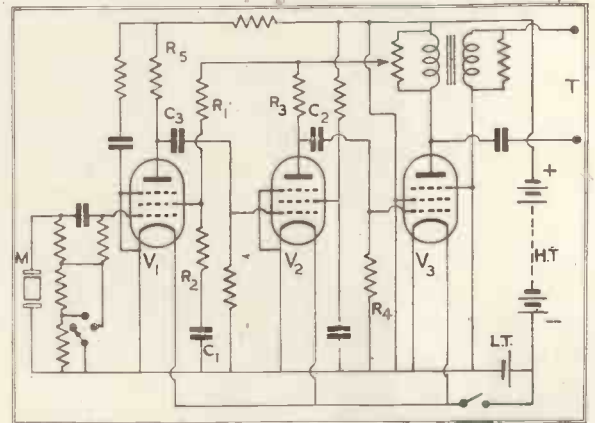
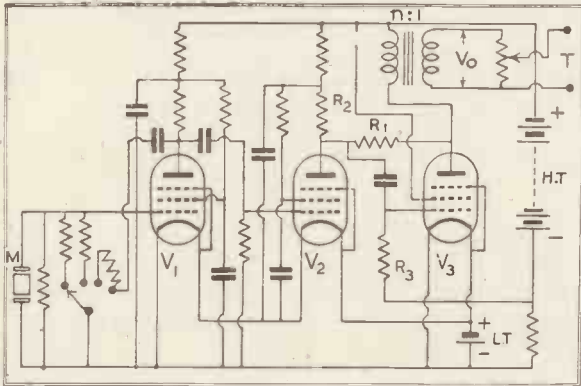

Fig. 2. Voltage feed-back between anode and grid of output stage.

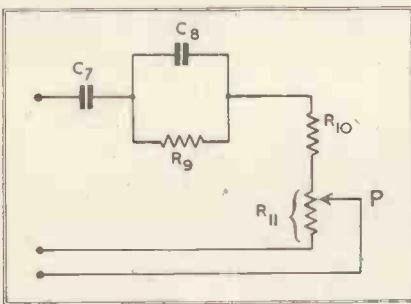
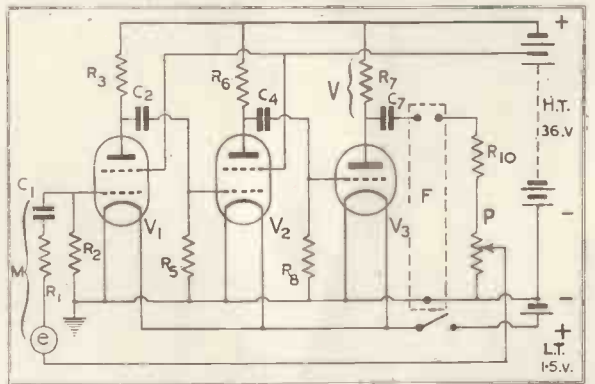

Fig. 3 (top right). Use of positive feed-back to counteract fall in battery voltage.

Fig. 4. Frequency corrected negative feed-back amplifier.

Fig. 5 (left). Simple 2-terminal network used with Fig. 4.



will be seen that a fraction of the output voltage  $V_o$  is applied to the grid of valve 3. The circuit values are as follows:  $R_1 = 0.5 \text{ M}\Omega$ ,  $R_2 = 1 \text{ M}\Omega$ ,  $R_3 = 5 \text{ M}\Omega$ . An interesting circuit incorporating negative feed-back to improve fidelity of reproduction, and a measure of positive feed-back to counteract the effects of falling battery voltage, is described in U.S. Patent No. 552,331, due to the Western Electric Co., Inc. As shown in the circuit arrangement of Fig. 3 a fraction of the output voltage from the tapped resistor shunting the output transformer is applied to both the first and the last valve. In the former case the feed-back voltage is impressed upon the screen grid through the resistances  $R_1$ ,  $R_2$ , and condenser  $C_1$ , in the latter case upon the grid through the resistance  $R_3$ , condenser  $C_2$  and resistance  $R_4$ . Positive feed-back with increasing H.T. battery resistance is applied to the grid of valve 2.

In both the circuits described, a form of control of the frequency response characteristic is incorporated in the input circuits relying on the shunting effect of different resistors across the capacitive crystal microphone.

The ideal frequency response

characteristic of a hearing aid is the subject of some controversy, and a few notes on the various considerations involved will be of interest here.

**Frequency Response Characteristics of Hearing Aids**

Audiograms, *i.e.*, plots of hearing acuity against frequency, taken from a large number of deaf people have shown that the shape of the hearing loss characteristics between different patients varies appreciably. Indeed, the position of the maximum hearing loss is of great diagnostic value to the otologist in locating the defect in a patient's hearing mechanism. Middle and outer ear deafness is usually characterised by a flatter hearing loss curve than defects in the inner ear, where damage to the basilar membrane or lesions of the associated cranial nerve usually result in a more pronounced loss in the upper register. It may be stated with some degree of certainty that in the majority of cases the upper frequency region, *i.e.*, above 2,000 c/s., is impaired. So far as articulation is concerned, this represents a very important part of the spectrum and its absence causes in general more inconvenience to the patient than a similar loss at lower

frequencies. If in such a case the hearing aid has a flat response characteristic then although amplification is provided where it is required, at the higher frequencies, speech may be severely masked by the relatively over-emphasised lower frequencies, such as traffic noise, etc. In the attempt to provide adequate high frequency level, the low frequencies may then well have been amplified to the level of the threshold of pain.

In deciding upon the optimum frequency response characteristic of a hearing aid it would seem at first sight that the amplification should be made complementary to the audiogram of each patient. The hearing loss characteristic, however, is a curve of threshold intensities, while optimum intelligibility is obtained generally some 30 to 40 db above threshold. Owing to the non-linear characteristic of the human ear, the corresponding curve at higher levels will in general differ somewhat from that given by the audiogram. The labour which would be involved in determining a "loudness contour," such as *e.g.*, the 40 phon level, prohibits any such measurements for the purposes of prescribing hearing aids.

A subjective difficulty is also en-

countered here. The onset of deafness is usually a gradual process and the patient progressively "educates" himself to his changing condition. If he suddenly finds himself provided with almost fully corrected hearing he will need a period of time in which to adjust himself before the outside world sounds natural to him again.

Although the need for the individual correction in the frequency response characteristic of hearing aids is now generally appreciated, an understanding of the factors outlined above is essential in the application of tone control.

Apart from these difficulties there are several other reasons why individual frequency correction has not yet been universally adopted. One of the difficulties has been the use of the more sensitive carbon microphone with the older type of hearing aid and the pronounced diaphragm resonances which defied any attempt at frequency correction. The higher amplification obtainable with valve amplifiers has made possible the use of microphones whose frequency characteristic is substantially flat, such as the piezo-electric microphone. Another important achievement has been the recent development of a magnetic receiver of the midget type having a frequency response characteristic which is linear to within 3 db between 100 to 5,000 c/s.<sup>6</sup>

One of the main objections to the incorporation of tone control in valve amplifiers has been the fact that frequency correction must inevitably be effected by the attenuation of the less wanted frequency region—rather than by the boosting of the wanted range. This results in an apparent loss in gain which, at least from a commercial point of view, was considered undesirable in an instrument of strictly limited size. Another factor is the large number of different amplifier circuits which would have to be provided to cover the range of audiograms encountered in practice.

Some of these difficulties have been overcome by an experimental hearing aid designed by the authors. This amplifier affords maximum possible gain over the whole of the frequency spectrum, when used for low sound intensities where there is little danger of exceeding the threshold of pain. As the sound intensity from the source is increased and the volume control is turned down a gradual change is effected in the shape of the frequency curve which finally approaches the conjugate of the individual hearing loss curve. A simple control is provided, and use is made of the advantages of negative feed-back at the lower settings of this control.

The amplifier proper is made as a unit and possesses a substantially flat frequency response characteristic. In

addition, a number of small separate filter units are provided to meet the majority of frequency correction demands as derived from statistical surveys of hearing loss characteristics, such as the results of tests on 750,000 visitors at the New York World's Fair.<sup>7</sup> The filter units contain two- or three-terminal networks and the required frequency response is obtained merely by plugging the appropriate unit into a socket provided on the amplifier. In the following paragraph a more detailed description is given of the circuit arrangement and its characteristics.

**The Frequency Corrected Negative Feed-back Hearing Aid**

In order to illustrate the principle, its application to a three-stage resistance-coupled amplifier will be considered here. In Fig. 4 is shown the circuit diagram of the amplifier which employs two tetrode stages  $V_1$  and  $V_2$  followed by an output triode  $V_3$ . The microphone  $M$  is of the piezo-electric type and its equivalent reactance and resistance are shown in series with the generator voltage  $e$ .  $R_l$  represents the output load with the output voltage  $V$  appearing across it. A portion of this voltage is fed back to the grid of  $V_1$  via the potential divider  $P$  and the correction network  $F$ . It will be seen that in the present circuit degenerative feed-back has been made variable by the adjustment of the potentiometer  $P$ . This control serves primarily as a gain control, so that in listening to close or excessively loud sources of sound as the volume

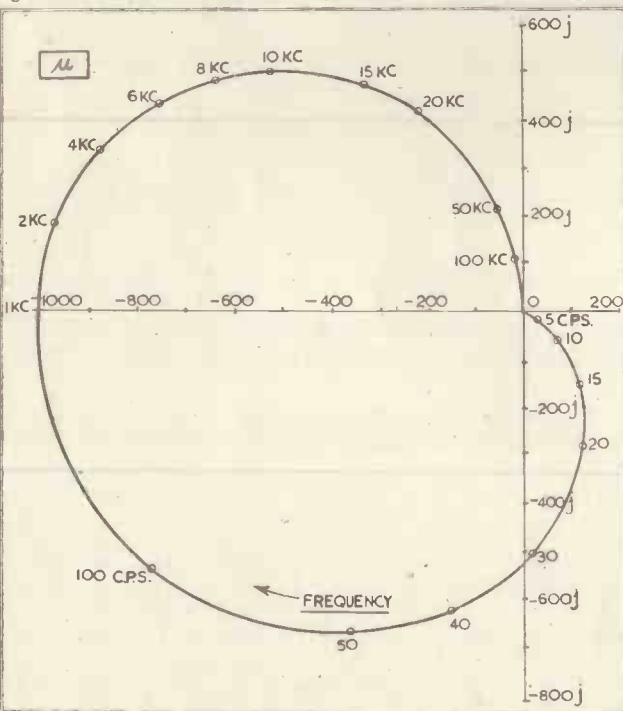
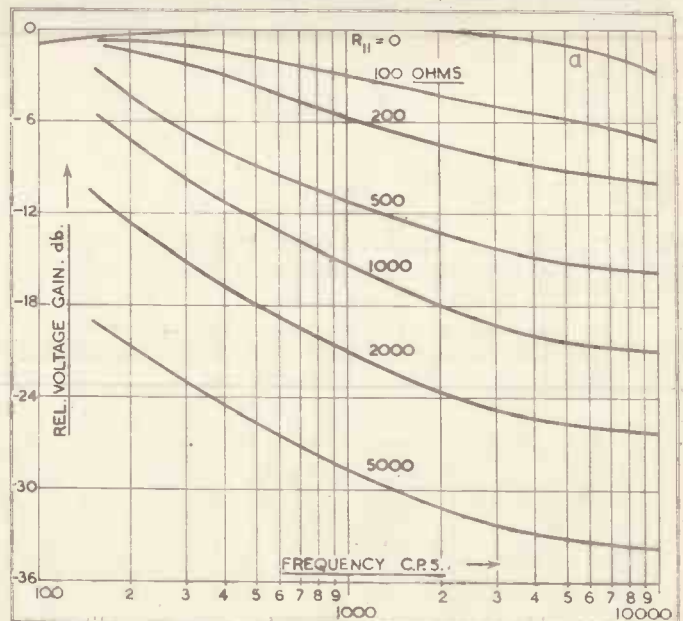

Fig. 6a (left).  
Fig. 7 (right).



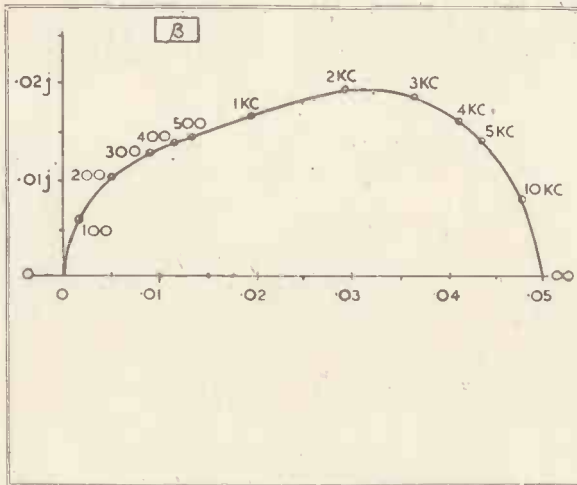

Fig. 6b. Ratio of output to input voltage.

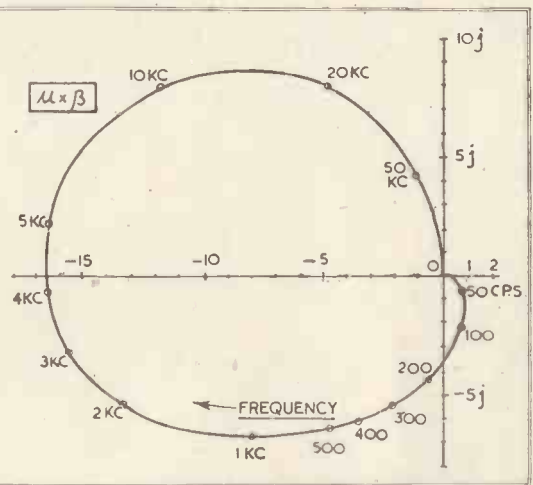

Fig. 8. Loop gain for max. feed-back.

at the receiver is decreased the advantages of negative feed-back are utilised. Further, a network providing such frequency correction as may be necessary for the individual patient is applied in the feed-back path as previously mentioned.

When listening to a source of adequate sound intensity the user will turn the "gain" control towards the position of minimum volume, providing full frequency correction and the fidelity afforded by degeneration. In less favourable circumstances the volume is increased by reducing the feed-back voltage, at the same time reducing the amount of correction and utilising the hearing aid at the maximum gain of which it is capable.

The circuit arrangement has the further advantage of permitting the use of a variety of networks of simple type having differing frequency characteristics. These networks need contain only a minimum number of components making it practicable to provide these in the form of auxiliary plug-in units. This affords the possibility of individual assistance to the patient, in particular it becomes practicable to extend the usefulness of a hearing aid over a period of time, or treatment, by the consecutive use of slightly differing networks in accordance with changes in the hearing mechanism. The present paper does not permit a detailed description of the various networks proposed and their characteristics, but it is hoped to treat these at a later occasion, with particular reference to statistical results of audiometric investigations. It may be noted here, however, that in cases where frequency correction of the

type of resonance curves is required, it was found desirable to avoid the use of inductive elements, and to use capacitive and resistive circuit components instead. Apart from the bulkiness of induction coils, difficulties were experienced due to the pick-up of mains hum, and instability of the amplifier at the extremities of the frequency range.

To illustrate the operation of an amplifier of the type described the circuit of Fig. 4 will be examined when used with a simple two-terminal network as shown in Fig. 5; here,  $C_s = .0016 \mu F$  and  $R_v = 0.1 M\Omega$ . An equalising circuit of this type would find use in cases requiring increased amplification at the lower frequencies. Considering first of all the voltage gain of the system without feed-back, this may be determined from a knowledge of the voltage gain characteristics of the individual equivalent circuits of each of the three stages. Fig. 6a shows this gain,  $\mu$ , in the complex plane. Each point of the diagram therefore represents, in phase and magnitude, the tips of the vector of the output voltage at a particular frequency relative to an input voltage of magnitude 1.0 and phase angle zero. It will be seen that the gain at mid-frequency is  $-1,020$ . The minus sign, or phase angle of  $180^\circ$ , is, of course, due to the fact that the amplified voltage has experienced three complete phase reversals. A portion of the output voltage when fed back to the input through a substantially resistive  $\beta$ -network will therefore be in phase-opposition to the original input signal.

The actual circuit constants under these conditions were as follows:—

	Stage 1	Stage 2	Stage 3
Anode Impedance	1.33 M $\Omega$	1.33 M $\Omega$	8,250
Amplification factor	75	75	5.0
Anode load	1.0 M $\Omega$	1.0 M $\Omega$	4,000
Grid leak	5.0 M $\Omega$	2.0 M $\Omega$	2.0 M $\Omega$
Coupling condenser	—	.002 $\mu F$	.002 $\mu F$
Grid-cathode capacity	0	0	34 pF

Fig. 6b shows the ratio of output to input voltage, in magnitude and phase at maximum feed-back for the correction network. Inserting the complex values for  $\mu$  and  $\beta$  in the

expression  $M = \frac{\mu}{1 - \beta\mu}$  the gain

over the working frequency range may be found for various settings of the potentiometer 'P'. In Fig. 7 are shown the absolute values for seven different settings of the control. It will be seen clearly how at lower volume settings the frequency response gradually approaches the fully corrected characteristic. One serious difficulty in the application of feed-back lies in the fact that although a desired characteristic may be achieved over the wanted frequency range, conditions outside this range may be such as to allow oscillations to be set up. Until about a decade ago the conditions for stability of an amplifying system were not fully understood and it was generally assumed that oscillations would necessarily build up when the total loop gain was equal to or greater than the losses around the circuit and the phase angle zero at the same time. This conception, however, was shown to be incorrect. By studying the effect on the output voltage of a disturbance of finite duration, rather than considering the steady

(Concluded on page 455.)



# Condensers in Series-Heater Circuits

By G. S. LIGHT, B.A.Sc. (Toronto), Grad.I.E.E.

RADIO receivers and other electronic devices may have the valve heaters connected in series (provided they are of the same current rating) and supplied direct from A.C. or D.C. mains via a voltage dropping resistor. If operation from A.C. mains of one frequency only is contemplated, the resistor may be replaced by a capacitor. Some characteristics of this arrangement are discussed in this article, and the pros and cons are considered.

### General Considerations

Good quality paper dielectric condensers are the most suitable type for this application, and they should have a D.C. working voltage at least 50 per cent. greater than the R.M.S. mains voltage on which they are to be used.\* They can be expected to have an indefinitely long life, an advantage not shared by wire-wound resistors and line cords. Moreover, condensers remain cool in operation as the heat to be dissipated should not normally exceed a milliwatt or so. This is a distinct advantage over resistors which in typical cases dissipate 20 to 50 watts for which ventila-

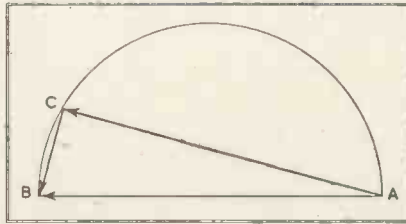

Fig. 1. Vector diagram.

tion has to be provided, and even then there is likely to be undesirable heating of other components on the same chassis, particularly tuning coils and condensers. The consumer, of course, pays for this waste heat at the same rate as for that doing useful work inside the valve cathodes. With the condenser arrangement, much less power is drawn from the mains than with a resistor, and somewhat less than with a transformer. As the P.F. is leading one would expect supply undertakings to be in favour of its widespread adoption. Indeed, for P.F. correction, a permanent quadrature current load could be provided by arranging that the condensers should remain in circuit when the receiver is switched off (by short-circuiting the valve heaters).

### Calculation of Capacity

Most valves suitable for use with the series-heater connexion require

either 0.3, 0.2, or 0.15 amp. The condenser voltage is in quadrature with that across the heaters, and the capacity required is calculated as in the following example. A receiver employs three valves of 6.3 V, 0.3 A rating, and two of 25 V, 0.3 A, and is to be used on 230 V 50 c/s. mains. Total heater voltage

$$= 3 \times 6.3 + 2 \times 25 = 68.9V$$

Voltage across condenser

$$V_c = \sqrt{230^2 - 68.9^2} = 219.5V$$

Required capacity in  $\mu F$

$$\frac{10^6 \times I}{2\pi f \times V_c}$$

$$= \frac{10^6 \times 0.3}{2\pi \times 50 \times 219.5}$$

$$= 4.35 \mu F$$

This calculation takes no account of harmonics present on the mains voltage—a variable and usually an unknown quantity, neglect of which fortunately does not lead to serious errors. For this reason and also because commercially available condensers of this order of capacity have usually a tolerance of  $\pm 10$  per cent., one would use a nominal 4  $\mu F$  condenser and then add 0.1  $\mu F$  condensers in parallel until the current reaches 0.3 A.

### Self-Regulating Action

If the total valve heater voltage is not more than about a third of the

\* British Standard 415-1941 lays down the following requirements for isolating condensers used in radio receivers:—Test voltage for one minute should be 1,500 V D.C., or 3 x R.M.S. working voltage, or 2 x peak working voltage, whichever is the greatest; insulation to be better than 100 megohms at 500 V D.C.

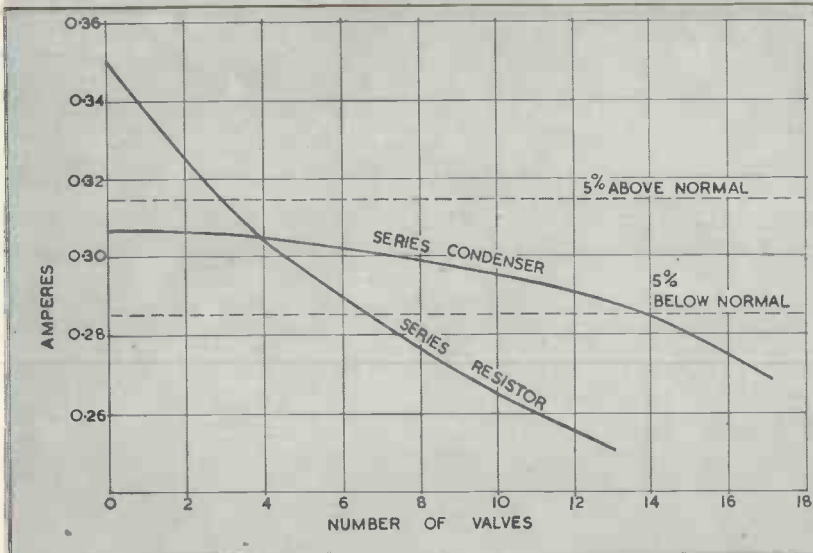

Fig. 2. Curves of current regulation.

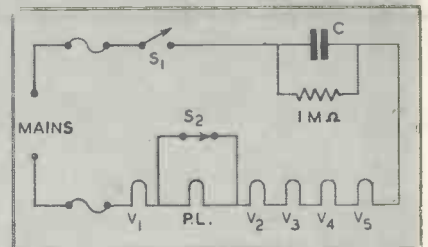

Fig. 3. Delayed double switching for pilot lamp.

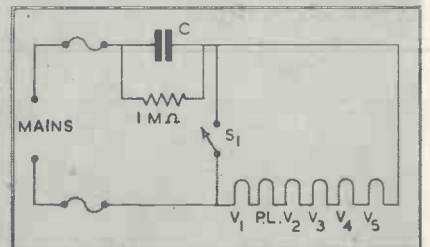

Fig. 4. Alternative connexion for on-off switch.



mains voltage, there is a self-regulating action, the current remaining almost constant irrespective of the number of valves. The reason for this can be seen from the vector diagram (Fig. 1). Here  $AB$  = mains voltage,  $AC$  = condenser voltage, and  $BC$  = total heater voltage; the semicircle is the locus of  $C$ . It is obvious that if  $BC$  is small compared with  $AC$ , the latter does not differ much from  $AB$ . As the condenser voltage is nearly constant, the condenser current and hence the heater current is nearly constant also.\* The current regulation with series-resistor and series-condenser circuits is shown in Fig. 2. These are experimental results using 6.3 V, 0.3 A valves on 210 V, 50 c/s. mains.

This self-regulating action of the series-condenser circuit is useful in experimental set-ups in which the final number of valves is not known initially. As the design progresses, valves may be added without time having to be wasted on consequent adjustments to the heater supply. Another point is that if one valve develops a heater-cathode short-circuit in such a way as to short-circuit the heaters of some valves, the current through the heaters of the remaining valves remains almost the same and no damage is done except to low-value resistors in the cathode circuit of the faulty valve. With a series-resistor the current rises considerably and within a few minutes both the resistor and the valves remaining in circuit may be irretrievably damaged.

Of course the condenser does not, like the barretter, compensate for varying mains voltage.

### Transient Effects

With the series-condenser circuit the current during the first few cycles after switching on is nearly always abnormal. Assuming no initial charge on the condenser (ensured by shunting it with a resistor of 1 or 2 megohms), the maximum possible current during the transient period is  $E/R$ , where  $E$  is the peak mains voltage and  $R$  is the cold resistance of the heaters. In typical cases this may be ten to twenty times the final steady value. With indirectly heated valves and a 50 c/s. supply no harm is done, because the warming-up time is much longer than the transient period (say, the first five cycles).

\* This principle has been applied to lighting circuits: see A. W. Ashton, "Condensers in Series with Metal Filament Lamps," *J.I.E.E.*, 1912, XLIX, 703.

The writer has had one set going long enough to be able to say with assurance that valve life is not reduced. The snag is with pilot lamps; any attempt to include them in the series circuit results in a high casualty rate on lamps. The 0.35 A size lamps used on the 0.3 A circuit survive on the average only about five switchings-on. This is because the lamp's warming-up time is comparable with the transient period. One may have delayed switching as in Fig. 3: here  $S_2$  is opened a short time after  $S_1$  is closed. Or one may wire the on-off switch as in Fig. 4: here  $S_1$  is opened for "ON" and closed for "OFF." The condenser takes current all the time, but this does no harm and as mentioned above provides P.F. correction, the quadrature current required by inductive loads on the same circuit being supplied by the condenser.

### Warming-up Time

Another disadvantage of the series-condenser is the increased warming-up time. This also applies to a barretter and for the same reason, *vis.*, the constant current characteristic. The constant voltage heating methods (accumulator, transformer) are superior in this respect due to the low resistance of valve heaters when cold. The warming-up time with a series-resistor is intermediate between those obtained with the constant voltage and the constant current methods.

### Conclusion

The advantages of the series-condenser over the series-resistor may be summarised:—

1. Indefinitely long life.
2. Less power drawn from the mains.
3. Practically no heat to dissipate.
4. Self-compensating for different numbers of valves.
5. Less damage results if one valve develops a heater-cathode short-circuit.
6. Incidentally provides some P.F. correction.

And the disadvantages:—

1. Set is suitable for single frequency A.C. only, instead of being universal.
2. Slightly higher initial cost.
3. Special switching arrangements required for pilot lamps.
4. The warming-up time is 4 or 5 seconds longer.

## Negative Feed-back in Hearing Aid Amplifiers

(Conclusion.)

state of the amplifier, Nyquist<sup>8</sup> established the following criterion: An amplifying system with feed-back is stable if the loop gain  $\mu\beta$  when plotted as a polar diagram for frequencies from zero to infinity does not include the point of unity gain and zero phase angle.

Fig. 8 shows the complex loop gain  $\mu\beta$  of the present amplifying system for maximum feed-back. Although there is a small amount of positive feed-back owing to the effect of the coupling condensers and feed-back network at low frequencies, it will be seen that the system is stable, for the point (1, 0) is situated outside the polar diagram. On increasing the gain of the amplifier the loop will shrink in size proportionally, retaining the same shape, and the point (1, 0) will be still further remote from the diagram.

Finally, a brief mention may be made of the effect of the type of feed-back circuit adopted here on the terminal impedances of the amplifier. It is well known that the application of voltage feed-back will result in a reduction of the effective output impedance presented to the receiver. At the lower values of gain this reduction will be appreciable, resulting in better damping of the receiver diaphragm and consequent suppression of the effects of resonance. Conversely, it is desirable for obtaining optimum results from a piezo-electric microphone to operate this into a high impedance line. In the circuit shown in Fig. 4 the input impedance is increased at reduced gain by the use of series feed-back.

Until recently considerable difficulties have been experienced in assessing the exact performance of hearing aids. A full account of this subject is given in an interesting paper by T. S. Littler<sup>9</sup> describing modern methods which have been evolved for the measurement of the overall gain and characteristics of systems of this type. Reference may also be made to this paper regarding other aspects of modern hearing aid technique.

### Bibliography

- 1 *British Medical Journal*, July 3, 1937.
- 2 H. S. Black, *Bell Syst. Tech. Jour.*, 1934, p. 1.
- 3 I. Kamen, *Electronics*, July, 1942, p. 32.
- 4 W. C. Beasley, *Jour. S.M.P.E.*, July, 1940, p. 59.
- 5 E. Strommen, *Jour. A.S.A.*, April, 1944.
- 6 S. K. Hilliard, *Jour. S.M.P.E.*, March, 1943, p. 143.
- 7 H. C. Montgomery, "Analysis of World's Fairs' Hearing Tests," *Bell Lab. Record*, December, 1939, pp. 98-103.
- 8 H. Nyquist, *Bell Syst. Tech. Jour.*, January, 1932, p. 126.
- 9 T. S. Littler, *Jour. I.E.E.*, June, 1944, p. 67.

# Scanning Systems for Colour Television

By L. C. JESTY, B.Sc., M.I.E.E.\*

RECENT papers and discussions regarding the future of Television<sup>1</sup> indicate the desirability of a clear understanding of the issues which are important in relation to colour television. These issues can be divided into two main groups: Items relating to colour scanning, and items relating to the radio transmission system available (wavelength, bandwidth, etc.). If a satisfactory method of scanning a colour picture was known, then picture standards (number of lines, interlacing sequence, etc.) could be stated for any available bandwidth of transmission. If desirable, field tests could then be carried out to determine the practical value of such a system or the relative performance of different systems. It might then be found that the demands of the scanning system on the bandwidth available did not produce a picture of sufficient definition or brightness, or that the introduction of colour produced objectionable colour "ghosts" on the picture due to multiple reflexions of the radio signal, interference pick-up, etc. But if, in the first place, no satisfactory colour scanning system is known, then obviously colour television must wait until this problem is solved. It is proposed to examine this aspect of the situation in detail.

## The Fundamental Principles of Colour Reproduction

All the systems of colour reproduction so far evolved are based on the splitting up of the colours in the subject into two, or preferably three, suitable primary colours. Experience in the photographic field has shown that three colours are essential to obtain satisfactory results, and the two-colour process has now disappeared, except for advertisements, cheap magazine illustrations, etc., which do not claim to give true colour reproduction.

Early attempts at colour photography and cinematography were made by taking simultaneous or successive photographs through red, green and blue filters, so chosen that they "added up" to white when due

allowance for the colour sensitivity characteristic of the photographic emulsion had been made. In the case of still photographs, the print was made by printing on white paper in suitable colours (using "minus" red, "minus" blue, and "minus" green dyes or inks) from the three negatives obtained (e.g., the Carbro process).<sup>2</sup> In the case of cinematography, either the three negatives were taken at once, each through its appropriate colour filter, and then projected simultaneously through similar filters, the pictures being superposed optically on the projection screen; or alternatively the separate photographs of the film were taken at an increased speed through a revolving three-colour filter in front of the camera lens, so that successive exposures were made through each filter in turn, and projected similarly. In the latter case persistence of vision allowed the three separate colour pictures to appear as one correctly coloured picture.<sup>3</sup>

All these early attempts at a solution to the problem suffered from one common fault—lack of registration of the colours, producing colour fringes round the image. In the examples cited above, the separate processing and final superposition of each colour primary introduced errors due to film shrinkage, parallax, optical distortion, etc., and the final difficulty of accurate superposition. The case of the film running at increased speed gave a further type of colour fringing on moving objects, where the successive colour primaries were slightly displaced in the direction of motion, due to the motion of the object between each frame of the film. As will be seen later, both types of colour fringe give rise to difficulty when considering methods of colour television but it should be noted that the latter type can be reduced to an unnoticeable level by increasing the speed sufficiently.

It was not until the advent of the self-coloured film, requiring no special optical/mechanical devices for taking and reproducing, and obviating the registration of the three separated colour images, that colour

processes began to gain popularity. Not only did the self-coloured film eliminate the necessity for special equipment (an important factor in the cinema industry, where projectors had become standardised), but equally as important the reduction in image quality due to colour fringing was overcome. The survival of the superposition method is found in the commercial reproduction of large quantities of colour pictures for magazines, etc., and in the "Technicolor" film process, where the expense of the equipment for producing accurate registration of the colours can be justified. The very inferior picture quality which occurs when the registration is not perfect is familiar to most people.

Two basic methods of self-coloured photographic film have been evolved. One is the colour mosaic method, available commercially as the Finlay process, Dufaycolor, etc. The other is the integral tri-pack method, depending on the use of special dye-coupler developers, and available commercially as Kodachrome, Agfacolor, etc. In the former a three-colour mosaic of very fine texture is superposed on the photographic emulsion, which is suitably matched in colour sensitivity to the three basic colours in the filter matrix. The texture of the filter is made fine enough to give no noticeable loss of definition. The photograph is developed as a negative, reversed or printed to a positive, and viewed as a transparency through the colour mosaic—or projected, in the case of cinema film. The filter matrix is a fixture with regard to the emulsion behind it when taking and viewing, so that there is no colour fringing effect, either due to inaccuracies of superposition, or to movement of the subject in the case of motion pictures. A variation of the mosaic filter method, which is very ingenious, is the Kodacolor process. In this method the mosaic is replaced by a series of embossed cylindrical lenses on the face of the film through which the light passes on its way to the sensitive emulsion. There are no colour filters incorporated in the film itself, but three colour filters are

\* Research Laboratories, The General Electric Co., Ltd., England.

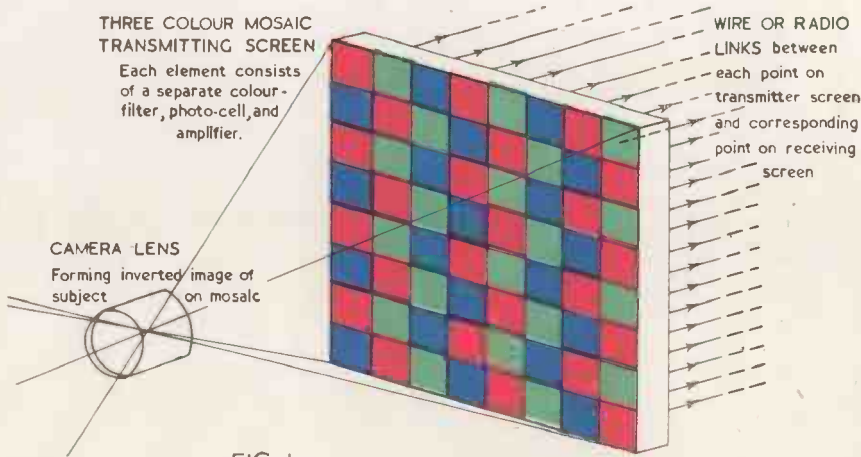
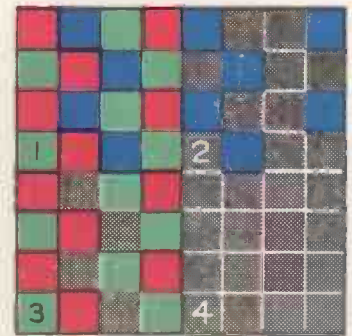

FIG. 1.

Colour television system not involving scanning.



RECEIVING SCREEN of separate lamps and colour filters connected to appropriate channel from transmitter.

- 1. Condition when receiving "white"—all filters illuminated
- 2. Receiving blue 3. Receiving yellow — (minus blue) 4. Black—all lamps out.

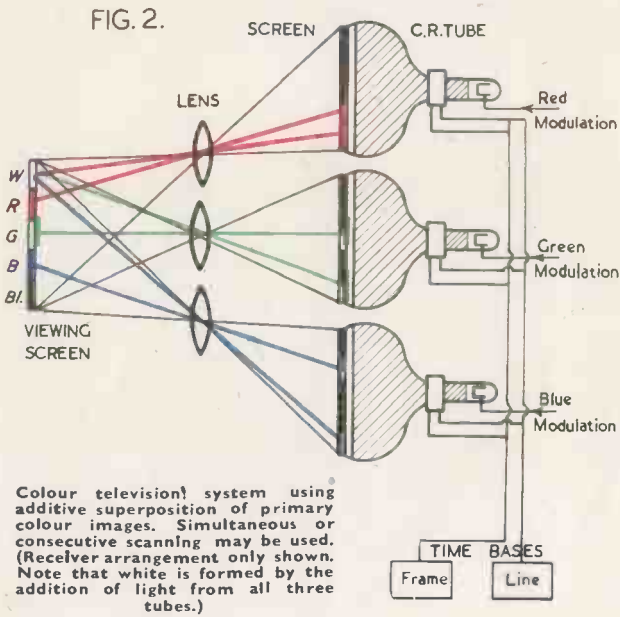

Colour television system using additive superposition of primary colour images. Simultaneous or consecutive scanning may be used. (Receiver arrangement only shown. Note that white is formed by the addition of light from all three tubes.)

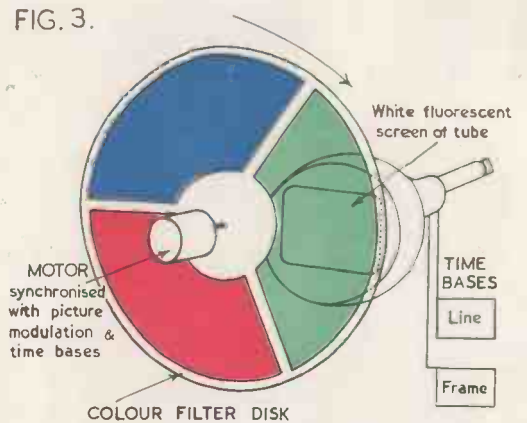

Colour television system using moving colour filters. Filter colour changes at frame frequency. (Receiver arrangement only shown.)



## Methods of Colour Scanning



4

Fig. 4. Scanning each picture point consecutively in three additive primary colours. (8-line picture shown; 10 picture points per line. Frame and line scan frequency as for monochrome picture.)



5

Fig. 5. Scanning each picture line consecutively in three additive primary colours. (8-line picture shown. Frame frequency as for monochrome picture; line frequency three times monochrome.)

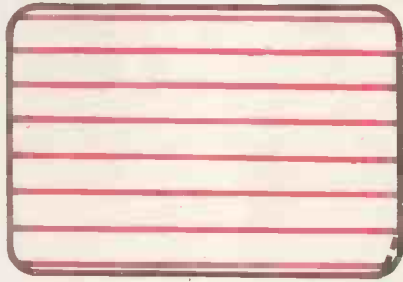

6



Fig. 6. Scanning each picture frame consecutively in three additive primary colours. (8-line picture shown. Frame and line scan frequency two to three times that of same definition monochrome picture.)

Fig. 7. Modification of Fig. 6, using 2/1 interlace, as adopted by C.B.S.<sup>6</sup> (9-line picture interlaced  $4\frac{1}{2}/4\frac{1}{2}$  shown. Colour fields 1 and 4 interlace to give a complete red picture, etc.)



7





incorporated in the taking (and projecting) lens system, with their adjacent edges parallel to each other and to the cylindrical lenses on the film. The latter are sufficiently small to avoid loss of definition, and their focal length is so arranged as to image the three parallel colour filters in the main lens system as a filter matrix on the emulsion.

In the integral tri-pack method of colour reproduction the sensitive film is usually made up in the form of a sandwich of colour filters and colour-sensitive emulsion layers. The film is exposed in the normal way, then developed, reversed, and at a suitable point in the processing, the three layers of emulsion are dyed with special dye-couplers and the silver bleached out. This leaves a transparency in colour suitable for viewing or projection. This method has the advantage over the mosaic method, of greater transparency and freedom from graininess. The mosaic method is, however, more easily processed, requiring only normal dark-room facilities. Both methods give excellent colour rendering and demonstrate the great improvement which the addition of colour brings to the reproduced picture.

It appears, therefore, from an examination of the development of the coloured photograph and printing techniques that the following conclusions can be arrived at:—

1. A three-colour system is essential for satisfactory results.
2. Superposition methods can give rise to objectionable colour fringes of two types: (a) those produced by inaccurate registration of the separate colour images when superimposed; and (b) those produced by movement of the object between each separate colour frame, in the special case of the cinematograph quoted above.
3. Self-coloured methods, in which the colour is recorded on the negative and reproduced in the final positive without any physical separation of the three-colour pictures contained in the photographic material, do not suffer from either of the colour fringing defects described in 2.

#### The Application of Colour to Television

Examination of the literature available shows that all the systems of colour television proposed have a parallel in one or other of the colour reproduction systems discussed above.

Television systems, as such, fall broadly into two classes: (a) those dependent on scanning and persistence of vision, and (b) those using a direct link between each picture point in the transmitted and received picture, such as banks of photo-cells in the transmitter linked one for one to banks of lamps in the receiver. The only successful commercial television systems so far evolved are of the first type, and it is interesting to note that all the colour television systems so far demonstrated (by Baird,<sup>4</sup> Bell Telephone,<sup>5</sup> and Columbia<sup>6</sup>) are also of this type.

If method (b) above were available for television transmission, then the introduction of colour would be a straightforward step, involving treble the number of channels required for a black-and-white picture, each picture point being reproduced by three separate colour channels (see Fig. 1). But such a television system has so far proved impracticable due to cost and complexity of the equipment.

Coming to the methods employing some form of scanning therefore, it will be seen at once that it is not possible to obtain the equivalent of the photographic self-coloured picture, and that the picture is therefore liable to suffer from colour fringes in one form or another, unless a suitable scanning sequence can be found. This is because of the finite time which must elapse between the reproduction of one colour and the next, and the problem is to reduce this time to such an extent that persistence of vision gives the required impression of simultaneity in the colours to avoid colour fringing. It has been proposed to use three separate channels, one for each colour, with separate camera and receiving cathode ray tube. It has also been proposed to use separate cameras and/or cathode ray tubes (beams) for each colour component, switching them sequentially on a common channel.<sup>7</sup> Such systems would be a compromise between the two methods (a) and (b) above. In this case the difficulty would be to obtain accurate simultaneous registration of the three colour primary pictures in the transmitting cameras and in the receiving tubes. This brings out a further reason why method (a) has so far proved the only successful one both for black-and-white and colour. Electronic cameras and cathode ray tubes, which are necessary for transmitting and receiving

the picture, depend on the scanning of an electron beam, and as workers with cathode ray oscillographs will readily agree, it is possible to obtain a very high order of relative accuracy with these devices, but absolute accuracy is of a much lower order. When used for television purposes therefore, they give very accurate relative positioning of the adjacent picture points and lines, and it is for this reason that the electronic methods have proved superior to mechanical scanners. Local variations in magnification of the reproduced picture occur, due to non-linearity of deflection, slight pin-cushion or barrel distortion, etc., but do not appear critical, even for local displacements of several picture points in magnitude. They would be critical, however, if separate pictures have to be superposed from three receiving tubes (e.g., by optical projection as shown in Fig. 2), and at the present stage of the art it is suggested that any method in which the picture is analysed in more than one camera and synthesised by more than one cathode ray beam or screen is ruled out of consideration.

It would appear, therefore, that if colour television is possible in the immediate future (i.e., without carrying out a major research on any new methods of television recently invented), it must be based on straightforward scanning methods using a single camera and receiver tube in conjunction with suitable colour filters—either fixed or synchronously driven. With this convention the following alternative methods of scanning the complete picture are available:—

1. Scanning each picture point successively in the three primary colours<sup>8</sup> (Fig. 4).
2. Scanning each picture line successively in the three primary colours<sup>9</sup> (Fig. 5).
3. Scanning each picture frame successively in the three primary colours<sup>10</sup> (Fig. 6).

Interlacing can be used as found advantageous, and theoretically the same applies to the choice between moving and fixed colour separation filters. Practically, however, it would not appear possible to move the colour filters synchronously at higher frequency than the frame frequency (method 3—see Fig. 3).

If the picture is to be capable of

being viewed direct on the face of the cathode ray tube without the aid of any auxiliary devices such as mirror drums, etc., then the use of fixed filters, of a mosaic or "reseau" type<sup>5</sup> in either method 1 or 2, is ruled out because of the difficulty of accurate registration between the picture on the C.R.T. screen and the required filter mosaic. For reasons stated above, method 1 also suffers from a colour "aperture distortion" due to the scanning spot being of the same order of size as the mosaic elements.

A further factor which must be taken into consideration is that storage in the camera appears to be essential, in order to get adequate light sensitivity, even for black-and-white reproduction. Storage has to be for a number of lines for reasonable sensitivity, and if moving colour filters are to be used, method 3 is the only one which will allow the transmitter mosaic to store a reasonable amount of information in one colour at a time.

It would appear, therefore, that unless some accurate method of registration of a colour mosaic can be contrived, both in the transmitting and receiving tubes,<sup>6</sup> then method 3 is the only possible solution.

The Columbia Broadcasting System seem to have come to this conclusion in America. Their papers<sup>7</sup> deal exclusively with this type of system and go very thoroughly into the effect of the various combinations of colour sequence and interlace on such things as flicker and colour fringing in the image.

Of the combinations of scanning sequence examined by Columbia, the one they found most satisfactory is their System 3, with 120 colour fields/sec., 40 colour frames/sec., 60 frames/sec., and 20 colour pictures/sec., interlaced 2/1 (see Fig. 7). They show that this should be reasonably free from flicker and colour fringing defects, up to highlight brightnesses of 2 e.f.c. Various observers who have reported on the picture quality to the writer, state that colour fringing was either not present in the demonstrations, because of the choice of slow-moving subject-matter, or was noticeable but tolerable in view of the great improvement given to the picture by the addition of colour.

It is of interest to make a rough

calculation of the magnitude of the colour fringes produced by such a system. Suppose a white object is moving across a black background and the reproduced picture is 10 in. (250 mm.) wide. Suppose, further, that the white object takes about 4 seconds to move the width of the screen, i.e., travels at about 60 mm./second on the screen. Then it will move  $\frac{1}{4}$  mm. (about one line width on a 400 line picture) between each colour field and if an observer allows his eye to follow the moving object, he will see that the leading and trailing edges have two colour fringes of this width.

### Conclusion

Summing up, it appears that there is only one method of scanning a colour television picture which is practicable, in the light of present published knowledge and experience, bearing in mind the need for the use of electronic scanners at transmitter and receiver. The basic principle of this method is to scan each picture frame successively in each of the three primary colours. This method is likely to suffer from colour fringing on fast-moving objects, but this price may be worth paying for the addition of colour.

Fink states in his paper<sup>1</sup> (Section 2.11), referring to the C.B.S. demonstrations,<sup>8</sup> that "present technical opinion in America holds that a channel wider than 6 Mc/s. is required for a colour television system, if it is to be competitive with the present black-and-white images" (referring to a 375 line colour picture compared with a 525 line black-and-white). If colour is to be introduced as a commercial service in conjunction with higher definition in the picture—which seems logical—then the investigation of the colour scanning sequence/interlace combinations possible will have to be carried further than that described by C.B.S., and it is possible that with a higher number of lines, the same solution would not be arrived at. For British television the existence of a different supply mains frequency (50 instead of 60 c/s.) would also have to be allowed for.

It is desirable to replace the colour filter disk or drum, rotating in front of the cathode ray tube in the re-

ceiver, with some more compact, preferably electronic device, for producing the necessary colour scanning sequence. This may impose certain limitations on the scanning sequences available. The commercial solution of these problems must be achieved if colour is to be ready for inclusion in an improved television system.

### References

- 1 B. J. Edwards, "A Survey of the Problem of Post-War Television" (Paper read to the Radio Section, I.E.E., 23/2/44). Donald G. Fink, "Television Broadcasting Practice in America, 1927-44" (Paper read to the Radio Section, I.E.E., 24/1/45). "Colour Television" (Discussion—Radio Section, I.E.E., 13/3/45, opened by L. C. Jesty).
- 2 D. A. Spencer, "Colour Photography in Practice," Isaac Pitman & Sons, Ltd., 1938.
- 3 A. B. Klein, "Colour Cinematography," Chapman and Hall, 1939.
- 4 J. L. Baird, *Nature*, Aug. 18, 1928, pp. 232-4. *Television*, Vol. 1, No. 7, pp. 20-21; Aug., 1928, pp. 9-10; Oct., 1928, pp. 4, 26-31. *Wireless World*, Feb. 17, 1938, p. 148; Aug. 17, 1939; Feb., 1943, p. 41. *Electrician*, Jan. 1, 1943, p. 41. *J. Television Society*, Vol. 8, No. 6, pp. 171-174.
- 5 Bell Telephone Labs.: H. E. Ives, "Television in Colour," *Bell Lab. Rec.*, Vol. 7, pp. 439-444, July, 1929.
- 6 Columbia Broadcasting System: P. C. Goldmark, J. N. Dyer, E. R. Piore and J. M. Hollywood; "Colour Television," Part I, *Proc. I.R.E.*, April, 1942, Vol. 30, pp. 182-185. P. C. Goldmark, E. R. Piore, J. M. Hollywood, T. H. Chambers and J. J. Reeves, "Colour Television," Part II, *Proc. I.R.E.*, Sept., 1943, pp. 465-478. *Magazine Life*, Sept 22, 1941.
- 7 A. T. and T. and J. E. Pollack, Pat. No. 318,565. G.E.C. and L. C. Jesty, Pat. No. 424,093. B.T.H., Pat. No. 424,743. Loewe and K. Schlesinger, Pat. No. 426,138. Scopony and A. H. Rosenthal, Pat. No. 514,776. J. L. Baird, Pat. No. 562,168.
- 8 Westinghouse and V. K. Zworykin, Pat. No. 255,057.
- 9 K.B. and C. N. Smythe, Pat. No. 508,037. J. L. Baird, Pat. No. 562,344.
- 10 Baird Television and J. L. Baird, Pat. No. 473,323. Baird Television and J. L. Baird, Pat. No. 508,039. C.B.S., U.S. Pat. No. 2,304,081. C.B.S., U.S. Pat. No. 2,339,256.
- 11 G.E.C. and L. C. Jesty, Pat. No. 443,896.

### Gallium

The element gallium, of which the public still hears little, is, in fact, 150 times as abundant as silver and thirty times as abundant as mercury. Both silver and mercury, however, have been used for centuries in comparatively large quantities because minerals rich in these metals occur in many parts of the world. Gallium is "rare" only in the sense that no commercially useful sources of it are at present being exploited. If reasonably cheap sources of some of these rare elements could be exploited valuable industrial uses would undoubtedly be found for them.—*Monthly Science News*, Nov., 1944.



# Aerial-Coupling Circuits

## A Series of Data Sheets

### Part III.—Shunt Capacitance Aerial Coupling

By S. W. AMOS, B.Sc.(Hons.), Grad.I.E.E.

THE circuit of the shunt capacitance method of aerial coupling is given in Fig. 1(a) and in the electrical equivalent of it, shown in Fig. 1(b), the aerial-earth system has been replaced by an equivalent generator as explained in Part I. The mathematical analysis of the performance of the circuit is carried out in the appendices at the end of the article and expressions are there derived for the reflected capacitance (Appendix I), voltage gain (Appendix II) and the selectivity factor (Appendix III). These three expressions, which describe completely the performance of the circuit, are as follows:—

**Reflected Capacitance**

$$\Delta C_2 = \frac{1}{\omega^2 L_2 \left( 1 - \omega^2 L_2 (c + C_1) \right)}$$

**Voltage Gain**

$$\frac{V_2}{V_1} = \frac{1}{R_2 \left( r + \frac{1}{j\omega C_3} \right) + r \left( j\omega L_2 + \frac{1}{j\omega C_1} \right)}$$

in which

$$C_3 = \frac{c C_1}{c + C_1}, C_4 = \frac{C_1 C_2}{C_1 + C_2} \text{ and}$$

$$C_2 = \frac{1}{\omega^2 L_2} - \Delta C_2$$

**Selectivity Factor**

$$= \frac{1}{1 + \frac{r}{R_2 \left( 1 + \frac{C_1}{c} \right)^2}}$$

**Reflected Capacitance**

Examination of the expression for the reflected capacitance given above shows that  $\Delta C_2$  will be positive if  $\omega^2 L_2 (c + C_1) < 1$  and negative if  $\omega^2 L_2 (c + C_1) > 1$ . In order that most of the medium waveband may be covered  $C_1$  has to be fairly large (a normal value is .002  $\mu$ F) so that  $\omega^2 L_2 (c + C_1)$  invariably exceeds unity and hence  $\Delta C_2$  is negative for this type of aerial coupling circuit. This means that the tuning capacitance in the secondary

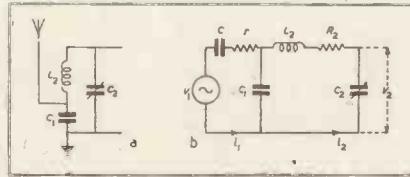

Fig. 1

circuit is effectively reduced by the coupling to the primary circuit and the effect of the coupling on the tuning range of the circuit as a whole is to cause a curtailment at the low frequency end of the band.

We will calculate the reflected capacitance for  $\omega = 8 \times 10^6$  rads/sec. and  $C_1 = .002 \mu$ F,  $L_2, Q, r$  and  $c$  having the values 157  $\mu$ H, 100, 40 ohms and 200  $\mu$ F respectively.

$$\Delta C_2 = \frac{1}{\omega^2 L_2 \left( 1 - \omega^2 L_2 (c + C_1) \right)}$$

$$= \frac{1}{\omega^2 L_2 \left( 64 \times 10^{12} \times 157 \times 10^{-6} - 99.5 \mu\text{F} \right)}$$

$$= \frac{1}{\omega^2 L_2 (c + C_1)} = \frac{1}{64 \times 10^{12} \times 157 \times 10^{-6} \times 2,200 \times 10^{-12}} = 22.1$$

$$\therefore \Delta C_2 = 99.5 \times \frac{1}{1 - 22.1} = -4.715 \mu\text{F}$$

In a similar way the values of  $\Delta C_2$  may be calculated for other frequencies and for other values of  $C_1$ . The results are given in Fig. 2 for  $C_1 = 0, 200, 500, 2,000$  and  $5,000 \mu$ F.

In Fig. 2 the low frequency limit reached with each value of  $C_1$  is indicated. It should be realised, when these curves are examined, that the lowest frequency which can be obtained with any particular value of  $C_1$  can be reduced still further by the inclusion of a trimmer condenser connected in parallel with  $C_2$ . Unfortunately there is an upper limit to the capacitance of the trimmer which can be used in this way, for too large a value will cause a curtailment at the high frequency end of the waveband. We can very easily calculate the low frequency limits for any value of  $C_1$  as follows.

Consider the case when  $C_1 = 200 \mu$ F. In series with the tuning condenser there is a condenser comprising  $C_1$  and  $c$  in parallel, giving a total capacitance of 400.  $\mu$ F. The maximum value of tuning capacitance possible, therefore, in parallel with  $L_2$  is given by

$$\frac{510 \times 400}{910} = 224.3 \mu\text{F}$$

In this 10  $\mu$ F has been allowed for stray capacitance in parallel with  $L_2$ . Such a value of capacitance resonates with an inductance of 157  $\mu$ H at a frequency given by

$$\omega = \frac{1}{\sqrt{L_2 C}} = \frac{1}{\sqrt{157 \times 10^{-6} \times 224.3 \times 10^{-12}}} = 5.33 \times 10^6 \text{ rads/sec.}$$

The low frequency limit has similarly been evaluated for other values of  $C_1$  and they are indicated on Figs. 2, 3 and 4.

**Voltage Gain**

Using Expression (7) of Appendix II (given in col. 1) the voltage gain will be calculated for  $C_1 = .002 \mu$ F and  $\omega = 8 \times 10^6$  rads/sec.

$$\left| \frac{V_2}{V_1} \right| = \frac{1}{r \left( j\omega L_2 + \frac{1}{j\omega C_3} \right) + R_2 \left( r + \frac{1}{j\omega C_1} \right)}$$

where  $C_3 = \frac{1}{\omega^2 L_2} - \Delta C_2$

$$C_2 = 99.5 - (-4.715) = 104.2 \mu\text{F}$$

$$C_3 = \frac{1}{\omega^2 L_2} - \Delta C_2 = \frac{1}{64 \times 10^{12} \times 157 \times 10^{-6}} - 181.8 \mu\text{F}$$

$$C_4 = \frac{C_1 C_2}{C_1 + C_2} = \frac{200 \times 104.2}{200 + 104.2} = 99.04 \mu\text{F}$$

$$j\omega L_2 = j8 \times 10^6 \times 157 \times 10^{-6} = j1,256 \text{ ohms}$$

$$j\omega C_4 = \frac{1}{8 \times 10^6 \times 99.04 \times 10^{-12}} = -j1,262 \text{ ohms}$$

$$j\omega C_3 = \frac{1}{8 \times 10^6 \times 181.8 \times 10^{-12}} = -j687.4 \text{ ohms}$$



Variation of Reflected Capacity with Frequency (Fig. 2)

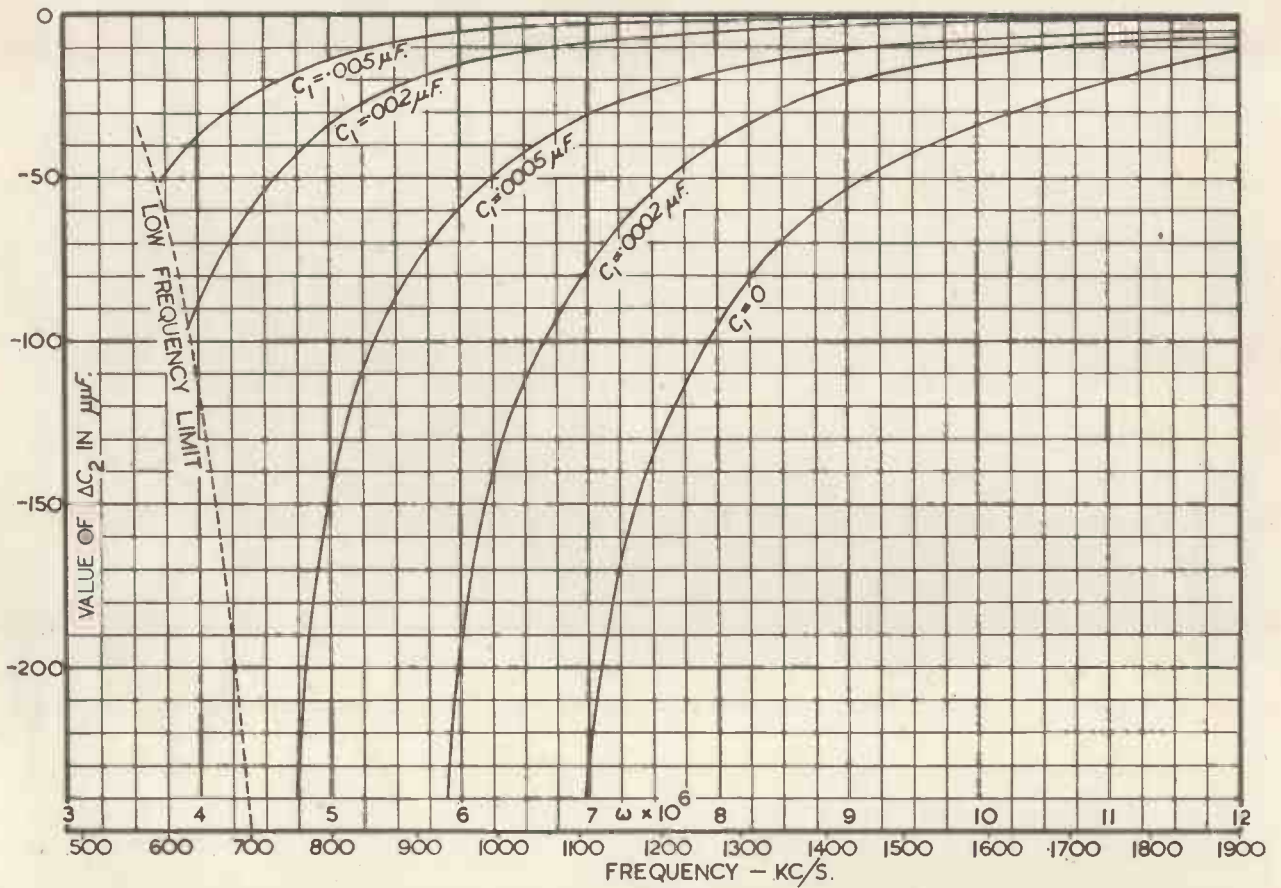

$R_2 = 12.56$  ohms (from the table in Part I).

$$\text{Selectivity factor} = \frac{1}{1 + \frac{R_2^2 \left(1 + \frac{C_2}{c}\right)^2}{r}}$$

$$\frac{|V_2|}{|V_1|} = \frac{64 \times 10^{12} \times 2,000 \times 10^{-12} \times 104.2 \times 10^{-20}}{40(1,256j - 1,262j) + 12.56(40 - 687.4j)}$$

$$= \frac{64 \times 10^{12} \times 2,000 \times 10^{-12} \times 104.2 \times 10^{-20} \times 8,880}{8.445}$$

At  $\omega = 8 \times 10^6$ ,  $R_2 = 12.56$  ohms as before, so selectivity factor

The variation of voltage gain with frequency, for various values of  $C_1$ , is illustrated in Fig. 3. An outstanding feature of this aerial coupling circuit is the extreme constancy of the gain when  $C_1$  is large.

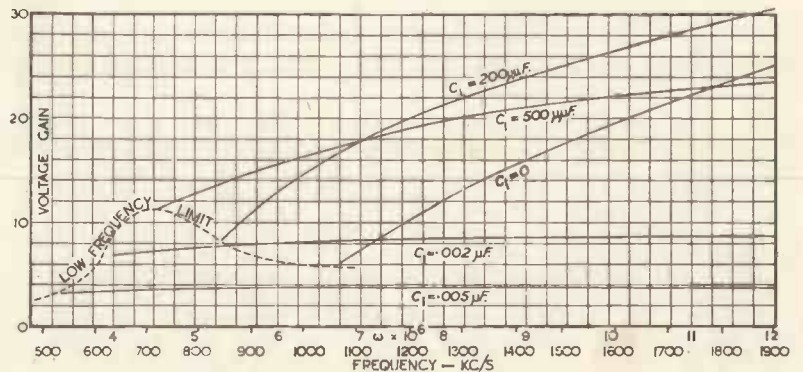
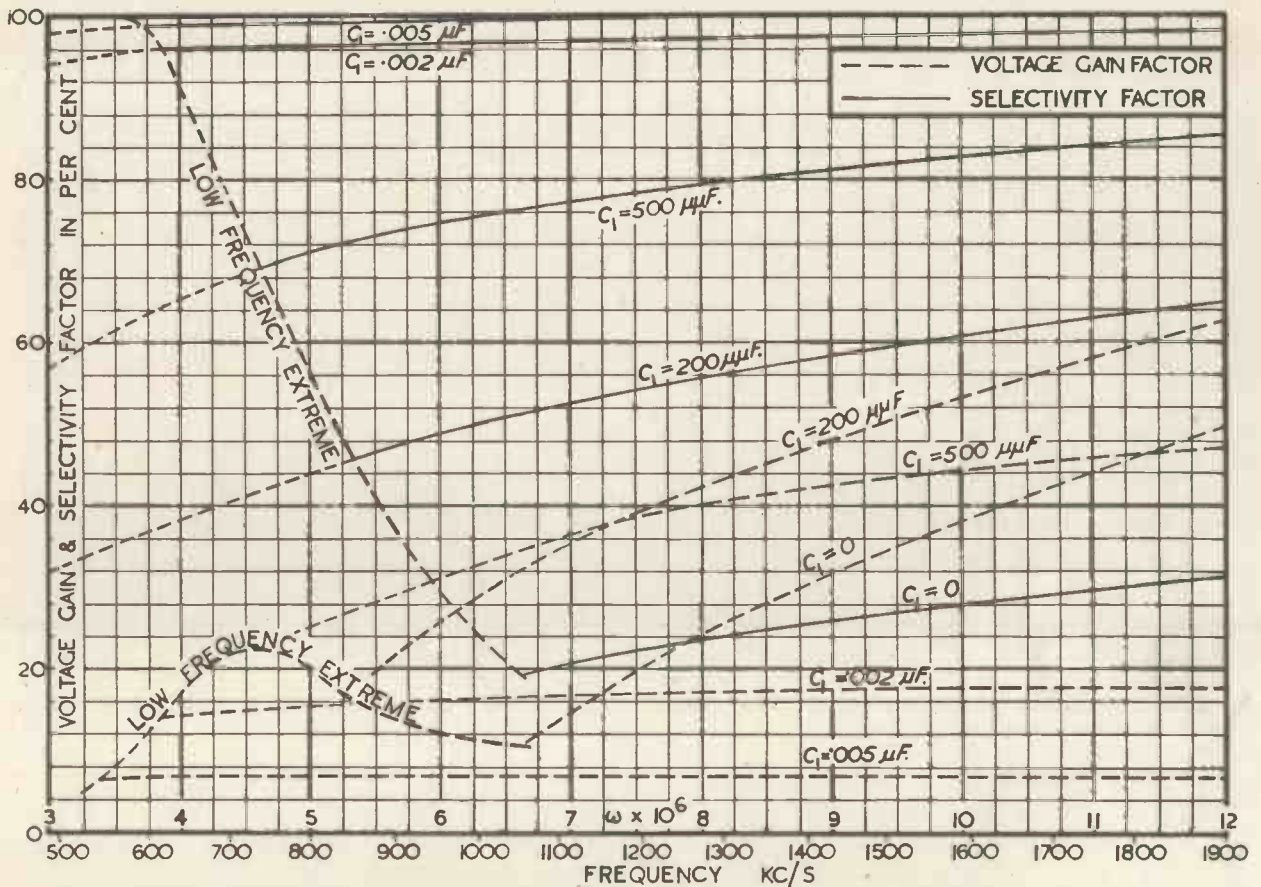

Fig. 3. Effect on voltage gain of varying  $C_1$ .

Selectivity Factor

As a numerical example of the calculation of this, let  $C_1 = .002 \mu\text{F}$  and  $\omega = 8 \times 10^6$  rads/sec. as in earlier numerical examples.

Variation of Selectivity and Gain with Frequency (Fig. 4)



$$= \frac{1}{1 + \frac{40}{12.56 \left(1 + \frac{2,000}{200}\right)^2}} = \frac{1}{1 + .0263} = .975 \text{ or } 97.5 \text{ per cent.}$$

The variation of selectivity factor with frequency and with the value of  $C_1$  is indicated in Fig. 4, together with those of the voltage gain factor, the value of which property, at any particular frequency, expressed as a percentage, is just double the value of  $V_2$  — at that frequency.

Interpretation of Curves

A glance at Fig. 4 shows that this aerial coupling circuit gives a very much better performance with respect to selectivity than to voltage gain. Moreover, for large values of  $C_1$ , the selectivity and reflected capacitance are remarkably constant with variations of frequency. This circuit is,

for this reason, frequently used in the aerial coupling to communications receivers, when constancy of gain and high selectivity are particularly desirable.

For example, a trimmer of  $40 \mu\text{F}$  and a value of  $C_1$  of  $.002 \mu\text{F}$  will enable a waverange of 550-1,500 kc/s. to be covered. A point in favour of this particular type of aerial coupling circuit, which the various curves do not bring out, is that provided  $C_1$  is fairly large then the characteristics of the aerial-earth system have practically no effect on the performance of the circuit with respect to reflected capacitance, voltage gain and selectivity.

Appendix I

Reflected Capacitance

Applying Kirchoff's laws to the equivalent electrical circuit of Fig. 1(b), we have:—

$$V_1 = i_1 Z_p - \frac{i_2}{j\omega C_1} \dots \dots \dots (1)$$

in which

$$Z_p = R_p + jX_p = r + \frac{1}{j\omega c} + \frac{1}{j\omega C_1} = r - j \left( \frac{1}{\omega c} - \frac{1}{\omega C_1} \right)$$

$$\text{and } 0 = i_2 Z_s - \frac{i_1}{j\omega C_1} \dots \dots \dots (2)$$

$$\text{in which } Z_s = R_s + jX_s = R_2 + j\omega L_2 + \frac{1}{j\omega C_2} + \frac{1}{j\omega C_1} = R_2 + j \left( \omega L_2 - \frac{1}{\omega C_1} - \frac{1}{\omega C_2} \right)$$

From (2)  $i_1 = j\omega C_1 Z_s i_2$ . Substituting for  $i_1$  in (1)

$$V_1 = j\omega C_1 Z_p Z_s i_2 - \frac{i_2}{j\omega C_1}$$

from which  $V_1 =$

$$i_2 = \frac{V_1}{j\omega C_1 Z_p Z_s - \frac{1}{j\omega C_1}}$$

Since  $V_2 = \frac{i_2}{j\omega C_2}$ , we have

$$\frac{V_2}{V_1} = \frac{\frac{1}{j\omega C_2}}{j\omega C_1 Z_p Z_s - \frac{1}{j\omega C_2}} = \frac{1}{\omega^2 C_1 C_2 Z_p \left( Z_s + \frac{1}{\omega^2 C_1^2 Z_p} \right)}$$

The expression  $Z_s + \frac{1}{\omega^2 C_1^2 Z_p}$  represents the impedance of the secondary circuit in the presence of the primary. If we let

$$Z = Z_s + \frac{1}{\omega^2 C_1^2 Z_p}$$

then we have

$$\frac{V_2}{V_1} = \frac{1}{\omega^2 C_1 C_2 Z_p Z} \quad (3)$$

which gives the value of the voltage gain at any frequency and for any value of  $C_2$ . We are only interested, however, in the case when  $C_2$  is adjusted so that the circuit resonates, as a whole, at the applied frequency. Rationalising the expression for  $Z$ , we have

$$\begin{aligned} Z &= Z_s + \frac{1}{\omega^2 C_1^2 Z_p} \\ &= R_s + jX_s + \frac{1}{\omega^2 C_1^2} \frac{R_p + jX_p}{R_p - jX_p} \\ &= R_s + jX_s + \frac{1}{\omega^2 C_1^2} \frac{R_p^2 + X_p^2}{R_p} \\ &= R_s + \frac{1}{\omega^2 C_1^2 (R_p^2 + X_p^2)} \\ &\quad + jX_s - \frac{jX_p}{\omega^2 C_1^2 (R_p^2 + X_p^2)} \end{aligned}$$

At resonance the reactive terms vanish, giving

$$jX_s - \frac{jX_p}{\omega^2 C_1^2 (R_p^2 + X_p^2)} = 0$$

Neglecting  $R_p$  in comparison with  $X_p$  and rearranging

$$X_p X_s = \frac{1}{\omega^2 C_1^2} \quad (4)$$

Thus, at resonance,

$$Z = R_s + \frac{R_p}{\omega^2 C_1^2 (R_p^2 + X_p^2)} \dots (5)$$

Substituting for  $X_p$  and  $X_s$  in (4)

$$\begin{aligned} & - \left( \frac{1}{\omega C} + \frac{1}{\omega C_1} \right) \left( \omega L_2 - \frac{1}{\omega C_2} - \frac{1}{\omega C_1} \right) \\ &= \frac{1}{\omega^2 C_1^2} \end{aligned}$$

Multiplying out and rearranging as an expression for  $C_2$ , we find

$$C_2 = \frac{c + C_1}{\omega^2 L_2 (c + C_1) - 1}$$

In the absence of a primary circuit

and  $C_1$ ,  $C_2 = \frac{1}{\omega^2 L_2}$ . By definition

$$\Delta C_2 = \frac{1}{\omega^2 L_2} - \frac{1}{\omega^2 L_2 (c + C_1) - 1} = \frac{1}{\omega^2 L_2} \frac{1}{1 - \omega^2 L_2 (c + C_1)} \dots (6)$$

**Appendix II**

**Voltage Gain at Resonance**

Substituting in (3) the value of  $Z$  given in (5)

$$\left| \frac{V_2}{V_1} \right| = \frac{1}{\omega^2 C_1 C_2 Z_p \left[ R_s + \frac{R_p}{\omega^2 C_1^2 (R_p^2 + X_p^2)} \right]} \approx \frac{1}{\omega^2 C_1 C_2 \left( Z_p R_s + \frac{R_p}{\omega^2 C_1^2 X_p} \right)}$$

But, from (4), at resonance

$$\frac{1}{\omega^2 C_1^2 X_p} = X_s \quad \therefore \left| \frac{V_2}{V_1} \right| = \frac{1}{\omega^2 C_1 C_2 (Z_p R_s + R_p X_s)}$$

Substituting for  $X_p$ ,  $R_s$ ,  $R_p$  and  $X_s$ , we have

$$\begin{aligned} \left| \frac{V_2}{V_1} \right| &= \frac{1}{\omega^2 C_1 C_2 \left[ R_2 \left( r + \frac{1}{j\omega C} + \frac{1}{j\omega C_1} \right) + r \left( j\omega L_2 + \frac{1}{j\omega C_2} + \frac{1}{j\omega C_1} \right) \right]} \\ &= \frac{1}{\omega^2 C_1 C_2} \quad \text{in which } C_3 = \frac{c C_1}{c + C_1} \\ & R_2 \left( r + \frac{1}{j\omega C_3} \right) + r \left( j\omega L_2 + \frac{1}{j\omega C_4} \right) \quad \text{and } C_4 = \frac{C_1 C_2}{C_1 + C_2} \end{aligned} \quad (7)$$

**Appendix III**

**Selectivity Factor**

Expression (5) has already shown that the resistance of the secondary circuit in the presence of the primary is greater than without it ( $R_2$ ) at resonance, by the amount  $R$  given by

$$R = \frac{R_p}{\omega^2 C_1^2 (R_p^2 + X_p^2)}$$

Substituting for  $R_p$  and  $X_p$  gives this increase of resistance as

$$\begin{aligned} R &= \frac{r}{\omega^2 C_1^2 \left[ r^2 + \left( \frac{1}{\omega C} + \frac{1}{\omega C_1} \right)^2 \right]} \\ &= \frac{r}{\omega^2 C_1^2 \left( r^2 + \frac{1}{\omega^2 C_s^2} \right)} \end{aligned}$$

Neglecting  $r^2$  in comparison with

$\frac{1}{\omega^2 C_s^2}$ , we have

$$R = \frac{r C_s^2}{C_1^2} = \frac{r}{\left( 1 + \frac{C_1}{c} \right)^2}$$

Hence selectivity factor ... (8)

$$\begin{aligned} &= \frac{1}{R} = \frac{1}{r} \\ &= \frac{1}{R_2} \frac{1}{1 + \frac{C_1}{c}} \end{aligned}$$



# The Principles and Design of Valve Oscillators

## Part III—The Heterodyne Oscillator

By A. C. LYNCH, M.A.,\* and J. R. TILLMAN, Ph.D.\*

### 7. Principle of the Heterodyne Circuit

THE essentials of a heterodyne oscillator are two similar oscillators and a means of obtaining from them a frequency equal to the difference of their frequencies. This type of oscillator is of considerable importance in practice; it involves no additional problems of a fundamental nature, but there are many minor points worthy of attention in the design. The general layout of a heterodyne oscillator is shown in Fig. 6. Some oscillators omit the primary frequency amplifiers here shown; and the diagram does not show the output control, whose location in the circuit is discussed below.

The name "oscillator" is commonly used for the complete equipment and also for either of the two oscillators supplying signals to the mixer. To avoid this ambiguity we suggest, and shall use in this article, the description "primary oscillators," or simply "primaries," for the latter; the name "oscillator" will be reserved for the complete equipment, to which it is by now too firmly attached to be easily removable.

The main advantages of the heterodyne arrangement for variable-frequency oscillators include the wide range of frequency obtainable with a single control, and the comparative constancy of output level as the frequency is changed. It can more easily be made to give low harmonic content; and in an audio-frequency oscillator the inductors and capacitors are of more convenient sizes and can often be made to have higher "Q" and hence give better frequency stability. Of the disadvantages, the only inherent one is the greater complication, although a badly-designed or badly-maintained oscillator may produce signals of several spurious frequencies mixed with the wanted one. It is possible, though only by careful design, to obtain frequency stability and permanence of calibra-

tion that are of the same order as those of a "straight" oscillator using components of similar quality. In general these properties are inferior, as shown below, except for the effect of the probably higher "Q."

### 8. The Primary Oscillators

The primary oscillators may be of any type giving adequate stability. (Resistance-capacitance tuning would be permissible, but does not seem to have been used in practice.) They should be of similar design, so that changes of supply voltages and of ambient temperature will produce approximately proportional changes in the frequency of each. They should be sufficiently well screened from each other to prevent any tendency to locking when their frequencies are nearly the same, for otherwise the waveform at low frequencies will be poor. Small permanent changes in the "constants" of either tuning circuit need not cause serious errors in the frequency calibration if, as is usual, a zero beat control is incorporated. This control enables the beat frequency at zero scale reading to be adjusted to zero; it usually takes the form of a small variable condenser connected in parallel with the main tuning condenser. The magnitude of the errors remaining after use of this control is discussed below, in Section 11.

The variable primary usually has its maximum frequency, rather than its minimum, equal to the fixed frequency, because the components used in the two tuning circuits are then more nearly alike. The fixed frequency may be of any value greater than twice the highest wanted frequency. If it is too near this limit, the performance required in the low-pass filter is difficult to obtain; if it is too high, the beat frequency, which is then the small difference of two large quantities, becomes unduly sensitive to small differences between the properties of the two primaries. A fixed frequency of from five to ten times the highest wanted frequency is usually a reasonable choice.

The signals should be extracted from the primaries without detriment either to the frequency stability or to the waveform of the signals. Pick-up coils, loosely coupled to the inductors of the tuning circuits, are commonly used, and are satisfactory if rigidly mounted. But other methods are available. A capacitive potential-divider can be used, though the tuning capacitance must be reduced to allow for it; it need introduce no loss in the tuning circuit. A resistive potentiometer can be used provided the reduction in the "Q" of the tuning circuit is small; it has the advantage of not disturbing the reactive components of the tuning circuit. Where

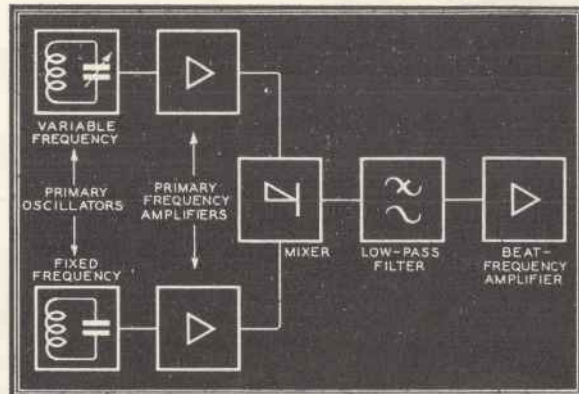

Fig. 6. Schematic diagram of heterodyne oscillator.

\* Post Office Research Station.

possible, it is usually satisfactory to make use of electron-coupled electrodes; *e.g.*, in a pentode, to use the grid and screen-grid as an oscillating triode and to take the output from the anode circuit. The preference for pick-up coils seems to be based, partly at least, on tradition; in some early oscillators the signals were immediately superposed and this process is facilitated if pick-up coils are used. But the method is not on that account to be recommended generally. The main criterion is that the impedance contributed by the device, represented as shunting the resonant circuit, should be constant or very high.

The highest level of signal which can be extracted from the primary without detriment to overall performance is, in many cases, insufficient for injection into the mixer. An amplifier operating at the primary frequency is then necessary. The use of two such amplifiers is in any case desirable, as it avoids the increased coupling between the primaries which results if their signals are fed directly into a common impedance.

### 9. Properties of Mixers<sup>16</sup>

The mixing device will in general produce, from the primary frequencies  $f_0$  and  $f_1$ , a series of frequencies given by the general formula  $pf_0 \pm qf_1$ , where  $p$  and  $q$  are integers or zero. This series includes: the wanted frequency  $f$ ; some high frequencies which are easily removed by a low-pass filter having a cut-off at some frequency between the maximum of  $f$  and the minimum of  $f_1$ , and also harmonics of  $f$ , which cannot be filtered out for all values of  $f$  except by the almost impracticable plan of varying the cut-off frequency of the filter as  $f$  is varied.

An idealised mixer need not give rise to any terms for which the sum of  $p$  and  $q$  exceeds 2; such a device would exist if its characteristics were accurately the straight lines or parabolae to which those of certain actual mixers approximate. Such a mixer would not generate any unwanted frequency within the range of output frequencies required; except that harmonics of the wanted frequency would be produced if there were harmonics present in both primary signals. Thus harmonic production is avoided if one of the primaries is free from harmonic; it is easy to reduce the harmonic in the fixed primary to a low level and this precaution is sufficient for the whole range of wanted frequencies.

A valve working on its anode-bend characteristic, which usually approximates to a parabola, approaches this ideal condition. So also do certain multi-electrode valves in which the signals are applied to two of the grids.<sup>16</sup> The failure to reach the ideal results in the generation of unwanted frequencies at low levels—perhaps of the order of 30 to 40 db below the level of the wanted frequency.

The level of the output signal depends in general on the product of the levels of the input signals. The range of the variable primary is usually so small a proportion of its frequency that it can easily be adjusted to give not only good waveform, but also nearly constant output, over this range. The harmonic may be as low as 50 db below the fundamental. Alternatively, the variable-primary signal may be made large, causing an on-and-off switching action in the mixer; the output signal level is then independent of the level of this large signal, but the harmonic production is somewhat higher—perhaps 30 db below the wanted signal. This effect can be produced either in an anode-bend mixer, if the signals do not remain within the parabolic part of the characteristic, or in a multi-electrode valve. Either choice of signal levels can lead to an output level which is independent of frequency.

### 10. Control of Oscillator Output

The location in the circuit of the main output control varies considerably in current designs of heterodyne oscillators. It should be such that the control causes no limitation to be imposed on the level of the signals extracted from the primaries; further, a change of setting of the control should cause no change in beat frequency. In some oscillators the control shunts the pick-up coils, with the slider of the control connected to the input of an amplifier; this circuit results in a capacitance, whose value depends on the setting of the control, being thrown across the tuning circuit. In order to maintain the beat frequency sufficiently independent of the setting of the output control, a severe limitation is placed on the number of turns on the pick-up coil or on its tightness of coupling to the tuning inductor, and hence on the voltage of the signal extracted. This factor alone leads to a need for amplification at the primary frequency. If amplification is provided for other reasons, and pentodes having a small grid-to-anode capacitance are used,

the output control may immediately follow the fixed-frequency amplifier.

Otherwise, the output control should follow the mixer, *e.g.*, as the termination of the low-pass filter. In this case the harmonic content, relative to the fundamental, is independent of the setting of the control (assuming the output amplifier to be distortionless). Any form of control previous to the mixer will almost certainly cause the harmonic content to vary according to the signal level. For certain applications, one characteristic or the other may be advantageous.

### 11. Frequency Stability of Heterodyne Oscillators

Errors in the frequency given by a heterodyne oscillator may be classified thus:—

A. Long-period: due mainly to mechanical changes.

B. Medium-period: occurring during a few hours, and due to thermal changes in the tuning circuits.

C. Short-period: due to supply-voltage fluctuations. The zero beat control will be used to compensate for "A" and, probably, for "B"; but it will be shown below that an error usually remains even after this adjustment. The zero beat control would probably not be used to deal with "C"—particularly as, in a good oscillator, "C" would not cause an error at zero frequency.

For the sake of simplicity, each primary will be assumed to have a tuning circuit consisting of one inductor only, shunted by one or more capacitors; similar considerations will be found to apply to more complex tuning circuits.

Then the errors "A" may be further classified as due to changes in the fixed primary:—

- (1) A frequency change for any reason;
- and in the variable primary:
  - (2) In the inductance  $L$  of the inductor;
  - (3) In the capacitance  $C$  of the variable condenser;
  - (4) In the capacitance  $K$  of the fixed condenser.

Use of the zero-beat condenser corrects (4) perfectly; it restores the capacitance  $K$  to its original value. It attempts correction of (1) and (2) by changing the minimum circuit capacitance; but the capacitance increment  $C$  at any other setting is no longer correctly proportioned to the total capacitance, neither is the wanted frequency the intended fraction of the fixed frequency. Assuming

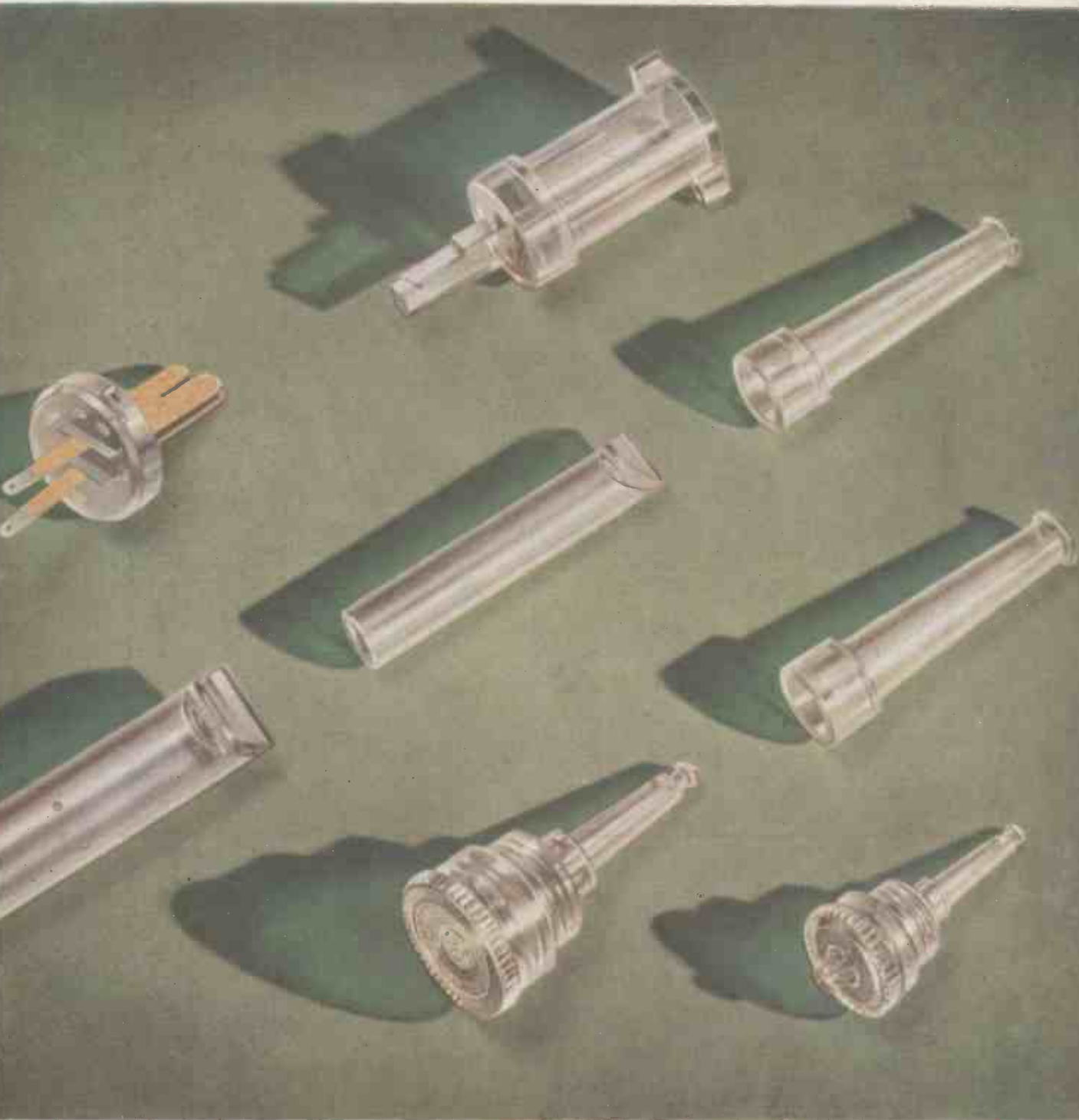

*Injection Mouldings in BX-Distrene ★ (Regd.)*

## **BX PLASTICS LTD**

**LARKSWOOD WORKS LONDON E.4**

**Larkswood 4491**

★ *"Distrene" Book available on application*



# HUNTS

TRADE MARK

## Capacitors



For your post-war Radio and Television Receivers we offer a complete range of Capacitors of the highest quality backed by a reputation that is second to none in the Industry.

Paper, Mica, Silver-mica, Ceramic and Electrolytic Capacitors in a wide range of capacities, types and sizes for all electronic and industrial applications.  
*Technical enquiries invited.*

**A. H. HUNT LTD., WANDSWORTH, LONDON, S.W.18**

that  $C=0$  at zero frequency, the zero-beat control cannot affect (3).

Assuming the zero-beat control to be adjusted in each case, the errors are (writing  $f_0$ ,  $f_1$ , and  $f$  for the fixed, variable, and beat frequencies respectively):—

(1) When  $f_0$  becomes  $f_0(1+a)$ , the error in  $f$  is

$$af \left( \frac{f_0^2 + f_0 f_1 + f_1^2}{f_0^2} \right)$$

or, when  $f_0 \gg f_1$ ,  $3af$ .

This is three times the error of a "straight" oscillator.

(2) When  $L$  becomes  $L(1+b)$ , the error in  $f$  is

$$bf \left( \frac{f_0 f_1 + f_1^2}{2f_0^2} \right)$$

or, when  $f_0 \gg f_1$ ,  $bf$ .

This is twice the error of a "straight" oscillator.

(3) When  $C$  becomes  $C(1+c)$ , the error in  $f$  is

$$cf \left( \frac{f_0 f_1 + f_1^2}{2f_0^2} \right)$$

or, when  $f_0 \gg f_1$ ,  $cf$ .

This is twice the proportional change in the variable frequency, but the comparison is not very useful as a straight oscillator would not employ fixed and variable condensers in the same proportions.

In practice, over long periods, a combination of the above three changes will take place.

The use of a second frequency check, at a frequency near the highest required, is claimed to increase the calibration accuracy by a factor of about 10. The control used should change the frequencies of both primaries simultaneously so that the zero-beat setting is unaffected.

The errors grouped as "B" are governed by the temperature coefficients of the two tuning circuits, provided that the primary driving circuits are well designed. If the fixed primary has a temperature coefficient of frequency  $a$ , and the variable one  $b$ , then the beat frequency at a setting  $f$  will change by

$$t \{ bf + (a-b)f_0 \}$$

when the temperature of each tuning circuit rises by  $t$ . The term  $t(a-b)f_0$  manifests itself as an error even at zero frequency and can be eliminated by readjustment of the control. If the rise in temperature differs in the two tuning circuits, the change of beat frequency will, in general, be much greater. Also, if the temperature coefficient of the variable condenser differs from that of the re-

mainder of the tuning circuit, as well it may, a more complicated expression results for the change in beat frequency.

There is the possibility of making this variation zero for some one value of  $f$ ; but the thermal characteristics of tuned circuits are difficult to control (notwithstanding certain manufacturers' claims), and in any case the temperatures of the two circuits may not change together. It is therefore more profitable—though still not easy—to attempt to make both  $a$  and  $b$  separately zero. It will be seen that when the temperature rises are equal, and  $a=b$ , the temperature coefficient of  $f$  equals that of either primary.

The utmost precautions must be taken therefore when designing and manufacturing the components of the tuning circuits of a heterodyne oscillator intended to be in the precision class to ensure that they have, separately, the highest possible stability.<sup>15</sup>

The short-period errors "C" result from the changes of frequency of the primaries with supply voltage; these changes are proportional to the respective frequencies if the primaries are truly similar. Hence the change of beat frequency bears the same relation to this frequency. Once again it is not sufficient that the two primaries should be similar; each should have the highest possible stability separately if the beat frequency is to be stable.

### Acknowledgments

The authors are indebted to the Engineer-in-Chief of the Post Office Engineering Department for permission to publish these articles, and to their colleagues who, in many discussions, have helped to develop the ideas presented. The opinions expressed, however, are the responsibility of the authors alone.

### References

- Books: Terman, *Measurements in Radio Engineering*, pp. 298-303, McGraw-Hill, 1935.  
 Reich, *Theory and Applications of Electron Tubes*, pp. 348-354, McGraw-Hill, 1939.  
 15 Strutt, *Proc. I.R.E.*, 22, p. 981, 1934; Herold, *Proc. I.R.E.*, 30, p. 84, 1942.  
 16 Wing, *Proc. I.R.E.*, 29, p. 121, 1941; Jarvis and Clarke, *P.O.E.E.J.*, 35, p. 23, 1942.  
 17 Slonczewski, *E.S.T.J.*, 19, p. 407, 1940.  
 18 Griffiths, *W.E.*, 11, p. 234, 1934; 12, p. 357, 1935.

### Corrections

#### Part I (February issue)

- P. 382, Fig. 2 caption—  
 "Negative resistance characteristics of transistor measured statistically";  
 should read—"Negative resistance characteristics of transistor measured statically."  
 P. 383, col. iii, line 18—  
 "different frequencies with different";  
 should read—"different frequencies with different phase shift."

## NOTES FROM THE INDUSTRY

### South Wales Branch of the Institute of Physics

Physicists employed in industry in South Wales and the surrounding district have for some time felt the need of local opportunities for the interchange of knowledge and experience of Applied Physics. At their request the Board of the Institute of Physics has therefore authorised the formation of a South Wales Branch of the Institute which is to be centred on Swansea.

Further particulars of the Branch may be obtained from the Acting Honorary Secretary, Dr. T. V. I. Starkey, A.Inst.P., the Technical College, Mount Pleasant, Swansea.

### Birmingham Electric Furnaces

Birmingham Electric Furnaces, Limited, of Tyburn Road, Erdington, Birmingham, inform us that they have decided to change their name to BIRLEC, LTD.

The company, a subsidiary of the Mond Nickel Co., has pioneered all types of industrial electric heat treatment and melting furnaces in this country, and, in addition, manufactures specially designed gas furnaces, induction heating apparatus and drying equipment.

### Dr. J. N. Aldington

The degree of Ph.D. (Externally) has been awarded by the University of London to Mr. J. N. Aldington, B.Sc., F.R.I.C., F.Inst.P., for a thesis on "The High Current Density Mercury Vapour Arc."

Dr. Aldington is Assistant Works Manager and Head of the Laboratories of Siemens Electric Lamps and Supplies, Limited, Preston.

### Marconi Patent Chief Retires

After 34 years' service with Marconi's Wireless Telegraph Company, Limited, of which 25 were spent in the Patent Department and the last 17 as Joint Chief of that Department in charge of Patents, Mr. W. H. ("Inductance") Nottage has retired on reaching pension age, and has been succeeded by Dr. G. F. Brett.

### Clix Sales Manager

C. A. Edgell has been appointed Sales Manager of British Mechanical Productions, Ltd. (Clix Radio Components). He has for nearly three years been administrative manager of the company's factories concerned mainly with the production of radio components and, before joining the company in 1942, served as an officer in the Royal Air Force Volunteer Reserve.

# Low Frequency Amplification

## Part VI. The Screen Decoupling Circuit

By K. R. STURLEY, Ph.D., M.I.E.E.

THE screen circuit of a L.F. amplifier can have considerable influence on low-frequency response. In the diagram of Fig. 37 the resistances  $R_1$  and  $R_2$  form a voltage divider for the total H.T. voltage, and the capacitance  $C_s$  acts as a bypass to earth for A.C. currents produced in the screen circuit by the grid A.C. input voltage. If  $C_s$  has a reactance comparable to the resistance of  $R_1$  and  $R_2$  in parallel at frequencies which are to be amplified, screen current changes caused by the input voltage produce voltage components in the screen circuit. These components react upon the anode current causing a change in opposition to that produced by the grid input voltage, and so the effective overall amplification of  $C_s$  increases as the frequency falls, and decrease of input frequency causes a progressive decrease in amplification to a value which would be obtained if  $C_s$  were omitted altogether. The effect is actually similar to that produced by the rising reactance of the cathode self-bias capacitor.

To understand the effect of the screen circuit on overall amplification it is necessary to find the relationship between anode current and screen voltage. We are familiar with the expression for the anode current in a tetrode of internal resistance high compared with the load resistance; it is

$$\Delta I_a = g_m \Delta E_g \quad 31$$

where  $\Delta I_a$  is the change of  $I_a$  produced by a small change of grid

voltage  $\Delta E_g$ , and  $g_m = \frac{\partial I_a}{\partial E_g}$  (the

partial derivative of anode current with respect to  $E_g$ ) is the differential of  $I_a$  with respect to  $E_g$  when all other voltages ( $E_s$  and  $E_a$ ) are constant. Now  $I_a$  is not a function simply of  $E_g$ , but is also affected by  $E_s$  and  $E_a$ , and a small change of screen voltage,  $\Delta E_s$ , produces a small change of anode current in accordance with the expression

$$\Delta I_a = g_s \Delta E_s \quad 32$$

where  $g_s = \frac{\partial I_a}{\partial E_s}$ , the differential of

anode current with respect to screen voltage when  $E_g$  and  $E_a$  are constant.

Change of anode voltage has a similar effect and the corresponding change of anode current is

$$\Delta I_a = g_a \Delta E_a \quad 33$$

where  $g_a = \frac{\partial I_a}{\partial E_a}$ , the differential of

anode current with respect to anode voltage when  $E_g$  and  $E_s$  are constant.

If the changes of grid, screen and anode voltages are taking place simultaneously, the total anode current change is the sum total of the separate changes, thus

$$\Delta I_a \text{ (total)} = g_m \Delta E_g + g_s \Delta E_s + g_a \Delta E_a \quad 34$$

A similar expression is obtained for total screen current change, which is

$$\Delta I_s \text{ (total)} = G_m \Delta E_g + G_s \Delta E_s + G_a \Delta E_a \quad 35$$

where  $G_m = \frac{\partial I_s}{\partial E_g}$ , the differential of

screen current with respect to grid voltage when screen and anode voltages are constant, and  $G_s$  and  $G_a$  are similar derivatives of screen current with respect to screen and anode voltages respectively.

When the voltage changes in the screen and anode circuits are a direct result of the grid voltage change, i.e., they are caused by changes in the screen and anode currents, these voltages are in such a direction as to oppose the current changes. For example, an increase in screen or anode current due to increase of grid

voltage in a positive direction causes a reduction in screen or anode voltage. We can therefore write

$$\Delta E_s = -\Delta I_s Z_s \quad 36$$

$$\text{and } \Delta E_a = -\Delta I_a Z_o \quad 37$$

where  $Z_o =$  the anode load impedance  
 $Z_s =$  the total impedance of the screen circuit

$$Z_s = \frac{R_1 R_2}{R_1 + R_2 + j\omega C_s R_s}$$

and  $R_s =$  the equivalent A.C. resistance component in the screen circuit, which is made up of a potential divider for D.C. voltages consisting of  $R_1$  and  $R_2$ . These two resistances, in series for D.C., are in parallel as far as A.C. is concerned.

$$\text{Thus } R_s = \frac{R_1 R_2}{R_1 + R_2}$$

Combining 34, 36 and 37, and neglecting the effect of the cathode self-bias circuit,

$$\Delta I_a = g_m \Delta E_g - g_s \Delta I_s Z_s - g_a \Delta I_a Z_o$$

$$\Delta I_a = \frac{g_m \Delta E_g - g_s \Delta I_s Z_s}{1 + g_a Z_o} \quad 38$$

Combining 35, 36 and 37,

$$G_m \Delta E_g - G_s \Delta I_s Z_s$$

$$\Delta I_s = \frac{G_m \Delta E_g - G_s \Delta I_s Z_s}{1 + G_s Z_s} \quad 39$$

Replacing  $\Delta I_s$  in 38 by Expression 39,

$$\Delta I_a = \frac{[g_m(1 + G_s Z_s) - g_s G_m Z_s] \Delta E_g}{(1 + g_a Z_o)(1 + G_s Z_s) - g_s G_a Z_o Z_s} \quad 40$$

$$\text{Overall amplification, } A = \frac{\Delta I_a Z_o}{\Delta E_g}$$

$$= \frac{Z_o [g_m(1 + G_s Z_s) - g_s G_m Z_s]}{(1 + g_a Z_o)(1 + G_s Z_s) - g_s G_a Z_o Z_s} \quad 41$$

When  $Z_s = 0$

$$A_o = \frac{g_m Z_o}{1 + g_a Z_o} = \frac{g_m Z_o}{Z_o} = g_m R_a \frac{Z_o}{R_a + Z_o}$$

$$= \frac{\mu Z_o}{R_a + Z_o}$$

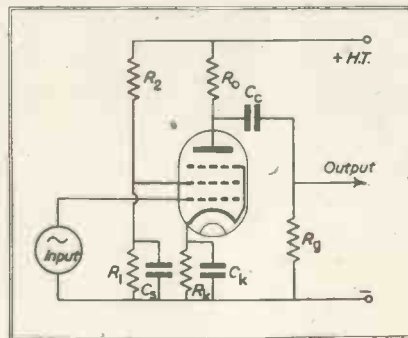

Fig. 37. A tetrode R.C. amplifier.



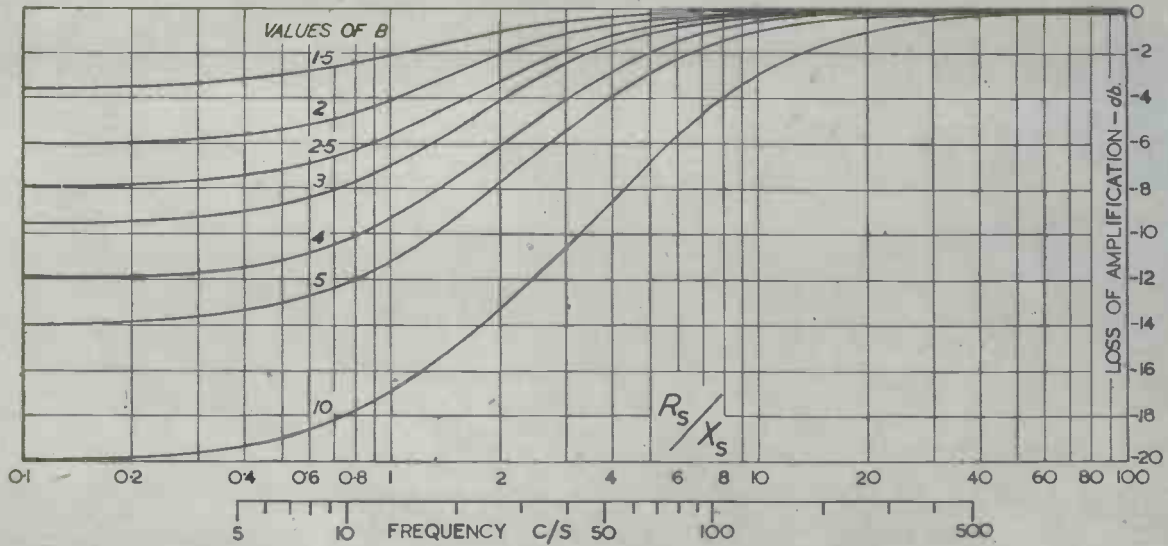

Fig. 38. Frequency response curves for the screen decoupling circuit.

The ratio of amplification without screen circuit degeneration to that with, is

$$\frac{A_o}{A} = \frac{g_m (1 + g_o Z_o)(1 + G_s Z_s) - g_o G_s Z_o Z_s}{(1 + g_o Z_o)[g_m(1 + G_s Z_s) - g_o G_m Z_s]}$$

$$= \frac{1 + G_s Z_s - \frac{g_o G_s Z_o Z_s}{1 + g_o Z_o}}{1 + G_s Z_s - \frac{g_o G_m Z_s}{g_m}} \dots\dots\dots 42a$$

Replacing  $Z_s$  in 42a by  $\frac{R_s}{1 + j\omega C_s R_s}$

$$\frac{A_o}{A} = \frac{1 + j\omega C_s R_s + R_s \left[ G_s - \frac{g_o G_s Z_o}{1 + g_o Z_o} \right]}{1 + j\omega C_s R_s + R_s \left[ G_s - \frac{g_o G_m}{g_m} \right]} \dots\dots\dots 42b$$

If  $Z_o = \frac{R_o R_g}{R_o + R_g} = R'_o$

$$\left| \frac{A_o}{A} \right| = \sqrt{\frac{B^2 + \omega^2 R_s^2 C_s^2}{D^2 + \omega^2 R_s^2 C_s^2}} \dots\dots\dots 42c$$

where  $B = 1 + R_s \left[ G_s - \frac{g_o G_s R'_o}{1 + g_o R'_o} \right]$

and  $D = 1 + R_s \left[ G_s - \frac{g_o G_m}{g_m} \right]$

But  $\frac{\partial I_o}{\partial E_k} = \frac{G_m}{g_m} \frac{\partial I_a}{\partial I_s} = \frac{G_s}{g_s} = \frac{G_a}{g_a}$

so that  $B = 1 + R_s G_s \left[ \frac{g_s R'_o G_a}{1 + g_s R'_o} - \frac{G_s}{G_s} \right]$   
 $= 1 + R_s G_s \left[ \frac{g_s R'_o}{1 + g_s R'_o} - 1 \right]$

$$= 1 + \frac{R_s G_s}{1 + g_s R'_o} = 1 + \frac{R_s G_s}{R_a}$$

and  $D = 1 + R_s(G_s - G_g) = 1$  where  $R_{sg} = \frac{R_s}{G_s} = \frac{R_s}{\partial I_s} =$  slope resistance of the  $I_s E_s$  characteristic

The loss of amplification expressed in db is

$$-20 \log_{10} \frac{A_o}{A} = -10 \log_{10} \left[ \frac{B^2 + \omega^2 C_s^2 R_s^2}{1 + \omega^2 C_s^2 R_s^2} \right] \dots\dots\dots 43a$$

$$= -10 \log_{10} \left[ \frac{B^2 + \left( \frac{R_s}{X_s} \right)^2}{1 + \left( \frac{R_s}{X_s} \right)^2} \right] \dots\dots\dots 43b$$

and it is identical in form to that

of the cathode self-bias circuit; the frequency-response curves in Fig. 38 are the same as those given in Fig. 30 of a previous article. The low-frequency loss becomes asymptotic to a value of  $10 \log_{10} B^2$  or  $20 \log_{10} B$ , and maximum loss is

$$20 \log_{10} \left[ 1 + \frac{R_s R_a}{R_{sg}(R_a + R'_o)} \right]$$

Figs. 31, 32 and 33 of the previous article (Part IV) for phase angle displacement, time advance and time error are applicable to the screen decoupling circuit by changing the horizontal logarithmic scale from  $R_k/X_k$  to  $R_s/X_s$ .

To illustrate the use of Fig. 38, we shall consider a tetrode valve circuit of the following constants,  $g_m = 2\text{mA/volt}$ ,  $R_a = 1\text{M}\Omega$ ,  $R_{sg} = 20,000\Omega$ ,  $R_o = 200,000\Omega$ ,  $R_g = 1\text{M}\Omega$ ,  $R_2 = 30,000\Omega$ ,  $R_1 = 20,000\Omega$ ,  $C_s = 1\mu\text{F}$ . Assuming that the reactance of  $C_c$  is always much less than  $R_s$ ,

$$R'_o = \frac{R_o R_g}{R_o + R_g} = 166,666\Omega$$

$$R_s = \frac{R_2 R_1}{R_2 + R_1} = 12,000\Omega$$

$$\frac{R_s}{R_{sg}} = \frac{12,000}{20,000}$$

$$B = 1 + \frac{R_s}{R'_o} = 1 + \frac{12,000}{166,666} = 1.515$$

$$f_o = \frac{1}{2\pi R_a C_a} = \frac{10^6}{6.28 \times 12,000 \times 1} = 13.3 \text{ c/s.}$$

Approximate frequency response is read from the curve  $B=1.5$  after locating  $f=13.3$  c/s. against  $\frac{R_a}{X_s}=1$  as shown in Fig. 38. Thus at 20 and 50 c/s. there are losses of  $-1.4$  and  $-0.3$  db respectively. Screen circuit attenuation and phase distortion can be cancelled by suitably proportioning the anode load and anode decoupling circuit in the same manner as was possible for the cathode self-bias circuit.

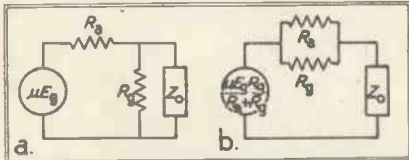

Fig. 39 (a). A valve generator with an anode load consisting of two parallel paths.  
Fig. 39 (b). Thévenin equivalent of Fig. 39 (a).

**Appendix : Thévenin's Theorem**

Thévenin's theorem states that any two terminal network, transmitting voltage and current may be resolved into a generator of internal impedance equal to the total impedance looking into the pair of output terminals, and of generated voltage equal to the

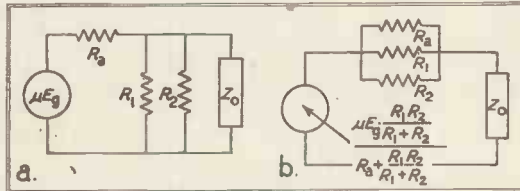

Fig. 40 (a). A valve generator with an anode load consisting of three parallel paths.  
Fig. 40 (b). Thévenin equivalent of Fig. 40 (a).

open-circuit voltage across these same terminals. Taking the circuit of Fig. 39a, it means that the equivalent generator (Fig. 39b) has an internal impedance of  $R_a$  and  $R_g$  in parallel

and a generated voltage of  $\frac{\mu E_g R_g}{R_a + R_g}$

The proof is as follows:—

$$E_o \text{ (Fig. 39a)} = \frac{\mu E_g \frac{R_g Z_o}{R_g + Z_o}}{R_a + \frac{R_g Z_o}{R_g + Z_o}}$$

$$E_o \text{ (Fig. 39b)} = \frac{\mu E_g R_g}{R_g + R_a} \cdot \frac{Z_o}{R_g R_a + Z_o(R_g + R_a)} = \frac{\mu E_g R_g Z_o}{R_g R_a + Z_o(R_g + R_a)}$$

$$= \frac{\mu E_g R_g Z_o}{R_g R_a + Z_o(R_g + R_a)} = \frac{\mu E_g R_g Z_o}{R_g R_a + Z_o(R_g + R_a)}$$

Similarly, Figs. 40 (a) and (b) are identical.

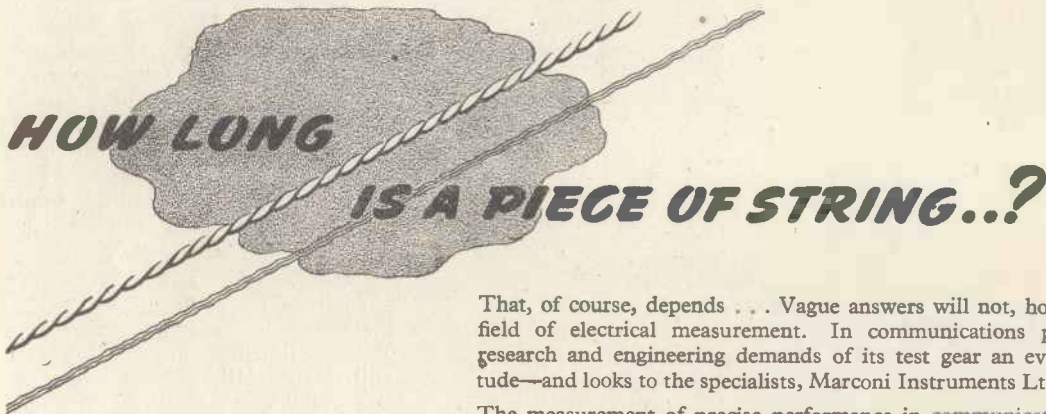

That, of course, depends . . . Vague answers will not, however, suffice in the field of electrical measurement. In communications particularly, modern research and engineering demands of its test gear an ever-increasing exactitude—and looks to the specialists, Marconi Instruments Ltd., to provide it.

The measurement of precise performance in communications equipment and their components is an intricate art, calling for a wide range of measuring instruments. And whatever the strides in radio technique, so too must the scope of measurement develop.

The unique experience of the Marconi organisation—gained since the very origins of radio—enables it to meet all demands, so that to-day, for the indispensable tools of his trade, the communications engineer confidently specifies Marconi.

# The Mervyn Reactance Alignment Comparator

**A** PAPER read before the Television Society\* by P. D. Saw of the Mervyn Sound and Vision Co., describes two new types of instrument developed in their laboratories for production checking. The following is a brief summary of the characteristics and use of a reactance comparator which, although intended for tests on television equipment, is adaptable to radio receiver testing or component checking.

The instrument matches or checks condensers, inductances, or a combination of the two, to a high degree of accuracy.

Fundamentally, it contains two similar LC circuits, consisting of the coils and condensers to be checked against one another.

One LC circuit forms part of a stable oscillator which is loosely coupled to the other LC circuit operating as a high-Q resonator. The natural frequency of the resonator is varied about its mean figure in synchronism with a pointer vibrating in front of a scale. At the instant when the natural frequency of the resonator is equal to the oscillator frequency, the scale over which the pointer moves is illuminated by a light source of short duration. (Fig. 1.)

This action is repeated 50 times a second so that the pointer appears to be stationary due to the stroboscopic effect.

The natural frequency of the resonator is varied by means of a small condenser, the moving vane of which is carried by a reed vibrating at 50 c/s., maintained by means of a coil energised by the A.C. mains. (Fig. 2.)

The output of an oscillator  $L_1C_1$  with automatic amplitude control and resonator  $L_2C_2$ , with manual magnification control, are fed into a mixer

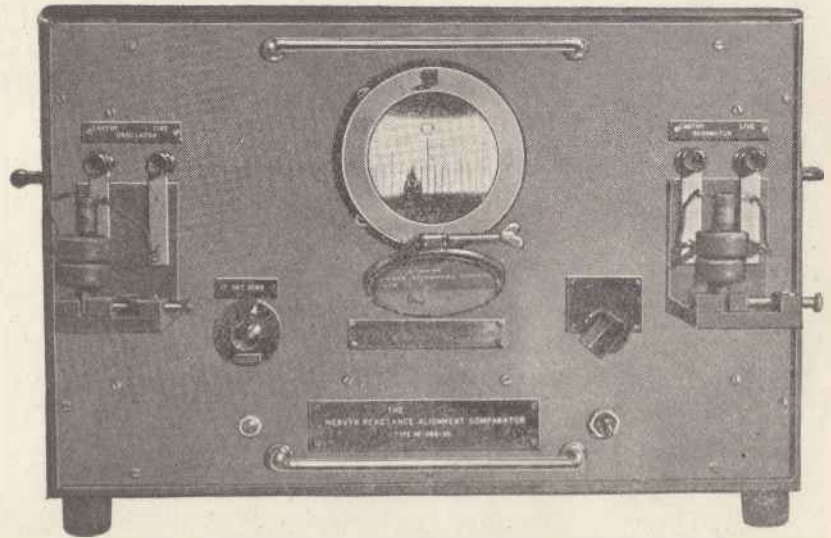

Fig. 1. The comparator, showing illuminated pointer and scale.

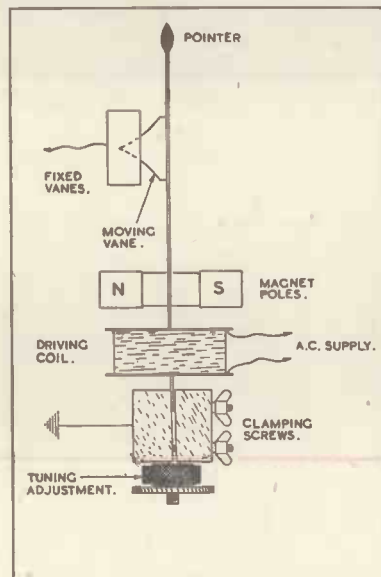

Fig. 2. Method of varying the resonator frequency by vibrating reed.

stage, then into a differential circuit and pulse generator which triggers a thyatron. This strikes the neon lamp and illuminates the scale against which the pointer appears silhouetted.

The sensitivity of the indicator can be varied by altering the capacity swing of the indicator condenser, and the ultimate sensitivity is only limited by a blurring of the pointer which occurs with very small frequency deviations. At a working frequency of  $\frac{1}{2}$  Mc/s., a difference of about  $1/10$  picofarad can be readily observed.

The two sections of a two-gang tuning condenser can be matched to one another very simply by connecting the two sections across the two tuned circuits of the instrument.

Secondly, the instrument will compare sample inductances with a known standard inductance. In this case the scale will read in arbitrary units depending upon the LC combination in use.

The range of inductances which can be checked in this way runs from about  $20 \mu H$  to 2 H. The lower limit depends largely upon the Q of the coil, and the ability of the oscillator to work at high frequencies.

A useful feature of the instrument in connexion with checking coils is the fact that the Q value is examined critically if the sample is connected to the resonant circuit, one short-circuited turn in the largest coil being sufficient to reject it.

### Setting-up Tuned Circuits

A third operation which this instrument will perform is the adjusting of complete tuned circuits to some exact frequency. A typical instance is the pre-tuning of double-wound I.F. transformers, for which purpose the indicator is set to zero against one side of a known standard transformer. The standard is then replaced by an untuned sample which is adjusted until the pointer again appears at the centre of the scale.

We understand that Messrs. Leland Instruments, Ltd., have been appointed sole distributors of laboratory and production test gear manufactured by the Mervyn Sound and Vision Co., Ltd.

\* Jour. Tel. Soc., Vol. 4, No. 4, p. 76.



# Gasfilled Tubes as Pulse Generators

By F. J. G. van den Bosch, D.Sc.

A description of some new types of gasfilled tubes designed to overcome the drawbacks of the conventional types. This article forms part of a paper given by the author before the Institution of Electronics on March 23, 1945

WHEN a grid is introduced in a gasfilled tube with a hot cathode its purpose and function is different from that in a high-vacuum valve. The grid function is solely to prevent the initiation of an arc from cathode to anode until the grid and anode potentials have been adjusted to cause breakdown. Once the discharge has started the grid loses its control, and the anode voltage must be removed or reversed to permit the tube to deionise before the grid regains control. Large negative voltages may stop the discharge and therefore allow higher breakdown potentials to be used. The ionisation time in these tubes is only a few microseconds, but the deionisation time or average time for the grid to regain control after circuit interruption is of the order of 10 to 1,000 microseconds. This deionisation time will be smaller for tubes with short interelectrode spacings, smaller load circuits, reduced gas pressure, and greater negative grid potential, but in any event it puts a finite limit to the frequency response of the tube.

With regard to the characteristics these can be improved by using positive grid characteristics, which may be obtained by increasing the number of grid baffles and by reducing the size of the holes in these baffles. The first transition in this type of improvement is shown in Fig. 1 between "a" and "b." In this type of construction the cathode-grid region is completely shielded from the anode potential. The discharge can only be started by making the grid sufficiently positive to accelerate the electrons so that they may reach the grid-anode field. By using a fourth electrode and placing this between the baffles of the shield the control of such a tube can be made very sensitive, and conduction may be started by an impulse, or by a shift in phase of an A.C. grid voltage, or by a change in the magnitude of an A.C. voltage on the grid, but in this last case the control of the tube can only

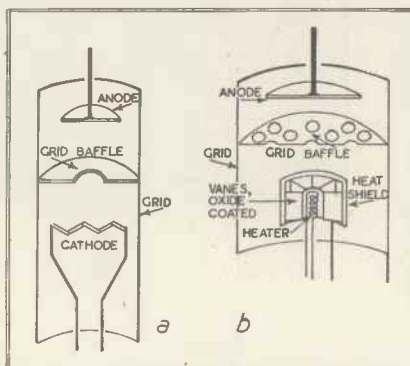

Fig. 1. Types of thyatron construction.

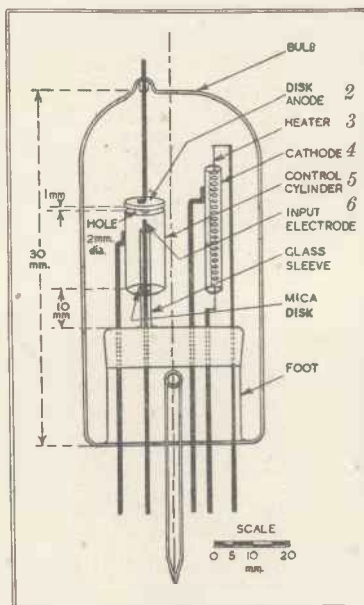

Fig. 2. The "Neutron," type "A."

be effective for one fourth of the cycle.

Grid-controlled tubes filled with a rare gas are unaffected by temperature, and generally have only one grid-control curve. This curve is not a vertical characteristic, but near the cut-off should be asymptotic, since it is that portion which covers the "dark" current before actual ionisation takes place, which subsequently

will then give rise to the vertical characteristic required.

To sum up, hot-cathode grid-controlled gas-discharge tubes are capable of being adapted as pulse generators and, in fact, in combination with other tubes, they can be adapted to give a good square wave. Other tubes which must be mentioned here are the glow-discharge rectifiers and grid-glow tubes, both of which can be used to generate square wave in combination with other tubes, or they can be used as limiters in an arrangement for producing square waves.

Suppose, then, we make an attempt at designing a gas-discharge device which will act as a pulse generator with as high an efficiency as technical considerations permit.

The best conditions for pulse generation would be with a grid-controlled device, but there is the drawback in the ionisation time, *e.g.*, the time the tube takes to establish conduction (or striking). We have, therefore, to design a tube which will have the former and obviate the latter characteristic.

The first electrodes to consider in the tube will have to be concerned with keeping the gas in a permanent ionised state, independently of the operating electrodes. This may be achieved with a thermionic cathode of the directly or indirectly heated type. The next electrodes to be considered will be the operating electrodes, which in their simplest form will consist of a cathode, grid, and anode. The discharge when passing from cathode to anode will, therefore, have a clear and positive break. Such a tube is shown in Fig. 2, which for the purpose of the publication has been called a "neutron." The drawing has been detailed to facilitate reproduction.

On the drawing 3 represents the heater, 4 the cathode, 6 the input electrode, which is shown as being enclosed in the control cylinder, 2 represents the output or output elec-

trode, while 5 represents the control cylinder functioning as a control grid. The construction is simple, as can be gauged from the drawing; the features requiring most attention are, first, the necessity for covering the input electrode over the greater part of its length with a glass shield or a refractory material which can be sprayed on and then baked on (magnesium oxide is a good substitute); second, and most important, is that the sensitivity of the tube will depend on the disposition of the three operating electrodes—6, 5 and 2. The larger the hole in the grid, the less the control, while the further away the input electrode is situated the more sudden the discharge will be once the grid loses its control. The dimensions and material given in the illustration are for a tube which has operated satisfactorily at frequencies up to 20,000 c/s. The operation of the tube when generating clear-cut pulses can easily be understood. The cathode maintains the gas in an ionised state, and if we apply an A.C. voltage on the grid, the tube will only strike at the positive peaks of each cycle, as the D.C. circuit going through input and output electrode will be positively interrupted and convert this D.C. into a pulsating form of current. On examining the waveform of the pulse, however, it will be found to be not yet perfectly square, and from this first stage of development of a new tube, which has improved the ionisation time, we can now examine the second stage which will mainly concern an improved waveform and greater control over sensitivity.

This second stage is illustrated in Fig. 3, which gives the details of the "NEUTRON" type "B." Referring to Fig. 3, this shows the heater, 7 the cathode, 5 input electrode control cylinder "A," 6 the output electrode control cylinder, while 4 is a nickel wire passing through both "A" and "B" cylinders and constituting, therefore, a common electrode. In operation, this tube is rather different from the Neutron type "A," for in the latter tube, simple grid control of a gas discharge is used, while in the tube under consideration, a different principle is being used to generate pulses. Assume now that we connect electrode 4 to the anode of an amplifier valve, and control cylinder "A" to the positive of the high-tension supply; when the valve operates, a glow discharge will

take place between electrode 4 and electrode 5, any increase or decrease in voltage due to variation of the grid voltage of the controlling valve resulting in a lengthening or shortening of the glow length along the electrode 4. This principle was applied by Pressler in the neon tuning indicator which was in use some years before the war.

The operation of this type of tube is now easily understood. Voltage is applied between electrode 4 and control cylinder "A" in such a manner that the glow discharge covers nearly the whole length of electrode 4; thus a small addition in voltage will bring the glow discharge in contact with control cylinder "B," so providing this electrode with a potential, or alternatively closing a circuit of which control cylinder "B" is part. By applying an alternating potential between electrode 4 and control cylinder "A," the peaks of this A.C. potential can be used to trigger the circuit and form a pulsating current. These peaks can also be provided by connecting electrode 4 and control cylinder "A" in the anode circuit of a control valve, as previously described. A circuit of this type can be made very sensitive, even a small variation of the order of microvolts on the control grid of the valve will cause an appreciable variation in the anode circuit of the valve, which will be of sufficient value for the glow to extend and touch control cylinder "B." Thus we have a device which with the help of, for example, a valve will generate perfect square pulses. The device will be very sensitive and overcome the circuit difficulty an ordinary valve would present due to "Miller effect."

Since the use of a thermionic cathode will impair the efficiency of the device, because in time it will add impurities to the gas-filling which will cause a falling-off in sensitivity, let us now consider how we could dispense with this thermionic cathode and yet retain the advantage gained by its use, namely, to keep the gas in an ionised state.

Referring to Fig. 3, we see three control electrodes consisting of electrode 4 acting as a cathode and a control cylinder at each end. If now we bring these two cylinders closer together, separate the central wire into two portions, and insert a controlling device such as a grid in between the two portions, we will have an entirely new tube, illustrated

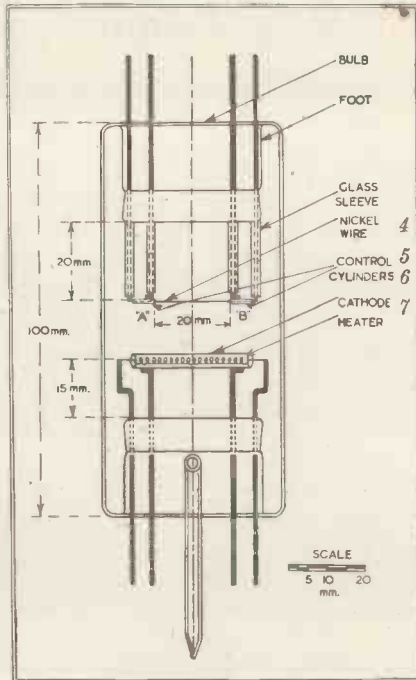

Fig. 3. "Neutron," type "B."

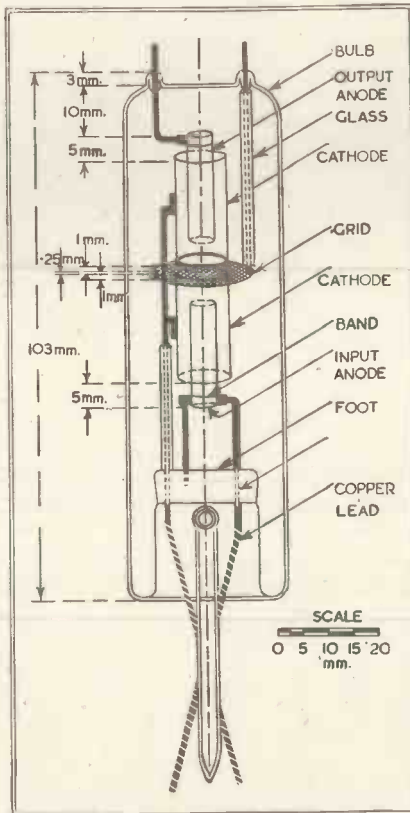

Fig. 4. "Pulsatron."



in Fig. 4. This has been called a "Pulsatron." The principle of operation is as follows:

A substantially constant potential between cathode and anode maintains a field of ionisation, an input electrode, connected to a source of controlling potential, distorting this field. An output electrode is arranged in the path of the distorted field, and connected with the apparatus to be controlled. It will be appreciated with this arrangement that a field of ionisation is maintained irrespective of the value of the controlling potential.

By arranging the input electrode between the two parts of the cathode, the field of ionisation may either be retained between the anode and the first part of the cathode only, but when the potential on the input electrode is the same as that of the cathode the ionisation field will extend into the second part of the cathode. As an alternative construction the cathode may be tubular in form and divided into two parts across its axis, the anode being axially arranged in one of the parts and the output electrode in the other. The input electrode is arranged between the two parts of the cathode. The input electrode may be in the form of a ring concentric with respect to the two parts of the cathode, or it may be a grid extending between the two parts. It will be seen that with this arrangement any stray ionisation field is prevented from spreading outside the tubular cathode. The operation of the tube is somewhat more involved, since the input electrode functioning as a grid has to be controlled by a valve. This, of course, entails the possibility of rendering the device very sensitive as a pulse generator, but the circuit arrangement to obtain this maximum efficiency is complicated. It is advisable to add some device which will stabilise the current going through the tube so that evenness of response is achieved. We have thus created a gas-discharge device which can generate perfect square wave pulses if adapted in a suitable circuit, and

## A New Radio-Frequency Crack Detector

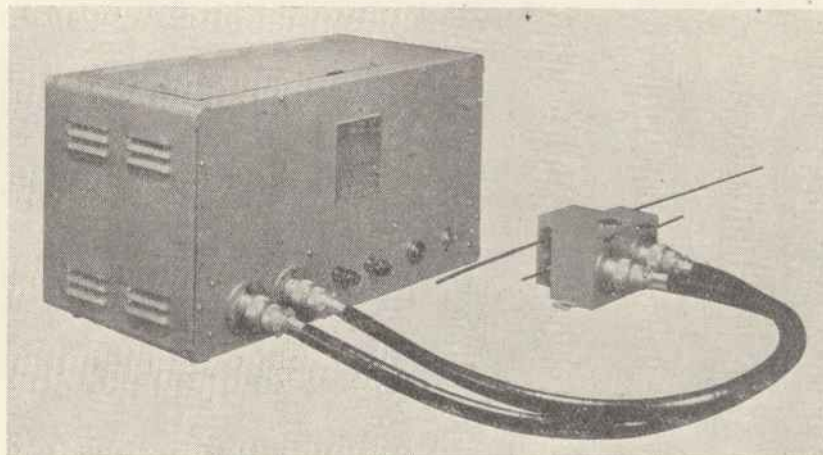

**T**HIS apparatus, which is of entirely new design, comprises a radio-frequency generator in a rectangular case which is provided with leads of any convenient length, to the ends of which interchangeable coils may be plugged in to deal with different sizes of material.

The material to be tested should be in the form of bar stock, wire or strip, and may be fed through the detecting coils in continuous lengths at any speed up to one foot per second. The bar stock may be round, square, hexagonal or any other shape.

Cracks are indicated by a lamp, bell or meter, and the equipment may be arranged if desired to stop the machine feeding the material when a crack is present. Alternatively, means may be provided to reject defective portions.

The Salford R.F. Crack Detector is based on the tendency of currents at radio frequencies to travel only

through the surface of conductors so that if surface cracks exist the currents will be restricted and the alteration in circuit conditions is used to enable the instrument to indicate the presence and dimensions of cracks.

This detector may be used for testing material from 0.05 in. to 2 in. diameter or width and will detect cracks from a minimum depth of .0005 in. upwards. It is suitable for testing ferrous or non-ferrous metals. When fitted with a meter it may be calibrated to indicate the depth of crack for any particular material.

The standard model is suitable for operation from the ordinary A.C. mains, but special models for use on D.C. can be provided. The overall dimensions are approximately 16 in. long by 9 in. high by 10 in. deep.

—Salford Electrical Instruments, Ltd.

we have overcome the difficulty of ionisation time without having recourse to a thermionic cathode. In conclusion, three distinct possibilities have been found during the examination of the design requirements for a gas-discharge tube made with the specific purpose of generating a perfect square waveform coupled with absence of striking time. There is no doubt that these may lead to other

types of tube, but even they will be influenced by the three different methods we have introduced, either jointly or individually. They provide a solution to the problem of perfect pulse generation, provided the circuit in which they are components is well designed, and provided it is understood that because they are gas-discharge tubes their frequency response is limited.



# WEIGHT REDUCING

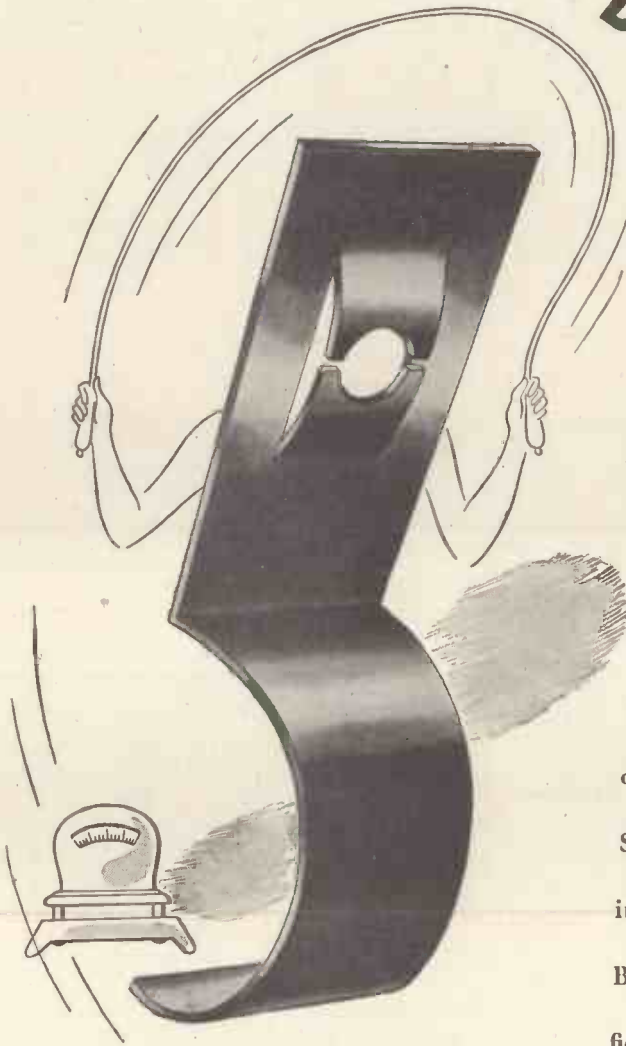

WHEN you adopt some form of Spire fixing for a light assembly job, you certainly save weight. For one thing you won't need washers. For another the Spire nut is lighter than an ordinary nut. And if we can make the Spire device part of the component you won't even need a Spire nut. You may say that weight saving in your case is a minor matter any way. But is it a minor matter to cut out all that fiddling and fumbling with nuts and washers? Is the saving in cost a minor matter? Or the strength and permanence of the fixing?

**THAT'S Fixed THAT!** You may say the NB 1455 is obvious. So it is once it exists—like a lot of other good ideas. The Spire nut device is made part of the component and so these cable clips are screwed direct to their base without need of separate washer or nut. The NB 1455 was developed for a Government Department but it has found wide uses throughout industry.



# Spire

\* **A BETTER way of fixing**

Simmonds Aerocessories Limited · Great West Road · London · A Company of the Simmonds Group

## BOOK REVIEWS

### Porcelain and other Ceramic Insulating Materials, Vol. I

By Dr.-Ing. Ernst Rosenthal. 286 pp. (Chapman and Hall, 28s.)

The author's object in writing this book is 'apparently first of all to give the electrical engineer a clear picture of the characteristics, uses and manufacture of ceramics, thereby encouraging the greater use of porcelain and similar materials for electro-technical and other purposes. With this aim he has collected considerable data from a great variety of periodicals, books and other published literature. The book also contains a number of tables and figures concerning the physical properties and characteristics of porcelain and other ceramic materials, thus giving any reader (especially the electrical engineer) a greater knowledge of the subject. In devoting himself to this task, the author renders a valuable service to the industry generally; herein lies the real purpose for which the book can be recommended.

It is usual in ceramic text-books to open with a chapter on raw materials, but the author begins with one dealing with porcelain, its formation and structure, followed immediately by a short and certainly inadequate chapter on insulators for sparking plugs and a separate chapter dealing with the influence of glazes on the technical characteristics of porcelain. It is only when we get to page 72 that we find a detailed description of raw materials. Readers would more easily grasp the formation and structure of porcelain and its characteristics if an account of these were preceded by an explanation of the raw materials, their physical behaviour and chemical reactions.

It would be advisable to introduce far more details of ceramic raw materials than is done in this first edition. In this connexion another question of the arrangement of the book arises, *viz.*, that of references. If the author desires to write a general and well-balanced text-book either on the production of porcelain or its application, then there is no absolute need to refer to previous publications. If, however, this book is supposed to interest the reader in the study of scientific details, far more and better selected references should be given and these citations should refer to the original publications.

It is quite natural that a book dealing with an industrial field in which

few purely scientific publications exist, should give proper credit to the industrial companies who have done the work. This is not undue advertising. However, one company in particular should not receive special mention while others, although of equal importance, are omitted.

The writer agrees with the author that a book of this type should not be nationalistic in tone and that wherever German illustrations are better than similar English, American or French they should be published together with references to scientific work published in German. Where, however, machines are manufactured as excellently or better in England or America than in Germany, they should be given preference over the German.

It is a disadvantage that a certain number of the tables of physical properties, etc., are taken from the original and not converted into a uniform standard. To speak in one instance of the tensile strength of a porcelain body in pounds per sq. in. and another time in kg. per sq. cm. does not facilitate the use of the data. The use of both systems is suggested because this form of comparison may gradually familiarise the reader with the decimal system which is to be preferred for scientific and technical work.

Where the author gives most valuable conversions (*e.g.*, on p. 117: a comparison between different sieves) very careful reading of the proof is necessary, otherwise this conversion table is quite confusing. Sieves are not classified by the number of wires per square centimetre, or by the number of wires per square inch, but according to the number of wires per *linear* centimetre or *linear* inch, or by the number of meshes per square centimetre or square inch.

There are several other printing errors such as  $Al_2O$  instead of  $Al_2O_3$  (p. 238).

These suggestions are evidence of the writer's belief that a second improved edition will be needed.

However, it is certain that the first will serve the purpose of bringing much detailed knowledge concerning porcelain and other similar insulating materials to the notice of the electrical engineer. FELIX SINGER.

### "High Frequency Transmission Lines"

By Prof. Willis Jackson. Methuen's Monographs on Physical Subjects. 148 pages. Price 6s.

The subject of the performance of transmission lines at high frequencies has acquired great importance during the last few years. This little book, which is well up to the standard of this series of monographs, treats the subject from the theoretical point of view.

Opening with a chapter on some applications of lines at H.F. the author proceeds with a discussion of the characteristic equations of lines both from the field theory and engineering point of view.

In the third chapter on propagation characteristics some useful equations are given on the effect of small variations in dimensions and eccentricity in the line constants, as well as the usual relations for minimum attenuation and maximum capacity for the transmission of power. The question of line terminations and discontinuities is covered in the next chapter which also deals with such points as the fallacy of the resistive disk termination, reflexion coefficients and the Brukman method of impedance measurement.

Chapter V deals with the properties of resonant lines, their "Q" and dynamic resistance values as well as the question of the measurement of certain characteristics of dielectrics and the measurement of impedance by means of resonant lines.

A good deal of useful information on impedance transformation by means of quarter wave transformers and stubs is provided in the last chapter. In this chapter data are given for the construction of circle diagrams which greatly reduce the labour involved in designing matching networks.

Though the reviewer had hoped to see treated the question of radiation losses in resonant lines and the use of multiple quarter wave line matching for the transmission of wide band channels, this book can be recommended as a short survey of the properties of transmission lines at high frequencies. C. L. H.

**Books reviewed on this page  
or advertised in this Journal,  
can be obtained from**

**H. K. LEWIS & Co. Ltd.**  
136 Gower Street, W.C.1

*If not in stock, they will be obtained  
from the Publishers when available*



# PAINTON VITREOUS RESISTANCES

From the time of its incorporation Painton & Company has concentrated on the manufacture and supply of electrical components of the grade required by transmission engineers in equipments designed for telephone administrations, broadcasting companies, etc. We will gladly send you particulars:

**PAINTON & CO LTD  
NORTHAMPTON**

# PULSE CIRCUITS



Whether or not this treatment is good for his pulse circuit we do not know, but we do know that for radio pulse circuits MYCALEX is just what the doctor ordered.

Power Factor (1 meg & over) .002	Tensile Strength (lbs./sq. in.) 5,800
Permittivity ... 6.7	Water Absorption NIL
Electric Strength (volts/mil.) .550	Plastic Yield ... 450°C.

Send for illustrated brochure.

**MYCALEX COMPANY LIMITED • CIRENCESTER • GLOS.**



## Improved Battery Charging CLIPS



Well made of steel, double ridged for strength. Teeth on three sides of lower jaw and special design of upper jaw ensure firm grip and good contact.

Wingard products are always equal to the job they have to do. For our own sakes—as well as yours—they bear our name, because the reputation of the maker is, in the last analysis, the best guarantee of the product.

**Wingard**  
LTD.

CHURCH ROAD · HENDON · LONDON · N.W.4

**MELTON**  
**METALLURGICAL**  
**LABORATORIES**  
LTD.

## Liquid Silver

Platinum & Gold  
Solutions

For Metallising  
Mica Ceramic  
Quartz etc.

Low Melting  
Point Solder and  
Non - Corrosive  
Liquid Flux (A.I.D. Approved)

IPSWICH ROAD (A.I.D. Approved)  
TRADING ESTATE  
SLOUGH, BUCKS. 'Phone: Slough 20992

Agents for Australia:

A. S. HARRISON & CO. PTY. LTD.  
85 CLARENCE STREET, SYDNEY

## APRIL MEETINGS

NOTE.—In general, visitors are admitted to the meetings of scientific bodies on the invitation of a member, or on application in writing to the Organising Secretary at the address given. In certain cases (marked \*) tickets may also be obtained on application to the Editorial offices of this Journal.

### Institution of Electrical Engineers

All meetings of the London Section will be held at The Institution of Electrical Engineers, Savoy Place, Victoria Embankment, London, W.C.2.

#### Radio Section

Date: April 4. Time: 5.30 p.m.

Lecture:

"Studio Technique in Television:"

By:

D. C. Birkinshaw, M.B.E., M.A.,  
and D. R. Campbell.

Date: April 17. Time: 5.30 p.m.

Discussion on:

"Design of Broadcast and Television Receivers for the Post-war Market."

Opened by:

L. H. Bedford, O.B.E., M.A.,  
B.Sc.(Eng.).

#### Informal Meeting

Date: April 23. Time: 5.30 p.m.

Discussion on:

"Electrical Aids to Public Speaking."

Opened by:

P. G. A. H. Voigt, B.Sc.(Eng.).

The Secretary:

The Institution of Electrical Engineers, Savoy Place, Victoria Embankment, London, W.C.2.

#### Cambridge Radio Group

Date: April 24. Time: 6 p.m.

Held at:

Cambridgeshire Technical School.

Lecture:

"Aircraft Wireless Aerials."

By:

F/Lt. C. B. Bovill.

Group Secretary:

D. I. Lawson, c/o Pye Ltd., Radio Works, Cambridge.

#### Institute of Physics

##### Electronics Group

Date: April 28. Time: 2.30 p.m.

Held at:

The University, Edmund Street, Birmingham.

Lecture:

"Atomic and Molecular Beams."

By:

Dr. H. Kuhn.

Group Secretary:

A. J. Maddocks, M.Sc., F.Inst.P.,  
Messrs. Standard Telephones and  
Cables, Ltd., Oakleigh Road,  
London, N.11.

### The Television Society\*

All meetings will be held at The Institution of Electrical Engineers, Savoy Place, W.C.2.

Date: April 4. Time: 5.30 p.m.

Note: This is a joint meeting with the Radio Section of the I.E.E., by kind invitation of the Committee. See previous column.

Date: April 27. Time: 6 p.m.

Lecture:

"Beam Tetrodes."

By:

S. Rodda, B.Sc.

Lecture Secretary:

G. Parr, 43 Shoe Lane, London, E.C.4.

General Secretary:

O. S. Puckle, 8 Mill Ridge, Edgware, Middlesex.

### Kingston-upon-Hull Electronic Engineering Society

Date: April 13. Time: 7.30 p.m.

Held at:

Hull Corporation Electricity Show-rooms, Ferensway, Hull.

Lecture:

"The Principles of the Thermionic Tube."

By:

H. R. Smith, A.M.I.E.E.

The Secretary:

H. W. Akester, 720 Anlaby Road, Hull.

### Bradford Electronics Society

Meetings will be held at the Technical College, Bradford.

Date: April 5. Time: 7 p.m.

Lecture:

"Electronics in Post-War Applications."

By:

R. Moxham.

Date: April 27. Time: 7 p.m.

Lecture:

"Signalling Systems."

By:

W. Saville, A.M.I.E.E.

Hon. Secretary:

G. N. Patchett, The Technical College, Bradford.

# MULLARD

*Introduce*

## THE ALL-GLASS TECHNIQUE



*A new method of construction  
which overcomes many of the  
problems of maintaining  
efficient valve operation at high  
radio frequencies*

# ABSTRACTS OF ELECTRONIC LITERATURE

## TELEVISION

### Television Broadcasting Practice in America—1927-1944

(D. G. Fink)

This paper reviews the history of television broadcasting in America from 1927 to the present, with particular emphasis on current practice. Section 1, the historical survey, traces the evolution of standards of transmission, frequency allocations, and broadcasting practice. Noteworthy programmes are recalled. Section 2, on present practice, gives a detailed account of the standards of transmission governing public broadcasting under the current regulations of the Federal Communications Commission. The stations currently operating are listed. Typical equipment used in these stations is described in four categories, studio equipment, transmitters, radiators, and mobile pick-up equipment. The design of current (*i.e.*, immediately pre-war) receiving equipment is described. The paper concludes with a digest of post-war prospects.

—*Jour. I.E.E.* (to be published).

## CIRCUITS

### Beam Blanking Circuit for Oscilloscopes

(W. Richter)

The photographing of a transient recorded on a cathode-ray oscilloscope screen is made possible by designing a circuit in which the sweep operates continually and the beam is released only for the desired exposure. In this manner the transient is divided up into a number of segments depending upon the period of the sweep. The circuit described in this article is a trigger circuit which can be tripped by an impulse transmitted through a capacitor to the proper point in the circuit. A complete beam-blanking equipment built as a separate unit for use with any oscilloscope is illustrated.

—*Electronics*, Sept., 1944, p. 128.\*

### Improved High-Frequency Compensation for Wide-Band Amplifiers

(A. E. Bereskin)

In order to obtain the best results from wide-band amplifiers of the type employed in television video amplifier and cathode-ray amplifier circuits, it is usually desirable to provide a means for producing high-frequency-response compensation.

It is the purpose of this paper to show how, by proper design and at

no additional cost, a single compensating element can be made to provide compensation equivalent to that obtainable in a circuit using two compensating elements and to discuss the characteristics of this type of compensation. The circuit under consideration will provide uniform response to a frequency approximately half an octave higher than that obtained with the single compensating element circuit extensively used at the present time.

—*Proc. I.R.E.*, Oct., 1944, p. 608.

## ELECTRO-MEDICAL

### Medical Uses of the Cyclotron

(F. G. Spear)

The Cyclotron was first designed for use in the domain of atomic physics, but it has provided medicine and biology with two new instruments for research, *viz.*, a beam of very penetrating uncharged particles or neutrons, and an array of artificially radioactive substances which can be used in two different ways. They can be administered in quantities so small that their presence can be detected only by sensitive physical apparatus, and in this high dilution no biological effects of the substance can be observed with the means at present available. The progress of the radioactive atom through the organs of plant, animal or man can, however, be followed by physical detectors, and yields information otherwise unobtainable. Illustrations of the use of these "tagged atoms" or tracers in biological and clinical research are given.

—*Jour. Sci. Inst.*, Vol. 22 (Feb., 1945), p. 21.

## INDUSTRY

### Electric Induction Heating Laboratory

The Ohio Crankshaft Co. has recently completed a new high-frequency induction experimental laboratory which is believed to be the largest of its kind, devoted solely to induction heating advancement. It is equipped with 24 test units supplied by 2,000 kW of power and having a frequency range varying from 960 to 1,000,000 cycles. The induction heating and testing equipment of this laboratory are briefly described.

—*Steel*, 4/12/44, p. 116.\*

\* Abstracts supplied by the courtesy of Metropolitan Vickers Electrical Co. Ltd., Trafford Park, Manchester

## THERMIONIC DEVICES

### Pentode Ignitrons for Electronic Power Converters

(H. C. Steiner, J. L. Zehner, H. E. Zuvers)

The introduction of multiple grids in ignitron tubes provides certain characteristics which are essential to inverter operation. It is the purpose of this paper to describe some of these characteristics and the design and construction of the pentode ignitron tube which is a high-voltage gas-filled steel tube with three grids.

—*EL. Eng.*, Oct., 1944, p. 693.\*

### Characteristics of Voltage Multiplying Rectifiers

(D. L. Waidelich and C. L. Shakelford)

A combined experimental and theoretical analysis is used to determine the manner in which the characteristics of the half-wave and full-wave voltage-doubling rectifier circuits depend upon the resistance of the diodes and upon the load resistance. The characteristic curves reproduced include those for the load voltage, ripple voltage and maximum tube currents. Since it was found that the rectifier characteristics are nearly independent of the load-resistance parameter in the usual operating range, it is possible to obtain general characteristics which hold not only for the doublers but also for multiplier rectifier circuits of higher order. Various combinations of these multiplying circuits are also discussed.

—*Proc. I.R.E.*, Vol. 32 (Aug., 1944), p. 470.

## RADIO

### Loop Antennas with Uniform Current

(D. Foster)

The properties of a circular loop carrying uniform current are calculated for loops of any size relative to the wavelength. The radiation resistance and the greatest directivity pass through a series of maxima and minima as the frequency is increased. At frequencies below that for which one wavelength is contained in the circumference, the directivity graph is nearly independent of frequency. As the frequency is increased, additional lobes appear, the principal lobe tending to point more nearly in the direction normal to the loop. The paper includes a note on other loops and a mathematical appendix dealing with certain integrals involving Bessel functions.

—*Proc. I.R.E.*, Oct., 1944, p. 603.



**Technical Reasons Why**

**★ ERSIN  
MULTICORE SOLDER**

**Is the Finest Cored Solder in the World**



**3 CORES OF FLUX**

Three Cores of Flux ensure flux continuity. No lengths without flux are wasted. Consistent high quality joints are obtained with comparatively unskilled labour. Exactly the correct proportions of solder to flux are provided. Separate fluxing operations are obviated and no extra flux is required. The three cores of flux being evenly distributed over the cross section of the solder provide thinner

solder walls than otherwise. This gives rapid melting and speeds up soldering. The flux does not tend to run out of the cores ; so there is always a supply available for the next joint. The utmost economy of solder and flux is achieved.



Ersin, contained in the three cores of Ersin Multicore Solder, is the fastest, non-corrosive flux. Possessing all the non-corrosive advantages of rosin, it enables joints to be speedily made on oxidised or "difficult" surfaces such as nickel. Ersin not only avoids oxidation during soldering but removes surface oxide already present—this is particularly advantageous in respect of materials that

have been in stock or apparatus that is being serviced. The use of Ersin Multicore, with correct soldering technique, avoids "HR" or dry joints.

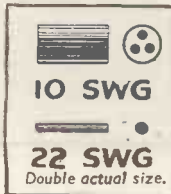

Ersin Multicore Solder is made in most gauges between 10 and 22 S.W.G. (-128—028") (3.251—7109 m/ms). For general radio and electrical production and maintenance 13 and 16 S.W.G. are in most demand.

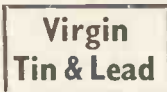

Five alloys of Ersin Multicore Solder, made from virgin metals, are available—all antimony free. Under present circumstances 45% tin and 55% lead is the most widely used alloy.

Technically, Ersin Multicore Solder is far superior to any other cored solder. A practical laboratory or production test will demonstrate this and show you that it is the most economical solder to use. The majority of British and overseas manufacturers already enjoy the advantages of Multicore. If you do not, and are engaged upon Government contracts, write for further technical information and free samples.

Single reel rate nominal 1 lb. reels.

**13 SWG - 4/10**

**16 SWG - 5/3**

Above prices subject to usual trade discount.

½ cwt.—ton lots at bulk rate. 6d. cartons for home use, available at most good radio and electrical dealers, ironmongers, etc.

**MULTICORE SOLDERS LTD.** Commonwealth House, New Oxford St., London, W.C.1 Tel. : CHAncery 5171-2



**STATIC TWO-DIMENSIONAL** visual delineation of any recurrent law.

**RELATIVE TIMING OF EVENTS** and other comparative measurements with extreme accuracy.

**PHOTOGRAPHIC RECORDING** of transient phenomena.

**SIMULTANEOUS INDICATION** of two variables on a common time axis

INDUSTRIAL INDICATING and TESTING afford increasing scope for the Cathode Ray Tube as the only device with the above inherent features, of which the last is unique in the Cossor DOUBLE BEAM Tube.

The Model 339 Cossor Oscillograph thus equipped is invaluable on all problems of research, production or operational testing, when the effect examined is applied as a voltage. When recurrent the traces are studied visually and when transient are recorded photographically, using Model 427 camera.

**A. C. COSSOR Ltd.,**

INSTRUMENT DEPT.

Cossor House, Highbury Grove, London, N.5

\*Phone: CANonbury 1234 (33 lines).

\*Grams: Amplifiers Phone London.

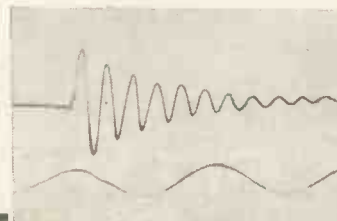

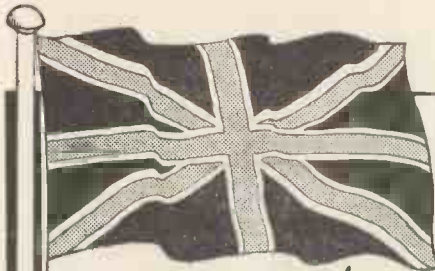

The Services rely on

**RELIANCE**

VICTORY PRIORITY.

After . . . . . The wealth of our 24 years' experience will be at YOUR service.

RELIANCE Potentiometers are well worth the waiting.

**RELIANCE**

Manufacturing Co. (Southwark) Ltd.  
Sutherland Rd., Higham Hill,  
WALTHAMSTOW - E. 17

Telephone : : Larkwood 3245

## TRANSFORMER APPLICATIONS and DESIGNS

The advance of electronic engineering has been phenomenal. With its transformer technique has grown in complexity. Specialised study is now essential if the most advantageous employment of a transformer is to be guaranteed.

The unique knowledge and experience of our Technical Department can be directed upon your problems if you so desire.

Let us help you in your development work by offering constructive criticism concerning your proposed transformer applications.

Telephone:

Abbey 2244

**PARTRIDGE**  
**TRANSFORMERS LTD**  
76-8, PETTY FRANCE, LONDON, S.W.1.

### CLASSIFIED ANNOUNCEMENTS.

The charge for miscellaneous advertisements on this page is 12 words or less 4/- and 4d. for every additional word. Box numbers count as four words, plus 1/- extra for replies. Remittance should accompany advertisement. Cheques and P.O.'s payable to Hulton Press Ltd., 43 Shoe Lane, E.C.4. Press date—15th month for following issue.

#### FOR SALE

**IN STOCK**, Rectifiers, Accumulator Chargers, Rotary Converters, P.A. Amplifiers, Mikes, Mains Transformers, Speakers of most types, Test Meters, etc., Special Transformers quoted for.—University Radio, Ltd., 22, Lisle Street, London, W.C.2. Ger. 4447.

**VALVE TESTER**. British and American, all types 50 v.G.B. Condition as new. 2 ft. square counter model. Gee, Essenden, Hatfield, Herts.

#### LOUDSPEAKERS

**LOUDSPEAKERS**—We carry on. Sinclair Speakers, 12, Pembroke Street, N.1.

**LOUDSPEAKER** repairs, British, American, any make, moderate prices.—Sinclair Speakers, 12, Pembroke Street, N.1.

#### MISCELLANEOUS

**WE WILL BUY** at your price used radios, amplifiers, converters, test meters, motors, pick-ups, speakers, etc., radio and electrical accessories. Write, phone or call, University Radio Ltd., 22, Lisle Street, London, W.C.2. Ger. 4447.

**WEBB'S** Radio Map of the World enables you to locate any station heard. Size 40" by 30" 2 colour heavy Art Paper, 4/6, post 6d. Limited supply on Linen, 10/6, post 6d.—Webb's Radio, 14, Soho Street, London, W.1 Phone: GERrard 2089.

**MORSE Practice Equipment** for Class-room or Individual Tuition. Keys, Audio Oscillators for both battery or main operation. Webb's Radio, 14, Soho Street, London, W.1 Phone: GERrard 2089.

**BERRY'S (SHORT-WAVE), LTD.**, for Quality RADIO AND ELECTRONIC EQUIPMENT. C.R. Tubes, 1½ in., 55s., 2½ in., 66s., 4½ in., £6 1s. od. Meters 0-1mA, 77s. 6d., 0-5mA, 57s. 6d., 0-10mA, 63s. Amplifiers, 5w, £16 10s. od., 15w, 25 gns., 30w, 33 gns. Variables .0005 mfd., single, 8s., dual, 14s. 11d. Ceramic S.W., .0001, 4s. 6d., .00016, 4s. 9d., .15 mmf., 3s. 6d., 25 mmf., 3s. 9d., 40 mmf., 4s. 6d., 75 mmf., midget, 6s. Reactions and Differentials, all values; Midget I.F.'s, 10s. each. Metal Cabinets with hinged lid, panel and chassis, 39s. 6d., 65s. 2 Jacks, Jack plug and 2 yd. cord, 8s. 6d. Pilot lamp indicators, all colours, 1s. 9d. P.M. Speakers, 2½ in., 27s., 3 in., 30s., 6 in., 24s. 6d., 8 in., 27s. 6d., 10 in., 42s. Fuseholders, single, 2s. 6d., twin, 3s. 6d. Glass shackle insulators, 2s. Stand offs, 6d., 8d., rod. Couplers, rigid, 6d., flexible, 1s. 3d. Switches, DP/ST, 3s. DP/DT, 3s. 6d., 10-way, 4s. 6d. Yaxley 2 bank, 6s. 9d., 3 bank, 8s. 6d., 5 bank, 10s. 6d. Ceramic Valvebases, feed throughs, formers, etc. Radio Manuals, etc. Send S.A.E. for List "E," to Berry's (Short-Wave), Ltd., 25, High Holborn, London, W.C.1. (Tel. HOLborn 6231).

**THE TECHNICA CAMERA CO.**, 21, William IV Street, W.C.2, consulting photographic engineers to H.M. Government Departments, undertake the solving of photographic engineering problems.

**RADIO-ELECTRIC PATENTS**. Well known London Radio Component manufacturers are open to consider patents or designs for post-war period. Write: Progress c/o Alfred Bates and Son, Ltd., 130, Fleet Street, London, E.C.4.

**MECHANICAL ENGINEERS** to the Electronic Industry. Precision and Optical Instruments of all types designed and constructed in collaboration with Electronic Engineers. Tecnaphot, Ltd., Mile Lane, Coventry.

#### NEW COMPONENTS

**BRAND NEW COMPONENTS** only, at list prices, for discriminating amateurs, and professional constructors. Suppliers to British and Allied Services and Government Departments.

Cathode Ray Tubes: G.E.C., 1½ in., £2 15s. od. Cossor 23D, 2½ in., £3 6s. od. Cossor 26D, 4½ in., £6 10s. od. Cossor GDT1B, gas-filled triode, 24s. 4d. High voltage rectifiers and condensers: Weston 0-1mA, £2 10s. od. rMA instrument rectifier: 12s. 6d. Single contact 12 position switch, 3s. 6d. Wire-wound Precision Resistors, plus or minus 1 per cent., 4s. 6d. each; plus or minus .05 per cent., 5s. 6d. up to 50K. Carbon pots, 4s. 6d.; with switch, 6s. 6d. Wire-wound pots, 6s. 6d. each. Crystals, 100Kc, 45s. 450/470Kc resonator crystals, single, £1 15s. od. Band-pass,

### Classified Announcements (Contd.)

£2 10s. od. (P.O. Permit). Rothermel Pick-ups, £3 13s. 6d. and £3 18s. 9d.

Wide range of British and American Valves. Vitavox, Celestion and Goodman Speakers. I.F. Transformers, Steel Cabinets and Chassis, any specification, callers only. Unlimited resources for technical information to callers. Post and packing extra on all goods. Enquiries invited. Write to Dept. "E." Business hours 9 to 5.30 every day except Thursday, 9 to 1.

**TELE-RADIO (1943), LTD.**, 177a, Edgware Road, London, W.2. (Corner of Edgware Road and Marylebone Road). Phone: Pad. 6116.

#### SITUATIONS VACANT

**RADIO**. Fully experienced Technical Salesman wanted. Amateur HAM not objected to. Permanency, full particulars, salary required, etc., to Berry's (Short-Wave), Ltd., 25, High Holborn, London, W.C.1.

**PATENT AGENT**.—Well-established firm requires a PATENT AGENT of British Nationality, preferably specialising in Electronics, as Assistant in Patent Department, permanently or for duration of war. Subjects: Control Apparatus, Electronics. Salary £700-£900 or upwards, according to qualifications and experience.

Applicants should write quoting F.3427XA to the Ministry of Labour and National Service, Appointments Dept. Central (T. and S.) Register, Room 5/17, Sardinia Street, Kingsway, London, W.C.2 for the necessary forms which should be returned completed on or before 11th April, 1945.

#### SITUATION WANTED

**ELECTRICAL ENGINEER** (30), University qualifications, 5 years' drawing office experience, seeks suitable employment. Box 720, "Electronic Engineering."

#### WANTED

**WE OFFER** cash for good modern Communication and all-wave Receivers.—A.C.S. Radio, 44, Widmore Road, Bromley.

**URGENT**—Iconoscope Television Pickup Tube, state manufacture, size, number and price. Box 719, "Electronic Engineering."

For

**RELIABILITY**

Just

**TRIX**

**SOUND**

Quality Equipment

AMPLIFIERS FROM 5 to 500 WATTS FOR PRIORITY WORK

**THE TRIx ELECTRICAL CO. LTD.**  
1-5, MAPLE PLACE, TOTTENHAM CT. RD.  
LONDON W.1.  
TELE: MUSEUM: 5817 'GRAMS & CABLES: TRIxRADIO WESDO LONDON



**P. X. FOX, LTD.,**  
**HORSFORTH, YORKSHIRE**

FOR STANDARD OR SPECIAL TYPES OF—

**TOROIDAL  
 POTENTIOMETERS**

**BRAY CERAMIC INSULATORS**  
 for L.F. and H.F. Components; also capacitor dielectrics



made by  
**GEO. BRAY & CO., LTD. LEEDS, 2**  
 Established 1863 Phone Leeds 20981



**Dainite**  
 MOULDED RUBBER PARTS  
 As soon as the war is won we hope to offer our usual "DAINITE" Service for Moulded Rubber Parts. In the meantime, enquiries for permitted essential lines will receive every attention.

THE HARBOROUGH RUBBER CO. LTD., MARKET HARBOUROUGH

**"After the War" Television**

With the coming of Peace, and backed by the Technical advances that have resulted from the war years, TELEVISION will again spring to life and offer opportunities, as never before, to the trained man.

Now is the time to prepare for this new "market." Our Home-study "Television" Course is comprehensive, up-to-date and suitable both for the amateur and experienced Radio Engineer.

We definitely guarantee  
**"SATISFACTION—OR REFUND OF FEE—"**

You are advised to send for details of this special Television Course immediately, to investigate its possibilities. Details will also gladly be sent of A.M.I.E.E. and A.M.Brit.I.R.E., Examinations and other courses in all branches of WIRELESS ENGINEERING, including particulars of our special SHORT WAVE and RADIO SERVICE COURSES which are in such demand—Free.

**BRITISH INSTITUTE OF ENGINEERING TECHNOLOGY**  
 337, Shakespeare House, 17/19, Stratford Place, London, W.1

**FLOATING ROTOR**

**DOUBLE CONTACT**

*Only in the famous*

**DAIK SWITCH**



Available in a wide range of circuit combinations for Radio, Television and other applications.

Manufactured by  
**BRITISH N.S.F. CO. LTD.**  
 KEIGHLEY, YORKSHIRE

Phone: Keighley 4221/4 Grams: Enesef, Kelghley



**A  
 TAYLOR  
 FAMILY**

- MODEL 500  
5" scale.  
Size 6½" x 5½"
- MODEL 400  
4" scale  
Size 4½" x 4½"
- \*MODEL 350  
3½" instrument type.  
Flush or Projecting.

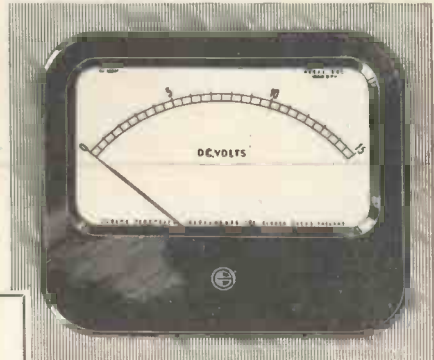

These moving coil instruments are very soundly constructed, and are accurate and dependable in use. A very large number of ranges are available in moving coil, Rectifier and Thermocouple type instruments. Model 400 and 500 instruments are also available with illuminated dials. All models are supplied in black moulded insulated cases, and Alnico magnets and stainless iron polepieces and cores are used.

We also manufacture several other sizes of moving coil instruments with scales of 2" and up

**IMMEDIATE DELIVERY.**  
 For some time past we have been carrying a small varied stock of most ranges of moving coil instruments. We are able to give immediate delivery for urgent orders.



Send your enquiries to  
**TAYLOR ELECTRICAL INSTRUMENTS, LTD**  
 419—424 Montrose Avenue, Slough, Bucks.  
 Telephones: Slough 21381, (4 lines). Grams: "Taylins, Slough."



# THE SYMBOL OF RELIABILITY

We quote (and substantiate on test) figures giving the sensitivity, selectivity and general performance of the "358X" receiver. But this is only half the story.

Service requirements dictate the highest reliability, made possible in this receiver by many years experience in the design and production of specialized radio components and apparatus.

The continuous reliability exemplified by the "358X" is the outcome of efficient, over-all design allied with extreme attention to electrical and mechanical details. Complete technical details available in 30-page Instructional Booklet on "358X" including all circuit values. Price 2/6, post free.

## EDDYSTONE '358X'



### Communication Receiver



MANUFACTURED BY

**STRATTON & CO., LTD.**

TELEPHONE: PRIORY 2231  
LONDON AGENTS:-

**WEBB'S RADIO, 14, SOHO STREET, OXFORD STREET, LONDON. W. I.**

TELEPHONE: GERRARD 2089

EDDYSTONE WORKS

**BIRMINGHAM.**

CABLES: 'STRATNOID' BIRMINGHAM.