

Electronic Engineering

INCORPORATING ELECTRONICS, TELEVISION AND SHORT WAVE WORLD

PRINCIPAL CONTENTS

Improved Colour Television System
Investigation of Ceramic Materials
Anode-Cathode Drop in A.C. Discharge Tubes
Making Up Odd Impedances
Electron Optics—Part 2

2/- JAN., 1943

TORSIONAL FLEXIBLE REMOTE CONTROL



The TREATISE:

The whole subject of Torsional Flexible Remote Control is fully detailed and combined with a mass of technical data and information, in the now well known Treatise upon Flexible Remote Control published by the Company. A copy of this standard work will be sent to all those genuinely able to make use of it. In applying, mention should be made of the name of your concern and your status.

THE S. S. WHITE COMPANY of GREAT BRITAIN LTD.

BRITANNIA WORKS • ST. PANCRAS WAY • CAMDEN TOWN • LONDON N.W. 1

Cable address: WHICODENTA, WESDO, PHONE, LONDON.

Telephone: EUSTON 4758, 4759

Going one better

IN COMMUNICATIONS



To-day, wherever Bullers Low Loss Ceramics are used, reception is clearer and better than ever before.

Years of research in Bullers Laboratories have developed these materials to such a high level of efficiency that Dielectric Loss is virtually eliminated. Bullers Ceramics are now playing a vital part in maintaining communications under all conditions.

BULLERS LIMITED

THE HALL, OATLANDS DRIVE, WEYBRIDGE, SURREY

Telephone: Walton-on-Thames 2451

Manchester Office: 196 Deansgate, Manchester

Made in Three Principal Materials:

FREQUELEX. An Insulating material of Low Dielectric Loss. For Coil Formers, Aerial Insulators, Valve Holders, etc.

PERMALEX. A High Permittivity Material. For the construction of Condensers of the smallest possible dimensions.

TEMPLEX. A material of medium permittivity. For the construction of Condensers having a constant capacity at all temperatures.

Bullers

LOW LOSS CERAMICS



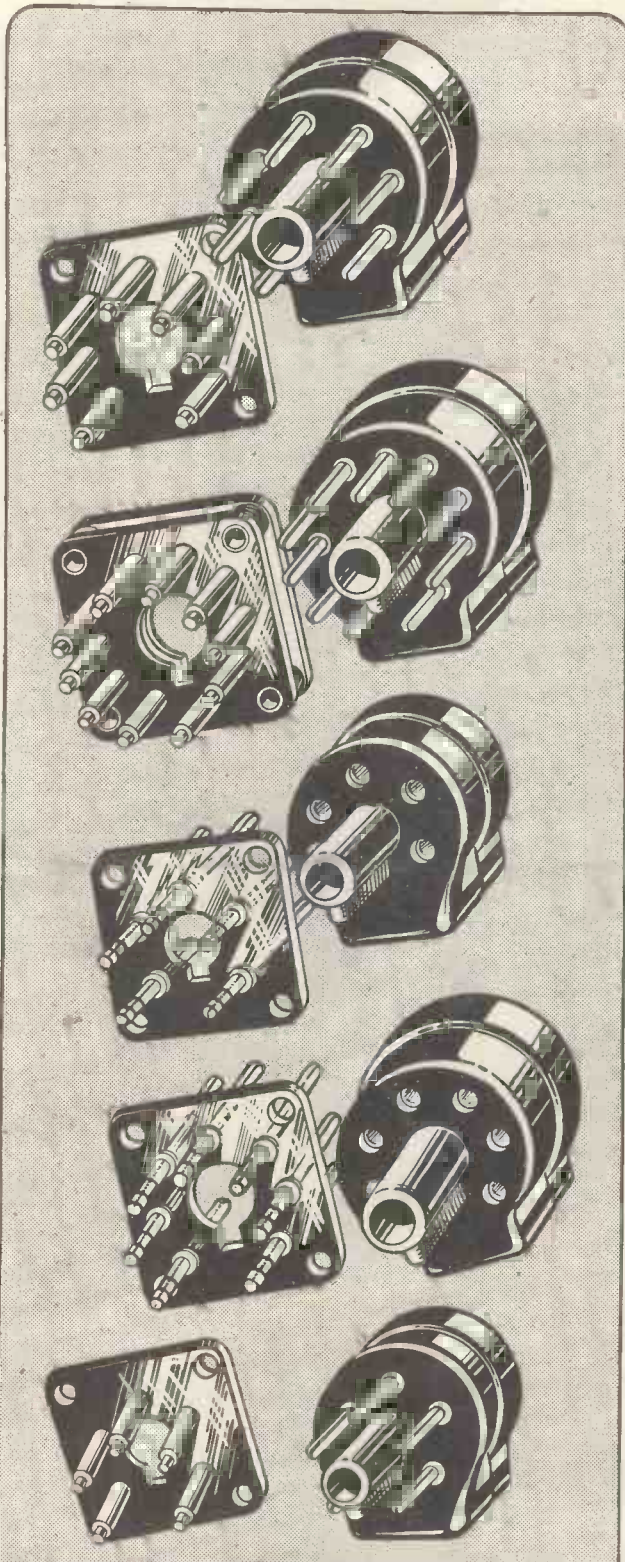

1 2 3 inches

BELLING & LEE LTD
CAMBRIDGE ARTERIAL ROAD, ENFIELD, MIDDX

G.P. 6872

**TUCKER
EYELETS**



AND TAGS

GEO. TUCKER EYELET CO. LTD.
WALSALL ROAD, BIRMINGHAM, 22
Phone: BIRchfields 5024

SHAW'S

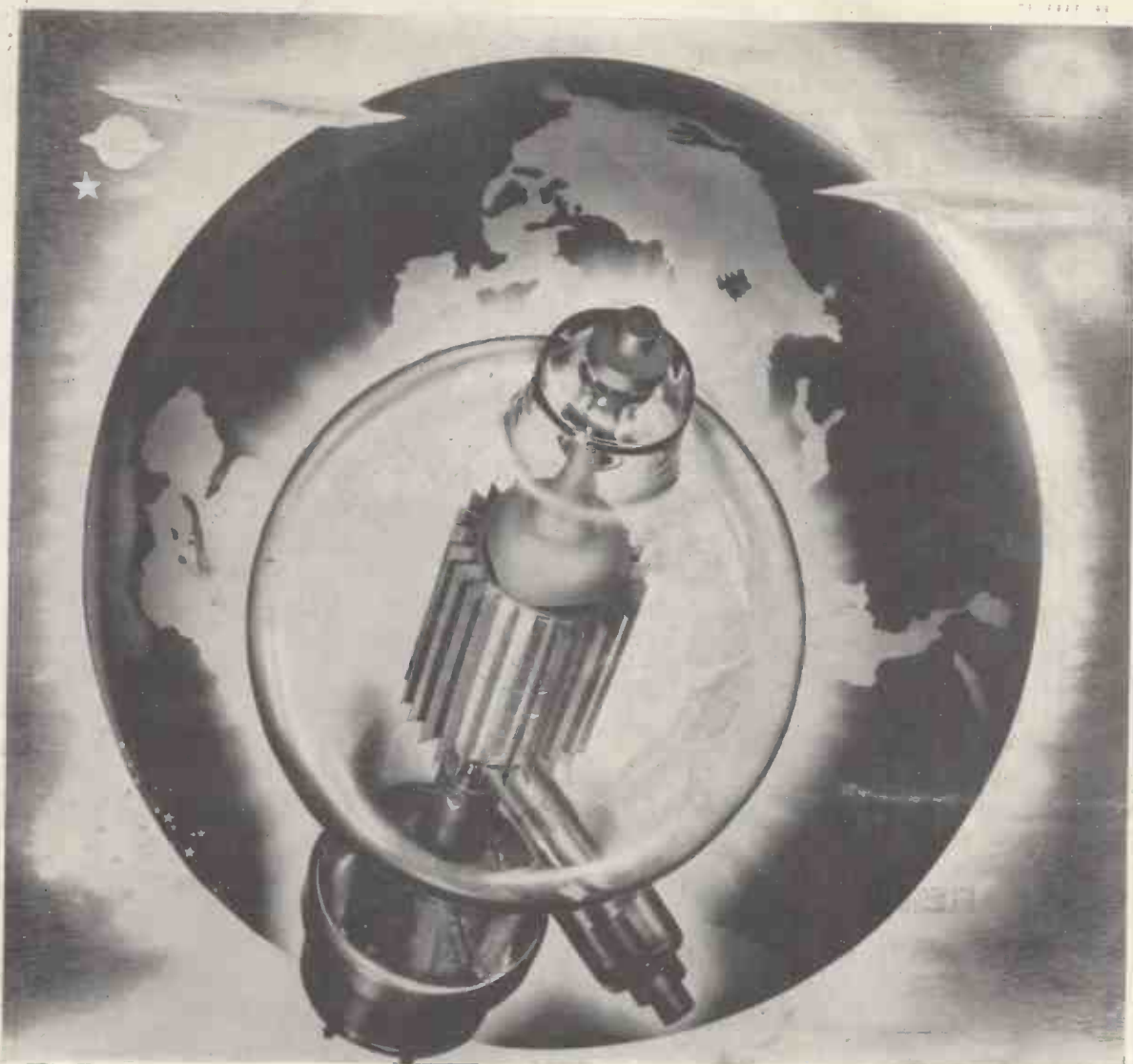

This is a "GLOBAL" war... A man-made globe — the electronic tube — is today one of the key weapons of battle. Eimac tubes have assumed a rank of "high command" in this "global" war. Again they are "first choice in the important new developments in radio"

THE JOINT ARMY-NAVY "E" awarded September 4, 1942... first award of this kind to a manufacturer of electronic tubes.



EITEL-McCULLOUGH, INC.
SAN BRUNO, CALIFORNIA

Export Agents: Frazier & Company, Ltd., 301 Clay St., San Francisco, Calif.

Eimac
VALVES

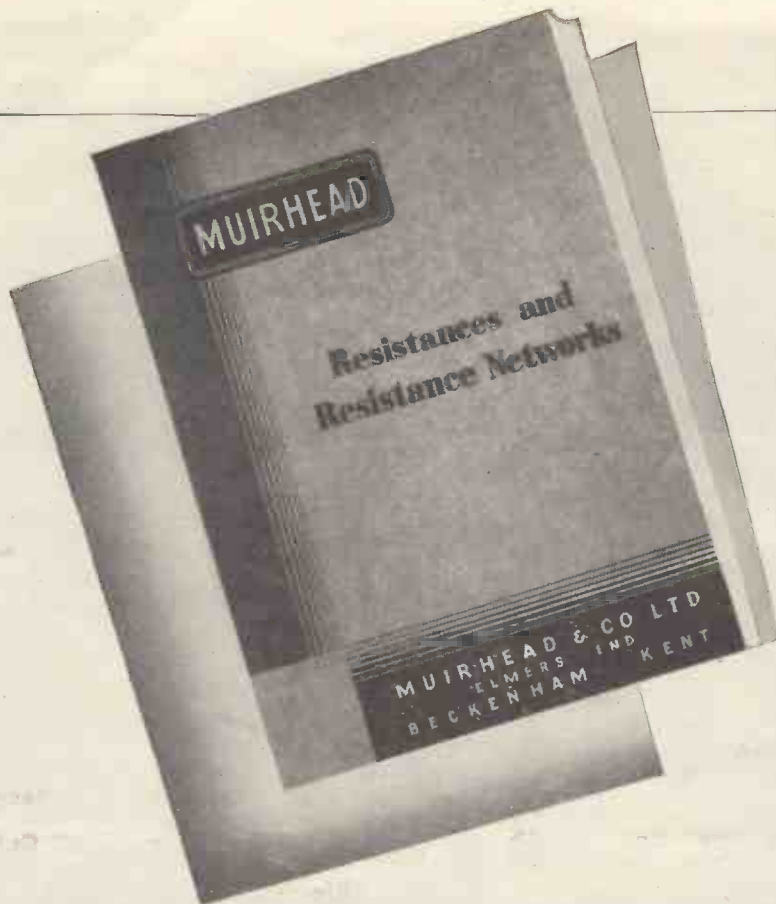

RESISTANCES AND RESISTANCE NETWORKS

PUBLICATION C-102-A

Now available to executives engaged in war industry. A 54-page catalogue containing valuable information on Resistance Boxes and Units, Slide Wires, Fixed Resistors, Fixed and Decade Attenuators, Potentiometers and Gain Controls. *Write to-day for your copy.*

MUIRHEAD

MUIRHEAD & COMPANY LTD., ELMERS END, BECKENHAM, KENT. BECKENHAM 0041-0042

FOR OVER 60 YEARS DESIGNERS AND MAKERS OF PRECISION INSTRUMENTS



SPECTRUM ANALYSIS

The exact composition of materials used in the manufacture of WESTINGHOUSE METAL RECTIFIERS is determined by spectroscopic apparatus, and spectrograms are prepared of specimens as required. The illustration shows the arc method of excitation in use.



In spite of greatly increased production we are unable to supply Westinghouse Rectifiers as freely as we would wish. We hope customers will understand and accept our assurance that the constant research now going on in our laboratories and designing department, is resulting in Rectifiers of remarkably advanced design which will be available after the war.

Westinghouse Rectifiers

WESTINGHOUSE BRAKE & SIGNAL CO., LTD.,
PEW HILL HOUSE, CHIPPENHAM, WILTS.



Transformers to
TROPICAL
specification



from 10 VA - 10kVA

Every precaution, including vacuum impregnation special materials and exceptional care in manufacture, is taken to ensure that Woden Transformers made to tropical specification will give reliable service under the most arduous conditions.

WODEN Transformer Co.
THORNLEY STREET · WOLVERHAMPTON
TEL: WOLVERHAMPTON 22829

MAKERS OF TRANSFORMERS, POWER PACKS, & SPECIAL RECEIVING & TRANSMITTING APPARATUS

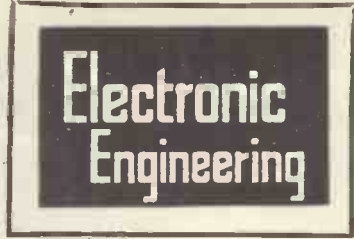

JANUARY, 1943

Volume XV.

No. 179.

CONTENTS

	PAGE
Editorial	319
Investigation of Ceramic Materials by Optical and X-Ray Analysis	320
Measurement of the Anode-Cathode Voltage Drop of an A.C. Discharge Tube	324
J. L. Baird's Improved Colour Television	327
Electron Optics—Part 2	328
The Life of Newton	332
Making-up Odd Impedances	333
Some Applications of Non-Linear Current Potential Characteristics	339
Book Reviews	342
R. F. Power Measurement	344
Miniature Electrocardiography	346
Improved C. R. Tube Circuit for Frequency Comparison	347
Planned Science (Correspondence) and December Meetings	348
Abstracts of Electronic Literature	350
Patents Record	352
Notes from the Industry... ..	354

CONDITIONS OF SALE—This periodical is sold subject to the following conditions, namely, that it shall not without the written consent of the publishers first given, be lent, re-sold, hired out or otherwise disposed of by way of Trade except at the full retail price of 2/- and that it shall not be lent, re-sold, hired out or otherwise disposed of in a mutilated condition or in any unauthorised cover by way of Trade, or affixed to or as part of any publication or advertising, literary or pictorial matter whatsoever.



PROGRESS . . .

Never content to rest upon their present best . . . striving always to find new ways to improve what is already as perfect as human minds and hands can devise . . . Thus have Mazda maintained their reputation.

MAZDA
RADIO
VALVES

THE EDISON SWAN  ELECTRIC CO. LTD
155 CHARING CROSS ROAD, LONDON, W.C.2

For full particulars write to Technical Sales Department.

Electronic Engineering

PROPRIETORS :

HULTON PRESS LTD.,

EDITOR

G. PARR.

EDITORIAL, ADVERTISING AND PUBLISHING OFFICES, 43-44, SHOE LANE, LONDON, E.C.4

Monthly (published last day of preceding month) 2/- net. Subscription Rates : Post Paid to any part of the World— 3 months, 6/6; 6 months, 13/-; 12 months, 26/-. Registered for Transmission by Canadian Magazine Post.

TELEPHONE:
CENTRAL 7400

TELEGRAMS :
HULTONPRES LUD
LONDON.

Newton



THIS month the scientific world has been celebrating the three hundredth anniversary of the birth of Sir Isaac Newton, "who excelled the human race in power of thought."

The Royal Society, the Physical Society, the Institute of Physics, and other learned societies have contributed their quota of praise to the man who founded the law of gravitation and a host of other laws and principles, including the binomial theorem and the calculus. And all these before he was twenty-five!

His "Principia," in three volumes, is, as Prof. Andrade says, "not an easy book to read." It is written in Latin. (If modern scientific papers were compelled to be written in the same language it might act as a useful deterrent and help to solve the paper shortage.) It was also made deliberately abstruse in order to avoid his being baited "by little smatterers in mathematics." It is, however, worth looking through the volumes in order to gain a true perspective of his genius and to appre-

ciate why this work has been called "pre-eminent over all the other productions of the human mind."

Of all the anecdotes about Newton, perhaps the most interesting is the one about his lightning solution of a problem which had baffled all the mathematicians of Europe for

six months. The problem was to find the shape of the curve down which a particle must slide, without friction, under the influence of gravity to pass from one point to another in the same vertical plane in the least time (the so-called *brachystochrone* curve).

Newton heard of the problem, which was put forward by Bernoulli, one day on his return from the Mint, and sat down after dinner and solved it, together with another minor problem for good measure.

Twenty years later (1716) when he was seventy-four, he repeated this feat and solved the problem of finding the orthogonal trajectories of any one-parameter family of curves after his day's work. He acknowledged that the only mathematical problem which ever gave him a headache was that on the lunar theory. As E. T. Bell says: "Newton has had no superior (and perhaps no equal) in the ability to concentrate all the forces of his intellect on a difficulty at an instant's notice."

Investigation of Ceramic Materials by Optical and X-Ray Analysis

By DR. ING. E. ROSENTHAL

Dr. Rosenthal's article on the Electrical Properties of H.F. Ceramics, published last September, aroused interest both in this country and America. His book on Ceramics is in preparation and will shortly be published by Messrs. Chapman & Hall.

IN addition to the traditional chemical, electrical and mechanical methods of testing ceramic materials, optical and X-ray analyses have been increasingly used for this purpose in recent years. The purpose of these tests is to further investigate both ceramic raw materials and the structure of ceramic fired bodies in industrial laboratories and particularly in research laboratories. With the help of the microscope, the elutriating method of investigating the fineness of the ground raw materials and the grain size of the ball clays and their sandy admixtures can be supplemented, and the nature of the crystals and of the glassy and colloidal particles can be investigated. X-ray analysis, on the other hand, provides valuable information about the crystals present in raw materials and bodies, and their crystalline structure.

Both methods are of equal importance and supplement each other. The optical method shows, first of all, whether the material consists of a mixture of crystals or colloidal or glassy substances, and secondly, the shape and size of the crystals. The X-ray method of analysis assists the optical method and makes possible the identification of the crystals which, either owing to their smallness, or their similarity to other crystals, cannot be identified by the microscope.

Since the nature of X-ray analysis is not generally known, a few remarks explaining the physical principles underlying it, will be of interest.

If a beam of light is passed through a glass plate, on the surface of which 100 or 200 fine lines per millimetre are scratched, the light beam is diffracted. As is well known, the white light of the sun is a mixture of all the colours of the spectrum and contains all the rays of various wavelengths radiated from the sun. This light, if passed through the glass plate (into which the fine lines mentioned above are scratched) will diffract rays of larger wavelengths more than those of short wavelengths, i.e., red rays are diffracted more than the violet ones. The glass plate described is called "an optical diffraction grat-

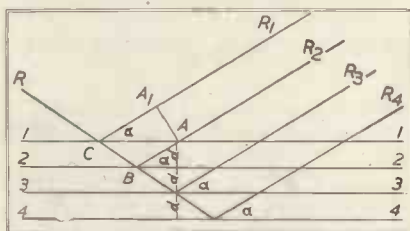

Fig. 1. Diagram illustrating diffraction of X-rays by crystals.

ing." Red rays have a wavelength of 7,600 Angstrom Units ($7,600 \times 10^{-8}$ cm.) and violet rays 3,800 Angstrom Units ($3,800 \times 10^{-8}$ cm.). The wavelengths of X-rays are 1,000 times smaller than the wavelength of light.

If X-rays are passed through the optical diffraction grating described, no diffraction occurs. The finest grating which it is possible to scratch on a glass plate consists of 1,700 lines per millimetre, but this does not diffract X-rays either. It would be necessary to prepare a glass plate having a million lines per millimetre in order to cause a diffraction effect. Such a device is, however, impossible to produce, but Nature has put at our disposal diffraction gratings of the necessary fineness. In crystals the atoms are arranged in the form of a grating. They create planes and interstices between the planes—the distance between the planes being about 8 Angstrom Units (8×10^{-8} cm.) which is comparable to the wavelengths of X-rays. Diffraction spectra are, therefore, readily obtained. Whereas in the case of an optical diffraction grating the spaces between the lines are of the same magnitude as the wavelengths of light, the spaces between the lattice planes of a crystal are of the magnitude of the wavelengths of X-rays (0.3-1.3 Angstrom Units).

In the original method of observing diffraction devised by Laue* a narrow beam of X-rays is passed through a slice of a crystal and falls on a photographic plate. The spot formed by the direct beam is surrounded by a series of diffraction spots according to the reflexion of the

incident beam by the lattice unit planes of the crystal. The distances of the diffraction spots from the centre are, therefore, dependent on the angle of the various planes and on the different wavelengths of the rays passed through the crystal slice. This dependence, and how interference effects occur when X-rays pass through the crystal are explained by Sir W. L. Bragg,† who showed that if the beam strikes the crystal planes at an angle α the difference between reflexion from different planes is $CB = 2 \sin \alpha d$, d being the distance between two planes.

If an appreciable beam is to be reflected from the successive lattice planes 1, 2, 3, 4—the waves have to be in phase, or $2d \sin \alpha = m\lambda$, λ being the wavelength. m must be an integer, otherwise the waves are not in phase and interfere with each other, extinguishing each other. If they are in phase, however, a strong beam is reflected from the crystal in the direction R, as if the rays R_1 , R_2 , R_3 , and R_4 were reflected from point C on plane 1.

In ceramics, X-ray analysis is generally used not so much to investigate a well-defined crystal, but a mixture of crystals of various forms and sizes. In such a case a mass of the crystal powder to be investigated may be pressed and shaped into the form of a cylinder and mounted on a hair in the centre of a cylindrical chamber around the inner periphery of which a photographic film is fixed. The cylindrical mass of powder provides a random arrangement of particles which give reflexion from all the crystal planes present and produce a series of lines corresponding to each reflecting lattice plane.‡

The technique of X-ray analysis is a matter of experience. The experienced investigator will have no difficulty; but the beginner has to collate his experience gradually. Fortunately, in the course of time a procedure has been built up so that it takes only a relatively short time even for a beginner to acquire the necessary experience in order to enable him to read X-ray photographs and

* Proc. Cam. Phil. Soc., Vol. 27, Proc. Royal Society, Vol. 89

‡ Debye & Scherrer, Phys. Zeit. Vol. 17, 1916.

* Bayerischen Akademie der Wissenschaften, June 1912.

to come to the correct conclusions. X-ray analysis is suitable for identifying and characterising the structure of crystals whereas amorphous or glassy particles which may exist in the same test specimen are difficult to ascertain by this method. For such cases the microscope is used, as explained later.

Crystal-containing materials are characterised by variation in crystal size, shape, orientation and extent of crystallisation, all of which have a great influence on the mechanical and dielectric properties of the materials in question. X-ray analysis gives exact information about these items. For instance, an experienced investigator has no difficulty in obtaining an accurate idea of the relative quantities in which the various crystals are present, except when the crystal content is less than 5 per cent. In this case the characteristic lines in the X-ray spectrum (called "X-ray nomogram") are too feeble.

X-ray analysis of both ceramic bodies and ceramic raw materials is relatively simple because as previously mentioned above, they are primarily of a crystalline nature. All the crystals present are easy to identify. For example, Dolomite, Calcite, Magnesite and Feldspar have very distinct nomograms.

As is well known, there are various kinds of feldspar crystals. It is rather difficult to distinguish between them by X-ray analysis since their nomograms are very similar.

X-ray analysis makes it possible to identify the modifications of silica present in such raw materials as kaolins, clays, etc., and the modifications into which they are transformed in the ceramic bodies during the firing process.

X-ray analysis is very enlightening in connexion with all those ceramic bodies which are mainly of a crystalline nature. If, however, vitrification has taken place, in which case the crystalline structure is partially dissolved, interference makes the reading of the nomogram difficult.

X-ray analysis plays an important part in the detection and identification of the crystals which are formed in low-loss ceramic materials, like clinoenstatite, rutile, magnesium-orthotitanate and cordierite bodies, and how these crystals influence the technical characteristics.

To give an example, ceramic bodies prepared mainly of talcum have been and are being used extensively and are designated "Steatites." These talcum bodies are made plastic by the addition of small amounts of plastic clay. In order to obtain a vitrified Steatite body a small amount of feld-

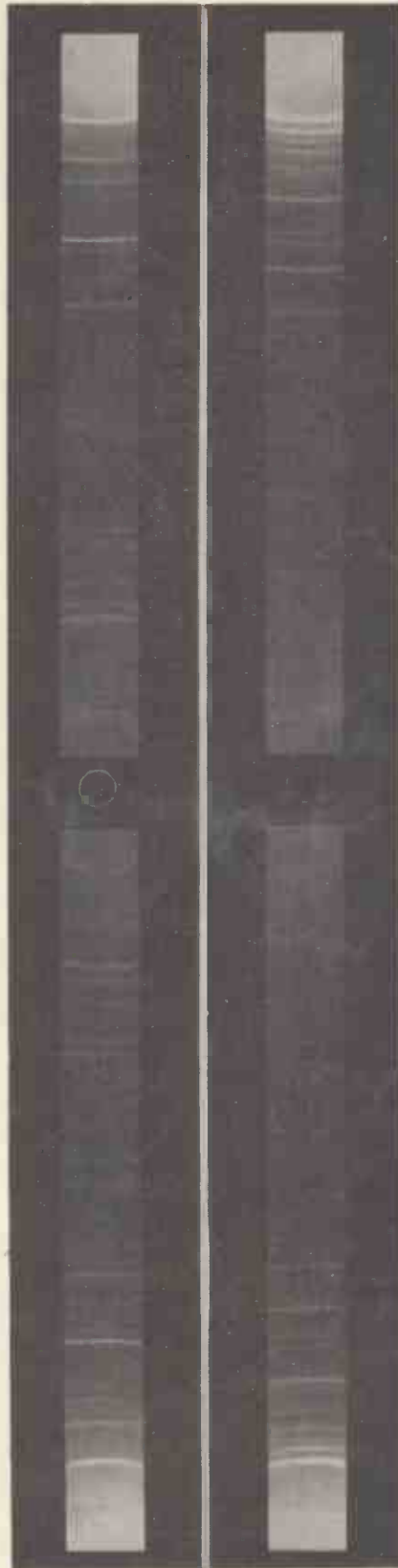

Fig. 2. X-ray diffraction patterns of Clinoenstatite body (left) and Rutile body (right).

spar is admixed. When fired at about $1,300^{\circ}\text{C.}$ - $1,400^{\circ}\text{C.}$, the mixture becomes dense. Steatite articles were found to possess very favourable dielectric properties at high frequencies (much more so than porcelain). These Steatite bodies were later on improved by replacing feldspar by other fluxes like barium oxide, calcium oxide, etc., the mechanical and dielectric characteristics being improved by these alterations. (These improved Steatite articles are known under such trade names as "Frequelex," "Frequentite," etc.). The reason for this improvement can be explained only by X-ray investigations. It has been ascertained that the nature of the fluxes (although added in very small quantities) has a considerable influence on the clinoenstatite crystals formed during the firing process.

X-ray nomograms divulged that, by the alterations mentioned above, more crystals are formed and that the crystalline structure of the whole body is much more regular. The power factor is thereby considerably decreased.

A comparison between various bodies proves clearly the accuracy of the supposition that the more homogeneous the body structure and the more regular the crystalline structure, the more favourable are the dielectric characteristics, especially the power factor. Investigations carried out on other low loss ceramic materials have led to similar conclusions. For instance, take the case of rutile bodies (which are characterised by their high dielectric constant), and the case of magnesium titanate bodies (whose dielectric constant is independent of temperature changes). X-ray analysis has proved that the smaller the amount of plastic ingredients and fluxes added to the materials forming those crystals which impart their electrical characteristics to the ceramic body, the more regular is the shape and size of the crystals formed and the more favourable the technical characteristics of the fired body.

On the other hand, in the case of vitrified porcelain bodies, X-ray analysis is less useful because of the presence in considerable quantities of glassy and amorphous states. Nevertheless, it offers the best method of identifying the various undissolved silica particles and their crystalline structure. In other words, it discloses whether these particles are quartz, cristobalite or tridymite.

Much knowledge has been gained of kaolinite crystals by X-ray analysis which otherwise could not have been obtained, the reason being that the particles of clay substance are too small for optical investigation. The smallest particles which can be in-

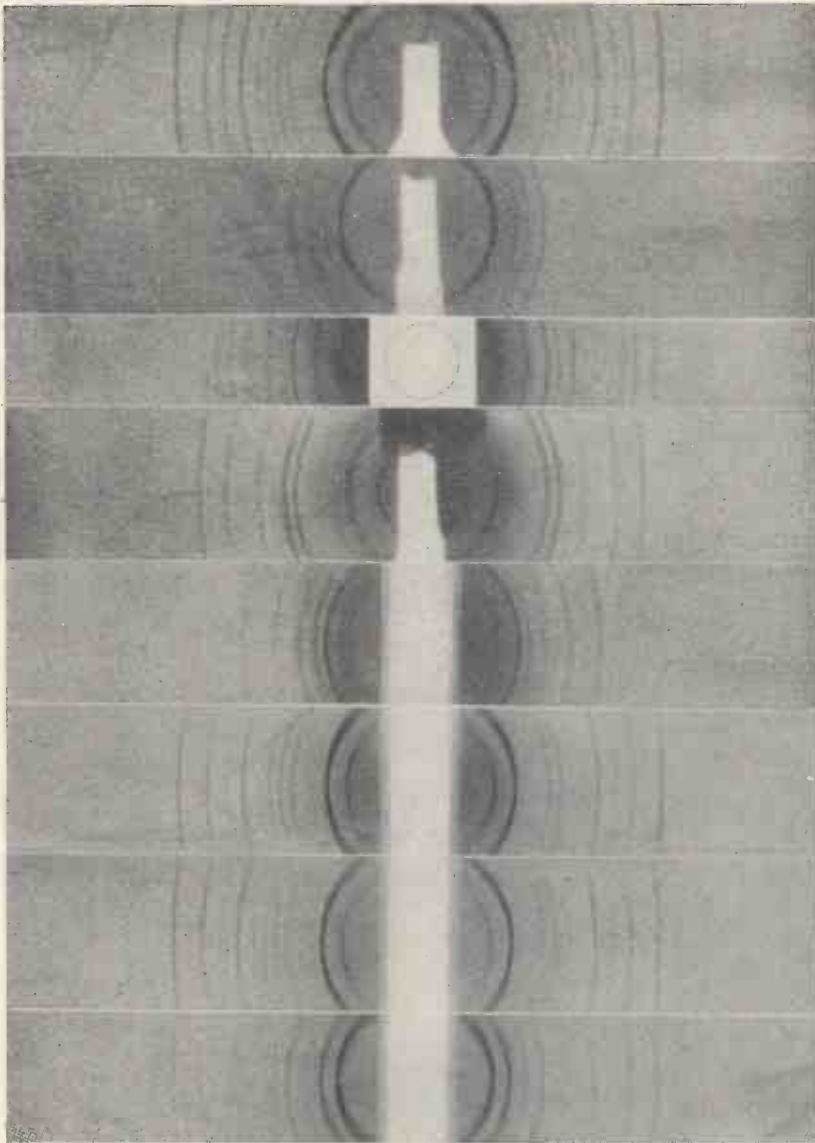

X-RAY NOMOGRAMS.

1. β -Quartz.
2. β -Cristoballite.
3. γ -Tridymite.
4. Nakrite.

5. Feldspar.
6. Sand—unfired.
7. Sand—fired at S.C. 7.
8. Sand—fired at S.C. 9-10.

(from Lehmann & Mields)

investigated with an optical microscope have a grain size of $1/1,000$ th of a mm. (1μ .)

X-ray analysis has ascertained that many of the clay substance minerals hitherto bearing different names are in fact identical and has also led to the finding of other new crystals belonging to this group.

Of special interest is the fact that it has been found that a considerable part of the clay substance particles which, for a long time had been considered amorphous, are in fact crystals of very small size. They were considered amorphous due to the fact that they have a particle size smaller

than 1μ —as small as 0.5μ and even smaller, and could not be identified as crystals by classical chemical methods. The knowledge gained by these investigations enables one to form a picture of how kaolinite or clay substance particles, in combination with water, impart the important quality of plasticity to the clay.

X-ray analysis has, moreover, made possible the gaining of valuable knowledge of the crystals forming the extremely plastic and interesting substance "bentonite." Bentonite is made up of montmorillonite and similar crystals. It is a material similar to Fullers Earth and is very im-

portant in connexion with the manufacture of certain low-loss ceramic materials. Very small quantities of it transform unplastic materials, such as rutile powder, into plastic materials. Knowledge of the structure of these crystals makes the extremely plastic qualities of bentonite easily understandable. It has been found that the crystal lattice expands if water comes in contact with the dry crystal and that it contracts again when the water evaporates, like an accordion. This quality can be termed "inner crystalline swelling" and gives very interesting information about the plastic nature of clays generally.

X-ray crystallography has only been used for ceramic research work within recent years. The microscope, however, has for a long time played an important part in this field, and has imparted valuable knowledge to ceramists with regard to the structure of ceramic materials. To digress for a moment: It is well known that with certain materials it is only necessary to examine a highly polished surface, or the fractured surface of a test specimen. In the case of fired ceramic materials microscopic examination of the surface under reflected light is, however, not very instructive.

In order to obtain a clear picture as to the structure of any fired ceramic article, a transparent thin section of the material has to be prepared. The photographs shown with this article are taken with a magnification of 75 diameters. Such magnification can cover a sufficient area and renders very small crystals clearly visible. The study of such micrographs with a magnifying glass shows smaller crystals which, with the naked eye, cannot be seen on the microphotograph.

Microphotograph 1 shows a thin section of insulator porcelain. It indicates that the material under observation is absolutely densified and free from pores. It consists of undissolved quartz particles, some being of considerable size, and of a glassy matrix in which a network of hundreds of tiny crystals is included. It may be of interest to explain how this structure came into being. It is generally known that a porcelain body consists of kaolin (china clay) ball clay, flint and feldspar. During the firing of a porcelain insulator in the kiln (in which the temperature is gradually raised to about $1,300^\circ \text{C}$.), the feldspar melts and the kaolin and ball clay ($\text{Al}_2\text{O}_3 \cdot 2\text{SiO}_2 \cdot 2\text{H}_2\text{O}$), dissociate into mullite ($3\text{Al}_2\text{O}_3 \cdot 2\text{SiO}_2$) and Silica (SiO_2). The molten feldspar dissolves part of the quartz particles and the silica which is set free by the

Microsections of Ceramic Bodies

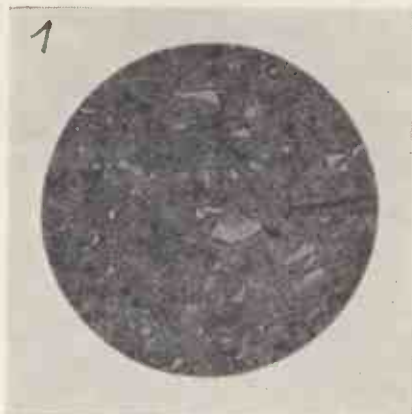

1. Section of insulator porcelain showing quartz particles.

2. Section through insulator at junction of glaze coating.

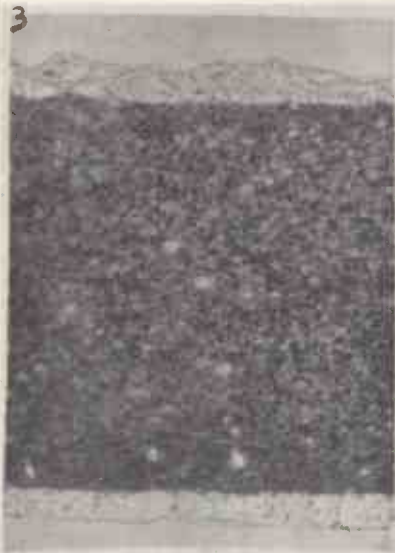
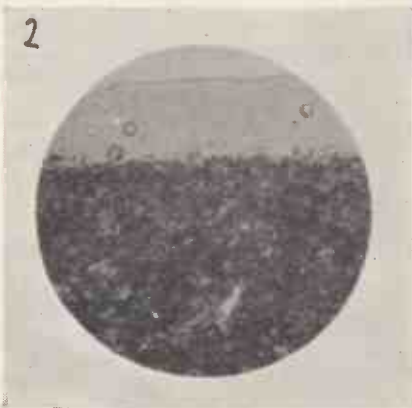

3. Section of porcelain crucible showing smaller quartz particle size.

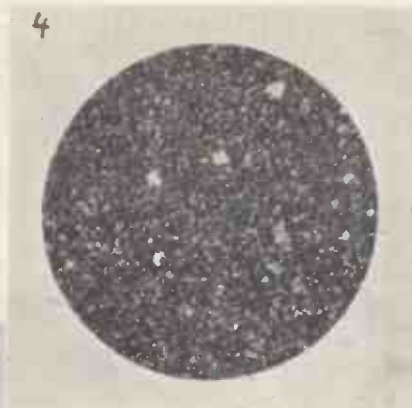

4. Fired rutile body showing crystalline formation.

5. Section of steatite with clinoenstatite crystals.

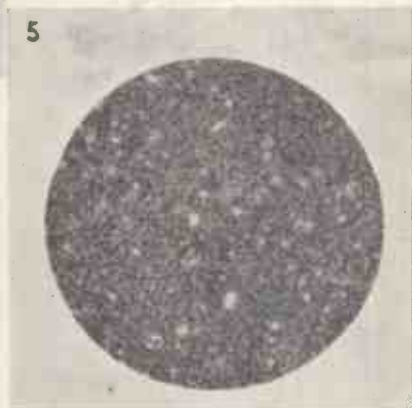

dissociation of the clay substance forms a glassy matrix. The network of tiny crystals shown consists of mullite crystals.

As mentioned, it can be clearly observed from the microphotograph that relatively large grains of quartz are left undissolved at the temperature used. These have a favourable influence on the mechanical properties of insulator porcelain.

Insulators are generally covered by a glaze. Microphotograph 2 shows the junction of the glaze with the porcelain body. It can be seen that parts of the surface of the porcelain body have been dissolved by the glaze and have fused with its glassy matrix. An intermediate layer has thus been

formed between porcelain and glaze consisting of a mixture of glaze and the glass matrix of the body and some partially dissolved mullite crystals and quartz particles.

Microphotograph 3 shows the magnification of a thin section of a porcelain crucible used in chemical laboratories. It is very similar to the section of the insulator porcelain (shown in microphotograph 1) except that the undissolved quartz particles are much smaller. This is the result of special treatment, which has been applied to the body in order to increase the resistance of the porcelain to sudden temperature changes.

Microphotograph 4 shows a transparent thin section of a fired rutile body taken with a magnification of 75 diameters. It shows that the material consists almost exclusively of tiny, regular crystals. A few larger crystals are included. These were formed by the material admixed with the purpose of making the rutile body plastic.

Microphotograph 5 shows a thin section of an improved steatite

article. It can be seen that it is formed almost exclusively of a mass of very fine crystals. X-ray analysis, as mentioned above, has identified these as clinoenstatite crystals. The microphotographs 4 and 5 show ceramic materials possessing a very homogeneous crystalline structure resulting in very favourable dielectric properties.

The photographs reproduced on this page have been prepared by the Lomax Palæo-Botanical Laboratories, Bolton, and the X-ray nomograms of the rutile body and the steatite body have been prepared by Dr. E. Schäfer in the Cavendish Laboratories, Cambridge.

Measurement of the Anode-Cathode Voltage Drop of an A.C. Discharge Tube

By R. H. BAULK, M.Sc., Grad.I.E.E.

This article describes a method of measuring the voltage between the anode and cathode of an alternating current discharge tube, during the interval when current is flowing i.e. the arc drop of the tube, if the type of discharge is an arc.

A KNOWLEDGE of the value of the anode-cathode voltage gives an indication of the length of further satisfactory service that can be expected from certain discharge tubes, e.g., phanotrons, etc. The drop rises towards the end of the life of the tube. With regard to rectifier installations of the heavy power type, the efficiency of the rectifier plant depends more on the value of this potential drop than on any other single cause, in fact the loss in the arcs very often exceeds the sum total of all the other losses, with the exception perhaps of high voltage rectifiers.

In most discharge tubes including lamps, thyratrons, kenotrons, radio valves, and arc rectifiers as used in heavy engineering, the voltage waveform taken across the tube appears curves shown diagrammatically in Fig. 1.

Curve (a) shows the voltage waveform between the electrodes of an a.c. discharge lamp, in which the electrodes operate alternately as anode and cathode. The drop is therefore the height of the horizontal part of the curve above or below the zero line.

Curve (b) is a sketch of the waveform of the anode-cathode voltage of a single phase uncontrolled rectifier and certain types of lamps. For the three phase rectifier the negative part of this curve is modified and becomes identical to the negative portion of curve (c), but the negative parts of the curves are of no importance with regard to the voltage drop. In this case the drop is the height of the horizontal part of the curve above the zero line as before.

Curve (c) is a typical curve for a grid controlled discharge tube, and the curve shown is that of a three phase rectifier bulb. The shape of the positive part of this curve is unaffected by the number of phases except that the duration is decreased as the number of phases is increased. The duration and maximum value of the "Forward Peak" voltage depends on the instant of release of the discharge by the grid.

It should be noted that with poly-phase rectifiers and with full wave single phase rectifiers the peak value of the negative part of the curve is equal to the sum of the peak value of

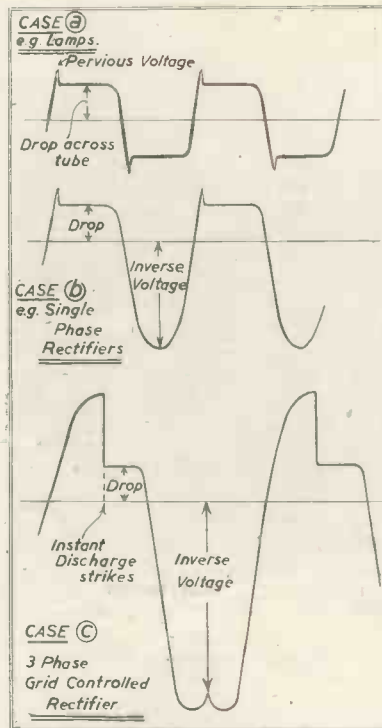

Fig. 1. Typical discharge tube waveforms.

the phase to neutral voltage of the transformer and the d.c. output voltage, i.e., nearly twice the d.c. voltage. The importance of realising this fact will be evident later in this article.

If an ordinary voltmeter were placed across the electrodes, it would give the r.m.s. (or average) voltage of the whole cycle, i.e., including the inverse voltage. Should however the voltmeter be disconnected or short-circuited during the inverse part of the cycle (by means of a valve connected so that the voltmeter is unaffected by the reverse voltage, the current being limited by a resistance in series with the voltmeter) then it would read the r.m.s. (or average) voltage of the positive part of the cycle taken over the whole period. It will be realised however that neither of the above methods measure the voltage we require. The voltage that it is desired to measure is that between the anode and cathode during the firing period, and it is the average value

taken over the firing period only that is required.

Methods of Measuring the Drop¹

Known methods of measuring the drop fall into three distinct classes, those using direct current, those in which the drop is determined from the power loss in the discharge, and those using a Peak Voltmeter.

In the method using direct current, it is usual to supply one anode with d.c. and the rest with a.c. This appears to be quite a simple method, but it should be remembered that the conditions are not the same as would be obtained in practice because the discharge is not dynamic, and the losses due to restriking the discharge do not occur, also the heating conditions are different, since in the discharge path the full anode current is flowing for the whole cycle, whereas in actual practice it would only flow intermittently. This increase in temperature in the path under test, causes a very considerable increase in the measured drop.

The following two methods are representative of the Power Loss class:

(a) In the first of the two methods the tube is cooled by water and the heat dissipated by the bulb to the water is the loss in the arc or arcs as the case may be. This loss can be converted into electrical units, and thence the arc drop can be deduced by dividing this by the output current. The objection to this method is that unless the bulb is water cooled under operating conditions, the temperature conditions are very greatly altered, also it assumes that the drop in each discharge path (if there is more than one) is the same.

(b) The second power loss method overcomes these objections by measuring the loss in one path by means of a wattmeter. However, this method has rather a limited application since firstly it can only be used for low currents because wattmeters for very heavy currents are not easily made and secondly it gives a very small wattmeter deflection, as the voltage coil has in most cases to withstand a low voltage in one direction (when the current is flowing) and a high voltage in the reverse direction. It has been suggested that the wattmeter

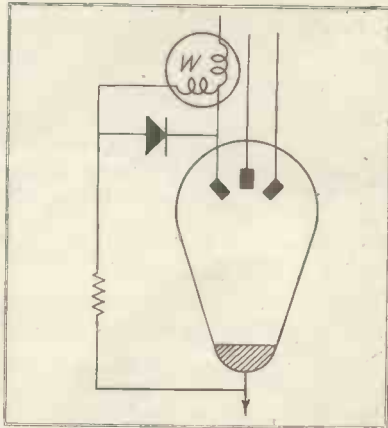

Fig. 2. (left) Arrangement of wattmeter to measure power loss.

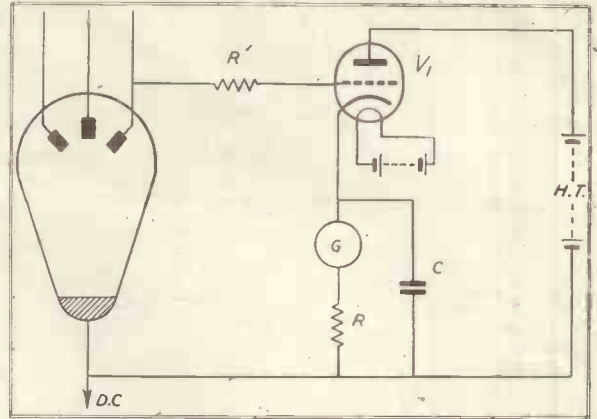

Fig. 3. (right) Measurement of voltage drop by peak voltmeter.

pressure coil could be short-circuited during the period of inverse voltage, but this would necessitate using a series resistance in the pressure coil as shown in Fig. 2 to limit the reverse current. This would counteract the advantage gained by having a low voltage pressure coil.

The method of measuring the drop directly from an oscillograph record can be included in the third category. If this method is to prove at all reliable, a cathode-ray oscillograph must be used, as an electromagnetic instrument takes quite an appreciable current, and the vibrator (which consists of a single loop of phosphor-bronze wire carrying a small mirror, suspended between the poles of a powerful magnet, the whole being immersed in oil for damping purposes), has a considerable inertia effect. The latter type of oscillograph can only have low voltages applied to it, and must therefore have a resistance connected in series with it and be short-circuited during the inverse voltage period. This resistance would cause quite a considerable voltage drop, thus making the method most inaccurate. With regard to the cathode-ray oscillograph, this does not take any appreciable current, but the image obtained is comparatively small, and the screen is curved, thus rendering accurate measurements difficult. This can, of course, be overcome by the use of an oscillograph with a large screen, but such instruments are very expensive.

Peak Voltmeter Method²

The above methods can be used on all three types of discharge tubes, and have one point which is essential to any method, that is, *they only read when the current is flowing, i.e., they ignore the negative part of the cycle, and the forward peak voltage of case (c).* It will be noticed that in all three cases the voltage is constant during the period of current flow. This suggests that it is possible to

measure the drop using a voltmeter which registers the maximum voltage occurring during a cycle, commonly known as a Peak Voltmeter. This type of voltmeter can be employed provided the necessary auxiliary equipment is added to prevent the inverse voltage, and in case (c) the forward peak voltage as well, from affecting the instrument reading. This can be done by short-circuiting (by means of a valve) the voltmeter at all times except during the period of current flow.

Taking the simplest case first, a voltmeter suitable for measuring the drop in cases (a) and (b) will be described, this description will be followed by an "adaptation" to make it suitable for all three cases.

The circuit diagram for such a Peak Voltmeter is shown in Fig. 3. This particular voltmeter requires no auxiliary circuit for cases (a) and (b) since it is only affected by the voltage in one direction. The valve V_1 is a high vacuum triode, thus the voltage applied to the grid permits and controls the current flowing in the H.T. circuit, in such a manner that the condenser C is charged up to a value which bears an approximately linear relationship to the positive peak of the applied voltage. This automatically increases the amplifier bias which prevents the grid drawing current. The galvanometer circuit connected across the condenser is used to measure the condenser voltage, hence the galvanometer deflection is proportional to the applied voltage. As the instrument takes no appreciable current the value of R' is quite arbitrary. Although the negative voltage has no effect on the reading it must be taken into account when selecting a suitable valve. The valve must be capable of withstanding the full negative voltage between cathode and grid. Valves are manufactured which will withstand 1,200 volts cathode to grid, e.g., G.E.C. valve A577, therefore no serious limitations are placed on this method.

If, however, a valve capable of withstanding the high negative voltage is not available, it is possible to modify this circuit by using a diode to short-circuit the voltmeter (R' being used to limit the inverse current) during the negative part of the cycle. In this case the value of R' should be made as low as possible.

It has been mentioned briefly before, that in order to make the Peak Voltmeter read the arc drop, it must be ensured that the voltmeter itself is protected from all voltages higher than the arc drop. This difficulty only arises in case (c) and to do this it is essential to short-circuit the voltmeter during the period of the forward voltage peak, i.e., until the discharge strikes. This condition can be satisfied by short-circuiting the Peak Voltmeter in the forward direction except when current is flowing from the anode under test. This can be done by a second valve V_2 , Fig. 4, which is blocked by a negative voltage only when current is flowing in the anode under test. This makes it necessary, by some means or other, to produce a voltage wave in phase with the anode current which can be applied to the grid of this valve in order to block it. Such a voltage wave should be preferably rectangular in shape, so as to apply the voltage drop to the Peak Voltmeter for as long a time as possible. A method of doing this is shown in Fig. 4, but it should be stressed that this method is only suitable where the rate of rise and fall of anode current is very high.

The circuit diagram is shown in Fig. 4. The original Peak Voltmeter is used with the addition of V_2 , a thyratron, V_2 a tetrode, two potentiometer rheostats P_1 and P_2 and a current transformer. The function of V_2 is to short-circuit the Peak Voltmeter in the forward direction, when no voltage is applied to its grid. A screen grid valve is used because of the low anode-cathode voltage applied to it. It is advisable to choose this valve so

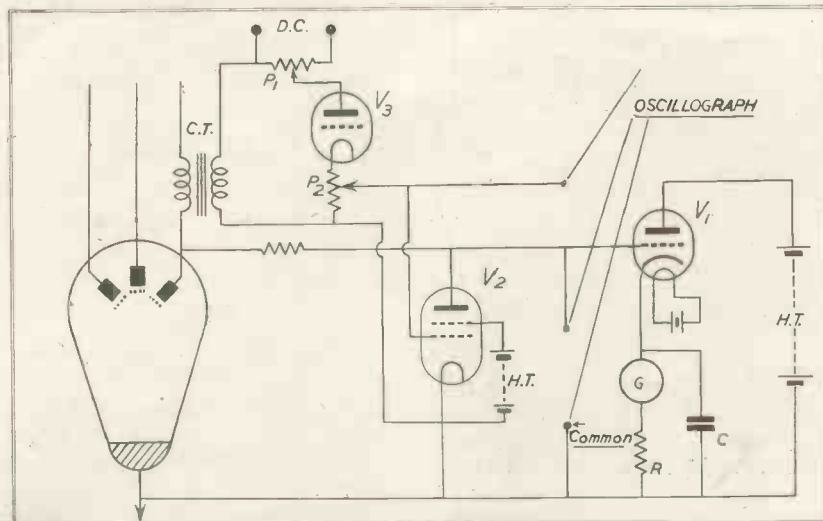

Fig. 4. Circuit using peak voltmeter with short circuiting arrangement.

that it has a high impedance when blocked by its grid.

The rectangular shaped wave for blocking V_2 during the firing period is produced by the section of the circuit containing the current transformer, the primary of which is connected in the anode lead of the rectifier and the secondary in series with a source of variable d.c. potential, a thyatron, and a potentiometer rheostat P_2 .

The voltage induced on the secondary side of the current transformer consists of a positive peak at the instant of ignition and a negative peak at the moment of extinction. The positive peak is used to ignite the thyatron and the variable d.c. voltage is adjusted so that it maintains the current flowing until the negative peak extinguishes the thyatron. This produces the required rectangular form of potential across the resistance P_1 . It is important to ensure that the thyatron does not re-ignite after the negative peak has extinguished it, until the positive peak recurs. This can be seen by connecting the oscilloscope across P_1 . The value of this rectangular wave can be varied by means of P_2 and in order to ensure that sufficient voltage is being applied to the pentode to block it the oscilloscope is arranged so that it can also be connected across the Peak Voltmeter part of the circuit.

Comments

It will be seen that the original Peak Voltmeter can be used on any type of discharge without modification provided that the voltage drop waveforms are similar to the positive parts of cases (a) or (b). However, the method described for adapting this voltmeter for use on grid controlled bulbs can only be used on discharge

devices in which the anode current rises and falls rapidly. This is because the method of producing the rectangular waveform depends on the fact that the rapid rise and fall induces a positive and negative voltage peak in the secondary. In the case of single phase rectifiers and many lamps, the anode current consists of the positive half of a sine wave. No doubt the ingenious electronic engineer will be quite capable of

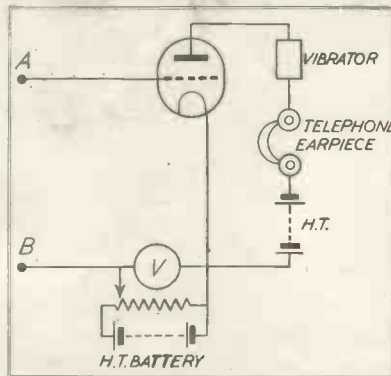

Fig. 5. Measuring previous voltage peak.

modifying the circuit described so as to produce the required rectangular wave by other means.

In practice it is often desirable to measure the value of the initial "Previous Voltage Peak," since this affects the paralleling of rectifiers very considerably. The circuit shown in Fig. 5 is suggested as being suitable for measuring this voltage.³ Very briefly the method of using the circuit is that with the terminals A and B connected together; the d.c. voltage "V" is adjusted until the current in the H.T. circuit is zero. The terminals A and B are then connected to the electrodes and "V" is re-adjusted. The differ-

ence between the two readings gives the Previous-Voltage. The method of detecting the current in the H.T. circuit is capable of responding to as low as 10^{-8} amps. It is suggested that a very simple vibrator can be made by scraping one lead up and down a file, the other being in electrical contact with the file. This circuit has been used in similar cases with success by "old timers" of the profession.

BIBLIOGRAPHY

- Marti & Winograd. "Mercury Arc Power Rectifiers." McGraw Hill Book Co. 1930 (Book).
F. C. Orchard. "Mercury Arc Rectifier Practice." Chapman & Hall (Book).
Prince & Vogdes. "Mercury Arc Rectifiers and Circuits." McGraw Hill Book Co. 1927 (Book).
- Hull & Brown. "Mercury Arc Rectifier Research." *Trans. Am. I.E.E.* 1931. 50. 744.
H. W. Lord & O. W. Livingstone. "End of Life Meter." *Electronics*, September, 1936.
- R. Rompe & H. Schmelleneier. *Zeitschrift für Technische Physik. Bd. 15* (1934), p. 265.

Electrical Properties of Polystyrene

WE have recently investigated the direct current conductivity of polystyrene with a view to its use in instruments for radiological work. A cylindrical condenser was used for this purpose, with a closely fitting cap to exclude air ionized by cosmic rays, and the charge was observed by an electrometer after standing for a period of the order of 1-2 weeks. Great care was taken to keep the surface of the insulator clean and dry.

The result found for an average sample of polystyrene was a specific resistance of 3×10^{20} . Surface leakage could not be eliminated completely, and this figure is, therefore, a lower limit. It is, however, some 1,000-10,000 times the values that have been published from time to time, and greatly in excess of the value for ordinary insulators, such as glass, ebonite, etc.

When X-rays are passed through the substance its resistance falls; the amount of fall depends on the intensity and the duration of the radiation, but may be by a factor of 10^8 or more. Moreover, it has been found that the conductivity so induced lingers for a very considerable time after the X-rays have been cut off. At the end of 80 hours the material is still far from back to its original state.

F. T. FARMER.

—*Nature*, Vol. 150. No. 3,809
October 31, 1942, page 521.



Photograph of experimental apparatus for showing coloured pictures with two-colour filter disks

In all the experimental colour television systems to date, the projection of successive colour frames has been accomplished by the method (first shown by Mr. Baird) of rotating disks carrying colour filters which are interposed between the reproduced picture and the observer.

Systems have been developed by J. L. Baird and The Columbia Broadcasting Co. (Dr. Goldmark), and while very successful results have been obtained, the presence of the rotating filter disk has been a disadvantage in comparison with the cathode-ray tube method of projection, using no moving parts.

The disadvantage of the filter disk has now been eliminated in the latest colour television system demonstrated to us by J. L. Baird just before Christmas, photographs of which are shown.

The apparatus uses the principle of superimposing coloured images corresponding to the primary colours. These images are produced and combined on the receiving screen by the following device.

Three images corresponding to the three primary colours, blue, red and green (or blue-green and orange-red where a two filter process is employed) are reproduced one above the other in sequence on the fluorescent screen of the cathode-ray tube at the receiver. Lenses with their optical centres on perpendiculars through the centres of each of the three images and at a distance from the images equal to the focal length of the lenses project parallel beams on to a large lens separated from the receiving screen by a distance equal to its



Close-up of lens mounting showing filter disks in front of each lens.

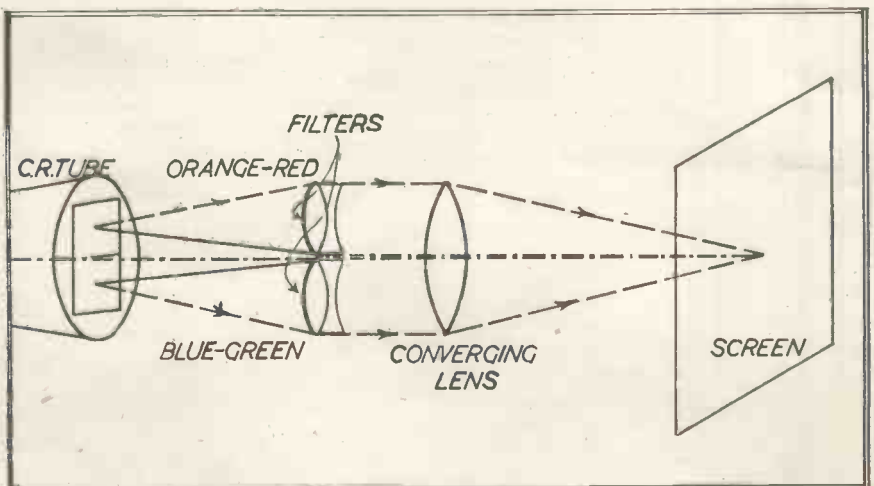

Diagrammatic layout of apparatus for reproducing colour pictures with two-colour filters.

J. L. Baird's Improved Colour Television

focal length. The pictures are thus caused to overlap on the screen. The arrangement as shown in the diagram applies to a two filter process.

The apparatus demonstrated was a receiver adapted to receive a 600 line two filter transmission (blue-green and orange-red). The two images corresponding to the blue-green and orange-red components appear in sequence on the flat face of a 7 in. projection type cathode-ray tube operating at 26,000 volts. In the lens system, which is shown in the photograph, single lenses have been employed (owing to the difficulty of obtaining special lenses) at present which entails a certain loss of optical efficiency. The actual aperture has nevertheless the fairly large value of approximately 3.5. The size of picture shown is 6 in. x 5 in. Proper registering of the two pictures presented several initial difficulties, great accuracy being necessary. These difficulties have been overcome and a very accurate registration is obtainable. The device is of course equally applicable to the transmitter.

Electron Optics—Part II

A lecture delivered before the Electronics Group on October 31, 1942 — continued from p. 295, December issue.

By D. GABOR, Dr. Ing.*

THE IDEAL ELECTRON LENS.

Years ago, when I was still active in electron optics, I often thought that it might be a useful approach to some of its problems, if we knew particular cases in which aberration free, completely stigmatic imaging can be achieved. Such rigorous solutions play a certain part in the design of optical instruments.

A well-known example is the rigorous imaging of two spheres with radii nR and R/n by a spherical lens with radius R . This is utilised in certain microscopic objectives. I knew, of course, that such a lens could not be realised with ordinary means, but I thought also that once the ideal were clearly before our eyes, ways and means might be found to realise it. I tried to approach the problem with trajectory methods, but even to formulate it was almost impossible. But now, when I was preparing this lecture and tried to translate its problems into Hamiltonian language, the solution came to me almost without an effort. Though the result may not be of any practical importance, the method by which I arrived at the ideal lens may be of interest to workers in the field.

Let us start by a somewhat new illustration of the action of electron lenses, using this time not the Hamiltonian Analogy, but Hamilton's Principle. (Fig. 10). Let us remember that every electron trajectory will satisfy a condition

$$\int n \cdot ds = \text{minimum}$$

We can illustrate this as follows:— Let us map the meridian plane of the electron lens on a surface in such a way that to every point of the meridian plane there is a corresponding point on the surface, and to every line element ds in the plane there is a corresponding line element dS , of such a length that

$$n \cdot ds = dS$$

In this case Hamilton's principle becomes

$$\int dS = \text{minimum},$$

i.e., the representation of a trajectory becomes a shortest, "geodesic" line on the surface.† We have only to pull a string taut over it to obtain a trajectory. We will call such a surface a "geodesic" surface of the lens.

* B.T.H. Research Laboratory.

† This method is closely related to the ideas introduced into dynamics by Heinrich Hertz. Cf. E. Schrödinger, Ann. d. Phys, 4, 79, 489, 1926.

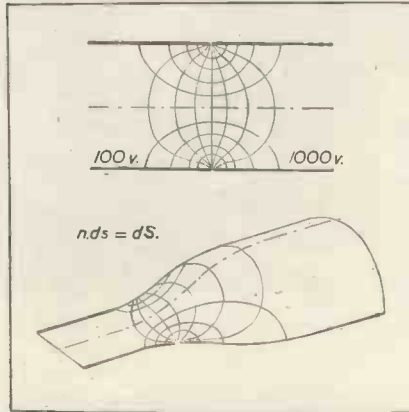

Fig. 10. Section of an electrostatic lens and approximate shape of its "geodesic surface," on which the distance between two points is proportional to the action, and the trajectories as they are curves of least action are represented by geodesics.

In the following we will consider only an electrostatic field, so that n is isotropic, independent of the direction. We have seen, however, that in the rotating meridian plane n is isotropic also in a magnetic field, the results are therefore to a certain extent valid also in the general case. This means that the "geodesic surface" must allow isomorphic (conformal) mapping of the meridian plane on it, so that angles are preserved, i.e., the shape of infinitesimal figures is not distorted, and the linear magnification is n or \sqrt{V} . Fig. 10 is an approximate illustration of an example.

This method leads us straight to the ideal lens. What would be the geodesic surface of an ideal lens? The answer is obvious, it would be a sphere. (Fig. 11). On a sphere the geodesic lines are great circles, and all the great circles passing through a point will intersect again in the antipole to the point considered.

We can construct the lens corresponding to a sphere as a geodesic surface by any of the isomorphic methods used in cartography. Of these we choose the stereographic projection for its symmetry. The stereographic mapping is explained in Fig. 11. It consists in placing the sphere on a plane and projecting by straight lines, from its apex A . It is obvious that we obtain a central symmetrical distribution of n and if we rotate it, we obtain a spherically symmetrical distribution, i.e., the linear magnification in the

stereographic projection is

$$1 + r^2/(2R)^2$$

where r is the distance of the point P' from the centre and R the radius of the sphere. Writing r_0 instead of $2R$, we obtain therefore a distribution of the refractive index

$$n = \frac{n_0}{1 + r^2/r_0^2}$$

where n_0 is the refractive index at the centre. The ideal lens* is therefore a sort of nebula, with a density gradually diminishing from the centre, as shown in Fig. 12. The corresponding electrostatic potential V is proportional to the square of n .

Fig. 12 shows also the rather interesting family of trajectories which can be produced by this lens. As the geodesic lines on the sphere are circles, and the trajectories are their stereographic projections, these will be all ellipses. The figure shows a group of trajectories passing through two points A and A' on the circle with radius r_0 . This circle will be imaged in itself. A point P inside this circle will be imaged in a point P' , their

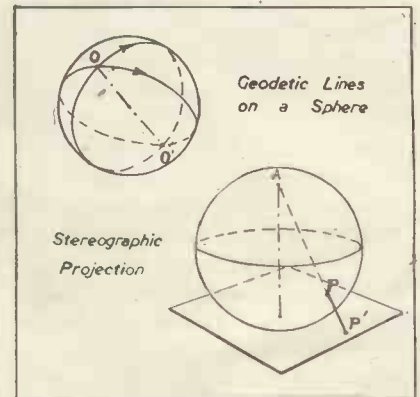

Fig. 11. Derivation of the ideal lens. On a sphere all geodesics are great circles, and all great circles passing through a point O intersect again in its antipole O' . The sphere can be mapped conformally, i.e. without distortion of infinitesimal figures, on a plane by stereographic projection.

distances from the centre r and r' being connected by the relation

$$r \cdot r' = r_0^2$$

Conjugate image points are therefore obtained by inversion with respect to the circle r_0 . The imaging is per-

* I have stated here without proof that there is only one ideal lens. In fact, the lens obtained could be transformed into another ideal lens by a further isomorphic transformation. But the only isomorphic transformation in three dimensional space is inversion by reciprocal radii, and this transforms the ideal lens into itself. The ideal lens is therefore unique.

fectly stigmatic for any pair of conjugate points; moreover, as inversion is an isomorphic transformation there is no distortion of infinitesimal objects.

An ideal lens exists therefore (in the mathematical sense of "existence,") but it is impossible to realise it without space charge. This must be positive inside the radius r_0 , negative outside it. It is even the simplest way to understand the ideal lens, by imagining that the electrons are circling in and around a spherically symmetrical space charge, gradually diminishing with distance.

It may be asked whether the ideal lens could not be realised at least approximately by a combined electro-magnetic field. The calculation shows, however, that this is possible only for a small region near the centre, outside this region we should require an imaginary magnetic field!

Whereas the ideal spherical (axially symmetrical) lens is unique, there exist an infinite number of ideal cylindrical lenses. We obtain one of these if, instead of rotating the density distribution.

$$n/n_0 = [1 + (r/r_0)^2]^{-1}$$

round an axis, we extend it cylindrically in a direction at right angles to the plane of r . The others are derived from this one by any conformal transformation $ds \rightarrow ds'$, if at the same time the refractive index is

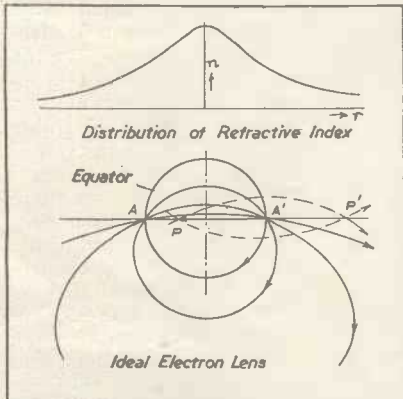

Fig. 12. The ideal lens. The top figure shows the distribution of the refractive index, the bottom figure the trajectories, which are one and all ellipses. A circle which corresponds to the equator of the projecting sphere is imaged in itself, and is itself a trajectory. The inside of the circle is imaged on its outside by "inversion," and vice versa.

transformed according to the relation $n.ds. = n'.ds'$ in other words if the action is kept invariant in the transformation.* Some of these ideal cylindrical lenses may be capable of approximate realisation.

* These transformations are a special case of the "extended point transformations" (Whittaker, "Analytical Dynamics" p. 293), which are themselves a special case of the general "contact transformations" of Hamiltonian dynamics.

It is not unlikely that conformal transformations of the kind considered (with invariant action) may have useful applications in electron optical problems, especially those arising in connexion with beam power valves and electron multipliers.

THE TELEVISION TUBE.—After this necessarily very incomplete survey of

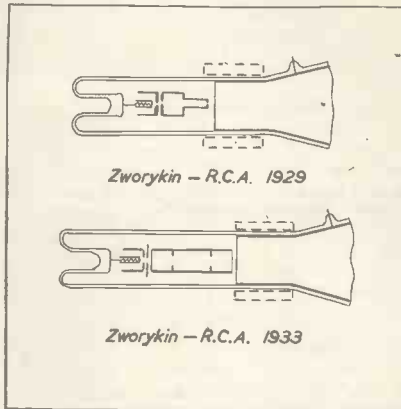

Fig. 13. The first modern television tubes, both by Zworykin, R.C.A. Electrostatic focusing, magnetic deflection.

the older "space" electron optics, I want to discuss a few applications of the older art, before proceeding to the discussion of the new "space-time" electron optics. The selection is necessarily somewhat arbitrary, and will include only two examples, the direct vision television tube and the electron microscope.

Perhaps on no other electronic device was as great a scientific effort spent as on the television tube. This development has now come to a temporary end, in this country three years ago, in the United States a year ago. The time which divides us from the past period of development ought to make it easier to sum up the situation in a fair and candid way.

The modern television tube has many ancestors. We could start its history in 1897, when Ferdinand Braun made the first cathode tube, or even in 1894 when the Frenchman A. Hess first proposed it, but I do not think it unfair to the older workers (of whom the author was one) if we start the tale after 1927, when Busch laid the foundations of electron optics. It is a rather curious tale, because I think that the main line of evolution in the twelve years which followed can be illustrated by only four types of tubes; only four out of the hundreds which have been developed in the meantime.

The ancestor of all modern television tubes is the "Kinescope" described by Zworykin in 1929, and made I think in 1928, which is shown in

Fig. 13, top figure. It contains already the two most essential elements of every modern television tube, the small cathode and the modulating electrode. It contains also an electron lens of sorts, in the shape of the field between the narrow tubular end of the first anode, and the second anode which already in this tube is realised as a conducting coating of the envelope. With the strongly diverging field between the first and second anode Zworykin wanted to increase the deflecting sensitivity. This was a fallacy, we know now that no increase of deflecting sensitivity is possible if magnetic deflection is used. Zworykin dropped it in his second model (described 1933) instead for the first time he took full advantage of the properties of electron lenses to focus rather wide bundles. This tube of the R.C.A. was used without any essential modifications for several more years.

In 1934 the American inventor Farnsworth took a bold step and dropped practically the whole electron gun, leaving only the cathode, the modulating cylinder and a funnel shaped electrode connected with the conducting coating and he fell back on magnetic focusing instead of the electrostatic focusing used in the Zworykin-RCA tubes. Finally, in 1937 even the funnel was dropped. I think that this step was taken first by Mr. Price of the Edison Swan Electric Co. At the same time the tube was considerably shortened. This type of tube was by far the most popular in this country until the war, and I believe also in other countries. It may be noted that all these tubes in the abridged family tree of the modern television tube have magnetic deflection. (Fig. 14).

Is this the whole story of twelve years of electron-optical development? There is, of course, more to it, but the rest is mostly a sad tale of thousands of wasted hours. Almost as soon as the first Zworykin Kinescope became known, research workers in all countries set to work to improve the television tube. If the first application of electron optics to the television tube brought such good results, how much better will it be after a few more years of refinements? But a few disagreeable surprises were in store for the optimistic workers.

First of all, efforts to improve the electron gun in the direction that at the same voltage it should produce a smaller spot at larger currents had only very limited success. Finally, D. B. Langmuir cleared up the situation in an important paper,¹ by showing that the inventors were after a

¹ D. B. Langmuir, Proc. I.R.E., 25 August, 1937.

perpetuum mobile! (This is not only figuratively true, as Langmuir's Theorem is a consequence of the Second Principle of Thermodynamics, which states the impossibility of a *perpetuum mobile* of the second kind). In a slightly simplified form Langmuir's result is as follows:—The largest current density i_s obtainable in the spot of a cathode-ray tube is

$$i_s = i_c \frac{V_s}{T_c} \cdot \sin^2 \theta$$

where i_c is the current density at the cathode, V_s the screen voltage (total driving voltage), T_c the cathode temperature expressed in volts (1 volt = 11,600°K) and θ the semi-angle of convergence at the spot.

This is the performance of an ideal gun. When the performances of actual guns were checked against it, it turned out that already Zworykin's gun of 1933 was within about 50 per cent. of the theoretical optimum. There was therefore very little room for improvement by design, and when this was recognised, patents on electron guns with miraculous performances were coming in at a much reduced rate.

Though the inventors were checked as regards spot size, their activities did not cease, not even as regards the electron gun. Even if the spot size could not be made much less, there was still much room for improvements. Here is a short and incomplete list of some of the electron guns which were developed.

Guns with constant spot size, regardless of voltage variations. (Fixed focus electron guns).

Guns with constant spot size regardless of current.

Tetrode and pentode guns with extra high modulation sensitivity.

Guns with automatic focus correction during scanning.

Guns with minimum spherical aberration.

Guns with curved axis, to avoid the "ion spot" and guns with two or more of these properties. We have seen already what the answer of practice was to these propositions. No improved gun design was a practical success, because the most successful of all cathode-ray tubes had practically no gun at all!

The other centre of inventive activity was *deflection*. Though the "abridged family tree" of the television tube starts and ends with tubes with magnetic deflection, it must be remembered that the intervening years saw the birth of the cathode-ray tube with purely electrostatic focusing and deflection. For a while these were even the best tubes on the market. But when the *short magnetic*

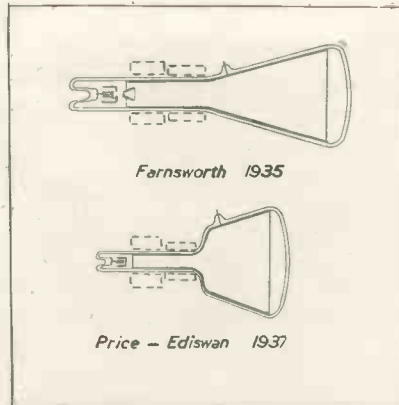

Fig. 14. Further development of the television tube. Magnetic focusing and deflection.

tube came on the market, the electrostatic tube was finally defeated. The picture quality at wide scanning angles was inherently better for magnetic deflection. Efforts were made to overcome this by specially shaped deflectors and other compensating arrangements, but these were complications which were all swept away by the general trend towards *extreme simplification* of the cathode-ray tube. I want to mention also the attempts towards cathode-ray tubes with increased deflection sensitivity by after-acceleration, *i.e.*, deflection first and acceleration afterwards. These were defeated, too, and the story of these defeats contains a lesson which is worth remembering:—

Almost all improvements on electron guns and deflecting systems were undertaken with the intention to make the outer circuits of the television tube simpler and cheaper. The electron optical tube designer hoped that the simplification of the outer circuit would ultimately pay for the complication of the tube. *But whenever the electron optician tried to solve a problem which could be solved also by the circuit engineer, he was defeated.* In the end it was always the circuit designer who solved the electron optical problems, because his solutions were compatible with the extreme simplicity preferred by the manufacturers of cathode-ray tubes, and because, curiously enough, these gave a better picture quality.

What was the secret of the circuit engineer by which he solved electron optical difficulties? The answer is extremely simple: *High voltage!* This is an electron optical panacea which we have already mentioned, and which we will meet again in the case of the electron microscope. It is easy enough to understand. If we increase the voltage, according to Langmuir's Theorem we can reduce the area of the spot in the same proportion. At the

same time (in spite of the reduced spot size!) the screen input increases in proportion to the voltage increase, but the luminous output of the screen goes up even steeper, as at least up to about 10,000 volts, the efficiency of fluorescent materials increases with voltage. A further gain is the reduction of space charge effects. We can also choose to use some of the gain to reduce $\sin \theta$, and by this reduce spherical aberration which is proportional to $\sin^3 \theta$.

On the other hand if we want to reduce the voltage, no amount of electron optical ingenuity can make up for the loss of say 20 per cent. of the driving voltage. If practical proof were needed, it was not lacking. It must have been very clear to anybody who before the war walked through the annual television exhibitions at Radiolympia. Many manufacturers exhibited their tubes and sets, and the television pictures were of varying quality. But the best picture at 3,500 volts was never quite as good as the worst at 5,000! If you walked through the exhibition and tried to classify the exhibits, the picture quality always broadly coincided with the voltage: 3,500 volts, poor to middling. 5,000 volts, good. 6,000 volts or more excellent!

This, I think is the main reason why in the end the trend towards extreme simplification triumphed. The high voltage and the absence of electron optical compensations gave the circuit engineer a few difficult problems (*e.g.*, distortion-free scanning at wide angles, requiring considerable power in the scanning circuits) but these were all satisfactorily solved.

I must, however, mention one more reason which I think played a considerable part in the defeat both of the electrostatic gun and of the electrostatic deflection. It is true that these had some inherent disadvantages, but electron optical refinements were much more easily applied in them, and in fact the performance of the best specimens was little if at all behind the performance of the best magnetic tubes. But it is also a fact, that the average lagged considerably behind the best specimens, unlike magnetic tubes, which showed a far more uniform quality. One reason is, of course that the electrostatic electrode systems must be very accurately shaped and aligned, and no later correction is possible, as in the case of the magnetic tube, where the coils can be adjusted to optimum performance. But the results were even worse than one would have expected, in many cases even much worse, and the reason is that even with perfect shaping and

alignment of the electrodes one could never be quite sure that the field would be as theoretically expected, because of what for lack of a better word may be called *polarisation layers*. The potential of the surface of an electrode can depart by as much as a hundred volts or even more from the actual potential of the electrode! I think almost everybody who has ever worked with electrons must have come across them, yet I do not know of any systematic treatment of these layers in physical literature. Indeed, this is almost a prototype of the problem which is likely to be neglected. Academic circles cannot be expected to be interested in them, as they are off the main road of progress, and do not promise much of fundamental scientific interest. Moreover, this is no problem for beginners, it takes a master of the experimental art to devise perfectly clean experiments on impurities! Industrial physicists have no time for this sort of problem, if they come across them they will remove the difficulty by some *ad hoc* solution, or class them as "hoodoos" and walk in a wide circle around them. And Irving Langmuirs, who are attracted just by this kind of problem and are capable of wresting results from them which are both of practical and of scientific interest, are so few and far between that I must apologise even for the plural!

The magnetic type of television tube, as it accelerated the electrons on as short a path as possible to maximum speed was almost entirely free of these troublesome effects. Until we learn how to master the "polarisation layers" there is one lesson which we must learn from the story of the television tube, and which I should like to call the first principle of practical electron optics: "Do not slow down your electrons more than you can help."

If any further illustration is needed to the curious story of the television tube, I cannot think of anything that can characterise it better than the following fact:—Though the television tube is quite a new invention, altogether only 13 years old, and in this time many hundreds of patents have been issued on it, any manufacturer could to-day produce a tube as good as any on the market without infringing a single patent! Compare this with the story of other electronic device, e.g., the modern X-ray tube or the electron valve, developments marked from the beginning by pioneer patents, ardent patent fights and ingenious attempts to evade master patents, to realise how extraordinary this situation is! For my part I think it rather regrettable, as it does not encourage the great industrial firms to

spend money on electron optical research. We can only comfort ourselves by the thought that after all television has just started, and there may be still a chance for electron optics to produce something quite new that will start another era of development.

The Electron Microscope.—As a second example of the applications of the electron optical art I have chosen, what is probably its proudest achievement, the electron microscope. The following discussion is necessarily short and incomplete, among others for the reason that I have no first hand experience with the subject, and must rely entirely on its literature.

The simplest type of electron microscope is the cylindrical or spherical type. In the first, a thin wire is stretched in the axis of a tube, in the second a wire with a finely pointed end which is approximately a small hemisphere is placed in the middle of a spherical envelope. In both cases a potential of a few thousand volts is applied to the envelope. Electrons starting at very nearly right angles to the specimen proceed on rectilinear paths to the wall which is coated with a fluorescent substance and produce on it a projected image, immensely enlarged. Magnifications of 250,000 have been realised.

The magnifications obtainable with these simple devices are so astounding that you can actually see single ions crawling about on the surface, shown up by the increased emission which they produce in their immediate neighbourhood. I think this is one of the most thrilling sights in modern physics, to see a live ion on a metal surface! (Even the Wilson chamber, the most wonderful of all scientific inventions, shows only the tracks of atomic particles, after the event).

These simple microscopes are almost without counterpart in ordinary optics, almost but not quite. Everybody knows that the mercury in a thermometer looks considerably enlarged. If, as in electron optics, we could make the glass with a refractive index of say a thousand, nobody could tell the thermometer from a solid rod of mercury. Similarly a raindrop containing a grain of soot would appear as a solid ball of carbon!

The so-called "supermicroscopes" do not for the time being exceed the simple microscopes in magnification, but their field of application is incomparably wider. We have no time to follow the development from its beginnings, going back to Knoll and Ruska, but I want to show you the first *commercial* supermicroscope, manufactured by the Radio Corporation of America. (Fig. 15).

It is a beautifully self-contained instrument. The special 60 kv direct current supply is contained in the column, together with the high speed oil-diffusion pump. Only the mechanical backing pump is separate, to avoid vibrations. Specimens and photographic plates are introduced through air-locks, without breaking the main vacuum. It is claimed that any laboratory assistant will be able to use it after a few days training.

Electron optically the instrument is built on orthodox lines. It uses magnetic lenses, of the type as used already in the first magnetic electron microscope of Knoll & Ruska (1931) from which it differs mainly through the addition of a third magnifying lens, the "intermediate image projector." No electron optical refinements are mentioned by the designers, James Hillier and A. W. Vance. There is no evidence even of their using the suggestion of Rebsch, mentioned on page 299. Yet the resolving power of this microscope is without rival. How has it been achieved?

To put it in a nutshell, after some years of electron microscopy, it has become clear, that the *high power electron microscope must not be an imitation of the high power light microscope*. It need not have, nay, it *must not have* wide angle illumination and high power objectives! Light microscopes had to take this line because of the relatively long wavelength of visible light. But the de Broglie wavelength of high speed electrons is so short, even compared with the finest objects so far investigated, that the high power electron microscope is more like the cheapest pocket microscope, but with even narrower apertures! In fact, in the instrument the very opposite of wide angle illumination has been applied, almost parallel illumination. Moreover the aperture (not shown in the drawing) has been made as small as possible, near to the limit when diffraction effects would become marked. The divergence of the beams used in imaging is made so small, that the lens defects become practically negligible. The resolving power is no more limited by lens defects, not because these have been corrected, but on the contrary, because conditions have been chosen in which the first order (Gaussian) imagery is a very good approximation!

But there is one kind of lens defect which appears also in first order imagery and cannot be suppressed by small apertures. This is the "chromatic" defect, electron, optically the inhomogeneity of electron velocities. This can have two sources: Inhomogeneity of the primary (illuminating)

(Continued on page 337)

The Life of Newton

A summary of a paper read before the Institute of Physics (London Branch) on December 5, 1942
on the occasion of the Tercentenary of the birth of Sir Isaac Newton

By H. LOWERY, D.Sc., F.Inst.P.*

"Nature and Nature's laws lay hid in night;
God said, 'Let Newton be,' and all was light."

SO runs Pope's famous couplet which is appropriately inscribed on a tablet in the bedroom at Woolsthorpe Manor House in the parish of Colsterworth near Grantham, where Sir Isaac Newton was born on Christmas Day (old style) 1642, a premature child—"scarcely big enough to fill a quart mug," as his mother used to say—certainly giving no promise of 85 years of active life, and no suspicion of that future greatness that led to his being called "He who in genius surpassed the human kind."

His early years were spent on the farm, and what little education he had was received from the local village schools of Skillington and Stoke. Through the interest of his maternal uncle, the Rev. William Ayscough, Newton left Woolsthorpe at the age of 12 to attend the King's School at Grantham. From 14-16 he was back again at Woolsthorpe to help with the farm work—but as it was obvious that he was not cut out for a farming career—he was sent back to Grantham (again on the advice of the Rev. William Ayscough), to prepare for the University of Cambridge, which he entered as a member of Trinity College in 1661. While at school he had given evidence of plenty of ability to excel at the ordinary school subjects should he so desire, but he had above all revealed his keen interest in practical things and laid the foundations of that manual skill that was to serve him in such good stead later on in his craft as an experimental philosopher.

While an undergraduate, Newton seems to have applied himself reasonably well to the prescribed studies and in due course obtained his degree; in 1667 he was elected to a Fellowship of his College, and in 1669 succeeded his former teacher, Isaac Barrow, as Lucasian Professor of Mathematics in the University. The years 1665-1666 were spent at Woolsthorpe, as the University was closed owing to the plague; they were not however spent in idleness, indeed Newton appears to have been glad of the opportunity to pursue uninterrupted certain mathematical investigations in which he had become interested during the undergraduate period. He had already discovered

the binomial theorem and from this time may be dated the discovery of the law of gravitation, in spite of the fact that the initial calculations were in error due to the assumption of an inaccurate value for the radius of the earth, on account of which the publication of the results was delayed for 20 years. Either of these two discoveries would by itself have been sufficient to establish the reputation of any ordinary person, but with Newton they were merely the forerunners of a long series of outstanding achievements which seemed to embrace the whole of mathematical and physical science.

He was the first to describe the spectrum and give an explanation of the phenomenon of colour based on work begun while an undergraduate; then followed the invention of the reflecting telescope, the investigation of the colours of thin films (such as soap bubbles and "Newton's rings"), the geometry of curves and the development of the differential calculus (fluxions), the calculation of areas and volumes leading to the foundation of the integral calculus, the study of the chemical properties of metals, with the culmination of a long period of the most concentrated mental activity in the publication of the great "*Philosophiæ Naturalis Principia Mathematica*" in 1687 which laid down the principles of mechanics, hydrostatics and hydrodynamics, and the theory of planetary motion. The fundamental and far-reaching character of these various researches fully entitles us to regard Newton as the greatest scientist of all time, especially when we take into account the mystical nature of all pre-Newtonian science and the strangle-hold that the banalities of the schoolmen had gained over academical pursuits. He it was who really inaugurated the experimental era and broke through the barrier of the arid traditional learning.

Rising out of his personal efforts, when a deputation from the University of Cambridge waited upon King James II to protest against a violation of the rights of the University, through the King's request that an ignorant Benedictine monk should be admitted to the M.A. degree, Newton was elected Member of Parliament for the University. He served in this capacity for a year (1688-89) and probably gained by this experience a taste for public life. At any rate in 1695 he

accepted the office of Warden of the Mint on the invitation of the Chancellor of the Exchequer. In 1699 he became Master of the Mint and carried out successfully a difficult scheme to restore the much debased currency of the realm, a task which enabled him to employ his singular mathematical and chemical abilities in the service of his country.

It is indeed gratifying that Newton was permitted to enjoy the honours which his great scientific attainments merited. He was elected a Fellow of the Royal Society in 1672. No doubt he adorned the Society, but it must be admitted that the friends—notably Halley—to whom he was introduced by the Society did him great service in publicising his work, for it was one of Newton's little weaknesses to shrink from publication. He hated criticism and would rather have given up his studies than be involved in any disputes, though in actual fact there were plenty of these as a result of the revolution in ideas which his researches initiated.

In 1703 he became President of the Royal Society and was the acknowledged leader of science in England for the next quarter of a century. He had been elected Member of Parliament for his University again in 1701, and was knighted in 1705 on the occasion of a visit of Queen Anne to Cambridge. We may be sure that his fame was not confined to his own country when the cynical Voltaire could write that he "surpassed all men in genius."

Newton died in 1727. His body lay in state in the Jerusalem Chamber and was buried in Westminster Abbey with every mark of honour, the Lord High Chancellor, two Dukes and three Earls acting as pall-bearers. Monuments to his memory were erected in the Abbey and in Trinity College, Cambridge, where also are many relics of his life and work.

Great as were his achievements, Newton himself was extremely modest and looked upon himself as a privileged interpreter of Nature. In his own words, "I do not know what I may appear to the world, but to myself I seem to have been only like a boy playing on the seashore and diverting myself in now and then finding a smoother pebble or a prettier shell than ordinary, whilst the great ocean of truth lay all undiscovered before me."

* Principal, The S.W. Essex Technical College.

Making Up Odd Impedances

A graphical method of determining the values of a minimum number of standard components to produce any required value of impedance.

By J. C. FINLAY*

THE designer of electronic apparatus often requires circuit elements of odd values which are not ready to hand and which in many cases could not be obtained without special construction. In experimental work, particularly, the delays which might be caused through waiting for a particular resistor, choke or condenser of some specific value are often overcome by judicious arrangements of components already available. Even in the best-equipped workshops and laboratories, stocks of small parts are of necessity kept down to standard economic components as supplied by the trade, and the user must adapt these to his requirements.

The problem which thus frequently confronts designers, experimenters and service men is to build up a certain impedance value from a few standard components. This can be done by any number of networks of varying degrees of complexity, all based however on the simple well-known series and parallel rules of connexion, which for convenience are tabulated in Fig. 1.

Now it is at once evident that an arrangement in which the effective total value is given by the simple arithmetic sum of the component values (*i.e.*, $= a + b$ for two elements, a, b) is inclined to be clumsy where an awkward figure has to be satisfied, whereas a simple combination following the reciprocal rule (*i.e.*, $ab/(a + b)$ for elements, a, b) will often be more economical.

e.g. A pair of resistors, values 1,000 Ω and 10,000 Ω will give a combined effective resistance of 909 Ω in parallel connexion, whereas to produce the same result from series-connected standard components would require, say, a 500, 400 and 9 Ω set, these themselves possibly requiring further subdivision.

An odd value such as this could be built up in an infinite number of combinations from two parallel resistors or inductances or from two series capacitances, in the respective cases, and it is often a problem to decide which particular values to choose. It is the purpose of this article to describe a simple chart from which all the possibilities of impedance pairs can be read off at once against any required effective value. Some ex-







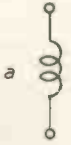

	RESISTANCE	INDUCTANCE	CAPACITANCE
Effective $\left. \begin{matrix} R \\ L \\ C \end{matrix} \right\} = a$			
Effective $\left. \begin{matrix} R \\ L \\ C \end{matrix} \right\} = a + b$			
Effective $\left. \begin{matrix} R \\ L \\ C \end{matrix} \right\} = \frac{ab}{a+b}$			

Fig. 1. Basic Elements of Linear Impedance Networks.

amples of the use of the method then follow. Apart from the time saved in tedious calculations, this graphical method enables any "round number" pairs to be quickly read off (and there will generally be at least one such pair within practical accuracy for any given effective value). Hence suitable values of standard components may be chosen. Alternatively, the complement to a stated component is directly given for a required effective value.

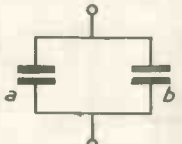
Construction of the Chart

The chart shows in effect three inter-related quantities— x, a and b , where $x = ab/a + b$. x is the parameter on axes of a and b . It will be noticed that logarithmic scales are used on both axes. This arrangement has three peculiar advantages:—

- (i) A wide range in $a : b$ is shown (*i.e.*, max. ratio of 100 : 1.01).
- (ii) The accuracy of reading is the same at all parts, as on a slide rule.
- (iii) The parameters of x are all of exactly the same shape, as proved in the Appendix. This is perhaps the most important property of all, because it en-

ables a sliding "cursor" to be used instead of estimating values by eye, between thickly drawn parameters on the chart.

The chart itself consists of standard double-logarithmic paper; the 10 in. square type No. 3L as supplied by Messrs. E. N. Mason, of Colchester being very suitable as it is accurately printed on strong waxed paper which is unlikely to change size with the weather. Each scale is marked from 1-100, and a diagonal line is drawn up from the origin to the top right-hand corner, as shown in Fig. 2.

A parameter has also been drawn for the condition $x=2$, relating all the possible ratios of $a : b$ which could form x (within the chart limits). When $a = b$, the solution for $x = 2$ is $a = b = 4$, this point therefore lying on the diagonal at 45° to the axes. When either a or b is made infinitely high, the other component approaches ever nearer to 2, representing a practically non-shunted resistance or other component. Thus the asymptotes to the curve lie over the lines $a = x$ and $b = x$. Two exact "round number" values of a and b are given in this case as 10 : 2.5 and 6 : 3. In practice one of these ratios could generally be

* Messrs. A. Reyrolle and Co.

produced from standard components, adjusting the decimal point to suit actual magnitudes.

Since the characteristic of the x parameter is always of the same shape, it follows that any other value of x could be examined by drawing the curve on tracing paper or (preferably, for hard use) on celluloid, together with the 45° diagonal and the index lines (i.e., the asymptotes) as shown in Fig. 2. On moving this cursor over the original chart so that the diagonals coincide and the index lines lie over $a = x$, $b = x$, all the possible ratios of $a : b$ lie under the curve, as before. The cursor could be traced from the printed page, but it is easy to construct more accurately and to a large scale by tracing over the logarithmic chart with which it is to be used, plotting a curve on some spare double-log paper from the figures tabulated in the table at the end of the article.

It will be noticed that two other lines are shown on the cursor, marked + and - 10 per cent. These can be plotted as a direct result of advantage (ii), and it is seen that any point lying within this envelope will produce an effective value within ± 10 per cent. of that required. In many applications, a tolerance of this order is permissible because of limitations in manufacturing accuracy or in non-critical operation, and the allowable range of component pairs is given straightaway. These boundary curves can be readily drawn in to individual requirements by tracing over a parent curve. In the present case, for instance, supposing a parent curve had been drawn on a spare graph sheet for $x = 2$, and the main curve on the cursor, together with the index lines and diagonal, had been traced from it, then it would only be necessary to shift the cursor in turn to the positions $a = b = .9x = 1.8$ and $a = b = 1.1x = 2.2$ and retrace the curve in each case to give the two boundary lines.

The per cent. displacement between any point and the $a : b$ curve may be accurately read off (if error lines are not drawn) by using the top scale of a 10 in. slide rule, which is identical with the graph scales if the paper referred to is used. The slide is laid horizontally across the point considered, with an index mark directly against the curve on the cursor. The percentage error is then read immediately against the point considered, e.g., if this appears at 1.08, the error is 8 per cent. too high or if on the other side of the index at .955 the error is 4½ per cent. too low. A slide rule scale has the advantage of being more finely divided than the usual graph paper, and saves drawing a

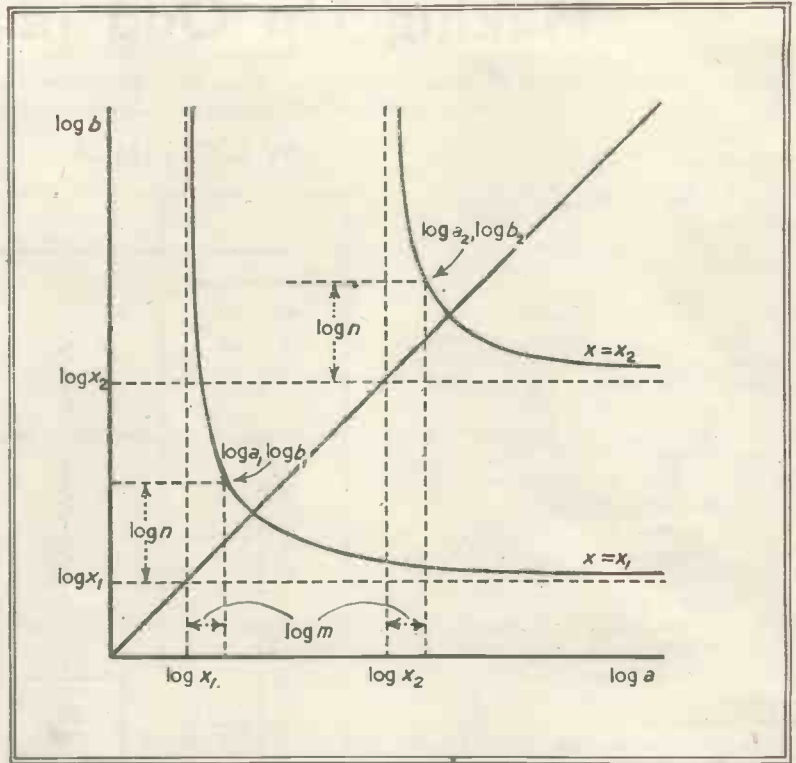

Fig. 4. To prove identical shape of x Parameters.

confusing multiplicity of error lines on the cursor. To save confusion, it will be best to use different colours for the various lines—say blue for index lines and diagonal, black for main curve and red for boundary curves.

Examples in Using the Chart

(1) *Bias Resistors.*—An output valve requires a bias resistance of 715 Ω . Find two suitable paralleled standard resistors to produce this resistance.

Placing the index lines over $x = 7.15$, a suitable "round number" ratio given within 1 per cent. is 10 : 25. Hence parallel resistors of 1,000 and 2,500 Ω may be used.

$$\text{Check: } x = \frac{25}{35} \times 1,000 = 715$$

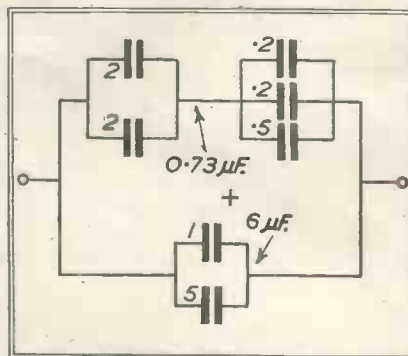

Fig. 3. Solution of Ex. 2.

This result is coincident, but in many cases 10 per cent. or more tolerance would be allowable, and a solution is generally given well within this value.

(2) *An Accurate Capacitance.*—In a certain measurements circuit, a capacitance of 6.73 μF is required to within ± 1 per cent. (i.e., $\pm .007 \mu\text{F}$) and a high-grade condenser plug-box of 0.1 to 10 μF is available. Devise a suitable arrangement of condensers from this box.

In this case it is evident that a simple two-element network will not be accurate enough, except by an extremely lucky chance in figures, and a slightly more complex arrangement must be sought.

A first attempt might be to produce 6.7 μF by simple paralleling of components, but this would not leave enough condensers to produce the remaining .03 μF by a series arrangement. Thus it would be better to try a round number of say, 6 μF , built up from paralleled components, and attempt to obtain the .73 μF left from the remaining condensers.

Putting $x = 7.3$, a possible ratio is 40 : 9.

$$\text{Check: } x = \frac{360}{49} \times .1 = .735 \mu\text{F, which}$$

is allowable (error = .005 μF): Hence

THE CHART AND CURSOR

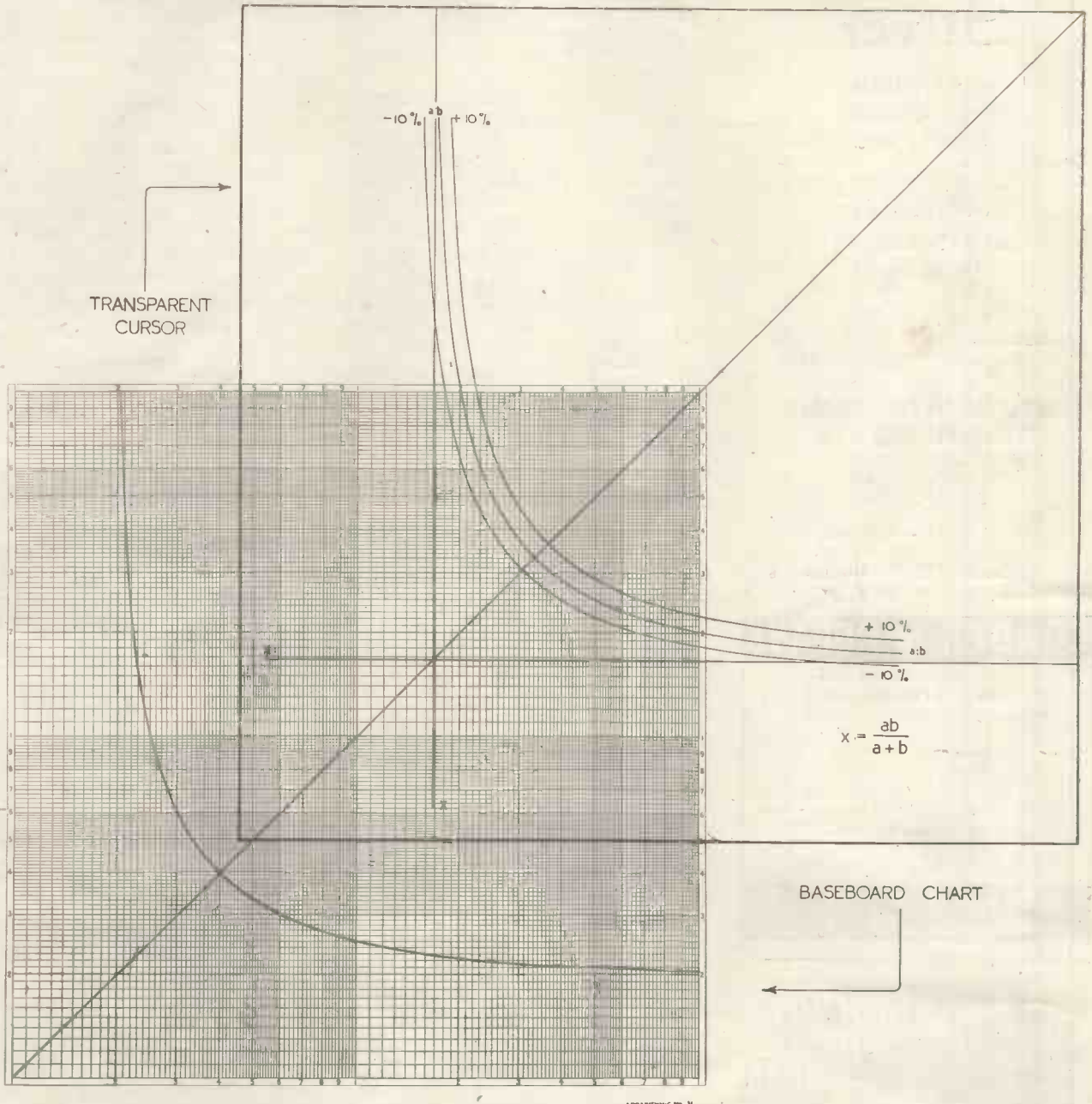

Fig. 2. Double logarithmic chart (reduced in size) and transparent cursor superimposed. The parameter $x = 2$ has been drawn on the chart together with a diagonal.

In addition to the main curve the cursor is marked with lines showing a 10 per cent. tolerance on the values obtained.

Liquid Silver

For Metallising
Mica Ceramic
Quartz etc.

Low Melting
Point Solder
and Solder in
Paste Form

Agents for Australia:
A. F. HARRISON & CO. PTY. LTD.
85 CLARENCE STREET, SYDNEY

MELTON METALLURGICAL LABORATORIES LTD.

IPSWICH ROAD
TRADING ESTATE
SLOUGH, BUCKS.

'Phone: Slough 20992

LONDEX for RELAYS

for A.C. and D.C.

TWO STEP RELAY LF/FS
(Heavy Silver Contacts)

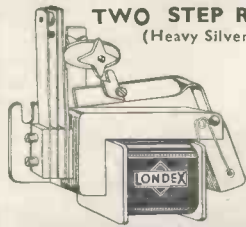

First Impulse "ON" Second Impulse "OFF"

Also Aerial Change-over Relays.

Ask for leaflet 88a/EO

LONDEX LTD

MANUFACTURERS OF RELAYS
207 ANERLEY ROAD, LONDON S.E. 20



EDWARD WILCOX & CO. LTD.
Sliding-interlocking and vibration-proof contacts and comprehensive adaptability are characteristics of interest to designers of unusual schemes in these unusual times.

Edward Wilcox & Co., Ltd., Sharston Road, Wythenshawe, Manchester.

a suitable arrangement from the plug box components would be as shown. (Fig. 3). This example was chosen at random and the figures may not always resolve so readily, in the first attempt. In that case, a different "heavy" value—e.g., 5 or 5.5 instead of 6 μ F might have been chosen and the figures reworked. It will be seen how much time and labour is saved by the chart in working out the reciprocal-rule elements.

(3) *An Economic Set of Condensers.* In a trial circuit for producing sound tones, the following approximate capacitances are required in conjunction with a 3H. choke for producing an octave in the oscillator:—

μ F :— .008, .009, .012, .016, .018, .020, .026, .032.

Find an economical set of standard small condensers which, when used with a suitable switching scheme, will enable any of the above capacitances to be approximately obtained.

Note: Standard condensers of the next order above the last decimal place required run .01, .02, .05, .1 μ F.

Then, referring to the chart for the solution of reciprocal arrangements, the following possibilities of connexion occur:—

Required μ F	Connexion	Best Arrangement
.008	Series	.01/.04
.009	Series	.01/.1
.012	Series	.02/.03
.016	Series	.02/.08
.018	Series	.02/.18
.020	Single	.02
.026	Series	.03/.2
.032	Series	.04/.16 (or .05/.09)

Examination of these series arrangements shows that some of the "round numbers" would have to be built up from simple paralleled standard values, as in Example (2), but the reader can readily see that the following set of standard condensers would enable all these combinations to be obtained:—

.01, .02, .02, .05, .1, .1 μ F.

Thus only six condensers are used to supply eight non-standard capacitances, and the calculation has been made logical and effortless by the graphical method. The saving is obvious over the number of standard units which would be required for

simple parallel connexion to obtain all the values specified.

Concluding Notes

Only a few simple examples have been given to show the potentialities of the method in reducing much of the labour in designing networks and in assisting towards more logical and economical working, but it is hoped that these will act as a guide in more difficult problems, and where greater accuracy, is required. For most purposes, a ready combination of two convenient elements will be found within sufficient limits, and it should be rarely necessary to extend calculations beyond a maximum of three "round number" units. Even then, the possibilities of coupling are boundless, as shown by Example (2), and leave the engineer wide scope for supplying his needs.

Appendix

Proof of the Cursor Construction

The two components, a , b must always be individually greater than their total effective value x .

$$\text{Thus let } a = mx \\ b = nx$$

$$\text{Then } x = \frac{ab}{a+b} = \frac{mn}{(m+n)x} = \frac{mn}{m+n} x$$

$$\text{or } mn/m+n = 1 \text{ or } mn = m+n$$

Hence $m=f(n)$ and is independent of x . Taking logs of the fundamental equations,

$$\log a = \log x + \log m \\ \log b = \log x + \log n$$

Thus if $\log b$ is plotted against $\log a$ on parameters of x ,

Then, taking any point $(\log a_1, \log b_1)$ on x_1

such that $\log a_1 = \log x_1 + \log m$

and $\log b_1 = \log x_1 + \log n$

and a point $(\log a_2, \log b_2)$ on x_2

such that $\log a_2 = \log x_2 + \log m$.

Therefore it follows that

$$\log b_2 = \log x_2 + \log n$$

since $n = f(m)$.

Hence the curves are all similar, resembling rectangular hyperbolæ in form (but not equation) which approach the rectangular asymptotes $\log x$ for any given value of x .

Table of Values of m and n for Constructing the Cursor.

Plot out on the double log paper and trace on to cursor.

$$n = m/(m-1) \text{ or } m = n/(n-1)$$

m or n	2	3	4	6	8	10	14	20	30	40
n or m	2	1.5	1.333	1.2	1.142	1.11	1.077	1.052	1.034	1.025



Fig. 15. The R.C.A. Electron Microscope

Acknowledgments to the R.C.A. Mfg. Co.

(Continued from page 331)

beam, due to fluctuations of voltage during the exposure, and inhomogeneity of the scattered beam, arising from electron losses in the scattering process. But as we have already mentioned on p. 299 this is automatically eliminated by the simple panacea of practical electron optics, *high voltages!* For thin specimens 60 kv are sufficient, in order to investigate thicker specimens Zworykin, Hillier and Vance have constructed a microscope with 300 kilovolts.²

There remains only one problem, the limitation of the resolving power by voltage fluctuation. This was solved by Vance³ by rectifying a current of 32 kilocycles, and using an ingenious feedback regulator. Once again, as in the case of the television tube we see that it is in the end the circuit engineer who solves the electron optical problems in practice!

There is also one more feature which reminds us of the story of the television tube. Hillier and Vance describe, that though with a new apparatus the resolving power is about



Fig. 16. (above) A comparison between light and electron micrographs, Typhoid Bacillus magnified 540 and 13,000 diameters



Fig. 17. (below) Polystyrene, magnified 38,000 diameters

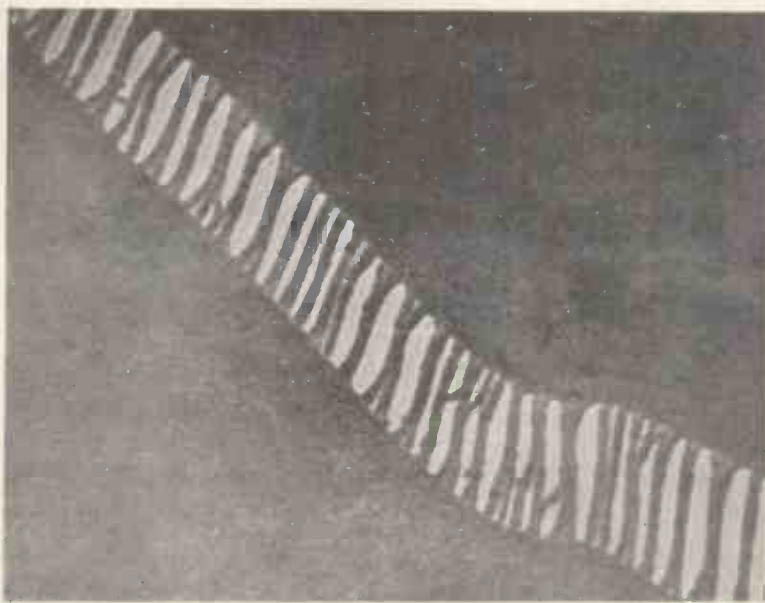

3×10^{-6} millimeters, after about two months not even 10×10^6 can be obtained. The reason is "that at the pressures obtained in a demountable system, a somewhat carbonaceous semiconducting material is deposited on all the diaphragms which are in the direct path of the electron beam. When these deposits become sufficiently heavy, the potentials of those parts of their surfaces which are exposed to the electron beam may become considerably different from the potential of the metal aperture."³ Here we meet again the "polarisation layers," which played such an important part in frustrating so many of the television tube designs. Fortunately they are not very harmful in the elec-

tron microscopes, it is sufficient to renew the apertures from time to time.

I want now to show you some of the achievements of the RCA commercial electron microscope.

Here the lecturer showed illustrations from G. A. Morton's paper "A Survey of the Research Accomplishments with the R.C.A. Electron Microscope" (R.C.A. Review, October 1941, p. 131). Two of the figures are reproduced above.

(To be concluded)

¹ V. K. Zworykin, J. Hillier and A. W. Vance, *Journ. Appl. Phys.* 12, 738, 1941.
² A. W. Vance, *RCA. Rev.* 5, 293, 1941.
³ Hillier and Vance, *l.c.*, p. 171.

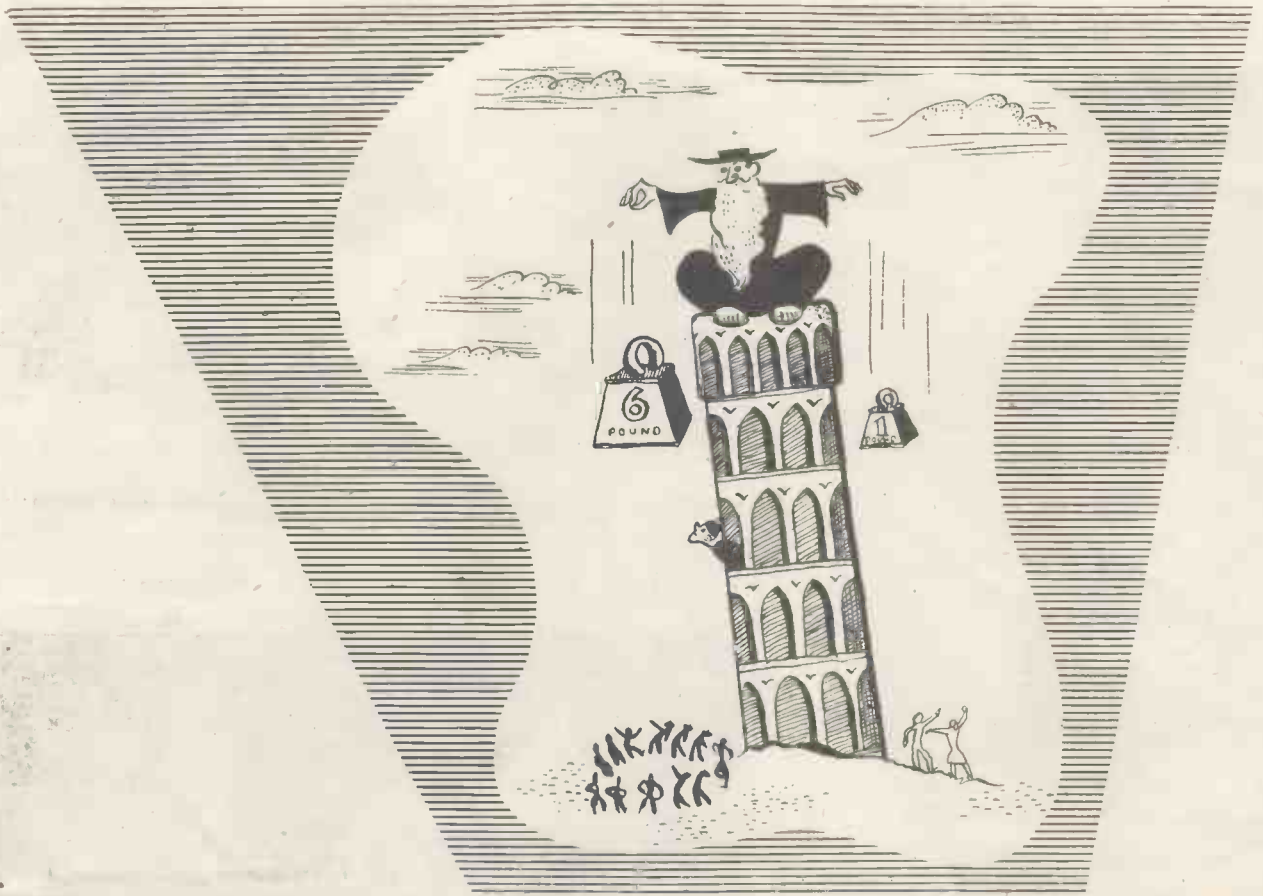

THEY FOUND IT HARD TO BELIEVE GALILEO

One of Galileo's discoveries was the equality of velocities of all falling bodies, no matter how large or small. He said that one object six times the weight of another object would fall through the same space in the same time, *not* in one-sixth the time. People disbelieved his theory, so he proved it by a practical demonstration from the Leaning Tower of Pisa. Electrical and radio engineers sometimes find it hard to believe the claims made for DISTRENE (Regd.)—until they have been proved by actual personal tests. This modern insulating material sets new standards; the data below shows how and why. May we send working samples?

SPECIFIC GRAVITY	1.06	COMPRESSION STRENGTH	7 TONS PER SQ. IN.
WATER ABSORPTION	NIL	COEFFICIENT OF LINEAR EXPANSION	.0001
DIELECTRIC CONSTANT	60-10 ⁶ CYCLES 2.60-2.70	POWER FACTOR UP TO 100 MEGACYCLES	.0002-.0003
SURFACE RESISTIVITY (24 HOURS IN WATER)		3 × 10 ⁸ MEGOHMS	

We are now the sole distributors in this country of DISTRENE (Regd.) in all its forms, including moulding powder.

BX PLASTICS LTD., LONDON E.4 AND ELSEWHERE

Some Applications of

Non-Linear Current Potential Characteristics

by E. E. SHELTON*

Introduction.

THE usual elementary explanation of detection of radio signals, with which readers are quite familiar, postulates an ideal discontinuous characteristic. This simplification is convenient for a first consideration, but whilst this characteristic gives sufficient conditions for detection they are by no means the only, or even necessary conditions. Detection can take place if a non-linear current-potential characteristic with no discontinuities is utilised, and although this is well known, it is not so generally realised that this is only a special case of a general principle. Not only in electrical circuits, but with mechanical and acoustic vibrations also, it is true that if any number of vibrations of different frequencies are applied to a linear responder, no new frequencies can be observed, but if the responder behaves non-linearly new frequencies arise.

The audibility of combination and difference tones between two musical notes sounded simultaneously can be taken as proof of the non-linearity of the response of the mechanism of the ear.

The particular applications which are of interest to radio engineers are to the problems of modulation, frequency multiplication, detection and frequency changing in super-heterodyne reception.

A resistance provides a simple example of linear response, for the current flowing varies linearly with the voltage applied. Now if two alternating voltages $E_1 = A_1 \sin \omega_1 t$ and $E_2 = A_2 \sin \omega_2 t$ (the first of amplitude A_1 and frequency $\omega_1/2\pi$ the second of amplitude A_2 and frequency $\omega_2/2\pi$) were applied in series to this resistance R and the current flowing were examined, no new components would be found in the resultant, the simplest expression for the current being:—

$$I = \frac{V}{R} [A_1 \sin \omega_1 t + A_2 \sin \omega_2 t]$$

If these two voltages $E_1 = A_1 \sin \omega_1 t$ and $E_2 = A_2 \sin \omega_2 t$ were applied in series to say a thermionic valve, metal-oxide rectifier or other non-linear device having a voltage-current characteristic which could be represented by $I = k E^n$ where k and n are constants for the given device, then the resulting current would be

$$I = k [V + A_1 \sin \omega_1 t + A_2 \sin \omega_2 t]^n$$

where V is the voltage value around which the variations take place (e.g.,

anode voltage and grid bias on a valve). The bracket term may be expanded into a series when it can be seen that a large number of new components has been introduced. The index n is usually between $3/2$ and $5/2$ for triode valves, depending on the potential fall along the cathode and on some geometrical features of the construction.

The special case where $n = 2$ is of interest as it gives a fair approximation to an actual characteristic for some devices and serves as a useful illustration:—

$$\begin{aligned} I &= k [V + A_1 \sin \omega_1 t + A_2 \sin \omega_2 t]^2 \\ &= k [V^2 + A_1^2 \sin^2 \omega_1 t + A_2^2 \sin^2 \omega_2 t \\ &\quad + 2VA_1 \sin \omega_1 t + 2VA_2 \sin \omega_2 t \\ &\quad + 2A_1 A_2 \sin \omega_1 t \cdot \sin \omega_2 t] \\ &= k [V^2 + A_1^2 (1 - \cos 2\omega_1 t)/2 \\ &\quad + A_2^2 (1 - \cos 2\omega_2 t)/2 \\ &\quad + 2VA_1 \sin \omega_1 t + 2VA_2 \sin \omega_2 t \\ &\quad + A_1 A_2 \cos (\omega_1 - \omega_2) t \\ &\quad - A_1 A_2 \cos (\omega_1 + \omega_2) t] \end{aligned}$$

This means that the two impressed voltages give rise to a current having six alternating components:—

- (a) One of double the first frequency, and one of double the second frequency, each with an amplitude proportional to the square of the corresponding original amplitude.
- (b) One of the first frequency, and one of the second frequency, each with an amplitude proportional to the corresponding original amplitude.
- (c) One with a frequency equal to the difference, and one with a frequency equal to the sum of the original frequencies, each with an amplitude proportional to the product of the original amplitudes.

The component to be selected depends on the operation considered.

Modulation.—If the operation is modulation $\omega_1/2\pi$ is, say, the carrier frequency, $\omega_2/2\pi$ is, say, a representative pure tone sound frequency and $(\omega_1 - \omega_2)/2\pi$ and $(\omega_1 + \omega_2)/2\pi$ are the two sidebands which arise as shown above, at the transmitter because of the non-linear modulation process performed nowadays by a valve.

Broadcasting stations at present transmit the carrier and both sidebands, but for some purposes such as commercial radio-telephony only one side-band, or the carrier and one side-band may be transmitted to economise power, the unwanted side-band being rejected by a filter, and the carrier by a push-pull or balanced modulator.

Reception.—The carrier and both side-bands or the carrier and one side-band can be dealt with by a normal receiver, but if only one side-band is

received, a local oscillator must supply the suppressed carrier frequency $\omega_1/2\pi$ before the detector stage.

Detection.—The simple analysis previously given can be extended to cover the application of voltages $A_1 \sin \omega_1 t$; $A_2 \cos (\omega_1 - \omega_2) t$ and $-A_2 \cos (\omega_1 + \omega_2) t$ to a detector and it will be found that two terms contribute to the current at the frequency $\omega_2/2\pi$, which terms have magnitudes proportional to $A_1 A_2$ and $A_1 A_2$ respectively, which means that both sidebands contribute to the low frequency output. Only the frequency $\omega_2/2\pi$ is normally accepted by the output circuit of the detector.

Frequency Changing.—When part of the pre-detector amplification is to be carried out at a frequency other than the signal frequency (i.e., in superheterodyne reception) a non-linear characteristic is again required. Two voltages, one at signal frequency and the other at local oscillator frequency, are applied in series to a valve. The anode current when analysed in a similar manner to the simple treatment given earlier, can be seen to have components at new frequencies, one of which, the intermediate frequency circuit accepts $I_1 = k A_1 A_2 \cos (\omega_1 - \omega_2) t$, or in some cases the other component $I_2 = k A_1 A_2 \cos (\omega_1 + \omega_2) t$ is used as in the once popular single-span receiver.

The various methods of using valves as frequency changers may be summarised conveniently as in Table A which follows approximately a classification given by Strutt. The numbers in the table refer to the schematic arrangements given in Fig. 1. Table A shows the more important frequency changers in larger type and it may be noted that three of these, the pentode, the octode, and the heptode mixer (6L7, etc.) owe some of their success to their high anode impedance (as compared respectively with the tetrode, the self-oscillating heptode and the mixing hexode³), which is due to the suppressor grid.

The action of the suppressor grid is not only to prevent secondary emission from the anode reaching the screen, but also to prevent screen secondary emission from reaching the anode, the latter effect being the more important one in H.F. valves.

Double-grid Valves.—Double-grid frequency changers have now become popular and are therefore worthy of particular attention. The anode current varies with the voltage applied either grid; a characteristic is the

* Mullard Radio Valve Co.

TABLE A.
VALVE FREQUENCY CHANGERS.

No. of electrodes.	Variable conductance.	Variable mutual conductance.	Grid-anode method.	Double grid mixing or reciprocal conductance.		
				Mixers only.	Self-oscillating mixers.	
2	Diode. (1)					
3	"Autodyne" Triode with grid current. (2)	Triode. (2)	Triode.			
4		Tetrode.	Tetrode. (4)	Bi-grid. (5)		
5		PENTODE.*	Pentode	PENTODE* with suppressor grid injection.		
6				MIXING HEXODE.* (10)	Hazeltine "Emission Valve." (9)	Philips† E 448 (8)
7				MIXING HEPTODE 6 E 7. (11)	PENTAGRID or heptode. (6)	
8						OCTODE. (7)

Notes to Table A :—* These types have a separate oscillator triode which, however, is incorporated in the same envelope in such valves as the triode-pentode and triode-hexode.
† In the Philips E 448 valve, the negative mutual conductance between a control grid and a preceding positive grid is utilised, while in the other self-oscillating mixers the positive mutual conductance between a control grid and a succeeding positive electrode is used to maintain oscillations.

reciprocal conductance. This quantity is a static characteristic expressing the "goodness" of a valve as a mixer for small signals. It will be noted that the output is proportional to the amplitude of the local oscillator; in practice there is an optimum amplitude because of the inability of the valve to handle large signals.

To return to the above treatment; after the step giving the alternating component of the anode current as

$$I_a = S_1 A_1 \sin \omega_1 t + S_2 A_2 \sin \omega_2 t + \frac{\Delta S_1}{\Delta v_2} A_1 A_2 \sin \omega_1 t \sin \omega_2 t$$

Kammerloher proceeds in his treatment :—

$$I_a = \left[\sqrt{(S_1 A_1)^2 + (S_2 A_2)^2 + \frac{2 S_1 A_1 \cdot S_2 A_2 \cos (\omega_1 - \omega_2)}{\omega_1 + \omega_2} \sin \left(\frac{\omega_1 + \omega_2}{2} t + \phi \right)} + \frac{1}{2} \frac{\Delta S_1}{\Delta v_2} A_1 A_2 \cos (\omega_1 - \omega_2) t - \frac{1}{2} \frac{\Delta S_1}{\Delta v_2} A_1 A_2 \cos (\omega_1 + \omega_2) t \right]$$

which is evidently an equivalent mathematical equation, but he deduces from this that the alternating current contains the following three "objectified" frequencies: $(\omega_1 + \omega_2)/4\pi$; $(\omega_1 + \omega_2)/2\pi$ and $(\omega_1 - \omega_2)/2\pi$ any one of which could be filtered out by a suitable resonant circuit. In the later part of the paper which is concerned with checking these theoretical results by taking actual oscillograms,

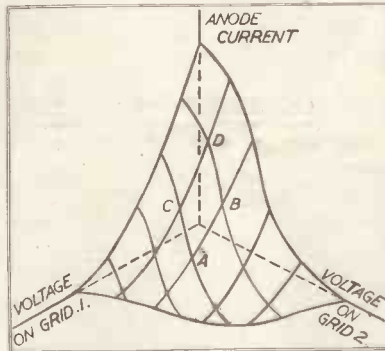

Fig. 2. Characteristic for double-grid frequency changer.

Kammerloher verifies the existence and magnitude of the current components of frequencies $(\omega_1 + \omega_2)/2\pi$ and $(\omega_1 - \omega_2)/2\pi$, but fails to find the frequency $(\omega_1 + \omega_2)/4\pi$. He ascribes this to the fact that he had not the means of filtering out this frequency! The explanation is not the lack of a suitable resonant circuit, but that there is no component at this frequency, and the warning to take is that physical deductions should not be made from the results of employing mathematical operations which have no physical counterpart. It should have been quite clear that the expression

$$\sqrt{(S_1 A_1)^2 + (S_2 A_2)^2 + \frac{2 S_1 A_1 \cdot S_2 A_2 \cos (\omega_1 - \omega_2)}{\omega_1 + \omega_2} \sin \left(\frac{\omega_1 + \omega_2}{2} t + \phi \right)}$$

does not represent a simple harmonic voltage of frequency $(\omega_1 + \omega_2)/4\pi$ because there is a harmonic term under the root sign, instead of this "amplitude" factor being a constant.

Distortion.—There are certain faults incidental to the use of a valve both in the applications quoted above, and where the non-linear characteristic is an undesirable feature. These are modulation rise and cross modulation in the H.F. stages and amplitude distortion in the L.F. stages. Modulation rise and amplitude distortion introduce harmonics of the required audio frequencies, and cross-modulation is the introduction of new frequencies from an unwanted modulated carrier.

At the detector we may get undesired effects, for example the apparent demodulation of a weak signal by an adjacent strong carrier; also as the detector input is increased until the valve is overloaded, we find that combination and difference frequencies between two sound frequencies and between harmonics of the required frequencies, rise rapidly in amplitude. This accounts for the very marked fall of quality of reproduction in a radio receiver when a detector is overloaded as compared with slightly marred quality when say the output stage is overloaded.

At the frequency-changer there is the possibility of introducing a "whistle" due to each new frequency beating with the oscillator fundamental or with a harmonic of the oscillator frequency. Modulation hum is another fault arising due to the non-linearity of a valve handling an H.F. signal. A voltage at the mains frequency is applied to the grid of the valve accidentally, and modulates the anode current at the same time as the received carrier, so giving rise to combination and difference frequencies which pass through the H.F. circuits.

External Cross-modulation.—Electromagnetic waves travelling in free space provide an example of vibrations applied to a perfectly linear

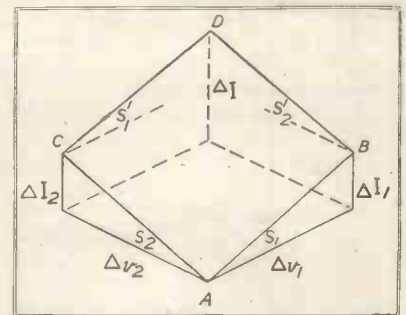

Fig. 3. Magnified view of the element ABDC of Fig. 2.

TABLE B.
SOME APPLICATIONS OF NON-LINEAR CURRENT POTENTIAL CHARACTERISTICS.

Application Device.	Modulation.	Detection.	Frequency Multiplication.	Measuring Instruments, Apparatus and Special Applications.
Crystal.		Carborundum or galena crystal detector.		
Metal-Oxide pair.	CARRIER CURRENT TELEPHONY.	"WESTECTOR" In radio receivers; also in CARRIER CURRENT TELEPHONY.		Mixer in beat frequency generator.
Coil with core of variable permeability.	Alexanderson's Method.	Marconi's Magnetic Detector.	Von Arco (Telefunken) Method.	Voltage regulating transformer.
Low pressure gas discharge (before the onset of arc or spark discharge).	"Luxembourg Effect."	"Soft" triode and Alkali Vapour Detector Tubes.		Various applications of the GAS DISCHARGE TRIODE or "Thyratron."
Thermionic Valve (pure electron discharge).	(i) Grid circuit injection. (ii) ANODE CIRCUIT INJECTION (Helsing).	(i) DIODE. (ii) "GRID" DETECTION WITH TRIODE. (iii) ANODE BEND DETECTION WITH TRIODE.	SHORT-WAVE TRANSMITTERS utilise frequency doubling with valves.	(i) VALVE VOLT-METER. (ii) Oscillators rich in harmonics, e.g., multiplier. (iii) Balanced modulator for carrier suppression, etc.

responder, and although waves of many different frequencies may be present at the same time, no interference between them is observed. If, however, a layer of ionised gas is interposed in the field of these waves new frequencies result.

We have an example of this in the "Luxembourg Effect" which is a special type of cross-modulation.* Presumably the Heaviside, Appleton . . . etc., layers in the upper atmosphere also give rise to harmonics of radio waves, and this may be an explanation of freak receptions of radio stations, on circuits tuned to a frequency which is a multiple of the allotted carrier frequency. Workers in one of the R.C.A. laboratories⁵ have observed cross-modulation external to a receiver, due to some nearby transmission line or faulty pipework having a non-linear characteristic. The offending metalwork may thus have an output at the frequency to which the receiver is tuned, on which is superimposed the modulation of a station working on quite a different frequency. It is clear that modulation hum can also arise due to this cause, and would be picked up by either a mains driven receiver or a battery receiver.

Summary of Applications

Table B summarises the more familiar applications of non-linear characteristics. Some are of historical interest only, while the important ones are in larger type. Although the "Luxembourg Effect" is not an "application," it has been included to show its relation to the rest of the table. Frequency changers would occupy another column had they not been given in table A. Presumably,

the gaps in the table B could be filled up, and also other devices than the valve be used for frequency changing if the incidental difficulties were surmountable.

Other non-linear characteristics in radio reception.

There are two main classes of applications of non-linear characteristics which cannot be dealt with here, and the reader may find it instructive to construct an extension to table B summarising these. They are (a) rectification for D.C. supply (metal-oxide, diode, mercury vapour hot cathode tube, mercury arc, and point-plane discharge) (b) variable bias systems including: variable Mu valves, automatic volume control, battery economy circuits, and methods of restoring the D.C. component in television signals.

BIBLIOGRAPHY

- "On Conversion Detectors," M. J. O. Strutt. *Proc. I.R.E.*, August, 1934.
- "Theory of the Mixing Hexode," J. Kammerloher. *Hoc. Tech. u. Elect.*, May, 1934.
- "The Triode-Hexode," E. E. Shelton. *Wireless World*, October, 5th, 1934.
- "The Interaction of Radio Waves," V. A. Bailey. *Wireless World*, February 26th and March 5th, 1937.
- "External Cross-Modulation," D. E. Foster. *R.C.A. Review*, April, 1937 p. 18.
- "Frequency Changer in All-Wave Receivers," M. J. O. Strutt. *Wireless Engineer*, April, 1937.

See also the *Theory of Thermionic Vacuum Tubes*. Chaffee (McGraw Hill), and the bibliographies at the end of the papers⁵ and⁶ by Strutt.

BOOK REVIEWS

Problems in Radio Engineering (5th Edition) E. T. A. Rapson, 136 pp. and figs. (Sir I. Pitman and Sons, 5/- net.)

The question of what constitutes a satisfactory training for radio engineers is being discussed at the present time by the responsible bodies, and it is generally agreed that a form of Higher National Certificate corresponding to that in electrical engineering will be essential for the radio industry.

At the Southall Technical College the author has been conducting a class in radio engineering as part of the National Certificate course and the problems collected in this book are reproduced from past examination papers.

Each section is prefaced by a short summary of the formulæ or methods involved in the solution of the problems and there are also reference to appropriate textbooks.

Both teachers and students of radio engineering will find this book of great use—in fact it is essential, to use an overworked word.

Experimental Radio Engineering. (2nd Edition) E. T. A. Rapson, 152 pp. and Appendix. (Sir I. Pitman and Sons, 8/6 net.)

This may be considered as a companion book to the above. Over 70 experiments in radio engineering are described ranging from series and parallel circuits to electro-acoustic tests.

The procedure is described for each experiment and a sample of the results is given in most cases. The student is invited to state his conclusions from each experiment, which can then be compared with those given by the author at the end of the book.

Where a large class is engaged on experimental work the question of shortage of apparatus always arises, and unless the author's department is singularly well-equipped with oscillators not many of the experiments can be performed simultaneously.

There seems to be no reason why such tests as valve characteristics and some of the a.f. measurements should not be done with the 50 c/s mains and the author might point this out in future editions (if he agrees).

Dictionary of Scientific Terms. C. M. Beadnell, 232 pp. and supplement. (Watts & Co., London, 2/- net.)

An excellent pocket dictionary issued in the "Thinker's Library" series. Over 6,000 terms are explained and the supplement contains useful physical data and constants. Well worth the money.



But why

THE commandos of industry—those executives whose minds are at once enquiring and courageously receptive to new ideas—are storming the barriers of outworn custom.

Tested and proved in the hard school of industry, the products of the Simmonds Organization are daily presenting the vital short cut to simplicity of manufacture, economy of manpower and acceleration of output.

S I M M O N D S

THE SIMMONDS "1037" NUT
SIMMONDS-CORSEY CONTROLS
SIMMONDS CONTENTS GAUGES
FOR AIRCRAFT.
SIMMONDS POSITION INDICATORS
SIMMONDS ELECTRIC TEMPERATURE
AND PRESSURE GAUGES
SIMMONDS AIRCRAFT FLOORING



SPIRE "1037" NUTS
FRAM OIL & ENGINE CLEANER
SIMMONDS INDUSTRIAL AND
MARINE CONTENTS GAUGES
SIMMONDS JOINTING COMPOUND
SIMMONDS CRYSTAL UNITS
SIMMONDS-GOUDIME
NAVIGATIONAL INSTRUMENTS

SIMMONDS AEROCESSORIES LTD

A COMPANY OF THE SIMMONDS' GROUP
LONDON · MELBOURNE · PARIS · NEW YORK.

P.12.

ALL ENQUIRIES TO GREAT WEST ROAD, LONDON.

R.F. Power Measurement

A Convenient Bolometric Method

By W. BACON, B.Sc. (Eng.)

A CONVENIENT method often adopted for measuring R.F. power consists in applying the power to a load incorporating a lamp. The light output of the lamp is measured, either by means of a photo-electric cell or by comparison with a second lamp of known power consumption. A reading depending on the R.F. power is thus obtained.

When using the photo-electric cell this reading appears on a current meter. In the comparison method it is usual to increase the current and voltage of the second lamp till it is of the correct brilliance and then measure both current and voltage. Two measurements and a calculation are thus necessary.

It is possible, however, to use an improved form of this method, which, with accuracy of at least the same standard, has the following advantages:

- (1) Direct reading of power.
- (2) Power directly proportional to meter reading.
- (3) Elimination of human element involved in adjusting two lamps to equal brilliance.
- (4) Necessitates one D.C. meter only, the exact range of which is not critical.

The fundamental idea is of particular interest since it appears to have received a good deal of attention in Germany and has there been applied to the measurement of powers at wavelengths of the order of 20 cm.^{1,2} The German articles not being available to the writer he is unfortunately unable to comment on them.

The present article shows a scheme suitable for measuring powers of the

order of a few watts at frequencies around 100 Mc/s.

The Bolometer

The bolometer forms the basis of the method. The fundamental circuit of this (see Fig. (1)) is a bridge, one arm of which contains an element the value of which is varied by the power it is desired to measure. A flash lamp bulb provides a cheap and suitable element, though it is not, of course, the only one which might be used.

If the meter is balanced when the R.F. power is zero, the meter will read zero for zero power and its pointer will move across the scale as power increases and the bridge becomes unbalanced. A direct reading of power is thus obtained.

Separation of D.C. and A.C. Components

Components

The simple method so far described suffers from the following disadvantages:

- (1) R.F. is present in the source of D.C. supply.
- (2) D.C. is present in the source of R.F.
- (3) When the bridge goes off balance a radio-frequency current flows through the meter. This may be much larger than the direct current which the meter normally passes and there is therefore considerable danger of burning out the meter. This danger is greater since it is concealed; even though on the point of burning out the meter needle may not be deflected by the R.F.

In order to overcome these disadvantages the output load into which the R.F. power is fed is split into two parts as shown in Fig. (2). Each half consists of a resistance, absorbing the

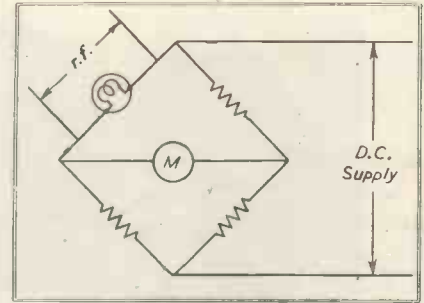

Fig. 1.

bulk of the power, in series with a flashlamp bulb. The junctions of the resistances and bulbs are connected to the two points on the bridge where the single bulb formerly went.

The network ABCD then forms a second bridge. An e.m.f. applied between the points A and C will have no effect on the potential between the points B and D; and an e.m.f. between B and D will have no effect on the potential between A and C.

Thus no R.F. is fed to the D.C. bridge, and no D.C. is fed to the source of R.F. The resistance of the lamps is, however, still affected by the R.F. power, and can also throw the bridge out of balance. The meter accordingly deflects in the same way as before. This time, however, it passes no R.F. current.

D.C. Voltage Required

It will be seen that the D.C. voltage applied and the meter range are interconnected. Thus if the applied D.C. is increased a meter of lower full scale deflection can be used and vice versa; or alternatively, for a meter of given full scale deflection, increasing the D.C. voltage will increase the R.F. sensitivity. This is subject to the restriction that the D.C. through the lamps must be small compared with the R.F.

The system is thus flexible enough to meet a wide range of conditions. The D.C. voltage required for a given meter may be calculated as follows:

Let resistance of lamps = R_4 total at zero R.F.

Let resistance of lamps = R_5 at any other R.F. power which is required to produce full deflection.

Let E = voltage of D.C. supply.

Let R_1, R_2 = resistance of remaining bridge arms as marked.

Let R_M = resistance of meter.

Let I_M = current through meter at full scale deflection.

Let $R_3 = k.R_4$.

By Thevenin's Theorem, assuming the D.C. supply is of negligible resistance, the circuit of Fig. (3) may be replaced by the equivalent circuit of Fig. (4).

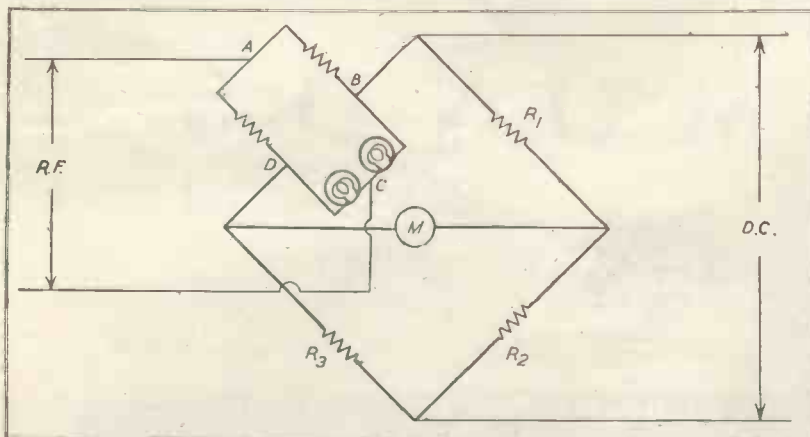

Fig. 2.

Then $I_M =$

$$E \left\{ \frac{R_2}{R_1 + R_2} - \frac{R_3}{R_3 + R_5} \right\}$$

$$\frac{1}{1/R_3 + 1/R_5} + \frac{1}{1/R_1 + 1/R_2} + R_M$$

$$E \left\{ \frac{1}{1 + R_1/R_2} - \frac{1}{1 + R_3/R_5} \right\}$$

$$\frac{1}{1/R_3 + 1/R_5} + \frac{1}{1/R_1 + 1/R_2} + R_M$$

But

$$\frac{R_5}{R_3} = \frac{kR_1}{R_3} = \frac{kR_1}{R_2}$$

$$E \left\{ \frac{1}{1 + R_1/R_2} - \frac{1}{1 + kR_1/R_2} \right\}$$

$$I_M = \frac{1}{1/R_3 + 1/R_5} + \frac{1}{1/R_1 + 1/R_2} + R_M$$

Generally R_M is much greater than the other terms in the denominator. If this is so, then neglecting them in comparison with R_M ,

$$I_M = \frac{E}{R_M} \left\{ \frac{1}{1 + R_1/R_2} - \frac{1}{1 + kR_1/R_2} \right\}$$

$$\text{or } E = \frac{I_M R_M}{\frac{1}{1 + R_1/R_2} - \frac{1}{1 + kR_1/R_2}}$$

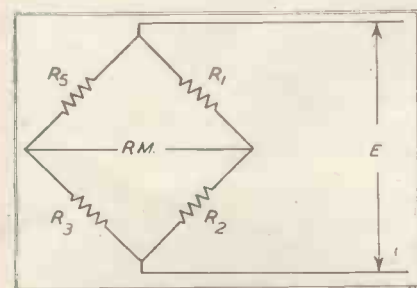

Fig. 3.

Results Obtained

The practical circuit used is shown in Fig. (5). The meter has a resistance of one hundred ohms with a full scale deflection of 1 mA. One of the bridge resistances is made variable in order that an initial balancing of the bridge to compensate for small changes may be carried out.

With the bridge D.C. voltage adjusted to 0.34 volt the curve of power input-meter reading shown in Fig. (7) was taken. It will be seen that sensitivity is greatest on the lowest portion of the curve, and in particular that between 0.1 and 0.4 milliamps the curve may be considered linear.

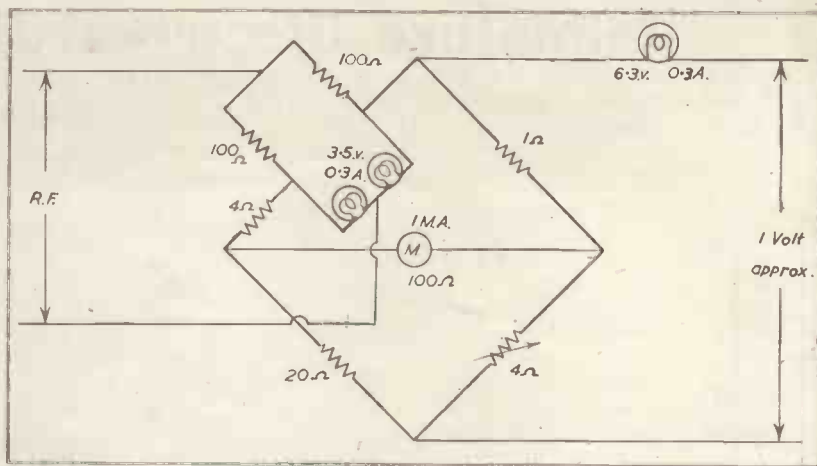

Fig. 5.

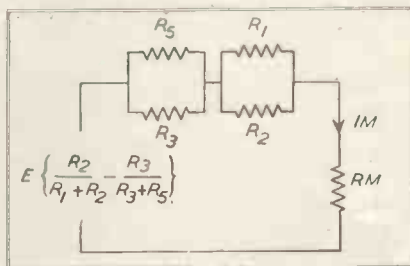

Fig. 4.

If the bottom bend of the curve is eliminated by increasing the standing current of the lamps a direct reading power meter is obtained in which meter deflection is directly proportional to power. The use of a 100 micro-amp meter would thus give full scale reading for a power of approximately half a watt.

Lamps Used

The lamp used had a rating of 3.5 volts 0.3 amp. The lamp rating determines the power input which can be handled; it is necessary to work with a current through the lamp much smaller than its normal one. The power-deflection curve departs from linearity as the point at which the lamp begins to glow is approached.

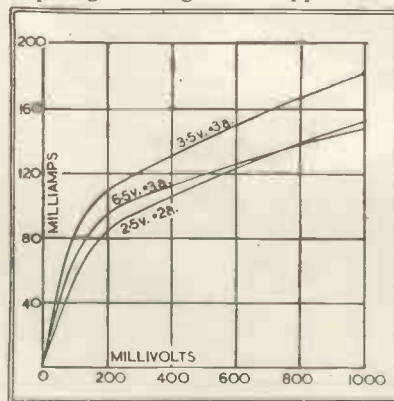

Fig. 6.

To handle a greater input would necessitate the use of a lamp with a greater current rating. Typical curves for various lamps are shown in Fig. (6). The knee of the curve occurs approximately at the point where the lamp begins to glow. For linearity it will be seen that it is thus advisable to restrict the lamp current to one quarter of its normal value.

Stabilisation

As it stands the apparatus is very sensitive to any variations of the D.C. supply. The effect of these at zero input may be counteracted to some extent by inserting lamps in the resistance arm connected to the lamp arm and the D.C. source, and making these two arms approximately equal. This does not, however, pre-

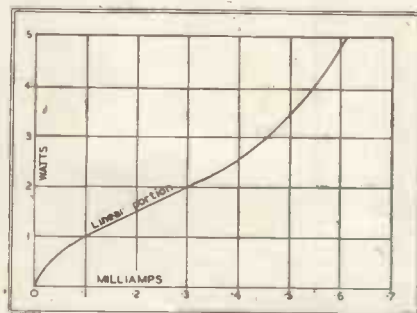

Fig. 7.

vent errors from occurring when there is R.F. input.

A simple stabilising system may be made by connecting a lamp between the D.C. source and the bridge, of such a rating that it is working just above the knee of the current voltage curve. Changes in input voltage then cause much less than proportionate changes in current. The effect of this is an improvement of the order of 5 to one.

1 Wallauschek, E.N.T., November, 1941.
2 H. Melnke, E.N.T., March/April, 1942.

Miniature Electrocardiography

The Both Electrocardiograph, of which a description is given below, is noteworthy for the method used for obtaining the record and for its extreme portability. The information and photographs are supplied by courtesy of Messrs. Stanley Cox Ltd., the makers

THE main problems in the design and construction of electrocardiographs are in the high gain required for producing a readable trace on the recording apparatus and the method of obtaining a permanent record which can be filed for reference.

A high gain amplifier capable of reproducing the complex cardiogram wave-form usually requires to be battery operated in its initial stages and is sensitive to microphony and vibration. Background "mush" is also prominent owing to the comparatively large number of stages and special precautions have to be taken against external interference being magnified to such an extent as to mar the record.

The usual method of obtaining a permanent cardiograph record is by photographic means, the trace on the screen of the cathode-ray tube or galvanometer being focused on to bromide paper which is run through the camera at a known speed. Some types of cardiograph employ ink writers which have the advantage that the operator can see the whole series of heart beats without the delay of photographing and developing the record. Such ink writers, however, require power for their operation and involve extra amplifying stages and considerably increased weight.

In the Both (pronounced to rhyme with Goth) Cardiograph, an ingenious method has been used to overcome some of the disadvantages mentioned above. The principal feature is that the amplification of the record is partly accomplished by optical means and the electrical amplification is correspondingly reduced. This saves one stage in the amplifier and considerably reduces the weight and size of the equipment. The low gain used in the amplifier stages give a correspondingly quiet background to the trace. The record which might be accurately described as a "micro-record" is traced directly in a semi-permanent form and can be observed while being recorded—one of the most desirable features in an electrocardiograph.

The Record

The cardiogram is recorded on a smoked disk of glass about 3 in. in diameter, driven at a speed of 1 revolution in $4\frac{1}{2}$ minutes by a clockwork



View of top panel of Electrocardiograph, showing recording disk and microscope in place. The patient leads are plugged into the sockets near the front edge.

The sockets on the left are for the insertion of a calibrating milliammeter. The microscope folds flat on the panel for transport.

motor mounted on the underside of the top panel. (Fig. 1).

A diamond stylus presses on the under surface of the disk and traces a miniature cardiogram approximately $1/40$ th standard size. The stylus mounting can be moved radially across the smoked surface so that a single continuous spiral record can be traced lasting for 27 minutes. Alternatively 3 or 6 traces from separate leads can be recorded, one below the other, without overlapping.

Above the disk is mounted a microscope through which the trace is observed while it is being cut. A miniature lamp under the edge of the disk transilluminates the record and throws it up as a thin white line on the black background.

The record is sufficiently permanent to be stored and referred to at any time. The permanent filing record is made by printing from the disk on to paper which is already marked with the standard scales (Fig. 2). To do this, the disk is placed in position on an enlarger and turned to present the portion it is desired to print. Before printing the record the bromide paper

is first exposed to a negative which reproduces the standard scale markings (1 cm. to 1 mV.) and these will then appear simultaneously with the trace on development. The enlarger is adjusted to magnify accurately forty times, and the finished cardiogram is thus of standard size.

It is not necessary to use one disk per patient, and in practice up to twenty patients could be recorded on one disk with suitable identification markings which would appear on the finished print.

Amplifier

The amplifier is housed on the opposite side of the cabinet to the recording apparatus and is a standard three-stage battery operated circuit using two pentodes (W.21) and a power triode (L.P.2) for driving the stylus.

The H.T. required is 100 v., from a standard H.T. battery, the consumption being less than 5.0 mA. A small 2 v. accumulator in the base of the cabinet supplies the valve and the pilot lamp for illuminating the record. The time constant of the stages is 6 seconds.

Re-Entrant Loops on a C.R. Tube

An Improved Circuit for Frequency Comparison

The output from the amplifier is fed to a moving coil of the usual type, mounted in a permanent magnet field. The whole field magnet and coil system is coupled mechanically to the lead selector switch, so that the stylus is automatically moved to a fresh position on the record when the connexions to the leads are changed. When the record is finished, operation of the "off" switch depresses the stylus clear of the disk and switches off the lamp. A separate switch is used for the amplifier.

Calibration

In order to ensure that the finished record is of standard size, the gain of the amplifier must be carefully checked before each series of recordings. This is done by injecting a calibrating voltage of 1.0 mV. into the amplifier circuit from a known resistance. This is supplied from the 2 v. cell through a meter having a fixed calibration mark, and the pointer is adjusted to the mark by a pre-set potential divider on the panel. On turning the selector switch to "Calibrate," a series of square-topped waves is traced on the disk, the interruption of the D.C. being made by a small contact breaker driven from the recording motor shaft.

The calibration meter also serves to indicate the state of the 2 v. accumulator, as when it is run down it will not be possible to set the pointer up to the calibration mark on the scale.

Cabinet

In addition to those mentioned the top panel (Fig. 1) carries sockets for the input leads from the patient (which are kept in a drawer at the bottom of the cabinet), control switch marked "Off"; "Light"; "Light and Trace," for operating the recorder, and a gain control knob.

The calibration check meter is plugged into sockets at the front of the panel, and is normally kept out of circuit when not required.

The cabinet measures only 10 in. by 8 in. by 16 in. and weighs 40 lb. It is an excellent example of joinery with the sloping sides to the panel recess and neat finish of the cover. The magnifier folds flat over the panel when packed for transport, and the whole cabinet can be carried without any effort.

It is possible that other uses for this novel combination of optical and electrical recording will suggest themselves. Of its portability and convenience there can be no doubt, and ingenious workers could adapt the record for direct projection on to a screen and turn it into a useful demonstration apparatus for a variety of electrical phenomena.

G.P.

IN a paper before the Physical Society* in 1924 Dye showed how two widely differing frequencies could be compared by a combined magnetic and electrostatic deflection of the beam of a cathode-ray tube. A circular trace is obtained on the screen by means of a phase-splitting circuit and the higher frequency is applied both in series with one of the deflector plates and to a pair of coils mounted outside the neck of the tube.

By rotating the plane of the coils relative to the deflector plates, the radial movement of the beam is modified by the magnetic field of the coils and the trace becomes re-entrant, forming a series of loops on the circumference of the circle. (Fig. 1).

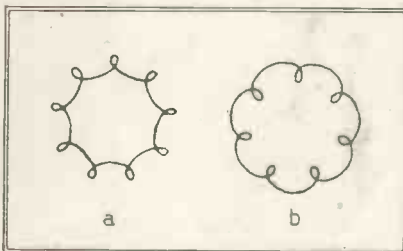

Fig. 1. Re-entrant traces produced by combined magnetic and electrostatic deflection at different frequencies.

These loops can be inverted or everted, depending on the relative direction of rotation of the forces on the beam. If the direction of movement of the loops is the same as that of the circle, the ratio of the two frequencies is obtained by adding one to the number of loops. If the direction of rotation of the circle is opposite to that of the loops (everted loops of Fig. 1a) the frequency ratio is one less than the number of loops.

An improved circuit, avoiding the extra complication of a pair of deflecting coils, has been described by G. H. Rawcliffe in a recent paper published in the *Journal of the Institution of Electrical Engineers*.†

The circuit, which is shown in Fig. 2, is a double phase-splitting circuit in which each of the alternating sources is divided into two components in phase quadrature, one component from each source being applied to the vertical plates and one to the horizontal plates of the tube.

After phase-splitting, each source would produce a circular or elliptical trace on the screen and when the two effects are combined the same type of deflection as Dye's is produced.

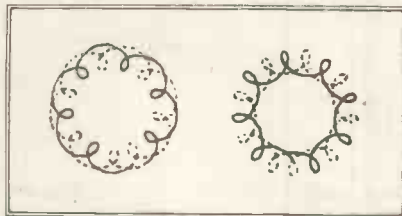

Fig. 3. Duplex traces produced by fractional ratios.

In order to add the two deflecting force vectors, suitable a.f. transformers are used and if necessary amplifiers may be interposed between the deflecting potentials and the plates.

If the higher frequency is a fractional multiple, e.g., 9/2, 5/2 of the lower frequency, the trace becomes as in Fig. 3. The author shows that the frequency ratio can then be expressed as $(T \pm m)/m$ where T is the total number of loops and m the degree of multiplicity. The multiplicity can be deduced by counting the number of loops for similar and opposed rotations, and halving the difference between them. The calculation of the higher frequency in complex patterns which are drifting (owing to the frequency being an inexact multiple) is shown to give the frequency ratio as:

$$r = \frac{T \pm m}{m} \frac{\phi T}{mf_1}$$

where the angular velocity of the drift is $2\pi\phi$ and f_1 is the lower frequency.

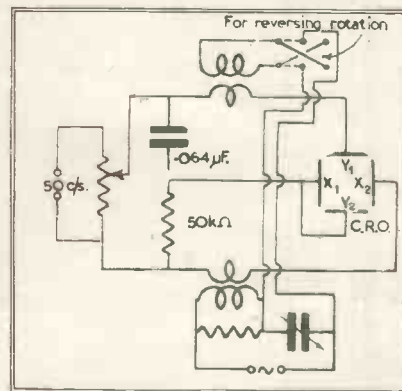

Fig. 2. Improved circuit for producing re-entrant traces.

The author also describes a method of finding the direction of rotation of a circular time base by connecting an auxiliary condenser across the resistive part of the phase-splitting circuit. From the direction of the major axis of the resulting ellipse on the screen the direction of rotation of the original circle can be deduced.

* Proc. Phys. Soc. 37, p. 158, 1924-5.
† Jour. I. E. E. Vol. 89 Pt. 3 p. 191, 1942

Planned Science

Further Correspondence

DEAR SIR,—Referring to the articles of Messrs. Baker and Bernal in recent issues—the important point is, who is to do the planning, and with what end in view? I think there is no real difference of opinion between the two learned men of science who have opened this discussion—Dr. Baker would surely not deny the advantages of free exchange of information between scientific workers, which exchange must certainly be organised according to some plan, and Dr. Bernal obviously does not contemplate any “regimentation” of men of science of the kind feared by Dr. Baker. But there they both stop, and it is now up to somebody else to continue this extremely interesting and supremely important discussion. A “plan” of some sort for scientific development after the war seems an obvious necessity. But until he knows who is going to use him in such a plan, and what the real, behind-the-scenes, objectives of the planners are, even the least sophisticated man of science must regard with caution attempts at canalising his work and talents. The appalling misuse of scientific discovery and its applications during even this century, which is going on right now in a particularly sensational manner, must constitute a grave warning to all decent scientific workers and technicians of the dangers of anti-social exploitation by mercenary and narrowly nationalistic interests. Plans are made, it must be remembered, by devils as well as angels, and the former can make use of the plans of the latter. A plan for science would be good. A plan for the use of science would be far better. And that—the fact must be faced sooner or later by all those concerned in the progress of science—means going in for “politics” and taking an active part in the grim and distasteful hurly-burly of unscientific human affairs. Are men of science, and their assistants the technicians, willing to do this? They owe it to the community that makes their activities and livelihoods possible. They have no right to set giant forces loose in society and then blandly deny all responsibility for the results on the plea that they are only interested in “pure” science. If they are going to take a hand effectively in human affairs after this war, it is high time they devoted to “politics” some of the impartial criticism and cool study that they lavish upon inanimate objects, and, when they have decided

upon what is desirable action, to take it unswervingly and without being corrupted and misused by selfishly interested parties. If they do not, they will become even more of a curse to suffering humanity than they have been in the past, and if they get very short shrift from an eventually infuriated and despairing mankind, they will have only themselves to blame.

London.

RECONSTRUCTOR.

SIR,—Every reader of Prof. J. D. Bernal's book, *The Social Function of Science*, must have noticed that it contains passages directly contradictory to the main thesis. These passages left open a way of escape by confusion of the issue, against the time when the inevitable attack on the main thesis should come. Now that the attack has come and grows steadily in weight, Prof. Bernal parades the contradictory passages as though they contained the essence of his message. In so far as Prof. Bernal contradicts his main thesis, he and I agree.

Let it be remembered that Prof. Bernal sneered at science outside the Soviet Union as an elegant pastime and a cheap source of profit (*New Statesman and Nation*, Feb. 24, 1940). He likened the pursuit of pure science to the solution of crossword puzzles and the reading of detective fiction (*Social Function*, p. 97). He attacked the ideal of pure science as presented by Thomas Henry Huxley, and said that it was a form of snobbery. He sought to reduce freedom in science and was a most persistent propagandist for the central planning of research. Now, in *Electronic Engineering*, he reverses his position by quoting the contradictory passages in his book.

Prof. Bernal cannot have it both ways. He first sought to implant in the growing generation of young scientists a sense of fundamental dissatisfaction with those very ideals which it is their true social function to cultivate. Now he claims that he always supported the arguments of his opponents.

The true and essential principles of scientific progress were never in danger in Britain until the advent of Prof. Bernal and the group associated with him, who now seek to retain support by a show of wisdom and moderation. The phase of moderation is exemplified in Prof. Bernal's article in *Electronic Engineering* and also in

his letter in *Endeavour* (Vol. 1, p. 91, July, 1942). These writings compare strangely with his earlier ones, and especially with the main thesis of *The Social Function of Science* and with his letter in the *New Statesman and Nation* (Feb. 24, 1940), in which the plea of academic freedom was called “mere cant” and was attributed to commercial and political vested interests. Change of opinion may be genuine and admirable, but only when the former error is frankly admitted.—Yours faithfully,

JOHN R. BAKER.

Editorial Note.—It is regretted that space does not permit further correspondence on this interesting subject. For an announcement of a lecture by Dr. Baker, see below.

Forthcoming Meetings

The Institute of Physics

The next meeting of the London Branch of the Institute of Physics will be held at the Royal Institution at 6.0 p.m. on January 20, when a paper will be read by Dr. P. K. Schofield (Rothamstead Experimental Station) on “The Distribution and Properties of a Liquid in a Pore Space.”

On February 17, at the Royal Institution, Albemarle Street, W., the annual general meeting of the Institute of Physics will be held at 6.0 p.m.

This meeting will be followed by a paper by Dr. J. R. Baker (Dept. of Zoology, Oxford University) on “Freedom in Science.”

Electronics Group

Mr. J. Maddock (Standard Telephones & Cables) has been elected Honorary Secretary of the Group in succession to Dr. Lowery, who has been acting Hon. Secretary *pro tem*.

Notice of the next meeting will be issued in due course.

Information on the constitution and activities of the Electronics Group can be obtained from the Secretary, The Institute of Physics, Reading University, or from the offices of this journal.

British Kinematograph Society

At a meeting to be held in the Gaumont British Theatre, Wardour Street, W.1, on February 17. Mr. A. E. Carrick will read a paper on “Set Design and Construction.”

Tickets for non-members can be obtained from the Hon. Secretary, Mr. R. Cricks, Dean House, Dean Street, W.C.2.

"Just the Contact for the Job"



Write for Booklet 112, giving details of J. M. C. contacts and contact materials.



The selection of suitable contact materials and types of contact, presents problems to designers in all grades of electrical engineering. It is accordingly our keen desire to be of service by presenting the fullest available information and guidance to those who seek assistance in determining the most suitable contact for a specific job. May we assist you?

JOHNSON, MATTHEY & CO. LIMITED

73/83, HATTON GARDEN, LONDON, E.C.1

Telephone: HOLBORN 6989

PAINTON COMMUNICATION COMPONENTS

WIRE WOUND POTENTIOMETERS

PAINTON & CO. LTD.

NORTHAMPTON

HEWLETT-PACKARD



LELAND INSTRUMENTS LTD.

Resistance Tuned Oscillators Model 200, covers the Frequency Range of 7-200,000 cycles per second Write for full details of the series.
21, JOHN ST., BEDFORD ROW, LONDON W.C.1.
TELEPHONE: CHANCERY 8765

Clough-Brengle • Boonton • Ferris • Ballantine • Hewlett-Packard

ABSTRACTS OF ELECTRONIC LITERATURE

THERMIONIC DEVICES

A 20 Million Electron-Volt Betatron (D. W. Kerst)

The details of construction of an improved induction accelerator which gives electrons 20 million electron volts energy are described. The accelerator has a 19 inch diameter pole face and weighs approximately 3.5 tons. The X-ray output as measured in a thick wall ionisation chamber is 16 r.p.m. at one metre. The most important improvement incorporated in this accelerator is the electro-magnetic expansion of the equilibrium orbit which can be timed to send the electrons against the target at any desired energy up to 20 million electron volts. The accelerator is now in use at the University of Illinois.

—*Rev. Sci. Inst.*, Vol. 13, No. 9 (1942), page 387.

RADIO RECEPTION

The Frequency Stability of Tuned Circuits (C. W. Eggleston)

This paper covers the general considerations in the design of high-stability radio-frequency tuned circuits with particular reference to commercial radio-receiver development.

—*I.E.E. Students Quarterly Jour.* to be published.

Reduction of Band Width in F.M. Receivers (D. A. Bell)

This paper discusses the possibility of using a high degree of negative feedback of frequency modulation in the I.F. section of a frequency modulation receiver, for the purpose of (a) minimising the necessary I.F. band width and (b) making the detected output independent of amplitude without the use of an amplitude-limiter in the I.F. amplifier.

—*Wireless Eng.*, Vol. 19, No. 230 (1942), page 497.

MEASUREMENT

The Measurement of the Temperature Coefficient of Capacitance of Small Condensers (T. I. Jones)

A simple apparatus is described for use in conjunction with a dielectric test set for the measurement of the variation of capacitance of small condensers with temperature. Measure-

ments at room temperature—30° C., and near room temperature again can be carried out in the course of half an hour with an accuracy of 0.005 $\mu\mu\text{F}$.

—*Jour. Sci. Inst.*, Vol. 19, No. 11 (1942), page 166.

Electric Gauges (H. P. Kuehni)

A brief description is given of an electromagnetic gauge which will measure any mechanical quantity which can be translated into a relative displacement between two parts. The quantity to be measured acts upon one or more arms of an a.c. bridge and the bridge output is rectified and observed with a d.c. instrument, though for high frequencies an oscillographic recorder may be used. Mention is made of other types of electric gauges and the article is profusely illustrated.

—*G.E. Review*, September, 1942, page 533.*

CIRCUITS

Static Conversion of D.C. to A.C. with Grid-controlled Mercury-Arc Mutators (R. Feinburg)

The push-pull mutator inverter is a d.c. arrangement with grid-controlled mercury-arc mutators operating alternately and causing an a.c. to flow in the load circuit. In the case of resistance load practically any shape of alternating voltage wave-form between rectangular form and triangular form can be produced. The shape of the alternating voltage waveform depends upon the capacitance of the inverter capacitor. A large capacitance giving the alternating voltage a rectangular form and a large value making it triangular. The ripple factor of the d.c. is governed by the smoothing effect of the inductance in the d.c. circuit, a small inductance causing the d.c. to flow intermittently. The degree of regulation of alternating voltage at any change of load is determined by the capacitance of the inverter capacitor. A large capacitance may produce such a large voltage regulation that the curve of power output plotted against load describes a V form, the power output being increased when the load is reduced. The inverter stops working when overloaded.

Calculations are carried out for approximate circuit conditions. The results of experiment agree satisfactorily with the theory.

—*Jour. I.E.E.*, Vol. 89, Part 1, No. 22 (1942), page 462.

THEORY

The Zero Beat Method of Frequency Discrimination (C. F. Sheaffer)

A method of frequency discrimination in which the frequency of balance is determined solely by the frequency of the controlling oscillator is explained. The method utilises the phase turnover, which occurs at zero beat, between two beat sources when one of the beating signals is dephased by 90 degrees before it is applied to one of the beat detectors. A network is inserted in one of the beat sources which shifts in its phase an additional 90 degrees and makes its output a direct function of the frequency. The beats are then amplified and supplied to a balanced rectifier from which a direct voltage is available which changes polarity with the direction of frequency deviation.

—*Proc. I.R.E.*, Vol. 30, No. 8 (1942), page 365.

INDUSTRY

Contact Resistance (R. W. J. Cockram)

Methods of decreasing contact resistance are discussed with reference to various types of contacts. Typical means employed are the fusion of silver or special alloys on to the contact tips or increasing of the contact area and pressure. These methods are applicable to knife, point butt and line butt contacts. The design of taperbutt surface contacts for heavy currents is described and their outstanding features are pointed out. Reference is made to methods of testing rotary contact switches.

—*El Rev.*, August 21, 1942, page 231.*

"Mar Resistance" of Plastics (L. Boor)

It is shown that the term "hardness" is applied to many aspects of the behaviour of plastics and that determinations of order of hardness depend on the definition and method of measurement chosen. An adaptation of a method involving a glossmeter as used for paint films is considered and results are given for the measurement of the "mar resistance" (*i.e.*, resistance of the glossy surface to abrasive action) of plastics. The A.S.T.M. mar resistance test apparatus and the standard procedure for calculating percentage original gloss are described.

—*Mod. Plastics*, September, 1942, page 79.*

*Supplied by the courtesy of Metropolitan-Vickers Electrical Co., Ltd., Trafford Park, Manchester.

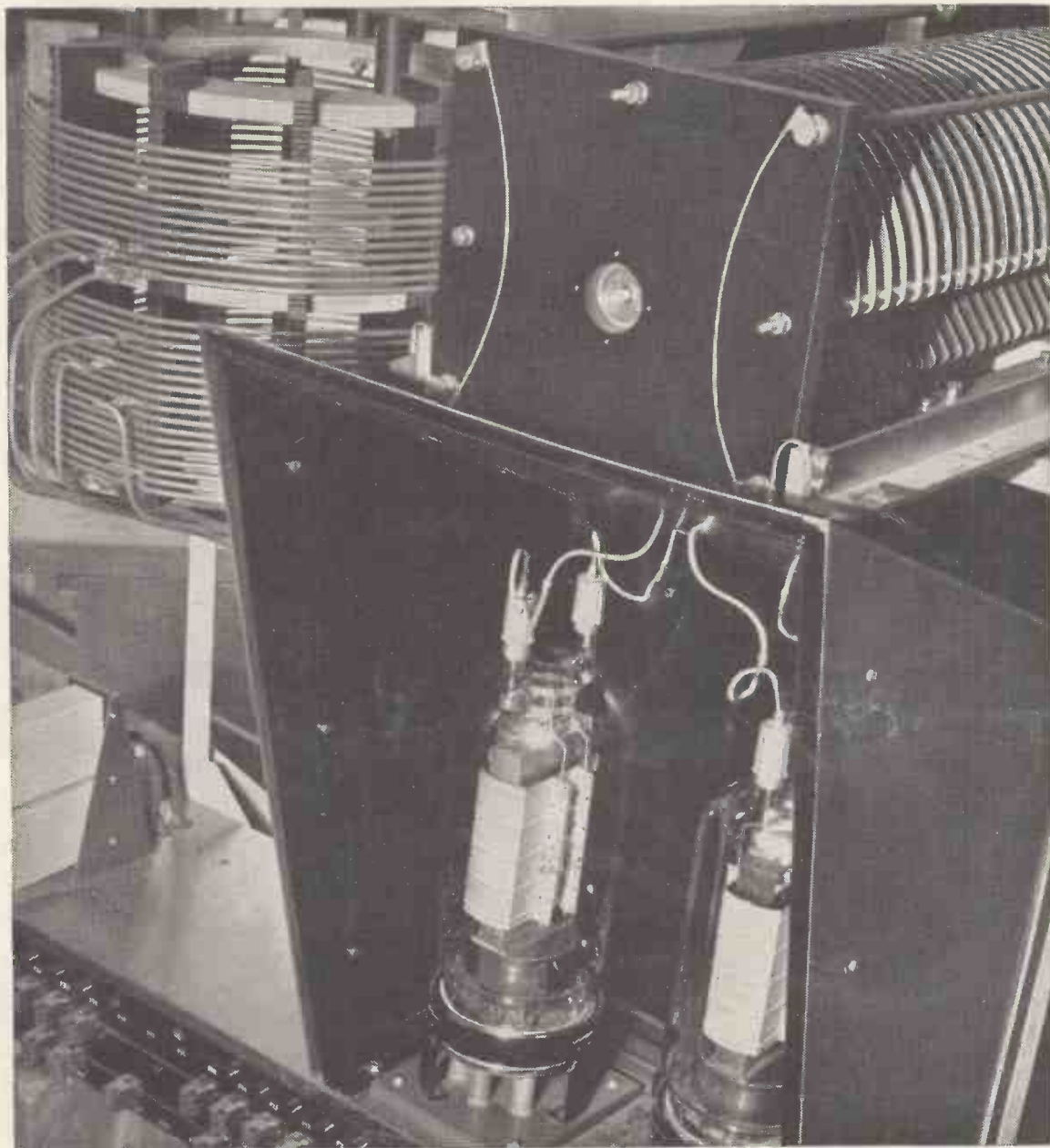

Good Team Work by the various components of communication equipment depends on sound engineering design.

REDIFFUSION LIMITED

A subsidiary of
BROADCAST RELAY SERVICE LIMITED

DESIGNERS AND MANUFACTURERS OF COMMUNICATION EQUIPMENT
VICTORIA STATION HOUSE • VICTORIA STREET • LONDON • S.W.1 (PHONE VICTORIA 8831)

PATENTS RECORD

The information and illustrations on this page are given with the permission of the Controller of H.M. Stationery Office. Complete copies of the Specifications can be obtained from the Patent Office, 25, Southampton Buildings, London, W.C.2, price 1s. each.

TELEVISION

Television Reproducing Tube

A cathode-ray tube of conventional gun design has an optical window mounted opposite a luminescent screen on which the picture is scanned. This screen consists of a large number of short lengths of tungsten wire mounted in line, each approximating to a picture element in size.

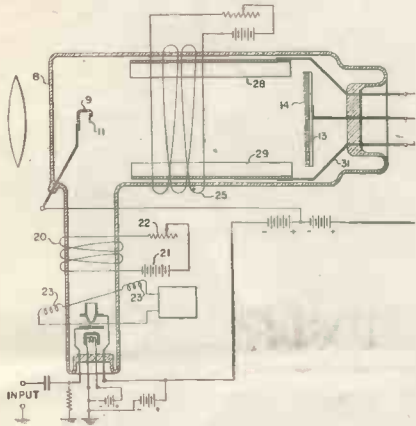

On scanning, the impact of the electron beam heats the tungsten elements to emission point, and this emission (corresponding to a line of the scan) is focused on to a second screen which incandesces under the impact. Owing to the thermal lag in emission from the tungsten points a storage effect is produced. The light emitted from the second screen is projected by the optical system in the usual way.

—Farnsworth Television Corpn.
Patent No. 547,529.

Television Projection System

A special projection tube is provided with a screen composed of an outer and inner wall with an evacuated space between them. The inner wall is coated with a reflecting silver layer on the side nearest the electron gun of the tube and the space between the walls is filled with paraffin wax. Light from a lamp is condensed on to the silver layer and reflected back through the paraffin layer to the projection objective and prism.

In the absence of signal, the paraffin layer is opaque and disperses the transmitted light from the lamp so that the amount of light reflected from the silver is small. When the picture is produced on the silver layer the

increase in temperature produced by impact of the electron beam melts the wax immediately above the spot and allows the light to be reflected from the silver without dispersion. The dispersing characteristic of the wax is proportional to its degree of melting and the light intensity of the reflected beam thus corresponds to the variations in light intensity of the picture on the screen of the tube.

—Farnsworth Television Corpn.
Patent No. 547,075.

Improvements in Television Transmission

In television pictures the average weight of the picture varies from time to time and this results in a shifting of the mean carrier frequency, and the peaks of deviation due to synchronising impulses will not fall in the proper position in the frequency spectrum.

By using a d.c. insertion method and keeping the peak deviations of synchronising pulses at the same position with respect to frequency, it is claimed that the synchronising impulses will always be in the same place in the bandpass frequency characteristics and will not suffer distortion when the nature of the picture changes.

—Marconi's Wireless Telegraph Co., Ltd. (Assignees of H. E. Goldstone). Patent No. 548,443.

CIRCUITS

Electrical Oscillation Generators and Time Bases

A generator for generating a voltage which varies with time by charging or discharging a condenser through a resistor from a source of constant potential. The condenser is connected to the grid of the first valve of a two stage amplifier. The two valves have their cathodes connected together, through a common resistor to a fixed low (earth) potential, each having a re-

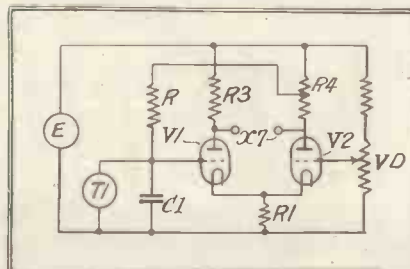

sistor in its anode circuit. The second valve has its grid connected to a point more positive. Voltage variations at the anode-load resistor, of the first or second valve or at a tapping point on load resistor are introduced in series with the charging resistor into the charging circuit.

—Marconi's Wireless Telegraph Co., Ltd. and N. L. Yates-Fish.
Patent No. 548,518.

Thermionic Oscillation Generator

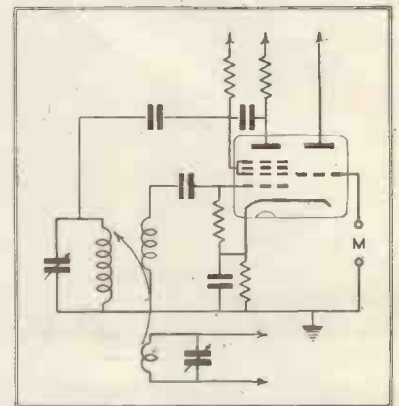

This consists of a variable frequency feedback oscillator of a pentode valve type with feedback paths from both anode and screen grid to the first control grid. The paths, so far as they are separate from each other, are free from reactance at oscillation frequencies. The potential of the second grid is varied to vary the frequency of oscillation.

—A. C. Cossor, Ltd. and O. H. Davie. Patent No. 548,148.

Amplifier-Rectifier Circuits

Relates to combined amplifier-rectifier circuits in which rectification is effected by using the suppressor grid of a multi-grid valve fed from the anode. This grid should be kept at a potential below that of the anode to ensure the return of secondary emission electrons from the anode.

The effect of the suppressor grid potential on the space current is relatively small compared with that of the control grid so that a.c. derived from the anode may be fed to the suppressor grid with small reaction only upon the a.c. in the cathode-anode circuit.

—Standard Telephones and Cables, Ltd. (Assignees of F. B. Anderson). Patent No. 548,501.



WHEN THE FLOOD OF WAR HAS SUBSIDED

the bird of Peace will bring with it the demand for products to assist in the enjoyment of freedom and security. Goodmans Industries then, as in pre-war days, will be able to concentrate on "The Attainment of an Ideal"—the perfect reproduction of sound.

In the meantime the whole of our organisation is devoted to the design and production of the best possible acoustic apparatus.

The best of today will in turn lead to something better still in the future, in which Goodmans Industries will maintain their reputation for establishing standards of design for high fidelity sound reproducers.

Goodmans Industries

LTD.

GOODMANS INDUSTRIES LIMITED ★ LANCELOT ROAD ★ WEMBLEY ★ MIDDX.

THINGS TO COME

*A new dawn for Radio as a
greater than ever public benefit;
announcing the blessings of peace
instead of the horrors of war.*

TRADE **HUNTS** MARK
*The
Home of Condensers*

NOTES FROM THE INDUSTRY

Joint Council of Professional Scientists

A joint council of professional scientists, representing over 10,000 qualified scientists, has been set up under the chairmanship of Sir Robert Pickard, F.R.S., by the Institute of Chemistry and Physics in association with representatives of professional botanists, geologists, mathematicians and zoologists. The Council has been established to voice the collective opinion of qualified scientists on matters of public interest, to provide a liaison between professional organisations of scientists for co-ordinated action in matters of common interest.

Communications to the Council should be addressed to Dr. H. R. Lang, honorary secretary, Joint Council of Professional Scientists, c/o The Institute of Physics, at its temporary address, The University, Reading, Berks.

The Television Society

The fourteenth annual general meeting of the Television Society was held at the Institution of Electrical Engineers on December 5, 1942, and in spite of war conditions there was a good attendance of members.

The formal business was followed by a short review of the progress of Colour Television, by Mr. G. Parr, the Hon. Lecture Secretary.

Brit. I.R.E. Change of Address

The Secretary of the British Institution of Radio Engineers announces that new premises have been taken to accommodate the rapidly expanding activities of the Institution and that after December 18 all communications should be addressed to 9 Bedford Square, W.C.1.

By courtesy of the Institution of Structural Engineers, meetings will be held at 11 Upper Belgrave Street, S.W.1, until further notice.

The next meeting of the Institution will be on January 23, when a paper will be read on "Modern Condenser Technique" by J. H. Cozens, B.Sc.

Ediswan Lighting Equipment

This new Ediswan folder—L.E. 1237 gives detailed information on 80 watt fluorescent lighting equipment in a concise form. Specifications and drawings for twelve types of reflector are given together with notes and illustrations on auxiliary control gear, wiring accessories, circuit diagrams and the "Portalux" portable unit.

Copies may be obtained upon application to any Ediswan branch office or from the Lighting Department, The Edison Swan Electric Co., Ltd., Ponders End, Middlesex.

Technical Books

Messrs. W. & G. Foyle have issued (November, 1942) their catalogue of technical books, covering electricity, chemistry, physics, radio and most of the industrial arts. The catalogue is priced with new and second-hand values wherever possible, and includes books temporarily out of stock owing to war-time shortage, but likely to be available soon. Copies can be obtained from Foyle's, Charing Cross Road, reference Dept. 7.

Messrs. H. K. Lewis have issued a supplementary list of library books available, covering the period 1938-1941. It also includes a classified index of subjects. Price to non-subscribers 4s.; to library subscribers 2s.

British Standards Institution

The new handbook of the British Standards Institution, with a supplement added October, 1942, is available, price 1s. 6d. plus postage. A list of specifications under preparation is given at the beginning of the list, so that any interested parties may have an opportunity of giving their views to the institution.

The specifications on interference and radio receiver testing are in abeyance for the duration.

It sounds like "coals to Newcastle" but U.S.A., the home of cored solder, found it worth while to import British made Ersin Multicore—the A.D. approved solder wire with three cores of non-corrosive Ersin flux, although Ersin Multicore, after paying freight and duty, cost American manufacturers fifty per cent more than American made solders.

Why? With the correct, rapid soldering technique, H.R. or "dry" joints are impossible with Ersin Multicore, and production is speeded up. Present conditions do not permit the export of Multicore to U.S.A., but after Victory, U.S.A. manufacturers will, once again, be able to use "the finest cored solder in the world."

**Sorry U.S.A. -
after Victory we'll be with you**

**ERSIN
Multicore
THREE CORE
SOLDER**

ERSIN MULTICORE

**THE SOLDER WIRE WITH 3 CORES
OF NON-CORROSIVE ERSIN FLUX.**

MULTICORE SOLDERS LTD. BUSH HOUSE, LONDON, W.C.2

Telephone : TEMple Bar 5583/4

COMMUNICATIONS DEPEND....

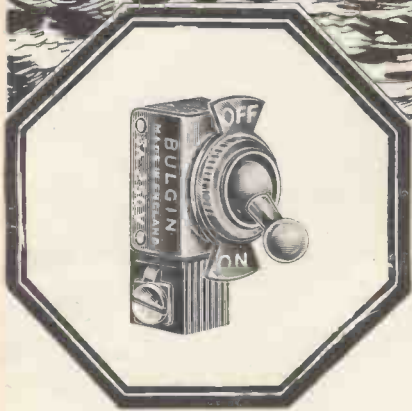

ON SMALL PARTS....

IN countless instances quite intricate pieces of apparatus are wholly dependent on the proved reputation and reliability of their component parts.

All products from the House of Bulgin are pre-eminent for superior design and workmanship, and every article bearing our Trade Mark has to pass exacting and exhaustive tests during the course of its production.

We ask the kind indulgence of the Trade on delivery until peaceful conditions return.

The Choice of Critics

BULGIN FOR SWITCHES

The best Radio and small Electrical Switches in the world. Every one is the finest of its class, and the best for any job. Snap-action, low and constant contact resistance, reliable performance for tens of thousands of operations: all these are permanent characteristics. Over 100 types to choose from.

"The Choice of Critics"

BULGIN

REGISTERED • TRADE • MARK

A. F. BULGIN & CO. LTD., BY-PASS RD., BARKING, ESSEX

Tel. Rippleway 3474 (4 lines)

AFTER THE WAR!

The advance in Radio Technique after the war will offer unlimited opportunities of high pay and secure posts for those Radio Engineers who have had the foresight to become technically qualified. How you can do this quickly and easily in your spare time is fully explained in our unique handbook.

Full details are given of A.M.I.E.E., A.M.Brit. I.R.E., City and Guilds Exams. and particulars of up-to-date courses in Wireless Engineering, Radio Servicing, Short Waves, TELEVISION, Mathematics, etc., etc.

Prepare for to-morrow's opportunities and post-war competition by sending for your copy of this very informative 112-page guide NOW—FREE.

British Institute of Engineering Technology (Dept. 337a) 17, Stratford Place, London, W.1.

Varley

Quality Components

- I.F. TRANSFORMERS
- WIRE WOUND RESISTANCES
- L.F. CHOKES & TRANSFORMERS
- MAINS TRANSFORMERS
- DELAY SWITCHES

Varley (Prop. Oliver Pell Control Ltd.)
Cambridge Row Woolwich, S.E.18

RADIO

—ENGINEERING AND TELEVISION

Complete Postal Courses of Instruction. Recommended to all who desire to obtain a thorough technical and practical knowledge.

Apply:—
BRITISH SCHOOL OF TELEGRAPHY LTD.
179, Clapham Road, London, S.W.9.
(Estd. 1906)

LOUDSPEAKERS

WE CARRY ON

SINCLAIR SPEAKERS

170 Copenhagen Street, London, N.1

FOYLES

BOOKSELLERS TO THE WORLD
New and Second-hand Books on Engineering and every other subject.
Books Bought.

119-125 Charing Cross Road, London, W.C.2
Tel: Gerrard 5660 (16 lines). Open 9-4 Inc. Sat

TRANSFORMERS

to customers' specifications or in accordance with standard list.

W. BRYAN SAVAGE LTD.

Westmoreland Road, London, N.W.9. Colindale 7131



Higher load

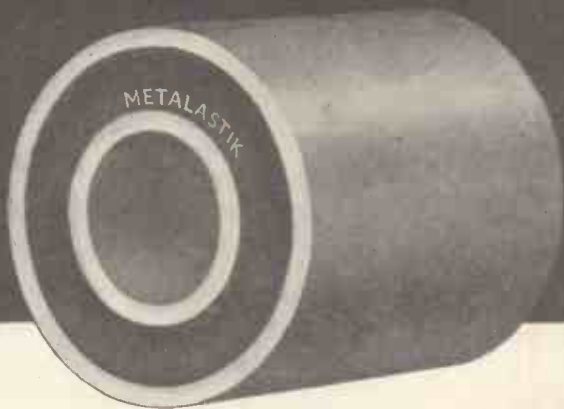

METALASTIK BUSHES are typical examples of the scientific application of Rubber-to-Metal Weld.

The rubber, being welded to the metal is used to the maximum efficiency, and the whole volume can be stressed in every conceivable combination of torsion, shear, compression or tension.

Thus it is that higher loads can be applied or smaller bushes employed.

The range of METALASTIK Rubber-to-Metal Weld Bushes is practically unlimited and covers such widely differing loads and frequencies as are called for in Automobiles, Ships, Railway Engines and Rolling Stock, Machine Tools, and in Agricultural, Textile and Domestic Machinery.

METALASTIK LTD.

METALASTIK
RUBBER-TO-METAL WELD

LEICESTER

CONSULT US ON ALL YOUR VIBRATION PROBLEMS



or smaller bush



The centre for S/W equipment



If it is anything to do with short-wave radio you are most likely to find it at Webb's. Not that under present conditions we can supply everything, or always everybody, but there still is a very extensive (though short staffed) service available. We can supply practically any short-wave component at our Retail Sales Department, 14, Soho Street, and we print alongside a selection from the many items actually in stock.

Schools type Oscillator chassis view. Chassis is contained in a grey crackle cabinet.

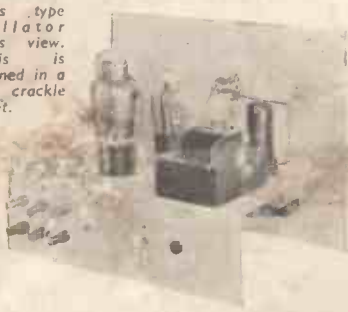

Some features of Webb's Service

SERVICE OF COMMUNICATION RECEIVERS. We can now give restricted service on all types of Communication Receivers, but it is essential to communicate with us before despatching instruments.

SPECIAL PRODUCTS DEPT. For Official requisitions we can offer highly skilled facilities for the design and construction of specialized Radio Transmitters, amplifiers and kindred apparatus. The illustration shows a typical 75 watt telephony and morse transmitter.



MORSE EQUIPMENT FOR CLASSROOM AND INDIVIDUAL PRACTICE.

An exceptionally wide range of morse equipment is available. Keys include the new American type as well as a variety of Bar Type Keys of standard Post Office Pattern. A selection is listed here:—
 Streamline Metal Key, U.S.A. pattern ... 6/6
 G.P.O. Bar Type Practice Key ... 8/6
 G.P.O. Bar Type Keys, first grade finish (2 contacts) 17/6
 G.P.O. Bar Type Keys, first grade finish (3 contacts) 22/6
 G.P.O. Bar Type Heavy Duty Operating Key (3 contacts) ... 28/6

Audio-Oscillators include a heavy duty schools model (operated from A.C. mains) with alternative outputs for 20 or 50 pairs of high resistance headphones or for 2 loudspeakers. It gives a note that is variable in pitch and volume and is priced at £7 10s., complete with valves. Two smaller oscillators for individual practice are available, the Junior Oscillator £2 5s. employing 2 valves A.C. operated for up to three pairs of telephones, and Type B.1, 27/6, for battery use from 2 volt accumulators or 3 volt dry cell. Both give a pleasing audio note and are ideal for preliminary or advanced home practice. A wide selection of Headphones are usually in stock at prices from 17/6 to 57/6.

COMPONENTS FROM STOCK

HIGH FIDELITY Suspension Loud-Speakers, in piano-finish mahogany or dark walnut cabinet, size 13 1/2" square, 6" deep. Rola 10" Permanent Magnet unit, limited number available only. Quality reproduction plus pleasing appearance.
 Price, low impedance, 2 1/2 ohms ... £5 15/-
 Or fitted with tape transformer £6 3/-

KNOBS. Instrument knobs and dials in great variety available ex stock. A few only are listed. (All 1/8" shaft fitting.)
 2 1/2" dia. fluted instrument knob ... 2/-
 2 1/2" dia. fluted instrument knob - Eddystone 1076 with brass insert ... 2/6
 1076 knob with 4" dia. satin finish scale (as Eddystone 1077) ... 6/6
 Milled Edge Knobs 1 1/2" dia. ... 1/9
 Milled Edge Knobs 1 3/8" dia. ... 1/6
 Milled Edge Knobs 1" dia. ... 1/3
 Skirted knobs, 1 1/2" dia. skirt with white indicator ... 3/6
 Wheel knobs, black or green 1 1/2" dia. Johnson (U.S.A.) transmitting type handles—
 With 4" indicator scale (1/8" shaft) ... 4/6
 With 6" indicator scale (3/8" shaft) ... 6/6

MICROPHONES
 Rothermel-Brush D. 104 Crystal £5 5 0
 Rothermel-Brush D. 104 Crystal with control switch handle ... £6 6 0
 Rothermel - Brush D. 104 lapel Crystal ... £2 10 0
 Rothermel-Brush Crystal on heavy desk stand ... £5 0 0
 Moving Coil, highest quality with transformer ... £5 5 0
 Microphone Stands for M.C. Mike £2 2 0

VALVES. We carry comprehensive stocks of all British and U.S.A. types. A limited number of the "sticky" types of U.S.A. tubes have just come to hand for distribution for civilian replacement purposes.

Additional charge of 1/- for postage and packing on orders below 10/-.

WEBB'S RADIO

14 SOHO ST., OXFORD ST., LONDON, W.1 Phone: GERard 2089:
 Hours of Business: 9 a.m. - 4 p.m. (Sats. 9 a.m. - 12 noon).