

Electronic Engineering

INCORPORATING ELECTRONICS, TELEVISION AND SHORT WAVE WORLD

PRINCIPAL CONTENTS



The Generation and Amplification of Micro-Waves. Part II
The Electrical Properties of H.F. Ceramics
Electronic Aids to Safety
Review of Progress in Electronics. Part VI
A Diode Slide-back Peak Voltmeter
The Technique of Receiver Measurements. Part II

V/6^D SEPT., 1941

2 hallicrafter precision built instruments

which
incorporate

MODEL SX24

This incorporates many new features besides the new electrical BANDSPREAD and Dickert Noise Limiter. A built-in frequency meter and accurate calibration of the main dial assure extremely easy location of stations, whilst the double-balanced crystal filter gives knife-edge selectivity. Provision is made to plug in headphones. Overall sensitivity and signal-to-noise ratio are both very high, and the audio response broad. The SX24 offers performance that can be favourably compared to any communication receiver regardless of price, and it has all the features and qualities needed for outstanding reception. Coverage 6.8 to 555 m., 9 tubes; adaptable for battery operation. The metal cabinet is finished instrument grey and all controls are cleanly marked.



DELIVERY

This advertisement serves to show only the type of equipment produced by Hallicrafters, for whom we are the sole British Distributors.

No communication receivers are now available to the general public. But they can still be supplied

FOR DIRECT WORK OF NATIONAL IMPORTANCE

Ask for latest Catalogue

MODEL SX28

The finest example of modern radio engineering produced by the U.S.A. in 1941. Employs 15 Valves, including two R.F. Amplifiers, two I.F. and amplified AVC and Noise Limiters. Frequency coverage continuous from 43 M/cs. to 550 K/cs.

Push Pull, high fidelity, audio output; Band Pass audio filter. Temperature controlled high frequency oscillator.

Straight Line Frequency band spread is obtained by the use of multi-capacity band-spread condenser gang.

WEBB'S RADIO

14 SOHO STREET, OXFORD STREET, LONDON

*On National
Service*

**Osram
Valves**

MADE IN
ENGLAND

for

INDUSTRIAL APPLICATIONS

•

ELECTRO MEDICAL
EQUIPMENT

•

THERMIONIC INSTRUMENTS
and TEST GEAR

•

VITAL COMMUNICATIONS
and WARNING SYSTEMS
ETC.

THE GENERAL ELECTRIC CO. LTD.
Magnet House, Kingsway, London, W.C.2



EFFICIENT PERSONNEL MANAGEMENT IS ESSENTIAL



“Remember that you must secure the whole-hearted co-operation of your workpeople. Look closely to their welfare. Many of them may be new to industry ; be patient and help them all you can during the first difficult weeks. A little foresight will reduce your labour turnover.”

Read the new booklet “THE EMPLOYMENT OF WOMEN . . . SUGGESTIONS TO EMPLOYERS.” Problems created by the increasing influx of new women workers into war factories are dealt with clearly and concisely. The suggestions contained in the booklet will be of great value to you! Instruct your secretary to write TO-DAY, to the local Employment Exchange, asking for pamphlet P.L. 87/1941.

(Above is Point No. 4 of the Minister of Labour's “4-POINT PLAN TO INCREASE PRODUCTION,” addressed to Management.)

THE OTHER THREE POINTS IN THE PLAN ARE:

- 1.** Skilled men are needed for the really skilled jobs.
- 2.** Training schemes must be developed to the greatest possible extent.
- 3.** Prepare, now, to employ more and more women.

THESE ARE THE CONTENTS OF THE BOOKLET

- | | |
|--|--|
| 1 Appointment of a Woman Personnel Officer. | 4 Interviewing of candidate. |
| 2 Her Functions. | 5 On engagement. |
| 3 Consultations preparatory to the introduction of Women. | 6 Reporting for duty. |
| | 7 During first month of employment. |
| | 8 Working hours. |

SPECIAL NOTE: It will be particularly appreciated by your women workers if you arrange work-shifts so that they will all have some time off during shopping hours.



MOBILISE FOR

ISSUED BY THE MINISTRY OF LABOUR & NATIONAL SERVICE

TUCKER TAGS

for **RADIO**

GEO. TUCKER EYELET CO. LTD. • WALSALL ROAD, BIRMINGHAM, 22 • Phone: BIRchfields 5024

SHAW'S



You just 'plug in' with Solon *Electric* Soldering

With the Solon you can work wherever there's a lamp holder—and do better work! Solon Electric Soldering is easy, neat, strong and clean. No stopping to heat up—constant heat maintained at point. 15 hours' soldering uses only 1 unit.

Made for following standard voltages:—200/220, 230/250.



Handyman model supplied complete with Resin - Cored Solder Flex and Lamp - 9/4 Adaptor.
Solon Resin-Cored Solder per reel 6d.

W. T. HENLEY'S TELEGRAPH WORKS CO., LTD.
(Dept. 23/v.) Engineering Sales Dept., Milton Court, Westcott, Dorking, Surrey

SUSPENSION FOR DIRECTING SOUND DOWNWARDS —

—TO THE LEFT—

—OR TO THE RIGHT.

ADDRESS YOUR STAFF THROUGH A

CELESTION LOUDSPEAKER

with a volume sufficient to overcome local noise.

The same speaker will carry music to your staff—true music, not just a volume of sound.

The Celestion method of suspension enables the sound to be directed wherever you want it.

Standard Model, 6 watts input. Cadmium plated and sprayed battleship grey

CELESTION LTD

Kingston - upon - Thames, Surrey

Telephone: KINGston 5656-7-8

POWER SUPPLY

for all electronic devices

The Westinghouse metal rectifier plays an important part in modern electronic engineering, where its outstanding qualities of high efficiency and very long life ensure a reliable power supply.

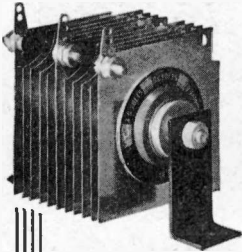

There is a range of H.T. units for use in radio receivers. The H.T. 14 illustrated has an output of 130 volts 20mA, and there are numerous other types for H.T. and L.T. power supply, detection, A.V.C., etc.

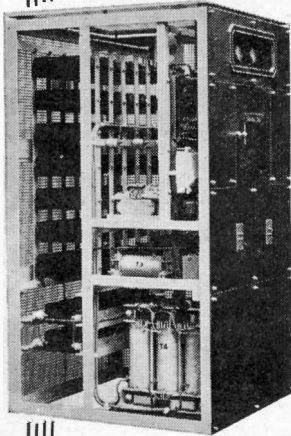

One of a range of power supply units for radio transmitters working on M.C.W. or telephony. All the power equipment is mounted in one framework and the unit illustrated gives H.T., G.B. L.T. and control supplies, the L.T. supply being for indirectly heated valves.

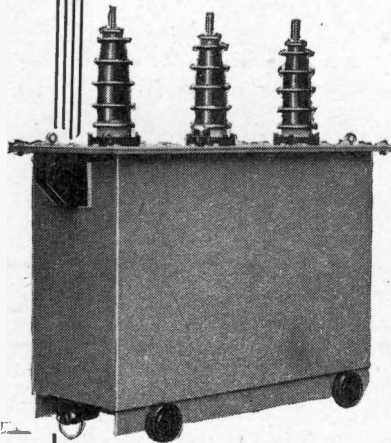

150 kV. oil-immersed rectifier for power supply to an impulse generator giving an output of over 1,000,000 volts.

Write for descriptive literature to Dept. E.C., Westinghouse Brake and Signal Co., Ltd., Pew Hill House, Chippenham, Wilts.

WESTINGHOUSE

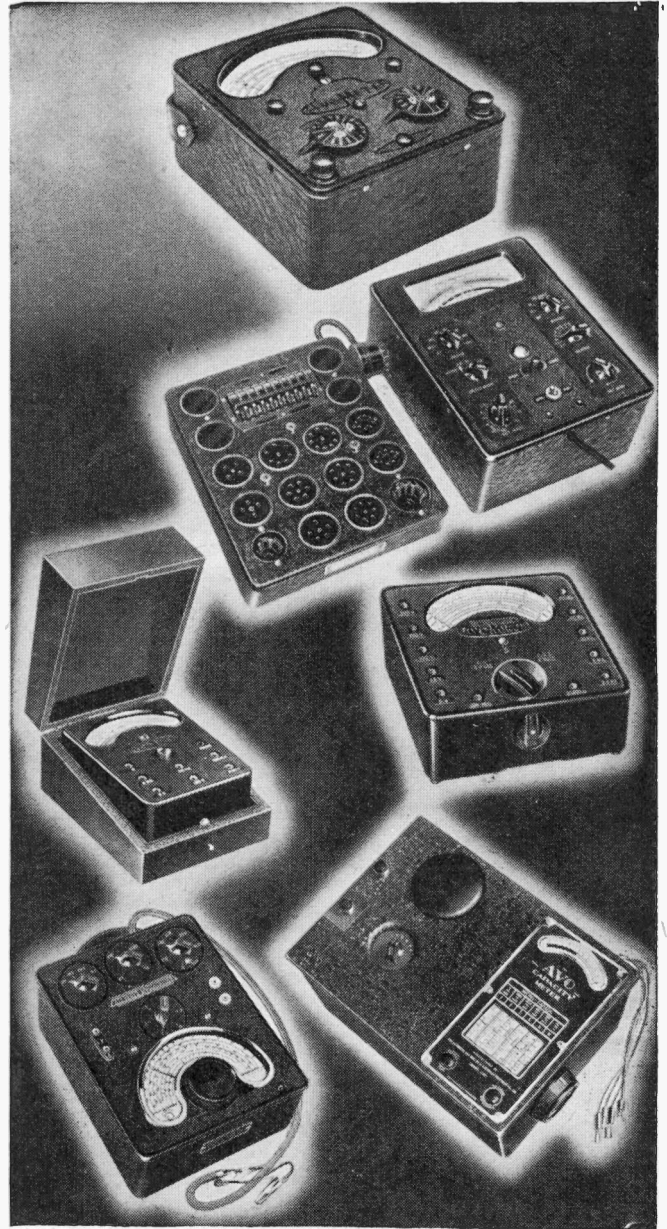

‘AVO’

ACCURATE TESTING INSTRUMENTS

HIGH accuracy, simplicity, exceptional versatility and proven reliability have won for "AVO" Instruments a world-wide reputation for supremacy wherever rapid precision test work is demanded. There is an "AVO" instrument for every essential electrical test.

In spite of greatly increased production, some delay in delivery of Trade orders is inevitable, but we shall continue to do our best to fulfil your requirements as promptly as possible.

The word "AVO" is our registered Trade Mark

● Send for descriptive literature and current prices.

THE AUTOMATIC COIL WINDER & ELECTRICAL EQUIPMENT Co., Ltd.
Winder House, Douglas Street, London, S.W.1. Phone: VICTORIA 3404-7

The portable power supply for
Radio Transmitters and
Receivers.

Public address systems.

Scientific apparatus.

Emergency power supply systems

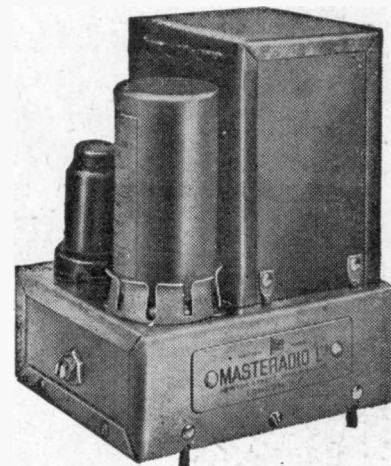

Masteradio

VIBRATOR PACKS

British made equivalents of all American Types Plus the New Patented Silent Surge Circuit.

EFFICIENT PORTABLE POWER

Write for details :-

MASTERADIO LTD., VIBRANT WORKS, Watford, Herts.
Grams : Mastiola. Phone : Watford 9885-9890

GREENWOODS

15w. AC & 12-VOLT DC AMPLIFIER

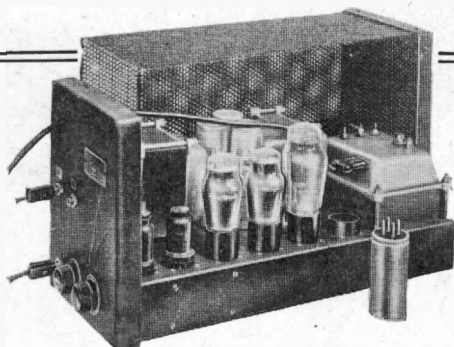

TYPE CP20

Prices: Plus 20% War Increase
AC and 12-volt CHASSIS with valves, etc. **£12 12 0**
AC only CHASSIS with valves, etc. **£8 18 6**
Gauze Case for either chassis 12/6 extra.

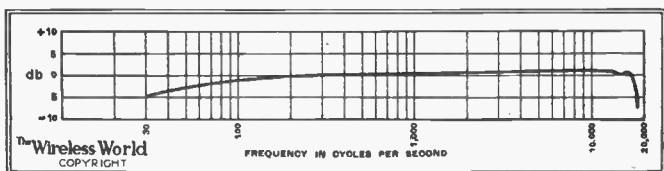

Any response curve supplied to order
Prompt deliveries on Priority A1 Contracts

THIS small Portable Amplifier operating either from AC mains or 12-volt battery, was tested by "THE WIRELESS WORLD," October 1st, 1937, and has proved so popular that at Customers' demand it remains unaltered except that the output has been increased to 17.2 watts and the battery consumption lowered to 6 amperes. Read what "The Wireless World" said, —

"During tests an output of 14.7 watts was obtained without any trace of distortion so that the rating of 15 watts is quite justified. The measured response shows an upper limit of 18,000 c/s and a lower of 30 c/s. Its performance is exceptionally good. Another outstanding feature is its exceptionally low hum level when AC operated even without an earth connection. In order to obtain the maximum undistorted output, an input to the microphone jack of 0.037 volt was required. The two independent volume controls enable one to adjust the gain of the amplifier for the same power output from both sources, as well as superimpose one on the other, or fade out one and bring the other up to full volume. The secondary of the output transformer is tapped for loud speakers or line impedances of 4, 7.8 and 15 ohms."

VORTEXION LTD.

257, The Broadway, Wimbledon, S.W.19

Phone: LIBerty 2814

THE GRID SYSTEM USES...

Dependability is the first consideration in a vast undertaking like the Grid System ... That is why Ediswan Batteries are used in over 30 sub-stations of the system.

If your requirements call for a battery which will never fail you, Ediswan will fulfil your need with unqualified satisfaction.

The Ediswan Service through the 28 Branches is behind every Ediswan Battery and provides for expert after-sale service. Write for particulars.

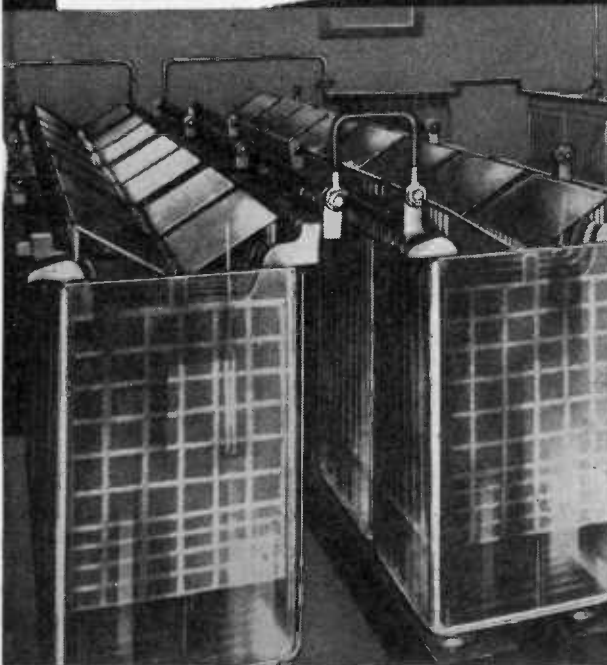

EDISWAN BATTERIES



THE EDISON SWAN ELECTRIC CO. LTD., PONDERS END, MIDDLESEX

BL.9

Monthly (published last day of preceding month) 1/6 net. Subscription Rates: Post Paid to any part of the World—3 months, 5/-; 6 months, 10/-; 12 months, 20/-. Registered for Transmission by Canadian Magazine Post.

Electronic Engineering

PROPRIETORS :

HULTON PRESS LTD.,

Editor: **G. PARR.**

TELEPHONE :
CENTRAL 7400

TELEGRAMS :
HULTONPRES LUD,
LONDON.

No. 163 Vol. XIV

SEPTEMBER - - - 1941

EDITORIAL, ADVERTISING AND PUBLISHING OFFICES, 43-44, SHOE LANE, LONDON, E.C.4

CONTENTS

	PAGE		PAGE
Editorial...	383	Design of Receivers for Export	396
The Generation and Amplification of Micro-Waves. Part II	384	Technique of Receiver Measurements. Part II	404
Electrical Properties of H.F. Ceramics	388	Radio Manufacturers and the War...	410
Review of Progress in Electrons—VI	391	Notes from the Industry	412
Application of Electronics to Industry	393	Abstracts of Electronic Literature	418
A Diode Slide-Back Peak Voltmeter	395	Correspondence	421

Reluctance

THE radio valve saw active service in the last war, over twenty-three years ago. As Air Commodore Leedham said in an address reported elsewhere in this issue, the present war is a radio war, and millions of valves are being relied on to maintain communications and aid defence.

The literature of the photo-cell, another electronic device, dates back to 1913, and in a book published over eight years ago commercial apparatus was shown in a variety of situations and time and labour saving suggestions were made, all of value to industrial concerns.

The cathode-ray tube is the youngest of the electronic family—only eight years ago did it emerge from the laboratory into the limelight as the “instrument of a thousand uses.” Exaggeration apart, certainly over a hundred distinct applications have been listed in technical literature. The precision of the tube and its associated circuits was developed to such a degree that television pictures requiring an accuracy of timing of less than one part in one hundred thousand were reproduced night after night with the minimum of attention on the part of the viewer.

And yet, in spite of these proofs of the reliability of electronic apparatus,

there is still a reluctance on the part of some manufacturers to take them into their factories and make use of their unique capabilities.

How many doors in factories are reinforced with sheet steel panels to take the impact of a heavy trolley pushing its way through, or the impact of a heavy boot kicking them open? Photo-cell door openers are available and do not even require to be thanked for doing the job.

Valve amplifiers are available to magnify whispers into roars, and yet foremen have to shout to be heard across a noisy shop.

How many factories have cathode-ray tube equipment as part of their routine checking gear? Its use is not confined to electrical engineering processes.

It would be interesting to have a Gallup survey, or whatever is the correct term, of the reasons why certain manufacturers have not yet adopted electronic aids. One can only surmise in the absence of definite information, and it is probable that their main objections come under the heads of expense, intricacy, or unreliability.

Expense can only be a relative term. If any apparatus will minimise accidents or faulty products its cost can

only be thought of in terms of lives saved or reputation gained. Intricate? So is an adding machine or a chronometer and both are capable of being kept in order by trained men.

The charge of unreliability against any apparatus is the most difficult to rebut. There always have been cases and always will be cases of things refusing to work when they are wanted.

Human nature being what it is, the times that apparatus fails are remembered and the times that it has worked without fault are at once discounted when trouble occurs. Every wrong number on the telephone is a grievance which offsets hundreds of right ones. The intricacy of the telephone system far outweighs the most complicated electronic “box of tricks,” but even the most grudging would give credit to the system for 99 per cent. reliable service.

The Post Office, of course, uses thousands of those fragile-looking complicated structures in glass bulbs, called valves. They work day in, day out, for months or years without attention, so they can't be so unreliable after all!

Electronic engineering is always ready to co-operate with any other engineering, but it cannot devise an apparatus to overcome prejudice.

The Generation and Amplification of Microwaves

By C. E. LOCKHART

Negative Grid Valves—Part 2

CONTINUING the review of negative grid valves as oscillators, it will be instructive to consider possible methods of improving the performance and also to review the actual performance of some existing U.H.F. valves.

As will have been realised from the preceding discussion it is essential to keep the transit times small compared with the periodic time of oscillation if efficiency is to be maintained. If we have electrons starting at rest and being accelerated towards the grid, then for parallel plane structures with space-charge limitation the transit time (τ_1) between cathode and grid is given by

$$\tau_1 = \frac{3d_1}{59.5 (V_{eff})^{1/2}} \text{ microseconds}^{9,7} \dots \quad (6)$$

where d_1 = cathode to grid spacing in cms.

V_{eff} = effective lumped voltage.

$$V_{eff} = \frac{E_a}{\mu} + E_g + e \dots \quad (7)$$

where E_a = Anode or screen voltage.

E_g = Grid voltage.

e = Contact potential.

μ = Amplification factor.

d_2 = Grid to anode or grid to screen spacing (cms.)

For this type of structure the transit time τ_2 between grid and anode (or grid and screen) is given by ⁶:

$$\tau_2 = \frac{2}{59.5} \left\{ (V_{eff})^{1/2} + (V_a)^{1/2} \right\} d_2 \text{ microseconds} \quad (8)$$

Expressions are also available for round concentric structure.⁶ From the above expressions it will be seen that there are two ways of reducing transit times, *i.e.*, by the reduction of gaps and by the increase of anode and screen voltages. The latter change reduces the transit time by increasing the velocity of the electrons.

If we try and reduce the transit times by reducing electrode spacings we will also have to reduce the other dimensions (area) in order to prevent the capacity increasing. Thus, for example, if we reduce all dimensions by a factor of two, we will have one quarter of the previous cathode area. The mutual conductance per unit area is proportional to $1/d_1^2$ and therefore the total mutual conductance will remain as before. The capacity per unit area being proportional to

$1/d$, the total input capacity will be halved. With V_{eff} remaining unchanged the transit time is halved and the input loss is therefore reduced by four.

Alternatively, we could have specified a constant value for the capacity. In that case the halving of the gap dimensions would involve reducing the other dimensions by $\sqrt{2}$, resulting in halving the electrode area. The mutual conductance for a given value of V_{eff} would then be doubled and the input loss halved.

The advantage of expressing the transit time and input loss in this manner is that it illustrates that unless the cathode current density I_0 is allowed to increase rapidly, the transit time τ_1 is only reduced slowly with reduction of gap dimensions. Thus, if in the above example we had halved the spacing d_1 but kept I_0 constant by modifying the value of V_{eff} the transit time τ_1 would have only been reduced to 0.8 of its previous value.

The improvement of performance of valves for ultra-high frequencies is intimately linked up with the provision of emitters that will stand very high current-density operating conditions, as quite apart from the increased current-density implied by equations (9) and (10) the induced or displacement current to the grid can attain much higher values than the calculated low-frequency anode current. This induced current is provided by electrons from the cathode or filament until emission saturation is reached.

In some of the valves to be discussed later such as the 316A, 4316A and 3B/250 the dimensions have been reduced to such an extent that only a limited emission is available and this seriously limits the output that may be obtained at the lower frequencies. (See Fig. 9).

Further limitations to the reduction of the dimensions of a valve are (1) a stage is soon reached where the grid wire can no longer be reduced in proportion to the reduction of the grid to cathode gap. (2) The reduction of the grid to cathode and grid to anode gaps soon result in excessive heating of the grid and leads to grid emission, which limits the power that may be dissipated by the anode. (3) The necessity for small size electrodes coupled with the requirement of very short leads also limits the usable anode dissipation if the glass seals are to remain effective.

Acorns

The first attempt at improved U.H.F. performance by the reduction of valve size resulted in the well known "Acorns" R.C.A. 954 and 955.^{20, 24} As these valves were mainly intended for receiver use or, at the most, in very low power transmitters, the reduction in size was accompanied by very restricted anode dissipation. The characteristics of these valves are given in Table 1.

Grid to cathode gaps of the order of 5 thousandths of an inch are employed on the indirectly heated models.

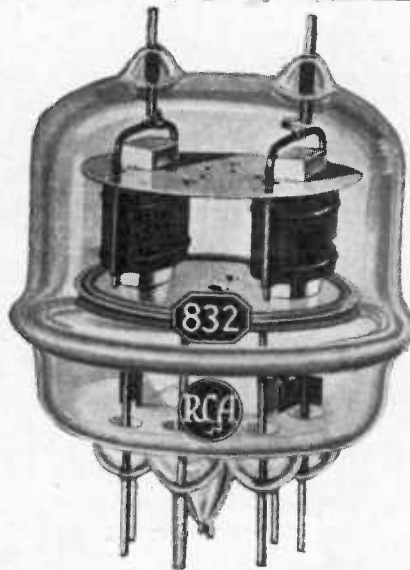

Fig. 10. 400 v. 15w Push-Pull Beam Power Amplifier with 100% ratings down to a wavelength of 200 cm. (150 Mc/S) Bulb dia. : 2" approx.

These big improvements in performance have, however, been obtained at the expense of a large increase of the current density at the cathode. If we write cathode current per square centimetre as I then by Child's Law:

$$I_0 \propto (V_{eff})^{3/2} \div d_1^2 \dots \dots (9)$$

and the above-mentioned improvement in performance has been obtained at the cost of quadrupling the current density at the cathode. In fact by combining equations (6) and (9) we can write

$$\tau_1 \propto (d_1/I_0)^{1/3} \dots \dots (10)$$

and as $2\pi f \tau_1 = \theta$, the transit angle between grid and cathode,

$$I_0 \propto \frac{f^3 d_1^3}{\theta_1^3} \dots \dots (11)$$

and the input admittance I/R_1 is proportional to g_{r1}^2 or $K_{1g} \left(\frac{d_1}{I_0}\right)^{2/3} \dots \dots (12)$

Typical operation of R.C.A. 955 Acorn. Triode as an R.F. Power Amplifier and Oscillator.

Plate Modulated or C.W.

Anode volts	... 180
Grid volts	... -35
Anode current (mA)	... 7
Grid current (mA)	... 1.5
Power output (watts)	... 0.5

The 955 triode was mainly intended for operation in the wavelength range from 50 to 500 cms. The available power output of the order of 1/2 watt given in the table above is for the latter wavelength. This output is only moderately reduced for wavelengths down to the order of 100 cms. Below 100 cms. the power output falls rapidly with any further reduction in wavelength. The limit of oscillation is reached in the vicinity of 40-45 cms. (750-670 Mc/s).

The 954 straight H.F. pentode and the 956 V.M. H.F. pentode reach the limit of usefulness in the region of 70 cms. (430 Mc/s).

Acorn triodes are now manufactured by the majority of British valve manufacturers (Mazda A40, Mullard AT4 and 4671, etc.) Pentodes of the 954 variety are also available (Mullard AP4 and 4672).

With the exception of pin spacing and heater voltage variation the specifications are similar to the American designs. In America a range of directly heated filament Acorns for use with dry cells has also been introduced and the characteristics of these valves are also given in Table I.

Power Valves

The problem of providing large power outputs at very short wavelengths with negative grid valves involves great difficulties, as large power outputs

TABLE I.

Characteristics of American Acorn Valves

Type No.	Pentode 954	Triode 955	Pentode 956	Triode 957	Triode 958	Pentode 959
Type of Cathode	I.H.C.	I.H.C.	I.H.C.	O.C.Fil.	O.C.Fil.	O.C.Fil.
Heater Volts	6.3	6.3	6.3	1.25	1.25	1.25
Heater Current	0.15	0.15	0.15	0.05	0.1	0.05
Operation as Class A Amplifier:						
Anode Volts	250	180	250	135	135	135
Screen Volts	100	—	100	—	—	67.5
Grid Bias Volts	-3	-5	-3	-5	-7.5	-3
Anode Current (mA) ..	2.0	4.5	5.5	2.0	3.0	1.7
Screen Current (mA) ..	0.7	—	1.8	—	—	0.4
Mutual Conductance (g) (mA/V.)	1.4	2.0	1.8	0.65	1.2	0.6
Amplification Factor (μ) ..	>2000	25	1440	16	12	480
Anode A.C. Resistance (Meg.)	> 1.5	.0125	0.8	.0246	0.01	0.08
Grid Bias for g ₂ μA/V. ..	—	—	-45	—	—	—
Interelectrode Capacities:						
Grid—Anode μμF. ..	0.007	1.4	0.007			
V Grid—Cathode μμF.	3	1.0	2.7			
V Anode—Cathode μμF.	3	0.6	3.5			

require large cooling surfaces and these in turn mean increased capacities, which are anathema at these frequencies. The alternative use of reasonably-sized anodes with high anode dissipations necessitates an increase in electrode spacing in order to limit the grid temperature.

In practice the problem has been tackled in four ways according to the order of wavelength and power for which the valves have been designed.

(a) Low or medium power valves capable of operating at wavelengths below 60 cms. (500 Mc/s) such as the 316A, 4316A, 3B/250 and D.156548 and possibly the 1628. In general this group of valves (with the exception of the 1628) operates at comparatively low anode voltages (300 to 500 volts) and employ microscopic gaps (grid-cathode gaps as small as 6 thousandths of an inch and grid wire of 1 thousandth of an inch diameter have been used) to achieve small transit times. All the electrode dimensions have to be kept very small in order to obtain sufficiently low capacities, and in order to obtain usable values of emission, the filaments operate at higher temperatures than normal. This results in a comparatively short life.

In the case of the first three valves the reduction in dimensions has resulted in a very limited available emission from the filament (of the order of 400 mA). This limits the available power output at the lower frequencies (see Fig. 9). Take for example the 316A which has an allowable anode dissipation of 30 watts. At medium frequencies an anode circuit efficiency of 65-70 per cent. may reasonably be expected for valves designed for medium frequency operation. This efficiency of

66 per cent. would, however, require an input of 90 watts, providing an output of 60 watts. This in turn entails a mean anode current of 300 mA. and a peak cathode current (including grid current) of the order of 1.6 amps., which is four times the available emission.

In other words the great reduction in dimensions required to produce a valve capable of operating at wavelengths below 60 cms. (500 Mc/s) has resulted in the reduction of the power output available at the medium frequencies from 60 to about 9-10 watts.

Alternatively for the limited permissible anode input of 36 watts (see Table II) the power output at medium frequencies would normally have been of the order of 24 watts.

The R.C.A. 1628 is an exception in this section, as while it is designed for C.C.S. operation on the lines of section (c) its performance classifies it in section (a).

(b) Medium power valves for operation down to wavelengths of the order 100 cms. (300 Mc/s) with anode voltages of 400-500 volts. The valves in this section are push-pull beam tetrodes with indirectly heated cathodes such as the 832, 829 and 815, which are designed for C.C.S. operation and in general have reasonable efficiencies at medium frequencies. Their H.F. performance is obtained by the use of small gaps between electrodes.

While the capacities of the individual electrode sections are comparatively high, the use of a push-pull circuit reduces the effective loading.

(c) Medium power valves for operation down to wavelengths of the order of 100 cms. (300 Mc/s) with anode voltages of the order 1,000 to 1,500 volts.

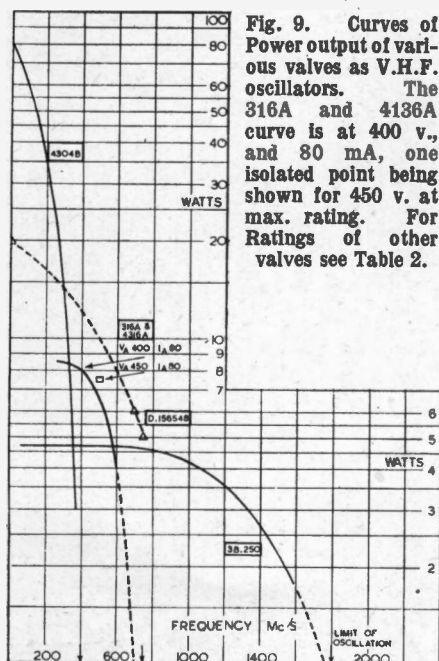

Fig. 9. Curves of Power output of various valves as V.H.F. oscillators. The 316A and 4316A curve is at 400 v., and 80 mA, one isolated point being shown for 450 v. at max. rating. For Ratings of other valves see Table 2.

The valves in this section (for example 304B, 4304B, 834, 826, 356A) reduce the filament emission requirements by operating at two or three times the anode voltage of section (a). The available emission of the valves in this section, however, still limits the output obtainable at medium frequencies by curtailing the permissible power input. The efficiencies obtained are, however, appreciably higher than in the case of section (a).

The use of the higher anode voltages also enables more reasonable clearances to be employed. Due to their C.C.S. ratings the size of the electrodes has not been reduced to the same extent as in the case of section (a) and this results in higher inter electrode capacities all round. All the valves mentioned are fitted with thoriated tungsten filaments.

(d) Large dissipation valves of small size capable of operating down to a wavelength of the order of 100-120 cms. (250-300 Mc/s). The permissible physical dimensions of the valves are severely limited by the requirements of the low operating wavelength, so that the only way to keep down the emission demand on the filament is to operate the anode at a very high voltage. The maximum usable anode voltage is, however, limited by the fact that the power dissipated in dielectrics is proportional to the square of the anode voltage swing and increases directly with the frequency. In order to permit a high dissipation water cooling is usually employed. Two water-cooled valves coming under this classification are the 887 and 888 which have a permissible dissipation of one kilowatt and operate at 3,000 volts with C.C.S. ratings. The available power output at medium frequencies is, however, still limited by the emission obtainable with the restricted dimensions.

The G.E.C. G.L.8002 1.2 kilowatt valve is remarkable for the high available emission considering its small size. The allowable anode input of 3,000 watts is thus only a little lower than would be provided with a normal medium frequency design.

As a general statement it can be said that all valves in sections (a) (c) and (d) are limited to varying degrees in their medium frequency output due to restricted emission. They do not, however, employ dielectrics in positions of high flux densities (electrode spacers) and are therefore not seriously affected by dielectric loss. The valves in section (b) due to their high emission oxide-coated cathodes are not restricted by emission and provide large power outputs with high efficiencies at medium frequencies. The lower efficiency of the 832 is due to its high "knee" voltage.

The performance of a number of representative transmitting valves is given in Table II. The first column specifies

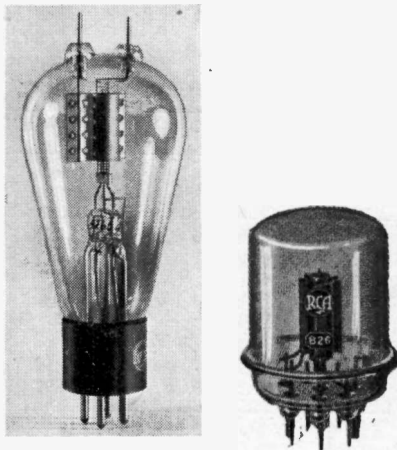

Fig. 11 (left). R.C.A. 834 triode. 1,250 v. 50 watts with 100% ratings down to 300 cms. (100 Mc/s). Limit of oscillations is in region of 400 Mc/s. Bulb diam. 2½".

Fig. 13 (right). R.C.A. Type 826 Triode 1,000 v. 60w. with 100% ratings down to 120 cms. (250 Mc/s). This valve has a centre-tapped filament and double anode and grid lead-outs. The bulb is 2½ dia.

the type of cathode or filament employed, *i.e.*, whether an indirectly heated or a thoriated tungsten, etc. With the exception of the R.C.A. 887 and 888 and the General Electric G.L. 8002 all the valves in the table have low-temperature emitters.

The legend attached gives information on the operating conditions under which the mutual conductance figure is measured.

Three columns tabulate the static inter-electrode capacities. In the case of the push-pull beam tetrodes such as the R.C.A. 832, R.C.A. 829 and R.C.A. 815 the total input and output capacities of each section are of greater interest and are therefore shown. The same system is employed for the R.C.A. 954 and 956 and the R.C.A. 827-R.

The next ten columns give the maximum operating conditions for Class C telegraphy operation.

The power output figure is that obtainable at medium frequencies unless otherwise specified.⁴⁹ Similarly, the grid driving power is that required at medium frequencies and does not include transit time loading or other losses. This grid power is approximately equal to the product of the peak R.F. grid volts times 0.9 (mean grid current)^{47, 49}.

The remaining columns in Table II give some information as to the limiting effect of frequency on the operation of the individual valves. As the operating frequency is increased a stage is reached when the anode voltage of a valve may have to be reduced due to any of the following three reasons:—

(a) Due to transit time effects a frequency is reached where the anode efficiency is reduced so as to necessitate a

reduction in the input watts in order to keep within the maximum dissipation rating.

(b) The electrode capacity current flowing through the connecting leads increases directly with frequency f . Also the H.F. resistance of the connecting leads (excluding dielectric loss) goes up as \sqrt{f} . If we designate the peak R.F. anode voltage by E , then the watts dissipated in the portion of the wire in the glass seal are proportional to $E^2 f^{3/2} C^2$.

As E is a function of the applied anode voltage and the excitation it is necessary to limit either above a certain frequency in order not to overheat the seals. The reduction of the anode voltage is the more efficient of the two methods. (c) The power lost in any dielectric is proportional to

$$E^2 f \cos \phi$$

so that as in the case of (b) the anode voltage has to be reduced above a certain frequency.

In the case of valves designed for operation at very high frequencies the limitation (a) is usually the most serious and is encountered first. The remaining columns of Table II therefore indicate the highest frequency at which 100 per cent. of the maximum rated anode voltage and anode input wattage may be used, and what percentage may be used at higher frequencies.

A complete Bibliography of references in English covering the first two articles in this series is given on p. 414. The series will be continued next month.

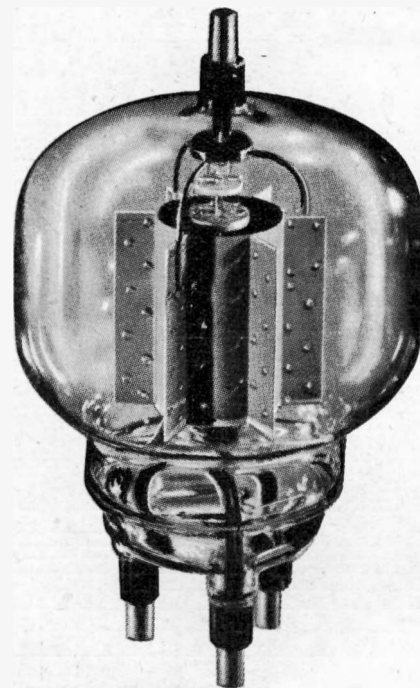

Fig. 12. 4,000 v. 350 w. triode type 357A (Western Electric) with 100% ratings down to 100 Mc/s. The leads are made of solid copper sealed through the glass.

TABLE II

VALVE TYPE	R.C.A. 832A	R.C.A. 815	S.T.C. 3B/250	316A 4316A	R.C.A. 829	R.C.A. 162B	W.E. D. 15654B	304B 4304B	R.C.A. 826	R.C.A. 827R	R.C.A. 887	R.C.A. 888	G.I. 8002
Rating (I)	C.C.S.	C.C.S.	T.T.F.	T.T.F.	I.H.C.	C.C.S.	T.T.F.	C.C.S.	T.T.F.	C.C.S.	T.T.F.	C.C.S.	T.T.F.
Type of Cathode (II)	I.H.C.	I.H.C.	T.T.F.	T.T.F.	I.H.C.	T.T.F.	T.T.F.	T.T.F.	T.T.F.	T.T.F.	T.T.F.	T.T.F.	T.T.F.
Total Max. Anode Dissipation (Watts)	15	20	25	30	40	40	50	50	60	800	1000	1000	1200
Fill Volts ... (III)	6.3	6.3	1.4	2.0	6.3	3.5	1.5	7.5	7.5	7.5	11	11	16
Fill Current Amps. (III)	1.6	1.6	5.0	3.65	2.25	3.25	9.0-9.25	3.25	4.0	2.5	24	24	39
Amplification Factor μ	—	—	8	6.5	—	23	2.0	11	31	—	10	30	8.9
Mutual Conductance g (IV)	3.0	4.0	2.5	2.4	8.5	—	7	2.0	—	—	—	—	—
Inter-electrode Capacities: (V)	A-G 0.05 G-C 7.5 A-C 3.8	0.2 13.3 8.5	0.2 1.0 0.7	1.6 1.2 0.8	0.1 15.2 6.5	2.0 2.0 0.4	1.5 1.5 1.0	2.5 2.0 0.7	2.9 3.7 1.4	0.18 21 13	6.9 2.5 2.7	7.8 2.8 2.5	7.8 8 0.5
Anode Volts DC	400	400	300	450	500	1000	500	1250	1000	3500	3000	3000	3000
Screen Volts DC	250	145	—	—	200	—	—	—	—	700	—	—	—
Grid Volts DC	—60	—45	—	—	—45	—65	—	—	—	—300	—	—	—
Total Anode Current (mA)	90	150	85	80	240	50	125	100	125	428	400	400	1000
Total Screen Current (mA)	18	17	—	—	32	—	—	—	—	185	—	—	—
Total Grid Current (mA)	3	4.5	—	12	15	15	—	—	35	100	45	80	—
Total Peak R.F. Grid Volts (VI)	124	116	—	—	124	123	—	—	350	520	925	650	—
Total Driving Power (Watts) (approx.)	0.18	0.23	—	—	0.7	1.7	—	—	4.5	50	35	45	—
Total Nominal Power Output (Watts)	22	44	47	7.5	8.3	35	5-20	85	86	1050	800	800	1800
Total Max. Anode Input (Watts)	36	60	25	36	120	50	62.5	125	125	1500	1200	1200	3000
Operating Frequency Mc/s.	100	100	100	100	100	100	Max. Anode Voltage may be used at any frequency provided dissipation is not exceeded.	100	100	100	100	100	100
and Anode Voltage	93	80	70	89	83	83	Max. Anode Voltage may be used at any frequency provided dissipation is not exceeded.	80	80	100	100	100	100
Percentage Permissible	82	70	70	89	83	83	Max. Anode Voltage may be used at any frequency provided dissipation is not exceeded.	70	80	100	100	100	100
Maximum	500	500	500	500	500	500	500	500	500	500	500	500	500
Range of Max. Anode Voltage	500	500	500	500	500	500	500	500	500	500	500	500	500
Maximum	650	650	650	650	650	650	650	650	650	650	650	650	650
750	750	750	750	750	750	750	750	750	750	750	750	750	750
1800	1800	1800	1800	1800	1800	1800	1800	1800	1800	1800	1800	1800	1800

LEGEND FOR TABLES I AND II

- (I) C.C.S. AND I.C.A.S. RATINGS. C.C.S. or Continuous Commercial Service ratings are based on providing a long life and maximum reliability of operation. I.C.A.S. or Intermittent Commercial and Amateur Service Ratings permit the use of much larger power inputs and provide considerably more power output at the cost of a reduced operating life. This shorter life may, however, be more economical for certain applications as it may avoid the use of a much more expensive larger valve.
- (II) TYPE OF CATHODE. I.H.C.: Indirectly Heated Cathode. O.C.F.: Oxide Coated Filament. T.T.F.: Thoriated Tungsten Filament. T.F.: Tungsten Filament.
- (III) FILAMENT OPERATION. The 3B/250 and the D. 15654B have filaments designed for operation on a current basis.
- (IV) MUTUAL CONDUCTANCE per section taken under following operating conditions:— R.C.A. 832 Ia = 30 mA R.C.A. 815 Ia = 25 mA S.T.C. 3B/250 Ia = 50 mA 316A & 4316A Ia = 67 mA Va = 250 v Va = 450 v
- (V) INTER ELECTRODE CAPACITIES. In the case of the R.C.A. 815, 832 and 829 Beam Power Amplifiers the capacity figures given for the Grid-cathode and Anode-cathode are actually the total input and total output capacities per section respectively. The same applies to the RCA 954, 957 and 827K valves.
- (VI) GRID DRIVING POWER. The grid driving power given in Table II is the power required at low frequencies excluding the extra power required at higher frequencies due to transit time loss and other losses. The power required at low frequencies is approximately equal to 0.9 times the mean grid current multiplied by the peak value of the R.F. grid volts. In the case of push pull valves R.C.A. 815, 829 and 832 the Peak R.F. grid volt figures are the peak R.F. grid to grid voltage.
- (VII) POWER OUTPUT. Nominal Available Carrier Power Output at the Lower Frequencies unless otherwise stated.
- 316A and 4316A. A nominal Power Output of 7.5 watts is available at 500 Mc/s. For other frequencies, see text and curve.
- D. 15654B. A nominal Power Output of 5 watts is available at 750 Mc/s and 6 watts at 700 Mc/s the power rising to 20 watts at low frequencies. This valve is designed for operation at the specified filament current, the filament voltage being approximate.
- GL 8002. Power Output at 200 cm (150 Mc/s).

The Electrical Properties of High Frequency Ceramics

By DR. ING. E. ROSENTHAL

(Dr. Rosenthal is Ceramic Consultant to Messrs. Bullers, Ltd., and was formerly Managing Director of Rosenthal-Isolatoren, Ltd. He is one of the pioneers of the development of low-loss ceramics and their application to H.F. circuits. Much of the data in this article has not been hitherto published.—Ed.)

THE technique of high-frequency ceramics which has come into being in the past few years has resulted in the appearance on the market of a number of new ceramic materials. Previously, the ceramic industry had developed various bodies for use as insulating materials in the electrical industry which may be classified into two groups. One is porous and refractory and is mainly used to carry and insulate the heating elements of electric heating apparatus, both for household and industrial purposes; the other group includes the various types of porcelain having a dense vitrified structure used for insulating high-tension and low-tension direct and alternating current of low frequencies. The mechanical and dielectric properties at these frequencies are good and give complete satisfaction. Only in cases where extraordinarily strong mechanical characteristics were required, a material called steatite was preferred and especially used on the Continent, where greater accuracy than that obtainable with porcelain and greater mechanical resistance were required.

Porcelain is a material made of china clay, ball clay, felspar, quartz or stone containing felspar and quartz. Owing to the plastic quality of the clay, it can be formed by various methods into the most complicated shapes. It is fired at a temperature of between 1,300° C. and 1,410° C., the first being the standard temperature in this country and America, whereas in the Continental factories a temperature of 1,410° C. is standardized for electro-technical porcelain. During the firing process the felspar dissolves the quartz and part of the clay, which itself is dissociated into the crystal mullite and cristobalite, the latter being a silica crystal and dissolved at the firing temperature by the felspar. After having cooled down, the structure of the fired porcelain is a conglomerate of mullite crystals, felspatic glass and undissolved quartz particles, and this structure results in a power factor which is quite sufficient for the technical frequency of 50 cycles, but is not longer sufficient at radio frequencies owing to the development of heat. This heat development, owing to the dielectric losses, becomes so considerable at higher frequencies that the dielectric losses further increase and cause an early destruction of materials having at room temperature at radio frequencies a power factor exceeding $20 \times 10^4 \tan \delta$.

Steatite as manufactured for many years, especially on the Continent, consists of soapstone or talcum, a magnesium silicate ($3 \text{ MgO} \cdot 4 \text{ SiO}_2 \cdot \text{H}_2\text{O}$), a plastic material, which, in order to become more plastic, is mixed with a small quantity of clay, and felspar is added to obtain at a firing temperature of 1,410° C. an absolutely vitrified material.

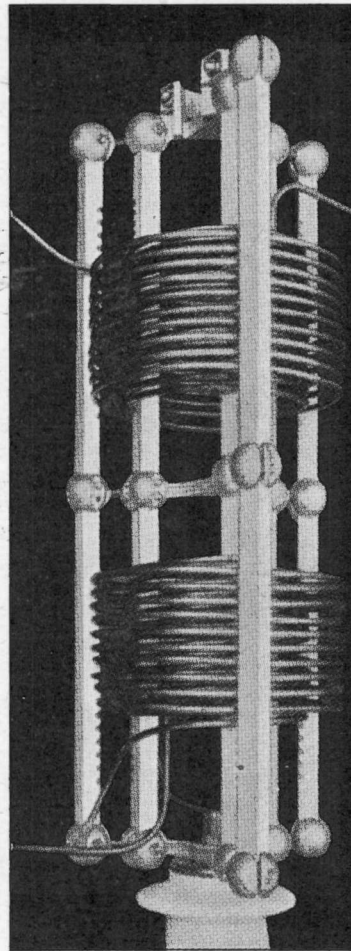

A coil measuring 3 metres by 1 metre for a short-wave transmitter assembled on a ceramic former.

The structure of the fired steatite material is much more homogeneous than that of porcelain and consists chiefly of clinoenstatite, a magnesium silicate of the composition MgO SiO_2 and of felspatic glass matrix. The power factor at radio frequency is about $20 \times 10^4 \tan \delta$, and being much smaller than that of porcelain steatite was used

in the early stages of short-wave apparatus manufacture, but the manifold and increasing technical requirements of the short-wave industry made developments of new materials necessary. The ceramic industry has succeeded in solving many of these problems by developing various new insulating materials. These have very different dielectric characteristics. They have only one characteristic in common—a low power factor at radio frequencies, because otherwise however favourable one or the other of the dielectric or mechanical properties may be they could not be used in a strong high-frequency field.

Since radio engineers, as a rule, are not specialists in high-frequency ceramics, and, on the other hand, engineers in the insulator industry are not specialists in short-wave problems, a very close collaboration between the designer of high-frequency apparatus and the manufacturer of high-frequency ceramics is of special importance.

The various ceramic materials for high-frequency purposes developed in recent years may be classified into four groups.

Firstly, the clinoenstatite bodies. These represent an improvement on the steatite bodies mentioned above. Owing to the clay and felspar contents a certain amount of the soapstone, which forms the main constituent of the steatite bodies, is dissolved, and part of the structure consists of felspatic glass, thus forming a conglomerate of glass matrix and crystals and preventing the crystals from imparting their dielectric characteristics to the fired body. By certain alterations of the composition—first by omitting the felspar as a flux—the resulting structure becomes homogeneous and crystalline and consists to a very great extent of pure clinoenstatite (MgO SiO_2).

X-ray photographs have proved that as more of this crystal is formed and the more homogeneous the structure, the more favourable are the dielectric properties, especially the power factor. The power factor is entirely a function of the crystalline structure. There are, for instance, various modifications of the clinoenstatite denominated α and β . Under normal firing conditions and if the soapstone content of the body mixture is a very high one, primarily clinoenstatite of the α modification is formed, but a long heating may form the β modification, which deteriorates the power factor, probably because a mix-

ture of the various crystal modifications does not give the same homogeneous structure.

The described modification of the steatite improves at the same time the mechanical characteristics. Owing to the fact that soapstone is plastic and can be worked by the methods used hitherto in the ceramic industry, such as jollying, turning, extruding, casting, wet pressing, and in addition by dry pressing, these clinostatite bodies can be formed into the most complicated shapes, and this is the reason why this group is the most important of the various high-frequency ceramics and is being used for the manufacture of many important components in the high-frequency industry to an ever-increasing extent.

Secondly, rutile bodies. These are characterized by the fact that they consist mainly of the crystal rutile, a titanium-dioxide (TiO_2). The main characteristic of rutile is the very high dielectric constant (perpendicular to the crystal axis 80, and parallel 173), and it imparts this characteristic to ceramic bodies which consist mainly of this material, and which are mixed with a small portion of plastic clay or bentonite only for the purposes of being made workable. Owing to the fact that a larger proportion of clay would decrease

strongly negative temperature coefficient, of which property very much use is made nowadays for the manufacture of temperature compensating capacitors.

Thirdly, the magnesium orthotitanate bodies, characterized by the formation of the crystal magnesium orthotitanate ($2MgO \cdot TiO_2$). (Other titanates may prevail according to the composition of this body.) This crystal is formed up to 80 per cent. in certain bodies and imparts its favourable dielectric charac-

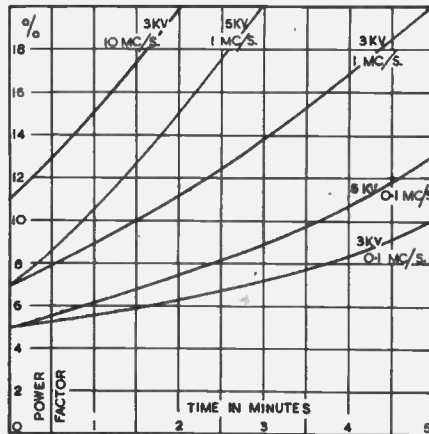

Fig. 4. Power-factor of bakelised paper in strong high frequency fields at various frequencies and voltages.

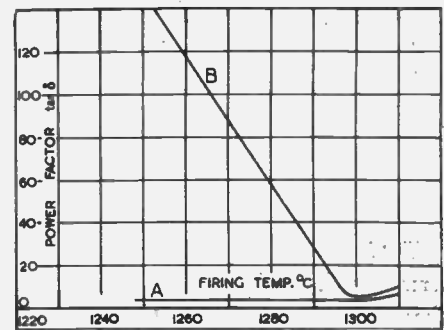

Fig. 3. Variation of power-factor of a steatite group material with maximum firing temperature ($f = 1 \text{ Mc/s}$).
(a) In a dry atmosphere of calcium chloride.
(b) In an atmosphere of 75% relative humidity.
(Robinson, Jour. I.E.E., Nov., 1940.)

teristics to this type of material. The power factor is smaller than that of mica, and the temperature variation of the permittivity is negligible. The permittivity being three times as great as that of mica, this material is the ideal dielectric for condensers. Since only a very small addition of plastic material is permissible, these kinds of bodies can also be formed only into simple shapes like tubes, caps and disks, as required for the manufacture of high-frequency condensers.

Fourthly, cordierite bodies. The mineral cordierite which has the formula ($2MgO \cdot 2Al_2O_3 \cdot 5SiO_2$) has an extremely small thermal expansion and imparts this property to ceramic bodies in which it forms the main constituent. Cordierite bodies are very useful in all cases where a small heat expansion is required. The structure of these bodies is, however, not so homogeneous, and the power factor is higher than in the bodies described above. The body contains a considerable proportion of plastic

clay and can be worked like a porcelain body, and practically all shapes which can be made of porcelain can be made of cordierite bodies as well. The more important dielectric characteristics of the four groups of ceramic materials and their thermal expansion are given in the following table. For purposes of comparison, the corresponding figures of porcelain are added:—

The figures with regard to the power factor are obtained at room temperature and in a dry atmosphere. Fig. 1 shows that within the range between zero and 100° C. the clinostatite bodies, the rutile and magnesium-orthotitanate bodies practically do not change their power factor, whereas the porcelain and steatite bodies have a power factor

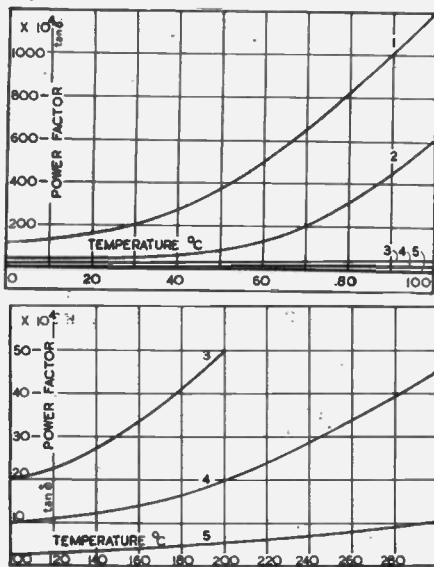

Fig. 1. Temperature-Power Factor curves of various materials at high frequency (1 to 10 Mc/s). (1) Porcelain. (2) Steatite. (3) Rutile body. (4) Clinostatite body. (5) Magnesium-Orthotitanate body. In Fig. 1a curves 3, 4 and 5 have been extended on the temperature scale.

the dielectric constant to a great extent, and deteriorate considerably the favourable low-power factor, this kind of material is not very plastic and can only be formed into simple shapes, such as tubes, caps or disks as required for the manufacture of condensers. The dielectric constant of the rutile crystals has a

characteristics to this type of material. The power factor is smaller than that of mica, and the temperature variation of the permittivity is negligible. The permittivity being three times as great as that of mica, this material is the ideal dielectric for condensers. Since only a very small addition of plastic material is permissible, these kinds of bodies can also be formed only into simple shapes like tubes, caps and disks, as required for the manufacture of high-frequency condensers.

Fourthly, cordierite bodies. The mineral cordierite which has the formula ($2MgO \cdot 2Al_2O_3 \cdot 5SiO_2$) has an extremely small thermal expansion and imparts this property to ceramic bodies in which it forms the main constituent. Cordierite bodies are very useful in all cases where a small heat expansion is required. The structure of these bodies is, however, not so homogeneous, and the power factor is higher than in the bodies described above. The body contains a considerable proportion of plastic

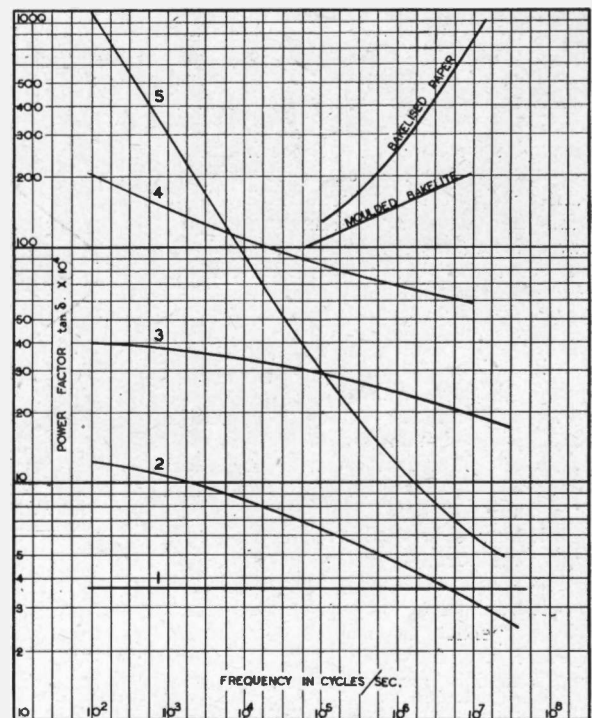

Fig. 2. Variation of Power-factor with Frequency. (1) Rutile body (Improved). (2) Clinostatite body. (3) Clinostatite body containing Felspar. (4) Porcelain. (5) Rutile body.

which increases with increasing temperature. Since the high power factor of the two latter materials results in heat development in strong high-frequency fields, it can be seen that even without additional heating these materials are not suitable for high-frequency purposes. Fig. 1 (a) shows the power factor at radio frequency of three low-loss ceramic materials between 100° C. and 300° C., and shows that for the clinostatite type and the magnesium-orthotitanate type the figures are extremely favourable. This is of special interest to the valve designer.

The trade names which are given by the various manufacturing firms to the various high-frequency ceramic bodies are as follows:—

Bodies	Bullers	Steatite and Porcelain Products	Continental	U.S.A. (a) Isolantite Inc. (b) Lava Corporation
Clinostatite ..	Frequelex ..	Frequentite	Calit Frequentia Rosalit	(a) Isolantite (b) AlSiMag 35 " 196 " 197 " 211
Rutile ..	Permalax ..	Faradex ..	Condensa Kerafar R and S	AlSiMag 190 " 192
Magnesium-Titanates	Tempalex ..	Tempradex	Tempa Kerafar T and U	AlSiMag
Cordierite ..	Sepalex ..	—	Sipa ..	AlSiMag 72 " 202

The variation of the power factor with frequency of various materials is shown in Fig. 2, from which can be seen that all dense ceramic materials have a negative frequency coefficient, the frequency coefficient of the magnesium-orthotitanate bodies being negligible over a very wide frequency range, the frequency dependence of the clinostatite and rutile group being almost negligible at radio frequency. Porcelain and steatite have a negative frequency dependence also, but the fact that the high-power factor causes internal heating at radio frequencies makes the negative frequency dependence a purely theoretical consideration.

Fig. 3 shows the variation of power factor of a clinostatite group material with firing temperature in dry atmosphere and in an atmosphere of 75 per cent. relative humidity.* It shows that only completely dense materials retain in humid atmosphere the favourable power factor measured in dry atmosphere.

The smallest degree of porosity causes considerable deterioration in the dielectric properties in humid atmosphere. This refers, of course, not only to ceramic materials but also to other kinds of insulating materials. Since with the exception of quartz glass no other materials possessing a sufficiently low power factor in dry atmosphere are free

* Robinson: *Journal I.E.E.*, Nov., 1940.

from air interstices, ceramic materials are much superior in this respect.

It is very interesting to compare the power factor of ceramic materials with that of synthetic resin-bonded paper of relatively good quality. In Fig. 4 the increase of the power factor during the first five minutes is shown. A disk of 80-mm. diameter and 5-mm. thickness was subjected to a strong high-frequency field between two electrodes, the voltages being 3 kv and 5 kv, and the frequency 0.1 Mc/s, 1 Mc/s and 10 Mc/s. The curves show that with increasing voltage and increasing frequency the deterioration of the material increases rapidly. The curves also show that resin-bonded or resin-impregnated materials are not suitable as insulating

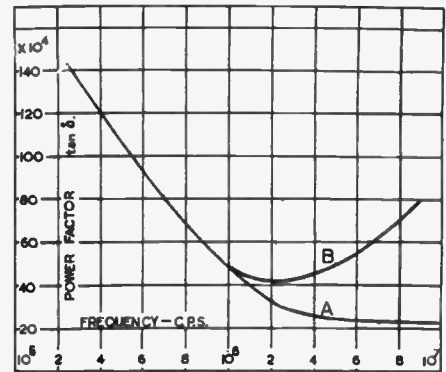

Fig. 5. Variation of Power-factor with frequency. (a) Low-loss ceramic, (b) Bakelised paper, coil formers.

materials for radio frequency. For instance, at a frequency of 1 Mc/s and a voltage of 5 kv, the already very high initial power factor increases almost threefold within the first three minutes and at a frequency of 10 Mc/s, and at a somewhat lower voltage of 3 kv the deterioration progresses even more rapidly.

If a component consisting of bakelized paper is not subjected to such a strong high-frequency field as in the test arrangement described above—for instance, in the case of a coilformer—the disadvantageous consequences of the higher power factor are, of course, not so conspicuous, especially for lower frequencies; but the superiority with regard to the power factor of a ceramic coilformer compared with bakelized moulded material is extraordinary and specially marked at frequencies above 1 Mc/s. This is illustrated in Fig. 5.

Curve (a) shows the power factor of a coil, the wire being fixed on a coilformer of a low-loss ceramic material; whereas curve (b) shows the power factor of a coil, the wire being wound round a former made of bakelized material.

Similar conditions also prevail with regard to other components used in a high-frequency field, and this is one of the reasons why high-frequency ceramic materials should be provided wherever such losses would otherwise occur. If the permittivity or its temperature coefficient is not of special importance, and if a low heat expansion is not required, the material which is most suitable is that of the clinostatite type.

(To be concluded next month.)

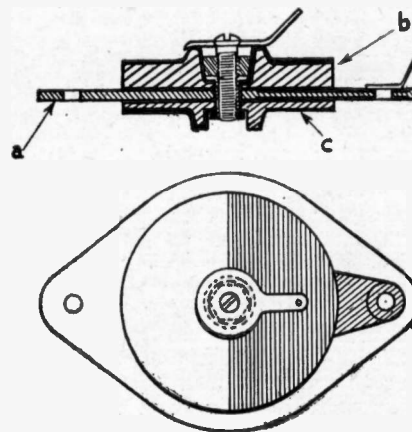

Fig. 6. Condenser designed for compensating for temperature coefficient. (a) Clinostatite base. (b) Disk of rutilite body, the metal coating of which is in electrical contact with that of c, a Clinostatite.

Material	Power Factor at 10 Mc/s × 10 ⁴	Dielectric Constant	T.C. × 10 ⁻⁶ Dependence of Capacitance on Temperature	Thermal Expansion Coefficient
Clinostatite bodies	3—6	5.5—6.5	+140	6.2 × 10 ⁻⁶
Rutile bodies (1) ..	2.7—5	80	-720—820	7-8 × 10 ⁻⁶
Rutile bodies (2) ..	6—8	40	-400	6-7 × 10 ⁻⁶
Magnesium Orthotitanate bodies ..	0.7	14—16	+40—+70	6.2 × 10 ⁻⁶
Cordierite bodies ..	40—70	5.5	+150	1.1 × 10 ⁻⁶
Porcelain ..	70—120	50—65	+150—+250	3-5 × 10 ⁻⁶

Review of Progress in Electronics

VI.—Thermionic Emission

By G. WINDRED, A.M.I.E.E.

“According to the electronic theory the conduction of electricity in metals is effected by the motion of electrons which are free temporarily from the atoms of which they form part . . . now it is known that, if the temperature of a body be raised sufficiently, the speed of agitation of the molecules becomes so great that they break free . . . and it might be expected that, if the electrons share in the agitation, they should also break free, if the metal is hot enough, and give rise to an electric current from the metal to surrounding bodies.”—N. R. Campbell, in “A History of the Cavendish Laboratory,” 1910.

THE liberation of electrons from a conductor by the action of heat is one of the most important of the phenomena forming the background of applied electronics, as may be readily appreciated by consideration of the wide range of electronic apparatus relying on this principle for its operation. A vast amount of experimental work has been carried out on the various aspects of thermionic emission since the time of the basic discoveries at the end of last century, and a correspondingly vast literature has grown up round the subject.

Early Researches

In 1880, the physicists Elster and Geitel made the first definite experimental inquiry into the electrical effects produced by the increase of temperature of a conductor. They used an evacuated glass vessel containing a filament, either of metal or carbon, near which was located an exploring electrode in the form of a small metal plate, externally connected to an electroscopes. The filament was heated by passing current through it, and under these conditions it was observed that the electroscopes indicated the presence of a negative charge on the exploring plate electrode. This experiment showed conclusively that the hot filament was able in some way to project across the evacuated space a negative charge of electricity; some of which was collected by the plate.

The next step was made in 1883, during experiments carried out by Edison in connexion with his early carbon filament lamps. On this occasion he was trying to discover the cause of filament failure which he had noticed was associated with a progressive darkening of the inside of the glass bulb. In an attempt to determine the nature of this deposit, caused evidently by the hot filament, Edison sealed into one of his lamps a metal plate with an external terminal, to which was connected a galvanometer. It was found that when the free end of this instrument was connected to the positive side of the filament supply, there was indication of a feeble current, but no current flowed if the connexion was made to the negative side of the filament supply.

The practical possibilities of these discoveries by Elster, Geitel and Edison

were not realised at the time; in fact, the state of electrical science was not suggestive of any application, and for many years the subject remained in the stage of academical experiment. It was brought from this stage to the very forefront of potential application mainly as a result of the series of painstaking researches carried out by Sir J. A. Fleming between the years 1889 and 1896, culminating in the development of the radio valve. This investigator has given a very instructive account of his own and contemporary research in this sphere.¹

The evolution of the radio valve and the almost immediate application of this device to communications gave an immense impetus to theoretical and experimental study of thermionics. Systematic study from the theoretical

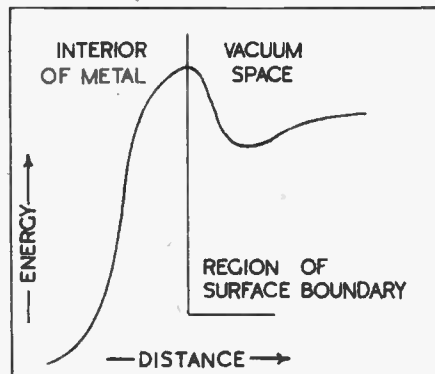

Fig. 1. Energy changes in thermionic emission of electrons

point, supported by experiment, dates from 1901, when O. W. Richardson² published a paper on the negative radiation from hot platinum. In 1903 the same author published a paper³ on the electrical conductivity imparted to a vacuum by hot conductors. This paper, occupying some fifty pages of the Royal Society's *Transactions*, is one of the oft-referred-to classics of thermionics. An excellent survey of this and subsequent literature on thermionic emission, especially that bearing on the subject of valve filaments, has already been published.⁴

General Theory

A great deal of attention has naturally been directed to the problem of the mechanism of thermionic emission with a view to finding out just how the electrons escape from the metal to the sur-

rounding space. As a beginning, it was natural to assume that these electrons were the normal “free electrons” contained in a conductor, and attempts were made to formulate theories on the basis of the classical theory of free electrons whose behaviour is analogous to that of the molecules of an ordinary gas; collisions with metallic atoms being comparable with collisions with the walls of the vessel. These ideas had to be abandoned.

The region of discontinuity at the surface of an emitting body leads readily to the idea of a potential hill at the surface; the steepness and shape of the hill determining the energy of the escaping electrons. An instructive mechanical analogy has been suggested by W. Schottky,⁵ in which a flat-bottomed bowl with sloping sides contains a number of perfectly elastic spheres. The two-dimensional velocity distribution of these spheres as they roll about on the bottom of the bowl represents the three-dimensional freedom of the electrons in the conductor. If the spheres, representing electrons, are agitated sufficiently, some of them will roll up the sides of the bowl, the slope of these sides representing the energy necessary for the climb. Spheres approaching the sides with sufficient energy are able to complete the climb and drop over the edge, thus escaping from the bowl into the surrounding space.

This idea is taken a step further in Fig. 1, representing the approximate shape of the actual surface potential barrier, which is seen to have a hump representative of the critical amount of energy which just suffices to secure escape of the electron. Its behaviour after escape is dependent upon the external field, and can be represented by suitable shapes of the portion of the curve following the hump. These ideas form the background of the modern theory of thermionic emission, which is dealt with in several treatises, notably those of Reimann⁶ and de Boer.⁷

Experimental Work

Many of the earlier experiments were carried out under conditions which would now be regarded as very crude, owing to accumulated knowledge on various aspects of the subject. Foremost among the recognized essentials is the

necessity of precise information concerning the physical state of any conductor under investigation, and particularly the state of its surface, which has a profound effect upon the thermionic emission. From this point of view a metal is only "clean" when its surface is as free as possible from contamination due to oxides, sulphides, etc., adsorbed gases or other metals. It may be said that no metal prepared in air can be really clean, and any measurements of emission from a contaminated surface will be representative of this contamination rather than of the metal itself.

During the course of various refined experiments on emission, some interesting facts came to light. In his early papers, Richardson had established that the saturation current per unit area of an emitting surface was given by

$$i = A \sqrt{T} \exp(-b/T)$$

where T is the temperature and A and b are constants for particular materials. It is seen that according to this formula the current is independent of the applied anode voltage, so that however strong the field produced by this voltage the number of electrons emitted is dependent

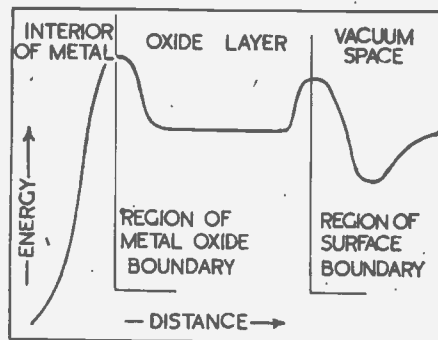

Fig. 2. Energy changes in emission from oxide coated metal

only upon the temperature in a given case. It was shown by Schottky,⁸ however, that the number of electrons increased with the strength of the applied field at the surface, and that in consequence there could be no true saturation current. This condition, which became known as the Schottky effect, necessitated modification of Richardson's formula, and also of ideas concerning emission.

Another interesting phenomenon is the *shot effect* representing a fluctuating emission current due to the fundamentally random nature of the thermionic emission. The escape of electrons is a random event, so that the emission may be compared with a stream of shot. The number of electrons emitted in a given time, and therefore the average current, may be constant under steady conditions, but there are instantaneous fluctuations because of the random escape of individual electrons. Schottky⁹ has given a quantitative explanation of the effect which agrees well with observations.

The *flicker effect* also represents a

current variation, particularly noticeable in the case of composite cathodes. The effect was observed in 1925 by J. B. Johnson¹⁰ and examined by Schottky,¹¹ who suggested that it was due to the arrival or loss of individual atoms at the emitting surface, causing changes in the emission at the corresponding points of the surface.

Valve Cathodes

As long ago as 1904 A. Wehnelt¹² published the results of his work on emission from metallic oxides, leading to the development of the oxide-coated or Wehnelt cathode with an emission much greater than a corresponding metal filament. The technique of coating is somewhat special, and is followed by an activating heat treatment which considerably enhances the emission. The thickness of the coating has no appreciable effect on the emission, and it has been found that a monomolecular layer emits as well as a coating several thousands of molecules in thickness. It may be noted, however, that according to recent work the emission from a given coating is influenced to some extent by the core material. With an oxide-coated cathode the energy discontinuity tending to retain the electrons has the general form showing in Fig. 2, which is seen to have two humps corresponding to the boundaries from metal to oxide and oxide to free space respectively.

The process of activation of a coated cathode varies considerably according to its size and the nature of the coating. In general, the cathode is heated in the usual way and a current drawn from it at the same time. The duration of the process varies from a minute or two in the case of small cathodes to several days in the case of large ones. Some idea of the effect of the process may be gained from the curve in Fig. 3, representing the results of tests by W. Espe¹³ with various values of anode voltage and emission current.

The greatly increased emission obtained from tungsten filaments to which a trace of thorium oxide (thoria) had been added during manufacture was reported by Langmuir¹⁴ in 1914. Perhaps the best account of the work done on thoriated filaments up to 1930 is that given in Section 7 of the Report under Item 4 of the accompanying bibliography.

Another objection to direct heating arises from considerations of current distribution. In order to preserve a uniform temperature along a directly heated cathode it is necessary that the heating current should be at least three times the emission current. Since the emission current flows through only a part of the cathode in obtaining egress from it under normal conditions, different parts of the cathode will be traversed by different currents and will thus be raised to different temperatures unless the heating

current is so large that the heating effect of the emission current may be neglected. In order to avoid high heating currents and associated difficulties with vacuum seals, etc., the indirectly heated cathode is reverted to for values of emission current exceeding the order of about 2 amperes. No exact figure can be given owing to the wide range of types of cathode and service conditions. The use of an independent heater allows a small heater current at higher voltage in order to obtain the required heat dissipation. In the case of gas-filled tubes there is a fairly low upper limit of heater voltage, according to the gas used, owing to the possibility of discharge between the heater wires unless special means are incorporated for insulating them, as by complete enclosure in the seal.

In the case of large valves, where the complication is warranted, efficiency is greatly increased by the use of heat-screened indirectly heated cathodes, in which the heater and emitting surfaces of the cathode are enclosed in a cylindrical metal sheath with smooth interior reflecting walls, designed to reduce heat loss to a minimum.

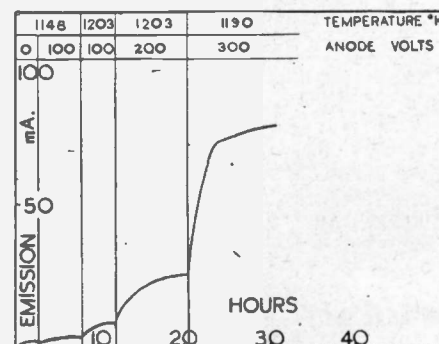

Fig. 3. Variation in activity of barium-oxide coated cathode (W. Espe)

Bibliography

- 1 J. A. Fleming: "The Thermionic Valve," London (Iliffe), 2nd Edn., 1924.
- 2 Proc. Camb. Phil. Soc., 11, 1901, p. 286.
- 3 Phil. Trans. Royal Soc., 201, 1903, p. 497.
- 4 W. S. Stiles: "Thermionic Emission" (D.S.I.R. Radio Research Special Report No. 11), London (H.M. Stationery Office), 1932.
- 5 Zeits. f. Phys., 14, 1923, p. 63.
- 6 A. L. Reimann: "Thermionic Emission," London (Chapman & Hall), 1934.
- 7 J. H. de Boer: "Electron Emission and Adsorption Phenomena," Cambridge, 1935.
- 8 Phys. Zeits., 15, 1914, p. 872.
- 9 Ann. d. Phys., 57, 1918, p. 541; 68, 1922, p. 157.
- 10 Phys. Rev., 26, 1925, p. 71.
- 11 Phys. Rev., 28, 1926, p. 74.
- 12 Ann. d. Phys., 14, 1904, p. 425.
- 13 Wiss. Veröff. a.d. Siemens-Konzern, 5, 1927, p. 29.
- 14 Phys. Rev., 4, 1914, p. 544.

The Application of Electronics to Industry

I. Safety Devices

by John H. Jupe

WITH the increasing introduction of women and intensively trained male labour into factories engaged on war production, the need for safety devices becomes even more urgent now than in more normal times. Work at high speed and long hours are both conducive to accidents, and there is much scope for electronic apparatus to ensure that these are kept down to a minimum.

These safeguards are sometimes avoided, owing to cost and also to a certain amount of conservatism among engineers. Both these reasons are economically wrong, because nothing that safeguards life is ultimately expensive and the production value of such apparatus to the manufacturer lies in what it does and not what it costs.

Many of these electrical schemes for protection save money and therefore have the strongest claims to be considered, yet they are overlooked. This saving may be indirect, as in the case of insurance companies who allow concessions in the premiums on machinery which has proved by X-ray examination to have sound castings or forgings.

Reliability hardly enters into the question, as valves, photocells and relays, which are so much used in electronic work, have all demonstrated themselves to be sound engineering tools by their uses in other fields.

The principles governing the use of electronic safeguards and alarms fall into two groups:—

(1) Devices which give warning of impending danger, improper operation, or which indicate when set limits are exceeded.

(2) Devices which actually operate gear for the direct protection of life and property.

In most cases it is easily possible to convert (1) into (2) by the addition of suitable relay gear, but in actual practice it is often sufficient to allow human action to be the final one. This may be owing to the extremely complicated apparatus that would otherwise be involved or to the fact that the hazard is not extremely great.

Nearly all the electronic phenomena can be used in some way or other, photo-electric emission, X-rays, gas ionization, cathode rays, etc., each could

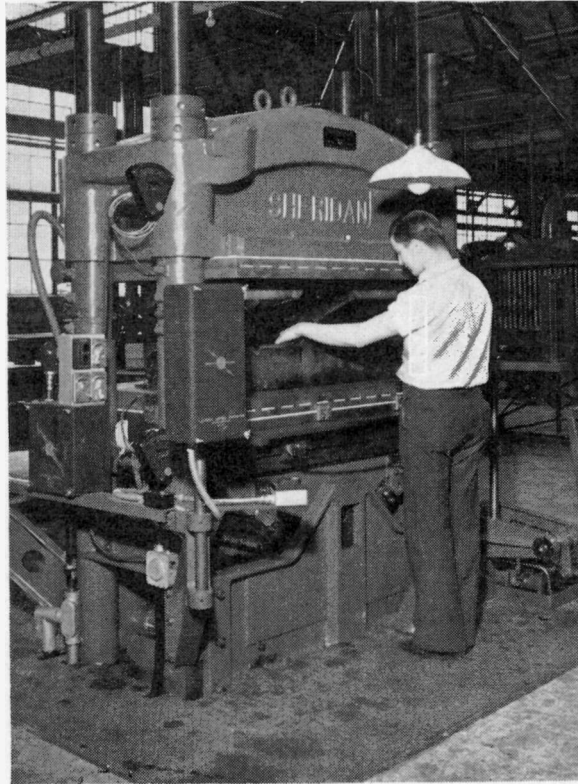

Fig. 1. Electronic safety guard for power press operator. The light beam is interrupted by the shoulder (white rectangle). This press is also fitted with electronic time delay circuits to allow it to remain closed for a predetermined length of time. (Courtesy, Arvey Corporation, Detroit, U.S.A.)

be quoted in many instances as examples of how the electron may be an ally in our never-ending search for safety.

These have been used for many years for the detection of faulty metal parts, but only in a few works are they used for routine tests. There is no need for the entire output of an article to be tested, although sometimes this is absolutely essential. For example, some 400,000 feet of welding on the great Boulder Dam in the United States was examined on site by this method.

Defects are easily detected by X-rays and comprise cracks, pockets formed by gas in castings, sand or slag impurities, porous textures and pronounced granulation where masses of metal are concerned.

Or there are totally different uses, such as the examination of the boundaries of rubber and fabric in motor tyres and the detection of foreign bodies in tinned goods. This last use has been of great value in difficult cases, such as the detection of internal bruising

(causing deterioration) in hams, and such an instance serves well to emphasize one of the greatest advantages of X-ray tests—that they are non-destructive. With a nation at war the careful examination of tinned goods is obviously of paramount importance.

Light ray guards are firmly established for some purposes, and an example of how fool-proof they may be is in the motor-car industry, where they have been applied to the protection of operators of large power presses (Fig. 1).

The light projector is in the foreground and throws a curtain of light, twelve inches in height and one and a half inches in thickness, completely round the danger area of the press. Any interruption of this beam stops the press, which may be fitted with auxiliary electronic devices, such as "Automatic Repeat Control," which allows operation to continue only if the operator was in his correct (safe) position for the last period of the opening stroke.

Another application of the photo-cell circuit which, though not industrial in its application, is worthy of note is the light-ray apparatus for the protection of mental patients and sleepwalkers in hospitals. As shown in the sketch, a beam of light from the projector A is thrown across the bed on to a receiver alarm B. Should the patient get out of bed, the ray is interrupted and a bell rings in the nurse's room* (Fig. 2).

Photo-cells can also be very successfully applied to the task of watching for flashes, or flames exceeding their normal limits. For flame control, it is possible to use another totally different electronic principle, depending on the fact that there are ions present in the flame, with the result that it is a conductor of electricity. In apparatus of this kind the chief feature is an electrode mounted in a ceramic insulator and connected to the grid of a thermionic valve. If it is desired to give warning when the flame diminishes, the electrode is normally in contact with it, whilst if it is required to detect an excessively large flame the electrode is just outside the normal boundary. In either case, the valve receives a change of grid bias when the flame varies and warning or control takes place via relays, etc.

* *Lancet*, Sept., 1934.

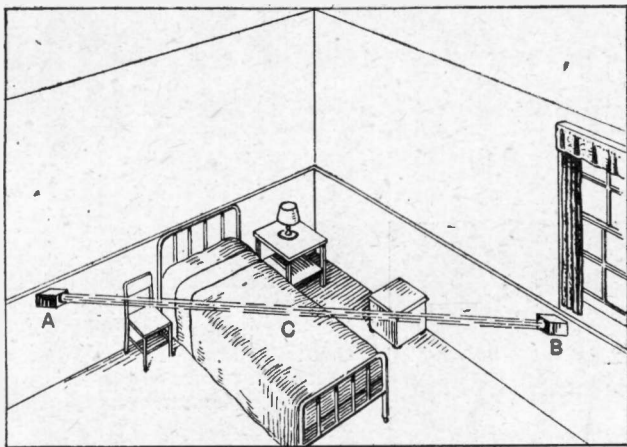
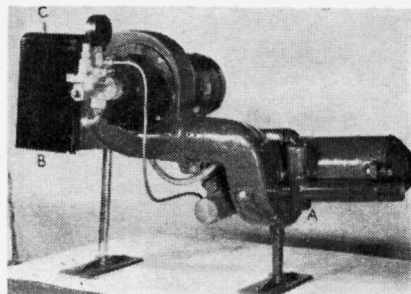

Fig. 2. Typical installation of Sleep-walker Protection Apparatus. (a) Projector. (b) Receiver. (Courtesy, Radiovisor Parent Co., Ltd.)

Another very important place where the electron may be used to safeguard life is anywhere where there is mercury. This substance is used in several industries, more so in war time; and it gives off a dangerous vapour at all times, at room temperatures. Such vapour attacks the worker's health and will also very quickly attack photographic films and jewellery. One method of detecting it is to expose a test card coated with selenium sulphide to a current of warm air rising from a lamp. Should mercury



(Courtesy Radiovisor)

vapour be present the yellowish sulphide will turn brown, and comparison with a standard chart may be made photo-electrically, permitting the detection of as little as one part of mercury in a hundred million parts of air.

Another method, of even higher sensitivity, depends on the fact that any vapour will absorb light of the same colour as it would emit if it were itself excited by heat or by some other means. So, by using a discharge lamp of the mercury type and a photo-cell working on the differential principle, balance can be obtained between the light leaving the lamp and that arriving on the cell. Accumulation of mercury vapour in the atmosphere will upset this balance and may thereby operate warning devices.

Food or other products sometimes have metallic impurities, and their detection provides further scope for the electron safety device. It uses the tuned inductance bridge and an associated amplifier and by working on a frequency of some 1,000 kc very small particles may be found, the change being in the

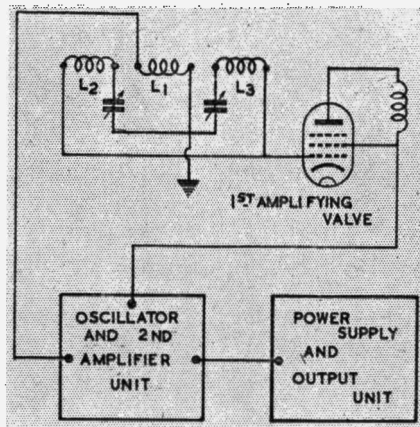

Fig. 3 (left). Flame control apparatus attached to oil burner. Fig. 4 (above). Circuit for detecting metallic impurities in food.

voltage or phase they cause in the arms of the bridge. Such an instrument is worthy as an example for those engineers who are rather sceptical regarding new departures, for it can be built from standard radio components in any research or development department, will remain stable under factory conditions for months, is not affected by vibration, does not employ large numbers of valves and is only limited in its speed of operation by the speed of a sensitive relay (Fig. 3).

Further examples of electronic safety devices are given in the appended table.

BIBLIOGRAPHY.

Stansbury and Brown: "An Electronic Phase-failure Relay." *Electronics*, p. 46, 1933.
 van Steewen: "Optical Train Control." *The Electrical Review*, pp. 187-88, Feb. 9, 1934.
 Broekhuysen: "A Practical Metal Detector." *Electronics*, p. 17, April, 1938.
 Jupe: "A New Electro-sonic Altimeter." *Aircraft Engineering*, p. 444, Dec., 1939.
 Knight: "Theory and Characteristics of Hot Cathode Rectifiers and Thyratrons." *B.T.H. Activities*, Vol. 15, No. 5, 1939.
 Research Department, A.C. Cossor, Ltd.: "The Cossor Electronic Engine Indicator."
 Mayer: "Cathode Ray Oscillograph Applications." *Electronics*, April, 1938.
 Walker and Lance: "Photo-electric Cell Applications." Published by Pitman.
 Zworykin and Wilson: "Photocells and their Applications." Published by Wiley (New York).
 Barnard: "The Selenium Cell." Published by Constable.
 Campbell and Ritchie: "Photo-electric Cells." Published by Pitman.

Type of Protection	Name of Device.	Electronic Principle.
Lift.	Automatic levelling.	Cage intercepts photocell beam to operate "inching" gear.
Purity of water.	Automatic chlorinator.	Photocell observes titration of sample.
	Turbidity indicator.	Interception of photocell beam by turbid liquid.
Fire.	Photocell smoke alarm.	Interception of light beams by smoke in ventilating ducts.
Boiler water level.	Photocell level and control alarm.	Beam interception by water in gauge glass.
		Beam refraction by water in gauge glass.
Collision.	Iceberg detector.	Thermocouple and indicator.
	Craft detector.	Reflection of radio signal.
	Optical train control.	Photocell operating warning gear.
	Electric-sonic altimeter.	Reflection of high audio frequency impulse.
Synchronizing of power circuits or mechanical devices.	Automatic synchronizer and frequency control.	Resonant circuit and amplifier.
	Photoelectric locks.	Piezo oscillator and amplifier.
Wholesomeness of food.	Photocell colorimeter.	Light beam secures alignment of parts.
Dust protection.	Electrostatic precipitator.	Foreign bodies, bad samples, undercooking noted by colour.
Casting testing.	Automatic pitch tester.	High-voltage charge on metal grids.
Danger area or condition.	Sound-film giving spoken warning.	Sound analyser sorts castings by pitch emitted when struck.
		Endless film operated by light beam, body capacity or switch.

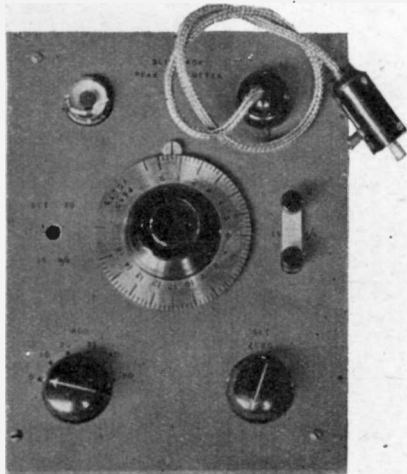

Front view of voltmeter panel. The probe is shown inset in the diagram on the right.

IN view of its various advantages, the slide-back type of peak voltmeter seems to have been treated with a surprising amount of neglect.

The instrument to be described operates from A.C. mains; reads from 0.1 volt to 65 volts (or considerably more if required); uses no meter, and will not be damaged by overload. Further, it reads true peak values, its input resistance can be substantially infinite, and its input capacitance as constructed is only $3.5 \mu\text{F}$., though even this can be reduced to $1.5 \mu\text{F}$. by the sacrifice of mechanical protection for the probe valve.

The circuit comprises a television type diode V_1 mounted on the end of a flexible lead, with a 10-megohm cathode resistance R_1 which, in series with R_2 , a .1-megohm grid current limiter, also forms the grid leak of a D.C. amplifier V_2 . This valve is operated with only a few microamperes anode current, and so is chosen to have the sharpest possible cut-off in order to obtain maximum gain. A 2-megohm resistance R_3 forms both the anode load of V_2 and the grid leak of a "magic eye" indicator V_3 , the various electrode and slide-back potentials being tapped off the H.T. potentiometer R_5 - R_{11} . A simple stabilizing circuit is included to compensate for mains voltage fluctuation, and using this circuit the zero adjustment of the instrument has been found to remain constant during months of use.

The grid potential of V_2 is adjusted by the zero setting potentiometer R_7 to give an anode current of such a value that the resultant voltage drop across R_3 just causes the edges of the shadow in V_3 to touch but not overlap. Assuming for the moment that $R_8=0$ and that the slide-back potential is zero, then the total bias applied to the grid of V_2 will include a fraction of a volt due to the diode V_1 contact potential current through R_1 .

The E.M.F. to be measured is applied to the input of the diode, which will

A Diode Slide-back Peak Voltmeter

By C. E. COOPER

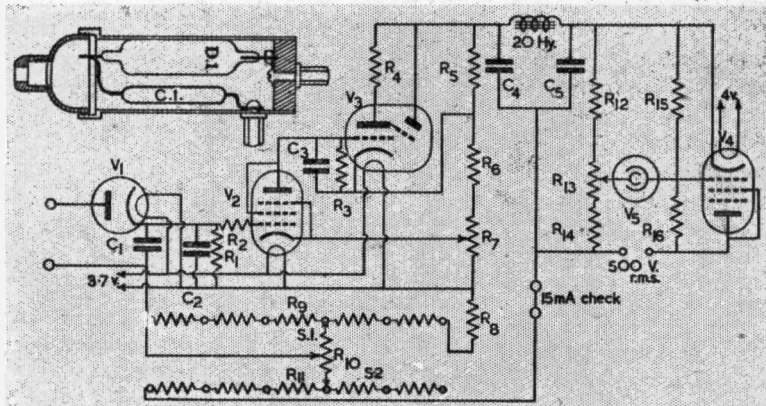

VALUES OF COMPONENTS

C_1 0.0005 μF	R_3 2 megohms	R_{10} 1,000 ohms (calibrated)
C_2 0.01 μF	R_4 1 megohm	R_{11} 5×666 ohms each
C_3 0.02 μF	R_5 15,000 ohms	R_{12} 50,000 ohms
C_4 8.0 μF	R_6 1,000 ohms	R_{13} 50,000 ohms
C_5 8.0 μF	R_7 200 ohms	R_{14} 50,000 ohms
R_1 10.0 megohms	R_8 50 ohms. (See text.)	R_{15} 0.25 megohms
R_2 0.1 megohms	R_9 5×666 ohms each	R_{16} 1 megohm
Values: V_1 Mazda DI V_4 Mazda Pen 45		
V_2 Mazda SP41 V_5 Cossor S 130		
V_3 Mullard TV4		

conduct on alternate half-cycles, the resulting pulses of current through R_1 being smoothed by C_2 and driving V_2 grid more positive. The anode current of V_2 will thus rise, increasing the voltage drop across R_3 ; i.e., driving the grid of V_3 more negative and thus causing the edges of the V_3 shadow to overlap.

By now increasing the slide-back voltage in a negative direction, a point may be reached at which the diode only conducts on extreme peaks of the input signal, and when the mean value of the current pulses is the same as that originally due to diode contact potential the V_3 shadow angle will return to its original position where the edges touch but do not overlap. If, however, the slide-back potential be made too high, the diode current will be completely cut off, V_2 grid will become more negative than when the zero adjustment was effected, and the shadow angle will open.

The slide-back potential necessary to repeat the shadow angle of zero adjustment will be a very accurate measurement of the peak value of the input signal, the accuracy decreasing with increasing "peakiness" of waveform, but remaining very satisfactory even on sawtooth and "flick" impulses. The waveform error decreases with decreasing contact potential current during zero adjustment; and may be eliminated en-

tirely by adjusting for zero diode current.

This may be done by giving R_8 such a value as to just balance the contact potential of the diode, thereby providing the additional advantage of an infinite input resistance (other than glass leakage in the diode, etc.). Unfortunately, there will then be no positive indication of too high a slide-back potential, since the diode current cannot now be reduced below that of zero adjustment.

Where the highest possible input resistance is not required, and a very slight waveform error can be tolerated, it is recommended that the value of R_8 be chosen by the following method:—

(a) With the probe valve removed, and the slide-back potential at zero, adjust the zero-set control R_7 to give the minimum clearly visible separation between the shadow edges, i.e., an angle of some 10° .

(b) Insert the probe valve, short-circuit the input terminals, and adjust the value of R_8 until the shadow edges just touch but do not overlap. The shadow angle of adjustment (a) will be the maximum indication of too high a slide-back potential, the diode current then being a small fraction of a microamp.

To work with zero diode current, the

(Continued on page 417)

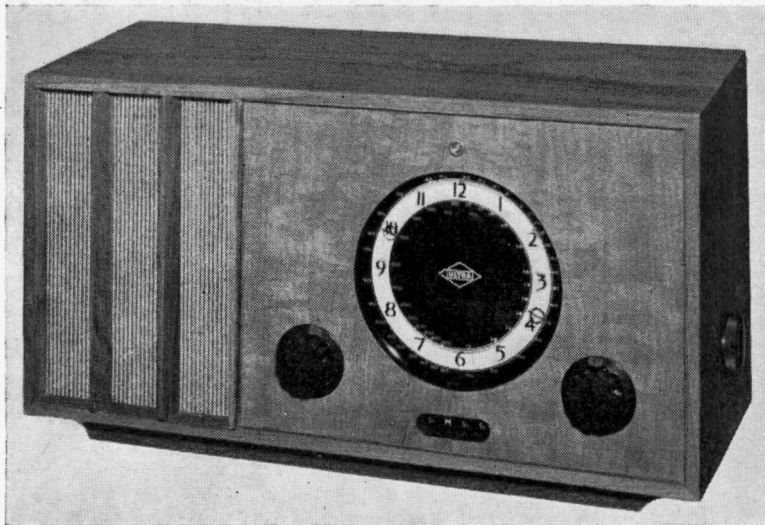

The Requirements of Radio Receivers for Export

By R. O. LAMBERT

THIS article deals chiefly with the design of radio receivers for sub-tropical conditions such as are experienced in South Africa, parts of India, and New Zealand. These climates, although having high temperatures, are not unduly damp, and therefore the humidity is comparatively low.

The waveband coverage should be continuous from 13.5 metres to 550 metres. Long waves are not necessary outside Europe, with the exception of Turkey, but it is essential to ensure good shortwave reception and the receivers should have a sensitivity of between 5 μ V. and 25 μ V. absolute, dependent on the type and price of the receiver. There must also be a high signal-to-noise ratio as this defines the usable sensitivity.

It is advisable to design a receiver incorporating a radio-frequency stage, as it should then be possible to obtain a sensitivity of the order of 5 μ V. without much variation over the tuning range, and the signal-to-noise ratio would be good. A receiver without a radio-frequency stage can give quite useful results, however, providing special attention is given to the design of the frequency-changer circuits, and an efficient intermediate-frequency filter is provided in the aerial circuit. With this type of receiver it is necessary to give every consideration to the intermediate frequency that is used, and it is essential to know the power and wavelengths of the main transmitters of the country for which the receiver is intended, so as to take steps to prevent any interference from the image frequency of possible local stations.

Frequency drift can be very troublesome, but providing care is taken in the design of the oscillator circuit and in the choice of suitable trimmers and associate components, it is possible to keep this to a minimum.

The tuning scale should be calibrated

in both wavelength and frequency, and if the receiver is to be exported to one definite country, a dial marked with the main station names is an asset.

In an A.C. receiver the design and assembly of the mains transformer requires careful attention. It must run as cool as possible and should be capable of working at an operating temperature as high as 75° C. Mains transformers should be baked and impregnated and bitumen is strongly recommended for the purpose, although a suitable varnish may be used. This must be specially selected, as many react with the enamel insulation of the wire, with disastrous effect.

Wax impregnation may be used, but even with this method the windings should be finally sealed with bitumen. If the transformer has metal covers, they must be provided with sufficient air vents to enable a flow of air to pass freely and prevent the winding becoming overheated.

Small transformers, chokes and loudspeakers, field coils, etc., should be treated in the same manner as suggested for the mains transformer. Paper inter-leaving between windings avoids any chemical action between impregnating compound and insulating materials.

The majority of mains supplies are comparable with the home market, i.e. 200/250 volts, 50 c.p.s. A.C. and 200/240 volts D.C.; also 100/120 volts D.C. or A.C. 50 c.p.s.

An important thing to note is the fluctuation of mains supplies in some countries which is of the order of $\pm 5\%$ and particularly in India where $\pm 7\%$ is quite common. Even higher fluctuations have been experienced.

Radio-frequency coils, including I.F. coils, should be treated as follows: the former (if Paxolin or bakelised paper) must be impregnated with a suitable wax before winding the coils. Campbell's L.A.B.C.—19 wax has been found

most suitable for this purpose, but there are several other waxes supplied by this company which can be used having a melting point in excess of 75° C. and with no acid content. Generally speaking, the wax is suitable for impregnation at approximately 120° C. and the formers should be immersed for about twenty minutes. The coil is then wound and finished off by giving it a quick dip in the wax at just above melting point. Low-grade Paxolin tubes and formers made of bakelised paper will tend to warp under some climatic conditions. This is especially noticeable where iron dust cores are used, and the warping will in some cases be sufficient to prevent the core from being readjusted.

Tubular type paper condensers have been found satisfactory for the general export market, but special types are produced for tropical use which are in completely sealed containers. In using the standard type of tubular condenser, it must be sealed with wax which should be just above melting point, and should be dipped in the wax two or three times. (See above.) The final sealing should be watched very carefully to make sure that no air-bubbles are left in the outer wax covering. Mica-cased and silvered mica condensers can be treated in the same manner.

It is detrimental to use a fabric sleeving having a vegetable-oil base varnish for wiring receivers intended for use in the tropics, and the majority of manufacturers use a heat-resisting rubber-covered wire having a low sulphur content; alternatively, pull-back wire which has been impregnated in wax is quite satisfactory.

It is essential that all condensers and resistors be well anchored so as to counteract any jolting that may occur in shipment; this is an important point and should be given careful consideration. It is advisable to avoid the use of ebonite, but if this is not possible it should be lacquered. Valve holders

made of Paxolin or a similar material should be impregnated with L.A.B.C.—19 wax.

Resistors with a rating of less than $\frac{1}{2}$ watt should not be used, regardless of whether the current flowing is within their rating. For other types of resistances where any heat is developed the load should not be allowed to exceed more than 80 per cent. of the normal working rating. Mains dropping resistances in A.C./D.C. receivers should be kept away from other components and should work well below their normal rating, but it is better to avoid the use of such resistances where possible. Line cords specially treated are easily obtainable. It is not necessary to supply mains plugs with export receivers, as in the majority of cases overseas standards are different from those used in this country.

Metal parts should be treated very thoroughly. For steel parts, such as chassis, screening shields, scales, etc., it is necessary to cadmium-plate and finish with either lacquer or cellulose paint; alternatively, they may be zinc-plated, in which case no other finish is necessary.

All brass parts should be nickel-plated and lacquered. Where nuts and bolts, etc., are concerned, they should be nickel-plated and lacquered when fixed to the chassis or component. It might be just as well to mention at this point that it is essential to use locking washers on all the nuts and bolt fixings. Zinc is, of necessity, used to a greater extent than usual, and should be treated with a light quick-drying varnish such as "Cronak" to prevent corrosion at the edges.

For the treatment of loudspeakers, volume controls, wave-change switches and gang condensers, it is advisable to consult the manufacturers, as they have usually good experience on tropical requirements; this also applies to some extent to the cabinet construction and finishing.

Special attention should be given to veneers, and a non-hide glue which is both heat- and water-resisting should be used. Teak is the only solid wood which is thoroughly recommended as its natural qualities for tropical use are excellent. In addition, it gives a very good appearance to the finished receiver.

If plywood is used in the construction of the cabinet, all end grain should be sealed and the inside of the cabinet sprayed with cellulose enamel. Bakelite of a high grade is excellent for this purpose, and has also proved most satisfactory for loudspeaker grilles and escutcheons.

A very important point is reliability of construction, and it is considered that this should be the foundation of any receiver designed primarily for export.

Humidity Chamber

In conclusion, brief constructional details of a suitable humidity chamber which the author has used with success for the testing of components and small radio receivers may be of interest.

The case is of very rigid construction, 16 S.W.G. mild steel covered with $\frac{1}{4}$ in. asbestos being used, strengthened in all corners with angle pieces of the same material. The door of a humidity chamber must of necessity fit very well, and to ensure this it is faced with hard rubber about $\frac{1}{2}$ in. thick. The size of the chamber is approximately 3 ft. 6 in. long by 2 ft. 6 in. high by 2 ft. deep, and a small boiler capable of 75 lb. pressure per sq. in. is situated at one end (see photograph).

The boiler is electrically heated with three tubular heaters which can be switched as desired, and the steam from it is passed through a turn-cock to a small diameter pipe which runs completely round the chamber. This pipe has small holes drilled in it about two inches apart from each other.

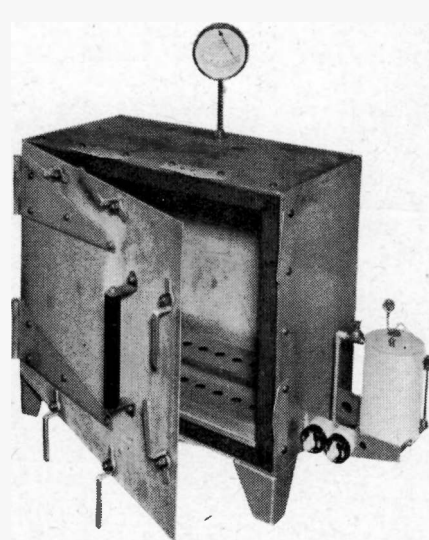

Special humidity chamber for testing export receivers under conditions of heat and damp.

Mounted on each side of the chamber is an electric heater which can be switched in either series or parallel according to the temperature required. Also inside are two sockets wired to A.C. and D.C. mains which are used for supplying the receiver under test. Mounted in the top of the chamber is the hygrometer and thermometer. It is necessary to have several holes in the bottom of the chamber so that any water caused through condensation may run away into a suitable tray. When a receiver or components under test are inserted in the chamber, they should be covered with a screen to prevent any

externally condensed moisture falling on them.

A reasonable test to apply is as follows: operate the receiver in the chamber with a mains input 10 per cent. higher than normal for periods of twelve hours with cyclical temperature variations between 25° C. and 45° C. and a relative humidity between 65 per cent. and 95 per cent. This test should be maintained for about six weeks.

These notes have mainly dealt with A.C. or D.C. mains receivers, but it is advisable to make a few observations with regard to battery models. The author considers that there is an excellent market overseas for a really good battery receiver working from a 6 volt accumulator using a vibrator for I.T. supply. A receiver of this type, giving an output of the order of two watts to a good permanent magnet speaker, is an excellent proposition.

The receiver shown at the head of this article is an Export type specially designed by Ultra Electric Ltd.

Improved Soldering Fluxes

Recent investigations have been concerned with ammonium and amine salts of stearic, oleic and palmitic acids, particularly of stearic acid. Many of these salts have been found to be good fluxes for copper, some have appeared to be non-corrosive, and a few effectively flux steel.

The stearic acid salt of diethylene triamine appeared to be particularly attractive as a flux for both copper and iron. It not only made an excellent effective flux, but did not decompose unduly and gave a residue that was as non-corrosive as rosin. Unfortunately, this flux has a disagreeable odour, hence it may not be adaptable where good ventilation is not available.

The oleic acid salt of diethylene triamine also was found to be effective flux on steel and copper, although it was more corrosive than the stearic acid salt. Unlike zinc chloride, it was not hygroscopic and was completely soluble in water without formation of an insoluble oxysalt.

Some of the fluxes decomposed rather rapidly if a relatively high soldering temperature were used, and in most cases proper ventilation was required to maintain good working conditions.

Stearamide, produced by heating the ammonium salt of stearic acid, was found to be an excellent flux for copper and gave slight corrosion only while heating during soldering.

—"Tin and Its Uses": *Quarterly Review*. Issued by the Tin Research Institute. July, 1941.



Going one better
IN COMMUNICATIONS

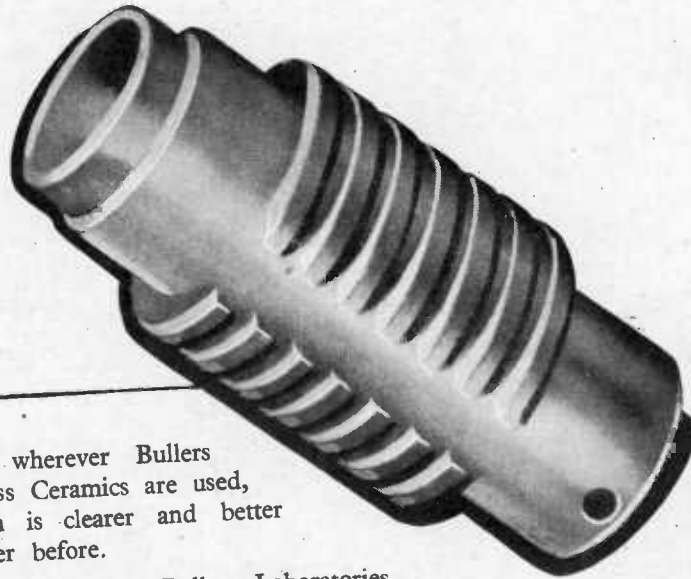

To-day, wherever Bullers Low Loss Ceramics are used, reception is clearer and better than ever before.

Years of research in Bullers Laboratories have developed these materials to such a high level of efficiency that Dielectric Loss is virtually eliminated. Bullers Ceramics are now playing a vital part in maintaining communications under all conditions.

BULLERS LIMITED
 THE HALL, OATLANDS DRIVE, WEYBRIDGE, SURREY
 Telephone: Walton-on-Thames 2451
 Manchester Office: 196 Deansgate, Manchester

Made in Three Principal Materials:

FREQUELEX. An Insulating material of Low Dielectric Loss. For Coil Formers, Aerial Insulators, Valve Holders, etc.

PERMALEX. A High Permittivity Material. For the construction of Condensers of the smallest possible dimensions.

TEMPALEX. A material of medium permittivity of Condensers having a constant capacity at all temperatures.

Bullers



LOW LOSS CERAMICS

DATA SHEETS IX, X & XI

On the Resonant Length of Capacity Loaded Transmission Lines

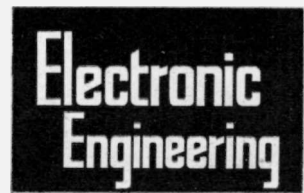

IN last month's issue equations and curves were given for the computation of the length of an anti-resonant capacity loaded transmission line and it is proposed to illustrate the use of Data Sheets VI, VII and VIII by some practical examples.

Example 1.

To find the line length required to tune a line with a characteristic impedance of 100 ohms with a loading capacity of $2 \mu\mu\text{F}$ to a quarter-wave anti-resonant circuit at a wavelength of 50 cms. $C = 2 \mu\mu\text{F}$, $Z_0 = 100\omega$, and $\lambda = 50$ cms; therefore, $CZ_0 = 200$ ohms $\times \mu\mu\text{F}$ and $C/\lambda = 0.04 \mu\mu\text{F}$ per cm.

Using Data Sheet VI we read off $l = 7.37$ cm. or using Data Sheet VIII we have $l = 50/4 \times 59/100 = 7.37$ cms.

The Data Sheets are, however, not limited to the calculation of quarter-wave lines. As was explained last month and illustrated in Fig. 2, jX_s passes through its correct value (jX_s) = $(j/\omega C)$ at increments of $\beta l = \pi$; that is: $X_s = X_1$ at values of $\beta l = a$, $\beta l = c$, $\beta l = e$ (see Fig. 3) where $c = a + \pi$ and $e = a + 2\pi$. Now the increment $\beta l = 2\pi/\lambda = \pi$ is equivalent to a line length $l = \lambda/2$, and, therefore, when considering $\frac{1}{4}$ -wavelength, $\frac{5}{4}$ -wavelength, etc., anti-resonant lines it is only the length of the first quarter wavelength of line (the one nearest the loading capacity C) that is shortened by capacity loading.†

Example 2.

To find the line length required to tune a line with a characteristic impedance of 250 ohms with a loading capacity of $4 \mu\mu\text{F}$ to a $\frac{3}{4}$ -wavelength anti-resonant circuit at a wavelength of 200 cm. $C = 4 \mu\mu\text{F}$, $Z_0 = 250\omega$ and $\lambda = 200$ cm., therefore $CZ_0 = 1,000$ ohms $\times \mu\mu\text{F}$ and $C/\lambda = 0.02 \mu\mu\text{F}$ per cm. Using Data Sheet VI or VII we read off the length of the first quarter wavelength of the line as $l = 26$ cms., therefore the total length of line required is

$$l = (200/2) + 26 = 126 \text{ cms.}$$

Example 3.

To find the value of capacity required to tune a line with $Z_0 = 100$ ohms and length 5 cms. to a quarter wave anti-resonant circuit at 35 cms.

† This statement is true in all practical cases where the capacity C is always smaller than the values required to remove completely the length of the first quarter wavelength of line.

Using Data Sheet VI we find that value of $CZ_0 = 150$ ohms $\times \mu\mu\text{F}$ is required and therefore $C = 1\frac{1}{2} \mu\mu\text{F}$. The same result is obtained from Data Sheet VIII, where given $Z_0 = 100$ ohms and $1/\frac{1}{2}\lambda = 57\%$ we find that $C/\lambda = 0.0425 \mu\mu\text{F}$ per cm. is required and therefore $C = 1\frac{1}{2} \mu\mu\text{F}$.

Example 4.

To find the wavelength to tune a line $17\frac{1}{2}$ cms. long with $Z_0 = 200$ ohms to a quarter wave anti-resonant circuit with a tuning capacity of $10 \mu\mu\text{F}$. The value of $CZ_0 = 2,000$ ohms $\times \mu\mu\text{F}$, and we therefore have to use Data Sheet VII where we find the required wavelength to $212\frac{1}{2}$ cms.

This type of problem can only be solved on Data Sheet VIII by trial and error.

Example 5.

To find the length of line required to tune a line of $Z_0 = 75$ ohms and a tuning capacity of $60 \mu\mu\text{F}$ to a quarter wave anti-resonant circuit at a wavelength of 300 cms.

We have $C = 60 \mu\mu\text{F}$, $Z_0 = 75\omega$ and $\lambda = 300$ cm., therefore $CZ_0 = 4,500$ ohms $\times \mu\mu\text{F}$ and $C/\lambda = 0.2 \mu\mu\text{F}$ per cm. This problem is outside the wavelength and CZ_0 range of Data Sheets VI and VII.

At first sight it also appears to be outside the scope of Data Sheet VIII; however, a consideration of equation (17) (see correction below) from which Data Sheet VIII has been plotted will show that $l/\frac{1}{2}\lambda$ is only a function of λ/CZ_0 or $1/CZ_0\lambda$. If, therefore, we wish to use values of C/λ outside the range of Data Sheet VIII, it is only necessary to alter the Z_0 values on the curves by the inverse ratio of the change in the C/λ scale. It will be seen, for example, that $Z_0 = 100$ $C/\lambda = 0.08$ give the same value of $l/\frac{1}{2}\lambda = 37.3\%$ as $Z_0 = 200$ $C/\lambda = 0.04$. Thus, if in the present example we double the C/λ scale in order to bring $C/\lambda = 0.2$ within the scale, then it is necessary to divide the Z_0 values by two. Thus reading against $C/\lambda = 0.1 \mu\mu\text{F}/\text{cm.}$ and $Z_0 = 150\omega$ we find that $1/\frac{1}{2}\lambda = 21.6\%$ and, therefore, $l = 16.2$ cm.

Effective Length of Shorting Link.

Though in the preceding examples we have been considering lines shorted at the receiving end, the effect of this shorting link on the length of the line has been neglected for simplicity.

The effective length of the shorting link " l_s " for the case of low-loss lines at H.F. (and provided the shorting link is low-loss and at right angles to the line) is:

$$l_s = \frac{L_s}{L_0} \text{ cms.} \quad \dots \quad (18)$$

where L_s is the inductance of the shorting link and L_0 is the inductance per cm. length of line.

Thus, if we take the case of a parallel round wire line, then at high frequencies

$$L_0 = 4 \log_e \left[\frac{D}{d} + \sqrt{\left(\frac{D}{d}\right)^2 - 1} \right] \times 10^{-9} \text{ henries/cm.} \quad (19)$$

$$\approx 4 \log_e \left(\frac{2D}{d} \right) \times 10^{-9} \text{ henries/cm.}$$

where D is the spacing between the axis of the wires and d is the diameter of each wire (see Data Sheets IV and V, July issue). Equation (20) has been plotted on Data Sheet XI, together with equation (19) dotted, from which it will be seen that the approximation is satisfactory over the range most commonly used in practice.

The Inductance of a straight round wire of length " l " and diameter " d "

$$L = 2l \left[\log_e \left(\frac{4l}{d} \right) - 1 \right] \times 10^{-9} \text{ H.} \quad (21)$$

and this is plotted on Data Sheet IX. In the case of the shorting link

$$L_s = 2D \left[\log_e \left(\frac{.4D}{d} \right) - 1 \right] \times 10^{-9} \text{ H.} \quad (22)$$

if we make the shorting link of the same wire as the line the effective length l_s is given by

$$l_s = \frac{L_s}{L_0} = \frac{2D \log_e (2D/d) - 1}{4 \log_e (2D/d)} \text{ cms} \quad (23)$$

$$= \frac{D}{2} \left[1 - \frac{.307}{\log_e (2D/d)} \right] \text{ cms} \quad (24)$$

$$= \frac{D}{2} (1 - (37/Z_0)) \text{ cms} \quad (25)$$

from equations (24) and (25) it will be seen that as $2D/d$ and Z_0 become large the effective length of the shorting link " l_s " tends to half its actual length, i.e., $D/2$ and at low values of

Electronic Engineering

DATA SHEET
No. 9.

THE INDUCTANCE OF A STRAIGHT
ROUND WIRE AT HIGH FREQUENCY.

$$L = 0.002\lambda \left(\log_e \frac{4\lambda}{d} - 1 \right) \mu\text{H.}$$

λ = Length of Wire in cms.

d = Diameter of Wire in cms.

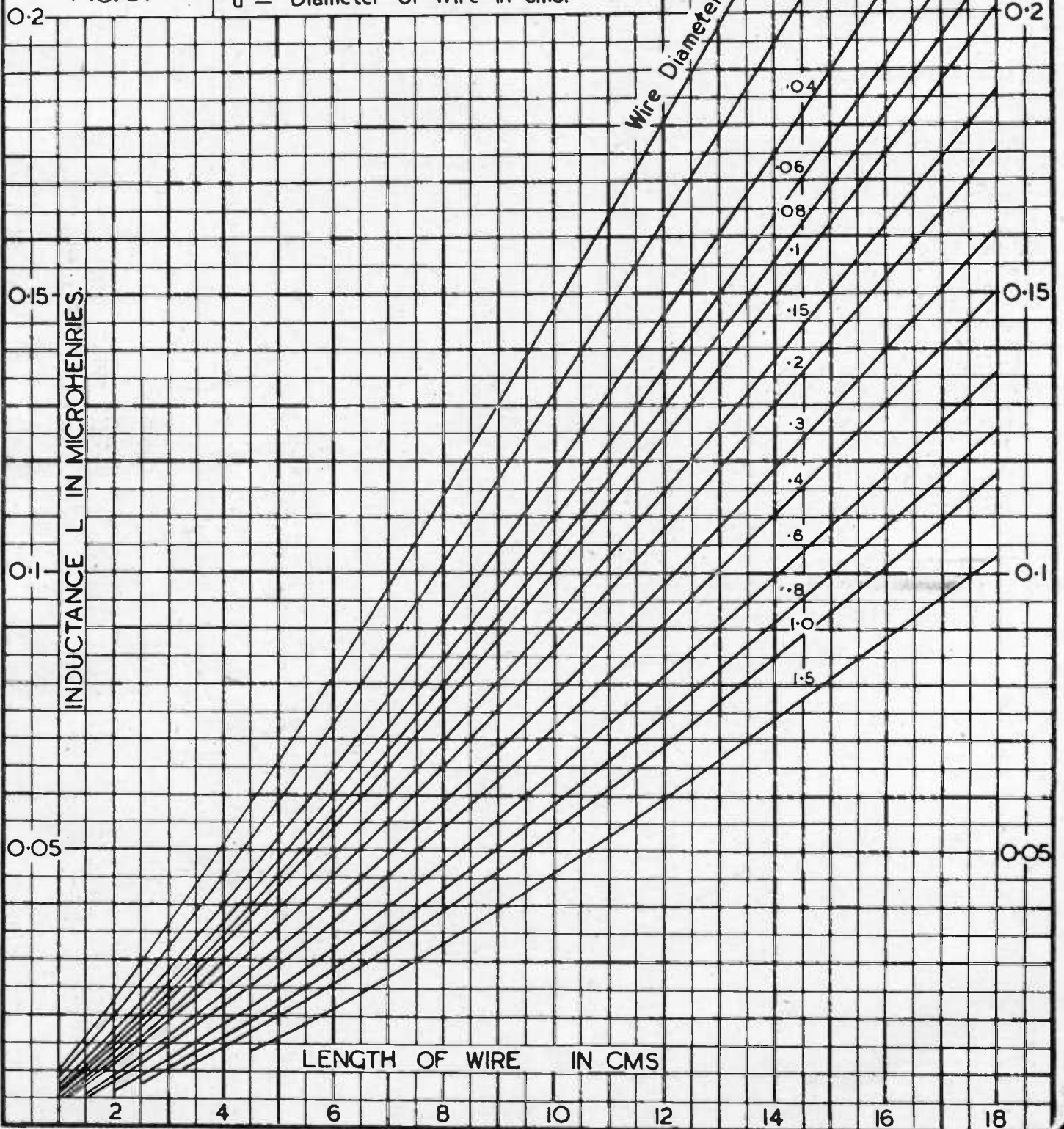

RESONANT LENGTH OF CAPACITY
LOADED $\frac{1}{2}$ -WAVE TRANSMISSION LINE

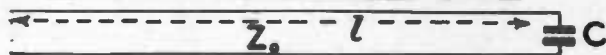

$$l/\lambda = \frac{1}{\pi} \cot^{-1} \left(-\frac{5.3 \cdot \lambda}{Z_0 \cdot C} \right) = \frac{1}{\pi} \tan^{-1} \left(\frac{5.3 \cdot \lambda}{Z_0 \cdot C} \right) + \frac{1}{2}$$

C in mmfd. λ in cms. Z_0 in ohms.

**Electronic
Engineering**

DATA SHEET
No.10

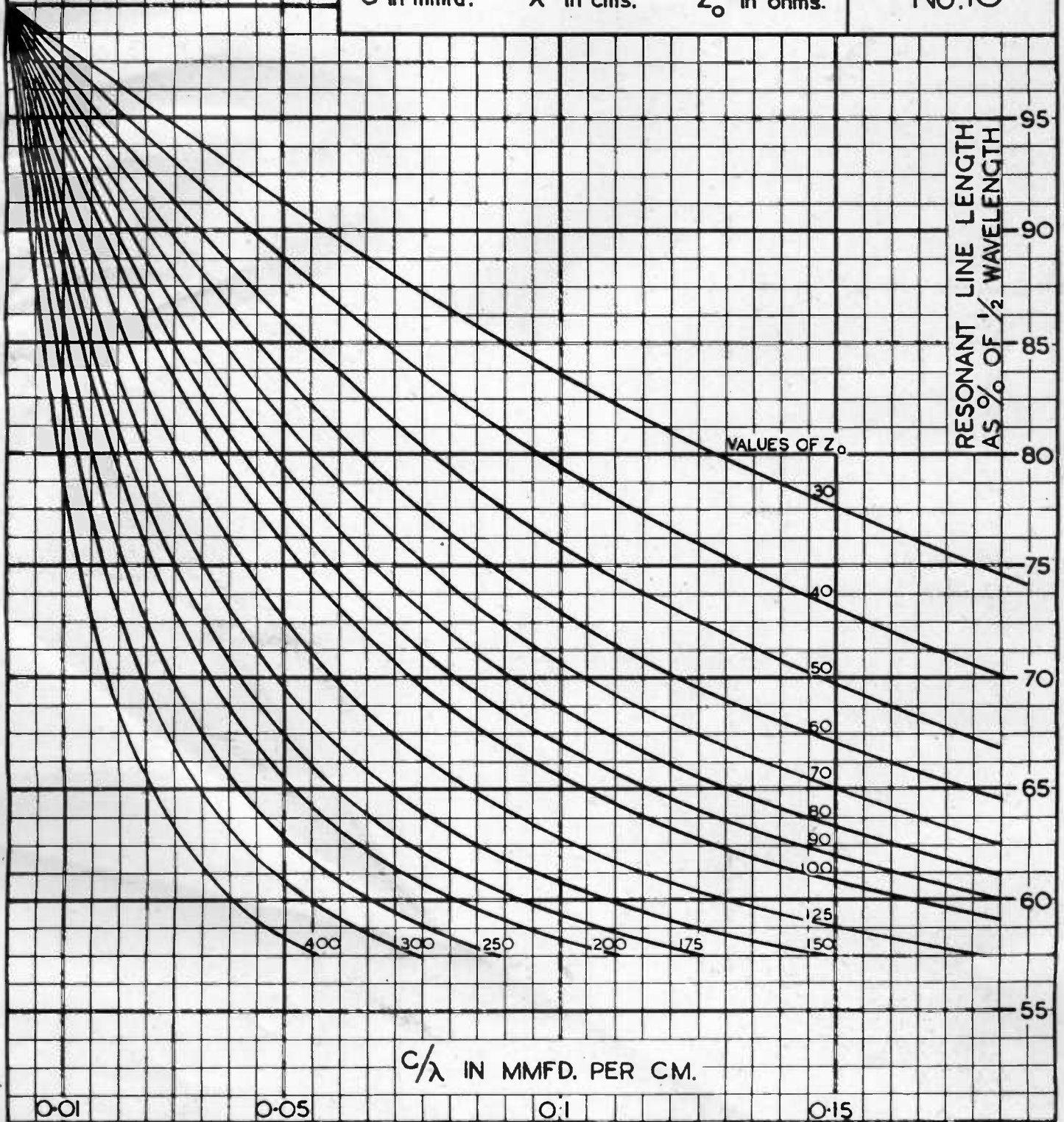

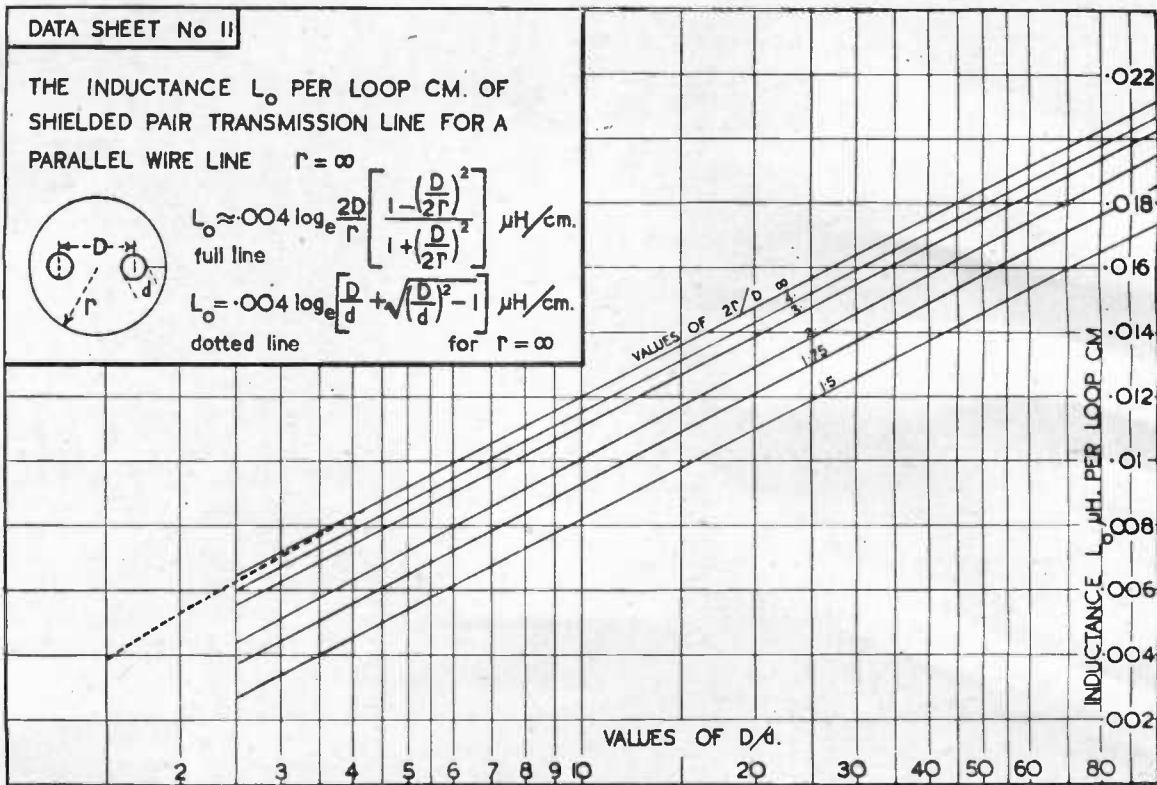

$2D/d$ and Z_o the value of " l_s " is less than $D/2$.

Example 6.

To determine the length of line required to tune a line made of wire 0.4 cm. in diameter, spaced 2.44 cm. between wire centres, to a quarter wave anti-resonant circuit. The loading capacity $C = 5 \mu\mu\text{F}$ and the wavelength is 200 cms. From Data Sheet IV we have for $D/d = 6.1$ that $Z_o = 300$ ohms. As $CZ_o = 1,500$ and $C/\lambda = 0.025$ we have from Data Sheet IX $L_s = 0.01074 \mu\text{H}$. From Data Sheet XI $L_o = 0.01 \mu\text{H/cm.}$, therefore $l_s = 1.07$ cm. By equation (25)

$$l_s = \frac{2.44}{2} \left(1 - \frac{37}{300} \right) = 1.22 \times .877 = 1.07 \text{ cm.}$$

From Data Sheet VII the total length of line required is 19.6 cm. and the actual line length would have to be made $(19.6 - 1.07) = 18\frac{1}{2}$ cms.

Open Ended Lines.

Instead of using a line shorted at its extremity it is possible to replace the shorting link by a section of line open at its far end. From Fig. 1a and equation (1) we then have $Z_r = \infty$ $I_r = 0$ and

$$Z_s = Z_o / \tanh pl = Z_o \coth pl \quad (26)$$

then as before if the line is very low-loss, i.e., very small then $p = j\beta l$

$$jX_s = -jZ_o \cot \beta l \quad (27)$$

and this has been plotted on Fig. 3 dotted curves. By the same reasoning

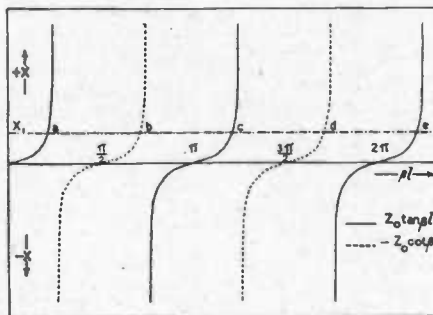

Fig. 3.

as used in deriving equation (12) we have

$$1/\omega C = -Z_o \cot \beta l = -Z_o \cot (2\pi l/\lambda) \quad (28)$$

if we express l and λ in cms. and C in $\mu\mu\text{F}$ then

$$l = \lambda/2\pi \cot^{-1} (-5.3\lambda/CZ_o) \text{ cms.} \quad (29)$$

and

$$l\frac{1}{2}\lambda = 1/\pi \cot^{-1} (-5.3\lambda/CZ_o) \text{ cms.} \quad (30)$$

This expression has been plotted on Data Sheet X where $l/\frac{1}{2}\lambda$ is plotted as a percentage against C/λ for different values of Z_o .

As will be seen from Fig. 3 an anti-resonant circuit is obtained (whenever $-Z_o \cot \beta l = X_1$) at values of βl equal to "b" "d," etc., that is as before at increments of $\beta l = \pi$ or of $l = \lambda/2$, so that $d = b + \pi$, etc.

Example 7.

To find the length of line required to provide a half wave anti-resonant

circuit with a line of $Z_o = 200$ ohms and a loading capacity $C = 10 \mu\mu\text{F}$ at a wavelength of 200 cms. We have $c/\lambda = 0.05 \mu\mu\text{F/cm.}$ therefore from Data Sheet X.

$$l = 200/2 (65.6/100) = 65.6 \text{ cms.}$$

Equation (27) could also have been written as

$$X_s = Z_o \tan (\beta l - \pi/2) \dots \quad (31)$$

and therefore equations (29) and (30) could be written alternatively as

$$l = 2\lambda/2\pi \tan^{-1} 5.3\lambda/CZ_o + \lambda/4 \quad (32)$$

$$l\frac{1}{2}\lambda = 1/\pi \tan^{-1} 5.3\lambda/CZ_o + \frac{1}{2}$$

From equation (32) it will be seen that only the first quarter-wave length of line is shortened by the capacity loading and that this shortening is identical in value to that present with lines shorted at the distant end. The problem in Example 7 could therefore also be solved by the use of Data Sheet VII. With $CZ_o = 2,000$ we find that

$$l = 15.6 + 200/4 = 65.6 \text{ cms.}$$

ERRATA

Data Sheets 6, 7 and 8

Eq. 16, p. 351, should read :

$$l = \lambda/2\pi \tan^{-1} [(5.3\lambda/CZ_o)]$$

Eq. 17, *ibid.* should read :

$$l\frac{1}{2}\lambda = 2/\pi \tan^{-1} [(5.3/Z_o) \times (\lambda/O)]$$

Both these equations are correctly given on the data sheets themselves.

The right-hand portion of the horizontal scale on Data Sheet 8 should read .11 .12 .13, etc., and not .2 .3 as shown.



MULLARD MEASURING APPARATUS

MEASURING BRIDGE TYPE G.M.4140

A sturdy and compact instrument for the measurement of resistance and capacity. Built-in standards give direct measurement of resistances from 0.1 ohm to 10 megohms and capacities from 10 micro-microfarads to 10 microfarads. In the "open-bridge" position these ranges may be extended by the use of external standards, and a second scale is calibrated in terms of percentage differences.

Accuracy on all measurements is better than 2%.

The instrument operates from A.C. mains of 100-250 volts and is completely self-contained. It is unaffected by vibration and may be used in any location.

These features, together with the fact that it is extremely simple to use, make it the ideal instrument for routine factory measurements of resistances and capacities.

The use of the Mullard Bridge in the actual production line will greatly reduce rejects and consequent loss of time in "trouble shooting", while at the same time skilled labour will be set free for more valuable work.

Full technical details are given in a leaflet available on request. For a copy of this leaflet or for information about any of our instruments, send a postcard to the address below.

RANGES

0.1—10 ohms.	10—1,000 ohms.
1,000—100,000 ohms.	0.1—10 megohms.
10 mmfd.—1,000 mmfd.	1,000 mmfd.—0.1 mfd.
0.1 mfd.—10 mfd.	

DIMENSIONS

7" × 5½" × 5½"

WEIGHT

6 lbs. approx.

PRICE £14-14-0 nett



THE MULLARD WIRELESS SERVICE CO. LIMITED

MEASURING APPARATUS SECTION

CENTURY HOUSE, SHAFTESBURY AVENUE, LONDON, W.C.

The Technique of Receiver Measurements - Part 2

By G. T. CLACK

LOW frequency response is expressed in the form of a curve showing variation in power output at different frequencies. The reference point, 0 db, can be any frequency between 400-1,000 c.p.s. at a convenient output level and against which is plotted an increase or decrease in decibels at various frequencies between 50-10,000 c.p.s.

The connexions for response measurements are shown in Fig. 7.

The procedure is to set the L.F. generator to 400 c.p.s. and adjust the volume control on the grid of the L.F. amplifier until a convenient output level, say, 100 milliwatts, is read on the output wattmeter. The volume control is left at this setting for the remainder of the test.

Upon resetting the L.F. generator to 1,000 c.p.s., any change, positive or negative, in output power is observed on the wattmeter. A reading should be taken at every 1,000 cycles up to 10,000 c.p.s. and at several convenient points below 400 c.p.s. The figures obtained can be tabulated as below or plotted as a smooth curve on "log" paper (3 cycle x linear).

f	db
400~	0
300	0
200	- 2
100	- 2
70	- 4
50	- 7

f	db
1,000~	+ 2
2,000	+ 1
3,000	+ 1
5,000	- 1
7,000	- 2.5
10,000	- 5

The L.F. input to the amplifier must be kept at the same voltage for all frequencies. If the generator does not possess its own meter for monitoring purposes it will be necessary to connect a high resistance A.C. voltmeter across the generator output so that any variation at different frequencies can be corrected. Some of the more recent generators can be operated throughout the range 50-10,000 c.p.s., without monitoring as the output volts remain fairly constant, but with most of the less expensive types it is sometimes necessary to make an adjustment each time the frequency is changed.

If an output wattmeter is not available, then either an A.C. ammeter or voltmeter can be used to measure current or voltage ratios in the output load resistance. (Fig. 8.) These ratios are referred to decibels change in output power by:—

$$db = 20 \cdot \log E_2/E_1 \text{ (or } I_2/I_1)$$

When an A.C. voltmeter is used to measure voltage across the load resist-

ance, the voltage at each frequency must be expressed as a ratio + or -, to the voltage read at 400 ~ then by multiplying the logarithm of this ratio by 20, the output power change in decibels is obtained. A few figures would appear something like this:—

f	db	f	db
400	Reference 1.6 volts = 0	1,000	$20 \times \log \left(\frac{2.02}{1.6} \right) = + 2$
200	$20 \times \log \left(\frac{1.27}{1.6} \right) = - 2$	5,000	$20 \times \log \left(\frac{1.43}{1.6} \right) = - 1$
50	$20 \times \log \left(\frac{.71}{1.6} \right) = - 7$	7,000	$20 \times \log \left(\frac{1.2}{1.6} \right) = - 2.5$

Actually, the above is a tedious way of doing the job, and a quicker way is to use a slide rule. Alternatively, the use of a graph showing voltage or current ratios as a function of the db will prove even less laborious. Such a graph is illustrated herewith, and once drawn out can be used for future reference.

Precisely the same procedure is followed when measuring the current ratios in the output load, except that —

is replaced by $\frac{I_2}{I_1}$ where I_1 or E_1 repre-

sents the current or voltage at 400 ~ and I_2 or E_2 indicates the new level at a different frequency.

For the voltage measurements either a vacuum tube or rectifier instrument can be employed. The metal rectifier meter must have a resistance of at least

10 times that of the output load and an operating range of 50-10,000 cycles/sec.

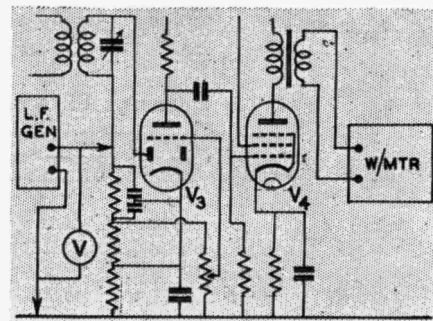
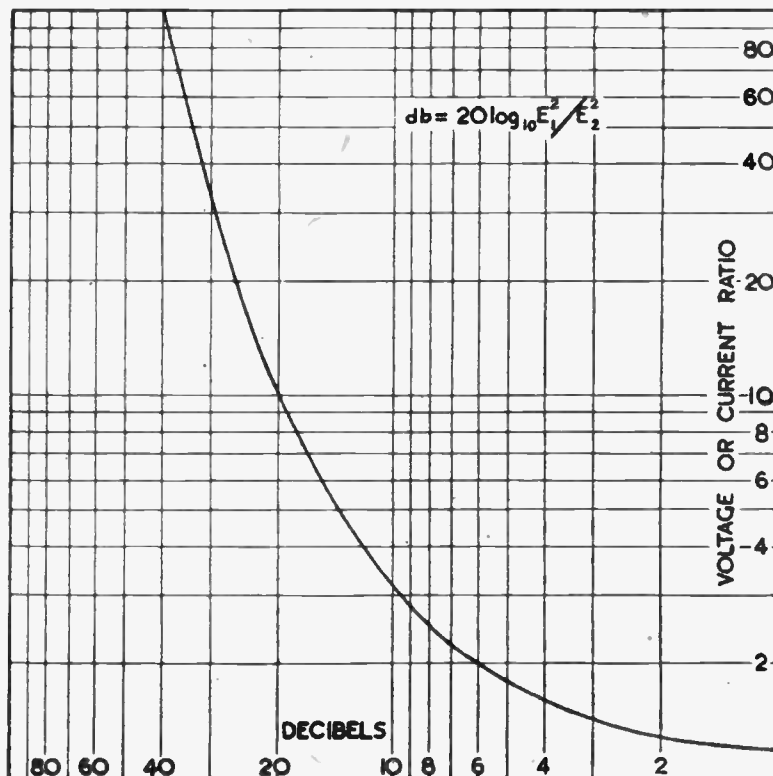

Fig. 7. Connexions for L.F. response measurement.



Curve of decibel equivalents to voltage or current ratios.

DECADE OSCILLATOR

Type D-105-A "...as easy to use as a resistance box"

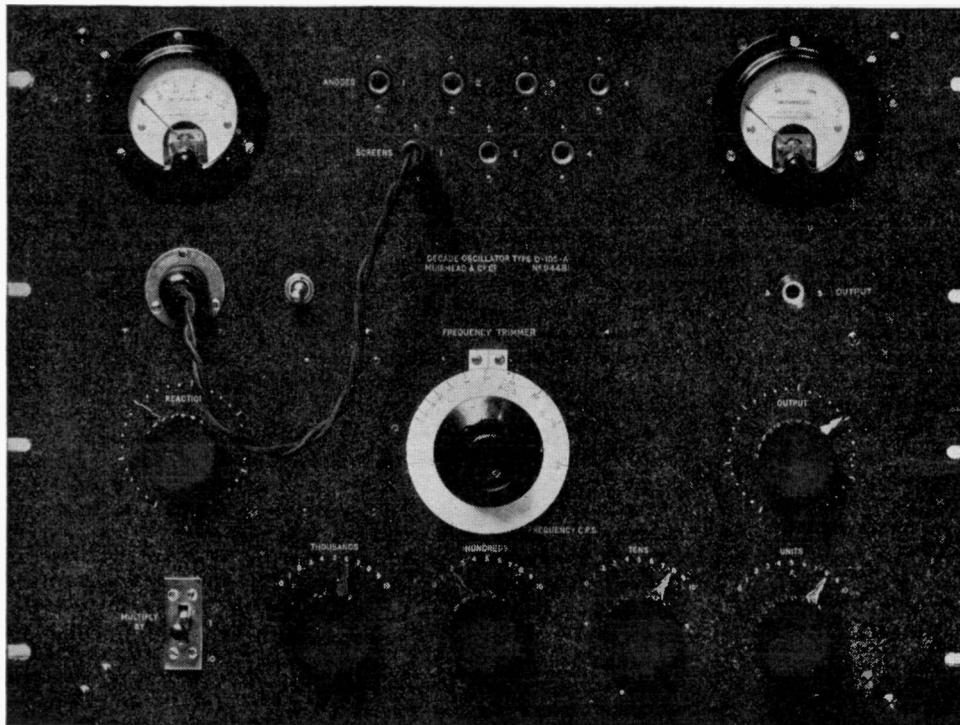

The **MUIRHEAD-WIGAN DECADE OSCILLATOR** Type D-105-A, illustrated, is an instrument of outstanding performance embodying something entirely new in oscillator design.

FREQUENCY IS DIRECT READING TO PRECISION ACCURACY ON FOUR DECADES. There are no troublesome calibration charts to refer to or engraved scales to adjust.

For full particulars of this and other Decade Oscillators, write for Bulletins B-320-A, B-321-A and B-528-A.

**MUIRHEAD & CO. LTD., ELMERS END,
BECKENHAM, KENT**

Telephone: Beckenham 0041-0042

Specification :

FREQUENCY

1 c.p.s. to 111.1 Kc/s on two ranges :—
1 c.p.s. to 11.11 Kc/s by 1 c.p.s. steps.
10 c.p.s. to 111.1 Kc/s by 10 c.p.s. steps.

ACCURACY

± 0.2% or 2 c.p.s. over the entire frequency range.

OUTPUT 2 watts maximum.

HARMONIC CONTENT

2% at 2 watts : 1.25% or less below
1 watt.

POWER SUPPLY 200 to 250 v. 50 c.p.s.

MUIRHEAD

FOR OVER 60 YEARS DESIGNERS AND MAKERS OF PRECISION INSTRUMENTS

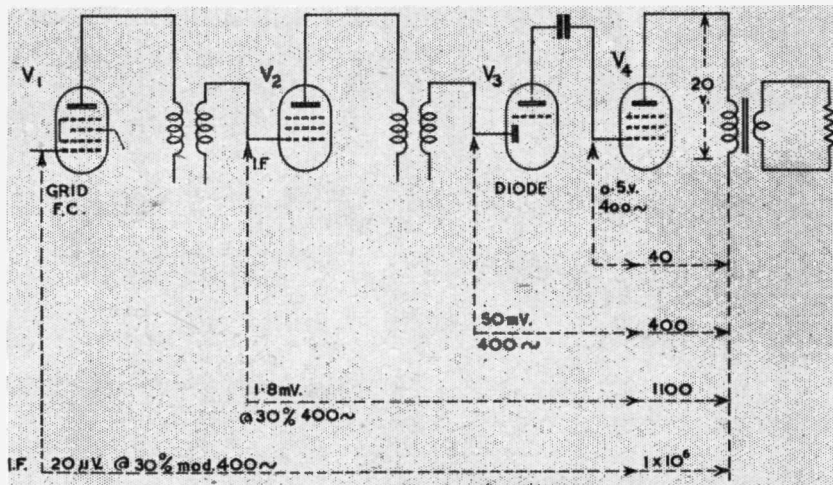

Fig. 10. Figures illustrating overall sensitivity from F.C. to Output.

For current measurements a low resistance transformer-input rectifier instrument must be used as any appreciable resistance introduced into the output load circuit will modify the results.

The response characteristic usually deteriorates with each successive stage away from the output valve. In view of this, it is worth while taking measurements at three points; in this case they are (1) output valve grid, (2) L.F. valve grid, (3) diode anode. It will be seen in Fig. 7 that the input is shown connected to the diode anode, and as the radio signal is taken from this point it will give a fair approximation of the overall L.F. response.

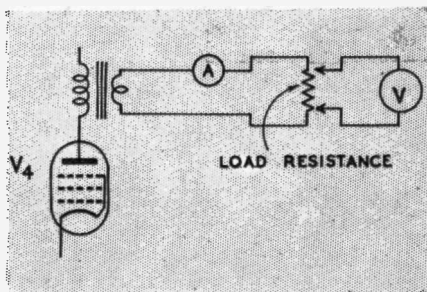

Fig. 8. Use of voltmeter and ammeter in lieu of wattmeter.

The effect of each stage is obvious; for instance, the 1st I.F. levels off the slight gain that is obtained from the output stage by itself. Again, for the diode curve it will be observed that a very slight loss of 1 db occurs at the L.F. end and also one of 2 db at the H.F. end. This is due to the insertion of the diode load R.C. network into the input circuit of the L.F. amplifier. (See L.F. response curves.)

These losses are of little importance as the frequency discrimination of the combined R.F. and I.F. circuits reduce the overall response to a much lower level as will be seen later on.

I.F. Circuits

The next series of tests are connected with the Intermediate Frequency stages (Fig. 9).

The I.F. frequency is injected between the grid of the I.F. Amplifier (V₂) and Chassis, and the trimmers adjusted for maximum output. It is an improvement to employ some form of damping across the winding that is not being adjusted as this prevents it from "pulling" the winding that is being tuned. The procedure is as follows:—

Connect a resistance R between 20,000 to 40,000 Ω in series with a condenser C between .05 to .2 mfd., and terminate the outer ends with crocodile clips to afford rapid and easy connexion to the I.F. windings.

Connect this "damper" across the primary of the 2nd I.F. transformer then inject sufficient I.F. signal until a convenient output is indicated on the output meter, and peak the secondary trimmer for highest reading. Then connect this "damper" across the secondary winding and peak the primary trimmer.

The input at 465 kc/s. modulated 30% at 400 c./s. to produce 50 mW from the receiver in question was 1.8 mV. This gives an apparent gain of only 27 times for the I.F. stage if referred to L.F. sensitivity at the diode anode. This is due to the detector inefficiency at low inputs and a repeat test with a higher I.F. input will reveal a gain of 80-90 times. This gain was not realised until the input to V₂ was raised to about 9 mV., i.e., until there was about 1 volt of I.F. at the diode anode.

With the R.F. generator connected between grid of V₁ and chassis, use the "damper" on both primary and secondary of 1st I.F. transformer as before when aligning this stage, and this will result in a symmetrically placed I.F. response curve.

The gain for this stage is found by the ratio of sensitivities at the grids of the frequency changer and I.F. amplifier, i.e., 20 μV to 1,800 μV or 90 times.

The overall sensitivity from the grid of the frequency changer to the output transformer is illustrated by Fig. 10.

These figures are representative of those obtained with an average re-

ceiver. Bias and screen potentials of the I.F. stage should be adjusted for maximum gain, but not at the cost of stability on weak signals. When a point has been reached where the maximum gain has been achieved then a test for stability is to inject about 1 volt at I.F. frequency into the frequency changer grid, V₁, with the earth return of the generator taken to the A.V.C. line and not chassis. If there is no D.C. circuit through the generator lead, then connect a resistance of 10,000 ohms across the generator output lead.

If the receiver has any tendency to feed-back or the A.V.C. is not operating correctly then it may "motorboat" or oscillate. It should handle the 1v. signal quite well with very little noise increase if the A.V.C. is operating properly. A measurement at this point could be made on the A.V.C. volts generated, but as this will not give all the information required it will be discussed later on.

Selectivity

Refers to the ability to discriminate between wanted and unwanted frequencies. The gear required for the recommended method comprises two similar R.F. generators and an output meter fed via a filter which passes only the 400 cycle modulation component. These conditions can be fulfilled in a laboratory, but with the average experimenter the possession of two similar generators is rare, so in view of this, a simpler system is described which uses one generator. The usual method is to express sensitivity in terms of bandwidth at 10, 100 and 1,000 times the input. The I.F. frequency is

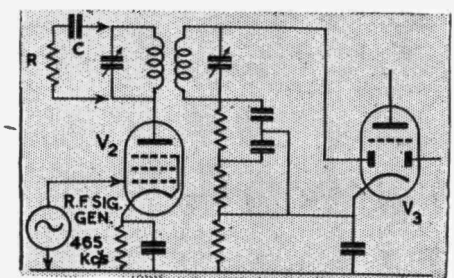
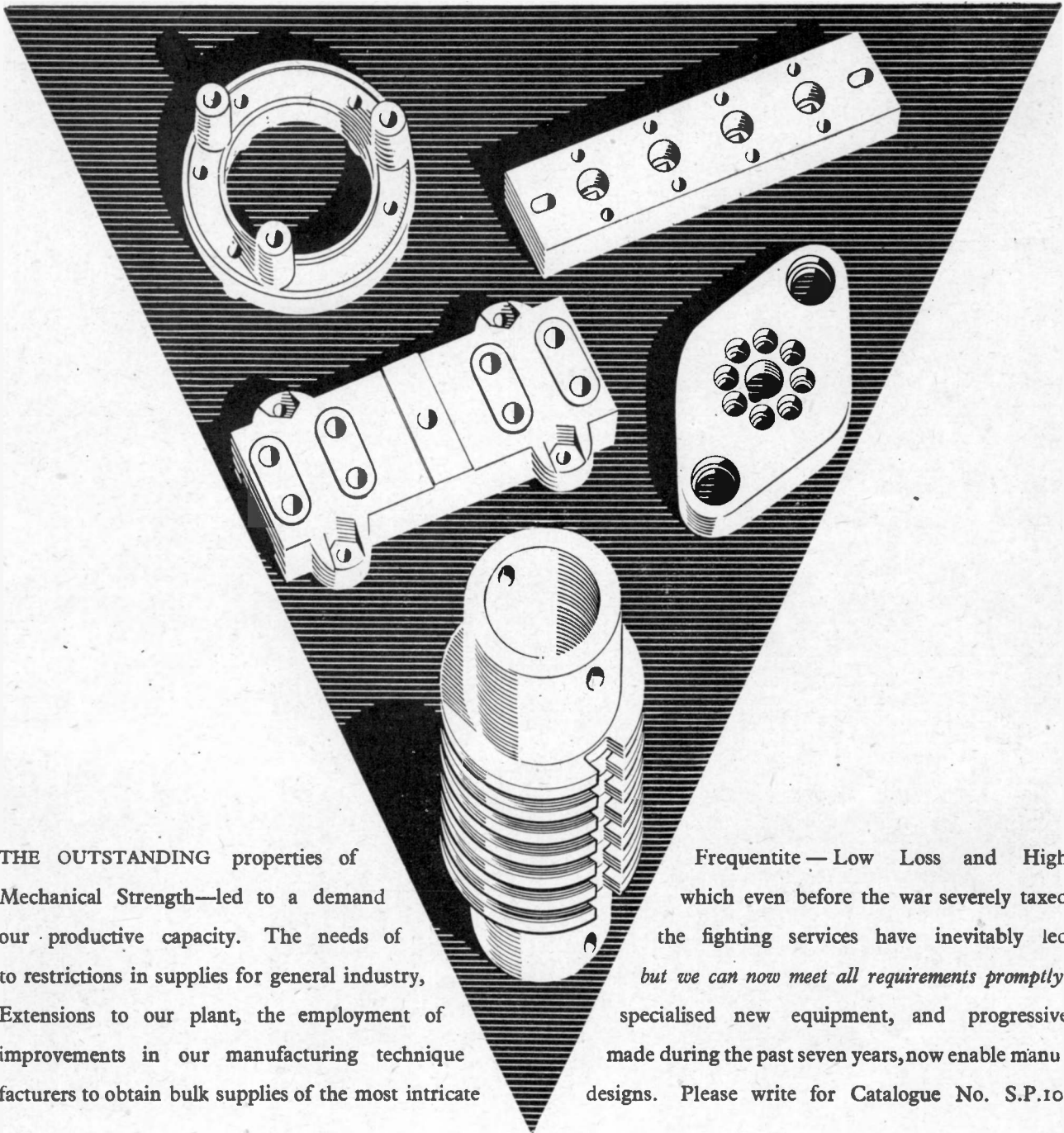

Fig. 9. Checking I.F. stages.

injected into the grid of the frequency changer, with the generator returned to chassis, and the input adjusted until an output level of 50 mW is reached on the output meter. This input figure should be noted and then increased 10 times (from say 20 μV to 200 μV) and the generator detuned to the L.F. side of the I.F. frequency until the output meter once again reads 50 milliwatts. The frequency to which the generator is now tuned should be noted and this procedure repeated for 100 and 1,000 times the input. The generator can then be tuned to the H.F. side and the process repeated for 10, 100, and 1,000 times the input as before. The figures obtained can be

F R E Q U E N T I T E



THE OUTSTANDING properties of Mechanical Strength—led to a demand our productive capacity. The needs of to restrictions in supplies for general industry, Extensions to our plant, the employment of improvements in our manufacturing technique facturers to obtain bulk supplies of the most intricate

Frequentite—Low Loss and High which even before the war severely taxed the fighting services have inevitably led *but we can now meet all requirements promptly.* specialised new equipment, and progressive made during the past seven years, now enable manu designs. Please write for Catalogue No. S.P.10

The Pioneer British-Made Low Loss Ceramic
STEATITE & PORCELAIN PRODUCTS LTD.

Head Office and Works :

STOURPORT - ON - SEVERN, WORCS.

Telegrams: Steatite, Stourport.

S.P.

Telephone: Stourport 111.

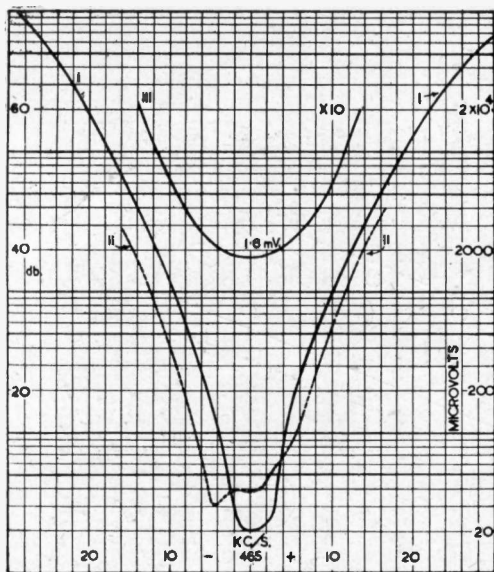

Fig. 11 (left). Selectivity curves.
The upper curve gives L.F. response at 3 points in the circuit.

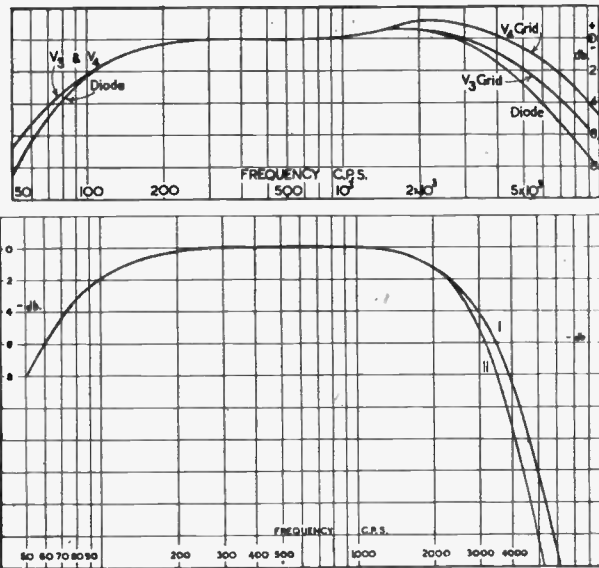

Fig. 12 (lower right). Overall I.F. fidelity curves.
The upper curve gives L.F. response at 3 points in the circuit.

noted as shown or set out on log scale paper (See specimen: Fig. 11).

	-f	+f	c/s. Band-width
X 10	4.9	5.3	10.2
X 100	11.4	12.6	24
X 1,000	19.5	21.5	41

From the curve it is seen that an interfering signal voltage 5 kc/s. away must be 10 times as strong as the signal voltage at resonance to produce the same output. In terms of power output, this represents a ratio of 100:1 between wanted and unwanted signals of equal voltage.

One must compromise between response and selectivity. If high selectivity is required then the higher modulation frequencies are discriminated against by low order response of the I.F. to side band components above 4,000 c.p.s. For a less degree of selectivity the effect is not so severe and the above cited figures (Fig. 11) represent a good example giving reasonable selectivity without too serious top cutting. The bottom of the I.F. curve is interpolated as it is difficult to measure with accuracy closer than 2 or 3 kc/s. off resonance with the average generator. If, however, instead of increasing the input to 10 times right away, the curve is plotted for small increments in input to small changes in frequency above and below resonance to keep the output constant (at 50 mW) then a truer picture is obtained of the shape as it approaches resonance.

Beyond 10 times the input, there is no need for further intermediate points other than the previously mentioned 100 and 1,000 times the input.

There is no need to disconnect the A.V.C. from the I.F. amplifier provided the output is not greater than 50 mW as with practically all receivers A.V.C. will not be in operation at this low level of output with maximum L.F. gain.

The effect of varying the coupling between primary and secondary windings can be studied by taking two or more curves for different coupling positions and superimposing them on a sheet of 3 cycle log. linear paper. The change in gain and shape of curve will be quite obvious. As the coupling is increased the gain will rise at resonance until "double humping" commences. The curves illustrated in Fig. 11 show I.F. response for (i) normal coupling, (ii) over-coupling, (iii) 2nd I.F. only.

At this point it is usual to take an overall I.F. fidelity curve to ascertain the loss in top response introduced by the I.F. transformers. This is carried out in a similar manner to the L.F. response measurements with the exception that about 100 mV of I.F. (modulated by the test frequencies from 50-10,000 c.p.s. at a depth of 30%) is injected into the grid of the frequency changer V1. Curve I in Fig. 12 shows that quite an appreciable drop in top response has taken place; 6,000 c.p.s. is -20 db as opposed to -10 db at the diode anode. This is as well, for had the response been better the overall selectivity would be affected and interference from adjacent channel stations more obvious.

(To be concluded next month.)

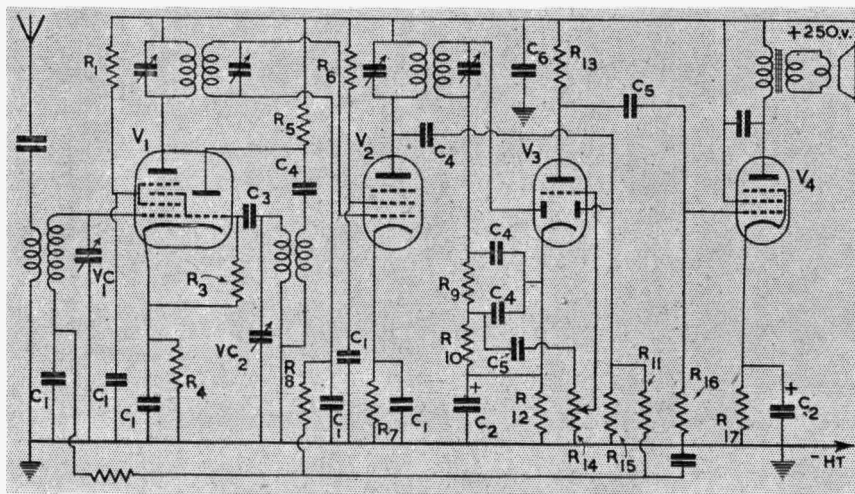

Circuit diagram of receiver under discussion.

R 13 should be 50,000 ohms and not 5,000 ohms as given last month.



Leadership

won in the face of extreme odds

From an infant beginning facing giant competition... these tubes have paved the way for many of the great improvements in radio... gained the confidence of the leading engineers through their superior performance capabilities, their in-built stability and stamina, their dependability and economy in operation . . . today they occupy an important niche in the industry. The only tube unconditionally guaranteed against premature failures caused by gas released internally.

Once you put Eimac tubes to work you'll see why they are first choice for the important jobs in radio communications . . . why the world's leading engineers . . . amateur, commercial and military . . . use and recommend them wholeheartedly.

Follow the leaders to

Illustrated:
Eimac 35TG, 75T, 100T and 250T tubes

Eimac
TUBES

Export Agent

FRAZAR & CO. LTD.

301 CLAY STREET

SAN FRANCISCO, CALIFORNIA, U. S. A.

Radio Manufacturers and the War

Air Commodore Leedham's Address

AT the last monthly meeting and luncheon of the Radio Industries Club the guest of honour was Air Commodore H. Leedham, O.B.E., of the Ministry of Aircraft Production. In his address to members after the luncheon, he revealed some interesting facts about the co-operation of the radio industry with the Ministry, a summary of which is given below, with the permission of the Ministry of Information.

Opening his speech, Air Commodore Leedham said he was glad of the opportunity to meet his good colleagues in the radio industry. He wanted to speak to them of production from the administrative point of view rather than that of the factory.

Dealing with the period preceding the war, he said that up to twelve years ago all experimental development for the Royal Air Force had been undertaken by the Royal Aircraft Establishment at Farnborough, and up to that time not a single developmental contract had been entrusted to the radio industry. The main reason for this was the fact that the development of radio equipment, particularly transmitting equipment for use in aircraft, was an entirely new art and necessitated, in addition to research on the new problems entailed, the availability of various types of aircraft and flying personnel.

In recent years, however, so much of the production of aircraft radio equipment had been entrusted to industry that the experience gained thereby made it possible to entrust nearly 50 per cent. of the development programme to various firms in the radio industry, and to-day that figure has increased to 98 per cent.

Passing to production, the speaker stated that the problems encountered were as great as if not greater than those obtaining in any other section of the munitions field and were primarily due to the rapidity with which the art is advancing—thus necessitating the constant introduction of new and greatly improved types, and rendering it almost impossible to ensure unbroken continuity of the production lines. He paid a tribute to the wonderful way in which the industry had reacted to these most trying conditions.

At first it had not been possible to give contracts sufficient to keep the whole industry employed, and a certain amount of domestic production had been permitted in order to keep the skilled personnel in the industry, ready for future Service contracts.

It had been found, however, that in domestic production the proportion of machine tool to assembly and wiring work was far too small for the production of Service equipment, and conse-

quently the radio industry had had to be provided with many more machine tools, and in some cases work had to be placed outside the industry where there was more machine-tool capacity.

This extra machine-tool capacity might prove an embarrassment after the war unless it could be properly utilized. There was scope for vision and planning on a grand scale, and it was not too early to think of what use could be made of this capacity.

The speaker was convinced that a production panel of "leaders of the industry" which had been mooted from time to time since war began would be unsatisfactory and find itself severely handicapped. He himself had been entrusted with the secrets of individual firms in the industry because he obviously had no axe to grind except in the national good, but what other individual, within the industry, would be entrusted with those secrets? In consequence, he claimed to have a greater knowledge of the industry than any other single person inside the industry.

Passing to another subject, Air Commodore Leedham said that there was a high degree of co-operation between the M.A.P., the Army and the Admiralty as far as radio production was concerned.

In giving out contracts it was necessary to split them among a number of firms. Though this did not help the industry, it was felt to be better to plan on an uneconomic basis than to jeopardize safety by giving the whole of each contract to an individual firm.

Air Commodore Leedham then went on to explain why it had been necessary recently to curtail domestic radio production, and gave figures showing the demands of the Services for valves. With the expansion of radiolocation this demand had greatly increased, and steps had been taken to double the capacity of the valve industry.

The Inter-Services Valve Production Committees and the B.V.A. had applied an unofficial control which had worked extremely well. There was no actual ban on domestic production, and during the next six months one and a half million valves would be released for replacement purposes, together with a supply sufficient to fit the incomplete sets which were on the manufacturers' lines when the control was applied. Moreover, valves would continue to be freed for domestic purposes whenever possible, though the vital Services' programme must come first.

On the subject of materials and components the speaker said that considerable attention had been paid to the securing of duplicate sources of supply of special products, and many firms had

communicated to others important and valuable details of their special technique. He commended all such firms for their patriotism in this respect.

Finally, Air Commodore Leedham referred to the wonderful role radio was playing in the victory effort. This was a radio war—radio was no longer merely a means of communication: it had now entered the arena as a combatant itself. The industry should feel proud of the decisive job radio was doing and proud, too, of the important part in it which is taken by production.

The address was enthusiastically received by a record attendance of members and friends, which included many officials from the three Services.

The Radio Industries Club, under the presidency of Sir Louis Sterling, is designed to promote mutual understanding and good will among those engaged in the radio and allied industries.

Membership is open to all actively engaged in the radio industry, and full particulars can be obtained from the Hon. Secretary, Mr. W. E. Miller, Dorset House (Room 510), Stamford Street, S.E.1.

Electrostatic Screening at High Frequencies

It is well known that screening difficulties increase with frequency, and at very high frequencies effective electrostatic screening becomes a serious problem.

There is, however, one way in which these difficulties can sometimes be overcome. If, for example, it is desired to pass a control shaft into a screening box containing high-frequency apparatus, very little leakage will occur if the shaft is made of insulating material and is surrounded by a conducting cylinder connected to the screening box. This cylinder should have a length large compared with its diameter and will then serve as a very effective attenuator of high-frequency voltages. Calculation shows that the attenuation of such a cylinder having a length equal to four times its diameter will be of the order of 160 db. Arrangements of this kind are very suitable for use in high-frequency signal generators.

The same principle can be applied to screening boxes. It is frequently difficult to obtain satisfactory electrical contact between the lid and the box. The goodness of this contact will, however, be of little importance, provided that the overlap between the lid and the box is sufficient to ensure that any leakage gaps are long compared with their widths.—E. M. I., Ltd.



Let the **RAF** train you in vital ground duties

Some of you will soon have to join one of the Services—now is the time to choose a form of effort which will suit your inclinations and yet be of real help to your country. The R.A.F. cannot maintain its supremacy without the help of the men on the ground, and men who are not volunteering for flying duties are urgently required for training in important trades. Here are some of the jobs and a brief indication of the required qualifications.

Remember—if suitable you will be trained in the trade you choose and this may stand you in good stead on return to civil life. Go today to the R.A.F. Section of your nearest Combined Recruiting Centre, and tell them which trade you wish to volunteer for. If you cannot call, post the coupon for further details.

RADIO/Wireless Mechanic

Servicing and repairing the most up-to-date radio and wireless equipment, including the famous Radiolocation system. For men 18 to 34 with sound elementary education. Older men with radio experience also considered.

FLIGHT MECHANIC

Maintaining Britain's bombers and fighters in the finest of fighting trim. Repairing air frames, engines, etc. For men 18 to 42. If you are a handyman or have a flair for tinkering with machinery you will like this work.

ARMOURER

The man who tests and maintains aircraft armament, loads and fuses bombs—work essential to the offensive power of the R.A.F. For men 18 to 42 with a keen mechanical sense.

ELECTRICIAN

Looking after the intricate electrical devices of our aircraft. For men 18 to 42 who are handy at electrical repairs, and have an elementary knowledge of the theory of electricity.

To Air Ministry Information Bureau, Kingsway, London, W.C.2. Please send me latest details of
 Radio/Wireless Mechanics
 Flight Mechanics
 Armourers Electricians
 X against the one in which you are interested.

NAME

ADDRESS

T16/Aug.



USED
WHEREVER DEPENDABILITY
IS VITAL

DAGENITE and PERTRIX

FOR RADIO, CARS,
MOTOR CYCLES AND COMMERCIAL VEHICLES

YOU, TOO, SHOULD USE
DAGENITE AND PERTRIX—
THE DEPENDABLE BATTERIES

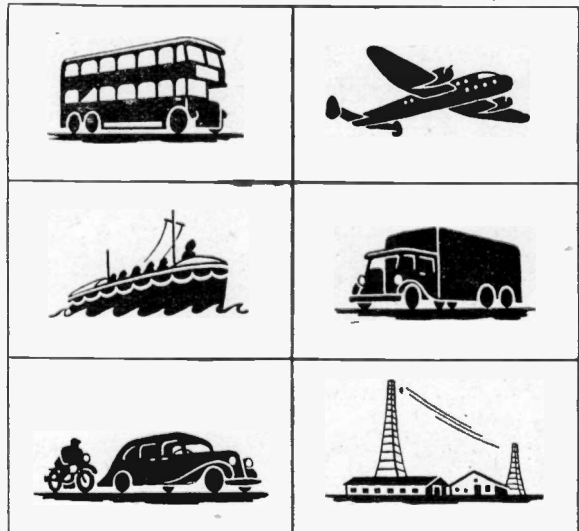

D1/41

OBTAINABLE FROM HOLSUN SERVICE STATIONS
AND USUAL DEALERS.

Sales Concessionaires :

HOLSUN BATTERIES LIMITED
137 Victoria Street, London, S.W.1.

NOTES FROM THE INDUSTRY

Catalogues Received

Messrs. Ellison Insulations, Ltd., of Perry Bar, Birmingham 22—descriptive booklet on "Tufnol" and its uses. Tufnol is an insulating compound which can be machined like metal and has a density half that of aluminium. It is oil and petrol-proof, to say nothing of white ants and rats. A booklet on the machining of Tufnol is also available on request.

Messrs. Rotherham & Sons, Coventry.—Time control mechanisms for quick making or breaking of circuits at the end of a predetermined time interval. The Type E mechanism has four timings—2, 5, 15 and 40 sec. delay. The latter should be useful for delay switching in H.T. power rectifier circuits or amplifiers.

Premax Products, Niagara Falls, U.S.A.—Antenna Manual. Contains a detailed description of all types of aerial and beam aerial arrays for short waves. Twenty recommended designs for the latter are given, some of which have been referred to in Q.S.T. and "Radio." A list of these articles is also given for reference.

R.C.A. Mfg. Co., U.S.A.—Transmitting tubes. Illustrated brochure giving concise details of all types of R.C.A. transmitters and power rectifiers. A table of operating conditions is also given. The types include those specially designed for U.H.F.

Heintz & Kaufman, California, U.S.A.—"Gammatron" valves. Fully illustrated catalogue of transmitting valves with operating data and recommended circuits. The feature of the Gammatron construction is the elimination of internal supporting insulation for the electrodes, each electrode being mounted directly on a stem sealed through the side of the bulb. This enables the majority of the types to be used on U.H.F. Bulbs are of Nonex and electrodes of tantalum.

Clarostat Mfg. Co., N.Y., U.S.A.—Resistors and potentiometers. In addition to the usual well-known types, wire-wound resistors are obtainable disguised as all-metal valves (Series MT). The units will safely dissipate 50 watts in the larger size and make useful voltage dropping resistors for all-mains receivers. It would be as well, however, to distinguish between the octal socket for the rectifier and the octal socket for the resistance. Constant impedance output attenuators of small over-all dimensions are also listed, and special power resistors for fluorescent lamps.

International Correspondence Schools, Kingsway, W.C.2.—"Electrical Engineering." A descriptive booklet covering all the correspondence courses available

from this well-known institution. Of particular interest are the arrangements between the Admiralty and the I.C.S. for a special course of instruction to naval ratings who wish to qualify while afloat. A copy of a special prospectus will be sent to naval personnel on application. Part of the fee for each course is paid by the Admiralty.

Detailed information from any of the catalogues on file at this office will be furnished on application, but engineers are recommended to apply direct to the manufacturers for full particulars of their products.

Publicity Films

The "trailer" film, interspersed with regular features, has been recognized by a number of manufacturers as a valuable advertising medium, provided that the subject is not presented in too blatant a fashion. A good example of the educational type of advertising film has recently appeared in "Signs of the Times," a magazine publicity film distributed by Wallace Publicity, Ltd., which has been appearing regularly at principal cinemas since 1938. The Edison Swan Electric Co. have utilized the possibilities of the film to the full in showing interesting "flashes" of lamp-manufacturing processes combined with carefully chosen propaganda for improved lighting by the use of Ediswan lamps. The best test of an advertisement is whether it is remembered after an interval of other distractions and, judged by this standard, the Ediswan publicity film will certainly be successful.

The possibilities of the film might be considered very seriously by radio manufacturers, as it gives a unique opportunity of a practical demonstration of their products to hundreds of thousands of viewers and listeners. A demonstration of the simplicity of control of a television receiver, for example, combined with a short talk on optimum adjustment would have had a wide appeal to London audiences in the days of A.P. transmissions.

British Kinematograph Society

The B.K.S., which is noteworthy for its correct spelling of cinematograph, has arranged a lecture programme for the months of September and October, meetings to be held at Film House, Wardour Street. The Journal is being published as usual, and the Society is actively engaged in co-operating with the B.S.I. on matters of interest to the film industry. Students who have recently completed the B.K.S. course in cinematography at the Polytechnic are now engaged in technical duties in connexion with the war effort. A new course commences on 16th September, and candidates will first be approved by the B.K.S. Full particulars of membership can be

obtained from Mr. R. H. Cricks, the Hon. Secretary, Dean House, Dean Street, W.1.

Messrs. Wright & Weaire

Messrs. Wright & Weaire, Ltd., of Tottenham, N.17, report that Messrs. R. H. Fox and R. W. Merrick, who have been in the service of the Company for many years, have now been appointed on the Board of Directors. Mr. Fox will assume office as Works Director, and Mr. Merrick as Sales Director.

Solon Electric Soldering Irons

Due to restrictions in the supplies of raw materials Henley's are discontinuing the manufacture of the popular "Handyman" 65-watt model Solon electric soldering iron. They are now concentrating on the range of Industrial Models which includes various 65-watt, 125-watt and 240-watt models suitable for a wide range of uses.

The increasing cost of production have made some revision in the prices of the Industrial Solons unavoidable, but at present only the 65-watt models are affected. Full details are obtainable from Messrs. W. T. Henley's Telegraph Works Co., Ltd., Milton Court, Westcott, Dorking, Surrey.

BOOKS

By REYNER on RADIO

SHORT WAVE RADIO

By J. H. Reyner, B.Sc., A.C.G.I., etc. This is a comprehensive, practical survey of modern developments in the use of short, ultra-short and micro-waves. It provides a great deal of valuable data concerning the practical methods of their use in radio and television transmission. 10s. 6d. net. INSTITUTE OF ENGINEERS, STUDENTS' QUARTERLY JOURNAL says: "One of the finest short-wave treatises available."

MODERN RADIO COMMUNICATION

Also by Reyner. Vol. I. Seventh Edition. Includes all recent developments and full descriptions of latest apparatus and instruments. 7s. 6d. net. Vol. II. Third Edition. Specially written to assist students preparing for City and Guilds Examinations, but with its companion volume, it provides a complete groundwork in the theory and practice of modern radio engineering. 7s. 6d. net.

CATHODE-RAY OSCILLOGRAPHS

Reyner again. A simple guide to the practical application of cathode-ray tubes to the examination of oscillations or wave-forms and to numerous other purposes. It is most valuable for everyone who uses or wishes to understand the cathode-ray oscillograph. 8s. 6d. net. ELECTRICAL TIMES says: "Anyone desiring a clear understanding of the cathode-ray oscillograph . . . cannot do better than purchase this moderately-priced book."

Pitman's, 39, Parker Street, Kingsway, W.C.2

GET THEM FROM
PITMAN'S

★ *The Pioneers of Low Loss Ceramics*



MANUFACTURERS OF:—

SILVERED MICA CONDENSERS
SILVERED CERAMIC CONDENSERS
CERAMIC TRIMMER CONDENSERS

Send for brochure

CONTRACTORS TO GOVERNMENT DEPARTMENTS
ON A.I.D. APPROVED LIST

UNITED INSULATOR CO. LTD.

12-16, LAYSTALL ST LONDON, E.C.1.

Telephone: TERMINUS 4118-9

Telegrams: CALANEL SMITH LONDON.

CLAUD CAMPBELL & CO., LTD.

Manufacturers of

WAXES

for the

Impregnation, Coating and Filling of
all Electrical and Radio Components,
such as

- TRANSFORMER WINDINGS
- CONDENSERS
- SMALL COILS
- BAKELITE &
- CERAMIC PARTS, ETC.

Impressive details of the advantages
that our Waxes provide for most
classifications of insulating work will be
gladly given on application.

4, LLOYD'S AVENUE
LONDON, E.C.
'Phone: Royal 5403-4-5.

ROLA

TRANSFORMER
LAMINATIONS

EIGHT STANDARD SIZES
CORE WIDTHS $\frac{1}{8}$ " to $1\frac{1}{2}$ " (E's and I's)

AVAILABLE FROM STOCK

A Comprehensive Bulletin together with details
of Associated Covers and Clamps with design
data will be sent to manufacturers on request.

BRITISH ROLA LIMITED
MINERVA ROAD, PARK ROYAL, N.W.10
WILLESDEN 4322

Generation of Microwaves

Bibliography for Parts I & II

INPUT ADMITTANCE OF AMPLIFIERS AT H.F.

- ¹ Theory of the Internal Action of Thermionic Systems at Moderately High Frequencies. W. E. Benham. Part 1, *Phil. Mag.*, March, 1928; Part 2, February, 1931.
- ² Vacuum Tube Electronics at Ultra High Frequencies. F. B. Llewellyn. *Proc. I.R.E.*, November, 1933; *Bell Sys. Tech. Jour.*, January, 1934.
- ³ Phase Angle of Vacuum Tube Transconductance at very High Frequencies. F. B. Llewellyn. *Proc. I.R.E.*, August, 1934.
- ⁴ A Note on Vacuum Tube Electronics at Ultra High Frequencies. F. B. Llewellyn. *Proc. I.R.E.*, February, 1935.
- ⁵ Operation of Ultra High Frequency Vacuum Tubes. F. B. Llewellyn. *Bell Sys. Tech. Jour.*, October, 1935.
- ⁶ Input Resistance of Vacuum Tubes as Ultra High Frequency Amplifiers. W. R. Ferris. *Proc. I.R.E.*, January, 1936.
- ⁷ Analysis of Effect of Space Charge on Grid Impedance. D. O. North. *Proc. I.R.E.*, January, 1936.
- ⁸ Test Measurements on H.F. receiving valves between 1.5 and 60 Mc. *Philips Setmaker's Bulletin*, February, 1936.
- ⁹ Some General Relations in Vacuum Tube Electronics. W. E. Benham. *W. E. & E. W.*, August, 1936.
- ¹⁰ Equivalent Networks of Grid Vacuum Tubes at Ultra High Frequencies. F. B. Llewellyn. *B.S.T.J.*, October, 1936.
- ¹¹ Extension of Measurement of Admittances of High Frequency Amplifying Valves up to 300 Mc. *Philips Setmaker's Bulletin*, March, 1937.
- ¹² Effect of Electron Transit Time on Efficiency of a Power Amplifier. A. V. Haefl. *R.C.A. Rev.*, July, 1939.
- ¹³ Characteristic Constants of H.F. Pentodes. M. J. O. Strutt and A. van der Ziel. *W. Eng.*, September, 1937.
- ¹⁴ The Causes of Increase of the Admittances of Modern High Frequency Amplifier Tubes on Short Waves. M. J. O. Strutt and A. van der Ziel. *Proc. I.R.E.*, August, 1938.
- ¹⁵ A Contribution to Tube and Amplifier Theory. W. E. Benham. *Proc. I.R.E.*, September, 1938; Correction, December, 1938.
- ¹⁶ Operation of Electron Tubes at High Frequencies. H. Rothe. *Proc. I.R.E.*, July, 1940.
- ¹⁷ Gain Control of Radio Frequency Amplifiers. C. E. Lockhart. *Elec. & Tel.*, August, 1940.
- ¹⁸ Large Signal H.F. Electronics of Thermionic Vacuum Tubes. Chao-Cheng Wang. *Proc. I.R.E.*, April, 1941.
- ¹⁹ Electron Inertia Effects. F. B. Llewellyn. Monograph published by Camb. Univ. Press.

GENERAL ARTICLES ON VALVES FOR THE AMPLIFICATION AND GENERATION OF U.H.F. AND MICRO-WAVES.

- ²⁰ Vacuum Tubes of Small Dimensions for Use at Extremely High Frequencies. B. J. Thompson and J. M. Rose. *Proc. I.R.E.*, December, 1933.
- ²¹ Vacuum Tubes as High Frequency Oscillators. M. J. Kelly and A. L. Samuel. *Elec. Eng.*, November, 1934.
- ²² Vacuum Tubes for Generating Frequencies above 100 Mc. C. E. Fay and A. L. Samuel. *Proc. I.R.E.*, March, 1935.
- ²³ Development of Transmitters for Frequencies above 300 Mc. N. B. Lindénblad. September, 1935.
- ²⁴ Recent Developments in Miniature Tubes. B. Salzberg and D. G. Burnside. *Proc. I.R.E.*, October, 1935.
- ²⁵ A Power Amplifier for Ultra High Frequencies. A. L. Samuel and N. E. Sowers. *Proc. I.R.E.* November, 1936.
- ²⁶ A Negative Grid Triode Oscillator and Amplifier for Ultra High Frequencies. A. L. Samuel. *Proc. I.R.E.*, October, 1937.
- ²⁷ Extending the Frequency Range of the Negative Grid Tube. A. L. Samuel. *Jour. App. Phys.*, October, 1937.
- ²⁸ The Requirements and Performance of a New Ultra High Frequency Power Tube. W. G. Wagner. *R.C.A. Rev.*, October, 1937.
- ²⁹ Developmental Problems and Operating Characteristics of Two New Ultra High Frequency Triodes. W. G. Wagner. *Proc. I.R.E.*, April, 1938.
- ³⁰ A Push-pull Ultra High Frequency Beam Tetrode. A. K. Wing. *R.C.A. Rev.*, July, 1939.
- ³¹ A High Gain Amplifier for 150 Mc. G. Rodwin and L. M. Klenk. *Proc. I.R.E.*, June, 1940.
- ³² A New U.H.F. Tetrode and its Use in 1 Kilowatt Television Sound Transmitter. A. K. Wing and J. E. Young. *Proc. I.R.E.*, January, 1941.

USE OF LOW LOSS RESONANT LINES, CHAMBERS, Etc., FOR VALVE CIRCUITS.

- ³³ A New Type of U.S.W. Oscillator. I. E. Mourontseff and H. V. Noble. *Proc. I.R.E.*, August, 1932.
- ³⁴ Generation and Utilisation of Ultra Short Waves in Radio Communication. F. A. Kolster. *Proc. I.R.E.*, December, 1934.
- ³⁵ Frequency Control by Low Power Factor Line Circuits. C. W. Hansell and P. S. Carter. *Proc. I.R.E.*, April, 1936.
- ³⁶ An Ultra High Frequency Oscillator. A. Peterson. *Communications*, December, 1937; *Gen. Rad. Expr.*, October, 1937.
- ³⁷ Special Tank U.H.F. Oscillator Circuits. H. E. Hollman. *Electronics*, December, 1938.
- ³⁸ New Type of Short Wave Tuned Circuits. *Wireless World*, March, 1935.
- ³⁹ Oscillator for U.H.F. W. L. Barrow. *Rev. Sci. Inst. Vol. 9, p. 170, June, 1938.*

APPLICATIONS.

- ⁴⁰ Microwaves in N.B.C. Remote Pick-ups. R. M. Morris. *R.C.A. Rev.*, July, 1936.

- ⁴¹ A Terrain Clearance Indicator. L. Espenschied and R. C. Newhouse. *B.S.T.J.*, January, 1939.
- ⁴² 40 cm. Waves for Aviation. *Electronics*, November, 1939.
- ⁴³ R.C.A. Television Field Pick-up Equipment. T. A. Smith. *R.C.A. Rev.*, January, 1940.
- ⁴⁴ A 500 Megacycle Radio Relay Distribution System for Television. F. H. Kroger, B. Trevor and J. E. Smith. *R.C.A. Rev.*, July, 1940.
- ⁴⁵ R.C.A. Portable Television Pick-up Equipment. G. L. Beers, O. H. Shade, and R. E. Shelby. *Proc. I.R.E.* October, 1940.

GENERAL.

- ⁴⁶ The Figure of Merit of H.F. Valves. C. E. Lockhart. *Elec. & Tel.*, March, 1941.
- ⁴⁷ Determination of Grid Driving Power in Radio Frequency Power Amplifiers. H. P. Thomas. *Proc. I.R.E.*, August, 1933.
- ⁴⁸ Grid Temperature as a Limiting Factor in Vacuum Tube Operation. I. E. Mourontseff and H. N. Kozanowski. *Proc. I.R.E.*, March, 1936.
- ⁴⁹ Simplified Methods of Computing the Performance of Transmitting Tubes. W. G. Wagner. *Proc. I.R.E.*, January, 1937.

Salford Electrical Instruments Ltd. New Valve Voltmeters

WE have received particulars of two new instruments recently designed and put into production by this Company.

The first of these, Type BW.211, has been introduced for general laboratory voltage measurement of frequencies from 20 c.p.s. to 200 Mc/s per second.

It is suitable for use on 200/250 volts A.C. mains without adjustment, and has five voltage ranges, namely, 0/1.5, 0/5, 0/15, 0/50, and 0/150 respectively.

The second new type, BW.218 has three ranges, 0/5, 0/25 and 0/100 volts, is battery operated and entirely self-contained.

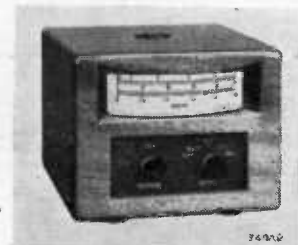

The photograph shows the front view of the instrument and its controls.

Both these new models are provided with substantial well-finished walnut cases.

Quick delivery can be given in the case of high priority orders.



THE vacuum switch shown in the illustration is mounted on a standard 4-pin valve base.

It is a light and convenient relay to handle up to 5 amps A.C. or D.C.

Its principal features are :

- LONG LIFE
- TOTALLY ENCLOSED CONSTRUCTION
- A.C. or D.C. OPERATION
- NON-INDUCTIVE CONTROL CIRCUIT
- ADJUSTABLE TIME DELAY UP TO 15 SECONDS
- WEIGHS ONLY 2 OUNCES

Write for Leaflet No. 101-2A
For larger relays see leaflet No. 101-2



VACUUM SWITCH
SUNVIC CONTROLS LTD., 1, KINGSWAY, W.C.2
Temple Bar 8202

THE DIAGRAMS IN THIS JOURNAL ARE LETTERED WITH

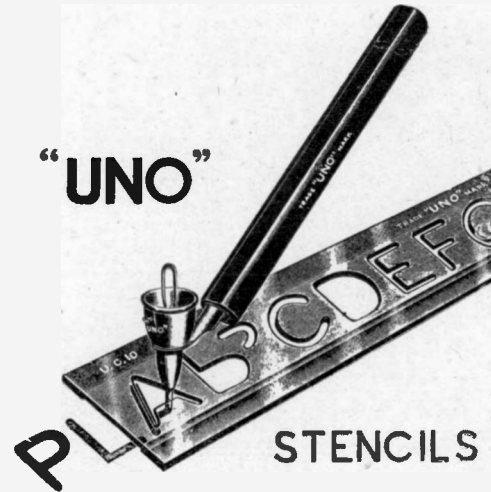

STENCILS FOR LEGIBILITY & NEATNESS

A. WEST & PARTNERS, LTD.
36, Broadway,
WESTMINSTER

THE "FLUXITE QUINS" AT WORK



*When the aerial wire broke loose
OI cried
"FLUXITE,
quick! What the deuce!"
Yelled OH
"Look out mate!
You'll come down,
sure as fate"
And he did—
in the pond—
what a goose!*

See that FLUXITE is always by you—in the house—garage—workshop—wherever speedy soldering is needed. Used for 30 years in government works and by leading engineers and manufacturers. Of Ironmongers—in tins, 4d., 8d., 1/4 and 2/8. Ask to see the FLUXITE SMALL-SPACE SOLDERING SET—compact but substantial—complete with full instructions, 7/6. Write for Free Book on the art of "soft" soldering and ask for Leaflet on CASE-HARDENING STEEL, and TEMPERING TOOLS with FLUXITE.

To CYCLISTS! Your wheels will NOT keep round and true unless the spokes are tied with fine wire at the crossings and SOLDERED. This makes a much stronger wheel. It's simple—with FLUXITE—but IMPORTANT.

THE FLUXITE GUN puts FLUXITE where you want it by a simple pressure. Price 1/6, or filled 2/6.

FLUXITE LTD. (DEPT. T.V.),
BERMONDSEY ST., S.E.1.



ALL MECHANICS WILL HAVE

FLUXITE

IT SIMPLIFIES ALL SOLDERING



Spare-Time Training by Post in all Electrical Subjects

The International Correspondence Schools, largest and most successful institution of its kind in the world, offers thoroughly sound Courses of Instruction to cover the following subjects —

- Complete Electrical
- Electrical Designing
- Electric Lighting
- Electric Power
- Electric Traction
- Electrical Transmission and Distribution
- Electric Illumination and Heating
- Hydro-Electric
- Oil-Power Electric
- Power-House Attendants
- Steam Electric
- Telegraph Engineering
- Telephone Engineering

Also the following Examinations —

- Associate Membership, I.E.E.
- City and Guilds Elec. Eng. Practice, Elec. Installation and Telecommunications
- P.M.G. Certificate for Wireless Operators
- Provisional Certificate in Radio Telephony and Telegraphy

WRITE FOR OUR SPECIAL FREE BOOKLET

(Use this Coupon. Penny stamp on unsealed envelope)

INTERNATIONAL CORRESPONDENCE SCHOOLS LIMITED

Dept. 68, International Buildings, Kingsway, London, W.C.2.
Please send your Booklet "Electrical Engineering" (72 pages).

I am especially interested in

Name..... Age.....

Address





“COSMOCORD”
CRYSTAL PICK - UP

FOR CLARITY AND TONE

LICENSED BY BRUSH CRYSTAL CO., LTD., under Brit. Pat. Nos. 366,252 and 454,595

Retail Price 25/- Plus Tax
SOLE SELLING AGENTS
SALE, TILNEY & Co., Ltd.,
3, LLOYD'S AVENUE, LONDON, E.C.3

Great Possibilities for
TECHNICALLY QUALIFIED ENGINEERS
KEY MEN IN WARTIME AND AFTERWARDS

The finest posts and the majority of posts in this war are technical and when the war is over, the immense increase in technique and mechanisation created for war purposes will be applied to reconstruction and commerce. An age of great possibilities for qualified engineers is here. Study at home with The T.I.G.B. and take a Recognised Engineering Qualification such as A.M.I.R.E., A.F.R.Ae.S., A.M.I.Mech.E., A.M.I.E.E., etc. In which examinations T.I.G.B. Students have gained 25 FIRST PLACES and hundreds of passes. Write now for "The Engineer's Guide to Success" — 200 Courses — covering all branches — Aeronautical, Tele-communication, Mechanical, Electrical, Chemical, etc. etc.

Free!



THE TECHNOLOGICAL INSTITUTE OF GREAT BRITAIN
160, Temple Bar House, London, E.C.4.

LOUDSPEAKER & TRANSFORMER SERVICE
(BRITISH AND AMERICAN)

TRANSFORMERS DESIGNED AND REPAIRED.

NEW SPEAKERS 5" to 18" P.M. and MAINS ENERGISED.

SPEAKERS OF ALL KINDS FROM 10/6.

SINCLAIR SPEAKERS
12, PEMBROKE ST., COPENHAGEN ST., LONDON, N.1. TER 4355

Make sure of your copy regularly . . .

SUBSCRIPTION RATES

All over the world
12 Months . . . 20/-
6 Months . . . 10/-

To avoid disappointment you should place an order with your newsagent to deliver this journal each month or send your subscription direct to us.

All subscriptions are payable in advance. Cheques and Postal Orders should be made payable to "Electronic Engineering"

HULTON PRESS LTD., 43-44 SHOE LANE, LONDON, E.C.4



MATHEMATICS
FOR THE
RADIO AMATEUR

For the past nine months the Radio Society of Great Britain, through its monthly Journal, "The T. & R. Bulletin," has published a series of articles entitled *Mathematics for the Radio Amateur*

These articles have covered a wide range of subjects, and are being continued throughout the current volume. Radio amateurs on active service find them of special value as do those who are training for the R/T and W/T trades. Each issue of "The T. & R. Bulletin" contains 40 pages of technical and topical information written by and for radio amateurs.

During the past four months over 500 new members have been elected. If you are a keen amateur experimenter or are engaged upon radio work in the Services, you are invited to apply for a copy of the current issue of "The T. & R. Bulletin," price 1s., and details of membership.

The Amateur Radio Handbook Britain's most popular radio text book, is also available, price 4s., post free. The 1941 Edition contains 328 Pages, 300 Illustrations and 25 Sections.

CONSTANT VOLTAGE

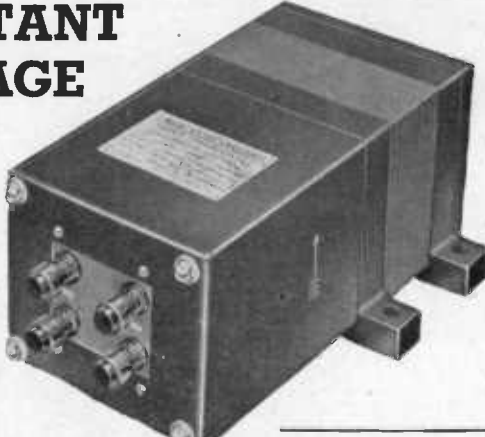

A NEW **ADVANCE** IN TRANSFORMER DESIGN

Line voltage variations of **± 15% reduced to ± 1%**

Stabilize your Electrical Instruments by using an "ADVANCE" Constant Voltage Transformer

TYPICAL SPECIFICATION :

Input Voltage:	190-260 v. 50 c.
Output Voltage:	230 v. ± 1%
Max. load:	150 watts.
Input power factor over	90%.

Write for details. Price on application.

ADVANCE COMPONENTS LTD.,
Back Rd., Shernhall St., Walthamstow, London, E 17
Telephone : Larkswood 4366-7

To The Secretary-Editor,
Radio Society of Great Britain,
16, Ashridge Gardens, London, N.13.

Dear Sir,—Please send me :—

..... Copy(ies) of "The Amateur Radio Handbook"

..... Copy(ies) of "The T. & R. Bulletin"

..... Details of Membership.

I enclose remittance for.....

NAME

ADDRESS

.....

Please write in BLOCK letters.

A Diode Slide-Back Peak Voltmeter—continued from page 395.

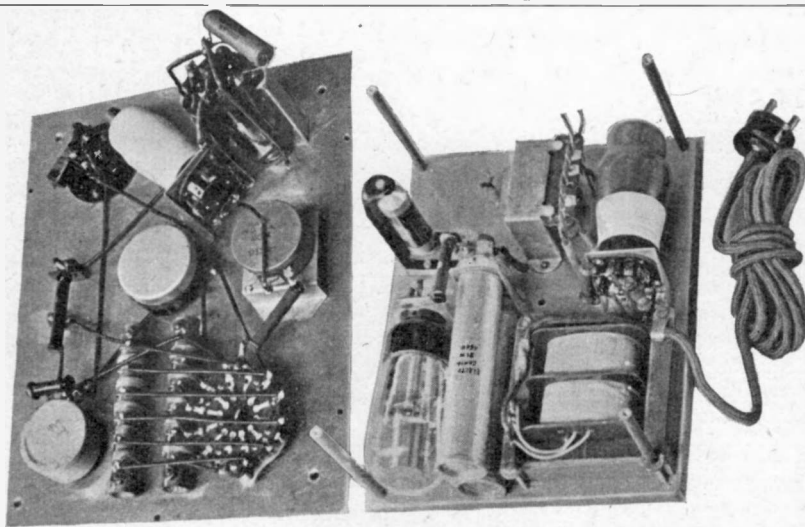

Left. Back view of panel. Right. View of Sub-panel assembly.

adjustment (a) should be for zero shadow angle, care being taken that R8 is not then made too high. In view of the difficulty of setting the slide-back potential without indication of its being too high, the zero diode current operation is only recommended where it is required to measure waveforms with a peak-to-mean ratio exceeding 50:1, or with the higher values of input, where the error of setting will be a small percentage of the voltage being measured.

Due to the initial curvature of the diode characteristic a small correction must be added to the slide-back reading, but above some 5 volts input the correction remains constant at approximately .5 volts, and so may automatically be included in the reading by using a second displaced cursor line on the calibrated slide-back potentiometer. Below 5 volts the slide-back reading will be approximately 10 per cent. low, and must be calibrated, D.C. being suitable for the purpose.

The two slide-back controls R11 and the R9 R10 S1 S2 combination have been chosen to provide respectively continuous variation of 15 volts and five additional steps of 10 volts each, with a 15-milliampere drain through the H.T. potentiometer. Terminals are provided for an occasional check of this current. Adjustment, when necessary, is effected by using R13 to vary the overall H.T. voltage, the stabilizing circuit compen-

sating for mains voltage fluctuations.

The method of construction will naturally depend upon requirements and the facilities available, that illustrated having been chosen mainly from the viewpoint of compactness. The chassis and panel are separately assembled and wired, with a minimum of interconnecting wires, the two assemblies being fixed together by means of a pillar at each corner (see photograph). The probe is constructed from a miniature bayonet cap lamp holder and a piece of 3/8-inch brass tubing, and is plugged into a socket on the panel as shown.

Insulation of this socket, and of V1 and V2 holders, must be of the highest order, since leakages at these points will limit the maximum useable values of R1, R3, R4, which together determine the sensitivity of the magic-eye adjustment. It may be advantageous to mount these three sockets on short insulating pillars.

Both the probe diode and V2 are operated with only 3.7 volts on their heaters in order to reduce heater-cathode leakages; the M.E. indicator V3 will usually operate satisfactorily on the same voltage, otherwise it must be fed direct, and V1 V2 via a resistance from a 4-volt supply. The heater supply to V1 should be through a tightly twisted pair, to avoid hum pick-up on the adjacent V2 grid lead, it being found unnecessary to screen this lead separately.

'Kodatron' Photographic Lamp

The new Kodatron high-speed lamp for photography provides a flash lasting 1/30,000th sec., which is caused by the discharge of a 112 μ f condenser through a column of Xenon-Krypton mixture. It is calculated that the passage of the impulse corresponds to an average current of over 6,000 amperes. The lamp has a life of 5,000 flashes, corresponding to a total life of one-sixth of a second!

Hallicrafter H.T.7 Frequency Standard A Correction

We regret that in the description of the Hallicrafter Frequency Standard on page 366 of the August issue, the specification of one of their communication receivers was inadvertently included. The list of valves also refers to the communication receiver, but the values of components correctly relate to the circuit diagram of the frequency generator shown.

Ode Partridge No. 7

RADIOLOCATION

'Twas over thirty years ago
When wireless, then in embryo,
Thrilling us with dot and dash
Ate deeply into our spare cash.

We hunted round for formers, wire,
Wound coils for hours and did not tire,
Waxing tubes, and waxing hot
When wanting bits we had not got.

Complete at last, with headphones tight
We fished around to get a "bite,"
And when the magic signal came
We felt we were ear-marked for fame.

How marvellous was this science then
Which harnessed things beyond our ken,
And who'd have thought that three
decades

Would put such triumphs in the shade ?

But yet 'tis so, and now our sons
Can trace the course of flying Huns,
Doom them to annihilation
By means of Radio Location.

N. Partridge

B.Sc., A.P.I.E.E.

King's Bldgs., Dean Stanley St.,
LONDON S.W.1

Telephone: VICTORIA 5035

Incendiary BOMB Detector

Incendiary Bombs can
be rendered non-effective
if they are dealt
with PROMPTLY

This can be done if you
install a
DETECTOR

Many installations completed.

Proved by experience.

AUTOMATIC — INEXPENSIVE

Don't delay—apply for particulars to:

RADIOVISOR PARENT LTD.,
1, STANHOPE STREET,
LONDON, N.W.1.

Telephone: Euston 5905/6.

TRIX

QUALITY SOUND EQUIPMENT

Designed and built for reliability and high quality sound amplification



Let us send you full details

Amplifiers
4-400 Watts
Horns
Microphones
Loudspeakers



Equipment available for priority work, factories, etc.

The **TRIX** Electrical Co., Ltd.
65 BOLSOVER STREET, LONDON, W.1
Phone: EUSton 5471/2 Grams: Trixadio, Wesdo London

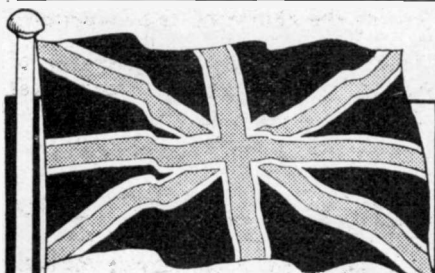

The Services rely on
RELIANCE

... who are producing high degree controls for the Air Ministry, Admiralty, Ministry of Supply, Post Office, etc. If in doubt regarding variable resistance problems it pays and profits to consult

RELIANCE

Manufacturing Co. (Southwark) Ltd.
Sutherland Rd., Higham Hill,
WALTHAMSTOW, - E.17

Telephone : : Larkwood 3245

ABSTRACTS OF ELECTRONIC LITERATURE

Television and C-R Tubes

Secondary Emission (H. Moss)

The paper is limited to effects in high-vacuum, sealed, low-voltage, cathode-ray tubes. A brief discussion is given of the loading of the deflector plates of a C.R. tube due to returning secondary electrons from the screen and deflector plate characteristics for high-negative anode potentials are given and discussed. The effects of secondary emission from the splitter anode of a double beam tube are described, together with a form of interaction between the X and Y plates due to returning secondary electrons from the screen.

—*Wireless Engineer*, Vol. 18, No. 215, August, 1941, page 309.

Circuits

Stray Capacitances (L. I. Farren)

If the stray capacitances of a coil in a metal container are replaced by effective lumped capacitance across the coil and from each end of the coil to the container, formulæ can be obtained for the effective inductance of the coil in terms of the absolute inductance and these lumped capacitances.

Such formulæ are obtained for the cases in which the inductance of the coil is measured by the resonance method, by the unbalanced transformer bridge method and by the balanced transformer bridge method, for the various possible connexions of the metal container.

Further, the effects of the stray capacitances of the coils in a "constant-K" band-pass filter and in a band-pass crystal lattice filter are discussed, and methods of overcoming these effects are given.

—*Wireless Engineer*, Vol. 18, No. 215, August, 1941, page 313.

An Electronic Humidity Meter (E. Moen)

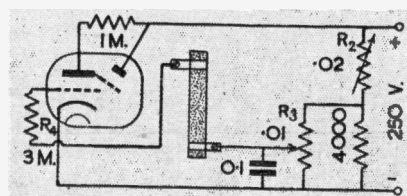

The electrical resistance offered by a strip of paper containing a deliquescent salt depends upon the moisture in the surrounding air. The resistance may vary over a range of 10 to 1, usually in the range of 10 to 100 megohms. A peculiarity of the action is that the change is instantaneous for a change in the direction dry-to-wet, but displays

a fifteen-minute delay in the direction wet-to-dry.

A means of putting this effect to use is shown by the circuit. A 6G5 tuning eye valve is used. The variable resistor R₂ is used to balance the circuit. From the grid of the 6G5 to R₄ a short one-inch lead is used, but from R₄ to the contact clamp a three-foot rubber-covered wire serves to collect a stray electrostatic component from the 110 volt 60 c.p.s. power lines. When there is a high resistance between the contact clamps, this stray signal will serve to close the eye of the 6G5. As the paper element path between the contact clamps increases in conductivity the control potentiometer R₃ can be turned to a point where the eye just opens. Calibration of the resistor dial gives points of observation which can be recorded, say, at half-an-hour intervals during the day.—*Electronics*, June, 1941, page 76.

Valve Keying (B. Goodman)

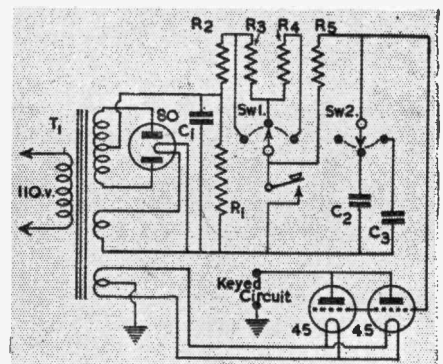

C₁. 2 μF., 600-volt paper (not electrolytic).
C₂. 0.003 μF mica. C₃. 0.005 μF mica.
R₁. 0.25 megohm. R₂. 50,000 ohms.
10 watt. R₃, R₄. 5 megohms. R₅. 0.5 megohm.

Sw1, Sw2. 3 position 1-circuit rotary switch.
T₁. 325 volts each side c.t., with 5 volt and 2.5 volt windings.

To obtain clickless keying of any transmitter, it is necessary to use a filter circuit that will slow up slightly the "make" and "break" of each character. The most common system uses an inductance in series with the key lead and a capacity across the key.

If the anode circuit of a valve is substituted for the key in a transmitter, a high value of negative voltage on the grid will prevent any current flow through the valve, and reducing the grid voltage to zero will allow current to flow and a signal to be transmitted. By changing the constants of the grid-circuit filter the keying of the transmitter can be controlled. The circuit shows a valve keyer designed to give some degree of adjustment after installation.

ABSTRACTS (contd.)

The number of valves used in parallel is determined by the current through the keyed circuit.

If Sw_1 is set so that only R_2 is in the circuit, and Sw_2 is set on the open point, no lag is introduced in the keying, because the grid voltage applied to the keyer valves is immediately removed when the key is closed and immediately replaced when the key is open. Adding capacity across the grid circuit softens both "make" and "break"; adding resistance between the key and R_2 softens the "break."

—Q.S.T., Vol. 25, No. 6, June, 1941, page 30.

Balanced Inductive Coupling for U.H.F. (M. Mix)

For coupling in its usual form, a coil, which is approximately self-resonant, is used on the anode circuit of the driver. The push-pull grid coil of the following amplifier is divided into two equal sections, one on each side of the driver anode coil. One of the difficulties which is almost always encountered with this arrangement is that of obtaining symmetrical drive to the grids of the amplifier or doubler. An effective method of

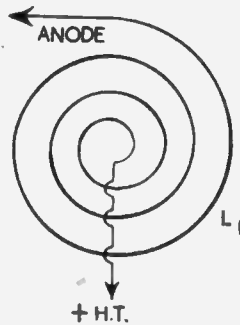

Fig. 1

overcoming this difficulty is to make L_1 in the form of a spiral winding as shown in Fig. 1. Capacity coupling to either side of L_2 is then made equal. The coil may be wound with No. 14 or No. 12 wire so as to be self-supporting.

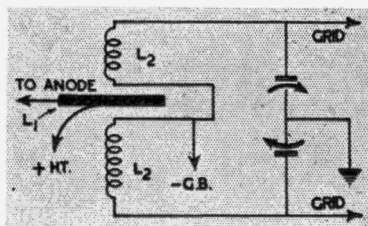
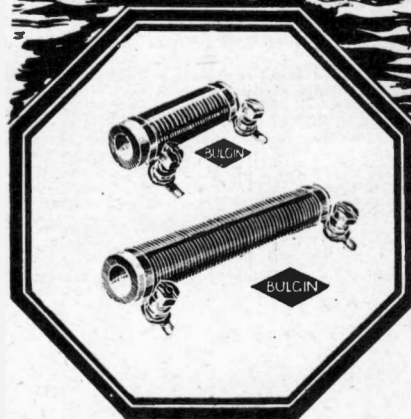
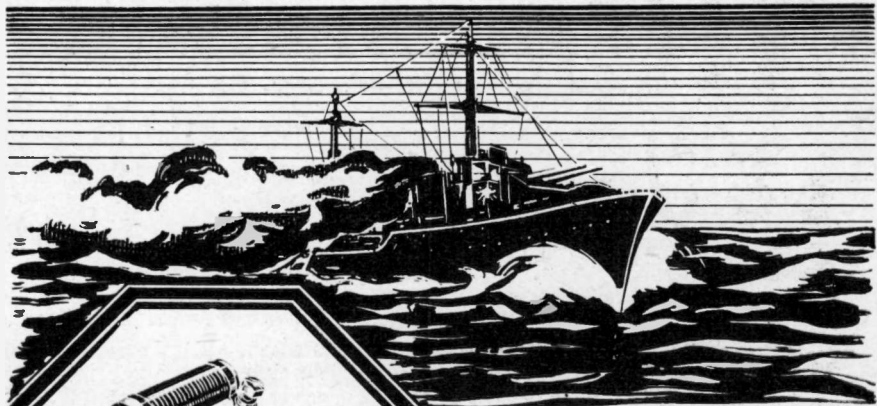

Fig. 2

To reduce capacity coupling to either side as much as possible, the anode should be connected to the outside turn as shown in Fig. 2. This arrangement also results in a more compact assembly.

—Q.S.T., Vol. 25, No. 6, June, 1941, page 56.

COMMUNICATIONS DEPEND....



ON SMALL PARTS....

In countless instances quite intricate pieces of apparatus are wholly dependent on the proved reputation and reliability of their component parts.

All products from the House of Bulgin are pre-eminent for superior design and workmanship, and every article bearing our Trade Mark has to pass exacting and exhaustive tests during the course of its production.

That is why every manufacturer of national importance incorporates Bulgin Components.

The Choice of Critics

BULGIN FOR RESISTORS

The largest and most comprehensive range of Resistors. Values from 0.10 to 150,000 Ω in wire-wound types, ratings of from 2 to 100W. Solenoidal-wound and double-spiral models available. Special accuracies of $\pm 1\%$ to order, at special prices. Only the finest materials are used throughout.

Let us send you

Our new 80 pp. Radio Service Manual, profusely illustrated and fully described with text and pictorial drawings as well as diagrams. A valuable and essential reference. A new edition is being printed and will be available for distribution shortly. Price 1s. 3d. post free.

ALWAYS DEPEND ON

BULGIN

REGISTERED • TRADE • MARK

A. F. BULGIN & CO. LTD., BY-PASS RD., BARKING, ESSEX

Tel. Rippleway 3474 (4 lines)

PREMIER RADIO

PLEASE NOTE—ALL S.W. KITS ARE NOW SUBJECT TO PURCHASE TAX. THIS IS INCLUDED IN THE PRICE.

PREMIER SMOOTHING CHOKES

Type	Current	Henrys	Res	Prices
C 40/500	40 MA	20-34 H	500 ohms	6/-
C 60/180	60 MA	8 H	180 ohms	6/-
C 60/400	60 MA	25-34 H	400 ohms	8/8
C 60/500	60 MA	18-30 H	500 ohms	8/8
C 100/400	100 MA	20-34 H	400 ohms	10/8
C 150/185	150 MA	20-34 H	185 ohms	15/4
C 200/145	200 MA	20-34 H	145 ohms	18/-
C 250/120	250 MA	25 H	120 ohms	20/-

Premier Pick-ups.
 Heads (Will fit any cone-arm) ... 8/9
 Premier Pick-ups with Volume Control Tone Arm ... 17/6

ANOTHER SPECIAL OFFER.
 Rothermel Brush Plexo Crystal Pick-ups.
 De Luxe Pick-up Head ... 34/9
 (Will fit any cone-arm) ...

PREMIER 1941 HIGH FIDELITY AMPLIFIER KITS
 Each Amplifier is Individually tested with specially matched valves.

	Completely Wired and Tested
4-watt A.C. Amplifier ...	£3 11 6
6-watt A.C. ...	£7 13 6
8-10-watt A.C./D.C. ...	£7 9 0
15-watt A.C. ...	£9 8 0

Black Crackle Steel Cabinet 17/6 extra.

MAINS TRANSFORMERS

Wire-ends. All L.T. Windings Centre-Tapped

SP. 250	250-0-250 v. 60 m.a. 4 v. 1-2 a, 4 v. 2-3 a, 4 v. 2-3 a ...	13/4
SP. 300	300-0-300 v. 60 m.a. 4 v. 2-3 a, 4 v. 2-3 a, 4 v. 2-3 a ...	13/4
SP. 301	300-300 v. 150 m.a. 4 v. 2-3a, 4 v. 2-3a, 4 v. 1a, 4 v. 1a ...	17/4
SP. 350A	350-350 v. 100 m.a. 5 v. 2a (not C.T.), 6.3 v. 2-3 a ...	16/-
SP. 350B	350-350 v. 100 m.a. 4 v. 2-3a, 4 v. 2-3a, 4 v. 2-3a ...	16/-
SP. 351	350-350 v. 150 m.a. 4 v. 1-2a, 4 v. 2-3a, 4 v. 3-4a ...	17/4
SP. 351A	350-350-150 m.a. 4 v 3 a, 4 v. 2-3 a, 4 v. 1 a, 4 v. 1 a ...	22/-
SP. 352	350-350 v. 150 m.a. 5 v. 2a, 6.3 v. 2a, 6.3 v. 2a ...	18/-
SP. 811	300-300 60 m.a. 4 v. 1 a. (not C.T.), 4 v. 5 a. C.T. ...	8/11

Auto Transformers. Step up or down. 125 v. to 200, 230 or 250 v. A.C., 60 watts, 11/4; 125 watts 15/-; 250 watts, 22/-.

L.T. Transformers, all C.T.

4 v. 2-3 a. ...	11/4	6.3 v. 2-3 a. ...	11/4
2.5 v. 5 a. ...	11/4	7.5 v. 3 a. ...	11/4
5 v. 2-3 a. ...	11/4	12 v. 3-4 a. ...	18/-

Push-Pull Driver Transformers, ... 6/6
Class B Driver 1:1 Ratio Stepdown 6/6
Universal Output Transformers. 1:1
 Ratios Single or Push-Pull ... 6/6
Push-pull Speaker Transformers, 50-1 C.T. ... 4/6
Heavy Duty Type for G.12 ... 6/6

MATCHMAKER UNIVERSAL OUTPUT TRANSFORMERS

Will match any output valves to any speaker impedance.
 1:1 ratios from 13 : 1 to 80 : 1, 5-7 watts, 16/10, 10-15 watts, 21/10, 20-30 watts, 36/10.
 Paxolin Valve Holders, chassis mounting, 4 or 5 pin, 4d. each. 7 pin, 4d. each.

PREMIER MICROPHONES

Transverse Current Mike. High grade large output unit. Response 45-7,500 cycles. Low hiss level, 23/-.

ALL ENQUIRIES MUST BE ACCOMPANIED BY 2/- STAMP.

"LEARNING MORSE"

Premier Morse Practice Key on Bakelite Base and Brass Movement	3/3
General Purpose Morse Key ...	5/9
Bakelite Buzzers ...	2/-
3 Henry Chokes ...	7/6
Complete Oscillator as described in above W.W. publication mounted on Steel Chassis, complete with Valve	27/6

NEW PREMIER S.W. A.C. RECEIVER

In response to many requests we have now produced an A.C. version of the popular Premier Short Wave SG3 Kit. Circuit: Pentode H.F. Stage, Pentode Detector, Pentode and F.W. Rectifier, 200-250 v. A.C. Operation. Built-in Power Pack. Hum-free operation. For use with Phones or P.M. Speaker.

Complete Kit of Parts with drilled chassis, all components. Plug-in Coils covering 13-170 metres, 4 valves and full instructions and circuits. **£6-14-6**

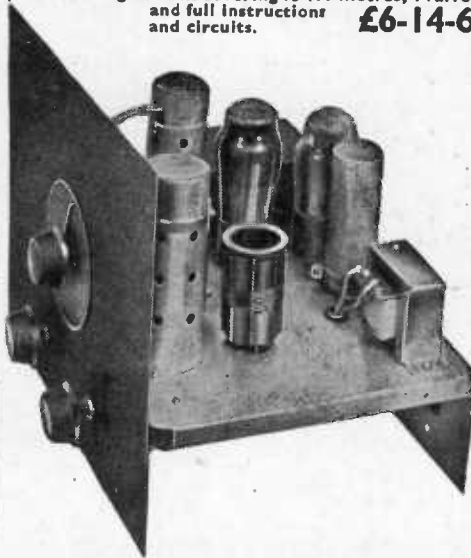

Battery Version also available Kit £4 15 4
 Extra Coils 9-15, 200-2000m. also available
 "The Wireless World" said they were
 "very much impressed ..."
 See full Test Report pp. 492-3 December issue
 Send for full details

PREMIER BATTERY CHARGERS for A.C. MAINS

Westinghouse Rectification complete and ready for use

To Charge : 6 volts at 1 amp. 26/-
 2 volts at 1/2 amp. 13/4 12 volts at 1 amp. 28/-
 6 volts at 1/2 amp. 22/- 6 volts at 2 amps. 43/6

MOVING COIL SPEAKERS
 All complete with transformer. Rola 6 1/2 in., 15/-; 10 in. P.M.s., 22/6; Goodman 8 in. P.M.s., 20/-.

ENERGISED MODELS
 Plessey 8 in., 175 ohm field, 7/6
 Plessey 8 in., 2,000 ohm field, 15/-

Moving Coil Mike. Permanent magnet model requiring no energising. Response 90-5,200 cycles. Output .25 volt average. Excellent reproduction of speech and music. 49/-.

DE LUXE S.W. KITS

Complete Kit, including all Valves, coils, wiring diagrams and lucid instructions for building and working. Each Kit supplied with a steel Chassis, Panel and plug-in coils to tune from 13 to 170 metres.
 1-V. S.W. Receiver or Adaptor Kit ... 24/6
 1-V. S.W. Superhet Converter Kit ... 28/-
 2-V. S.W. Receiver Kit ... 35/6

PREMIER DIALS (2-Speed)

3-Band ...	7/6
4-Band ...	9/-
Telsen Disc Drives ...	1/6

SHORT-WAVE CONDENSERS

Trolitul insulation. Certified superior to ceramic. All-brass construction. Easily ganged
 15 m.mfd. ... 2/4 100 m.mfd. ... 3/-
 25 m.mfd. ... 2/6 160 m.mfd. ... 3/7
 40 m.mfd. ... 2/6 250 m.mfd. ... 4/-

SHORT-WAVE GEAR

Short-Wave Coils, 6-pin types, to fit 7-pin holder Type 2, also to fit Eddystone coil holder Type 3, 13-26, 22-47, 41-94, 78-170 metres. 2/- each, with circuit.

Bakelite Dielectric Variable Condensers. .0005 mf. Suitable Tuning or Reaction, 1/6 each. 0001 and 00075 6d. each.

Short-Wave H.F. Chokes. 10-100 m., 10 1/2 d. each. High grade Ple-Wound U.S.A. type, 2/- each.

Lissen Dual Range Screened Coils. Medium and Long Waves, 2/9 each.

PREMIER REPLACEMENT VALVES

4 volt A.C. 5-pin Types, A.C./H.L., A.C./L. A.C./P., A.C./V.M., A.C./S.G. All 5/6 each.
 Premier I.P. Trans., 450-470 k/cs., Air cores. With or without Top Grid connection. 5/-
 Flexible Couplers. 1/2-in. bore. 11d. each.
 Valve Screens for International and U.S.A. types, 1/2 each.

Jacks. Single or Closed Circuit. 1/9.
 Electric Soldering Irons, 200-250 volts, 5/10. Super Model 11/9.

Potentiometers, all resistances, 3/6 each; with switch, 4/6.

Beehive Stand-offs, 2 1/2 in., 7d. each.
 Mains Noise Suppressors, comprising double wound Choke and Conds., 6/6 each.

Microphone Cable, weatherproof. Shielded and Rubber covered, 1/- yard.

Small 0005 2-gang, with trimmers, 3/6 each.

Ditto 3-gang, fully screened, with trimmers, 5/- each.

Utility 3-gang fully screened, 0005, with trimmers, 4/6 each.

2,000 25-watt Res., with 5 Tapping Clips 1/6 each.

ELECTROLYTIC CONDENSERS.

Cardboard cases. 25 mfd. 25 volt, 1/6; 50 mfd. 12 volt 1/6; 15 mfd. 100 volts, 1/3; 8 mfd. 125 volt tub, 1/6.

Microphone Transformers. Suitable for all mikes. Tapped primaries, A, 20 and 40 : 1; B, 30 and 60 : 1; C, 50 and 100 : 1. 6/6 each.
 Microphone Stands. Floor Type, 32/6.

All orders under 5/- 6d. post extra.

PREMIER RADIO CO.

ALL POST ORDERS to: JUBILEE WORKS, 167, LOWER CLAPTON ROAD, LONDON, E.5 (Amherst 4723).
CALLERS to: Jubilee Works, or 169, Fleet Street, E.C.4 (Central 2833), or 50, High Street, Clapham, S.W.4 (Macaulay 2381).

CORRESPONDENCE

DEAR SIR,

The field of application of my proposals for clarifying the decibel probably needs further explanation.

It would hardly be possible for me to disagree with Mr. Gill's remarks when the subject is considered in the light of work where input and output impedance remain at the value of 600 ohms. I agree, too, that it would be better to leave the decibel alone if that were possible.

There has, however, grown up a vast volume of allied work in which a unit of this nature is highly desirable but in which the above conditions are much more difficult to obtain. The decibel has hence been seized hold of forcibly and made to do the work, despite its partial incompetence.

This has led to a state of some confusion. My suggestion was an attempt to deal with this.

The design of all equipment to a standard impedance would at once solve the problem. But is this commercially possible? Will the purchaser of a gram amplifier pay several shillings more simply to know that his equipment has an input impedance of 600 ohms—a feature which is of little practical use since the impedance of the pick-up does not substantially affect the performance of the amplifier in any case?

The output side presents fewer problems, but even here there are pitfalls, although the value of 600 ohms is in many cases already in use. The impedance of a modulator, for example, is determined by the characteristics of the valve into which it modulates. The introduction of an extra transformer would not only lower efficiency but is in many cases—e.g., aircraft transmitters—out of the question.

If standardization is not possible, then either a logical way should be found of using the decibel or some other unit, or quantities should be stated in full as done by Mr. Voigt in his letter. The latter is, of course, a very sound method.

I hoped to suggest a unit which presented the same information a little more briefly and had certain advantages in calculation. I cited the example of a transformer.

Yours faithfully,
W. BACON.

DEAR SIR,

Having read Mr. Bacon's article on "The Decibel," in the August issue of your magazine, I feel that he should be commended for tackling—and surely successfully—a problem that tends to become more and more chaotic, due in no small degree to "sloppy" advertising.

The use of the "voltage db," as Mr. Gill suggests, is perfectly legitimate

when the input and output impedances are standardised, but, outside commercial apparatus this is by no means the rule. Mr. Gill also justifies—quite rightly—the use of the decibel in the case of field strengths referred to a standard—this is surely but one step behind Mr. Bacon's scheme.

The application to transformers is not only interesting, it is useful, and a transformer rating including these specifications would give a good deal more information than is usually supplied.

That the scheme will not receive application at once is almost certain due to a regrettable conservatism that seems to creep into so many scientific minds—a discussion on this subject had best be left alone, however.

To an amateur, then, Mr. Bacon's suggestions seems highly satisfactory in getting rid of several difficulties met in this field, replaced perhaps by some juggling of signs, but this surely is no more difficult than using logarithms in many other problems.

Yours faithfully,

M. G. SAUNDERS, B.Sc.

Stockport.

RECENT AMERICAN VALVES

The following valves are among those announced by the R.C.A. since April, 1941:—

12 H6.—A double diode similar to type 6H6. The heater rating is 12.6 volts 0.15 ampere.

6 SS 7.—A variable-mu H.F. pentode. The heater rating is 6.3 volts 0.15 ampere.

12 SN 7-GT.—A double triode amplifier having separate cathode terminals for each triode unit. It is recommended for use in resistance-coupled circuits as a voltage amplifier or phase inverter. The heater rating is 12.6 volts 0.3 ampere.

7 S7 (GL).—A triode-hexode converter. The heater rating is 6.3 volts 0.3 ampere.

117 P7.—A diode beam power amplifier similar to type 117 N7-GT but has a lower power output. The heater rating is 117 volts 0.09 ampere.

117 Z4 GT.—An indirectly heated half-wave rectifier. The heater rating is 117 volts 0.04 ampere.

Transmitter

8001.—The 8001 is a transmitting beam pentode suitable for power amplifier, modulator, and oscillator service. Because its driving power requirements are low, and because neutralization is generally not required, the 8001 is particularly useful in all band transmitter designs. In Class "C" telegraph service, the 8001 will provide a power output of approximately 230 watts at frequencies as high as 75 megacycles. Its anode dissipation is 75 watts.

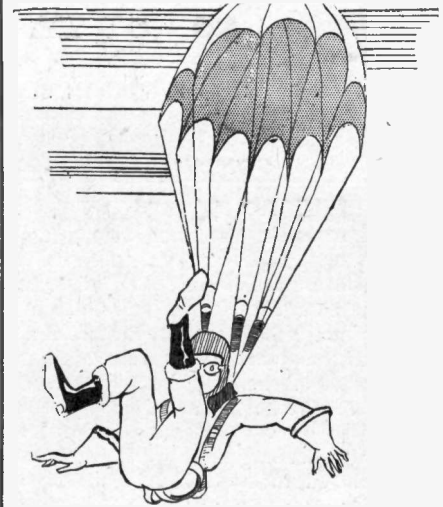

AIR COOLED

Our artist was apparently not familiar with this term. Are you familiar with the personal and highly skilled service we offer?

We manufacture transformers and chokes to B.S.S. and other relevant specifications of normal and special forms, ranging from small "stripped" types for incorporation in equipment to oil-filled 3-phase plant up to 15 k.V.A. for voltages up to 50 k.V.

We also supply special types, such as:—

Variable voltage transformers.

Constant voltage (flux regulated) transformers.

Transformers with high leakage reactance.

Scott groups.

Swinging chokes.

High current (plating) transformers.

Battery chargers, d.c. supply units, flash testers, amplifiers, etc.

Send us your enquiries.

W. ANDREW & COMPANY LTD

BRYCE

BOREHAM WOOD

HERTS.
TELEPHONE • ELSTREE 1875

PATENTS RECORD

The information and illustrations on this page are given with the permission of the Controller of H.M. Stationery Office. Complete copies of the Specifications can be obtained from the Patent Office, 25, Southampton Buildings, London, W.C.2, price 1s. each.

RADIO AND COMMUNICATIONS

Reception

A thermionic amplifier arranged to amplify simultaneously with the received signal, a second locally derived signal known as a checking signal, which is maintained at a determined value and is separable from the received signal. The gains of the amplifier with respect to the received and checking signal are dependent on variable valve parameters and the checking signal output e.m.f. is employed to control the gain of the amplifier so as to maintain the output e.m.f. reasonably constant. The gain will also be constant with respect to the received signal.

—*Radio Transmission Equipment, Ltd.*
Patent No. 536,538.

A short-wave oscillator where stability is obtained by "tapping down" by means of a reactance potentiometer. This comprises a circuit resonant at, or just beyond, one end of the tuning range of the oscillator so that, in effect, the electrical position of the tapping point moves with frequency as required. The circuit diagram is shown below.

—*Marconi's Wireless Telegraph Co., Ltd.; C. S. Cockerell, J. D. Brailsford and M. H. Cuffin.* Patent No. 536,500.

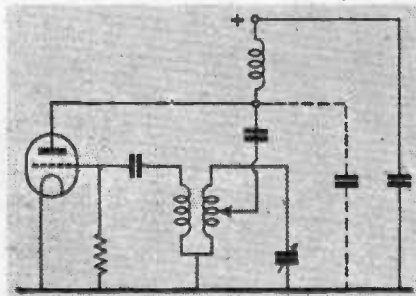

A thermionic valve repeater or amplifier circuit having a number of output stages and including inverse feed-back arrangements. The feed-back potentials are obtained across a load impedance in the screen grid circuit of a multi-grid valve in at least one of the stages.

—*Amalgamated Wireless, Ltd.* Patent No. 536,616.

TELEVISION

Scanning

A circuit arrangement for generating under the control of a series of saw-tooth oscillations, electrical impulses having a rectangular waveform and of adjustable duration and time of commencement in the saw-tooth cycle. This comprises a pair of valves arranged to become saturated at different times

during each saw-tooth cycle, one of the valves causing a predetermined change to take place and in a direct current circuit, and the other valve restoring the direct current circuit to its original condition.

—*Standard Telephones and Cables, Ltd.; R. M. Barnard and W. Kram.* Patent No. 537,142.

This invention refers to a time base amplifier comprising a thermionic valve, the output of which is fed via a transformer to the magnetic deflection coils of a cathode ray tube. The output is fed back in inverse phase to the input to neutralize in the output current the distortion produced by the leakage inductance of the transformer. This is obtained from across a self-inductance in the circuit of the secondary winding of the output transformer.

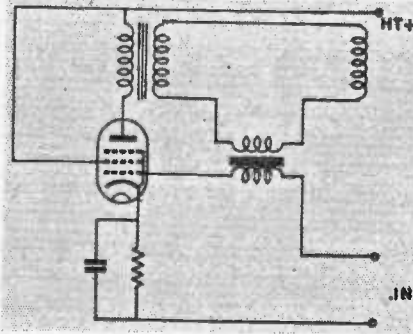

If too small an output transformer is employed, the frequency response may fall off at low frequency due to insufficient primary inductance in the transformer. Provided the leakage inductance is neutralized, the remaining frequency (and phase) distortion can be completely compensated for by means of a simple R.C. network on the input side of the amplifier.

—*Standard Telephones and Cables, Ltd., and W. A. Montgomery.* Patent No. 537,119.

THERMIONIC DEVICES

Valves

To provide simplified and improved means for controlling the potential distribution among a series of valves, e.g., H.T. rectifiers. A number of valves are connected in series and each has a condenser connected in parallel with it for equalizing the rapid changes of voltage. A resistor, made of special material having an inverse voltage-resistance characteristic is connected in parallel with each valve for equalizing the slow changes of voltage.

—*The British Thomson-Houston Co., Ltd.* Patent No. 536,516.

Cathode Ray Tubes

A method of modifying an electric current by applying a potential difference corresponding with the current across the cathode-anode of an ionic discharge tube.

Modification of the current is achieved by applying a magnetic field transversely to the electrostatic field in the tube to cause at least some of the anode current to be diverted to a collector electrode.

—*L. J. Blumenthal and A. Perelmann.* Patent No. 537,175.

Discharge Tubes

To reduce the stabilizing impedance required to be connected in series with a gas-filled discharge lamp, a conductive transparent layer is coated on the interior surface of the bulb and connected to one of the electrodes.

—*General Electric Co., Ltd., and M. Pirani.* Patent No. 536,928.

INDUSTRY

Control

An electro-magnetically operated switch sealed into a gas-filled bulb, in which the contacts are closed or opened by the action of a spring released by a soft iron core C. A solenoid S mounted externally controls the action. See diagram. Patent No. 412,753 also refers.

—*Birka Regulator and C. Appelberge.* Patent No. 536,524.

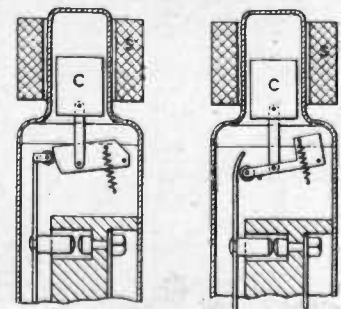

Measurement

A compact and economical transformer which may be used as both a potential and a current transformer and is claimed to be of extremely high accuracy. It comprises a magnetic core formed in two parallel parts on which primary and secondary current windings are wound, and primary and secondary potential windings also wound differentially with respect to the current windings.

—*The British Thomson-Houston Co., Ltd.* Patent No. 536,515.

GALPINS ELECTRICAL STORES

TERMS: Cash with Order
or C.O.D. Charges extra

21, William Street, Slough, Bucks.

Phone:
SLOUGH 20855

ALL GOODS SENT ON THREE DAYS APPROVAL AGAINST CASH

ELECTRIC LIGHT CHECK METERS, small, late type, well-known makers, first-class condition, electrically guaranteed, for A.C. Mains 200/250 volts 50 cy. 1 phase 5 amp. load, 10/- each; 10 amp. load, 12/6; 20 amp. load, 18/-; all carriage paid.

D.C. ELECTRIC LIGHT CHECK METERS, 200/250 volts, 5 and 10 amps., in new condition and electrically perfect; 7/6, post free.

AUTO. CHARGING CUT OUT AND VOLTAGE REGULATOR, ex-R.A.F., suit any dynamo up to 20v. at 15 amps., fully adjustable, with wiring instructions, complete in metal case, 3/6, post 9d.

WIRELESS CHASSIS (bomb surplus), containing many valuable modern components, shortly unobtainable, late type only, satisfaction guaranteed, 7/6 and 12/6 each, carriage paid.

SOLID BRASS LAMPS fitted small B.C. double contact holder and 12 volt bulb-price 3/- post free.

110 VOLT D.C. MOTOR, totally enclosed, rated at 8 amps., ball bearing, in new condition, make good slow-speed dynamo, weight approx. 75 lbs., price 45/- carriage forward.

EX R.A.F. SWITCH PANEL with case (new), fitted six small knife switches, complete in wood case, 2/6 each, post 6d.

1/2 H.P. 110 V., D.C. MOTOR, as new, ball bearing, totally enclosed, 25/-, carriage forward.

POST OFFICE MORSE KEYS, standard pattern, solid brass construction, in first class condition, 12/6, post free.

8 WAY Press Button switches, fitted paxolin terminal strips, 2/- each, post free.

P.A. SPEAKER CABINETS, not polished, size 22 in. by 18 in. by 13 in., to take 14 in. dia. cone, the whole made of 1/2 in. thick plywood. Price 20/-, carriage 2/6; Ditto, in Resine, slightly soiled, 17/6, carriage 2/6.

WIRELESS CHASSIS, late type (Bomb damage surplus), fitted very useful components all round for repairs, etc., these components will shortly be unobtainable, so buy now. Price 7/6 or 12/6 each, carriage paid.

UNIVERSAL CHASSIS, late type, all components sound, no valves, 4 and 5 Valve models, worth double, for parts only. Price 12/6.

ASSORTED WIRE END resistances and tubular condensers, all good and useful sizes, 2/6 per doz., post free.

SMALL TRANSFORMERS, for rewinding, sound windings on but rating unknown. Price 4/6, post 6d.

1 KW. TRANSFORMER, for rewinding, fitted sound mains winding (Ex large tungsten rectifiers). Price 35/-, carriage forward.

2 KW. TRANSFORMER, ditto as above. Price 50/-, carriage forward.

EPOCH, Super Cinema Loud Speaker, 20-watt size, 6 volt 2 amp. field, in good working order. Price £3 10s. 0d., carriage forward.

SLIDER RESISTANCE, fitted worm and wheel control, resistance 2,500 ohms, to carry 200 milliamp, 20/-, post free.

PHILLIPS, 1 MF, condensers, 4,000 volt working, large size, price 10/- each, carriage 1/6.

LARGE TRANSFORMER, 230 V. 50 cycle, 1 PH input; output 2,000—0—2,000 volts at 200 M/A and two L.T.'s, 11 volts and 4 volts, in first class condition, price 50/- each, carriage forward.

MILLIAMMETER, by "Werton," 2 1/2 inch dia, flush fitting, moving coil, reading 0—3 milliamps, in first class condition and working order, price 40/-, post free; Ditto milliammeter reading 0—50 M/A, 30/-, post free; Ditto, Milliammeter reading 0—200 M/A, 30/-, post free.

LARGE 1 KW. Transformers for rewinding, rating unknown, price 20/-, carriage forward

GUNMETAL PULLEYS, 7 in. dia., to take 1 in. dia. rope, complete with rope guard and hook, price 7/6, carriage 1/6.

110 V. BULBS 150 C.P., Ediswan screw fitting, half watt gas-filled, 2/6 each, post free, or 22/6 per doz., post free.

SHEET EBONITE, size 12 in. by 11 in. by 3/8 in., best quality, price 3/- per doz., post free.

ZENITH VITREOUS RESISTANCES, all useful sizes, in perfect working order, price per doz. assorted 10/-, post free.

1,000 YARDS of hard rolled **COPPER WIRE**, 14 gauge, bare, suitable for outdoor telephone wire, etc., on drum, unused, price £3 10s. 0d., carriage forward.

ELECTRIC BELLS, maker "Tangent," for heavy duty, working on 6 to 24 Volts D.C., fully adjustable, ironclad, fitted heavy 6 in. dia. gun metal gong, loud ringing, price 15/- each, carriage 1/6.

FRACTIONAL H.P., D.C. MOTORS, for 110 volt and 220 volt D.C. mains, only from 1/8th to 1/2 H.P., state size and voltage required, price, small, 7/6 and large 10/- each, carriage 1/6.

TELEPHONE MAGNETOS, or hand calling generators, 3 and 4 magnet type, unboxed, in good working order, price 7/6, post free.

ASSORTED Wire End Condensers and one watt resistances, tubular, all useful sizes, in good condition, price 2/6 per doz., post free.

ROTARY CONVERTOR, D.C. to A.C.; input 80/110 volts D.C. at 33 amps.; output 180/240 at 11 to 8 1/2 amps., 500 cycles single phase, also 24 volt at 12 1/2 amps. 200 cycles single phase, Ball Bearing, 2,500 r.p.m., in good condition and perfect working order, price £25, carriage forward.

PHILCO SIGNAL GENERATOR, Model No. 088, all wave, calibrated from 110 to 20,000 K.C., in five bands, condition as new, in perfect working order, price £6, carriage paid.

FIXED RESISTANCE wire wound on slate, 40 ohms, to carry 1 1/2 amps., protected, new and unused, price 6/-, post 9d.

COSSOR CATHODE RAY APPARATUS

THE DEMAND HAS BEEN SO GREAT for this equipment that all separate components have been sold. We can still offer, however, the apparatus complete with C.R. Tube, in Cabinets as mentioned below. It can be adapted to a variety of purposes, including Oscilloscopes, and those interested in Research and Development should not miss this opportunity, as such apparatus is no longer obtainable through normal channels.

Equipment as illustrated, with C.R. Tube type 3244, diameter approx. 6", complete in Walnut Table Cabinet (12"x21"x16 1/2"). Carr. fwd., plus 2/6 packing ... **£17**

As above, but with C.R. Tube type 3221, diameter approx. 7 1/2", complete in Walnut Pedestal Cabinet (15"x20"x36"). Carr. fwd., plus 2/6 packing ... **£18.5.0**

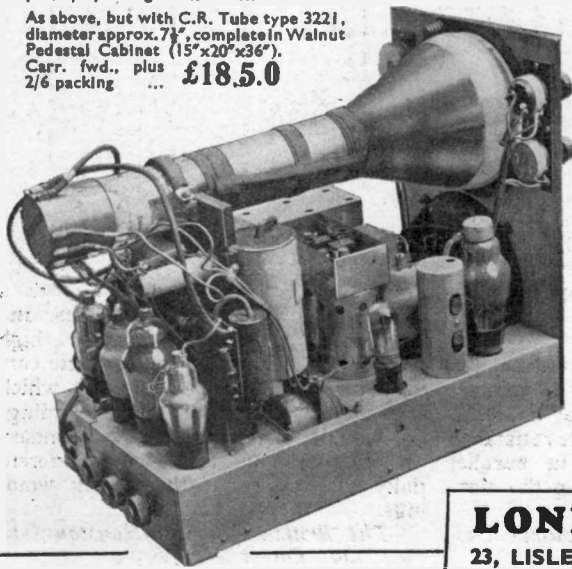

Further exceptional offers of Cathode Ray and Radio Equipment.

POWER PACK AND AMPLIFIER CHASSIS. Includes heavy mains transformer 350-0-350, 120 m.a. with 4 tappings. High voltage transformer for supplying C.R. Tube. Various condensers including 16 x 16 mfd. 550 v. working, 1-16 mfd. 450 v. working, 50 x 50 x 2 mfd. B.I. Electrolytics, etc. Pentode output transformer; chokes; resistors; trimmers; bias electrolytics; mica and tubular condensers; short-wave coils, etc. The quality of the workmanship and components is of the highest class. **67/6**
Valve diagram free ...
Carr. fwd. Add 2/6 for packing.

TIME BASE CHASSIS. For 8in. Cathode Ray Tube. Well-made cadmium-plated chassis, size 17in. x 14 1/2in. x 2in., containing approximately thirteen fixed resistors ranging from 15,000 ohms to 1 megohm, five variable resistors, 2,000 to 20,000 ohms, approximately 14 various tubular and electrolytic condensers, also sundry focus and scanning coils and chokes. (Complete circuit and service manual available, price 6d. each.) **30/-**
Carr. fwd. Add 2/6 for packing.

CATHODE RAY TUBES (MAGNETIC TYPE). Not available through ordinary channels. 10in. £5, 12in. £6, 15in. £8. All tubes must be collected by buyer.

EAS0 TELEVISION DIODES. 6.3 v., 0.15 amp. Limits: Vd. max. 50 v., Id. max. 5.0 m.a., Vd. max. (Id. = plus 0.3 µa) = 1.3 v., Vrk. max. 50 v., Rfk. max. 20,000 ohms ... **10/6**

VISION UNITS. To fit on Time Base. Consists of 3 Mullard T.S.E.4 and 1 Mazda D1 Valves. Approximately 25 resistors ranging from 75-75,000 ohms, about 30 condensers of various values, together with Reflector, Grid and various Band Pass Coils, also approximately 10 chokes of various descriptions and W6 Westector. Completely wired and screened. (Complete circuit and service manual available, price 6d. each.) **40/-**
Post and packing 1/6 ...

MAINS TRANSFORMERS. Originally made by Television Power Packs where accuracy and robustness are essential. Weight 12lb., size 5 1/2in. x 4 1/2in. overall. 350-0-350 v. 120 m.a. Tapped. 4 v. 2 a.; 4 v. 8 a.; 3 v. 3 a.; 20 v. 1 a. Dia-gram free. Post and packing 1/6... **25/-**

HEAVY DUTY MAINS TRANSFORMER. Input 240 v. A.C. One tapping at 5,000 v. max. 20 amp., and one for supplying filament of Mullard HVR 2 (6.3 v. at .65 amp.). Shrouded in metal box, carr. fwd. ... **10/6**

B.I. CONDENSERS. 1 x 1 mfd. 7,000 volt d.c. test with porcelain insulators ... **20/-**

4-VALVE 5-WATT AMPLIFIER CHASSIS for 220-250 A.C. Shock-proof chassis. 2 triodes output stage with super 10in. energised M/C speaker, special output transformer and volume control. Complete. Carr. and packing 2/6 extra **6/6ns**

LONDON CENTRAL RADIO STORES

23, LISLE STREET, LONDON, W.C.2.

'Phone: GERrard 2969

THE TELEVISION SOCIETY

(FOUNDED 1927)

President: SIR AMBROSE FLEMING,
M.A., D.Sc., F.R.S.

The war may have temporarily checked the development of television in this country, but the interest of hundreds of amateurs has not waned. If you are one of those who wish to keep in touch with television developments and meet fellow enthusiasts, the TELEVISION SOCIETY offers you every facility.

Write for particulars of membership to the
Hon. General Secretary:

Mr. J. J. DENTON,
17 Anerley Station Road,
London, S.E.20

OFFERS

by **A. C. S.**

- AMERICAN CAPEHART Auto Record Changer, takes 20 mixed 10 in. and 12 in. records, and turns them over. Cost £100. As new ... **£65 0 0**
- A.C.S. SPECIAL, with all-wave and quality feeders, Super amplifier, Bass and treble corrector, Presto Recorder, grammo, with Rothermel Studio Pick-up, in magnificent massive walnut cabinet, with Voigt Walnut Corner Cabinet Speaker. As new **£190 0 0**
- CELLOPHONE RADIOGRAM, 13—2,000 metres, with photo-electric ribbon type grammo. In attractive modern walnut cabinet. Pre-war list 55 gns. As new with small set of records ... **£35 0 0**
- EKKO MODEL C511 Push Button Console, 13—2,000 metres, 3 bands. Motor tuning. New, at pre-tax price ... **£17 17 0**
- SCOTT IMPERIAL, 27 valve Radiogram, with expander, 13—2,000 metres, perfect condition, complete in Teak Cabinet ... **£75 0 0**
- SCOTT IMPERIAL, Radiogram, as above, but in Scott Warwick Grande period hand carved 6 ft. Cabinet ... **£95 0 0**
- SCOTT PHILHARMONIC, latest type, dem. soiled only. 30 valves, 5—2,000 metres, six bands, chassis, amplifier and 3 speakers. Choice of Cabinets available for Philharmonic if desired ... **£145 0 0**
- MARCONI RADIOGRAM, Q286, 5 v. Superhet. Broadcast bands, as new ... **£18 18 0**
- AMERICAN GENERAL ELECTRIC Radioforte Console, Push button tuning, broadcast band only, Beamscope interior aerial, handsome cabinet. Pre-war list 68 gns. Showroom soiled only **£27 0 0**
- MURPHY TABLE BATTERY MODEL B. 89, 4 valves. Broadcast bands. With accumulator, less battery. New, pre-tax value ... **£7 7 0**
- PARMEKO RECORDER, with M.S.S. cutting head, and Parmeko straight line recording amplifier. New condition ... **£110 0 0**

Carriage extra. Packing cases chargeable, but credited on return. Personal inspection and collection invited and preferred.

A.C.S. RADIO

44, WIDMORE ROAD, BROMLEY, KENT
RAVensbourne 0156. Open until 6 p.m. Sats.

MOVING COIL PICKUPS

"Coil" and Voigt Stockists

HOLIDAY & HEMMERDINGER Ltd.
74-78, Hardman Street, Manchester.

The "Ultra" Incendiary Detector Test Figures

Since the publication of the article in last month's issue on the "Ultra" Incendiary Bomb Detector, the B.S.I. have issued Standard Specification BS/ARP. 60, covering the requirements of performance of photo-electric devices for bomb detection.

The following paragraphs are of principal importance in assessing the performance of the "Ultra":—

Clause 2. All light-collecting devices shall be affixed to the detector device as to be not readily detachable.

Clause 3. The operating distance in any direction shall be determined in a prescribed manner (given in Appendix).

Clause 4. The device shall cause an alarm to operate in any of the following circumstances:—

Failure of current supply to the detector.

Failure of valve.

Failure or breakage of any part of the detector circuit.

An important point is the conditions for minimum operating distance obtained by the use of a specially mounted lamp which is moved up to the detector from a distance. The minimum distance at which consistent operation occurs is taken as the sensitivity index and is multiplied by a factor of 7 to give the operating distance for the device.

A polar curve of the sensitivity of the "Ultra" detector is given below. In every respect it conforms to the requirements laid down in the B.S.S., including those cited above.

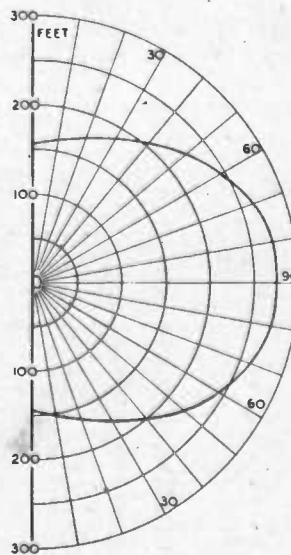

(Note: Copies of BS/ARP. 60 can be obtained from the British Standards Institution, 28 Victoria Street, S.W.1, price 8d., post free.)

Classified Announcements

SCALE OF CHARGES

The charge for miscellaneous advertisements on this page is 12 words or less 2/-, and 2d. for every additional word. Single-column inch rate displayed, 12/6. All advertisements must be accompanied by remittance. Cheques and Postal Orders should be made payable to Hulton Press, Ltd., and crossed, and should reach this office, 43, Shoe Lane, London, E.C.4, not later than the 15th of the month previous to date of issue.

LOUDSPEAKERS

3,000 SPEAKERS P.M. and energised 4" to 14", including several Epoch 18". Sinclair Speakers, Pulteney Terrace, Copenhagen Street, N.1.

MISCELLANEOUS

ALL TYPES of Rotary Converters, electric motors, battery chargers, petrol electric generator sets, etc., in stock, new and second-hand.

A.C.-D.C. Conversion Units for Operating D.C. Receivers from A.C. Mains, 100 watts output, £2. 10 150 watts output, £3. 10.

WARD, 37, White Post Lane, Hackney Wick, E.9.

LOUDSPEAKER repairs, British, American, any make, 24-hour service; moderate prices.—Sinclair Speakers, Pulteney Terrace, Copenhagen Street, N.1.

MORSE EQUIPMENT

FULL range of Transmitting Keys, practice sets and other equipment for Morse training.—Webb's Radio, 14, Soho Street, London, W.1. Phone: GERard 2089.

MORSE TRAINING

FREE. "Book of Facts," tells you all about The Candler System of Code training. Courses for Beginners and Operators.—Write: Candler System Co. (55B) 121, Kingsway, London, W.C.2.

RADIO MAP AND GLOBE

WEBB'S Radio Map of the World enables you to locate any station heard. Size 40" by 30" 2 colour heavy Art Paper, 4/6d., post 6d. Limited supply on Linen, 10/6, post 6d. WEBB'S Radio Globe—superb 12" full-colour model. Radio prefixes, zones, etc. Heavy oxydised mount. Post Paid. 27/6.—Webb's Radio, 14, Soho Street, London, W.1. 'Phone: Gerrard 2089.

TUITION

WIRELESS. Students of both sexes trained for important War time Radio Appointments, also for peace time careers in all branches of Radio & Television. Boarders accepted. Low inclusive fees. College in ideal peaceful surroundings. Prospectus Free. Wireless College, Colwyn Bay.

PRACTICAL POSTAL COURSES, radio television, test equipment design, trade-test coaching for R.A.F. post, I.P.R.E. and I.W.T. exams.; booklet free—Secretary, I.P.R.E., Bush House; Walton Avenue, Henley-on-Thames.

WANTED

ALL TYPES of used Radio Sets, Radio and Electrical accessories. Bought for cash. University Radio, 22 Lisle Street, W.C.2. 'Phone: GER. 4447.

KIT OF PARTS, complete or incomplete, for Fultograph.—Write sending specification to Box 642, Hulton Press, Ltd., 43-44, Shoe Lane, London, E.C.4.

STEEL WIRE RECORDING UNIT. Any condition. Good price paid.—Box 644, Hulton Press, Ltd., 43-44 Shoe Lane, London, E.C.4.

TECHNICAL BOOKS

English and Foreign Books on Radio and Electrical Engineering supplied from stock or obtained promptly to order.

(Catalogues post free on application.)

LENDING LIBRARY

Annual Subscription from One Guinea. Details of revised terms free on request.

H. K. LEWIS & Co. Ltd.

136 Gower Street, London, W.C.1
Telephone: EUSon 4282 (5 lines)

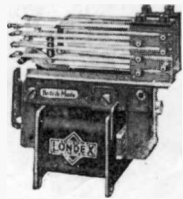

Multiple Contact Relay LF.



High Sensitive Relay, H.S.

RELAYS

For A.C. and D.C.

2V.A. coil consumption, from 2-600 volts, tested to 2000 volts. Time lag relays, High Sensitive Relays, Synchronous Process Timers, and complete Control Plants.

Ask for leaflet SPN/EO,

LONDEX LTD.

Electrical Remote Control Engineers & Manufacturers
Anerley Works, 207 Anerley Rd., London, S.E.20
Phone: Sydenham 6258/9

INDEX TO ADVERTISERS

A.C.S. Radio	424
Advance Components, Ltd.	416
Air Ministry Information Bureau	411
Automatic Coil Winder and Electrical Equipment Co., Ltd.	380
British Institute of Eng. Technology	Cover iii
British Radio Engineering College	Cover iii
British Rola, Ltd.	413
Bryce, W. Andrew, & Co., Ltd.	421
Bulgin, A. F., & Co., Ltd.	419
Bullers, Ltd.	398
Campbell, Claud, & Co., Ltd.	413
Celestion, Ltd.	379
Edison Swan Electric Co., Ltd.	382
Fluxite, Ltd.	415
Foyles, Ltd.	Cover iii
Frazar & Co., Ltd.	409
Galpins	423
General Electric Co., Ltd.	377
Henley's, W. T., Telegraph Works Co., Ltd.	379
Holiday & Hemminger, Ltd.	424
Holsun Batteries, Ltd.	411
International Correspondence Schools, Ltd.	415
Leslie Dixon, Co.	Cover iii
Lewis, H. K., & Co., Ltd.	424
Lockwood & Co	Cover iii
Londex, Ltd.	Cover iii
London Central Radio Stores	423
Masteradio, Ltd.	381
Ministry of Labour	378
Muirhead & Co., Ltd.	405
Mullard Wireless Service Co., Ltd.	403
Partridge, N.	417
Pitman's	412
Premier Radio Co.	420
Radio Society of Great Britain	416
Radiovisor Parent, Ltd.	417
Reliance Manufacturing Co. (Southwark), Ltd.	418
Safe, Tilney & Co., Ltd.	416
Savage, W. Bryan, Ltd.	Cover iii
Sinclair Speakers	416
Steatite & Porcelain Products, Ltd.	407
Sunvic Controls, Ltd.	415
Technological Institute of Great Britain	416
Television Society, The	424
Trix Electrical Co., Ltd.	418
Tucker Eyelet Co., Ltd.	379
United Insulator Co., Ltd.	413
Universal Electrical Co.	Cover iii
Varley	Cover iii
Vortexion, Ltd.	381
Webb's Radio	Cover ii, iv
West, A., & Partners, Ltd.	415
Westinghouse Brake and Signal Co., Ltd.	380

"LESDEX" EMERGENCY LIGHTING

Emergency Electric Lighting for Shelters, Headquarters, homes and factories.

Have your own Petrol-Electric Lighting and Charging Plant.

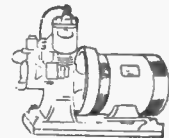

500-watt, single cyl. 2-stroke, water-cooled, self-oiling Pelapone engine mag. ign. coupled to 50/70 volts, 10 amps., shunt dynamo, 1,000 r.p.m. Fuel and Water Tanks. These are £45 sets ready for immediate delivery. Price £17 10 0

150-watt engine on similar lines, but coupled 25/30 volts, 6 amps., dynamo. £13 10 0

PLEASE NOTE NEW ADDRESS

We have left Upper Thames Street, and our new Offices and Showrooms adjoin our Works at Battersea, S.W.8. No. 137 bus passes the end of Broughton Street, 2d. fare from Sloane Square or Clapham. Nearest Railway Station Queen's Road (S.R.).

Stamped envelope for all replies, please.

LESLIE DIXON & CO.

19, BROUGHTON STREET,
Queenstown Road, BATTERSEA, S.W.1.

TELEVISION:

Concise Postal Course of Instruction for Radio Engineers

Apply—

BRITISH RADIO ENGINEERING COLLEGE

179, CLAPHAM ROAD, LONDON, S.W. 9

(Do not delay. Be conversant with subject now and prepared for business after the War.)

CASES

In WOOD, METAL and REXINE for RADIO and RADIO INSTRUMENTS

Details of Radio Cases for the Home will be forwarded on receipt of 2½d. In stamps.

LOCKWOOD & CO. (Dept. E.)
65, LOWLANDS ROAD, HARROW,
MIDDLESEX

Phone: BYRON 1818

Varley

Quality Components

- I.F. TRANSFORMERS
- WIRE WOUND RESISTANCES
- L.F. CHOKES & TRANSFORMERS
- MAINS TRANSFORMERS
- DELAY SWITCHES

Varley (Prop. Oliver Pell Control Ltd.)
Cambridge Row Woolwich, S.E.18

FOYLES

* BOOKSELLERS TO THE WORLD *

New and secondhand Books on every subject.
Join The Scientific Book Club!
113-125 Charing Cross Road, London, W.C.2
Telephone: Gerrard 5660 (16 lines)

TRANSFORMERS

to customers' specifications or in accordance with standard list.



W. BRYAN SAVAGE LTD.

Westmoreland Road, London, N.W.9. Colindale 7131

UNIVERSAL ELECTRICAL CO.

221 CITY ROAD, LONDON, E.C.1

Telephone: CLERK 7030

ROTARY CONVERTERS

"E.D.C." 230 D.C. Input 230 v. A.C. Output in Silence-soundproof Cabinet and Radio Filter Unit, 180 watts	£9 10 0
Ditto as above, 120 watts	£7 10 0
Ditto as above, 60 watts	£5 5 0
Dynamo, ½ h.p., 12/15 v., with extended shaft	£4 10 0
"Crompton" 220 D.C. Input, 230 A.C. Output, 2½ KVA.	£22 10 0
"Westinghouse" 110 D.C. Input, 110 A.C. Output, 750 watt	£12 10 0
"E.D.C." 50 D.C. Input, 230 A.C. Output, 500 watts	£15 0 0
"Crypto" 230 D.C. Input with Transformer Output A.C. 200/220/240, 6 KVA.	£35 0 0
"Siemens" Alternator self-cited 230 v. 5/Ph, 1500 r.p.m., 6 KVA.	£25 0 0
Photo-Electric Cells	each 15 0
"Crypto" 2 H.P. 415 v. 3 Ph. 50 c. 710 r.p.m. S/Ring with Starter	£17 10 0
"Foster" and "Hackbridge" Transformers, 100/110 to 200/230, 2 KVA.	£5 0 0
"Brooks" 15 h.p. Motor, 240 v. 5/Ph. 50 c., with Starter	£20 0 0

ALL TYPES OF ROTARY CONVERTERS SOLD AND PURCHASED

"AFTER THE WAR" TELEVISION

With the coming of Peace, and backed by the Technical advances that have resulted from the war years, TELEVISION will again spring to life and offer opportunities, as never before, to the trained man.

Now is the time to prepare for this new "market." Our Home study "Television" Course is comprehensive, up-to-date and suitable both for the amateur and experienced Radio Engineer.

We definitely guarantee

"SATISFACTION—OR REFUND OF FEE"

You are advised to send for details of this special Television Course immediately to investigate its possibilities. Details will also be sent of A.M.I.E.E. and A.M.Brit.I.R.E. Examinations and other courses in all branches of Wireless Engineering. Our literature is free.

BRITISH INSTITUTE OF ENGINEERING TECHNOLOGY

Principal: Prof. A. M. Low.

337, Shakespeare House, 17/19, Stratford Place, W.1.

RADIOLOCATION!

The word should have been coined for the new EDDYSTONE 358 Communication Receiver; instead, it has come to represent to the man in the street the latest developments in radio technique applied to locating hostile aircraft, U-boats, etc.

For "Radiolocation" of those long distance "Difficult-to-Receive" Short Wave Stations for the reception of which precision instruments only are of use, the Eddystone "358," like the famous lighthouse, represent a landmark in Communication Receiver design. It is ruggedly built, British to the core, and our engineers have incorporated every advanced detail to assure that performance shall be equal to present-day tasks.

Outstanding Features.

32 M/cs. to 120 K/cs.
Accurate calibration.
High sensitivity. Very high signal-to-noise.
Logging scale. All-circuit meter. Separate power pack.



EDDYSTONE components and Receivers have for some time been difficult to obtain. The demand is still colossal, mainly from Government Departments, but we have overcome most of our war-time set-backs and have now in **ENERGETIC PRODUCTION** a range of components to meet most requirements. This range is being added to quickly. The "358" and its counterpart medium frequency model "400" with or without band-pass crystal filters are available for

WORK OF NATIONAL IMPORTANCE

WEBB'S RADIO

14, SOHO ST., OXFORD ST., LONDON, W.1

OPEN 9.0 a.m. to 6 p.m.; SATS. 1 o'clock. *PHONE: GERRARD 2089

