

HALVING COST OF OUR TELEVISOR!

Television

and *SHORT-WAVE WORLD*

DECEMBER, 1937

No. 118. Vol. x.

1/-
MONTHLY

**SOMETHING NEW : A FINE PICTURE
ON A SMALL TUBE**

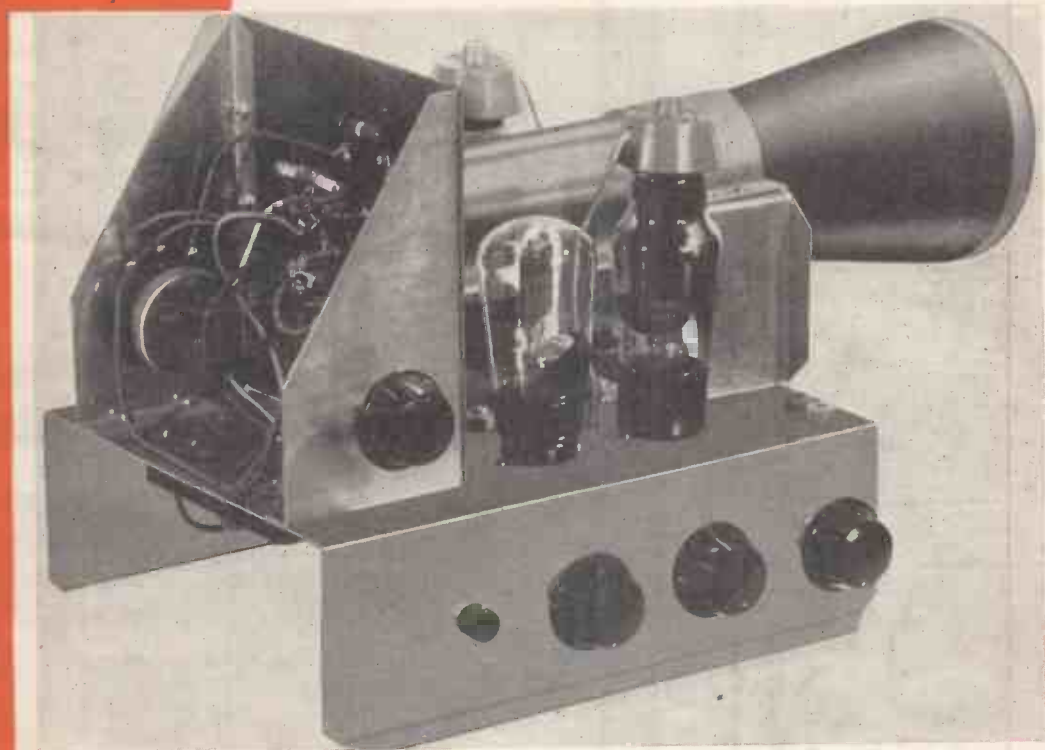

Alternative tube holder and time base unit which with simplified power pack makes possible a televisor at approximately half cost.

**CATHODE-
RAY TUBES**

**VALUABLE
WORKING
DATA**

**and
MANY USES
EXPLAINED**

SHORT WAVES :

**SINGLE VALVE TRANSMITTER
S.W. CONVERTER
A
I-V-I RECEIVER**

**BERNARD JONES PUBLICATIONS LTD.
CHANSITOR HOUSE, CHANCERY LANE
LONDON W.C.2.**

THE FIRST TELEVISION JOURNAL IN THE WORLD

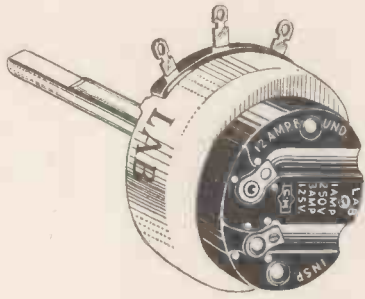

FIT
LAB
TESTED

LAB Controls are precision-built products, specially designed for amateur constructors and service engineers. Each control is laboratory tested for noise level, contact efficiency, etc. Spindles are 1 3/4" long for cutting to required length.

LAB Controls are precision-built products, specially designed for amateur constructors and service engineers. Each control is laboratory tested for noise level, contact efficiency, etc. Spindles are 1 3/4" long for cutting to required length.

- Without Switch ... 3/-
- With Single-Pole Switch 3/6
- With Double-Pole Switch 5/-

From all Dealers. Write for leaflet giving full details to—
RADIO RESISTOR CO. LTD., 1, Golden Sq., London, W.1



Said Holmes, "Though I'm long past my prime,
I've learnt about **FLUXITE** in time.
Now I know all along
This wiring's been wrong—
So I'm now reconstructing my crime."

See that **FLUXITE** is always by you—in the house—garage—workshop—wherever speedy soldering is needed. Used for 30 years in government works and by leading engineers and manufacturers. Of Ironmongers—in tins, 4d., 8d., 1/4 and 2/8. Ask to see the **FLUXITE SMALL-SPACE SOLDERING SET**—compact but substantial—complete with full instructions, 7/6. Write for Free Book on the art of "soft" soldering and ask for Leaflet on **CASE-HARDENING STEEL and TEMPERING TOOLS** with **FLUXITE**.

To **CYCLISTS**! Your wheels will NOT keep round and true unless the spokes are tied with fine wire at the crossings and **SOLDERED**. This makes a much stronger wheel. It's simple—with **FLUXITE**—but **IMPORTANT**.

THE FLUXITE GUN

Is always ready to put Fluxite on the soldering job instantly. A little pressure places the right quantity on the right spot and one charging lasts for ages.
Price 1/6.



ALL MECHANICS WILL HAVE

FLUXITE

IT SIMPLIFIES ALL SOLDERING

FLUXITE LTD. (Dept. T.V.), DRAGON WORKS, BERMONDSEY ST., S.E.1

FUSES AND FUSEHOLDERS

It is definitely our policy to provide all mains fuses with a safety carrier so that they can be withdrawn only after the circuit is dead and replacements made in safety. A great deal of attention is given to creepage distances and breakdown between mains and earth. The new "Mag-Nickel" fuse is a real delay type depending upon the flashing of magnesium deposited on a nickel wire the melting point of which is 1,500° C. The magnesium flashes at 600° C., instantly generating some 3,000° C. At present they are available only in three ratings: 250, 500 and 750 m/A. They withstand twice as much instantaneous overload as the ordinary type and must not be confused with filled types depending upon heat radiation for their operation. Belling-Lee make fuses of many shapes and sizes for a multitude of purposes on land, sea, and air.



TWIN SAFETY FUSE-HOLDER
Reg. Design 767316

Bakelite moulding, safe and efficient. Impossible to touch fuses unless cover withdrawn, when fuses are accessible, and disconnected from mains, and apparatus is dead. Mount on panel or baseboard. With two 1-amp. fuses.
No. 1033 ... Complete 2/9

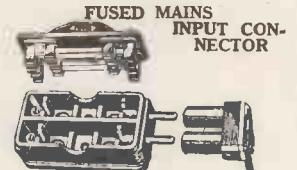

Heavy type with sockets and plugs to conform to B.S.S., 5 amp. standard. With fuses (1 amp. unless otherwise requested).
No. 1114. 5 amp. (B.S.S.)
Complete 4/3



SINGLE OPEN FUSE-HOLDER

A compact Fuseholder to take 1 1/2 fuses. Heavy phosphor bronze clips, soldering tags and terminals. With 1-amp. fuse.
No. 1034 ... Complete 10d.



FUSE PLUG

Bakelite moulding, B.S.S. and R.C.M.F. specification, 5 amp., but standard with 1 amp. cartridge fuses. One hole fixing, cord grip, small, ideal for radio receivers, portable lamps, electric clocks, etc.
No. 1278. Price, complete with two 1 1/2-in. fuses ... 2/-

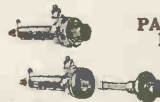

PANEL FUSE-HOLDER

Single hole fixing. Insulated from panel. Neat and compact; robust and reliable. Terminals for easy connecting. 1-amp fuse, or as required.
No. 1064 ... Complete 2/-



"WANDERFUSE"

Contains a 150 m/A. fuse. For use in the H.T.—lead. No higher than a wander plug. Particularly suitable for use in G.B. circuits. Black or red. With 150 m/A. fuse.
No. 1028 ... Complete 1/-



CARTRIDGE FUSES

Length, 1 1/2 in.
Cat. No. No. 1055/60 m/A. Black.
No. 1055/100 m/A. Grey.
No. 1055/150 m/A. Red.
No. 1055/250 m/A. Brown.
No. 1055/500 m/A. Yellow.
No. 1055/750 m/A. Green.
No. 1055/1 amp. Blue.
No. 1055/1 1/2 amp. Lt. Blue.
No. 1055/2 amp. Purple.
No. 1055/3 amp. White.

Length 3/4 in.
Short for Wandersfuse, etc.
No. 1052/60 m/A. Black.
No. 1052/150 m/A. Red.
No. 1052/250 m/A. Brown.
No. 1052/500 m/A. Yellow.
ALL RATINGS AND SIZES ONE PRICE ... Each 6d.

MAG-NICKEL DELAY FUSE

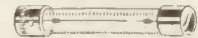

Length 1 1/2 in.
These Fuses will withstand twice as much instantaneous overload or surge as the normal type.
Cat. No. 338/250 m/A. Brown, 3-valve receivers.
338/500 m/A. Yellow, 4 to 8-valve receivers.
338/750 m/A. Green, Multi-valve sets, radiograms, television receivers, public address apparatus, etc.
All One Price, 9d.

Special Note and Warning re

H.T. Valveholder, No. 352/5. The phenomenon of corona was overlooked in the original specification when this component was stated to be efficient for 11,000 volts. Corona is first noticed at 7,300 volts 50 c/s. A.C. Bearing in mind the possibility of tracking, we now feel that this component is only suitable for medium voltages unless mounted on insulation pillars.

Write for literature

BELLING-LEE
FOR EVERY RADIO CONNECTION

Belling & Lee Ltd., Enfield, Middlesex.

ONE'S PINK AND SHELL-LIKE EAR is a remarkable organ, but there are some things it can't do. For instance, it can't distinguish accurately between closely approximate sound intensities. You can prove this for yourself with any receiver, by setting the volume control at a certain level while listening to the tuning note of a B.B.C. transmission, then giving it a haphazard turn, and asking a long-suffering acquaintance who did not see the original control setting to turn it back to give the first volume of output. There will be as many different re-settings as there are people to attempt the experiment.

SUPPOSE YOU WERE lining up a superhet "by ear": it is plain from the foregoing that your judgment of the peak settings of the I.F. trimmers is likely to be very unreliable if you depend on your ear alone to estimate output strength. Again, if you were doubtful about the gain provided by a certain H.F. or L.F. stage—how could you tell accurately by ear whether it was doing its bit conscientiously . . . No. To rely solely on the ear to judge output is asking for trouble. No serious experimenter does so. He uses an Output Meter.

AN OUTPUT METER may take several forms, ranging from an expensive valve voltmeter to the A.C. volts scale of a good multi-test meter. But there is one very convenient and inexpensive form of it, making use of a small neon tube. The majority of output indications do not require to be registered in watts: much more often, one needs simply to obtain fine comparisons of great or lesser output—e.g., when trimming I.F. circuits or checking stage gain.

A PRACTICAL INSTRUMENT using a neon tube is now perfected. The glow in the tiny neon tube varies its length according to the strength of output at the speaker, and instantaneously and accurately registers the effects of setting of I.F. and R.F. Trimmers, efficiency of L.F. stages over a range of audio frequencies and the like. No external power is needed. It works on any steadily-modulated signal—a broadcast tuning note or that of a test bench oscillator.

WRITE FOR THE INSTRUCTION
LEAFLETS—AND THE CATALOGUE

**NEON OUTPUT
MEASURING UNIT
V.T. 19**

Price : 20/-



**BULGIN
RADIO COMPONENTS**

COUPON

To Messrs. A. F. Bulgin & Co., Ltd., Abbey Road, Barking, Essex.

Please, send, post free, a copy of your new 120-page Catalogue No. 157, for which I enclose 3d. stamps.

NAME

ADDRESS

M

PLEASE USE BLOCK LETTERS.

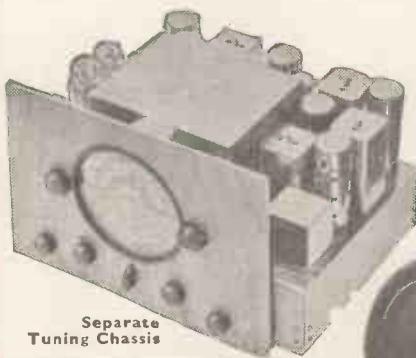

Separate
Tuning Chassis

Order that Xmas Radio NOW

AND REMEMBER

**The 1938 "NEW IMPERIAL"
TWIN CHASSIS ALL-WAVE
RECEIVER is the BEST**

MAKE this Christmas a memorable one by installing in your home a "NEW IMPERIAL" 15 valve Receiver.

In past years our products have set an extremely high standard of efficiency, but this latest model is far in advance of previous designs. The beauty of its reproduction NATURAL, in every sense of the word—its super-sensitivity has astounded many of the leading Radio critics. Its station getting capabilities are unsurpassed. London—New York—Java—Melbourne—all have been received with equal



York Console Model.

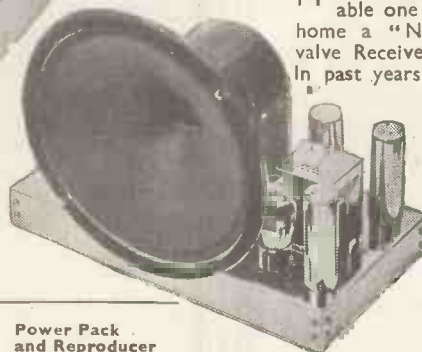

Power Pack
and Reproducer

**Giant 12-inch
Theatre Sonic
Loudspeaker**

strength and clarity. IT IS THE ONLY RECEIVER ON THE MARKET COVERING SO WIDE A WAVE-RANGE. Before ordering that new Radio, compare your choice with the new "Imperial" All-Wave Receiver. We invite you to call for a demonstration, and we shall leave it to the performance of the receiver to convince you of its merits. Can we say more? Write, telephone or call for our Illustrated Art Catalogue giving full details of this outstanding Set.

**DEMONSTRATIONS
DAILY AT OUR SHOWROOMS
OPEN 9-8, EXCEPT TUESDAY 9-6
PLEASE MENTION TELEVISION ON YOUR LETTERS.**

**MIDWEST
RADIO (MANUFACTURING) CO. LTD.,
16, OLD TOWN, CLAPHAM, LONDON, S.W.4.
TELEPHONE : MACAULAY 5005**

TELEVISION DEVELOPMENTS

A NEW LARGE DIAMETER TUBE FOR TELEVISION REPRODUCTION



**TYPE 12H
TUBE**

The Ediswan Type 12H tube has a screen diameter of 12" giving a television picture 10" x 7½" without distortion.

The screen is of special material giving a close approximation to a black-and-white picture.

Specification:

Indirectly heated high vacuum tube.

Heater Volts - - - 2.0

3rd Anode Volts - - - 6000

2nd Anode Volts - - - 1200

1st Anode Volts - - - 300

Sensitivity (mm./V.) - - 850/V*

Peak-Peak Modulating Volts - 15

*V=3rd anode volts

List Price £15. 15. 0

★ In "ELECTRONICS", Mr. Wilder of the International Union Radio Corporation of America, says:

"On Friday I visited the Ediswan plant...
"The pictures were the best I saw in
"England and the best I had seen by radio
"anywhere".

● We also supply
HIGH VACUUM RECTIFIERS
GAS-FILLED RELAYS
MERCURY VAPOUR RELAYS
for Television Scanning
circuits.

ENTIRELY BRITISH MADE

EDISWAN RADIO VALVES

THE EDISON SWAN ELECTRIC CO. LTD.  155 CHARING CROSS RD., LONDON, W.C.2

R.E.299

USED BY ALL GOVERNMENT DEPARTMENTS

TELEVISION

and SHORT-WAVE WORLD

Special Features

	PAGE
Low-cost Televisor	708
Electronic Light Relay for Large Pictures	716
Receiver Evolution	717
British Television Through American Eyes	721
High-voltage Power Supply Units for Television	726
The Tube of Many Uses	733
Cathode-ray Tube Terminology	735
Cathode-ray Tube Characteristics	736
The 240B Transmitter	741
T-125 Output Stage	745
Multi-range Short-wave Converter ...	747
Efficient 1-V-1 Receiver	745
Regenerative R.F. Amplifier	755
Building a Precision Oscilloscope ...	755

TELEVISION AND SHORT-WAVE WORLD

Proprietors :

BERNARD JONES PUBLICATIONS, LTD.

Editor-in-Chief :

BERNARD E. JONES.

Editor :

H. CORBISHLEY.

Editorial, Advertising and Publishing Offices :

Chansitor House, 38, Chancery Lane, London, W.C.2.

Telephones : Holborn 6158, 6159.

Telegrams : Beejapee, Holb., London.

Subscription Rates : Post paid to any part of the world—3 months, 3/6 ; 6 months, 6/9 ; 12 months, 13/6.

Published Monthly—1/- net.

(On the first day of the month).

Contributions are invited and will be promptly considered. Correspondence should be addressed according to its nature, to the Editor, the Advertisement Manager, or the Publisher, "Television and Short-wave World," Chansitor House, Chancery Lane, London, W.C.2.

IMPORTANT

"Television and Short-wave World" is registered at the General Post Office, London, for transmission to Canada and Newfoundland by Magazine Post. Entered as Second-class mail matter, Boston, Mass.

COMMENT OF THE MONTH

The Small-screen Receiver

IN this issue we present the first practical constructional details of a television receiver employing a four-inch cathode-ray tube. Reduced picture size may appear to be a retrograde step, but we can assure our readers that there is much to be said for the miniature type of receiver.

Let us say at once that the small picture produced by this receiver is the equivalent, as regards brightness and clarity, of receivers employing large tubes, in fact its only limitation is the size of the audience for which it will provide entertainment. This disadvantage is largely offset by the reduction in first and operating costs and the fact that considerably lower voltages are employed than is the normal practice, a matter which allows of all-round simplification. In addition a receiver of this description lends itself admirably to an introduction to cathode-ray tube operation and will provide the constructor with the knowledge and confidence to build receivers of a more ambitious type should this be desired on a future occasion. It can be thoroughly recommended to those who are anxious to get an insight into television receiver design.

As will be seen from the constructional details, the televisor comprises the vision receiver described in the October issue with its associated power unit, together with a simple time base unit and power pack operating with a maximum of 1,200 volts, a voltage which is not greatly in excess of that employed in an ordinary broadcast receiver. The entire design is based upon ordinary wireless principles and no more difficulty will be met in its construction and operation than would be the case with an ordinary broadcast receiver.

Television Publicity

JUDGING from the sparse amount of publicity that television receives in the ordinary sound programmes, the conclusion cannot be avoided that there is still a faction at Broadcasting House which is opposed to television. It is not, of course, the B.B.C.'s job to sell television receivers, but with the finest publicity medium in the world available it would appear that it should do its best to popularise the new service, instead of which television is almost totally ignored. It seems clear that there is little liaison between Broadcasting House and Alexandra Palace and such as does exist is of a spasmodic and unorganised character. Properly directed publicity through the sound broadcast channels would do wonders in popularising television.

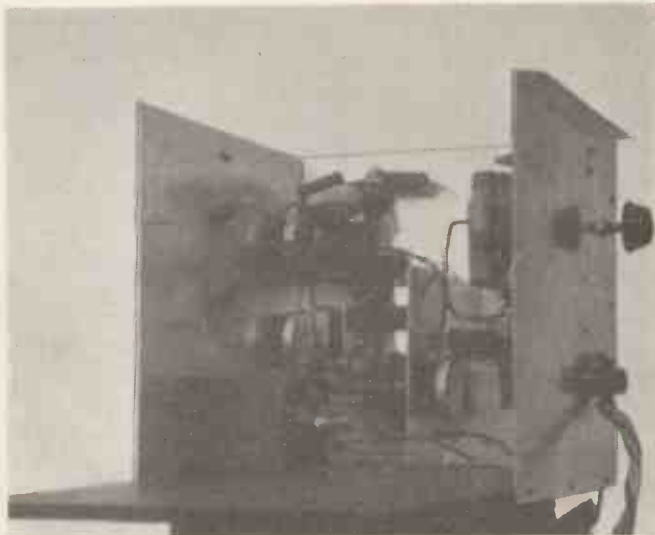
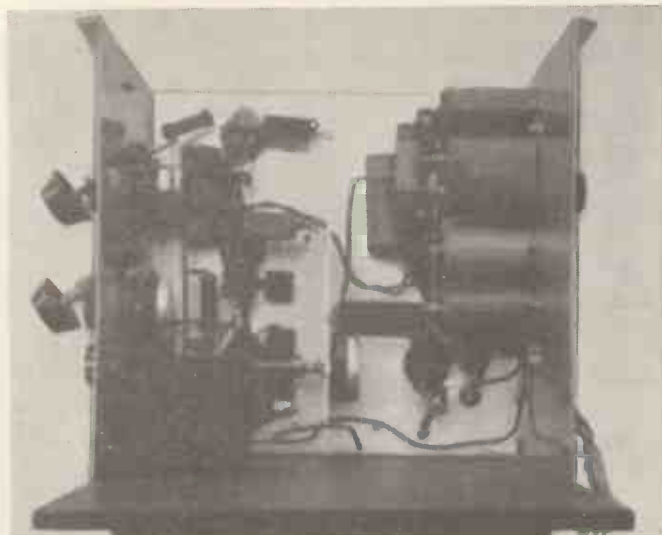

These two photographs show the time base unit with the wooden partition removed and make clear the assembly of the components.

THE NEW LOW-COST TELEVISOR FOR SIMPLE HOME CONSTRUCTION

By S. West

PART III.—MORE ABOUT THE TIME BASE :: BUILDING THE POWER PACK :: HOW THE COST CAN BE REDUCED :: DETAILS OF THE MODEL EMPLOYING A 4-INCH TUBE

As some of the drawings of the time base unit given in last month's issue were rather difficult to read three additional photographs are given here—two showing a front view with the centre wooden partition removed, and the other of the components mounted on the back aluminium panel.

One or two errors appeared in the description of the time base and C.R. tube unit described last month.

On p. 647, the drawing showing the connections to the C.R. tube socket. On the small panel carrying the resistances R26 and R30, read DX1 for DY2 and DY2 for DX2. For the potentiometers and resistances, read R30 and R33 for R26 and R27, likewise read R26 and R27 for R30 and R33.

For both these cases the theoretical circuits on pp. 648 and 649 are correct.

In the drawing on p. 649 that gives the dimensions of the chassis assembly. The drillings shown for the left-hand side of the time base are incorrect; they show the panel viewed from the wrong side. The correct drillings are shown on the new drawing, p. 709.

It is possible that some doubt may exist regarding the small metal panel that is shown in the drawing. The dimensions of this are 6 in. by 3 in. as marked. It serves to carry the potentiometer R21 and also to screen the line relay from the frame relay.

The potentiometer R21 is controlled by the bottom

knob of the three back controls on the left-hand side and the spindle of R21 is lengthened by means of an

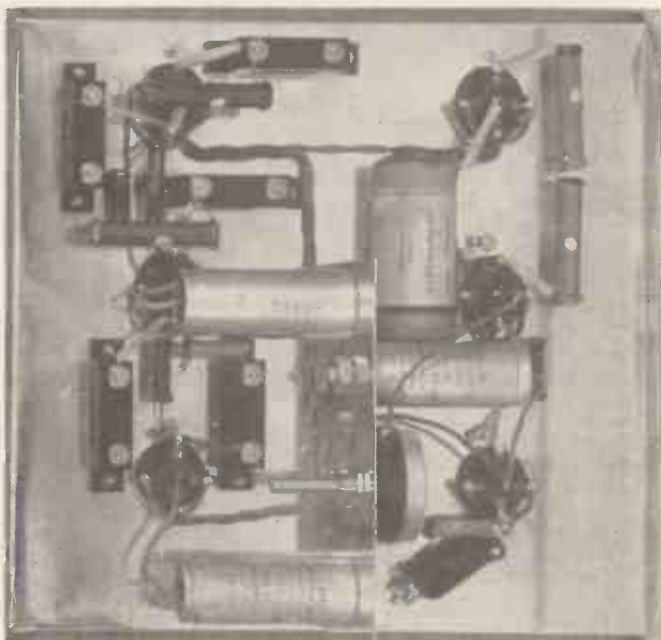

View of the back aluminium panel of the time base with the components assembled.

BUILDING THE POWER PACK FOR 10- AND 7-IN. TUBES

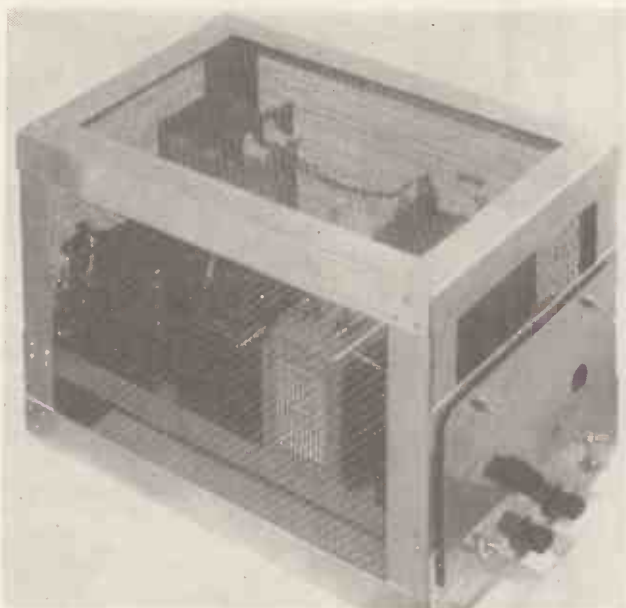

The cathode-ray tube and time base supply unit for use with 7-, 10- and 12-in. tubes.

Eddystone extension spindle to permit this. The panel holding R₂₁ serves as a between bases screen as well as holding the resistance R₂₁.

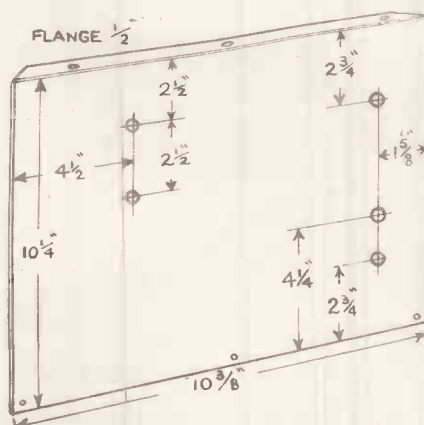

Corrected diagram showing the drilling of the left-hand panel of the tube mount and time base chassis.

The wood partition is also shown as being less in height than the sides. It is the same height.

The C.R. Tube and Time Base Power Supply Unit

When the design of a complete television receiver is contemplated, one of the principal details of the design, requiring consideration, is whether the positive or negative pole of the C.R. tube's high voltage unit will be earthed.

A decision on the point is necessary for the remain-

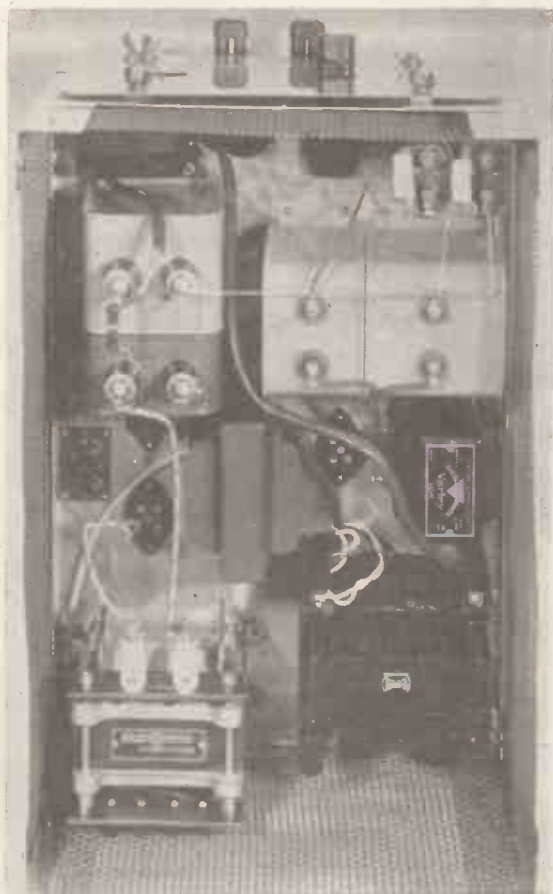

An interior view of the cathode-ray tube and time base power supply unit for 7-, 10- and 12-in. tubes.

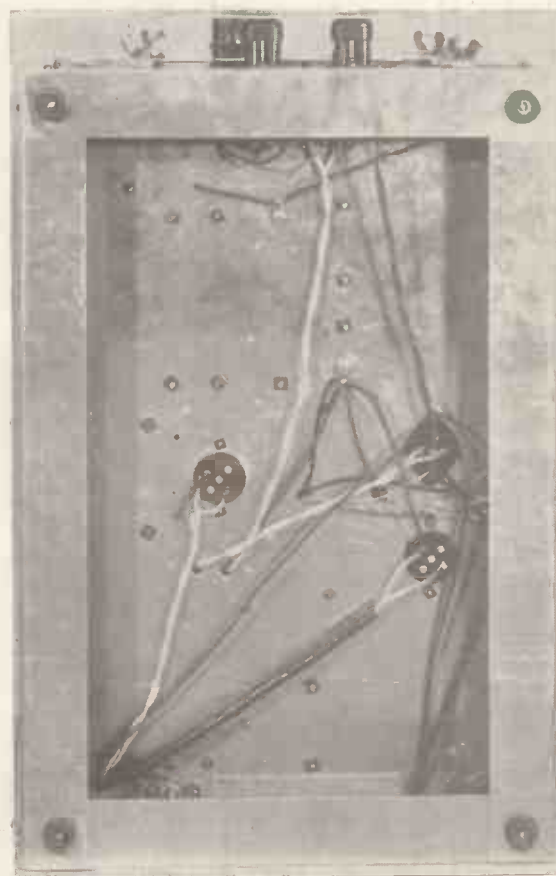

Underside view of the tube and time base power supply unit,

SAFETY PRECAUTIONS

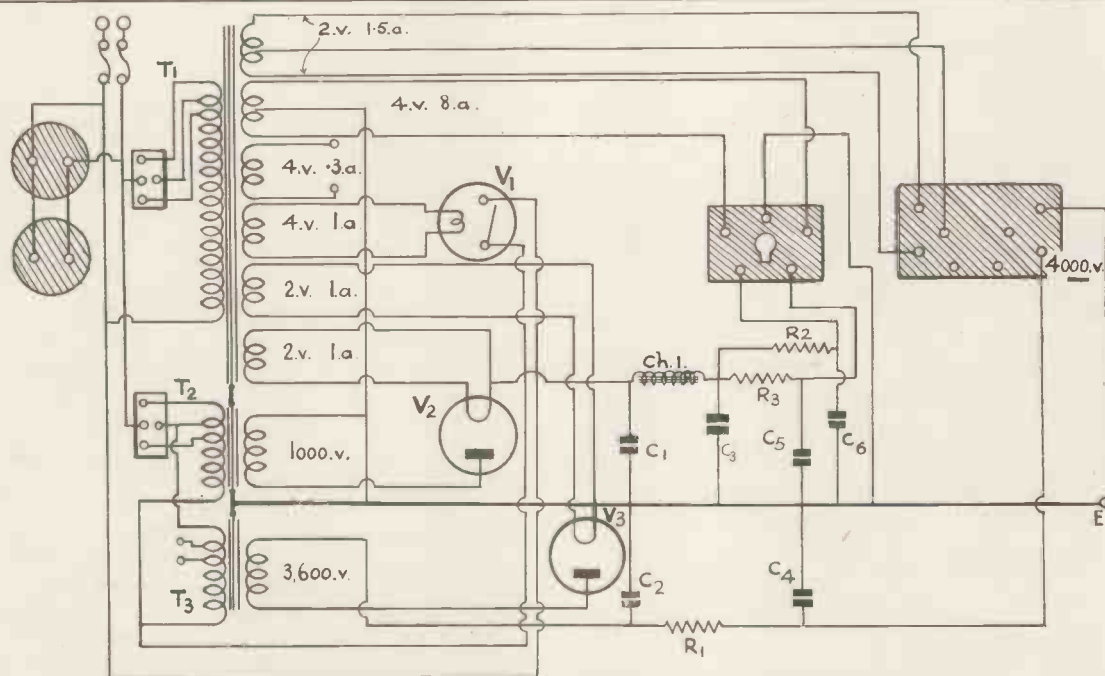

The circuit diagram of the cathode-ray tube and time base power supply unit for 7-, 10- and 12-in. tubes.

der of the design is affected according to the arrangement that is to be adopted.

A number of arrangements are possible each of which has its own inherent advantage. A measure of confusion can result when any attempt to arrive at a decision does not take into account certain definite recommendations of the makers of the C.R. tube to be employed.

It can be said, however, that one does not always adhere to manufacturers' recommendations, nor is it necessary always to do so. While this may in general be true, in the particular case under consideration the maker's recommendation is really quite definite. Furthermore, tests made by the writer reveal reason enough for adhering to the recommendation.

The tube employed is an Ediswan. It can be a 10-, 12- or 7-in. type according to the needs and pocket of the user.

The Ediswan Co. recommend that the positive pole of the tube's exciter volts be earthed, failing which it is desirable completely to screen the tube.

If this screening is not carried out the electron beam becomes extremely susceptible to external interference. This interference can be due to the magnetic fields of transformers and similar effects.

The cost of a screen that is suitable for this purpose is about 30s., and there seems no reason for entering into this additional expense.

There are other reasons, that it is not necessary to mention here, that influenced the decision, after very careful thought, to earth the positive pole of the tube's exciter voltage.

Another point that required some consideration was what steps should be taken effectively to prevent accidental contact with the high potential points existing in the power pack.

It was realised that at least during the early stages

and possibly in some instances, for some period after, while a suitable cabinet was being constructed, the complete receiver would be used without any external covering.

It was decided to enclose completely the entire power supply unit. The photographs show the arrangement adopted. This screening box is quite simple to make and does not call for elaborate tools or special ability.

The metal framework is carried out in 19 s.w.g. aluminium. The wire mesh is obtainable from most ironmongery dealers. Alternatively, ordinary perforated zinc may be used, though the appearance may not then be so professional.

Matters are so arranged that, before the front panel can be removed for purposes of adjustment to the interior, the supply is necessarily first disconnected.

Other arrangements offering equal safety will occur to the constructor. For example, if the various units are mounted into a framework, it will be a simple matter completely to enclose the bottom deck. The high voltage power unit is then housed in this compartment.

The screening box here described has, however, the advantage of permitting final layout of the complete receiver.

A plan view of the actual power unit is shown. It is seen that although it is not by any means excessively bulky, there is adequate spacing of the apparatus permitting ease of assembly and clean wiring. Especially note the spacing of the connections carrying high voltages.

Toward the front end will be seen the Bulgin 6-way high-voltage socket. This socket carries the current for the C.R. tube's heater also the 4,000 volts for tube excitation. It may also carry the 4 volts for a D.C. restoring diode.

The socket is mounted by means of 2 B.A. studding

POWER UNIT CONSTRUCTIONAL DETAILS

and $\frac{1}{2}$ in. diameter ebonite spacers, so that the sockets are well clear of the deck.

Near to this is the Belling-Lee 5-way socket that carries the heater current for the time base valves, also approximately 1,000 volts high-tension for the time base.

The Belling-Lee fused mains connector is next to this. The two-pin plug with this connector has a flanged head. This flange, as the plug is inserted through the removable panel, renders it essential first to remove the plug, thereby disconnecting the mains, before ingress to the power unit's interior is possible.

The fuses in this component also serve for the vision receiver power unit as the small Belling-Lee 2-way mains connector on the front of the screening box, that connects to the vision receiver power unit, is in circuit with it.

It will be noted that a spare connector is included to serve for any sound receiver power unit that may be used.

A separate earth terminal is included on the screening box for additional safety.

The Clix mains selector boards permit the unit to be used with any mains having voltages of from 200-250 volts. These small boards are obtainable with fused connecting bridges thereby providing an additional safeguard for each circuit.

Two Mazda type MU₂ mercury vapour rectifying valves are used. By using two similar valves subsequent replacement is simplified.

A Mazda type DLS₁ vacuum delay switch ensures that the various valve heaters attain their normal operating temperatures before application of high-tension.

Ignition cable of the very best quality must be used to inter-connect the 6-way Belling-Lee high voltage plugs and sockets. All wiring of the unit carrying the tube exciter voltage is kept at least $\frac{1}{2}$ in. from the metal work and the components. Here it is well to remember that the highest voltage exists at the cathode end of the C.R. tube, i.e., the C.R. tube's heater leads are at high potential with respect to earth. The voltages progressively reduce to the 3rd anode which is positive 4,000 volts and is earthed.

The theoretical circuit of the complete power supply

unit is given. Three mains transformers are used for, apart from the reduction in the required insulation this permits, the unit becomes flexible and is suitable for universal application.

The insulation of the transformers is such that, if for any reason it is desired to earth the negative pole of the C.R. tube's exciter volts, this may be done with complete safety. It will be obvious and therefore perhaps it is unnecessary to point out that when negative is earthed the heater leads of V₃ will require insulating for the full tube's 3rd anode voltage to earth. Also the connection of the heater of V₃ to earth is removed and is taken, adequately insulated, to the 6-way socket. The negative end of the H.V. secondary is then taken to chassis. Examination of the theoretical circuit will make clear these remarks.

For the reasons given above it is well to adhere strictly to the transformers specified unless the constructor is well acquainted with the principles involved in high-voltage transformer design.

It will be noted that an additional 1-volt winding is included on the heaters' supply transformer. The purpose of this is for supplying heater current to a diode valve that may be used to restore the D.C. component. If it is not intended to include this refinement this winding may be omitted from the transformer's specification.

Another photograph shows the underside of the unit. No bottom is fitted as it is presumed that the unit will always be used in its correct position. It is as well, however, to warn constructors that high potentials are present on some of the sub-chassis wiring. Consequently a cover is desirable if the unit is to be used in such a position that the underside is exposed.

The various photographs and diagram will ensure no constructional difficulty and the unit will be found simple to build. There is no more complication with a power unit of this description than with that of an ordinary supply unit. The higher potentials present, however, demand extra care being taken.

This unit completes the constructional description of the complete television receiver. In the January number full and precise instructions will be given for connecting and adjusting the entire assembly.

COMPONENTS, VALUES AND MAKES FOR CATHODE-RAY TUBE AND TIME BASE POWER SUPPLY.

TRANSFORMERS.

- T₁. Prim. 200-250 v.
Secs. 2 v. 1.5 a.
4 v. 8 a. C.T.
4 v. 0.3a. (optional see text.).
4 v. 1 a.
2 v. 1 a.
2 v. 1 a.

(Heybeard). Insulated to specification.

- T₂. Prim. 200-250 v.
Sec. 1,000 v. 20 m/s. (Premier).

- T₃. Prim. 220 v.
Sec. 3,600 v. 3 m/a. (Sound Sales).

CONDENSERS.

- C₁ 2 mfd. 1,500 v. type 951 (Dubilier).
C₂ 0.1 mfd. 4,000 v. type 951 (Dubilier).
C₃ 4 mfd. 1,000 v. type 951 (Dubilier).
C₄ 0.5 mfd. 4,000 v. type 951 (Dubilier).
C₅ 2 mfd. 1,000 v. type 950 (Dubilier).
C₆ 2 mfd. 1,000 v. type 950 (Dubilier).

RESISTANCES.

- R₁. 100,000 ohms 1W (Dubilier).
R₂. and R₃. 2,000 ohms 1W (Dubilier).

SMOOTHING CHOKE.

- 1—Varley type DP9.

SUNDRIES.

- 2—Belling-Lee valve holders type 35215.
1—Belling-Lee valve holder 4 pin chassis mounting.
2—Clix mains selector boards with fused bridge.
2—Belling-Lee mains connectors type 1014.
1—Belling-Lee 5 way connector type 1260.
1—Belling-Lee fused mains connector type 1098.
2—Belling-Lee valve thimbles.
1—Bulgin 6-way high voltage plug and socket type Proo and Pro1.

VALVES.

- V₁, Mazda type DLS 1 vacuum delay switch.
V₂, and V₃. Mazda type MU 2 mercury-vapour rectifiers.
Chassis, nuts and bolts, ignition cable, high voltage systoflex tubing, etc.

HALVING THE COST!

A PRACTICAL DESIGN EMPLOYING A 4-INCH TUBE

The following section deals with the practical construction of the time base and power unit for a 4-inch tube, employing the same vision receiver. This enables a considerable saving, which is approximately half, to be effected. Excellent pictures are obtainable with small tube and the construction, due to the lower voltages employed, is particularly simple.

IN a short article last month, the writer described the Mullard type A-41/B4 cathode-ray tube and considered its possibilities as a television picture reproducer.

It was pointed out that a great economy was possible because of the low exciter volts required for normal operation of the tube.

It was also remarked, as tests had revealed, that while the picture was small, its definition was extremely good, indeed that it was an accurate miniature of the conventional large tube picture.

The writer gave it as his considered opinion that the picture possible with the small Mullard tube had very definite entertainment value. Furthermore, as the circuits required for operation are in every particular similar to those used with large tubes, that some very valuable experience in the operation of C.R. tubes, particularly as applied to television reception uses, could be acquired by the construction of apparatus to receive the B.B.C.'s television transmissions.

Due to the low voltages and special design of the tube, this apparatus can be constructed at a very reasonable cost.

The receiver used for the tests of the small tube, was that described in the October number of TELEVISION AND SHORT-WAVE WORLD. Construction of this receiver is simple and straightforward. Only through deliberate carelessness can its performance become mediocre.

In the November number it was shown that the original design might easily be modified when it was intended for use in proximity to the transmitter, and that it was possible substantially to reduce the cost of parts and valves by omission of one or two of the three R.F. stages.

Actually all three of the R.F. stages can be omitted. This is not desirable, however, for two reasons. Without an R.F. stage the signal to noise ratio is not satisfactory. There is the possibility of radiation of interference on to neighbouring aerials.

It was felt that there were many amateurs who have desired to construct a television receiver, but had not previously found it possible for financial reasons to do so and these would welcome the description of a unit or units that employed the small Mullard tube and that together with the vision receiver referred to would comprise a complete television receiver.

Such a unit is described here. A study of the list of parts used for it and its power supply unit discloses that the cost is very low. This study will also reveal that a great many amateurs will have already, a number of components sufficiently similar to those specified to permit their being used alternatively.

Now before proceeding with the actual constructional details of these units, let us briefly examine the considerations responsible for the arrangement adopted.

It would have been possible easily to include the time base, and the power supply for this, all in one complete chassis, and at first this was the arrangement contemplated.

It was later seen, however, that if the time base was constructed as a single unit, existing power supply units, that might be available, could be utilised. Also the power supply unit described elsewhere in this number, and which is intended for tubes between 7 in. and 12 in., could very easily, by omission of the 4,000 volts components, be used, thus permitting an economical change to a large tube at some later date.

For these reasons a time base unit that employed a separate supply pack was decided on.

The theoretical circuit on p. 713 shows the time bases

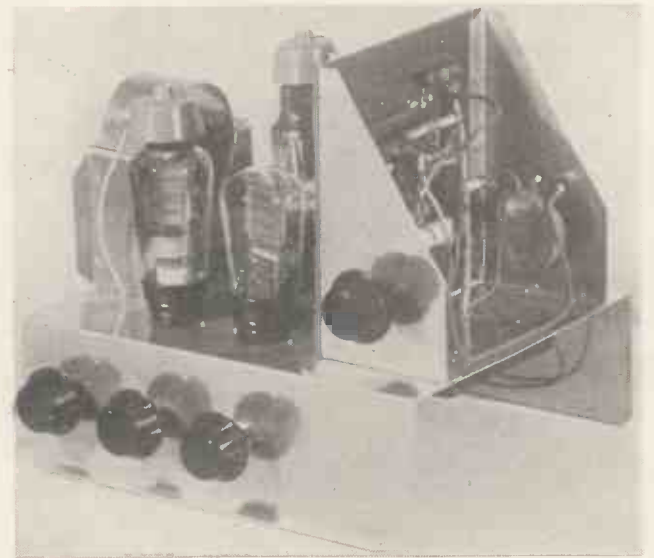

This photograph shows the time base unit and tube holder for the 4-in. tube.

and tube connections. The two valves on the left generate the line scan oscillations, those on the right, the frame. The line sweep voltage is applied to the D2 deflector plate while D2' in accordance with the tube maker's recommendation is strapped direct to the 2nd anode.

To preserve the proportions of the picture in the frame direction non-linearity of the frame sweep voltage is encouraged. This sweep voltage is fed to the D1 deflector plate while D1' is returned to the 2nd anode.

As the sweep voltages required are not particularly high, smoothing of the time base supply is obtained

DECEMBER, 1937

with the high value series resistances R_{25} and R_{27} in conjunction with the condensers C_{17} and C_{18} .

The voltage applied to the 2nd anode C.R. tube is about 1,150 volts. This permits a clear and bright picture to be obtained. At the same time the tube is receiving voltages not in excess of those recommended by its makers.

It was pointed out in the previous article that it was not possible to reduce the light spot to the size indicated by theory for a picture with dimensions such as those we are working with, but that, in spite of this fact, the picture definition is extremely good.

Further investigation discloses the reason for this. An examination of the light spot reveals that the illumination of its surface is not uniform and that the light is more intense at the centre. During the scanning of a picture, therefore, when the spot is in motion, the screen illumination is reduced proportionately to the area scanned. The edges of the light spot, being less luminous, tend to disappear, in effect reducing the diameter of the spot. To supplement this effect there is also modulation of the illumination intensity of the light spot when the picture modulation is applied.

There are one or two points concerning the time base and tube assembly unit that may well be described with more detail, as for a large number of constructors this will be their first introduction to the saw tooth oscillation generator. An acquaintance with the principles involved will assist materially construction and a knowledge of operation.

In considering the operation of the time base it is convenient to refer to one of the oscillators only as, apart from the employed constants, the design of both bases is identical.

The valve V_1 is the line scan oscillator. The series

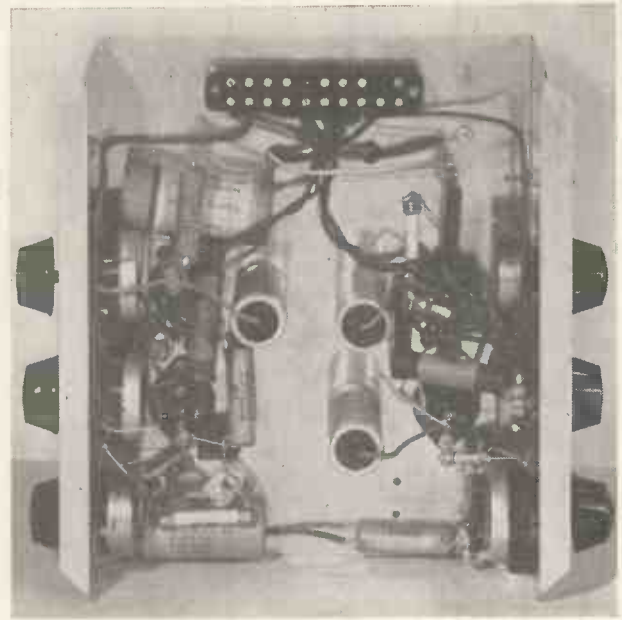

This photograph shows the underside of the time base unit for the 4-in. tube.

connected condensers C_3 and C_4 are charged through the resistances R_3 and R_4 , the value of which controls the rate of charge. At a certain voltage that is determined by the setting of R_5 , which controls the relay valve bias, the relay valve V_1 becomes conductive, rapidly discharging the condensers.

As this voltage, if linearity of sweep is to be maintained, has not sufficient amplitude for deflection pur-

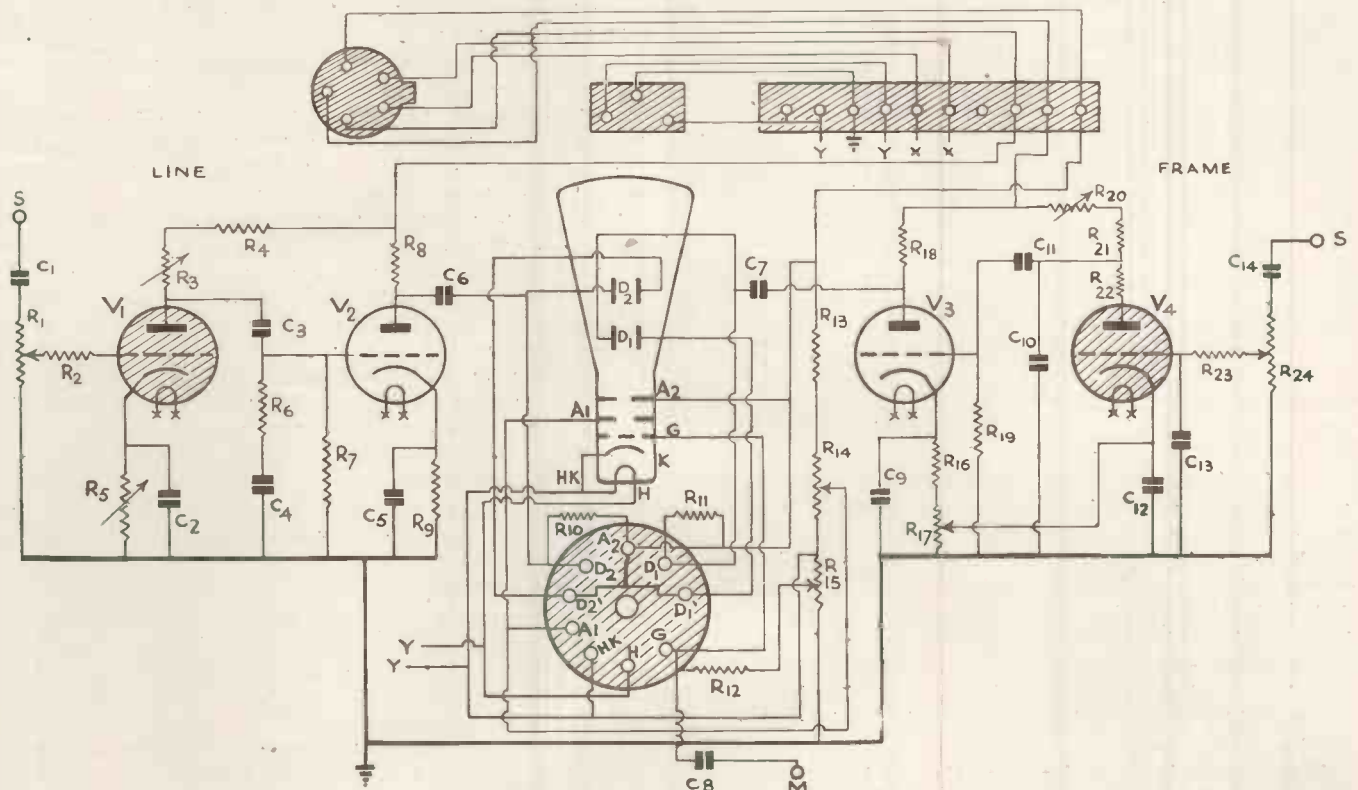

Fig. 1. The circuit diagram of the time base for the 4-in. tube.

poses, a portion of it is applied to the grid of the amplifying valve V2. In order better to handle the higher frequencies involved in the line scan base, the load resistance of this valve is lower than that of the similar resistance in the frame scan base. This amplified voltage is then fed through the condenser C to the tube deflector plate.

The purpose of the resistance R6 is to accelerate the speed of the retrace. It performs this function by developing a voltage during the flyback, that is in opposition to the retrace voltage.

The potentiometer R1 applies the transmitted sync pulse to the relay valve grid. This valve is arranged normally to fire at a lower speed than the required one. Consequently the arrival of the positive synchronising pulse fires the relay before its natural firing time. The correct operating frequency of the base is therefore accurately maintained by the transmitted synchronising pulses.

A photograph on page 713 shows the time base and tube support. Construction and wiring is simple and straightforward calling for little explanation. A protecting cover may be included at the rear of the tube socket panel thereby avoiding the possibility of acci-

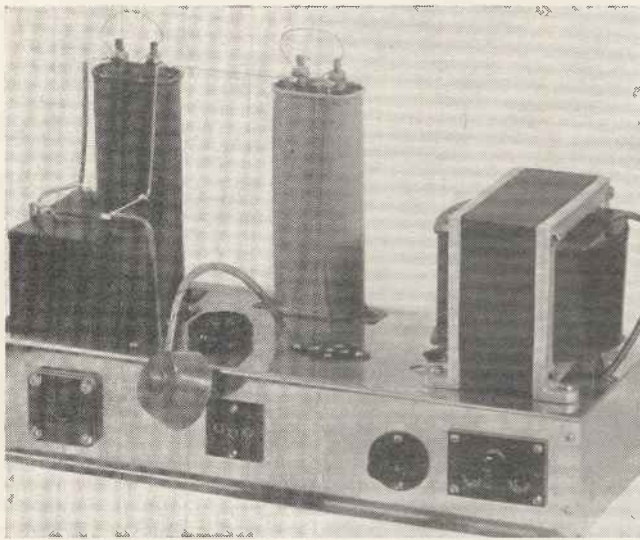

This photograph clearly shows the 1,200 volts power supply unit. Note especially the celluloid protecting covers fitted to the terminals of the voltage smoothing condensers. Fitment of these simple protection covers effectively prevents shock.

dental contact with a high voltage point. For the same reason a small strip of bakelite protects the heads of the bolts holding the resistance R12.

The brilliance and focus controls are mounted on the tube socket panel brackets, the time base controls being mounted on the chassis proper.

Above is the power supply unit. Here again the construction and wiring is straightforward and will be followed without difficulty. Connection to the time base unit is made via the Belling-Lee plugs and sockets.

Operation and adjustment of the time base will be found to be simple. Observation of the following procedure will ensure a minimum of difficulty in arriving at the correct settings.

The four resistances R3, R5, R16 and R19 are set at about half way round their full travels.

In passing it may be mentioned that the resistances

R3 and R19 are the charging resistances. Due to the method of furnishing synchronising pulses provided by the vision receiver, that these units are primarily intended for use with, fixed resistances could have been incorporated. However, it was considered that a large number of constructors already might have partly assembled vision receivers, and by incorporating variable charge resistances, the time base is rendered suitable for use with any normal synchronising system.

The tube and valves are inserted carefully and the two units interconnected by means of the 3- and 5-way Belling-Lee plugs and sockets.

Upon switching on, all the valve heaters and the rectifier filament should be seen to be glowing. The delay switch will also be seen to have lighted. Until it acquires a certain critical temperature, however, high tension is not applied to the tube and time base. It will probably be possible also to see the heater of the C.R. tube glowing. After an interval of approximately a minute the delay switch will close and the C.R. tube screen will be seen to be illuminated.

The potentiometer R14 controls the brilliance of this illumination and can now be adjusted to the correct amount to permit the adjustments to the time base to be observed visually.

Illumination of the screen should not be any higher than is required clearly to observe the effect of each adjustment.

Now with the potentiometers R5 and R16 adjust the raster to an approximate square, the corners of which just roll over the edge of the tube screen. The tube may now be approximately focused with the potentiometer R13. Movement of this will be found to affect the quality of the raster illumination and a position will be found where the effect, particularly at the edges, is more sharp and clean. Also as the correct adjustment is approached the flyback lines of the frame scan will become visible.

These preliminary adjustments completed, actual picture reception tests may be commenced.

It is assumed that the vision receiver has already been tuned to the transmitted signal. The M and earth terminals, also the S.L. and S.F. terminals are connected to their appropriate junctions on the vision receiver terminal strip. An increase in illumination of the raster will be noted. Examination of this will reveal production of patterns due to the picture modulation.

The remaining adjustments are now carried out in this order. The sync. feed potentiometers R1 and R23 are turned full anti-clockwise. The potentiometer R19 is rotated slowly and it will be observed that the screen pattern will tend to become steadier. Soon a position is reached where a horizontal dark area may be seen travelling vertically across the screen. Adjustment is continued until this dark area drifts slowly upwards. R23 is now slowly turned clockwise and this horizontal dark line will lock into position at the top of the screen and become invisible.

It will doubtless be found that the picture is no longer of the correct height and a slight readjustment of R16 will be required to restore the correct dimension. It is important to remember that R16 and R19 are to a large extent interdependent. Adjustment of the one will necessitate readjustment of the other. These remarks apply also to the line scan controls R3 and R5.

Having completed adjustment of the frame scan, the line scan adjustment may be commenced.

The potentiometer R3 is rotated slowly. As this

operation is performed, examination of the screen will reveal horizontal lines that at various settings rotate through the vertical. If while these lines are held upright the screen is examined closely, a number of pic-

tures, the number depending on the adjustment, will probably be seen.

There is one adjustment where, when the lines are held vertical and a single picture is formed. This is the correct one and the potentiometer R1 may be rotated clockwise until the picture locks into position. The width is now correctly adjusted as for the frame with the controls R3 and R5.

The picture can now be focused more accurately with the potentiometer R13. Adjustment of this is quite critical and some care is desirable in arriving at the optimum setting.

These time base adjustments are necessarily described at some length, but no particular difficulty in arriving at the correct settings will be experienced if the order of adjustment given above is adhered to.

There is one point that will require attention. If while the preliminary adjustments are being made, the power unit is switched off, a few minutes must be permitted to elapse, to allow the delay switch to cool, before again switching on.

Failure to observe this precaution may result in application of high voltages to the various condensers and a breakdown result.

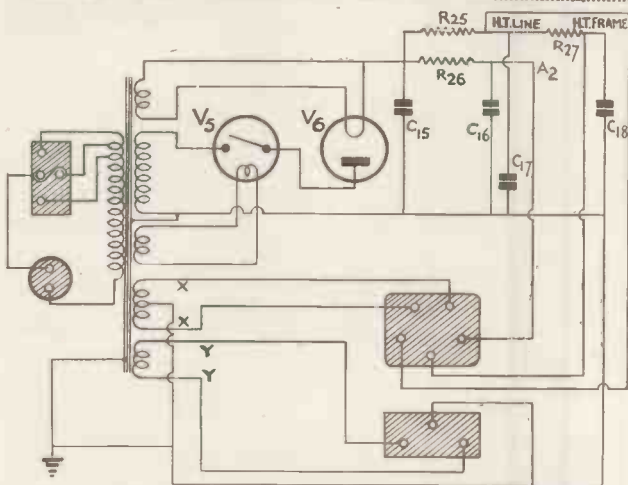
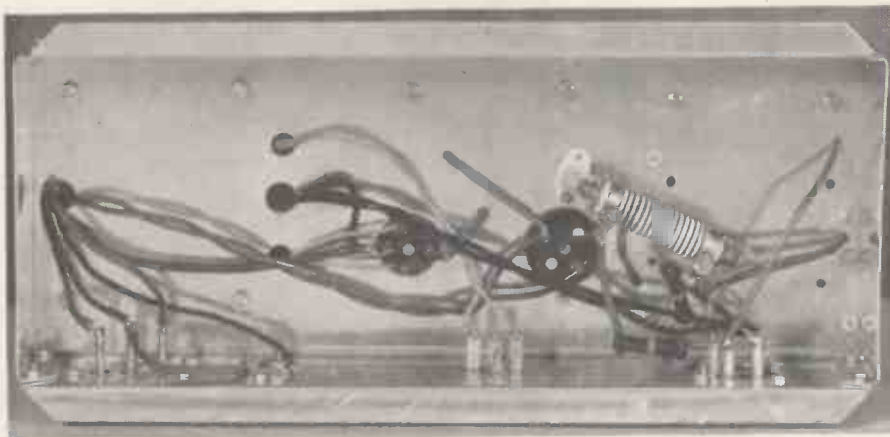

Fig. 3. Circuit diagram of power unit for 4-in. tube and time base.



Underside of power unit for 4-in. tube and time base.

LISTS OF COMPONENTS, VALUES AND MAKES.

- C1 0.001-mfd. type 670 (Dubilier).
- C2 50-mfds. 12 v. type 402 (Dubilier).
- C3 0.001-mfd. type 670 (Dubilier).
- C4 0.001-mfd. type 670 (Dubilier).
- C5 20-mfds. 50 v. type 402 (Dubilier).
- C6 0.005-mfd. type 670 (Dubilier).
- C7 0.1-mfd. type 4603/2 (Dubilier).
- C8 0.1-mfd. type 4603/S (Dubilier).
- C9 50-mfd. 50 v. type 3004 (Dubilier).
- C10 0.5-mfd. type 4608/S (Dubilier).
- C11 0.1-mfd. type 4603/S (Dubilier).
- C12 50-mfd. 12 v. type 402 (Dubilier).
- C13 0.001-mfd. 12 v. type 670 (Dubilier).
- C14 0.1-mfd. 12 v. type 4603/S (Dubilier).
- C15 1-mfd. type 950, 1,500 v. working (Dubilier).
- C16 2-mfd. type 950, 1,000 v. working (Dubilier).
- C17 2-mfd. type LEG (Dubilier).
- C18 2-mfd. type LEG (Dubilier).

RESISTANCES.

- R1 20,000-ohms Potentiometer (Reliance).
- R2 1,500-ohms Bulgin 1/2 w.
- R3 0.5 megohms Potentiometer (Reliance).
- R4 1 megohm 2 w. (Bulgin).
- R5 50,000-ohms (Reliance).
- R6 1,000-ohms 1/2 w. (Bulgin).
- R7 1 megohm 1/2 w. (Bulgin).
- R8 100,000-ohms 2 w. (Bulgin).
- R9 5,000-ohms 1 w. (Bulgin).
- R10 1 megohm 1/2 w. (Bulgin).
- R11 1 megohm 1/2 w. (Bulgin).
- R12 1 megohm 1/2 w. (Bulgin).
- R13 0.5 megohm 1 w. (Bulgin).
- R14 0.5 megohm Potentiometer (Reliance).
- R15 50,000-ohms Potentiometer (Reliance).
- R16 8,000-ohms 1 w. (Bulgin).
- R17 2,000-ohms Potentiometer (Reliance).

- R18 200,000-ohms 2 w. (Bulgin).
- R19 0.5-megohm 1/2 w. (Bulgin).
- R20 2 megohms Potentiometer (Reliance).
- R21 750,000-ohms 2 w. (Bulgin).
- R22 1,000-ohms 1 w. (Bulgin).
- R23 20,000-ohms 1/2 w. (Bulgin).
- R24 50,000-ohms Potentiometer (Reliance).
- R25 50,000-ohms type PR17 (Bulgin).
- R26 50,000-ohms 1 w. (Bulgin).
- R27 10,000-ohms 1 w. (Bulgin).

- Mains Transformer (Kesto).
- Prim. 200-250 volts.
 - Secs. 4 v. 1 a.
 - 4 v. 1 a.
 - 2-0-2 v. 5 a.
 - 1,000 v. 15 m/A.
 - 2 v. 2.5 a.

VALVES.

- 2—Type T31 thyratron valves (V1 and V4) (Mazda).
- 2—Type AC/P triodes (V2 and V3) (Mazda).
- 1—Type MU2 rectifier (V6) (Mazda).
- 1—Type DSL1 delay switch (V5) (Mazda).

C.R. TUBE.

Mullard type A41/B4, with holder.

SUNDRIES.

- 5—5-pin chassis mounting valve holders (Belling-Lee).
- 1—Type 352/5 valve holder (Belling-Lee).
- 3—Insulated valve caps type P92 (Bulgin).
- 1—Midget stand-ox insulator list No. 1078 (Eddystone).
- 2—Plugs and sockets list No. 1078 (Belling-Lee).
- 2—Terminals list No. 1001 (marked "shield" and "earth") (Belling-Lee).
- 1—10-way terminal block (Bryce).
- 1—Plug and socket (3-way) type 1119 (Belling-Lee).
- 1—Plug and socket (5-way) type 1260 (Belling-Lee).
- Chassis, paxolin panel, wire, nuts and bolts, etc.
- 1—Clix mains selector board with fixed bridge.

AN ELECTRONIC LIGHT RELAY FOR LARGE PICTURES

By W. H. Stevens

This article describes an entirely new method for large picture production which appears to have great possibilities.

THE possibility of obtaining large-screen television pictures has been attracting much attention of late, and some good results have undoubtedly been obtained under laboratory conditions. With present optical mechanical large-screen pictures, the brightness might be considered sufficient. Large projected pictures from a cathode-ray tube have necessitated high

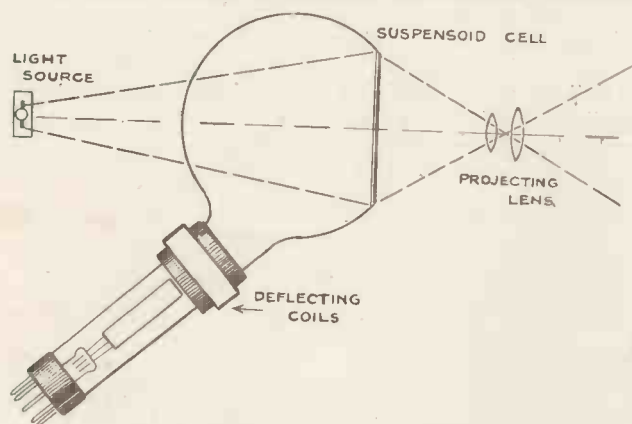

Schematic diagram showing the principle of large picture production by means of suspensoid cell.

voltages and expensive lenses, the brilliancy leaves much to be desired, and the tubes have had comparatively short life and up to the present the colour has not been pleasing.

It is the purpose of this article to describe a method of obtaining big pictures from a small cathode-ray tube by using the tube to produce a miniature picture, the modulation of which is in the form of varying degrees of opaqueness, rather like a frame of cinematograph film. Then, just as in a cinema, a large picture is obtained by illuminating this small transparent picture and projecting an image of it on to a screen. In this way, the cathode-ray tube is only required to reconstruct the scene from the transmitted information, and this can be accomplished with moderate voltages and a low beam current. The difficult job of supplying adequate, or, indeed, unlimited, brilliancy is left to a local light source, which can be a simple lamp, since it is not itself required to be modulated. In effect, the small picture produced by the cathode-ray tube acts as a relay to trigger off a big picture from a local light source.

The method of obtaining the transparent positive picture is rather interesting. It has been found that a colloidal suspension of graphite in an insulating medium has certain properties which open up attractive possibilities in this direction. The preparation known as "Oildag," manufactured by Messrs. Acheson, Ltd., is a fluid of this nature. If a thin film of this suspension is formed by sandwiching a drop

between two microscopic slides, and one of the slides is stroked with a wire at a potential of about a thousand volts, a transparent line appears in the otherwise opaque film. Similarly, such a film on the outside of a cathode-ray tube at the end which normally takes the fluorescent screen, indicates the path of the scanning spot by a transparent line. The effect is greater if the outer glass plate is rendered conducting by painting with a suitable transparent varnish, and connected to the cathode, or other point of fixed potential.

The explanation is believed to be that the graphite, although in minute particles, still retains its characteristic plate-like crystalline form, and that these crystals set themselves along the lines of force just as small pieces of paper tend to stand on end when dropped on to a charged metal plate. When the crystals are all edgewise-on in this manner they offer little obstruction to the passage of light through the film. When the charge on the surface of the glass leaks away, the particles return to their original haphazard orientation by the Brownian movement, and so stop the transmission of light. The speed of their return can be controlled partly by the rate of leakage and partly by varying the viscosity of the oil holding the graphite in suspension.

If such a suspensoid cell is scanned by a cathode-ray beam which is controlled by a vision receiver, a picture in the form of an electric charge is built up on the inner glass plate, a white area, where the beam current is at maximum, being an area of greatest charge. The laminae of graphite will rotate end-on to the charged glass plate, the rotation being most complete where the charge is greatest, that is, at a full white. Thus a picture will be formed in the cell which is capable of being illuminated and projected.

If matters are arranged to cause the Brownian movement to have its full effect in, say, $1/25$ th of a second, a picture will still persist even after the scanning beam

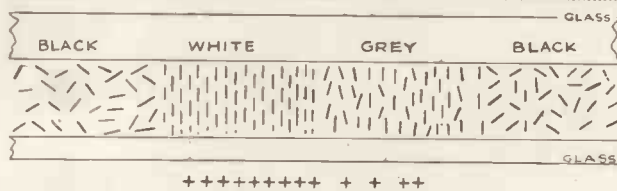

Diagram showing action of suspensoid cell.

has passed, and in effect, a storage of picture information results, which simplifies the projection problem since not just one picture point, but a whole frame, is transmitted at once.

Complications arise owing to secondary emission from the glass under bombardment by the electron beam, but this may be overcome by having the side of the cell which is scanned in the form of a photo-electric

(Continued on page 718)

1926-1937 THE EVOLUTION OF DESIGN AS EXEMPLIFIED IN THE BAIRD TELEVISION RECEIVERS

Baird television receivers provide the only historical survey in the world of design extending over a period of more than ten years

1926.

THE historic television receiver with which Mr. Baird gave a demonstration to members of the Royal Institution January 27, 1926, showing the transmission of

1931.

A receiver using a mirror drum scanner in conjunction with a hot cathode type neon lamp. The reconstructed picture was projected on to a screen at the front of the set.

1933.

First mirror drum and grid cell form of receiver giving a back projected picture 9 in. by 4 in.

1934.

(a) Large type mirror drum receiver giving a picture 14 in. by 6 in. similar to that installed in the listening room at Broadcasting House.

1934.

(b) The commercial mirror drum and grid cell receiver developed from the 1933 model. The picture size was 9 in. by 4 in., being viewed on a translucent telescopic screen at the front.

1935.

These two cathode-ray tube receivers were used by the Baird Company during the long series of high-definition television demonstrations which were conducted by them during 1934 and 1935. The signals were transmitted from the studios and laboratories at the Crystal Palace; one receiver gave a picture 12 in. by 9 in., and the other 8 in. by 6 in.

1936.

Baird Television Receiver, Model T5, giving a brilliant black and white picture 12 in. by 9 in. produced on a "Cathovisor" cathode-ray tube—

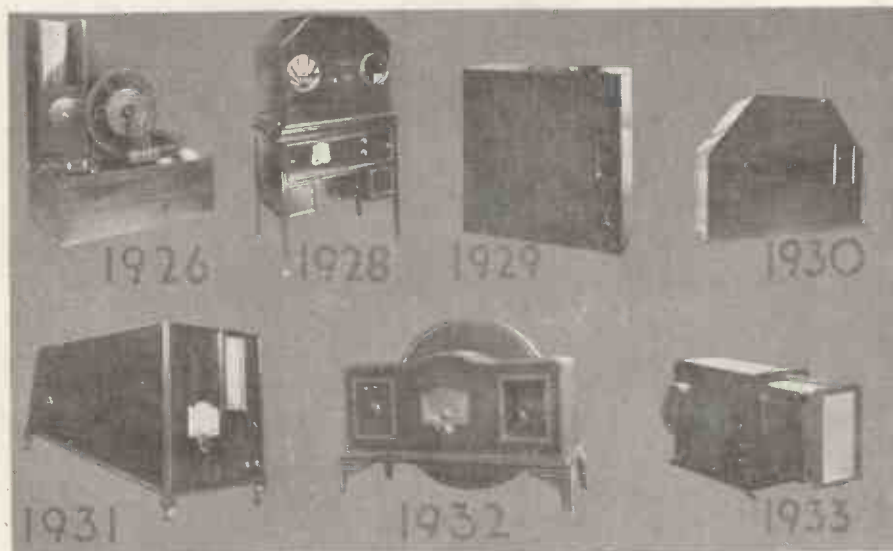

real images between one room and another by television. This was the first time in the world that real television had been shown.

1928.

Large model Baird disc receiver employing a flat plate neon lamp and 24-in. diameter disc having 30 apertures arranged in a spiral trace around the periphery. The vision and sound receiver was accommodated in the table on which the television set was resting.

1929.

Portable disc receiver employing a smaller type of neon lamp and disc than the 1928 model. This set was used by Mr. Barton-Chapple for the first provincial reception of television, pictures being demonstrated in Bradford on October 8, 1929.

1930.

This disc model receiver was shown for the first time at the 1930 Radiolympia Exhibition.

1932.

The commercial model disc receiver using automatic synchronising which had a large sale to the public for use during the B.B.C. low-definition transmissions.

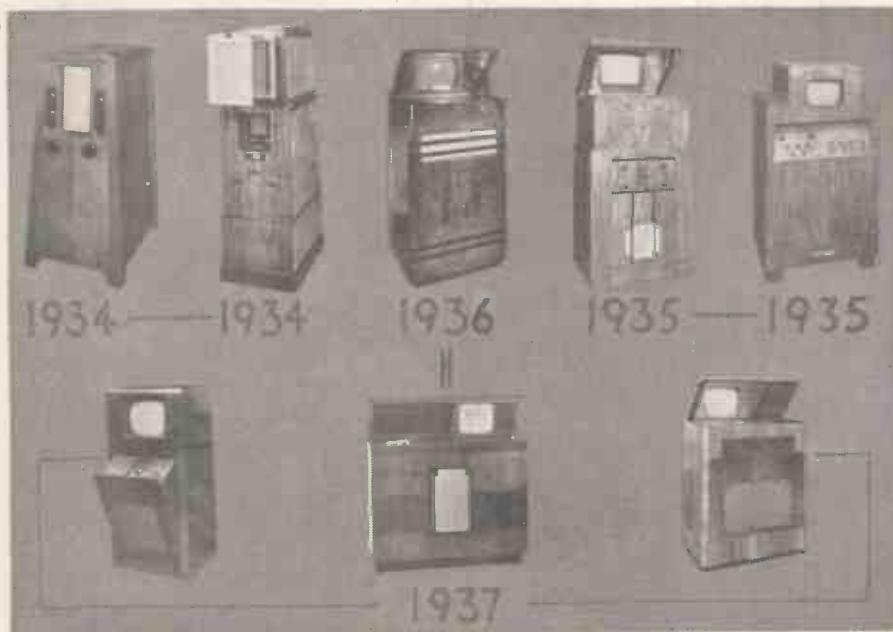

itself a Baird product. This was the largest picture obtainable on a commercial television receiver, being designed to receive the television programmes radiated from the Alexandra Palace, London.

1937.

(a) Baird Television receiver, Model T11, giving an outstanding brilliant black and white picture 10 in. by 8 in. viewed directly on the horizontally mounted 12 in. diameter "Cathovisor" cathode-ray tube. The receiver provides excellent picture detail, high fidelity sound, adequate angle of vision and splendid all-wave radio reception.

(b) Baird receiver, Model T13, giving a brilliant black and white picture 13½ in. by 10½ in., produced on

a "Cathovisor" cathode-ray tube. This model represents the latest technical achievement in combined television and radio entertainment for the home. Housed in the handsome walnut cabinet is a luxury television receiver, a high-fidelity all-wave radiogram with automatic record changer capable of playing records of any size in any order.

(c) Baird Receiver, Model T12, giving a brilliant black and white picture 13½ in. by 10½ in., viewed in a hinged part-mirrored lid, a 15-in. diameter "Cathovisor" cathode-ray tube being mounted vertically in the cabinet. This picture is the largest yet shown on this type of Baird cathode-ray tube. The receiver also incorporates an all-wave broadcast receiver.

An O.B. Transmitter for the National Broadcasting Co.

FOR the first time in America the National Broadcasting Co. is to carry out experiments with a mobile television transmitter for outside broadcasts.

The unit has been constructed by R.C.A. and an extensive series of tests in televising outdoor scenes is to commence immediately. Football and other sports, and news events are listed in the outdoor schedule, but the work is to be strictly experimental, with a view to improving the equipment and methods.

The new mobile television station will consist of two specially constructed motor vans. Apparatus for picture and sound pickup will be installed in one, and a vision transmitter, operating on a frequency of 177,000 kilocycles, in the other. In the metropolitan area, where many tall buildings make high-frequency transmission difficult, it is expected that the working range will be about 25 miles. Ten engineers will be required to operate the two television units. In the experimental field work N.B.C.'s present mobile sound transmitter will be included in the station.

The van containing the vision apparatus will be the mobile equivalent of a television studio control room. It will be fitted with television and broadcast equipment which will include two cameras, vision amplifiers, synchronising generators and rectifiers. The sound apparatus will include microphones, microphone amplifiers and sound mixing panels. All the equipment will be mounted on racks extending down the centre of the van, affording easy access to any part for repairs, and any alterations which may be found desirable.

"AN ELECTRONIC LIGHT RELAY"

(Continued from page 716)

mosaic somewhat similar to that used in the Emitron camera. The local light source will then create a positive bias on the mosaic by photo-emission, which is more or less cancelled by the modulated scanning beam depending on the instantaneous current in the beam. Either a positive or a negative picture can be produced at will by suitably fixing the potential on the outer plate, the reversal necessary to render a positive picture when the cell is acting negatively being obtained by changing the phase of the modulating signal on the grid of the cathode-ray tube.

PHOTOGRAPHING OSCILLOGRAPH IMAGES

ON p. 670 of last month's issue a description was given of the Mullard E40-G3 miniature cathode-ray tube. In connection with this tube the Mullard Company provide instructions for its operation together

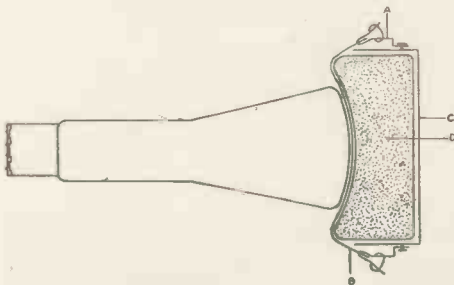

Showing method of obtaining photographs by direct contact.

with a number of examples of its application, and included in the latter are some hints on obtaining photographs of oscillograph images by very simple methods.

The simplest method of obtaining a photograph of an image is to place a sheet of sensitised paper directly upon the screen of the tube and allow a suitable exposure time. With this method, of course, no camera is required, but it has the disadvantage that the lines produced are considerably thicker than those on the actual screen and the result is that the finer detail is lost.

A fast bromide paper is recommended for this process and the ex-

posure should be from 2 to 4 seconds according to the intensity of the light spot on the screen.

A better way of employing this method is to use a rubber sponge to press the paper into even contact with the glass, as shown in the diagram. The rubber sponge D keeps the bromide paper fairly evenly pressed up against the screen of the tube, which, of course, is slightly curved. The sponge should be fitted into a tin box (C), the paper being held at each side by stout paper clips (A), as shown. As it is most important that the edges of the paper are in exactly the same direction as the axes of the deflecting plates, care must be taken in positioning it before an exposure is made.

If a camera is used for obtaining a record it is essential that it be of the long extension type or be fitted with a portrait attachment in order that the trace may be photographed approximately actual size. Films or plates with ample sensitivity in the green part of the spectrum are marketed by all leading manufacturers and working with a lens aperture $f/4.5$, an exposure of $1/10$ to $1/2$ a second will be required in order to obtain sufficient density with a full-size photograph of a simple stationary oscillogram of a total length of 15 cms. A shorter exposure time will be possible with smaller images, which will probably have a greater light intensity.

WORLD PIONEERS & MANUFACTURERS OF ALL TYPES OF TELEVISION EQUIPMENT

FIRST IN 1926

FINEST IN 1937

One of the factors contributing to the outstanding success of all Baird television receivers has been the consistently good quality of the "Cathovisor" Cathode Ray Tube. Baird Television, Ltd., as pioneers, have developed this Cathode Ray Tube to a design which fulfils all the conditions for excellent picture resolution.

For modern television, the requirements of the Cathode Ray Tube are that a bright, well-defined picture be formed on the screen by the electron beam, that the picture be in sharp focus all over the screen, that the focus remain always equally sharp with the variations of gradations from light to dark, and that these variations be a faithful reproduction

of the original gradations of the scene being televised. The developments in Cathode Ray Tube technique undertaken by Baird Television, Ltd., have ensured that these factors are complied with by their latest type "Cathovisor" Cathode Ray Tubes, which are the most satisfactory on the

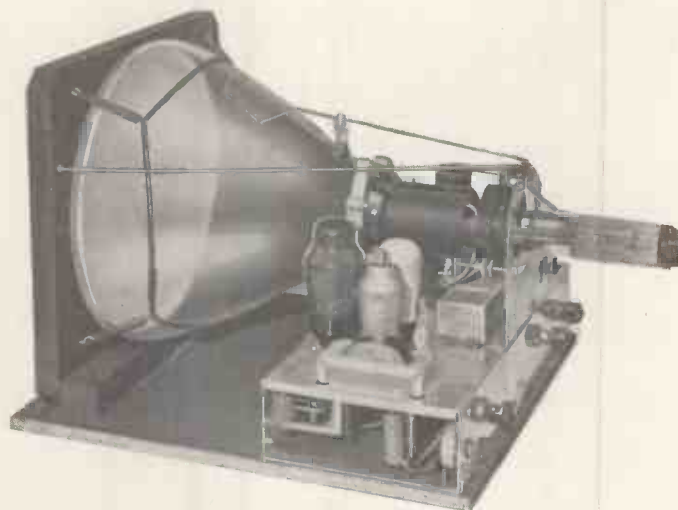

"Cathovisor" Cathode Ray Tube Type 12MW1, as arranged in one unit for the Baird T11 Receiver.

market. Not only is the electrode system extremely simple and robust but, due to the type of cathode employed and the magnetic focusing, a high intensity cathode ray beam is produced which results in a very brilliant picture on the screen. Screen grain does not impose a limit on spot size due to the special grading of the material used, and picture definition is outstandingly good.

Every tube receives stringent tests for total cathode emission, modulation range and illumination characteristics, filament rating and screen quality, and following normal picture reconstruction under service conditions, the completed Cathode Ray Tube is subjected to a further

high external air pressure test.

A special feature is that each tube is completely electro-magnetic in operation. Full details supplied on request together with information concerning scanning and focusing equipment.

TECHNICAL DATA

	TYPE 15MW2.	TYPE 12MW1.
Heater volts	2.2 volts approx.	2.2 volts approx.
Heater amps.	2.5 amps. ..	2.5 amps.
Peak to peak volts, between black and highlights	16.5 volts. ..	14 volts.
Maximum electro-magnetic sensitivity	2mm/AT.	2mm/AT.
Modulator/earth capacity	2 μF (approx.)	4½ μF (approx.).
Modulation sensitivity (slope)	17 μA/V (approx.)	17 μA/V (approx.).
Anode volts	6,500 volts (working)	4,900 volts (working)
Maximum input power to the screen	3.5 milliwatts/sq. cm.	4 milliwatts/sq. cm.
Screen colour	Black and white	Black and white.
PRICE	15 gns.	12 gns.

BAIRD TELEVISION, LTD.

Head Office :

Laboratories :

**Greener House, 66, Haymarket,
LONDON, S.W.1**

**Crystal Palace, Anerley Road,
LONDON, S.E. 19.**

'Phone: Whitehall 5454

'Phone : Sydenham 6030

Mullard introduce a new type of Cathode Ray Tube



A.41-G4

THIS NEW TYPE of Mullard Cathode Ray Tube has been specially designed to permit the pair of plates nearer the screen to be used with a non-symmetrical deflection circuit, thus considerably reducing the cost of the associated apparatus.

The design of the focusing electrodes enables an exceptionally small spot size to be obtained over the entire screen area.

Price £6 15s.

COMPLETE WITH SPECIAL SOCKET

ABRIDGED SPECIFICATION

Screen Diameter - 4 ins. (approx.)
Heater - - 4 volts, 1.2 amperes
Maximum Final } - 1,200 volts
Anode Voltage }
Deflection - Double Electrostatic
Focusing - - - - Electrostatic

FLUORESCENT COLOUR

A.41-G4 - - - - - Green
A.41-B4 - - - - - Blue

Full technical information from
THE MULLARD WIRELESS SERVICE CO. LTD.
Cathode Ray Tube Department,
225 Tottenham Court Road, London, W.1

DECEMBER, 1937

BRITISH TELEVISION THROUGH AMERICAN EYES

TWO engineers from the Hazeltine Service Corporation of America, have spent a considerable time in London studying the British television situation at first hand. This article is a report of their impressions and the comparisons they make with American progress.

Good Pictures

The picture of British television, here presented as it appears to American engineers, they say, is that of an operative system giving good stable pictures of acceptable detail, brilliance and interest. Some of the defects and the lines of future improvement are touched upon. That considerable improvement is possible within the band width available is evidenced. Some technical points of interest in the British system are described to point out wherein they differ from the United States proposals and practices. The nature of these differences in standardisation is illustrated by explaining certain features of operation which give improved performance through their use.

British Standards Best

That these British standards constitute a major improvement over present American practices* is an inescapable conclusion, because television is technically successful and an accomplished fact in England.

There is adverse criticism of the time during which programmes may be received and also of the character of the programmes and the fact that there is often repetition.

The criticism is not related to any inability to receive clear steady pictures of good brilliance. It sums up to this, the report states, completely operative television receivers may be purchased in England and a regular programme of good pictures and accompanying sound received. During the coming year nearly every large radio manufacturer will be producing television receivers as well as the re-

* The U.S. practices and standards referred to are those which (a) employ negative modulation of the carrier wave, (b) radiate a carrier which, through omission of the "d.c.," has no definite level for black, and (c) employ synchronising pulses which are inadequate in amplitude and duration. Recent information shows that not all U.S. stations employ these features.

Here are the impressions of two American radio engineers who have spent a considerable time in this country intensively studying the British television system. A laboratory was set up and in addition to observing the transmissions, measurements and tests were made. We are indebted to "Electronics" (New York) for the information given here.

gular quota of sound broadcast receivers.

Why this is possible only in Great Britain cannot be answered by simply referring to the Government subsidy of the British Broadcasting Company. In the United States the fact that television is still around the corner cannot be excused merely by asserting that we really are ahead, but that we prefer to wait and be sure; and then we will provide a superior system.

Britain has been fortunate in Government sponsorship, but they have also been fortunate, or wise, in their choice of standards. We, in this country, may have been equally fortunate in not having Government help, particularly if such help would have left us fixed with a less fortunate choice of standards.

We cannot avoid the fact that the situation in the United States is much less favourable. Unless changes are made in the type of signal which is now being used for experimental transmitters, American receivers will be more expensive, more difficult to service and will give performance inferior to British receivers. The bad performance will not be lack of detail in the transmitted picture, since, with its slightly greater number of lines the American picture can be provided with more detail than the British picture. It will be in steadiness and contrast that the American picture will suffer. Even with a more complex receiver the picture may show the fluctuations and loss of synchronism which has been noted in various American demonstrations.

A Laboratory Established

To know with certainty how British television does operate in its first

commercial setting, the authors established for the Hazeltine Service Corporation a temporary laboratory this summer in England for the purpose of making a survey. This survey included observing the transmissions and making measurements of the received signals with special equipment designed for the purpose. A major part of the survey called for visits to the transmitting station and contacts with receiver manufacturers and engineers.

First let it be said that the British pictures are remarkably good. They are steady; they are brilliant; they have an exceptional amount of detail. Scenes having a large number of actors on the stage come over clearly. Dancing and ballet subjects are very effective. Close-ups of the stars are, however, still the most effective shots since they emphasise the detail that the scene conveys by allowing careful scrutiny of the details of the face. For such scenes the detail in the highlights of the eyes, lashes, teeth and hair is particularly remarkable.

There is reason to believe that there is more detail in the British transmitted signal than the present receivers can utilise. Improved cathode-ray tubes having better spot size and modulation characteristics are one avenue of development. However, in spite of the excellence of the present signal there is also room for much improvement in the transmission within the standards which have been set.

British Receivers

First, as to reception. The white screens are quite brilliant and the level of black in the transmitted signal is so well maintained that excellent contrast and brilliance results. The resulting black and white picture is easily viewed in an average living room without drawing the shades, provided the receiver is placed to avoid direct reflection of sunlight (or lamp light in the evening) from the face of the tube. In this respect extraneous light seems less objectionable in the case of cathode-ray television than it is in the case of projected pictures such as home-movies.

In viewing the Alexandra Palace

AMERICAN AND BRITISH METHODS COMPARED

transmissions on a large variety of different receivers there were practically no cases of faulty synchronisation. In general, a receiver, after being switched on, is in a sufficiently steady state in the short time required for the voltages to rise so that the picture lights up on the screen locked in steady synchronism without any tearing of the lines or edges. There is no upset of synchronism when large changes in average lighting occur such as is often the case in transmitting film. The fact that the British pictures are remarkably good should not be forgotten in reading the following critical comments.

Now, as to defects: Motor car static, when excessive, results in a decided snowstorm on the screen. The accompanying noise on the sound channel is, however, much more irritating than the effect on the eye. Even the most excessive disturbances of this type apparently fail to have any disturbing effect on synchronisation. It is of interest that one disturbance which has been known to completely destroy signal and synchronism is the passing of an aeroplane directly overhead.

Good Synchronisation

An example of the extreme in steady synchronisation was the reception of the Alexandra Palace signal at eighty miles distance with a standard receiver. In this beyond-line-of-sight reception the signal was not visible except as a hazy movement of light on a grille of noise. Yet it was easily demonstrated that the grille was synchronised by throwing out the synchronising controls, in which case the horizontal and vertical bars of the framing signals were visible travelling across the screen.

The most frequently observed defect in receiver performance was failure of interlace. Examples of this ranged from no interlace to perfect interlace and included pairing of the lines and in some cases a slow weaving in and out of interlace. Such faults cannot be blamed upon the character of the transmitted signal since there are receivers that give perfect and steady interlace. Possibly the transmitted signal could be modified as to components which could make this problem easier in the receiver design. However, good engineering in the receiver design does

solve the problem and without adding to receiver cost.

For studio shots the average illumination employed on the subject is only 200 foot-candles. Although the Emitron tubes are probably the most sensitive and reliable pick-up devices which have been produced they are subject to the inherent defect of shading troubles. In the B.F.C. system, "tilt and bend" generators supply correcting signals to an illumination control unit. These controls require constant adjustment as the programme continues. The result is that two complete rehearsals are required, one of which is before the cameras. This enables the operators to know the corrections to be expected by viewing the programme on the monitors before going on the air. Where a programme is repeated, the improvement of illumination in the second showing is evident. The shading corrections are more difficult for film where the change of scene is more rapid and film subjects are conceded to be inferior to studio shots. The improvement in the successive showings of newsreels is very evident.

Titles on black or white backgrounds are difficult because of the shading effect which is here evidenced in streaking shadows which follow the individual letters or words. There is remarkably little of this streaking in the Alexandra Palace signal but it is frequently evident in the received image.

The contribution of the receivers to such shadows, is due generally to phase distortion. In the better designed receivers such effects seem to have been entirely eliminated and the receiver circuits apparently take advantage of all the frequency spectrum available. The cathode-ray tubes do not in all cases take full advantage of the signal since some may not have as fine a focus of the spot on the screen as others.

Cathode-ray Tubes

Since there is but the one transmitter and no additional ones contemplated in the London area the receivers are of fixed frequency with only a vernier tuning adjustment. Our American problem of tuning over a band to select one of several stations, therefore, has not been faced. Otherwise, England is a wonderful proving ground for all varieties of receivers.

The cathode-ray tubes are of all varieties as to structure, shape, scanning and focus. Generally they operate at about 6,000 volts. The so-called "onion" shape as against the "funnel" shaped tube appears to be favoured because of safety which the curved surfaces give to the design. With the safety factor which properly curved surfaces will give, the use of soft glass envelopes is increasing. At first glance these appear awkward but through good design these tubes of enormous size are completely housed in most presentable cabinets.

Scanning and Focusing Methods

Engineering opinion is apparently well divided on scanning and focus, and during the past year models in these types were available:

(a) Electrostatic focus—full electrostatic scanning, (b) electrostatic focus—full magnetic scanning, (c) Magnetic focus—full magnetic scanning.

All three types are continued and represented in the new models this year. A fourth type is also announced comprising electrostatic focus—electrostatic horizontal scan—magnetic vertical scan.

A minimum of four valves, a maximum of eight, are employed for the functions of synchronising separation and scanning. In this connection and also due to the wide band amplification problem in general a variety of new valves are appearing—particularly high slope valves having mutual conductance of the order of 7 to 10 m/A. per volt.

The scanning of the various receivers, as evidenced by the picture on the screen, is not always perfectly linear. The transmitter signal gives a blanking interval for the line fly-back or retrace which is 15 per cent. of the total line time. This is much longer than the 10 per cent. interval proposed for the United States. In micro-seconds the British standard allows for retrace a total of 15 micro-seconds. Since the U.S. system employs a higher line frequency our allowed retrace time is actually $7\frac{1}{2}$ micro-seconds. Nevertheless the achievement of a good linear line trace and a perfect return during the 15 micro-seconds blanking interval is not always accomplished. Some receivers may evidence a lighting on

[(Continued at foot of next page)

Scannings and Reflections



KINESCOPE PROJECTION TUBE

A NEW projection tube has been developed by R.C.A. technicians under the direction of Dr. Vladimir K Zworykin, Mr. W. H. Painter and Dr. R. R. Law. The new projection Kinescope is designed to produce a clear image 18 by 24 in. in size.

In the first demonstration of the projection tube by radio-transmitted images, the show consisted of both motion picture film and live entertainment. The show was picked up by Iconoscope cameras in the N.B.C. studios at Radio City, relayed by coaxial cable to the transmitter in the Empire State Tower, and from this point broadcast to receivers on the 62nd floor of the R.C.A. Building.

MORE MONEY FOR TELEVISION

In answer to a question by Commander Fletcher on November 8, the Postmaster-General said that the proportion of licence revenue payable to the Corporation would be subject to review soon on account of the de-

"BRITISH TELEVISION THROUGH AMERICAN EYES"

(Continued from preceding page).

the left side of the picture due to a slow retrace. A slight crowding or narrowing of objects, also generally at the left side of the picture, frequently gives evidence of imperfect line linearity. Frame linearity is generally good and there is little or no evidence of hum troubles from the 50-cycle mains.

It is rather evident that many of the defects discussed are rapidly being ironed out by experience. Such progress can, of course, only be realised where a standard and regular transmission is available.

The fact that careful engineering is required to achieve good line scanning with the 15 per cent. blanking interval has already been discussed. It seems clear that the art is much too young to reduce this interval and be fair to set manufacturers. Similarly adequate duration and amplitude of synchronising pulses is essential to set manufacturers for tolerance in design.

velopment of television. The expenditure incurred in the new service would then be taken into account. An announcement concerning the introduction and scope of the service would shortly be made by the B.B.C.

The capital expenditure incurred on the television service up to September 30, less depreciation written off, was £112,000, and the revenue expenditure up to that date, including depreciation and programme, engineering and staff costs, was £346,000.

"JOURNEY'S END"

Journey's End was the most ambitious dramatic experiment yet attempted in television. The play lasted seventy-five minutes and severely taxed the resources of the limited studio space, but the atmosphere of the play came over well.

THE C.B.S. TRANSMITTER

The Columbia Broadcasting System's new television transmitter is now being given its first power tests at Camden, N.J., and will be ready for delivery to New York early in January.

It is to be installed on the 73rd and 74th floors of the Chrysler Building. There it will provide television programmes from the nearby Grand Central Station studios.

THE CENOTAPH CEREMONY TELEVISED

For the first time in history, the Cenotaph ceremony in Whitehall on Armistice Day was televised and use was made on this occasion for the first time of a newly developed ultra-sensitive Emitron camera. This new camera is ten times more sensitive than those previously used for outside broadcasts and will enable scenes to be picked up under adverse lighting conditions. The unfortunate episode of interruption of the silence was clearly visible on the screens of receivers and viewers thus had firsthand knowledge of what was happening.

EXTRA HOURS FOR TELEVISION

It is understood that early in 1938 television broadcasting will occupy

four hours per day instead of the present two. One of the extra hours will be at a fixed time in the early evening and the other will be variable in order to suit any outside events which are suitable for transmission by the new medium.

TELEVISION AT SEA

Recently the Cunard-White Star liner *Britannic* picked up television pictures from the Alexandra Palace when passing down the English Channel, 30 miles from the south coast. This is believed to be the first occasion that high-definition television has been received by a ship at sea. Both the afternoon and evening transmissions were received.

After messages had been received from the ship reporting the successful reception, the television station transmitted the first "Telephotogram" to a ship at sea. This was a visual message of greeting to the Captain, officers, crew and passengers. A request was made from Alexandra Palace that the message should be photographed. Further tests are to be made on board the *Britannic* on its voyage across the Atlantic.

BOXING TOURNAMENT

Boxing offers some of the biggest thrills of the television screen, as was proved when the amateur championships were televised from the Alexandra Palace concert hall in February last. Another tournament will be featured in television in the evening of December 2 when bantam-weight, feather-weight, and welter-weight contests will be fought under the auspices of the Alexandra Amateur Boxing Club. It is hoped to televise one or more of these.

The bantam-weight match is between C. C. Gallie (Cardiff), Junior Champion of Great Britain, 1935, 1936, 1937, and F. Salmon, the English international amateur boxer. J. Harrington (Cardiff) is paired with J. O'Berg (Hull) in the feather-weight contest. S. Stockton, runner-up Junior Championship of Great Britain, 1935, will meet T. Quill, English international, in the welter-weight contest.

MORE SCANNINGS

One of the television cameras will probably be supported on a steel cradle giving an uninterrupted view of the ring. Another will be operated from the ring-side. Both will use telephoto lenses when occasion demands.

A 90-MINUTE PLAY

A ninety-minute play, the longest yet attempted in the studios at Alexandra Palace, will be televised in the afternoon programme on December 6. It is "Once in a Life-time," a funny satire on American film methods, by Moss Hart and George Kaufmann.

Joan Miller, television's "Picture Page" girl, who has already appeared in many dramatic productions at Alexandra Palace, will take the part of May, a member of an unsuccessful music hall trio, who "cashes in" on the sudden arrival of talking pictures by opening a school of elocution. By taking a correspondence course in the subject, she is able to keep one less ahead of her class. George and Jerry, the companions, who accompany her to Los Angeles, are also caught up in the film machine, to meet with adventures which should make splendid entertainment on the television screen.

The action is quick moving, and the scenes, ranging from a cheap lodging-house via Pullman cars to Los Angeles hotels and film studios, chase each other with a rapidity that will keep the television cameras busy.

ST. ANDREW'S DAY TELEVISION

Two American tourists "do" Scotland in a St. Andrew's Day programme which will be televised both afternoon and evening on November 30. "Stands Scotland . . . ?" is the title of this essay in contrasts, which in reality is a satire on present-day glorification of Scotland. The programme, devised by Andrew Cruickshank and Reginald Beckwith, will contrast the real Scotland of the misty Highlands with the popular stage and Hollywood versions.

"Stands Scotland . . . ?" will employ some of the devices of sound broadcasting, such as a team of narrators, and it should be interesting to note whether this fusion of sound and television technique is effective. Presentation will be by a Scotsman, Moultrie R. Kelsall, who, before his recent appointment as television pro-

ducer, was responsible for many dramatic broadcasts in the Scottish Region.

TELEVISION FROM ST. GEORGE'S HALL

No official confirmation is as yet forthcoming regarding the report that the variety programmes from St. George's Hall are to be televised, but it seems clear that this is the B.B.C.'s intention if certain technical difficulties can be overcome. Formerly adequate lighting appeared to be a snag, but with the recent development of a more sensitive camera there now remains little trouble on this score and probably the greatest trouble is the placing of the cameras so as not to interfere with the view of the audience. Tests are being made of various arrangements and the outcome of these seems very hopeful. It appears very likely that in the near future the variety programmes will form part of the regular television broadcasts.

TELEVISION AT CHRISTMAS

The Christmas television programmes, which open on December 20, will, it is hoped, be representative of the best yet radiated from Alexandra Palace. The season begins with a display of Christmas toys in the afternoon and evening programmes on December 20. "The Ghost Train," Arnold Ridley's thriller, will be performed on the same afternoon.

The afternoon programme on December 21 will include a star production of "Hundred Per Cent. Broadway," Cecil Madden's all-American cabaret show with David Burns and the Merriell Abbott Girls from the Dorchester. Arthur Marshall, the "school-mistress" broadcasting star, will make his television debut in the afternoon on December 22, and the "Picture Page" programmes on that day will have a special Christmas flavour.

"Hansel and Gretel," Humperdinck's fairy-tale opera, will be televised in the evening programme on December 23, and will be repeated a week later. The leading parts will be taken by children acting in mime with vocal accompaniment "off-stage." The B.B.C. Television Orchestra, conducted by Hyam Greenbaum, will be specially aug-

mented for the occasion. On Christmas Eve, Jack Payne and his Band will appear in both the afternoon and evening shows.

A Christmas edition of "Coffee Stall" will be televised in a snow-storm on the same afternoon.

CHRISTMAS DAY

Christmas Day programmes will open with a short address by the Rev. Pat McCormick. Viewers will then be taken into Alexandra Park for a football match between the Alexandra Palace Football Club and a Welsh team. On Christmas evening Harry Pringle will introduce a Music Hall Cavalcade with old-time artists. The studio will be decked out as an Edwardian music hall and an audience will be present.

Mr. Gillie Potter will be among the stars making solo appearances in the Christmas programmes. He will be seen in the evening programme on December 20 and again in the afternoon programme on Christmas Day. Noni, the clown, and his partner, who visited Alexandra Palace in the early days of television, will make a joyful reappearance in the afternoon programme on December 23. It is hoped that Lydia Lopokova, the celebrated ballerina, will appear in the different rôle of story-teller on December 23, recounting the adventures of Little Red Shoes in the afternoon programme. In the evening programme on the same day, Marcel Boulestin, the cookery expert, will explain how wine should be served. Irène Prador, the Viennese soubrette, who is one of the first stars created by television will sing German, French and English songs in the evening programme on December 24 and again on Christmas night. On Christmas Eve, Nicholas Bentley will draw cartoons and a commentary will be supplied by Captain Robert Hartman. The outstanding musical event will be a pianoforte recital by Irene Kohler in the afternoon programme on December 21.

On Boxing Day Reginald Smith hopes to present a television pantomime.

A winter sports programme will be transmitted on December 30 and on the last day of the old year a music-hall performance will bring more old-time artists to the television cameras in an informal setting.

AND MORE REFLECTIONS

ENGLAND-AUSTRALIA ON 5 METRES

Full confirmation has now been obtained of the new long-distance record set up by the Australian amateur station, VK2NO, on 5 metres. His phone transmissions from Sydney were picked up by Mr. Mellanby, of Pwllheli, North Wales, and the received data has been checked, so removing any possibility about the authenticity of the reception.

In future, VK2NO is keeping a regular schedule with the Belgian station, ON4AU, so that English listening stations, or those transmitting on 5 metres, should keep a lookout for a possibility of co-operating and making an England-Australia two-way phone contact.

AN AERIAL ON WHEELS

A remarkable innovation has been made at the new PCJ station owned by Philips and located at Eindhoven. The power of this station has been raised to 60 kW, and in order to overcome the difficulty of erecting numerous aerials to cover all directions, a special revolving aerial system has been designed.

American amateur stations have used a similar idea on a small scale, but never before has a commercial broadcaster erected such an aerial. Briefly, the aerial consists of two lattice masts 195 ft. high, mounted on a girder bridge, which is in turn mounted on a centre pivot and eight wheel trucks. The whole system turns on a circular steel track, the circle of the outer rail being 145 ft. in diameter with a 40 ft. inner circle. This aerial can be erected in any direction so that signals can be beamed on any particular part of the world. The aerial system proper consists of 12 vertical di-pole aerials on each mast, each aerial being fed separately with an input of 60 kW.

RECEPTION ON SHORT-WAVES

Reception conditions on short-waves again seem to be most peculiar. Despite the fact that wide claims are being made for reception of commercial broadcasters from all parts of the world, the fact remains that amateurs of every nationality are in complete agreement that conditions at the present time have never been so consistently bad. There are periods when it is absolutely impos-

sible to hear a station more than a thousand miles distant on 20 metres.

There are also periods when a complete fade-out has been experienced of all signals, both commercial and amateur. Immediately after such periods it has often been noticed that long-distance and very local stations can be heard simultaneously, which is most unusual. During one of these spells stations in Scotland, Ireland and the east coast of America were able to maintain continuous contact for a period of over 90 minutes.

It appears, however, that the 10-metre band is not subject to such extraordinary variations. On this wavelength between the hours of 1 p.m. and 7 p.m., stations from all over the world can be heard most consistently and operators know that outside these times the band will be completely dead. Despite the shortness of the time when this band is active it is at least helpful to know just when stations can be heard.

POLICE TRANSMITTERS USE TELEPHONY

The attitude of those in charge of police transmitters seems to be changing, for there is now a more general tendency to use telephony instead of telegraphy, as in America. Those users of true all-wave receivers covering the 140-, 160-metre band should make a point of hearing some of the interesting transmissions which emanate from police transmitters at Nottingham, Manchester, Glasgow, etc. Although the London police transmitter is at present using telegraphy, there seems to be a definite indication that when a suitable wavelength has been allocated telephony may be used, at least in certain circumstances.

SHORT-WAVE CONTEST

During the period February 5 to February 27, the Radio Society of Great Britain will be staging their annual B.E.R.U. contests. The success of these contests depends very largely on the number of stations operating on telephony. These contests, of course, are for those stations operating with telegraphy and if the telephony stations remain silent during the contest period the telegraphy stations can make contact with the very minimum of interference. It is hoped, in the circumstances, that telephony stations will remember this

point and reduce their transmissions during the contest period unless they too revert to telegraphy.

At the moment there are a number of stations which consistently use telephony so that their value to the State is greatly decreased. In Australia every amateur is obliged to use a certain amount of telegraphy so that his operating is kept up to a definite standard. The idea in mind is that in case of national emergency amateur transmitters could as a whole be taken over as radio operators without an undue amount of additional training. This, however, is only possible if operators keep up their proficiency with telegraphy.

Technical Books for
Christmas

HERE is nothing quite so suitable for Christmas presents as a good book, particularly when it is presented to somebody who is technically minded and can appreciate something like "Radio Engineering," "Communication Engineering," or the "Fundamentals of Vacuum Tubes." These three books have been chosen out of the huge number published by McGraw-Hill Publishing Co., Ltd., Aldwych House, London, W.C.2, and are about the best of their class.

"Radio Engineering," by F. E. Terman, Professor of Electrical Engineering, Stanford University, is priced at 30s. net, and includes 813 pages and 475 illustrations. Chapter headings include Vacuum Tube Amplifiers, Modulation, Radio Transmitters, Radio Receivers, Television and Radio Aids to Navigation.

"Communication Engineering," by W. L. Everitt, Professor of Electrical Engineering, The Ohio State University, is also priced at 30s. net and is a step-by-step analysis of the problems confronting the radio and television engineers. Amongst the chapters included are Filters, Bridge Circuits, Modulation and De-modulation, Class A Audio Frequency Amplifiers, Class A Radio Frequency Amplifiers, and Electro-Mechanical Coupling.

One of the best books of its kind is "Fundamentals of Vacuum Tubes," by Austin V. Eastman, M.S., Assistant Professor of Electrical Engineering, University of Washington. In the 438 pages is included practically everything that the advanced radio engineer is likely to want regarding radio valves. Also included is data on photo-sensitive cells and all kinds of valves of a similar type. The price of this book is 24s. net.

HIGH-VOLTAGE POWER SUPPLY UNITS FOR TELEVISION

By S. West

WHILE a comparatively large number of published circuits, commercial vision receiver reviews and transmitter power pack designs, has acquainted the amateur with the fundamentals of high-voltage power units, the design of these units to provide the high voltages

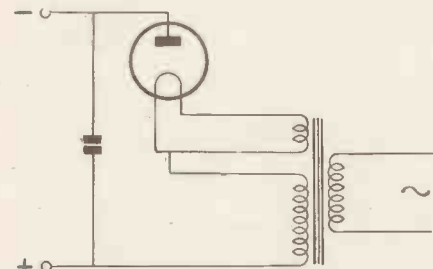

Fig. 1a. Circuit of half-wave rectifying arrangement.

required for television receiver operation, that is the C.R. tube and time base voltages, can present a number of disconcerting pitfalls to the uninitiated.

Also, as revealed below, an acquaintance with the principles involved is very desirable if damage is to be avoided when any change of the operating conditions that the apparatus is designed for is undertaken.

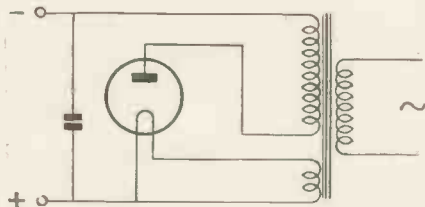

Fig. 2a. Circuit for use with earthed negative.

Considering first the exciter volts required for C.R. tube operation, these voltages are quite high, usually for 10 in. and 12 in. tubes, approximately 4,000 volts.

Fig. 1a gives the circuit of a half-wave rectifying arrangement that is largely used to provide these voltages. In order better to consider the circuit, its essentials are reproduced by Fig. 1b. Here the voltages occurring at each end of the second-

ary are represented by the curved line; this will assist in an understanding of the manner of operation. The shaded portion represents the rectified half-cycle.

It is seen that the maximum peak voltage that can occur across the high voltage secondary is $1.4 \times$ volts r.m.s. of the secondary. This is also the maximum voltage that can occur across the reservoir condenser.

The maximum voltage across the rectifying valve is twice this value during the non-conductive half cycle.

It is well thoroughly to grasp these facts as they are fundamental of any rectifying system.

If the positive of Fig. 1 is earthed (the various factors governing the desirability of positive or negative earthing are later considered) it will be seen that the inside end of the H.V. secondary is earthed. As a consequence very little insulation is required. The rectifier winding, and, of course, the outer of the H.V. secondary, as they are common, will require to withstand $1.4 \times$ volts r.m.s. of the secondary to earth. If, as is customary, the transformer is wound with the rectifier filament secondary on the outside, the minimum of insulation is entailed.

Now consider the same arrangement when negative is earthed. Then the inside end of the H.V. secondary will require to withstand $1.4 \times$ volts r.m.s. of the secondary to earth, the outside twice this voltage.

If a unit designed for positive earthing is used with a negative earth, it is easy to see that a breakdown will almost certainly result.

The arrangement, Fig. 2a, is more suitable when negative is earthed. Fig. 2b, again reproduces the essentials of this circuit.

It will be seen that here, the H.V. secondary insulation is the same as for the other circuit. The rectifier filament winding will, however, require insulating $2 (1.4 \times \text{volts r.m.s.})$ to the high voltage secondary and half this voltage to earth.

When positive is earthed, employing the circuit of Fig. 2, it is seen that the inside of the H.V. secondary will require insulating for $1.4 \times$ volts

r.m.s., the outside end for twice this voltage. The rectifier filament winding insulation to the secondary is the same as for negative earthing, but does not require insulating to frame.

From the foregoing it will be apparent that if the high voltage is furnished by a winding insulated for

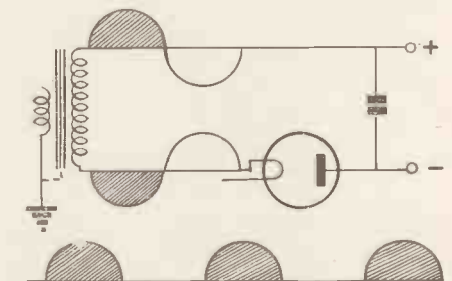

Fig. 1b. The characteristics of the circuit shown by Fig. 1a.

the inside end $1.4 \times$ volts r.m.s., the outside end for twice this voltage, and the rectifier filament voltage is provided by a winding insulated to the full voltage on a separate transformer which can conveniently be that supplying the voltages for the time base valves' heaters, etc., we have an arrangement that has universal applications at very little additional cost.

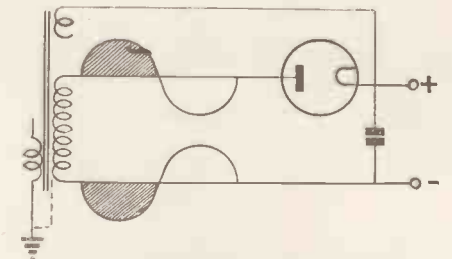

Fig. 2b. Characteristics of circuit shown in Fig. 2a.

This is the scheme adopted for the power unit designed for use with the television described in the October and November issues. Its practical construction is fully dealt with in this issue.

Another arrangement that has much to commend it is shown by Fig. 3. This shows what is known as a "voltage doubler" rectifier.

TRANSFORMER DESIGN FOR POWER PACKS

Consider first the rectifying valve V_2 . When A swings negative in respect to B, V_2 conducts, charging the condenser C_2 , the maximum voltage occurring across C_2 being $1.4 \times$ volts r.m.s. of the H.V. secondary winding.

During the following half-cycle, A swings positive with respect to B

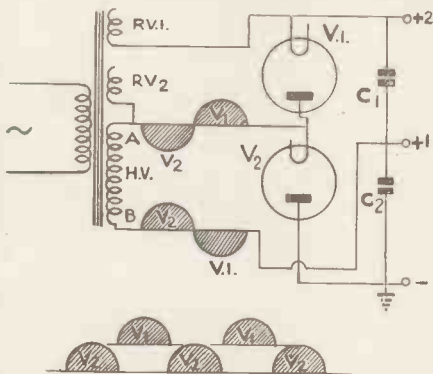

Fig. 3. Circuit of voltage-doubler rectifier.

and V_1 conducts, charging the condenser C_1 . Again, the maximum voltage across C_1 is the same as C_2 ; that is, $1.4 \times$ volts r.m.s. of the H.V. secondary.

C_1 and C_2 , it is seen, are in series; the voltages across these condensers is therefore additive. Thus a maximum voltage of $2(1.4 \times$ volts r.m.s.

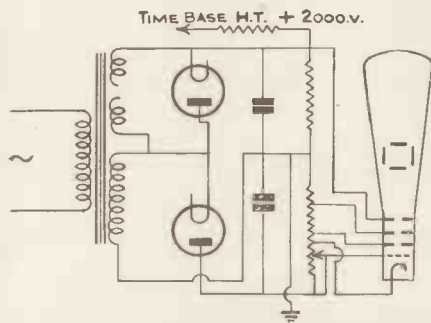

Fig. 4. Voltage-doubler circuit permitting positive earth.

sec.) occurs between +2 and negative. There is also half this voltage between positive 1 and negative.

These two voltages may very conveniently be used to furnish power for the time base and C.R. tube, thereby combining the two units into a single economical arrangement. The voltage available between negative and positive 1 will be rather higher than that required for normal operation of the time base if the total voltage is to be sufficient for satis-

factory tube operation. However, this is not a disadvantage, indeed the excess voltage may be dropped across series resistances, sufficient smoothing thereby being obtained to permit omission of smoothing chokes in the time base H.T. supply thereby effecting still further economy.

Unfortunately it will be obvious that it is only possible to employ this arrangement with a negative earth, unless matters are arranged as shown by Fig. 4.

Before leaving the voltage doubler circuit let us again consider Fig. 3 and determine the degree of insulation demanded for the various transformer windings.

The H.V. secondary will only require to have a voltage output of about half that needed for the half-wave rectifier arrangements of Figs. 1 and 2. To simplify, let us assume that this will be 2,000 r.m.s. volts.

Referring to Fig. 3. It will be seen that when B swings positive in respect to A V_2 conducts, charging C_2 . B is therefore 2,800 volts above earth. When B swings negative in respect to A, V_1 conducts, charging C_1 2,800 volts above C_2 , so that A will require insulating 5,600 volts from earth. As RV_2 and A are common, RV_2 will obviously require insulating for the same voltage. Similarly, the winding RV_1 will require to be insulated for 5,800 volts from RV_2 . The maximum voltage appearing across C_2 is 2,800 volts and that across C_1 the same. Therefore the maximum voltage that can occur between RV_1 and earth is 5,800 volts, plus the voltage drop across the rectifier that is conducting. As this voltage drop is small, it may be ignored, as has been done for the similar preceding cases.

Now throughout this reasoning we have been considering circuits with positive and negative earths and have even referred to an arrangement with an earthed centre point. It may well be asked, why not decide once and for all which pole it is better to earth and design accordingly. The fact is, however, that a certain arrangement is usually more suitable for a particular case, consequently it is desirable to design the power units with reference to the remainder of the complete vision receiver.

Fig. 5 shows an arrangement employing a D.C. feed to the C.R. tube grid, thereby retaining the D.C. com-

ponent. If negative of the C. R. tube exciter volts is earthed as shown by the broken line, any variation of the brilliance control R will affect focus as the cathode is moved nearer the other tube electrodes. For this reason it is preferable to connect the negative direct to the cathode of the tube. The earth connection is then

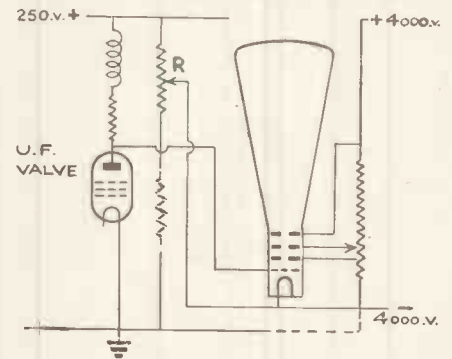

Fig. 5. Arrangement employing a D.C. feed to the cathode-ray tube grid.

completed through the lower limb of the potentiometer R. Bias for the tube is derived from the vision receiver H.T. supply. It is preferable, in order to avoid the possibility of allowing the C.R. tube grid to become positive in respect to the cathode, to include a fixed resistance in series with the potentiometer.

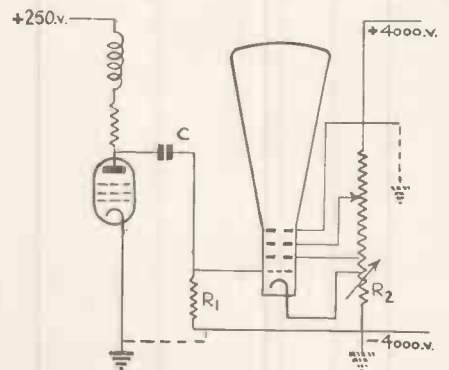

Fig. 6. Circuit allowing either positive or negative to be earthed.

It will be seen that earthing the positive pole of the C.R. tube exciter volts is not possible when using this arrangement.

Fig. 6 shows another arrangement that is extensively used. When this circuit is employed either negative or positive may be earthed. The grid of the C.R. tube is returned through the high resistance R_1 . Brilliance is

controllable by variation of the resistance R_2 . When positive is earthed with this arrangement, the condenser C will require to withstand the full tube 3rd anode voltage, and the resistance R_1 is necessarily returned to the end of R_2 .

It is seen that due to the condenser C the D.C. component is not retained,

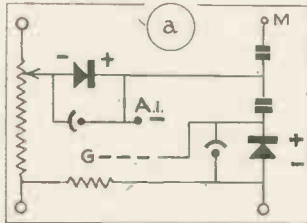

Fig. 7a. Shows the use of metal rectifiers (Westinghouse type J.25) for restoring the D.C. component. It will be noted that modulation is applied to the grid and first anode of the tube. When only grid modulation is used, a single unit suffices.

in either case, with this arrangement, and it is necessary to restore it by means of a diode or similar device (see Fig. 7).

If it were not for the desirability of connecting negative of the tube volts direct to cathode as explained above, it is possible that with a low cost design, a single power unit

would satisfactorily provide all the power required for operation of the entire receiver, that is, it would furnish exciter volts for the tube, and in addition, the current for the time base and vision receiver, permitting retention of the D.C. component as well. Whether in practice this difficulty precludes such an arrangement remains to be seen.

Other factors will, of course, present difficulties. For example decoupling will require to be rather elaborate. However, the decoupling requirements for a vision receiver are not particularly stringent.

Additional to the considerations above affecting the earthing requirements of the C.R. tube supply volts, another factor requires attention. It is essential that each deflector plate of the C.R. tube be returned to the 3rd anode through a suitable value resistance (2.5 megohms). Consequently these plates will be at the same potential as the 3rd anode. If negative is earthed the condensers through which the sweep voltages are applied will require to withstand the full 3rd anode voltage; as there are four of these they represent a comparatively expensive item. Their cost is, however, partly offset by the reduced cost of the modulation feed

condenser, and wholly offset by the cost of the apparatus required to reintroduce the D.C. component, if it is felt that this should be applied with the picture modulation. Recapitulating, it would seem that one ar-

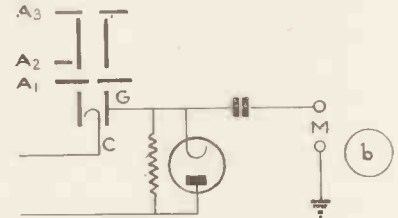

Fig. 7b. Shows a method of restoring the D.C. component by a diode valve. This diode is connected across the load resistance in the tube grid circuit and virtually rectifies the signal potential. The resistance of the load is thus reduced proportionately to the increase in video signal amplitude, thereby correspondingly increasing the picture brilliance. The heater winding of the diode will require insulating for the same amount as the modulation feed condenser.

angement is as good as another; perhaps that shown by Fig. 4 is the more economical. It thus becomes chiefly a question of individual choice and the arrangement most expedient to the remainder of the receiver design will be used.

SCOPHONY, LTD., WIN AN APPEAL

LAST June, Scophony Ltd., brought an action against Ernest H. Traub, International Television Corporation, Ltd., and I.M.K. Syndicate, Ltd., claiming an injunction restraining the three defendants from inducing Scophony's employees (three were named) to break their contracts of service or to disclose secret information regarding Scophony's business. The Judge held that Mr. Traub—one of the three defendants—had acted improperly, but his efforts were unavailing because of the loyalty of the Scophony servants, and that as there was no evidence that Mr. Traub would be any more successful in the future than he had been in the past, the Judge could not grant the injunction asked for and had no alternative but to dismiss the action with costs.

In due course Scophony, Ltd., appealed against that judgment. On October 29 last the Court of Appeal reversed the judgment of the Lower Court and gave Scophony the injunction claimed against the three defendants.

The Master of the Rolls, in his

judgment, said that Scophony is a company doing research and inventive work in connection with television. The two defendant companies are interested also in television. Mr. Ernest H. Traub, the first defendant, is or was at the relevant time the responsible manager of both defendant companies. Now the work in which both the research companies are engaged is work of novelty which requires and demands a high degree of competence on the part of their employees. The three servants whose names have come into the story were under stringent service agreements prohibiting them from disclosing confidential matters, and were in possession of information, the disclosure of which to the defendants would cause the plaintiffs irreparable damage.

It appears to me, said the Master of the Rolls, that once it is established (a) that the defendants through their servant Traub have been endeavouring wrongfully to persuade employees of the plaintiffs to disclose information of a confidential nature, and (b) that the disclosure of that in-

formation will cause irreparable damage to the plaintiffs, it is not right to draw the inference that those attempts will be no more successful in the future than they have been in the past. The plaintiffs are entitled to be protected against the risk of attempts of the kind succeeding. It appears to me, said the Master, that all the essential elements are present in this case for giving the Court the duty to grant an injunction to restrain attempts of this kind.

Lord Justice Romer and Lord Justice Mackinnin agreed with the Master's judgment, Scophony's appeal being allowed with costs of the action in the first Court and of the Appeal.

Recent tests in Germany with line transmissions have enabled a distance of 350 miles to be covered, over which distance satisfactory definition was obtained.

British research experts have now, in the laboratory, been able to demonstrate that pictures can be transmitted over 400 miles of land line with a quality picture superior to that obtained in Germany.

MARCONI-E.M.I. TELEVISION—

A YEAR'S MOST NOTABLE PROGRESS

THE mobile equipment to which I referred last year as having been ordered by the B.B.C. was duly completed and delivered, and this apparatus was employed in the televising of the Coronation Procession at Hyde Park Corner, with remarkable success, in spite of most depressing weather conditions, which rendered the task so much more difficult. Television viewers were enabled to enjoy the sight of the Royal Coach with a view of their Majesties clearer perhaps than most of those who lined the route.

This portable equipment has made possible also such things as the delightful series of transmissions from the Zoo, the championship tennis matches at Wimbledon, the ambitious broadcasts from the film studios at both Pinewood and Denham, and, more recently, the successful broadcast of the Lord Mayor's Show. In some of these the link between the scene and Alexandra Palace has been by wireless transmission, while in others it has been by a special cable with its terminal equipment invented and patented by us, of which some 14 miles have been laid down connecting the West End of London with Alexandra Palace.

These broadcasts have competed in popularity with the transmissions from the studio at Alexandra Palace. From there a great many successful indoor programmes have been sent out, and they are evidence of the courage that is being shown by the earnest group of enthusiasts who are striving to create a new art in the television studio.

The Emitron Camera

Work on the Emitron camera, to which I made reference last year, has proceeded with particular success. Those cameras employed at Alexandra Palace and on the mobile van during the year have been of extreme precision and of a sensitivity sufficient to enable scenes to be picked up with less lighting than that of an ordinary film studio. They have been considered as having set a standard, and we have actually supplied the Emitron, with its equipment, which is being installed in the new high-power

We give below abstracts from the speech of Mr. Alfred Clark (Chairman of the Company) at the Sixth Ordinary General Meeting of Electric and Musical Industries, Ltd., on Friday, November 12, a speech which deserves permanent record as a clear and authoritative statement of the position of television to-day. All our readers will be aware that Electric and Musical Industries, Ltd., are the owners of the Marconi-E.M.I. system.

television transmission station at the Eiffel Tower in Paris.

A New Camera

Certain discoveries, however, by our scientists and engineers have enabled them to achieve a considerable advance on this standard Emitron camera, which will be of great importance in television broadcasting. The sensitivity of this new instrument is in the nature of approximately ten times greater than that of our standard Emitron. This means that, with this apparatus, it will be possible to televise scenes in an ordinarily lighted public theatre and out-of-doors in very unfavourable light conditions. To those of you who may be technically minded, I would add that it picks up a scene at a much wider angle than at present, and has a much greater depth of focus, so that scenes may be taken on a much wider and deeper stage. It was used for the first time to televise the Cenotaph ceremony with outstanding success.

Receiver Sales

In view of this bright story of achievement you will expect to learn of large, or at least shall I say substantial, sales of television receiving sets. Frankly, sales have been disappointing, and a discussion here of the cause seems appropriate.

Price has been referred to sometimes as a deterrent to their popularity, but, on reflection, this seems an unlikely reason when one considers that the selling price of a television set to-day is comparable with that of a radio-gramophone, an instrument which has been sold in thousands at even higher prices.

There is, however, another and perhaps more convincing reason which has been advanced, and its force will be appreciated by all of those who possess television receiving sets. I refer to the large proportion of programmes which are being sent out and which have little or no entertainment value.

Programmes—Special Effort Necessary

It is within your knowledge that in this country television broadcasting may only be done by the B.B.C.—a policy with which we, of course, agree. But although we may not do it ourselves, we are deeply interested, nevertheless, in the successful carrying out of the broadcasting, for upon it depends in great measure the popularity of television and the extent of the sales of television receiving



A scale model of the Marconi-E.M.I. mobile equipment for outside television broadcasts. At the left is the Emitron camera.

THE BRITISH LEAD IN TELEVISION

sets. Are we not justified in feeling that, in the case of so wonderful an invention, a special effort should be made to see that the daily programmes are worthy of it?

Through lack of funds the installation of the studios at Alexandra Palace has been on too small a scale, and the general layout is, in no sense, commensurate with the requirements. The staff there is forced to work under the greatest difficulties, and, in view of what they have achieved, they are to be congratulated. They are not granted the financial means to enable the broadcasting to be carried out on an adequate basis.

There have been a sufficient number of splendid broadcasts to reassure anyone who has had the good fortune to see them of the high entertainment value of television. The Press is enthusiastic over the production of "Journey's End," but these successful ones have been far too few and mixed with them have been items of the utmost mediocrity due, without doubt, to a too scanty purse. As we all know, television will transmit to viewers an inferior actor or singer as accurately as a good one, and it is purely a question of expenditure of money whether first-rate artistes are employed. But unless they are it is impossible to expect much entertainment to result.

More Money Required

Television is being held back, we hope only temporarily, because of a lack of the necessary grant of funds for its exploitation. Such a grant should be sufficient to enable the B.B.C. to provide longer programmes with artists of first rank, and adequately to equip and carry on the necessary technical services in the studios.

The radio manufacturers of this country who are looking forward to the expansion of the television set market as a necessary development of their industry are fully alive to the needs I have expressed, and we hope that the Government will chose the simple expedient of an adequate grant.

We should greatly deplore the adoption by our Government in relation to television in this country of any of the methods practised abroad which involve the dependence for programmes on receipts from paid advertising.

The British Lead

It is now generally conceded by impartial observers that in television England leads the world. Engineers from all over the world, including France, Germany, and the United States, have visited us that they may learn the newest developments.

Philips' Cathode-ray Tubes

ALTHOUGH Philips' tubes are not readily available in this country we feel that the following abridged data will be of interest to experimenters if only for comparative purposes with the table of tubes printed elsewhere in this issue.

Altogether there are ten new Philips' tubes, of which six are for oscilloscope work and four primarily intended for television. Models 3951 and 3952 both have screen diameters of 160 mm., have 4-volt 1-amp. heaters and operate with a maximum 2nd anode voltage of 2,000 and require a negative grid voltage of 35. Model 3951 has a yellow-green screen and 3952 a blue-violet colour. Models 3957 and 3958 both have a screen diameter of 95 mm., and operate with 1,000 volts on the second anode, 600 on the first anode, and require a negative grid voltage of 45. Model 3957 has a yellow-green screen and 3958 a blue-violet screen.

Two other tubes, type 3971 and 3972 also have 160 mm. screens and are almost identical with models 3951 and 3952, being of a high-vacuum type with double electrostatic deflection. The tubes differ only in the fact that they have side contact bases instead of the more normal prong base, while the deflection plates instead of being taken to a contact on the bulb are connected to separate base contacts. This causes slightly higher inter-electrode capacity but has many compensating advantages.

Tube type 3962 has a screen diameter of 220 mm., and is intended for television work. It has a 4-volt 1-amp. heater, will handle a maximum second anode voltage of 6,000 and a maximum third anode voltage of 1,200, requiring a grid voltage of negative 60. It is intended for double electrostatic operation and gives a black and white picture.

A new tube is the DW31-2 of the

high-vacuum type giving a black and white picture. It has two pairs of deflecting plates so disposed that the movement of the beam is in two directions at right angles to each other. Brief technical data shows that it requires 4 volts at 1-amp. on the heater, will handle 5,000 volts on the third anode, 1,700 volts on the second anode and 250 volts on the first anode. Grid cut-off voltage is negative 60.

A similar tube is the MW31-2, which is constructed for magnetic focusing and double electro-magnetic deflection. Maximum second anode voltage is 6,000, maximum first anode voltage 250, with an accompanying grid cut-off voltage of minus 60. Screen diameter is 311 mm.

The largest tube in this range is the MW39-2. It has similar characteristics to the MW31-2, but has a screen diameter of 390 mm. The maximum second anode voltage is 6,000, the maximum first anode voltage 250.

Chassis Units for the Low-cost Televisor

Although the various chassis employed for the Low-cost Televisor have been designed in order that the construction will be within the ability of the average amateur who has only a limited number of metal-working tools, no doubt there are many amateurs who prefer to obtain these units ready made. The Mervyn Sound & Vision Co., Ltd., 4 Holborn Place, London, W.C.2, can supply all the chassis units ready drilled and only requiring assembly by means of small screws and nuts.

Television Components

Readers who desire to build up the various low-priced television units described in the issues of recent months and who have difficulty in obtaining components suitable for this work, or who wish to buy the units ready for assembly, should get in touch with Messrs. H. E. Saunders & Co., of 4 Gray's Inn Road, W.C.1, who have specialised in the requirements of amateur and professional experimentors for many years. The firm is always pleased to help experimentors with practical difficulties and give advice.

RECENT TELEVISION DEVELOPMENTS

A RECORD
OF
PATENTS AND PROGRESS
Specially Compiled for this Journal

Patentees: *The British Thomson-Houston Co., Ltd., and J. Moir* :: *Marconi Wireless Telegraph Co., Ltd., and G. F. Brett* :: *Baird Television, Ltd., and J. L. Baird.* :: *Baird Television, Ltd., and L. R. Merdler* :: *Baird Television, Ltd., and D. M. Johnson* :: *K. H. Barbour*

Regulating Picture Brightness (Patent No. 469,813.)

IN order to keep pace with incidental variations in the background illumination of a picture that is being televised, it is necessary to handle currents so low in frequency that they approximate to a direct-current component.

In order to preserve and amplify them, the coupling between the detector valve used at the receiving end, and a succeeding amplifier stage, is arranged so that the normal signal frequencies are transferred through a resistance-capacity combination from the anode of the detector, whilst the low frequencies, including the D.C. component mentioned, are developed across a second resistance inserted at the cathode end of the detector valve. This latter resistance is directly connected to the grid of the amplifier valve.—*The British Thomson-Houston Co., Ltd., and J. Moir.*

Electron Multipliers (Patent No. 469,900.)

Primary electrons from a cathode C are focused by screens S, S₁ on to

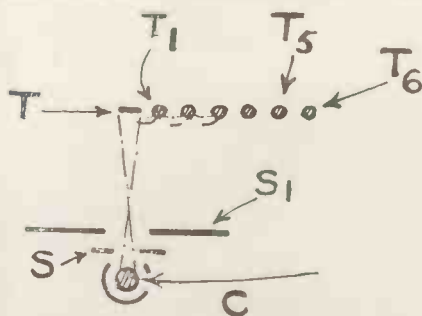

Electron multiplier. Patent No. 469,900.

a target electrode T, where they produce secondary electrons. These are caused to impinge, in turn, upon a series of other targets T₁—T₅ made in the form of stretched wires. The wires are spaced one or two millimetres apart, and are biased in an

ascending order of voltage, each being ten or twenty volts more positive than its left-hand neighbour.

The output current is collected by the last wire T₆, which acts as an anode. Owing to the narrow spacing between the target electrodes, no

The size of the received picture is thus made independent of the size of the cathode-ray tube.—*Baird Television, Ltd., and J. L. Baird.*

Trapezium Distortion (Patent No. 469,673.)

Owing to the different radial dis-

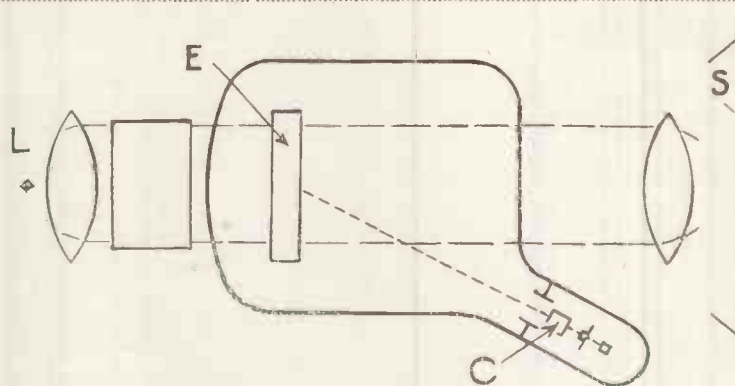

Electronic light relay. Patent No. 470,347.

special focusing is required to ensure that the stream passes in turn, from one to the other, on its way to the output anode T₆.—*Marconi's Wireless Telegraph Co., Ltd., and G. F. Brett.*

Scanning Systems

(Patent No. 470,347.)

The ordinary fluorescent screen of a cathode-ray television receiver is replaced by an electrode E which contains crystals of quinine sulphate in a colloidal solution. Normally the crystals are arranged higgledy-piggledy fashion, and are not transparent; but under the influence of the electron stream from the cathode C of the tube, they "set" themselves in such a way as to pass light from a lamp L on an external viewing-screen S.

The amount of light passed through the "crystal" electrode E depends upon the intensity of the electron stream, and since this is, in turn, controlled by the incoming signals, an image of the televised picture is thrown upon the screen S.

tances of the apertures in a scanning disc, and to similar effects when a mirror drum is used, the original rectangular outline of a picture is distorted into a trapezium or wedge-shaped area. This naturally causes a certain amount of distortion particularly near the margins of the screen.

The difficulty is overcome by giving the scanning aperture a real or apparent displacement during the process of scanning.

As shown in the figure the curved slots S on a scanning disc D are made to intersect with a slot S₁ on a fixed mask M, and the area so formed constitutes the effective scanning aperture. The slots S are suitably curved to correct for the type of distortion in question.—*Baird Television, Ltd., and J. L. Baird.*

Television Receivers

(Patent No. 470,920.)

When a set is fitted with an illuminated indicator dial there is a danger that the glow from it will dis-

The information and illustrations on this page are given with permission of the Controller of H.M. Stationery Office.

tract attention from the picture shown on the viewing screen.

To avoid this, the dial is located underneath the viewing screen, and the illuminated slit is set at such an angle to the cabinet that it can easily be seen by anyone operating the con-

than the ordinary horizontal type of broadcast aerial.

As shown in the drawing the two quarter-wave limbs A, A₁ of the aerial are connected to the receiving set by a coaxial feed-line F, the outer sheath of which is connected to the

A lightning-protector x is connected to the lower end of the limb A and is similarly bent out at right-angles to it so that it lies parallel to the feed-line. The lower end of the protector is, of course, earthed, but a bridge-piece Y is connected at such a distance that the two conductors form a rejector circuit of the Lecher wire type. This prevents the signal currents from being led away to earth.—K. H. Barbour.

Summary of Other Television Patents

(Patent No. 469,823.)

Method of making the mosaic-cell screens used in cathode-ray television transmitters.—H. E. Holman.

(Patent No. 469,907.)

Cathode-ray television receiver utilising the "afterglow" effect.—E. Michaelis.

(Patent No. 470,496.)

Method of concentrating the electron stream in a cathode-ray television receiver.—Radio-Akt. D. S. Loewe.

(Patent No. 470,729.)

Coupling circuits for an amplifier intended to handle a wide band of frequencies, such as are used in television.—Telefon-Akt. L. M. Ericsson.

(Patent No. 470,752.)

Generating saw-toothed oscillations for scanning by means of a back-coupled valve of the multi-grid type.—Telefunken Ges. für drahtlose Telegraphie m.b.H.

(Patent No. 470,785.)

Method of cutting out disturbing effects produced during the "fly-back" scanning movement in an electron camera.—Baird Television, Ltd., and V. A. Jones.

(Patent No. 470,885.)

Cathode-ray television receiver in which the glass contour is designed to prevent optical distortion.—Corning Glass Works.

(Patent No. 470,921.)

Method of winding and mounting a resistance wire for handling currents of the order of 50 megacycles.—Baird Television, Ltd., and L. R. Merdler.

(Patent No. 471,066.)

Scanning system utilising a light cell which is also subjected to transverse waves of supersonic frequency.—Scophony, Ltd., and G. Wikkenhauser.

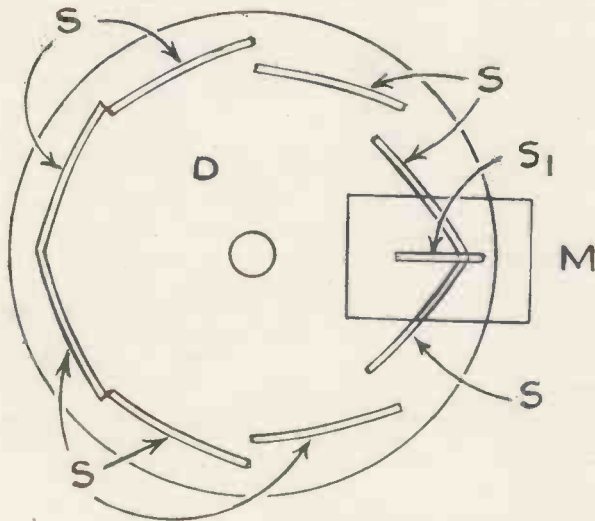

Method of preventing trap-
ezium distortion. Patent
No. 469,673.

trol knob, though it is screened from the eyes of an observer situated at the normal viewing distance from the screen.—Baird Television, Ltd., and L. R. Merdler.

Saw-Toothed Oscillators

(Patent No. 470,922.)

Scanning voltages for the electron stream of a cathode-ray tube are generated by a single pentode valve of which the first two grids are back-coupled. The main condenser is in the circuit of the control grid, and is charged up through a variable resistance from the H.T. source until the grid voltage rises sufficiently to set the pentode into oscillation. The oscillations last until the condenser is discharged, the frequency being stabilised by synchronising signals applied to the suppressor grid of the pentode.

The initial timing of the scanning voltage is adjusted by varying the resistance in the charging circuit of the condenser, whilst its amplitude is controlled by a second variable resistance included between the control grid and cathode.—Baird Television, Ltd., and D. M. Johnstone.

Television Aerials

(Patent No. 471,434)

Because of its exposed and elevated position, the dipole type of aerial used for receiving television is rather more open to danger from lightning

lower limb, and the centre wire to the upper limb, as shown. The feed line is bent away at right-angles, for a short distance from the point of connection to the aerial limbs.

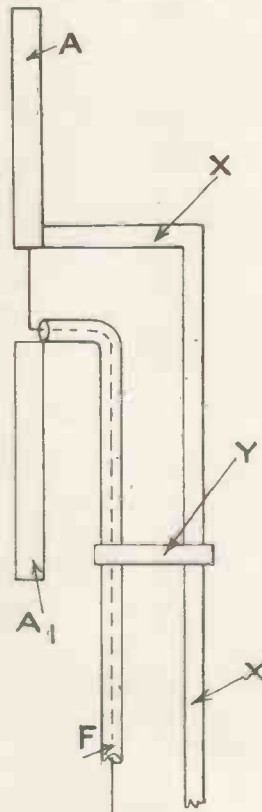

Television aerial. Patent No. 471,434.

The information and illustrations on this page are given with permission of the Controller of H.M. Stationery Office.

THE TUBE OF MANY USES

In this article G. Parr outlines the numerous applications of the cathode-ray tube apart from television reception and shows how it is one of the most useful aids in modern research.

THE uses of the cathode-ray tube are so many and so varied that it is now almost indispensable to the research engineer. It enables

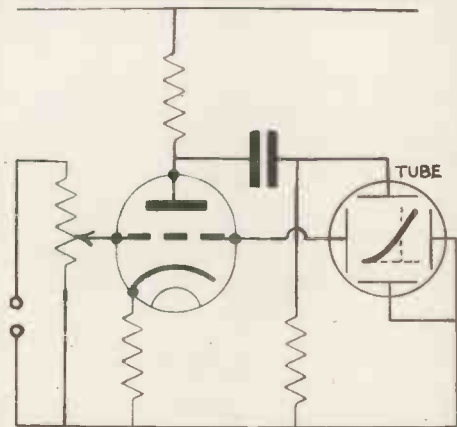

Fig. 1. Theoretical circuit for recording valve characteristic curves by a cathode-ray tube.

him to observe accurately phenomena varying at rates from several seconds to less than a millionth of a second, to record minute variations between two standards, to speed up production testing, and to do a host of other things which would formerly have required more elaborate and expensive apparatus.

Apart from radio there are uses for the tube in heavy engineering, motor engineering, physics, biology—in fact there is hardly a branch of

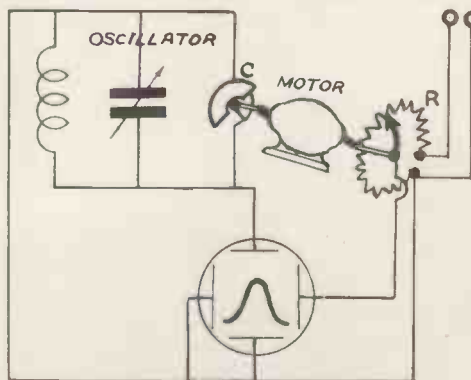

Fig. 2. How a response curve can be drawn on the screen. The resistance R is moved synchronously with the trimmer C.

science in which it cannot be found of use.

To appreciate the wide field of application it must be understood that

the cathode-ray tube is fundamentally a sensitive indicating instrument which is independent of frequency and which has no inertia—that is, it responds instantaneously to the slightest variation in the potential which is applied to its deflector plates. If the variation is too rapid to be followed by the eye a special compound on the fluorescent screen enables the movement of the beam to leave a mark which can be studied at leisure.

The power required to deflect the beam is negligible and hence the tube can be connected to circuits in which the presence of a load would upset the constants or affect the tuning. This, however, does not apply to very high frequency circuits in which the capacity of the deflector plates themselves is comparable with the capacities employed in the circuit.

The electrostatic deflecting system makes the tube a voltmeter, the deflection of the beam in either plane being directly proportional to the potential difference between the plates. Thus it can be made to indicate the peak value of the voltage in any circuit, the distance moved by the spot on the screen being calibrated by reference to a D.C. supply. The tube can then be used to show curves in which the vertical and horizontal scales are in terms of volts. If, as is more usual, one scale is to be in values of current, the deflecting voltage can be obtained across a resistance in the circuit and the scale converted to current by an appropriate factor.

For example, in investigating the characteristics of a rectifier circuit the horizontal plates can be connected across a portion of the load resistance, the resulting deflection being proportional to the load current if the resistance remains constant.

The dynamic characteristics of a valve can be shown on the screen by the circuit of Fig. 1. The grid voltage input is applied to the horizontal plates of the tube, amplified if necessary by means of a transformer, while the vertical plates are connected across the output of the anode circuit. The variation of input and output can then be observed by altering the swing applied to the grid.

In radio circuits it is frequently re-

quired to know the frequency response of tuning units, the voltage developed across the coil being plotted against frequency. This can be done by the cathode-ray tube if a relation between voltage and frequency can be obtained for the horizontal scale. The simplest method of doing this is by means of a condenser and resistance mounted on a common shaft. The condenser forms part of an oscillator circuit which is connected to the tuning circuit under test and the resistance is connected to the deflector plates of the tube (Fig. 2).

For each position of the condenser vane a known potential is applied to the plates from the moving arm of the resistance, and the horizontal

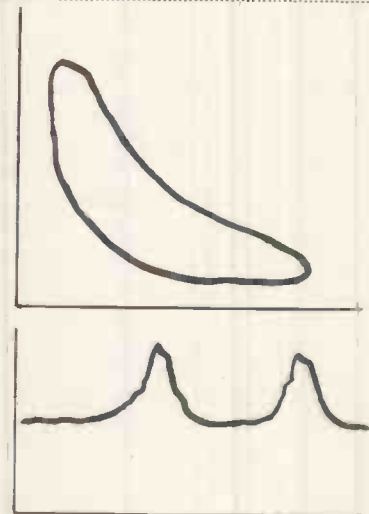

Fig. 3. An indicator diagram of an engine (top) and a curve of explosion pressure (below).

movement of the beam is thus proportional to the position of the condenser and to the frequency of the oscillator. This simple method has been developed into a precision instrument in which the frequency of the oscillator is varied several times a second within definite limits, the frequency response curve being drawn on the screen each time to present a continuous curve which can be accurately scaled.

When a linear time base is connected to the horizontal deflector plates the variations of potential from any source can be studied in relation to time. These variations may be of two kinds—recurring or non-recur-

ring. An example of the former is the familiar audio frequency waveform which appears stationary on the screen if the time-base is synchronised to the frequency of the input. Non-recurrent waves such as those of the spark occurring between points or transient impulses on power lines are observed with a time base giving a single sweep across the screen, the commencement of the sweep being

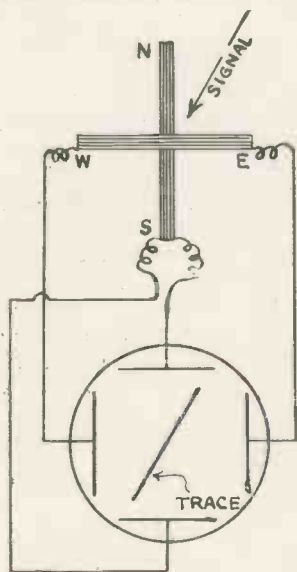

Fig. 4. Diagram to explain the use of the tube as a direction finder.

synchronised with the occurrence of the transient. It is in these cases that the recording camera is of use, the spot being focused on a strip of moving film or bromide paper. In such an arrangement the time base is, of course, unnecessary, the movement of the film providing the necessary time scale.

Engineering Uses

In mechanical and motor engineering the tube has been used to reproduce the conditions existing in a cylinder of an internal combustion engine when the mixture is fired. The pressure developed by the exploding gases is converted into potential difference by using a piezo-electric crystal or other arrangement for converting mechanical movement into electrical pressure. The curve on the screen can be made to show the variation of explosion pressure with time in a similar manner to waveform reproduction, or the tube can be made to show the "indicator diagram" of the engine. In this, the vertical scale is proportional to

pressure and the horizontal scale is proportional to the displacement of the piston in the cylinder. To obtain the latter scale the deflector plate potential is obtained from the movement of the crankshaft (Fig. 3).

In one form of engine indicator developed by the Cossor Co. the horizontal timing was developed from a cam attached to the shaft which was cut so as to vary an aperture between a beam of light and a photo-cell. The light falling on the cell was thus proportional to the movement of the shaft, which is in turn proportional to the piston displacement, and after amplification the cell output was used to provide the horizontal deflecting potential.

Another ingenious use of the photo-cell and the cathode-ray tube is in the recording of the light emitted from a lamp in various directions, obtaining the so-called "polar curve." In a method developed at the Brighton Technical College the light from the lamp is reflected into a photo-cell by a system of rotating mirrors. The spot is caused to rotate on the screen of the tube in synchronism with the movement of the mirrors and the variations of light intensity round the lamp are reproduced as indentations in the circular trace on the screen.

Direction Finding

Apart from industry, one of the most useful applications of the tube has been in direction finding and in the "radio-beacon"—the device which enables ships and aircraft to be steered on any course even though the visibility is obscured by fog. The theory of the tube direction finder is simple, depending on the fact that the movement of the beam is controlled by two deflecting forces at right-angles. If we imagine the plates of the tube to be connected to two frame aerials, as shown in Fig. 4, the voltage developed across each frame will depend on the angle at which the incoming signal arrives. The voltage is applied to the deflector plates through an amplifier and will thus be proportional to the strength of the input signal. The beam will accordingly be deflected into a position on the screen dependent on the relative strengths of the deflecting forces and the angle which the trace makes on the screen will indicate exactly the direction from which the signal is arriving.

A great deal of research has been done with direction-finding apparatus

in the investigation of atmospherics. The movement of the spot on the screen responds instantaneously to the arrival of an atmospheric disturbance and indicates from whence it came.

Medical Uses

In the medical field the cathode-ray tube has helped to diagnose disease and to keep a check on the efficacy of the treatment to be followed. It has been known for many years that nervous and muscular actions were accompanied by electrical impulses transmitted along the nerves, but their detection has been



Fig. 5. Typical tracing obtained from the electrical impulses of a nerve.

difficult owing to their very low value (some tens of microvolts) and the difficulty of amplifying and recording them.

With modern amplifying valves it is possible to obtain a magnification of several million and the output is then applied to the deflector plates of the tube.

For recording the electrical impulses developed by the heart, electrodes are strapped to the arm and leg and the wave observed with a linear time scale of slow speed. The average heart beat occupies 0.8 second and to enable this to be observed easily a slow-running time base is used with a screen having a long afterglow. The cardiogram then leaves a trace on the screen lasting several seconds, enabling it to be observed at leisure. If a film is used to obtain a photographic record the progress of disease can be studied and the effect of various stimulants on the heart's action.

The curve of Fig. 5 shows a typical tracing obtained on the screen from the electrical impulses in a nerve. The rhythmic nature of the bursts of impulses corresponds to the respiration.

It is not generally known that a sensitive cathode-ray tube can be used as a compass without any extraneous attachment!

If the tube is unshielded the beam is affected by the earth's magnetic field and hence will move according to the direction of the lines of force.

CATHODE-RAY TUBE TERMINOLOGY

Apparent Line Width: The apparent line width (the visible or recorded width of the moving spot) can be different from the apparent spot size of the stationary spot because screen luminescence is dependent upon the duration of excitation.

Apparent Spot Size: When the spot size is measured visually or from a photographic record, the resultant spot size is not necessarily the true spot size; therefore, the terms "apparent spot size" or "apparent spot diameter" should be used in such cases.

Beam Current: The current in the electron beam at the screen, usually measured in microamperes.

Beam Voltage: The instantaneous voltage of the electron beam at any point; usually referred to as the voltage of the beam at the point of deflection, where the beam voltage is substantially the same as the second anode voltage.

Candle Power-Distribution Characteristic: This characteristic shows how the candle power of a luminescent screen varies when the screen is viewed at different angles. When plotted it is invariably represented by a polar curve illustrating the luminous intensity of a cathode-ray tube in a plane of the tube axis and with the screen at the origin.

Deflection Sensitivity (Electrostatic): The ratio of the distance which the electron beam moves across the screen to the change in potential difference between the deflection plates; this is usually expressed in millimetres per volt. The sensitivity varies inversely with the beam voltage at the point of deflection.

Deflection Sensitivity (Magnetic): The ratio of the distance which the electron beam moves across the screen to the change in the flux density producing the motion. The sensitivity may be expressed in millimetres per gauss, but due to the difficulty in the determination of flux density, it is often more practical to express the sensitivity in millimetres per ampere-turn, or simply in millimetres per ampere. It varies inversely as the square root of the beam voltage at the point of deflection.

Defocused: A term used to describe a spot which is not optimum with respect to shape and size.

The following list of definitions are accepted in both this country (with slight modifications) and in America. The full list of British definitions in cathode-ray tube practice will be found in the B.S.I. Glossary of terms used in Electrical Engineering.

Efficiency, Gun-current: The ratio of the beam current to the current which leaves the cathode. This ratio, multiplied by 100, gives the gun-current efficiency in per cent.

Efficiency, Screen Actinic: The measure of the ability of a viewing screen to convert the electrical energy of the electron beam to radiation which affects a certain photographic surface. This term should be expressed in microwatts per watt, but is often expressed for ease of measurement in terms of actinic power per watt relative to a screen of well-known characteristics.

Efficiency, Screen Luminous: The measure of the ability of a viewing screen to produce visible radiation from the electrical energy of the electron beam. The efficiency should be measured in lumens per watt. For convenience of measurement, however, it is usually expressed in candle power per watt, because candle power is a measure of the luminous flux per unit solid angle in a given direction and can be converted to lumens where the candle power-distribution characteristic of the screen is known. It is the usual practice to measure candle power in the direction normal to the screen.

Efficiency, Screen Radiant: The measure of the ability of a viewing screen to produce luminescence from the electrical energy of the electron beam. The efficiency should be expressed in microwatts per watt, but due to the difficulty of making absolute measurements is more often expressed in radiant energy per watt relative to some screen of well-known characteristics.

Fluorescence: The luminescence emitted by a phosphor* during excitation. As applied to a cathode-ray tube, this term refers to the radiation emitted by the viewing screen during the period of beam excitation.

Line Width: The true width of the moving spot measured at right-angles to its direction of motion.

Luminescence: The term describing all forms of visible and heat-visible radiation which depart widely

from the black-body radiation law. It can be divided according to the means of excitation into many classes, such as: candoluminescence—the luminescence of incandescent solids; photoluminescence—the luminescence created by exposure to radiation; chemi-luminescence—the luminescence created by chemical reactions; electro-luminescence—the luminescence given off by ionised gas; bioluminescence—the luminescence emitted by living organisms; triboluminescence—the luminescence created by the disruption of crystals; crystallo-luminescence—the luminescence excited by emissions from radioactive materials; galvano-luminescence—the luminescence phenomena observed at electrodes during some electrolysis; cathode-luminescence—the luminescence produced by the impact of electrons, etc. In cathode-ray tubes, cathode-luminescence is principally involved; therefore, the luminescence of the screen is that radiation which is produced by the impact of the electron beam.

Luminescent Spot: The spot formed on the screen of a cathode-ray tube at the impact point of the focused electron beam.

Pattern Distortion: When the electron beam is moved by changing fields, a pattern is formed on the screen; the waveform of the spot movement will be identical with the resultant waveforms of the electrical phenomena producing these fields unless there is pattern distortion present. This distortion takes many forms, such as: amplitude, frequency, phase, brightness, persistence, spot size, etc.

Persistence Characteristic: The relation showing the brilliance of light emitted by a cathode-ray tube screen as a function of time after excitation. This characteristic is generally shown in a curve where relative brilliance as the ordinate is plotted on a logarithmic scale against time on a linear scale. "Relative brilliance" is used to denote luminous intensity per unit area evaluated in arbitrary units.

Phosphor: The solid material in the screen which produces luminescence when excited by the electron beam.

Phosphorescence: The luminescence emitted after excitation. As applied to a cathode-ray tube, this

(Continued on page 765)

* This term is more often used in U.S. than in this country.

CATHODE-RAY TUBE CHARACTERISTICS

References.	SIZE. Screen Dia. Approx.	MAKE	Type No.	Screen Colour.	Length m.m.		Heater Characteristics.		Max. Voltage. 3rd Anode.	Max. Voltage. 2nd Anode.
							Volts.	Amps.		
	1-INCH ..	R.C.A.	913	Green.	139	H.V.	6.3	0.9		
	2-INCH ..	COSSOR. DUMONT.	3277 24-XH	Blue. Green.	467 192	H.V. H.V.	0.6 6.3	1.25 0.6	3,000	600 600
* †	3-INCH ..	Marconiphone.	4/1	Green.	410	H.V.	4	1.3		1,000
		MULLARD.	E40-G3	Green.	165	H.V.	4	1		800
		R.C.A.	906	Green.	292	H.V.	2.5	2.1		1,200
		R.C.A. STANDARD.	906 4096AB	Blue. Blue.	202 260	H.V. H.V.	2.5 2	2.1 1.65		1,200 2,000
+ +	4-INCH ..	COSSOR.	3237	Blue.	345	Gas.	0.6	1.25	1,500	
		MULLARD.	A41-G4	Green.	349	H.V.	4	1.2		1,200
		STANDARD.	4050AG	Green.	330	Gas.	0.5	0.9		
§ 	5-INCH ..	COSSOR.	3273	Blue.	417	H.V.	0.6	1.25	10,000	2,000
		"	3232	Blue.	401	Gas.	0.6	1.25	1,500	
		"	3278	Blue.	490	H.V.	0.6	1.25	10,000	2,000
		"	3236	Green.	409	Gas.	0.6	1.25	1,500	
		EDISWAN.	5H	White.	450	H.V.	2	1.5		3,500
		R.C.A.	1801	Yellow.		H.V.	2.5	2.1		3,000
		"	904	Green.	407	H.V.	2.5	2.1		4,600
"	905	Green.	414	H.V.	2.5	2.1		2,000		
+ + +	6-INCH ..	COSSOR.	3276	White.	407	H.V.	0.6	1.25	3,000	600
		MULLARD.	E42-G6	Green.	450	H.V.	4	1		2,000
		STANDARD.	4063AW	White.	535	H.V.	2	1.85	6,000	1,800
§ 	7-INCH ..	EDISWAN.	7H	White.	510	H.V.	2	1.5	6,000	1,200
		STANDARD.	4050BG	Green.	460	Gas.	0.5	0.9		
 	9-INCH ..	EDISWAN.	9MH	White.	528	H.V.	2	1.5		
		Marconiphone.	6/5	White.	570	H.V.	4	1.3		6,000
		R.C.A.	903	Green.	518	H.V.	2.5	2.1		7,000
		"	1800	Yellow.	518	H.V.	2.5	2.1		7,000
+ + + 	10-INCH ..	EDISWAN.	10H	White.	560	H.V.	2	1.5	6,000	
		FERRANTI.	T10	White.	610	H.V.	2	1.5		
		MULLARD.	E46-G10	Green.	580	H.V.	4	1	5,000	1,700
		STANDARD.	4095AW	White.		H.V.	2	2	5,000	1,700
		COSSOR.	3241	White.	580	H.V.	4	0.9	5,000	1,000
** 	12-INCH ..	BAIRD.	12MW1	White.	570	H.V.	2.2	2.5		
		COSSOR.	3242	White.	670	H.V.	4	0.9	5,000	1,000
		"	3272	White.	655	H.V.	0.6	1.25	5,000	650
		EDISWAN.	12H	White.	660	H.V.	2	1.5	6,000	1,200
	"	12MH	White.	700	H.V.	2	1.5			
	FERRANTI.	T12	White.	610	H.V.	2	1.5			
	MULLARD.	E46-12	White.	660	H.V.	4	1	5,000	1,700	
	"	M46-12	White.	680	H.V.	4	1.2		6,000	
	Marconiphone.	6/6	White.	697	H.V.	4	1.3		6,000	
	 	15-INCH ..	BAIRD.	15/MW2	White.	850	H.V.	2.2	2.5	
FERRANTI.			T15	White.	700	H.V.	2	1.5		
MULLARD.			E46-15	White.	680	H.V.	4	1	5,000	1,700
"			M46-15	White.	750	H.V.	4	1.2	6,000	

* Long-persistence. † Short-persistence. ‡ Also in blue. § Also in blue and green.

BAIRD CATHODE-RAY TUBES

As Baird cathode-ray tubes are entirely electro-magnetic here are given the sensitivity figures together with the peak to peak volts for their 12 and 15-in. tubes.

CHARACTERISTICS OPERATING DATA ON OSCILLOGRAPH AND TELEVISION TUBES AVAILABLE IN GREAT BRITAIN

Max. Voltage. 1st Anode.	Beam Cut-off Voltage.	Operating Characteristics.					Modulator Earth Capacity. uuF.	Def. Plate Capacity.		PRICE.
		3rd Anode Voltage.	2nd Anode Voltage.	1st Anode Voltage.	Def-Sensitivity.			CD ₁ D ₁ ' uuF.	CD ₂ D ₂ ' uuF.	
					X1 and X2 mm/V.	Y3 and Y4 mm/V.				
500										1 17 6
250 300	-250 -60	3,000	600 500	250 100	0.12 0.17	0.12 0.19	10	11	11	8 8 0
200 300 400 400 400	-12 -30 -60 -60 -40		800 800 1,200 1,000 800-2,000	160 200 345 285	0.6 0.19 0.27 0.33	0.55 0.12 0.29 0.35	6.7	2.9	3.7	6 6 0 3 10 0
500 2,000	-150 -45 +15	600	1,000	400 350	0.5 0.39 260/V	0.4 0.28 280/V	9 6.5	5 4.5 3.2	5 5.5 3	5 10 0 6 15 0 5 5 0
300 300 400 1,000 1,500 600	-350 -150 -300 -150 -60 -140 -60	10,000 1,000 10,000 1,000	2,000 800 3,000 4,600 2,000	300 400 1,000 970 450	0.075 0.375 0.09 0.375 0.45	0.25 0.09 0.25 0.45	4.5 9 4.5 9 10 10	0.7 5 0.7 5 3	5 0.7 5 1.5	12 12 0 7 10 0 14 14 0 7 10 0 8 8 0
250 600 250	-200 -35 -25	3,000 5,000	600 2,000 1,350	250 400 150	0.13 0.32 650/V	0.12 0.26 650/V	10 12 15	11 6 5	11 7 3.5	8 8 0 8 8 0 8 10 0
400 2,000	-60 +15	3,500	1,200	250 350	0.12 440/V	0.12 440/V		3.2	3	10 10 0 6 10 0
6,000 1,000 2,000 2,000	30-60 -20 -120		4,000 7,000 7,000	4,500 800 1,360 2,000			12			9 9 0 11 11 0
5,000 250 250	-100 to 250 -50 -60 -30 -330	4,000 5,000 5,000	1,200 800 1,000	400 4,000 250	0.12 0.13 0.85 0.096	0.12 0.11	15 15 14	15 5.5 11	15 6.5 11	12 0 0 12 12 0 12 12 0
250 400	330 -250 -60	5,000 5,000 5,000 4,000	1,000 650 1,200	250	0.12 0.16	0.12 0.15	4.5 14 10	11 11	11 11	12 12 0 15 15 0 15 15 0
6,000 5,000 250 250 1,000	-30 to 60 -50 -60 -60 -20	5,000 5,000	1,400 5,000 4,000	250 5,000 4,000 250 250 800	0.17 0.17	0.17 0.13	15 6.0	15 5.5	15 6.5	15 15 0 13 13 0 15 15 0 12 12 0 15 15 0
5,000 250 250	-20 -50 -60 -60	5,000	1,400 5,000	6,500 4,000 250 250	0.15	0.13	2 15 6.0	5	4	15 15 0 21 0 0 15 15 0

|| Magnetic. || Combination of electrostatic and magnetic. ** Also green.

VISOR TUBES.

Type	Electro-magnetic sensitivity	Peak to peak volts
12 M.W.1	2 m.m./A.T.	14
„ 15 M.W.2	2 m.m./A.T.	16.5

Telegossip

By Lumen

An Outsider's Impressions

RECENTLY I had a long chat with Mr. Imago Gomez, Director of *Radio Revista* and *Ciencia Poupilar*, two well-known South American journals. Mr. Gomez has been touring Europe and the United States for the express purpose of studying the television situation in different countries at first hand. His impressions, as an outside observer, therefore, are of value and interest. He was greatly impressed by the state of development that had been reached in this country and he contended that we were far ahead of anything which he had seen elsewhere either in Europe or America.

On the Continent

In Germany there was considerable reluctance on the part of the concerns engaged in television development to give any demonstrations and when eventually they were prevailed upon to do so the demonstrations were under laboratory conditions and the results were comparatively poor. He formed the opinion that although the scanning frequency (441 lines) was higher than we have here there was such considerable loss in various directions that the picture detail was only equal to 180 lines. In the course of his tour of these concerns, which included Fernseh and Telefunken, there was a great amount of secrecy and officialdom and he was invariably accompanied by officials who kept a very watchful eye upon him. Of course, the Germans may have more up their sleeves than they were prepared to show Mr. Gomez, but he came away with the idea that what has been accomplished in Germany has been staged for propaganda purposes and that the Germans are a long way from any real practical development. It is an interesting point that this impression obtained at the time of the Berlin Exhibition. Estimates of receiver costs, such as he saw, were round about £80.

In Paris he was also disappointed with the results that are being obtained though the system now being used is very similar to our own—that

is Iconoscope cameras are being used though there is a difference in the synchronising method which does not appear very satisfactory. Until recently the new Eiffel Tower transmitter has been operating experimentally on a power of three kilowatts, which has lately been increased to five. Synchronising, even at short distances—that is, three or four miles—is unstable and picture quality is poor. The impression was formed that the French engineers are as yet lacking in practical experience in receiver design and in some of the fundamentals of transmission.

Developments in America, he thinks, have reached a more advanced stage than either in Germany or France, but here again all demonstrations were under laboratory conditions, and American methods as used up to the present are not so good as ours, a point which is borne out by the report of American engineers on the British system, which appears on another page of this issue. Allowance must, of course, be made for the fact that there is no regular schedule operating in these countries and that in some cases the demonstrations were purposely arranged, but even so, Mr. Gomez is of the opinion that we in this country have obtained a very substantial lead.

British Television

On another page in this issue is a report from two American engineers who have investigated British television at close quarters and have some very complimentary things to say about it. Certainly it is difficult to understand why the American systems are not unanimously in favour (or favor) of D.C. working seeing that it is so successful. When Dr. P. C. Goldmark, of the Columbia Broadcasting system, was over here he was very much impressed by the B.B.C. transmitter, and it is probable that his recommendations will be based on what he has seen. One

of his assistants is Mr. J. C. Wilson, late of Baird and Ferranti, whose book has recently been published. Dr. Goldmark did a lot of work on an optical television system of his own invention at one time, but no doubt it has been temporarily displaced by the cathode-ray tube.

"Televisione"

A new journal has made its appearance in Italy with the above title containing articles in French, German and English, besides Italian. von Ardenne has contributed an article to the first issue on the possibilities of utilising ultra-short waves, and points out that seven years ago he proposed to transmit simultaneously on the same short-wave carrier several other carrier frequencies modulated with different acoustic frequencies.

This scheme was not pursued at the time owing to lack of experience of ultra-short wave technique, but it is worth development in the light of modern research experience.

With a slight knowledge of French and Latin it is quite easy to get the gist of the Italian articles, and one giving the Italian equivalents of British and American television terms is worth quoting:

"Pairing-off"—*espressione usata per indicare il difetto che si verificata quando nell'analisi alternata, le linee non sono egualmente distanziate.*

"Retrace Time" (Flyback)—*tempo che passa tra la fin di un'analisi verticale e l'inizio della successiva ovvero fra la fine dell'analisi di una linea e l'inizio della successiva.*

Pretty, isn't it?

Technical Hitch

What a pity the B.B.C. should have had one of their rare technical hitches on the night of Messrs. Jesty and Winch's paper to the Television Society. They were just demonstrating the effect of an illuminated surround on the tube screen when one of those depressing blanks occurred accompanied by gramophone records. It is quite a long time since the B.B.C. have had a hitch, so we cannot grumble. One happened to synchronise with a visit of members of the Women's Electrical Association to the works of one of the cathode-ray tube manufacturers, and after a long and careful explanation of the marvels of television they were rewarded with the spectacle of a blank screen

READ TELEVISION
& SHORT-WAVE WORLD
REGULARLY



Osram Valves

MADE IN ENGLAND.

INTERESTING NEW TYPES FOR
THE SHORT-WAVE AMATEUR
TRANSMITTING FIELD

NO. **1. TYPE PT5**

A Radio Frequency Transmitting Pentode, is suitable for use as an Oscillator, Radio Frequency Amplifier, or Frequency Multiplier, and for use on Telephony it may be modulated by the anode, control or suppressor grids.

The anode is brought out separately through the top of the bulb to ensure low interelectrode capacities.

TYPE PT5 may be operated :

(1) As a Class "C" amplifier for telegraph transmissions with a control grid bias approximately 100 volts negative, a peak radio frequency output of 140 volts being required from the driver.

(2) As a suppressor modulated Class "C" amplifier for telephony transmissions.

For a modulation depth of 100 per cent. a negative bias of 60 volts should be applied to the suppressor, requiring an L.F. input of 75 volts R.M.S.

(3) As an electron-coupled self-oscillator.

G1 and G2 are employed as the grid and anode of an R.F. oscillator, and the load circuit is connected to the anode.

CHARACTERISTICS — TYPE PT5

Filament Voltage	...	4.0.
Filament Current	...	1.7 amp. approx.
Anode Voltage	...	1,250 max.
Screen Voltage	...	300 max.
Anode Current	...	32 mA.
Screen Current	...	6.0 mA. approx.
Anode Dissipation	...	40 watts max.
Screen Dissipation	...	10 watts max.
Mutual Conductance	...	4.0 mA./Volt ; measured at Ea. = 1,250, Es. = 300, Anode Dissipation 40 watts.

PRICE EACH **£8 - 5 - 0**

Write for technical leaflet including characteristic curves

For your Bookshelf



"The All-Metal Way, 1938" is an invaluable addition to the library of every experimenter, containing as it does chapters on the operation of A.C. mains and universal Radio; mains supply of H.T. and L.T.; energising moving-coil loudspeakers from A.C. mains; trickle charging; the use of Westectors for detection, A.V.C. and battery economy; metal rectification for television and other high-voltage circuits, &c., &c.

Write for your copy to-day, to Dept. "T," enclosing 3d. in stamps. :: ::



METAL RECTIFIERS

WESTINGHOUSE BRAKE & SIGNAL CO. LTD.,
82, York Road, Kings Cross, London, N.1.



THE SOLUTION
TO UNSTABLE
SUPPLY
VOLTAGE

The Stabilovolt tube is a voltage dividing potentiometer and voltage regulator. The voltages tapped are independent to a precision of about .1% from the supply current variations, 1-2% from the varying one another. Currents tapped, .01% from voltages of unlimited values subdivided into parts of 70 volts each. Light weight, small size, simple and safe in operation. Stabilovolt tubes from £1.16.0. to £62.10s. to £17.6. Full particulars from:—

MARCONI'S
WIRELESS TELEGRAPH CO. LTD.
Electra House, Victoria
Embarkment, London,
W.C.2.

S.3b



PIEZO QUARTZ CRYSTALS

A CERTIFICATE OF CALIBRATION GIVING THE ACTUAL FREQUENCY CORRECT TO PLUS OR MINUS 0.1% IS SUPPLIED WITH EACH CRYSTAL.

A Q.C.C. CRYSTAL AND HOLDER

Are Specified for the
SINGLE VALVE 240B TRANSMITTER

1.7mc., 3.5mc., and 7mc. Bands.

STANDARD TYPE— (For use with up to 300 anode volts).	15/-	POWER TYPE—(For use with up to 500 anode volts).	20/-
--	------	--	------

100 Kcs. Quartz Bars within plus or minus 25 cycles, £1

Q.C.C. CRYSTAL HOLDERS

Type A.—An open type holder,
for general experimental use,
Keramot base. Price 4/6.

Type B.—A totally enclosed dust-
proof holder of the plug-in type,
instantly interchangeable. Price,
with base, 8/6. Postage paid
to all parts of the world.



Send for a copy of our Catalogue "T.S." 1½d. Post Free.

THE QUARTZ CRYSTAL CO., LTD.

(G2NH & G5MA)

63 & 71 KINGSTON ROAD, NEW MALDEN
SURREY Telephone: Malden 0334

The 240-B Transmitter

We have had so many requests for details of this transmitter which was originally published in November, 1936, the issue of which is now out of print, that we have had to republish. The components have been modified in view of later developments, so that the transmitter now represents an ideal means of gaining knowledge of radiating by the beginner.

BESIDES providing a considerable amount of amusement, this little one-valve transmitter can be treated very seriously, for it has quite a wide range on either C.W. or phone. The original tests were entirely satisfactory, R7 reports being received over a distance of 30 miles. Subsequent

mitter from advance information supplied and have had every success with it. They have, of course, obtained an artificial aerial licence which enabled them to make all their adjustments to experiment with voltages and values of grid leak so as to obtain maximum radiation, and in fact to gain a working

gives good quality on phone and actually can be used by the serious experimenter with a full radiating licence on most of the amateur bands.

The Circuit

A rough check on the circuit will give some idea as to how the transmitter is arranged. The Class B valve, actually a Cossor 240B, is used as an oscillator and modulator. This valve is a twin triode with a common filament and designed for Class B operation. As can be seen from the circuit one triode section is used as a low-frequency amplifier. A high-output microphone is fed into the primary of a 70-1 microphone transformer which supplies an appreciable voltage to the grid of the triode section. Energising voltage for this microphone is obtained from the filament supply, so that one switch only is used to cut out the transmitter, modulator and energising voltage.

The second triode has in its grid circuit a quartz crystal of the frequency required. This actual unit has a crystal with a frequency of 7,100 kc, which is right on the edge of the amateur band, so missing most of the interference which one experiences with a crystal in the middle of the band.

This point is rather important if satisfactory results are to be obtained with low power. If, on the other hand, the transmitter is to be used on different wavelengths, the crystal should be ground to the band required, while the coil will have to be altered with regard to inductance, to match up with the crystal frequency chosen.

The crystal is anchored down to earth, but across it is a 1-watt, 20,000-ohm resistance to provide bias for the transmitting side of the 240B.

Power Supply

20,000 ohms gave the greatest output with 150 volts high-tension, but if the high-tension can be increased, the grid resistance should be increased to correspond. This resistance is the only variable quantity in the entire transmitter, and it will pay to vary it to obtain best results. In fact it will pay to use a variable resistance in this position until the correct value has been obtained, when it can be replaced with a fixed resistance of the value determined by using the variable resistance.

Making the Coil

The coil is rather special. It uses a length of screwed low-loss former made by Peto-Scott. This is suitable for use



In this transmitter the coil is mounted on the panel but gapped about half-an-inch with two small pillars. Similarly with the valveholder, which is of the ceramic chassis type, this is mounted off the baseplate on two stand-off insulators. The crystal, seen on the right-hand side, should be of the wavelength on which the operator intends to work.

tests with a tapped-on aerial have enabled us to work French and Belgian stations QSA5.

This does not sound particularly good, but it must be remembered that the entire transmitter, which includes what is virtually a speech amplifier, can be run from a standard H.T. battery or mains unit, for the total current consumption is between 10 and 15 m/A.

None of the components are of a special type and most of them can be obtained from any good radio dealer.

Home-made Coil

The coil is home constructed and is made in such a way that it can be wound and completely finished in less than five minutes by even the most inexperienced constructor. Altogether there are only eight or nine components that have to be mounted and as the entire baseplate is only 6 in. by 7 in., there is no need for us unduly to stress the simplicity of this little transmitter.

Some schoolboys made up this trans-

knowledge of how a simple crystal oscillator functions.

For that reason, we realise that this unit will have a very big appeal amongst youthful experimenters as for the first time it will enable them to build a simple transmitter with less trouble than it takes to construct the average short-wave receiver. Even though only one double valve is used, the apparatus is crystal controlled,

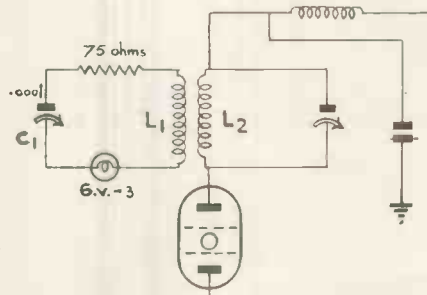

The dummy aerial is made up in this way, and L1 and L2 should be fixed.

Crystal Control :: Phone or C.W.

right down to 10 metres. It is wound with 18 turns of 12 gauge tinned copper wire and is mounted, as can be seen from the illustration, directly on to the panel above the variable condenser. Two little bushes made from wander plug heads just space the coil off the panel by about $\frac{1}{4}$ in.

Three tappings are made on this coil, one being in the centre, others being made equal distances between centre and end. But more about these tappings later.

The H.T. side of the coil is connected to a high-frequency choke and by-passed to earth by a .001 mfd. condenser. Without this condenser, the transmitter will refuse to oscillate. Also, if a different type of high-frequency choke is included, make sure that it does not resonate at the frequency of the crystal. This choke is soldered directly on to the last turn of the coil, so making the connections short and rigid. The H.T. side of the choke is then fed into the low-frequency choke, to which is connected also the output from the modulator. In this way the speech currents are impressed on the carrier, so giving modulation.

The percentage of modulation depends on the output from this modulator valve, but with 150 volts, ample output is obtained.

Output

On 40 metres the transmitter has an input of about 3 watts and about 2 watts on 20 metres. This may not sound very much, but it is surprising just how much can be done with this low power providing conditions are reasonably good and the interference is not too bad.

Those who are going to use a dummy aerial should make up two coils, the second one being without any tapping

even with low-power such as in this instance, it is essential to use a dummy aerial. Do not obtain the wrong impression that a dummy aerial is of little value, for, if correctly used, a great deal of information and experience can be gained without interfering with other transmitting amateurs on the air when bad transmissions are radiated.

This 240B Transmitter can quite

that is tuned so that the anode current flowing in the circuit drops to minimum, the dummy aerial should be coupled and tuned to give the maximum light.

When this position has been obtained, fix the aerial permanently and then everything is ready for comprehensive tests to be made for example, the value of the resistor across the crystal, which is nominally 20,000 ohms, may not quite be correct for the particular valve used.

On the left-hand side is the main switch with the single tuner in the centre and the microphone jack to the right. The tuning drive is not geared owing to the use of a very low capacity condenser.

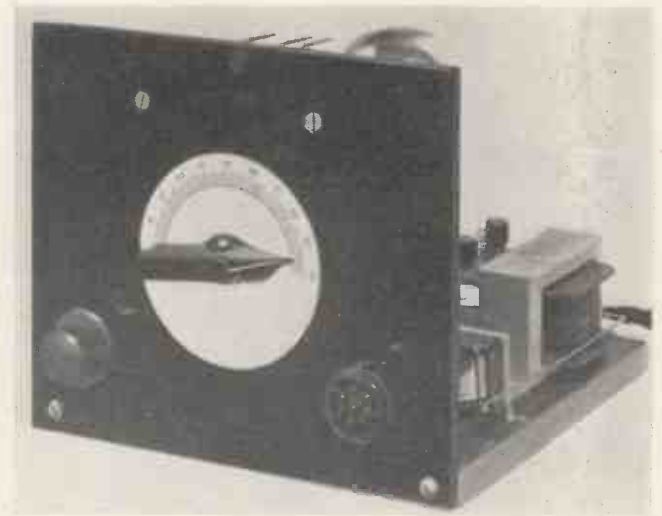

easily cause a lot of interference to other stations on the 40 metre band if it is operated incorrectly or in an unstable condition. So before attempting to radiate make all tests on a dummy aerial. This aerial should be loosely coupled to L₂, as shown in the theoretical circuit and then it has more or less the same characteristics as an elevated aerial. Adjustments of all kinds can be made and the effect noted by an increase or decrease in brilliance of the 6 volt .3 bulb.

In the original circuit this was the most suitable value, but valves vary so that the resistance may need some modification. Then as regards bias in the L.F. amplifier, officially the 240B does not require any bias, with certain specimens $1\frac{1}{2}$ volts greatly improves the quality. Then, of course, those who use different types of Class B valves may pick upon

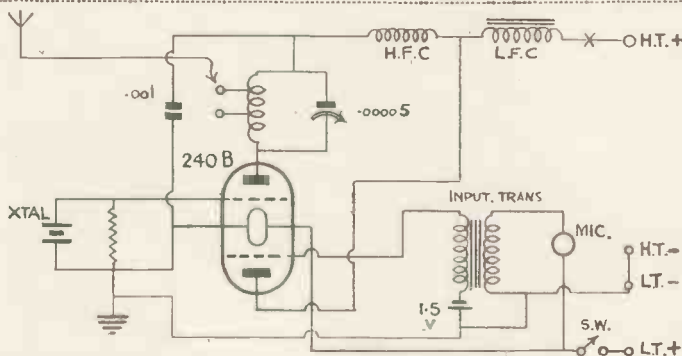

The wavelength on which this transmitter operates is governed by the coil and crystal, but the output is adequate for all normal purposes on 160 and 40 metres. It has been used on 20 metres, but owing to the fragility of crystal it is not to be recommended for beginners to try.

points. This second coil has to be tuned and should have in series with it a small flash-lamp bulb. It must be mounted end-on to the anode coil, roughly tuned to resonance, and then tests made to give maximum light in the bulb.

Whenever making tests or experimenting with transmitting apparatus,

It will be appreciated that if the dummy aerial is not accurately fixed then variations in coupling can occur, in which circumstances all information obtained loses its value. L₁ is almost identical to L₂ with the exception that it is not necessary to have any tapping point. With L₂ adjusted to resonance,

Components for THE SINGLE VALVE 240B TRANSMITTER

- BASEBOARD AND PANEL.**
1—Steel Panel 6 in. by 7 in. by $\frac{1}{4}$ in. (A.P.A.)
1—Steel Chassis 7 in. by 6 in. by $\frac{1}{4}$ in. (A.P.A.)
- CHOKE, HIGH-FREQUENCY.**
1—Type SW68 (Bulgin).
- CHOKE, LOW-FREQUENCY.**
1—Type HT35 (Wright & Weaire).
- COILS.**
2—To specification in text (Peto-Scott).
- CONDENSERS, FIXED.**
1—.001-mfd. type 690W (Dubilier).
- CONDENSERS, VARIABLE.**
1—.0005-mfd. type Apex (Webb's Radio).
- DIAL.**
1—Type 1027 (Eddystone).
- HOLDER, VALVE.**
1—7-pin type SW 51 (Bulgin).
- RESISTANCE, FIXED.**
1—20,000-ohm type 1-watt (Erie).
- SUNDRIES.**
1—Jack type J2 (Bulgin).
1—Quartz Crystal for 7 MC. with holder (Q.C.C.).
- SWITCH.**
1—Type S91 (Bulgin).
- TRANSFORMER MICROPHONE.**
1—Type LF35 (Bulgin).
- MICROPHONE.**
1—Type transverse current (Premier Supply Stores).
- VALVE.**
1—Class B type 240B (Cossor).

(Continued on page 744)

A T-125 Output Stage

This amplifier has been designed for those who are going to use the new T-125 triode. The amplifier has been designed by W9LIP of the Taylor Tube Co. Inc.

A NEW valve has just made its appearance in this country from America and from preliminary information appears to have numerous uses that can be applied to amateur radio. This valve, the Taylor T-125 triode, is rated for 125 watts anode dissipation and has a carbon-tantalum anode.

There are still a number of amateur experimenters in this country who prefer a single-ended amplifier to push-pull owing to the fact that possible diffi-

Slope, 4.4 m/a per volt.
Amplification factor, 25.
When operated as a Class C amplifier the following conditions should be observed:

Maximum anode voltage, 2,000.
Maximum D.C. anode current, 200 m/A.

Maximum D.C. grid current, 60 m/A.
Maximum R.F. grid current, 10 amps.

R.F. output, 300 watts.

Efficiency, 75 per cent.

At the rated anode dissipation of 125

stage. The values recommended hold good for both anode neutralised single-ended and push-pull amplifiers, operated with 2,000 volts on the anode and 200 m/A. per valve. It will, of course, be appreciated that varying operating conditions will call for a slightly different tank capacity which can be calculated because it varies inversely as frequency and applied voltage and directly as the anode current.

The recommended tank capacities are as follows:—

1900 kc. 137 mmfd. 14200 kc. 18 mmfd.
3750 kc. 70 mmfd. 28500 kc. 9 mmfd.
7150 kc. 36 mmfd. 58000 kc. 5 mmfd.

Under these conditions with maximum input the efficiency should be approximately 75 per cent. and the output approximately 300 watts. Automatic bias is recommended and is 4,000 ohms for one valve, or 2,000 ohms for a push-pull stage. For C.W. or buffer operation the rectified grid current is approximately 30 m/A. or 50 m/A. when phone modulated. Under no conditions must the rectified grid current exceed 60 m/A. in order to prevent grid heating.

Approximately 10 watts of grid drive are required for efficient C.W. or buffer amplifier operation, or 20 watts for phone operation. For those who are at present using the 03A should note that the T-125 is interchangeable with that valve with the exception of neutralising condenser capacity.

The T-125 has the anode taken to the top cap with the grid brought out to the side of the bulb. This enables a stage to be built with the minimum amount of loss, such as the one described in these pages. This amplifier shows the best way of building an amplifier using the T-125 or other highly efficient low-capacity valves of a similar type. For example, those who are interested in the low-power T-20 could use this suggested amplifier with only the very minimum of alteration.

The complete output stage with filament transformer and auto-bias resistor can be accommodated on a chassis 17 in. wide and 13 in. deep. The valve is mounted in a Johnson socket, actually on to the chassis and there is no need to worry about arc-over, for both anode and grid have been removed from the base.

A filament transformer, preferably of the shrouded type, is mounted in the left-hand corner of the chassis, and under the chassis is R₂, the 4,000-ohm bias resistor. In this stage there is no need to worry about a special grid coil, for a conventional 4-pin plug-in coil with a ceramic base will do excellently. It is, however, important to mount the



This lay-out is most effective and provides the maximum possible efficiency.

culties are halved, while only one neutralising condenser is required. For such amateurs the T-125 should be of particular interest, for with its rating of 125-watts dissipation it is capable of 400 watts input, for those who want such high power.

It is of the low-capacity type and has the commendably high gain factor of 25 with an A.C. resistance of 5,700 ohms. Neutralising is particularly simple and an approximate capacity of 4.5-mmfd. is required. Tantalum fins have been embodied in this valve so that it is more efficient than many other valves, of a similar inter-electrode capacity, on the higher frequencies. These fins project inwardly towards the grid and filament, effectively producing the needed characteristics of higher-capacity valves without increasing the effective capacity. General characteristics are as follows:—

Filament voltage, 10 volts.

Filament current, 3.85 amps.

A.C. resistance, 5,700 ohms.

watts and with an efficiently designed amplifier stage the carbon-anode does not show any trace of colour, but if it should do, switch off immediately and look for the lack of efficiency in the circuit. Under normal operating conditions, however, the tantalum fins operate at a bright orange colour.

In order to obtain maximum efficiency the tank condenser should have a specific capacity depending on the frequency at which the valve is being operated. In addition the tank coil should have the maximum inductance it is possible to obtain. If the value of the tank condenser is too high this will give a lower tank impedance and a slightly lower degree of efficiency, but the harmonic content will also be less, giving better linearity with a modulated stage.

A low-capacity tank condenser gives slightly better anode efficiency, but there will not be any appreciable difference in fundamental output. The harmonic contents will also be higher with poorer linearity in the modulated

300 Watts Output :: 5-band Operation

grid tuning condenser, T₁, that has a capacity of .0001-mfd., off the baseboard on stand-off insulators. This enables one side of this condenser to be taken directly to the grid pin on the valve holder, which as previously mentioned, comes out to the side of the bulb.

The neutralising condenser is similarly mounted, and if fixed in the position shown will enable the grid lead to be about 1 in. in total length. The anode contact to the neutralising condenser is also very short and goes to one end of the anode tuning condenser. A point to remember is that the contact from the neutralising condenser and from the tank coil, L₃, which both go to the same set of plates on C₂, should be connected at the same point. It does make leads shorter if the neutralising condenser is connected to one side of the plate, and the tank coil to the other, but this upsets the circuit and is not to be recommended.

A special wide-gap condenser is required for C₂, and we suggest the Eddystone type 1078, which is a split-stator having a capacity of .0001-mfd. However, a standard .0001-mfd. Caldwell is recommended by the Taylor Tube Co., and this can be obtained from Messrs. Webb's Radio. Particular care must be taken in building the tank coil. We recommend that it be wound on a ceramic National former and mounted well off the baseplate on stand-off insulators. The coil dimensions are as follows:

COIL CHART.

Band.	L ₂	L ₃
160	46t. No. 18. 2½ in. diameter close wound.	60t. No. 12. 3 in. diameter. 5 in. long.
80	26t. No. 18. 1½ in. diameter close wound.	30t. No. 10. 3 in. diameter. 4 in. long.
40	12t. No. 18. 1½ in. diameter close wound.	20t. No. 10. 2½ in. diameter. 4 in. long.
20	8t. No. 18. 1½ in. diameter. 1¾ in. long.	12t. No. 10. 2½ in. diameter. 4 in. long.
10	6t. No. 14. 1½ in. diameter. 1¾ in. long.	6t. No. 10. 2½ in. diameter. 4 in. long.

L₁ should be one or two turns at the cold end of the coil, the spacing to be determined experimentally. L₄ is one or more turns at the centre of the coil, the exact number depending on the impedance of the aerial system.

The stage has been built as symmetrical as possible, both mechanically and electrically. Neutralising should hold over a wide range of frequencies, while the use of a single valve is less likely to cause parasitic oscillation.

Components for A T-125 OUTPUT STAGE

- CHASSIS.**
1—Steel finished black 17 ins. by 13 ins. by 3 ins. (A.P.A.).
- CHOKES, HIGH-FREQUENCY.**
1—Type CH-500 (G5NI Ltd.).
- COIL FORMS.**
4—Ceramic type 4-pin HF₄ (G5NI Ltd.).
1—Ceramic type 4-pin HF₄ 2½-in. dia. (Webb's Radio).
- 2—Ceramic coil forms grooved and ribbed 3-in. dia. (Webb's Radio).
3—Ceramic coil forms grooved and ribbed 2½-in. dia. (Webb's Radio).
- CONDENSERS, FIXED AND VARIABLE.**
1—.0001-mfd. type 1082 (C₁) (Eddystone).
1—.0001-mfd. type 1078 (C₂) (Eddystone).
1—.002-mfd. type tubular 1,000 volt working (C₃) (Dubilier).
1—2-12 mmfd. type 1067 (C₄) (Eddystone).
1—.006-mfd. type tubular 1,000 volt working (C₅) (Eddystone).
1—.005-mfd. type tubular 1,000 volt working (C₆) (Eddystone).
1—.002-mfd. type mica 5,000 volt (C₇) Webb's Radio).
- HOLDERS, VALVE.**
1—4-pin type ceramic chassis (Webb's Radio).
1—50 watt socket type Johnson (Webb's Radio).
- METER.**
1—0-500 M/A Moving Coil type 2 in. (Ferranti).
1—0-50 M/A Moving Coil type 2 in. (Ferranti).
- RESISTANCES, FIXED.**
1—4,000-ohm type 20 watt (R₁) (Premier Supply Stores).
1—200-ohm type 20 watt (R₂) (Premier Supply Stores).
- TRANSFORMER FILAMENT.**
1—Shielded type 10V. 6.3A. (Premier Supply Stores).
- VALVE.**
1—Taylor T-125 (Webb's Radio).
- SUNDRIES.**
7—Stand-off insulators type 1049 (Eddystone).

Because the maximum to minimum capacity ratio of tuning condensers large enough to handle the voltages involved is rather small, 55 to 14, or ap-

proximately 4/1, it is necessary to compromise somewhat on the L/C ratio at both ends. The L/C ratio on 80 metres is somewhat higher than the optimum value for good linearity, and on 10 metres is somewhat lower than the optimum value for best efficiency. A compromise has been selected and satisfactory results should be obtained if resonance is reached on 80 metres with the condenser as close to maximum capacity as will permit of proper tuning. On

10 metres the inductance should be increased so that the minimum possible tuning capacity is employed. As regards components, the recommended types and values are given in the list in this page. R₁ and R₂ should be at least 20 watts rating, while C₃, C₅ and C₆ are 600-volt working. C₇ should be capable of withstanding 5,000 volts, while the radio-frequency choke should be of the multi-section type capable of passing a continuous current of 500 m/A.

The T-125 amplifier stage can be link-coupled to almost any transmitter that already has an output of 20 watts, and it will operate satisfactorily on five wavebands. As we realise that the demand for high inputs is not great it should be realised that the most important feature of this amplifier is the particularly good and efficient design.

"The 240—B Transmitter"

(Continued from page 742)

one which is of the biased type, in which case adjustments will have to be made in the grid circuit.

It is also advisable to use as many turns as possible on L₁ and to have the parallel tuning condenser at least half out of mesh. In this way maximum efficiency will be obtained.

It is also a good point temporarily to

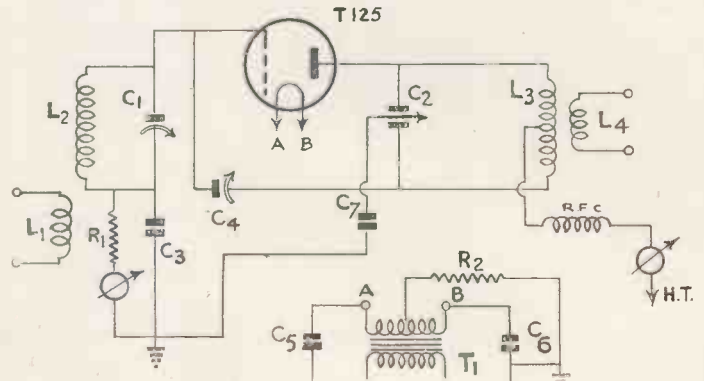

The suggested circuit for use with the Taylor T-125. It is suitable for 5-band operation down to 10 metres.

connect a milliammeter reading 0/60 or 0/100 M/A at the point marked with a cross in the circuit diagram. The positive side of this meter goes to H.T. positive and the negative side to the low-frequency choke.

One final word of warning, before this transmitter is constructed a licence must be obtained from the G.P.O., Radio Division, The Office of the Engineer-in-Chief, Armour House, Aldersgate Street, E.C.1.

With the Amateurs

By G5ZJ

This feature is in response to requests from our amateur readers. We shall appreciate information from radio societies for publication each month.

FOR those amateurs who use phone the most interesting news this month is the new regulations in ZL. Until just recently no New Zealand stations were allowed to use telephony in any circumstances, but the N.Z.A.R.T. have at last persuaded the postal authorities to grant licences for telephony operation on the 20 metre amateur band. There are, however,

been entirely rebuilt and the first photograph of the new equipment is shown in this page.

W9DXX operated by Alice R. Bourke, has been off the air for several months, but during that time three new transmitters operating on three wavebands have been built and installed. Looking from left to right, the first transmitter operates exclusively on 10

station G2VV at St. Margarets-on-Thames. J. N. Roe, the owner and operator, is shown in this page, and he has sent me some interesting details of his present transmitter. An input of 50 watts is used and the transmitter comprises a crystal oscillator, frequency doubler and final amplifier. It is keyed in the frequency doubler stage, while the entire equipment can be operated on 28, 14 and 7 Mc.

Receiving equipment is very simple, but in view of the DX worked is apparently most efficient. It consists of a battery operated detector and pentode coupled to the transmitting voltage fed Hertz aerial.

This station was first licenced in 1929, and is now licenced for all amateur wavebands. Although W.A.C. and W.B.E. certificates have been obtained, these contacts were made with a self-excited oscillator running from dry batteries with an input of under 10 watts.

It appears as if the more recently licenced amateur stations are keen on commercial-looking equipment. G2AI is a very good example of this, while his results more than come up to the professional appearance of the equipment. This station, operated by Leslie Gregory from Mill Hill, is very well known on the 7 Mc band, and is rapidly acquiring an international reputation on 14 Mc. The transmitter consists of an RK39 crystal oscillator, capacity coupled to a second RK39 as coupler or sub-amplifier, which is in turn link-coupled to a T20 running with an input of 25 watts.

Phone is principally used and the speech equipment consists of a transverse current microphone feeding into a 30, 32, AC/HL, MH4 and a 50-watt PX50.

A Windom aerial is used, being half-wave on 40 metres, and full-wave on 20 metres. DX with this aerial is so far W.A.C. on phone, 26 countries covering three wavebands.

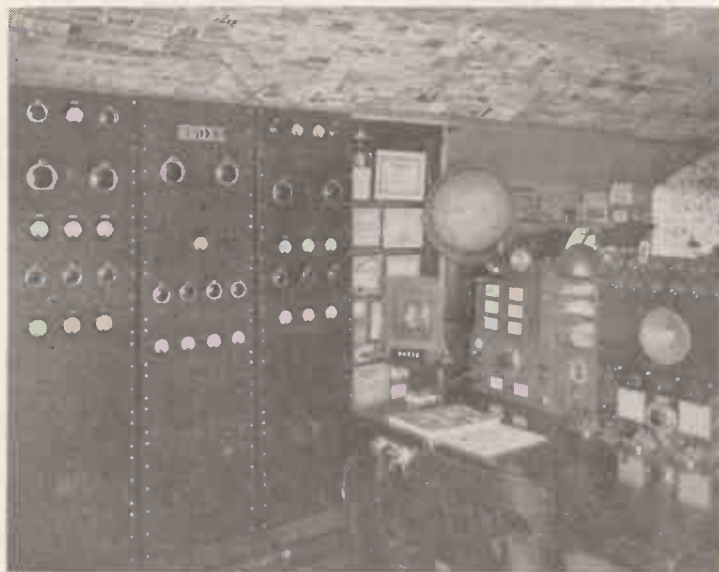

This is the first photograph of the new equipment at W9DXX situated at Chicago. Three bands are used with phone and C.W. and a maximum input of 1,000 watts.

many restrictions, but these should not prevent British amateurs contacting New Zealand on phone in the very near future.

The main restrictions are:—Stations using phone must operate between 14,150 kc. and 14,250 kc., which is unfortunately within the American phone band. Transmitting times are restricted to between midnight and 7 a.m., New Zealand time, which is ten hours in advance of G.M.T. No interference with any other service will be permitted, while telegraphic standard and frequency standards are to be maintained.

Transmissions of records or music of any kind is forbidden, while tests have to be made on artificial aeriels. Although it is generally agreed that no licences will be issued before the beginning of January, it is understood that at least two stations have already anticipated their licence and have made contact with "G" stations on telephony.

W9DXX

One of the most popular photographs ever published of an amateur station was that of W9DXX, in Chicago. Almost every amateur periodical has at one time or another published this photograph, but the station has now

metres, having a pair of 100TH's in the final with an input of 450 watts. The second transmitter is the original 20-metre equipment hotted up to operate



J. N. Roe at the operating table of station G2VV

with a kilowatt input. On the right is the third transmitter using a pair of 203A's on 40 metres with an input of 650 watts.

The receiving equipment is more or less as before and W9DXX is now on the air on three bands looking for European contacts. Telephony and C.W. are used and strong signals should be received in this country.

G2VV

The Hon. Sec. to the Thames Valley Radio and Television Society operates

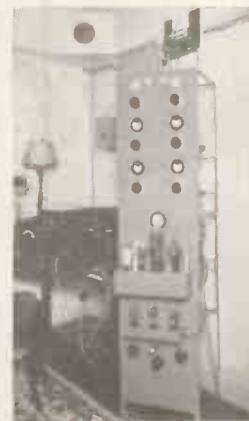

Those who have heard or worked G2AI on 7Mc. will be interested in this illustration of his transmitter and receiver.

A New Beam Aerial

By W8JK

W8JK Beam

Most amateurs have heard, and in many cases, tried the W8JK beam which is so popular in America. I have just received a most interesting letter from the designer of this aerial, John D.

69 ft. was erected and this was trimmed until connection or disconnection on to the tank coil did not require the tank condenser to be retuned for minimum dip. The length obtained was then divided by 7 and the feeder tapped on one-seventh of the total length from the middle of the aerial. This arrangement

these stations have been received in England using telephony. Very few amateurs appear to have worked XZ so it is well worth while keeping an eye on these stations who are particularly keen on contacting Great Britain.

The Wirral Amateur Transmitting and Short-wave Club found a good way of making their meetings interesting. At the last meeting on November 10 each transmitting amateur present was called upon to deliver a 5-minute talk on some branch of amateur radio. Call signs were drawn from a hat and the titles of subjects for discussion from another hat. The club meets at Beechcroft Settlement, Whetstone Lane, Birkenhead, on the second and last Wednesday evenings in each month.

Slade Radio, the Hon. Sec. of which is G. C. Simmonds, Esq., of 38 Rabone Lane, Smethwick, have an interesting series of lectures arranged for their autumn quarter. Details can be obtained from the Secretary. On December 2, however, there is the annual supper and on December 16 the A.B.C. of short-wave listening will be discussed by Mr. G. Evans, G8MC.

The Southend and District Radio and

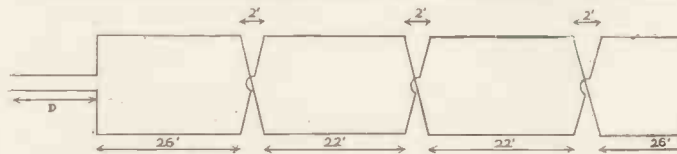

A new aerial designed by W8JK which can be a broadside or end-fire radiator as explained in the text.

Kraus, who has promised to send me all the information on some new beam aerials suitable for low-power British stations. He also included in his letter an aerial for my own personal use which seems to meet the requirements of amateurs in general. It consists of four sections and is end-fed, giving broadside radiation covering an angle of between 40 and 45 degrees. The total length of garden space required is less than 100 ft., while one of its main virtues is that radiation can be made broadside or end-fire without moving from the operating table.

seems to work very well and can be recommended for those who like Windom aerials.

Pocket Radio

In a recent lecture at Brighton, the local Chief Constable, Capt. W. J. Hutchinson, gave some interesting data on the Brighton Police Radio. He mentioned that the pocket set was a one-valver in two sections made up of the receiver and the earphone. The receiver

For end-fire radiation the feeders are joined together and coupled to the tank coil through a parallel tuned coil. This coil is also effectively earthed so that the circuit is practically the same as for the Windom coupling system, also shown in this page. For end-fire radiation the aerial is used more or less as a harmonic aerial, while for broadside operation as a normal beam with tuned feeders. This aerial is at present in use at G5ZJ, but insufficient data has yet been obtained to give any details as to radiation properties. However, several other stations are co-operating and it is hoped very shortly to be able to have some concise data. If any amateur is interested in these aerials I shall be glad to hear from him.

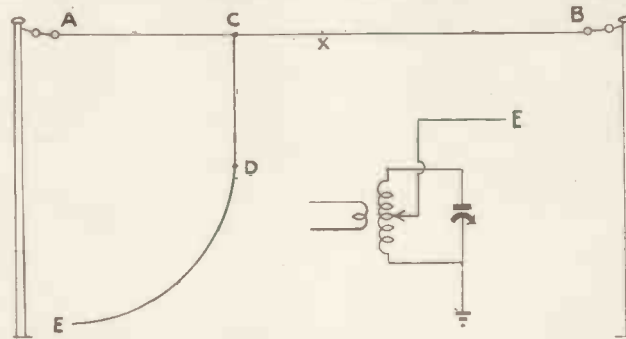

F3JD'S Windom aerial with which he has worked so much D.X.

W.A.Z.

While on the topic of aerials, I have been in touch with Lucien Champonnois, F3JD, who is doing some remarkably good long-distance work on telephony with an input of only 25 watts. I well remember his first 20-metre phone contact in August, 1935, but since that date has worked all continents and obtained practically every worth-while certificate available. His latest achievement is to work 40 zones on phone and to work every country in 16 of those zones. In view of all this I inquired as to the aerial system used and I was surprised to hear that it was a full-wave Windom as shown in the circuit on this page, coupled by ling-coupled aerial arrangement.

also contained the H.T. battery and accumulator, while a special calling device was included in the earphone. The total weight is a little under 2 lbs., and the range between 6 and 7 miles. A bell on the earphone rings directly the transmitter at Police Headquarters is switched on, and directly the constable presses a small knob on the side of the headphone he is in contact with the transmitting station.

Scientific Society have their own call sign, G5QK, while the Hon. Sec. is Mr. F. S. Adams, Chippenham, Eastern Avenue, Southend-on-Sea, who will be glad to meet prospective members.

An interesting series of lectures has been arranged for the Golders Green and Hendon Radio Scientific Society which includes an outline of Electron Optics by S. Rodda, Esq., B.Sc., on December 9, a visit to the Odeon Cinema Swiss Cottage to inspect the sound and vision apparatus on December 21, and a visit to the G.E.C. research laboratories at Wembley on January 8, 1938. Details can be obtained from Lt.-Col. H. Ashley Scarlett, 60 Pattison Road, N.W.2.

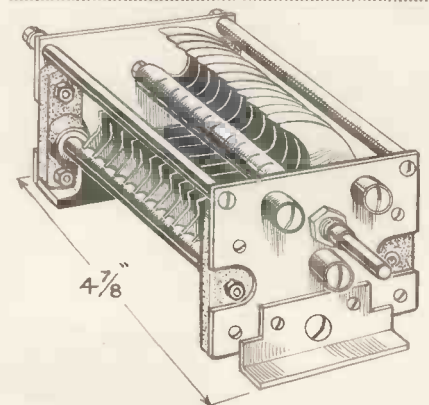

Those who use low power should obtain details of this new Eddystone condenser type 1083 which is suitable for flashover voltage of 3,500.

Formulas are not used when erecting this Windom. A top length of about

Amateur stations in Burma are now using the call-sign XZ and several of

A Multi-Range Short Wave Converter

By Kenneth Jowers

Two Models — Mains- or Battery-operated

In this article are described two short-wave converters, one for battery and the other for mains operation. With care in construction the minimum wavelength covered is approximately 5 metres, so that they are suitable for both amateur stations and television sound programmes reception.

A MULTI-RANGE short-wave converter has many uses, particularly for those who at present use a standard broadcast receiving set. In such circumstances a converter will enable results to be obtained with a standard set that are in every way comparable with a modern all-wave receiver.

Even those who are sufficiently fortunate to own a good all-wave set will probably feel at some time or other that they would like to be able to pick up the Alexandra Palace television sound transmission, which is on a wavelength rather lower than that usually covered by the average all-wave receiver.

A short-wave converter is simplicity itself and fundamentally is nothing

E.C.O.

Regeneration is obtained by taking the cathode back to earth via a small portion of the coil L_1 . In normal circumstances this makes the whole stage go into complete oscillation, but with a pentode valve such as the TSP4, the amount of regeneration can be controlled by varying the resistance, VR_1 , which applies the voltage to the screening grid of the pentode valve. In this way a very smooth and accurate control of regeneration can be obtained without that roughness of regeneration so noticeable with the ordinary capacity controlled circuits more generally used.

The efficiency of a circuit of this kind depends very largely on the valve used and the impedance of the high-frequency

value of 200-ohms. The shunt condenser C_1 has a value of .01-mfd.

In the aerial circuit is a three-point rotary switch, and to the centre point of this is taken the actual aerial feed-line. A second point connects to the fixed plates of VC_2 , while the third point is taken directly to the aerial terminal on the parent receiver. In this way the converter can be left permanently in circuit, merely switching the aerial to the broadcast set or to the converter as required.

A power supply of 250 volts at 10 M/a is required with a filament current of 4 volts 1.3 amperes. This supply can generally be obtained from the main receiver, but alternatively a small power pack can be built up specially for the converter.

In order to overcome the necessity for modifying the main broadcast receiver in order to obtain the necessary power supply, it is suggested that a tapped socket be obtained from Messrs. A. F. Bulgin, that has terminals connected to the heater pins. This socket is then plugged into the most convenient valveholder in the receiver and two leads taken from the terminals on the side of the adaptor going to the heater terminals of V_1 . Notice that there is no need to allow for an H.T. negative connection as this is made automatically when the converter is earthed, but the H.T. positive can usually be taken from the high potential side of the primary of the output transformer, generally a part of the loudspeaker.

All the components for a converter of this kind can be accommodated on a metal chassis 6 by 7 by $1\frac{1}{2}$ in., with a panel 6 by 7 in. all made in 18 gauge steel.

There is no need to screen the valve for the normal metal coating is quite sufficient in this simple circuit. All the components with the exception of L_1 , L_2 , and VC_1 are mounted beneath the baseplate, and all are of a standard type with the exception of the coils which must be home-built. As the coils are the same for both battery and mains operated converters, the same details, of course, apply to both circuits.

Four coils are required to cover 15 to 200 metres and an additional two coils of a special type to cover 5 to 15 metres. But first of all here are the constructional details of the higher wavelength coils.

Coil 1 for 15 to 31 metres is wound on a $1\frac{1}{2}$ in. diameter former with 26

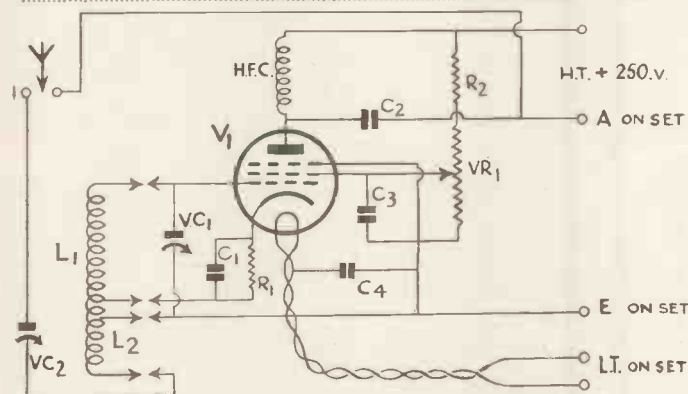

Providing L_1 and L_2 are wound in the manner suggested this A.C. operated converter gives quite a high gain right down to 5 metres. VC_2 is optional but enables the constructor to have more latitude in coil winding.

more or less than a single stage oscillating detector covering the required wavebands. In the past many of these converters have been used, but not always with complete success owing to the fact that little attention was paid to efficient design and to mechanical considerations, such as a tuning scheme suitable for the very high frequencies involved.

The A.C. Version

Refer a moment to the circuit above, which is a straightforward short-wave converter suitable for use with an A.C. operated broadcast set. It consists of a pentode valve used as an electron-coupled oscillator which is about the only satisfactory method of operation below 15 metres. The grid circuit consists of L_1 and VC_1 , while L_2 is the aerial coupling coil, having in series with it VC_2 , a variable condenser used for adjusting the load imposed on the grid of V_1 .

choke in its anode circuit, so for that reason it is to be stressed that the correct valve and choke must be used. In this particular instance a type SW69 Bulgin choke was found to have the correct impedance for use with a TSP4.

The output from this stage is fed into the grid circuit of the following broadcast receiver via a small condenser, C_2 , which has a capacity of .0001-mfd. Another condenser, C_3 , having a value of .1-mfd. is used to by-pass the screen of the pentode to earth, and this condenser must be connected directly from the screen terminal on the valve holder to the nearest earth point. Another condenser, C_4 , by-passes one side of the heater to chassis. This is rather unusual, but it will be found that without it traces of modulation hum will be noticed, particularly when the equipment is tuned to a powerful station.

C_1 and R_1 in the cathode circuit of the TSP4 are fairly critical in value, particularly R_1 , which must have a

5-200 Metres :: Battery or Mains

gauge wire with the turns spaced $\frac{1}{8}$ in. A total length of 3 in. is required which is more than sufficient for the higher wavelength coil and a little long for the short wavelength coil.

L₂ consists of 4 turns tapped $\frac{3}{4}$ of a turn from the earth end. The beginning,

approximately half of one turn from the earthy end.

The reason for specifying solid former is that with $\frac{1}{8}$ in. diameter it would not be possible to use a valve pin held in position by a nut as it is not easy to hold the nut inside the former. However,

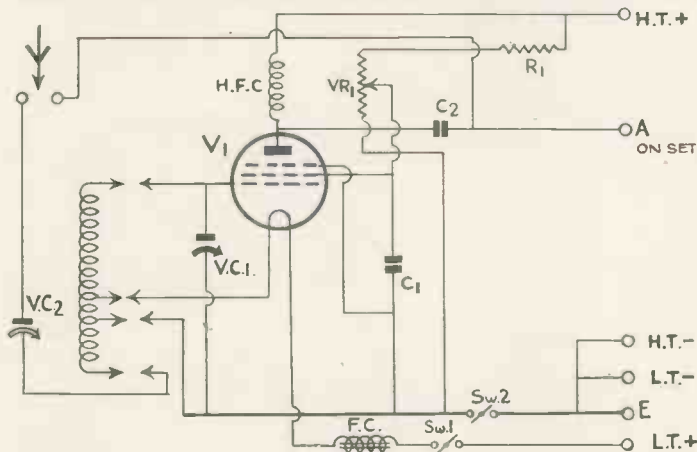

This is the battery version of the A.C. converter showing the negative filament return being connected to earth via the end of the grid coil. FC is a special filament choke explained in the text.

end and tap of this coil are terminated in a 6BA valve pin which is bolted through the wall of the former. A $\frac{1}{4}$ in. away from the earthy end wire on a further 4 turns of the same gauge wire and spacing as for L₁ to make L₂.

The second coil, covering 20 to 46 metres, requires 6 turns for L₂, $8\frac{3}{8}$ for L₁, the tap point being made $1\frac{1}{2}$ turns from the end of L₁. Wire and spacing are exactly the same as for coil No. 1.

The third coil, covering 45 to 98 metres, is made up of 10 turns for L₂, 23 turns for L₁, tapped 3 turns from the earthy end of L₁. The spacing on this coil, however, is approximately the diameter of the wire.

Coil No. 4, covering 95 to 200 metres, is made up of 48 turns on L₁, tapped 6 turns from the end, and 17 turns on L₂. The spacing between L₁ and L₂ is $\frac{1}{4}$ in., and both coils are close wound.

The two ultra-short wave coils are not quite so simple, and even with the correct figures for guidance, will have to be carefully checked in operation. Obtain a 6 in. length of $\frac{1}{8}$ in. solid celluloid obtainable from the British Xylonite Co., which is sufficient to make two ultra-short wave coils.

The first coil, covering 5 to 9 metres, requires 4 turns for L₁ and 2 turns for L₂, the gap between coils and between turns is $\frac{3}{16}$ in. It is impossible to give the exact point for the cathode tap, but this is approximately $\frac{1}{4}$ turn from the earthy end of L₁. It is advisable, however, to terminate the cathode lead in a crocodile clip and experiment in order to obtain the correct tap point. This point will be critical to within $\frac{1}{4}$ in.

The second coil, covering 8 to 16 metres, requires 7 turns for L₁, 3 turns for L₂, with the same gap as for the first coil. The cathode tap in this case is

with solid rod this can be tapped to take 6BA valve pins without any trouble at all. It is, however, advisable to drill the former under water.

Five insulated sockets should be mounted on the chassis and if all the coils are made with the same pin gap then the coils can be interchangeable from 5 to 200 metres.

The battery-operated version is very similar, but as the VP2B pentode valve recommended does not have a cathode, an alternative means has to be em-

ployed. The most satisfactory arrangement is again to take the negative filament back to chassis via small portion of the grid coil. But in the positive lead has to be connected a special iron-cored filament choke specially made by Messrs. Stratton and Co., for this circuit. The type number of this choke is 982. Other than this the circuit arrangement for the battery converter is identical with the A.C. version including the system for controlling regeneration by means of a variable screen voltage resistance.

When constructing take all earth return leads to a common point on the chassis, and for this purpose it is advisable to fix a bolt in the centre of the chassis and use this as the earth point. All fixed condensers should be connected as closely as possible to their respective components, having as short a lead as possible. The grid and aerial leads should be kept well away from the chassis, for although this does not have very much affect on ordinary short-waves, below 15 metres it is inclined to affect the minimum wavelength to which the converter will tune.

As in both circuits the pentode valves have top-cap grid connections it is a good plan to mount the tuning condenser, VC₁, high up above the chassis so that the fixed plates are on a level with the top of the valve. In this way the grid is kept short.

It is suggested that the converter be permanently connected to the main receiver. In the case of the A.C. model the aerial and earth should be removed from the main set, and reconnected on to the aerial and earth terminals on the converter should then be connected to terminal A on the receiver with as short a length as possible. The earth terminal should be similarly joined.

The main set is then tuned to a silent spot at about 1,100 metres and the converter tuned and adjusted so that it is almost in complete oscillation. In this way the converter operates as a conventional autodyne detector oscillator with the main set as the intermediate frequency stages.

Similar operating conditions apply to the battery version except that a common LT and HT supply will, of course, be used. In no circumstances, however, use a second H.T. negative connection. On the ultra-short wavelengths it may be advisable to retune the main receiver down to 200 metres instead of the 1,100 metres recommended for the normal short wavelengths, but this again is a matter for experiment.

These converters are suitable for use in front of any straight or super-het receiver, but if a straight set, there must be at least one high-frequency stage. They cannot in any circumstances be used with a receiver not employing a high-frequency stage.

Components for A MULTI-RANGE SHORT-WAVE CONVERTER

CHASSIS AND PANEL.
1—Chassis metal 6 by 7 by $1\frac{1}{2}$ ins. finished black (A.P.A.).

1—Metal panel 6 by 7 ins. finished black (A.P.A.).

CHOKE, HIGH-FREQUENCY.

1—Type SW60 (Bulgin).

CONDENSERS, FIXED.

1—0.01-mfd. type 601 (C₁) (Dubilier).

1—0.001-mfd. type 690W (C₂) (Dubilier).

1—1-mfd. type 4603/S (C₃) (Dubilier).

1—1-mfd. type 4603/S (C₄) (Dubilier).

CONDENSERS, VARIABLE.

1—900/100 (VC₁) (Eddystone).

1—Type 1013 (VC₂) (Eddystone).

COILS.

Home built to specification in text.

DIALS.

1—Type 1026 (Eddystone).

HOLDER, VALVE.

1—Type ceramic chassis less terminals (Clix).

PLUGS, TERMINALS, ETC.

1—Plug top connector type 1156 (Belling-Lee).

RESISTANCES, FIXED.

1—200-ohm type 1 watt (R₁) (Erie).

1—20,000-ohm type 1 watt (R₂) (Erie).

RESISTANCE, VARIABLE.

1—50,000-ohm type potentiometer (VR₁) (Erie).

SUNDRIES.

1—3-pin socket strip type 110 (Belling-Lee).

1—3-pin plug type 1107 (Belling-Lee).

1—2-way strip type 1252 (Belling-Lee).

SWITCH.

1—Type S02 (Bulgin).

SUNDRIES.

Paxolin coil forms to specification (Peto-Scott).

4—Insulated sockets type 12 (Clix).

4—Plugs type 1 (Clix).

VALVE.

1—TSP4 Met. (Mullard.)

The Short-wave Radio World

IT is most unusual for amateurs all over the world to be in agreement on any particular technical point, but it does seem as if a very high percentage feel that one of the most effective small radiators ever produced is the flat-top beam designed by W8JK and published in *Radio*.

Very few beam aerials are suitable for use in this country where garden size is usually limited, so aerials of the diamond and horizontal V type are

A Review of the Most Important Features of the World's Short-wave Developments

this antenna it will be found that the lengths are not at all critical, but the leg L should never be more than one-half wavelength long, for this provides a current node at each of the insulators, 1, 2, 3 and 4.

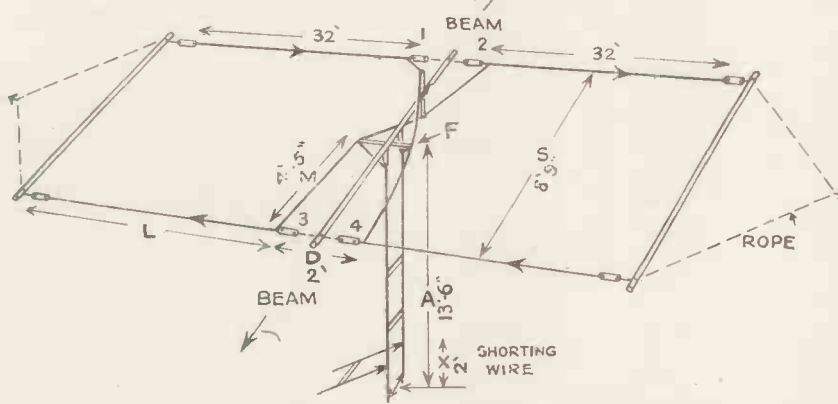

Fig. 1. The Flat-Top beam aerial has proved very popular during the few months it has been in use. It is only suitable for broadside radiation.

generally out of the question. Those who are limited to a 67 ft. top will appreciate that this flat-top beam will give at least a 6 db gain over a conventional half-wave radiator. The angle of radiation is concentrated very much broadside although a certain measure of end-fire radiation can be obtained by using a simple variation on the aerial shown in Fig. 1.

The fundamental flat-top beam aerial is shown in Fig. 1, from which it can be seen that it consists of two double-Zepp aerials spaced $\frac{1}{2}$ -wavelength and fed 180 degrees out of phase.

For convenience, the aerial is made up of two full-wave lengths crossed over at the middle. It can be fed by a tuned Zepp line, or a non-resonant feeder in conjunction with a stub section.

Three spreaders are required and these should be made of bamboo or $1\frac{1}{4}$ in. square Columbian pine. The centre spreader should, however, be as light as possible, otherwise there will be a decided sag in the middle of the aerial. On the centre feeder should be mounted two Beehive type stand-off insulators, to which are connected the stub line or Zepp feeders.

The cross-over wires should be spaced in the middle by means of a thin piece of wood and this space should be the same as the gap between the two wires in the Zepp feeder. When building

With a tuned stub as shown the distance A plus M is equal to about $\frac{1}{4}$ or $\frac{3}{4}$ of a wavelength, depending on whether a $\frac{1}{4}$ or $\frac{3}{4}$ wavelength stub is to be used.

Where space is limited, the length of L can be decreased and this decrease compensated for by moving the shorting wire on the stub section further down the stub. In the case of Zepp feeders, retuning can be done at the station end, so that the total overall length can be decreased as much as 10 per cent. without affecting the directivity of the aerial.

The dimensions given in Fig. 1 are suitable for a frequency of approximately 14,050 kc., while the following figures will enable constructors to build an aerial suitable for their own particular frequency.

L	M	S	D
429,000	63,000	123,000	28,000
f	f	f	f
$A(\frac{3}{4})$	$A(\frac{1}{4})$	X	f
675,000	185,000	28,000	
f	f	f	

In the above table f is the frequency at which the aerial is to resonate. The values for A and X are only approximate for this figure depends very much on location, the size of wire, height above ground, etc. The remaining dimen-

sions are not critical so that the wire can be cut exactly to formula.

The flat-top beam as shown in Fig. 1 has a total overall length of 63 ft. when cut to operate in the middle of the 14 mc. band. As previously mentioned, the three section beam aerial has a gain of 6db at 20 metres over a half-wave aerial, while additional sections can be employed, such as three or four sections giving a correspondingly higher broadside gain. A four-section aerial which requires approximately 130 ft. of space and has a gain of no less than 10 db, which is an extremely high figure and comparable with the smaller type of diamond.

A single section can be end-fed with either half-wavelength or full-wavelength sides, but in either case the aerial should be correctly terminated. Our experiments with a full-wavelength single section have proved most satisfactory, for westerly radiation with an aerial erected north/west, south/east. This point is of interest to those who are unfortunately not able to erect a north and south aerial for American transmission.

Constructors will find that the measured feeder current with an aerial of this kind is extremely high owing to the narrow spacing between wires. For example, a half-wave Zepp antenna into which .6-ampere could be measured at the tank coil end, when changed over to the flat-top beam gave a measured current of 1.1 amperes.

The array is ideal for use on 10- and 5-metre bands for the physical dimen-

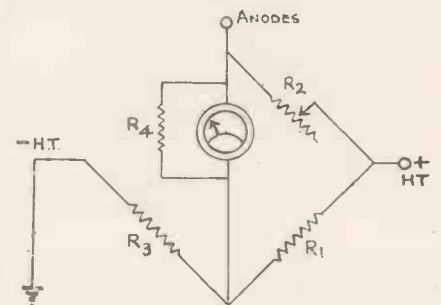

Fig. 2. It is hoped that in time all receiving stations will include an R strength meter in their equipment. This meter was designed by W9LFE.

sions are so much smaller, but providing light spreaders are obtainable the aerial can even be used on 40 metres. Two of these aerials erected at right angles will give world coverage and a greatly increased field strength over the normal type of half-wave aerial. Our own tests show that the claim of 6 db and 10 db for the two-section and

four-section aeri-als is no over-statement and in our opinion the aeri-als are ideal for amateur use in this country.

A Sensitive "R" Meter for Amateur Use

Until all amateur stations are equipped with some accurate means of checking carrier strength input listeners' reports will continue to be unreliable. It is almost impossible to tell by ear whether or not the carrier strength of any station goes up or down without having a meter of an efficient type to measure the actual input through the receiver.

The percentage modulation of a transmitter has a very great effect on the signal strength obtained, so for that reason a high power station under-modulated very often obtains a weaker report than a low power station over-modulated. From time to time we have noticed that stations have received R9 reports when their actual carrier strength was barely R7. We did not, however, lose sight of the fact that the volume level from the loudspeaker was probably very high, so giving the impression of strong carrier level.

Users of communication receivers and R strength meters very often become unpopular by giving genuine reports of carrier strength. However, if all listeners were equipped with a meter reading actual carrier strength then all reports would be in line and obtained on a similar basis, so that an R7 report in one locality would be comparable with an R7 report from another operator in a different locality.

Bridged Circuit

The difficulty is, however, constructing an R meter that can be added to existing receivers, but a very simple instrument has been designed by R. C. Higgy, W9LFE. The circuit is shown in Fig. 2, which is a conventional grid circuit with R1 and R2 the familiar ratio arms of the bridge, R3 being the comparison resistor, and R0 the unknown anode resistance of the valve controlled by the A.V.C. system. R1 and R3 can be 1-watt carbon resistances and R2 the conventional potentiometer.

R2 provides a method of setting the meter on zero for changes in anode and grid voltage, and can be pre-set and left at the back of the chassis.

A Shunted Meter

An 0-1 D.C. milliammeter should be shunted so that an R9 signal reads .6 m/A. This shunt resistor varies in value according to the type of meter in use but is generally between 30 and 50 ohms. It is very difficult to standardise on a typical R9 signal and this still remains the one fluctuating constant. Until some standard is arrived at, the best way is to calibrate the meter with R9 at a point which is rarely exceeded and equal to a deflection of about three-

fifths of the full scale. Dividing this scale between zero and R9 into 9 equally spaced divisions will give R units that will be more or less accurate. Any reading beyond the agreed R9 can then be given as R9 plus.

This meter can be installed in any receiver using A.V.C. by the addition of three resistors and a milliammeter in the Wheatstone bridge circuit. With varying bias voltages applied to the R.F. and I.F. valves through the A.V.C. system the resistance of the anode circuits will vary, increasing with signal strength. A bridge circuit arranged to measure this anode resistance of one or of a group of valves will therefore provide a satisfactory upward reading R meter.

Two-valve

56 Mc. Transmitter

The new modern tetrodes can be put to full advantage in ultra-short wave transmitters, for, as electron-coupled oscillators they give a high stable output in the correct type of circuit. Don B. Knock, VK2NO, has designed a most effective two-valve transmitter for 5-metre operation, using two 6L6 beam power tetrodes, the English equivalents of which are Hivac AC/Qa's.

The first valve is used as electron-coupled oscillator with the grid-cathode circuit at 10 metres, and with the anode

Connection to the feeders is shown as being two tappings on the amplifier tank coil, but, of course, this is merely a suggestion and normal systems can be embodied if required.

The power pack should be 400 volts at 150 mA., so it is advisable to use a high output rectifier of the 83 type. Ample smoothing will be obtained with one choke and two 8-mfd. condensers, but it is essential to include choke input. The same power pack will also be suitable for use with valves of the 807 heavy-duty type, although maximum advantage will not be obtained from this valve unless the voltage is increased to approximately 600.

Two 6L6 valves in Class A will easily modulate the final 6L6 providing they are driven by a fairly high-gain valve of the 6C5 type. Most amateurs, however, will probably have a standard amplifier giving approximately 10 watts of audio, which will be suitable for modulating the 6L6.

It is important when tuning to make quite sure that the anode of the first 6L6 is accurately tuned to 5 metres. A conventional absorption wave-meter will be suitable for this purpose, which need not be calibrated, provided it is known to cover the amateur 5-metre band.

With the power supply recommended, a good D.C. note is obtainable, while

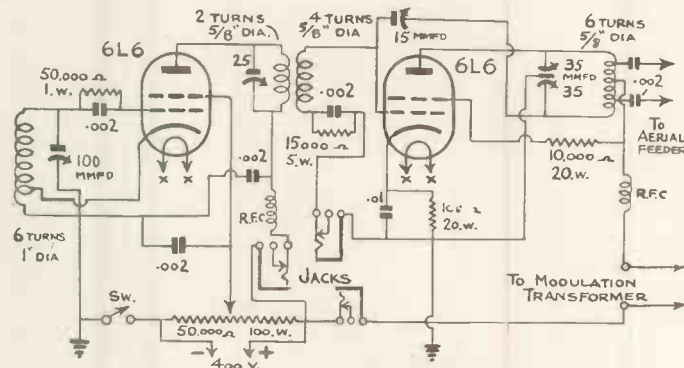

Fig. 3.—This circuit is self-explanatory, and with 6L6 or AC/Qa valves, the values recommended will be quite satisfactory.

circuit tuned to 5 metres. The output on the harmonic is surprisingly high, and is more than sufficient fully to load another 6L6 as a power amplifier.

Inductive coupling is used for the amplifier with an untuned grid coil in relation to the oscillator anode coil. According to the designer, this system is more satisfactory than capacity coupling, as the grid drive can be more accurately adjusted by varying the number of turns or the spacing of the coil. Also the gap between coils can be very easily varied in this system.

As the 6L6 is not a pentode it has to be adequately neutralised owing to the fact that there is not sufficient internal screening. Tests show that both the 6L6 and the AC/Qa can be easily neutralised when the external capacity is approximately 15-mfd.

the transmitter is excellent for long-distance C.W. tests. Speech quality is good for local working, providing modulation percentage is not too high.

"Efficient I-V-I Receiver."

(Continued from page 749)

to cover up to 2,000 metres. The potentiometer for controlling the screen voltage in the tetrode circuit must be noiseless, and although a fixed condenser from slider to negative end usually takes care of this point, it is advisable to use a reliable component in the first instance which is guaranteed by the makers to be free from noise when passing a current of between 2 and 3 m/A.

The First International 5-metre Transmitting and Receiving

FOLLOWING on the successful 10-metre International contests in 1935 and 1936 which did so much to popularise high-frequency working, the R.S.G.B. have just announced details of the first 5-metre contest for both transmitting and listening stations.

The rules for the transmitting contest are as follows:—

1. The contest will commence on January 1, 1938, and conclude on December 31, 1938.

2. The contest will be open to any radio amateur who is licensed to operate his station in the 56 Mc band.

3. The winner of the contest will be the operator of the station scoring the most points based on the following system:—1 point for each contact over a distance between 200 and 1,000 miles, 5 points between 1,001 and 2,000 miles, 10 points between 2,001 and 3,000 miles, 15 points between 3,001 and 4,000 miles, 20 points between 4,001 and 5,000 miles, and so on, at the rate of 5 extra points for each additional 1,000 miles or part of each thousand. All distances to be calculated by the Great Circle.

To count for points the readability, strength and tone, both incoming and outgoing must be logged, together with date, time and call sign.

4. In addition, and in order to collect current data, each contestant must send to the Radio Society of Great Britain, a monthly report of stations heard and/or worked, together with notes concerning conditions, power used for contacts, etc.

5. The Radio Society of Great Britain will present a suitable trophy to the winner of the contest, whilst certificates of merit will be awarded to the leading station or stations in each country.

6. No entrant may employ interrupted continuous waves, modulated continuous waves, telephony, or any other form of modulated carrier, for contacts claimed in this contest.

7. At the time of a contact both stations must be operating on 56 Mc. from their fixed station addresses.

8. Only one contact with a specific station may count for points in any 7 day period.

9. Entrants must adhere to the terms of their licence.

10. Final entries must be received by R.S.G.B., 53 Victoria Street, S.W.1, not later than February 28, 1939.

In this contest 5-metres actually means the amateur band of between 56 and 60 megacycles.

So that those who are only equipped for listening on ultra-high frequencies, a reception contest has been organised in order to encourage these non-transmitting amateurs to collect and tabulate phenomena relative to the 5-metre

Contest

In view of the greatly increased interest in amateur contests we are publishing these details so that listening stations can co-operate and have the opportunity of winning some of the excellent trophies presented by the R.S.G.B.

amateur band. Provided sufficient entries are received the R.S.G.B. are going to offer a trophy to a non-transmitter whose log covering the period January 1 to December 1, 1938, is considered by the Council to contain the most valuable data. Certificates of merit will be awarded to those submitting the most valuable information at the conclusion of the contest. Logs must be received not later than February 28, 1939. For the purpose of this contest a non-transmitter is regarded as a person not holding a radiating licence on January 1, 1938.

B.E.R.U.

As usual, the B.E.R.U. contests for 1938 are to be divided into three sections; senior (high-power), junior (low-power) and the receiving section. The contests are open to all British subjects living within the British Empire and British Mandated Territory, excluding Egypt and Iraq which are no longer considered part of the British Empire. There are also certain other regulations regarding club memberships.

A trophy will be awarded to any regular member of the R.S.G.B. scoring the highest number of points in one of the three sections. Certificates of merit will also be awarded to the first three stations in each contest, and also to the leading station in each prefixed zone.

The Senior Contest

The senior contest extends from 19.00 G.M.T. Saturday, February 5 to 19.00 G.M.T. Sunday, February 6, and will be continued from 19.00 G.M.T. Saturday, February 12 to 19.00 G.M.T. Sunday, February 13, 1938. Fifteen points will be scored for the first contact with a British Empire station located in any

prefixed zone outside the competitor's own zone. Fourteen points will be scored for the second contact with the same zone, 13 points for the third contact, and so on. Of course, only one contact can be made with a specific station in each band. Any amateur frequency band can be used providing input to the final stage does not exceed 250 watts.

Junior Contest

Regulations for the junior contest are very similar, but the contest extends from 21.00 G.M.T. Saturday, February 19 to 21.00 G.M.T. Sunday, February 20 and be continued from 21.00 G.M.T. Saturday, February 26 to 21.00 G.M.T. Sunday, February 27, 1938. In the junior contest the input to the final stage must not exceed 25 watts.

For Listeners

For those interested in reception this contest extends from 19.00 G.M.T. Saturday, February 5 to 19.00 G.M.T. Sunday, February 6, and continued on Saturday, February 19 from 21.00 G.M.T. to 21.00 G.M.T. Sunday, February 20, 1938. One point will be scored for each British Empire station heard working another British Empire station provided stations heard are located outside the competitor's prefixed zone.

An additional 50 points will be scored for each prefixed zone heard irrespective of band providing the station heard is in contact with another British Empire station. Before a point can be claimed the following information must be logged. Call of station heard, call of station being worked, entrance report on the signals of the station heard (readability, strength and tone), the readability, strength and tone given by the station heard to the station being worked. CQ and test calls will not count for points, while the same station may only be logged once on each band during each week-end of the contest.

Entry forms can be obtained from the R.S.G.B. or from overseas representatives. New Zealand counts as one zone only to entrants from British Isles, Irish Free State, Australia and New Zealand, while inter-New Zealand contacts will not count for points. No less than 17 Empire societies are collaborating in these contests, which in view of the interest in amateur activities at the moment, should be one of the most successful ever sponsored by the Radio Society of Great Britain. Full information can be obtained direct from the Society.

**READ TELEVISION
& SHORT-WAVE WORLD
REGULARLY**

A Regenerative R.F. Amplifier

AS the congestion on short-wave bands is increasing the need for a selective pre-amplifier is becoming more evident. In November, 1935, was published a two-stage amplifier for mains operation that has solved the problem for those who have mains receivers, but I have received a number of requests for a similar amplifier, but for battery operation.

A simple circuit has been designed which is shown in this page, and as one stage is regenerative, the selectivity is of a very high order and despite this excellent feature, the use of valves of a special type has overcome any tendency for instability.

The unit is made up of two straightforward radio-frequency stages. It is not intended that full gain be obtained from both stages but rather that selectivity be of the highest possible order. The first stage is regenerative by taking the negative filament to earth through the end of the grid coil and by having a small choke in series with the positive filament. The amount of regeneration is controlled by VR₁, a 50,000-ohm potentiometer. Coil L₁ with four turns on the 20-metre band gives sufficient selectivity in normal circumstances, but the selectivity of this stage can still further be increased by reducing the number of turns between points 3 and 4.

This first R.F. amplifier is used in a tuned transformer circuit, again having the virtue that the primary can be adjusted to give the required degree of selectivity. It has also been found that this system of coupling enables high gain to be obtained over all bands.

Both L₂ and L₄ are tuned at the same

With modern valves it is a comparatively simple matter to design and build a high-gain and selective pre-selector. The circuit suggested will enable amateurs to obtain much more satisfactory results from the higher frequency bands where congestion is very bad at the present time.

time with a ganged .00016-mfd. condenser, but in order to prevent ganging difficulties which are considerable at high frequencies, a triaming condenser is wired in parallel with L₂. All four coils have to be accurately wound but small variations in construction may call for variations in winding up

the first stage is almost unstable when regeneration is at maximum, voltage variation would make the amplifier tricky to handle.

CH₁ calls for comment for this is not a true low-frequency choke, although in the circuit diagram it is shown with an iron-core. Actually it is an R.F. choke with a small iron-core to increase inductance and is of a special type made by Eddystone for this amplifier. With the pre-selector in front of the average superhet receiver an exceptionally high degree of selectivity can be obtained. The regeneration control should be well backed off and

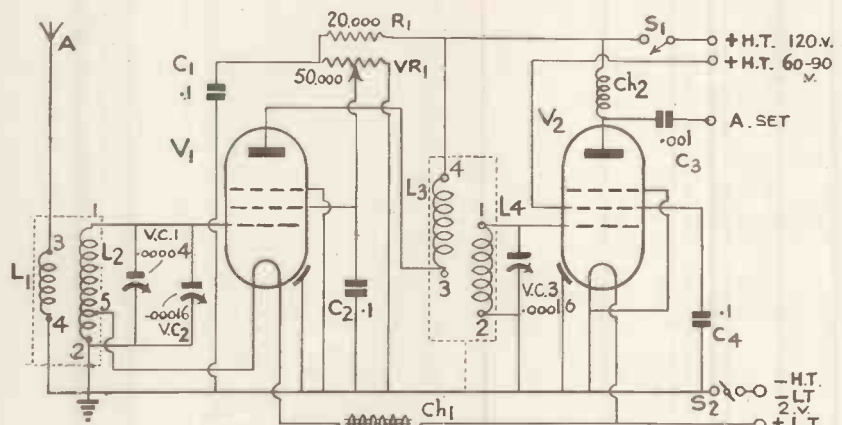

All the component values are given in the list on this page, while coil data is given in the text.

to half a turn. If, however, the coils are made in the following manner they will approximately cover the bands shown.

the main tuner left in the middle of the band. Stations should be tuned in on the main receiver, after which the pre-selector can be brought to resonance

COIL TURN DETAILS.

Range in Metres.	L ₁	L ₂	Cathode tap, turns from earth end.	L ₂	L ₄
15-31	4	4	1 1/2	4	5
29-46	6	8 1/2	2	6	9 1/2
45-98	10	23 1/2	3	10	24 1/2

Special valves are available with grid to the top cap that enable the grid leads to be kept very short. Actually, if the valves are mounted on either side of the tuning condenser the top of the valve can be connected directly to the stator plates on the tuning condensers. The length of lead need not exceed one inch. In the output circuit of the second valve is CH₂, a high-frequency choke which must not resonate between 10 and 150 metres, so that if there is any doubt as to the efficiency of the choke on the higher frequencies it is advisable to have two chokes in series, one suitable for short wavelengths and one suitable for ultra-short wavelengths.

The H.T. voltage required is approximately 130 to 150 volts when the current flow is an average of 10 mA. It is, however, essential to make quite sure that the voltage is steady for when

and the regeneration increased to give the required degree of selectivity or sensitivity. It will be noticed that where a station is inclined to be jammed by stations on either side, if the pre-selector is accurately tuned, when regeneration is increased the unwanted stations almost disappear, leaving the wanted station in the clear.

When constructing it should be remembered that even though the VP2B valves are metallised this does not provide sufficient screening at high frequencies, so that the valves must be additionally screened with some sort of can similar to the Colvern valve cans. Also it is not advisable to have coil screens as this materially affects the performance and inductance of the coils. It is quite sufficient to screen one stage from the other by means of a double screen down the centre of the chassis.

Components for

A REGENERATIVE R.F. AMPLIFIER

CHASSIS AND PANEL.

- 1—Metal chassis finished black 14 by 8 by 2 ins. (A.P.A.).
- 1—Metal panel finished black 14 by 7 ins. (A.P.A.).

CHOKES, HIGH-FREQUENCY.

- 1—Type 1062 (CH₁) (Eddystone).
- 1—Type SW68 (CH₂) (Bulgin).

COIL FORMS.

- 1—Type CT₄ (G5NI Ltd.).
- 1—Type CT₆ (G5NI Ltd.).

CONDENSERS, FIXED.

- 1—.1-mfd. type 4603/S (C₁) (Dubilier).
- 1—.1-mfd. type 4603/S (C₂) (Dubilier).
- 1—.001-mfd. type 690W (C₃) (Dubilier).
- 1—.1-mfd. type 4603/S (C₄) (Dubilier).

CONDENSERS, VARIABLE.

- 1—40-mmf. type 900/40 (VC₁) (Eddystone).
- 1—.00016-mfd. two-gang type E (VC₂, VC₃) (Polar).

HOLDERS, VALVE.

- 3—7-pin type V₂ less terminals (Clix).
- 1—4-pin type V₁ less terminals (Clix).

RESISTANCE, FIXED.

- 1—20,000-ohm type 1/4-watt (R₁) (Bulgin).

RESISTANCE, VARIABLE.

- 1—Type potentiometer, 50,000-ohm (VR₁) (Reliance).

SUNDRIES.

- 1/2-lb. enamelled copper wire (Webb's Radio).
- 2—Two-socket strip type A (Clix).

SWITCH.

- 1—Type S₁₂₃ (S₁, S₂) (Bulgin).

VALVES.

- 2—Type VP2B Met. (Mullard).

Below Five Metres

Practical Aspects of 112 and 224 Mc. Operation

By

O. J. Russell,
Reading University

ALTHOUGH many experimenters in this country are now engaged in active research work in the five-metre band, there seems to be little activity among amateurs on the higher frequencies. The real reason for this may be due to a feeling that practical difficulties are too great although this is actually far from true. In some respects operation on $2\frac{1}{2}$ and $1\frac{1}{4}$ metres is

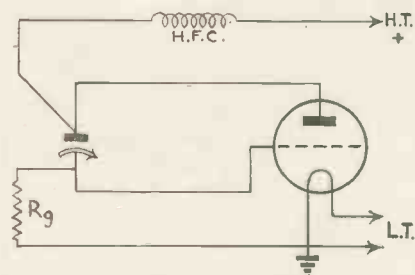

Fig. 1.—Conventional Franklin-Hartley Oscillator.

far easier than on 5 metres. The circuits and apparatus themselves may be extremely simple, in consequence of which operation is easy, and high efficiency may be obtained with normal valves and apparatus.

The object of this article is to give information sufficient to enable the keen experimenter to make a start upon this fascinating sphere of activity. It may be of interest to state that as far back as 1926, oscillation was obtained at one metre with normal valves in normal circuits.

With regard to the circuits employed for obtaining oscillation on these frequencies, consider the normal Franklin-Hartley arrangement in Fig. 1. It is obvious that if the normal tuning capacity is reduced to zero, the oscillation frequency can still be controlled by varying the value of the grid condenser. The actual tuning capacity across the coil is composed of the anode to grid capacity of the valve, in series with the grid condenser. As this value is low, a much larger value of inductance than normal can be used with a high L/C ratio, and high efficiency. The reader will no doubt recollect that G5BY employed this principle of "series tuning" in his record-breaking 5-metre transmitter.

There is one point of interest and importance with this circuit when used in the oscillatory circuit, shown in Fig. 2, which is originally due to Goutton-Touilly. The advanced experimenter will at once appreciate that when the series condenser becomes equal to the valve capacity, the circuit becomes automatically neutralised, and oscillation is impossible. For this reason a tuning

condenser greater in value than the valve interelectrode value has to be employed. The full benefit of this circuit is therefore not obtained unless a low-capacity valve is used. The advanced experimenter who uses the new 4316 type transmitting acorn manufactured by Standard Telephones and Cables, will find that the loop can consist of a single turn of from 10 to 12 inches for 112 mc., and about 5 to 6 inches in diameter for 224 mc. With more normal valves, the loop will be 3 inches in diameter for 112 mc., but owing to variation, no exact figure can be given. This value, however, is approximately correct for the Tungram LP220 and P215, which oscillate readily at 112 mc.

It will be appreciated that high efficiency can be best obtained by using

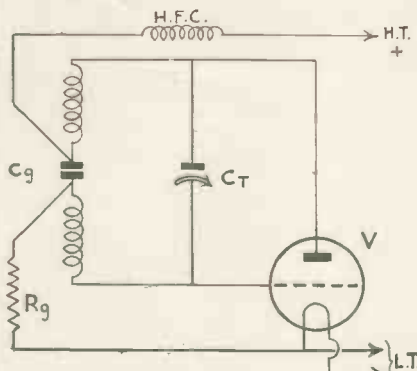

Fig. 2.—The Goutton-Touilly Circuit.

the minimum possible tuning capacity, and the maximum possible value of inductance. If this is done, variation of tuning can only be effected by variation of the inductance. The circuit in Fig. 3 shows this in practical form. The inductance here consists of two parallel rods, shorted by a heavy sliding contact. This bears a superficial resemblance to the so-called "Long Lines" circuit, but as previously explained in this journal, the Long Lines circuit requires careful matching of the impedance of the "Lines" to the input impedance of the valve. The circuit in Fig. 3 is actually very similar to that of Goutton-Touilly in Fig. 2, but while in Fig. 2 the capacity is variable, in Fig. 3 a little extra efficiency is obtained by using a variable "Goal Post" type inductance. The capacity of the fixed

grid condenser will vary with the valve. For all normal valves, the capacity can be 50-mmfd.

If special low-capacity valves are used, it may be lowered, with a consequent increase in efficiency, although as previously stated, it may not be lower than the actual valve capacity. For the circuit in Fig. 2 an Eddystone 40-mmfd. microvariable is ideal for conventional valves. For the acorn tube, the special neutralising types of low capacity condenser of about 10 mmfd. maximum is suitable.

Valves capable of oscillation at the frequencies in question are more numerous than might be supposed. As already stated, the inefficient valves of 1926 could be induced to oscillate at one metre.

Theoretical considerations show that the maximum frequency obtainable with a triode in the normal types of circuit, is directly proportional to the

quantity $\sqrt{\frac{V}{2D}}$, where D is the

anode to grid spacing, and V is the anode potential in volts. Limitations with any given valve are imposed by the potential which can be applied to it. In spite of this, the Tungram battery valves, type P215 and the LP220, will oscillate at 112 mc. readily. The P215 in particular will oscillate, without overrunning, down to a wavelength of 1.6 metres. These valves are, therefore, of great value to the experimenter desiring to experiment upon high frequencies, and who does not wish to buy expensive special valves.

Actually it appears that with care, almost any type of battery tube of the small power class is worth trying as an

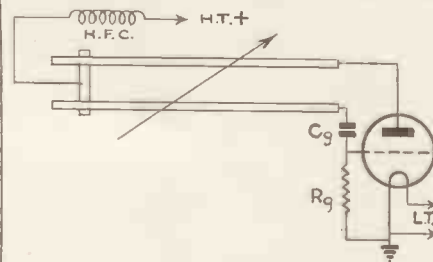

Fig. 3.—The Goal Post Inductance Tuned Circuit.

ultra-high frequency oscillator. There are also a number of mains triodes that will give good results at these frequencies. The 362 Valve Co., in fact, recommend their ACPX4A type mains power valve for ultra-high frequency work. This valve can be supplied already decapped for work below $2\frac{1}{2}$ metres, upon special order.

NOW READY

Premier 1938 New enlarged Illustrated Catalogue, Handbook and Valve Manual! Send 6d. in stamps for 90 pages of Valve Data, Technical Articles, Circuits and Premier 1938 Radio.

PREMIER
SUPPLY STORES

Manufacturers of

**TRANSMITTERS, RECEIVERS,
MODULATORS, AMPLIFIERS,
COMPONENTS**

POST ORDERS

Jubilee Works,
167, Lower Clapton Rd.,
London, E.5.
Amherst 4723

CALLERS

50, High Street,
Clapham, S.W.4
Macaulay 2381
165 & 165a
Fleet Street, E.C.4.
Central 2833.



SHORT WAVE COILS

Low-loss interchangeable coils, 4- or 6-pin standard and other fittings.

12-26 metres 1/9 41-94 metres
22-47 metres each 78-170 metres
Other wavebands up to 2,000 metres from 2/6

S.W. Coil Formers as used in above coils, 2 1/2 in. long, 1 1/2 in. diameter, 4-, 6- or 7-pin fitting. Plain or threaded, 1/- each.

3 NEW PREMIER TRANSMITTERS

10-watt 'Phone Transmitter (as illustrated) 6L6G exciter. Regenerative Crystal Oscillator Doubler. 802 Pentode Amplifier with Suppressor Grid Modulation. Price complete with 4 Tubes and Crystal, £15.



10 watt A.C./D.C. C.W. Transmitter. Pentode Crystal Oscillator. Low crystal current. Minimum frequency drift. Price complete with Valves, Crystal and Key, £4 4s.

25-watt 'Phone Transmitter. 6L6G exciter Regenerative Crystal Oscillator Doubler. 801 Triode Amplifier. Grid neutralised grid and anode meters. Price complete with 6 Tubes and Crystal, £21.

H.P. TERMS TO SUIT YOU



SHORT WAVE CONDENSERS

TROLITUL insulation. Certified superior to ceramic. All-brass construction. Easily ganged.

15 m.mfd.	1/6	Double-Spaced
25 m.mfd.	1/9	Transmitting
40 m.mfd.	1/9	Types.
100 m.mfd.	2/-	15 m.mfd.
160 m.mfd.	2/3	40 m.mfd.
250 m.mfd.	2/6	160 m.mfd.

All-brass slow-motion Condensers, 150 m.mfd., Tuning, 4/3; Reaction, 3/9.

AMERICAN VALVES

We hold the largest stocks of U.S.A. tubes in this country and are sole British Distributors for TRIAD High-Grade American Valves. All Conceivable types in stock. Standard types, 5/6 each. All the new Metal-Glass Octal Base tubes at 6/6 each, 210 and 250, 8/6 each. 4-, 5-, 6- and 7-pin U.S.A. chassis mounting valveholders, 6d. each Octal Bases 9d. each.



EUROPA MAINS VALVES

Famous Europa 4 v. A.C. types, H.L., L., S.G., Var.-Mu-S.G., H.F.-Pens., Var.-Mu-H.F. Pens. 1 and 4-watt A.C. directly-heated-output Pentodes. Full-wave rectifiers, 250 v. 60 m.a. A.C./D.C. types. 20-volt. 18 amp. S.G., Var.-Mu-S.G., Power, and Pentode. All 4/6 each.

Following Types. Full-wave rectifiers, 350 v. 120 m.a. and 500 v. 120 m.a. 2 1/2 watt indirectly heated Pentodes. Frequency Changers (Octode), Double Diode Triodes, all 5/6 each. 2 1/2 watt Directly Heated Triodes, 6/6 each.

BATTERY VALVES. 2 volts, H.F., L.F., 2/3. Power, Super-Power, 2/9. S.G. Var.-Mu-S.G., 4- or 5-pin Pentodes, H.F. Pens., Var.-Mu-H.F. Pens., 5/- Class B, 5/-.

R.C.A. TUBES. 800, 65/-, 801, 29/-, 802 (=RK25), 25/6

POWER PACKS

Completely assembled on steel chassis. Finest components.

Outputs:

120 volts	20 m/A.	25/-	Westinghouse Rectification.
150 volts	30 m/A.	27/6	" "
250 volts	60 m/A.	33/-	" "
300 volts	60 m/A.	37/6	" "
150 volts	30 m/A.	17/6	Valve Rectification.
350 volts	120 m/A.	40/-	" "
500 volts	200 m/A.	65/-	" "
1,000 volts	250 m/A.	£5	" "
1,500 volts	200 m/A.	£6 10s.	" "
2,000 volts	150 m/A.	£7	" "

MODULATION TRANSFORMERS

Primary and secondary impedance to your requirements.

10 watts	...	14/-
25 watts	...	18/6
50 watts	...	26/-

TAYLOR TRANSMITTING TUBES

T.20	... 17/6	203A	... 72/-
T.55	... 45/-	203B	... 72/-
825	... 27/6	866	... 11/6
841A	... 40/-	866B	... 17/6
		866JR	... 7/6



OVER 20,000 PREMIER SHORT-WAVE KITS

have now been sold! BECAUSE they are simple, efficient and amazing value. Each Kit is complete to the last screw.

NEW 1938 1-VALVE SHORT-WAVE RECEIVER OR ADAPTOR KIT, 13 to 86 metres without coil changing. Complete Kit and Circuit, 12/6. **VALVE GIVEN FREE!**

DE LUXE MODEL, 14 to 150 metres, complete Kit with Chassis, 4 Coils and all parts, 17/6.

1937 SUPERHET CONVERTER KIT, 13/6. **DE LUXE MODEL,** 18/6.

S.W. SUPERHET CONVERTER, for A.C. Mains Receivers, 20/-. A.C. Valve given FREE!

NEW 1938 2-VALVE S.W. KIT, 13 to 86 metres without coil changing. Complete Kit and Circuit, 19/6. **VALVES GIVEN FREE.**

DE LUXE MODEL, 14 to 150 metres, complete Kit and Chassis, 4 Coils and all parts, 25/-. **VALVES GIVEN FREE. 3-VALVE S.W. KIT,** S.G., Det. and Pen., 42/-. **VALVES GIVEN FREE!** Metal Cabinet 10/6 extra.

PREMIER HIGH-FIDELITY AMPLIFIERS AND MODULATORS

Premier, 1938, Super 3-Watt Amplifier for A.C. or A.C./D.C. mains. 2-stage, high-gain circuit. Complete Kit, with metal chassis, all parts and 3 matched Valves, 40/-. Wired and tested, £2 15s.

Premier 1938 8-Watt Amplifier for A.C./D.C. mains. 3-stage, high-gain, with Push-Pull output. Complete Kit, with metal chassis, all parts and 5 matched Valves, £4 4s. Wired and tested, £5 5s.

Premier 1938 12-Watt P.A. Amplifier or modulator for A.C. mains. 2-Beam Power tubes in Push-Pull output, phase inversion high-gain, distortionless output. Complete chassis-built Kit, with 5 matched Valves, £5 5s. Wired and tested, £7 7s.

Premier 1938 30-Watt P.A. Amplifier and Modulator System for A.C. mains. Push-Pull R.C. coupled to 2-Beam Power tubes in Push-Pull output, high impedance input. Completely wired and tested with matched Valves, £12 12s.

Premier Mains Transformers.—Screened primaries 200-250 volts. Guaranteed 1 year. Wire end types.

HT8 + 9 or HT10 with 4 volts 4 amp., C.T. and 4 v. 1 a. C.T., 10/-. 250-250 v. 60 m/A. or 300-300 v. 60 m/A., with 4 v. 1.2 a., 4 v. 2-3 a., 4 v. 3-4 a., all C.T., 10/-. 350-350 v. 150 m/A., 4 v. 1 a., 4 v. 2 a., 4 v. 4 a., all C.T., 11/6. 350-350 v. 150 m/A., 5 v. 2 a., 6.3 v. 2 a., 6.3 v. 2 a., all C.T., 13/6. Fitted with Panel and Terminals, 1/6 extra. 500-500 volts 150 m/A., 4 v. 2-3 a., 4 v. 2-3 a., 4 v. 2-3 a., 4 v. 5 a., all C.T., 21/-. 500-500 v. 200 m/A., 5 v. 3 a., 6.3 v. 3 a., 2.5 v. 5 a. or 7.5 v. 3 a., all C.T., 25/-. 500-500 v. 150 m/A., 15/-, 1,000-1,000 v. 250 m/A., 21/-. 1,500-1,500 v. 200 m/A., 50/-. 2,000-2,000 v. 150 m/A., 57/6. Fitted with Panel and Terminals, 2/- extra. Surplus Transformers, brand new and guaranteed. Phillips, 250-250 volts or 300-300 v. 80 m/A., 4 v. 5 a., C.T., 4 v. 1 a. Tapped primary 100-250 v., 6/11. 450-450 v. 150 m/A. or 500-500 v. 100 m/A., 4 v. 4 a., C.T., 4 v. 4 a., 4 v. 3 a. Screened primary, tapped 100-250 v., 12/6.

PREMIER METERS.—Moving Coil 0-1 m/A. full scale, resistance 100 ohms, 3 1/2 in. diameter, flush mounting, 22/6. Multipliers, 1/- each. Tapped shunts: —10, —50, —100, —200 m/A., 4/- each. Moving Iron Meters, 2 1/2 in. diameter, flush fitting. Read A.C. or D.C. All readings from 0-10 m/A. to 0-10 amps., 5/9 each. 0-6 volts, 0-16 volts, 5/9 each. 0-250 volts, 8/6. Telsen Multimeters. Read A.C. or D.C., 0-6 volts, 0-16 volts, 0-250 volts; 0-30 m/A., 0-300 m/A., 8/6 each.

A Simple Home-built Relay

By G18TS

WHEN operating a transmitter from a distance it is often found that two difficulties have to be overcome. These are the risk of danger from H.T. voltage, and prevalence of key clicks, so for these reasons the keying leads must be kept as short as possible. With a simple keying relay the

to the small currents passing in these circuits a small relay, such as is to be described, can be conveniently used.

Construction

A keying relay consists of an electro-magnet which, when operated, will attract to it a light spring, or trembler,

base by two wood screws, another hole having to be drilled in the frame for one of them. There was no necessity for mounting a new trembler as one was already incorporated in the unit. However, as one of the bobbin connections was soldered to the frame this had to be disconnected and the two wires brought to two terminals A and B.

The make-and-break arrangement is quite simple. The small copper spring used for this purpose on the original bell unit was broken off and soldered on the opposite side of the trembler, as shown. When the trembler is drawn towards the magnet this spring makes contact with a screw terminal also supplied on the same card as the unit, thus making contact between the two and completing the circuit. Two terminals, C and D, are included on the base, one actually holding down the bar carrying the adjustable screw, and the other is connected to the chassis.

The only adjustment necessary is that the screw terminal should be set that it makes good contact with the trembler when the latter is attracted towards it. In this circuit are the battery, which should be a 2-volt accumulator, as the current consumption is too great for dry batteries, and the key.

It has been found that this relay works very satisfactorily up to speeds of 15 words per minute, but must be mounted close to the transmitter.

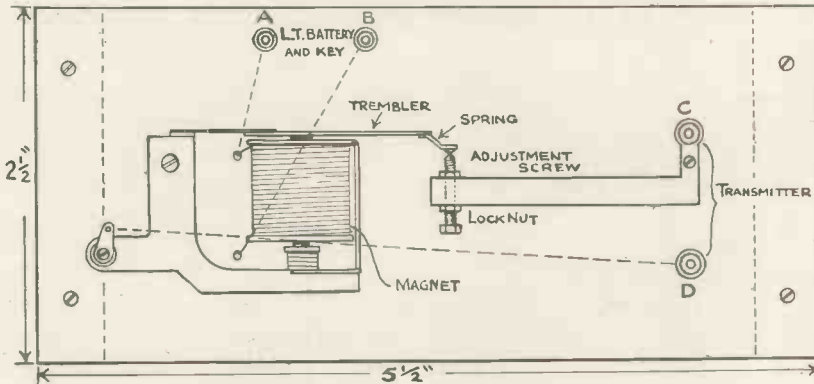

A relay of this type can be put to many uses by the average transmitting amateur.

transmitter can be operated from any distance, in the same way as if the key was in the direct circuit.

Pentode or tetrode valves when used as crystal or tritet oscillators have the advantage that they can be keyed in the cathode or screen circuits with very little risk of key-clicks resulting. Owing

which at the same time makes contact with a point and completes an electrical circuit. A unit carrying a bobbin is screwed down to a base $5\frac{1}{2}$ in. \times $2\frac{1}{2}$ in. with $\frac{1}{4}$ in. battens. This unit was actually a bell mechanism unit purchased in Woolworth's. As can be seen from the sketch this was held down to the

A New McElroy Key

C.W. enthusiasts will appreciate the introduction of a new McElroy key for 10s. Actually the original scheme was to supply the key complete with hummer and battery for £1, but at the same time, as the action of this key was so very good it was decided to sell it separately for transmitting amateurs.

The hummer is a combined telephone and microphone producing a steady note of about 1,000 cycles, which is very similar to a normal C.W. note heard when listening on a receiver. Two terminals are provided on the key to take the $4\frac{1}{2}$ -volt energising battery, with a second pair of terminals for headphones, so that a very compact morse practice set is obtained.

Hardened C.W. experts will be very surprised at the exceptional balance of this new McElroy key, and although it is light in construction it does not need screwing to the bench owing to the inclusion of a particularly heavy base.

Those who are endeavouring to learn the morse code should consider buying

one of these practice sets, for when the licence is ultimately obtained the key is ideal for general C.W. operation. Models can be tried under working conditions at Webb's Radio, 14 Soho Street, W.1.

A 15-watt Transmitter for Beginners

IN the November issue we published a full description of a 15-watt transmitter and unfortunately owing to a printer's error several lines on page 678 were transposed, so that the sense of the article was not immediately apparent to beginners. In order to clear up any misunderstanding that may have occurred we are reprinting this short section. The following text matter should be pasted in on page 678 in order to correct the original copy.

These valves make excellent oscillators and even with high voltage do not show any signs of stress and give an amazingly high R.F. output with low crystal current. Similarly when used as low frequency amplifiers, the output is much higher than would be expected despite the low grid input required. The first speech amplifier is an RCA6C5 which is a triode with an octal base, similar in characteristics to the AC/HL type of valve. At this point it is excusable to draw away from the point a little and deal with the input from the microphone. The 6C5 valve is used to follow a single stage speech amplifier so that a high quality microphone can be used. If, however, experimenters intend to use a carbon type of microphone, then exchange the 6C5 for a 6F5 which is interchangeable with the exception of the bias resistor which should be adjusted to give an anode current of .9 mA.

The 6C5 is rather sensitive as to anode load if maximum stage gain is to be obtained and with the power pack recommended the anode load, that is R3, should have a value of 50,000-ohms. R4 is merely for decoupling and has a value of 25,000-ohms.

Read
Television & Short-wave
World
Regularly

"WARD" EIGHTEEN VALVE CHASSIS

This chassis incorporates every worth-while modern refinement, and is carefully designed to make full use of every aid to efficiency. There are no passenger stages employed, and furthermore, no components are stressed to their limits. Thus extreme reliability and consistency of performance will prevail throughout a long and useful life. The brief specification given below will serve as a rough indication of the remarkable value offered in this idealistic design.



STAR FEATURES



- ★ 28 watts undistorted output.
- ★ Sensitivity Control.
- ★ 6 wave bands, $4\frac{1}{2}$ to 2,100 metres continuous.
- ★ Delayed A.V.C.
- ★ Squelch Control.
- ★ All L.F. Stages—resistance capacity coupled.

BRIEF SPECIFICATION

Circuit: 6K7 Radio Frequency Stage coupled to 6TH8 triode hexode frequency changer. Two high-gain intermediate frequency stages employing 6K7's followed by 6H6 double diode for rectification and A.V.C., squelch valve type 6C5, two 6C5 triode L.F. stages into 6C5 phase changer, the output of which is fed into two 6C5's in push-pull, and the output of these to four 6N6G in push-pull parallel. Two 5Z3 rectifiers are used for H.T. supply. Cathode-ray tuning indicator operates effectively on weak or strong signals on all bands. Provision for gramophone controlled by rotary switch. Dipole aerial connections, six wave-bands, $4\frac{1}{2}$ -10, 9.5-27, 26-73, 71-200, 200-550, 500-2,100 metres. 465 kc. intermediate frequency. Chassis size 19in. long, 12in. wide and to top of condenser drive $8\frac{1}{2}$ in.

CONSTRUCTIONAL NOTES

The chassis is of heavy gauge grey cellulosid steel. Yaxley wave-change switch. Rola G12 Speaker. Five controls on the front, i.e., combined volume control and main switch, sensitivity control, wave-change switch, tuning control and rotary gramophone switch. There is also a pre-set squelch control at the back of the chassis. Latest bar-type tuning condenser.

EIGHTEEN VALVE CHASSIS

PRICE **30** GUINEAS.

Hire Purchase Terms :

12 months. £4 14 0 down and £2 11 4 monthly.

18 months. £4 14 0 down and £1 15 0 monthly.

NOTE. We also have in the experimental stage a Thirteen Valve Chassis with six wave-bands, details of which will be issued in due course.

CHARLES F. WARD • 46 FARRINGDON STREET • LONDON, E.C.4

Telephone: HOLBORN 9703

A Precision Oscilloscope for Experimenters

THE design for this oscilloscope was discussed in last month's issue. This article describes the construction of the chassis and the wiring of the components. The concluding article next month will give details of the testing and finishing off.

The chassis on which the components are mounted is supplied by the A.P.A. Metalworks, Ltd., and consists of two

Amateurs and experimenters will find this full-size oscilloscope useful for checking waveform, testing receivers and observing the performance of a transmitter. A 4-in., 5-in. or 7-in. tube can be used.

are mounted at the back edge of the chassis as shown. Before fastening them down, holes must be drilled to

heater leads, and these could be fitted on either side of the secondary of T₃.

The large condensers C₄, 5, 6 and C₃ and C₂ should be fitted to clear the edge of the chassis by $\frac{3}{8}$ in. The chokes L₁ and 2 and C₁ are all on the same centre line as C₃. In the corner of the chassis near the panel is the fuseholder F and the mains socket P. The fuseholder should have two holes drilled near the edge of the chassis opposite the holes in the moulding to take the leads through to the switches. These are fixed in the front flap as shown by the holes S, S and at the same time a hole should be drilled for the Kabi condenser switch C₈.

A very neat job is made by tapping all the fixing holes 6 B.A., but clearing holes will be satisfactory with 6 B.A. screws and nuts.

After drilling all the holes, before fixing the components down, turn the chassis over and drill for the two condensers and Bulgin group boards. These are shown in position in the diagram of Fig. 2, each board being opposite a valveholder. The 1-mfd. condensers C₁₂ and C₁₅ are fastened to the flaps so as to rest against the underside of the chassis. One or two other holes will be required for leads, but these can be left till the wiring stage.



This 7-in. tube indicates the size of the complete oscilloscope. In our next issue the details will be given showing how this tube should be mounted on a special swivel mount.

trays measuring 2 ft. by 1 ft. with flanges $2\frac{1}{4}$ in. deep. The whole of the components are mounted on one tray, the other being fastened above it to act as a cover. Four angle iron strips are screwed at the corners of the trays to hold them rigidly. In the original design it was intended to mount the tube in the centre of the lower chassis, but Messrs. A.P.A. have now produced an improved tube holder which will allow the tube to be swivelled in any direction and this has been incorporated in the design. Although a self-contained tube has several points, there are many occasions in which it is desired to mount the apparatus in a position which would normally be difficult for viewing the tube, and the swivelling stand enables greater flexibility to be obtained.

Chassis Drilling

The chassis is supplied with the holes for the valveholders ready drilled and it is only necessary to drill clearing holes for screwing down the remainder of the components. It is not feasible to give a dimensioned drilling diagram owing to the tolerance between individual components, but an examination of the drawing of Fig. 1 will make the layout clear.

The three transformers, T₁, 2 and 3,

take the leads which pass through the metal. The primary windings which are not used can be taped up and tucked under the flange of the bobbin, leaving three leads to pass through on the primary side—common, shield, and mains voltage tap. On the secondary side of T₁, seven holes will be required for the L.T. windings. T₂ requires three primary and two on the secondary as one of the H.T. leads goes direct to the anode of the rectifier. T₃ has its secondary leads left above the chassis as they will be connected to the C.R. tube cathode. A refinement at this stage would be the provision of two H.T. porcelain terminal pillars to support the cathode

Front Panel

The front panel is shorter than the whole width of the chassis by the width of the two angle iron supports and should be filed to fit snugly between them. The one used in the original model measures $22\frac{1}{2}$ in. by 12 in. but it is better to allow a little extra and trim to size.

Either paxolin, ebonite, or wood may be used for the front panel in order of preference. Paxolin will be found expensive especially as $\frac{1}{4}$ in. thickness is desirable, and the choice will have to

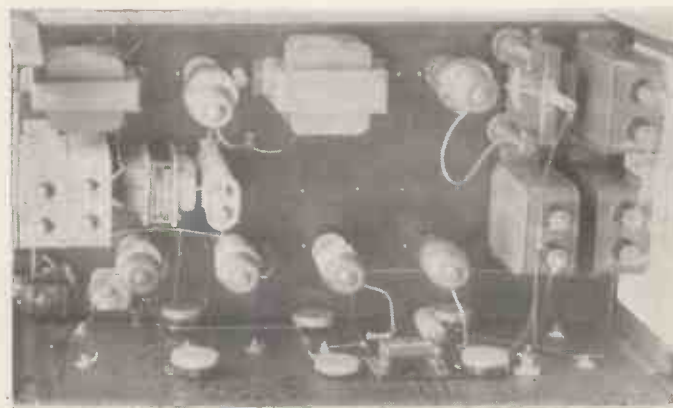

All the components on the baseboard can be seen from this plan view. Make a special point of following exactly the layout suggested by the designer.

G2NO
H. R. ADAMS

SELECTED ITEMS FROM
OUR LIST

MICROPHONES

Shure 701A. Grill type. 84/-
Astatic D104 75/-
Webb's Transverse Carbon,
with table stand. 25/-
With floor stand. 35/-

VALPEY CRYSTALS

7 Mc. mounted.
Calibrated to + or - .1 per
cent. 15/6
Unmounted, as above. 10/6

**DUMONT CATHODE
RAY OSCILLOSCOPE**

Model 164. 3-in. tube.
Vertical and Horizontal Ampli-
fiers. Amplified sweep.
Internal Power Pack.
Price complete 18 guineas
913 1-in. Cathode Ray Tube. 37/6

ACORNS. Price reduced.

Type 955 Triode. 25/6
Types 954, 956 Pentodes. 36/-

RAYTHEON TUBES

RK-34 Duplex Transmitt-
ing Triode. 22/6
RK-39 Beam Power TX 22/6
RK-47 (Beam Power RK-20).
105/-
100-TH, New Eimac. 95/-
RK-20A replacing RK-20. 95/-
RK-25 and RK-23. 27/6

TAYLOR

Taylor T.125. £4 5s. 0d.
Taylor T.20. 17/6
Taylor TZ.20. 17/6
Taylor 866 Junior. 7/6
Taylor 866 11/6
Taylor T.55 45/-

POWER TRANSFORMERS

Filament Transformers, single
winding. Up to 30 watts. 12/6
Twin Winding, up to 30 watts.
15/6
Triple Winding, up to 40 watts.
19/-
High Voltage Transformers.
750-0-750 at 200 mils, inter-
leaved. £2 13s. 0d.
1,000-0-1,000 at 200 mils.
£3 15s. 0d.
1,000-0-1,000 at 350 mils.
£4 10s. 0d.
1,000-0-1,000 at 500 mils.
£5 0s. 0d.
Swinging Chokes.
5 to 25H at 100 m.a. 15/6
5 to 25 H at 200 m.a. 21/-
Filter Chokes.
20 Henry at 120 m.a. 15/6
20 Henry at 200 m.a. 28/-
Other sizes to order.

CLEARANCE OFFERS

Genuine Reisz Microphones
Guaranteed in perfect order.
27/6
Mu-Metal Microphone Trans-
formers (cost 55/- each). 7/6
Mu-Metal Smoothing Chokes.
5.2 H, 120 m.a. 3/6
4-in. Transmitter Bakelite Dials.
½-in. spindle. 6d. each

EDDYSTONE ALL-WORLD
TWO, complete with valves;
colls, calibration chart, ready
for use. Price £3 17s. 6d.
Aerovox 2 mfd. 2,000 v. W.K.G.
9/6

G6VA

E. J. PICKARD

WEBB'S

PRODUCE THE RADIO AMATEUR'S GLOBE AND MAP OF THE WORLD

12" Radio
Globe
Mounted,
Fully
Coloured
International
Prefixes
Time Zones



PRICE
27/6

Immediate
Delivery

EQUIDISTANT AZIMUTHAL MAP OF THE WORLD CENTRED ON ENGLAND

ALL INTERNATIONAL PREFIXES MARKED
FULLY COLOURED: SIZE 30 in. by 40 in.

PRICE 4/6

A limited number of Maps mounted on linen, with roller, at 10/6.
BOTH AVAILABLE DECEMBER 1st.

TED McELROY, WORLD'S CHAMPION TELEGRAPHIST, RELEASES A NEW STRAIGHT KEY.

LARGE CONTACTS. HEAVY CAST BASE. DELIGHTFUL ACTION PRICE 10/-
MAC OSCILLATOR.

FOR PRACTICE. PRODUCES A 1,000 CYCLE NOTE - - - 10/-
KEY AND OSCILLATOR COMBINED - - - 20/-
1938 McELROY BUG KEY - - - 38/-

WEBB'S CARRY THE STOCKS WEEKLY CONSIGNMENTS

DIRECT FROM THE FACTORIES OF

RME, HALLICRAFTERS, TAYLOR, RAYTHEON,
HARVEY, etc.

ASSURE THAT YOU RECEIVE PROMPT DELIVERY AND BRAND NEW GOODS
EVERY MEMBER OF OUR STAFF IS A 100% 'OLD TIMER,' THOROUGHLY HAPPY
IN HIS WORK OF MAKING WEBB'S THE AMATEUR CENTRE

CALL AND ENJOY A PERSONAL CONTACT

WEBB'S RADIO

(C. WEBB, LTD.)

14 SOHO ST., OXFORD ST., LONDON, W.1.

Phone : GERrard 2089

MIDLAND DEPOT (FOR CALLERS ONLY)

41, CARRS LANE, BIRMINGHAM.

G2CY
H. W. STEWART

COMMUNICATION TYPE RECEIVERS

RME-69. 1938.
The Amateur's finest receiver.
Price £39 15s. 0d.

RME-69-LSI.
Incorporating the famous Lamb
Noise Silencer unit.
Price £43 10s. 0d.

RME-DB.20.
Two-Stage H.F. Pre-Selector.
9 to 550 metres.
Built-in Power Pack (230 v.).
Price £12 10s. 0d.

1938 HALLICRAFTER.
The New Super Sky Rider
Crystal Gate "R" Meter.
1,000 deg. Band Spread.
5 to 550 metres.
Price 230-v. model £32 0s. 0d.

1938 SKY CHALLENGER
9 tubes.
Fully calibrated.
9 to 550 metres.
Crystal Gate.
Price 230-v. model £25 0s. 0d.

1938 SKY CHIEF.
7 Tubes (1 R.F.).
Built-in Speaker.
Price complete £12 10s. 0d.

THE NEW SKY BUDDY.
5 Tubes.
17 to 550 metres.
Built-in Speaker.
Price complete £9 0s. 0d.

NATIONAL.
National "One-Ten"
The finest U.H.F. Receiver.
NOTE REDUCED PRICE.
Complete with Tubes. £18 10s. 0d.
Power Pack £4 10s. 0d.
National H.R.O. Senior
Price complete £49 15s. 0d.
National H.R.O. Junior.
Price complete £39 15s. 0d.

NEW NATIONAL 80X
Delivery is expected Decem-
ber 1st.
A.C./D.C. Operation.
Price £23 0s. 0d.

HARVEY TRANSMITTERS
UH-X-10
10 to 20 watts R.F.
5 to 160 metres.
Crystal Control.
Price Transmitter bare
£16 15s. 0d.

HARVEY 80T
Complete for two-band opera-
tion. £63 17s. 0d.

UH-X-35
20, 10, 5 and 2½ metres.
100 watts input.
Price complete £110 0s. 0d.

WRITE FOR LIST AND
DETAILED HIRE-
PURCHASE FACILITIES

WIJYN

TED McELROY

Construction :: Wiring

be made between ebonite or wood. There is no objection to the latter if of the best quality three-ply and it can be given a coat of black stain followed by

tween the "Focus" and upper "Shift" potentiometers a fifth group board is screwed to take the resistances of the H.T. feed to the tube.

to the H.T. leads and all insulation should be reinforced where it passes directly through the metal.

Note the direction of mounting of the valveholders, which will be found most convenient for wiring, and note also that they are not in order—V₄, V₃, V₅ and V₆. When all the components have been fitted the resistances can be fixed on the front panel, together with the terminals. As an additional guard against leakage a mica or paxolin washer should be fitted under the nut at the back of the terminal, and each one should be fitted with a soldering tag to facilitate connections later.

Do not fix the front panel in place at this stage as the majority of the wiring can be done on the underside of the chassis, resting it upside down on the condenser terminals.

Picking out the resistances that are connected to an H.T. + bend up their tags and run an H.T. wire along the top of the group boards. Do the same for the negative (earth) lead and terminate this under one of the component fixing screws. It is not safe to rely on chassis connection for earth and all earth points should be bonded.

The position of the tubular condensers C₁₉, C₁₆, etc., is indicated by the outlines, but these are not important and may be fitted in where convenient. They should be as rigid as possible to prevent them "flopping" when the chassis is turned right way up.

In wiring the transformer primary, take a lead from each fuse in the double

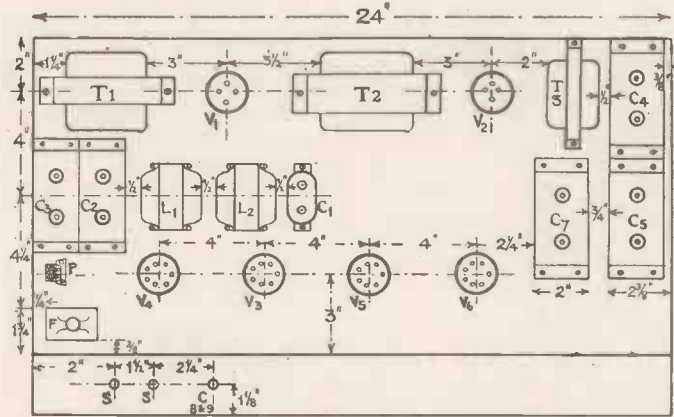

Fig. 1. Here is an actual drawing of the chassis showing the space between components.

one of shellac. The front panel should be approached to the chassis and three fixing holes marked at the lower edge to come in the centre of the flap, one in the exact middle of the width and the other 2 in. in from the corners.

2 B.A. countersunk screws and nuts should be used for fixing the panel and when it is in position the holes S, S and C8 should be scribed in place from the inside of the chassis to make sure that they register when the panel is finally fitted. After these have been marked, remove the panel again and proceed to lay it out according to the diagram of

Wiring Up and Fitting

As a preliminary to wiring up the group boards can be fitted with their resistances according to the chart of Fig. 2. They are screwed into place with their tags facing front and back, so that the leads will be short to the valveholders. The group board G₄, shown as containing the C₈ group of condensers, is fitted as follows: From left to right, 0.1, .01, .005, .001, .0005. (Note that a misprint in last month's article gave the last value as .005.)

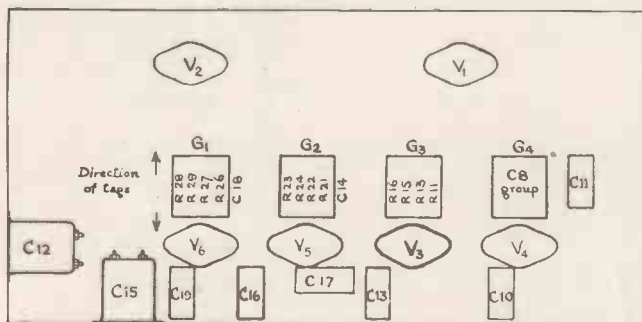

Fig. 2. Underneath the baseboard are four group boards carrying resistors and other components, and this drawing shows their exact location.

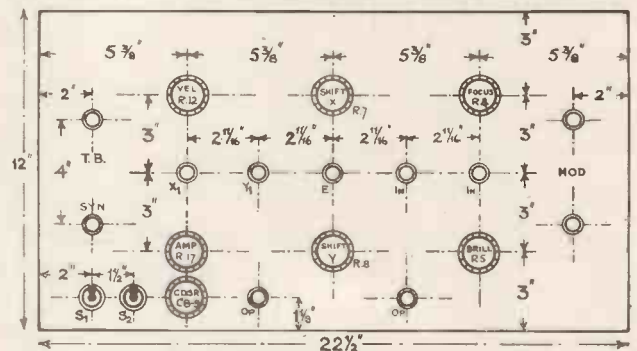

Fig. 3. The panel is of plywood painted black which should be drilled as shown by the dimensions in this drawing.

Fig. 3. Six of the controls are arranged symmetrically about the centre line, the only odd knob being that of C₈ which has to be as close as possible to the time-base valves.

The terminals are arranged across the centre of the panel, with two pairs at each end of the row as shown. The terminals OP for the output of the amplifiers are arranged to pass through the flap and will have to be marked out in place as in the case of the switch holes. On the back of the panel be-

After the group boards have been wired and screwed into place the components can be screwed down on the upper side of the chassis. When the transformer leads are threaded through the metal care should be taken that the leads are not kinked or that the systoflex does not leave a part of the wire bare. It is advisable to pass a thicker piece of systoflex over the smaller one where it passes through the chassis to prevent damage to the insulation.

This precaution particularly applies

holder to one side of the switch, as shown in the theoretical diagram of last month's issue (p. 696). Another point which should be noted is the incorrect connection of the condenser C₆ shown as going to the first anode. It should go to the grid tapping on the potentiometer. In certain cases it may even be necessary to include a condenser between first anode and cathode, but one as described is usually sufficient.

After the chassis has been wired, the

(Continued on page 762)

'AVO'

Accurate Testing Instruments
BRITISH MADE

Only precision instruments enable you to test accurately and trace radio faults efficiently. "AVO" instruments are outstanding for precision. They are the outcome of a constant effort to provide amateur enthusiasts and radio engineers with instruments of high accuracy and maximum utility at a moderate cost.



THE D.C. AVOMINOR

This accurate moving-coil instrument is 13 meters in one. It has 13 ranges: voltage ranges for measuring H.T., L.T., Grid Bias, Mains and Eliminator Voltages; Milliamp ranges for testing receiving valves and apparatus; Resistance ranges for all resistance measuring. In case, complete with testing prods, crocodile clips, leads and instruction booklet. **45/-**



THE AVODAPTER

Simplifies valve testing. Enables all valves to be tested under actual working conditions without need for cutting connections and groping about inside the set. Instantly adaptable for 4-pin, 5-pin and 7-pin valves. Price **27/-**

9-PIN AVO-COUPLER

Attachment (not illustrated) renders Avodapter suitable for 9-pin valves. **12/6**



UNIVERSAL AVOMINOR

This compact precision moving-coil instrument provides facilities for all A.C. and D.C. testing. It has 22 ranges covering A.C. voltage, D.C. voltage, current, and resistance. All readings are direct. Total resistance of meter, 200,000 ohms, ensuring accurate readings. Complete with testing prods, crocodile clips and instruction booklet. **£5.10s.** Leather Case, 10/-.

Deferred Terms if desired.

Write for illustrated literature giving full details of all "Avo" Testing Instruments

AUTOMATIC COIL WINDER & ELECTRICAL EQUIPMENT CO., LTD.

Winder House, Douglas St., London, S.W.1. Telephone: Victoria 3404/7.

New Edition!

RADIO SERVICING SIMPLIFIED

A new and considerably enlarged edition of this popular text book. It has been entirely re-written to conform with modern requirements and in the light of present-day standards of knowledge. It takes the reader by easy stages through the whole routine of testing modern radio receivers, and describes in a clear and interesting manner every test, and much other useful information of value to the radio enthusiast. 150 pages, 8½ in. x 5½ in. Numerous illustrations, diagrams and graphs.

2/6 Post Free
2/10

"The finest book published on Radio Engineering"!

Practical radio engineers, professors of radio engineering, students—everyone who requires a sound, comprehensive book covering all phases of radio communication are unanimous in their praise of

TERMAN'S RADIO ENGINEERING

New Edition

813 pages, 9 x 6, 475 illustrations.

30/-
NET

Read this list of Chapter Headings and see how this book can help you

- | | |
|--|--|
| 1. The Elements of a System of Radio Communication | 11. Sources of Power for Operating Vacuum Tubes |
| 2. Circuit Constants | 12. Radio Transmitters |
| 3. Properties of Resonant Circuits | 13. Radio Receivers |
| 4. Fundamental Properties of Vacuum Tubes. | 14. Propagation of Waves |
| 5. Vacuum-tube Amplifiers | 15. Antennas |
| 6. Vacuum-tube Amplifiers (Cont.) | 16. Radio Aids to Navigation |
| 7. Power Amplifiers | 17. Television |
| 8. Vacuum-tube Oscillators | 18. Sound and Sound Equipment |
| 9. Modulation | Appendix. Formulas for Calculating Inductance, Mutual Inductance, and Capacity |
| 10. Vacuum-tube Detectors | Index |

McGraw-Hill Publishing Co., Ltd.
Aldwych House London, W.C.2

(Continued from page 760)

front panel can be fitted on and the switches inserted through the holes. The screwed portion of the switch C8 will not be long enough to pass through both metal and wood or ebonite and it will be necessary to fix the nut against the metal. It is advisable to insulate the shaft with additional washers and bush, or drill a large clearing hole, as the insulation of the switch may give rise to leakage if dirt collects.

Before wiring the front panel, the following holes will need to be drilled to take through wires:

Four in line in front of the "Amplitude" potentiometer.

One in line with the T.B. terminal.

One adjacent for the synchronising connection.

One near the H.T. + side of the time-base condenser.

A wire through the latter will connect to the H.T. busbar on the group boards.

Panel Wiring

The group board at the back of the panel should be wired before being screwed down, as follows:—

From top to bottom, the tags running across the width of the panel, R₃ (two resistances) R₉, R₁, R₂.

These will be found to fit in conveniently with the potentiometers and the earth terminal on the centre of the panel. The connections to the tube will be by means of flexible leads passing through the top of the chassis and

these can be left till last to enable the length to be gauged accurately.

Taking C₄ and C₅, the outer terminals are joined together and to earth, while the inner terminals are bridged by the resistance R₆ (200,000 ohms). From the inner terminal near the valve holder a flexible lead is taken to the anode cap of V₂.

C₇, the modulating condenser, is for applying a timing or modulating signal to the grid of the tube and care must be taken that the leads are well clear of any other. The upper terminal of the pair marked "MOD" may be made the "live" one and the other

The input terminals to the amplifiers have short leads taken direct to the valve tops, a grid leak being connected from the terminal to the earth wire to close the grid circuit.

The synchronising condenser C₂₀ can be fixed on the chassis near the fuse-holder, but if desired it can be fitted at the back of the panel so that a screw-driver adjustment can be made. In certain cases it may be required to increase the coupling between the time base and input by the addition of a parallel condenser, but the value given has been found to be the best.

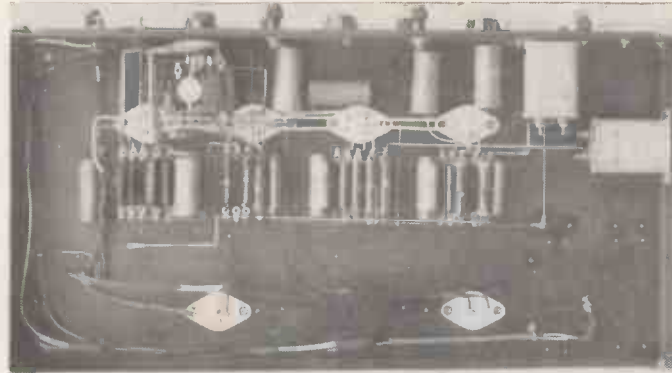

This is the sub-chassis completely wired with all components in position. Carefully notice which wires have been screened.

connected to earth. It must be remembered that the upper terminal is then live to chassis by 3,000 volts when the set is on and it should not be connected without due care.

The terminals X₁ and Y₁ have resistances R₁₈ and R₁₉ of 2 megs. each joining them to earth, and flexible leads are taken from the terminals direct to the plates of the tube.

Specified by *the Experts*

SOUND SALES

Special TRANSFORMERS

FOR USE WITH

CATHODE RAY EQUIPMENT

AND

HIGH VOLTAGE TRANSMITTING APPARATUS

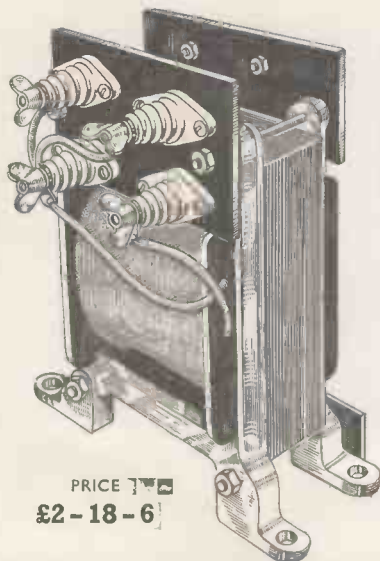

We illustrate our model Tel, EHT., for 200/240 volts at 40/100 cycles. Secondary output 1,750 volts at 20mA.

Send for details of our full range of Transformers, Chokes, etc.

PRICE **£2-18-6**

SOUND SALES LIMITED

Marlborough Road, Upper Holloway, London, N.19
Phone: Archway 1661-2-3 (Contrs. to G.P.O., etc.)

A.P.A. EXCLUSIVELY SPECIFIED

for the

- Oscilloscope for experimenters.
- Single Valve 240 B Transmitter.
- Regenerative R.F. Amplifier.
- A T-125 Output Stage.
- A Multi-range Short-wave Converter.

ALL DESCRIBED IN THIS ISSUE

Useful list of stock metal parts and aids to construction free on request.

**CABINET
PANEL
SCREEN
CHASSIS**

by



for
**ANYTHING
IN
METAL**



METALWORKS

171c, Battersea Park Road,
London - - - S.W.8

Write or 'Phone: **MACAULAY 4840**

Receivers and Components for Amateurs.

WE were privileged to see just how and where necessary components and sets built for amateur constructors were actually made, when we visited the factory of Messrs. Premier Supply Stores, Ltd., at Clapton. We spent nearly a full day seeing mains and filament transformers of every kind in all stages of construction and we left this section quite assured that if any of the transformers developed a fault it was most unlikely that it was due to any slip in manufacture. Every winding is insulated from its neighbour by a layer of paper, while the main bobbin is particularly robust so that breakdowns to core are almost impossible.

Another interesting component that we saw was a high-frequency choke wound on a ceramic former for use in amateur transmitting circuits. We took two or three samples at random before they were even tested and tried these out both in the laboratory and under working conditions. The chokes were excellent in every respect and were free from peaks from 5 to over 200 metres, and would stand 400 M/a quite comfortably.

Several new amateur communication receivers were in course of construction

and these will cause quite a stir when they ultimately are ready for sale early in December. One multi-valve communication receiver with a regenerative R.F. amplifier will sell at an extraordinary low price and will compete with many of the multi-valve American receivers which are at present so popular in this country.

Variable condensers were seen in the course of construction and we were impressed with the way in which these were carefully checked at various stages and finally checked for characteristics before despatch.

Coils, condensers, dials, transformers, mains units and components of every kind are built at these Clapton works for the use of amateur constructors. Those who are interested in short-waves can purchase a complete 10-watt phone transmitter for 25-watt phone or C.W. already tested at a price that is very competitive. They also construct a 10-watt A.C./D.C. transmitter for 4 guineas, a battery operated Class B amplifier, a 10-watt volume expansion P.A. amplifier that gives perfect quality and is complete with nine valves for 10 guineas.

For those who are interested in high quality transmission they have a Globe crystal microphone priced at 4 guineas, with an output level of 58 db.

A complete range of American communication receivers and Taylor valves is available.

Premier components take up no less than 65 pages of their new catalogue, a copy of which can be obtained for 6d. from their retail shops at 50 High Street, Clapham, and 165 Fleet Street.

Headphones and Short-wave Reception.

WITH small short-wave receivers not capable of giving a high output even on the most powerful stations, the use of a good pair of headphones becomes essential. Even with multi-valve receivers when conditions are not too good a high noise level is often experienced. In such circumstances it is advisable to reduce the overall gain and to use headphones, for the hearing becomes much more selective and it is then possible to distinguish call signs which would be lost if a loudspeaker only is employed.

Suitable instruments for this purpose are the well-tried Ericsson super-sensitive type which are priced at 15s. They are obtainable in three resistances, of 120 ohms, for use with an output transformer, and also 2,000 and 4,000 ohms. We suggest that those interested in very long-distance reception should get in touch with Ericsson Telephones, Ltd., 22 Lincoln's Inn Fields, W.C.2.

THE FRONT ROW OF THE STALLS OF THE AIR IS YOURS

If you are one of those earnest listeners . . . who like to feel in close communion with the performance . . . who wants to feel every subtle nuance of the music . . . then you simply must listen apart from the world around you. You must listen on a pair of **ERICSSON SUPER-SENSITIVE TELEPHONES.**

Then you will start listening in earnest. Made for the music lover, for their tone is astonishingly correct and pure and obtains a lot of what the loudspeaker misses.

Very comfortable in wear; 3 resistances:—120, 2,000 and 4,000 ohms. One price, 15/-.

All good radio dealers. If any difficulty write direct to:

ERICSSON TELEPHONES LTD.
22 Lincoln's Inn Fields,
London, W.C.2.

Tel: HOLborn 6936.

Ericsson

SUPERSENSITIVE TELEPHONES



AN
IDEAL &
UNUSUAL
XMAS
PRESENT!

THE MIDWEST "NEW IMPERIAL" CHASSIS

MULTI-VALVE receivers do have that very big advantage that whatever stations are received can be retained for long periods at good entertainment value. The careful tuning so necessary with small receivers on short-waves is completely overcome with a set such as the new Midwest 15-valver. During our tests there did not appear to be any weak stations, for either a station was so powerful it gave an output of between 10 and 15 watts, or else it was not heard at all.

The technical specification is most interesting and is more or less ideal, both for long-distance reception and for local station quality reception.

The valve sequence is pre-selector, triode oscillator, modulator amplifier, two stages of intermediate-frequency amplification, audio demodulator, A.V.C. amplifier, A.V.C. rectifier, electro beacon control valve, audio amplifier and four pentodes in parallel push-pull, followed by a rectifier. All these valves are of the new international type with Octal bases, so that British or American valves can be used at will.

One of the high-spots of the new Imperial is its comprehensive tuning range covering six wavebands between $4\frac{1}{2}$ and 2,400 metres, so covering all amateur short-wave bands, commercial short-wave broadcasters, television

sound programmes, and all medium and long-wave stations. In fact, with this set practically every transmission channel can be covered.

A special two-speed tuning dial giving ratios of 18-1 and 100-1 enables even the ultra high-frequency stations to be picked up quite simply. The dial is full scale, calibrated in kilocycles on long and medium waves and megacycles on short waves.

A special 12-in. auditorium loud-speaker gives perfect quality even at maximum output, while a separate base expander and treble attenuator enables the quality to be varied to suit individual requirements.

We were very impressed with the effective A.V.C. action even on ultra-high frequency stations. As the A.V.C. is slightly delayed there is absolutely no loss in signal strength even when receiving the 9-metre American Police cars. Over 40 ten-metre phone stations were heard in a period of 30 minutes, while the 13-metre broadcasters were receivable at terrific volume and absolutely free from fading or interference.

All idea of distance is eliminated with this multi-valve receiver, for, as previously mentioned, stations are either on a par with medium wave broadcasters or else they are not picked up at

all. This is a very fine feature and automatically makes readers appreciate the value of the short-wave channels.

Selectivity is genuine 9 kc., which is more than adequate for general requirements. Even on short-waves, where only a very modest aerial is required, stations such as Daventry and Eindhoven, on 16 metres, can be received free from mutual interference. The four stations on the 13-metre channel can all be picked up at such strength as to be heard at a distance of 50 yards, again without any mutual interference. Amateurs may find it difficult to give accurate reports on the strength of stations received owing to the fact that during our tests all stations were picked up at R₉, irrespective of distance, and as the noise-level was also negligible, no true indication of carrier strength could be obtained. However, for those who want a really sensitive set we can thoroughly recommend this 15-valve new Imperial which in chassis form is priced at £35 10s. There are other models ranging from the Glendale Console at £43 10s., up to the Windsor, a radio-gramophone with automatic changer at £68 10s., but full information on these and other models can be obtained from the manufacturers, The Midwest Radio Manufacturing Co., Ltd., of 16 Old Town, Clapham, London, S.W.4.

RAYMART CRAFT A CREED

Every month there are Raymart components used in apparatus described in this journal. **THIS MONTH** it is **COIL FORMS** for a Regenerative R.F. Amplifier. You need one each of types C.T.4 at 1/8 and C.T.6, 1/11. Then for the T-125 output stage, you will want a **CHOKE**, type CH500 at 8/6, and 4 Ceramic Coil Forms, type H.F.4 at 4/6 each.

WE SPECIALISE IN SHORT-WAVE COMPONENTS AND CARRY LARGE STOCKS.

We are Sole Distributors for BLILEY, THORDARSON, TAYLOR TUBES, RME, NATIONAL, BASSETT CONCENTRIC CABLE, HOYT METERS, ETC., ETC.

We are also Authorised Distributors for NATIONAL.

NOTE THE SPEAKER BARGAINS QUOTED BELOW

W.B., P.M. type, 8-in. cone, complete with transformer, 12/6. Ditto, extension type, low impedance, 7/6.

MAGNAVOX, 10-in. energised, 1,000 or 2,500 ohm, 19/6.

JENSEN, 8-in., 2,500 ohm, with transformer, 7/6.

JOHNSON Q ANTENNAE: 20-metre, 39/6; 10-metre, 26/6; 5-metre, 27/6. Full range Bassett Concentric Feeders in stock.

COMMUNICATION Equipment. Send 1½d. stamp for latest bargain list. It will save you pounds.

LATEST 3-GANG low minimum all-wave condensers, fitted airplane dial, 8 and 80: 1, 8/6; Yaxley 3-gang 3-band switches, 2/11; ditto, 4-gang, 4-band, 3/11.

RAYMART SHORT-WAVE MANUAL 6d. Post Free 7½d.

Raymart Short-Wave Catalogue, 16 pages, 1½d.

RADIOMART

65NI (BIRMINGHAM) LTD.
44, HOLLOWAY HEAD, BIRMINGHAM
Telephone: Mid. 3254.

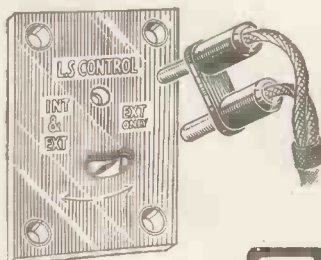
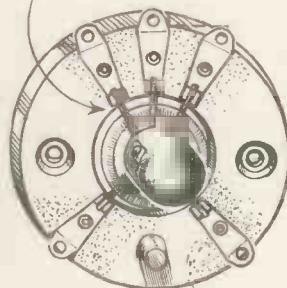
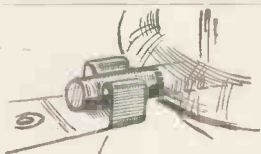

Clix "Acorn" Valveholders

In addition to their low-loss characteristics occasioned by the Frequentite bases, the method of contacting the Valve pins with Silver Nickel clip sockets makes for knife-edge binding. Contact side-play is obviated because the positioning of the clips is provided for at the time of moulding and continual insertion and extraction of the valves cannot weaken contact at any point.

The Frequentite base is protected against splitting when mounting on chassis, by the use of Clix metal inserts which take the rivet or the screw heads.

ENGLISH, 90 degrees; AMERICAN, 60 degrees, 2/- each

CONTACTS FOR XMAS

Have everything radio and electrical ready for Xmas Festivities. Don't be without a spare 2-pin plug; it's sure to be wanted. Keep a terminal and wander plug or so in readiness for emergency hook-ups. What about control of speakers in distant rooms?

WALL PLUG for radio or electrical apparatus. Typ M, 5 amps. 6d.

LOUD SPEAKER CONTROL PANEL

Gives instantaneous method of switching Extension Speaker in or out and allows internal speaker to be kept in operation or cut out.

Price complete as illustrated 1/-

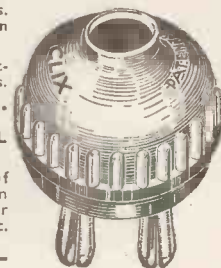

BRITISH MECHANICAL PRODUCTIONS LIMITED
79a ROCHESTER ROW LONDON S.W.1

Television and the Science of Lighting.

IN the twenty-second Guthrie Lecture just delivered before the Physical Society by Dr. C. C. Paterson, the lecturer dwelt on the increasing difficulties in the appraisal of lighting and seeing.

While photography is now being used for registering the effects of lighting on the human eye and permanently recording them on photographic plates whose characteristics in regard to light are in some ways similar to the eye, it was to the technique of television that he looked for future advance. This new technique, he said, offers an opportunity for controlling contrast. This is because details of the original picture and the reproduced picture at one stage are both held in terms of electrical energy and can be manipulated.

It is interesting to find this new application of television to the solution of the more delicate problems of an old science, and probably the physics of illuminating may in turn have their influence on the further development of television.

Special Programmes for the International Short Wave Club.

ASERIES of special programmes not including propaganda or advertising matter have been arranged for the benefit of International Short-wave Club members.

The first programme is on December 1 from HP5A, Panama City, on 11.7 megacycles. Reports are requested from British listeners who pick up this transmission, and they should be forwarded to the Secretary of the I.S.W.C., Mr. Arthur Bear, of 100 Adams Gardens Estate, London, S.E.16. Also on this day from W2XAD and W2XAF in Schenectady are special programmes which are to be radiated between 9.30 and 10 p.m. Eastern Standard Time. Owing to the fact that this programme will only be receivable in England during the early hours of the morning, that is, between 2.30 a.m. and 3 a.m., comparatively few English listeners will probably hear this programme, so in view of that an additional programme from W2XAD and W2XAF has been scheduled for December 20. This programme will be on the air from 9 to 9.30 p.m. G.M.T.

W2XAF will be transmitting a programme on December 21 from 4 a.m. to 4.30 a.m. which are sponsored by the American branch of the I.S.W.C.

On Christmas Eve there is to be a special broadcast from Pontoise, the French station, TPA4, on 25.6 metres. This is scheduled for 4.45 to 5.45.

Rome on 31.13 metres will be on the air with a special I.S.W.C. programme from 40 minutes after midnight to 1.50 G.M.T. on December 9, Prizes will be given to the listeners who send in the best reports on these programmes.

"CATHODE-RAY TUBE TERMINOLOGY"

(Continued from page 735)

term refers to the radiation which persists after the electron-beam excitation has ceased.

Spectral Characteristic: The relation between the radiant energy per element of wavelength and each wavelength of the spectrum. It is generally shown in a curve plotted with relative radiant energy against wavelength in angstroms, microns, or millimicrons. "Relative radiant energy" is expressed in arbitrary units of radiant energy.

Spectral Characteristic, Actinic: The relation between the energy per element of wavelength which affects a certain photographic surface, and each wavelength of the spectrum. This is generally shown in a curve plotted with relative actinic energy against wavelength in angstroms, microns, or millimicrons. "Relative actinic energy" is obtained by multiplying the relative radiant energy values (taken from the screen's spectral characteristic) for each wavelength by the relative sensitivity of a given photographic surface at that wavelength.

Spectral Characteristic, Visual: The relation between the luminous energy per element of wavelength and each wavelength of the spectrum. It is generally shown in a curve plotted with relative luminous energy against wavelength in angstroms, microns, or millimicrons. "Relative luminous energy" is obtained by multiplying the relative radiant energy values (taken from the screen's spectral characteristic) for each wavelength by the relative response of the eye at that wavelength.

Spot Diameter: The term used to express the true size of a round spot.

Spot Distortion: A term used to describe the condition of a spot which is not optimum with regard to shape.

Spot size: The true dimension or dimensions of the spot. Spot size may be measured under various conditions, and is commonly designated by such names as "spot diameter" or "line width." When the spot is stationary its size can be measured in any direction, but is usually determined by its dimensions along the longest and shortest axes.

TELEVISION'S CHASSIS and COILS

- Time Base Chassis (Metal Parts). With Tube Mounting Kit **19/6**
- Vision Power Pack Chassis **7/6**
- Vision receiver chassis Kit With nuts and bolts **45/-**
- Complete set of coils, H.F. Oscillator I.F. **6/3**

In addition to the above there is available a supply of high voltage and ordinary condensers and other apparatus at bargain prices.

SEND US YOUR REQUIREMENTS.

THE MERVYN SOUND & VISION Co. Ltd.,
4, HOLBORN PLACE, W.C.1
HOL 7709.

Engineers' Guide

Shows how to qualify in Television, Sound Recording, Radio Engineering and Servicing, Wireless Communications, etc., by studying at home with The T.I.G.B. Write to-day for this Great Guide containing world's widest choice of engineering courses and which alone gives the Regulations for A.M.I.E.E., A.M.I.R.E., A.M.I.T.E., etc.

Free!

THE TECHNOLOGICAL INSTITUTE OF GREAT BRITAIN
160 Temple Bar House, London, E.C.4
(Founded 1917. 20,000 Successes)



To Success

Read
"Television
and
Short-wave
World"
Regularly

Amateurs' Meeting Place

WE make a special point of advising our readers to go along to Webb's Radio, 14 Soho Street, to inspect the new stock that has just arrived. There is no need for us to point out that there is a complete range of communication receivers of every kind actually in stock that can be demonstrated under comparatively good conditions. One of the high-spots of the month, however, is a globe specially suitable for transmitting and receiving short-wave amateurs.

This globe is marked with all amateur prefixes, time bases and one very important feature, the actual make-up of the six continents as used by amateurs.

Those who intend to make the most of their aerials and to erect them in such a way that the main radiation lobes are in the required direction, will find this globe of great help. We were particularly interested to see that magnetic north has been accurately marked so that the radiation pattern of an aerial can be more accurately calculated.

This globe is 12 in. in diameter, mounted on an ebonised base with oxidised brass fittings. It is priced at 27s. 6d., and makes an ideal Christmas present, but in addition to this, is a genuine asset to every amateur station.

Also available is a map of the wall

type produced in full colour on heavy art paper, measuring 40 by 30 in. The net price is 4s. 6d.

The projection is a modified Azimuthal centred on London so that an accurate idea as to the direction of any



Webb's new Amateur Globe Price 27/6.

country from London can immediately be obtained. No amateur can really erect an aerial with any degree of accuracy without a map of this kind, and at the low price of 4s. 6d., we feel that it should be very popular. There is a limited quantity of maps fitted with rollers and printed on glazed linen, which are available at 10s. 6d. each.

We understand that the licensing authorities are not too happy about the more general use of electron-coupled oscillators. The popularity of this system appears to be due to the fact that crystals are rather expensive bought in quantity, although this is now rather an obsolete idea. Valpey crystals are now available already mounted in an enclosed holder for 15s. 6d., or without holders for 10s. 6d. We have been trying some of these crystals and find that they oscillate very freely and most vigorously. When used in tritet circuits they have proved quite satisfactory for frequency doubling, and the sample that we checked was used with great success on 28 Mc.

When using tetrode valves as oscillators or doublers it is essential that the screen voltage be accurate and stable. The best way of obtaining this screen voltage is to use a low-resistance potentiometer across the mains supply and tap-off with a semi-variable contact on the potentiometer. Webb's have a large stock of Aerovox resistors in 75 and 200-watt types.

IS IT THE BAND OR YOUR RECEIVER?

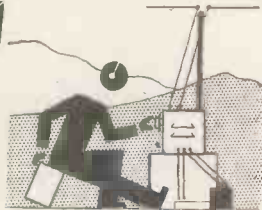

When things seem bad, are you sure it is not your receiver which is at fault? The fine Communication Receivers handled by A.C.S. Radio give you all that's going. Don't take our word for it, come and try the receivers for yourself in our Showroom.

Here are a few typical examples:—

1938 Super Sky rider (5-550 m.), 11 Valves	£32
Sky Chief (14-550 m.), 7 Valves	£12 10s.
Sky Buddy (16-550 m.), 5 Valves	£9
Sky Challenger (7.5-550 m.), 11 Valves	£23
National N.C.100 (10-550 m.), 12 Valves	£35
Hammarlund Super Pro (7.5-240 m.), 16 Valves	£72 10s.
Patterson PR10 (8-550 m.), 15 Valves	£35
RME69 (10-550 m.), 9 Valves	£39 15s.

All these receivers are laboratory checked and "hotted-up" for maximum performance. Easy terms and part exchanges. Loose leaf lists and technical data free on request.

Transmitters.—Standard types are specially built to your requirements.

A wide range of transmitting and receiving equipment in stock for immediate delivery.

A.C.S. RADIO, Technical Manager. **G2NK**
52-4 Widmore Road, Bromley, Kent
Ravensbourne 0756-7

Cheap Day Return to Bromley North, 1/6. (20 minutes from Town)
Open until 8 p.m. (except Weds., 1 p.m.)

HIVAC

THE SCIENTIFIC
VALVE

BRITISH MADE

THE SIGN OF A GOOD VALVE

MONTH AFTER MONTH, and for many months at that, HIVAC have consistently informed readers of this journal of their valve developments—have given details of HIVAC valves specified for apparatus described by "Television and Short-wave World"—have featured the "Midget" and Special HIVAC range for Short-wave work; AND NOW they offer readers

THE 1938 HIVAC REPLACEMENT CHART
which gives details of their complete range.

MAY WE SEND YOU A COPY?
Please mark your request (Dept. "T.S.")
and post it to:—

HIGH VACUUM VALVE CO., LTD.
111-117 Farringdon Road, London, E.C.1

W. A. Z.**(Worked all Zones)**

This short list completes the 40 zones into which the radio world is split up. Those who have not the zones from 1 to 25 should obtain a copy of the October and November 1937 issues. We should be interested to hear if any British stations, other than those already listed in Television and Short-Wave World, have worked all zones.

ZONE 26.

South-Eastern Zone of Asia.

India (Upper and Lower Burma only).

French Indo-China.

Andaman Islands.

Siam.

ZONE 27.

Philippine Zone.

Philippine Archipelago.

Guam.

Yap.

Caroline Islands.

Mariana Islands.

Islands east of Philippines, west of Long. 163° E., north of Lat. 2° N., and south of a line from 153° E., 40° N. to 131° E., 23° N.

ZONE 28.

Malayan Zone of Asia.

Malay States (Federated and Non-Federated).

Johore.

Straits Settlements.

Malay Archipelago, including Netherlands Indies (Dutch East Indies).

Java.

Sumatra.

British North Borneo.

Sarawak.

Papua.

New Guinea (VK6).

Borneo (PK6).

Solomon Islands.

Timor Islands.

Portuguese East Indies.

Islands between Lat. 2° N. and 11° S., and west of Long. 163° E.

ZONE 29.

Western Zone of Australia.

Australia.

Western Australia.

North Australia.

Central Australia.

ZONE 30.

Eastern Zone of Australia.

Australia.

Queensland.

New South Wales.

Victoria.

Tasmania.

South Australia.

Islands south of Lat. 11° S. and west of Long. 163° E.

ZONE 31.

Central Pacific Zone.

Hawaiian Islands.

(Continued on next page)

GALPINS ELECTRICAL STORES

75, LEE HIGH ROAD, LEWISHAM, LONDON, S.E.13

Telephone: LEE GREEN 5240.

Terms: CASH WITH ORDER OR C.O.D.

All good sent on 3 days' approval against cash.

XMAS BARGAINS

MOVING COIL METER MOVEMENTS by Ernest Turner, Everett Edgcombe, etc., 2½-in. dial for recalibrating into multirange. All test meters, 5/- each. **DITTO**, Larger Type, 4, 6, 7-in. dials, 6/6, post 9d.

MOVING COIL 2½-IN. DIAL METERS by "Weston," E. Turner, etc. 0 to 30 volts, 7/6; 0 to 1½ thermo ammeters, 12/6; 0 to 100 volts, 12/6; 0 to 300 m/A., 12/6; 0 to 3,000 volts, 4-in. dial, 25/-; 0 to 400 m/A., 4-in. dial, 17/6. 2-Reading m/A. Meter, 4-in. dial, 0 to 5 and 25 m/A., 20/-. 3-Reading ditto, 5 to 50 and 250 m/A., 25/-; 6-in. dial 2-reading, 6½ and 65 m/A.; ditto, 0 to 5 and 50 m/A., 27/6 each; ditto, Hot Wire, 0 to 1,000 m/A., 25/-; 2½-in. dial, 0 to ½ ampere, 5/-; Hot Wire.

ELECTROSTATIC VOLTMETERS, 8-in. dial, 0 to 6,000 volts for A.C., 35/-; 0 to 2,500 v., 2½-in. dial for D.C., 15/-.

SWITCHBOARD VOLT AND AMPMETERS, 0 to 40 v., 8/6; 0 to 120 v., 12/6; 0 to 250 v., 17/6; 0 to 10, 20, 30, 50, 100 ammeters, 12/6 each, any size. All above are Moving Coil type **HOT WIRE VOLTMETERS**, 6-in. dial, 0 to 120 volts, 15/-; 0 to 250 v., 17/6. Please send us your requirements.

LARGE TRANSFORMERS by "Foster": 200 volt to 24 v., and a 100 amps 500 cycles, 50/-. Another, 230 volts 50 cycles input, 3,200 v. 350 m/A. twice and 20 v. 10 amps. twice, £5. Another, 7 kVA, 200 volts input, 20,000 v. at 375 m/A. 300 cycles, 70/- C/F.

ELECTRO DYNAMIC ROTARY CONVERTORS, 200/250 volts D.C. input, 150 v., 200 A.C. output, 75/-; Ditto, 220 volts A.C. 100 watts output, 65/-; Ditto, 250 volts A.C. 2 amp. output, 75/-; One only M.L. 200 volts D.C. input 220 v. 365 m/A. A.C. output, 60/-.

WILSON 12-volt D.C. Electric Motors, 7/- each.

A.C. INDUCTION MOTORS, approx. ½ h.p., 1,425 r.p.m., 200/250 volts 50 cycles 1 phase, suitable for pumps, sewing machines or any small power work. Condition new, 22/6. Post free.

EX R.A.F. 2-VALVE TRANSMITTERS, less valve. Useful to the experimenter, 7/6 each. Post Free.

EX R.A.F. 3-VALVE RECEIVER, 150 to 2,500 metres. Useful for experimenters, 6/-; 4-valve ditto, 7/6. C/Paid.

EX R.A.F. WAVEMETERS, 200 to 500 metres, visual type, 3/-; 300 to 2,500 metres, valve type, 7/6.

LARGE MAINS TRANSFORMERS, 3½ kW., 100/120 volts to 200/250 v. or vice versa, not auto wound, 70/6. 2 kW., 50/-; 1 kW., 35/-. Auto wound, 150 watts, 10/-; 100 w., 8/6; 60 w., 6/6.

CHARGING DYNAMO, 50/75 volts, 10 amps., shunt wound, condition as new, 60/-.

ROTARY CONVERTOR, 14 volts 5 amps. D.C. input, 2,000 v. 150 m/A. D.C. output, 70/-. Another, 6-12 v. D.C. input, 750 v. 100 m/A. D.C. output, 25/-.

MAINS TRANSFORMERS, 200/250 volts input, 350/0/350 v. 100 m/A., 4 v. 4 a. and 4 v. 2 a., C.T., 6/6 each. **POLAR 2-GANG .0005 CONDENSERS**, 3/9. Plessey 3-gang Superhet, 110 k.c., 2/9 each.

CHARGING OR LIGHTING DYNAMOS, all shunt wound, fully guaranteed, 15 volts 12 amp., 21/-; 12 v. 8 amp., 17/6; 25 v. 8 amp., 32/6. Regulators to suit these and other dynamos from 10/- to 15/-.

EX G.P.O. GLASS TOP HIGHLY SENSITIVE RELAYS, Type B, operating current approx. 1 m/A. 7/6 each. Post 6d.

MAINS TRANSFORMERS, double wound, 200/250 in 100/260 volts output, tapped 250 watt, 15/-; 150 watt, 10/6; another, 230 v. in 2 v. 160 amps output, 25/-.

12-INCH SPARK COIL, complete with Condensers, Discharge Rods, etc., in polished case, in new condition, 75/- C/F.

X-RAY BARGAIN FOR THE EXPERIMENTER, a 12-inch Coil with Condenser, Discharge Rods, Tube and meter holder, complete with brand new X-Ray Tube and Moving Coil 2-reading m/ampmeter 0 to 5 and 50 m/A., the lot, 100/- C/F. Packing free.

16-INCH SPARK COIL, with Condenser, 65/-; 10-inch ditto, 55/-; 8-inch ditto, 50/-. All in good condition. C/F.

FLUORESCENT SCREENS, "Platinum," 12 by 9 inch in frame. Good condition, 35/-.

X-RAY TUBES, with Tungsten Targets, 17/6. With Platinum Targets, 25/-; Packing free. C/F.

2-INCH SPARK COIL, complete with Condenser and High-Speed Contact Breaker, 6 to 12 volt input, 19/6.

ALTERNATOR, self-exciting, 200 volts single phase, 200 watt output, ball bearing, as new, 60/-.

MORSE INKER TAPE RECORDER, clockwork driven with actuating sounder, for automatic recording on tape of morse signals, price 50/-.

HIGH VOLTAGE CONDENSERS, 1 m.f., 4,000 volt working, 10/-; 1 m.f., 2,000 v. working, 2/6 each. Post 6d.; ½ m.f., 1,500 v. working, 1/9 each. Post 6d. .01 m.f., 5,000 v. working, 2/6.

QUARTERLY TYPE ELECTRIC LIGHT CHECK METERS, 200/250 volts 50 cycle 1 phase, 5, 10, 20 amps. for workshops, garages, subletting, etc., fully guaranteed, 6/- each. Post 1/-.

BURGOYNE "FURY FOUR" VALVE UNIVERSAL CHASSIS, 200/250 volts A.C. or D.C. mains in working order, less valves, 12/6 each. Post 1/-. Cheap enough for components. Valves used: SP13, HP13, PEN 26, UR3, or equivalent.

BURGOYNE FOUR-VALVE SUPERHET CHASSIS for 200/250 volts A.C. mains in working order, less valves. Useful for components: Mains Transformer 350/0/350 v. 80/100 m/A., 2 L.T.'s, 2-gang Condenser, 12 x 8 x 25 m.f. Condenser, approx. 25 useful Resistances, etc., 15/-; Post 1/-. Valves used: FC4, VP4B, 2D4A, PEN A4, 1W4/350.

SULLIVAN .0005 GLASS-CASED Transmitting Variable Condensers, heavy brass valves, 10/6 each.

EX-NAVAL MARCONI RADIOGONIOMETERS, large size calibrated dial, 15/- C/F.

HIGHLY SENSITIVE SILVERTOWN GALVANOMETERS, flat type calibrated dials, in good condition, 6/6 each.

ZENITH RESISTANCES, 2,000 ohms 100 m/A., 1/-; 3,000 ohms 200 m/A., 2/-; 126 ohms 500 m/A., 1/6.

MAINS POWER PACKS, 2 x 20 henry 60 m/A. Chokes, 2 x 2 m.f. Condensers, 2/6 each; another, with Transformer, 250/0/250 volts 30 henry Choke, 12 m.f., Block Condenser, 5/-. Cossor 2-volt general purpose Valves, 3 for 2/6. Microphone Buttons, 9d. "Mike" Transformers, all ratios, 2/-. Resistance Mats, 24 ins. square 600 ohm ½ amp. 4/-. Magnetic Triple Action Keys, low-voltage working, 1/6. R.A.F. Cutouts, 20 volts 3 amp., 1/6. 9-oz. Bobbins of 26-gauge D.C.C. wire, 9d. 6-volt Bright Valves, 1/-. Twin 14/36 Flex, braided and rubbered, 1/6 per doz. yds. Ex-R.A.F. Heavy Duty Morse Tapping Keys, 2/6. 1,000 ohm single earphones, 9d., or a pair with bands, 1/6.

HAND GENERATORS, 800 volts, 100 and 6 v., 4 amps. output, or can be used 6 v. input same output, 50/-.

AERO DYNAMOS, shunt wound, in new condition, 12 volt 8 amps, 12/6. Post 1/6. Small 100 v. D.C. Motors with laminated pole pieces, easily converted for A.C., approx. power, ½ h.p., 5/-; Post 1/-.

Ellice Islands.
Gilbert Islands
Islands between Lat. 11° S., and
40° N., and between Long. 163° E.
and 140° W.

ZONE 32.

New Zealand Zone.
New Zealand.
Loyalty Islands.
Tahiti.
Fiji. New Hebrides.
Samoa.
New Caledonia.
Chatham Islands.
Islands south of Lat. 11° S. and be-
tween Long. 163° E. and 120° W.

ZONE 33.

North-western Zone of Africa.
French Morocco.
Spanish Morocco.
Rio de Oro.
Tunisia.
Algeria (Northern and Southern).
Ifni.
Madeira.
Canary Islands.

ZONE 34.

Northern Zone of Africa.
Libya.
Egypt.
Anglo-Egyptian Sudan.

ZONE 35.

Western Zone of Africa.
French West Africa.

Nigeria.
Ivory Coast.
Gambia.
Cape Verde Islands.
French Guinea.
Liberia.
Portuguese Guinea.
Dahomey.
Ashanti.
Sierra Leone.
Senegal.
Gold Coast.
French Sudan.
Togoland.

ZONE 36.

Equatorial Zone of Africa.
Angola (Portuguese West Africa).
Cameroons.
Spanish Guinea.
French Equatorial Africa.
Belgian Congo.
Northern Rhodesia.
Cabinda.
Rio Muni.
Gabon.
St. Helena Island.
Ascension Island.

ZONE 37.

Eastern Zone of Africa.
Mozambique (Portuguese East
Africa).
British East Africa.
Kenya.
Uganda.

Tanganyika.
Nyasaland.
Ethiopia (Abyssinia).
Italian Somaliland.
British Somaliland.
French Somaliland.
Eritrea.
Zanzibar Islands.
Socotra Islands.
Mafia Islands.

ZONE 38.

Southern Zone of Africa.
Union of South Africa.
Southern Rhodesia.
Swaziland.
Busutoland.
British South-west Africa.
Bechuanaland
Tristan de Cunha Island.
Gough Island.
Bouvet Island.

ZONE 39.

Madagascar Zone.
Madagascar.
Reunion Island.
Seychelles Island.
Admirante Island.

ZONE 40.

North Atlantic Zone.
Greenland.
Iceland.
Svalbard (Spitzbergen).

NEW YEAR RESOLUTIONS !

If by some chance you have been ploughing a lonely furrow in your experimental work why not make a New Year's Resolution to join the Radio Society of Great Britain ?

The annual subscription is moderate (London 21/-, Provinces 15/-).

The Society, founded in 1913, to-day has a membership well in excess of 3,000. Each month the T. & R. Bulletin is sent post free to members. This Journal contains on an average 60 pages of up-to-date technical and topical information—written by and for radio amateurs.

The November issue includes important contributions dealing with such widely different subjects as Third Harmonic Suppression, a low power battery operated transmitter, The Month on the Air, 23 and 56 Mc. activities, International and local Contests, Bright Ideas, and a full length article on the Construction of Transmitters, the latter being Part VIII of the popular "Helping Hand" feature.

In addition "Uncle Tom" commences a new series of monthly contributions under the title "Twelve Years Back."

Resolve to-day to write for a copy of this issue (price 1/- post free) and ask for full details of membership.

All communications to:

The Secretary :
RADIO SOCIETY OF GREAT BRITAIN
53, VICTORIA STREET, LONDON,
S.W.1.



TELEVISION DEVELOPMENTS

Are you keeping abreast of modern television developments? Whether amateur or professional you *must* be in touch with the latest trend of research.

The Television Society enables you to meet fellow workers in the field of television, both in this country and abroad.

Founded some 10 years ago The Television Society provides a scientific and non-partisan platform for discussion on all aspects of the subject. Meetings are held monthly during the session (October-June) and are reported in full in the Society's Journal which is sent free to all members.

The Society's activities are shortly being enlarged to meet the growing interest in the subject and members will have a unique opportunity of furthering their knowledge by contact with well-known television engineers.

Full particulars of membership qualifications may be had from the Hon. General Secretary :- J. J. Denton, 25, Lisburne Road, Hampstead, London, N.W.3.

THE TELEVISION SOCIETY

(Founded 1927)

President : Sir AMBROSE FLEMING, M.A., D.Sc., F.R.S.

DECEMBER, 1937

Special Valves for Ultra-high Frequency Use.

AMATEURS will be very pleased to hear that the RK39 radio-frequency pentode and RK34 twin triode with top cap connections have now been reduced in price. Both can be obtained from Webb's Radio, 14 Soho Street, for 22s. 6d. each.

The RK39 will give a very high R.F. output as either tritet, doubler or sub-amplifier, while they are excellent low-power final amplifiers. Those who are interested in working down to 2½ metres should consider these RK39's.

Twin triodes are very useful as push-pull oscillators, push-push doublers, on almost any frequency, and lend themselves for use in long-line transmitters

"E.D.C." Converters. 180 Watt 230DC input 230 AC Output £8 0 0
"E.D.C." " 120 " ditto " " " £6 10 0
"E.D.C." " 90 " ditto " " " £5 5 0
Parcels of 24 Condensers and Resistances as used in latest Television Receivers 6/- post free. "Ferranti" R.I. Varley Transformers, Chokes, etc. in stock.

THE UNIVERSAL RADIO CO.,
221, City Road, E.C.1 London

FOYLES
BOOKSELLERS TO THE WORLD
Stock of nearly three million new and second-hand volumes. Catalogues free on mentioning your interests.
119-125 Charing Cross Rd., London, W.C.2.
Telephone: Gerrard 5660 (14 lines)

LOW PRICE TELEVISION RECEIVER
CHASSIS FOR VISION ASSEMBLY. Price 45/-
TIME BASE CHASSIS as specified: Price 19/6
CHASSIS FOR VISION POWER PACK, 7/6
C.R. TUBES " " " " " from £3 15s. 0d.
We supply ALL APPARATUS IN KIT FORM AS REQUIRED. TIME BASE, EXCITER UNIT, POWER PACKS.
New List available.
H. E. SANDERS & CO., 4, Grays Inn Road, London, W.C.1. Phone: Chancery 8778.

INDEX TO ADVERTISERS

A.C.S., Ltd.	766
A.P.A. Metalworks	762
Automatic Coil Winder & Electrical Equipment Co., Ltd.	761
Baird Television, Ltd.	719
Belling & Lee, Ltd.	Cover ii
British Institute of Engineering Technology	768
British Mechanical Productions, Ltd.	764
Bulgin, A. F., & Co., Ltd.	705
Clix	764
Cossor, A. C., Ltd.	Cover iv
Edison Swan Electric Co., Ltd.	706
Ericsson Telephones, Ltd.	763
Fluxite, Ltd.	Cover li
Foyles, Ltd.	Cover iii
G5KA	Cover iii
G5NI (Birmingham), Ltd.	764
Galpin's	767
General Electric Co., Ltd.	739
High Vacuum Valve Co., Ltd.	766
McGraw-Hill Publishing Co.	761
Marconi's Wireless Telegraph Co., Ltd.	740
Mervyn Sound and Vision Co., Ltd.	765
Midwest Radio, Ltd.	705
Mullard Wireless Service Co., Ltd.	720
Premier Supply Stores	755
Quartz Crystal Co., Ltd.	740
Radio Resistor Co., Ltd.	Cover li
Radio Society of Great Britain....	768
362 Radio Valve Co., Ltd.	Cover iii
Technological Institute of Great Britain	765
Sanders, H. E., & Co.	Cover iii
Sound Sales, Ltd.	762
Television Society, The	768
Universal Radio Co.	Cover iii
Ward, Chas. F.	757
Webbs Radio, Ltd.	759
Westinghouse Brake & Signal Co., Ltd.	740

MISCELLANEOUS ADVERTISEMENTS
The charge for advertisements in these columns is 12 words or less, 2/-, and 2d. for every additional word. All advertisements must be accompanied by remittance. Cheques and Postal Orders should be made payable to Bernard Jones Publications Ltd., and crossed, and should reach this office not later than the 15th of the month previous to date of issue.

CONDENSERS. Fixed paper, in Metal Containers. 1000volt Wkg. 1mf 2/6. 2mf 4/9. 4mf 7/6. 8mf 10/6. Bakelite Tubulars. 1000volt Wkg. 1mf 2/6. 0.5mf 2/-. 0.25mf 1/9. 0.1mf. 1/3. 0.01mf 9d. The Static Condenser Co. 11, Eden Street, Hampstead Road, London, N.W.1. "Makers of Good Condensers."

RADIO AMATEURS HANDBOOK 1938, 500 pages, 500 illustrations, Formulas, charts and Tables. 5/5d. post free. Smith, bookseller, 6, Racquet Court, London, E.C.4.

SHORT WAVE Variable Directional Aerials. 360° rotating armchair control O-V-1, O-V-2, T.R.F., Super, state receiver and enclose 1½d. stamp for full details to A. W. Mann, 62, Costa Street, Middlesbrough, Yorks.

BEAUTIFULLY built 100 watt C.W. 30-watt Phone transmitter in black crackle finished cabinet for 7, 14 and 28 Mc. with separate power pack. Commercial equivalent would retail at over £60. First £30 or nearest offer will secure. Demonstrate in London, Box No. 16.

SERVICES REQUIRED practical skilled man, experience high vacuum technique, production photo electric surfaces, glass blowing, etc.—Box No. 17.

OFFERS.—Ediswan 12H, GU7, N43, D42, KT66, Oil condensers, etc. Seen Appointment. Box No. 18.

AMERICAN A.R.R.L. Type Sectional Wood Aerial Masts, complete, insulated guy wires, strainers, pulley, 100 ft. cotton rope, all metal galvanised. 50 ft. 64/6d. Creosoting extra 2/6d. White Painting, two coats, 7/6d. "Fibromet" panels and chassis, "Works like wood," but screens like metal," 1/6 sq. ft. to size. Low Impedance feeder, 75 ohm approx., 2/9d. 50 ft. Cash with Order. Carr. Fd.—Radio 2.CNT. Co (G.6.Q.F.), Atherton.

PATENT AND TRADE MARK AGENTS

GEE & CO., patents and trade marks throughout the world (H. T. P. Gee, Mem.R.S.G.B., A.M.I.R.E., etc.). Estab. 1905. 51-52, Chancery Lane, London, W.C.2 (2 doors from Government Patent Office). Phone: Holborn 4547 and 4548. Handbook free.
KINGS PATENT AGENCY LTD. (B. T. King, Patent Agent) 146a, Queen Victoria Street, London, E.C.4. ADVICE, Handbook and Consultations free. Phone City 6161.

Radio Amateur's Handbook
1938 Edition

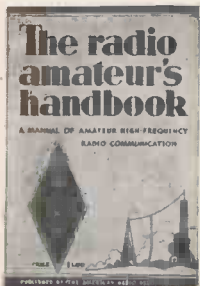

Send 5/6 at once for your copy of this very famous handbook—now in its 14th edition. All orders by return of post.

Watch this space for details of other 1938 releases.

The Hams' Bookshop

G5KA, 41 Kinfauns Road, Goodmayes, Ilford, Essex (Dept. T)

Read
Television &
Short-wave
World
Regularly.

SPEAK TO THE WORLD
WITH AN
R.F.P.15 TRANSMITTING PENTODE

CHARACTERISTICS :

Filament Volts ..	4 v
Filament Amps.	1 a
Anode Volts ..	500 v
Max. Anode Input ..	25 watts
Max. Anode Dissipation ..	15 watts
Anode Load ..	10,000 ohms
Screen Volts ..	300 v
Speech Input ..	1 watt
Radio Input ..	6 volts (R.M.S.)

Price 30/-
362 RADIO VALVE Co. Ltd.
324/6 LIVERPOOL RD.,
LONDON, N.7.

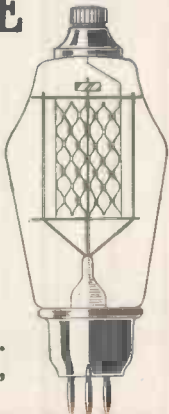

NORTH 1853

TELEVISION.
A NEW COURSE OF INSTRUCTION,
We have pleasure in announcing that our new "Television" Course has met with remarkable success. The enormous demand for the Course has shown, beyond any shadow of doubt, that it fills that long-felt need which we anticipated when we went to such trouble and expense in its preparation.
We shall be happy to send full details of this special "Television" Course on request. Particulars are also available of other Courses in all branches of Wireless, Television, Talking Picture Engineering, etc., and of the easiest way in which to prepare for the A.M.I.E.E., A.M.I.W.T., A.M.I.R.E., etc., Examinations.
We teach by correspondence, and guarantee "NO PASS—NO FEE." Our Technical Consultant is Professor A. M. Low.
Send for full particulars to-day. Free and without obligation.
THE BRITISH INSTITUTE OF ENGINEERING TECHNOLOGY
337, SHAKESPEARE HOUSE, 17/19, STRATFORD PLACE, LONDON, W.1.

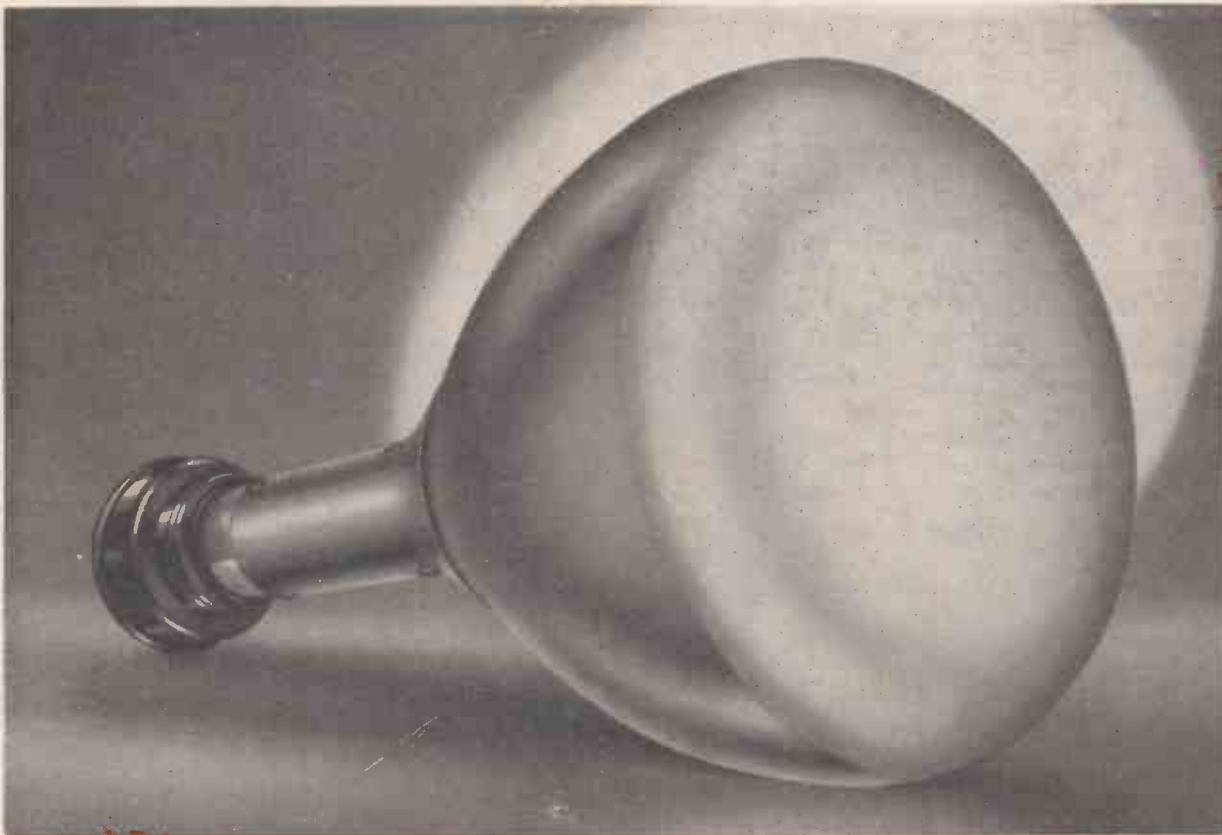

The NEW
COSSOR
TELEVISION CATHODE RAY TUBE

The Illustration
shows the 3241 K.S. tube fitted
with a mu-metal screen which
obviates interference from external
fields.

THE acknowledged fineness of trace obtainable with Cossor Cathode Ray tubes has been obtained by the use of a remarkably small cathode. This feature is retained in the new tube by the adoption of a more robust indirectly heated cathode construction.

In incorporating the modifications entailed in the electron optics of the earlier part of the electrode system other advantages have been introduced which are of particular value in Television. A considerably improved modulation characteristic and sensitivity are secured, in addition an uniform distribution of the light spot has been obtained, thus the lines of the Television picture appear less obvious with a marked improvement in picture detail and contrast.

TYPE 3241 K.

Giving a black and white
picture of great brilliance.
Picture size, 8" x 6½"

PRICE £12.12.0

Type 3241 K.S. fitted with Mu-Metal
shield against external fields 25/-
extra.

Indirectly heated Cathode
4v. 0.9 amp.
Max. anode voltage - 5000
Bulb diameter (overall) - 295 mm.
Screen diam. - 280 mm.
Tube length (overall) - 580 mm.
Standard 12 contact Television
Tube base.

Full details of this tube and
the full Cossor Range will
be sent on application to
Instrument Dept.

A. C. COSSOR LTD., Highbury Grove, London, N. 5

3513