

USING SMALL TUBES : SOME PRACTICAL POINTS

Television

and *SHORT-WAVE WORLD*

NOVEMBER, 1937

No. 117. Vol. x.

1/-
MONTHLY

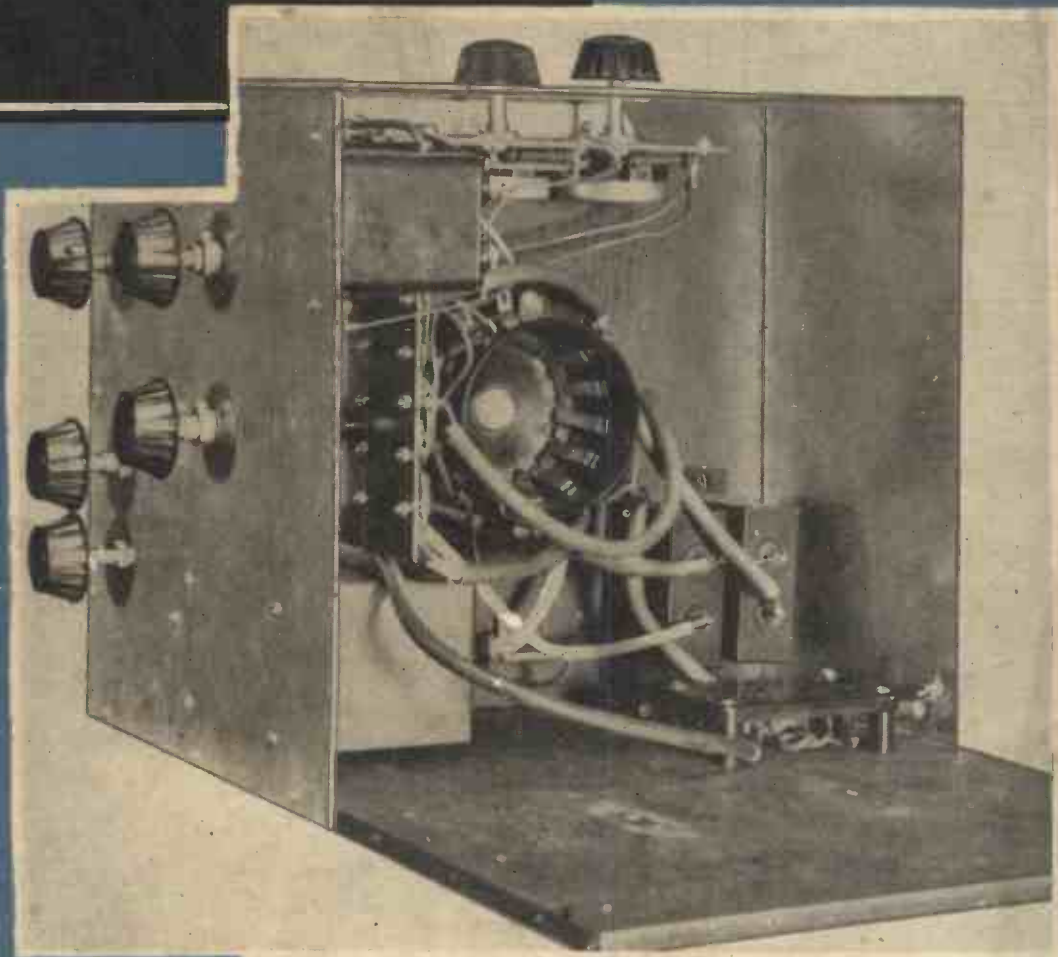

HOME-CONSTRUCTOR LOW-COST TELEVISOR

Showing the Time Base and Tube Mount.

(See page 644)

**HALVING
COST OF
HOME-
BUILT
TELE-
VISOR**

BERNARD JONES PUBLICATIONS LTD.
CHANSITOR HOUSE, CHANCERY LANE
LONDON W.C.2.

THE FIRST TELEVISION JOURNAL IN THE WORLD



*Cried a wireless enthusiast from Brighton,
"This constructional fact you can bite on ;
When doing your wiring
You'll find it less tiring
and much better, too—with FLUXITE on !"*

See that **FLUXITE** is always by you—in the house—garage—workshop—wherever speedy soldering is needed. Used for 30 years in government works and by leading engineers and manufacturers. Of Ironmongers—in tins, 4d., 8d., 1/4 and 2/8.

Ask to see the **FLUXITE SMALL-SPACE SOLDERING SET**—compact but substantial—complete with full instructions, 7/6. Write for Free Book on the art of "soft" soldering and ask for Leaflet on **CASE-HARDENING STEEL and TEMPERING TOOLS** with **FLUXITE**.

To **CYCLISTS** ! Your wheels will **NOT** keep round and true unless the spokes are tied with fine wire at the crossings and **SOLDERED**. This makes a much stronger wheel. It's simple—with **FLUXITE**—but **IMPORTANT**.

THE FLUXITE GUN

Is always ready to put *Fluxite* on the soldering job instantly. A little pressure places the right quantity on the right spot and one charging lasts for ages.
Price 1/6.



ALL MECHANICS WILL HAVE

FLUXITE

IT SIMPLIFIES ALL SOLDERING

FLUXITE LTD. (Dept. T.V.), DRAGON WORKS, BERMONDSEY ST., S.E.1

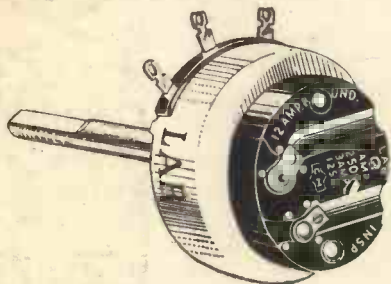

DATED TODAY

Use the "LAB" Volume Control, the latest product of its type, the outcome of intensive research. Precision built. Will never develop faults, **LOGARITHMIC** or **LINEAR** TYPES. All values from 2,500 ohms to 2 megohms.

The

LAB VOLUME CONTROL

- Less Switch...3/-
- With Switch...3/6
- With Double Pole Switch...5/-
- From all radio dealers.

RADIO RESISTOR Co. Ltd., 1 Golden Sq., London, W. 1

COMPONENTS & ACCESSORIES SPECIALLY DESIGNED TO WITH- STAND HIGH VOLTAGES

For some time now there has been a tendency towards higher voltages, emphasised by the advent of television. High potentials call for care in design on such points as creepage distances and breakdown to earth. Ordinary connectors cannot be used—first, because they are rarely safe, and, secondly, it is impracticable to load them with high tension cable.

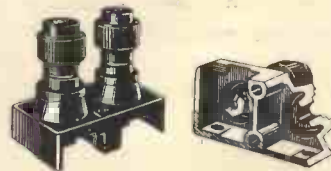

TERMINAL MOUNT

Re-designed to increase creepage distances and is now safe up to 7,000 volts. Originally designed for "B" type insulated terminals, but takes two of any make. No. 1039..... Price each 6d.

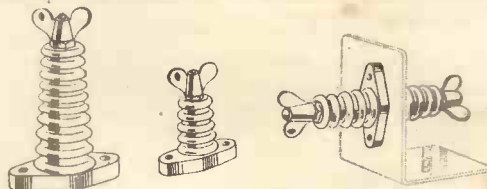

"STAND-OFF" LOW LOSS INSULATORS

For high frequencies and/or high voltages, as support or as a terminal.
No. 1292, 2 in., 10,000 volts Price 2/-
No. 1277, 1 in., 5,000 volts Price 1/6
No. 1296, Bushing 7,000 volts Price 2/-

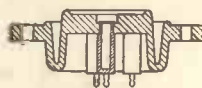

VALVE HOLDER. High Voltage (11,000 volts)

Specially designed for rectifier valve supplying H.T. to C.R. tube in television receivers. Also used for time base tubes. Extra long creepage distances. No. 352/5 Price 1/-



HIGH TENSION SHROUDED PLUG AND SOCKET

Suitable for television and similar purposes. Spout entry accommodates H.T. cable. Can be handled with perfect safety while carrying 6,000 volts. No. 353 Price 4/6



TELEVISION COUPLING

Safe up to 2,500 volts, three pin, each part adequately shrouded. Many applications. No. 1285
Price complete 4/9

TWIN SAFETY FUSEHOLDERS AND FUSED MAINS INPUT CONNECTORS

In general appearance these are unaltered, but they have been modified so that the breakdown to metal chassis is 2,500 volts.
No. 1033, Twin Safety Fuseholder Price 2/9
No. 1114, Fused Mains Input Connector Price 4/3

"Radio and Electrical Accessories," 150 illustrations, 75 blue-prints of curves, diagrams and constructional details. Send 8d. for a copy, post free. Free literature also available on request.

BELLING-LEE FOR EVERY RADIO CONNECTION

Belling & Lee Ltd., Enfield, Middlesex.

MANY A GOOD RECEIVER comes into a service department requiring no more attention than a touch of a screwdriver to the I.F. trimmers. The owner, not possessing a modulated test oscillator, has given it up in despair after hours of knob twiddling enlivened by the porcine squeals of second-channel whistles.

MOST OF THE GAIN in a superhet comes from the Intermediate Frequency amplification. That is what I.F. stages are for. If they do not function correctly, all sorts of troubles arise, from morse backgrounds to sheer lack of punch. These are often blamed on perfectly innocent components, with attendant waste of time, money and temper. One of the commonest of faults in the I.F. stages lies, not in broken wires, corroded joints, O.C. resistors or condensers and the like, but in simple non-alignment, or even complete mis-tuning, of the primaries and secondaries of the I.F. Transformers.

IT IS ASTONISHING how often men will spend an extravagant amount of time and money over testing everything except the alignment of the I.F. tuned circuits, It may be due to lack of knowledge, but quite often it is due to hesitation about keeping apparatus on hand, possibly on account of expense, for the purpose of lining up. There is no real need for this hesitation. It is certainly not justified in these days when two out of every three receivers employ the superhet principle of reception, and on standardised intermediate frequencies at that in the great majority of cases. The serious experimenter, and certainly the service man, ought to keep a form of oscillator by him if he can possibly afford to do so.

SIMPLE BUT GOOD apparatus for this purpose is readily available. We refer to the neat little 15/- gadget illustrated below. It has no batteries. It is small enough to go into a good sized pocket. It generates modulated H.F. signals at the exact frequency to which it is factory-set.

WRITE FOR THE INSTRUCTION LEAFLETS—AND THE CATALOGUE.

Three types are available. All work on the principle of neon tubes connected as relaxation oscillators.
V.T. 17 is accurately tuned to the popular I.F. of 465 kc/s.
V.T. 20 generates 110 kc/s signals and is invaluable for re-aligning earlier types of superhet.
V.T. 21 puts out accurately fixed signals at 200, 333, 350, 500 and 1,000 metres, for ganging R.F. tuned circuits of superhet receivers.



PRICE 15/- EACH

BULGIN
RADIO COMPONENTS

COUPON
 To Messrs. A. F. Bulgin & Co., Ltd., Abbey Road, Barking, Essex.
 Please send, post free, a copy of your new 120-page Fully Illustrated Catalogue No. 157, for which I enclose 3d. stamps.
 NAME
 ADDRESS
 PLEASE USE BLOCK LETTERS.

ANNOUNCING THE NEW 1938 "Imperial" Twin Chassis All-Wave Receiver

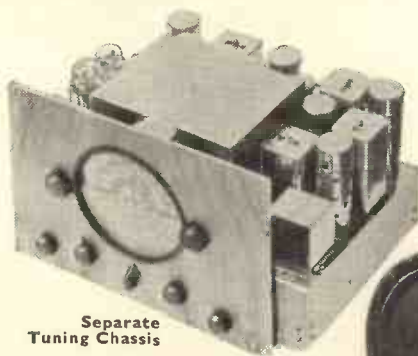

Separate Tuning Chassis



Power Pack and Reproducer

Giant 12-inch Theatre Sonic Loudspeaker

WE are proud to bring before the Radio public the latest 15-valve All-Wave Radio Receiver. In past years our products have set an extremely high standard of efficiency, but this latest model is far in advance of previous designs. The beauty of its reproduction **NATURAL**, in every sense of the word—its super-sensitivity has astounded many of the leading Radio critics. Its station getting capabilities are unsurpassed. London—New York—Java—Melbourne—all have been received with equal



York Console Model.

strength and clarity. IT IS THE ONLY RECEIVER ON THE MARKET COVERING SO WIDE A WAVE-RANGE. Before ordering that new Radio, compare your choice with the new "Imperial" All-Wave Receiver. We invite you to call for a demonstration, neither shall we press you to do so. We shall leave it to the performance of the receiver to convince you of its merits. Can we say more? Write, telephone or call for our Illustrated Art Catalogue giving full-details of this outstanding Set.

DEMONSTRATIONS DAILY AT OUR SHOWROOMS
OPEN 9-8, EXCEPT TUESDAY 9-6
 PLEASE MENTION TELEVISION ON YOUR LETTERS.

MIDWEST
 RADIO (MANUFACTURING) CO. LTD.,
16, OLD TOWN, CLAPHAM, LONDON, S.W.4.
 TELEPHONE : MACAULAY 5005

TELEVISION DEVELOPMENTS

A NEW LARGE DIAMETER TUBE FOR TELEVISION REPRODUCTION



TYPE 12H TUBE

The Ediswan Type 12H tube has a screen diameter of 12" giving a television picture 10" x 7½" without distortion.

The screen is of special material giving a close approximation to a black-and-white picture.

Specification:

Indirectly heated high vacuum tube.

Heater Volts - - - 2.0

3rd Anode Volts - - - 6000

2nd Anode Volts - - - 1200

1st Anode Volts - - - 300

Sensitivity (mm./V.) - - 850/V*

Peak-Peak Modulating Volts - 15

*V=3rd anode volts

List Price £15. 15. 0

★ In *ELECTRONICS*, Mr. Wilder of the International Union Radio Corporation of America, says:

"On Friday I visited the Ediswan plant...
"The pictures were the best I saw in
"England and the best I had seen by radio
anywhere".

● We also supply
HIGH VACUUM RECTIFIERS
GAS-FILLED RELAYS
MERCURY VAPOUR RELAYS
for Television Scanning
circuits.

ENTIRELY BRITISH MADE

EDISWAN RADIO VALVES

THE EDISON SWAN ELECTRIC CO. LTD.  155 CHARING CROSS RD., LONDON, W.C.2

R.E.299

USED BY ALL GOVERNMENT DEPARTMENTS

TELEVISION

and SHORT-WAVE WORLD

Special Features

The New Televisor for Easy Home Construction	644
New Idea for Large-screen Pictures	653
Vision for £18.	657
Multiplier Photo-cells	662
The Design of the G.E.C. Television Receiver	663
A Picture on a One-inch tube	668
Miniature Cathode-ray Tube	670
15-watt Transmitter for Beginners	676
Direct-coupled Amplifier	680
Aerials for Ultra-short Waves	681
Class B Amplifier Design	687
Precision Oscilloscope for Experimenters	696

TELEVISION AND SHORT-WAVE WORLD

Proprietors :

BERNARD JONES PUBLICATIONS, LTD.

Editor-in-Chief :

BERNARD E. JONES.

Editor :

H. CORBISHLEY.

Editorial, Advertising and Publishing Offices :

Chansitor House, 38, Chancery Lane, London, W.C.2.

Telephones : Holborn 6158, 6159.

Telegrams : Beejapee, Holb., London.

Subscription Rates : Post paid to any part of the world—3 months, 3/6; 6 months, 6/9; 12 months, 13/6.

Published Monthly—1/- net.
(On the first day of the month).

Contributions are invited and will be promptly considered. Correspondence should be addressed according to its nature, to the Editor, the Advertisement Manager, or the Publisher, "Television and Short-wave World," Chansitor House, Chancery Lane, London, W.C.2.

IMPORTANT

"Television and Short-wave World" is registered at the General Post Office, London, for transmission to Canada and Newfoundland by Magazine Post. Entered as Second-class mail matter, Boston, Mass.

COMMENT OF THE MONTH

The Problem of the Cheap Receiver

IN the early part of this year we went to some pains to ascertain the factors which were preventing the average amateur from building his own television set. These factors, it was soon proved, were cost and complication.

At the time it did not appear that either of these could be reduced to any great extent, but it was decided to explore every possibility, and in carrying out a large number of tests and experiments we were fortunate in securing the collaboration of Mr. S. West.

It was evident that from the home-construction point of view only standard components and valves must be employed and that the actual construction of the complete equipment must be no more difficult than the average mains receiver. Also it was appreciated that the receiver should be "elastic," or in other words that without any fundamental alteration it should be suitable for reception beyond the ordinary service area or, with a little modification, for purely local reception.

With these objects in view several experimental receivers were built and from the experience obtained a final design evolved and detailed information on its construction was commenced in the preceding issue of this journal. This receiver in its original form has a range of approximately 65 miles and employs a 10-in. cathode-ray tube, and gives very fine results. For more local reception the cost can be reduced by using a fewer number of stages in the receiver.

The cost of a television receiver depends primarily upon picture size, and a little explanation will make it clear why this is the case. The complete televisor consists of a number of units—the vision receiver, the time bases, the power supplies, and the cathode-ray tube. Whatever the size of picture desired *the vision receiver remains the same* and its only modification would be for long-distance or local reception. With a smaller tube, however, it is possible to effect economies in several ways. Considerable saving can be effected in the power supply units, as lower voltages are employed, which means cheaper transformers and condensers. Economies can also be effected in the time bases by the employment of special design and finally, of course, the cathode-ray tube is much cheaper.

So great a saving is possible that the cost of the complete receiver, when using a small tube, is *half* that of the normal arrangement and therefore *not greatly in excess of an ordinary wireless set*.

The same vision unit as described last month is used, for as has been mentioned earlier, *the vision unit is fundamental*, whatever size of tube is used, and readers may be assured, therefore, that in building this they have *the nucleus of a televisor capable of producing pictures from 1 in. to 12 in.*

An article by Mr. S. West explaining some of the technical considerations in the employment of a small tube appears on page 657.

Alteration of publishing date : Will readers kindly note that in future "Television and Short-wave World" will be published on the first day of each month.

LOW COST

SIMPLE UNIT
CONSTRUCTION

STANDARD
COMPONENTS

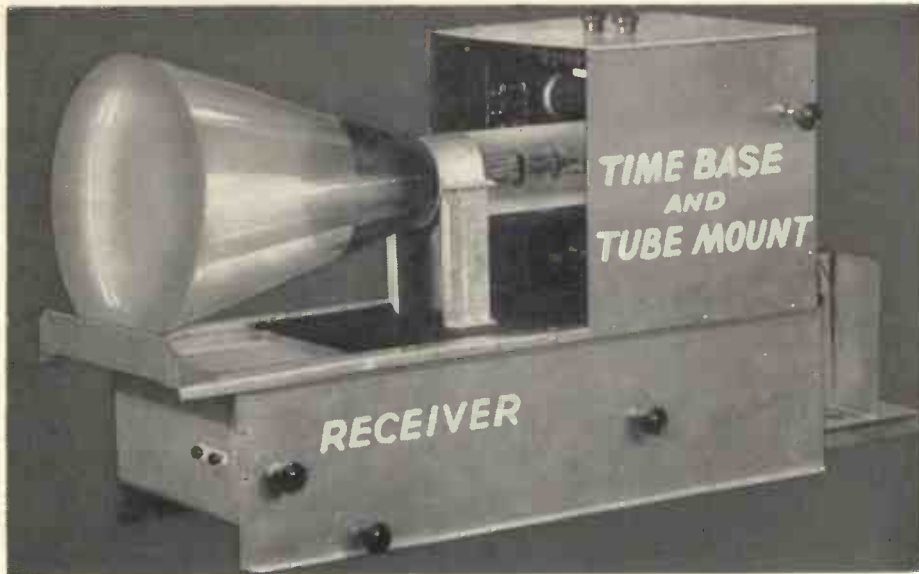

THREE
RANGES

AMPLE
RESERVE OF
POWER

NOVEL SYN-
CHRONISING

THE NEW TELEVISOR FOR EASY HOME CONSTRUCTION

Designed by S. West

PART II.—REDUCING THE NUMBER OF STAGES FOR LOCAL AND MEDIUM DISTANCE RECEPTION :: THE TIME BASE, THE CATHODE-RAY TUBE NETWORK AND THE RECEIVER POWER PACK

The first part of this article was published last month (October) and it described the construction of the vision receiver which, together with the time base, receiver and tube power packs comprise the complete vision equipment. In this issue details of the time base, tube network and receiver power pack are given. The final unit, the tube power pack, will be described next month.

This televisior is the result of several months experimental work in the provision of a suitable design for amateur construction. Cost is low, all components and valves are standard and readily obtainable and the unit construction is so simple that it is virtually impossible to go wrong.

It is designed to be suitable for three ranges—65 miles, 35 miles and 20 miles according to the number of vision-frequency stages incorporated. Either a 10 in. or 7 in. cathode-ray tube can be employed.

The construction is just as simple as any ordinary wireless set and requires no special knowledge. Lining up is of the simplest character and the time bases are very simple to adjust. The amateur constructor can have every confidence in his ability to build the receiver and get excellent pictures immediately.

TELEVISION to a large extent follows conventional radio practice. Amateurs who have had experience in tuning and adjusting normal broadcast receivers will have no difficulty whatever in adjusting a vision receiver, though certain additional technique is ordinarily required because of the need for inclusion in a complete vision receiver of the time base, which is a departure from ordinary radio practice.

With a normal sound receiver we get noises that, even in the worst cases, have something recognisable about them and it is a relatively simple matter to complete the tuning while aurally observing the effect of each adjustment.

With a vision receiver, the actual transmitted scene, or perhaps more correctly, the synchronising pulses accompanying the scene, can be heard. The actual receiving section of the complete outfit can, therefore, be adjusted, more or less accurately, by listening to the signal with headphones or a fairly sensitive loud-speaker. If this signal, however, is applied to the C.R. tube, the chances of a picture resolving are extremely remote, the reason being that the time bases are not operating at their respective correct frequencies.

Adjustment of a time base of the usual type is outside the knowledge of the home constructor. He has not previously handled anything that is similar to it.

CIRCUIT OF THE VISION RECEIVER FOR LOCAL RECEPTION

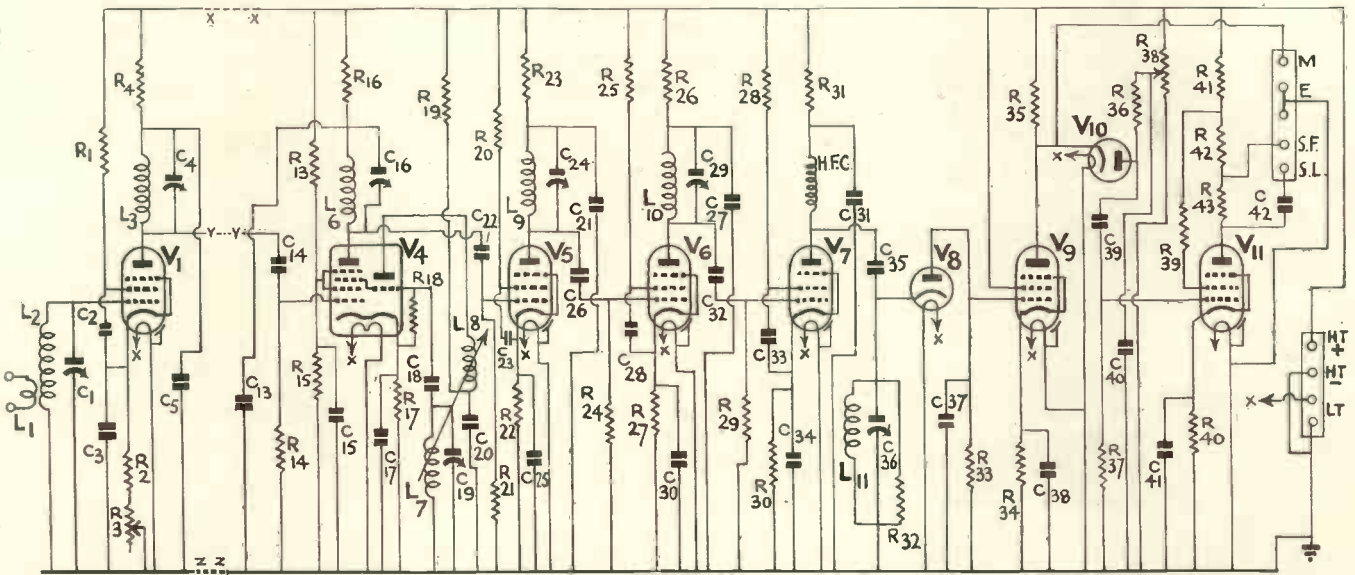

This diagram shows the circuit of the vision receiver modified for local reception. If it is compared with the circuit given last month it will be seen that two vision-frequency stages have been cut out. The two stages removed are shown below and from these and the key letters X, Y, Z it will be clear that the removal of either one or two stages according to the distance at which it is wished to use the receiver (20 miles one vision frequency stage, 35 miles two stages and 65 miles three stages, is quite a simple matter and does not affect the design in any way. It is suggested that no alteration be made to the actual chassis in the event of using a fewer number of stages as the saving that would be effected is trivial.

It has been observed by the writer that with previous home-constructed vision receivers, the novice experiences his greatest difficulty with the initial adjustments required to the time base.

The reason for this is simply that he has a large number of controls to manipulate. These controls are all more or less interdependent and he is able to get such a large variety of combinations, that the correct adjustment becomes elusive and until he gets something resembling the transmitted picture, he is literally groping blindly.

It is not an easy matter to give operating instructions for a time base. If a normal time base employing a Thyatron relay to generate the saw tooth oscillations is considered, the controls are: Relay bias, charging resistance, paraphase tapping resistance, synchronising feed and picture shift, i.e., there are five controls and this is for one base only, either frame or line. There are thus twice this number of controls for the complete time base.

In giving adjustment instructions for this type of base, initially the picture shift and perhaps the paraphase feed controls may be ignored. We still have, however, six controls to adjust.

It is usual to specify the approximate size to which the raster is to be adjusted. Then a description of the effects when the correct adjustment is approached are detailed. It is not at all easy to describe these effects. Furthermore, they are too transitory to photograph. Obviously some simpler arrangement is very desirable.

Now a time base can be what is termed "Self running," i.e., one in which the voltages are generated at approximately the correct frequency. Accurate control is maintained by the transmitted synchronising pulses. Or it can be what is termed a driven or distant controlled time base, that is, the operation is entirely controlled by the transmitter.

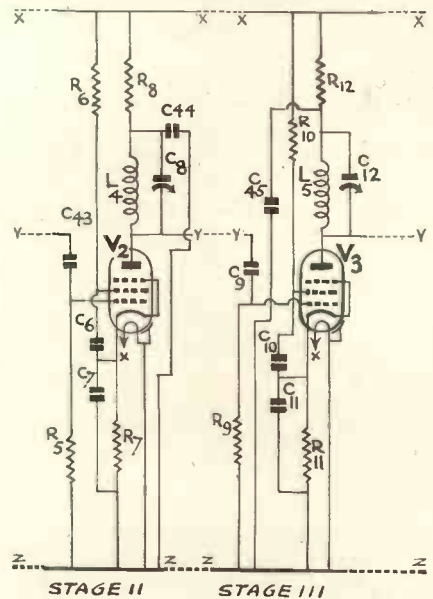

This diagram shows the two stages removed and it will be apparent that the procedure is the same for either one or two. The key letters X, Y, Z indicate the original connections

Each type have their respective advantages. In general it may be said that the first, which is almost exclusively used in most contemporary designs, is more stable with a fluctuating signal and when interference is present. The second has the advantage of adjusting itself when the synchronising pulses are applied.

A combination of the two principles would seem the ideal.

The method employed in the vision receiver unit to separate the synchronising pulses gives a pulse free of picture content and of constant amplitude.* For this reason it is possible to use a time base that is, as has

* A New Synchronising Control System. Paul D. Tyers, page 609, October issue of *Television and Short-Wave World*.

BUILDING THE TIME BASE

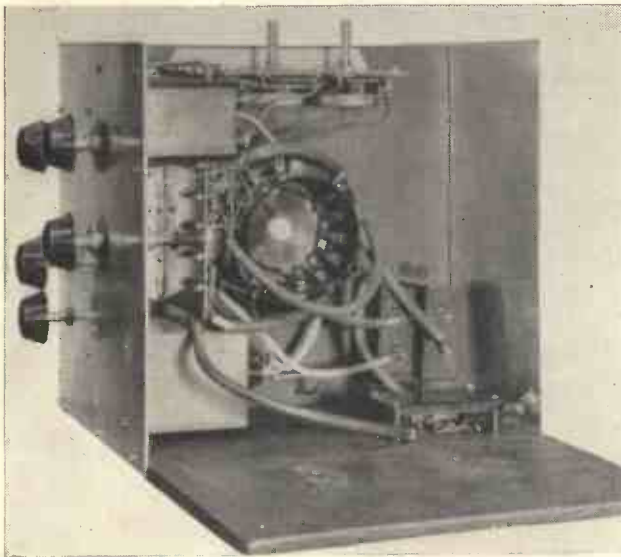

This photograph shows the front of the time base and the tube mount. A detailed drawing showing the wiring is given on the opposite page.

been suggested above, the ideal, i.e., a combination of the two systems described.

Full constructional details of this time base are given here. Its adjustment is extremely simple. Actually, there is only one control, incorrect adjustment of which will destroy the recognisability of the picture. With this control correctly set, an extremely simple task, as it is only necessary to watch the screen and rotate the control until the picture appears, the remaining controls can be finely adjusted so that the picture is of the correct size and proportions.

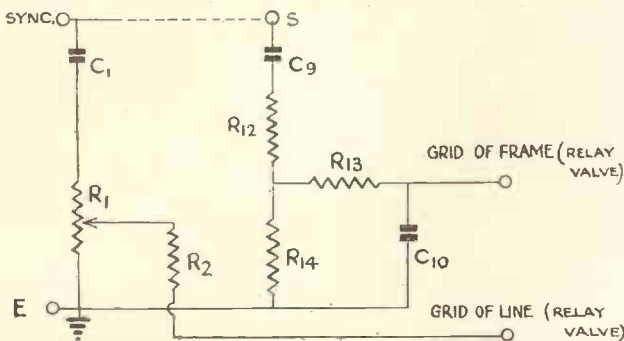

The circuit of the synchronizing pulse application network.

The question of proportions of a television picture is rather important. If the voltages fed to the deflector plates of the C.R. tube are not sensibly symmetrical, form distortion often occurs.

This type of distortion is not to be confused with that occurring when the height/width of the picture is incorrect. When this is so, the distortion applies to all parts of the picture. Figures are either tall and elongated, or squat and broad.

With non-symmetrical deflecting voltages, this distortion is restricted to a part of the picture. One form of it is for features to be elongated towards the top of the picture, exaggerating hair and brow.

In general it may be assumed that if opposite sides of the raster are parallel, the deflector plates' voltages are balanced. The method of correctly adjusting the controls to ensure an optimum picture will be fully dealt with in the operating instructions.

If the photographs of the time base are studied, it will be seen that the assembly takes the form of a complete self-contained unit, that also includes the C.R.

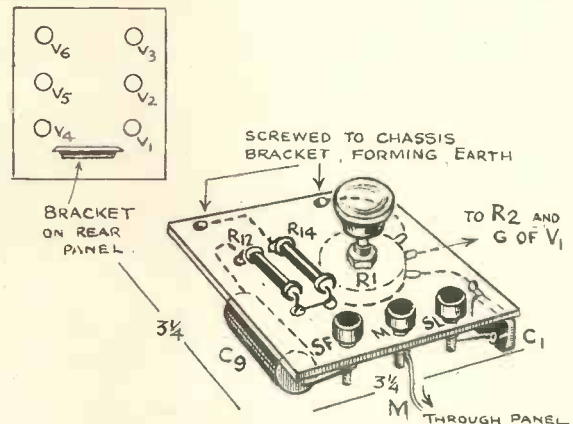

The synchronizing pulse application network panel.

tube electrode potentials network, tube base and support. This method of assembly permits short connecting leads. Also as the high-voltage potential divider is enclosed, possibilities of unpleasant accidental contact are eliminated. It will be observed that the necessary controls are grouped accessibly around the end of the tube.

The theoretical circuit of the time base is shown on page 648, and it will be seen that the number of components is minimal. (The charging resistances in the anodes of the type T.31 relays are fixed. Correct operating speeds are approximated with the variable

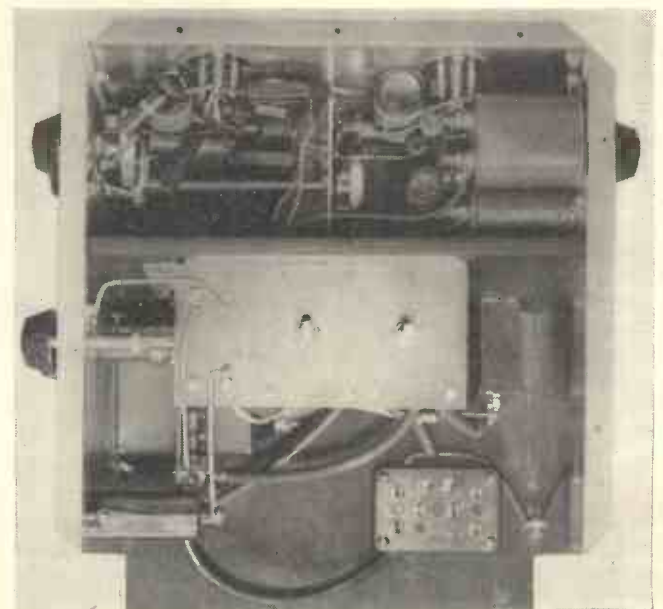

A plan view of the time base and tube mount with the top removed.

THE TIME BASE WIRING

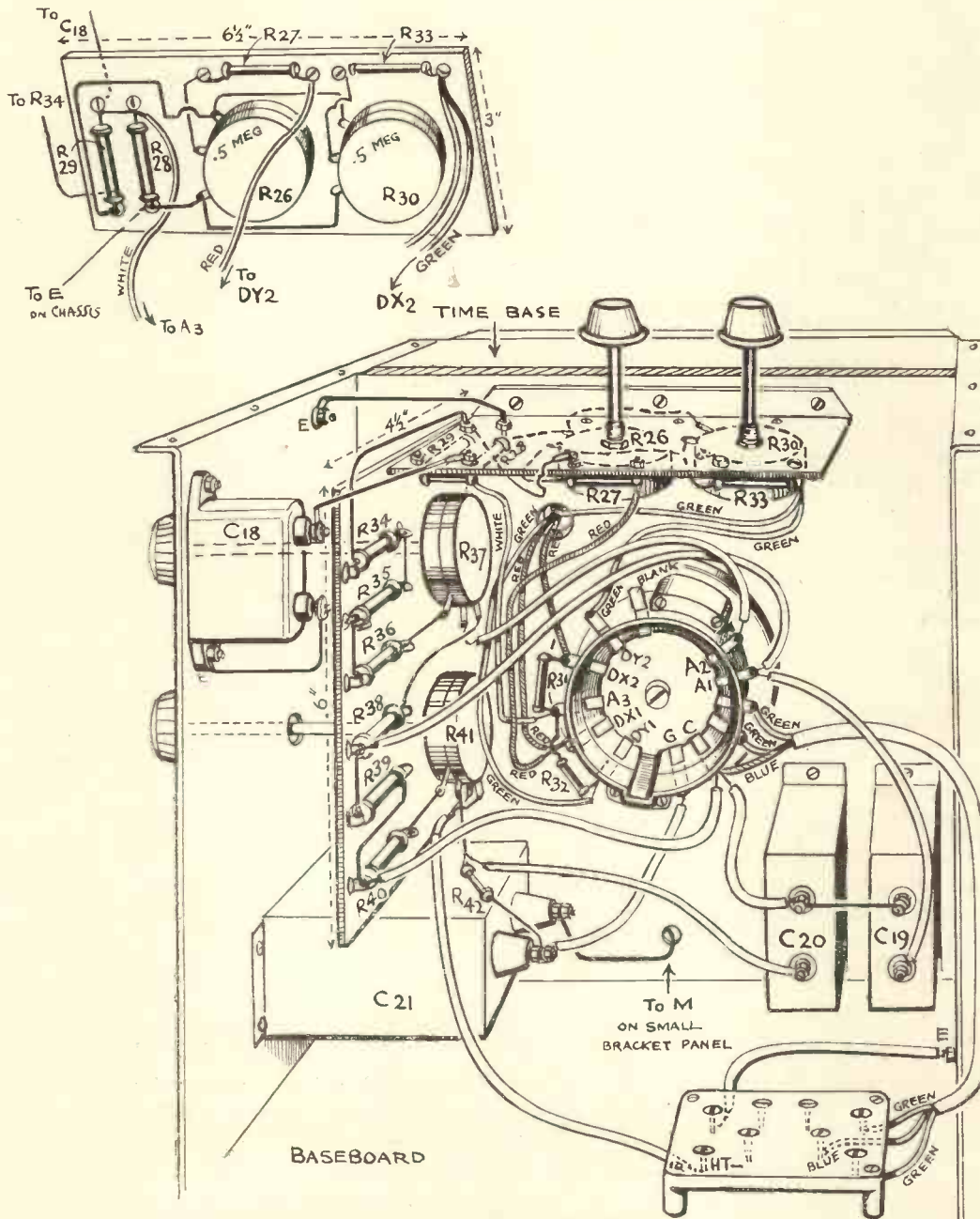

This drawing shows the front assembly and wiring of the time base and tube mount.

bias controls of these two valves. Picture size is, with certain reservations, controlled by the resistances R8 and R23.

A large number of valves have been tried and no troubles at all have been experienced owing to this simplification. There is a remote possibility, however, that the characteristics of a relay may differ largely from the average. In this case it is a simple matter to increase or decrease slightly the resistance R3. It is not considered, however, that this eventuality will arise, as the large number of valves used in tests may be said to be representative of any normally purchased.

It may be mentioned here that the picture size is

inversely proportional to the C.R. tube's third anode volts. It is well, therefore, to ascertain that this voltage is correct before attributing any difficulty in securing the correct picture size to a fault in the time base.

The synchronising pulse application network is shown on page 646.

Considerable latitude is permissible here and for this reason the unit is not actually incorporated in the time base proper. At the outset, in the interests of economy, the potentiometer R1 may be replaced by two fixed resistances proportioned R/5R with R approximately 5,000 ohms.

The potentiometer is, however, invaluable for impart-

MORE ABOUT THE TIME BASE

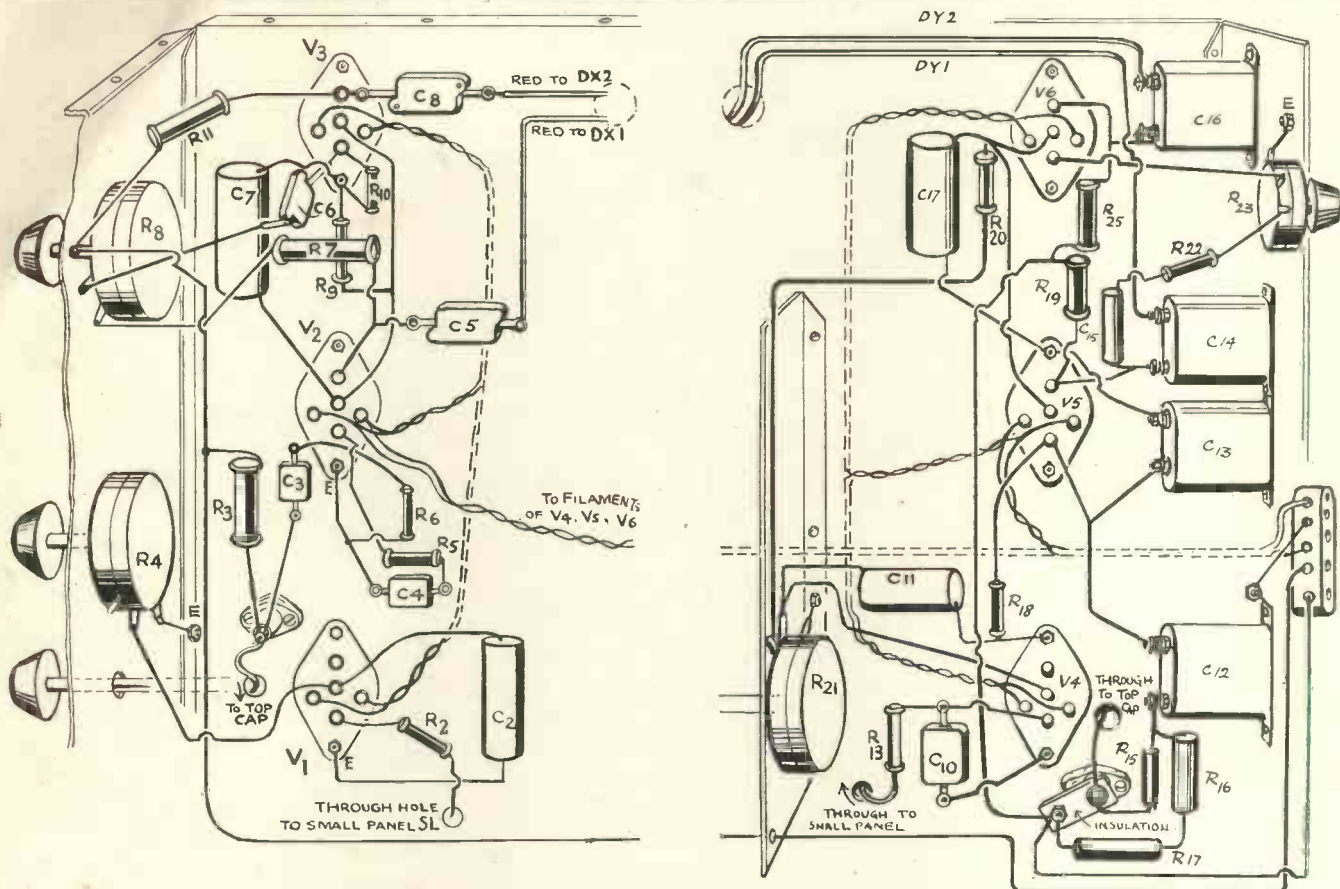

Assembly of components and wiring of left- and right-hand sides of time base chassis.

ing a fine control to the line base. It is in any case desirable when interference is heavy.

Liberties may be taken with the frame pulse feed network as this is not at all sensitive.

The circuit of the tube electrode potentials network shows that a shift voltage for correctly centering the picture is derived from the 3rd anode end of this network. The total series resistance of the network across the tube volts is 4.95 megohms = R_1 plus the

potentiometer network from which the picture shift potentials are derived. The total resistance of this

$$= \frac{1}{\frac{1}{R_1} + \frac{1}{R_2} + \frac{1}{R_3}} = 0.2 \text{ megohms} = R_2.$$
 The available shift potential thus = $\frac{R_1}{R_1 + R_2} \times E$, where E = full tube H.T. volts = 4,000 volts.

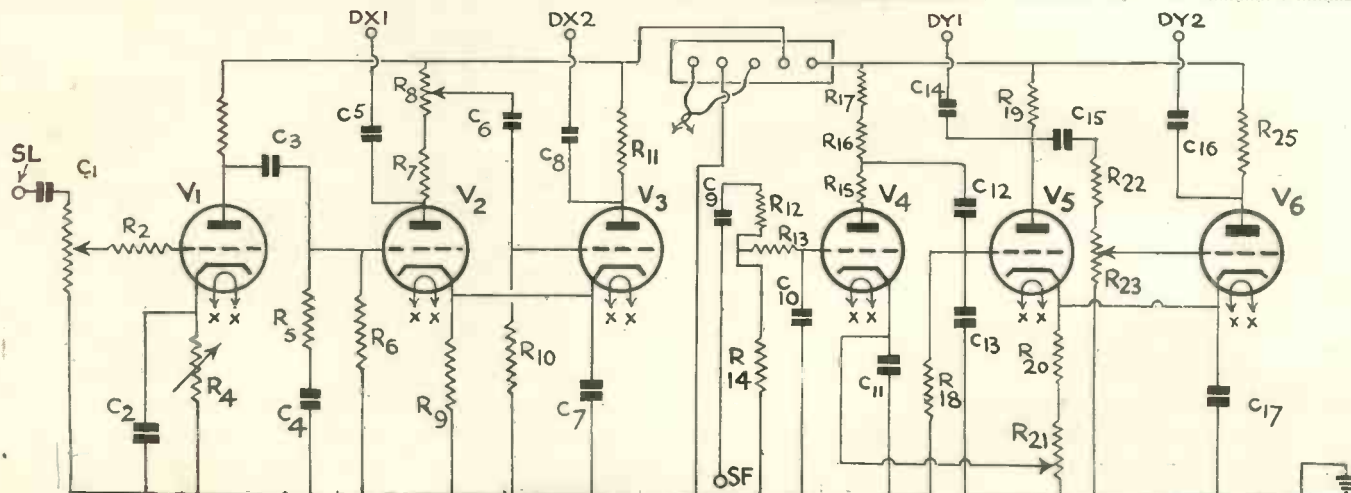

The theoretical circuit of the time bases.

THE TUBE ELECTRODES POTENTIALS NETWORK

This drawing gives the constructional details of the time base chassis. Sheet aluminium is used with a wooden dividing partition on which the tube holder is mounted.

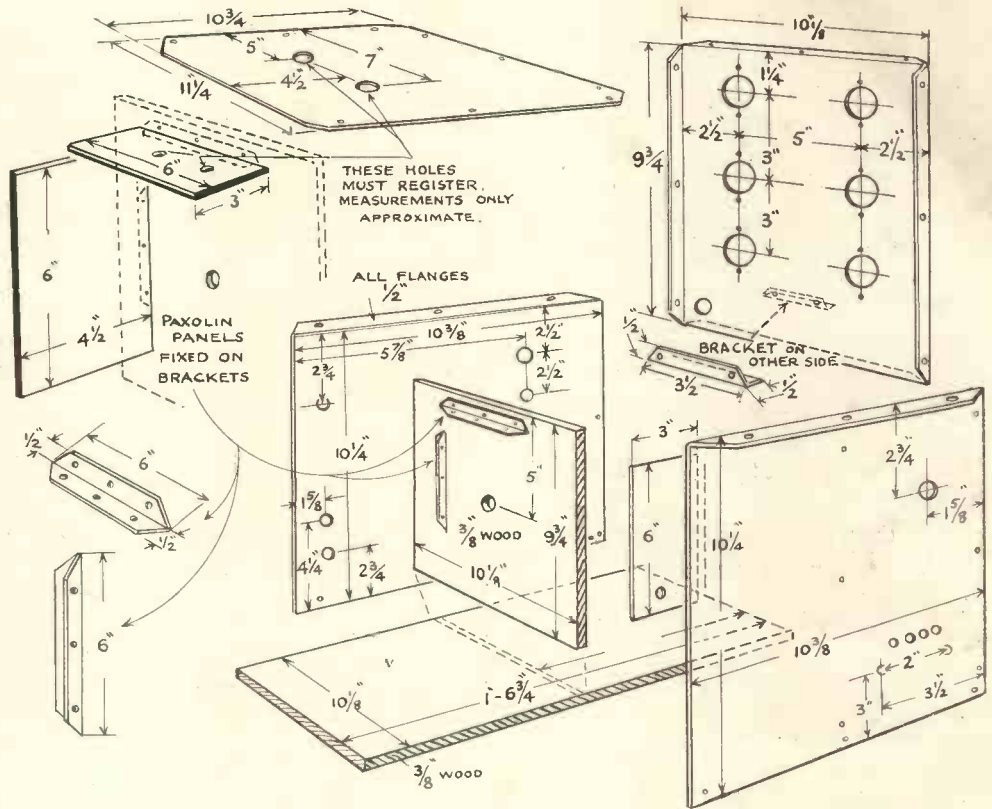

There is, therefore, a voltage available for centring the picture of 155 volts approximately or half this voltage each side of the 3rd anode. This voltage has proved adequate in all cases.

It is permissible to ignore any current taken by the tube electrodes in calculations such as those above as these currents are of a very small order.

Due to the characteristics of individual C.R. tubes varying, it may not be possible to focus the tube correctly when using the specified network. Correct focus of the tube is achieved when it is possible plainly to see each line composing the raster.

In this event the value of R38 may be slightly varied. Correct focus is important, otherwise definition suffers. (The cases of the condensers C19 and C20 must not be allowed to come into contact with the chassis, each other, or any earthed point. If the constructional directions are adhered to this condition is fulfilled.

The protecting cover of the C.R. tube base may be left off as there is no possibility of accidental contact with its terminals. This facilitates connection of the X and Y plates through their high resistances to the base terminals. The diagram makes this clear. They are the resistances R31 and R32.

It is advisable to use heavy rubber covered cable to the tube heater and cathode. Similar cable must be used for the high voltage (4,000 volts) negative lead to the unit. Elsewhere the insulation of good quality, slide-back wire will be adequate.

For the C.R. tube heater and H.T. supply a Bulgin 6-way high-voltage plug and socket is used. The time base power is supplied via a 5-way Bryce block. This makes it impossible to confuse the supplies. At the same time it ensures ease of connection between units.

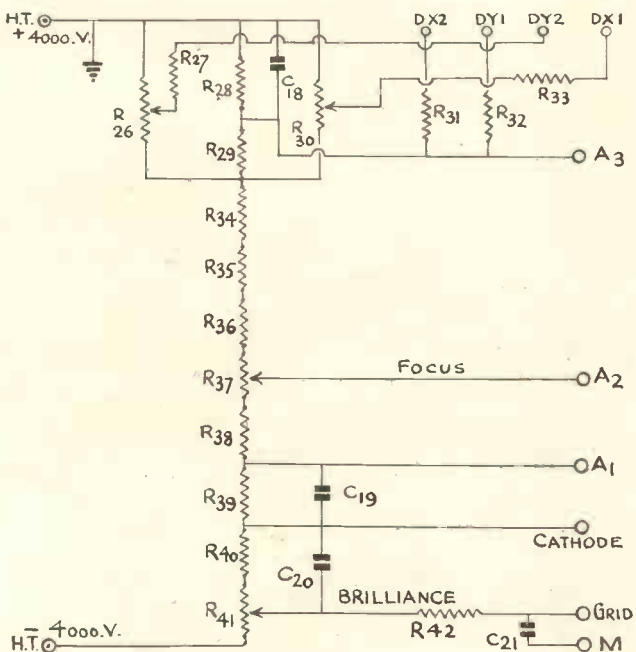

The theoretical circuit of the cathode-ray tube resistance network.

WIRING THE TUBE H.T. SUPPLY



This photograph shows the complete vision receiver power pack.

Actually the entire vision receiver may be moved and reconnected in a few moments.

The H.T. voltages to the time base are comparatively high and reasonable care should be taken with the wiring to avoid short circuits occurring at a later date.

Great care must be taken with the disposition of the

Having switched on, turn this control clockwise until the raster is just visible. If this control does not affect the raster illumination and it is very brilliant, switch off at once and check the connections. Particularly examine the resistance R42. If everything is in order it should be possible completely to extinguish the raster when R41 is turned full anti-clockwise.

If the raster is small in size it is advisable to open it up with the controls R4, R8, R20, R23, in order to spread the electron bombardment evenly over the screen.

It is well to cultivate the habit of turning the raster out before switching off and to turn it up to the required brilliance after switching on.

It should not be thought that because these precautions are described at some length, the use of a C.R. tube is in any way hazardous. On the contrary, it is a very simple piece of apparatus to use.

Few constructors have, however, had previous experience of C.R. tubes and these few notes will doubtless prove of some assistance.

The Receiver Power Pack

The vision receiver power unit is so straightforward that very little description is required.

The circuit of the vision receiver power pack.

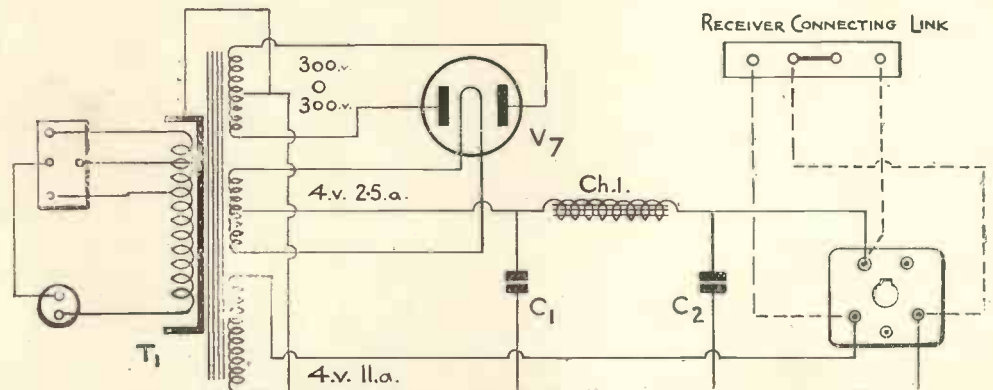

wiring and components comprising the tube H.T. network. The voltages necessary can leap quite large gaps, particularly when dust has accumulated, thereby encouraging the break over by providing a low resistance path.

It is, perhaps, as well to repeat the warning so often given, regarding the high voltages used in vision equipment.

Under no circumstances must adjustments be made to the interior of the chassis with the supply on. It is advisable also to ensure that condensers are not holding a charge.

If these simple rules are adhered to there is no danger whatever.

If tests of the unit are made before the final operating instructions are given, observation of the following precautions will avoid possible damage to the C.R. tube.

The resistance R41 is turned anti-clockwise to the extent of its travel.

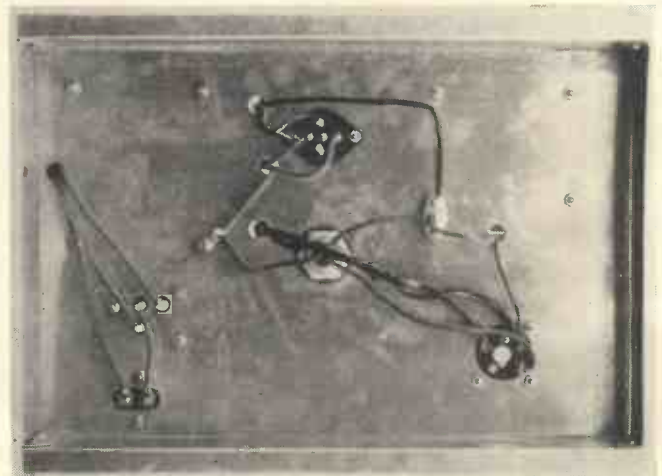

Photograph showing the underside of the vision receiver power pack.

CONDENSERS.

- C1 0.001 mfd. type 760 (Dubilier)
- C2 50 mfd. 12 v. type 402 (Dubilier)
- C3 0.001 type 620 (Dubilier)
- C4 0.001 type 620 (Dubilier)
- C5 0.005 type 620 (Dubilier)
- C6 0.005 type 620 (Dubilier)
- C7 20 mfd. 50 v. type 402 (Dubilier)
- C8 0.005 mfd. type 620 (Dubilier)
- C9 0.1 mfd. type type 4423/S (Dubilier)
- C10 0.003 type 670 (Dubilier)
- C11 50 mfd. 12 v. type 402 (Dubilier)
- C12 0.5 mfd. type 950, 1,000 volt working (Dubilier)
- C13 0.2 mfd. type 950, 1,000 volt working (Dubilier)
- C14 0.1 mfd. type 950, 1,000 volt working (Dubilier)
- C15 0.1 mfd. type 103, T.C.C.
- C16 0.1 mfd. type 950, 1,000 volt working (Dubilier)
- C17 50 mfd. 50 v. type 3004 (Dubilier)
- C18 2 mfd. (Dubilier), type BB.
- C19 1 mfd. type LEG (Dubilier)

- C20 1 mfd. type LEG (Dubilier)
- C21 0.1 mfd. 4,000 volts working, (T.C.C.)

SUNDRIES.

- 2—Extension spindles. List No. 1008 (Eddystone)
- 1—5-way connecting block (Bryce).
- 2—Insulated valve caps. List No. P92 (Bulgin)
- 3—4 B.A. Terminals
- 1—6-way high voltage connector. List No. Proo & Prior (Bulgin)
- 3—Sheets paxolin, 6 ins. x 3 ins., 6 ins. x 4½ ins. 3½ x 3½ (Peto-Scott)
- Chassis, nuts and bolts, ignition cable, etc.
- 6—5-pin chassis mounting valve holders (Belling-Lee)

VALVES FOR TIME BASE

- V1 Mazda T31
- V2 Mazda AC/P
- V3 Mazda AC/P
- V4 Mazda T31
- V5 Mazda AC/P
- V6 Mazda AC/P

LIST OF COMPONENTS, VALUES AND MAKES FOR VISION RECEIVER POWER PACK

- 1—Mains Transformer. type 300T/100 200-250 volts Primary
Secs. 300-0-300 at 100 milliamps
2-0-2 at 2.5 amps
4 volts at 11 amps (Sound Sales)
- 1—Smoothing choke 60 henries, 80 milliamps type 60/80T (Sound Sales)
- 1—8-8 mfd. electrolytic condenser type 9203E (Dubilier)
- 1—3-way mains selector board (Clix)

- 1—Mains connector, List No. 1014 (Belling-Lee)
- 1—5-way plug and socket, List No. 1260 (Belling-Lee)
- 1—Valve holder, List No. 1135 (Belling-Lee)
- 1—Midget stand-off, List No. 1019 (Eddystone)

- VALVE.**
- V7 Mullard 1W3 (Rectifier)

NEW OPTICAL METHOD OF TELEVISION RECEPTION

A RECENT SCOPHONY DEVELOPMENT

(French Patent—817 994, Scophony Limited and F. Okolicsanyi).

THIS patent describes several new methods of television reception employing supersonic waves. Some of these methods dispense entirely with the high-speed scanner, some with the slow-speed scanner as well. The common feature of the various combinations is that two light relays are placed in the light path of a light source. The light passes successively through the two relays. At least one light control is of the supersonic type, the other is either similar or of the Kerr cell type. Electrically, the one is fed with the picture current, the other with the synchronising signals.

In one of the examples the patent indicates that the light of a constant light source is modulated in the orthodox way by a Kerr cell. The light then passes through a liquid cell in which a quartz crystal generates supersonic waves. The associated high-frequency oscillator is suppressed until the saw-toothed synchronising impulses permit the oscillations for a very short time. A wave group is started from the crystal and can be made visible on a screen with the usual interference methods and with the light modulated by the Kerr cell. In conjunction with a mechani-

cal slow speed scanner the picture is then built up. This system is suitable for any practical line number, because the starting of the wave group is effected without time lag and in a most direct way, since time bases, etc., are not necessary.

The electrical connections are interchangeable and another example of receiver design can be demonstrated by feeding a Kerr cell with the synchronising signals and the supersonic cell with the picture current. In this case a kind of supersonic record is projected from the crystal into the liquid and if the cell is long enough, the record will persist for the duration of a line. The Kerr cell then stroboscopically projects the picture cell, flashing each line in turn on the screen. An increased light efficiency is obtained if the light source also flashes synchronously with the Kerr cell.

We understand that the above system is producing practical pictures—that is, receiving the B.B.C. trans-

missions. It appears to be a third type of reception, providing a new method of scanning in addition to the existing mechanical and electronic methods. The supersonic cell cannot be regarded as replacing mechanically moving solid scanners by liquid ones, since it is not the movement of liquid which effects the scanning, but purely the propagation of compression waves in the liquid. The device is, therefore, inertialess.

We hope to publish full details of the scheme, described by the inventor, Dr. Okolicsanyi, in next month's issue of TELEVISION AND SHORT-WAVE WORLD.

THE INVENTOR OF RADIO

There is still considerable controversy as to who was the inventor of radio. It is claimed in certain quarters that scientists Hertz, Lodge and Popoff, discovered the existence of electric waves many years before Marconi ever thought about it. During a patent action in America, Judge Townsend stated, "other inventors venturing forth on the sea of electrical movement met the rising tide of the Hertzian waves and allowed them to roll by without appreciating that this new current was destined to carry onward the freight and traffic of the world's commerce. They noted their manifestations, suspected their possibilities, disclosed their characteristics and hesitated, fearing the breakers ahead, imagining barriers of impracticable channels and shifting sand bars. Marconi daring to hoist his sails and explore the unknown current first disclosed the new highway."

The next issue of Television and Short-wave World will be published on Wednesday, Dec. 1st.

A NEW IDEA FOR LARGE-SCREEN PICTURES

DETAILS OF A SUGGESTED SCHEME FOR EMPLOYING THE CATHODE-RAY TUBE AS A LIGHT VALVE

ONE of the disadvantages of the cathode-ray tube is that the "effects" which it produces are confined within a glass vessel which must be absolutely airtight. If the cathode beam could be made to operate in air it is probable that better use could be made of it than the production of fluorescence. Many suggestions have been made for util-

though in practice it would form part of its complete assembly.

In order to make the idea and its method of working clear it will be helpful to outline the physical phenomena which it is believed underlie the principles involved.

It is well known that if two bodies have their surfaces brought very near together there is an attractive force

position characteristic of the substance. These forces exerted within a substance are represented by the term "cohesion." At the surface of a substance, however, the forces exerted on the molecules are not in balance, there being an unbalanced force such that attraction will occur between the surface of the substance and that of another body close thereto. This attraction is generally termed "adhesion."

Since in accordance with the above theory the adhesion between two bodies is due to electric attraction, it should be possible to neutralise this attraction, and thereby reduce or cancel out adhesion, by suitably charging electrically one of the bodies. Experiment has shown that adhesion can be reduced or cancelled out in this way.

Varying Reflective Power

The working principle of this suggested valve makes use of the above fact, namely, adhesion between bodies may be controlled or varied electrically. For example, by providing a large number of minute bodies in combination with an optically prepared surface of another body, the positions of the former may be varied by varying the electrostatic state of charge and so the optical characteristics of the combination will be altered.

It is proposed to employ this phenomenon by causing it to vary the reflective power of a prism, the arrangement being as shown schematically by the drawing. A totally reflecting prism (a) occupies the large end of a cathode-ray tube, there not being, of course, the usual fluorescent screen. Light from a source b is projected via a suitable lens system c and the prism on to a viewing screen. The light, therefore, passes into the prism and is totally reflected from the reflecting surface a₁ and then passes through a further lens system d to the screen. The totally reflecting face of the prism is optically polished and

(Continued at foot of next page)

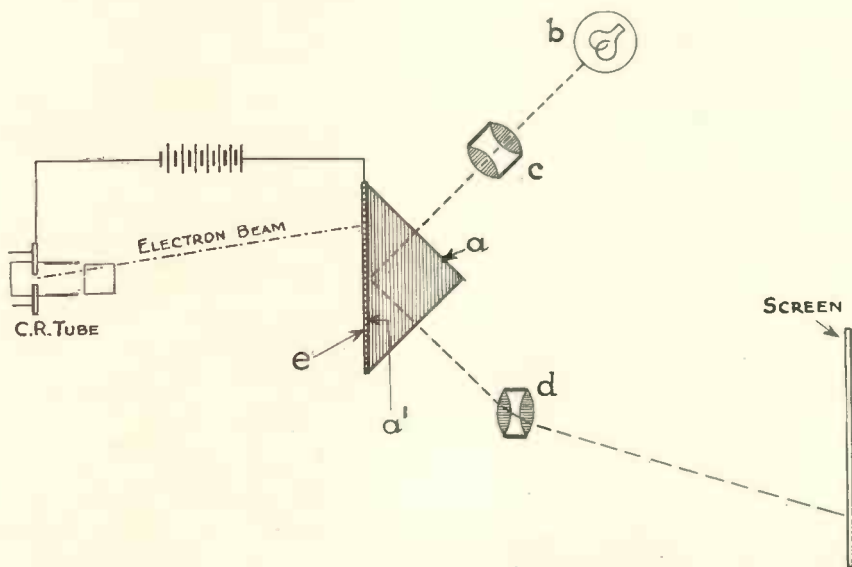

The suggested scheme for the employment of a combination of cathode-ray tube and prism as a light valve

ising the beam in a different manner with the object of allowing greater latitude in its use, but although several of these are ingenious none as yet appears to have reached the stage of practical development, if we exclude optical projection of the actual light spot which, of course, entails an intensely bright spot and certain consequent difficulties in its production.

An idea to make the beam act as the control of a light valve is the subject of a patent* which has been granted to Marconi's Wireless Telegraph Co., Ltd., L. M. Myers and E. F. Goodenough. This light valve is of a new and special type and is external to the cathode-ray tube,

between them. For example, if two pieces of glass having optically planar surfaces be placed with those surfaces together a substantial force is required to pull them apart. Similarly, two pieces of polished mica when placed together will at once form optical contact even in air, while a similar phenomenon is exhibited with liquids—for example, the adhesion between a mercury surface and a copper plate.

The generally accepted explanation of these physical facts is that the molecules disposed within a substance are subject to electrostatic forces of surrounding molecules, the electrostatic forces within the substances being so balanced that the molecules take up a particular dis-

* Patent No. 466,031.

Telegossip

By Lumen

Verbiage

MOST of us know the story of the doctor who advised his patient to include a proportion of carbonised carbohydrates in his diet, which on inquiry turned out to be common or garden toast. This peculiarity of the medical profession, which seeks to wrap up a simple description in a wealth of abstruse terms, seems to be infecting the television profession.

In a recent text-book we find the simple term "focusing" replaced by the word "fasciculating," which is certainly in the O.E.D., but is no better for having been brought out. The B.S.I. glossary does not use it, and I very much doubt whether any manufacturers would appreciate being asked for a "magnetically fasciculated tube." He would probably charge extra for it.

Another word in the same book is "Bildpunkt" for picture element. We are slowly absorbing the word "raster" since there seems to be no exact equivalent in English, but why go out of one's way to translate picture element into German? It would look much prettier in Latin as *punctus scenarum*, but wouldn't help the unfortunate beginner who is trying to master a new science. No, let us try and keep to the simple terms and leave the complication to the theory of the subject.

Communal Television

What has happened to those luxury flats which were being piped for television? Are the occupants looking in every night? Have they a set of sockets marked "Video," "Sync." and "Sound," or, as I strongly suspect, just a communal aerial and have to button their own sets on to it? Perhaps some luxury flat dweller will let me have his experiences. Talking of flats, I heard of a case the other day where a television set showed a violent snowstorm effect at intervals, in spite of the fact that there were no neons, cars or other objectionable things in the neighbourhood. Quite by accident it was found that the snow scene coincided with the movements of the person next door,

who happened to be a bit heavy-footed, and on tracking down the trouble it was found that the water pipe, which served as an earth connection, crossed a bit of conduit under the boards. (The ponderous tread of the neighbour had caused the pipe to make intermittent contact with the conduit, and since neither of them were doing their job efficiently all sorts of stray interference was getting back to the set. Moral: A sound connection to the water pipe is not always a sound connection to earth. Also, old conduits were not screwed as is the practice nowadays, and they weren't very particular with the bonding either, apparently.)

Haywire

The radio experimenter who scorns neat layouts and soldered joints—you know the type—a piece of plywood that has been used for four years, the condensers hanging on by one screw, and the bias battery hanging on its flex will have been almost killed (literally) by television.

Fancy trying to wire up an H.T. circuit on a breadboard with odd bits of flex! And yet there are still some of them who pursue their way happily. One went into a dealer's the other day and said "I have the parts of an old Four, and I have just got a second-hand short-wave kit. Can I use them to build a television set?" The dealer tactfully said it would be a difficult job, and inquired where the H.T. supply for the tube was coming from. "Oh," said the enthusiast, "I've got four old eliminators, and I thought I'd put them in series."

A Pioneer Society

I note with interest that the Television Society starts this month on its tenth session with the good wishes of all who know what an uphill fight the pioneers had in the early days. It was formed at the suggestion of Mr. Baird in 1927, and two of the original founders, Mr. Denton and Mr. Mitchell, are still in honorary office in the Society. Very wisely, the Council have dissociated themselves from any commercial organisation and have confined their activities

to purely television matters. The enthusiasm of the members and the full attendance at the monthly meetings shows that the Society fills a definite place in present-day scientific activities.

The Society has a special appeal to the amateur worker in television as there is no other method by which he can hear the views of professional television engineers and discuss his own problems with them. Readers of this journal would do well to ask themselves if they are not missing an opportunity of furthering their knowledge of the subject by neglecting to apply for membership which is open to all interested in television. Particulars of membership are given elsewhere in this issue.

"A New Idea for Large-screen Pictures."

(Continued from preceding page)

upon this face are scattered extremely small particles, such as mica crystals, of a thickness not amounting to more than about 100 molecules. These particles are represented in the figure by the broken line.

Owing to adhesion effect, optical contact will normally take place between the crystals and the prism face, and with such optical contact existing the prism will cease to totally reflect by reason of the absorption effect of the particles. If, however, at any particular point on the face of the prism the small particles be so charged electrically as to cancel out or reduce the adhesion force, so that optical contact ceases to exist, the prism will be totally reflecting at that point.

For the purposes of obtaining television pictures it is proposed to scan the mica or other particles upon the totally reflecting face of the prism with a cathode beam so that the reflecting qualities of the prism at the individual elements of its operating face will be varied in accordance with the television signals. Other suggestions are made for the employment of the underlying principle, as, for example, the use of carbon particles and also a very thin mica sheet which can be caused to vary its contact with the prism face, and although so far as is known no practical development has as yet been made on the lines indicated, the idea is an ingenious suggestion for the development of a light relay or amplifier which would simplify the production of large-screen pictures.

BAIRD TELEVISION LTD.

**WORLD PIONEERS & MANUFACTURERS OF
ALL TYPES OF TELEVISION EQUIPMENT**

★ **FIRST IN 1926** ★

★ **FINEST IN 1937** ★

Brilliant pictures, freedom from distortion, excellent detail, wide angle of vision, extremely simple operation, high fidelity sound and all-wave radio are among the factors contributing to the first-class performance of all Baird Television receivers. Incorporating all the latest features in television development, every model in the range represents the high-water-mark of achievement.

★ ★ ★ ★

Each television receiver incorporates a Baird "Cathovisor" Cathode Ray Tube which has the outstanding advantage of being completely electro-magnetic in operation. These tubes can be supplied separately with the necessary scanning equipment where desired. Apart from manufacturing processes, stringent tests are made for electrical emission, tube characteristics, filament rating, and screen quality, and following normal picture reconstitution under service conditions, every Baird Cathode Ray Tube, on completion, is subjected to a very high external pressure test. Baird "Cathovisor" Cathode Ray

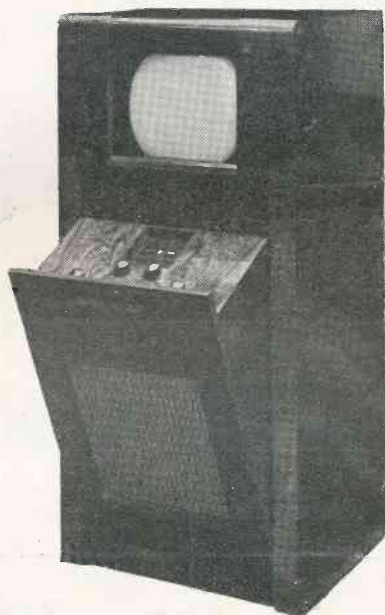

One of the New Baird Receivers
Model T.11

Tubes are the ideal solution for high quality television pictures.

★ ★ ★ ★

A large number of Flat installations have already been undertaken by the company, and amplifier equipment for this purpose is now available. Vision and sound are provided "on tap" in any room desired, and technical advice will be given by the company's experts on all points.

★ ★ ★ ★

Another new development is the Baird Multiplier Photo-electric Cell, of which there are two main types, suitable for either a concentrated light beam or diffused light. The Baird Multiplier is a chain of electron permeable grid stages, and under service conditions current gain factors of the order of 100,000 can be obtained. Cathode sensitivity is approximately 30 micro-amps per lumen. These Multiplier Cells are suitable for all television and sound on film work, together with many industrial applications where high gain, coupled with sensitivity and extremely high signal to noise ratio, is essential.

Write for latest literature describing:
BAIRD RECEIVERS MODELS T5C, T.11, T.12 and T.13.
MULTIPLIER PHOTOCELLS.
 12 in. and 15 in.
"CATHOVISOR" C. R. TUBES.
"CATHOVISOR" C. R. TUBE SCANNING EQUIPMENT.
 Post free on request.

Head Office :

Laboratories :

**Greener House, 66, Haymarket,
LONDON, S.W.1**

**Crystal Palace, Anerley Road,
LONDON, S.E. 19.**

*Phone: Whitehall 5454

*Phone: Sydenham 6030

Progress in Television

THE MULLARD CATHODE RAY TUBE

Type M. 46-15

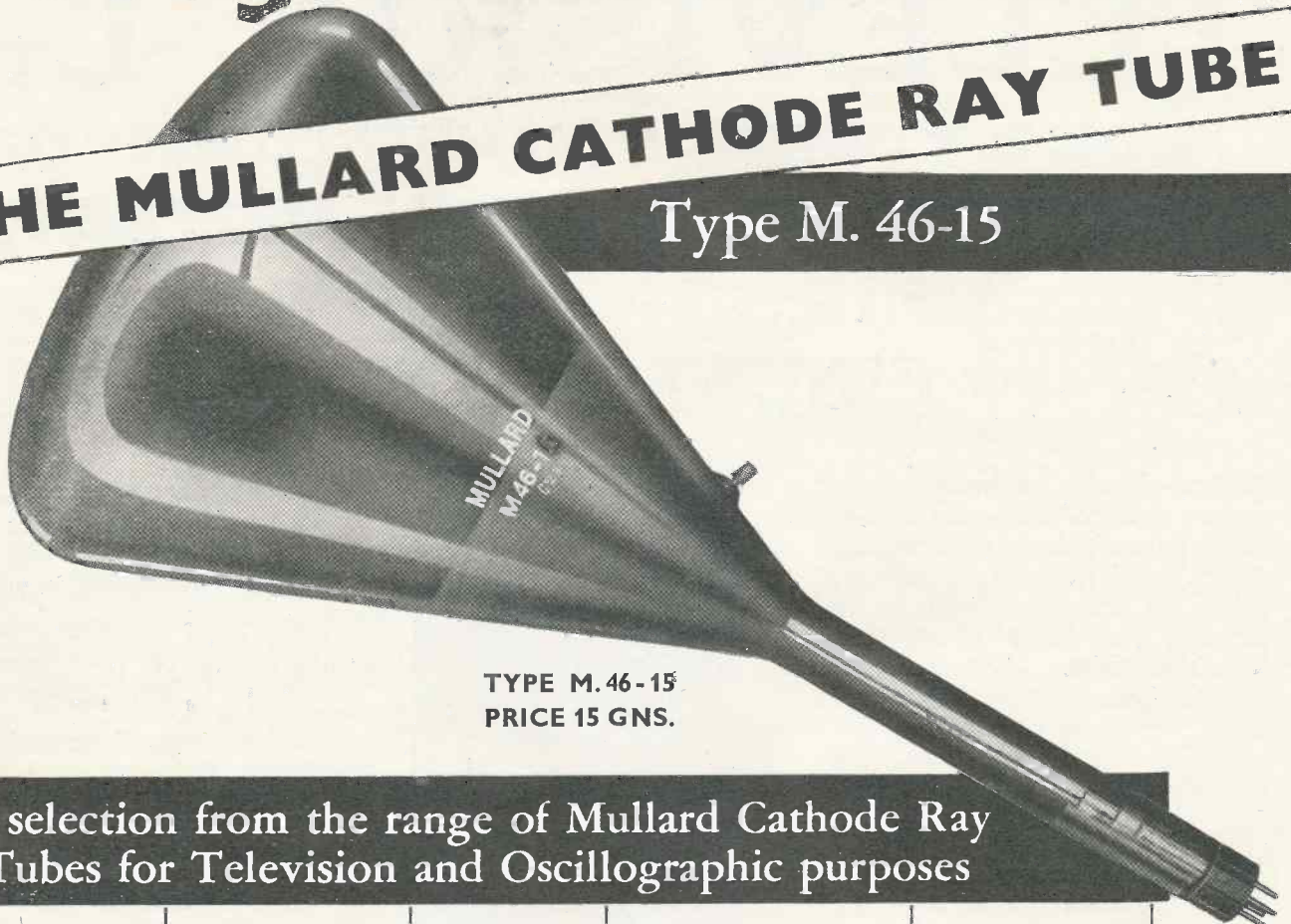

TYPE M. 46-15
PRICE 15 GNS.

A selection from the range of Mullard Cathode Ray Tubes for Television and Oscillographic purposes

TYPE NO.	SCREEN COLOUR & APPROX. DIAMETER	MAX. ANODE VOLTS	DEFLECTION METHOD	LIST PRICE
M.46-15	White 15"	5,000	Electro-Magnetic	£15 15s.
M.46-12	White 12"	5,000	Electro-Magnetic	£12 12s.
EM.46-12	White 12"	5,000	Electro-Static Electro-Magnetic	£15 15s.
E.46-12	White 12"	5,000	Double Electrostatic	£15 15s.
E.46-G10	Green 10"	5,000	Double Electrostatic	£12 12s.
E.42-B6	Blue 6"	2,000	Double Electrostatic	£ 8 8s.
A.41-N4	Green* 4"	1,200	Double Electrostatic	£ 6 15s.
E.40-G3	Green 3"	800	Double Electrostatic	£ 3 10s.
4002	Green 4"	1,000	Double Electrostatic	£ 6 15s.

★ Special Long Persistence Screen.

Write for Technical
Information Sheets,
giving full data, to:—

Mullard

Wireless Service Co. Ltd.,
Cathode Ray Tube Dept.,
225 Tottenham Court Road,
London, W.1.

Experiment has shown that excellent pictures are obtainable on small tubes with a resultant very great economy



in receiver cost. This article is a preliminary to a series describing the practical construction of a really cheap receiver.

HALVING RECEIVER COST!

THE POSSIBILITIES OF SMALL TUBES

By S. West

A LARGE proportion of the cost of a home-constructed television receiver is accounted for by the C.R. tube and the high voltage gear that its use entails.

Recently a small high-vacuum C.R. tube primarily intended for oscillograph work was introduced by Mullards. This tube, designated the A41-G4/B4, has a 4 in. diameter screen, employs electrostatic deflection and focusing and requires an anode voltage of 1,000-1,200 volts. Two types of screen are available, either blue or green. A special electrode assembly is employed that enables a non-symmetrical deflection circuit to be used with one set of deflector plates.

To amplify this last statement somewhat it may be said that it is customary to use a push-pull output to the deflector plates of an electrostatically operated C.R. tube in order that the voltages applied to these plates may be balanced in respect to earth. This is necessary, otherwise the picture suffers from trapezium distortion. This distortion would not be important if shape only were affected. Unfortunately, however, the entire picture area is distorted.

It occurred to the writer that it might be possible to use this tube as a television picture reproducer, as its characteristics appeared quite suitable.

A few preliminary calculations were first made to ascertain the size of picture that could be accommodated on the 4 in. screen.

The formula for finding the picture size is

$$H = \frac{D}{\sqrt{1 + r^2}} \text{ and } W = \frac{D}{\sqrt{1 + \frac{1}{r^2}}}$$

where H = height of picture.
W = width of picture.
D = diameter of the tube screen,
r = ratio $W/H = 5/4 = 1.25$.

This is derived from the fact that the square on the hypotenuse, i.e., the diagonal of the picture and therefore the diameter of the tube, is equal to the sum of the squares on the two sides.

Converting to m/ms for convenience. The diameter 4 in. = 103 m/ms. approximately.

Thus a picture 80 by 64 m/ms. can be accommodated on the screen of the tube. We can permit the corners to roll over the edge of the tube a little and aim at a picture, say, 90 by 72 m/ms.

The deflection sensitivity of the tube is given as .39 mm/V. for one set of plates and .28 mm/V. for the other.

If we assume that the plates with the lower sensitivity are to be used for the large dimension of the picture we calculate the deflection voltages necessary when connected in this way, then regardless of the arrangement ultimately used, the deflecting voltages will prove adequate.

The long side of the picture is to be 90 m/ms. The voltage required to deflect the spot to this measurement is $\frac{90}{.28}$ volts, that is 320 volts approximately.

So far everything has been quite simple. We have not yet considered,

Fig. 1

The resistance R1 reduces volts applied to the second anode. It should be noted that any change to its value necessitates slight readjustment of the focus potentiometer R2. Symmetrical deflection is furnished when the X and Y plates are connected as shown by dotted lines. The values of C2 and C3 must then be accurately calculated.

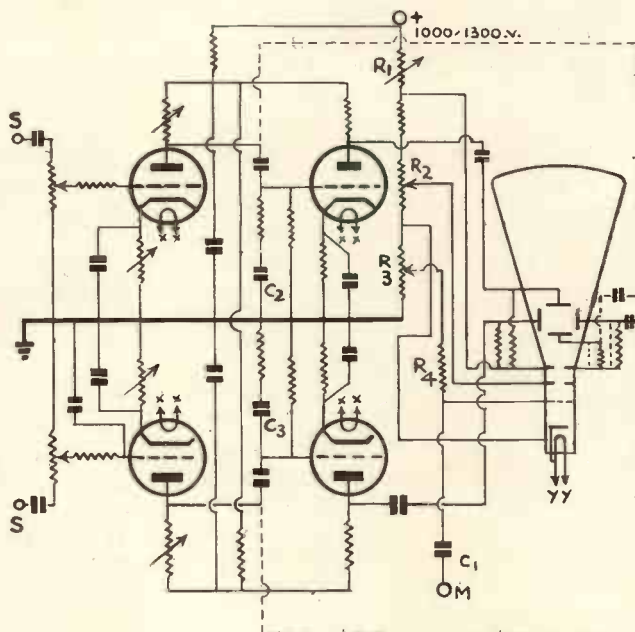

EXCELLENT PICTURES ON A SMALL TUBE

however, the permissible size of the light spot with this small picture.

The picture vertically is composed of 405 lines. The light spot should

therefore not exceed $\frac{72}{405}$ m/ms.

diameter. That is, .18 m/m. diameter. Now it is not possible to reduce the light spot to this size with this type of tube. We can reduce it somewhat by increasing the anode voltage, but this is not desirable. It should be remarked that the above observations do not take into account that part of the picture relegated to purposes of providing synchronism. This eases the position somewhat.

At this juncture it was decided to make a rough test with a picture this size, utilising gear that was already connected. Accordingly the picture on the screen of a 10-in. tube was reduced to the dimensions that the small tube can accommodate.

In spite of the fact that the tube was not focused, definition was quite good. It would therefore seem, although this is a little difficult to explain, that for a small picture the spot diameter may exceed the thickness of a line.

It was therefore decided to conduct some tests with the small Mullard tube.

The receiver employed for these tests was that designed by the writer and described in the October issue. For those desirous of effecting a large economy and content with a small picture, the small tube offers an alternative that will give some excellent entertainment and some very valuable experience in the handling of C.R. tubes, as the circuits employed are in every way similar to those required with a large tube.

The time base circuit and tube network used for the tests are shown by Fig. 1. It will be seen that the same H.T. supply is used for the tube and time base, the reason for this being that a 1,300-volt power pack was already available. It is not necessarily the best arrangement. The resistance R₃ controls brilliance and R₂ focus.

The adjustment of this latter resistance is critical and some care was necessary in arriving at the optimum setting. The resistance R₁ was fitted partly to reduce the H.T. applied to the second anode and also to observe the effect of increasing volts on this electrode above normal.

Existing 10,000-cycle and 50-cycle saw-tooth voltage generators were used to furnish sweep voltages. These were modified to provide an unbalanced output, i.e., two valves only in each were used, a relay and a triode amplifier.

Modulation was applied through the condenser C₁, the grid of the tube being returned through the 1-megohm resistance R₄. As the cathode end of the tube is earthy, it is obviously preferable to use a direct

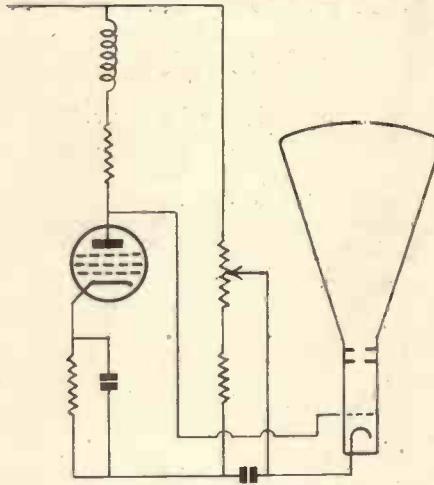

Fig. 2. Method of obtaining bias

grid connection obtaining bias for the tube from a potentiometer across the vision receiver H.T. supply. See Fig. 2. The method used was, however, more convenient. It will be noted that no means for centring the picture are provided. For the initial tests this was not considered necessary and subsequently it was found that the picture was almost central in spite of this. No doubt in some cases a shift voltage will be required. It is a very simple matter to provide this.

This arrangement was then connected to the output of the vision receiver. With the brilliance and focus controls correctly adjusted a good picture was obtained.

It was observed that the picture tended to compress at the base, the top half of the picture being elongated. Several alterations were made to the slow speed base which effected improvement. It is considered that it may be desirable to

use some form of symmetrical deflection to one set of plates. At the time of writing no such arrangement has been tried. It is desired to avoid this complication if possible. There was found to be an optimum arrangement of deflector plate connections to obtain the best proportions and shape for the picture.

The tube is very simple to use. The writer used a tube with a blue screen. This gives a pleasant picture. Due probably to the robust composition of the screen, the picture when viewed through the glass walls of the tube seemed very much brighter than when viewed in the usual way. (It is hoped to arrange for the production of tubes with a normal black and white screen.—Ed.)

An entire evening programme was enjoyed with the small tube. The small size of the picture and its unusual colour assume unimportance after the first few minutes viewing.

It is possible easily to read all captions, including those in the "News reels." The individuals comprising a group are quite clear and defined. In brief it can be said that the picture is an accurate miniature of the conventional large tube picture and it has very definite entertainment possibilities. The low cost of the tube and the gear associated with it places television within the reach of a vastly increased number of home constructors.

Television Lectures

A series of lectures on television is to be given on Tuesday evenings from 8 p.m. to 10 p.m., by Mr. H. J. Barton-Chapple, B.Sc., A.C.G.I., D.I.C., A.M.I.E.E., at the L.C.C. Norwood Technical Institute, Knight's Hill, West Norwood.

The syllabus is very comprehensive and includes the following: Historical development; reasons and methods for scanning; electron cameras; limitations; correcting devices employed; radiating the vision signal; types of modulation; ultra short waves; signal range; electrified layers in atmosphere; forms of light modulation and control; photo electricity; modern photo-electric cells and electron multipliers; co-axial cable distribution; cathode-ray tubes; time base generators; electrostatic and electromagnetic operation; synchronising; different types of complete television receivers, etc.

Will readers kindly note that the December issue will be published on the 1st of the month, Wednesday.

Scannings and Reflections

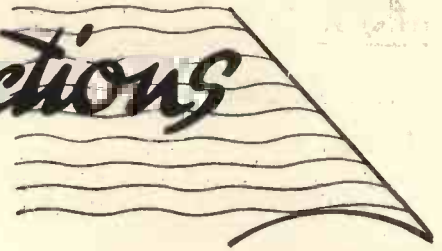

HOME CONSTRUCTION

TECHNICAL constructors are beginning to realise that they can make their own television receiver much more cheaply than was at first anticipated, if they are prepared to build some of the components. The mystery which surrounded the design of television components in the early days is now being slowly dispersed. Constructors are finding that I.F. and H.F. coils can be very easily made and at very low cost, and, as some seven or eight coils are generally required in every receiver, the home-constructed coil represents a very big saving.

Careful buyers can also obtain components at very reasonable prices by asking for radio components rather than television components, which appear automatically to be priced higher.

BRITISH LEAD IN TELEVISION

One of the clearest indications that Britain leads in the design of television transmitters and receivers is shown by the number of visitors that have come from foreign countries to gain first-hand knowledge of our developments. Not only are we ahead technically and theoretically, but we have put our knowledge to every practical advantage. Visitors from most European States, America, Australia, South Africa, and even Persia, have come along and been most agreeably surprised at the progress made in the last year or so. Perhaps some of these foreign countries have been wise in letting us do all the spade-work for they can now go ahead with their own installations without having to worry very much about experimenting with transmitters and receivers. British design will apparently be used in most parts of the world.

FIVE-BAND ALL-WAVE RECEIVERS

The introduction this year of a number of all-wave receivers covering the 7-metre sound channel has helped the sale of television receivers more than was at first expected.

Many listeners in the television service area who have been hearing the accompanying sound transmission sent out from Alexandra Palace have had their curiosity aroused to such an extent that they have purchased a television receiver in order to see all that is going on. When all sets cover 7 metres so that listeners can get some idea of the television programmes then a further increase in sales of television sets can be expected.

Modern all-wave receivers with higher efficiency and effective automatic volume control have to a great extent made reception of short-wave signals more certain, but so much more could be done if our Colonial and foreign transmitting friends could realise just how important it is to use multi-wavelength transmitters. Probably the Americans do more in this line than any others, with perhaps the B.B.C. as a very good second. For this reason alone British listeners tune in to American short-wave stations most of all.

W10XDA

Those who like hearing unusual transmissions should make a point of endeavouring to pick up station W10XDA, which is the call sign of the schooner *Morrissey*, which is now coasting off Labrador. This schooner is actually on a scientific expedition but has on board a very powerful 20-metre short-wave transmitter with which it keeps in contact with American and other stations. Those who have a good all-wave receiver will be able to hear this vessel most evenings after about 9 p.m.

TELEVISION MAKE-UP

Owing mainly to the efforts of the make-up expert, Mary Allan, at the Alexandra Palace, artists are finding that the make-up required when facing the television camera is, if anything, less than that required in the film studio. Those who have seen the two television announcers, Elizabeth Cowell and Jasmine Bligh, have remarked on the fact that their

studio make-up is very slight and would pass unnoticed out of doors. Some notable people who have been televised have declined to be made up with, apparently, very little loss.

LINKING SOUND AND VISION PROGRAMMES

It is interesting to note that the B.B.C. are toying with the idea of relaying, for the benefit of those having vision receivers, the Saturday night variety from St. George's Hall. There are a number of technical difficulties, but first of all, the co-axial cable which now links B.H. with the Alexandra Palace has to be moved to St. George's Hall.

There is also the problem of fixing the Emitron camera on the stage at St. George's Hall in such a way that it will not affect the view of the audience. However, it is hoped that these difficulties will be overcome and that by the middle of December television programmes will include the excellent variety now restricted to the use of medium wave listeners.

This is but the beginning of a general improvement in television programmes for there is no reason why some more of the better sound transmissions cannot be televised. This will save the B.B.C. money, for if they can make one programme serve for both sound and vision, then so much the better.

A RELAY FROM ELSTREE

Those who saw the relays from the Pinewood Film Studios must have realised that this was but an introduction to outside broadcasting. (The Pinewood relay was one of the most successful ever carried out via the television van, and it is hoped that the new relays from Elstree, which are scheduled for November 23 to the 26 inclusive, will be equally as popular amongst viewers. Associated British Pictures control the Elstree studios, and it is hoped that Charles Laughton will be televised, for he will be on the "set" during the period when the relays will take place.

MORE SCANNINGS

A NOEL COWARD PLAY FOR TELEVISION

Mr. Noel Coward has cabled from America permission for the televising of his play "Red Peppers." Those who were fortunate enough to see "To-night At 8.30," will remember that "Red Peppers" was one of the famous one-act series featured in it. It is being broadcast on November 1 and 5, and is being produced by Reginald Smith. The part of George Pepper is to be taken by Richard Murdoch, and Marjorie Sandford will be Lily Pepper. This will be the first Noel Coward play to be televised.

RELAYS TO THE NORTH POLE

The Russian expedition to the North Pole appears to be well looked after. They have been in contact with amateur transmitting stations in various parts of the world, including two from Britain, and are in communication with Moscow, so that messages from relatives are sent every day. At the end of September a special relay of music was sent from Paris via Moscow to the North Pole, and reports just received indicate that 100 per cent. reception was obtained. There does not seem to be any limit to the tie-ups that can be made on short-waves, and in fact, the difficulty seems to be of finding new out-of-the-way spots that have not so far been brought into prominence by means of short-wave broadcasting.

RECEPTION ON 10 METRES

Those who have a modern all-wave receiver that covers the 10-metre band should make a point of listening occasionally on this channel during the afternoons. Although, generally speaking, there are about 20 hours a day when the 10-metre band is almost devoid of signals, the odd four hours are well worth finding. After lunch most days, particularly when the weather is good, signals can be picked up from all over the world at unbelievable strength. There is also a curious mixture of stations, such as American, British, European, Australian, and even Siamese, which have been heard in the space of one hour.

TRANSMITTERS FOR EMERGENCY USE

In America they make every use of miniature 5-metre transmitters for re-

laying Press messages on race tracks, and even on police cars. In this country the 5-metre and ultra-short wave bands generally are ignored by commercial bodies, but this apparently is due not to lack of imagination but to the failure of the various people concerned to obtain the transmitting permit from the G.P.O. One of the leading London boroughs has been endeavouring to obtain permission for the fitting of a 5-metre transmitter and receiver to a fire-engine, the idea in mind being to keep in touch with the fire station when a telephone is not handy. So far their endeavours have been fruitless, for they have completely failed to obtain the necessary licence.

AMERICAN BIG-SCREEN TELEVISION

A new type of television receiver has been developed in the Kolorama laboratories at Irvington, New Jersey. The tests have been most successful with a screen 4 ft. by 5 ft. in size, with fair definition. This apparently is the first public demonstration of big-screen television in America, but from reports it does not appear to have reached the standard of results given by British receivers of a similar type. The American picture is shown on a glass screen, and the cathode-ray tube has been completely eliminated.

THE LORD MAYOR'S SHOW

On November 9 is to be televised the Lord Mayor's Show, and it is felt that this relay will be quite as successful as the televising of the Coronation. Three cameras are to be in use in Trafalgar Square, so that a comprehensive view of the procession will be obtained as it moves down the Strand and turns into Northumberland Avenue. Two cameras will be used for long shots, while a third is being erected in a position to obtain excellent close-ups.

ARMISTICE DAY

An interesting problem has arisen over the televising of the Cenotaph Service on November 11. Again three cameras are to be used, of

which two are to be at first-floor level on Richmond Terrace. The third is to be used for a long-shot down Whitehall, and including Big Ben. It is hoped that precisely at 11 o'clock the face of Big Ben will be televised, but this rather depends on weather conditions. If the weather is dull, then everything will be satisfactory, but if the sun should be shining, it so happens that on November 11 it will be directly over Big Ben at 11 a.m. and will be shining in the lens of the camera, so making transmission impossible. The televising of the Cenotaph service will be rather a big thing, for it will include long-shots of the King, and of everything that happens during the morning.

VALVES FOR AMATEURS

During the past few months more than the usual quota of American valves suitable for amateurs have been imported into this country.

This, fortunately, seems to be a blessing in disguise, for no less than four British valve-makers have decided to produce valves suitable for amateurs, both as regards characteristics and price, and to do so without delay. It appears that the small market always quoted by our prominent valve-makers is not quite so small as it was made out to be. Hence the sudden interest in amateur activities.

A NEW PROGRAMME FROM ALEXANDRA PALACE

Those who saw the "Mizzen Cross Trees" series of presentations by Stephen Thomas, will be glad to know that a similar series is scheduled for November 1 and 5, entitled "Powder and Pipe Clay." It will be remembered that "Mizzen Cross Trees" dealt with early sea shanties. "Powder and Pipe Clay" is a presentation of soldiers' songs since the days of Agincourt. The earliest song to be dramatised is the Agincourt song, written in 1415.

The Tipperary of Cromwell's day, Lillibullero, also Polly Oliver, and several other songs of a similar type, will be re-lived. This programme will call for very quick changes, for soldiers are to be shown in period costumes, while for one section there will be a number of French women soldiers, or vivandières, of the Post-Revolution era. Irene Prador is to be featured in this programme.

Alteration of Publishing Date

Commencing next month the publishing date of Television and Short-Wave World will be the 1st of each month.

AND MORE REFLECTIONS

TELEVISION SPORTS EVENTS

There is a considerable amount of apprehension in certain quarters over the success of the special football game televised from Highbury. This experiment was most successful, for in spite of the smallness of the screen it was possible to identify each player. Sports promoters feel that this may have the effect of reducing attendances at London matches, so very shortly a decision is to be taken as to whether television and football games are to "get together."

INTERFERENCE TO RADIO

Not so very long ago a committee was set up to investigate the problem of interference to broadcasting. Certain suggestions were put forward and it seemed at the time as if interference to radio would eventually be overcome. To date, however, nothing very much has happened, despite the fact that interference is now much more of a problem than it was a year ago, owing to the more general use of all-wave receivers. Those who are operating television receivers also find a considerable amount of local interference which sometimes spoils synchronising and the picture. It is about time that legislation made it possible for the Post Office to eliminate the interference after once it has been located. At the present moment, although their efficient detector vans are more than capable of finding local interference, they have no power to stop it even when it has been found.

Probably if the B.B.C. television outside broadcasts are ruined a little more often by preventable interference, then something may be done.

JOURNEY'S END

A very fitting transmission for November 11 is *Journey's End*, the famous war play by R. C. Sherriff, which is to be televised during the evening performance for a period of one hour. The production will be handled by George More O'Ferrall, and it is hoped to reproduce the atmosphere of the trenches by the use of film sequences in addition to sound and other effects.

BIG-SCREEN TELEVISION
IN CINEMAS

The new Odeon Alhambra, in Leicester Square, is to have a big-screen television installation. This is

quite an innovation, and if satisfactory, every Odeon cinema within the television service area will be so fitted. Just how this television is going to be used has not been made quite clear, but it is supposed that important events, such as the Boat Race, will be televised direct to cinema patrons.

GERMAN TELEVISION

Work on two new mountain-top television transmitters in Germany is still progressing. They will probably be finished by the end of this year, although at the moment the scaffolding has not been removed from the higher parts of the Brocken tower. It will be very interesting to find out just how far transmissions from Brocken tower can be received.

AMERICAN POLICE AND
TELEVISION

The American police method of lining up suspected criminals before a whole crowd of interested persons for identification purposes is well-known by means of the many films that have been made of this particular feature. This system is to be extended, and a recent demonstration at the N.B.C. Headquarters at Radio City has proved that the line-up of criminals and suspects could be televised to a large number of police stations in a

given area. This would increase the possibility of suspects being identified owing to the large number of people who could watch the parade simultaneously.

The Television Society.

10th Session, 1937-38

THE following lectures are announced by the Society for the opening of the Tenth Session:

Wednesday, November 10, at 7.30 p.m.—"Television Images—An Analysis of their Characteristics," by L. C. Jesty, Esq. (Assoc. Mem.), and G. T. Winch, Esq., of the G.E.C. Laboratories.

Wednesday, December 15, at 7.30 p.m.—Demonstration of the "Murphy" Television Receiver, by K. S. Davies, Esq. (Fellow).

All the above meetings will be held in the Physics Lecture Theatre, University College, Gower Street, London, W.C.1.

Tickets of invitation are available to non-members on application to the Lecture Secretary, G. Parr, Esq., 68 Compton Road, N.21, and full particulars of membership can be obtained from him, or from the General Secretary, J. J. Denton, Esq., 25 Lisburne Road, N.W.3.



Miss Patience, the "dream girl" of the National Broadcasting Company's television technicians, has become a reality. She is a beauty created exactly to specification for the Iconoscope camera; strong enough and patient enough to withstand the rigors of the long experimental periods.

MULTIPLIER PHOTO-CELLS

A DESCRIPTION OF TWO NEW TYPES THAT ARE COMMERCIALY AVAILABLE



*Baird Multiplier photo-cell
type ML.*

SECONDARY-EMISSION photo-cells are now a commercial article. Baird Television, Ltd., produce two types employing the Weiss principle of secondary emission which are specially suitable for the amplification of weak signals with a wide frequency band without distortion. The advantages of this type of cell are a very high gain without the disadvantages of valve amplifier stages such as the Schott effect, instability and microphony.

The multiplier photo-cell combines the principles of secondary and photo-electric emission. If an electron strikes a metal surface at a sufficiently high velocity, the impact may cause secondary electrons to leave the surface. The ratio of secondary electrons to primary depends upon the nature of the surface and the velocity of the primary electrons and with suitable conditions factors of 8 to 10 are obtainable. Secondary emission starts when the velocity of the primary electrons is approximately 10 volts and rises to a maximum between 250 and 500 volts.

As the mechanism of secondary emission is similar to primary photo-electric emission, and not akin to amplification by ionisation, which introduces a time factor into amplification, the output of the multiplier follows the modulation of the primary emission without time lag even at the high frequencies required for television. The only attenuation is that due to the very small inter-electrode capacity of the electrodes.

Baird multiplier photo-cells are at present available in two main types:

Type MS has a small cathode of 15 sq. cms. for use with a concentrated light beam, while type ML has a large cathode of 250 sq. cms. for diffused light operation. Other cells can also be supplied to suit individual requirements.

How the Cell Functions

The Baird Multiplier photo-cell has a chain of secondary amplifying stages, and the electron current passes in sequence down the chain, being amplified at each stage. The stages consist of grids, the surfaces of which are specially prepared and treated to have a high secondary factor. The primary electrons incident upon the first grid liberate secondaries at low velocity which are attracted by a positive potential through the meshes to the second grid. This they strike with sufficient velocity to liberate further secondaries, which are in turn attracted onward down the chain.

The grids are parallel circular discs inside a metal screen with an aperture to allow the electrons from the photo-electric cathode to reach the first grid.

A secondary emitting plate is provided at the end of the multiplier, and the electrons from the last multiplying grid impinge on this. As mentioned earlier, a secondary factor of 8 can be obtained by a solid surface and hence a large multiplication takes place in the last stage. The electrons liberated from the plate are collected by an unsensitised open mesh grid and pass into the output circuit of the multiplier.

Technical Data

The photo-electric cathode has a primary sensitivity of about 30 micro-amperes per lumen and as it has the usual spectral sensitivity for caesium the cells may therefore be used for infra-red detection and the amplifica-



*Type MS Multiplier photo-cell for
use with concentrated light beam.*

tion of infra-red signals. For special requirements rubidium cells can also be supplied.

Multiplication

The overall multiplication obtainable with these cells is, of course, dependent upon the number of stages and the voltages supplied to each stage. Satisfactory results have been obtained, using an overall voltage of 1,000 to 1,500 in the 9-stage multiplier, which corresponds to 100 to 150 volts only between successive stages. Under these conditions, an overall multiplication of 10,000 to 20,000 can be obtained, but using higher voltages and/or more stages any factor of multiplication can be obtained. The limit to the useful number of stages used and voltages applied is governed by the output current, which should not exceed 1 milliampere to ensure stable operation. The amplification factor per stage is dependent upon the voltages applied to the grids and is variable up to 4. The ratio of signal to unwanted background noise is of the order of 200 times that given by a thermionic valve amplifier of equivalent gain.

The electrical connections to supply the potentials to the multiplier grids can be made from a potentiometer supplied with direct current from a rectifier or batteries, and the output circuit connections will depend upon particular requirements. These cells have an extremely long life.

SCOPHONY, LTD.

The telephone number of Scophony, Ltd., of Thornwood Lodge, Campden Hill, London, W.8, has now been changed to Park 9494.

THE TELEVISION ENGINEER

THE DESIGN OF THE G.E.C. TELEVISION RECEIVER

(MODEL BT 3701)

By D. C. ESPLEY, M.Eng., A.M.I.E.E., and G. W. EDWARDS, B.Sc., D.I.C.
Research Laboratories of The General Electric Co., Ltd.

This article gives data of the design of the G.E.C. Model BT3701 television receiver and includes the circuit arrangements of the several units employed.

THE receiver channel itself is of the superheterodyne type for both the vision and sound signals according to the G.E.C. system in which a single local oscillator provides the heterodyning frequency for the two carriers. It is thus possible by tuning to the sound signal, as in a normal radio receiver, to obtain simultaneous correct tuning adjustment for both channels.

The local oscillator frequency is located between the incoming carriers at 41.95 mc. giving sound and vision intermediate frequencies of 0.45 mc. and 3.05 mc. respectively.

The general arrangement of the receiver is shown in Fig. 1. Sound and vision signals, received on a common aerial, are first amplified by a single radio frequency stage and fed to a frequency changer, both of which provide common amplification for the two signals. (The sound and vision

The chassis of the G.E.C. television receiver showing the sound and vision receiver beneath the cathode-ray tube and the time base on the right.

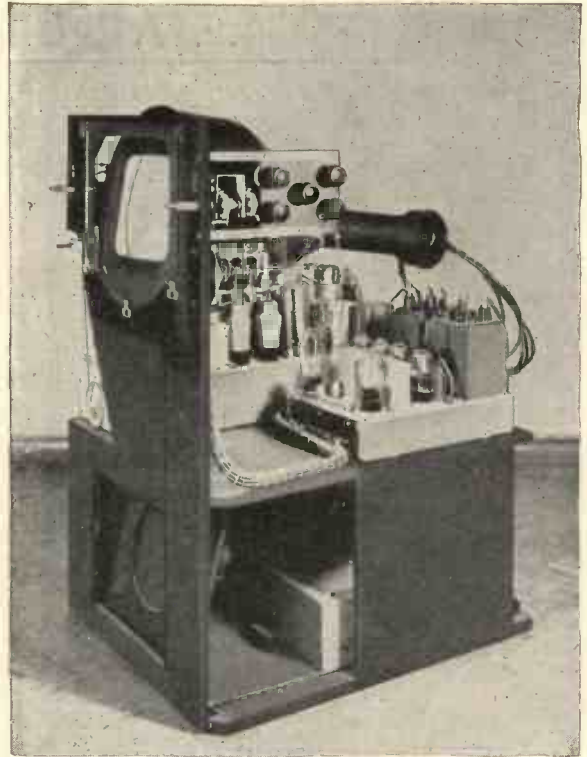

modulated I.F. carriers are separated in the frequency changer anode circuit and fed to their respective I.F. amplifier channels. Following I.F. amplification the sound channel is largely of conventional design. The vision signal after rectification is fed to a single stage picture frequency amplifier supplying the necessary modulation voltage for the cathode-ray tube. A separator stage feeds synchronising impulses to two time bases providing the scanning voltages for the cathode-ray tube.

Operating voltages for all parts of the receiver are obtained from a power supply unit.

For the purpose of description, the receiver can conveniently be divided into three parts:

- Receiver unit—sound and vision channels.
- Time base unit.
- Power supply unit.

Vision Channel

The vision channel consists of an R.F. amplifying stage followed by a frequency changer, five I.F. stages, signal rectifier and picture frequency output amplifier with synchronising signal separator.

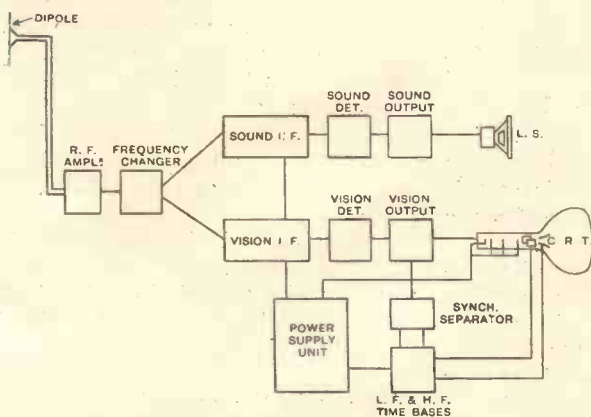

Fig. 1.—Schematic diagram of receiver circuit.

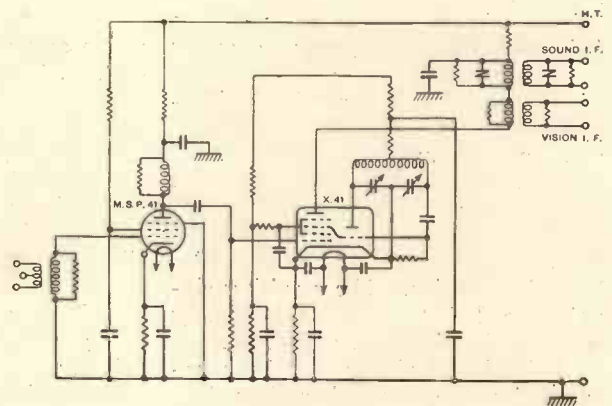

Fig. 2.—R.F. Amplifier and frequency changer.

R.F. AMPLIFIER AND FILTER UNIT

It will be considered under the following sections:—

- Aerial and input circuit.
- R.F. stage and frequency changer.
- I.F. amplifier stages.
- Rectifier and picture frequency amplifier.
- Synchronising signal separator.

The concentric feeder from the dipole aerial is terminated at the receiver end in a step-up transformer to match it to the input circuit of the first valve. This transformer also serves the purpose of reducing the effect of any direct pick-up on the feeder.

Since the aerial is used to receive both sound and vision signals, the secondary is tuned to 44 mc. by the grid-earth capacity of the R.F. am-

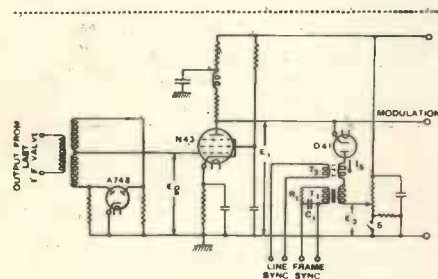

Fig. 3.—Signal rectifier and output circuits.

plifier valve (pentode, MSP41) and damped by a terminating resistance to cover the necessary band width of both the sound and vision channels.

R.F. Amplifier (MSP 41) and Frequency Changer (X41)

The conversion of both sound and vision incoming carriers to frequencies suitable for I.F. amplification is obtained by the use of a single local oscillator situated between the two carriers.

The triode portion of an X41 (triode-hexode) frequency changer provides the local oscillator frequency of about 42 mc. The resulting difference frequencies of 0.45 mc. and 3.05 mc. in the anode circuit of the hexode, produced respectively from the 41.5 mc. sound and the 45 mc. vision carriers, are separated by means of filters tuned to these mid-band frequencies. The resulting signals are fed to the corresponding sound and vision I.F. amplifiers.

Oscillating stability has been secured by the use of a low loss balanced oscillator circuit using a high Q coil and a series gap low con-

tact resistance condenser of rigid construction.

Oscillator Voltage and Tuning Range Constancy

The circuit shown by Fig. 2 gives a maximum oscillator voltage of 10 volts and a conversion conductance of 570 microhms at 42 mc. A tuning range of 35 mc. to 55 mc. is obtained.

Radiation

Interference between adjacent receivers is in general much more serious on vision than on sound due to the wider frequency band transmitted, and to its effect on synchronism as well as picture definition.

It is normally caused by difference frequencies produced between the local oscillator and the unwanted neighbouring radiation, or between the incoming signal and the neighbouring radiation, appearing with the required I.F. signal within the transmission range of the I.F. filters.

The former is the more serious, since, when present, its amplitude is far greater than any other type.

After the signal rectifier the beat between these two frequencies appears as an irregular striation, over the area of the picture, of frequency dependent on the frequency of the interfering signal.

By the disposition of the local oscillator frequencies in the G.E.C. receivers, the most serious form of interference (i.e., the appearance of the interfering local oscillator as the image of the transmitter signal) is eliminated.

It is, however, considered necessary to reduce the radiation to such a level that no appreciable interference could be produced, even in an aerial situated some few yards away and using any possible intermediate frequency.

This result is obtained:—

- (i) by the use of a complete high conduction screen within the normal chassis which is at this point also arranged to form a complete second screen.
- (ii) by the provision of complete decoupling for all leads carrying R.F. at their exit from both screened compartments.
- (iii) by provision of a high frequency amplifier, acting as a buffer stage, to prevent direct radiation from the X41 grid circuit.

By these means an overall attenuation of radiation of about 50 Db. is obtained.

In addition to its use in reducing radiation, the MSP41 amplifying stage also serves the purpose of preventing direct pick-up at vision intermediate frequencies. This is important, since the pass range of the I.F. channel includes part of the medium-wave broadcast band.

The R.F. stage provides a certain amount of gain for both sound and vision channels at a signal level sufficiently low to give negligible cross modulation.

Vision I.F. Amplifier Stages

Since the majority of the amplification of the vision channel is obtained at intermediate frequency, the design of the I.F. filters largely determines the picture quality, and the band width is included in the channel specification.

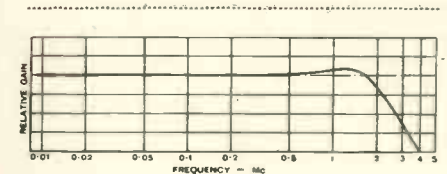

Fig. 4.—Picture frequency amplifier characteristic.

Design of Filter Unit

The design of a filter to cover a band width of 3.5 ms. with arithmetic mid-band frequency of only 3 mc., at first appears to present difficulties in application of normal band filter design data, due to the variation of effective values of the filter elements over wide frequency ranges.

It has been found in practice, however, that available data can in principle be applied to filters of this type, provided allowance is made for the distribution and effect of stray capacities.

The gain obtainable per stage with high impedance valves (e.g., MSP41), working with the relatively low loads necessitated by large band width is accurately given by

$$gZ_a$$

where g is the mutual conductance in amps./volt, and Z_a is the effective anode load vector.

SYNCHRONISING SIGNAL SEPARATOR

Signal Rectifier

Rectification of the L.F. signal is obtained by means of a double diode A748. Owing to the low filter terminating resistance necessitated by the broad band width, it is difficult to obtain linear rectification at low signal levels.

By the use of the A748, which is of especially low impedance, it is possible to reduce the initial curvature to a negligible value.

The output from the two rectifier valves is balanced, resulting in maximum rectification efficiency and removal of the carrier frequency component from the picture signal. (The second harmonic (6 mc.) is well outside the required picture frequency band, and is entirely removed in the following picture frequency amplifying circuits.

Picture Frequency Amplifier

The output picture frequency voltage from the diode rectifier is insufficient to modulate the cathode-ray tube directly, and in the circuit shown would give a signal opposite in sign to that required, i.e., a negative picture.

An amplifier to supply the neces-

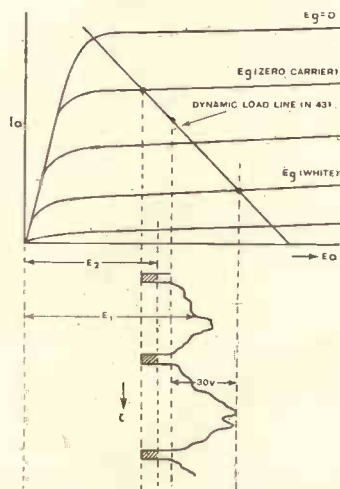
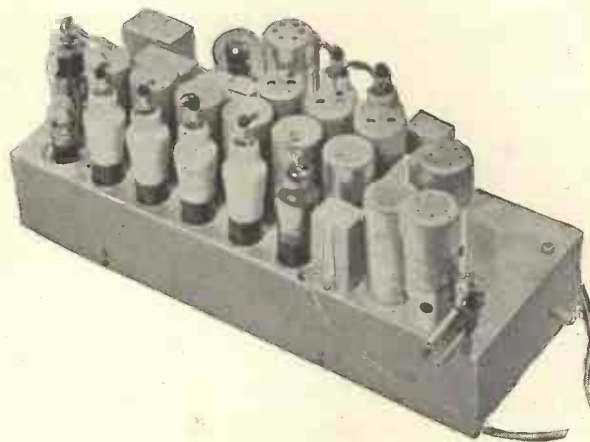

Fig. 5.—Operation of impulse starter.

sary modulator voltage has to meet the following requirements:—

- (a) An output voltage of approximately 30 volts for picture signal, and 20 volts maximum for the synchronising signal (240 line system).

The sound and vision chassis of the G.E.C. receiver showing aerial connection at the front and single tuning adjustment in the right foreground.



- (b) A frequency and phase characteristic approximately linear up to 2 mc.
- (c) Maintenance of the mean brightness level of the picture necessitating correct amplification at zero frequency.
- (d) A small input capacity to avoid high-frequency loss on the input circuit.

Conditions a, b and d are met by the use of an N.43 high slope high frequency pentode, with compensated anode load (see Fig. 3). The resulting high frequency characteristic is shown in Fig. 4, and is arranged to be similar in high frequency loss to that produced in a single I.F. filter section.

The further requirement c has been met by the use of a D.C. amplifier circuit following the signal rectifier.

The cathode of the rectifier is therefore directly earthed and the output rectified voltage from the diode taken directly through a D.C. connection to the N.43 picture frequency amplifier grid (Fig. 3) so that the correct signal with its mean brightness is produced at this point.

The Synchronising Signal Separator

The synchronising signals appear as part of the combined signal available in the output circuit of the N.43 picture frequency amplifier. The voltage to be applied to the cathode-ray tube must contain these signals as they provide "blacker than black" suppression of the beam current during the flyback period. On the other hand, the time base control circuits must not have a voltage applied to them which is in any way character-

istic of picture modulation. The synchronising signals must therefore be separated from the combined signal by a combination of amplitude and frequency discrimination.

Means are provided so that when the combined output voltage is below a certain critical level, a current is passed through a unilateral device, such as a diode, to apply an input to two different frequency selective circuits associated with their appropriate time bases. The arrangement is shown in Fig. 3. The operation of the circuit can be explained with reference to Fig. 5. The anode current of the N.43 which corresponds to zero carrier is fixed, and the change of grid voltage E_g can only increase the value of anode voltage. The total output voltage is E_1 and it will be seen that if a bias voltage E_2 is provided in the anode circuit of the diode, then adjustment can be made so that current can only flow when E_1 is less than E_2 (i.e., for periods shown shaded in Fig. 5). As signals according to the two transmissions have different values of percentage synchronisation, it is found advisable to adjust E_2 to optimum by providing a switch S to be operated by the main receiver change-over switch.

Substantially rectangular current pulses pass through a network including the primary windings of two transformers T_1 and T_2 . These transformers act as highly selective transmission circuits to supply specially shaped impulses, of the appropriate frequency range, to their associated time bases. The impulses are of such a form that the time bases are triggered in an extremely stable manner.

The low frequency transformer alone is not sufficient to remove all

THE DOUBLE TIME BASE

traces of components characteristic of the line synchronising signal and it is found desirable to include a resistance capacity network R_1C_1 in the secondary circuit. A similar type of circuit is used in conjunction with the high-frequency transformer, but, of course, with a smaller time constant, to reduce the possibility of high-frequency noise and picture components reaching the gasfilled relay.

The Time Base Unit

The time base unit provides the required frame and line scanning voltages for deflecting the electron

black margin associated with each direction of scanning.

- (e) When the picture is transmitted by the interlaced system, it is necessary that the frame and line timing circuits should be free from "crossfire" and dependent only on the incoming synchronising signals in order to maintain accurate interlacing.
- (f) Means have to be employed in order to locate the picture information central with respect to the cathode-ray tube mask.

Fig. 6 shows the circuit of double time bases which meet all the above requirements. For reasons which follow later, it will be seen that the

ode-ray tube have been designed to work effectively even with this departure from symmetry of the sawtooth voltage.

As the two time bases are similar in many respects the detailed description will be confined mainly to the high frequency case.

The timing circuit is shown within the dotted lines on the diagram, and it is here that the controlling sawtooth voltage waveform is produced by a relaxation oscillator employing a specially developed gasfilled relay now designated Osram G.T.I.B.

Although the required anode dissipation is quite low, the peak current to be handled is in some cases

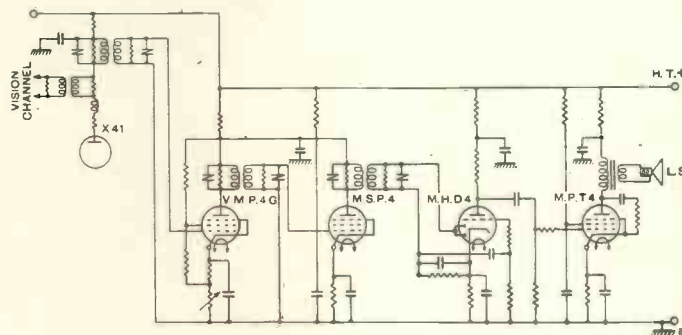
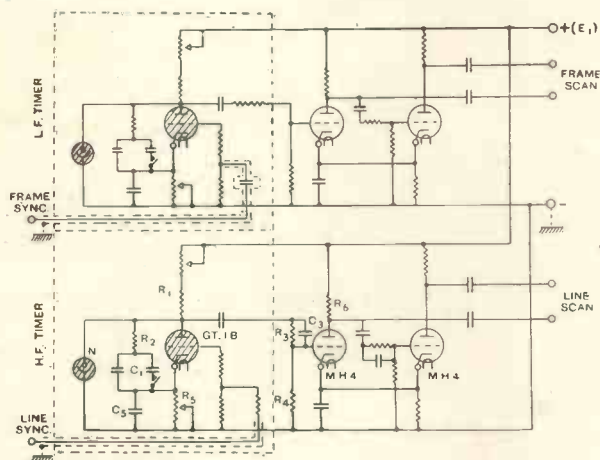

Fig. 6 (left).—Double time base circuit.

Fig. 7 (right).—Sound channel circuit.

beam over the screen of the cathode-ray tube. The electrostatic deflection type of cathode-ray tube had reached an advanced stage of development by the time the receiver was planned, and the choice of this type enabled the following specification to be drawn up for the double time bases:

- (a) Peak to peak voltage of 800 volts between either the front or back deflecting plates to give a picture scan of 8 in. in the vertical direction or 10 in. in the horizontal direction.
- (b) The scan distortion expressed in terms of change of spot velocity in either direction must not exceed 5 per cent.
- (c) At any instant of time the mean voltage difference between either pair of deflecting plates and the final accelerator should be small.
- (d) The flyback time of each time base must not exceed a limit set by the length of the picture

actual timing circuit is not coupled directly to the output.

The approximate sawtooth voltage generated by the timing circuit must be shaped and amplified considerably before application to the deflecting system of the cathode-ray tube. The amplifier comprises two MH4 valves in cascade, and its design must be such that the linearity of scan is well within the prescribed limits. As the voltage swings of both anodes are large, there is appreciable non-linearity of the output voltage of the stages taken separately. Condition (b) is much more important than condition (c), and the circuit is proportioned so that the voltage difference between the two anodes shows a linear rate of change, although it will be found that with this adjustment the second valve provides an appreciably greater voltage output than the first.

The deflecting plates of the cath-

as high as 0.5 amp. if the flyback time is to be short enough. It is this peak current which partially dictates the form of the electrode system, and in the G.T.I.B. the distribution of ionisation is definitely controlled so that the effects of glass wall charges and random ionisation are avoided. The discharge always takes place along a definite path, and it is this feature which enables an exceedingly steady trigger action to be obtained. One consequence of using amplification after the oscillator is that the conditions within the relay are rendered less severe, and an excellent life is realised. An advantage of this type of timing circuit is that the relay is very sensitive to synchronising signals, making it possible to use a simple form of synchronising separator circuit.

It will be seen from Fig. 6 that the whole of the time base circuit is operated from a common H.T. supply

POWER SUPPLY UNITS

which is actually one-half of the output of the voltage doubling rectifier circuit associated with the cathode-ray tube. The series charging circuit R_1C_1 is connected to the supply of about 1,100 volts. Condenser C_1 charges at an almost constant rate until a limit voltage is reached: at this point there is a rapid discharge through the gasfilled relay.

The two amplifier valves can be arranged to compensate each other

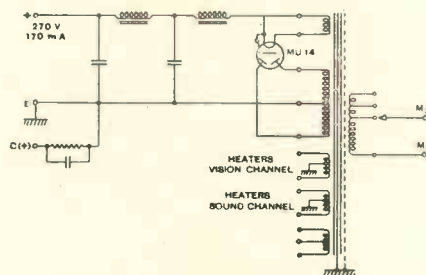

Fig. 8.—Power supply unit—anode and heater voltages.

for non-linearity, but by slight modification of this condition the small distortion can be included in this compensation to give an overall result of substantially linear rate of change of voltage between the deflector plates. If a voltage difference between plates of 800 volts is required to deflect the scanning spot across a picture side, the effect of unbalance of the two anode voltages can be reduced to a negligible amount by suitable design of deflecting plates.

Non-linearity introduces an apparent shift of the picture. A non-linear flyback has the same effect, but as there is less control over the shape of this part of the wave, it is preferable to avoid the disturbance by reducing the flyback time to a value consistent with good synchronisation.

It will be seen from Fig. 6 that the discharge of condenser C_1 is limited by a resistance R_2 in order to restrict the peak current conditions in the gasfilled relay.

Although the voltage across the relay can have a suitable waveform, it does not follow that the amplifier has an appropriate phase and frequency characteristic to give the required output, unless special means are employed. The earth capacity of the output leads and deflector plates appears in parallel with the anode loads and, in the case of the H.F. time

base, has a large influence on flyback time.

The H.F. scan gives a flyback time of about 12 per cent. at 10,125 cycles per second, and 8 per cent. at 6,000 cycles per second. Both these values are covered by the transmitted H.F. black-out period, and are therefore satisfactory.

The flyback time for the L.F. scan is relatively very much faster, being about 1 per cent. of the scan time for both 25 and 50 cycles per second.

As the H.T. rectifier supplying the time bases is of the directly heated type, it is necessary to protect the discharge condensers and gasfilled relays from over-voltage during the heating-up period. For this purpose small indicator type neon lamps are connected from the anodes to earth

circuit of the X41 frequency changer feeds the resulting 0.45 mc. carrier and side-bands to two I.F. amplifier stages.

The first valve has variable- μ characteristics, and is used to provide control of the output sound volume. The second stage is a straight I.F. amplifier of fixed gain. The second I.F. stage is followed by a normal double diode triode as detector and first low frequency amplifier.

Power Supplies

It was found most economical to provide high voltage supplies from two rectifier circuits using three rectifier valves, viz.: A single full wave,

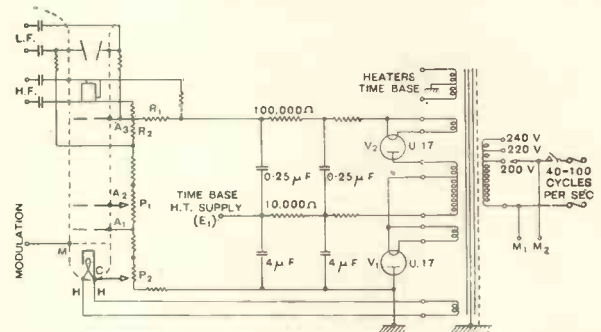

Fig. 9.—Power supply unit—high voltage circuit.

to limit the peak voltage to about 180 volts.

Sound Channel

The circuit of the sound channel is shown in Fig. 7. The secondary of the separating filter in the anode cir-

indirectly heated, M.U.14 rectifier to supply the combined sound and vision channel anode and screen currents; and a voltage doubler circuit using two U.17's to supply the time base voltage and the main cathode-ray tube voltages. The circuits of these are shown by Figs. 8 and 9.

THE BAIRD CATHOVISOR TUBE

ON page 602 of last month's issue a photograph was shown of the Baird Cathovisor cathode-ray tube and it was stated in the caption that this was the 15-in. magnetically focused tube. Actually, the tube shown by the photograph was the 12-in. size and the description was therefore incorrect. The photograph reproduced

here shows the 15-in. magnetically focused Cathovisor tube and it will be seen that the design differs from that which was shown last month.



NOVEMBER, 1937

megohms. The potentiometer condenser (0.5 mfd. originally) gave insufficient amplitude and was reduced to 0.25 mfd. The bias resistance was reduced by the connection of a 25,000-ohm parallel resistance, which gave a much smoother control of picture speed.

An important point which showed on testing was the insulation of the feed condenser to the plates. This is

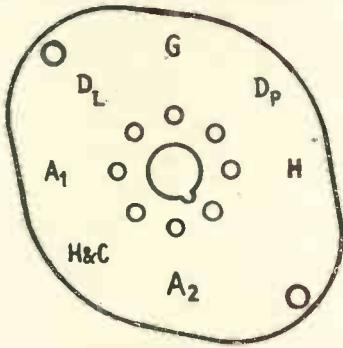

Fig. 2.—Rear view of tube socket showing connections to vertical (D_p) and horizontal (D_x) deflector plates. Note the position of the key.

given as 0.1 mfd. for the picture frequency and if there is a slight leakage through it the picture will be displaced off the screen. It is desirable to use 1,000 volts working tubular condensers if available.

To obtain the picture right way up, the tube should be mounted in the bracket with the locating key downwards. The grid contact is then uppermost, and the deflector plates are wired as shown in the diagram of Fig. 2. Each plate must be connected to the anode by a 2-megohm leak, which can be of $\frac{1}{2}$ -watt rating or smaller. The slots in the bracket will allow the tube to be moved sufficiently to align the picture.

The drawing here, Fig. 3, shows the connections of the octal sockets for the 6K7 valve used as a triode.

To avoid interaction between the time bases, the condensers should be as near the edge of the chassis as possible, and leads going to each side of the time base should not run together.

After checking the wiring, leave the tube out of its socket and switch on the H.T. unit. The thyratrons should glow faintly and the note of the high speed scan should be audible as a faint whistle. If this is heard the time base is probably operating correctly.

Before trying the tube, switch off and make sure that the resistances at the back of the bracket are not touching the metal.

Turn the brilliance control as far over to the right as possible and switch on. After a short time, turn the control back until a green glow appears over the surface of the screen. If a black spot appears at the centre of the screen it is due to the charge described before* and can be removed by switching off and on again. If the lines are on the screen try the effect of altering the amplitude and speed of each scan. The amplitude under working conditions is sufficient to carry the lines right off the screen.

This is not a disadvantage, and gives in effect a larger picture than if the screen area was within the circle of the glass.

Although it is possible to check the picture frequency with a 50-cycle

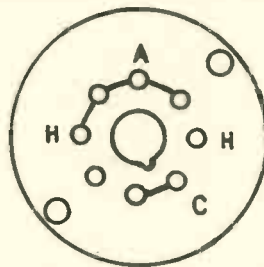

Fig. 3.—Under view of socket for 6K7 showing connections for use as a triode.

waveform, it is only possible to make final adjustments with the transmitter working. Under these conditions it will be found that the brilliance can be reduced and the focusing can be improved. If the line screen is focused without a picture it will appear very dim, but this improves immediately the modulation is applied.

Quality Reception On Six Wave Bands.

ONE of the new Pilot model 106 receivers has been undergoing tests in our laboratory and its performance has even surprised those who are accustomed to using multi-valve receivers of all kinds.

It is one of the first receivers of its kind built in this country which fulfils the needs of every type of listener.

The model 106 uses 10 valves in a particularly sensitive circuit. It is not, however, the large number of valves which call for special note. First in our estimation is the fact that all wavelengths between 4.5 and 2,200 metres are covered without a break with a high degree of sensitivity on all channels. So many of the multi-band receivers do not

give a good account of themselves on the shorter wavebands.

Another important feature is the special tone control which allows the operator to adjust the percentage of bass response according to total volume output.

On all bands there is a stage of radio-frequency amplification so accounting for the complete suppression of image interference. Also owing to the generous amount of R.F. amplification available the noise level is very low so that good quality can be obtained from long distance short-wave stations.



A Headphone jack is also included for weak station reception.

In the output stage there are two high-gain triodes in push-pull that provide no less than 14 watts to a 10-inch loudspeaker that has been carefully matched up and fitted to avoid resonance.

Selectivity is more than sufficient to handle the congested conditions found at present on almost all wavebands, but this selectivity is not obtained at the expense of top note reproduction.

A six range dial is calibrated in wavelengths and station names, but unlike some dials which are so full up with names that stations are difficult to find, each band is illuminated separately as the appropriate band is switched into use.

For those who wish to know what sort of television programmes are being transmitted the sound transmission from Alexandra Palace can be received at great volume. At a distance of nearly 40 miles from London the volume from the television signals was very great.

This 10 valve receiver in table form is priced at 25 gns. at which price it represents excellent value for money. For those who need a receiver for all world listening this Pilot model 106 appears to be highly satisfactory.

Full details can be obtained from the maker, Pilot Radio, Ltd., 87 Park Royal Road, London, N.W.10.

* See p. 523, Sept issue

THE MULLARD MINIATURE CATHODE-RAY TUBE

FOR OPERATION AT LOW VOLTAGES



Mullard cathode-ray tube E40-G3, screen diameter 7 cm.

THE Mullard Wireless Service Co., Ltd., have produced a cathode-ray tube of a particularly interesting design and with several novel features. This tube, designated the E40-G3, is primarily intended for oscillograph purposes, and it has the outstanding advantage

face of the screen, the graphite layer being in electrical connection with the second anode.

The diagram shows the electrode arrangement of the tube and it will be seen that the cathode is connected inside the tube to one side of the heater. The following are the technical data relating to this tube.

Negative grid bias is obtained from the sliding contact of the potentiometer R_5 ; the spot brightness is controlled by varying this grid bias. The resistance is of sufficiently high value to supply the maximum bias of -30 volts, which is needed for suppressing the beam. (This diagram also shows the load in watts of the various resistances employed and the operating voltages are indicated in brackets after the capacities of the smoothing condensers. R_6 and the condenser between k and g provide for the smoothing of the grid bias.

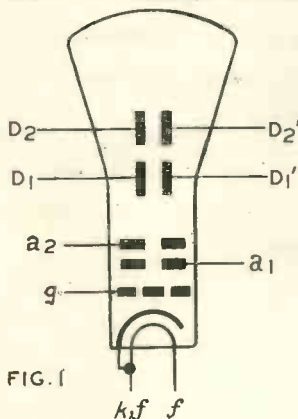

FIG. 1

g = grid a_1 = 1st anode
 a_2 = 2nd anode
 D_1, D_1', D_2, D_2' = deflecting plates.

that it can be operated at very low anode voltages of from 300 to a maximum of 800. The screen diameter is 7 centimetres, or roughly 3 in., and the overall length is approximately 16 centimetres. Despite the short length of beam, however, the tube has a very high degree of sensitivity.

The usual two pairs of deflecting plates are provided, but the design of the tube is such that electro-magnetic deflection can be applied if desired. The tube is of the high-vacuum type and can therefore be used for measuring very high frequencies.

As will be seen from the photograph the inner side of the bulb has a coating of graphite which collects secondary electrons from the sur-

Technical Data

- Heater voltage, 4.0 volts.
- Heater current, 1.0 amp.
- Second anode voltage, 500-800 volts.
- First anode voltage, 140-200 volts.
- Grid voltage, 0-25.0 volts.
- Cathode internally connected to heater—

Deflection sensitivity of plates nearest cathode, 0.30-0.19 mm/V.

Deflection sensitivity of plates nearest screen, 0.20-0.12 mm/V.

Capacities.

- Grid to all other electrodes, 6.7 $\mu\mu\text{F}$.
- Between deflection plates nearest cathode, 2.9 $\mu\mu\text{F}$.
- Between deflection plates nearest screen, 3.7 $\mu\mu\text{F}$.

The recommended circuit for the supply of high-tension to the E40-G3 tube is shown by the second diagram. The mains transformer has a high-tension winding of 800 volts r.m.s., current being fed to the tube by means of a half-wave rectifying valve, type HVRI, which is capable of supplying rectified current up to 5 milliamps., which is ample for the operation of the tube.

The necessary voltages between the cathode and anodes a_1 and a_2 and between the cathode and grid, are obtained by tapping from a potentiometer. R_3 is a variable potentiometer and supplies voltage for the first anode a_1 . By adjusting the potentiometer the image can be focused to maximum sharpness and

Sensitivity

Sensitivity is inversely proportional to the voltage between a_2 and the cathode. At the maximum permissible anode voltage of $a_2 = 800$ volts, sen-

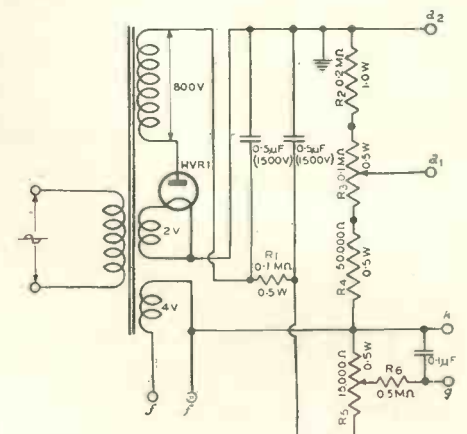

H.T. supply circuit for the E40-G3.

sitivity is at its minimum, being 0.19 and 0.12mm/V. respectively for plates D_1 and D_2 , but the installation is then least susceptible to the disturbing influence of external fields. At a low anode voltage of 500 volts, sensitivity is respectively 0.30 and

(Continued on page 674)

OF TECHNICAL IMPORTANCE

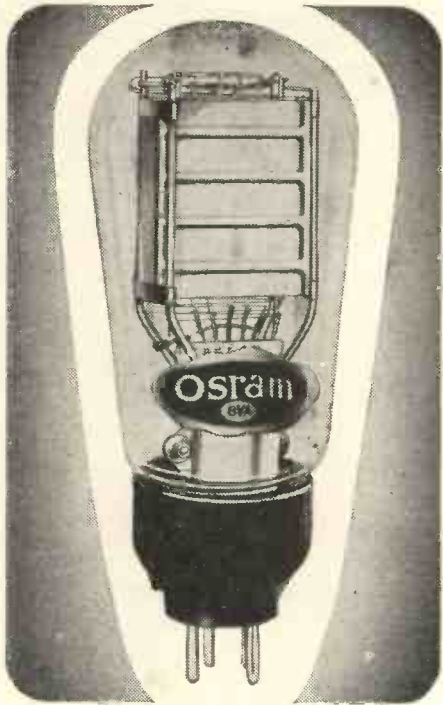

Osram Valve TYPE PX4

STILL GREATER UNDISTORTED POWER

The Osram PX4 output Triode—recognised by designers and constructors of 'Quality' amplifiers as setting a standard in its class—is now released with **increased rating of anode voltage and Power.**

The increased rating—fully covered by exhaustive life tests without which no rating for an Osram Valve is approved—enables the PX4 valve to deliver greater power output and handle higher peak voltage without distortion.

OSRAM PX4 VALVE

Directly heated Power Triode for filament heating from A.C.

Filament voltage . . .	4.0
Filament current . . .	1.0 amp approx.
Anode volts	300 max.
Anode dissipation . . .	15 watts max.
Amplification Factor . .	5
Impedance	830 ohms
Mutual conductance . . .	6.0 m. a/volt
Grid bias (at 300v.) . .	— 42v. approx.
Bias resistance	950 ohms
Anode load	4000 ohms

Ideal for push-pull operation in home "super quality" receivers and Amplifiers

★ **NOTE**
NO INCREASE IN PRICE 12'6

Osram Valves

MADE IN
ENGLAND

CHARACTERISTIC CURVES AND
FULL TECHNICAL DETAILS
AVAILABLE ON REQUEST

Write to Osram Valve Technical Dept.

OSRAM VALVES · DESIGNED TO ASSIST THE DESIGNER

Advt. of The General Electric Co. Ltd., Magnet House, Kingsway, London, W.C.2.

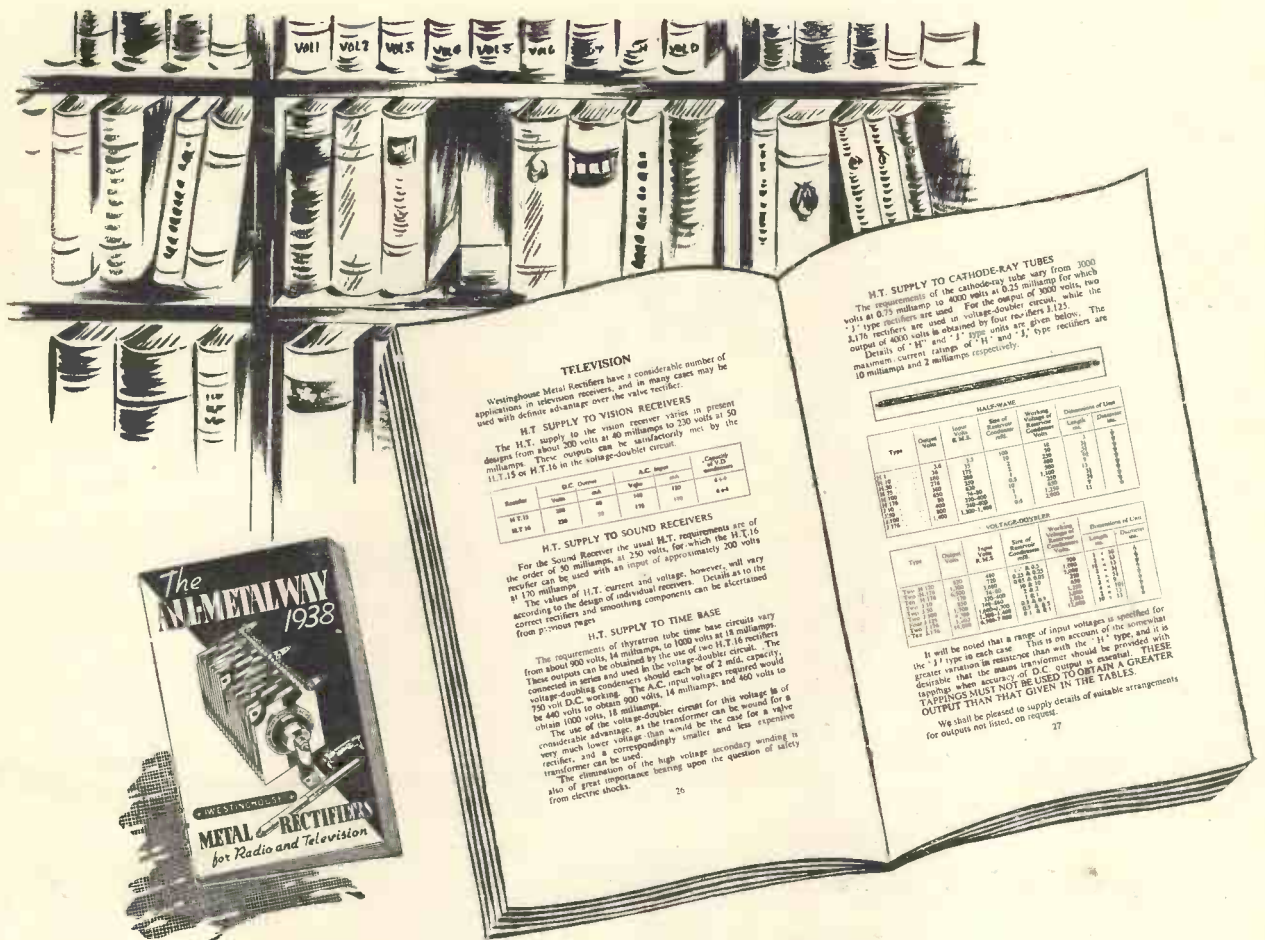

TELEVISION

Westinghouse Metal Rectifiers have a considerable number of applications in television receivers, and in many cases may be used with definite advantage over the valve rectifier.

H.T. SUPPLY TO VISION RECEIVERS

The H.T. supply to the vision receiver varies in present design from about 200 volts at 40 millamps to 230 volts at 50 millamps. Three outputs can be satisfactorily met by the H.T.15 or H.T.16 in the voltage-doubler circuit.

Model	D.C. Output		A.C. Input		Capacity μF/Volts
	Volts	ma	Volts	ma	
H.T.15	200	40	150	100	4 + 4
H.T.16	230	50	170	100	4 + 4

H.T. SUPPLY TO SOUND RECEIVERS

For the Sound Receiver the usual H.T. requirements are of the order of 80 millamps, at 250 volts, for which the H.T.16 rectifier can be used with an input of approximately 200 volts at 120 millamps.

The values of H.T. current and voltage, however, will vary according to the design of individual receivers. Details as to the correct rectifiers and smoothing components can be ascertained from previous pages.

H.T. SUPPLY TO TIME BASE

The requirements of thyratron time base circuits vary from about 900 volts, 14 millamps to 1000 volts at 18 millamps. These outputs can be obtained by the use of one H.T.16 rectifier connected in series and used in the voltage-doubler circuit. The voltage-doubling condensers should each be of 2 mfd. capacity, and 400 volts to obtain 900 volts, 14 millamps, and 600 volts to obtain 1000 volts, 18 millamps.

The use of the voltage-doubler circuit for this voltage is of considerable advantage, as the transformer can be wound for a very much lower voltage than would be the case for a valve rectifier, and a correspondingly smaller and less expensive transformer can be used.

The elimination of the high voltage secondary winding is also of great importance bearing upon the question of safety from electric shocks.

H.T. SUPPLY TO CATHODE-RAY TUBES

The requirements of the cathode-ray tube vary from 3000 volts at 0.75 millamp to 4000 volts at 0.25 millamp for which "J" type rectifiers are used. For the output of 3000 volts, two 2,176 rectifiers are used in voltage-doubler circuit, while the output of 4000 volts is obtained by four rectifiers 2,176. Details of "H" and "J" type units are given below. The maximum current ratings of "H" and "J" type rectifiers are 10 millamps and 2 millamps respectively.

HALF-WAVE						
Type	Output Volts	Load A.C. S.S.	Size of Cathode Voids	Working Voltage for Cathode Voids	Number of Rectifiers	Dimensions of Case Length, Depth, Height
H.T.16	230	50	170	100	2	4 1/2 x 4 1/2 x 4 1/2
H.T.15	200	40	150	100	2	4 1/2 x 4 1/2 x 4 1/2
H.T.16	230	50	170	100	2	4 1/2 x 4 1/2 x 4 1/2
H.T.15	200	40	150	100	2	4 1/2 x 4 1/2 x 4 1/2
H.T.16	230	50	170	100	2	4 1/2 x 4 1/2 x 4 1/2
H.T.15	200	40	150	100	2	4 1/2 x 4 1/2 x 4 1/2
H.T.16	230	50	170	100	2	4 1/2 x 4 1/2 x 4 1/2
H.T.15	200	40	150	100	2	4 1/2 x 4 1/2 x 4 1/2
H.T.16	230	50	170	100	2	4 1/2 x 4 1/2 x 4 1/2
H.T.15	200	40	150	100	2	4 1/2 x 4 1/2 x 4 1/2
H.T.16	230	50	170	100	2	4 1/2 x 4 1/2 x 4 1/2

VOLTAGE-DOUBLER						
Type	Output Volts	Load A.C. S.S.	Size of Cathode Voids	Working Voltage for Cathode Voids	Number of Rectifiers	Dimensions of Case Length, Depth, Height
H.T.16	230	50	170	100	2	4 1/2 x 4 1/2 x 4 1/2
H.T.15	200	40	150	100	2	4 1/2 x 4 1/2 x 4 1/2
H.T.16	230	50	170	100	2	4 1/2 x 4 1/2 x 4 1/2
H.T.15	200	40	150	100	2	4 1/2 x 4 1/2 x 4 1/2
H.T.16	230	50	170	100	2	4 1/2 x 4 1/2 x 4 1/2
H.T.15	200	40	150	100	2	4 1/2 x 4 1/2 x 4 1/2
H.T.16	230	50	170	100	2	4 1/2 x 4 1/2 x 4 1/2
H.T.15	200	40	150	100	2	4 1/2 x 4 1/2 x 4 1/2
H.T.16	230	50	170	100	2	4 1/2 x 4 1/2 x 4 1/2
H.T.15	200	40	150	100	2	4 1/2 x 4 1/2 x 4 1/2
H.T.16	230	50	170	100	2	4 1/2 x 4 1/2 x 4 1/2

It will be noted that a range of input voltages is specified for the "J" type in each case. This is on account of the somewhat greater variation in resistance than with the "H" type, and it is desirable that the mains transformer should be provided with taps when accuracy of D.C. output is essential. THESE TAPINGS MUST NOT BE USED TO OBTAIN A GREATER OUTPUT THAN THAT GIVEN IN THESE TABLES.

We shall be pleased to supply details of suitable arrangements for outputs not listed, on request.

AN INVALUABLE REFERENCE

"THE ALL-METAL WAY, 1938," contains full working details of, and circuits for use with Westinghouse Metal Rectifiers and Westectors. It is more than a mere catalogue, it is a full treatise on A.C. Mains Radio, detection and A.V.C., loudspeakers, etc.

Television rectifiers are fully discussed and there is much information on the operation of mains receivers, eliminators, mains energised loudspeakers. No enthusiast can afford to be without this book. Get your copy to-day from Dept. T.



METAL RECTIFIERS

COUPON

WESTINGHOUSE BRAKE & SIGNAL CO. LTD.,
82, York Road, King's Cross, London, N.I.

Please send me a copy of "THE ALL-METAL WAY, 1938," for which I enclose 3d. in stamps.

Name _____

Address _____

TEL. 11/37

RECENT TELEVISION DEVELOPMENTS

A RECORD OF PATENTS AND PROGRESS *Specially Compiled for this Journal*

Patentees: *Farnsworth Television Inc. :: Baird Television Ltd. and G. E. G. Graham :: H. G. Lubszynski :: E. Michaelis :: Scophony Ltd. and J. H. Jeffree :: Marconi's Wireless Telegraph Co. Ltd.*

Projection Tubes

(Patent No. 468,795.)

INSTEAD of using a fluorescent screen, the picture is reproduced by the heating effect of an electron

Stereoscopic Pictures

(Patent No. 468,837.)

In order to produce a stereoscopic effect in television, it is necessary to make separate scanning of the pic-

ary and extraordinary rays produced when light is passed through a doubly-refracting substance such as a calcite crystal.

Each ray is used to scan the picture from a different angle, and the two rays are then passed on to two separate photo-electric cells. The output from both cells can be fed to a common transmission channel—or modulated on the same carrier-wave—by altering the frequency-band of one set of signals so that it does not overlap with the other.

At the receiving end, a doubly-refracting crystal is similarly used to separate the two signals and project them simultaneously on to the viewing screen. The same arrangement can be used to produce two-colour television pictures.—*Baird Television, Ltd., and G. E. G. Graham.*

Television Systems

(Patent No. 469,033.)

A cathode-ray tube, as used in television, is provided with electron-multiplier "targets" inserted between the photo-sensitive screen and the output electrode.

As shown in the drawing, the electron stream from the cathode C is swept over a permeable mosaic screen

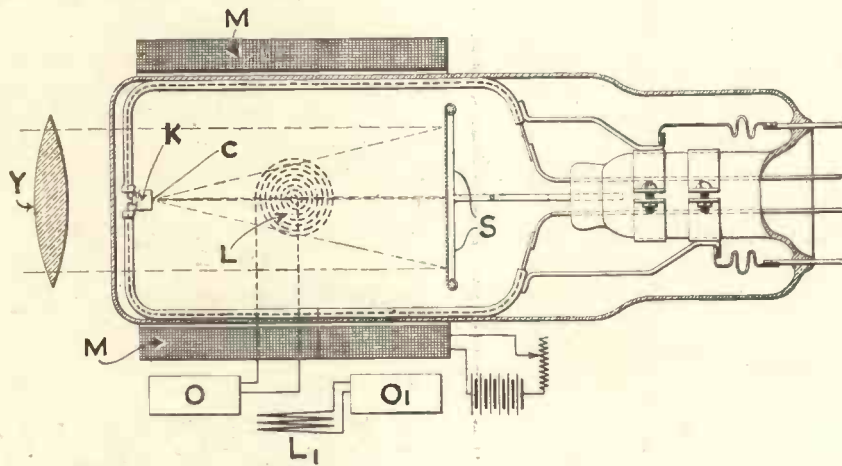

Projection tube. Patent No. 468,795.

stream projected against a very thin screen of metal.

As shown in the figure, a concentrated electron beam is projected from a cathode C against a thin metal screen S. The intensity of the beam is controlled by the signal voltages applied to the Wehnelt cylinder K, whilst the field from an external magnetic winding M keeps it concentrated into a thin pencil.

Scanning voltages are applied to a pair of deflecting coils L, L1 from saw-toothed oscillation generators O, O1.

The impact of the electron beam raises the screen S to varying degrees of incandescence, corresponding to the tone values of the original picture. The light so produced is projected back from the screen surface on to a lens Y which amplifies and focuses the picture on to an external viewing screen. Owing to the intense illumination of the screen S, the enlarged picture is of high brilliance.—*Farnsworth Television Inc.*

ture, simultaneously these being subsequently combined to give the effect of right-eye vision plus left-eye vision.

According to the invention the two separate scans are made by the ordin-

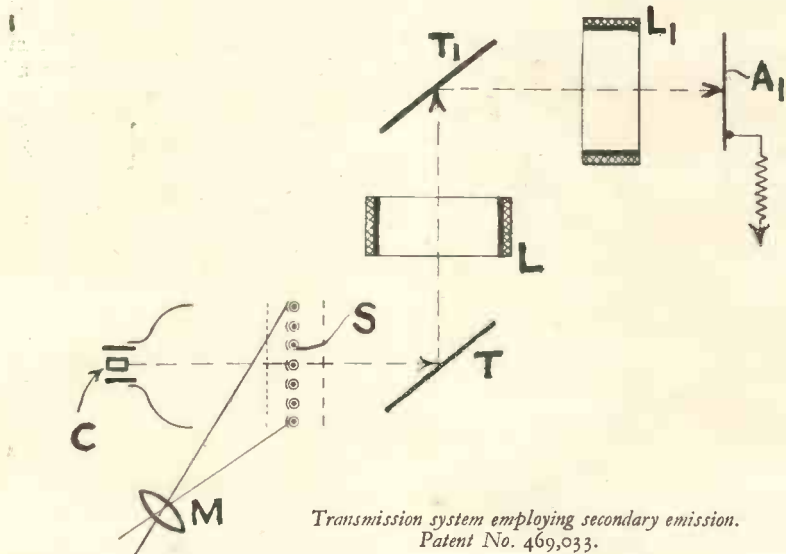

Transmission system employing secondary emission. Patent No. 469,033.

The information and illustrations on this page are given with permission of the Controller of H.M. Stationery Office.

S, and passes through on to an inclined target electrode T, where it produces secondary emission. The amplified stream is then caused, by focusing coils L, L₁, to impact against another target T₁, giving rise to further secondary emission, before finally reaching the output electrode A₁.

The picture to be televised is focused by a lens M on to the permeable mosaic screen S, which is made as an open grid of small photo-sensitive elements. The impact of the scanning beam controls the potential of each of the small cells and so regulates the strength of the emerging beam in accordance with the varying light-values of the original picture.—*H. G. Lubszynski.*

Cathode-ray Tubes

(Patent No. 469,127.)

In order to increase the intensity of the spot of light thrown on to the fluorescent screen, a cathode-ray tube is fitted with several different cathodes, all mounted on the same support, and arranged so that the separate electron streams are all brought to a focus at the same point on the screen.

As shown in the figure, three cathodes C₁, C₂, C₃ are arranged in a plane perpendicular to the axis of the tube. Each has a separate Weh-

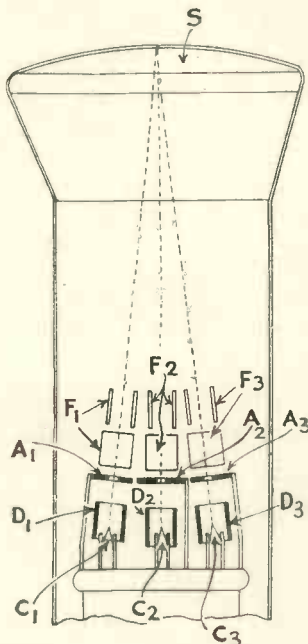

*Cathode-ray tube with multiple cathodes.
Patent No. 469,127.*

nelt cylinder or control electrode D₁, D₂, D₃ and a separate anode A₁, A₂, A₃. Each stream passes through its

own pair of deflecting plates F₁, F₂, F₃ and reaches the fluorescent screen S at the same point.

Alternatively, the different streams may be merged, so that they pass through the aperture of a common anode, before reaching the deflecting plates, in which case only a single pair of deflecting plates will be required.—*E. Michaelis.*

Scanning Systems

(Patent No. 469,427.)

A ray of light is passed first through a combination of a spherical and cylindrical lenses, to produce a wedge-shaped beam, which is then directed on to a series of right-angled prisms which rotate the beam through 90°. The resulting flat-shaped beam is then passed through a light valve, which is subjected to mechanical vibrations of supersonic frequency.—*Scophony, Ltd., and J. H. Jeffree.*

Electron Multipliers

(Patent No. 469,477.)

When an electrode is subjected to bombardment, it will emit secondary electrons, the number of which depends in part upon the material of the electrode, and in part upon the potential difference between it and the source of primary electrons. An emission of three or more secondary electrons for every impacting electron can readily be obtained from sensitised electrodes at potentials of 300 or 400 volts. If the primary stream is caused to strike against a number of sensitised electrodes in succession, it is possible in this way to obtain an amplification up to a million-fold in a single tube.

The invention is concerned with the electrode system of an electron multiplier of this kind, the various targets being so arranged that substantially none of the electrons miss their mark in passing through the tube, thus ensuring an optimum amplification factor.—*Marconi's Wireless Telegraph Co., Ltd.*

Summary of Other Television Patents

(Patent No. 468,808.)

Preserving the lower signal frequencies in a television receiver arranged for interlaced scanning.—*Radio-Akt. D. S. Loewe.*

(Patent No. 468,891.)

Rectifier unit for producing the high operating voltages required to run a cathode-ray television receiver.—*Radio-Akt. D. S. Loewe.*

(Patent No. 468,965.)

Electron focusing arrangement for causing the scanning beam in a cathode-ray tube to strike the screen vertically at all points on its surface.—*H. G. Lubszynski.*

(Patent No. 469,018.)

Method of producing mechanical vibrations of supersonic frequency by means of a piezo-electric crystal for use in a television light valve.—*Scophony, Ltd., and J. H. Jeffree.*

(Patent No. 469,245.)

Matching the impedance of a television aerial to its feed-line over a wide band of signals.—*E. C. Cork.*

(Patent No. 469,394.)

Supplying operating voltages to the cathode-ray tube and time base circuits of a television receiver.—*The General Electric Co., Ltd., and D. C. Espley.*

(Patent No. 469,404.)

Electron multiplier with secondary-emission electrodes formed of fine wire mesh inclined at different angles.—*W. E. Williams.*

"The Mullard Miniature Cathode-Ray Tube"

(Continued from page 670)

0.20 mm/V. for the plates D₁ (near the cathode) and for plates D₂ (near the screen).

When using a time-base unit the time-base voltage is usually applied to D₂ and D_{2'}—the plates farthest away from the cathode. The two plates D₁ and D_{1'} are nearer to the cathode and hence possess greater sensitivity, and are less exposed to the damping effect of secondary emission from the screen, than the other parts. It is usually more advantageous, therefore, to use this pair of plates for carrying out a voltage measurement.

On the basis of the above sensitivity values of the tube, the voltage can be calculated which must be applied between the deflecting plates in order to deflect the light-spot from one side of the screen to the other side. For the plates D₁ and D_{1'} (the pair near the cathode) this voltage amounts to 370 volts at an anode voltage of V_{a₂} = 800 volts, and to 230 volts at V_{a₂} = 500 volts. These values refer to a maximum voltage. It will be clear, therefore, that for normal operation, considerably lower voltages than those mentioned will be satisfactory.

The price of the tube is £3 10s. od.

The information and illustrations on this page are given with permission of the Controller of H.M. Stationary Office.

THE COSSOR CATHODE-RAY TUBE UNIT

A GENERAL-PURPOSE INSTRUMENT EMPLOYING A HIGH-VACUUM TUBE



The Cossor model 3313 high-vacuum tube unit.

As is well known, Cossors have devoted a great deal of attention to the production of test instruments employing the cathode-ray tube. Included in these are various oscilloscopes and a high-vacuum cathode-ray tube unit. This latter may be described as the nucleus of all cathode-ray recording equipment and is a general purpose tube unit containing tube and power pack with essential controls, but without amplifier or time base incorporated, on the assumption that special requirements of amplification and frequency range can be better met by the use of separate external units.

Visual or Photographic Records

The instrument can be used for either visual or photographic recording and for the latter purpose a beam trigger has been incorporated so that the beam can be turned on or off very suddenly either by means of an electrical pulse or an external mechanical contact.

The unit is shown by the photograph and consists of a metal chassis provided with removable metal sides, lid and base, to give complete access to the tube in the upper part and the power pack in the lower part of the case. The tube is mounted horizontally in an adjustable mounting and is surrounded by a mu-metal screen to avoid magnetic interference from the mains transformers and external fields. The screen is viewed through a large circular aperture at

the end of the case on which are mounted the controls.

The controls comprise the usual brilliancy and focus, a press switch with a rotary locking movement for manual control of the beam switch, a high tension voltage selector switch to give two alternative anode voltages, and an on-off switch and pilot light. All the terminals are at the rear of the case and are as follows: X₁, X₂, Y₁, Y₂, for the deflecting plates AN for the anode of the tube, E for the earth connection to the metal case, M and EL for the mechanical and electrical operation of the beam trigger, and COILS for connection to the deflecting coils. The transformer tapping plate and mains plug are also at the rear of the case. Separate terminals have been provided for the anode and metal case, as the former is at a potential above earth when the tube unit is used with D.C. amplifiers. These terminals, therefore, are normally connected by the link provided, but all the tube circuits can be isolated from the metal case when required.

particular purposes condensers of suitable capacity must be employed externally.

The beam trigger action is obtained by modulating the 1st anode potential by means of a triode "trigger" valve. This valve when conducting loads the feed resistance to the 1st anode, whose potential is thereby decreased, so that the beam is consequently turned off. The grid of the trigger valve is biased from a high resistance potentiometer connected across the H.T. supply, the beam switch being connected so as to short circuit part of this potentiometer and hence to alter the bias on the trigger valve. Any external contact connected between the M and AN terminals will be in parallel with the beam switch on the front panel. With the beam switch or external contact closed, the valve grid is biased positively thus reducing the potential on the 1st anode and turning the beam off. When both the internal and external beam switches are open, the grid is biased negatively and the 1st anode regains its normal operating

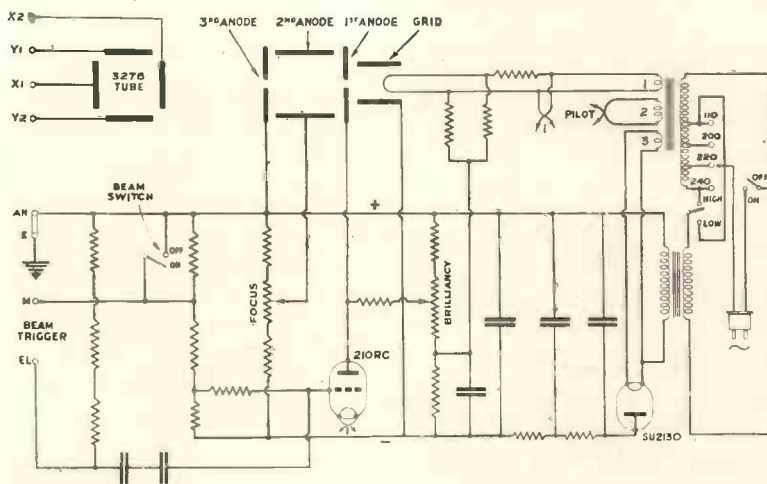

Circuit of the Cossor Cathode-ray tube unit model 3313.

An essential requirement when the tube unit is used with D.C. amplifiers are direct connections between the deflector plates and terminals without the use of stopping condensers and these have been provided. For par-

potential as controlled by the brilliancy control. The beam is therefore turned on for as long as either the internal or external beam switches are open. The potential of terminal

(Continued on page 703)

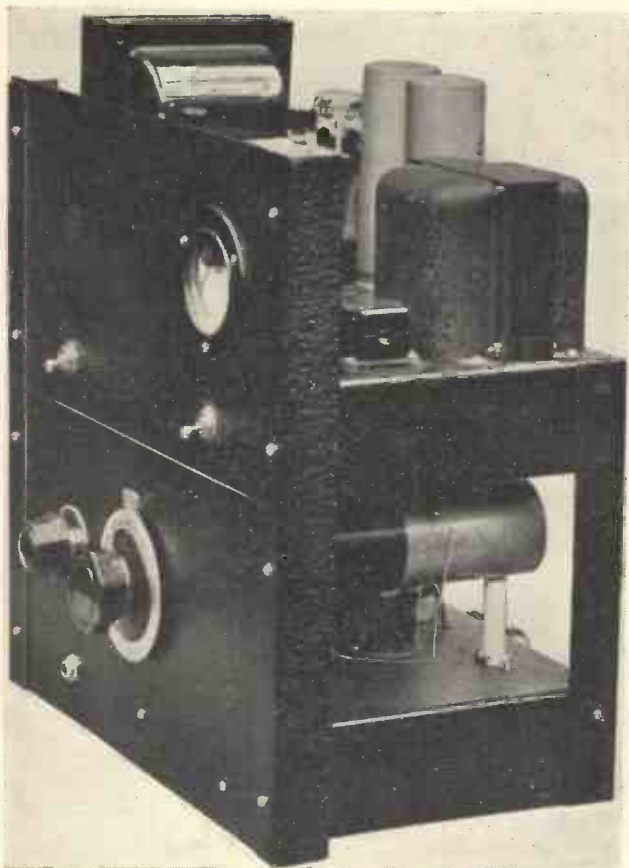

A 15-watt Transmitter for Beginners

By Kenneth Jowers

This transmitter has been designed specifically for the beginner but the carrier power of 10 watts makes it ideal for emergency use. It is capable of wide range if the appropriate wavelength is employed.

A special chassis has been made for this transmitter and it is completely collapsible. The cost is low, a point which will appeal to constructors. Notice the new type of dial for adjusting the P.A. condenser.

WITH this transmitter I have attempted to provide a design for a very simple self-contained unit that is very cheap to build, and it has only been made possible by the introduction of some new high-efficiency valves which, fortunately, lend themselves to amateur use.

Knowing as I do how careful is the amateur about the cost of equipment, before going into the design of this transmitter I first of all persuaded several manufacturers to introduce inexpensive components specially for my purpose.

Four Valves

The result of all this has been a really compact transmitter complete with speech amplifier and modulator, so that the constructor will be able to obtain a carrier power of 10-watts with the minimum of expense. Only four valves are used throughout, these being transmitter, speech amplifier, modulator and rectifier.

Before going into the technicalities surrounding the design of this little transmitter, let me explain just for what purpose it was designed and approximately the results that can be obtained with it.

First, the original intention was to produce a transmitter for emergency work that could be used on any wave-band with the minimum amount of

trouble. Very often amateurs are, for example, operating on 20 metres, and then find that they wish to make a hurried contact on, for example, 40 metres. This transmitter is ideal for that purpose, for it has sufficient output for most amateur needs.

The short-wave listener who, after listening to the activity on the short-wave bands, feels that he would like to experiment himself with transmitting

apparatus, will at first be limited to an input of 10 watts. For that reason complicated apparatus is unnecessary, for after the experimenter has gained sufficient experience to design his own equipment he is usually more interested in building his own apparatus to his particular requirements.

The total cost of this transmitter is so low that the beginner will find it difficult to design anything equally as effective without exceeding this cost. Another point of interest is the fact that two of the valves are of American design and two British, but for those who are interested, four British or four American valves can be used as required.

10-watt Carrier

As mentioned previously, the carrier power developed is approximately 10 watts, and this carrier can be adequately modulated by one beam-power tetrode

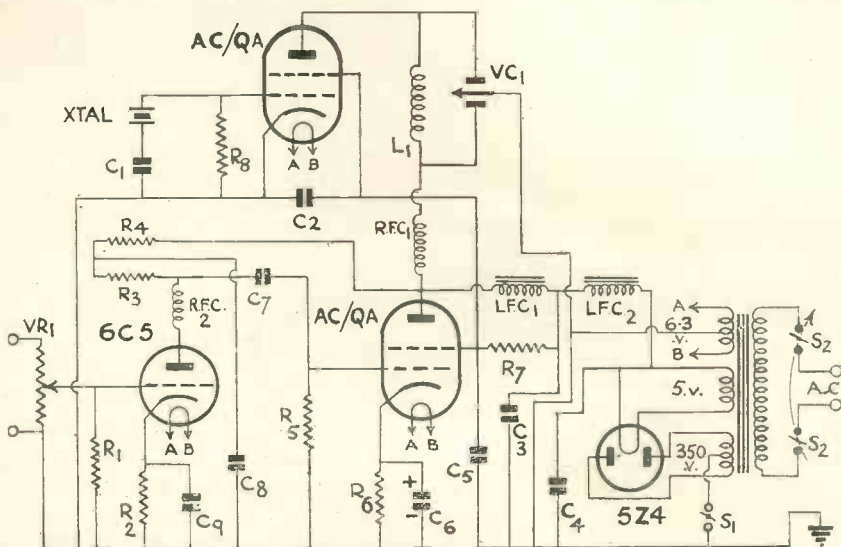

Two tetrodes are used in this circuit, one for modulation and one as an oscillator amplifier. These valves are interchangeable with the American type 6L6.

What the Transmitter Will Do

running from the same power supply as the oscillator amplifier.

On the 40-metre band the number of

lings. This rack is made up of two 10 in. by 7½ in. by 2 in. chassis, two 12 in. by 6 in. panels, and four lengths

capable of handling the weight of the power pack, while at the same time it is perfectly rigid.

In designing this transmitter it was segregated into two distinct parts; the speech amplifier, modulator and transmitter in one section, and a common power pack in the second section.

First of all consider the power pack which is rather important for it has to supply a high-current output with a maximum of 350 volts. A special Raymart mains transformer has been included which gives 350 volts at 150 mA., also 6.3 volts for the heaters, and 5 volts for the 5Z4G rectifying valve. The output from this transformer after rectification is smoothed by two 8-mfd. Dubilier condensers and a high-inductance Savage low-frequency choke. This choke, also of a new type with very low D.C. resistance, ensures that the voltage regulation is sufficiently good despite possible current change.

A Special Modulation Choke

Difficulties were experienced with the modulation choke which is mounted in the power pack, for when modulation was increased beyond 60 per cent., many chokes tried gave audible indication of the modulation, so causing feedback to the microphone. Finally, a Bulgin choke which is very tightly wound and mounted in a metal container was found to be entirely free



The transmitter, single speech amplifier and modulator are all housed in the bottom rack with the power pack and modulation transformer in the top rack. The two chassis are interconnected by means of 5-way cable.

contacts made has been very little fewer than those made with a much higher-power transmitter using exactly the same frequency. Stations have been worked in all parts of England, France, Holland, Belgium, Denmark, and even French Morocco. This is surely ample proof that a low-power transmitter is satisfactory on the amateur wavebands.

By changing over crystal and coil the transmitter can be used on 80 or 160 metres, but at the moment the balance of the tests have been confined to the 160-metre band. On this wavelength, despite the high noise level, a very satisfactory number of stations have been worked, varying from the North of Scotland to Manchester, South Wales, and, of course, many stations in South London.

Despite the fact that the transmitting valve works as an oscillator and power amplifier simultaneously, modulation, providing it is not increased beyond 80 to 85 per cent., does not cause appreciable frequency shift, although many amateurs still feel that at least two stages are required in any transmitter. This point of view is perfectly correct, but only when maximum modulation is to be employed.

Transmitting racks, no matter how small, are generally expensive, but in this instance I am indebted to Messrs. A.P.A. for designing a special rack on new lines which costs but a few shil-

of 1 in. angle iron to act as supports. In this way a very compact and rigid chassis is built up that is more than



On the bottom rack can be seen the single tuning control, volume control in the microphone circuit, and the microphone input jack. On the top rack is the main on-off switch and on the right the stand-by switch.

Tetrodes for Oscillator and Modulator

from vibration even at maximum modulation. This choke can be seen mounted next to the mains transformer.

The layout of the components in the power pack can be seen from the illustration, and this section should be completed first. With the exception of three wires all the connections are be-

frequency amplifiers the output is much higher than would be expected, despite the low grid input required.

The first speech amplifier is an R.C.A. 6C5, which is a triode with an Octal base, similar in characteristics to the AC/HL type of valve. At this point it is excusable to draw away from the

recommended the anode load, that is to be obtained, and with the power pack. The 6C5 is rather sensitive as to anode load if maximum stage gain is R₃, should have a value of 50,000 ohms. R₄ is merely for decoupling and has a value of 25,000 ohms.

R₁ is not strictly essential owing to the fact that VR₁ is shunted across it, but it has been noticed that sometimes VR₁ is left at almost open circuit so that the grid of the 6C5 is not anchored down in any way. This is the purpose of R₁.

As an oscillator amplifier, the AC/Oa is fed with approximately 300 volts, with 275 volts on its screen obtained through R₇, which is common to both oscillator amplifier and modulator. Under such conditions the modulator has a total cathode current of 75 mA. when R₆ has a value of 500 ohms.

The oscillator amplifier, when out of tune, has a peak current of considerably over 100 mA., but when tuned to resonance the efficiency is such that the current drops to a maximum of 15, and with careful construction and coil building, sometimes to under 10. When the aerial is connected the coupling should be adjusted until the input is approximately 10 watts. Those unacquainted with the operation of transmitting valves should remember that the valve when tuned to resonance without the aerial connected will only take a very low current, but as the aerial coupling is increased, anode current will rise to a very high maximum, so it is for this reason that the coupling should be adjusted until the input is only 10 watts. Allowing for slight voltage drop, owing to chokes, wiring, etc., the total

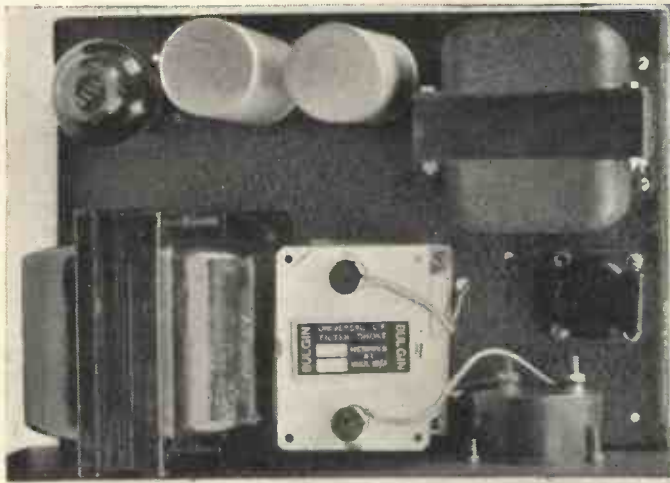

This plan view shows the layout of the power pack, while a special note should be made of the smoothing choke in the right top corner and the modulation choke, which is next to the mains transformer.

neath the baseplate. The output leads all terminate in a Belling-Lee 5-pin socket, the five pins being needed for L.T., H.T., and also a special lead for taking the screen voltage down to the transmitter and modulator valves. This could have been avoided but only by having the modulation choke on the same chassis as the transmitter and speech amplifier, which would have meant overcrowding.

Next comes the actual transmitter itself and mounted on the bottom rack. Three valve-holders, the crystal, power plug and coil are all mounted on the chassis. The volume control in the microphone circuit and split-stator condenser are actually mounted on the front panel. The crystal holder is isolated from the chassis by means of a bush, for reference to the circuit will show that between the negative side of the crystal and chassis is inserted C₁ condenser of .002-mfd. capacity. Through the centre of the chassis is fixed a bolt with two or three soldering tags above and below. All earth returns are made to these soldering tags, so that the earthy sides of all by-pass condensers, etc., go to a common point.

A New Tetrode Valve

Perhaps the most important component in this transmitter are the valves employed. The actual transmitting valve and modulator are both Hivac AC/Oa, which are interchangeable equivalents of the 6L6 tetrode. These valves make excellent oscillators and even with high voltage do not show any signs of stress and give an amaz-

ingly high R.F. output with low-crystal current. Similarly when used as low-point a little and deal with the input from the microphone. The 6C5 valve is used to follow a single stage speech amplifier so that a high quality microphone can be used. If, however, experimenters intend to use a carbon type of microphone, then exchange the 6C5 for a 6F5, which is interchangeable with the exception of the bias resistor, which should be adjusted to give an anode current of .9 mA.

Components for A 15-WATT TRANSMITTER FOR BEGINNERS

- | | |
|---|---|
| <p>CHASSIS.
2—Special steel chassis with panels and supports finished black (A.P.A.).</p> <p>CHOKES, HIGH-FREQUENCY.
1—Type 1022 (RFC₁) (Eddystone).
1—Type 1066 (RFC₂) (Eddystone).</p> <p>CHOKES, LOW FREQUENCY.
1—L.F.21 (LFC₁) (Bulgin).
1—20 henry 150 M/a (LFC₂) (Bryan Savage).</p> <p>COIL FORMER.
1—Length Paxolin 6½ in. by 2 in. (L₁) (Wright & Weaire).</p> <p>CONDENSERS, FIXED
1—.002-mfd. type 600W (C₁) (Dubilier).
1—.002-mfd. type 600W (C₂) (Dubilier).
1—8-mfd. type 0281 (C₃) (Dubilier).
1—8-mfd. type 0281 (C₄) (Dubilier).
1—.01-mfd. type 4601/S (C₅) (Dubilier).
1—25-mfd. 25 volt working type 3016 (C₆) (Dubilier).
1—.01-mfd. type 4601/S (C₇) (Dubilier).
1—2-mfd. type BB (C₈) (Dubilier).
1—12-mfd. 50 volt working type 3016 (C₉) (Dubilier).</p> <p>CONDENSERS, VARIABLE.
1—Type E two-gang (VC₁) (Plover).</p> <p>CRYSTAL.
1—Standard crystal for 7 Mc. or 1.7 Mc. mounted in enclosed holder (Q.C.C.).</p> <p>DIAL.
1—Special Crowe (A.C.S. Ltd.).</p> <p>HOLDER, FUSE.
1—F18 complete with 1 amp fuses (Bulgin).</p> <p>HOLDERS, VALVE.
4—Octal (Clux).</p> | <p>METER.
1—Flush mounting type E66M 0-150 M/a (Sifani).</p> <p>MICROPHONE.
1—Transverse current type with table stand (Premier).</p> <p>PLUGS, TERMINALS, ETC.
1—Plug type P15 (Bulgin).
1—Jack type J2 (Bulgin).
2—5-way sockets with plugs type 1260 (Belling-Lee).</p> <p>RESISTANCES, FIXED.
1—500,000-ohms type ½ watt (R₁) (Erie).
1—1,000-ohms type 1 watt (R₂) (Erie).
1—50,000-ohms type 1 watt (R₃) (Erie).
1—25,000-ohms type 1 watt (R₄) (Erie).
1—250,000-ohms type ½ watt (R₅) (Erie).
1—500-ohms type 5 watt (R₆) (Erie).
1—5,000-ohms type PR9 (R₇) (Bulgin).
1—100,000-ohms type 1 watt (R₈) (Bulgin).</p> <p>RESISTANCES, VARIABLE.
1—5-megohm potentiometer (VR₁) (Erie).</p> <p>SUNDRIES.
¼—lb. 22 gauge enamelled covered wire (Webb's Radio).
24—6BA bolts, nuts and washers (Webb's Radio).
2—Coils Quickwre (Bulgin).
2—Stand-off insulators type 1020 (Eddystone).
1—Volume control dial type IPI (Bulgin).</p> <p>SWITCHES.
1—S80T (S₁) (Bulgin).
1—S126 (S₂) (Bulgin).</p> <p>TRANSFORMER, MAINS.
1—350-0-350 6.3 volt and 5 volt (G5NI Ltd.).</p> <p>VALVES.
2—AC/Oa (Hivac).
1—5Z4G (Tungsram).
1—6C5 (Webb's Radio).</p> |
|---|---|

Metal or Glass Valves :: The Licence

anode current to the oscillator amplifier should not exceed 30 mA.

Bias to the AC/Qa as a transmitter is obtained automatically by virtue of the grid current across R8, which has a value of 100,000 ohms. This resistance is as shown, connected between grid and earth. The conventional by-pass condenser in the anode circuit has been omitted owing to the fact that VC₁ is a split stator condenser, so providing the correct value of by-pass capacity required.

Although the resistance values have been definitely specified, R₂ and R₈ are subject to slight variation in case of changes in valve characteristics. R₂ should be adjusted so that the total cathode current is 4 mA. This current is obtained in the original model when R₂ had a value of 100,000 ohms, but subsequent models have used 900 and 1,500 ohms, due to changes in valve impedance.

R₈ provides sufficient bias for the oscillator amplifier, but should it be found that oscillation is rough and difficult to control, then this value should be decreased, but never less than to 50,000 ohms.

All of these remarks apply irrespective of whether British or American valves are used, while glass and metal types are interchangeable except that the metal shield of the valve used as an oscillator amplifier must not be earthed.

Next comes the coil L₁. Notice that there is only one and it is in the anode of the coil, L₁, should be wound to cover the band on which the transmitter is to be used. Generally speaking, this will either be 40, or 160 metres, so provision must be made for using two coils that can be changed-over quite quickly. For this purpose a former 6½ in. by 2 in. is required. On 160 metres wind on sufficient turns of 20 gauge enamelled covered wire close wound to cover 2½ in.

Coil L₁ is not tapped and is terminated in two soldering lugs, while the extreme ends of the former are mounted on stand-off insulators. For 40 metres the same gauge wire can be used, but a total of 26 turns are required, each turn spaced approximately the gauge of the wire. It is most unlikely that amateurs will use this transmitter on 20 metres owing to the expense of the crystal, but for those who would like to experiment with this band, a coil can be constructed of 12 turns of 16-gauge wire, spaced the gauge of the wire.

When winding these coils, owing to the glossy surface, difficulty may be experienced in keeping the spacing accurate, but providing the wire is kept very taut the coils will look quite presentable when finished.

Next refer to the controls on the front panel. On the top rack there are two

switches, the left-hand one being of the double-pole variety for switching off both sides of the mains input. The second switch on the right-hand side is in series with the centre tap of the H.T. winding on the transformer and the chassis. It is used as a standby switch and merely cuts off the entire H.T. supply, while listening to other stations, but leaves the valve filaments still heated. This switch can be used externally as the remote control switch.

On the bottom panel there is the main tuner, to the right the volume control, which is directly across the microphone input circuit, and finally a jack for the microphone leads.

The dial has to be carefully mounted and is of a new type supplied by Messrs. A.C.S., that fits directly on to the spindle of the tuning condenser and is held by a single grub screw.

This type of dial is being used owing to the request of amateurs who do not

A point to remember is that there is a comparatively high voltage on the 5-pin sockets at both ends, so that the hole made to take the socket should be as large as possible to prevent arc-over at voltage surge.

It is not possible to recommend just what frequency crystal should be employed as this depends very much on amateurs in the locality where the transmitter is to be used. It is, however, advisable to have a crystal well within the limits of the band until experience has been gained, in case of possible frequency shift, due to mishandling.

The Licence

For those who are going to construct this transmitter under an artificial aerial licence the following details will be appreciated. A dummy aerial can be made up quite simply and only requires externally one tuning condenser.

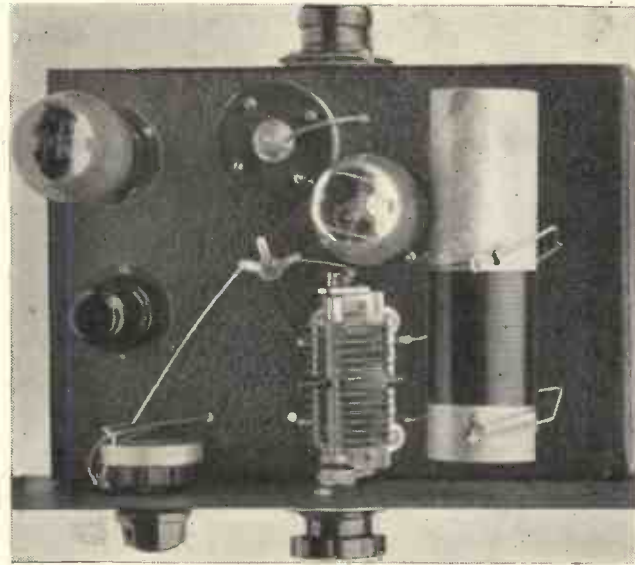

Most of the wiring in this transmitter and amplifier section is beneath the chassis. The space on the coil former is for the aerial coupling coil.

like the trouble of cutting large holes in steel panels when using more complicated dial systems.

Also supplied with this dial is a simple vernier arrangement which has to be accurately fitted, but will not present any difficulties, for a drilling template is supplied.

After the two sections have been wired and checked, measure the voltages on the 5-pin plug on the power pack chassis. The H.T. supply should read about 375 volts, the 6.3-volt winding between 6.4 and 6.5, and the 5-volt winding approximately correct voltage. A 5-way cable should then be made up, making sure that the two wires for the 6-volt filament supply is of heavy gauge to prevent voltage drop.

This cable can be pinned to the edge of the chassis and if the five wires are plaited this cable will not look untidy.

A coil equivalent to the one already built should be wound on to the same former as the anode coil, and spaced approximately half an inch. In parallel with this connect a .0002-mfd. or .0003-mfd. tuning condenser with a 75-ohm non-inductive resistance in series with one leg, and a small quarter-amp. bulb in series with the other leg. The transmitter can then be adjusted to give maximum brilliance in this bulb.

In no circumstances can experimenters build this transmitter without a Post Office licence, but an artificial aerial licence will permit them to experiment without actually radiating. Full details of this and other licences can be obtained from the Office of the Engineer-in-Chief, Radio Division, General Post Office, Armour House, Aldersgate Street, E.C.1.

A Direct-coupled Amplifier

By W. J. PURVIS

ALTHOUGH the direct-coupled amplifier was developed many years ago by Loftin & White, until quite recently, little attention has been paid to it, as the disadvantages at that time did not outweigh the advantages to any appreciable extent. Of late, however, with the improvements in valve characteristics and the ease with which the extra high-tension that the system requires can be obtained, the system is receiving a little of the attention that it deserves.

Properly constructed and with due care given to its design, the amplifier will prove a boon to both the amateur and professional, because of its high gain, exceedingly low distortion level, portability, and low cost in comparison with other amplifiers constructed on orthodox lines. As there is no transformer or coupling condenser, the res-

The direct-coupled amplifier designed a few years ago, can now be put to real advantage by using modern high slope valves. The main advantages of this simple system are described in this article.

required will be equal to that necessary on the output anodes (normal voltage) plus the anode voltage of V_1 (50-75 per cent. of the normal) plus the bias required on the output valves and dropped through R_4 . This involves the use of voltages in excess of those normally used, and is one of the drawbacks of the system, although, as has previously been stated, it is a comparatively simple matter to build a power-pack with an output of 600 volts.

Using PX25's an anode voltage between 350 and 400 will suffice and 150 volts on the anode V_1 will be ample (it

made 150 volts positive to earth. In other words, taking V_3 as the example, point C must be less positive with respect to earth than point E by an amount equal to the bias required, which thus makes the grid negative with respect to the cathode. Resistances R_1 , R_2 and R_3 should have an approximate ratio of 2:1 and be not less than 250,000 ohms total. R_2 will be a fractional value of R_1 and is variable to enable the anode current of V_2 to be adjusted equal to that of V_3 . Therefore, R_1 , R_2 have to drop a voltage equal to the anode voltage of V_3 minus the voltage difference between points E and X minus the grid voltage required.

Volt. diff. CE = Anode volts.

$V - (\text{volt. diff. (EX) - grid volts } V)$
 R_6 and R_7 are merely to drop voltage for the screen of V_1 ; R_8 is a hum control, usually of the order of 100 ohms, whilst R_9 keeps the grid of V_1 less positive in respect to earth than the cathode. As the current of V_1 is very small a bias resistor of 50,000 ohms is usual, therefore R_4 must be calculated so that the grid of V_1 is approximately 2 volts negative to the cathode. The resistance R_4 can be assumed to be a constant of $\frac{1}{2}$ meg. for practical purposes and from the bias on V_2 we can find the anode current of V_1 .

$$\text{Anode M/a. } V_1 = \frac{\text{total H.T.} - \text{bias } V}{1,000}$$

The condensers of C_1 , C_2 can also be assumed to be constants with a capacity of 4 mfd. as C_1 is a de-coupling condenser whilst C_2 is for the hum control.

Finally, it may be borne in mind that the smoothing of the H.T. supply need be only 50 per cent. of that normally used.

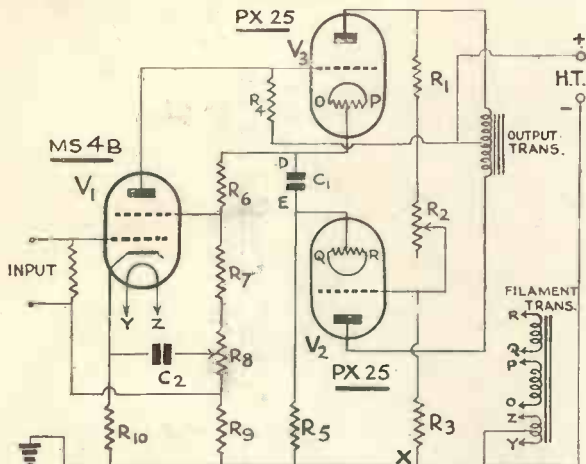

A screen-grid valve correctly used will give more than sufficient gain fully to load a pair of PX25 valves. The hum level on a receiver of this kind is extremely low, while the voltage can be obtained with comparative ease.

ponse curve will remain reasonably flat between 30 and 8,000 cycles. Further, the objectionable grid blocking, experienced with resistance-capacity when high low-frequency gain is desired, is obviated.

Examine the circuit and note the method of voltage distribution; as the voltage variations of V_1 are impressed directly upon the grid of V_3 it follows that given a valve with a high magnification factor at V_1 , the output valves, V_2 , V_3 will be required to handle a very large grid voltage. This is an important feature to be remembered when designing the amplifier. If a S.G. valve with an amplification factor of, say, 500 is used at V_1 , then the output valves must be able to handle an input far in excess of that given by the same S.G. valve in an orthodox amplifier: incidentally two PX25's can be comfortably fed from a valve of the MS4B class. Using such a combination it is possible to obtain an output of 10 watts with a gain of 65 Db.

A typical push-pull circuit is shown. It is obvious that the total H.T.

should be noted that, as a large resistance is used in the cathode of V_1 , the anode current of that valve will be very small, to the order of micro-amps.).

The circuit should be memorised before attempting to calculate resistance values, which, for the most part, alter with different valves chosen: if this is done the system will be by no means as complicated as it appears at the first sight. All that is necessary is a knowledge of Ohm's law and a small amount of patience. Firstly, the resistances R_4 , R_7 , R_8 , R_9 and R_2 must be of such a value so as to drop the total H.T. minus that required on the anodes of V_2 , V_3 . R_5 will, of course, be equal to the sum of R_6 , R_7 , R_8 , R_9 .

Voltage Required

Assuming that the total H.T. is 600 volts and 400 volts are required on V_3 , then the voltage at points D and E will be 200 positive with respect to earth (X). If 50 volts negative are wanted as bias for V_1 , then the grid must be

Meeting Place for Amateurs

WEBB'S Radio, of 14 Soho Street, W.1, is becoming a meeting place for amateurs who call in to see the latest British and American short-wave components and receivers as they arrive. Amongst some of the new items which we have just seen is the new Taylor 125 carbon-anode triode, which will handle a full input of 400 watts.

For those who are thinking of buying a new receiver, the various new season's models can all be compared side by side in the showroom. There is the RME69 and DB-20 pre-selector, a combination which many feel is unbeatable. There is also the new Hallicrafter Sky Challenger at £23, the Ultra Sky Raider, a 10-valve 4-band super-het, the Sky Buddy, one of the most popular inexpensive receivers in the country, and many others of all types.

Aerials for Ultra-short Waves

A Review of Aerials Suitable for Television and 2.5-10 Metre Reception

By
Kenneth Jowers

AERIALS for reception distinctly favour pick-up in a given direction according to the length and type of the aerial just in the same way as the transmitting aerial radiates in a definite pattern. This pattern can always be predetermined within reasonably narrow limits, so that listeners wishing to concentrate on a particular

given frequency more often than not forget the all-important matter of directivity.

Maps are now available that give the true direction of various countries in relation to Great Britain, so that experimenters can determine with a high degree of accuracy the position of an aerial to receive stations from any particular area. This latter point applies mainly to 10-metre world-wide reception rather than to ultra-short wave listening usually to one or more stations in a given locality.

In the London area at the present time one notices a considerable number of vertical di-pole aerials, some with reflectors and some without, used for reception of Alexandra Palace television signals. These aerials are usually half-wavelength long and pick up signals most strongly that are in a broadside direction to the aerial. This type of aerial is, of course, bi-directional, that is to say, it receives stations equally well on both sides, unless a reflector is included, as in Fig. 1. In this aerial maximum pick-up is broadside and in the opposite direction to the reflector.

An aerial of this type is essentially for broadside reception and, generally speaking, for use when the listener is concentrating on the reception of one particular station. However, the directivity can be broadened by doubling the

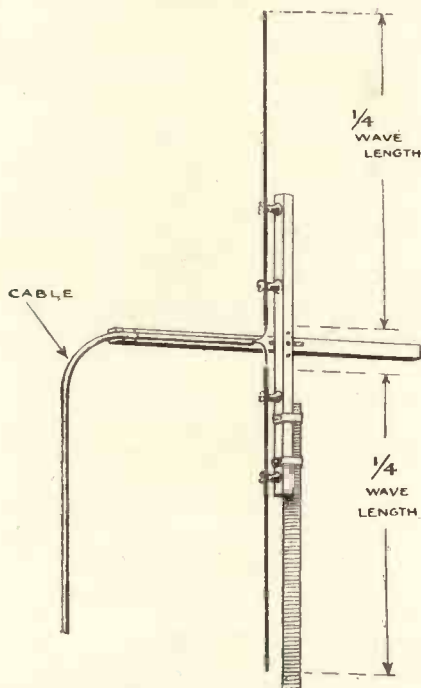

Fig. 1.—The conventional di-pole aerial with reflector mounted vertically for television reception.

area can erect an aerial that will give maximum pick-up from stations in the given direction to the exclusion or partial exclusion, of stations at right angles to the required stations.

I have noticed that listeners who have taken particular care to erect an aerial of the required length to resonate at a

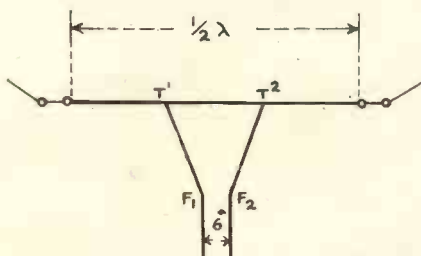

Fig. 2.—A matched impedance aerial suitable for all wavelengths and using a high-impedance feeder line.

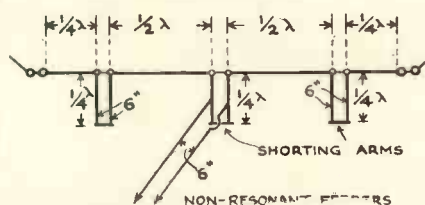

Fig. 3.—Two half-waves in phase with matching stubs suitable for broadside reception.

length of the aerial when, instead of there being only two lobes at right angles, four lobes are obtained, these being spaced equally around the aerial at a point midway between broadside and the end of the aerial. A full-wavelength aerial with four such lobes is a very good all-round aerial for general coverage.

There still appears to be a considerable number of experimenters who do not wish to use aerials of the di-pole type with low impedance cable. For that reason the arrangement shown in

Fig. 2 has much in its favour. It is a half-wave matched impedance aerial fed by a 600-ohm line with the end fanned out at F1 and F2 and tapped on to the aerial at T1 and T2. In this way the impedance of the line is matched up to the tapped points on the aerial. Again, this system is very much broadside so that it has to be erected in the correct

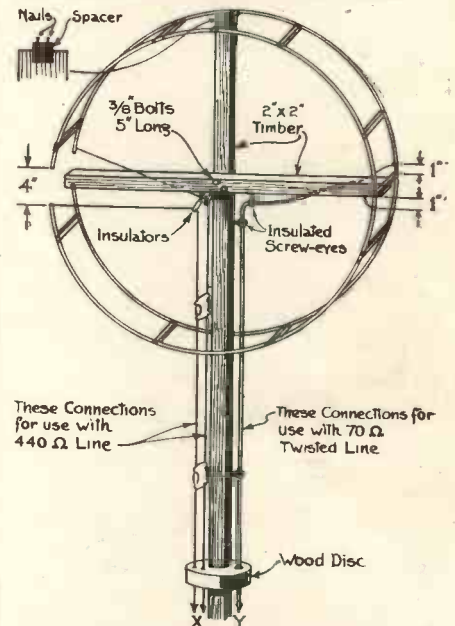

Fig. 4.—The popular Reinartz rotary beam for transmission or reception.

direction for pick-up off the ends of the aerial is comparatively small.

In order to obtain maximum results with this matched impedance aerial the tapping points have to be accurately determined. The distance between these two tap points can be arrived at by using this simple formula

$$T_1/T_2 \text{ (in ft.)} = \frac{492,000}{f} \times 0.24$$

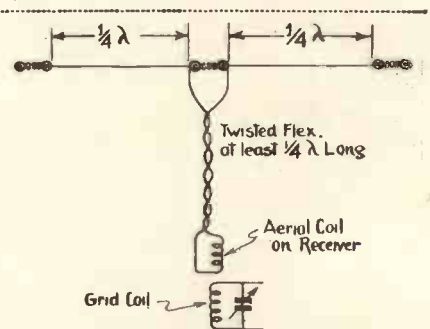

Fig. 5.—One of the most popular aerials used by amateurs is this half-wave doubler with twisted pair lines.

Rotating Aerials :: The Diamond

The Y section from T₁ to F₁ and T₂ to F₂ must also be cut to length and calculated by means of this formula

$$Y \text{ (in ft.)} = \frac{147,000}{f}$$

For general ultra-short wave reception this aerial has much to recommend

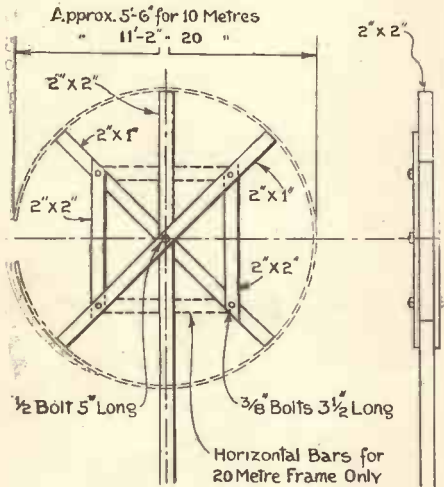

Fig. 6.—Here are the dimensions for the Reinartz rotary beam which can be adapted for use on almost any wavelength.

it, for losses are extremely low, and owing to its comparatively small physical dimensions, it can be made rotary so as to increase the efficiency and the pick-up from stations in a given area.

If it is possible to erect an aerial at right angles to the station it is wished to receive, then there are several variations and refinements that can be added to the average full-wave aerial so as to increase the maximum pick-up at right angles, at the expense of reception off the ends of the aerial.

For example, refer to the scheme shown in Fig. 3. This aerial is popularly known as two half-waves in phase. Actually the aerial consists of two half-waves with a quarter-wave matching section in the exact centre. The half-wave top lengths have to be cut

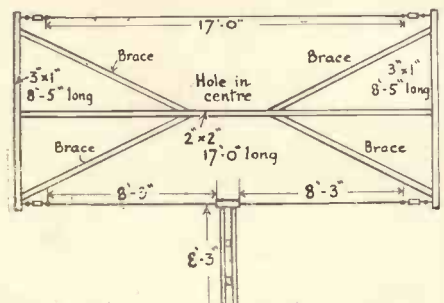

Fig. 7.—A bi-directional rotary beam, particularly recommended for 10-metre work.

accurately by formula, while the stub section is approximately half the length of the top section. The spacing between the stub section is approximately 6 in., while the final shorting bar is made adjustable so that any inaccuracies in construction can be taken up.

If this aerial is used with a receiver needing twin-feeder input, then the feeder cannot be connected directly on to the end of the aerial, so a matching section has to be connected, also as shown in Fig. 3. This matching section is identical with the stub section in the centre of the aerial and is, in practical effect, a matching transformer. The impedance of this transformer, at the shorting bar end, is extremely low, being considerably under 100-ohms, which rises at the aerial end to a figure in excess of 2,000-ohms. It will be appreciated from this that any type of feeder can be attached to this aerial at the correct point by merely determining the correct point of impedance on this transformer.

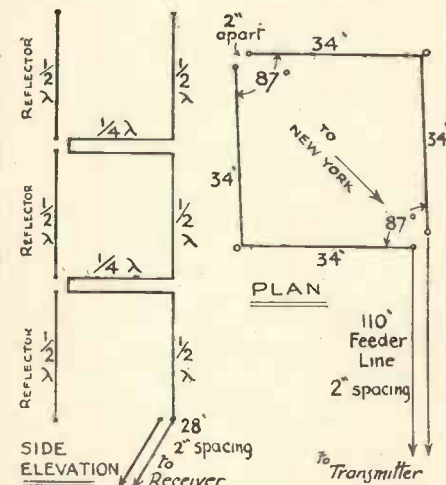

Fig. 8.—On the left is a special three-section Franklin aerial with reflectors, and on the right a highly directional Diamond beam aerial for transmission. Data given is for 5-metre reception and transmission.

An aerial that is not very much used in this country, but has proved its possibilities in America, is the Reinartz rotary beam, shown in Fig. 4. This aerial is highly directional, so for that reason has to be rotary unless only one station, such as Alexandra Palace, is to be picked up. The dimensions are given in the diagram, and it can be seen that the aerial is suitable for either low or high impedance line. Actual wire lengths can be obtained from the diagram in Fig. 6, while alterations can be made so that the aerial will cover any wavelength from 2 1/2 to 20 metres. Its use on higher wavelengths is only prevented by the reason of its dimensions.

At 5 metres the diameter of the aerial is only a little over 30 in., while the direction of pick-up is broadside to and opposite the open ends of the aerial. The increase in gain in the correct direction is nearly six times that of the pick-up at right angles to the diameter of the aerial. As, of course, this aerial is for single-direction reception, constructors should make it so that it is suitable for rotation through 360 degrees. A quarter-wave matching stub can also be used with this aerial for those who wish to make use of odd impedance feeders.

One of the most popular ultra-short wave aerials is the conventional doublet

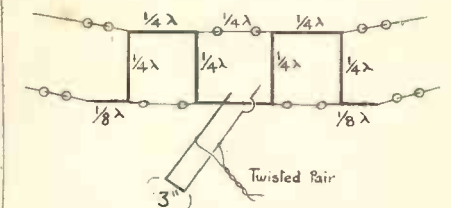

Fig. 9.—The folded Bruce aerial, suitable for use on all amateur bands.

mounted either horizontally or vertically. The arrangement is shown in Fig. 5, and the total length can be obtained from the formula

$$L = \frac{492,000}{f}$$

The length given by this formula will be for both quarter-waves, so that the aerial has to be cut in half, the centre spacing being approximately 3 in. Feeder lines can be either low-loss 72-ohm Belling-Lee cable or constructed with conventional Eddystone transposition blocks. The feeder lines are terminated in a coupling coil which is wound on top of or close to the grid coil in the receiver. The spacing between aerial and grid coils determines the coupling, which can be adjusted to give most satisfactory results.

As there is little to choose between aerials of all types of a given length, marked increases in efficiency can only be obtained by using aerials concentrated on a given area or locating arrangements that can be beamed on to

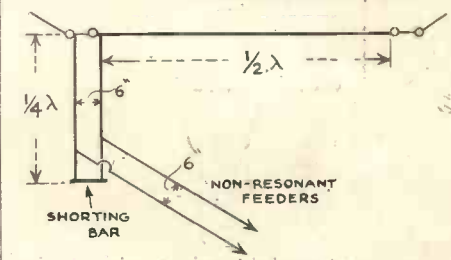

Fig. 10.—For those who must end-feed the aerial, try this half-wave arrangement with matching stub.

Directional V Aerials :: Coupling Methods

the required station. A system that has proved very popular in Australia is shown in Fig. 7. This is, of course, a rotating beam which is suitable for 10-metre reception.

The centre length of wood is approximately 17 in. long and 2 in.

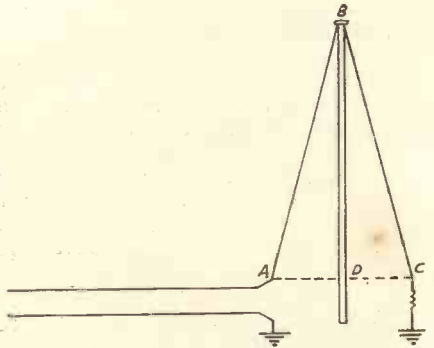

Fig. 11.—The horizontal V can be made highly directional, and very useful when interference is experienced from a station not in the direction of the one being received.

square with a hole cut directly in the centre. This hole takes a length of short piping which acts as a support for the aerial. It is fed by means of a Q-section matching arrangement on to which can be tapped a 600-ohm, or in fact, any similar type impedance line. By switching the feeders the amount of pick-up can be increased from one side of the aerial to the other, so that the beam aerial, in addition to being rotary, can be made bi-directional.

When interference is being experienced, this type of aerial can be very useful, for it will only pick up signals in one direction at a time, so that if the interfering signal is in the opposite direction to the received signal then the interference will be reduced to the absolute minimum. This aerial can

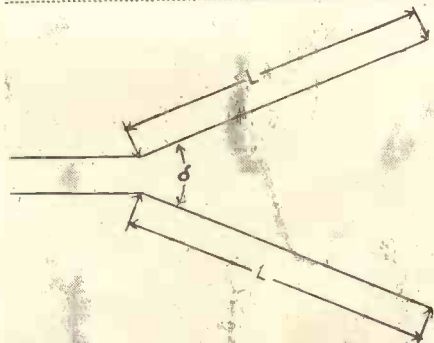

Fig. 12.—For those who have limited space, the inverted V has many advantages.

be constructed for television or 5-metre reception by merely modifying the lengths shown in Fig. 7.

Most of the long-distance ultra-short wave records in this country have been made by Hylton O'Heffernan, who uses

the aerial system shown in Fig. 8. The receiving aerial, with which we are mostly concerned at the moment, is on the left-hand side, and is a comparatively large Franklin aerial for reception consisting of three half-waves in phase, with a three half-wave reflector, so as still further to increase broadside reception and to prevent as much as possible pick-up in the opposite direction. This aerial is, without question, one of the most efficient for long-distance ultra-short wave reception providing it is possible to erect it in the correct direction.

Also in Fig. 8 is shown a Diamond aerial which is mainly used for transmitting. It does, however, offer very great possibilities for highly directional ultra-short wave reception and for that reason is finding favour amongst the more advanced experimenters in this country.

The dimensions shown are for 5-metre operation, and these lengths will have to be increased in proportion for 7 or 10-metre use. Pick-up is greatest across the Diamond from the direction of the point of feeder connection, so that unless the aerial can be erected so that the point of connection is directed at the station it is wished to receive, the arrangement will be useless.

The length of feeder is immaterial, but it should be arranged so that the aerial is as high as possible and that the feeder is in free space as much as possible.

For those who wish to use low-impedance cable, then a matching system must be employed, as indicated for Fig. 3, after which any type of feeder can be correctly terminated.

The folded Bruce aerial is a very satisfactory substitute for the Diamond and has the added advantage that a long length of wire can be erected in a comparatively short space. It can be seen from Fig. 9 that this aerial consists of seven folded quarter-waves beginning and terminating in eight wave sections. Again, a matching section is required in order to obtain the correct terminating point for the feeder line, and this should be connected as indicated.

As it is not always convenient to centre feed an aerial, many amateurs utilise a half-wave end-fed aerial with matching section. This is shown in Fig. 10. The top length is obtained from the formula previously given for half-wave aerials, while the total length of the matching section is slightly more than half-wavelength. Here again, any impedance feeder can be used providing it is connected at the proper point of impedance on the matching section. This aerial is most suitable for broadside reception, and it is essential that on ultra-short waves it be erected in a

position so that it is broadside to the stations to be received.

As would be expected, the horizontal V aerial, as shown in Fig. 11, is highly efficient and perhaps provides the greatest possible pick-up on ultra-short waves. The sides of this aerial should be at least one wavelength long in order to obtain adequate directivity, and if the wires are made several wavelengths long, then the angle of pick-up decreases in proportion. For example,

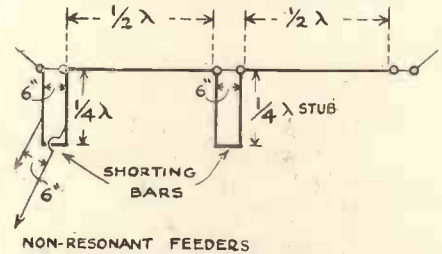

Fig. 13.—Another broadside arrangement which has a very high gain over the conventional di-pole.

if used on 10 metres or more accurately 28 Mc., one wavelength sides call for an angle of 104 degrees, two wavelengths, 75 degrees, four wavelengths, 52 degrees, and eight wavelengths 39 degrees. Experimenters at a considerable distance from station could, by using eight wavelengths, greatly increase the possibilities of long-distance reception by decreasing the angle of pick-up in this way.

As the horizontal V takes up a considerable amount of space at eight wavelengths, a variation is the inverted V which is a typical receiving aerial for ultra-short waves. It has the advantage of being more or less resonant over a wide band of wavelengths so that it does not have to be so accurately cut as the horizontal V. Maximum reception is in the direction away from the feeder lines. The inverted V has a gain of seven times at 10 metres over a normal half-wave aerial, and on this wavelength and below, can be erected in even the smallest garden. For long-distance reception it can be mounted on a pole which is in turn fixed to a high

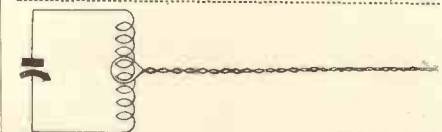

Fig. 14.—Non-resonant lines should be terminated at the receiving end in a coupling coil in this manner.

chimney-stack, or at any point where the feeder lines are of not too great a length. It offers considerable advantages for long-distance television reception and typical dimensions are as follows. Assuming the height of the mast from D to B is 40 ft., the length of wire ABC should be approximately

(Continued on page 703)

With the Amateurs

By G5ZJ.

This new feature is in response to requests from our amateur readers and we should appreciate information from radio societies for publication each month.

OWING to abnormal sun-spot activity conditions on the shorter wavelength bands are at the moment worse than I have ever known them for many years; they account for the comparative lack of signals, both amateur and commercial. Those listeners who have written to me complaining of complete fade-out on 20 metres will be glad to know that this is due not to their receivers, but to poor

kinds. Until just recently, however, D4ZMI has been working extensively on 80 metres with an input of 15 watts. The transmitter is an electron-coupled oscillator using a type 59 valve, which can double into 40 and 20 metres. The final valve, when using high power, is an RK25 with an input of 45 watts on 40 metres, and 40 watts on 20 metres. This transmitter can be seen in the photograph on this page which also in-

An Italian Ban

At the moment, however, German stations are temporarily off the air, in company with the Italians. Although there has been an official ban on Italian transmitting stations for some time there has been a number of Italian amateurs on 20 and 40 metres, who have been picking their own call signs. In a letter just received from a prominent Italian amateur I am told that in the north of Italy the official ban is now being exercised more thoroughly, so for the time being Italian amateurs must confine their activities to a receiving set.

W8CPC

For those who are interested in high-power transmission W8CPC must surely be a model station. It is operated by Burton T. Simpson, from Buffalo, New York, and is mainly on 20 metres.

The aerial in use is one of the now famous signal squirter which is rotary and consists of quarter-wave sides. In this way the transmitted beam can be concentrated into one particular area, so giving greatly increased field strength. An H.R.O. receiver is also in use at this station, and coupled to the transmitting beam aerial, so that as a general rule any stations that can be heard can be worked, and vice versa.

The illustration of this station is most interesting, for it shows, looking from left to right, the 10, 20, 40 and 80 metre transmitters with the receiving bay on the extreme right. A crystal microphone is in use, a practice that seems to be more or less universal in America.



This is the 10 and 20-metre station operated by Dorothy Hall under the call-sign W2IXY. Listening stations can always be assured of receiving a QSL card from W2IXY.

conditions generally. There is, however, every indication that by the middle of November conditions will be more or less back to normal.

A Popular 20-metre Station

Very few amateurs can have failed to hear W2IXY on 20 or 10 metres. This station, operated by Dorothy Hall, is one of the most consistent American amateur transmissions heard in this country, and the schedule between W2IXY and VU2CQ in Bombay has been carried on for many months. At the moment this transmitter operates with an input of 90 watts, but in normal circumstances the input is increased to 230/250 watts with high level modulation.

Some idea as to the layout of the station can be obtained from the illustration in this page, where the transmitter, H.R.O. receiver, monitor, barometer and crystal microphone are shown. All reports to this station are acknowledged, providing International Reply coupons are sent, and the QSL card is quite an asset to a receiving station.

D4ZMI

German stations are not too happy at the moment for there is a temporary bar on amateur transmitting of all

cludes a monitor wavemeter and a tuned R.F. receiver for 20, 40 and 80 metre operation.

An ingenious system of switching with indicator lamps enables the high and low-tension voltage to be switched from the transmitter to the receiver through suitable resistances, contact being indicated by a red lamp for high tension and a white lamp for low tension.

The aerial in use is a conventional Zepp of 39 metres length with feeders 19.5 metres long. Power supply is 500 volts full-wave rectified for the P.A., 350 volts for the crystal oscillator and doubler, 250 volts for the receiver and monitor, and half-wave rectified 200 volts for grid bias. Those who have heard the note of D4ZMI will be interested to know that a valve keying system is always used with a bug key.

To obtain a licence in Germany one must be a member of D.A.S.D., and must at first have experience of short-wave listening in the same way as our B.R.S. listeners. D4ZMI was originally listening station, DE2280. After approximately one year a transmitting licence can be obtained after an examination by post has been passed. This examination costs 3.50 marks followed by a licence fee of 2 marks per month for 50 or 100 watts, but it is particularly difficult to obtain a 100 watt licence.



Those who operate on 80 metres and are keen on C.W. should contact this German station, D4ZMI, who is consistently heard in this country.

Ultra-short Waves in Belgium

Switching is carried out by means of a master switch linked with a number of relays which can be seen in the bottom right-hand corner of the photograph. Also in this photograph can be seen the portable transmitter that covers four wavebands and which has been heard in this country on 10 and 20 metres.



W8CPC in Buffalo, uses high power on 10, 20, 40 and 80-metre bands. A rotary beam aerial is used in conjunction with these transmitters.

U.H.F. in Belgium

Ultra-short wave transmissions, including the signals from Alexandra Palace, have been picked up by ON4AP, in Belgium. This station uses a straight ultra-short wave receiver with an Acorn R.F. pentode fed by a rotating beam aerial which is illustrated in this page. The transmitter, which is used on 10, 20, 40 and 80 metres, has already worked all continents on phone and C.W., while some long-distance work has been carried out on 2.5 and 5 metres. The transmitter and receiver for these two bands is on the right of the illustration.

ON4AP is wishing to make schedules for ultra-short wave check work, and if any station would like to co-operate, would they please drop a card to ON4AP, the address being 23 Rue Basse, Audenaerde, Belgium.

The number of pirate stations seems to be in the increase, and the latest station to be subjected to this trouble is G8KA, operated by G. E. Clarke, of The Abbey, Cranbrook, Kent. The genuine G8KA operates only very rarely and has not been on the air for some time, while the pirate station has been reported on 6965.21 kcs. Would anybody hearing a transmission that is signed with G8KA please send a report to the address given above.

With the winter months activities in this country are greatly on the increase, particularly amongst the amateur societies in this country. I strongly advise interested amateurs to join their local society, for the social side of amateur radio is quite as important as the purely technical and experimental aspect. Here are but a few of the societies which are particularly active.

The *Bideford and District Short-wave Society*, whose headquarters are at Mignonette Walk, Bideford, have arranged an interesting programme for the coming season. This includes an installation of a transmitter, morse classes, practical lectures and demonstrations, and also some hints on general con-

struction. The new president is Mr. A. J. Forsythe, G6FO, who many readers will remember as a contributor to this journal. The secretary would be glad to furnish further information on this society.



A typical European station is ON4AP, who is mainly interested in ultra-high frequency work. His 2.5 and 5-metre receiver and transmitter can be seen on the right of this photograph.

Gerald Marcuse, G2NM, is the president of the new *West Sussex Short-wave and Television Club*. At the last meeting held on Tuesday, October 5, a lecture was given by the president on his past experiences, commencing in pre-war days. Club nights are Thursdays from 8 p.m. until 10 p.m., and the next meeting takes place on November 2, at 8 p.m. Full information can be obtained from the Hon. Secretary, Mr. J. Williams, 2BBB, H.Q. Flight, 43 (F) Sqdn. R.A.F., Tangmere, Sussex.

Readers in the vicinity of *Leicester* who are interested in amateur radio, should drop a line to Talbot Cribb,

2BHT, at 55 Knighton Drive, Leicester. Amongst the members are G6VD, G6JQ, G5ZP, G8VA, G2XD and G2CZ. The activities of this society include 5-metre transmission, short-wave transmission and reception, home-recording and high quality reproduction. Meetings are being held on Tuesdays at 8 p.m. at Winn's Turkey Cafe, Granby Street, Leicester. The next dates are November 2, November 16, when G6GO is to be the lecturer, November 30, and December 14.

Exeter

At the last meeting of the *Exeter and District Wireless Society* there was a talk and demonstration by Dr. Wroth on high-frequency apparatus, after which members were taken to the Royal Devon and Exeter Hospital to inspect the apparatus in use there. Meetings of this society are held at 5 Dix's Field, and information can be obtained from the secretary, Mr. Ching, at 9 Sivell Place, Heavitree, Exeter.

A society of interest to London readers is the *Battersea and District Radio Society*, who meet on Tuesday and Friday of each week at the Battersea Men's Institute, Latchmere Road, S.W.11. A morse instruction class is held, while a new short-wave receiver will shortly be in use at the Club Room. Particulars are available from S. H. Harris, G5SH, at the above address.

One of the oldest societies in the country is the *Eastbourne and District Radio Society*, which has just started its winter session. For the absolute beginner they are introducing a series of interesting talks with practical examples, while the transmitting and more advanced amateurs will find much to interest them. Full details can be obtained from the Hon. Sec., Stewart Thorpe, at 74 Brodrick Road, Hampden Park, Eastbourne.

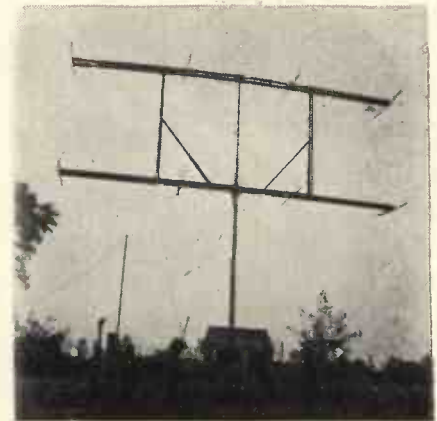

Much of the success attained by ON4AP must be attributed to this beam aerial. Signals from Alexandra Palace have been heard on a straight receiver.

Programme Pointers for Short-wave Listeners

By A. C. Weston

SHORT-WAVE programmes as far as Europe is concerned had a very bad set-back during the end of September and the early part of October owing to the extraordinary bad conditions which prevailed on practically all



Ozzie Nelson and Harriet Hilliard re-open the Bakers' Broadcast for the fifth year. This programme can be heard over NBC blue network each Sunday at 12.30 a.m. (NBC photo.)

commercial wavebands. Listeners with large receivers were able to hear stations fairly consistently, but fading and a high noise level prevented most programmes being of entertainment value.

A host of letters received from listeners indicate that in several parts of the country there was complete fade-out for several days at a time when nothing but European stations could be heard. However, this bad period now seems to be passing over and reception conditions are returning to normal. During November I anticipate that the



"Love and Learn," heard Mondays to Fridays at 5 p.m. over W3XAL, introduces Florence Freeman.

afternoon and early evening stations on 16 and 19 metres will be of particular interest, while the 31-metre band should be carefully watched after 9 p.m.

Although W2XAD is perhaps my most popular station, I have found that W2XAF, which relays the same programme during the overlapping period, very often provides a stronger signal, so this point should be borne in mind.

NBC station, W3XAL, on its 16 metre channel, is now becoming a true international broadcaster, for its programmes, when transmitted on a two-directional beam aerial, have been heard in such places as China, India, Afghanistan, Turkey, Palestine, Straits Settlement, Nigeria, Rhodesia, Somaliland, South Africa, Australia, and New Zealand.

W3XAL, which is on the air for sixteen hours a day, uses English, French, German, Spanish, Italian and Portuguese, and during the day carries the best of the NBC blue and red networks, so that listeners hear the pick of the programme transmitted by W2XAD, W2XAF and W8XK.

For this reason concentrate on



John Barrymore in streamlined versions of Shakespeare can be heard each Monday night over NBC blue network.

W3XAL during the next month and just see whether or not better and more consistent short-wave listening does not result. This station is on the air from 2 p.m. until 1 a.m. on a wavelength of 16.8 metres.

Most Sundays at 4.30 p.m. brings the Green Brothers Orchestra which is always well received owing to the fact that a directional beam aerial is in use. The most popular American short-wave broadcast comes on the air at 7 p.m. every Sunday, and is the well-known Magic Key, which differs in make-up each week.

Marion Talley, at 10 p.m. each Sunday is also another popular broadcaster, while a new item which is as yet unknown to the majority of European listeners, is Ernest Gill and his Orchestra at 11 p.m. every Sunday.

There is no need to remind listeners about Jack Benny at midnight.

From Washington, at 11 p.m. most Mondays, is a relay for 30 minutes of the U.S. Army Band, and this is usually well received. The Barry



Jack Benny and Mary Livingston, with Kenny Baker and Don Wilson, who resume their broadcasts at midnight each Sunday over NBC red network.

McKinlay broadcast has been retimed and is now on the air at 5.30 p.m. on Tuesdays. The N.B.C. Music Guild, which during the course of the year covers all types of play, have 30 minutes at 7.30 p.m., also on Tuesdays. String Time, directed by Jack Meakin, has produced a huge quantity of fan mail from England, so proving the popularity of this broadcast. It is timed for 11 p.m. also on Tuesday evenings.

For those who are able to listen in the afternoon, hear the Honeymooners at 3 p.m. or Joe White at 5.45 on Wednesday. Continental Varieties, which



Internationally famous stage and screen star, Ina Claire, is now being featured with Osgood Perkins over NBC station W3XAL.

include Celia Branz, are a regular listing at 8.30 p.m. each Wednesday, while Harry Kogen and his Orchestra provide Dinner Music at 11 p.m.

Class B Amplifier Design

In view of the increasing interest in Class-B amplifiers, we publish this comprehensive survey of the fundamental principles. We are indebted to Taylor Tubes Incorporated, of Chicago, and to Earl I. Anderson, W8UD, for this information

A REVIEW of the principles involved in Class-B operation seems to be in order because a knowledge of the fundamental principles is essential if proper operation is to be realised. This is particularly true if the voltages or tubes, or both, are not the ones specified in the operating data furnished with the transformers. The amateur is usually forced to use as much of the equipment at hand as possible when changes are made. He can not always, for example, purchase new power supplies if the ones at hand deliver voltages slightly higher or lower than the optimum values. Nor does he wish to purchase new Class-B transformers when he replaces his modulator tubes with other types, if it is at all possible to use the ones he has.

On the other hand, it is extremely important to have the audio equipment working properly. Harmonic content or distortion must be kept at the absolute minimum. Every one wishes flat frequency response, yet frequency response from an amateur standpoint should be a secondary consideration to low harmonic content. A signal with low harmonic content, whether it has wide-range frequency response or not, will occupy only the minimum amount of territory necessary for voice communication, but a station with high harmonic content will spread and splash into adjacent channels and unnecessarily interfere with other signals. Even if an amateur did not care particularly how good his quality might be, he would owe it to other amateurs to keep his signal as clean as possible—and any improvement in this respect will necessarily improve the quality.

In speaking of distortion, we do not refer to frequency discrimination, but to distortion of the wave form. Such distortion results in the generation of frequencies which are harmonics or multiples of the input frequency. Harmonics may be kept at a minimum if all of the tubes in the speech equipment are operating under proper conditions. They may originate in the low-level speech equipment as well as in the modulator stage, but improperly-operated modulators—and this applies to Class-A as well as Class-B—are chiefly responsible in so great a proportion of the cases that the factors involved are worthy of the consideration of every amateur.

Transformer Operation

Except for over-modulation, the commonest source of distortion is an overloaded modulator or one where the reflected load impedance is incorrect. Many amateurs seem to have a mis-

taken conception of the operation of an audio transformer. Audio transformers act exactly as do power transformers. The principles are exactly the same although, of course, the requirements are different. Perhaps this fact has been overlooked because power transformers are rated in terms of voltage, and current, while audio transformers are spoken of in terms of impedance or impedance ratios. It is sometimes assumed that if the secondary of an output transformer is marked 2,500, 5,000, 10,000 ohms or some other value, that the secondary is of that definite value regardless of any other consideration;



This is the Taylor T-555 carbon anode triode for R.F. or audio work. As an audio amplifier the output for two values is 250 watts with 1,500 volts H.T.

and if that secondary is terminated in a load of any other resistance or impedance, there will be a loss in power or fidelity. In other words, there will be a mismatch between secondary and load.

Such is not the case. There is never any mismatch between secondary and load nor without any other qualifications is the impedance of the secondary the value marked on the secondary. If the primary is open and the secondary impedance measured, it should theoretically be infinity, and in any event will be many times the value marked on it. What the transformer manufacturer is trying to say is that with the specified modulator tubes, operating at the specified voltage, the secondary should be terminated in a load whose resistance or impedance is the modulator plate voltage is higher or lower, or if more or less output is required, the value probably would be different.

The purpose of a Class-B output transformer is to take the power developed by the modulators which has a certain ratio of voltage to current, and change it to the ratio of voltage and current required at the secondary. If this ratio is correct it is said that the impedances are properly matched, because the ratios are expressed in terms of impedance. Under these conditions the power efficiency of the modulator will be the maximum obtainable with low distortion. If the ratios are not correct, one or more undesirable effects, discussed later, will be evident.

Transformer Design

The primary reflected load impedance depends upon the turns ratio of the transformer and the value of the impedance or resistance in which the secondary is terminated. If we had a transformer with the same number of turns on both primary and secondary, the turns ratio would be 1 to 1 and the impedance ratio would also be 1 to 1. If we were to measure the impedance of either winding with the other winding open, the impedance would be some very high value; but if we connected a 5,000-ohm resistor across the secondary and then measured the primary impedance we would find it to be 5,000 ohms also.

If the resistor across the secondary were changed to 2,500 ohms, the primary impedance would also be 2,500 ohms. When the transformer had twice as many turns on the secondary as on the primary, the turns ratio would be 2/1, or 2, and since the impedance ratio is the square of the turns ratio, the impedance ratio would be the square of 2, or 4. In this case, if we put a 5,000-ohm resistor across the secondary and measured the primary impedance it would be one-fourth of 5,000 or 1,250 ohms. Similarly, if we put a 10,000-ohm resistor across the secondary, the primary impedance would be 2,500 ohms. We are assuming that there are no losses in the transformer, a permissible assumption because in well-designed units the losses are small enough to be ignored in making the necessary calculations.

The arrangement in Fig. 1 is the circuit for all Class-B tubes. The components and operating potentials are varied to suit the tubes, but the circuit stays the same. The tubes are biased to cut-off, or nearly so. So far as audio is concerned, the centres of both input and output transformers are at ground potential. If a.c. is applied to the primary of the input transformer, at any given moment the phase of the voltage

Impedance :: Matching

applied to tube A will be opposite to that applied to tube B. For instance, when tube A is being driven positive, tube B is being biased further negative, and being cut off entirely. On the other half of the cycle, tube B is driven positive and tube A is cut off entirely. From this it may be seen that only one tube need be considered when making the necessary calculations.

So far as the tube is concerned the primary of the output transformer is a resistance, so the circuit for one tube might be drawn as shown in Fig. 2. A certain proportion of the supply voltage may be developed across R_p . It is impossible to develop all of the supply voltage across R_p because some voltage

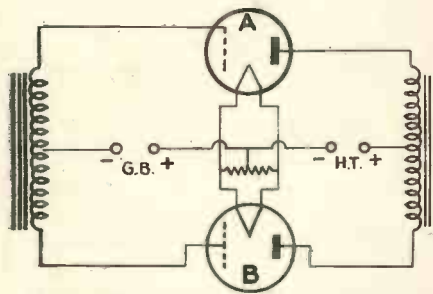

Fig. 1.—The essential class B amplifier circuit.

is required at the plate of the tube to attract enough electrons from the filament to permit the necessary plate current to flow. Also, the grid must never become positive with respect to the plate. In general, approximately 80 per cent. of the applied voltage may be developed across R_p . The power developed will depend upon the current as well as the voltage and may be calculated by

$$(I_{pmax})^2 \times R$$

2

where I_{pmax} = peak plate current to one tube

R = reflected load impedance to one tube (one-fourth plate-to-plate value)

We can also calculate according to the following expression, substituting ER_p (peak developed voltage) for R

$$(I_{pmax}) \times (Er_p)$$

2

Assume that the plate-supply voltage is 1,000 and that the drop across the tube is 200 volts. This would permit a development of 800 volts peak R_p . Also assume that the maximum recommended peak plate current is 0.5 ampere. $800/0.5 = 1,600$ ohms reflected load impedance for one tube. The correct plate-to-plate load would be four times that value, or 6,400 ohms. The audio output would be

$$\frac{0.5^2 \times 1,600}{2} = 200 \text{ watts}$$

2

There is a very big drop in output if the wrong load is used, say 2,500 ohms per tube instead of 1,600. With 800 volts across 2,500 ohms, the peak plate current would be $800/2,500$ or 0.320 amp.

$$\text{Power} = \frac{0.320^2 \times 2,500}{2} = 128 \text{ watts audio output}$$

From this it should be obvious that if the reflected load impedance is too high, the amount of power obtainable without distortion will be reduced.

On the other hand, suppose the reflected load impedance is lower than the optimum value of 1,600 ohms—say 1,200 ohms—and we require 200 watts of audio. Using the formula and solving for the unknown, we have

$$\begin{aligned} (I_{pmax})^2 \times 1,200 &= 200 \text{ watts} \\ (I_{pmax})^2 &= \frac{200}{600} \\ (I_{pmax})^2 &= 0.333 \\ I_{pmax} &= 0.577 \text{ amp.} \end{aligned}$$

With the correct value of reflected load impedance the peak plate current was only 0.5 amp., but now 0.577 amp. is necessary for the same output. As we mentioned previously, the recommended maximum peak plate current for this hypothetical tube was 0.5. The extra 77ma. of peak plate current may introduce distortion and shorten tube life. In addition, the plate dissipation will be increased. In the previous case, with 800 volts developed across the plate load and a peak current of 0.5 amp., the plate dissipation at peak plate current would be 200×0.5 or 100 watts. In the second case, we are developing $0.577 \times 1200 = 692$ volts and the plate dissipation at peak plate current would be $308 \times 0.577 = 178$ watts. If plate dissipation is one of the limiting factors the tube will be badly overloaded.

The Importance of Impedance Matching

This should answer the often-asked question of how important it is to match impedances. The situation may be summarized by saying that if the reflected load impedance is too high, the maximum power output without distortion will be reduced, although the efficiency will be good and the harmonic content low. If an attempt is made to obtain more power with excessive drive to the grids distortion will increase tremendously.

The peak output, which is the important consideration in modulation, will not increase greatly but the average power may be increased considerably because of alteration of the waveform. For this reason, even though it may be impossible to obtain enough peak power to modulate 100 per cent., it may appear from the action of the meters that

the capabilities of the modulators exceed 100 per cent. modulation if no facilities are available for examining the waveform. The spurious frequencies due to the distortion will also make it appear at a receiving point as though the signal were over-modulated when, in fact, the voltage output from the modulator is insufficient to swing the carrier from zero to twice its unmodulated value—the requirement for complete modulation.

When the reflected load impedance is too low the situation is about as bad. The power efficiency of the modulator stage is reduced and the plate dissipation increased. If, in attempting to develop the necessary power and voltage, it is necessary to drive the plate current of the tube to a point where the filament emission is exceeded, the distortion will be high and tube life will be shortened. The effects of the distortion will be the same as if the reflected load impedance were too high, and it may or may not be possible to modulate 100 per cent.

In general, a variation of approximately 10 per cent. from the optimum value is about the maximum permissible for best performances.

It is important to remember that the optimum value of reflected load impedance varies with the output desired and the applied voltage. For example, for an audio output of 200 watts from a pair of 203-A's with 1,000 volts on the plates, optimum performance would be secured with a plate-to-plate load of 6,900 ohms. If only 100 watts of audio were required, the optimum plate-to-plate load would be twice that value of 13,800 ohms. If 200 watts were desired and the plate voltage were 1,250, the optimum value of reflected load impedance would be 11,800 ohms.

Because there are so many variables and because the consequences of im-

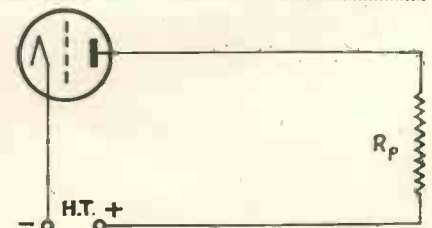

Fig. 2.—Equivalent circuit of one Class B valve. The load resistance R_p is one-fourth the anode-to-anode load.

proper operation are so serious in our crowded bands, it is extremely important that each amateur be able to make the necessary calculations. Fortunately these are easily made with the simplest of mathematics. Knowing the optimum value of reflected load impedance for the available plate voltage and desired

(Continued on page 692)

SENSITIVITY SUPREME

S. G. Brown

SUPERIOR HEADPHONES



Type "A" (Adjustable Reed)

THE SENSITIVITY, FREQUENCY RESPONSE and REALITY of REPRODUCTION, are POSITIVELY AMAZING AND UNSURPASSED.

These headphones are generally recognised as the finest and MOST sensitive in the World. Signals are radiated from a Spun Aluminium Diaphragm, which is attached to an adjustable reed accurately tuned to 900 C.P.S.

It is often found that signals are received at excellent volume and quality, which are INAUDIBLE or UNINTELLIGIBLE with OTHER MAKES AND TYPES.

PRICE **50/-** PER PAIR

ANY RESISTANCE

ALSO

Type "D"
35/-

Type "F"
20/-

THERE ARE OTHER HEADPHONES on the market to-day, which sell because they are low in price. That does not mean they are cheap.

BROWN'S Headphones now as always, are precision built from the finest materials, and are individually tested and adjusted to the very high standard of perfection which characterises all products of S. G. BROWN LTD.

These instruments are essential for perfect results on the Short Wave Bands.

S. G. BROWN LTD., Victoria Rd., Acton, W.3.

ACO 1174

PREMIER RADIO

**SUPPLY
STORES**

3 NEW

PREMIER TRANSMITTERS

10 watt A.C./D.C. C.W. Transmitter. Pentode Crystal Oscillator. Low crystal current. Minimum frequency drift. Price, complete with Valves, Crystal and Key, £4 4s.

10-watt 'Phone Transmitter (as illustrated). 6L6G exciter. Regenerative Crystal Oscillator Doubler. 802 Pentode Amplifier with Suppressor Grid Modulation. Price complete with 4 Tubes and Crystal, £15.

25-watt 'Phone Transmitter. 6L6G exciter Regenerative Crystal Oscillator Doubler. 801 Triode Amplifier. Grid neutralised grid and anode meters. Price complete with 6 Tubes and Crystal, £21. **H.P. TERMS TO SUIT YOU**



MICROPHONES

Premier Transverse Current Mike 20/-
Premier Moving Coil Mike 42/-

**AMERICAN MICROPHONE CO.'S
PRODUCTS**

Crysta Mike £3 7s. 6d.
Moving Coil Mike £5 5s. 0d.
Lapel Mike £1 2s. 6d.
Crystal Lapel Mike £3 19s. 6d.
Hand Mikes from £1 2s. 6d.

PREMIER L.T. TRANSFORMERS

Primaries tapped 200-250 volts. Tested 1,000 volts.
2.5 volts 8 amp., C.T. 8/6
4 volts 3 amp., C.T. 8/6
4 volts 5 amp., C.T. 9/6
5 volts 3 amp., C.T. 8/6
6 volts 2 amp., C.T. 8/6
6.3 volts 3 amp., C.T. 8/6
7.5 volts 3 amp., C.T. 8/6
5 volts 3 amp. + 6.3 volts 3 amp. 10/-
5 volts 3 amp. + 2.5 volts 8 amp. 14/6

Tested 2,000 volts.
10 volts 3-4 amp., C.T. 14/6
14 volts 4 amp., C.T. 14/6
2.5 volts 5 amp., C.T. 11/6
2.5 volts 10 amp., C.T. 12/6

PREMIER ALL-WAVE SUPERHET COILS
13-2,000 metres in 3 bands, 465 kc. Pair of Coils with switch and 5 valve, A.C. circuit, 17/6. Suitable I.F. Transformers, 3/11 each.

RESISTANCES

1 watt wire end, all values, 6d. each.
4 watt wire wound, up to 50,000 ohm, 1/- each.
8 " " " " " " " " 1/6 " "
15 " " " " " " " " 2/- " "
25 " " " " " " " " 2/6 " "

Potentiometers, all values, 2/- each. With switch, 2/6 each.

**TAYLOR TRANSMITTING
TUBES**

T.20 ... 17/6 203A. ... 72/-
T.55 ... 45/- 203B ... 72/-
825 ... 27/6 866 ... 11/6
841A. ... 40/- 866B. ... 17/6
866JR. ... 7/6

PREMIER METERS

Moving Coil 0-1 m/A. full scale, resistance 100 ohms, 3½ in. diameter, flush mounting, 22/6.

Multipliers, 1/- each. Tapped shunts: -10, -50, -100, -200 m/A., 4/- each.

Moving Iron Meters, 2½ in. diameter, flush fitting. Read A.C. or D.C. All readings from 0-10 m/A. to 0-10 amps., 5/9 each. 0-6 volts, 0-16 volts, 5/9 each. 0-250 volts, 8/6.

Telsen Multimeters. Read A.C. or D.C., 0-6 volts, 0-16 volts, 0-250 volts; 0-30 m/A., 0-300 m/A., 8/6 each.

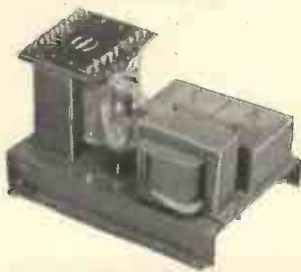

POWER PACKS

Completely assembled on steel chassis. Finest components.

Outputs:

120 volts 20 m/A. 25/- Westinghouse Rectification.
150 volts 30 m/A. 27/6 " " "
250 volts 60 m/A. 33/- " " "
300 volts 60 m/A. 37/6 " " "
150 volts 30 m/A. 17/6 Valve Rectification.
350 volts 120 m/A. 40/- " " "
500 volts 200 m/A. 65/- " " "
1,000 volts 250 m/A. £5 " " "
1,500 volts 200 m/A. £6 10s. " " "
2,000 volts 150 m/A. £7 " " "

MODULATION TRANSFORMERS

Primary and secondary impedance to your requirements.

10 watts ... 14/-
25 watts ... 18/6
50 watts ... 26/-

SWINGING CHOKES

Designed for use immediately after Mercury Vapour Rectifier.

250 m/A. 80 ohm, 2,000 volts insulation 10/6
150 m/A. 160 ohm, 3,000 volts insulation 18/-
500 m/A. 100 ohm, 4,000 volts insulation 15/-

PREMIER QUARTZ CRYSTAL

Certificate of actual frequency sent with each crystal, plus or minus 1 per cent. Accepted by licensing authorities as evidence of accuracy of calibration. 1.75 mc., 3.5 mc., and 7 mc. Band Crystals.

Standard Type Up to 300 volts anode, 15/-
Power Type. Up to 500 volts anode, 20/-

Open holders, 4/6 each. Closed type, 8/6 each.

CONDENSERS

U.S.A. Wet Electrolytics:
8 mfd. 450 v. ... 1/9
8 + 8 mfd. 450 v. + 8 mfd. ... 2/6
250 v. ... 2/6
8 + 8 mfd. 500 v. + 4 mfd. ... 2/9
250 v. ... 2/9
8 + 8 mfd. 475 v. + 10 mfd. 50 v. ... 2/6
4 or 8 mfd. 320 v. ... 1/6
8 + 8 mfd. 320 v. ... 2/-
Oil Filled—4 mfd. 1,000 v., 10/6; 4 mfd. 2,000 v., 14/-

Dubilier:
8 mfd. or 4 mfd. 500 v. ... 2/6
8 + 4 mfd. 500 v. ... 4/-
8 + 8 mfd. 500 v. ... 5/-
8 mf. 450 v., wet ... 2/3
T.C.C. 8 mfd. 650 v., dry 4/-

Mansbridge:
4 mfd. 500 v. ... 4/-
4 mfd. 800 v. ... 6/-

DIALS

Utility 2-speed micro dial, ratio 100:1, listed 8/6. Our price, 3/9.

Premier Full Vision All-Wave 2-speed dial, 10:1 and 150:1, 5/9.



HAND TELEPHONE

Highly sensitive. Suitable ultra S.W. transmitters, strong, good quality speech, switch in handle, 6/6 each.

PREMIER SMOOTHING CHOKES

Heavy duty.
25 m/A. 20 hy. 500 ohm ... 2/9
40 m/A. 30 hy. 500 ohm ... 4/6
60 m/A. 40 hy. 300-500 ohm ... 6/6
80 m/A. 30 hy. 350 ohm ... 7/6
150 m/A. 40 hy. 200 ohm ... 11/6
250 m/A. 40 hy. 200 ohm ... 21/-
Speaker Field Replacement Choke.
60 m/A. 40 hy. 2,500 ohm ... 6/6

MOVING COIL SPEAKERS. All fitted with Output Transformers.

Magnavox Mains Energised:
DC.154, 7-in. cone, 2,500 ohm, handle 4 watts 15/-
DC.152, 9-in. cone, 2,500 ohm, handle 5 watts 19/6
DC.152, Magna, 9-in. cone, 2,500 ohm, handle 7 watts 37/6

Magnavox P.M.'s:
P.M. 254, 7-in. cone, 16/6; P.M. 252, 9-in. cone, 22/6; R. & A. Energised, 7-in. diameter, 2,500 ohm or 1,350 ohm, 10/6; larger model, 8 in. diameter, 12/6.

Rola, latest type, 8-in., P.M.'s, 15/-
Celestion Soundex, 6½ in., P.M., 10/6.
B.T.H., 10-in. energised, hefty 1,600 ohm pot, handle 8-10 watts, 14/6.



SHORT WAVE COILS

Low-loss interchangeable coils, 4- or 6-pin standard and other fittings.

12-26 metres 1/9 41- 94 metres
22-47 metres each 78-170 metres
Other wavebands up to 2,000 metres from 2/-.

S.W. Coil Formers as used in above coils, 2 1/2 in. long 1 1/2 in. diameter, 4-, 6- or 7-pin fitting. Plain or threaded, 1/- each.



OUTPUT TRANSFORMERS

Secondaries tapped for 7 ohm and 15 ohm speech coils.

Push-Pull PX4's	...	12/6
" " PX25 or 25A's	...	21/-
" " 6B5's	...	12/6
" " 6L6G's (30 watts)	...	21/-
" " 6L6G's (60 watts)	...	25/-
Power or Pentode	...	2/6
Multi Ratio	...	5/9

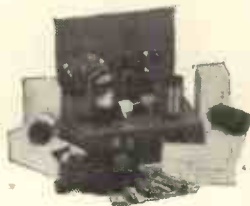

PREMIER 1938 SHORT WAVE KITS

3-Band 1 valve S.W. Receiver or Adapter Kit, 13 to 86 metres without coil changing. Complete Kit and wiring diagram, with 2-volt Valve, 12/6.

2-Valve S.W. Kit, det. and LF, 13-86 metres, with two 2-volt Valves, 19/6. S.W. Superhet Converter Kit, 13 to 86 metres with 2-volt Valve, 15/-.

1-Valve de Luxe S.W. Receiver or Adaptor Kit, 14 to 150 metres. Complete Kit of parts with metal chassis, 4 coils and 2-volt Valve, 17/6.

2-Valve de Luxe S.W. Kit as above, with two 2-volt Valves, 25/-.

3-Valve de Luxe S.W. Kit, S.G., det., Pen. 14 to 150 metres. Complete Kit with three 2-volt Valves, 42/-.

S.W. Superhet Converter Kit de Luxe, 14 to 150 metres, with 2-volt Valve, 20/-.

S.W. Super-het Converter Kit for A.C. receivers, 14 to 150 metres, with A.C. Valve, 22/6.

U.S.A. VALVES

PREMIER are sole British Distributors for **TRIAD FIRST QUALITY HIGH-GRADE VALVES**

Following Types 5/6 each.

01A	6A6	12A7	36	58
1A6	6A7	18	37	59
1B5	6B5	24	38	71A
1C6	6B7	25B5	39/44	75
1V	6C6	25Y5	41	76
2A5	6D6	25Z5	42	77
2A6	6D7	27	43	78
2A7	6E5	30	45	79
2B6	6F7	31	51	82
2B7	6G5	32	53	83
5Y3	6Z4	33	55	84
5Z3	12A	34	56	85
6A4	12A5	35/51	57	89

80, 4/6 each; 210 and 250, 8/6 each; 48, 10/- each; 2A3, 8/- each. All the new Octal Base Glass and Metal Glass Tubes in stock at 6/6 each.

EUROPA 4 VOLT A.C. MAINS VALVES

AC/HL	AC/HF	DH/Pen	} 4/6	20 volts .18 types, all types, 4/6 each.	} 5/6 each.
AC/L	Pen	1 watt			
AC/SG	AC/VM	DH/Pen	} each.	F.W. Rectifiers, 350 volts 120 m/A.	} 5/6 each.
AC/VMS	HFP	4 watt			
				IH, AC Pens...	...
				DDT, PX4	...
					6/6 each.
				Battery Valves, 2 volts, HF, LF, 2/3 each.	Power, Super Power, 2/9.
				VM/SG, 4- or 5-pin Pentodes, HF, Pens.-VM/HF Pens., Class B, 5/- each.	S.G.,



PREMIER HIGH-FIDELITY AMPLIFIERS AND MODULATORS

Premier, 1938, Super 3-Watt Amplifier for A.C. or A.C./D.C. mains. 2-stage, high-gain circuit. Complete Kit, with metal chassis, all parts and 3 matched Valves, 40/-.

Premier 1938 8-Watt Amplifier for A.C./D.C. mains. 3-stage, high-gain, with Push-Pull output. Complete Kit, with metal chassis, all parts and 5 matched Valves, £4 4s.

Premier 1938 12-Watt P.A. Amplifier or modulator for A.C. mains. 2-Beam Power tubes in Push-Pull output, phase inversion high-gain, distortionless output. Complete chassis-built Kit, with 5 matched Valves, £5 5s.

Premier 1938 30-Watt P.A. Amplifier and Modulator System for A.C. mains. Push-Pull R.C. coupled to 2-Beam Power tubes in Push-Pull output, high impedance input. Completely wired and tested with matched Valves, £12 12s.

Premier Mains Transformers.—Screened primaries 200-250 volts. Guaranteed 1 year Wire end types.

HT8 + 9 or HT10 with 4 volts 4 amp., C.T. and 4 v. 1 a., C.T., 10/-.

250-250 v. 60 m/A. or 300-300 v. 60 m/A., with 4 v. 1.2 a., 4 v. 2-3 a., 4 v. 3-4 a., all C.T., 10/-.

350-350 v. 150 m/A., 4 v. 1 a., 4 v. 2 a., 4 v. 4 a., all C.T., 11/6.

350-350 v. 150 m/A., 5 v. 2 a., 6.3 v. 2 a., 6.3 v. 2 a., all C.T., 13/6.

Fitted with Panel and Terminals, 1/6 extra.

500-500 volts 150 m/A., 4 v. 2-3 a., 4 v. 2-3 a., 4 v. 2-3 a., 4 v. 5 a., all C.T., 21/-.

500-500 v. 200 m/A., 5 v. 3 a., 6.3 v. 3 a., 2.5 v. 5 a. or 7.5 v. 3 a., all C.T., 25/-.

500-500 v. 150 m/A., 15/-.

1,000-1,000 v. 250 m/A., 21/-.

1,500-1,500 v. 200 m/A., 50/-.

2,000-2,000 v. 150 m/A., 57/6.

Fitted with Panel and Terminals, 2/- extra.

Surplus Transformers, brand new and guaranteed. Phillips, 250-250 volts or 300-300 v. 80 m/A., 4 v. 5 a., C.T., 4 v. 1 a. Tapped primary 100-250 v., 6/11.

450-450 v. 150 m/A. or 500-500 v. 100 m/A., 4 v. 4 a., C.T., 4 v. 4 a., 4 v. 3 a. Screened primary, tapped 100-250 v., 12/6.

NOW READY

Premier 1938 New enlarged Illustrated Catalogue, Handbook and Valve Manual! Send 6d. in stamps for 90 pages of Valve Data, Technical Articles, Circuits and Premier 1938 Radio.

Orders over 5/- post free, under 5/- add 6d. postage.
All post orders to Jubilee Works, 167, Lower Clapton Road, London, E.5. Amherst 4723
Callers to 165 and 165a, Fleet Street, E.C.4. Central 2833
50, High Street, Clapham, S.W.4 Macaulay 2381



SHORT WAVE CONDENSERS

TROLITUL insulation. Certified superior to ceramic. All-brass construction. Easily ganged.

15 m.mfd.	1/6	Double-Spaced
25 m.mfd.	1/9	Transmitting
40 m.mfd.	1/9	Types.
100 m.mfd.	2/-	15 m.mfd.
160 m.mfd.	2/3	40 m.mfd.
250 m.mfd.	2/6	160 m.mfd.
		2/9
		3/6
		4/6

All-brass slowing-motion Condensers, 150 m.mfd., Tuning, 4/3; Reaction, 3/9.



MORSE SETS. Ideal practice set. Will tap, flash or buzz. Complete with battery and Morse Code, 3/6 each.

PREMIER MORSE KEYS, strongly made, light action. Engraved Morse Code, 2/9 each.

"BUSY BEE" BUZZERS, bakelite cased, strong signal, 1/- each.

LOUD TONE BUZZERS, walnut cased, 2/6 each.



PREMIER ALL-WAVE AERIAL KIT for 15 to 2,000 metres. Complete with matching transformer and weatherproof wire, 15/-.

PREMIER DOUBLET AERIAL KIT includes all parts for first-class Short-Wave Aerial Kit, complete, 10/-.

Theoretical Considerations

(Continued from page 688.)

output, as well as the impedance ratio of the output transformer, it becomes a matter of simple ratio. Assume the optimum value is 10,000 ohms and the transformer is marked 8,000 ohms on the primary and 5,000 on the secondary. The ratio would be

$$\begin{aligned} 10,000/X &= 85 \\ 8/X &= 50,000 \\ X &= 6,250. \end{aligned}$$

Thus the load resistance of the modulated amplifier should be 6,250 ohms. The plate input to the modulated amplifier should be twice the audio output of the modulator.

It is always necessary correctly to determine the proper conditions under which audio valves operate. The most important condition to determine is the load impedance of the modulated amplifier from the impedance ratio of the transformer. Let us use the same hypothetical valves which we previously used as examples. Manufacturers' ratings look something like this.

CLASS-B A.F. MODULATOR.

- Power output (2 tubes), 200 watts.
- D.C. plate voltage, 1,000 volts.
- Load resistance plate-to-plate, 6,400 ohms.
- Max. av. D.C. plate current (2 tubes), 317 m/A.

Peak Plate Current

From this information we wish to get two figures of vital importance which are not given. We want the recommended peak plate current and the drop across the tube at that current. With that information we can calculate the maximum output obtainable at the plate voltage available, together with the optimum reflected load impedance; or, if that output is greater than is necessary, the proper operating conditions for the required output may be obtained.

The peak plate current to one tube may be obtained by dividing the maximum average plate current with sine wave input to both tubes by 0.636. $317/0.636 = 0.5$ ampere. This value should never be exceeded.

The drop across the tube is obtained indirectly by subtracting the voltage developed across R_p from the supply voltage. With a plate-to-plate load of 6,400 ohms the reflected load impedance to one tube would be $6400/4$ or 1600 ohms. With a peak plate current of 0.5 ampere, the peak developed voltage would be 0.5×1600 , or 800 volts. With a supply voltage of 1,000, the drop across the tube, therefore, must be 200 volts. The following formula should be used:

$$\text{U.P.O.} = \frac{(I_{pmax}) \times E_p}{2}$$

Suppose the power supply available

for the modulators delivers only 900 watts.

(Case 1).

$$\text{U.P.O.} = \frac{0.5 \times (900-200)}{2}$$

$$\text{U.P.O.} = \frac{0.5 \times 700}{2} = 175 \text{ watts.}$$

The optimum value of reflected load impedance would be $700/0.5 = 1400$ ohms for one tube, or 5600 ohms plate-to-plate.

If the power supply delivered 1100 watts, the calculations would be

(Case 2).

$$\begin{aligned} \text{U.P.O.} &= \frac{0.5 \times (1100-200)}{2} \\ &= \frac{0.5 \times 900}{2} = 225 \text{ watts.} \end{aligned}$$

The optimum value of reflected load impedance would be $900/0.5 = 1800$ ohms for one tube, or 7200 ohms plate-to-plate. Suppose we had 250 watts



The Tungram P28/500 is a new British valve designed for Class B operation.

input to the modulated amplifier, in which case we would require only 125 watts from the modulator. Assuming a modulator plate voltage of 1050.

(Case 3).

$$\begin{aligned} 125 &= \frac{I_{pmax} \times (1050-200)}{2} \\ 125 &= \frac{850 \times I_{pmax}}{2} \end{aligned}$$

$$I_{pmax} = \frac{250}{850} = 0.294 \text{ amp. peak plate current}$$

$850/0.294 = 2,900$ ohms R_p or 11,600 ohms plate-to-plate. If the turns ratio of the transformer is known, the calculations need not be made in terms of impedance, but may be made directly in terms of voltage ratios. The turns ratio may be taken directly from the impedance ratio and is the square root of the impedance

ratio. A transformer with an impedance ratio from secondary to total primary of $\frac{1}{8}$ would have a turns ratio of $\sqrt{\frac{1}{8}} = \sqrt{0.625} = 0.79$. This ratio is for the whole primary; the ratio from secondary to one-half primary would be $2 = 0.79$ or 1.58.

In experiment 1, we were able to develop 700 volts across R_p , which is half the primary, so the peak voltage across the secondary will be $700 \times 1.58 = 1106$ volts. The modulated amplifier plate voltage will always work out to be 1106 volts so long as the modulator plate voltage is 900 and the same transformer ratio and modulator tubes are used. The modulator will deliver 175 watts of audio so the input to the modulated amplifier could be a maximum of 350 watts. At 1106 volts, the plate current to the modulated amplifier should be $350/1106 = 316$ m/A.

In experiment 2, we were able to develop 900 volts across R_p , or one-half primary. $900 \times 1.50 = 1422$ volts across the secondary. The audio output is 225 watts, so the input to the modulated amplifier may be a maximum of 450 watts. $450/1422 = 316$ m/A. modulated amplifier plate current.

Operating

When making the calculations only one precaution need be observed, namely, that the input to the modulated amplifier must not exceed twice the audio output of the modulator. If more input is applied to the modulated amplifier, the plate voltage and current should be increased in proportion. Of course, 100 per cent. modulation without distortion cannot be realised with appreciably greater inputs. If less input is desired the plate voltage should be maintained at the calculated value, but the plate current may be decreased. This will increase the modulated-amplifier load impedance and also the reflected load impedance to the modulators. However, as the input to the amplifier is reduced less audio is required, and under these conditions the reflected load impedance should be increased, and it will increase in exactly the correct proportion.

Perhaps this will be more readily understood if one considers that for a given tube and value of plate voltage, the developed voltage across R_p will be approximately the same for all values of current below filament saturation, and if the ratio of the transformer is not changed the voltage across the secondary will be the same. This is not strictly true because at lower values of plate current the drop across the tube will be slightly less. The difference is small and need not be taken into consideration for amateur applications.

(Continued on page 694.)

The RADIO AMATEUR'S CENTRE

All items advertised can be delivered from stock and carry guarantee of satisfaction.

R.M.E., Hallicrafters, Harvey, etc. are all co-operating with us whole-heartedly to assure efficient British distribution of their products. Weekly shipments, made direct from the works of R.M.E. and Hallicrafters and a full supply of service spares is carried.

RME69 Crystal Model, 1938, £39 15s. 0d.	RME69 LS1 With noise silencer 1938, £43 10s. 0d.	RME DB20 Pre-Selector, 1938, £12 10s. 0d.
---	--	---

NEW COMPONENTS

McELROY'S STRAIGHT KEY, heavy base and contacts. Delightful action	10/-
McELROY'S HUMMER FOR MORSE PRACTICE : Gives 1,000 cycle note	10/-
Key and Hummer combined	20/-
NEUT CONDENSERS, Transmitting type, 4 and 8 m.mfd., 3,000 volt working	6/-
JOHNSON FEED THRU INSULATORS	each 8d. & 10d.
JOHNSON Q ANTENNAE, 20Q, 39/6 ; 10Q, 26/6 ; 5Q, 27/6	
JOHNSON 50-watt and Jumbo Sockets	6/-
JOHNSON 10-watt Baseboard Sockets	3/-

**AEROVOX 75 WATT AND 200 WATT
ADJUSTABLE RESISTORS**

From 1,000 to 100,000 ohm
75 watt, 6/6. 200 watt, 11/6.

**COMPONENTS FOR "TELEVISION" DESIGNED RECEIVERS
AND TRANSMITTERS**

TAYLOR TUBES—T.55	45/-
TZ.20 and T.20	17/6
RAYTHEON—6L6 and 6L6G	7/6
Ceramic Octal Bases	each 1/6

U.T.C. and THORDARSON Modulation Transformers.

SEE THE HARVEY UHX-10 TRANSMITTER,
5 to 160 metres—10 to 20 watt R.F.

**HIRE
PURCHASE**
Facilities available on all Receivers and Transmitters. Send for H.P. Terms

NEWS!
G5BJ JOINS WEBB'S
At Birmingham Depot.
Full Stocks of Advertised Goods for Callers only.
41, Carrs Lane.

EDDYSTONE
Calibrated Buzzer Wavemeter, 8 to 500 metres. List price 63/-, to clear, 17/6.
Full range EDDY-STONE components in stock.

EVERY 1938 HALLICRAFTER IN STOCK.

SEE THE SUPER SKYRIDER,
5 to 550 metres, £30 and £32.

The New CHALLENGER, £32 and £25.
The BUDDY at £9. The CHIEF at £12 10s. 0d.

Send 2d. for Illustrated List T.S.

WEBB'S
RADIO
LONDON

At your service :
H. R. Adams, G2NO.
E. J. Pickard, G6VA.
H. W. Stewart, G2CY.
T. R. McElroy, W1JYN.
'Phone : Gerrard 2089.

14, SOHO ST., OXFORD ST., LONDON, W.1



Are our Resistances the best?

WE think they are—but how can we prove it to you? We can say our resistances last longest, are the most reliable and make lots of other claims for them, but you'll just reply that we're biased — and maybe we are. Of course, we might mention at the same time that we've been making resistances for many years, that we've shown the way with new types and the majority of the big radio manufacturers fit our components. And that's something that does not have to be proved.

DUBILIER

DUBILIER CONDENSER CO. (1925) LTD.

DUCON WORKS, VICTORIA RD., NORTH ACTON, LONDON, N.W.3.



C. R. Casson 18

"Class B Amplifier Design"

(Continued from page 692)

One of the commonest questions asked is, "What should the meter read?" The question has no definite answer when voice input is used. The current value we have been dealing with in making calculations is a peak value which never shows up on any meter. In settling the ratings for Class-B audio, an average value is stated. This is what the meter would read with sine-wave input, and is determined by multiplying the peak value by 0.636. In other words, the average value with

sine-wave input for two tubes is 0.636 of the peak value for one tube. However, with voice input, because of the difference in wave-form the same peak output and peak plate current are realised at much lower average values of plate current. Usually the average plate current with voice input is approximately 50 per cent. of the value for sine-wave input at the same peak output. Only an oscilloscope will give a correct answer to the question, "What should the meter read?"

In calculating operating conditions, the information presented herewith must be tempered with good judgment.

From the figures only it might seem possible to take a pair of 10's and transformers designed for use with them and by raising the plate voltage high enough modulate a kilowatt. However, it cannot be done.

The peak voltage from plate to filament will be the applied voltage plus the developed voltage. For instance, if the applied voltage is 1,000 and the developed voltage 800, the peak voltage from plate to filament would be 1,800 volts. The voltage from plate to grid would be greater by the amount of the peak grid voltage plus the bias, which would be approximately the drop across the tube, say, 200 volts. Thus the peak voltage from plate to grid would be about twice the supply voltage. Consequently, the applied voltages should be in line with the maximum voltage ratings of the tubes or breakdown may be experienced.

Best transformer design involves the use of as small a core window as possible to accommodate the required amount of insulation and wire, and the minimum amount of insulation should be used to permit the tightest possible coupling between windings. For this reason, audio transformers use the least amount of insulation which will provide a reasonable safety factor. Consequently, if the voltages across the transformer are increased above the values for which it was designed, the safety factor will be reduced.

Increasing the voltage across the windings also adversely affects the low frequency response, though this is a less important consideration because the low-frequency cut off for most transformers is below the lowest frequencies obtained with voice input. The amount of D.C. through the secondary should not exceed the maximum rated value because it may result in core saturation, which necessarily must cause high harmonic content. In general, for safe operation, the voltages across and the currents through the windings of the transformer should be in line with those at which the transformer was intended to operate.

The 28 Mc. Band

It should be noted by those who intend to make more extensive use of the 28 Mc. band that this channel has been built up into several sections by the United States Government to avoid interference between amateur stations. The following frequencies are being used: 28,000 to 28,500 kcs., C.W. only; 28,500 to 30,000 kcs., C.W. and telephony. This leaves 500 kcs. clear of local telephony as far as the U.S. amateurs are concerned. It is hoped that European amateurs will operate between 28,600 and 29,900 kcs., so leaving a small part of a wide band clear of local telephony for local stations still using C.W., and who wish to work long distance.



**NOTHING SIR — PASSES
PILOT ALL - WAVE RADIO**

Included in the new range of Pilot All-Wave Superhets, is an amazing model employing 10 valves. It is capable of bringing to you at real entertainment value, the World's broadcasts on all wavelengths from 4.5 metres to 2,200 metres. The six wavebands covered are:—4.5 to 15, 12.25 to 30, 26 to 70, 65 to 195, 190 to 550 and 750 to 2,200 metres. There are many advantages in a "big" set, such as this Pilot Model 106, which has 10 valves. It is a super-superhet. No undue strain is placed upon any component or valve: each one is only called upon to do just that work for which it is designed. This results in perfection of tone, consistent performance, stability over all wave-lengths is obtained through the incorporation of no less than 18 separate coil assemblies, controlled by the one wavechange switch. There is so much reserve power that the weakest of stations is receivable at good volume. The 14 watts output can be controlled to suit any size room.

Television sound, police, aviation, and even the World's amateur transmissions, in addition to the World's normal broadcasts are all under your control with this Pilot model 106.

ONLY 25 GNS.

The range of 1938 Pilot All-Wave Receivers and Radiograms includes several models costing from 11½ to 40 guineas and all capable of giving owners "All-world listening." There are models for Battery operation; A.C. Mains, D.C. Mains or Universal models for either A.C. or D.C. supply.

PILOT MODEL U475

A De-Luxe 7-valve All-wave Superhet, for A.C. mains. Covers 4 wavebands, giving "All-world listening" on 16-52, 48-150, 175-550, and 750-2,000 metres. Electronic tuning beacon. Compass dial illuminates to show the waveband in use. A World-getter, with splendid tonal quality and ample controllable volume. **17 GNS.**

PILOT FOR ALL-WAVE RADIO

Pilot Models from **8½ TO 40 GNS.**

H.P. terms available



PILOT MODEL 106
Superhet Receiver for A.C. Mains. 10 Valves. 6 Wavebands, 4.5 to 2,200 metres. 10" dynamic speaker. Selectively illuminated compass dial, Electronic tuning indicator, and many exclusive features.

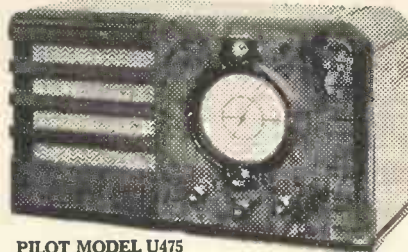

PILOT MODEL U475

PILOT ALL-WAVE RADIO COUPON
FREE Please send me without obligation, details of all Pilot All-Wave Superhet Receivers, etc.; and special Pilot Standard Time Conversion Chart "T.S."

Name
ADDRESS.....

Place Coupon in unsealed envelope, 3d. postage.

PILOT RADIO LIMITED, Park Royal Road, London, N.W.10.

Pilot Pilot



'AVO'

Accurate Testing Instruments
BRITISH MADE

Only precision instruments enable you to test accurately and trace radio faults efficiently. "AVO" instruments are outstanding for precision. They are the outcome of a constant effort to provide amateur enthusiasts and radio engineers with instruments of high accuracy and maximum utility at a moderate cost.



THE D.C. AVOMINOR

This accurate moving-coil instrument is 13 meters in one. It has 13 ranges: voltage ranges for measuring H.T., L.T., Grid Bias, Mains and Eliminator Voltages; Milliamp ranges for testing receiving valves and apparatus; Resistance ranges for all resistances measuring. In case, complete with testing prods, crocodile clips, leads and instruction booklet. **45/-**

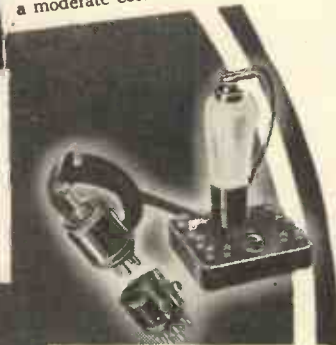

THE AVODAPTER

Simplifies valve testing. Enables all valves to be tested under actual working conditions without need for cutting connections and groping about inside the set. Instantly adaptable for 4-pin, 5-pin and 7-pin valves. Price **27/-**

9-PIN AVO-COUPLER

Attachment (not illustrated) renders Avodapter suitable for 9-pin valves **12/6**

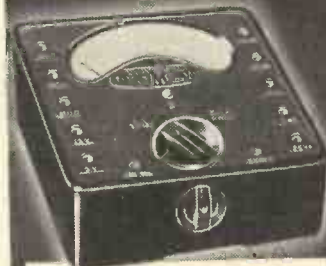

UNIVERSAL AVOMINOR

This compact precision moving-coil instrument provides facilities for all A.C. and D.C. testing. It has 22 ranges covering A.C. voltage, D.C. voltage, current, and resistance. All readings are direct. Total resistance of meter, 200,000 ohms, ensuring accurate readings. Complete with testing prods, crocodile clips and instruction booklet. **£5.10s.** Leather Case, 10/-.

Deferred Terms if desired.

Write for illustrated literature giving full details of all "Avo" Testing Instruments

AUTOMATIC COIL WINDER & ELECTRICAL EQUIPMENT CO., LTD.

Winder House, Douglas St., London, S.W.1. Telephone: Victoria 3404/7.

New Edition!
RADIO SERVICING SIMPLIFIED

A new and considerably enlarged edition of this popular text book is now ready. It has been entirely re-written to conform with modern requirements and in the light of present-day standards of knowledge. It takes the reader by easy stages through the whole routine of testing modern radio receivers, and describes in a clear and interesting manner every test, and much other useful information of value to the radio enthusiast. 150 pages, 8½ in. × 5½ in. Numerous illustrations, diagrams and graphs.

2/6 Post Free
2/10

A new enlarged edition of this practical book covering all phases of radio communication!

Radio Engineering

By **FREDERICK EMMONS TERMAN**
Professor of Electrical Engineering, Stanford University

813 pages, 9 × 6, 475 illustrations, 30s. net
SECOND EDITION

THIS book gives a comprehensive treatment covering all phases of radio communication. It is written from the viewpoint of the engineer who is interested not only in qualitative descriptions of radio phenomena, but also in making quantitative analyses for facilitating design and research.

The first part of the book is devoted to the theory of tuned circuits and the fundamental properties of vacuum tubes and vacuum tube applications in the light of their importance and interest to every electrical engineer.

The latter part takes up more specialised radio topics, such as radio receivers and transmitters, wave propagation, antennas, and direction finding. In this part of the book are chapters on radio aids to navigation, sound and sound equipment, and a new chapter on television.

In this thoroughly revised and enlarged edition, all but the first few chapters have been rewritten in line with rapid advances in radio communication, and more than half the illustrations are new.

Contents

- | | |
|--|--|
| 1. The Elements of a System of Radio Communication | 11. Sources of Power for Operating Vacuum Tubes |
| 2. Circuit Constants | 12. Radio Transmitters |
| 3. Properties of Resonant Circuits | 13. Radio Receivers |
| 4. Fundamental Properties of Vacuum Tubes | 14. Propagation of Waves |
| 5. Vacuum-tube Amplifiers | 15. Antennas |
| 6. Vacuum-tube Amplifiers (Cont.) | 16. Radio Aids to Navigation |
| 7. Power Amplifiers | 17. Television |
| 8. Vacuum-tube Oscillators | 18. Sound and Sound Equipment |
| 9. Modulation | Appendix. Formulas for Calculating Inductance, Mutual Inductance, and Capacity |
| 10. Vacuum-tube Detectors | |

McGraw-Hill Publishing Co., Ltd.
Aldwych House London, W.C.2

A Precision Oscilloscope for Experimenters

WE make no apology for introducing a design for a complete cathode-ray test equipment for the amateur transmitter. The use and advantages of such a unit have been amply demonstrated for some years, and in America it is the exception rather than the rule to find a transmitting station without a cathode-ray monitor.

Commercial models have been produced in this country and America at prices ranging from £20 to £50, but they do not always fulfil the special requirements of the amateur, and there is, in addition, the valuable experience to be gained in the construction of the unit which leads to a far better appreciation of what is actually being measured.

In designing such equipment, the following points have been considered: Size of tube: Although the miniature tube is popular it is obvious that better measurements can be made on a larger diameter. There is also the possibility of later use for television reproduction which indicated at least a 4 in. tube.

The design allows a choice of types.

Circuit: A linear time base is essential for straightforward measurements of wave-form, etc., and it must be capable of a high speed. For this reason a hard valve time base was selected, giving a maximum speed of 100 kc. This enables waves of a megacycle to be seen easily and 20 mc. can be distinguished as separate waves.

Amateurs and experimenters will find this full-size oscilloscope useful for checking waveform, testing receivers and observing the performance of a transmitter. A 4-in., 5-in. or 7-in. tube can be used.

Amplifier: For small radio frequency inputs an amplifier for the deflection is required. This is of the screened pentode type which will give ample deflection with an input of 0.1 volt at audio frequencies and 1.0 volt radio frequency. The amplifier can be cut out of circuit at will and a separate valve is used for each pair of plates.

Layout: The unit must be accessible and at the same time shockproof. This is done by assembling it on a standard chassis with a paxolin front panel holding the controls. On top is mounted a similar chassis to act as a cover, and the sides can be protected with perforated metal if desired. The unit is not heavy, and can be carried about by means of a handle on top of the chassis. The tube is in the centre of the panel and is provided with a scale mounted in front of the screen for calibration.

The circuit is shown below where the H.T. supply is obtained from the conventional rectifier, with extra smoothing for the time base valves and amplifiers. Three transformers are used, one for the cathode of the tube which requires specially insulating if the anode supply is earthed. The H.T. windings are on a separate transformer

and the heater windings for the rectifiers and valves on the third. Two switches are used to control the primaries, one putting on the heaters of the tube and the valves and the other applying the H.T. to the rectifiers. Fifteen seconds delay between switching 1 and 2 ensures that the insulation of the valves is not strained.

The H.T. for the tube is obtained from the potentiometer chain marked R₁, etc. Note that the potential for centring the deflection is derived from two potentiometers R₇ and R₈ across the upper part of the chain. As the final anode is tapped at a point midway between the ends of these the potential can vary by a slight amount positive or negative to the anode. A safety resistance is included in the anode lead to limit the current in the event of flash-over. Arrangement has been made for a modulating signal to be applied to the grid of the tube through a condenser which must be capable of withstanding the full working H.T. voltage. This is useful for injecting a timing signal, quite apart from its possible use in television.

The hard valve time base is the "Kipp relay" type in which a small current through the discharge valve triggers the grid to reduce the impedance suddenly and allow a much heavier current to flow.

The main condenser is charged through a resistance R₁₁ and R₁₂, the overall voltage being high enough to ensure linearity of charge over the range of the condenser voltage. The discharge valve V₃ across the condenser

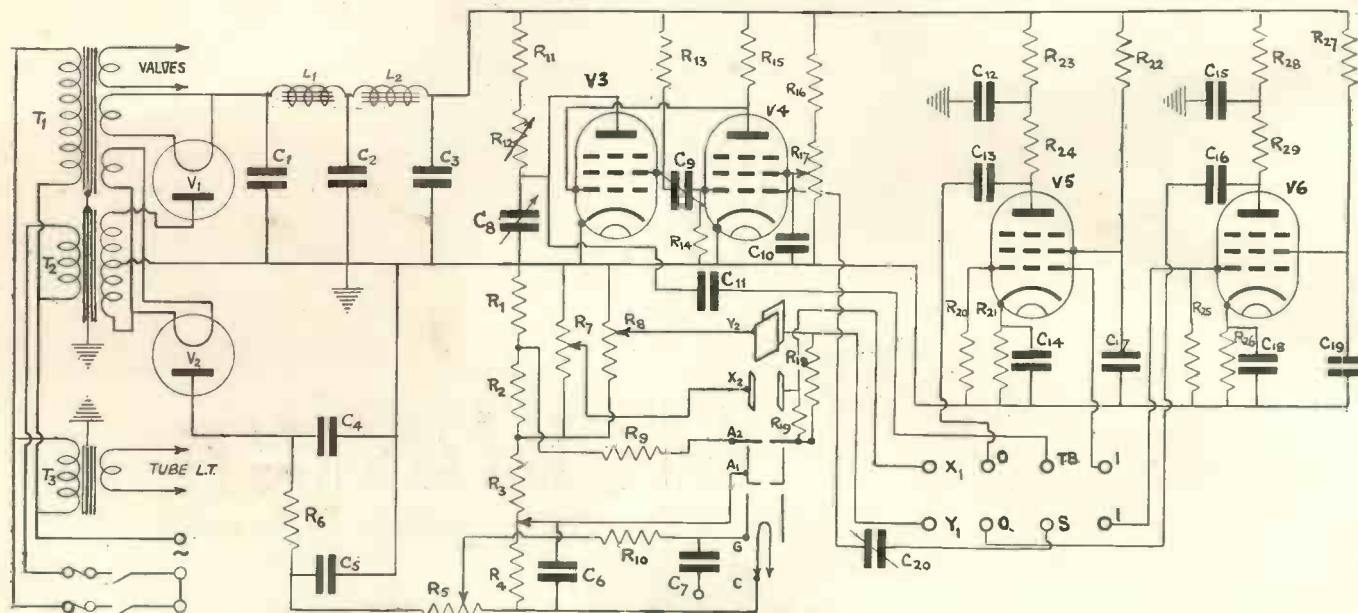

Constructors making this oscilloscope will have a ready means always at hand of conducting tests of all kinds with the highest accuracy.

has its grid connected to the anode of the triggering valve V_4 , the impedance of which is controlled by the screen potentiometer R_{17} . No current flows through V_3 until a minimum value of anode potential is reached, which is supplied by the charging condenser. As soon as V_3 passes current the grid of V_4 receives an impulse from the screen of V_3 via the coupling condenser C_3 and this impulse, amplified, is handed back to the grid of V_3 , reducing its bias and causing a heavy current to flow from the condenser through the valve. When the condenser volts fall to a low value the current ceases, and the bias "re-sets itself" until the condenser charges again.

With suitable values of condenser and coupling condenser this time base can operate at speeds up to a megacycle or more, but the amplitude of sweep becomes progressively less unless special precautions are taken with the circuit. However, with an additional valve after the discharge valve to act as a sweep amplifier no trouble will be found in obtaining full scale sweep.

For radio frequency amplification, the single stages shown are connected to the deflector plates. It is possible to cut the amplifier out by switching, but this sometimes leads to unwanted capacity and it is therefore preferable to use terminals mounted as close as possible to the deflector plates. At high frequencies considerable loss is found if the deflector plate leads are long and the limitation of the tube for high frequency measurements will probably be found to depend on this.

The deflector plates and the output from the amplifier valves are brought out to separate terminals mounted on the front of the panel. These terminals are shown below the negative lead in the circuit diagram and are arranged as follows:—

Deflector plates X_1 and Y_1 are taken direct to two terminals as shown, the circuit between them and the anode of the tube being closed by two 2-megohm resistances. The value of these resistances represents the dead load of the deflector plates so far as the external circuit is concerned, and if it is expected that the tube will be used for accurate measurements in tuned circuits it is recommended that the resistance be increased to 5 megohms.

The output from the time base is connected to the terminal marked T.B. The amplifier grid is connected to the terminal marked "I" (input) and the anode feed condenser to the output terminal "O." Thus, if the time base requires amplification at the higher frequencies, T.B. is connected to I and the O terminal to the X_1 plate.

On the Y plate, which is the normal one for wave form investigation, there

is the choice of feeding through the amplifier with O connected to Y_1 and the input connected to I, or direct connection may be made to Y_1 . For synchronising the time base to the input wave the terminal S is connected to the Y plate terminal. This feeds a proportion of the input wave to the grid of the discharge "trigger" valve. In some cases the effect of the input voltage is to produce a distortion of the trace on the screen, and in low frequency work the amount of input voltage for synchronising should be kept to a minimum. The condenser C_{20} , which controls the synchronising voltage is of 14.5 mmfd.

capacity and is adequate for the average audio frequency wave.

In radio frequency work the amplification of the AC/SP.3 stage will be decreased and a boost can be given by means of an H.F. choke wired in the anode circuit. The value is not important and most experimenters have one available from stock.

Input controls have not been included in the amplifiers owing to the liability to hum pick-up from the mains. In using an oscillograph for tests on transmitters it is usually preferable for the

(Continued on page 699)

Satisfied with your reproduction? WAIT TILL YOU HEAR THIS!

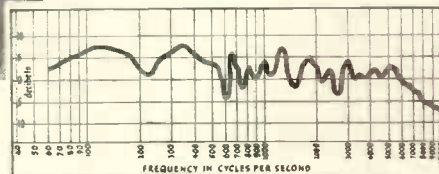

Make no mistake—here is no mere superficial alteration in design.

An observant glance at speech coil, centring device, and cone, will show you a few of the differences; and two or three minutes of listening will show you many more.

Another 600 cycles of top response—complete absence of 3000 cycles peak—slight gain in average sensitivity—it takes a keen ear to analyse this new smoothness and fidelity, but no ear can fail to detect it.

Prices (at present), remain at the old level—17/6 to 45/-. Get your new Stentorian speaker now!

Mr. Kenneth Jowers, the well-known Short-wave Editor of "Television and Short-Wave World" has expressed the following opinion:—
W.B. Loudspeakers embody so many unique features that they should become the automatic choice of all radio constructors and listeners

Kenneth Jowers



ANOTHER NEW

Stentorian

DIFFERENT—& BETTER STILL

WHITELEY ELECTRICAL RADIO CO., LTD. (Vision Dept.) MANSFIELD, NOTTS.

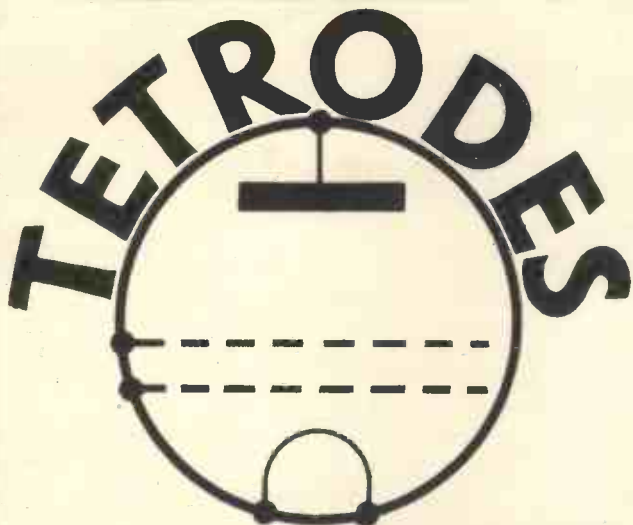

HIVAC SPECIFIED

FOR THE 15-WATT TRANSMITTER.

Two Hivac Beam Power
Tetrodes with Octal bases.

Obtainable through your dealer.

Descriptive Folder "T.S." Free

HIGH VACUUM VALVE CO., LTD.,
111-117, Farringdon Rd., LONDON, E.C.1

TYPE
AC/Qa

PRICE
18/6

VISION !!

Long before there were any British television transmissions or commercially made television receivers available to the British public, this company with its many years' experience in design of transformers and chokes, had designed such components for the television experimental work carried out by manufacturers and private individuals who were interested in the development of television.

The technical staff of this journal show their confidence in Sound Sales products by specifying our components for the

Low Cost Televisor described in this issue.

The specification includes:—

Sound Sales Transformer

Type 300T/100 30/-

Sound Sales Choke

Type 60/80 T. 22/6d.

And for the Precision Oscilloscope two Sound Sales Low Frequency Chokes

Type 30/H (Shrouded). 12/6d.

The range of Sound Sales products is of interest to all readers of this journal, so why not send for our latest literature on Transformers, Chokes, etc., etc.



Marlborough Road, Upper Holloway, London, N.19
Phone: Archway 1661-2-3 (Contrs. to G.P.O., etc.)

RAYMART

CRAFT A CREED

SPECIALISED SHORT-WAVE
COMPONENTS ALWAYS IN STOCK

SPEAKERS

We carry large stocks.

W.B., P.M. type, 8-in. cone, complete with transformer, 12/6. Ditto, extension type, low impedance, 7/6.

MAGNAVOX, 10-in. energised, 1,000 or 2,500 ohm, 19/6.

JENSEN, 8-in., 2,500 ohm, with transformer, 7/6.

JOHNSON Q ANTENNAE: 20-metre, 39/6; 10-metre, 26/6; 5-metre, 27/6. Full range Bassett Concentric Feeders in stock.

COMMUNICATION Equipment. Send 1½d. stamp for latest bargain list. It will save you pounds.

LATEST 3-GANG low minimum all-wave condensers, fitted airplane dial, 8 and 80: 1, 8/6; Yaxley 3-gang 3-band switches, 2/11; ditto, 4-gang, 4-band, 3/11.

We are Sole Distributors for

BLILEY, THORDARSON, TAYLOR TUBES, RME, NATIONAL, BASSETT CONCENTRIC CABLE, HOYT METERS, ETC., ETC.

RAYMART SPECIFIED
for the

15-WATT TRANSMITTER

Type M.T.6. MAINS TRANSFORMER.

350-0-350., 6.3 volt and 5 volt.

Price 10/6 Each.

RAYMART SHORT-WAVE MANUAL

48 pages in all, 32 on receivers, transmitters, aerials, circuits, etc., etc., and 16 on short-wave components, 6d., or post free, 7½d. Short-Wave Catalogue, 16 pages, 1½d.

G5NI (BIRMINGHAM) LTD.
44, HOLLOWAY HEAD, BIRMINGHAM
Telephone: Mid. 3254.

CLIX

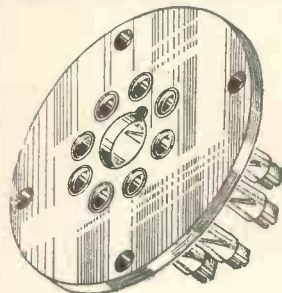

"OCTAL"

CLIX VOLTAGE SELECTOR

PLATES have the tappings so placed as to make incorrect insertion impossible. Sockets are entirely insulated and the turn plug is dead when out of circuit. Be safe—FIT CLIX as specified for the Television Vision Power Pack.

3 Way Plate 8d.

Shorting Plug 3d.

TWO DESCRIPTIVE FOLDERS 'T.S.' FREE.

BRITISH MECHANICAL PRODUCTIONS LIMITED
79^a ROCHESTER ROW LONDON S.W. 1

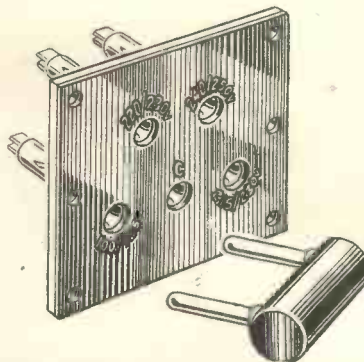

"OCTAL" VALVEHOLDERS
as specified for the "15 Watt Transmitter" employ
Clix patented helically slotted sockets which give
perfect, full surface contact with any valve pin.

10d. each.

"CLIX" VALVEHOLDERS
The Short-wave type with ceramic bases are specified
for the "Oscilloscope"

7-Pin 1/2d.

4-Pin 10d. each.

"A Precision Oscilloscope for Experimenters."

(Continued from page 697)

user to control the input to the plates at the source by tapping rather than to apply a high input to the amplifier stage and reduce it by a volume control. Again it should be noted that the load of the amplifier is represented by the grid leaks of 2-megohms which are the highest satisfactory value for H.F. pentodes of this type.

In next month's issue the instructions for the chassis and panel assembly will be given. By arrangement with the A.P.A. a ready drilled chassis will be available for the unit, and perforated metal screens can also be obtained.

**Components for
A PRECISION OSCILLOSCOPE FOR
EXPERIMENTERS**

CHASSIS.

1—Double Steel Chassis to specification finished black (A.P.A.).
Expanded metal side shields (optional).

CONDENSERS, FIXED.

C1—2-mfd. 1,000 volt working type 950A (Dubilier)
C2—4-mfd. 1,000 volt working type 951B (Dubilier).
C3—4-mfd. 1,000 volt working type 951B (Dubilier).
C4—1-mfd. 4,000 volt working type 951C (Dubilier).
C5—1-mfd. 4,000 volt working type 951C (Dubilier).

C6—5-mfd. type 4608/S (Dubilier).
C7—1-mfd. 4,000 volt working type 951C (Dubilier).
C8—1-mfd. or-mfd. .005-mfd. .001-mfd. 005-mfd. type 680 (Dubilier).
C9—005-mfd. .001-mfd. .0002-mfd. .0001-mfd. .00005-mfd. type 680 (Dubilier).
C10—5-mfd. type 4608/S (Dubilier).
C11—1-mfd. 1,000 volt working (Dubilier).
C12—1-mfd. type 955A (Dubilier).
C13—1-mfd. 1,000 volt working type tubular (Dubilier).
C14—50-mfd. 12 volt working type 3016 (Dubilier).
C15—1-mfd. 1,000 volt working type 950A (Dubilier).
C16—1-mfd. 1,000 volt working type 680 (Dubilier).
C17—1-mfd. 1,000 volt working type 680 (Dubilier).
C18—50-mfd. 12 volt working type 3016 (Dubilier).
C19—1-mfd. 1,000 volt working type 680 (Dubilier).

CONDENSERS, PRE-SET.

C20—14.5-mmfd. type SW54 (Bulgin).

CHOKES, LOW-FREQUENCY.

2—30 h. 50 M/A. (L1, L2), type 30H (Sound Sales)

HOLDERS, FUSE.

1—Type 1054 (Bulgin).

HOLDERS, VALVE.

4—7-pin ceramic chassis type less terminals (Clx).
2—4-pin ceramic chassis type less terminals (Clx).

PLUGS AND TERMINALS

6—Top connectors type P92 (Bulgin).
2—Terminals type B marked "Mod." (Belling-Lee).
1—Terminal type B marked "Earth." (Belling-Lee).
2—Terminals type B marked "Input." (Belling-Lee).
2—Terminals type B marked "output" (Belling-Lee).
2—Terminals type B marked "X1," "Y1," (Belling-Lee).
2—Terminals type B unmarked (Belling-Lee).

RESISTANCES, FIXED AND VARIABLE

R1—100,000-ohm 1 watt (Erie).
R2—100,000-ohm 1-watt (Erie).
R3—2-megohm and 1.2-megohm 2-watt (Erie).
R4—5-megohm potentiometer (Reliance).
R5—1-megohm potentiometer (Reliance).
R6—200,000-ohm type 1-watt (Erie).
R7—5-megohm potentiometer (Dubilier).
R8—5-megohm potentiometer (Dubilier).
R9—100,000-ohms 1/2-watt (Erie).
R10—2-megohm 1/2-watt (Erie).
R11—5-megohm 1-watt (Erie).
R12—2-megohm potentiometer (Reliance).
R13—50,000-ohm type 1 watt (Erie).
R14—50,000 ohm type 1/2-watt (Erie).
R15—200,000-ohm 2-watt (Erie).
R16—25,000-ohm 2-watt (Erie).
R17—100,000-ohm potentiometer (Reliance).
R18—2-megohm 1/2-watt (Erie).
R19—2-megohm 1/2-watt (Erie).
R20—2-megohm 1/2-watt (Erie).
R21—200-ohms 1-watt (Erie).
R22—5-megohm 2-watt (Erie).
R23—50,000-ohm 2-watt (Erie).
R24—50,000-ohm 2-watt (Erie).
R25—2-megohm 1/2-watt (Erie).
R26—200-ohm 1-watt (Erie).
R27—5 megohm 2-watt (Erie).
R28—50,000-ohm 2-watt (Erie).
R29—50,000-ohm 2-watt (Erie).

SUNDRIES.

5—5-way group boards type C31 (Bulgin)
Paxolin Panel to specification (Bulgin).

SWITCHES.

1—ganged 5-way Rotary switch 1039K (F. W. Lechner).
1—ganged 3-way Rotary switch 1039K (F.W. Lechner).
2—S80T switches (Bulgin).

TRANSFORMERS.

1—4 v. 4a.
2—v. 2a to specification (T1) (Premier).
2—v. 2a.
1—1000-0-3500 v. to specification (T2) (Premier)
1—2 v. 2a. to specification (T3) (Premier).

VALVES.

2—M.U.2. (Mazda).
2—AC/S2PEN (Mazda).
2—AC/SF3 (Mazda).
1—Type 5H C.R. Tube with socket (Ediswan).

PETO-SCOTT EVERYTHING ALL-WAVE

1919

1938

PETO-SCOTT'S 1938 Range of ALL-WAVE and SHORT-WAVE APPARATUS is again unsurpassed for RELIABILITY, QUALITY and VALUE. This all-round supremacy is the natural outcome of PETO-SCOTT'S long experience in Direct-to-the-Public Radio.

You knew in 1919 . . . you know TO-DAY, that you may order from PETO-SCOTT in the knowledge that you will receive BRAND-NEW GOODS, backed by a GUARANTEE of SATISFACTION. Post the COUPON below TO-DAY for FREE books and Blueprints which will put you on the road to SUCCESSFUL ALL-WAVE CONSTRUCTION.

FREE - 2 ALL-WAVE BOOKLETS and 8 BLUEPRINTS!

The PILOT

"SHORT and ALL-WAVE EXPERIMENTER"

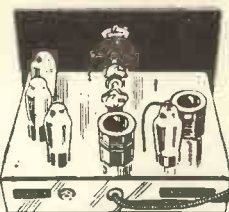

POST COUPON FOR FREE COPY!

The Pilot "Short and All-Wave Experimenter" is a booklet of 24 pages featuring 9 new PILOT Short-Wave Kits, one of which is illustrated. Each of these designs incorporates standard chassis and panel. Commencing with a 1-valve Adaptor-Converter, you may, when you please, build this up, on the same chassis, into varying forms of 1, 2, 3 and 4-Valve Short-Wave Receivers.

The PILOT "ALL-IN" KIT (illustrated above without cabinet) includes every single item necessary to build any of 8 short-wave sets and includes black crackle finish steel cabinet for housing the receivers. Every component tested, matched and guaranteed. Complete with all instructions and drawings. List value £5/11/5

Cash or C.O.D. **£4:8:0**
Or 7/6 down and 11 monthly payments of 8/-

Post the Coupon for your free copy of this 6d. booklet, together with a set of 8 Blueprints, for each of the sets described.

Peto-Scott ALL-WAVE and GENERAL CATALOGUE

POST COUPON FOR FREE COPY!

Whether you require a small condenser or a 9-Valve All-Wave Superhet Receiver, Peto-Scott will supply you by post, for Cash, C.O.D., or on Easy Terms, at astonishingly low prices, made possible by our direct-to-customer trading. Every item in the new Peto-Scott range of quality radio apparatus is contained in an art catalogue free to all who post Coupon. Below is a brief outline of the contents of this invaluable little booklet:

- | | |
|---------------------------|-------------------------|
| All-Wave Kits and Chassis | Microphone |
| All-Wave Receivers | Portable Receiver |
| All-Wave Aerial | Pick-ups |
| Amplifiers | Short-Wave Pre-Selector |
| Chargers | Short-Wave Kits |
| Eliminators | Speakers |
| Gramophone Motors | Valves |
| Gramophone Pick-ups | |

ALL-WAVE S.G.3 KIT.

● 4 Wavebands. 14-31, 28-62, 200-550, 900-2,100 metres. Ready-assembled switched coil unit simplifies construction. Peto-Scott Duplex Epicyclic slow-motion tuning simplifies world reception. KIT "A." All parts including ready-drilled chassis, drawings and instructions, less valves, speaker, batteries. List Value £4/9/3.

OUR PRICE £3:3:0 Or 5/- down and 11 monthly payments of 5/9. Kit "B," with valves, £4/5/9, or 8/6 down.

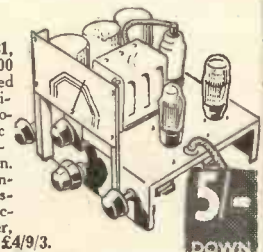

PETO-SCOTT CO., LTD., 77 (T1), City Rd., London, E.C.1.
West End: 62, (T1), High Holborn, London, W.C.

Clissold 9875-6-7
Holborn 3248.

NAME

ADDRESS

EST. 1919

All Postal Orders must be crossed and made payable to Peto-Scott Co., Ltd. All currency must be registered.

A Single-valve Self-quenched Receiver

By G. T. Clack

THIS receiver consists of a standard grid-blocking regenerative detector designed in such a manner that losses are kept to a practical minimum for the components used, and is capable of giving excellent results when used in conjunction with the average broadcast aerial.

Despite its apparent simplicity, the

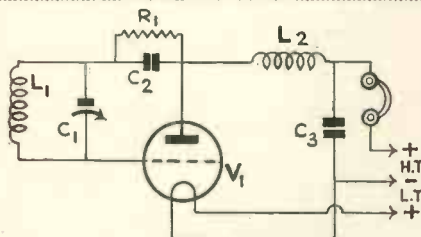

Fig. 1.—The simple circuit of the 5-metre receiver.

receiver possesses equal sensitivity to the more usual regenerative detector and separate quench valve. As a standby or emergency receiver it has no equal, and another point which will appeal is the low cost. Most experimenters have already spare condensers and grid leaks, while some might prefer to make the U.H.F. choke themselves, so reducing the total cost to less than 13s.

It is general practise to use a resonant aerial for U.H.F. work, but in this case a definite increase in signal strength is obtained when some form of harmonic aerial is employed as opposed to a resonant aerial.

Referring to the diagram, Fig. 1, it will be seen that the coil and tuning condenser L_1C_1 are between grid and plate of the detector valve. Direct connection is made from one side of L_1C_1 to the grid, the other side being connected to plate via condenser C_2 and grid resistance R_1 . H.T. feed to the valve is through the filter choke L_2 , which serves as an effective barrier to the H.F. component yet permits the passage of audio to the headphones. The by-pass condenser C_3 should not be less than .006-mfd., otherwise the quench effect is "patchy" and instability will be experienced. In view of the background hiss on carriers less than about R_5 , it is desirable to keep up the response and any attempt to use a heavy by-pass condenser to reduce background hiss will not be satisfactory, as the signal will be muffled and readability lost.

Regarding the valve, it is not always possible to substitute different types and obtain optimum efficiency. The values

of C_2 R_1 given are for the Tungram P220 or nearest equivalent. If a higher impedance valve is to be used, such as an L.F. or H.L. type, then the con-

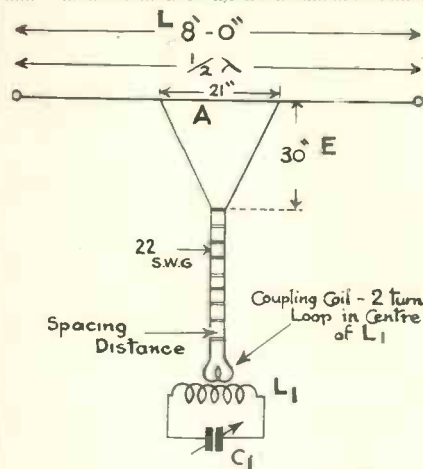

Fig. 2.—A simple 5-metre aerial.

structor may find a slightly higher value of R_1 is required, say, 750,000 to 1,000,000 ohms. In such circumstances mount two small clips on either

A.P.A. ARE PROMINENT AGAIN

IN THIS ISSUE A.P.A. CHASSIS are specified for the 15-Watt Transmitter and Oscilloscope.

Useful list of stock metal parts and aids to construction free on request.

CABINET
PANEL
SCREEN
CHASSIS

by

for
**ANYTHING
IN
METAL**

Write or
Phone:



METALWORKS
171c, Battersea Park Road,
London S.W.8

MACAULAY 4840



**YOU WILL FIND
A WIDE CHOICE
OF
'HAM' RECEIVERS
at A.C.S.**

including

NATIONAL NC100 10-550 m.	12 Valves	£35
1938 SUPER SKYRIDER 5-550 m.	11 Valves	£32
SKY-CHALLENGER 7.5-550 m.	9 Valves	£23
HAMMARLUND SUPER-PRO 7.5-240 m.	16 Valves	£72 10s.
PATTERSON PR10 8-550 m.	15 Valves	£35
RME 69 10-550 m.	9 Valves	£39 15s.
RCA ACR 111 9-550 m.	16 Valves	£57 10s.
SKY BUDDY 16-550 m.	5 Valves	£9
SKY CHIEF 14-550 m.	7 Valves	£12 10s.

All laboratory checked and "hotted-up" for unbeatable short-wave reception. Demonstrations in our own showrooms, without obligation, to enable you to select apparatus to meet your own needs. Easy terms and part exchanges. Send for useful folder containing complete technical data.

SPECIAL CROWE DIAL
Specified for the Beginner's Transmitter. Delivery from stock. 7/6

A wide range of transmitting equipment, valves, components, etc., stocked; apparatus built to order. Unbiased technical advice from

Take a cheap day return to Bromley North—1/6. Only 20 minutes from town. Open until 8 p.m. except Wednesdays (1 p.m.)

G2NK
Technical Manager

A.C.S. Radio
52/54, Widmore Road,
Bromley, Kent.
Ravensbourne 0516/7.

side of C₂ and try various values of R₁ under actual working conditions. There is always a value that will give a very noticeable improvement for a given type of valve.

C₂ is .0002-mfd., tag or wire end type. If the capacity is more than .0003-mfd. a high pitched whistle will be noticed, but if it is lower than about 75-mmfd. the valve will oscillate but difficulty will be found in making it super-regenerate smoothly over the whole of the bands.

L₁ consists of five turns of 12 s.w.g. bare copper wire of 3/4 in. diameter, and a length of 1 1/2 in. It is mounted directly on to C₁, which is an Eddystone micro-inductor with a maximum capacity of 22.5 mmfds.

The U.H.F. choke consists of 45 turns of 22 s.w.g. enamelled copper wire. It can be wound on a pencil then slipped off and suspended with the turns slightly spaced.

Details concerning assembly are clearly shown in the drawing. It will be seen that apart from the L.T. and one phone lead no other connections are made to the receiver. The valve holder is mounted directly on to C₁ together with the coil, and the only alteration necessary to facilitate the assembly is the substitution of the small terminal (from moving vanes) on C₁, with a 2 in. length of screwed 6B.A. brass rod inserted. Reassembly of the grid socket is made directly on the rod. The valve holder is turned until one of the screw holes in the base is directly opposite one of the supports for the fixed vanes, and with a little pressure it can be made to slip over the end thus giving the second point of support. C₂ and R₁ are connected directly between the anode terminal of valve holder and the 6 B.A. rod supporting the coil.

Should the aerial coupling be too tight the receiver will stop quenching at two or three spots over the tuning range and if too tightly coupled will stop oscillating altogether. The simplest method is to make a small loop in the aerial lead and slip it over the anode terminal of the valve holder, even so this may have to be loosened still further. Coupling to the plate is better in the case of a harmonic aerial than to the plate end or grid end of the coil.

The resonant aerial in Fig. 2 can be coupled to the receiver by a two turn loop 3/4 in. diameter inserted in the centre of L₁. It is recommended that a 600 matched impedance line is used with an 8 ft. top, and the feeders can then be of any convenient length.

One phone lead is connected to the small midjet stand-off insulator anchoring the U.H.F. choke and the other phone lead goes to positive + of a 100 volt H.T. battery. The negative of the H.T. battery is taken to negative of the accumulator.

Super-regeneration will cause a high pitched hiss which decreases immedi-

ately a carrier is tuned in. An R₈ or R₉ carrier will cause the hiss completely to disappear and any modulation will be heard perfectly. This hiss commences to become noticeable on strengths below R₅ as in the case of speech some words tend to merge with the background.

The receiver will operate as a straight regenerative if C₂ and R₁ are altered to 50 mmfds. and 2 megohms respectively. Furthermore, it is absolutely necessary to replace the existing U.H.F. choke with a similar equivalent wound on a suitable insulated former. The reason is that when used in a super-regenerative circuit, small variations in inductance of the air wound choke, caused by virtue of vibration while tuning the receiver, has little or no effect, but to obtain maximum efficiency when used as a regenerative detector, the receiver must be operated on the threshold of reaction and rigidity of the U.H.F. choke is necessary to reach this position.

The following details will assist in designing a 600 feeder using the most convenient size of wire to hand.

$$D = 75 \times d.$$

Where D is the spacing, centre to centre of the two wires, d is the diameter of wire to be used. This only applies to feeders for a surge impedance of 600.

The aerial can be cut (1) for a given frequency, and (2) the matching section obtained by the following.

$$(1) L^1 \left(\frac{1}{2}\right) = \frac{492,000}{f \text{ (in kcs.)}} \times .94.$$

$$(2) A \text{ (in feet)} = \frac{492,000}{f \text{ (kcs.)}} \times .23.$$

$$E \text{ (in feet)} = \frac{147,600}{f \text{ (kcs.)}}$$

**Components for
A SINGLE-VALVE SUPER-
REGENERATIVE RECEIVER**

BASEBOARD.

1—Wooden 6 ins. by 6 ins. by 1/2 in COILS.

1—4 turn type 1050 (Eddystone).

1—6 turn type 1050 (Eddystone).

2—bases type 1051 (Eddystone).

CONDENSERS, FIXED.

1—.0002-mfd. type 690W (Dubilier).

1—.006-mfd. type 601 (Dubilier).

CONDENSERS, VARIABLE.

1—type 900/20 (Eddystone)

CHOKE, HIGH-FREQUENCY.

1—type 1011 (Eddystone).

DIAL.

1—type 1026 (Eddystone).

HEADPHONES.

1—pair type D (S. G. Brown).

HOLDER, VALVE.

1—low-loss type SW21 (Bulgin).

PLUGS, TERMINALS.

1—plug type 5 marked H.T. negative (Clix).

1—plug type 5 marked H.T. positive (Clix).

1—spade terminal red type 14 (Clix).

1—spade terminal black type 14 (Clix).

SUNDRIES.

1—extension outfit type 1008 (Eddystone).

1—insulated bracket type 1007 (Eddystone).

Approximately 1 ft. 12 gauge bare copper wire (Webb's Radio).

Approximately 4 ft. 22 gauge enamelled covered wire (Webb's Radio).

1—2 ins. length 6BA studding.

1—stand-off insulator type 1019 (Eddystone).

VALVE.

1—type P220 (Tungsram).

RADIO CLEARANCE
The reliable Mail Order House offer
the following
BRAND NEW GOODS

BRYCE MAINS TRANSFORMERS. standard for the season. 250-0-250, 80 m/A., 2-0-2 volts 2.5 amp., 2-0-2 volts 4 amp., 8/6. 350-0-350, 120 m/A., 2-0-2 volts 2.5 amp., 2-0-2 volts 4 amp., 10/6. 350-0-350, 150 m/A., 2-0-2 volts 2.5 amp., 2-0-2 volts 4 amp., 2-0-2 volts 2 amp., 11/6. 500-0-500, 150 m/A. 2-0-2 volts 2.5 amp., 2-0-2 volts 6 amp., 2-0-2 volts 2 amp., 2-0-2 volts 2 amp., 17/6. All above transformers, centre tapped. Mains input 200-250 volts by means of screw adjustment.

BRYCE MAINS CHOKES. 30 henrys, 40 m/A., 500 ohms, 5/6; 80 henrys, 60 m/A., 2,500 ohms for speaker replacement, etc., 6/-.
LISSEN, 4 Valve A.C./D.C. Universal Receiver, complete with Ever Ready Valves, large Magnavox Speaker, in attractive cabinet with Station Named Clock Face Dial, list 8 1/2 gns., our price to clear, £3/12/6.

AERODYNE 4 Valve Transportable Battery Receiver, complete with Mazda and Mullard Valves, in most attractive walnut cabinet, large Rola P.M. Moving Coil Speaker, brand new, listed 10 gns., our price, £3/5/-.

SHORT WAVE COILS, 4-pin type; 13 to 26 metres; 21 to 47 metres; 41 to 91 metres; 79 to 170 metres. 1/9 each. Set of 4, 6/3.

SPECIAL CLEARANCE OF BRYCE TRANSFORMERS, ex large manufacturer's order, 300-0-300, 80 m/A., 4 volt 4 amp. C.T., 4 volt 2 amp. Mains input 200-250 volts adjustable, 6/- each.

PLESSEY 2,500 ohm Field Energised Speaker, fitted Pentode Transformer, 7 1/2-in. Cone, splendid job, 5/11 each.

ELECTROLYTIC CONDENSERS, by well-known manufacturer. All these Condensers are Cardboard type Electrolytics.

4 mfd. 450 volt working, 500 volt peak	2/3
6 mfd. " " " "	2/3
8 mfd. " " " "	2/6
4 plus 4 mfd. " " " "	2/6
6 plus 4 mfd. " " " "	2/9
8 plus 4 mfd. " " " "	2/9
8 plus 8 mfd. " " " "	3/3
16 plus 8 mfd. " " " "	3/11

4 mfd. Aluminium can, 1-hole Fixing, 450 volt working, 500 volt peak, 2/6. 8 mfd. Aluminium can, 1-hole Fixing 500 volt working, 550 volt peak, 2/11.

CENTRALAB VOLUME CONTROLS, Brand New, complete with Switch, 5,000; 10,000; 25,000; 50,000; 500,000; 2/6 each.

GARRARD UNIVERSAL GRAMOPHONE MOTORS, suitable for A.C. or D.C., complete with pick-ups, 59/6.

GARRARD A.C. GRAMOPHONE MOTORS, complete with pick-up, 42/6.

GARRARD AUTOMATIC RECORD CHANGERS, to play 10-inch or 12-in. records, listed 10 gns. our price A.C., £7/10/-; Universal, £8/8/-.

SET of 3 Lissen Iron Cored Band Pass Coils, complete with Switching and Circuit, listed at 37/6. our price, 8/11.

SET of 2 Lissen Iron Cored Coils, for Aerial and H.F., complete with Switching and Circuit, listed 25/-, our price, 6/3.

Lissen General Purpose Iron Cored Coils, complete with Reaction, suitable for Aerial and H.F., without switch, listed 8/6. our price, 3/3.

Speaker Cabinets, first-class Walnut Speaker Cabinets, modern design, constructed of Heavy Timber throughout. To take any speaker up to 10-in. in diameter, 8/11 each.

Special offer of American Constructrad Short Wave Kits. These Kits cover a Wave Band of 15 to 600 metres by means of 5 Interchangeable Plug-in Coils. Same are easily assembled and are sent out sealed as from the makers, complete with stamped metal chassis, metal panel and all necessary parts to make up a successful short wave Receiver. Orders for these kits must be accompanied by 1/- as part payment for postage.

2 Valve Battery Kit, complete with Valves, 22/11.

3 Valve Battery Kit, complete with Valves, 37/6.

3 Valve A.C. Kit, complete with Valves, 42/6.

All orders 5/- or over post free. Orders under 5/- must be accompanied by a reasonable amount of postage, C.O.D. orders under 5/- cannot be accepted. Orders from Ireland and special parts of Scotland are subject to certain increased postage rates, and customers are advised to apply for details of postage before ordering.

RADIO CLEARANCE
63, High Holborn, W.C.1
Holborn 4631

Some New G.E.C. Receivers

WE are glad to see that the General Electric Co. are looking after the requirements of those listeners who are still restricted to receivers run from dry batteries and accumulators. They have just introduced a luxury 4-valve 3-band super-het receiver which is complete with valves and power supply for 10 guineas.

This set, covering as it does from 16 to 50 metres and the usual medium and long wave bands, enables the user to pick up a good percentage of the most interesting programmes from Europe and other parts of the world.

Despite the fact that it is battery operated, this model, BC-3846, includes fully delayed automatic volume control, an 8-in. moving-coil loud-speaker with provision for an external loudspeaker if required, a special tuning dial calibrated with station names on all wavebands, and visual tuning.

As the receiver is obtaining its high-tension from a dry battery the current consumption has been reduced to the absolute minimum, but even so, quality is of a high order even at maximum output.

For those who are not interested in short-wave reception there is an alternative receiver, the Battery S.P.3, which is priced at £6 15s. od. It is an economical two-band receiver with an

efficient high-frequency stage allowing for good selectivity plus reception from a large number of continental stations. Despite the price, many of the refinements embodied in the more expensive receivers have been included, such as visual switching, single-knob tuning, and full vision station-named dial. For those who do not like the conventional reaction control, special note should be made of the fact that with this set pre-set reaction is included.

Total high-tension consumption is 7 mA., while the price includes valves, H.T. battery and accumulator.

One of the high-spots in the G.E.C. range this season is the A.C. All-wave 5, which is one of the cheapest sets of its kind at 9½ guineas. As its name implies, it is a 5-valve super-het receiver, covering three wavebands and designed to have an output of between 2 and 3 watts at high quality.

To overcome noises which are sometimes picked up via the mains leads, a special power line noise shield has been included. This is a very important feature not often found with receivers so low priced.

The standard receiver is suitable for A.C. mains of 190-250 volts, 40/100 cycles, while for an extra half-guinea, special models can be obtained for 110-130 volts, and 210-230 volts.

As we go to press news has been received of a 4-valve battery model receiver with Q.P.P. output. Current consumption is only 9 mA., while the output is very much greater than with normal pentode or triode valves. The price of this receiver is 11½ guineas.

Apparatus for Short-wave Listeners and Experimenters

A MOST comprehensive catalogue has just been introduced by Premier Supply Stores. It has no less than 90 pages and between its covers illustrates all kinds of transmitters, receivers, amplifiers and components.

Amplifiers for public address work and portable amplifiers for use with dance orchestras are also illustrated, together with no less than four pages devoted to microphones and associated equipment. Readers will find the pages devoted to mains transformers of particular interest, while a new feature is the listing of American communication receivers, such as the RME69. There is also a section devoted to circuit diagrams of 5-metre transmitter, transmitting aerial and modulator circuits.

All Taylor, R.C.A., Raytheon, Eimac, and Tungram transmitting valves are listed with full operating data. We recommend readers to write for a copy of this catalogue, which is priced at 6d., to the Head Office, 167 Lower Clapton Road, E.5.

100% RELIABLE-IF IT'S ELECTRIC SOLDERING

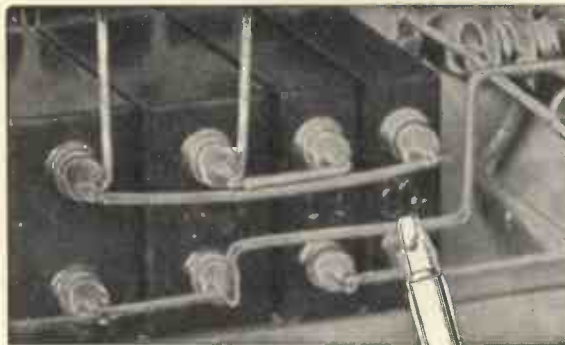

Every contact a neat, simple and lasting job—that's what Solon electric soldering gives you. Maintains constant heat where you want it—element clamped within the bit concentrates all heat at point.

8/6
DOMESTIC
MODEL
65 watts

Sold with Instruction Book
Resin-cored Solder, 6 ft. Flex
and Standard Lamp Adaptor.



W. T. Henley's Telegraph Works Co. Ltd., (Dept. Y4/78a/V.),
Holborn Viaduct, London, E.C.1.

Q.C.C. CRYSTAL AND HOLDER

Specified for the
15-WATT TRANSMITTER



1.7mc., 3.5mc., and 7mc. Bands.

STANDARD TYPE— (For use with up to 300 anode volts).	POWER TYPE—(For use with up to 500 anode volts).
15/-	20/-

100 Kcs. Quartz Bars within plus or minus 25 cycles.



CRYSTAL HOLDER AS SPECIFIED.
Type B.—A totally enclosed dustproof holder of the plug-in type. Instantly interchangeable. Price, with base. 8/6

Postage to all parts of the world.

NATIONAL CRM CATHODE RAY OSCILLOSCOPE.—Complete with 913 Cathode Ray tube and built-in 220/230 volt A.C. input power supply. £5 : 9 : 0

NATIONAL NC101X.—The finest value in communication receivers. Crystal filter, 12 metal valves, 10-in. speaker chassis, 220/230-volt built-in power supply. £5 : 10 : 0

We are authorised National Distributors, but we can supply all types of communication type receivers.

TRANSMITTING VALVES.—Raytheon RK20, 90/-; RK23 and RK25, 27/6; Taylor T55, 45/-; Taylor 866, 11/6; Eimac 35T, 50/-; Amperex HF 100, 57/-.

RECEIVING VALVES.—Raytheon or Sylvania types only. All types stocked at competitive prices.

VALVE-HOLDERS.—Ceramic-U.S.A. 4, 5, 6 or 7-pin, 1/- each. National Isolantite, baseboard or chassis mounting in 4, 5, 6, 7-pin, Octal, 2/- each. Send 2d. in stamps for a copy of our full American lists, including a copy of the New National Catalogue No. 270.

THE QUARTZ CRYSTAL CO., LTD.
(G2NH & G5MA)

63 & 71 KINGSTON ROAD, NEW MALDEN
SURREY

Telephone : Malden 0334

"The Cossor Cathode-ray Tube Unit."

(Continued from page 675)

M is approximately 1,000 volts negative to the AN terminal and earth. The beam trigger is operated electrically by connecting the EL terminal to any external circuit which produces a negative pulse, or conveniently to whichever terminal of the X or Y pairs whose potential is negative in operation. The beam switch is initially set so that the grid of the trigger valve is positive and the beam is off, the negative pulse driving the grid negative and turning the beam on. The time to reach full brilliancy is of the order of 20 microseconds, and owing to the time constant of the stopping condenser and resistance in the grid circuit, the beam is turned off automatically after approximately 0.25 second.

Fitted inside the mu-metal screen on opposite sides of the tube neck are a pair of deflecting coils. The deflectional sensitivity can be varied by connecting them in series or parallel as required or by shunting them externally. Alternative coils are available for higher or lower current ranges as required.

Short-wave Constructor Kits

A NEW booklet dealing with short-wave kit receivers of all kinds has just been published by the Peto-Scott Co., Ltd., of 77 City Road, London, E.C.1, and 62 High Holborn, London, W.C.1. Amongst the receivers illustrated is the Pilot Short-wave One, the parts for kit A costing £2 os. 4d., and a similar model with greater selectivity and a more flexible input circuit. Both of these kits are ideal for beginners on short-waves.

Model 260, a two-valve receiver, costs £2 17s. 4d. for kit A, and is made up of a detector and low-frequency amplifier. The chassis is so arranged that additional valves can be added without the original fundamental circuit having to be altered.

In all these Pilot kit receivers a standard chassis is employed to make up to four valves, so that the beginner can build a one-valve set and when he has gained sufficient experience, increase to 2, 3 or 4 valves, as required.

A three-valve model using 6-pin coils is priced at £3 1s. 8d. for kit A, while the largest receiver in the range, a short-wave four, costs only £3 12s. 11d. With every kit a constructor's envelope is included free, including 16 wiring diagrams, eight theoretical drawings, calibration chart, and an up-to-date list of short-wave stations with wavelengths and frequencies.

GALPINS

75, LEE HIGH ROAD, LEWISHAM,
LONDON, S.E.13. Telephone: LEE GREEN 5240

X-RAY GEAR

All Goods Sent on 3 days' approval against cash.

- 12-INCH SPARK COIL, complete with Condensers, Discharge Rods, etc., in polished case, in new condition, 75/- C/F.
- 10-INCH SPARK COIL, complete with High Speed Contact Breaker with Condenser, in Portable case, 95/- Ditto with Rotary Break, 95/- C/F.
- 16-INCH SPARK COIL, with Condenser, 65/-, 10-inch ditto, 55/-, 8-inch ditto, 50/- All in good condition. C/F.
- FLUORESCENT SCREENS, "Platinum," 12 x 9 in in frame. Good condition, 35/-.
- X-RAY TUBES, with Tungsten Targets, 17/6. With Platinum Targets, 25/- Packing free. C/F.
- COOLIDGE FILAMENT TRANSFORMERS, 200/250 volts input, 35/- Coolidge Tubes in new condition, 35/-.
- 10 K.V.A. X-RAY TRANSFORMER, 200/250 volts 50 cycles 1 phase complete with Auto Transformer Controls Time Clock. Meters, 0 to 5 amp. and 0 to 10 and 50 mA., all complete in oak cabinet guaranteed working, £20/- C/F.
- SINUSOIDAL CAUTREY AND LIGHT TREATMENT SET, for A.C. Mains, 200/250 volts, complete on stand in working order, £5/10/- C/F.
- MERCURY VAPOUR 1 KW. A.C. TO D.C. CONVERTOR, 220 volts A.C. input, 200 volts D.C. output, complete with spare tube. £5/10/- C/F.
- MERCURY ROTARY BREAKS, for 110 volts D.C., 25/- for 200/250 volts D.C., 35/- Control Boards for X-Ray Coils with Meter, Switches, Resistance, etc., 30/-.
- MILLIAMPER METERS, Moving Coil type in solid brass case, 6-in. dial, 0 to 5 and 50 mA., 27/6. 7-in. dial, 0 to 6½ and 65 mA., 27/6. 3½-in. dial, 0 to 5 and 25 mA., 22/6. 3½-in., 5-0-5-25-0-25 and 250-250 mA., 25/- Moving Coil Meter Movements for recalibrating into Multirange Meters, 2½-in. dial, 5/-, larger size, 4 and 5-in., 6/6. Post 9d.
- LARGE MAINS TRANSFORMERS, 3½ kW. 100/120 volts to 200/250 volts, or vice versa, not auto. wound, £3/10/- 2 kW., 50/-, 1 kW., 35/- Auto. wound, 150 watt, 10/- 100 watts, 8/6. 60 watts, 6/6.
- SHILLING SLOT ELECTRIC LIGHT CHECK METERS, 200/250 volts, 50 cycles, 1 phase, 5 and 10 amp., 17/6, C/F. Ditto, Quarterly type, 6/- Post 1/-.
- MAINS VARIABLE RESISTANCES, Sliders type, worm wheel drive; 2,000 ohms, carry 250 mA., 17/6; 400 ohms ½ amp., not w.w. type, 12/6; 10 ohms 4 amp., 10/-; 1½ ohms 20 amps., 15/-; Stud Switcharm type, 150 ohms 3 amp., 15/-; 300 ohms 1½ amp., 15/-; 300 ohms ½ amp., 10/-.
- WESTERN ELECTRIC MICROPHONES, 2/6. Microphone Transformers, 2/6. G.P.O. Hand-grip Earphones, 1/6. Telephone Hand Generators, 4/- Post, 6d.
- "CARTER" ROTARY CONVERTORS, for car radio, etc. Input 12 volts at 2½ amp., output 200 volt 40 mA., tapped at 90 volts and 45 volts. Complete with all smoothing Brand new. Listed £5. To clear, 32/6.
- TRANSFORMER, 2½ kilowatt, step up or down, 100/110 volts to 200/250 volts. Guaranteed, £3/10/- C/F.
- INDUCTION MOTORS, ½-h.p., for 200/250 volts, 1-phase, 50 cycles. Suitable for pumps, sewing machines, cinemas, etc. Condition as new, 22/6, post free.
- EX-G.P.O. GLASS TOP highly sensitive RELAYS, type B. Operating current approx. 1 mA., 7/6.
- CHARGING OR LIGHTING DYNAMOS, 110 volts 14 amps. Compound Wound, 1,350 r.p.m., 90/- 25 volts 25 amp., 1,000 r.p.m., 90/- 12 volts 8 amp. Shunt wound, 17/6. 12 volts 12 amp., 17/6. 25 volts 8 amp., 32/6. 35 volts 8 amp., 37/6. All fully guaranteed, regulators to suit 10/- to 12/6 each.
- MAINS CONDENSERS, 2 m.f. 250 volts working, 9d.; 4 m.f. 350 volt working, 2/- Dubilier Block Condensers, 4 x 2 x 2 m.f. 500 volt test, 2/6 each. T.C.C. Electrolytic Condensers, 8 m.f. 200 volt working, 1/6; 500 m.f. 40 volt working, 4/-; 1,000 m.f. 12 volt working, 6/6 each. Mains Chokes, 20/30 henry, 40, 60, 80, 120 m/amps., price 1/-, 1/6, 2/6, 4/6 each. R.A.F. Cut-outs, 20 volts 3 amps., 1/6. Microphone Buttons, 9d. Vitreous Resistances, 126 ohms ½ amp., 1/6; 2,000 ohms, 100 mA., 1/-; 3,000 ohms 220 mA., 2/- each. Resistance Mats, 600 ohms ½ amp., 4/-; 5 ohms 5 amp., 1/6 each. Bulgin D.P.D.T. Toggle Switches, 9d. each. Ex-Naval Short-wave Transmitting Condensers, .000024 m.f., 4/6 each. Dubilier ½ m.f. 2,500 volt test condensers, 2/ each. Magnetic Triple Action Keys, low-voltage working, 2/- each. Large 80 ohms 3 amp. Rheostats, in teak case, 2/6, 4 oz. Bobbins of 40 gauge D.C.C. instrument wire, 1/3. 9 oz. Bobbins of 26 gauge, 1/- Mains Power Pack 2 x 30 henry Chokes, 2 x 2 m.f. Condensers, 2/- each.

"Aerials for Ultra-short Waves."

(Continued from page 683)

35 ft. The resistance R, which is of a non-inductive type, carefully insulated so that it is not affected by weather, should have a value of 400-ohms, or equal to the impedance of the feeder lines.

This type of aerial is also suitable for use up to 40-metres, over which wavelength its advantages and directional properties become less noticeable. Constructional data is shown in Fig. 12.

A highly directional aerial that is particularly suitable for 10-metre work is shown in Fig. 13, where there are two half-waves in phase, the entire array beginning and terminating in two quarter-wave sections. Without a reflector this aerial is bi-directional and has a pattern that is very much broad-side and extremely concentrated. For wide coverage two aerials of this type would be needed and erected at right angles. The lengths of each section are given in Fig. 13 and can be calculated from the formula previously given for aerial lengths. The feeder lines are shown as 600-ohm, which are the most popular, can be of almost any impedance within the scope of the matching transformer.

The non-resonant line should be terminated in a coil of one or two turns, depending on the wavelength or the amount of coupling required, and looped over the grid coil in the receiver, as shown in Fig. 14. On 10 metres, however, it may be necessary greatly to increase the number of turns if the coils are of small diameter, but this can easily be checked by experiment.

An easy way of adjusting coupling is to have a small diameter coil inside the grid coil and to slide this in and out until optimum results are obtained. The coupling should then be fixed.

In this short article I have endeavoured to show some of the more suitable aerials for ultra-short wave reception, but the correct aerial for any particular purpose depends so much on location that the aerial finally chosen for any particular work cannot be definitely fixed without all the circumstances being known.

RELIANCE PRECISION POTENTIOMETERS

are Specified for the PRECISION OSCILLOSCOPE and the LOW COST TELEVISOR described in this issue.

5,000, 20,000, 50,000 and 100,000 ohms. Type T.W. (wire wound) 4/6 each

0.5 and 2 megohms Type S.G. Linear. 4/9 each

RELIANCE

THE PRODUCT OF SPECIALISED RESEARCH

RELIANCE MANUFACTURING CO (SOUTHWAIR) LTD
WESTBURY ROAD, LONDON E 17

W. A. Z.

(Worked all Zones)

The composition of zones 1-15 was given in our October issue with a description of how the *Worked All Zones* system operates. A further selection of zone boundaries is given in this page.

ZONE 16.

Eastern Zone of Europe.
European portions of U.S.S.R., including European portion of Soviet Russia, White Russia or Belorussia, Ukraine, and Novaya Zemlya.

ZONE 17.

Western Siberian Zone of Asia.
Asiatic U.S.S.R.
Ural.
Kirghiz.
Tadzhik.
Turkomen.
Uzbek
Kara Kalpak.
Kazak.

ZONE 18.

Central Siberian Zone of Asia.
Buryat Mongol.
Oyrat.
Siberian Krai (Eastern and Western).

ZONE 19.

Eastern Siberian Zone of Asia.
Yakutsk.
Far Eastern Area or Dalnevostchnyi.

ZONE 20.

Balkan—Asia Minor Zone.
Rumania.
Bulgaria.
Greece.
Crete.
Aegean Islands.
Syria.
Palestine.
Transjordanian.
Cyprus.

ZONE 21.

South-Western Zone of Asia.
Saudi Arabia (Hedjaz, Nejd).
Yemen.
Oman.
Aden.
Asir.
Iraq (Mesopotamia).
Afghanistan.
Persia.
India (Baluchistan only).
U.S.S.R. (Transcaucasia only, Georgia, Armenia, Azerbaijan).
Kuweit.

ZONE 22.

Southern Zone of Asia.
India (except Baluchistan & Burma).
Assam.
Sikkim.
Ceylon.

Nepal.
Mahe.
Maldiv Islands.
Laccadive Islands.
Karikal.
Bhutan.
Pondichery.
Goa.

ZONE 23.

Central Zone of Asia.
Chinese Republic, following portions only:
Tibet.
Sinkiang (Chinese Turkestan).
Tannu Tuwa (Tannou Touva).
China Proper (Kansu province only).
Outer Mongolia.
Inner Mongolia

ZONE 24.

Eastern Zone of Asia.
China Proper (except Kansu province).
Inner Mongolia (Chahar province).
Manchukua (Manchuria).
Kwangchow.
Macao.
Hong-Kong.
Darien.
Japan (Taiwan or Formosa only, 19).

ZONE 25.

Japanese Zone of Asia.
Japan (except Taiwan or Formosa).
Chosen (Korea).

The List of Zones will be completed in the December issue.



EACH MONTH AN AUTHORITATIVE ARTICLE APPEARS IN THE

T. & R. BULLETIN

under the above illustrated title

As the name implies the articles are designed to give a helping hand to the newcomer to the Amateur Radio Movement. If you are a non-member of the R.S.G.B. write for full details enclosing a Postal Order for 1/-, and receive the current issue of the

T. & R. BULLETIN

Features in the OCTOBER ISSUE include:

Twelfth Convention (fully illustrated)—A Two-Band Transmitter—56 mc. Receiver employing British Acorn valves—International 56 mc. Contest details—Month on the Air—Soliloquies from the Shack—28 and 56 mc. Bands—District and Empire News—Small Advertisements—Trade and Book Reviews, etc., etc.

Sixty pages of up-to-the-minute short wave information. Written by Amateurs for Amateurs.

All communications to,

The Secretary:

RADIO SOCIETY OF GREAT BRITAIN
53, VICTORIA STREET, LONDON, S.W.1.

Make Amateur Radio Your Hobby

TELEVISION DEVELOPMENTS

Are you keeping abreast of modern television developments? Whether amateur or professional you *must* be in touch with the latest trend of research.

The Television Society enables you to meet fellow workers in the field of television, both in this country and abroad.

Founded some 10 years ago The Television Society provides a scientific and non-partisan platform for discussion on all aspects of the subject. Meetings are held monthly during the session (October-June) and are reported in full in the Society's Journal which is sent free to all members.

The Society's activities are shortly being enlarged to meet the growing interest in the subject and members will have a unique opportunity of furthering their knowledge by contact with well-known television engineers.

Full particulars of membership qualifications may be had from the Hon. General Secretary:—J. J. Denton, 25, Lisburne Road, Hampstead, London, N.W.3.

THE TELEVISION SOCIETY

(Founded 1927)

President: Sir AMBROSE FLEMING, M.A., D.Sc., F.R.S.

WARD'S BARGAINS

WESTINGHOUSE RECTIFIERS, L.T.4 or L.T.5, with mains transformer and variable resistance, 22/6; Varley D.P.4 output transformers, 1-1 and 25-1, 9/6.

MAINS TRANSFORMERS, 350-0-350 v. 60 m.a., 4 v. 3 amps., 4 v. 25 amps., 12/-; 425-0-425 v. 120 m.a., 4 v. 1 amp., 4 v. 1 amp., 4 v. 7 amp., 4 v. 25 amp., for "W.W." Quality Amplifier, 26/-; L.T. transformers, with two 4 v. 3 a. C.T. windings or 2.5 v. 8 a., 5 v. 2.5 a., 8/6.

BRITISH RADIOPHONE CONDENSERS, fully screened, 110 kc or 465 kc., superhet, or straight type, 3-gang and 2-gang, 7/6.

VALVE HOLDERS, Chassis Type, 4- or 5-pin, 6d.; 7- or 9-pin, 6d.; R.C.A. American valve holders, 4-, 5-, 6- or 7-pin, 9d.

ASSORTED 1-gross Parcels of 1-watt and 1/2-watt Resistances by N.S.F., 12/6.

CONVERSION UNITS for Converting D.C. Receivers to A.C. Mains operation up to 110 watts, improved full-wave type, £2 10s.

VOLUME CONTROLS, with or without switch, by Rotor-ohm, Erie, Electrad, and other good makers, any valve, 2/6.

CENTRALAB RESISTANCES, 1-watt type, 6d.; 2-watt type, 1/2; 3-watt type, 1/9; B.I.C. 8 mf. and 4 mf. 550 volts peak electrolytic condensers, 3/3.

3,000 Brand New Wearite 110 kc. Pre-tune I.F. Transformers, type O.T.1, O.T.2 and O.T.2F., 1/6 each, or offer for quantity, 40 MFD. and 24 mfd. 200 Volts Peak Electrolytic Condensers, 2/6.

WE STOCK All Parts for "Wireless World" Quality Amplifier, Quality Amplifier Receiver, Imperial Short Wave Six, 1936 Monodial Q.A. Super, All-wave Super Seven, etc.

WE CAN SUPPLY Correct Equivalents for Any British Type of Valve, including side-contact Universals, H.F. pentodes, double diode triodes, 3-5-watt output pentodes, 500 v. indirectly heated rectifiers, octodes, double diodes, single diode tetrodes, etc., at an appreciably lower price.

"CORPACT" Capacity Operated Window Signs £5

CARRIAGE PAID, cash with order or c.o.d.; send for list.

CHAS. F. WARD 46, Farringdon St. LONDON, E.C.4
Tel: Holborn 9703.

INDEX TO ADVERTISERS

A.C.S., Ltd.	700
A.P.A. Metalworks	700
Automatic Coil Winder & Electrical Equipment Co., Ltd.	695
Baird Television, Ltd.	655
Belling & Lee, Ltd.	Cover ii
British Institute of Engineering Technology	Cover iii
British Mechanical Productions, Ltd.	698
Brown, S. G., Ltd.	689
Bulgin, A. F., & Co., Ltd.	641
Clx	698
Cossor, A. C., Ltd.	Cover iv
Dubilier Condenser (1925), Ltd.	693
Edison Swan Electric Co., Ltd.	642
Fluxite, Ltd.	Cover v
Foyles, Ltd.	Cover iii
G5NI (Birmingham), Ltd.	698
Galpin's	703
General Electric Co., Ltd.	671
Henley's, W. T., Telegraph Works Co., Ltd.	702
High Vacuum Valve Co., Ltd.	698
McGraw-Hill Publishing Co.	695
Midwest Radio, Ltd.	641
Mullard Wireless Service Co., Ltd.	656
Peto-Scott Co., Ltd.	699
Pilot Radio, Ltd.	694
Premier Supply Stores	690, 691
Quartz Crystal Co., Ltd.	702
Radio Clearance	701
Radio Resistor Co., Ltd.	Cover ii
Radio Society of Great Britain	704
362 Radio Valve Co., Ltd.	Cover iii
Reliance Mfg. Co. (Southwark), Ltd.	703
Sanders, H. E., & Co.	Cover iii
Sound Sales, Ltd.	698
Television Society, The	704
Ward, Chas. F.	Cover iii
Webbs Radio, Ltd.	693
Westinghouse Brake & Signal Co., Ltd.	672
Whiteley Electrical Radio Co., Ltd.	697

MISCELLANEOUS ADVERTISEMENTS

The charge for advertisements in these columns is 2s words or less 2/-, and 2d. for every additional word. All advertisements must be accompanied by remittance. Cheques and Postal Orders should be made payable to Bernard Jones Publications Ltd., and crossed, and should reach this office not later than the 15th of the month previous to date of issue.

CONDENSERS. Fixed paper, in Metal Containers. 1000volt Wkg. rmdf 2/6. 2mfd 4/9. 4mfd 7/6. 8mfd 10/6. Bakelite Tubulars. 1000volt Wkg. rmdf 2/6. 0.5mfd 1/9. 0.25mfd 1/3. 0.01mfd 9d. The Static Condenser Co. 11, Eden Street, Hampstead Road, London, N.W.1. "Makers of Good Condensers."

VALVES AT TWO-THIRDS LIST PRICE. We have still in hand a considerable number of valves of de-controlled types which are available at two-thirds of the list prices while stocks last. These include a practically full range of battery valves, including 4- and 6-volt valves, and also the following A.C. types:—ACSG 4, ACFC 4, ACHL 4, ACPX 4 and ACME 4. For example:—HL 2, list price 3/6d., de-controlled price 2/4d. SG 2, list price 7/6d., de-controlled price 5/0d. ACPX 4, list price 9/0d., de-controlled price 6/0d.—The 362 Radio Valve Co., Ltd., 324-6, Liverpool Road, Highbury, N.7.

WANTED—Laboratory Vacuum Equipment, cheap. Give description, where seen. BM/UGAT, London, W.1.

METALIZED FIBRE PANELS & CHASSIS, cut to size 3/16" 1/- per sq. ft. "Works like wood but screens like metal." Unit construction Transmitter Racks. 75 ohm feeder cable, Aerial Masts 50 ft. 6/2/6d., 45 ft. 5/2/6d. Radio z.C.N.T. Co., Tydesley Road, Atherton.

PATENT AND TRADE MARK AGENTS

GEE & CO. (Estab. 1905), patents and trade marks throughout the world (H. T. P. Gee, Mem.R.S.G.B., A.M.I.R.E., etc.), 51-52, Chancery Lane, London, W.C.2 (2 doors from Government Patent Office.) 'Phone: Holborn 4547 (2 lines). Handbook free.

KINGS PATENT AGENCY LTD. (B. T. King, Patent Agent) 146a, Queen Victoria Street, London, E.C.4. ADVICE, Handbook and Consultations free. Phone Clty 6161.

H. E. SANDERS & CO.

SUPPLY ALL TELEVISION COMPONENTS

4, Grays Inn Rd., London W.C.1. Chancery 8778

FOYLES

BOOKSELLERS TO THE WORLD
Stock of nearly three million new and second-hand volumes. Catalogues free on mentioning your interests.

119-125 Charing Cross Rd., London, W.C.2.
Telephone: Gerrard 5660 (12 lines)

THE HAMS' BOOKSHOP.

G5KA

"**RADIO "ANTENNA HANDBOOK.** It is, not generally realised among amateurs, that a given amount of time and money spent on increasing antenna efficiency, will do more to increase the strength of the distant received signal than increasing the power output of the transmitter several times. Get this book and work consistent DX with low power. 2/6d. post free.

JONES RADIO HANDBOOK. The most practicable book on amateur radio ever published. Also contains chapters on shortwave diathermy and television. No ham station is complete without a copy of this handbook. 7/- post free.

ORDER NOW!!! The 1938 edition of the **RADIO AMATEURS HANDBOOK (A.R.R.L.)** makes its appearance in this country about the beginning of December. There will be the usual big rush for this, so send your order now and make sure of getting your copy from the first consignment. The price remains the same, viz 5/6d. post free.

G5KA. 41, Kinfauns Road, Goodmayes, Ilford, Essex. Dept. "T."

Read
Television & Short-Wave World Regularly.

SPEAK TO THE WORLD

WITH AN

R.F.P.15 TRANSMITTING PENTODE

CHARACTERISTICS:

Filament Volts	..	4 v
Filament Amps.	..	1 a
Anode Volts	..	500 v
Max. Anode Input	..	25 watts
Max. Anode Dissipation	..	15 watts
Anode Load	..	10,000 ohms
Screen Volts	..	300 v
Speech Input	..	1 watt
Radio Input	..	6 volts (R.M.S.)

Price 30/-

362 RADIO VALVE Co. Ltd.
324/6 LIVERPOOL RD.,
LONDON, N.7.

NORTH 1853

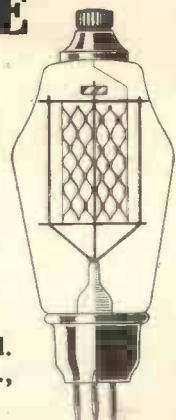

TELEVISION.

A NEW COURSE OF INSTRUCTION.

We have pleasure in announcing that our new "Television" Course has met with remarkable success. The enormous demand for the Course has shown, beyond any shadow of doubt, that it fills that long-felt need which we anticipated when we went to such trouble and expense in its preparation.

We shall be happy to send full details of this special "Television" Course on request. Particulars are also available of other Courses in all branches of Wireless, Television, Talking Picture Engineering, etc., and of the easiest way in which to prepare for the A.M.I.E.E., A.M.I.W.T., A.M.I.R.E., etc., Examinations.

We teach by correspondence, and guarantee "NO PASS—NO FEE." Our Technical Consultant is Professor A. M. Low.

Send for full particulars to-day. Free and without obligation.

THE BRITISH INSTITUTE OF ENGINEERING TECHNOLOGY
337, SHAKESPEARE HOUSE, 17/19, STRATFORD PLACE,
LONDON, W.1.



The **NEW**
COSSOR
TELEVISION CATHODE RAY TUBE
TYPE 3241.K

It has long been known that the fineness of trace obtainable with the Cossor Cathode Ray Tubes has been due to the remarkably small Cathode employed, which still renders these tubes the most suitable for Oscillography.

It was desired to retain this feature in the new tube when adopting the more robust indirectly heated cathode construction.

In the modifications that this entailed in the electron optics of the earlier part of the electrode system it was possible to obtain other advantages which were of particular value in Television. A considerably improved Modulation characteristic and sensitivity has resulted but, more important still the distribution of the light in the spot has been made uniform so that the lines of the Television picture appear less obvious, thereby improving markedly the picture detail and contrast.

Giving a black and white picture of great brilliance.
Picture size, 8" x 6½"

PRICE £12.12.0

When fitted with Mu-Metal shield against external fields 25/- extra.

Indirectly heated Cathode

4v.	0.9 amp.
Max. anode voltage	- 5000
Bulb diameter (overall)	- 295 mm.
Screen diam.	- 280 mm.
Tube length (overall)	- 580 mm.
Standard 12 contact Television Tube base.	

Full details of this tube and the full Cossor Range will be sent on application to Instrument Dept.

A. C. COSSOR LTD., Highbury Grove, London, N.5

3033