

A PRACTICAL OUTLINE OF TELEVISION

# TELEVISION

THE FIRST TELEVISION JOURNAL IN THE WORLD

and

# SHORT-WAVE WORLD

MONTHLY 1/-

AUGUST, 1935

No. 90. Vol. VIII.

BERNARD JONES PUBLICATIONS LTD.,  
CHANSITOR HOUSE, CHANCERY LANE,  
LONDON, W.C.2.

## TELEVISION

*First Steps in High-definition  
Television*

*Building a Photo-cell  
Amplifier*

*A Novel Scanning System*

*The Design of High-definition  
Amplifiers*

## SHORT WAVES

*Short-wave Band-spread Two*

*A New V-doublet Aerial  
System*

*British Amateur Radio, G5BY*

*Short-wave Apparatus at  
Radiolympia*

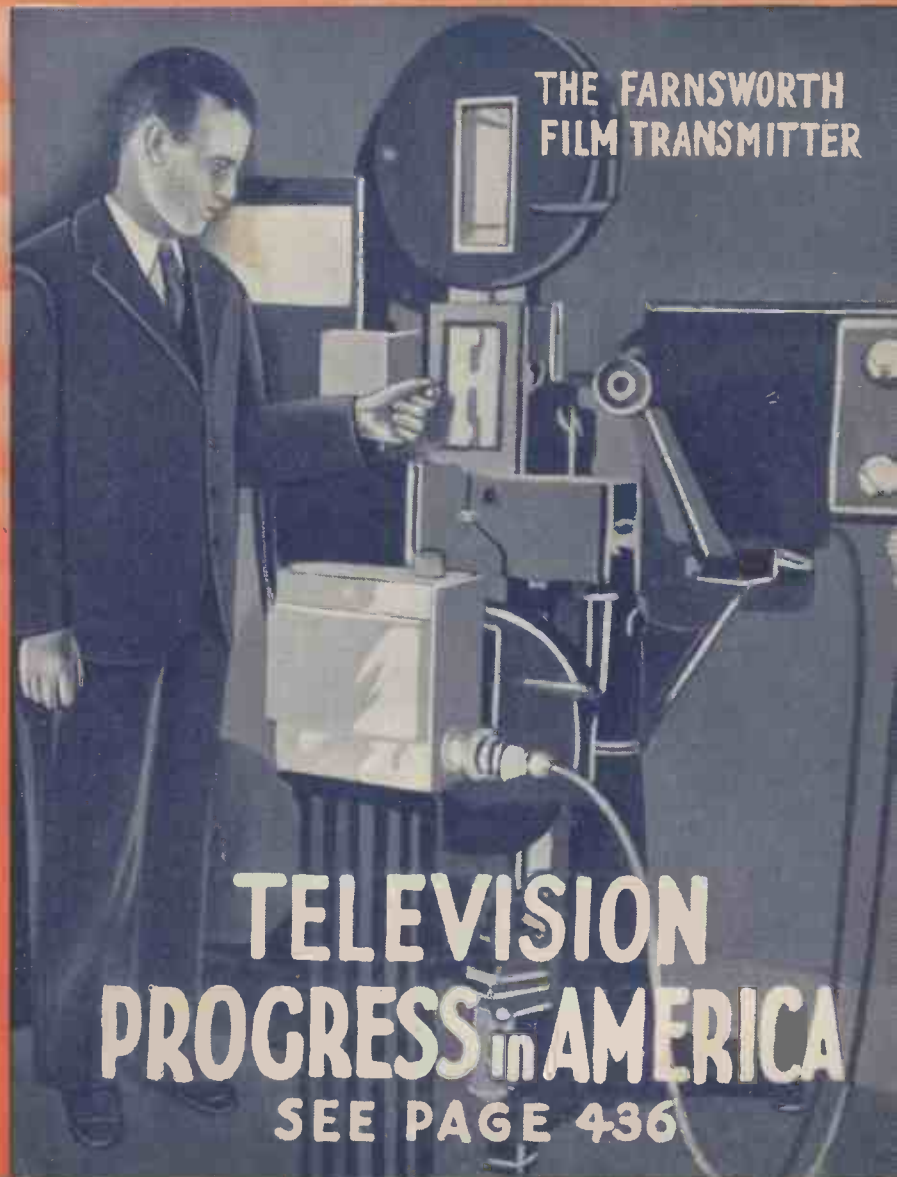

THE FARNSWORTH  
FILM TRANSMITTER

TELEVISION  
PROGRESS in AMERICA  
SEE PAGE 436



There was a wireless-enthusiast—of Crew  
Had NOTHING to learn—he KNEW!  
In THIS he is right—  
He always uses FLUXITE—  
In the "GUN"—so easy—why don't YOU?

See that FLUXITE is always by you—in the house—garage—workshop—wherever speedy soldering is needed. Used for 30 years in government works and by leading engineers and manufacturers. Of Ironmongers—in tins, 4d., 8d., 1/4 and 2/8. Ask to see the FLUXITE SMALL-SPACE SOLDERING SET—compact but substantial—complete with full instructions, 7/6. Write for Free Book on the art of "soft" soldering and ask for Leaflet on CASE-HARDENING, STEEL and TEMPERING TOOLS with FLUXITE

TO CYCLISTS! Your wheels will NOT keep round and true unless the spokes are tied with fine wire at the crossings and SOLDERED. This makes a much stronger wheel. It's simple—with FLUXITE—but IMPORTANT

### THE FLUXITE GUN

is always ready to put fluxite on the soldering job instantly. A little pressure places the right quantity on the right spot and one charging lasts for ages  
Price 1/6.

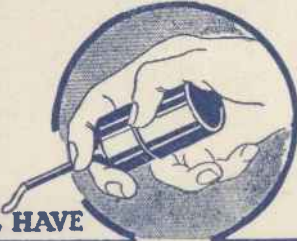

ALL MECHANICS WILL HAVE

# FLUXITE

IT SIMPLIFIES ALL SOLDERING

FLUXITE LTD. (Dept. T.V.), DRAGON WORKS, BERMONDSEY ST., S.E.1.



## SPECIFIED COMPONENTS

FOR

### DE LUXE CATHODE-RAY VIEWER

- 1—BRYCE Special Astatic Mains Transformer MODEL T2000. PRICE 50/-
- 1—H.T. Smoothing Choke 100 HY 10 M.A. MODEL T100 PRICE 15/-
- 1—L.T. Smoothing Choke 1 HY 1.3 amps. MODEL T.113. PRICE 16/6

### PEAK GUARANTEED CONDENSERS

- |   |            |
|---|------------|
| 2—2 mfd. 250v. Working Condensers, Type A.4.    | 2/9 each.  |
| 3—0.1 mfd. 650v. Working Condensers, Type C.9.  | 2/3 each.  |
| 1—2 mfd. 650v. Working Condenser, Type C.9.     | 6/- each.  |
| 1—1 x .1 mfd. Block Condenser, Type 1000.       | 3/- each.  |
| 2—.1 mfd. 2000v. Working Condensers, Type 6000  | 4/6 each.  |
| 1—.25 mfd. 2000v. Working Condensers, Type 6000 | 5/3 each.  |
| 2—1 mfd. 2000v. Working Condensers, Type 6000.  | 7/6 each.  |
| 2—4 mfd. 2000v. Working Condensers, Type 6000.  | 21/- each. |
| 2—2000 mfd. Smoothing Condensers, Type H.C.     | 12/6 each. |
- Resistors, 1 watt type, 9d. each.

Write for full list of other components which can be supplied for De Luxe Cathode-Ray Viewer to:

## W. ANDREW BRYCE & CO.

WOODFIELD WORKS, BURY, LANCs. Phone: 1251.  
London: 3-4, Ashland Place, W.1. Phone: Welbeck 1521.  
Export Agent: W. R. Everett, 63, Queen Victoria St., London, E.C.4.

Get this  
new book  
Price One Shilling

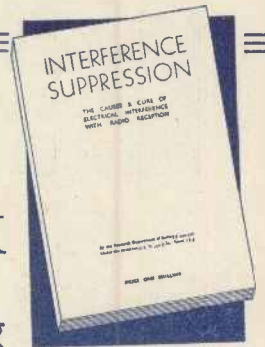

**AUTHORITATIVE  
COMPLETE  
UP TO DATE**

The world's most comprehensive manual on a vital subject: with full supplement listing the latest devices.



This is Atmosph Eric, the innocent one. He tells the world that Interference is about 95 per cent. man-made.

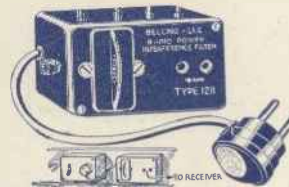

**SET INPUT SUPPRESSOR**, mains filter for back of any set, particularly portables. No. 1211. 17s. 6d.



**FLEX LEAD SUPPRESSOR**. For fans, cleaners, etc. Not noticeable when fitted. No. 1174. 6s.

**APPLIANCE PLUG SUPPRESSOR**. To suppress interference from 3-pin plug appliance: portable or semi-portable. No. 1212. 16s. 6d.



**STANDARD UNIT**. Fitted at meter board at listeners end. No. 1118. 10s. 6d.

## BELLING & LEE LTD

CAMBRIDGE, ARTIFICAL ROAD, ENFIELD, MIDD<sup>X</sup>

SEND  
THIS  
NOW

Please send a copy of the new manual, "Interference Suppression." One shilling remittance enclosed.

NAME.....

ADDRESS.....

Tele: 8-35.

**“WHERE TO FIND  
PEOPLE WHO KNOW  
REALLY GOOD  
AMPLIFIERS  
TRANSFORMERS & CHOKES  
WHEN THEY SEE THEM”**

Looking at the Exhibits on  
**SOUND SALES  
STAND No. 108**

on the Ground Floor at Radiolympia.

Owing to the popularity of our specially designed products we have moved into a more commodious factory, over six times the size of our original premises.



**NEW ADDRESS. SOUND SALES LIMITED.**  
MARLBOROUGH ROAD, UPPER HOLLOWAY, N.19.  
*(Contractors to the G.P.O., etc. Phone: ARC. 1661-2-3.)*

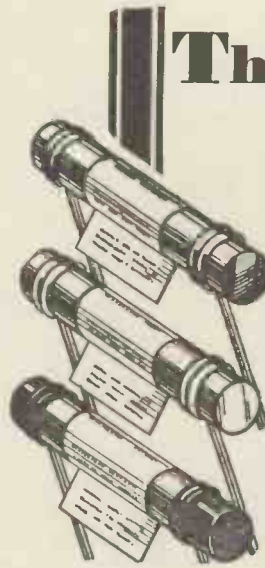

**The SAFETY  
you want**

No climatic conditions or changes in temperature affect Erie Resistors. They are made of a combination of carbon and rare earth, and are specially impregnated to withstand heat and damp. Erie engineers have marched ahead in perfecting the dependable resistance. That's why the leading radio manufacturers all use Eries:

**1/- PER WATT** Each resistor colour coded, labelled and Guaranteed in all values.

**ERIE  
RESISTORS**

★ Genuine Erie Resistors are hall-marked with the Erie label. Look for this guarantee of 100% safety.

Write for the invaluable "Erie Service Instruction Booklet," post free.

Erie Resistors can be seen at **Stand No. 15 RADIOLYMPIA**

**ERIE VOLUME CONTROL. 3/6**

Erie have produced a Volume Control that does not develop faults. The bone-hard Erie element and nickel silver contact ensure smooth and noiseless efficiency. Widely specified by designers.

or with built-in mains switch, 5/-.

**THE RADIO RESISTOR Co., LTD.**  
1 Golden Sq., Piccadilly Circus, London, W.1.

*If it's worth BUILDING  
it's worth building WELL!*

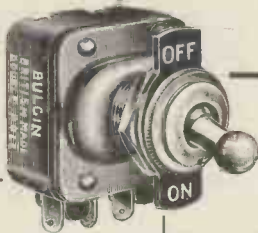

List No. S.104.

**BULGIN** Double Pole On-Off Toggle Switch, quick make and break. 2/- each.



List No. F.5.

**BULGIN** Single Fuseholder, Bakelite insulation. 6d. each.

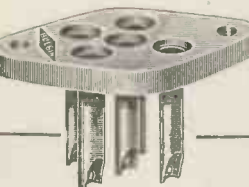

List No. S.W.41. **BULGIN** 5-pln S.W. Chassis Valveholders, Seatite insulation. 9d. each.



List No. B.C.3. **BULGIN** 5-way Battery Cable, with tinned ends. 1/6 each.

**BULGIN**

TESTED COMPONENTS

A. F. BULGIN & CO., LTD., ABBEY ROAD, BARKING, ESSEX  
Showrooms; 64, Holborn Viaduct, London, E.C.1.

Mention of "Television and Short-wave World" will ensure prompt attention.



Quick  
Fault-Tracing  
demands

# ACCURATE TESTING



Even the smallest degree of distortion in television calls for immediate remedy. Slight faults which might pass unnoticed in radio become, in television, glaringly apparent imperfections. More than ever is an accurate testing meter of first importance—vital to perfect reception.

THE WORLD-FAMOUS D.C.

## AVOMINOR

Regd. Trade Mark

is 10 accurate instruments in one. Circuits, valves, components, batteries and power units can all be tested quickly and easily. In handsome case, with leads, interchangeable crocodile clips, testing prods and instruction booklet.

## The UNIVERSAL AVOMINOR

Gives 22 different ranges of readings. The best of A.C. and D.C. meters. 3-inch scale. Total resistance 200,000 ohms. Complete with leads, crocodile clips, testing prods and instruction booklet.

"AVO" Instruments are  
BRITISH MADE

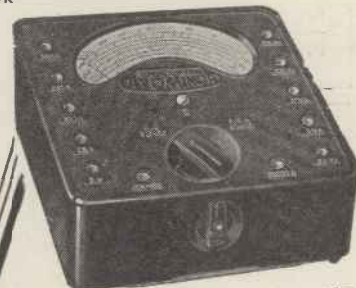

The UNIVERSAL AVOMINOR £5

D.C. VOLTS		A.C. VOLTS	
0—75 millivolts		0—5 volts	
0—5 volts		0—25 "	
0—25 "		0—100 "	
0—100 "		0—250 "	
0—250 "		0—500 "	
0—500 "		RESISTANCE	
		0—20,000 ohms	
		0—100,000 "	
		0—500,000 "	
		0—2 megohms	
		0—5 "	
		0—10 "	

Deferred Terms if desired

The D.C. AVOMINOR.

- CURRENT**  
0—6 milliamps  
0—30 "  
0—120 "  
**VOLTAGE**  
0—6 volts  
0—120 "  
0—300 "  
**RESISTANCE**  
0—10,000 ohms  
0—60,000 "  
0—1,200,00 "  
0—3 megohms

40/-

Deferred Terms  
if desired.



### AVO TESTING Accessories

Accurate—yet simple—testing is carried a further step forward by this boxed Kit of "AVO" Testing Accessories. It does away with those nondescript lengths of wire which confuse testing. You can test more quickly and are safeguarded against making dangerous mistakes. For use with any testing meters. 2/6

### New Enlarged Edition of "RADIO SERVICING SIMPLIFIED"

An invaluable Testing Manual

A complete survey of modern radio testing is explained in non-technical language. Every phase of fault-finding and multitudinous tests are so set forth as to be simply a matter of straightforward procedure. A book compiled for both engineer and amateur, enabling everyone to test sets and apparatus with ease and success.

2/6 Post Free 2/9

Be sure to see  
STAND  
103  
RADIOLYMPIA

★ If you do not visit the Radio Show, send for fully descriptive folders of the Avominors and other "AVO" Testing Equipment.

The AUTOMATIC COIL WINDER & ELECTRICAL EQUIPMENT Co. Ltd.  
Winder House, Douglas Street, London, S.W.1. Telephone: Victoria 3404-7

# TELEVISION

## and SHORT-WAVE WORLD

### Special Features

	PAGE
Television Progress in U.S.A. ...	436
Building a Phot-Cell Amplifier ...	437
What will they Televisé? ...	440
Short-wave Band-spread Two ...	441
New Reporting Code ...	444
Scanning with an Arc ...	445
A New V-doublet Aerial System ...	447
Simple Photometry ...	449
British Amateur Radio G5BY ...	452
Chronology of Television ...	453
A.B.C. of the Cathode-ray Tube ...	455
Recent Developments ...	457
First Steps in High-definition Television	459
Scannings and Reflections ...	461
Band Spreading in Amateur Receivers	463
A Practical Outline of Television ...	464
What Happens to the D.C. Component?	471
The Arc as a Light Source ...	472
The Design of High-definition Amplifiers	473
Correspondence ...	476
The De Luxe Cathode-ray Televiewer	479
When did Television Begin? ...	481
Heard on the Short-waves ...	483
Short-wave Radio World ...	485
Amateur-Crystal Grinding ...	486
A Novel Crystal Holder ...	488
Short-wave Apparatus at Radiolympia	489

### TELEVISION

#### AND SHORT-WAVE WORLD

##### Proprietors :

BERNARD JONES PUBLICATIONS, LTD.

##### Editor-in-Chief :

BERNARD E. JONES.

##### Editor :

H. CORBISHLEY.

Editorial, Advertising and Publishing

##### Offices :

Chansitor House, 38, Chancery Lane,  
London, W.C.2.

Telephones : Holborn 6158, 6159

Telegrams : Beejapee, Holb., London.

Subscription Rates : Post paid to any  
part of the world—3 months, 3/6 ;  
6 months, 6/9 ; 12 months, 13/6.

Published Monthly—1/- net.

(Last Wednesday in every month for  
following month).

Contributions are invited and will be  
promptly considered. Correspondence  
should be addressed according to its  
nature, to the Editor, the Advertisement  
Manager, or the Publisher, "Tele-  
vision and Short-wave World," Chansitor  
House, Chancery Lane, London, W.C.2.

### IMPORTANT

"Television and Short-wave World" is regis-  
tered at the General Post Office, London, for  
transmission to Canada and Newfoundland  
by Magazine Post.

## COMMENT OF THE MONTH

### *An Ill-advised Decision.*

**D**URING the past month we have been at considerable pains to ascertain the opinions of technicians upon the decision of the Television Advisory Committee to employ two types of scanning. This matter was the subject of comment in last month's issue and it is now interesting to note that the remarks then made are fully borne out in other quarters. Condemnation of the scheme is absolutely general; not a single opinion have we heard which by the greatest stretch of imagination could be construed as approving it in any particular. Some of these opinions are printed in the correspondence columns of this issue and we may say frankly that quite a number which we have received are unprintable.

Whilst appreciating that the Advisory Committee has been placed in a difficult position as arbitrator between two rival systems, obviously its first duty was towards the public—that is the arrangement of a television broadcasting system upon the most straightforward lines consistent with good results; in complicating matters at the outset the Committee has lost prestige with manufacturer and public alike. We ourselves would not dispute the advisability of employing one system or the other, though we have yet to be convinced that at the present stage of development, because of transmission limitations, any increase upon the 240-line 25-pictures per second as recommended by the Postmaster-General's Committee will give any material benefit. We do say, however, that one standard of scanning only should have been decided upon.

### *Television and Radiolympia.*

**B**Y putting a ban upon the display of television apparatus at the Radio exhibition, the Radio Manufacturers' Association has lost an opportunity of replacing that technical interest at the show which in these days of mass production and standardisation is fast dwindling away to nothing. It is certain that the inclusion of television apparatus would not have been in any way competitive with the sales of wireless receivers for, due to the delays which have occurred in the settlement of a policy, no manufacturer of television receivers is in a position at the present time to place his wares on the market. Television apparatus which could have been shown would therefore have been of educational, rather than commercial, interest and would have served to inform the public just how it stands with regard to the new service. Anti-television propaganda has been conducted so intensely during the past few months that the public is now becoming aware that there is a matter of policy behind it all, and the absence of any television apparatus at Olympia will only serve to confirm this.

## OUR STAND IS No. 7 AT RADIOLYMPIA

# TELEVISION PROGRESS IN U.S.A.

## AMERICA TO FOLLOW BRITAIN'S LEAD

By Our Special Correspondent

UPON the publication of the British Television Committee's Report American television and radio technicians wondered what effect this step would have upon the policies of the large American radio



The sound transmission gear of W<sub>9</sub>XBY.



The television studio of W<sub>9</sub>XAL. Transmissions are made upon ultra-short waves and sound goes out from W<sub>9</sub>XBY.



The sound and image control room of W<sub>9</sub>XAL and W<sub>9</sub>XBY.

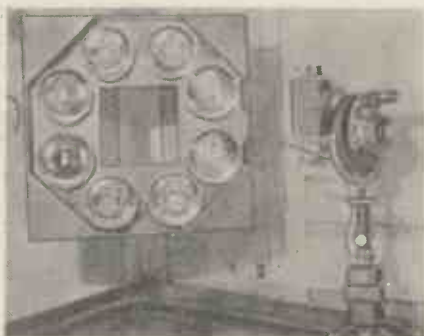

Photo-electric cell bank at W<sub>8</sub>XAT.

Photos Courtesy Radio-Craft

companies. The first sign that the report stimulated the industry was in the statement to stockholders of the Radio Corporation of America. This brief discussion of the Corporation's television activities included several comments on England's progress in the commercial field. Doubt was expressed on similar American experiments, due to the difficulties engendered largely by the geographic extent of the United States and the inability of short-wave transmission to render long-distance service.

However, on May 7, Mr. David Sarnoff, president of the Radio Corporation of America, at the annual meeting of the Corporation's stockholders, announced that field tests would be inaugurated shortly at an estimated expense of \$1,000,000. The installation of the complete service, he said, would require over a year and would be limited to a television service in some largely populated area. This, therefore, indicates that the present station on top of the 1,000-ft. Empire State Building in New York City would be placed into active daily service.

Aware of possible repercussions in the sales of radio receivers in the United States, Mr. Sarnoff was careful in delineating both the extent and limitations of present-day, high-definition television service. He remarked "that while television promises to supplement the present service of broadcasting by adding sight to sound, it will not supplant or diminish the importance and usefulness of sound broadcasting."

### Immediate Plans

Mr. Sarnoff further said: "In the sense that the laboratory has supplied us with the basic means of lifting the curtain of space from scenes and activities at a distance, it may be said that television is here. But as a system of sight transmission and reception comparable in coverage and service to the present nation-wide system of sound broadcasting, television is not here, nor around the corner. The all-important step that must now be taken is to bring the research results of the scientists and the engineers out of the laboratory and into the field."

The actual plans as outlined by Mr. Sarnoff are threefold: the establishment of a modern television transmitter, the manufacture of a limited number of receivers for reception studies, the development of an experimental television programme service to determine forms of entertainment.

Although the station of the Empire State Building has been in operation since 1931, its actual television service has been purely experimental and for test purposes, such as field-strength measurements and minimum field-strength requirements for visual transmission. Television programmes have been broadcast via a relay station at Mount Arney in New Jersey to the laboratories of the Corporation in Camden, New Jersey. Experiments in ultra-high-frequency transmission have been conducted for some time, such as the newly-announced "frequency modulation" system of Major Armstrong. The Empire State Building is the logical location for an aerial, as it is the highest point within the New York City area, which covers roughly a circle of twenty to twenty-five miles radius.

The plans for the transmission involve only high-definition television broadcasting on ultra-high-frequency channels. The number of lines to be used is 343 at a frame frequency of sixty per second. Why these odd figures were arrived at is somewhat vague, but it may be assumed that these may be used merely to discourage competition.

### Experimental Receivers

The four hundred receivers to be built are estimated to cost \$400 to \$500 apiece and will employ the cathode-ray oscilloscope developed by R.C.A. engineers under the guidance of Doctor V. Zworykin. With these receivers located in the homes of stockholders and possibly some employees, an idea will be arrived at as to suitable programmes, service and other matters. It must be remembered that this is extremely important in the light of sponsored programmes for advertising purposes.

(Continued at foot of page 439.)

The various types of experimental scanning arrangements which have been described from time to time in these pages all require a form of photo-cell amplifier to give the requisite

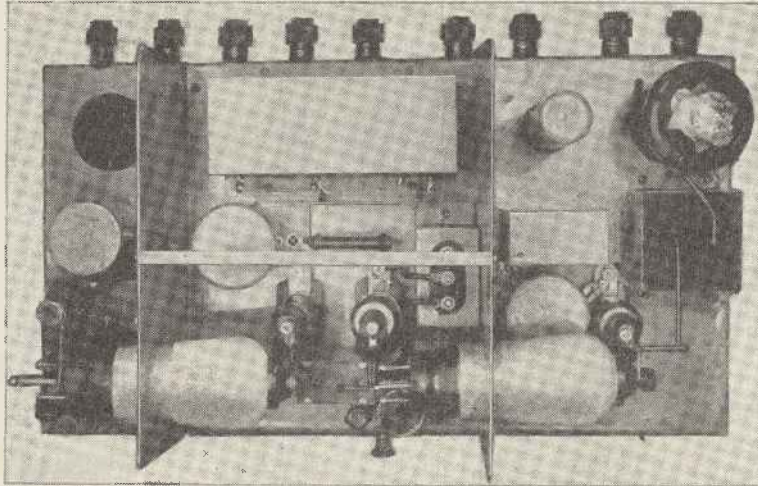

This photograph shows a plan view of the photo-cell amplifier.

signal to a cathode-ray tube or neon lamp. The circuit described in this article is that of a 3-valve R.C. coupled amplifier having a frequency response from 20 to 50,000 cycles.

## BUILDING A PHOTO-CELL AMPLIFIER

THE photo-cell amplifier described below can be well adapted to work in conjunction with the low-frequency tone source described in the July issue. The assembly is compact and adequately screened and will make a useful addition to the equipment of the experimental laboratory.

There is no space in this article to discuss the theory underlying the design of photo-cell amplifiers, but it is hoped to include a separate article on the subject at a later date. For the present it is sufficient to give a few brief notes on the circuit chosen.

### Screen-grid Amplifiers

The capacity of the photo-cell itself is in parallel with the grid-cathode capacity of the valve, and these, together with the anode-grid capacity, are in parallel with the grid leak resistance. The value of the grid resistance is made as high as possible in order that a given photo-cell current shall produce the maximum voltage across the grid-cathode circuit of the valve. The limit to the value of leak for any frequency is set by the stray capacities mentioned above. The anode-grid capacity, so far as the grid circuit is concerned, is multiplied by the amplification of the stage, which is almost the same as the amplification of the valve if the anode resistance is high. The use of a screen-grid valve instead of a triode in the first stage not only increases the magnification of photo-cell current obtainable, but greatly reduces the capacities in parallel with the photo-cell and grid leak.

This enables a higher value of leak to be used with a further increase in magnification. There is no question therefore of the superiority of the screened valve as an amplifier of photo-cell currents.

The values of components in conjunction with the valves are dictated by the frequency range and amplification required—the time constant of the coupling condenser and grid leak is  $\frac{1}{2}$  second. For higher frequencies the response of the amplifier is given a boost by means of air-core chokes in the anode circuits.

ease in soldering the seams and in making connections. Aluminium is lighter and easier to work but requires tongues to be left at the edges of the bent-over portions to enable the flaps to be riveted. The arrangement of the screened-grid valves was suggested to one of the writers by Mr. T. D. Humphreys and is very convenient in that it avoids long connecting leads to the coupling condensers.

The vertical screens, which are shown in the photograph, are cut from the same sheet metal and have holes drilled along one edge as shown. After

Circuit of three-valve R.C. coupled photo-cell amplifier with a frequency response of from 20 to 50,000 cycles.

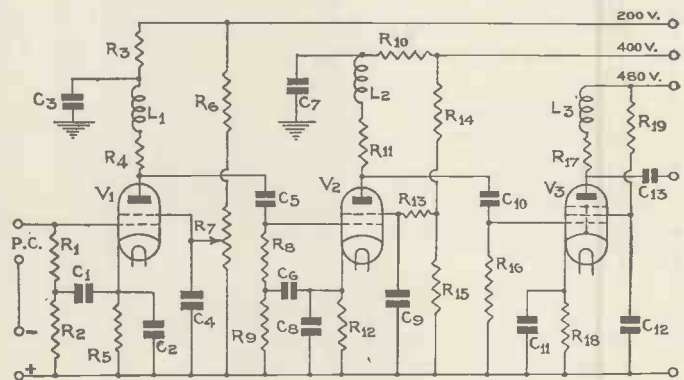

### Layout of Components

The photograph gives a good view of the assembly of the various components, and should be studied in conjunction with the diagram, which shows the layout of the chassis. The chassis is bent from 20 gauge sheet iron (tinned) or aluminium. The former material is to be preferred for

cutting the hole for the valve bulb the flap is bent over and the screens are ready for fixing on the chassis. They are made more rigid by the addition of a  $\frac{1}{4}$  in. square brass bar tapped at each end and screwed into position between the top edges of the screens. This is also seen in the photograph. The holes for the Belling-Lee terminals are then drilled in the back flap of

# A PHOTO-CELL AMPLIFIER FOR THE EXPERIMENTER

the chassis and a hole for the screen potentiometer in the front flap. The holes on the base of the chassis should be taken more as an indication than actual working dimensions, since a certain amount of latitude is allowable in the choice of components, and fixing down holes are best marked out when the components are laid out at the commencement.

screen, has a wire-wound anode resistance and 4-mfd. coupling condenser above the base, while under the base is a 4-mfd. output feed condenser and the pentode load resistance.

The chokes in the anode circuits were wound specially by Messrs. Varley and are supplied with screening cans. These have two lugs at the sides which are screwed on to the base of the chassis, the choke being held by a single screw passing through the wooden core of the choke former.

On the under side of the chassis a

resistance holder is fixed to hold the pentode load resistance. A composition 5-watt resistance was used for this in the original model, but wire-wound resistances are preferable if they are available. The sketches show other details of the assembly.

## Assembly

When the holes have been drilled and the chassis bent up the terminals

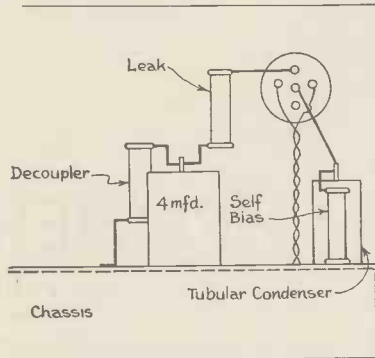

Details of assembly of bias resistances and condensers.

From left to right the chassis may be divided into three compartments, the first holding the grid decoupling condenser, screen condenser and photo-cell input. In the centre are the coupling resistance for the first anode, the coupling condenser (marked) and the grid leak of the second valve. At the back of these is a bank of condensers for decoupling and screen decoupling. The second valve, projecting through the

LIST OF COMPONENTS.	
R1	Grid leak, 0.25 meg., Erie 2 w.
R2	Decoupler, 50,000 o., Erie 2 w.
R3	Decoupler, 20,000 o., Erie 2 w.
R4	Coupler, 30,000 o., Varley W.W.
R5	Bias, 1,000 o., Erie 2 w.
R6	Screen, 50,000 o., Erie 1 w.
R7	Screen, 50,000 o., Reliance Potentiometer.
R8	Grid leak, 0.5 meg., Varley W.W.
R9	Decoupler, 100,000 o., Erie 1 w.
R10	Decoupler, 50,000 o., Erie 2 w.
R11	Coupler, 25,000 o., Varley W.W.
R12	Bias, 1,000 o., Erie 2 w.
R13	Screen, 0.1 meg., Erie 2 w.
R14	Screen, 0.05 meg., Erie 3 w.
R15	Screen, 0.05 meg., Erie 3 w.
R16	Grid leak, 0.25 meg., Erie 2 w.
R17	Coupler, 8,000 o., Varley W.W.
R18	Screen, 30,000 o., Erie 3 w.
C1	Decoupler, 4 mfd., "Peak" Type A.3.
C2	Bias, 25 mfd., "Peak" Type D.55.
C3	Decoupler, 4 mfd., "Peak" Type CB.5.
C4	Screen, 4 mfd., "Peak" Type D.48.
C5	Coupling, 1 mfd., "Peak" Type T.8.
C6	Decoupler, 4 mfd., "Peak" Type A.3.
C7	Decoupler, 8 mfd., 2 "Peak" Type CB.5.
C8	Bias, 25 mfd., "Peak" Type D.53.
C9	Screen, 4 mfd., "Peak" Type D.48.
C10	Coupler, 4 mfd., "Peak" Type T.8.
C11	Bias, 50 mfd., "Peak" Type D.52.
C12	Screen, 8 mfd., "Peak" Type D.4.
C13	Output, 4 mfd., "Peak" Type C.6.
L1	Varley special choke 2.5 mH.
L2	Varley special choke 2.5 mH.
L3	Varley special choke 8.0 mH.
V1	Mazda AC/S.2.
V2	Mazda AC/S.2.
V3	Mazda AC2/Pen.
H1	5-pin chassis mounting holder (optional).
H2	7-pin chassis mounting holder (optional).
H3	Holders for wire-wound resistances.

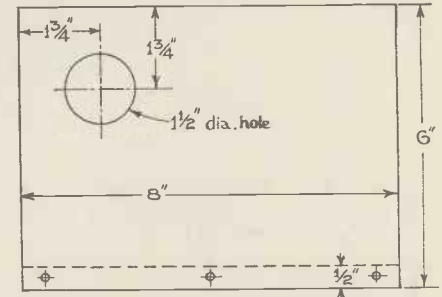

Dimensioned details of screens.

can be fixed in position, each with an insulating washer at the back, with the exception of the -ve H.T. terminal.

This is at the extreme left, viewing the chassis from the valve side, and is connected to the metal. In order from left to right the terminals run: +ve for photo-cell, H.T.+1 (200 volts), H.T.+2 (400 volts), H.T.+3 (500 volts); L.T. for heaters; output.

The condensers are screwed down with 6 B.A. round head 1/4 in. screws, the standard fastening for all the components. The first cathode circuit condenser at the left may be found to foul the screen potentiometer if the screw is left the full length, and it should be cut short accordingly. Do not insert the valves and upright screens until all the components are in place and the majority of the wiring is done. The leads for the heaters of the valves must be run in shielded flex. Two holes have already been drilled in the chassis where the leads will come up to the pins of the valves, and the ends can be brought through and left loose for the time being. Extra holes will be needed for connection to the components through the chassis.

Having wired up the anode circuits and the screens, the metal screens may now be screwed down and the valves fitted in place. The metal coating of the valve is connected to the cathode, and must not be allowed to touch the metal of the chassis, or

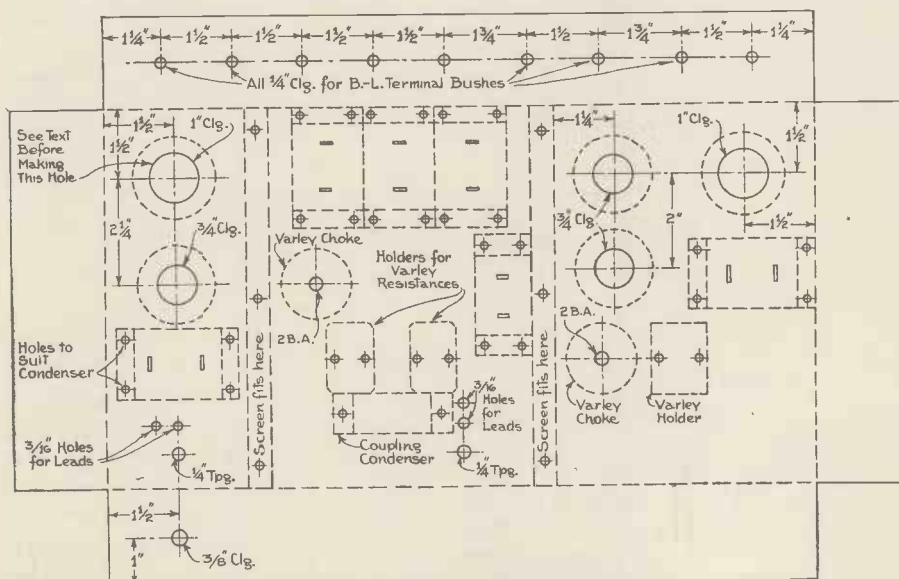

The layout of the components and the drilling of the chassis are shown in this diagram.



the self-bias resistance will be shorted. Before inserting the valves, therefore, wrap a piece of shellac cloth or tape round the lower part of the bulb where it wedges in the screen.

The valves must be quite rigid in the holes to avoid microphonic noises, and the connection between the anode terminal and the anode resistance should be made with 18 s.w.g. wire to anchor the valve firmly. The connection to the screen can now be made, together with the heater connections. The cathode pin is soldered to the top of the cathode condenser, as shown in the sketch. The grid of the input valve on the left should have its soldered connection well up the pin to allow of a socket being slipped on later for connection.

**Photo-cell Socket**

If the amplifier is to be used with a self-contained photo-cell mounting, it is convenient to fit the socket for the cell on the left-hand side of the chassis as shown in the photograph and drawing. The cathode of the cell can then be taken straight to the grid of the valve across the tops of the condensers. This lead will pick up interference unless shielded, but the shielding should be of low capacity to avoid high-note loss. A stiff wire from the cathode passing through the centre of a piece of 1/4 in. metal tube will be satisfactory. The

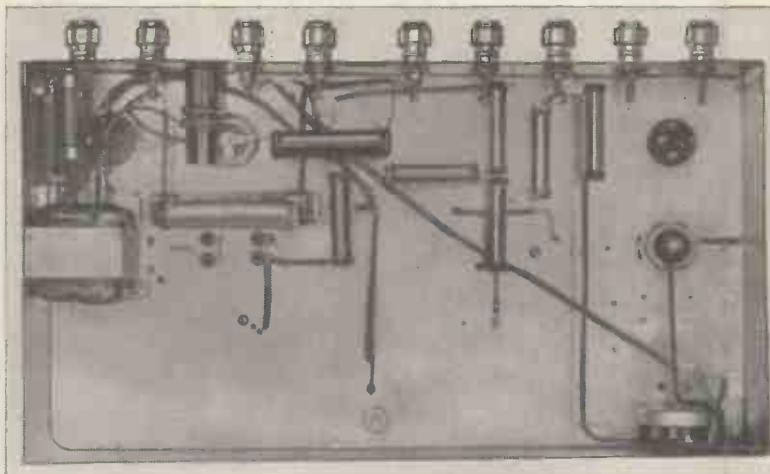

*A view of the underside of the chassis of the photo-cell amplifier.*

cell may be enclosed in a metal can similar to that described in the issue of November, 1934 (p. 506).

**Operation**

The supply to the amplifier should be from accumulators and H.T. batteries if absolute freedom from hum is required. The need for a steady source of H.T. has already been stressed in these articles, and while the value of voltage required may seem high, it is obvious that with R.C. coupling the drop in the load resistances will account for the majority of the H.T. applied. The pen-

tode anode load will account for 240 volts leaving 240 available across the valve. The photo-cell battery may be of the standard dry H.T. type, and is connected with its -ve terminal to the chassis, the +ve going to the anode of the cell. The volume control of the amplifier is by means of the screen potentiometer of the first valve. No tendency to instability was noted when the finished amplifier was tested, but if there is a tendency to pick up hum from external sources the whole chassis can be enclosed in a metal cover which is screwed to the side flaps.

**"Television Progress in U.S.A."**  
*(Continued from page 436.)*

Thus it is that New Yorkers will be the first to see modern television equipment in the United States. Although this preliminary service will not be available to the average man, the change in policy from secrecy to information is heartening to the television technician.

**New Television Companies**

It will be interesting to note the number of new "television" companies in the field. Although the restrictive laws passed in President Roosevelt's administration will prevent the sale of promotional stock, there is little doubt that some individuals will be caught in the snares of wily promoters. Another interesting situation will be one of patents. It has been rumoured that intense legal litigation will be started and that the issues and money involved will be tremendous. It is rather soon to

prophecy, but several quarters believe that the Government will soon step into the picture and that the possibilities of a regulated patent pool are not remote.

One cannot speak of television enthusiasts in the United States. Two or three years ago, the general public was keenly aware of television in its crude forms. However crude it may have been, the amateur was able to experiment with low-definition systems of 60 lines and 20 frames. In some instances, consistently excellent results were obtained. The pressure of economic forces reduced broadcasting to a very few intermittent stations and the activities of the large corporations further reduced the possibilities of experiments.

**Slow Morse Practice**

For the benefit of listening stations and those readers who wish to improve their morse, the R.S.G.B. have arranged a further series of slow morse tests for August 4 and August 11. The following are the exact times.

Aug.	4	at	00.00	1761.5	...	G2WO
"	4	"	09.30	1785	...	G5BK
"	4	"	10.00	1850	...	G6VD
"	4	"	10.15	173λ	...	G5JU
"	4	"	10.30	1911	...	G2JL
"	4	"	11.00	7104	...	G6PI
"	4	"	11.30	1761.5	...	G2WO
"	4	"	12.00	7102	...	G5GC
"	11	"	00.00	1761.5	...	G2WO
"	11	"	09.30	1785	...	G5BK
"	11	"	10.00	1850	...	G6VD
"	11	"	10.15	173λ	...	G5UH
"	11	"	10.30	1911	...	G2JL
"	11	"	11.00	7104	...	G6PI
"	11	"	11.30	1761.5	...	G2WO

**The General Electric Company and Television**

Lord Hirst, chairman and managing director of the General Electric Co., Ltd., speaking at the general meeting of the company held on June 27, said that technically they held a strong position in the television field, and their developments were well advanced. The possibilities of television held a dominating place in the outlook in their research laboratories.

# WHAT WILL THEY TELEWISE?

A speculative article by Jean Bartlett, B.A., who was lately assistant producer of the B.B.C. television programmes.

**A**MONG the many progressive recommendations of the Television Committee one statement leads immediately to the speculation, "What will they televise?" "The

be in action when the evening's programme includes a popular play, or a few seconds of the afternoon are reserved for the finish of an important race; or, when, in the summer,



Almost every receiver will be in use when the programme includes a popular play. This is an actual scene during a transmission from the Baird studios at the Crystal Palace.

time may come," says the Report, "when a sound broadcasting service entirely unaccompanied by television will be almost as rare as the silent cinema film is to-day."

Just what will they televise? This looking (or must we say televising?) demands a wholesale rearrangement of ideas. The looker, or rather the listener, as well as the B.B.C., must prepare for revolution.

## A Revolutionary Development

The advent of vision into broadcasting is an incomparably bigger revolution than the departure of the silent film. We went to the cinema as usual, and one day we heard as well as saw. For the adventurous among listeners who can already see as well as hear over the air, things are not as usual. The room is in more or less complete darkness. The distraction of another task for the eyes and hands, and the consequent lack of concentration upon the programme will be practically abolished.

And will the entertainment be worth all the trouble? Some of the television programmes of the future will, of course, be immensely and widely popular. Almost every receiver will

the lack of a seat at Wimbledon can be compensated in one's own sitting room.

There still remain, however, vast gulfs of time to be filled by programmes. What is the public going to demand, and the B.B.C. to provide? Perhaps neither knows and both are wondering.

Technical developments, to the lay reader, seem nothing less than miraculous. Can the imagination of the programme builders keep pace with them?

## Plenty of Scope

The B.B.C. will possibly find, as they progress with television entertainment, that it demands quality rather than quantity, and that the time will never come when there will be no sound broadcasting service un-

accompanied by vision, but that two services will be organised in parallel, because the sound service of to-day has features which can never be superseded by vision combined with sound.

Plays, variety, musical comedy and even, perhaps, grand opera, have always needed vision. The disembodied versions have been great achievements, but not the real thing, and when vision is perfected they will die a natural death.

For most people the voice over the ether conjures up a mental picture which will soon, at last, be actually seen over the ether. And, in addition, there lie before the programme builders and their audiences the other fields already experimentally explored by the low-definition which the B.B.C. has been broadcasting—all kinds of dancing, illustrated talks, exhibitions as diverse in interest as those already shown of antiques and animals, sculpture and mannequins.

## Educational Uses

For the Children's Hour and many broadcasts to schools television will, in time, be invaluable. Pure listening, to anything but music, is an unnatural strain on childish powers of concentration.

The material for television, therefore, seems unlimited. And yet there still remain daytime periods—and they are long and frequent—at present filled by gramophone recitals and relays from this, that and the other cinema and from provincial studio orchestras, which have no pictorial value, although they are invaluable to listeners who are at home either by choice or necessity, and can be entertained by light music while they are doing something else.

And so it does not seem gloomy to prophecy that television will never be an all day affair, but will be concentrated into the evening hours and week-ends when people can give themselves up to being entertained (or educated), with an occasional hour off during a week-day for a programme of very special interest. The concentrated attention of viewers will then demand a higher standard, and if its resources are not squandered throughout the day, the television service will be something very big.

An order placed with your  
newsagent will ensure regular  
delivery of TELEVISION  
AND SHORT-WAVE  
WORLD



The left-hand control is the master tuner, the dial on the right being for band spread.

# A Short-wave Band-spread Two

By Kenneth Jowers

*Most of the amateur DX records have been set up in conjunction with simple two-valve receivers. We publish this circuit in the belief that it is one of the most satisfactory of its kind and as it has undergone tests at various amateur stations its efficiency is guaranteed.*

ON the 20-metre band when conditions are not too good the only receiver that is capable of pulling in real DX stations is a simple two-valver. The large super-het will undoubtedly give a greater signal level, but very often when the static level is high the long-distance stations are generally obliterated.

A two-valve receiver has so little amplification to spare that every component in it must pull its weight. It must be easy to handle while the last ounce of amplification has to be obtainable without difficulty. Naturally, tuning should be very simple, while band spreading is essential. Most beginners to short waves make as their first set a two-valver with a triode detector, and manage to log a few local amateur stations and, of course, the usual American commercials.

It is not generally realised that any lack of DX on a two-valve set is

generally caused through weak points in design. Just recently I have been active on 20 and 40 metres, but owing to bad local interference the large super-het which I normally use has brought in too much background noise. On Sunday mornings a large number of more or less local 40-metre stations are heard, but after getting down to things I noticed that there were no real DX stations actually received.

In view of all this I designed a two-valve receiver so as to give maximum gain, a simple means of regeneration and, of course, band spread. The ordinary capacity type of reaction, while it can be made very efficient and

smooth, is not always the best for constructors. Often I have built a receiver to give perfectly smooth reaction, but a duplicate of the original model did not always prove perfectly satisfactory, the trouble being variations in the components.

To overcome these little troubles, here is a receiver that has been designed to take care of all these variations, and no matter how much the valves may vary the receiver will always give 100 per cent. results. I know that active transmitters will welcome this receiver while the beginner will also find this a good receiver for short-wave reception.

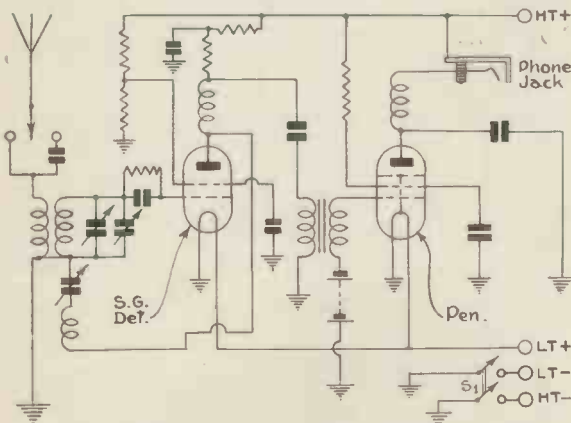

Take particular note of the screened grid detector and the method of obtaining smooth regeneration. This new method overcomes major variations in components.



An aerial preset condenser is fitted to the back of the chassis. It can be cut out of circuit by using the alternative aerial connection.

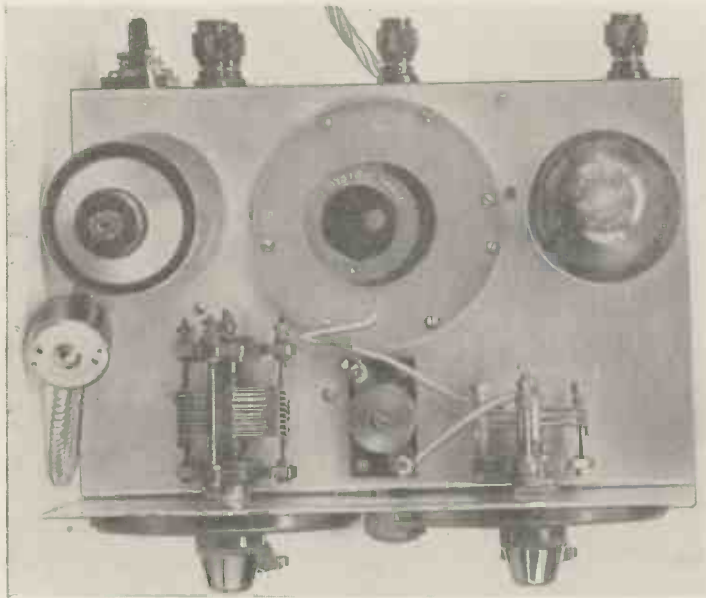

Between the two tuning condensers can be seen the preset reaction condenser. This should be adjusted very carefully as mentioned in the text.

**The Circuit**

First of all the circuit. It consists of a moderately low impedance screened-grid valve operating as a leaky grid detector. In the grid circuit is a normal tuning coil with a loosely coupled primary so that variations in aerial length will not affect calibration. For the beginner, that means that once a station has been logged a note can be made of the dial reading and the station will always come in at the same reading. Where greater selectivity is required, such as to separate two stations very close together, then an alternative aerial tapping is provided in series with which is a small Jackson pre-set condenser.

Regeneration is obtained by increasing the capacity of the .0002 preset condenser in series with the reaction coil. The condenser in question can be seen mounted between the two variable condensers. This pre-set should be left set so that the receiver is almost oscillating on the particular waveband in use. To put the first detector into an oscillating condition the screen voltage should be varied by means of the potentiometer mounted on the front panel.

In this way the impedance of the valve is varied and the circuit goes smoothly into oscillation. It is impossible to detect any pop and very weak stations can be pulled in quite easily.

The theoretical way to obtain maximum gain from the screened-grid detector is to make the external impedance as high as possible compared with the impedance of the valve. Maximum gain cannot be obtained with a battery valve for the resistance will have to be so high that somewhere

in the region of 400 volts H.T. would be required. To overcome this trouble a combination of R.C. and transformer coupling has been employed. This enables a reasonably high amplification to be obtained and at the same time the normal 3-1 step-up through the transformer is also gained. All these points coupled to a steep-slope pentode give the maximum possible output from a weak signal.

In the anode circuit of the pentode is connected an H.F. choke by-passed to earth with a .006 condenser. The idea of the choke is to prevent H.F. getting into the phone or speaker leads, so making the receiver difficult to handle, while, of course, the complete filter circuit must include a by-pass condenser. Incidentally the amount of top cut through this .006 mfd. condenser is not great, making reproduction peaked, essential for reading weak phone stations.

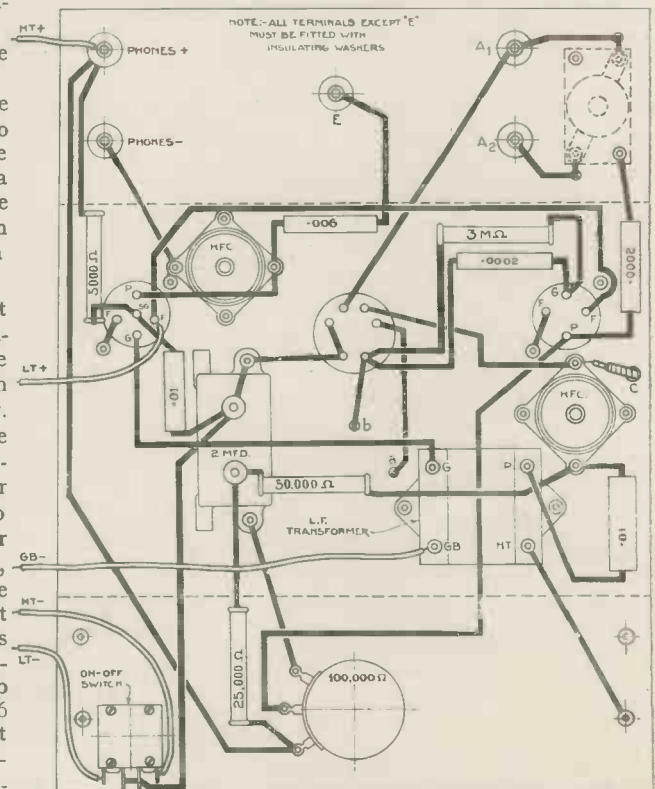
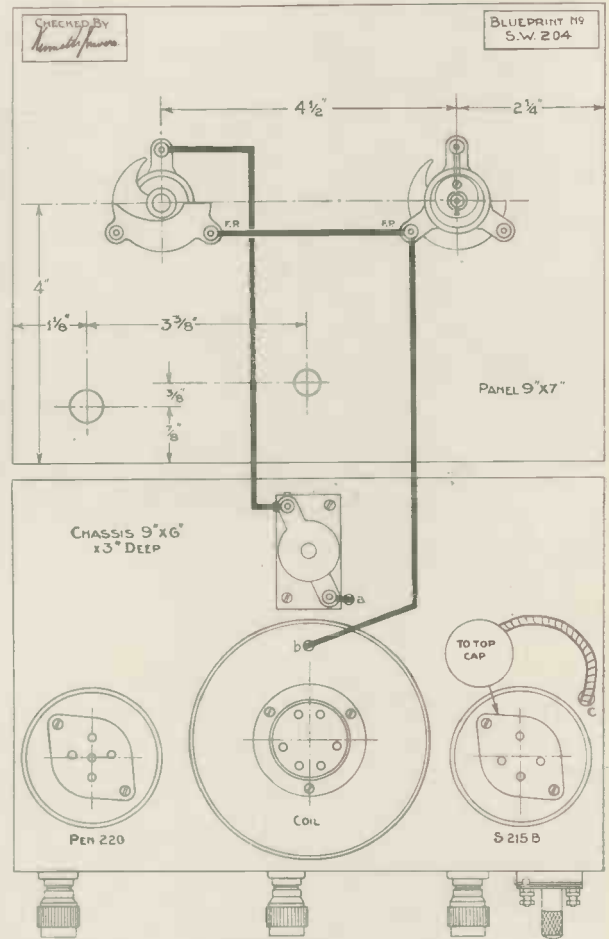

A full-sized copy of this blueprint can be obtained from the Blueprint Dept., "Television and Short-wave World," price 1/-.

**Constructional  
Points**

The detector valve and coil must be carefully screened, not so much to prevent instability but pick-up from local mains wires or from the transmitter. Very often I use this receiver as a monitor, which is only possible by virtue of the screening. The screen over the output pentode is not particularly necessary, but I get so tired of seeing hay-wire amateur-built sets that I thought the slight extra expense would be well worth while in view of the greatly improved appearance of the receiver.

**COMPONENTS REQUIRED****CHASSIS AND PANEL.**

1—Chassis, aluminium, 9 ins. by 6 ins. by 3 ins. (Peto-Scott.)

1—Panel, aluminium, 9 ins. by 7 ins. (Peto-Scott.)

**CHOKES, HIGH FREQUENCY.**

2—Type HFO. (Wearite.)

**COILS.**

1—Set type 959. (Eddystone.)

**CONDENSERS, FIXED.**

1—.0002-mfd. type tubular. (T.C.C.)

2—.01-mfd. type tubular. (T.C.C.)

1—.006-mfd. type tubular. (T.C.C.)

1—.1-mfd. 250-volt working. (T.C.C.)

1—.2-mfd. 250-volt working. (T.C.C.)

**CONDENSERS, VARIABLE.**

1—Type 942 .00016-mfd. (Eddystone.)

1—.000015-mfd. type 900. (Eddystone.)

2—.0002-mfd. preset. (J.B.)

**DIALS.**

2—Slow-motion. (B.T.S.)

**HOLDER, COIL.**

1—964 type. (Eddystone.)

**HOLDER, FUSE.**

1—Type F5. (Bulgin.)

**HOLDERS, VALVE.**

2—SW41. (Bulgin.)

**RESISTANCES, FIXED.**

1—3-megohm 1 watt. (Erie.)

1—50,000-ohm. 1 watt. (Erie.)

1—25,000-ohm. 1 watt. (Erie.)

1—5,000-ohm. 1 watt. (Erie.)

**RESISTANCE, VARIABLE.**

1—100,000-ohm potentiometer. (Erie.)

**SCREEN.**

1—Coil. (Colvern.)

2—Valve. (Colvern.)

**SWITCH.**

1—Type S104 toggle. (Bulgin.)

**TERMINALS, etc.**

5—Terminals type B marked A (2), E, L.S. +, L.S.

(Belling Lee.)

4—Wander plugs marked H.T. +, H.I. —, G.B.

+ , G.B. —. (Clix.)

2—Spade terminals marked L.T. +, L.T. —. (Clix.)

**TRANSFORMER, LOW FREQUENCY.**

1—DP22. (Varley.)

**VALVES.**

1—5Z15B met. (Mazda.)

1—Pen20. (Mazda.)

**SUNDRIES.**

Quantity 4 B.A. nuts and bolts.

1—Screened anode connector type 1224. (Belling-Lee.)

1—Five-way battery cord. (Bulgin.)

**ACCESSORIES.****ACCUMULATOR.**

1—2-volt 40-ampere. (Ever Ready.)

**BATTERY, HIGH-TENSION.**

1—120-volt 10 m/a discharge. (Ever Ready.)

**CABINET.**

1—Special. (Peto-Scott.)

A complete kit of parts is obtainable from Peto Scott Ltd.

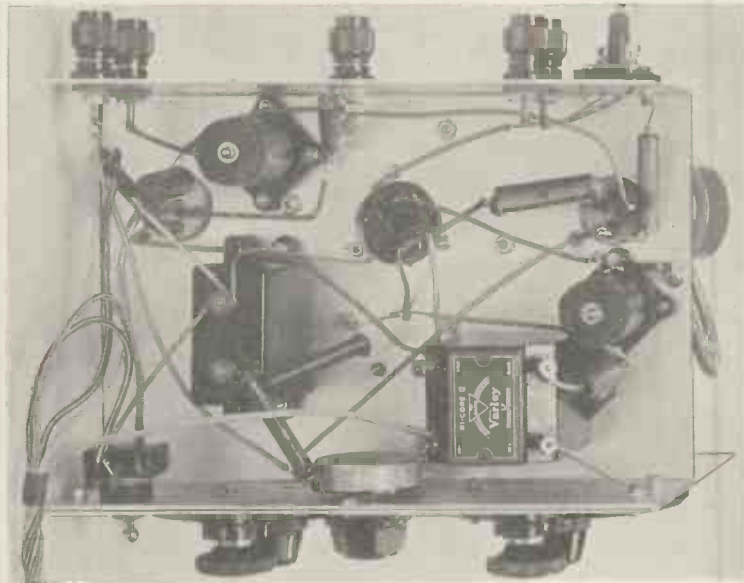

An underside view of the chassis showing the arrangement of the components.

tuning. This would make the receiver utterly useless, so to overcome this trouble put a small bolt through the side of the dial and fix it to the panel. By making a special coil the receiver worked excellently on 28 mc. (10 metres) without any trace of hand capacity. Actually the coil has three turns to the grid, three turns reaction, and two turns for coupling.

Band-spread tuning makes the receiver quite as easy to handle as a broadcast set. On 40 metres, for example, the band covers 70 degrees on the tuning dial, while on 160 the entire band would cover about 110 degrees, but as the dial only goes to 100 degrees the main tuner has to be brought into action as well. I use four coils and these cover 12-26, 22-47, 41-94 and 76-180 metres. There are other coils which go up to 500 metres, but they should not be used unless a very short aerial is employed and the receiver is not too close to a broadcast station. As mentioned before, if the set is to be used on 28 mc. the coil must be home constructed.

Any high-tension over 90 volts will operate the receiver satisfactorily, but a maximum of 150 makes a noticeable improvement in gain. Taking 120 volts as an average, the anode current is approximately 8 milliamps with  $4\frac{1}{2}$  volts grid bias. It is optional whether or not terminals or a phone jack are used. I prefer a phone jack, but for those readers who prefer terminals these are shown in the illustrations.

**OUR STAND**  
at  
**RADIOLYMPIA**  
is No. 7

Sometimes readers make up these receivers with any old components. Remember, however, that the Erie potentiometer has a dead spindle. If this is forgotten it is probable that both the valves will be burnt out. The Bulgin switch breaks both H.T. and L.T. simultaneously. This is essential, otherwise there will be a leakage across the potentiometer.

It may be commented that there is no anode to earth by-pass condenser in the detector stage. In the original set this was not required, but as a precautionary measure if difficulty is experienced in obtaining smooth reaction a condenser of approximately .0001—.0002 mfd. should be connected between the anode of the screened-grid valve and chassis.

As regards an aerial, anything over 40 feet in length does not apparently have any effect on the number of stations received, although it does reduce selectivity. As a general rule, I have been able to log amateur stations from all parts on a length of wire stretched a foot above my laboratory roof, approximately 10 feet high by 22 feet long.

This receiver will be on show at our stand, No. 7, at Olympia where readers will be welcomed.

**Wireless Patent Agreement**

Marconi's Wireless Telegraph Co., Ltd., has concluded an agreement with British Radiostat Corporation, Ltd., and has acquired rights under present and future patents controlled by the latter company, including exclusive licensing rights under the Stenode broadcast reception (sound and television) patents in Great Britain and Ireland.

# The New Reporting Code

By B. E. H. Jones, B.R.S. 770

**M**OST short-wave listeners will be familiar with the present system of reporting signals, i.e., the QSA1-5, R1-9, T1-9 system, without perhaps realising that in spite of it having been used for so long, it does not give in most cases a definite, concise indication of the signal as received.

In the first place, readability is reported by the QSA code, QSA1 indicating "hardly perceptible unreadable," and QSA5 "very good signals, 100 per cent. readable," although the correct meaning of QSA is "the strength of your signals is ....." On the other hand, signal strength, which should be an indication of actual degree of strength irrespective of whether the signal is fully readable or not, is reported by the R code, which—as will be seen from the table herewith—

of the two together without revision having caused the present ambiguity.

It must also be noted that signal strength is not the same thing as audibility or loudness; the former is independent of the amplification of the receiver, whereas the latter is directly dependent on it. Thus a signal of maximum strength should be reported as R9 whether received on phones on a single-valve set or on the loudspeaker of a powerful superheterodyne, but the degrees of loudness in the two cases would be vastly different. Unfortunately definitions of signal strength involving actual loudness, such as "heard several feet from phones" have crept into the R code.

## Contradictory Codes

The T code for reporting tone is as bad or perhaps worse than the two already mentioned, since, as will be seen below, several things besides tone are mentioned in it, whereas its function proper is to indicate roughly to what extent a signal is modulated by unwanted A.C., and hence no mention should be made of faults such as "key-clicks," "chirps," "back-wave," etc., which should be reported separately.

- T1—Poor 25, 50 or 60 cycle A.C. tone.
- T2—Rough A.C. tone.
- T3—Poor rectified A.C. tone (no filter).
- T4—Fair rectified A.C. tone (small filter).
- T5—Nearly D.C. tone (good filter, but key thumps or backwave noticeable).
- T6—Nearly D.C. (very good filter).
- T7—Pure D.C. tone (but key thumps and backwave noticeable).
- T8—Pure D.C. tone.
- T9—Pure crystal controlled D.C. tone.

It will be seen that typical combinations of codes such as R4, QSA3, T7 or R7, QSA2, T5, QRM are contradictory as regards signal strengths and readability, whilst the description of the tone as "Nearly D.C. tone (good filter, but key thumps or backwave noticeable)" is not much use without further remarks, to a distant station.

It is thus fairly obvious that the definitions need revision, and the well-known American amateur, Mr. A. Braatan (W2BSR), has evolved a new system, based on the commercial traffic "Frame" code, which he has called the "RST" code, cutting out completely the ambiguities of the older system.

First of all comes readability, which is indicated by a modification of the misused QSA code, using the letter R.

- R1—Unreadable.

R2—Barely readable; occasional words distinguishable.

R3—Readable with considerable difficulty.

R4—Readable with practically no difficulty.

R5—Perfectly readable.

Then comes S—signal strength, and here the number of divisions has been reduced from nine to five.

S1—Faint, barely perceptible.

S2—Weak signals.

S3—Fairly good signals.

S4—Good signals.

S5—Very strong signals.

All mention of loudness and readability have been carefully eliminated so as to make the report independent of the type of receiver used.

Tone he defines in nine stages as before, but the definitions have been completely altered so as to refer to tone only.

T1—Extremely rough, hissing note.

T2—Very rough A.C. note—no trace of musicality.

T3—Rough, low-pitched A.C. note, slightly musical.

T4—Rather rough A.C. note, moderately musical.

T5—Musically modulated A.C. note.

T6—Modulated note; slight trace of whistle.

T7—Nearly D.C. note with smooth ripple.

T8—Good D.C. note, with trace of ripple.

T9—Purest D.C. note.

If a station appears to be crystal controlled an X is added to the tone report.

When using the system the procedure is as follows:—

The report is given in the order R-S-T and Mr. Braaten proposes that this order be standardised to prevent confusion. Thus in reply to the question "RST?" the station reporting might say "Ur RST 348 QRM," meaning "You are readable with difficulty owing to interference, signal strength good and good D.C. note with a slight ripple." If signal strength was varying due to fading, making the signal very difficult to read, the report would be "Ur RST 24/28 QSB," meaning "Your signals are fading from good strength (S4) down to S2, making them barely readable," etc.

There is some difference of opinion regarding the cutting down of the number of degrees of signal strength to five, but as has been pointed out, in the older R1-9 code for signal strength each step represents a change in volume of about 6 decibels, and probable 10 decibels is the limit of accuracy for the human ear without any standard of reference, as when estimating the absolute strength of a signal.



Bob Everard's listening post is in Standon, Herts. A super-het receiver is used in conjunction with a convertor. 609 stations from all over the world have been heard.

depends to some extent on readability for definition of strength of signals.

- R1—Faint signals, just readable.
- R2—Weak signals, barely readable.
- R3—Weak signals, but can be copied.
- R4—Fair signals, easily readable.
- R5—Moderately strong signals.
- R6—Good signals.
- R7—Good strong signals that come through QRM and QRN.
- R8—Very strong signals, heard several feet from the phones.
- R9—Extremely strong signals.

Actually, this code is much older than the QSA code, which was intended to replace it; it was fairly satisfactory before the latter was introduced, the use



the actual carrier wave used to radiate the signals. It will therefore automatically start up the arc at the

The electrodes A and B of the screen are polarised from a direct current source D, the circuit including an adjustable resistance E, and choke coil F. As the arc speed is dependent upon the field strength and the current in the arc, the circuit including an adjustable resistance G, and choke coil F. As the arc speed is dependent upon the field strength and the current in the arc, the circuit including an adjustable resistance E, and choke coil F. As the arc speed is dependent upon the field strength and the current in the arc, the circuit including an adjustable resistance G, and choke coil F.

pressed upon the amplifier for modulation of the oscillator, and subsequently for transmission simultaneously with the photo-cell currents. The frequency of this oscillator is, however, low compared with the frequency of the photo-cell currents.

The operation of this synchronising system is briefly as follows: As the arc turns the corners at the right-hand side of the screen a voltage is induced in the input circuit of the amplifier and this voltage is of a pulsating uni-directional nature. After amplification these impulses are impressed upon the input of a valve within the synchroniser. Simultaneously with the impression of these impulses, other impulses from the oscillator are impressed upon another valve of the synchroniser which neutralises the impulse from the arc screen when the arc reaches the corners at the proper instants.

The output circuit of the synchroniser has a definite current flowing therein. To produce perfect neutralisation the frequency of the oscillator is adjusted in conjunction with the arc speed by rheostats E and G. At the proper arc speed, the impulses

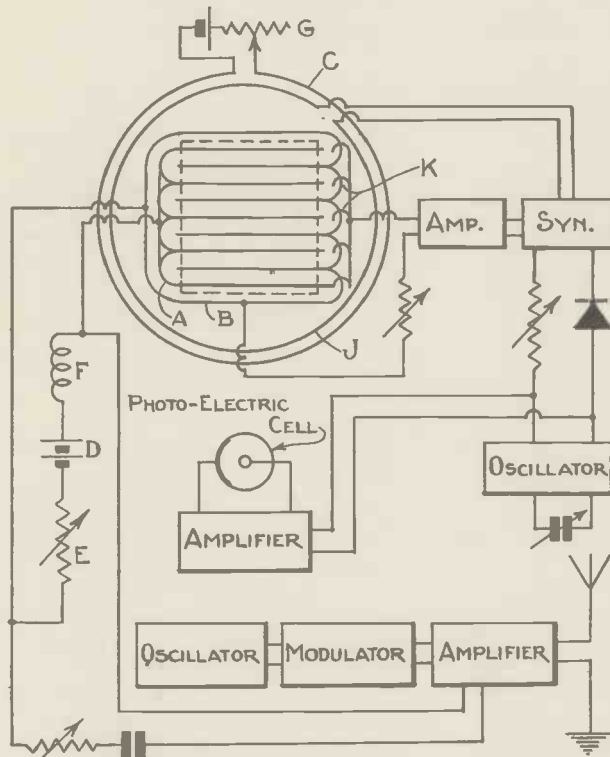

Fig. 5.—Schematic diagram showing the arrangement of the travelling arc transmitter.

receiving end at the same time as that at the transmitter.

Subsequent timing signals are also radiated each time the transmitter arc passes round one of the corners of the electrode system, by arranging a small projection at each "turning point" so as to shorten the length of the arc. This momentarily decreases its resistance and automatically applies a timing-impulse to the carrier wave, which it utilised at the receiving end to keep the local arc accurately in step with that at the transmitter.

How it is proposed to put this principle into practical operation will be understood from the following explanation and reference to the diagrams (Figs. 5 and 6) which show the transmitter and receiver respectively.

Referring to Fig. 5 an arc screen having electrode rails A and B, which are arranged in alternate steps in ladder formation to make a continuous arc path, is placed in an evacuated envelope containing suitable gases such as helium, argon, etc. The arc screen lies within a uniform magnetic field which is produced by a field coil C supplied from a source of direct current. C is a coil of many turns.

carrier frequency. The output of the modulator is amplified and then broadcast.

Also surrounding the arc screen there is a second field coil J, smaller than the coil C, which is connected to the output of a synchroniser. This synchroniser has two inputs, one of which is from an amplifier which is connected to probes K and to one of the electrode rails. In this input circuit is an adjustable resistance for the purpose of controlling the input to the amplifier. The other input to the synchroniser is from an oscillator through an adjustable resistance and a rectifier, the oscillator frequency being adjustable. The output of this oscillator is also im-

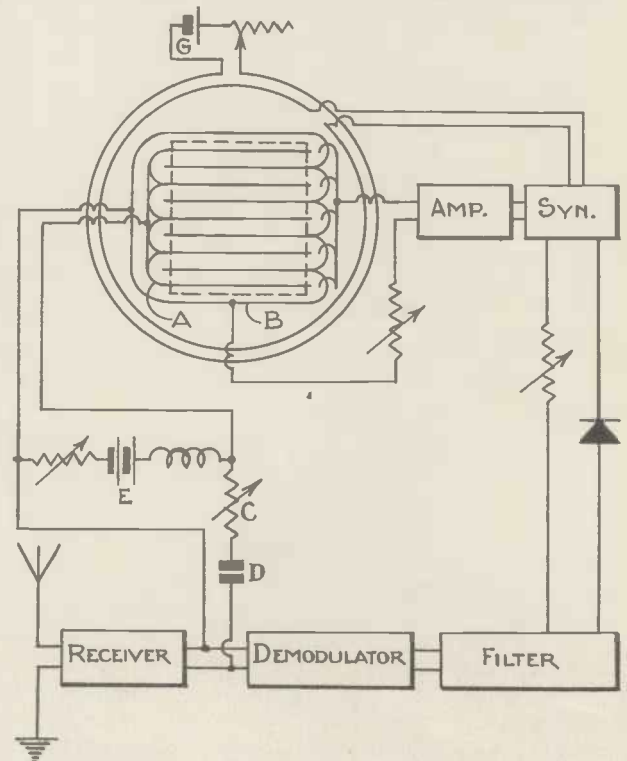

Fig. 6.—This is a diagram of the receiving arrangements which are very similar to the transmitter.

from the oscillator (which are rectified so that only a half cycle of each impulse is impressed on the synchron-

(Continued on page 448.)



# A New V-doublet Aerial System

*We are indebted to the General Electric Company of America for details of a new highly-efficient noise-suppressing all-wave aerial. The G.E. Company have been experimenting with receiving aerials in order to find the best system for use with their all-wave receivers.*

SHORT-WAVE enthusiasts do not hesitate to erect special aerials for short-wave reception, but it is a totally different matter when the ordinary broadcast listener decides to take up short waves. Even if sufficient space were available, it is very unlikely that anyone other than a fan

The old idea that an aerial should consist of a piece of wire slung as high as possible between two poles does not hold good if maximum pick-up is to be obtained. Short-wave broadcasting covers a very wide frequency range and is split up into several narrow wavebands. An aerial of any given

coupled to the receiver through a specially constructed transformer such as is supplied by Ward and Goldstone. The length of the transmission and coupling ratio of the transformer should be correct for proper electrical matching to give greatest energy transfer from aerial to the receiver.

Although atmospherics are comparatively slight on short waves, interference from man-made static can often be very troublesome. Such interference, usually of local origin and radiated by house wiring or from passing motor cars, is generally picked up by the down lead passing through the field of interference (Fig. 2). No matter how high the aerial is erected this interference will still be noticed.

This doublet aerial, however, by using a screened transmission line, overcomes to a very considerable extent this interference pick-up.

Fig. 3 shows how the transmission

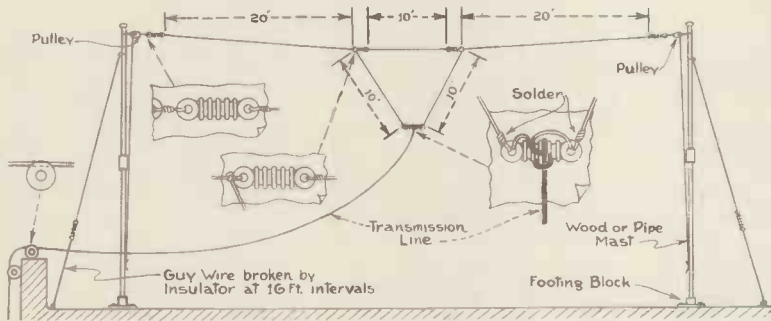

Fig. 1.—A sketch showing the essential features of the V-doublet aerial.

will erect an aerial specially for short-wave reception. It is a totally different matter if one aerial can be erected that, in addition to improving results and reducing noise on short waves, will also be an advantage when it is used with a broadcast receiver.

The General Electric Company in Schenectady have been experimenting for several years with different types of

length will be more efficient on one or more of these wavebands, while it will definitely fail on others. So aerials of the conventional single-wire or doublet types can never be 100 per cent. efficient, for there is no length which will give uniformity of pick-up over all wavebands.

From figures we have obtained it appears that the V-doublet is a distinct improvement over all other types of receiving aerial. As its name implies, the system incorporates a doublet, the centre portion of which takes the form of a V. The factor responsible for the non-uniform sensitivity of the conventional single-wire or doublet aerial is a development of standing waves along its length which results in points of high and low sensitivity at different frequencies. A V-doublet reduces these standing waves because the centre portion being tapered makes the system almost aperiodic. The first high impedance point is therefore extended out to such a high frequency that sufficient pick-up is obtained on the aerial itself, while the high impedance point does not have the usual effect on signal strength experienced with conventional doublets.

Signals picked up with the doublet are fed to the receiver through a balanced twisted pair of cables, commonly called a transmission line. A further function of the tapered V is efficiently to cover the high-impedance aerial to the low-impedance transmission line, so obviating the use of a transformer. This transmission line is

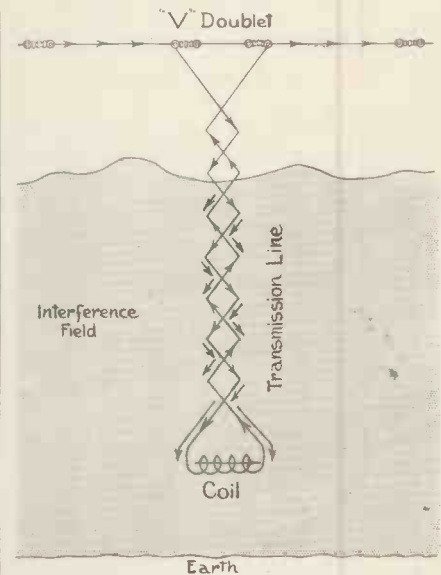

Fig. 3.—How the transmission line is connected and interference is cancelled out.

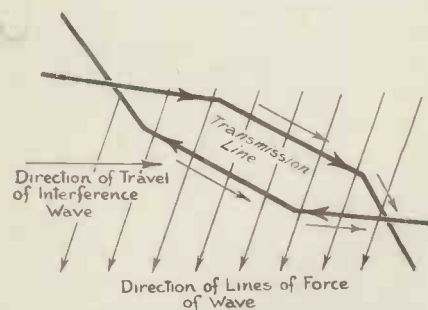

Fig. 2.—Diagram showing how interference is picked up by the down lead.

receiving aerials, because in America most receiving sets include both short and medium waves. It will be realised in such circumstances that the receiving aerial must be equally as efficient at 15 metres as it is at 500. We have already given details of a conventional inverted V aerial which met with great success in this country, but this is the first time that any details have been given of this latest development—the V-doublet (Fig. 1).

line is connected and how it can pass through the field of interference without feeding the noise into the receiver. Arrows drawn on the line represent the signal, while arrows drawn alongside represent induced interference. As the interference current does not flow through the coil the receiver is not affected.

A doublet aerial can be erected in numerous ways, either between two poles, above a guttering, between two chimneys or, in the conventional way,

between pole and house, while as the transmission line can be as long as 900 feet the aerial proper can be erected in any convenient spot without the down lead having any damping effect.

Generally speaking, the aerial should consist of 20 feet of wire either side of the V, while the distance between the end of the wire and the transmission line should be ten feet. The height of the aerial is immaterial, but, of course, the higher the better.

In Fig. 4 is shown the method of coupling between the transmission line and the radio receiver. It must be appreciated that a transformer is required in addition to the grid coil in the receiver.

This type of aerial has been in use at our laboratories for some time and on short waves in particular it has reduced pick-up from passing motor vehicles and from interference generated by domestic appliances. The 20-metre amateur band is now completely free from noise, although with a standard aerial motor cars prove very troublesome.

We wish to repeat that this aerial, although being of most use on short waves can also be used to advantage on a broadcast receiver, so that those

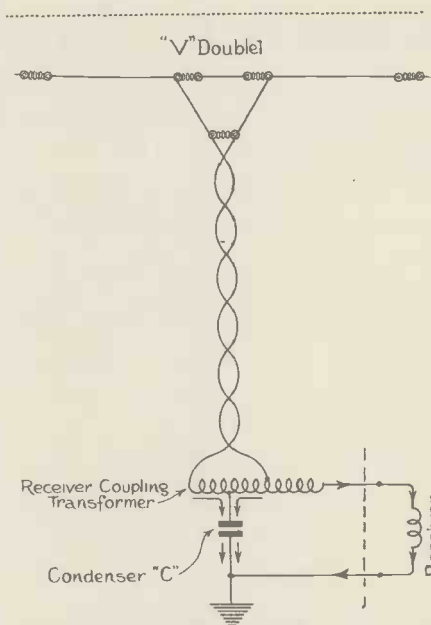

Fig. 4.—The method of coupling the transmission line to the receiver.

readers who have not sufficient space for two aerials would be well advised to utilise this aerial for all purposes.

**“Scanning With An Arc”**

(Continued from page 446.)

iser) neutralise those from the screen. However, should the arc be retarded or advanced in its travel between corners, a differential current will be produced in the output of the synchroniser, which will decrease or increase the current already in the winding J, thereby weakening or strengthening the field and producing the appropriate change in the speed of the arc.

At the receiving end the incoming signals are amplified and impressed upon a receiving screen having electrodes A and B, similar to those at the transmitter. Connections to the receiver screen include an adjustable resistance C and a condenser D. An arc on the screen is created by a direct current source E, the energy being supplied through an adjustable resistance and a choke coil. A field coil F is supplied with energy from a source G under control of a rheostat H.

The output circuit of the receiver is also connected to a demodulator for obtaining the synchronising frequency of the transmitter oscillator. This frequency is impressed through an adjustable resistance and a rectifier on a synchroniser similar to that at the transmitter. The remainder

of the synchronising circuit is the same as shown in Fig. 1.

This receiving screen operates as follows: the incoming impulses are impressed without demodulation, upon the electrodes A and B, thereby varying the intensity of the arc in accordance with the currents from the photo-electric cell at the transmitter. The image may be formed directly by the arc or may be projected upon a fluorescent screen. The synchroniser operates in exactly the same manner as the synchroniser at the transmitter, a filter being substituted for the transmitter oscillator.

It is stated that a mirror effect can be obtained at the transmitter which will allow of this being used as a monitor. In obtaining this mirror effect, although the intensity of the transmitting arc is evidently varied, there appears to be no tendency to decrease the efficiency of transmission, but there is the reverse effect, which can only be explained by the presence of regeneration. For instance, when the image being scanned is dark, less current is received by the photo-cell and less energy is thereby applied to the arc, while at light portions of the image, more current is applied to the arc, producing a brighter arc. This effect evidently aids scanning and improves transmission.

**Wheatstone Bridge Amplifier Relay**

THE well-known Wheatstone bridge can be put to good use by experimenters who use photo-electric and selenium cells in their work.

It is particularly useful in the case of the selenium cell, and even more so, where the cell has been constructed by the experimenter himself, and in cases where owing to the internal resistance of the cell being very high it may be found unsuitable for working in conjunction with a valve amplifier.

As can be seen from the diagram the cell is coupled into the Wheatstone bridge circuit where the unknown resistance would ordinarily be connected, and the usual galvanometer is replaced by an instrument type of relay.

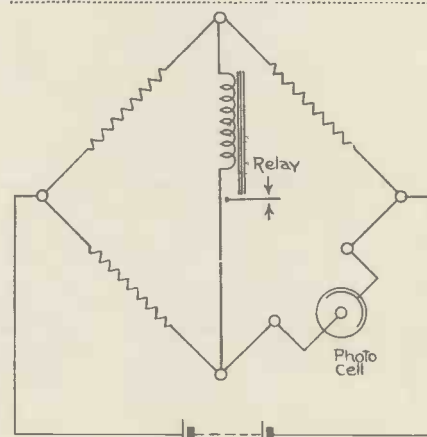

The Wheatstone bridge circuit is balanced to suit the cell and when the latter changes its resistance a proportionate current flows through the relay windings.

The principles of operation are very simple; when the Wheatstone bridge circuit is balanced up to suit the cell, no current will flow through the relay windings. Immediately the cell alters its resistance by picking up a beam of light, however, the bridge circuit will become unbalanced, and a current will then flow through the relay windings. This flow of current will be in proportion to the change in the internal resistance of the cell.

**Make a point of visiting  
Stand No. 7  
at RADIOLYMPIA**

# SIMPLE PHOTOMETRY

By R. L. Ashmore.

*Adequate illumination is of great importance in television and methods of measurement or comparison are essential. This article explains the early simple means and standards used.*



*It is from the candle flame that the unit of illumination originated.*

a fairly uniform amount of light and have served as a practical standard, but as the brightness of the flame depends on the length of wick (so that "snuffing" produces variation) the temperature of the surrounding air and other minor effects, the light emitted may vary by as much as some 20 per cent. Various other forms of standard light sources have been suggested, but these have all been referred back to the standard candle; they have generally consisted of special burners consuming different gases at some standard rate.

serves the purpose of comparing and defining amounts of illumination just as well as if it belonged to the family of the C.G.S. system.

It is evident that if we move a given source of light away from an object the intensity of the illumination of that object is decreased; actually the intensity of the illumination produced on the object by the source of light is inversely proportional to the square of the distance from the source of illumination. This can easily be proved experimentally.

From our standard candle a standard of illumination is derived by defining a certain distance at which this standard intensity produces a certain definite illumination, this arbitrary unit being termed one candle-foot, the unit of illumination. This unit is, of course, entirely empirical, but it

EVERYBODY is aware that the amount of light given out by various light sources differs. Obviously the ordinary 60-watt electric lamp gives more light than, say, a candle, and therefore we say that the illuminating power of the electric lamp is greater than the candle.

## The Standard of Illumination

Now in the measurement of light a simple and definite standard of light is greatly to be desired, but as yet we do not really possess one. The standard in this country is the standard candle, which is defined to be a spermaceti candle of definite dimensions, weighing one-sixth of a pound (avoirdupois) and burning at the rate of 120 grains per hour. These candles give

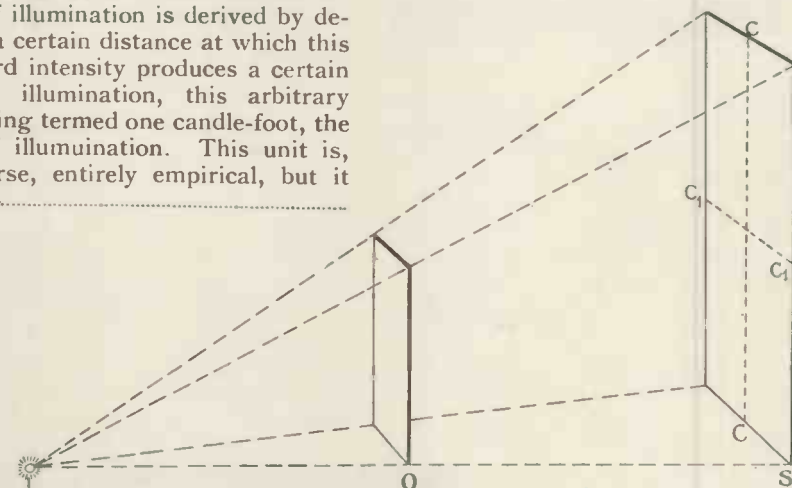

Fig. 2.—Rumford's simple photometer.

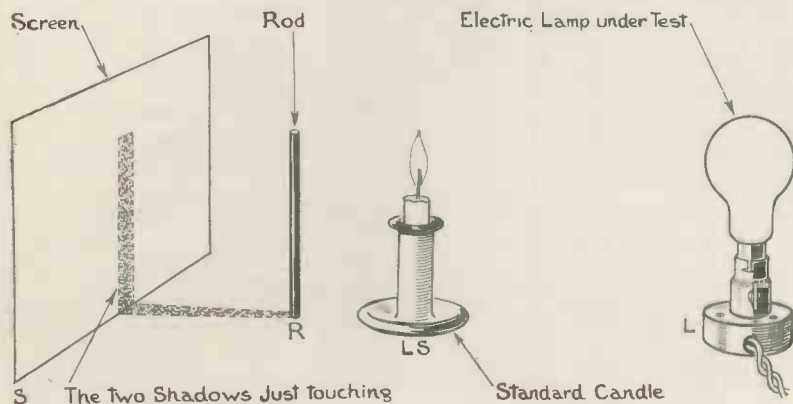

Fig. 1.—Diagram explaining how the illumination intensity is inversely proportional to the square of the distance.

## A Simple Experiment

Make a small square frame of wire O, Fig. 1, and place it half-way between a source of light L and the wall of a darkened room. The frame will throw a square shadow on the wall. Now cut a piece of paper the size of the shadow S and fold it across and across as shown by the lines C C and C<sub>1</sub> C<sub>1</sub>. The folded sheet will fit the frame O. As we have divided S into four parts each equal to O, the area of S is four times that of O and as the same amount of light which falls upon O is at twice the distance spread over

S four times the area, therefore, the intensity of illumination at S is one-fourth that at O.

This result depends upon the fact that light travels (as far as we are concerned) in straight lines, from which it follows that the areas of vertical sections of a beam at different distances are proportional to the squares of these distances.

Our experiment has shown us that we must be careful to distinguish between the illuminating power of a source of light and the intensity of the illumination it produces. The

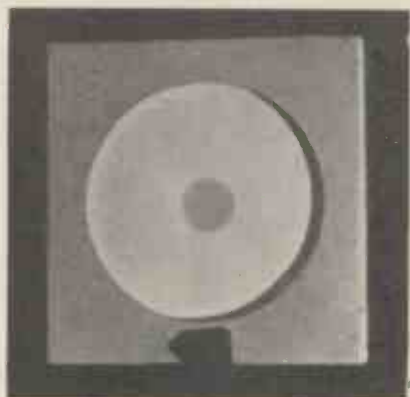

Fig. 4a.—Bunsen's photometer used with reflected light.

intensity of a light source is generally referred to as its intrinsic brightness, which is the strength of the light per unit area of the light-giving area, and where the standard foot-candle is used a logical unit of intrinsic brightness is one candle power per square inch. Although a measure of intrinsic brightness can be obtained by dividing the candle power of any light by the area of the luminous surface, this latter quantity is very hard to determine accurately as no usual source of light is anywhere near being of uniform brilliancy over its entire surface, excepting the filament of an electric lamp.

The following is an approximate table of the intrinsic brilliancies in candle power per square inch.

Sun in zenith, 600,000.

Sun in 30 degree elevation 500,000.

Sun on horizon 2,000.

Arc light 10,000 to 100,000; maximum at crater 200,000.

Electric filament lamp 200-300.

Melting platinum 130.

Acetylene flame 15-100.

Welsbach light 20-25.

Candle 3-4.

Experience has shown that for reading and writing the intensity of illumination should not be less than one candle-foot. For reading TELE-



Fig. 3.—Two shadows of a rod upon a photometer screen; note that the shadows are unbalanced.

VISION AND SHORT-WAVE WORLD two candle-foot is ample. Less illumination than half a candle-foot generally makes reading slow while one-tenth is very little use. It is quite instructive to find out the value of illumination under which we generally live, as, for instance, to compare the different values of daylight coming in at a window.

Approximately to make these observations very simple and cheap apparatus is all that is required.

One of the simplest photometers for comparing two normal sources of light is that of Rumford. All that is required is a sheet of thin paper (such as tracing paper), or a sheet of ground glass, and a length of some opaque rod, such as a pencil, which

are arranged as in Fig. 2. The operation is as follows. The light source L casts a shadow on the screen SS of the rod R, similarly LS the standard light source. The rod is moved till the two shadows just touch, then observing through the screen we will in all probability get the shadows appearing like Fig. 3, one stronger than the other.

Now move the light that produces the stronger shadow away from the screen (or the weaker one nearer) till the shadows are of equal strength. Then measure the distance D of each

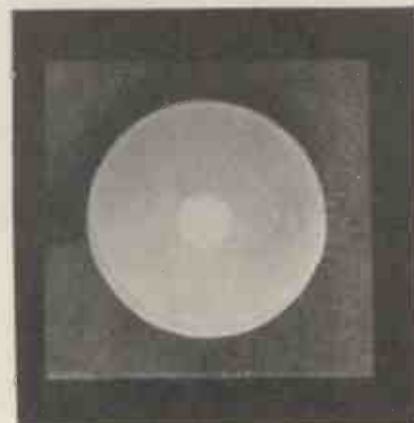

Fig. 4b.—Bunsen's photometer used with transmitted light.

light source to the point on the screen where the shadows just meet and the relative strength of the lights are as

$$\frac{L}{LS} = \frac{DL^2}{DLS^2}$$

If we are comparing daylight, say, from an open window, Rumford's photometer is not satisfactory as a sharp shadow of the rod is not easily produced and for this Bunsen's grease spot photometer is more suitable.

Very simple to construct, it consists, as its name indicates, of a grease spot on paper. Take a piece of unglazed paper upon which drop a spot of candle grease. Remove any excess of grease with a knife when solid and then melt the wax well into the paper with a hot iron or knife. The suggested size of the spot is about  $\frac{3}{4}$  in. diameter. Mount the paper in some suitable frame with the paper stretched as much as possible. Looking at the grease spot with the strongest light in front it appears dark (Fig. 4A), while if the light at the back is stronger the spot appears



Fig. 5.—Comparison of 25-watt lamp with a household candle with the Bunsen grease-spot photometer.

bright in comparison (Fig. 4B).

Comparing two lights, one is set upon one side of the grease spot and the other on the other (Fig. 5). Move one of the light sources up to the grease spot till a point is reached when the grease spot become all but invisible whichever side it is viewed from. Then, as before, the distance of one light from the other from the grease spot gives their relative brightness.

It must be mentioned that all photometry measurements should be done in a darkened room, preferably with dark or black walls to avoid reflection.

In the measurement of daylight if the grease spot is set up, say, on a desk in a window (Fig. 6), and a standard light (an electric lamp in this case) positioned till the spot is balanced out, we cannot measure the distance to the daylight, but knowing the strength of the light and the distance from the spot we can derive the intensity of the light falling on the window side of the grease spot. Actually for daylight a candle would have to be so near to produce the balance that it is better to use a known light source of higher intensity. Actually under the conditions illustrated the results will be inaccurate owing to general diffused reflec-



Fig. 6.—A grease-spot photometer is very easily set up as this photograph shows.

tion of the daylight coming in from such a large area.

The difference due to the reflection can be easily shown by placing a white sheet of paper above the grease spot on the room side and tilting the paper so that the main reflection falls on the grease spot.

Where it is required to measure illumination either of daylight or large rooms where the inaccuracies

caused by reflections cannot be tolerated, the standard light is totally enclosed in a box, of which one end is the grease spot. Such methods of photometry are entirely satisfactory where the eye only is making use of the illumination produced, but in picture recording—television or photography—such methods are practically useless as will be explained in a later article.

## E. K. COLE, LTD., AND TELEVISION

AT the annual general meeting of E. K. Cole, Ltd., on July 15, Mr. W. S. Verrells (chairman and managing director) outlined the policy of the company in respect of television. In the course of his speech he said:—"The development of television has been carefully watched by our research and patents departments over a number of years and various systems have been considered in the laboratory stages. As a result your directors arrived at decided conclusions which, after discussions and negotiations with the directors of Scophony, Ltd., resulted in your company taking a substantial interest in this television company, with two seats on the board. The Scophony system was described in the recent Report of the Television Committee as being one of the four most distinctive television systems in the country. Technically, the Scophony system is based on optico-mechanical methods which are quite distinct from the cathode-ray princi-

ple now employed in some other systems. The Scophony methods enjoy an inherent and considerable light efficiency. Furthermore Scophony are developing what we believe to be the only method for direct large-screen television for cinema theatres.

"The Scophony system may also have important application in commercial communications as well as in general cinematography.

"The system, originated by Mr. G. W. Walton, has been further developed in the Scophony laboratories. About eighty granted patents and a large number of pending patent applications cover the system in 28 countries, and owing to the absolute novelty of the basic principles the patent situation is considered to be one of great strength.

"Television receivers manufactured under Scophony patents, being entirely optical and mechanical, have no sensitive parts requiring replacement, and should be capable of manufacture by mass production methods.

"It seems therefore quite reasonable to expect that in the manufacture of such television receivers, we should be able to obtain a good share of the medium-priced home television receiver market when this new science reaches a stage or two further than at present, which can perhaps be described as making its first bow out of the laboratory into the commercial arena.

"I think it must be recognised that some years must elapse before television can become the medium of national or perhaps international entertainment and education which sound broadcasting has already become. Much more intensive development and research is necessary in this field, both on the transmitting and on the receiving side. Indeed it is very likely that the future technical conception of television may materially differ from the present one. We are satisfied that the Scophony Company is alive to such possible developments and therefore Scophony should play an important part in the future of commercial television."

# British Amateur Radio G5BY



Hilton L. O'Heffernan is the operator of G5BY situated in Croydon, Surrey.

WE cannot devote space to give details of all the achievements of G5BY, but here are a few of the records made during the past few years. In 1929 winner of the QST Station Description Cup for the World's Best Amateur Station. This was followed in 1930 by being the first British station to obtain a W.A.C. phone Certificate. Winner for G.B. in the International Relay Contest, May, 1927, February, 1928 (highest world score),

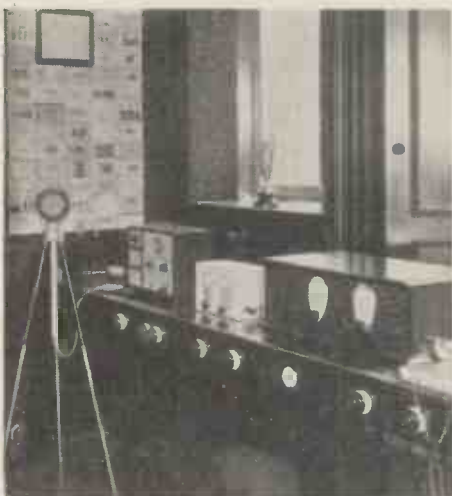

G5BY presents a most professional appearance. This is to be expected for it won the prize for being the best amateur station.

February, 1930, March, 1931 (highest world score), March, 1933, and March, 1934.

5BY was the leading British station in the 1932 International Goodwill Tests, while in 1933 a world's record was established for 56-mc. work. Two hundred miles were bridged using telephony from Snowdon to Hoddesdon.

The first British station to work Japan, Alaska and British Columbia was G5BY, while so far over a hundred

countries have been contacted including two-way communication with U.S.A. on 1.7, 3.5, 7, 14 and 28 mc. bands. Two-way communication has also been carried on with the Dyott Expedition in the Amazon; with Commander Byrd, in Little America, and with Mc-Millan, on the *Bowdoin*, during Arctic exploration. The keeping of a daily schedule with this station—when cut off from civilisation and unable to raise any station except 5BY for the fortnight—resulted in the presentation

of a barometer for "services rendered." During June over 100 contacts were made with W6, 7 and VE5 stations, some with two-way phone, some phone code, and others code only.

Amateurs who may decry the performance put up by G5BY on the score that it is not really an amateur station as the apparatus is commercially built. This then is a good opportunity to point out that transmitters, receivers, frequency meters, monitors, automatic sender, etc., have all been home-constructed from the raw material. All transmitting and receiving coils have been home-built, as were the transmitting condensers, while even crystal holders were turned out from solid ebonite.

The main transmitter which operates on 3.5, 7 and 14 mc. bands comprises an LS5B, 80-metre crystal oscillator, a DET 1SW as frequency doubler to 7 mc., and MB2/200 as 14 mc. frequency doubler with a 250-watt screened-grid valve as the final amplifier. Modulation is by two quarter-kilowatt valves in parallel, choke coupled—Heising system—to the power amplifier. This modulator gives over 100 watts of audio power, sufficient to

ensure complete absence of distortion even when the P.A. is 100 per cent. modulated. Actually four stages of L.F. amplification are in use

Three separate power supplies and filters are in use. A 500-volt 100-milliamp. pack feeds the crystal oscillator, a 1,000-volt 250 mA supply suffices for the frequency doublers, whilst both the final P.A. and modulator valves are fed from a 2,000-volt 400-mA source. Rectification is by high vacuum valve for the 500-volts and by mercury vapour

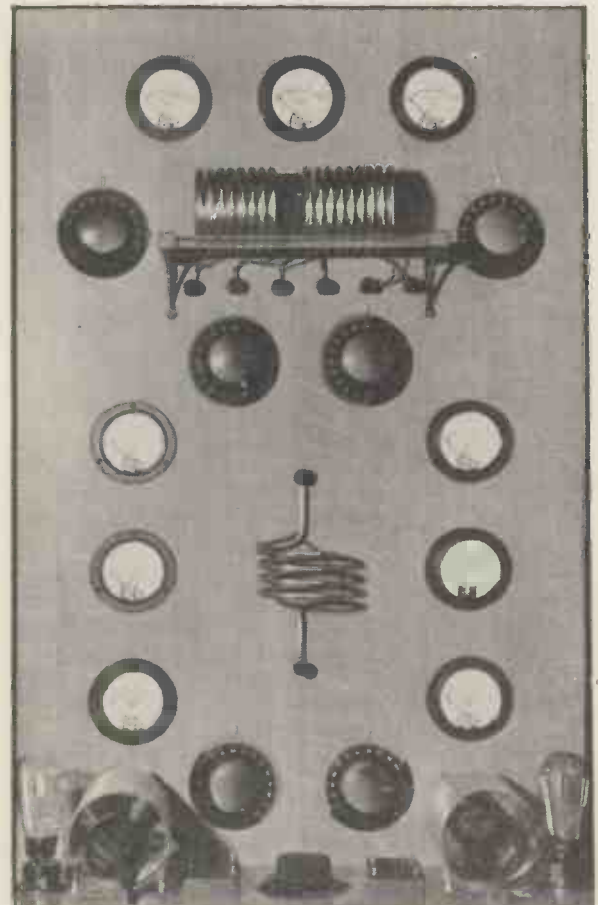

This is the way one of the transmitters has been constructed. It is rather unusual but the arrangement has much in its favour.

valves—1,074 and D.C.G. 1/125—for the two high voltage supplies.

The aerial system at present in use is a horizontal zepp with 49-foot feeders  
(Continued at foot of page 454.)

## THE CHRONOLOGY OF TELEVISION

## PART II—1931 to 1935

*The first part of this chronology appeared in last month's issue and dealt with the period of 1814 to June, 1931. This second instalment brings it up to date.*

- 1931, July.—Belin introduced a method of transmitting photographs which none but the possessor of a specially synchronised machine could receive.
- 1931, Aug.—Moscow newspaper *Isvestia*, transmitted copies of its pages experimentally by radio photo-telegraphy with a view to simultaneous publication.
- 1931, Aug. 7.—Photo - telegraphic station opened in Rome.
- 1931, Sept. 1.—Combined telephone and radio-photographic line opened between Hong Kong and Canton.
- 1931, Sept. 3.—Anglo-Italian photo-telegraphic service opened.
- 1931, Sept. 8.—Donald Short demonstrated in New York a portable television apparatus.
- 1931, Oct.—Philco Radio and Television Corporation of Great Britain formed.
- 1931, Oct. 24.—Radio photo-telegraphic service installed between Vatican and Paris.
- 1931, Oct. 31.—Gray, of U.S.A., introduced the "Photo-electric Integrator," an apparatus based on the photo-electric cell, "which turns involved mathematical problems into a beam of light and analyses the light to find the answer."
- 1931, Nov. 1.—Anglo - Norwegian photo-telegraphic service opened.
- 1931, Dec.—M. Thomas, a French engineer, invented the "Photo-electrographe," which enables the blind to read. Ulysses Sanabria demonstrated his system of television in New York.
- 1932, Jan. 1.—Photo - telegraphic service opened between Norway and Sweden and U.S.A., via London.
- 1932, Feb. 1.—Scenes broadcast by Baird television apparatus from London received on a train travelling between Sandy and Huntingdon at 60 miles an hour.
- 1932, April 18.—Photo - telegraphic service opened between Germany and U.S.A.
- 1932, April 29.—First public demonstration of Baird television by ultra-short waves (6.1 metres) given in London.
- 1932, May 19.—Visio-telephony service experimented with in Paris. By a combination of telephony and television the image of the person speaking could be seen.
- 1932, June 1.—Scene of the Derby, transmitted from Epsom to London.
- 1932, Aug. 1.—Photo - telegraphic services opened between Germany and Holland, and between Germany and Dutch East Indies. Dussaud demonstrated in Geneva a system of television in which scenes are recorded on wax discs and reproduced by means of an ordinary television receiver. Baird introduced a visio-telephone to enable telephone users to see each other.
- 1932, Sept.—W. Wadsworth Wood introduced in U.S.A. the "Vixaphone," an apparatus which lectures and projects pictures electrically and automatically. Marconi introduced a radio television system for telegraphic purposes.
- 1932, Oct. 16.—New York-Rome photo-telegraphic service opened via London.
- 1932, Nov. 8.—Successful demonstration of radio television took place between the British Broadcasting Corporation, London, and Arena Theatre, Copenhagen.
- 1933, Feb. 1.—London-Amsterdam photo-telegraphic service opened. Radio-photographic service opened between Germany and Siam.
- 1933, Mar. 3.—Franco-German photo-telegraphic service opened.
- 1933, June 15.—Public photo-telegraphy service opened between Great Britain and France.
- 1933, Aug.—Farnsworth introduced a system of television in San Francisco.
- 1933, Sept. 7.—First transmission from a mobile picture transmitter took place between Ballater and Edinburgh. A. C. Cossor, Ltd., developed the velocity-modulation system of cathode-ray television. Okalicsanyi introduced in Hungary a television system using a crystal of sulphide of zinc instead of a Kerr cell. Von Ardenne demonstrated in Germany a television system in which the intensity of the spotlight remains constant, but the speed of the scanning is varied. V. K. Zworykin, after ten years' experiment, produced a system of television utilising cathode-ray tubes.
- 1933, Dec. 30.—Photo - telegraphic service opened between Paris and Rome.
- 1934, Mar.—First authentic details of the Scopphony system (TELEVISION, March, 1934). Mar. 26.—Photo - telegraphic service opened between Paris and Amsterdam.
- 1934, April.—First Italian television station opened in Turin. Zworykin cathode-ray system used.
- 1934, May 15.—Postmaster-General's Committee appointed (Chairman, Lord Selsdon) to consider the development of television and to advise the Postmaster-General on the relative merits of the several systems and on the conditions under which any public service should be provided.
- 1934, June.—Robert William Hughes devised a television apparatus working on a 300-line basis and projecting the image from vibrating mirrors actuated by oscillatory valve circuits.
- 1934, Sept. 26.—Photo - telegraphy

used between Glasgow and the Continent for the first time.

- 1934, Oct. 18.—First picture transmitted by radio from Australia to London published.
- 1934, Oct. 24.—Copy of a cinematograph film transmitted from Australia by radio and exhibited in London.
- 1934, Oct. 24.—Four members of the Postmaster-General's Committee left for America to study conditions there. Other members of the Committee went to Germany.
- 1934, Nov.—Radio Corp'n. of America introduced "Photo-radio," a system of transmitting telegrams and other documents in facsimile.
- 1934, Nov. 22.—Edison Bell Company introduced the "Visiogram," an instrument intended to give a reproduction of sound and vision by means of a film record.
- 1935, Feb.—Report of the Postmaster-General's Committee published. Recommended a standard definition of 240 lines and 25 pictures per second, and the use of two systems—Baird and Marconi E.M.I. Television Advisory Committee appointed. Members: Lord Selsdon (chairman), Sir Frank Smith, Col. Angwin, Noel Ashbridge, Vice-Adml. Sir Charles Cappendale and F. W. Phillips.

Standard systems of television demonstrated at the Crystal Palace, London by Baird Television, Ltd., and results seen at six miles' distance. (a) The direct pick-up images of persons in the studio, (b) the transmission of sound films, and (c) the use of an intermediate cinematograph film for televising outdoor events. In the last-named case the scene was "shot," the film developed and then televised after the lapse of 30 seconds.

- 1935, Feb. 22.—Chauviere, a Paris engineer, gave a successful

- 1935, Mar. 22.—Television service opened in Berlin.
- 1935, April 1.—London - Brussels photo-telegraphic service opened.
- 1935, April 27.—First official French television broadcast took place by means of the Barthelemy system.
- 1935, May 18.—German Post Office opened four theatres in Berlin for free public demonstration of television of 180 lines and 25 pictures per second.
- 1935, June 6.—Postmaster-General announced that the first British high-definition television station would be located at the

*M. Barthelemy, inventor of the system used for the first television transmissions in France.*



demonstration of a television apparatus of his own invention.

- 1935, Feb. 25.—Paris - Cologne photo-telegraphic service opened.

Alexandra Palace, London.

- 1935, July.—First details of the Mihaly-Traub mechanical-optical system (TELEVISION AND SHORT-WAVE WORLD, July, 1935).

**"British Amateur Radio G5BY"**  
(Continued from page 452)

suspended north and south between two 60-foot masts. It is operated against ground for 3.5 mc. work and as a half- and full-wave zepp for 7 and 14 mc. respectively.

For reception the receiver comprises a stage of tuned R.F. with ganged tuning, leaky-grid detector followed by two L.F. stages embodying a low-pass filter for C.W. reception. A separate electron-coupled oscillator (S4VB) is also used for code work, this being coupled to the detector. Incidentally the detector operates in its most sensitive position on the threshold of oscillation, but never actually oscillating. This oscillator is very carefully shielded and the arrangement gives a stability in code reception which has to be experienced to be fully appreciated.

A telephony monitor with a West-ector is used for checking speech transmissions while a shielded oscillator performs a similar function when operating on code. A frequency meter having a

certified accuracy of 99.984 per cent. is available for accurate measurements. This meter won a certificate in the 1931 world frequency-measurement test.

Remote control of the main transmitter from the operator's bedside in another part of the house is a useful feature for early morning operation during winter months. A single switch controls the whole transmitter, a multiplicity of relays operating the main supply, changing over the aerial from reception to transmission and keying. The latter arrangement consists of two plates, with mica between, moving to and from each other giving a continuously varying capacity and taking the place of a normal feed condenser between the C.O. and the grid of the fre-

quency doubler. This obviates any chance of key clicks since the circuit is never actually broken.

An automatic "Test DX" or "Test U.S.A." sender relieves the operator of much tedious keying and enables adjustments to be made while the outfit is actually operating.

The 28-mc. transmitter is situated at the top of the house and feeds a half-wave vertical zepp aerial approximately 60 feet above ground. It is remotely controlled in the main operating room and comprises two pentode valves in a tri-tet circuit, with a 3.5 mc. crystal—the anode circuit of the second valve being tuned to 28 mc. This tank circuit feeds a Mullard screened-grid valve on the same frequency, which in turn drives two SW<sub>1</sub> valves in push-pull with an input of 250-watts. So far with this rig four American districts and three continents have been worked.

A good deal of research work continues to be done on 56 mc., and no doubt this station will in the future again put up performances as good if not better than our American friends.

**OUR STAND  
AT  
RADIOLYMPIA  
IS No. 7.**



# THE ABC OF THE CATHODE-RAY TUBE—V

By G. Parr

WITH the application of the cathode-ray tube to television reception a new word has crept into the technical literature of the subject, the one which stands at the head of this article. Whether it is necessary or not is not our province to discuss. It is German, and is the word used to describe the fluorescent lines drawn on the screen of the cathode-ray tube on which the television picture is reproduced. In mechanical systems we are accustomed to refer to the "screen" as meaning the ground glass or other screen on which the picture is shown, but in the cathode-ray tube we

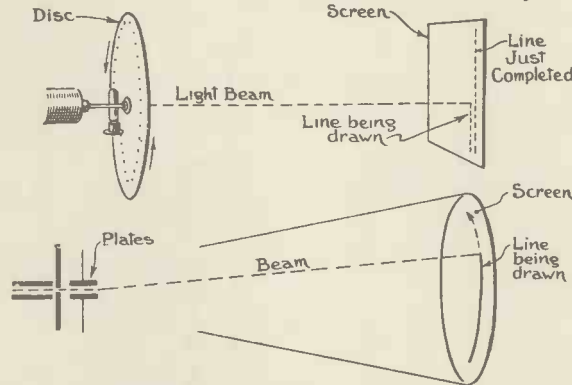

Fig. 1.—Analogy between the mechanical scanner and the cathode-ray tube.

owing to the conditions under which the picture is reproduced. The scanning lines cannot be a to-and-fro swing of the beam, they must all start from one side of the screen and finish at the other. Further, each line must be displaced slightly in the vertical or horizontal plane depending on the system of scanning used. And finally the movement of the beam must be uniform throughout its travel—it must not gain speed as it goes across the screen.

All these requirements have led to the development of special electrical circuits for scanning the screen, and we can now examine the simplest of these

## WHAT IS A RASTER?

already have this word to mean the end of the tube which is coated with the fluorescent material. So when we come to talk of the scanning lines produced on the fluorescent screen—the scaffolding of the picture, so to speak—we must distinguish between them and the surface on which they are drawn. The scanning lines are referred to as the "raster," although "line screen" seems to do the job equally well for ordinary people.

and see how various improvements have taken place as the need for accuracy and reliability have become more important.

Starting from the beginning, suppose a condenser is connected across an H.T. battery, through a resistance R, as in Fig. 2. As soon as the circuit is made, current will flow into the condenser until it is "charged" and the potential across it is the same as that of the H.T. battery. The flow of current is not uniform, however; it tails off as the condenser charges.

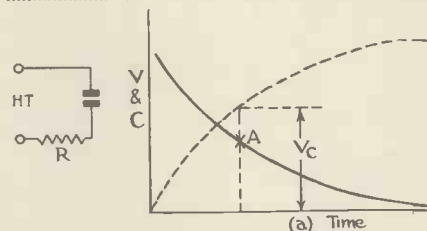

Fig. 2.—How a condenser charges from an H.T. battery. The black curve represents current flowing into the condenser and the dotted curve the potential across it.

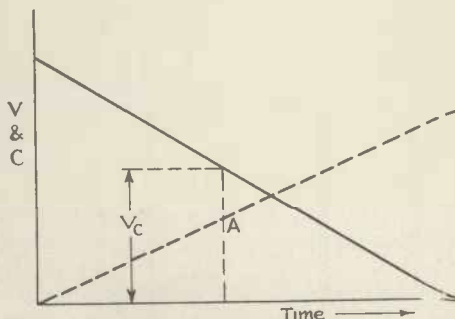

Fig. 3.—How the charging is altered by putting a pentode in place of the resistance. The difference is due to the shape of the pentode characteristic curve (Fig. 4).

### How the Scanning Lines are Produced

Now how are the scanning lines produced? In a rotating spiral-holed disc we can understand the method easily enough. Each hole is spaced so that the light passing through it falls on the screen to one side of the light shone through the previous hole. Thus as the disc rotates the holes appear to draw lines across the screen, each line just separated from the one next to it. At the end of the last line, when the disc has done one complete revolution, the light jumps back to the beginning of the picture again. This movement of the light spot has to be imitated in the cathode-ray tube, with the electron beam taking the place of the light beam and the fluorescent screen serving to make the path of the beam visible. (Fig. 1.)

We saw last month how to make the beam draw a line on the screen, and the movement we now require is similar but more complicated

If we represent the charging current by a curve, which is always a useful thing to show changes taking place in a circuit, it will look like Fig. 2a. The potential across the condenser will be the reverse of this, namely, the dotted curve of Fig. 2a. Incidentally, the higher the resistance R, the slower will the condenser charge, and we can make the charging rate as fast or as slow as we like by altering R. There is a formula for calculating the time taken by the condenser to attain any given value of potential, but there is no need to quote it here. Suppose we take a point A on the curve of charging current, as the potential is nearly half-way up to maximum.

The charging current flowing through the resistance will produce a drop in potential across it, which, by Ohm's Law, will be proportional to the current. So the curve of current will also stand for the potential drop across the resistance.

The sum of the drop across the

resistance and the potential of the condenser  $V_c$  at this, or any other particular instant will be equal to the potential of the H.T. battery, and as the condenser charges the potential across the resistance falls.

Now make the circuit a little more complicated by putting a pentode in place of the resistance.

The pentode has this difference over a triode—as the

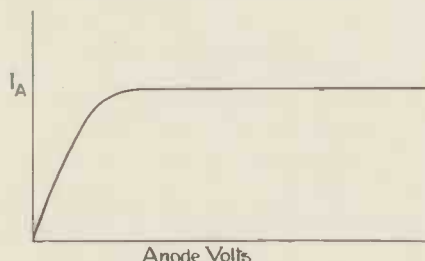

Fig. 4.—A pentode characteristic curve showing how the current remains constant with a wide change in anode volts.

potential across it is reduced the current through it remains more or less constant (Fig. 4).

It does not, therefore, behave like a true resistance, and this action has an important effect on the way in which the condenser charges. Suppose the condenser is switched on again with the pentode in series with it. The potential across the condenser rises and the potential across the valve falls as we saw just now. But this time the current flow remains unaffected, and the condenser goes on charging at a constant rate.

The curve of potential instead of being like A Fig. 3 is now a straight line. The rate at which the condenser charges can be controlled in the same way that the resistance is used to control it, but in this case we alter the impedance of the valve by altering the screen volts.

Now connect the terminals of the condenser to the deflector plates of the cathode-ray tube. The condenser potential will now be applied to the beam, and it will move across the screen as the volts rise. The movement will be *uniform*, the beam covering equal distances on the screen in equal intervals of time, and thus one of our requirements for scanning is met.

The next thing is to return the beam to the point from which it started, since the next movement must take place in the same direction as the first. That can be done on this occasion by simply short-circuiting the condenser. The voltage will fall instantaneously to zero and back will go the beam to its original position.

### Moving the Beam

Now we have to shift the beam over a little and allow the condenser to re-charge. The beam will then draw another line parallel with the first and the same length. The shifting of the beam can be done by applying a small potential to the other pair of plates, sufficient to move the beam by the thickness of a line or so. For instance, we could have a potentiometer connected to

another H.T. battery and turn the knob a fraction each time the condenser was short-circuited.

In this way, by charging and discharging the condenser and turning the potentiometer each time we could cover the fluorescent screen by a series of luminous lines which would imitate the movement of the scanning disc. The imitation would be quite successful but for one thing—we cannot hope to accomplish the movement at the speed required for television scanning!

So we set about producing the whole action electrically, and start by fitting up a similar circuit to the one just described to produce the "ratcheting" movement of the beam. This can be done by arranging the condenser to charge at one-thirtieth the rate of the other (still with reference to 30-line scanning).

Then, when the beam has finished the first of the lines and is being returned to the start, the second condenser has acquired sufficient charge to push the beam along slightly and start it on the second line alongside the first.

The drawing of Fig. 5 is an attempt to show the action of the two circuits on the beam. The curves of condenser voltage have been drawn in two planes to indicate their relative deflecting forces. In the centre

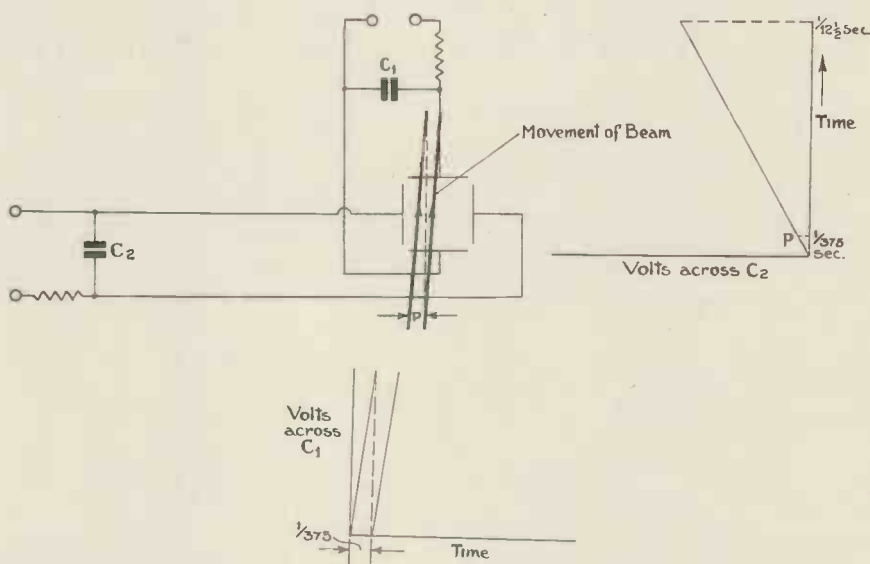

Fig. 5.—Showing the deflection of the beam in two planes by the condenser circuits  $C_1$  and  $C_2$ . The curves show the potentials applied to the plates which deflect the beam as shown by the thick lines.

of the diagram are the four deflecting plates of the tube, with the condensers connected across them.

$C_1$  condenser is charged in  $1/375$ th sec., while  $C_2$  charges in  $1/12\frac{1}{2}$ th sec. When  $C_1$  is charged, therefore,  $C_2$  will have a potential equal to the point P marked on its curve. This will give a lateral movement to the beam, shown by the distance P in the centre of the diagram. Assuming the condenser to discharge instantaneously the second line will be drawn immediately at the distance P from the first, and will travel as shown by the line marked 2. Finally, when 30 lines have been drawn, condenser  $C_2$  is fully charged and is discharged, returning the beam to the commencement of the lines. The beam has then accomplished one "frame" of the 30 frames per second.

# RECENT TELEVISION DEVELOPMENTS

## A RECORD OF PATENTS AND PROGRESS *Specially Compiled for this Journal*

Patentees:— *Telefunken Co.* :: *Suddeutsche Tekade* :: *G. B. Banks,*  
*J. C. Wilson and Baird Television, Ltd.* :: *Fernseh Akt.* :: *S. Loewe*

### Cathode-ray Receivers (Patent No. 426,173.)

It is already known that the brightness of the spot on the fluorescent screen can be controlled directly by

mounted between the polariser P and analyser A of the Nicol.

Light-filters F, F are provided to shut out the blue and ultra-violet light produced by the photo-electric

### Synchronising Signals (Patent No. 426,356.)

Instead of, or in addition to the usual sinusoidal signal used for synchronising, a complex wave is sent out from the transmitter, the fundamental frequency of the "complex" being equal to, or a multiple of, the line-frequency.

Preferably it is of saw-toothed form, since this is most efficient in synchronising the standard saw-toothed oscillator; or it may consist of a series of impulses produced from

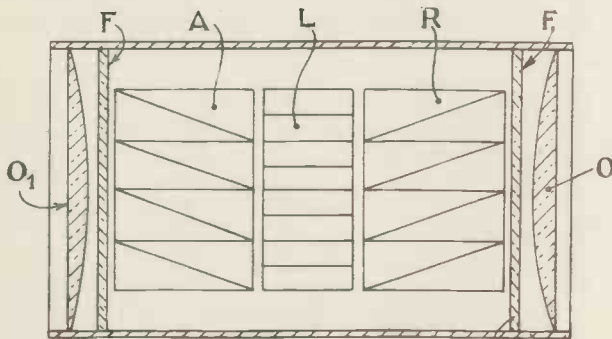

*A multi-crystal cell for the modulation of light.*

the modulated incoming signal, i.e., without previous rectification, provided the cathode stream is normally adjusted towards the edge of the gap in the screen, so that when deflected at carrier-frequency a rectifying effect is produced.

The same method is now applied to cathode-ray tubes of ordinary construction. The carrier frequency, which must be at least twice the highest picture signal-frequency, is passed through a heptode or octode amplifier before being applied to the cathode-ray tube, the control grid of the latter being arranged symmetrically with respect to the axis of the main electron stream. The method has the advantage of giving distortionless results over the whole band of picture frequencies.—(*Telefunken Co.*)

### Light Valves (Patent No. 426,233.)

A layer of doubly-refracting crystals is used as the electro-optic element in a Kerr cell, and the crystals together with the two Nicol prisms, a pair of objective lenses, and light-filters are all compactly mounted in a cylindrical casing. As shown in the figure a layer L of small crystals, ground to the same thickness, and covered with a layer of "sputtered" metal to shut out side-light, is

action of the crystals, L, and also to impose any colour compensation that may be necessary. O is the front and O<sub>1</sub> the rear objective lens.—(*Suddeutsche Tekade.*)

### Cathode-ray Scanning (Patent No. 426,254.)

It is well known that a gas-filled cathode-ray tube is liable to produce the so-called "ionic cross" on the fluorescent screen owing to the action of the free ions in producing a false concentration of the stream. In order to remove this defect, the two pairs of scanning electrodes are spaced apart as usual along the path of the stream, but a weak auxiliary field of constant strength is provided at right-angles to the main deflecting-field across each pair. The added fields are sufficient to prevent both the vertical and horizontal "strokes" of the undesired "cross," and so free the fluorescent screen from its shadow.—(*Telefunken Co.*)

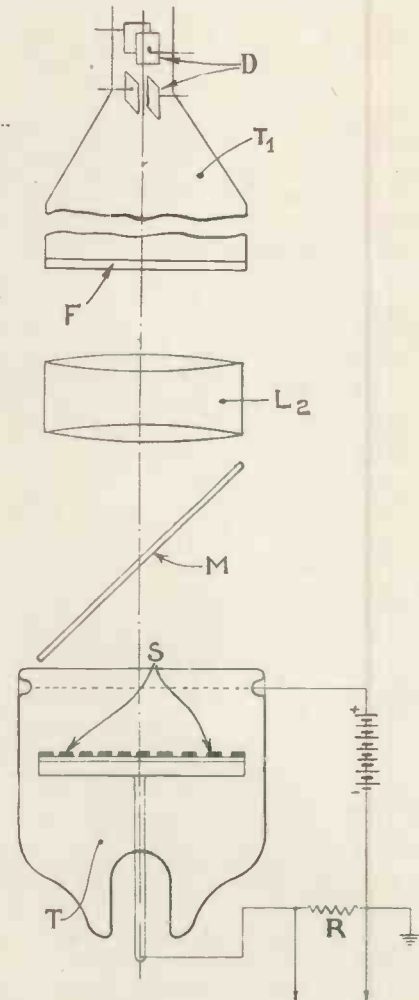

*Projecting an optical image on a mosaic screen of photo-electrically active elements.*

The information and illustrations on this page are given with the permission of the Controller of H.M. Stationery Office.



# FIRST STEPS IN HIGH-DEFINITION RECEPTION

By J. H. Reyner, B.Sc., A.M.I.E.E.

The information in this article provides a simple introduction to the reception of high-definition television signals and outlines the apparatus and conditions that are necessary. It will be of value to those who wish to receive the experimental transmissions being put out by the Baird Co. and make preliminary tests.

THE reception of high-definition television divides itself into two distinct parts. The first of these is the picking up of the transmission, and the second is the resolv-

effect, but otherwise little difficulty arises. On the other hand, 7-metre signals are subject, in much greater degree than ordinary broadcast wavelengths, to reflection and absorption by natural obstacles. Houses will throw shadows. Even trees will distort the wave front, while if one is situated under the brow of a hill—even a small one—it is possible that the waves, at any rate on the ground level, will skip certain areas altogether.

You may find, for example, that taking the whole equipment upstairs will result in good signals, whereas on the ground level nothing is heard.

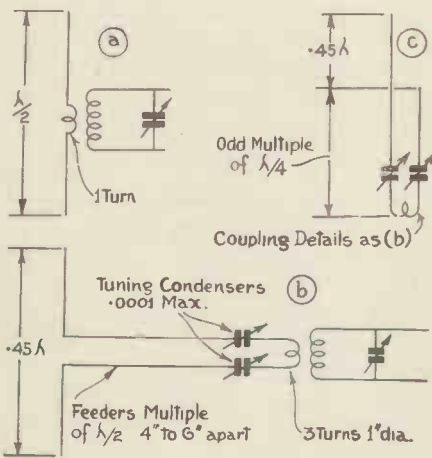

It is quite a good plan to build up a simple 7-metre receiver of the type described in the June issue of TELEVISION AND SHORT-WAVE WORLD in order to obtain some idea as to the field strength in one's own locality. If a strong signal is being received then it will be picked up quite easily on a short length of wire about 6 ft. long used as an aerial, but more generally some form of half-wave aerial is to be desired.

The second arrangement, known as a "current-feed aerial," employs a half-wave aerial some distance from the receiving point with a tuned feeder running from the centre point to the receiver.

The length of the feeder should be an approximate multiple of half a wavelength. If we assume the mean wavelength to be 7 metres, half a wavelength is 10.7 ft. The aerial should be slightly less than this, so that it should be 10 ft. long and the feeder section should be some multiple of, say, 11 ft. It is customary to make the feeder slightly longer than necessary and to tune the whole system to the proper wavelength by the turning condenser in each feeder at the receiving end, as shown in the diagram. About 30-40 ft. of feeder can be used without difficulty, but beyond this feeder losses begin to become troublesome.

Fig. 1.—Short-wave aeriels: (a) Simple half-wave aerial; (b) Current-feed aerial; (c) Voltage-feed (Zepp) aerial.

ing of the signals into a picture. Of the two the former is the more important because once the signal has been received experiments with different types of apparatus for the resolution of the picture become possible, whereas with absolutely perfect vision apparatus nothing can be done unless satisfactory signals are produced to drive it.

Let us consider first, therefore, the actual reception of the signals which are transmitted on wavelengths of the order of 7 metres. Many people imagine that the reception of such short wavelengths as this is a matter of some difficulty. Others avow that 7-metre reception is just as easy as ordinary broadcast reception and that there is nothing to make a fuss about. In point of fact both these ideas are incorrect.

Given a reasonable field strength the process of tuning in a 7-metre signal is not difficult. The coils, and condensers, have to be much smaller than usual and it is desirable to take precautions to avoid hand capacity

## Short-wave Aeriels

A half-wave aerial is a length of wire approximately half a wavelength long which is situated either at the

## Current-feed Aerial

The current-feed type of aerial is only satisfactory provided that the feeder wires can be led out at practically a right angle. Moreover, any sharp bends in the feeders are to be avoided so that in many cases it is simpler to use a voltage feed aerial. Here the same half-wavelength section is employed but the feeder is connected to the bottom end of the aerial, and the return feeder simply terminates in mid-air side by side with the first. The operation of this form of aerial, often known as a "zepp" aerial because it was used on the Graf Zeppelin very effectively, is a little difficult to understand at first, but it may be looked at in the following light. The voltage induced in a wire gradually increases as the length of the wire is increased up to half a wavelength. Beyond



Fig. 2.—The B.T.S. I.F. transformer.

receiver itself or some distance away and preferably at some height from the ground. Fig. 1 shows three possible arrangements. The first is, of course, the simplest, but is only satisfactory where there is a reasonable signal strength at or near the ground

## HIGH-DEFINITION TELEVISION RECEIVERS

this point the voltage induced is in the reverse direction for the next half wavelength, and then reverses again and so on. Consequently, if we have an aerial situated some distance up in the air, the voltages induced in the various sections will be in different directions and will tend to cancel one another out. By running a parallel feeder wire alongside the bottom part of the aerial up to within half a wave-

One can either use a separate triode oscillator with a hexode for the mixing or one of the new composite triode-hexode valves marketed by Osram's which are very effective and can be made to oscillate satisfactorily down to 5 metres.

The signal frequency coils are best made up of a few turns of 14 or 16 gauge copper wire wound to a diameter of about 1 inch. No former is

have a detector and one or two video-frequency stages. These are in effect ordinary i.f. stages but capable of going up to a frequency of over a megacycle.

Satisfactory testing can be carried out by using a pair of telephones in the anode circuit of the detector valve, because apart from the modulation, the synchronising signal gives an audible note which immediately serves to detect the signal.

The Baird transmissions in fact sound like a very high-pitched sing broken up by a rapid burble. The burble is due to the 25-cycle picture synchronising signal, while the high-pitched sing is the 6,000 line synchronising signal. The modulation, of course, ranges from 25 cycles up to a megacycle, which is quite inaudible.

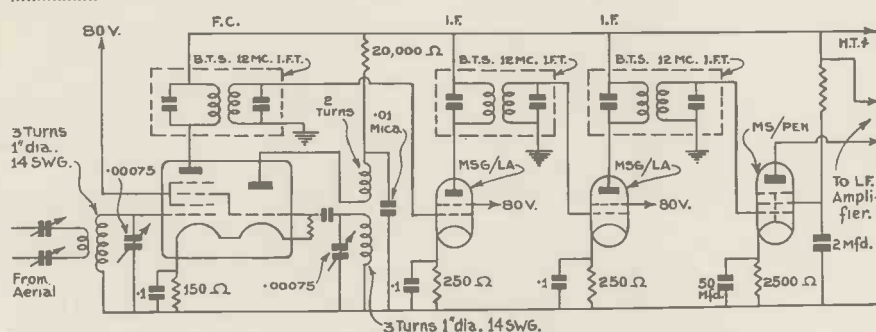

Fig. 3.—Circuit of I.F. amplifier. The screen voltage supplies and heater circuits are not shown in order to make the circuit simple

length of the top, we get equal and opposite voltages induced in the aerial lead-in and in the feeder, and these cancel one another out. Consequently, the only part of the aerial which is effective is the top half-wavelength portion which is just what we require.

The feeder in a voltage-feed aerial should be a quarter of a wavelength longer than with the current feed type, so that for 7-metre reception it should be  $5\frac{1}{2}$ ,  $16\frac{1}{2}$ ,  $27\frac{1}{2}$  feet, and so on. Once again it is tuned by including condensers at the bottom.

Now we come to the consideration of the reception itself. The principal difficulty here is the large band width required and opinions are divided as to the best way of doing this. My own experience has been with super-heterodyne receivers, using special wide band i.f. transformers. Fig. 2 shows an i.f. transformer made for the purpose by Messrs. B.T.S. These operate on 12 megacycles and are of band-pass construction giving an effective band width of approximately 1 megacycle. I have used these quite effectively in a high-definition receiver, the general arrangement being as shown in Fig. 3.

We start off with a triode-hexode frequency changer. This form of circuit is desirable to avoid pulling between the aerial and oscillator circuit.

necessary because the wire is sufficiently rigid to preserve its shape and the coil can be mounted directly on the tuning condenser. Eddystone short-wave tuning condensers of about 75 micro-microfarads are satisfactory, particularly if operated with the special extension handle made by the same firm.

Three turns for the tuned winding and two turns for the reaction winding will be satisfactory. Bare copper wire should be used treated with a light coating of shellac or some other insulating varnish to prevent the metal from oxidising. Tinned wire is not suitable because at the very high frequencies involved the current flows in the skin only of the wire and tin is a much poor conductor than copper.

### Amplification Requirements

The amplification per stage at the frequency of 12 megacycles which has to be used for the i.f. is only small compared with normal practice. Actually, a value of about 15 per stage can be obtained. Two stages of i.f. amplification are therefore desirable and even three can be used if it is found necessary. Generally speaking, however, two i.f. stages will be found sufficient. Following this we

### A World Clock

WE have recently had submitted a clock which shows at a glance the standard time throughout the world. This clock is shown by the photograph and it will be seen that instead of revolving pointers the dial rotates in an anti-clockwise direction past stationary hands. To ascertain the time in any part of the world no calculations are necessary and either summer time or standard time can be read directly to the minute. The small hand below the centre of the dial shows the

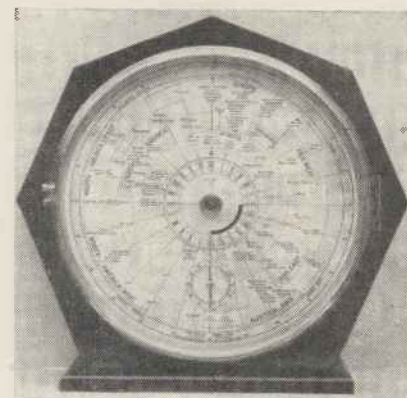

The Willis World Clock.

exact minute past each standard hour anywhere and the reverse end of this pointer shows simultaneously the number of minutes past the hours of those countries whose noons lie midway between the standard meridians. The clock is fitted with an 8-day movement and retails at £8 8s. od. It should prove of particular value to short-wave experimenters. The makers are J. H. Willis & Co., Ipswich Road, Norwich.

# Scannings and Reflections

By THE LOOKER



LATER accounts of Major Armstrong's "mystery" transmissions, to which I referred last month, show that reliable reception was obtained on a 7-metre wave over a range of 100 miles. It will be remembered that the system is based on the use of a frequency-modulated carrier at the transmitting end, and a special type of receiver.

The new system seems to have many advantages. For instance, the receiver is not appreciably more costly to produce than the standard type of set; in fact one can be converted into the other by a simple input "adaptor." Also on the transmitting side frequency-modulation is more economical to run than ordinary amplitude-modulation in the sense that it produces a more effective type of radiation from a given power-input.

Although there are many cases on record where 7-metre, and even 5-metre signals have been received over very long distances, the generally-accepted view, at present, is that ultra-short-waves are dependable only within the so-called optical range, say, from 25 to 30 miles of an elevated transmitter such as the one at Alexandra Palace.

If, therefore, Major Armstrong's claims for the new frequency-modulated system can be substantiated, they represent a big advance in television prospects. Two or three 7-metre transmitters, each with an effective service-range of 100 miles, would go a long way towards bringing high-definition pictures within the reach not only of those who live in the great cities, but of practically the whole countryside.

Visually and musically the Ballet Carnival was undoubtedly the most successful programme of the past month. The show attracted the attention of a national daily newspaper and the television correspondent of the *Daily Telegraph* praised the producers' efforts in quite enthusiastic terms:—"Undeterred by the restrictions of thirty-line television, Mr. Eustace Robb presented last night another

complete ballet. To crowd such complex movements on to the narrow screen was a considerable feat."

Apart from the amazing agility of Idzikowski, who never falters in the most intricate movements, and the graceful perfection of Sokolova, I was most impressed by the perspective in the picture.

Lookers will have noticed that they appeared to be facing a corner

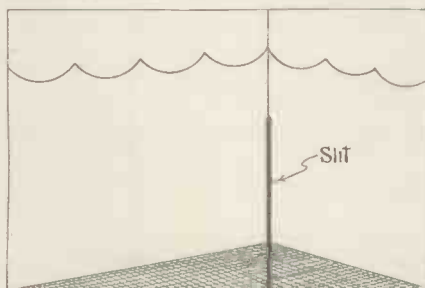

The novel backcloth used in the Carnival programme.

of the studio for the first time, while in fact the projector was in its normal position and the effect was secured by a trick.

A huge backcloth had been painted from the design for the original production of the ballet. This cloth was hung from a stout wooden boom hinged to a wall of the studio and when this piece of scenery was swung into position it gave the impression of a corner, as shown in the diagram.

For about six feet from the floor the backcloth was slit and dancers were able to appear and exit through this aperture as they did on the stage. An unusual sense of space was added to the picture by the false perspective of this device.

All of which suggests that an artist will be needed for the high-definition service. A man such as Bakst, who designed the original costumes for this ballet would be invaluable in the studios at Alexandra Palace. An enterprising designer might not be

wasting his time if he studied the problems. He must work in black and white at first.

Just as television is taking a step forward, the films enter a fresh phase, or so some critics believe. Technicolor seen in "*Becky Sharp*" is claimed to be the cinema's reply to developments in television. Will it revolutionise the talking picture?

In "*Becky Sharp*" colour is said to have stolen the picture and the new process is certainly an enormous advance on the crudities of some earlier tinted films. Though the progress of television could never be arrested, it might be retarded by the addition of colour to every film shown in cinemas in the country. The development of colour will be well worth watching. Dr. Kalmus, head of this Technicolor Corporation, has looked at thirty-line pictures with Eustace Robb, pioneer of another medium.

At Duxford watching the bombers fly overhead, at Aldershot as troops marched past, and more than ever at Spithead when the Royal Yacht led the Fleet to sea, I felt sad that high-definition television had missed the Jubilee by so small a margin. A year later and Baird's electron camera and the electric eye of E.M.I. might have brought these spectacles into our homes.

Some old friends will be seen on our screens in an illustrated natural history talk on July 31. D. Seth Smith, the Zoo Man of the Children's Hour, is again bringing along some of his pets from the gardens.

It was two years ago that this curator from the London Zoo first faced the televisor with a snake or two and a monkey. He had not then started his popular series in the Children's Hour and his manner was more formal than it will be on Wednesday, despite the slightly pompous billing of the show.

Charlie, the Capuchin monkey, the alligator, the python and the Singalese parrot will all be facing the beam

VISIT STAND No. 7  
AT OLYMPIA

again. D. Seth Smith also promises to show a panda, an animal which suggests a cross between a cat and a bear, and should make a good picture as its fur is red while its head and tail are black. Then we are to see a mongoose and a penguin, most fascinating bird, that nature might have coloured especially for television. And last of all some fish, for the first time.

Eustace Robb and the curator have chosen specimens that will make good pictures. The "striped fish"—black and white—and the bigger "trigger fish" will be seen in their tanks, but the "puffer" will be taken from the water so that we may see him expand like a football as he does whenever he is tickled. This fish has the right colouring too, he is dark with white spots.

\* \* \*

Most radio artists who have anything to offer to the televisor have already appeared in the studio, and it was therefore a surprise to discover Janet Joye in a programme of newcomers. It was an excellent cabaret.

Janet proved that impressions of film stars gain enormously from being seen. Bea Hutton, in a white dress with two black birds of paradise, showed us how much costume and carriage can improve an act for television even when the voice is as good as hers.

Charley sang Austrian songs in a vigorous, easy way, and since he has never broadcast before, I should recommend some of the aural producers to arrange an audition.

Sydney Jerome's orchestra and Freddy Wittop, a dancer, completed a strong bill that must have pleased all "middlebrow" lookers.

\* \* \*

Mr. Andrew W. Cruse, chief of the Electrical Equipment Division, Bureau of Foreign and Domestic Commerce, U.S.A., just back from a tour of Europe, has given his views on British television to a broadcasting convention at Colorado.

He thinks that the B.B.C. is doing an excellent job with thirty-line pictures and was pleasantly surprised to discover that, despite the low defini-

tion and flicker, the programmes do have an entertainment value for short periods.

So far so good, but he then goes on to say that when he asked about the number of television receiving sets in service in the British Isles, the British Post Office people, who were in the best position to make an estimate, gave a figure of *less than one hundred* (as reported in *World Radio*).

It is when assertions of this kind are published that one wishes for some reliable guide to the number of lookers such as the licence figures provide for listeners. Correspondence received by the producer and the circulation of this Journal suggest that the estimate is absurdly wide of the mark, but where is the proof?

\* \* \*

The sudden heat-wave which descended on us last month was responsible for what the newspapers called a "modern miracle." Within a few hours it transformed the famous collection of rose-trees in Queen Mary's Garden, Regent's Park, from a sombre bank of green leaves into a gorgeous display of multi-coloured blooms. Which only goes to show what can be done by the right kind of stimulus, applied at the proper time.

One is tempted to draw a parallel between the fact just recorded and the present position in television. Interest is ripe amongst the public and is ready to blossom out into a demand for sets, as soon as things start moving at the B.B.C. That is, of course, provided the manufacturers pull their weight too. But unless something in the nature of a "heat-wave" comes along pretty soon, interest may begin to flag, and the opportunity be lost for another whole year.

### New Showrooms for A. F. Bulgin & Co., Ltd.

A. F. Bulgin & Co., Ltd., announce that they have opened new showrooms at 64 Holborn Viaduct, London, E.C.1. A complete range of Bulgin components, including all the newest models, will be displayed there. Bulgin components can, of course, be obtained from all reputable dealers, but where there is any difficulty experienced in getting them inquiries should be addressed as above. The telephone number is Central 2751.



Television artists will be able to see the act in advance of their own in comfort. The photograph shows Varvarova and Allison, two well-known television dancers.



AUGUST, 1935

# Band Spreading in Amateur Receivers

By Malcolm Harvey.

*A short article previously published on band spreading created considerable interest, but it was obvious from the correspondence that many readers were not fully aware of the advantages of band spreading. In this article the author has endeavoured to give a clear idea of why every amateur receiver should include band spread.*

IT must be clearly understood that band spread is only suitable for short-wave working and when I have mentioned that it greatly simplifies tuning, do not get the idea that your broadcast set will be improved by its use.

Amateurs are only allowed to trans-

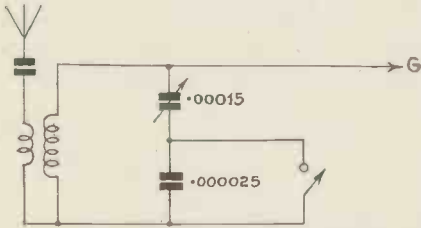

Fig. 1.—This arrangement is quite effective and can be embodied in a receiver with the minimum amount of alteration.

mit on definite wavebands such as 160, 80, 40, 20 and 10 metres. These bands are very restricted and do not allow many stations to operate simultaneously unless they are all very stable and crystal controlled. In practice a large number of stations are sandwiched in between the limits of these narrow bands and with a selective receiver no trouble should be experienced in making many contacts. Consider the 40-metre band for a moment. This actu-

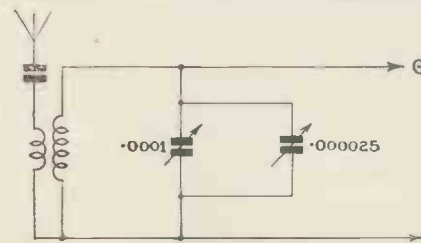

Fig. 2.—Providing the band spread condenser has a good dial this method will not upset the calibrations.

ally spreads between 41.1 metres 7,300 kilocycles, to 42.9 metres 7,000 kilocycles. An average short-wave receiver would tune between 20 and 60 metres with one coil so that 40 metres would spread over approximately 100 degrees of the tuning dial.

A simple calculation soon shows that the amateur 40-metre band will only occupy a very small section of the tuning scale, so an extremely fine slow motion dial has to be used if the stations are to be tuned in at all.

Band spreading enables the 1.7 metres comprising the amateur band to be

spread over at least 50 degrees of the tuning scale. In practice this makes a short-wave receiver as simple to tune as an ordinary broadcast set. In the circumstances it is surprising that so few receivers are fitted with this refinement. Actually the majority of transmitting amateurs use band-spread receivers, but this is not so with listening stations.

## An Easy Circuit

Fig. 1 shows the conventional connections for a simple band-spread circuit. The change from ordinary tuning to band-spreading is made by opening the switch contact. This connects a .00005 fixed capacity in series with the main tuning condenser and reduces the capacity of it so the actual wavelengths covered are decreased by 70 or 80 per cent. Any short-wave receiver can be modified in this way. The only difficulty is that the coil has to be very carefully wound so the band required comes well within the range of the tuning condenser when the small condenser is in series with it. Of course, the simplest way to overcome this little difficulty is to use plug-in coils. In Fig. 2 a .00005 midget condenser is shown connected in parallel with the main tuning condenser. The idea of this is that the receiver can be tuned in the normal way, but when finer tuning or band-spreading is required the main condenser is adjusted until the receiver is set below the bottom of the required band, say, 39 metres. The amateur band is then searched by means of the small .00005 midget condenser.

## Calibration

Provided the midget condenser is fitted with a calibrated dial, so that it can always be turned to zero, the receiver can be calibrated in the normal way. This is one of the most popular methods for there is no need to make any alteration to the receiver at all, while the problem of winding special coils does not arise. This is called continuous band-spread and can be embodied in receivers having several tuned circuits.

Eddystone condensers of the 900-type having a small capacity can be linked together so that band-spreading in several circuits is not difficult. Experimenters who are mainly interested in amateur bands where congestion is particularly bad will be well advised to consider the circuit shown in Fig. 3.

This arrangement makes use of tapped coils, the aerial being connected well down towards the earthing end of the

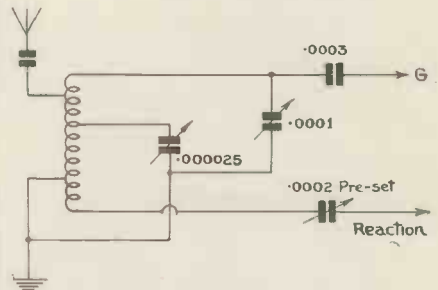

Fig. 3.—This may look complicated but actually it is quite simple. It is only to be recommended when a new receiver is being built.

grid coil with the earth connection still lower. The main tuning condenser is connected across grid and earth with a band-spread condenser connected between earth and a tapping mid way between the aerial contact and the end of the grid coil. The extreme end of the coil is returned to the anode of the detector valve through a small preset con-

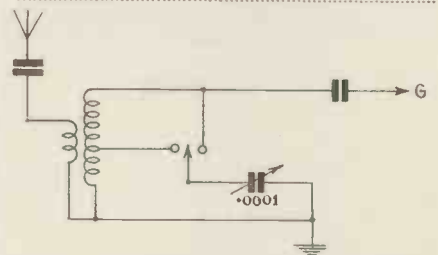

Fig. 4.—The coil used in this circuit must have a tapped secondary. Commercial coils can be adapted without difficulty.

denser such as the J.B. baseboard type. Control of regeneration is obtained by varying the voltage applied to the screen of a screened grid. I always advise a screened-grid valve for detection owing to the big increase in stage gain obtained if the valve is correctly coupled.

A tapped coil can be used in a variety of ways. Fig. 4 shows the arrangement. In this the tuning condenser when connected across the coil acts in the normal way, but when switched over to the second position only tunes a small percentage of the total number of turns on the coil. This arrangement is very satisfactory.

# A PRACTICAL OUTLINE

By Capt. A. G. D. WEST, M.A., B.Sc.,

From an address entitled "Television in the Cinema" delivered by the Director of Baird Television, Limited, we extract what is unaltered and presented by any well-known technician. In order to make the text more readable, illustrations accompanying the text have been

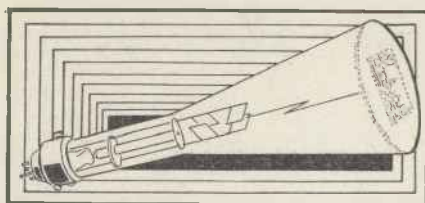

FOR some time past there have been many rumours with regard to television. So many of these rumours have been totally unreliable and in quite a large number of cases even expert opinion has been wrong. For instance, it was only just over a year ago that a highly placed and quite respected Government official, an engineer of great reputation, and quite justifiably so, made a statement that high-definition television for the home would not be possible for at least five years on account of technical difficulties, such as inability to transmit such a thing, or inability to receive it on account of the great electrical interference which would be experienced. We knew then, and we know now even more confidently, that such a statement was entirely wrong.

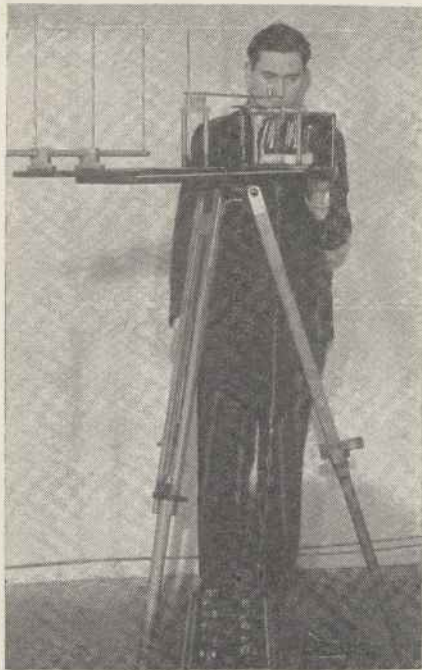

A micro-wave transmitter for relaying high-definition television programmes over a distance of 10 miles.

There are three fields into which television may enter immediately, namely, broadcast television for reception in the home, television for full-size cinema reproduction in the cinema, and thirdly, television in connection with the telephone service.

Broadcast television for home reception was definitely established as a practical possibility by the report of the Postmaster General's Television Committee, which appeared at the end of January, and the truth of this report was practically verified by the series of demonstrations given by the Baird Company, immediately after this publication.

## How Television Works

The process of transmitting a moving picture from one point to another consists essentially of three stages.

First of all, the scanning of a scene, that is to say, analysing it or dividing it up in a regular manner into small units

or parts and converting the light or shade values of these parts of the picture in sequence into corresponding electrical currents. In other words, converting the scene into its electrical equivalent.

Secondly, the electrical transmission of this from one point to another, and thirdly, the reconstitution of the picture at the receiving end, by building up in correct sequence the various units to form a picture exactly in accordance with the light and shade parts of the subject scanned.

In transmitting a television picture it is important to remember that two separate things have to be considered.

First of all, the transmission of synchronising impulses, so that the picture at the receiving end is re-formed exactly in step with the scanning at the transmitting end. Secondly, the vision signals themselves which convey the values of the light and shade parts of the picture so that when the picture is built up again by means of the synchronising impulses, various relative half-tone values are reproduced exactly in accordance with those of the subject.

## Scanning

It is necessary to determine the best way in which the picture can be scanned or divided up. As you know, in the case of a half-tone block for picture reproduction in a newspaper, a picture is divided up into a large number of little dots, or units, which, on account of their size or their depth of tone, convey, in the aggregate, the right effect in the reproduced picture.

In television, where there is only a limited channel of communication, these little dots cannot all be transmitted at once and so it is natural to take these units in some straightforward sequence.

The most practical way to do it is to divide the scene up into parallel strips, each of these strips being analysed along its length, and the strips being considered in orderly sequence in traversing the picture. By enabling the point of analysis to travel along each line in succession it is possible to register the tone value, and to convert it into a corresponding electrical value, so that the whole picture can be traversed in a given duration of time.

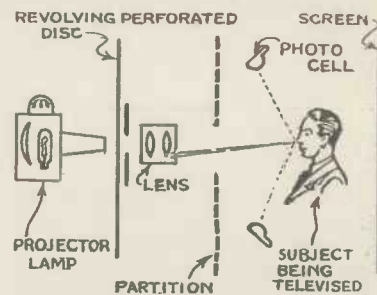

This diagram shows the elements of spot-light scanning at the transmitter in its simplest form.

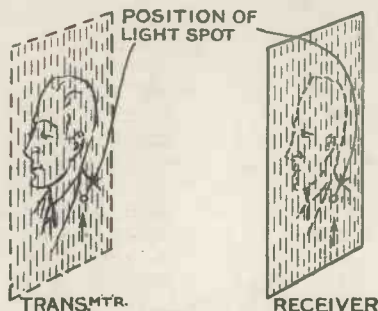

This diagram shows that it is essential that the spot position at the receiver corresponds with that at the transmitter.

# LINE OF TELEVISION

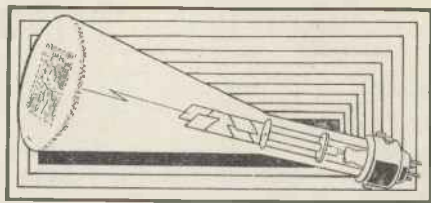

## Technical Director of Baird Television

overed by Capt. A. G. D. West, M.A., B.Sc., Technical  
doubtedly one of the most helpful outlines of television yet  
he outline more easily understandable we have added the  
anying the article.

The number of strips or lines into which the picture is divided is important because it determines the degree of definition which can be used. The larger the number of lines, in general, the better the definition obtainable, provided that all the subsidiary apparatus is capable of dealing with this number of lines.

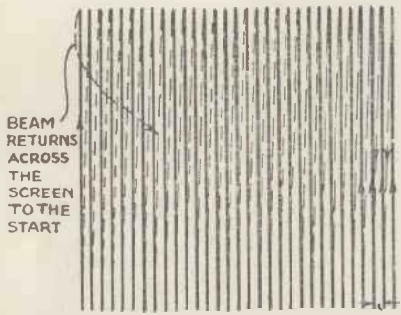

This diagram shows the spot traverse on the screen of a cathode-ray tube; the return traverse is so fast that it is not discernible; in the diagram it is shown dotted. Thirty-line scanning is represented by this drawing.

Low-definition television means a number of lines between 30 and 60 in the picture, with the picture repeated say  $12\frac{1}{2}$  complete times per second.

High-definition is given from 120 lines upwards and a picture repetition frequency of 25 or more.

It has been found in practice that a picture divided up on a 240-line basis can be transmitted and reproduced so as to give a result on the home receiver which has sufficient definition to be of considerable entertainment value.

## Transmission Limitations

The conditions of transmission are defined, and if one attempts to use a greater number of lines under these given conditions the result is usually inferior. Therefore the number of lines to give the best result is determined by the practicalities of the best amplifiers, radio link and reproducing devices that it is possible to have.

Scanning is usually effected by means of a spot of light travelling at very high speed over the subject to be transmitted, consecutively in the path of these parallel lines. The spot of light by doing this is able to analyse the picture in a form suitable for transmission. It is usually done by means of

a revolving disc, which has tiny holes punched round its edge, or by means of mirror drums or other mechanical optical devices.

In the case of the disc a powerful arc light throws light through the holes as they pass in succession through the gate, the holes being arranged in such a manner round the edge of the disc that each hole corresponds to a definite line in the picture and results in a spot of light travelling along that particular line or strip. With a high-definition 240-line picture a suitable scanning disc is about 2 ft. in diameter and the holes have a diameter of  $\frac{2}{1000}$  of an inch. In the case of the transmission of films, the light, in passing through a hole in the disc, gives an image of that hole focused on the film itself. The corresponding spot is sharply focused on the film and the consequent light transmitted through the film is picked up by a photo-electric cell and converted into variations of electric current, depending on the varying density of the film.

## Televising Scenes

In the case of the television of scenes by the spotlight method, as the spot travels over the subject so light is reflected back by the subject, to be picked up by large photo-electric cells in front of the subject. As the spot travels over a dark portion, such as a black coat, very little light is reflected, and as it passes over a face a good deal of light is reflected. The variations of reflected light are converted into similar variations of electric current by the large photo-electric cells.

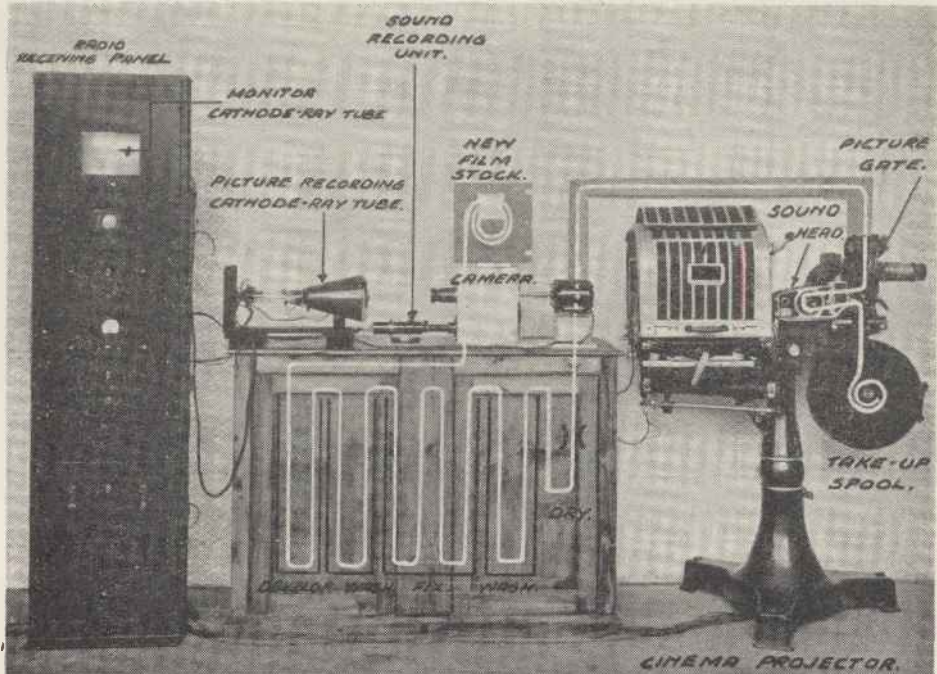

This photograph shows the Baird intermediate film scanner with the path of the film through the processing tanks and the projector outlined.

## HOW OUTDOOR SCENES ARE TELEVISED

In either case the photo-electric cell converts the high lights half-tones and shadows into corresponding electrical currents, at the same time a synchronising impulse is developed independently every time that the spot arrives at the end of a line, and another type of impulse is developed every time that the spot arrives at the end of the last line on the bottom of the picture.

These synchronising impulses are added, at a later stage, to the vision signals developed by the photo-electric cells in the studio or in front of the film transmitter. All these synchronising impulses serve the purpose of re-forming the picture at the receiving end.

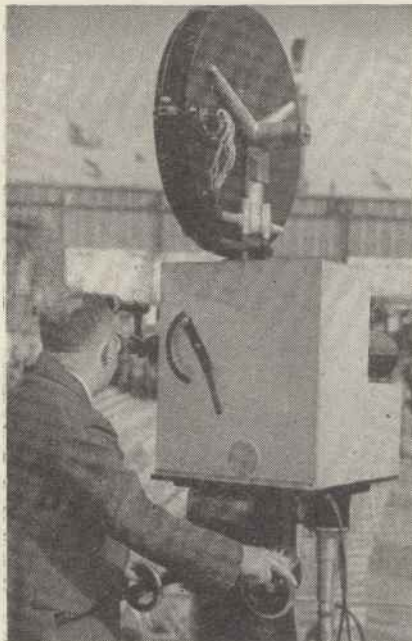

An intermediate film scanner used in Germany

The result is that we re-form a picture the same shape and proportions, built up of the same number of lines as the transmitted picture and having the same relative values of light and shade.

### Methods of Scanning

Several methods of scanning have been evolved and the following are the most important to-day for practical scanning.

First of all there is the original spotlight method of Mr. Baird used by him as far back as 1923, already referred to in describing the method of analysing a picture, by means of a flying spot of light. In high-definition television, owing to limitations in the amount of light available with this method, it is only possible to transmit close-ups of one or two artists, and not larger scenes.

There is no doubt that the best results in television to-day are obtained by using film material. The success of telecine scanning, as it is called, leads naturally to the development of the intermediate-film scanner.

This method, exclusively developed by the Baird Company, is regarded as the most successful method of transmitting large indoor or outdoor scenes. It consists of a cinematograph camera, which photographs the scene on motion

picture film and, at the same time, records sound on the same film.

The film is then rapidly developed, fixed and washed in a period of less than 30 seconds, and results in a perfect photographic negative of both picture and sound. This negative is then scanned in the same way as an ordinary talking film is scanned and the sound is also picked up off the film, both vision and sound having identically the same time delay, and thus being transmitted in exact synchronism.

The intermediate-film method is extremely flexible, and quite a small unit which can be moved about in the studio or on exterior work only is required. From a photographic point of view, this quick processing results in quite as good a negative as is obtained by processing in the ordinary manner.

### Cost of Intermediate-film Methods

There is a further particular advantage in the intermediate-film method. It might be thought that the cost would be high on account of having to use so much film, but this difficulty has been got over in one particular case by the Baird associated company in Germany, by using a continuous loop of celluloid, about 100 feet long, where, after the negative has been scanned, the emulsion is removed, the film is cleaned, then new emulsion is put on the film which, after drying, passes through the camera again.

In this continuous process the film cost is negligible, but I myself believe that the extra complication and slightly inferior results make it not so valuable a method of transmission as where new film is used every time.

The running cost of £12 per hour in our intermediate-film method is amply covered by the fact that you can save on production expenses and artists' fees, if you want to reproduce the same programme a dozen times, either at the same transmitting station or at other transmitting stations—an important economic point when it must be remembered that television at the moment, at any rate for broadcast purposes to the home, is a purely local pastime and that no means have yet been evolved of linking up so that transmitters in Cardiff, Birmingham, Manchester and Aberdeen can give the same television programme as is going on in London.

### The Electron Scanner

There is a fourth scanning method which is extremely valuable, which is known as the electron camera, commonly called the "electric eye."

In the particular type used by the Baird Company an image composed of electrons and corresponding exactly to the scene which is being televised is formed inside a vacuum tube. You cannot see this image, but it is there all the same and it is caused to move horizontally and vertically so as to be scanned by a tiny aperture in an electrode inside the tube.

The electron camera can be used for direct pick up of scenes and it can be placed in front of a projector for transmitting films. Moreover, as it is controlled in operation entirely by electrical circuits, it is possible, simply by turning a knob, to vary the number of lines from 100 to 700.

## PRODUCING ELECTRON IMAGES

This, of course, is a useful point in experimental work and enables a decision to be made as to which is the best standard for any particular form of transmission. By this means the Baird Company determined on a definition of 240 lines as being the best for television broadcasting to the home.

The highest number of lines obtained so far, namely 700 lines, results in a picture which is, even after a close examination, indistinguishable from the original in definition and quality. It may be that after many years' research work it



The dissector-multiplier camera for direct electronic scanning.  
(From the Journal of the Franklin Institute.)

will be possible to transmit over a distance, effectively, pictures having 500 lines or more, but with the present technique it is impossible to transmit more than 240-line effective definition. This is mainly on account of the limitations of the radio link (the best wavelength on which to operate, being round about seven metres) and questions of interference at the receiving end. In the meantime, the 240-line picture gives extremely good results and is an excellent standard to adopt both for the home and the cinema.

The currents developed by the photo-electric cells and by the electron camera are very small and have to be amplified, and there are two particular requisites in the amplifiers to ensure no loss of definition. Firstly, amplifiers must be able to handle satisfactorily a very wide frequency range, namely, from 10 cycles up to 2 million cycles. Not only must all frequencies of this large range be transmitted equally effectively, but the wave form of the signal must also be transmitted without distortion; that is called technically—"without any phase change."

One requirement, namely wide range of frequency, is necessary to give good definition. The other requirement, that is, transmission of all frequencies without phase change, is necessary to make certain that a black point comes out black and a white point comes out white.

## Transmission

### Methods

We must now consider how, having obtained electrical vision signals from the scene which is being scanned, we can transmit them from one point to another. Three things have to be transmitted (this compares with only one item

which has to be transmitted in ordinary broadcasting, namely, the sound), these are the vision signals which give the tone value of the various parts of the picture: the synchronising signals which are used at the receiving end to re-form the picture in proper frame and shape, and thirdly, the sound.

These three things can most economically be transmitted on two channels, one channel takes the vision and synchronising signals and the other channel takes the sound.

If radio transmission is employed in conveying television signals from one point to another, then it is necessary to have two radio transmitters, two separate wavelengths for transmission and two radio receivers at the receiving end. On the other hand if cable transmission is used then two cables are necessary, one of which must be capable of carrying a large enough range of frequencies without loss, so as to be able to convey the vision properly; the other cable only carrying the sound, need be nothing more than an ordinary telephone cable.

Let us now consider the properties and limitations of these two methods of transmission. If radio channels are used then great care must be taken with regard to choice of wavelength. Low-definition pictures can be transmitted on the ordinary medium broadcasting wave, but high-definition pictures with their very high modulation frequencies cannot be transmitted on medium wavelengths because if a medium wave transmitter were modulated with high-definition television, supposing that it could be operated on 300 metres, then the transmitter would cover at least a band from 150 metres to 600 metres, thus interfering possibly with all the broadcasting stations of Europe.

## The Best Wavelengths

It is found in practice that the best and, in fact, only possible waves to be used are ultra-short waves, between 5 and 10 metres. A high-definition modulation on a 6-metre wavelength only covers from about 5.9 to 6.1 metres. It is thus possible to fit in, in the wave range mentioned,

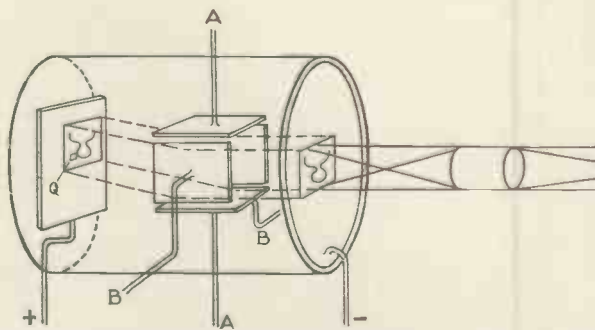

Diagram showing the principle of the electron camera. AB are the leads to feed the deflector plates with scanning potentials and Q is the electron image on the anode.

namely, 5 metres to 10 metres, 20 different television transmitting stations without interfering with each other.

Now ultra-short waves have almost the same properties as rays of light, that is to say they transmit practically only in a straight line and will not pass through obstructions like hills or large buildings. Therefore it is essential to

## HOW WAVELENGTH GOVERNS DEFINITION

select a transmitting site having aerials as high up as possible so as to cover the largest area. The transmitting aerials on the tops of the Crystal Palace Towers, which are 700 ft. above the sea, give an effective range of transmission of about 40 miles, which is reduced in certain directions where there are high hills.

### Wavelength and Definition

The best all-round wavelength for television is 7 metres, and this does to a certain extent pass over the tops of hills and curve down to points beyond them. The maximum definition available on this wavelength is something of the order of 240 lines. If a higher number of lines is tried out on this wave, say 400 is transmitted, then the highest value received is only of about 150 lines.

To be able to transmit 400 lines successfully it is necessary to go down to a wavelength of about  $1\frac{1}{2}$  metres and the range of transmission is then reduced because these very short waves will not pass over hills or round obstructions like large buildings or trees and will not penetrate into steel-frame buildings. There is a further difficulty which is encountered on wavelengths below 6 metres, namely that, as the wavelength is reduced, interference is experienced from motor-car ignition systems, electrical machinery, and domestic electric appliances, making practical reception very difficult.

The best solution for high-definition television is, therefore, to use a wavelength round about 7 metres and a definition of 240 lines. This, in fact, was recommended by the Television Committee as a result of the practical demonstrations which the Baird Company gave to them towards the end of last year.

### Transmission by Cable

Now it may be that when television becomes really universal it will not be possible to find room for all the television transmission required for home and for cinema use on the range of radio wavelengths available. This leads, therefore, to the use of cables for this purpose. Up to about 6 months ago it was impossible to make a cable which would carry high-definition television over a distance of more than about a quarter of a mile, but within the last few months cables have been developed which are capable of carrying television over distances of 10, 20 or even 100 miles. They consist of a metallic tubular casing about 2 ins. to 3 ins. in diameter and a thin inside conductor running down the centre of the tube. As well as being useful for high-definition television they can also be employed for carrying up to 100 telephone conversations simultaneously. Thus we shall find them within the next few years, in spite of their great cost, which is variously estimated between £300 to £1,000 per mile to put down, laid down by the Post Office between important centres of population. Already work has started on putting down a cable between Berlin and Frankfort, and on another between New York and Washington, D.C.

### Reconstitution

Now we must consider how the vision signals can be received and made use of to form a picture equivalent to the original. They arrive as modulation of an ultra-short wave radio carrier, or as signals on a cable.

In the former case it is, of course, necessary to use a radio receiver, which picks up the signals by means of a suitable aerial and delivers at its output electrical variations corresponding to the original signals in the transmitting studio and, at the same time, the synchronising impulses to hold the picture in step, in horizontal and vertical directions. These two sets of signals, as has been explained, come in together on the same carrier-wave and a properly-designed radio receiver sorts them out so that the result is to provide means of keeping the reconstituting device

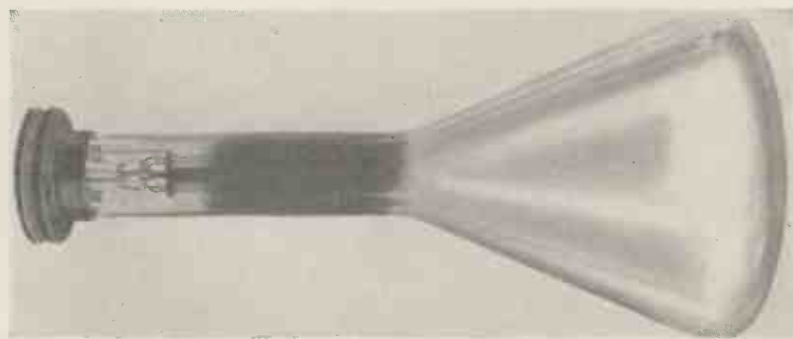

A typical example of a cathode-ray tube for television purposes. This is the latest Cossor Tube.

in step with the picture transmitted, and, secondly, controls the amount of light and shade produced at the reconstituting device in forming a picture of correct tone value.

There are three general methods of reconstituting the picture. The first is the mechanical method, which involves the use of parts like mirror-drums or pierced discs, moving at high speed, having the essential action of forming a flying



Using a cathode-ray tube for recording pictures on film for television reproduction in cinemas.



## A NEW METHOD OF OBTAINING LARGE PICTURES

daily two-hour service of full entertainment value, consisting of artistes and excerpts of films. The vicious circle of "no sets without transmission" or alternatively "no transmission without radio receivers" could, for all practical purposes, be broken. It was necessary, however, to wait for the publication of the Television Committee's report, which appeared on the last day of January this year. This report, which had the most energetic and sincere backing from Sir Kingsley Wood, put home television on the map as a commercial possibility, and can be regarded as a charter for the new science.

### The Home Receiver

I have already referred to the cathode-ray tube and it is around this that the television receiver for the home is built up. The receiver itself has about 18 valves in all, and the picture is suitable for entertaining a dozen people or more.

We have carried out a very large number of tests in all parts of London, receiving pictures from our Crystal Palace transmitter. In all we have visited about 50 sites, ranging from Southend in the east to Maidenhead in the west, Hatfield in the north and Sevenoaks in the south. We have taken measurements of signal strength received, and even installed our receivers and obtained excellent pictures in the whole of that area.

The Television Committee have taken over a part of the Alexandra Palace for the B.B.C. to conduct their tests of various systems. They have admitted that the Crystal Palace is the best site for the purpose, but they did not wish to favour any particular individual or company, not even the original inventor and pioneer, and have, therefore, chosen neutral ground in spite of the fact that full opportunities were given for the use of the opposite end of the Crystal Palace to that now occupied by the Baird Company.

### The Two Standards of Scanning

Unfortunately, the Television Committee have decided to adopt two standards of transmission for the Alexandra Palace, having different numbers of lines, and different numbers of pictures per second. In my opinion this is not only bad from an engineering point of view, but also from the commercial point of view. It is like choosing one gauge for the Southern Railway and another gauge for the Great Western Railway, and then trying to make them work together and interchange rolling stock. Baird receivers have been demonstrated to operate successfully on both standards of transmission, but I am afraid that the simple ideal for easy home operation has been knocked on the head.

### Television for the Cinema

There are various methods of producing large screen pictures, the three most important methods being the mechanical, the intermediate film, and the high-power cathode-ray projection tube.

(a) Television has been projected on to a large-size screen by means of mechanical methods, using large mirror-drums

rotating at high speeds. Mr. Baird has now developed a high-definition method of projecting large pictures, limited, however, at the moment to close-ups only. In this mechanical method he uses a system called interlacing, where lines are not scanned sequentially in order, but out of turn, which has the effect of reducing flicker.

(b) The method for which I have the most hope, at the moment, is the intermediate-film method, which gets over the great difficulty, experienced with mechanical and cathode-ray systems, of insufficient light. We are now working on providing a complete equipment which projects full-size pictures on to the cinema screen, having ample light and definition.

In this case a television picture is picked up by radio and transferred to a cathode-ray tube. The picture is then photographed on to a continuously moving film using a special form of camera. The camera has two rotating drums inside it, both moving at a constant speed. One is in the position where the picture is recorded, the other is for the recording of sound.

The film, after being exposed, to both vision and sound, runs straight into a developing bath, where it is developed for 20 seconds, washed for five seconds, fixed in 20 seconds, washed for a further 15 seconds and dried in less than a minute. After a total period of under 2 minutes it then passes immediately into the projector and after leaving the sound gate is taken up on the pick-up spool.

### The Projection Tube

There is another method, which is now in process of development, called the projection tube. This is a special form of cathode-ray tube having an intensely brilliant picture, something between 3 ins. and 6 ins. square, so bright and well defined, in fact, that it can be projected by means of a lens on to a screen with good brilliancy and detail.

At the present moment, only small screens, about three or four feet square can be filled in this manner. A brighter picture can be obtained on the tube, but there is then so much power put into the screen that it disintegrates. In any case, a voltage of up to 10,000 volts is necessary to produce enough brilliance to be able to project pictures of the small size mentioned, but it is a form of development which the cinema industry must certainly keep an eye on, because when it does become practicable, as it will do in the course of the next five years, it will possibly do away with the standard projector mechanism itself.

If I were asked how, at the present moment, a picture of the Boat Race or of an Albert Hall Boxing Contest, could be relayed to cinemas in London, I would say that it could be done by the following method:

An outdoor scanner, of the intermediate-film or electron-camera type, preferably the latter, could be installed in an aeroplane for picking up the Boat Race, or in the Albert Hall for scanning the fight. The signals developed would modulate a low-power micro-wave radio transmitter, which would shoot the vision signals straight at the Crystal Palace, to be picked up there and relayed from the high-power ultra-short-wave transmitter to the whole of the London area. This would then be picked up by radio receivers in cinemas and projected by the intermediate-projection process on to the full-size screen.



# THERE IS SOMETHING LACKING IN TELEVISION

## WHAT HAPPENS TO THE D.C. COMPONENT?

By J. McPherson

WHEN we look at a television image reproduced on an ordinary screen—neon, cathode-ray, or any other—we have no idea of the relative amount of light illuminating the subject in the transmitting studio. The light appears to correspond to the average brilliancy of the image, which is the brightness of the screen before the image comes on. Anyone watching either knows this, or soon realises it, for it stays the same all the time, which is certainly never the case with any stage presentation or cinema film.

Watch carefully next time you go to the cinema and observe how the brilliance of the screen varies the whole time. Different parts of a building will be variously lighted while outdoor scenes will be much brighter; moonlight or semi-darkness is often shown.

### Missing!

All this adds enormously to the interest and entertainment, though the audience may be unaware of such an influence. It is just natural. Perhaps more strictly we should say that the interest would be seriously impaired if such natural light changes were missing.

And yet all this is missing from any television broadcast that has been seen so far, and if it were not for the tremendous interest which television possesses *per se* it is probable that before now lookers would have been asking what was wrong.

Of course, television cannot indefinitely rely on the interest of novelty or wonderment, or whatever you like to call it, and if it were not for the fact that something is probably going to be done about it soon television might earn the sad reputation of dullness.

Let us make absolutely sure we understand what I am getting at. We will perform an experiment. You are looking at a television programme in your televisor at home. I happen to be a guest in the transmitting studio, whence comes your programme, at the B.B.C. The artists are illuminated by the scanning spot and there is also a dim lamp in the room. I am near some switches by

the door and, in a moment of rash boldness—just for your sake!—I turn on two 100-watt lights. (We must assume that the light comes either from an accumulator supply or D.C. mains free from ripple.)

Disregarding the producer's ire and my subsequent unpopularity in the studio (which you can in any case see nothing of as I am "off stage"), what effect does this sudden illumination of the studio subject have on the image you are watching? First, there is a sort of surging, lasting a second or two, during which time the image is probably blotted out,

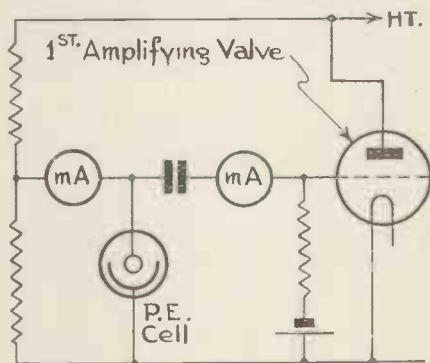

Diagram of photo-electric cell circuit with meters.

and then things settle down again to exactly the same average brightness. You in your home could not possibly know that the studio was now much more brightly lighted than before.

In order that you could reproduce the effect of a brighter studio I would have to ring you up and tell you what I had done, so that you could increase the bias on your Kerr cell, the current through the neon lamp, or the intensity of your cathode-ray beam!

We could do the experiment more artistically. Suppose a "dimmer," in other words a variable resistance, were in series with the studio lights, such as is used for effects on the stage and in film studios, and I brought on the lights gradually so that there was no surging due to the sudden transient effects of switching full on instantly. You would see *no change whatever* on your receiving screen during this operation.

Now this surely shows that there is something lacking from television—

that is, television as we have known it hitherto. There is, in fact, definite distortion due to the inability of the system to reproduce mean illumination intensity as well as the variations due to the scanning spot. At the receiving end we are obliged to compensate as best we can by adjusting the brilliancy of the screen to a value suitable for average conditions.

Of course, in view of this deficiency in the system there is no attempt made in the transmitting studio to vary the average lighting. Scenes depicting artists who are supposed to be out of doors and others sitting by firelight have been included in the same programme, but in the studio they were both done with exactly the same amount of light, because the producer knew it was no use trying any variation. Yet how much more realistic would it have been if, as on the stage or film, the proper contrast between the two conditions could have been represented! How limited is the scope of the television producer until this type of distortion has been conquered.

### The Reason

So far we have not considered the actual reason why this distortion occurs and it may be of interest to dwell briefly on the technicalities. Take a photo-electric cell which is being employed in a television transmitting studio for picking up the light reflected from the spot scanning the artists. The diagram shows a suitable circuit arrangement and, for experimental purposes, moving-coil microammeters are included, one in series with the cell, and another in series with the coupling condenser and grid leak of the first amplifying valve.

Assume everything is working properly but with the cell screened, for the moment, from any light, and observe the two meters. The former will register a very small current, known as the dark current of the cell, and the other will read zero. Now expose the cell to the scanning light and again look at the meters. The former shows a higher value of direct

(Continued on page 496.)

# THE ARC AS A LIGHT SOURCE

*The electric arc is the most intense source of artificial light known. Here are some simple facts relating to the use of the arc for projection purposes.*

THE idea of using the carbon arc as a source of light for television experiments must, of course, have occurred to many amateurs, who may be surprised that it has not a greater vogue for this purpose. The same remarks apply to the home cinema outfits, which invariably are fitted with lamps of the incandescent type. The sole reason for the use of the incandescent lamp is convenience; as a matter of fact the arc had considerable use in the older type of projection lantern and it superseded the lime light.

## How the Arc is Produced

The arc is produced between two carbon rods, and the light is due to

feed mechanism which will permit of the lamp burning for a very considerable time without attention. This, however, is impracticable in the case of small arc lamps for projection purposes and the carbons must be adjusted by hand as they become shorter.

The best arrangements for hand-feed employ a rack and pinion mechanism for adjusting the carbons, but the more simple method of having the carbons slide in insulated tubes is quite satisfactory when the light is not to be used for any great length of time. The sketch shows another type of simple hand-operated arc which is quite effective for short periods of use.

paratus by the voltage of supply. For normal television experiments a current of three to four amperes will be desirable, and to obtain this heater elements can be connected in parallel if it is found that one will not pass the requisite amount of current.

The temperature of the arc is in the neighbourhood of 3,500 degrees Centigrade and the amount of radiant heat is very considerable. For this reason it must not be placed too close to certain classes of apparatus, as for instance a Kerr cell; this, from the television point of view, is one of the greatest objections to its use, but provided that suitable precautions are taken in the matter of ventilation and distance the difficulty can be overcome.

It is desirable to use cored carbons which are obtainable from any electrical factors. The arc is struck by bringing the carbons together and then immediately separating them to a distance of about a quarter of an inch when the arc will continue to burn steadily until a further slight adjustment of the carbons becomes necessary. Both carbons must be made adjustable in order to maintain the arc in one position; in the case of direct-current supply the positive carbon burns away at about twice the rate of the negative, but when the arc is supplied from A.C. mains the rate at which each carbon is consumed is approximately the same. Thick carbons naturally last longer than thin ones, but with the former there is a shielding effect and it is usually found necessary to use a greater value of current. Carbons 5 mm. in diameter will be found very suitable for television purposes.

## Operating Voltages

The voltage required for the production and maintenance of the arc varies between forty and seventy volts, the usual figure being fifty volts. If the voltage is too low then the arc will not be maintained, and if it is too high a heavy and excessive current will pass. As a voltage of fifty or thereabouts is not ordinarily available, it is usual to employ resistances in order to limit the amount of current that can pass, or to use a transformer in the case of A.C. supplies. In

cases where the light is only to be used for short periods a resistance is the simpler de-

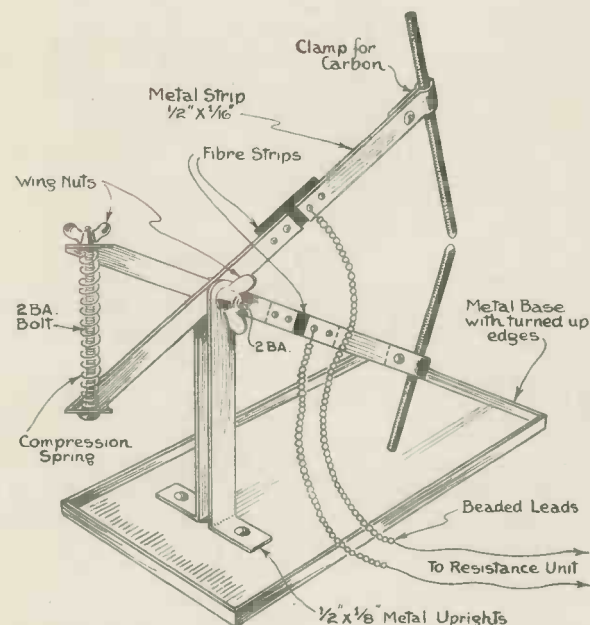

*This sketch shows a suggestion for a simple type of hand operated arc which can easily be constructed from odds and ends.*

the vapour from these being rendered incandescent. Obviously the result is that the carbons burn away and the gap between them increases, until finally it becomes too great for the arc flame to bridge and the light goes out. Commercial arc lamps for illumination purposes have automatic

vice, and it can be used either with direct- or alternating-current mains. Very suitable resistances for home use can be improvised out of the heater elements of bowl fires and radiators, the amount of current that any particular one will pass being arrived at by dividing the rated wattage of the ap-

## Remittances to the Mervyn Sound & Vision Co., Ltd.

Owing to a number of letters addressed to the Mervyn Sound and Vision Co., Ltd., having gone astray in the post we have been requested by the company to ask readers who have sent communications and have not received any acknowledgment to bring the matter to the notice of the postal authorities immediately.

THE TELEVISION ENGINEER

# THE DESIGN OF HIGH-DEFINITION AMPLIFIERS

By L. E. Q. Walker

This article is the first of a short series which will deal with the theoretical considerations in the design of high-definition television amplifiers. The introduction has been necessarily mathematical but the remainder of the series will be dealt with in a more simple manner.

## Part 1.—The response of amplifiers to signals of a transient nature.

IT is a fact very generally appreciated that to receive high quality broadcast programmes one must employ amplifiers capable of passing

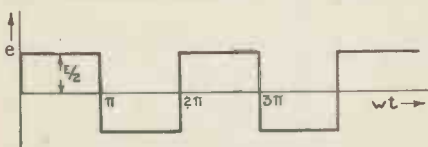

Fig. 1.—A.C. square wave which can be represented by a series of sine terms.

wide frequency bands. The statement is constantly made, for instance, that the human voice contains frequencies up to so many cycles per second, and it is taken for granted that, provided the amplifier used can deal faithfully with frequencies as high as this, perfect reproduction can be obtained. This statement is generally accepted simply because it is realised that the human voice never emits a pure acoustic note, and therefore, because undoubtedly notes of other frequencies are present, these may quite conceivably extend to the value quoted. When, however, we come to more specific cases, considerable doubt may exist as to the frequency content of various waveforms.

We know, for example, that a steady sinusoidal wave of current such as might be generated at an ideal



Fig. 2.—A periodic D.C. impulse which can be represented by the series for Fig. 1, plus a constant term.

power station, which has existed to all intents and purposes an infinitely long time and will exist an infinitely long time, can be represented by a very simple expression.

$$i = I \sin \omega t,$$

where  $i$  is the instantaneous value of the current at any time  $t$ ,  $I$  is the

maximum value of current, and  $\omega/2\pi$  is the frequency of the current. If we wish to amplify such a current we can do so by an amplifier which performs its function of amplification at only one frequency, and we need not worry about other frequencies.

Suppose, however, the wave is not sinusoidal, or suppose that it has not reached steady state conditions (i.e., it has not existed for an infinite time and terminates abruptly at some time in the near future). How are these conditions changed? Actually, these

$$f(\omega t) = b_0 + b_1 \cos \omega t + b_2 \cos 2\omega t + b_3 \cos 3\omega t + \dots + a_1 \sin \omega t + a_2 \sin 2\omega t + a_3 \sin 3\omega t + \dots \quad (1)$$

and that the series on the right-hand side, known as a Fourier Series, will be exactly equivalent to the function  $f(\omega t)$  for all values of  $\omega t$  between  $-\pi$  and  $+\pi$ . If  $f(\omega t)$  is periodic and of period  $T = \omega t$ , then the series represents the function for all values of  $\omega t$ .

We do not propose to enter here

Fig. 3a.—Showing how the wave of Fig. 1 is built up from its sine components.

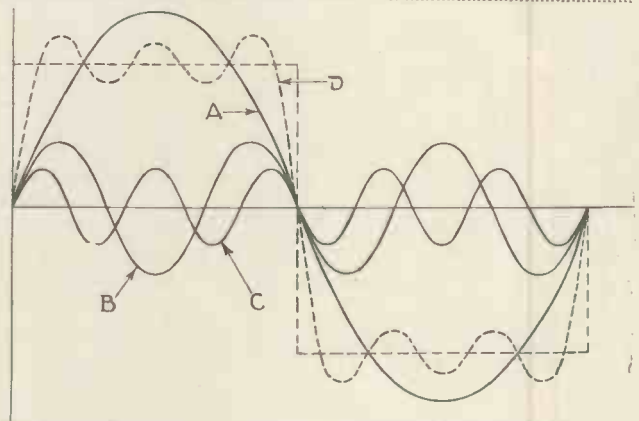

are conditions much more closely resembling practical conditions for the nature of the speech, music, or television signal we are receiving is continually varying; it never reaches true steady state conditions, and is

into the methods for determining the values of the coefficients  $b_0, b_1, \dots, a_1, a_2, \dots$  etc., as we are more concerned with the results of such analysis. More interesting informa-

Fig. 3b.—The result of adding together the first fifteen components of the series for the wave shown in Fig. 1.

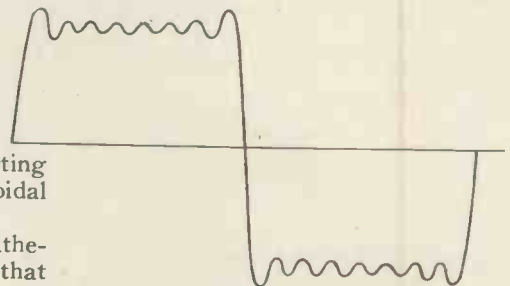

frequently of a waveform departing very greatly from the sinusoidal form.

In 1812, Fourier, a French mathematician, propounded a theorem that any function can be expressed in the form of a trigonometrical series. More specifically, he stated that a function of  $\omega t$ , say, could be expressed as the sum of a series of sine and

tion may be obtained by a slightly different statement of these results. We see, for instance, that a periodic impulse of e.m.f. of no matter how

THE TELEVISION ENGINEER

complicated a form, may be represented completely by a series of sinusoidal e.m.f. waves of different frequencies and amplitudes.

Moreover, the lowest sinusoidal or cosinusoidal frequencies which go to represent the wave are of frequency corresponding to the frequency of repetition of the impulse as a whole, and the frequencies of other terms are always integral multiples of this frequency.

Let us take the specific case of a square topped wave illustrated in Fig. 1. This wave can be represented

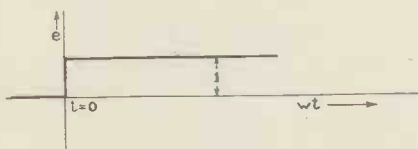

Fig. 4.—A unit amplitude D.C. wave taking place at time  $t = 0$ .

completely for all values of  $\omega t$  by the expression

$$\frac{2E}{\pi} \left[ \sin \omega t + \frac{1}{3} \sin 3\omega t + \frac{1}{5} \sin 5\omega t + \dots \right]$$

By adding a term  $\frac{E}{2}$  to this series we obtain a wave as shown in Fig. 2.



Fig. 5.—A unit amplitude D.C. wave taking place at time  $t = T$ .

It so happens that for this particular type of wave only sine terms are present in the series, and, moreover, only sine terms of odd multiples of the fundamental frequency. That such a wave can be built up in the manner described may easily be seen from Fig. 3. In Fig. 3a, A represents the term

$$\frac{2E}{\pi} \sin \omega t, \text{ B the term } \frac{2E}{3\pi} \sin 3\omega t$$

$$\text{and C the term } \frac{2E}{5\pi} \sin 5\omega t.$$

The result of adding these three terms together is shown at D, and this is seen to approximate to the square waveform of Fig. 1. In Fig. 3b, the result of adding the first fif-

teen terms is shown, and it will be seen that the resultant wave is very nearly that of Fig. 1.

It is instructing and interesting to derive the Fourier Series for other types of simple waveforms, and for those who wish to investigate the matter further many excellent works of reference are available.

Sufficient has been said here, however, to show that any type of steady state wave may be so represented, and that if we wish to amplify such a wave we must deal equally well with all the terms involved. This entails the distortionless amplification of frequencies from the fundamental frequency of the wave up to infinity. In practice, it is not, of course, possible to proceed beyond a definite value of frequency, but the higher this value can be made the more closely shall we arrive at perfect amplification.

It is unfortunate that, in dealing with television signals, we are dealing, not with waves which have attained a steady state, but with impulses which are continually altering in form, i.e., which are entirely transient. In order to develop any theory as to the performance of amplifiers under such conditions, we must first of all formulate some method for determining the frequency-content of such transient impulses in much the same way as was done in the case of steady state waves.

Obviously, analysis by Fourier Series will not hold, for such series are essentially periodic in nature, and unless the wave itself is periodic, will not hold for any values of the argument other than between  $-\pi$  and  $\pi$ .

An extension of the Fourier Series known as the Fourier Integral, provides us with an expression for any function of, say,  $\omega t$  between  $\omega t = -\infty$  and  $\omega t = +\infty$ , i.e., for all values of  $\omega t$ . The development of the Fourier Integral from the Fourier Series can be found in any text book on the subject. The reader is recommended to Byerley "Fourier Series and Spherical Harmonics" for a complete and easily followed exposition of the subject. The Fourier Integral has many forms. That given in the above-named work is as follows:

$$f(x) = \frac{1}{\pi} \int_0^{\infty} \cos \alpha (\lambda - x) d\alpha \int_{-\infty}^{+\infty} f(\lambda) d\lambda.$$

Let us write this in a form more suitable for application to impulses which are a function of time.

$$f(t) = \frac{1}{\pi} \int_0^{\infty} \cos \omega (\lambda - t) d\omega \int_{-\infty}^{\infty} f(t) dt. \quad 2$$

Now the final result of  $\int_{-\infty}^{\infty} f(t) dt$  will be the same as  $\int_{-\infty}^{\infty} f(\lambda) d\lambda$  and we may therefore write

$$f(t) = \frac{1}{\pi} \int_0^{\infty} \cos \omega (\lambda - t) d\omega \int_{-\infty}^{\infty} f(\lambda) d\lambda$$

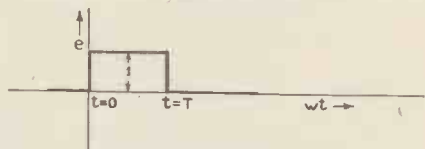

Fig. 6.—A unit impulse lasting from  $t = 0$  to  $t = T$ .

and expanding  $\cos \omega (\lambda - t)$  we have

$$f(t) = \frac{1}{\pi} \int_0^{\infty} (\cos \omega \lambda \cos \omega t + \sin \omega \lambda \sin \omega t) d\omega \int_{-\infty}^{\infty} f(\lambda) d\lambda$$

$$= \frac{1}{\pi} \int_0^{\infty} \cos \omega t d\omega \int_{-\infty}^{\infty} f(\lambda) \cos \omega \lambda d\lambda$$

$$+ \frac{1}{\pi} \int_0^{\infty} \sin \omega t d\omega \int_{-\infty}^{\infty} f(\lambda) \sin \omega \lambda d\lambda \dots 3$$

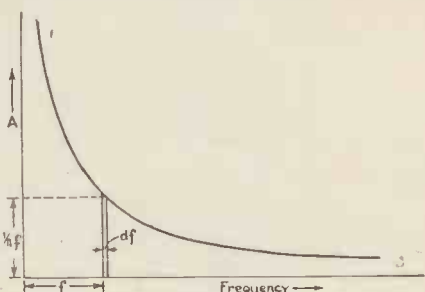

Fig. 7.—Showing how the frequency components of Fig. 4 are distributed in the frequency spectrum.

which is in a form suitable for our purpose.

Let us first investigate the analysis of what Oliver Heaviside called a "unit function." This is an impulse represented in Fig. 4, for which

$$f(t) = 0 \text{ for } t < 0$$

$$f(t) = 1 \text{ for } t > 0$$

i.e., a suddenly applied D.C. impulse of unit amplitude, applied at  $t = 0$ . Here

$$\int_{-\infty}^{\infty} f(\lambda) \cos \omega \lambda d\lambda = \int_0^{\infty} \cos \omega t dt$$

THE TELEVISION ENGINEER

$$= \frac{1}{\omega} \left[ \sin \omega t \right]_0^{\infty} = 0$$

since  $\sin \infty$  and  $\sin 0$  are zero. Also

$$\int_{-\infty}^{\infty} f(\lambda) \sin \omega \lambda \, d\lambda = \int_0^{\infty} \sin \omega t \, dt$$

$$= \frac{1}{\omega} \left[ -\cos \omega t \right]_0^{\infty} = \frac{1}{\omega}$$

since  $-\cos \infty = 0$  and  $-\cos 0 = -1$ . Hence, the complete expression for  $f(t)$  will be, in this case, from the

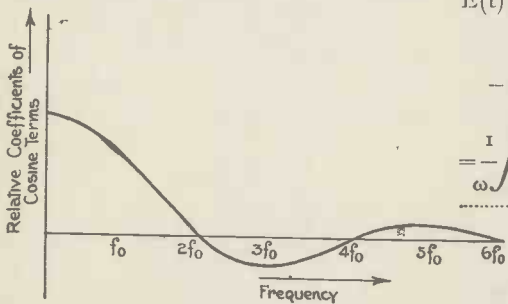

and for any other value of  $t$  it will be non-existent, for the unit function multiplier will be non-existent.

Let us then examine the expression for a single A.C. pulse of frequency (if it were regarded as periodic)  $\frac{\omega_0}{2\pi}$ . We have, according to the rule first enunciated, the impulse represented by the expression.

$$E(t) = \frac{1}{\pi} \int_0^{\infty} \frac{1}{\omega} \sin \omega_0 t \left[ \sin \omega t - \sin \omega (t-T) \right] d\omega$$

which may be expanded into

$$E(t) = \frac{1}{2\pi} \int_0^{\infty} \frac{1}{\omega} \cos \left[ (\omega_0 - \omega) t \right] d\omega$$

$$- \frac{1}{2\pi} \int_0^{\infty} \frac{1}{\omega} \cos \left[ (\omega_0 + \omega) t \right] d\omega$$

$$= \frac{1}{\omega} \int_0^{\infty} \frac{1}{\omega} \cos \left[ (\omega_0 - \omega) (t-T) + \omega_0 T \right] d\omega$$

Fig. 8.—Showing how the frequency components of the wave shown in Fig. 6 are distributed in the frequency spectrum.

equation (3).

$$f(t) = \frac{1}{\pi} \int_0^{\infty} \frac{1}{\omega} \sin \omega t \, d\omega + \frac{1}{2} \dots 4$$

the  $\frac{1}{2}$  being added as it is the average value of the function  $f(t)$  between  $-\infty$  and  $+\infty$ .

If the impulse takes place at  $t = T$  instead of  $t = 0$ , this expression is altered to

$$f(t-T) = \frac{1}{2} + \frac{1}{\pi} \int_0^{\infty} \frac{1}{\omega} \sin \omega (t-T) \, d\omega$$

and if the impulse lasts only from  $t=0$  to  $t=T$ , Fig. 6, we have clearly

$$f(t) = \frac{1}{\pi} \int_0^{\infty} \frac{1}{\omega} \sin \omega t - \frac{1}{\pi} \int_0^{\infty} \frac{1}{\omega} \sin \omega (t-T) \, d\omega \dots 5$$

for the wave can be written  $f(t) - f(t-T) =$

$$\frac{1}{\pi} \int_0^{\infty} \frac{1}{\omega} (\sin \omega t - \sin \omega (t-T)) \, d\omega$$

and this is equal to the above expression.

From this last we can obtain an expression for any type of impulse applied at  $t = 0$  and stopped at  $t = T$ , for clearly such an impulse will be represented by the Fourier Series for the impulse regarded as periodic multiplied by the expression for the unit function lasting from  $t = 0$  to  $t = T$ , for between  $t < 0$  and  $t > T$  the expression will represent the impulse,

$$+ \frac{1}{2\pi} \int_0^{\infty} \frac{1}{\omega} \cos \left[ (\omega_0 + \omega) (t-T) + \omega_0 T \right] d\omega \dots 6$$

Let us see what these somewhat complicated expressions mean physically. Taking the case, first of all, of the suddenly applied D.C. voltage, expressed by equation (4), we see that the integration involved is with respect to  $\omega$ . The significance of this is that the expression is built up by the summation of an infinite number of infinitesimal voltages of all frequencies. Put in a form analogous to the series of equation (1) we have the series not consisting of discrete frequency terms but of sine terms of every imaginable frequency from zero to infinity, and of amplitude proportional to the reciprocal of the frequency. Thus, in any network to which  $f(t)$  is applied, the net current due to  $f(t)$  will be obtained by summing up infinitesimal currents of all frequencies by integration.

In order to transmit this impulse perfectly, we should obviously need to transmit every frequency from zero to infinity. If we plot the amplitudes of the frequency components against frequency we obtain a curve as shown in Fig. 7, each frequency component of, say, frequency  $f$ , being of infinitesimal width and of amplitude proportional to  $\frac{1}{f}$ . The locus of the amplitudes lies on a hyperbola.

Turning now to the case of the D.C. pulse given by equation (5), if we let  $T = \frac{1}{2f_0}$ , an expression for the coefficient of each cosine component is

$$\frac{1}{\omega} \sin \frac{\pi f}{2f_0} = \frac{1}{\pi \omega} \sin \frac{\pi \omega}{2\omega_0}$$

The coefficients are therefore distributed in the frequency spectrum according to such a curve as shown in Fig. 8. The transmission of such a pulse is also a matter of transmitting a continuous band of frequencies. An important point is that if we consider  $f_0$  to be the fundamental frequency of the pulse if it were periodic, as in Fig. 1, it is in the neighbourhood of  $f_2, 3f_0, 5f_0, \dots$  that the larger components are found. A circuit whose steady state parameters show it will transmit these frequencies will be best for the transmission of the single pulse.

Finally, in the case of the single A.C. pulse, shown in Fig. 9, and represented by equation (6), we have two sets of side bands present, the

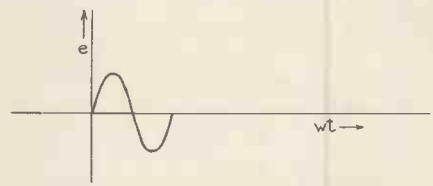

Fig. 9.—A suddenly applied A.C. pulse.

first represented by the first two integrals of (6) corresponding to the initiation of the pulse, and the second represented by the third and fourth integral corresponding to the sudden decay of the pulse. The coefficients of the components of each side band follow a hyperbolic curve. The transmission of such a pulse therefore entails a continuous band of frequencies from zero to infinity and with maximum energy concentration occurring at a frequency  $\frac{\omega_0}{2\pi}$ .

(To be continued.)

# B.B.C. TELEVISION RECEPTION IN SPANISH MOROCCO

Long-distance  
Reception

:: ::

The Mihaly-  
Traub System



Correspondence is invited. The Editor does not necessarily agree with views expressed by readers which are published on this page.

The Double  
Scanning Stan-  
dard

## Long-distance Television Reception

SIR,  
I note your article in TELEVISION AND SHORT-WAVE WORLD of July, 1935, on receiving television from the B.B.C. in Iceland.

It may be interesting for you to know that we receive the television transmissions from the B.B.C. at a still greater distance. We receive very well in Ceuta, Tetouan, Melilla, in Spanish Morocco.

The sets used are Mervyn disc scanners; very good results are obtained with 5-valve and 6-valve sets of American makes, but we have obtained wonderful results with the Mervyn Faraday 6-valve set, a second set being used for the sound.

The country is mountainous, and usually day receptions are not to be expected; on medium waves nevertheless we have received the afternoon transmission very well with the "Faraday"; at night with almost any good set.

We have had very little trouble with interference and fading, the pictures are of good quality; a number of sets are receiving in this country with equal success.

We hope that the B.B.C. will continue to give us 30-line programmes as they keep us in direct touch with England; a little of home sent to us by air.

T. SABLON  
(Ceuta, Spanish Morocco).

\* \* \* \*

## The Mihaly-Traub System

SIR,  
I was particularly interested in your first details of the Mihaly-Traub system of high-definition television, inasmuch as I had already devised this scheme of using multiple rotating mirrors in conjunction with only an arc of stationary mirrors.

Unfortunately I am not in the service radius of any high-definition systems and have therefore adapted my unit for the thirty-line transmissions from the B.B.C.

To any of your readers who are interested, I would point out that, to receive the thirty-line system, the arc of mirrors is built on a vertical plane with the spindle of the rotor set to lay horizontally. Instead of the Kerr cell source of light, I use the modulated light from a flat-plate neon lamp which is reduced, *en bloc*, through a square mask and lens to

tin ring segment is moved to cover the unwanted portions of the arc, thereby lifting or lowering the picture position on the screen.

The sketch shows the rear view of the layout of a unit for the reception of 30-line pictures, having only eleven mirrors to adjust. Mirrors A to E on the drum are inclined at suitable angles to form five long "blocks" on

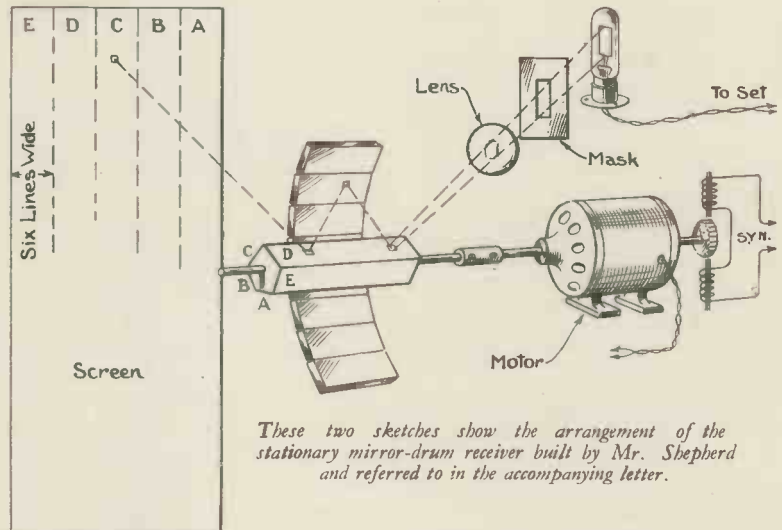

These two sketches show the arrangement of the stationary mirror-drum receiver built by Mr. Shepberd and referred to in the accompanying letter.

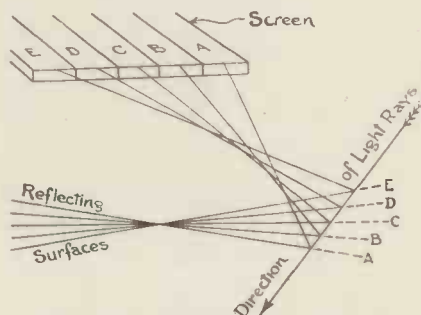

the required size of picture element and focused on the rotor mirrors. This uses *all* the light available instead of only a minute portion of it, as is the case when a neon lamp is shone through a disc.

As an aid to "framing" the picture, the arc of mirrors is extended at both ends, and a dull-black painted

the screen, A to E. Each "block" is made up of six long lines by adjusting the six fixed mirrors after the manner of an ordinary mirror-drum. The whole of the motor casing must be able to rotate for the purpose of "framing" the picture on the screen.

A really large-sized picture can be projected if a "Ti" lamp is used instead of the flat-plate neon, pictures 3 ins. by 6 $\frac{3}{4}$  ins. then being possible.

For high-definition reception the rotating mirrors could be tilted, each at a different angle, dividing the picture into blocks, say, one-inch deep, each mirror would then scan one block and move on, the successive mirrors forming a block under the one just completed until the full picture was formed when the first mirror face would be ready to start at the

beginning again. The rotor would revolve at picture speed. Units of these types are quite easy to construct by anyone with a tinkering nature and a little patience.

GEO. SHEPHERD (Wrexham).

\* \* \* \*

SIR,

In the description of the Mihaly-Traub system in your July issue of TELEVISION AND SHORT-WAVE WORLD the author indulges in a bit of mud slinging by writing "The system should, however, not be confused with the simple multiplying systems of the conventional kind, none of which gives satisfactory results. The inherent feature which makes the Mihaly-Traub system a technically

successful one is the fact that the light from the stationary mirrors is reflected back on to the top of the rotating polygon (apparently a mirror-drum) before being thrown on the screen." The underlined remark seems to ask for a reply. The fact that reflecting the light back on to a mirror-drum doubled the scanning angle is very well known: on page 356 of *Television To-day*, Part 8, in an article by N. Levin, the following passage is written, "Instead of reducing the number of mirrors and increasing the speed one can reflect the light back on to the mirrors by means of a mirror or right-angled prism. After the first reflection the beams are diverging at an angle of  $3^\circ$ . When reflected a second time this angle is

increased by another  $3^\circ$ , twice the angle between the mirrors on the wheel. Thus the same effect is achieved. This is Captain Wilson's method." In my Patent Specification 428,349 multipliers are shown (not the same as the Mihaly-Traub method) in which the beam of light is reflected back from the strip generating surfaces on to the mirror-drum. In your May issue a multiplier is described under the heading "240-line Pictures with a 30-line Mirror-drum," which makes use of blocks of glass and prisms for strip generation and strip location. The use of blocks of glass and prisms for generating and locating strips is described in my Specification No. 428,459.

H. RICHARDSON (Buxton).

## OPINIONS ON THE DOUBLE SCANNING STANDARD

### A Standard Type Necessary

SIR,

The prophecy of the Editor in Chief in last month's issue, "the winter of 1935-36 should make history," will, I hope, be fulfilled.

Whether or not the hope becomes fact appears to rest solely with the Television Advisory Committee who, up to the moment, appear unable to make up their minds as to what is necessary and what will produce the best service for both the owners of the system, and the public.

The question of the possible demand for receivers for 240 lines 25 frames per second, or 405 lines 25 frames per second, is one that is likely to excite considerable controversy. The two systems make the promised service semi-experimental. Consequently, there is bound to be some hesitation on the part of manufacturers to standardise sets with a view to big production; also obscure set royalty costs are likely to be encountered due to increased valve stages with the possibility of a double royalty on instruments capable of receiving both types of transmissions.

It would, in my opinion, have been far more satisfactory to have made a definite decision for a standard type of transmission and to arrange for apparatus from the two selected companies to be installed to conform to this standard. As the matter stands at present, it would appear to be necessary for manufacturers to decide whether to produce a set for 240- or 405-line reception.

My company have available a cathode-ray scanning unit together with ultra-short-wave sound and vision re-

ceivers and until these obscure requirements are known it is suitable, at the moment, only for enthusiasts.

With certain adjustments, the Mervyn 240-405 receiving unit is capable of receiving both 240 and 405 lines transmission. Naturally, the initial cost of production is higher on an instrument capable of receiving both transmissions, and the cost of upkeep is greater in the higher-powered more complicated set.

Again, interlaced scanning (one of the systems chosen) can provide some curious and disagreeable effects. For instance a trace of 50 cycle A.C. mains hum on the screen can be very objectionable with interlaced scanning, but the same amount with linear scanning can be tolerated. Likewise natural blinking of the eyes will also produce some curious stroboscopic effects.

The radio receiver for 450 lines will need to include more valve stages to produce the quality pictures possible to this fine image analysis. Unless the full definition can be achieved both at the transmitter and receiver, there is no point in scanning at 405 lines.

At the moment it would appear that manufacturers should concentrate on the production of 240-line receivers for the home, and, if this is so, prices should be within the reach of the majority, and the 405-line transmissions would then be left for the minority to enjoy.

Mechanical receivers will, undoubtedly, play a big part and the type being prepared by my company readily lends itself to mass production. This receiver will provide a

bright image with crisp definition, and will be low in first cost. It will be for 240-line definition only. Obviously mass production will be delayed until the situation is somewhat clarified.

Finally, I hope that the Advisory Committee will give full details of the types of transmission, and above all, a definite date for their commencement.

W. J. NOBBS (Managing Director, Mervyn Sound & Vision Co., Ltd.).

\* \* \* \*

### Increasing Receiver Costs

SIR,

In my opinion the recent ruling of the Television Advisory Committee that two types of scanning be employed for the forthcoming high-definition service is ill-advised for the following reasons:—

Under this ruling it will be necessary for manufacturers of television sets to employ both types of time-bases or one special time-base with switching arrangements. This would mean that the general public would have to pay more for their television receivers than they would have to do if one basic system were employed. The man in the street is averse to putting pen on paper to state his views. This is the only method the Committee can use to get a cross-section of opinion as to the advantages of one type against the other. In these circumstances I suggest the easiest and more business-like way of getting out of the difficulty is for the Committee with a number of the general public, to witness a public demonstration of two receivers, each

constructed to receive its respective system of transmission. In this way it would be possible to arrive at a standardised system of scanning.

Further, the two systems with standardised scanning could still be installed at Alexandra Palace, and this would lead to healthy competition between the two systems, all to the benefit of the general public.

Speaking as a manufacturer solely, I would welcome a standard system of scanning, such as could be adopted by foreign countries, thereby enabling British sets to be exported and used without any alteration.

HOWARD FLYNN,  
Managing Director, Edison Bell  
(1933), Ltd.

\* \* \*

**Problematical Improvement**

SIR,

I regard the adoption of the 405-line system by E.M.I. group as unfortunate mainly from the point of view of the stability of the new television industry.

On technical grounds one cannot be dogmatic. A concern of standing would not propose a system, nor would the Advisory Committee sanction its trial, unless it had something to commend it, although my own view is that the improvement is problematical. Even the increase from 180 to 240 lines does not result in a marked improvement in definition.

The German Post Office standardised some months ago on 180 lines and 25 pictures per second with the result that the industry knows where it stands. The indefinite policy of our own Government prevents any feeling of confidence in the minds of the manufacturers and, what is more important, adversely prejudices public opinion and defers still longer the eagerly awaited boom in television.

J. A. REYNER (Boreham Wood).

\* \* \*

**Greater Chaos**

SIR,

It has been shown, both on paper and in practice, that 180 lines represents a highly satisfactory definition, sufficient for a public service, and that 240 lines gives a picture of such excellence as to leave no room for criticism whatsoever. To go beyond this figure would be to go beyond the capabilities of the resolution of the eye. The limit of resolution can be regarded as one minute of an arc even under the worst possible conditions.

There is a second limitation, how-

ever, and that is the angle subtended by the whole picture to the eye. If the angle is too great, then the eye sees a bewildering mass of detail which cannot be grasped at a single glance. An example of this is to be had when sitting very close to the screen in a big cinema.

The second factor which must determine a standard of transmission is that of picture repetition frequency. Recent developments in television have produced such bright images on both cathode-ray and optical receivers that flicker becomes apparent, and sometimes annoying, even using 25 pictures per second. The obvious way to decrease flicker is to increase the picture repetition frequency to 50 pictures per second.

We may, therefore, sum up that the ideal standard of television, disregarding for the moment the technical difficulties, would be 240 lines, 50 pictures per second.

The technical problems associated with high-definition television are two-fold: (a) those on the television side, (b) those on the electrical and radio side.

From the laboratory point of view, working over a short wire, the definition of television images can to-day attain figures even in excess of the ideal standard of 240 lines.

The problem has, however, a very different aspect when we examine television from a public service point of view with radio or long distance cable transmissions. The truth is that television has to-day outstripped the capabilities of high-frequency radio terminal equipment.

Assuming equal definition both

in the horizontal and vertical direction and a 3 x 4 picture ratio, we find that we cannot accommodate our ideal standard of 240 lines, 50 pictures per second, as this would entail a maximum frequency of two megacycles. A compromise must therefore be made either in picture frequency or in definition, resulting in a choice of either 180 lines 50 pictures per second, or 240 lines 25 pictures per second. The choice between these two standards is largely a matter of personal opinion. I myself would go for 180 lines 50 pictures per second rather than a slightly increased definition with a certain amount of flicker.

In defence of the Committee, it must of course be pointed out that they found themselves in an extraordinarily difficult position, but it was the Committee's duty to create order where there was chaos; they have succeeded only in involving the industry in still greater chaos.

ERNEST H. TRAUB  
Technical Director, The International Television Corporation, Ltd.

\* \* \*

**Thickness of Lightning Flash**

SIR,

Can any reader furnish information as to the thickness of a flash of lightning? A very interesting series of articles on the subject of lightning photography was published in a recent *Strand Magazine*, but no information as to the possible size, diameter, or such other measure as might be used, of lightning was given. Has any research on this question ever been carried out?

R. E. JAY (Wembley).

**When to listen for Short-wave Stations during August**

By 2BWP, C. J. Greenaway.

B.S.T.	3.5 mc.	7 mc.	14 mc.
0100			
0500	W1, 2, 3		W1, 3
0600	W3	HC; TI	
0700		HP; K5; ZL	
0800		VK; ZL	
1800			W1, 2, 3
1900			VPU; VQ4; W1, 3, 8; ZD
2000		FM8; YI	SU; W1, 3, 8
2100		FM8; SU; YI	W1, 2, 3, 8
2200		FM4, 8; SU	CT3; CX; VE1, 2; W1, 2, 3, 8
2300		FM8; LU; SU; W3	CX; HP; TI; VE1, 2; W1, 2, 3, 4, 8
2400		W4	HP; W1, 2, 3, 9



# THE DE LUXE CATHODE-RAY TELEVISION VIEWER OPERATING THE SCANNING CIRCUIT

**A**LTHOUGH, as stated previously, the low-definition scanning circuit will have to be adapted soon to the reception of 240-line television, the constructor who has made it up will not have wasted his time, especially if it is his first essay in the technique of cathode-ray tube reception.

Familiarity with the various adjustments and the effects produced by varying them is essential if really satisfactory results are to be obtained from the higher speed scan, particularly as the degree of control required for the 240-line screen is much finer and less tolerance is allowed. It is only by gaining experience on the 30-line transmissions that the beginner in television can tackle with confidence the handling of the higher speeds of scan and more critical adjustments for 240 lines.

With this in mind, therefore, it is proposed to review the circuit and construction of the low-definition scanner and show in detail the operation of the various controls.

The circuit diagram, Fig. 1, reproduced from last month's issue, shows the complete scanning circuit and supply for the tube. Commencing with the left-hand side, the mains transformer is designed to feed both

the tube and the scanning circuit through the rectifier M.U.2. The H.T. supply is taken through the delay switch D to the tube potential network commencing R20 and finishing R25. Note that the second accelerator of the tube (marked 2 in the sketch) is connected to the end of

chain. Since the deflector plates are connected to resistances R15 and R16 right across the H.T. supply, the voltage applied to them can be slightly higher than that of the accelerator which prevents defocusing action and enables a wider degree of shift to be obtained.

Returning to the potentiometer system, the resistance R22 feeds the first accelerator (marked "1" in the diagram). The values chosen were suited to the Ediswan "AH" tube, but if it is not found possible to focus satisfactorily the potential of the first accelerator may be increased or decreased by altering the values of the resistances on either side of it. R21 for example may be reduced to  $\frac{1}{2}$  meg. and R23 increased to 1 meg., which will have the effect of raising the voltage obtainable from the potentiometer tap without affecting the current taken by the potentiometer chain. This current, by the way, is extremely small, since the total resistance of the chain is

$$.05 + 1.0 + 0.5 + 0.5 + .01 + 0.5 \text{ meg.} \\ = 2.56.$$

The current is therefore  $2,000/2.56$  microamps. or 0.8 mA approximately.

The cathode of the tube is fed from the Westinghouse "LT4" rectifier, which is connected through the L.F.

### EDITORIAL NOTE

Our readers will remember that at the commencement of the design of the "De Luxe Viewer" it was stated that the receiver section would need replacement by one of the short-wave type as soon as the high-definition service became established.

We have every reason to think that this time is coming sooner than was anticipated when the design was commenced.

In consequence we have decided that in our readers interests it is unnecessary to proceed with the description of a receiver for low-definition television, as this would only involve unwarranted expense and be rapidly displaced by one of the later type.

This article, the last but one of the series on the scanning circuit, will therefore be followed at a later date by a constructional article on a short-wave television receiver which will fit the "de Luxe" cabinet. The scanning circuit alterations will be described in due course.

R20 and 21. This means that the actual accelerator potential is less than H.T. maximum by the potential drop in R20 due to the feed current of the tube and potential divider

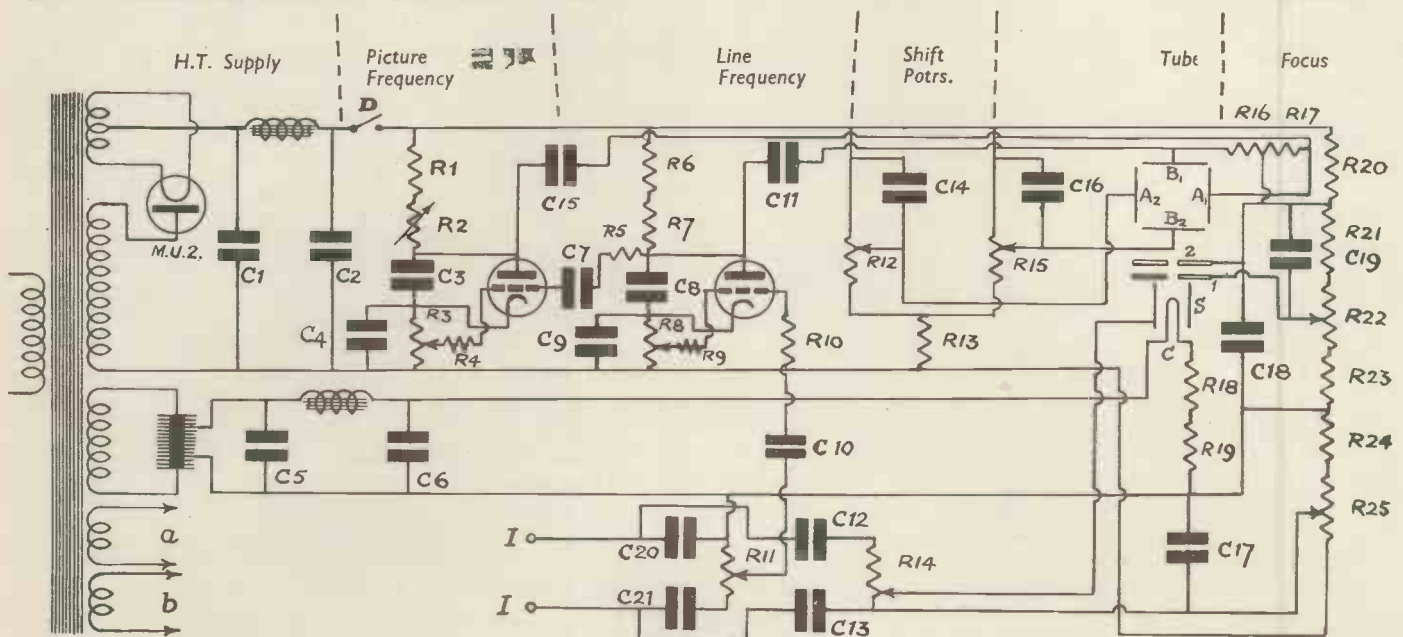

Fig. 1.—Diagram of the tube supply and scanning circuits of the De Luxe Cathode-ray Viewer showing the different sections.

choke and smoothing circuits C5 and C6. In series with the cathode are the two resistances R18 and R19. The normal cathode current is 1.0 amp. and it is preferable to use an ammeter to ensure that this current is passing. If the meter is only connected temporarily, however, its removal will mean that the resistance in series with the cathode will be decreased by

cathode is connected on the "wrong side."

To steady the voltage across it the condenser C4 is connected. The anode of the relay is taken to the deflector plate A1 through the condenser C15, which prevents a permanent D.C. potential being applied to the plates from the charging circuit. At the same time the plates

may present some difficulty, and in some cases the connection of an earth lead to the cathode-ray tube may introduce interference instead of removing it! The connection of an earth lead to the second accelerator terminal should be tried and the effect noted. If the line scan is perfectly free from interference without it there is no need to make the connection.

Having wired up the scanning circuit and checked the connections carefully, the whole may be tried out. Do not insert the tube at the start, but connect up the H.T. and the 4 V supply to the heater of the delay switch and the relay heaters. Then switch on the H.T. unit, taking care that the wires are clear of metal parts and that nothing is touching the H.T. leads:

The heaters will warm up instantly, and the striking of the delay switch after about 30 secs. will be shown by an increased glow in the rectifier. The relays should, of course, glow at the same time, but if they do not, cautiously turn the knobs controlling the bias. To identify them more easily they have been marked in the sketch of Fig. 2. If the relays still do not glow suspect one or other of the following:

Open circuit in R1 or R2.

Short circuit in C3.

No cathode connection to C3.

There is, of course, the possibility of no H.T. or defective relay, but if

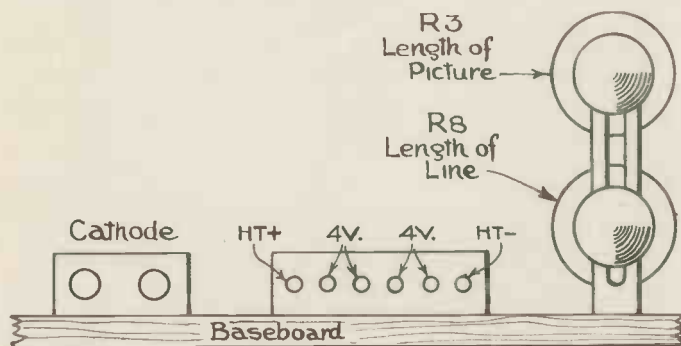

Fig. 2.—Back of baseboard showing terminal blocks and controls for length.

the resistance of the meter and the adjustment will be upset. There are two ways of avoiding this: the resistance of the meter can be measured and then a wound resistance of corresponding value can be connected in its place, or the temperature of the cathode can be noted with the correct current passing and the variable baseboard resistance increased slightly after the removal of the meter. On reconnecting the resistance can then be cautiously decreased until the same temperature, as near as can be judged by the eye, is attained.

The first method is by far the most satisfactory and accurate and was used in the testing of the apparatus. As a guide, the resistance of the Weston model 517 meter is  $\frac{1}{2}$  ohm approximately.

### Scanning Circuit

Since both vertical and horizontal scanning circuits are identical it is only necessary to consider one in detail. The charging condenser for the horizontal scan is the one marked C3 in the diagram, and this is connected to the H.T. through the resistances R1 and R2, R1 being fixed to give a finer variation in speed by alteration of R2. The bias for the relay across the condenser is obtained from the resistance R3 which is in series with the other two. It does not interfere with the speed of discharge, however, since the relay

must not be isolated altogether in order to avoid the accumulation of stray electrons from the beam, so they are connected to the accelerator through the high resistances R16 and R17. The opposite plate of each pair is taken to the shift potentiometers R12 and R15. These should only be necessary to adjust the position of the image slightly, and too much "shift" may produce distortion. If for some reason one of the plates becomes disconnected, the potential applied to the other will force the beam completely off the screen and this should be suspected in cases where the screen suddenly becomes blank!

### Synchronising

The line scanning circuit is connected to the receiver through the resistance R10 and C10 and the potentiometer R11. This applies a synchronising "kick" to the grid of the relay at the end of every line.

It is not necessary to synchronise the picture-scanning circuit as this can be kept in step by locking it to the line scan through C7 and R5. The television signal is fed to the shield S of the tube through a similar potentiometer R14, which is isolated from the rest of the receiver by the condensers C12 and C13.

These ensure that the H.T. supply is not accidentally connected to the receiver. With a common H.T. supply for the tube and scanning circuit the earthing of the whole receiver

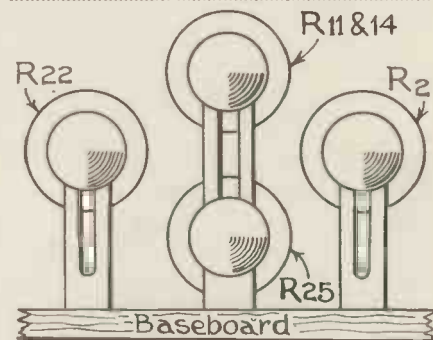

Fig. 3.—Front controls marked to correspond with diagram Fig. 1. R11 and R12 are special concentric potentiometers.

both are affected the possibility is that the H.T. is not reaching the condensers. If the relays are not striking and the H.T. is charging the condensers they will remain charged on switching off the unit and will give a spark.

(The concluding article on the 30-line viewer which will deal with the tube connections and obtaining the correct screen will appear next month—Ed.)

# WHEN DID TELEVISION BEGIN ?

*It is difficult to decide when the idea of "seeing at a distance" by electricity first originated, but it is certain that the schemes outlined in this article are among the first which were put forward. Needless to say they were impracticable, but they show some ingenious lines of thought.*

TELEVISION is generally regarded as a very modern invention, though as a matter of fact schemes for seeing by electricity were devised over fifty years ago and some of the fundamental principles which are in use to-day are fifty years old. If it can be assumed that television

Fig. 1 and it is an idea that has intrigued many inventors since, in fact, apparatus on these lines has been built and crude images obtained. Carey proposed to project an image by means of a lens upon a disc P. This disc is drilled with numerous small holes, each of which is filled with

Another suggestion made by Carey was to employ a form of spiral scanning, shown by Fig. 2. Clockwork revolves a shaft K, forcing the arm L and wheel M to describe a circle. The screen N, being fastened firmly to the shaft K, turns as wheel M revolves on its axis, thus turning the sliding piece P, and selenium pointed disc. The combination is arranged so as to cause the disc to describe a spiral line upon the glass TT, thus passing over every portion of the picture projected upon it. The selenium disc will allow the electrical current to flow through it in proportion to the intensity of the lights and shades of the picture projected upon the glass plate TT.

At the receiving end there is a similar device, but in place of the glass screen is a sheet of chemically-prepared paper which would be affected by the electrolytic action of the current from the transmitter. There is no record of any results obtained from this apparatus and it may be concluded that in practice the scheme was a failure.

A similar scheme to the first one of Carey was proposed in this country about the same time by Professors Ayrton and Perry, who pointed out that the discovery of the response of selenium to variations in light carried

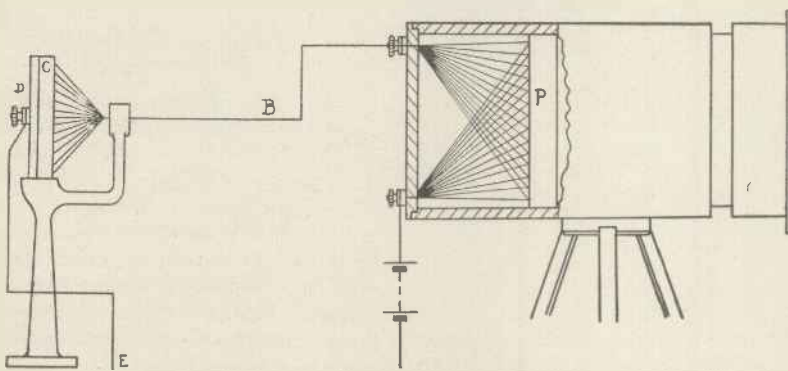

Fig. 1.—The suggestion of Carey, an American inventor, to use a bank of selenium cells.

has a definite relation to still-picture telegraphy, the difference being the speeding up process to a point where the persistence of vision effect is made use of, then we can go back eighty years, for an attempt to use the electric telegraph to transmit a rudimentary "picture" was made by Bachelier in 1854, a few years after the introduction of the morse system of signalling. His method, which was applicable to a simple pen-and-ink sketch, or to script in facsimile, consisted in drawing the picture in conductive "ink" on an insulating material. The prepared sketch was then rolled around a cylinder and explored by a stylus, which sent a signal to line at each contact.

The received signals were recorded on a paper impregnated with ferrocyanide solution. The system, as a matter of fact, clearly foreshadowed the present method of "still-picture" transmission and it employed the principle of scanning though it was devised twenty years before the advent of the light-sensitive cell.

In 1880 a man named Carey, of Boston, Mass., suggested a scheme for using a multiplicity of selenium cells. His suggestion is shown by

selenium, the selenium forming part of an electrical circuit.

The operation of the device was, of course, to depend upon the changes in electrical conductivity produced by the action of light on the selenium. The wires from the disc P were insulated and wound into a cable B. These

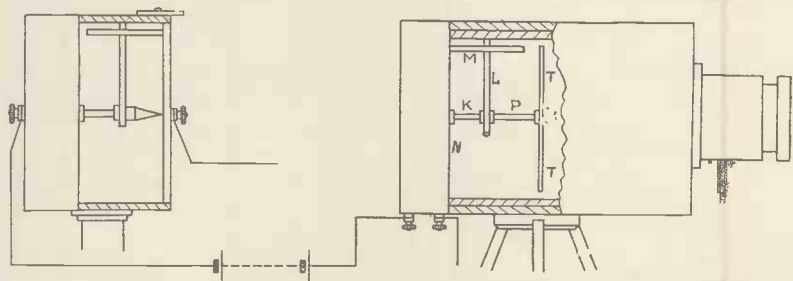

Fig. 2.—Another type of apparatus devised by Carey which was to employ selenium cells travelling over a spiral course and so scan the image to be transmitted.

wires pass through disc C of the receiving instrument at a distant point, and are arranged in the same relative position as in disc P.

A chemically-prepared paper is placed between discs C and D for the image of any object projected upon the disc P to be printed upon by electro-chemical action.

with it the possibility of "seeing by electricity."

Their scheme was to project a shadow of the object upon a bank of selenium cells, each cell being wired individually to a distant but similar bank of telegraphic relays. The relays were used to control a series of apertures interposed between a source

of light and a background of frosted glass, so that the resulting light-and-shade variations formed an image of the original object.

**Using the Kerr Effect**

As an alternative method of reception, they also suggested using the

French periodical called "La Lumière Electrique" an elaborate scheme for "seeing at a distance." This included a method of rapid "scanning" suitable for the reproduction of moving effects, together with a number of other details which were surprisingly in advance of the time.

As shown in Fig. 3, scanning is effected by a vibrating mirror M

slowly, in the plane of the paper, to carry the line of exploration systematically over the surface of the picture A. Meanwhile, the light from the scanned picture is reflected by the mirror on to the selenium cells.

**Alternatives to Light Cells**

Apart from the ingenuity of his

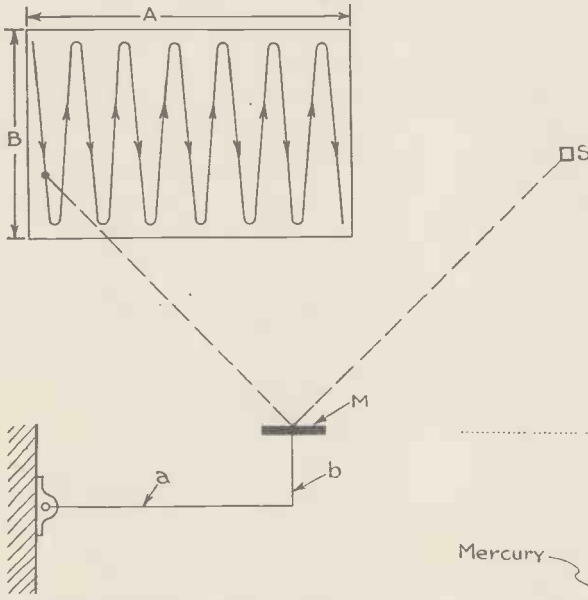

Fig. 3.—A system of line scanning devised by Maurice Le Blanc in 1880. A mirror vibrating in two directions was to be employed.

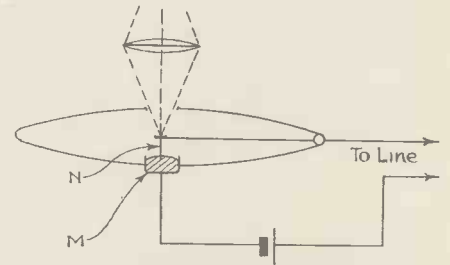

Fig. 6.—A light-sensitive device which operated by the pressure of light on a globule of mercury.

known Kerr effect in which the plane of polarised light reflected from the polished surface of an electromagnet is rotated in proportion to the strength of the signal current flowing through the magnet coils. This was probably the first proposal for a true television system within the definition given above, i.e., an electrical

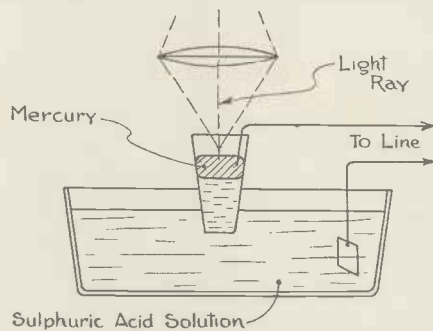

Fig. 5.—A modification of the light sensitive device shown by Fig. 4. The pressure of light on the flexible reed was to operate a contact dipping into mercury.

television system as a whole, Le Blanc showed a remarkable genius for finding alternatives to selenium as light-sensitive devices. It must be remembered that he was more than thirty years in advance of the thermionic amplifier and that the selenium cell in those days was a feeble affair. Had it been otherwise, television might by now be firmly established.

One suggested alternative was the Becquerel thermo-electric cell, which consists of two silver electrodes immersed in a silver-salt solution.

Another, shown in Fig. 4, consists of an evacuated glass bulb having a blackened surface except for a small window or aperture to admit light. Inside the bulb is a very fine and flexible strip of steel which is pivoted at o and covered with lamp-black at the part which receives the reflected ray from the scanning mirror. The

(Continued in 3rd col. of page 484).

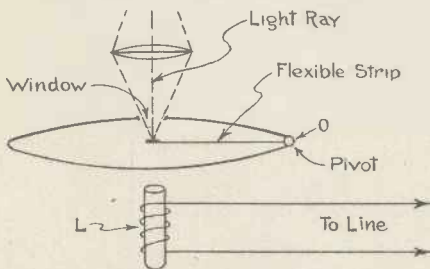

Fig. 4.—A light cell operated by the pressure of light on a flexible strip of steel.

mounted to oscillate in two directions at right-angles to each other. The short spring-blade b vibrates up and down through the plane of the paper, to give the rapid "line" scanning component B, whilst the longer spring-blade a moves comparatively

method of viewing a distant scene simultaneously with the event.

**Early Scanning**

A few months later, however—on December 1, 1880, to be exact—Maurice Le Blanc published in a

Fig. 7.—A light valve operated by electro-magnets. This also was a suggestion of Le Blanc.

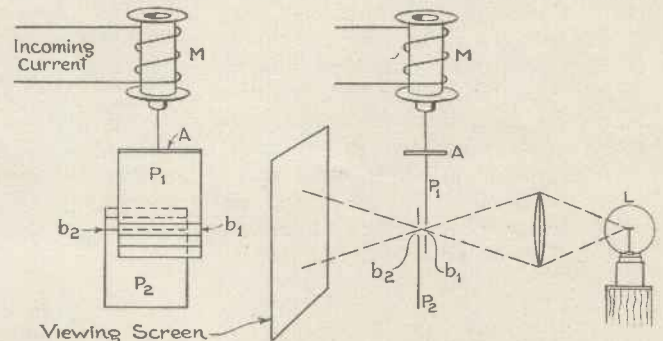

# Heard on the Short Waves

By Kenneth Jowers

FROM time to time I have said a few hard things about conditions on 1.7 mc. What with trawlers, terrific QRM and lack of stations, that band is only interesting for short periods of the year. If I had been more active on 7 mc. I don't suppose I should have said very much about conditions on 1.7, for that band, in comparison, is quiet and docile.

At the moment, the 40-metre band, in addition to being terribly congested,

## G5WW

A station which does do very well on the 40-metre band is G5WW, operated by P. Carment in North London. This station uses quiescent carrier telephony with great success. For those on dry batteries this idea has much in its favour for, according to 5WW, the equivalent of 10 watts can be obtained without excessive drain on the H.T. battery. The idea is to use a conventional transmitter wired for grid modulation. Grid bias on the P.A. is then increased until the anode current on the P.A. is reduced to zero with full drive. Modulation is then applied and it will be found that the P.A. anode current rises from zero to a value sufficient to transmit just the right amount of carrier signal for full modulation with a depth of speech provided by the modulator. Actually a whisper will produce a small increment in anode current, while a larger input causes a correspondingly larger increment.

No carrier is transmitted during periods of zero modulation so that P.A. anode current only flows intermittently, decreasing battery consumption.

## Poor Modulators

One feature I did notice during my trip around the home counties is that very few transmitting stations seem to

use a good speech amplifier. Although anode modulation is without question superior to grid, I should have thought that many of the smaller stations would have been wiser to have reduced the percentage of distortion in the amplifier and to use grid modulation. Admittedly this does not give maximum quality, but it would certainly have been better than some of the stations that are audibly distorting with anode modulation. One station in particular with a 60-watt carrier manages to obtain full anode modulation with a modulator valve having an anode dissipation of 10 watts. The explanation is that a high percentage of distortion is tolerated, which accounts for some of the reports I get from America commenting on bad quality from some of the 20-metre G stations. In such circumstances as these surely buffer or grid modulation would have been preferable. Probably when RK20's or their equivalents are available in this country, quality from the few poor G stations will improve.

A problem I have come up against is how to obtain a 1,000-volts H.T. without using mercury-arc rectifiers with or without delayed switching. The solution seems to be found in the use of the new Tungram valves I have been trying. These rectifiers are designated PV75/1,000 and rated at 75 watts. A 75-watt modulator is also available and both of these valves take



This is the operator of CM2RA with his 100-watt 20-metre phone transmitter. As usual, rack construction is favoured.

has so many other drawbacks that I am surprised at it being so extensively used. Congestion is only a minor difficulty which can be got round by electron coupling, while the over-modulated French stations do stop occasionally. The biggest problem on the band is bad station operation by some of the G stations. I have listened for upwards of half an hour to stations being tuned up on an elevated aerial making the most frightful noise, showing that the apparatus was badly out of tune. Incidentally more than half of these stations forget to give call signs so it is impossible to do anything.

It is most annoying to be in the middle of a QSO and to have a station come along on an adjacent frequency doing nothing else but knob twiddling. If dummy aerials were used more extensively when making adjustments a lot of this trouble would be overcome. Another point—not a complaint, but a suggestion—why not follow the American and Dutch idea of calling tests? It is very difficult to read some of the call signs, such as BW, whereas "Baltimore Washington" will usually beat the worst QRM. Of course, it does not matter so much for local working, but it appears to be essential to use this code for low power DX.

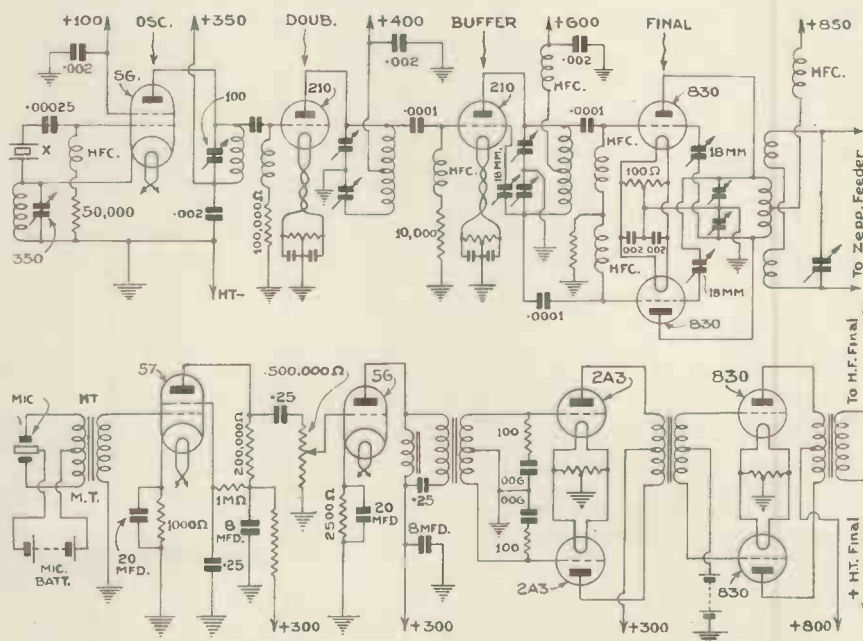

The speech amplifier and modulator in use at CM2RA has much in its favour. English amateurs would be well advised to consider class-B drive for push pull.

five seconds fully to heat. Actually in use the whole transmitter can be switched off at the mains by a single switch, so simplifying transmitter construction.

Readers will be glad to know that a special article on directional aerials is in the post from Rienzi B. Parker, better known as the operator of W1AJZ. American amateurs have made a study of the aerial end of transmissions, which probably accounts



For portable work this Pioneer Gen-E-Motor will be useful. A 7 in. by 5 in. by 3 in. unit will give 250 volts 50 m/a, from a 6-volt supply.

for why they are received so well in this country. A lot of G stations will probably give another reason—that of using up to 1 kilowatt, but I feel that Americans should be given some credit for their installations.

### Speech Amplifier with Class B Amplifier

Cuban station CM<sub>2</sub>RA, operated by Rigoberto Alvarez in Havana, Cuba, uses a most interesting speech amplifier and modulator. The microphone is fed into an R.C. coupled screened-grid valve followed by a triode amplifier. This amplifier then drives two valves in class B, which in turn drive two type 830's in class C. The actual transmitter is conventional, being a four-stage affair with final push-pull P.A. This station is being heard so consistently in Europe on 20 metres that I am sure amateurs will be interested in the circuit arrangement.

Readers will probably have heard about the wonderful results obtained by Douglas Walters with his station G5CV. A five-metre transmitter erected on the top of Mount Snowdon has made several DX contacts, the best being 207 miles two-way to Ormskirk. Further tests are to be made during August, so will any listening or transmitting stations interested get in touch with G5CV at 45 Fairfax Road, Bedford Park, W.4.

In view of these results readers have

been asking what sort of super-het it is best to use. All this information is to be given in an article at a later date, but for those who wish to get going right away here are a few details.

In the July issue, on page 406, were published details of how to use the new Marconi-Osram heptode on five metres. This is the arrangement to use, but instead of coupling it into a high wavelength I.F. coil use a wavelength of about 90 metres. My original experimental coils consisted of 50 turns of 36-gauge wire wound on a one-inch former for both primary and secondary. It is, however, an advantage to connect across these coils a small preset of the Jackson type so as to obtain perfect balance. Two I.F. stages only will be needed, while the fourth valve can either be a double-diode-triode with headphones in the triode anode, or a simple triode-second detector feeding a steep slope pentode.

The circuit lends itself to modification for picking up television transmissions, but, instead of using I.F. coils as previously suggested, three R.C. coupled I.F.'s will be ample, but, of course, attention must be paid to the design of the low-frequency amplifier.

I have been trying a novel circuit suggested by a German amateur which has much in its favour. It consists of a tuned R.F. amplifier followed by a heptode-detector oscillator, no I.F. amplifying valve, simply a second detector and pentode output. This circuit has the inherent selectivity of a super-het with the noise level of a straight set, while for DX, owing to the R.F. stage, it is excellent. Commercial receivers are being built on these lines and I have noticed they are very free from background noise.

### Present Conditions

Reception conditions at the moment, according to the latest reports, show that 160 metres is of little use after dark. The most active stations on the band appear to be 6GO, 50C and 5KJ. 2KT, who is usually very regular, is away on holiday, while, owing to the high noise level, most of the other stations, such as 6KV, appear to have migrated to 40 metres. The 80-metre band is still very steady and is excellent for European contacts.

Although conditions are good on 40 metres nearly all day they improve late at night with regard to sensitivity, but as a general rule QRM is very bad.

### "When Did Television Begin?"

(Continued from page 482.)

"pressure" of the light deflects the strip, in proportion to its intensity.

Fig. 5 shows a somewhat similar arrangement, in which the deflection of the strip inside the bulb thrusts a needle *N* deeper into a mercury cup *M* placed in series with the transmission line, thereby altering the effective resistance of the circuit.

Still another form of light-activated relay is shown in Fig. 6. Here the light-ray exerts sufficient pressure on the upper surface of a capillary "blob" of mercury to move it bodily, and so vary its surface of contact with a reservoir of sulphuric acid.

When he came to the receiving side, Le Blanc naturally found—in the absence of the thermionic amplifier—that he could not make direct use of the feeble currents from his light-sensitive devices to control the intensity of any source of light then known.

He accordingly devised an ingenious form of "light valve." This is shown in Fig. 7, where two plates of mica *P*<sub>1</sub>, *P*<sub>2</sub>, silvered except for a narrow horizontal band *b*<sub>1</sub>, *b*<sub>2</sub>, are placed one behind the other. The transparent bands are made partly to overlap, and in this way control the passage of light from a lamp. An armature *A*, fixed to the top of the plate *P*<sub>1</sub>, is moved to and fro by the incoming signals flowing through an electromagnet *M*.

It is particularly surprising to find the inventor, even at this stage, tackling the problem of television in natural colours. Unfortunately, he was of the opinion that the transmission of seven primary colours was required instead of three, thus adding an unnecessary complication to his task.

### Nipkow Disc

But even this is far from being a modern invention. On January 6, 1884—four years after the date of the Le Blanc publication—a German patent was issued to Paul Nipkow, of Berlin, for a system of wired television in which the characteristic rotating disc, pierced with a spiral series of holes, is employed for scanning.

# The Short-wave Radio World

## A Transmitter for any Band.

IN the June issue of *Short-Wave Craft*, W9LBV gives details of his simple transmitter which operates on 1.7, 3.5 or 7 mc. It is unconventional in many ways, but as the components in it are of a standard type we feel that many readers who are interested in transmission will find this circuit of use.

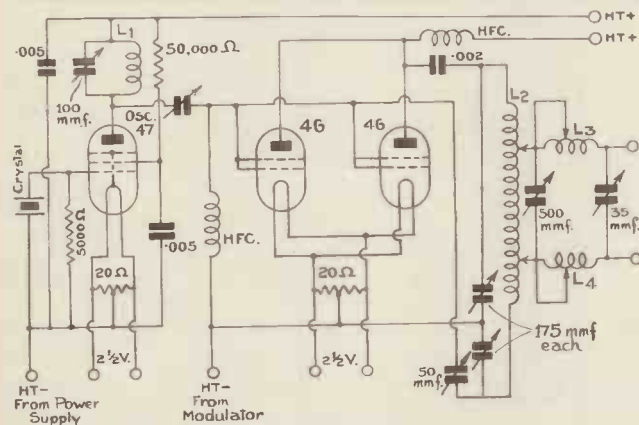

W9LBV uses this arrangement with great success. Notice the matched impedance aerial book-up.

It is simple to operate, and as series modulation is used no expensive transformers, modulation choke or large modulator valve is required. At the same time, series modulation, unlike grid modulation, does not cut the output of the transmitter.

To add series modulation to an existing C.W. transmitter of this kind is

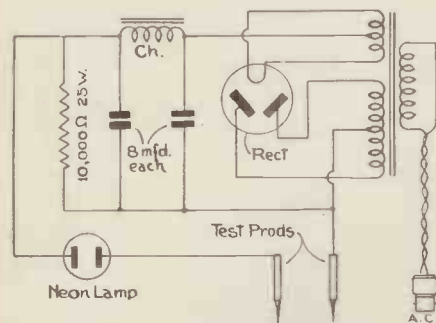

To test for condenser leakage this circuit is invaluable. The neon lamp is of the indicator type.

only necessary to connect the modulation in series with the H.T. negative lead of the power supply and the final amplifier. No other changes are required, while it can be used equally well on 56 mc. The crystal oscillator is of the type 47 which feeds into two 46's. This simple transmitter also includes matched impedance aerial system of a simple kind.

All the components with the excep-

## A Review of the Most Important Features of the World's Short-wave Literature

tion of valves can be obtained from any radio dealer, while three special valves are supplied by Claude Lyons.

## Condenser Tester.

*Radiocraft* published an excellent condenser tester which will appeal to the service man and the amateur. Although intended for use of A.C., the arrangement is also suitable for D.C. if the rectifying section is omitted. The diagram is self-explanatory. It consists of a mains transformer and a full-wave rectifying valve, the output of which is smoothed by means of a low-frequency choke and 16-mfd capacity.

This D.C. is then applied across a high wattage resistance and an indicating neon tube of a low wattage type. In operation a fixed condenser is connected across the two test prods, when the neon tube will flash once and once only if the condenser is a good one. Should there be an open circuit in the condenser the neon tube will not flash at all, but any trace of leakage will cause the neon to flash at intervals. The shorter the interval between flashes the greater the amount of leakage.

## An A.C./D.C. Deaf Aid

In the July issue of *Aerovox* is described a one-valve A.C./D.C. amplifier which can be used to boost the output from a microphone or as a deaf aid. This amplifier uses a 12-A7 dual-purpose valve in conjunction with microphone and headphone. The whole unit is built into a small metal case, approximately ten inches square and

connected to the nearest power point.

It is essential to use the specified valves, for they have all been chosen for a particular reason. It must be realised that this amplifier has a good rising characteristic essential for deaf-aid apparatus. The microphone is a sensitive single-button type which does not give very good bass response, while the input transformer T1 has a high ratio of 100-1 so as to boost the low speech input. The output transformer T2 was made to have an impedance of 50, 200 and 500 ohms so that one or

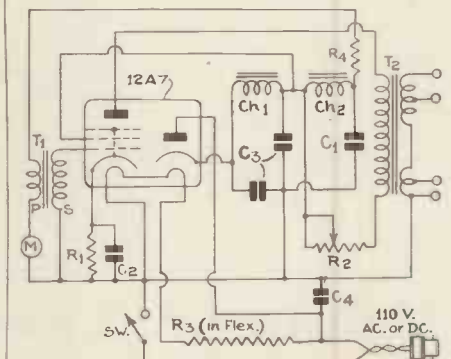

Primarily intended as a deaf aid this amplifier is useful as a microphone booster.

several pairs of head sets can be used simultaneously. A single earpiece has a normal impedance of about 500 ohms, but if the unit is intended for use in cinemas or churches, etc., then the 50-ohm tapping must be used so as to

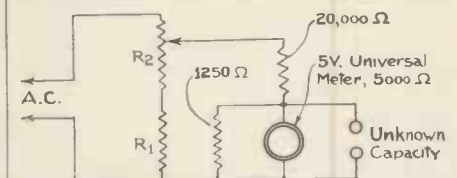

This is a very simple type of capacity bridge. It should prove useful.

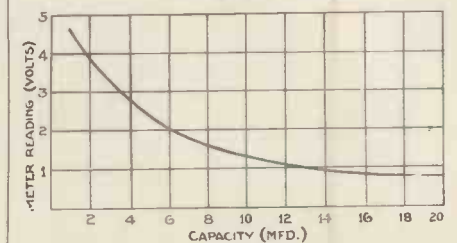

Here is the curve that goes with the capacity bridge.

accommodate several pairs of ear-phones.

## High-Range Capacity Meter

From the *Aerovox Research Worker* we have taken this capacity meter and

calibration curve. In the circuit, R<sub>1</sub> is a fixed 4,000-ohm resistance. R<sub>2</sub> is a potentiometer having a value of 1,000 ohms. Both of these resistors can be replaced by a 5,000 ohms with an adjustable tap. The potentiometer has the advantage that before each reading the meter can be set for line voltage, for example, by connecting a high-capacity condenser across the test terminals and adjusting to give a meter reading of, say, .7 volt.

For general test work, however, it is advisable to have a semi-fixed potentiometer, for it is difficult to know whether or not a variable potentiometer with panel control has not been tampered with. The meter in use is a 1,000-ohm per volt type with a five-volt scale and should be suitable for A.C. or D.C. operation.

This capacity bridge will read up to 20 mfd. and down to about a quarter of a mfd. as can be seen from the accompanying graph.

### Obtaining High Fidelity

Some of the original radio receivers which did not give good bass response and were rather inclined to accentuate

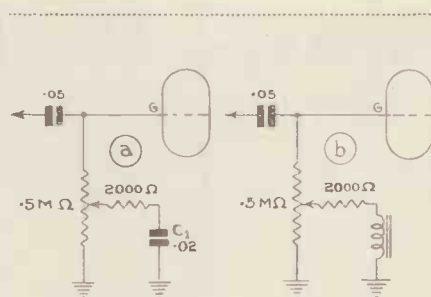

A high-frequency attenuator is shown on the left. It can be converted to decrease bass by using the circuit on the right.

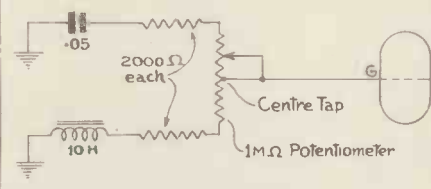

A combination high- and low-frequency attenuator can be constructed in this way.

the top notes can be adjusted so as to give a more level response. The diagram shows a circuit that can be added to any conventional low-frequency amplifier to vary either bass or top notes. The left-hand circuit shows a high-note attenuator, and the right-hand a low-note attenuator. Component values are given, while the circuit can be incorporated without difficulty in any set.

Although the use of these filters will not give perfect high-fidelity reproduction, it will assist very greatly in making an old receiver give good quality—almost as good as the average modern set.

Definition of high fidelity is level amplification between 40 and 15,000 cycles, so that even if the amplifier were capable of giving such quality the loud-speaker would fail above, say, about 8,000 cycles.

The third circuit, which is actually a combination of high- and low-frequency attenuators, can be embodied to advantage in almost any radio receiver or amplifier. With this equaliser in use quality can be varied to meet individual taste.

## Amateur Crystal Grinding

By G. A. H. Eckles, G5GC.

INSPIRED with the idea of trying to do my own crystal grinding I resolved to try my hand at this art in an endeavour to produce an efficient piezo-quartz crystal, with a frequency inside the 7 mc. amateur band, so that it could be used in a crystal oscillator to drive further stages in a 10-watt transmitter.

I do not intend to deal with the theoretical side of the performance and operation of piezo-quartz crystals, the object of this article being to convey to those interested a short description of the method adopted by a small circle of amateurs who have been successful in grinding a number of 1.7, 3.5 and 7 mc. crystals.

A quartz lens was obtained for 2s. 6d. These lenses were guaranteed to oscillate easily and were Y cut. Having fixed the concave side of the lens on to a glass slide with glue, the grinding was commenced on a small sheet of plate glass, using grade F carborundum powder and water. Great care had to be taken in the grinding process to ensure that the surface of the lens was being truly ground, and parallel with the unground surface.

The convex side having been ground off, the glass slide was removed and the lens carefully washed and tested in a crystal oscillator circuit. The lens would not show a sign of life, so it was again fixed on to the glass slide, but this time the ground surface was the one which was stuck on to the slide and the concave surface was ground.

Having ground the concave surface flat, the lens was again tested, and this time was made to oscillate on approximately 220 metres. Again the lens was carefully ground, and tested periodically, the frequency being followed down with the receiver. No difficulty was experienced employing this method of grinding, until the frequency of 1.6 mc. and below was reached, then the performance of the crystal decreased until it was found that near 3.5 mc., two definite points of oscillation were noticeable accompanied by severe sparking from the holder plates, which damaged many crystals in the early stages of my experiments. One or two more lenses were ground, but they all ceased to oscillate below 3.5 mc., and after checking the surfaces of these with a micrometer, it was found that definite humps or mounds were present, due to the uneven grinding process.

After many more attempts, using different methods of grinding which all produced uncertain results lower than 1.7 mc., an article by G5LT appeared in the T. & R. Bulletin, describing a special plate for grinding crystals, which appealed to the writer, and after some correspondence with G5LT, a plate was obtained. The plate consists of a square piece of steel 4 in. by ½ in. with a round recess 1½ ins. in diameter and .039 in. deep drilled out of the centre of the plate. If 7 mc. crystals are to be attempted, the depth of the recess will have to be .018.

The grinding procedure is exactly

the same as already described, but this time the crystal is placed in the recess of the plate, and fixed with candle wax.

When the lense has been ground level with the surface of the plate, it is taken out, tested, and again fixed into the recess, but this time a small piece of gummed paper the same size as the lense, is stuck on to it, so as to lift the crystal above the plate level. The procedure is repeated, but each time another thickness of gummed paper is added to that already fixed, and in this manner the lense is slowly and carefully ground to the frequency required. A finer grade of power must be used when the crystal is near to the frequency required. Before testing for oscillation in the C.O. the crystal must be carefully washed and dried.

A number of crystals have been ground through the 7 mc. band by accident, and owing to the remarkably fine thickness of the lense at this frequency. Being Y cut, it has been found impossible to grind the crystals anywhere near to the 14 mc. band as the slightest pressure applied breaks them up; the writer, however, does not believe it to be impossible to grind a 14 mc. crystal.

Recently local opticians have been visited, with a view to obtaining the lense at a more reasonable price, and old quartz pebbles have been purchased at 3d. each. After testing six of these pebbles, it was found that only two would oscillate straight away, but two more were found to be active after the concave and convex surfaces had been ground flat and parallel.

I am indebted to 2AWC, whose patience and perseverance have been the cause of the encouraging results during my experiments.



# TRANSFORMERS for CATHODE RAY TUBES

TYPE TU.1. 2000 volts and 2 volts C.T. **36/-** TYPE TU.2a. 1000 volts— 4v/C.T.— 4v/C.T.— **36/-**

Savage has built his reputation as a transformer specialist on the personal recommendation of satisfied customers. The high standard of performance and reliability of every Savage instrument is borne out by this testimony.

Smoothing Chokes and Transformers for all Television requirements are manufactured to standard and non-standard specifications at very competitive prices.



W BRYAN  
**SAVAGE**  
LIMITED

56a, Clerkenwell Road, E.C.1.

Phone : Clerkenwell 3068.



## USE FERRANTI RESISTANCES in your

The Resistances illustrated here are:

1. Interchangeable Wire Wound Cartridge Type "W."
2. Fixed Wire Wound Type "F." Maximum Dissipation: 2.5 watts. Accurate to within 2 1/2 per cent. of its rated value. Resistance from 300 to 100,000 ohms.
3. Carbon Resistances. Accurate to within 5 per cent. of rated value. Inductance and capacity negligible. From 140 ohms to 6 megohms.

## TELEVISION EQUIPMENT

Write for list to  
FERRANTI LTD., Radio Works,  
MOSTON, MANCHESTER, 110.



The Solon Electric Soldering Iron has the strongest heating element obtainable. Clamped in contact with the bit, it concentrates all heat. None is wasted. The Solon simplifies soldering. It is quicker, easier, more economical and more efficient. Plug in—solder in three minutes.

**7/6**

65 WATTS  
125 WATTS 22/6  
240 WATTS 37/6

See Stand No. 53  
Radiolympia

Use a

**SOLON**  
ELECTRIC  
SOLDERING IRON

W. T. Henley's Telegraph Works Co. Ltd. Dept. YAB 25,  
Holborn Viaduct, London, E.C.1

# WEARITE

Regd. Trade Mark

## Specified for the SHORT-WAVE BANDSPREAD TWO

**THE WEARITE H.F. CHOKE (TYPE H.F.O.)**  
A highly efficient H.F. Choke—one of the first to employ a laminated iron core, resulting in higher inductance, lower self capacity and less stray field.

Effective Impedance	...	10-2,000 metres.
D.C. Resistance	...	250,000 ohms.
TWO REQUIRED	...	each 4/6d.

**ARE YOU A SHORT-WAVE ENTHUSIAST?**

Then you must get details of the new Wearite coils for the "Ultra Shorts" made in three ranges — "A" 13-28 m., "B" 25-50 m., "C" 48-100 m. Price, 3/6d. per coil.

**COUPON**  
Please send me a copy of Catalogue T.834 together with constructional details, Blue Prints, etc., of Wearite (L.P.) series of receivers, the New Universal Coils and the NEW Short-Wave Coils.

**To WRIGHT & WEAIRE, LTD.,  
740, High Road, Tottenham, N.7.**

Name.....  
Address.....  
T.8.35

# A Novel Crystal Holder

By G5ZB.

**T**HIS crystal holder will be very useful to amateurs whose QRA's are in districts where, owing to impurities in the air, if an open crystal holder be used, it is necessary to bath the crystals frequently.

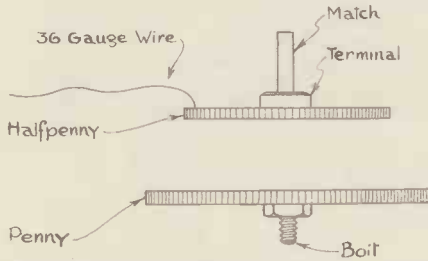

The two electrodes comprising the holder must be carefully ground down. A poor surface will stop the crystal oscillating.

The parts required are a penny piece, halfpenny piece—if these are well worn they will save a considerable amount of grinding—(two pieces of brass, one the size of the penny and the other the halfpenny will do as well), three pieces of ebonite rod  $\frac{1}{4}$  in. long and a chubby shaving stick holder. These latter are made of bakelite, the

top screws on and they are about 2 in. diameter by  $1\frac{1}{4}$  in. high.

First of all, rub the halfpenny or smaller piece of brass on an oilstone until one side is perfectly flat. Then on the other side, in the centre, solder a small terminal into which a match-stick is forced for use as a handle (see Fig. 1). The penny or larger piece of brass must be rubbed down in a similar manner, and on the reverse side of this solder the head of a bolt (Fig. 2).

The bottom of the shaving stick holder is then drilled—one hole in the

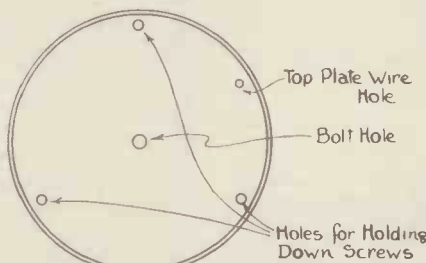

Three holes have to be drilled for the connecting wires to pass through.

centre for the bolt on the penny to pass through and three holes equidistant

for the holding-down screws to pass through. Finally, one very small hole to take the wire from the top plate to the grid of the valve is made (see Fig. 3). This wire must be soldered on to the top plate. The ebonite spacers should then be placed under the holes for the fixing-down screws and the bottom fastened to the baseboard (Fig. 4).

All that remains to be done now is to pass the wire from the top plate

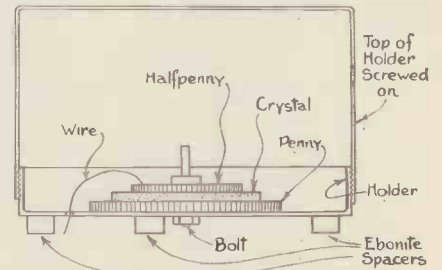

This is the finished holder complete with dust cover.

through the remaining hole and take it to the grid of the oscillator valve. The connection for the bottom plate is taken from the bolt passing through the bakelite. A terminal is then screwed on the bolt making the bottom holder dustproof, the top of the shaving plate secure. Finally, to make the stick holder is screwed on.

## The Journal of the Television Society

Published **THREE** times yearly by the Society—Subscription rate, 15/- per annum.

### PRICES OF BOUND VOLUMES

Parts I to XII (Volume I) of the *Journal of the Television Society* may now be had **BOUND** at the following rates :—

	Members of the Society.	
	Ordinary price.	Non-Members.
<b>CLOTH</b> case in Blue and Brown, complete with Index and Title page ... ..	30/-	40/-
<b>FULL LEATHER CASE</b> (Rich Blue Colour) complete with Index and Title page ... ..	31/6	41/6

(Packing and Postage 9d. extra.)

Single Copies of the **JOURNAL** may be had at 5/- per copy post-free or 2/6 per copy for Members of the Society.

**ORDERS** for **BOUND VOLUMES** to be sent to the Printers :

Messrs. Blacket, Turner & Co., Ltd.,  
34, Northbrook Street,  
Newbury, Berkshire.

**ORDERS** for single copies to be sent to the Editorial Secretary :—

W. G. W. Mitchell, "Lynton," Newbury, Berkshire.

# IRREDUCIBLE MINIMUM

In these New Clix Ultra Short Wave Valveholders for Baseboard mounting, metal and insulating material have been brought down to a minimum. The plate (see illustration) is of the finest quality Bakelite sheet obtainable. The Sockets are intersected by Air Slots (a patented Clix feature). The Sockets are slotted, thereby breaking up capacity mass—another beneficial feature.

The only metal employed in these light yet strongly constructed low-loss valveholders is the specially turned one-piece tagged sockets which eliminate dry point contact. The plate is supported by a new non-metal fixing process, and the supports are of ebonite possessing the highest of insulating qualities.

### CLIX ULTRA SHORT WAVE VALVE-HOLDERS.

(Baseboard Mounting.)

4-pin with terminals	1/9
5-pin "	2/-
7-pin "	2/3
9-pin "	2/6

Supplied without terminals at slightly less cost.

**LECTRO LINX LTD.**  
79a, Rochester Row, London S.W.1.

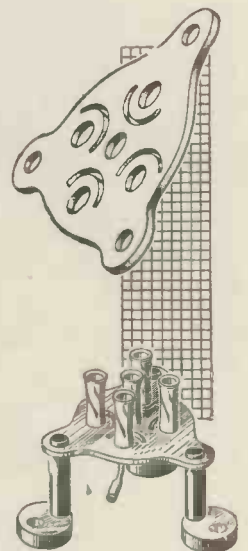

**STAND 115**  
**OLYMPIA**

# Short-wave Apparatus at Radiolympia

*There is every indication that at Radiolympia this year there will for the first time be a representative collection of short-wave components for the home-constructor. Over forty stands will show something for the short-wave amateur.*

*Automatic Coil Winder and Electrical Equipment Co., Ltd., Douglas Street, S.W. Stand No. 103.*—Keen amateurs should not miss the new signal generator displayed on this stand. It incorporates, in addition to the usual long, intermediate and medium wavebands, a separate section covering 5-25 megacycles. The output can be modulated or demodulated as required. It is complete with attenuator, internal dummy aerial and a constant impedance. The universal AvoMeter, Avo-Minor, Avo-oscillator, and Avo testing accessories will also be shown. Demonstrations of modern coil-winding equipment should also prove of interest.

*Belling and Lee, Ltd., Cambridge Arterial Road, Enfield, Middlesex. Stand No. 91.*—Several items of special interest to short-wave amateurs are being shown by Belling and Lee. A stand-off insulator of unique design, a low-loss valve hood and connector and stand-off bushes have been specially designed to meet the requirements of the home constructor. Mains high-frequency chokes for reducing electrical disturbances are also shown in various inductances. A universal valve voltage adjuster is another useful accessory, being self-contained with fused input. Terminal mounts constructed of high-quality bakelite are specially useful for short-wave working, while the Belling-Lee noise suppressors of various types will interest amateurs.

*A. F. Bulgin and Co., Ltd., Abbey Road, Barking.*—Stand No. 117.—This stand should be the home-constructor's paradise. Several hundred small components are manufactured by Bulgin.

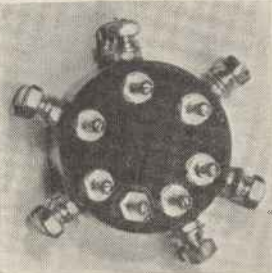

*The Bulgin split pin connector.*

Variable potentiometers, suitable for between 10 and 60 watts dissipation are obtainable from 50 ohms upwards. Snap switches handling 250 volts 3

amps. have been designed for every purpose. A recent addition is the special steatite ultra-short-wave valve holder, five-metre quench coils and tube-wound 5-25-metre coils, suitable for reception or transmission. Stand-off insulators, large crocodile clips, valve connectors with split contacts and all types of fuse holders are also available. Inexpensive milliammeters ranging from 0.8 milliamps. to 0.200 milliamps. will also be shown. The resistance and condenser group boards should also be examined

*Chloride Electrical Storage Co., Ltd., 205/231 Shaftesbury Avenue, W.C.2. Stand No. 59.*—Special miniature accumulators suitable for transceivers and portable work of all kinds will be a feature of this stand. Very cheap high-tension batteries for low discharge rates are also being shown.

*British Television Supplies, Ltd., Bush House, Aldwych, W.C.2. Stand No. 14.*—Forty-four short-wave components will be displayed on this stand. A new insulating material called Megacite, which is low-loss and has a high power factor, is being used extensively. Amongst the components displayed will be variable condensers, vernier drives with reduction ratios up to 500-1, all-wave chokes, microcondensers, four- and six-pin coil formers, L.F. chokes, wire-wound resistances, and carbon track potentiometers.

*H. Clarke and Co. (Manchester), Ltd., George Street, Manchester. Stand No. 83.*—Two entirely new Atlas mains units are being introduced this year. The complete range on the stand will be A.C.2, C.A.25, T.10/30, A.C.300, D.C.20 and D.C.15/25. The D.C.20 provides 20 milliamps. at 120 volts with intermediate tappings at 60 and 90 volts, while the new A.C.2 for alternating-current mains gives 12 milliamps. at 120 volts with alternative tappings at 60 and 90.

*Climax Radio Electric, Ltd., Parkhill Road, N.W.3. Stand No. 22.*—We are glad to see the introduction of an all-wave receiver that will provide good entertainment from short-wave stations. The new Climax all-wave super-het has a tuning dial calibrated in wavelengths even below 200 metres so that reception of the short-wave stations becomes no more difficult than the reception of some of the smaller European stations.

*(Continued on next page.)*

## ★ CONSULT MERVYN ON ALL TELEVISION

AND SHORT WAVE QUESTIONS

Recognised as leading Designers and Manufacturers of Apparatus and Component Parts of Sound and Vision Reception.

### ★ A FEW TESTED COMPONENT PARTS

Discs Lamps (Meraco  
Motors and Nuglo)  
Mirror Drums Mains Transformers

### ★ PIONEERS OF 30-LINE PICTURES IN THE HOME

our  
POPULAR RECEIVER KIT

now **55/-** complete  
only with new  
Meraco  
Lamp

#### LIST OF PARTS INCLUDED:

- |  |      |
|--|------|
| (1) 1 B.D. 4-D1:c, 15½ in. diameter ...                                  | 6/-  |
| (2) 1 B.M.4 Universal Motor ...  | 21/- |
| (3) 1 pair Motor Brackets ...  | 5/6  |
| (4) 1 Variable Resistance ...  | 6/6  |
| (5) 1 Fixed Resistance ...   | 4/-  |
| (6) 1 Lampholder ...   | 9d   |
| (7) 2 pairs of Terminals and Blocks ...                                  | 2/-  |
| (8) 1 Mervyn Meraco Lamp (maximum brilliance with low-current value) ... | 7/6  |
| (9) Baseboard Parts ...  | 3/6  |
- Easily assembled by the amateur—definite results. Full instructions are supplied with each kit.

Send 55/- today and experience your first "Looking-in" Thrill Tomorrow.

### ★ HIGH DEFINITION COMPONENTS

Complete Exciter Unit for  
Cathode Ray Tubes

3,000 volts, 3 variable voltages,  
2,000 volts, 2 variable voltages.  
Both of the above Types include  
Shield Control.

Time Base Helium-Filled Relays,  
and All Time Base Components.

### ★ MERVYN FARADAY ALL WAVE RECEIVER

The world's broadcasts available at the  
TURN OF A SINGLE KNOB  
Hear AMERICA, AUSTRALIA, etc.,  
direct during DAYLIGHT HOURS  
15-2000 metres on 4 Wave Bands.  
Full Details on Application

### MERVYN SOUND AND VISION COMPANY LIMITED

4, Holborn Place, London, W.C.1

Managing Director: W. J. NOBBS  
Telephones: HOLborn: 6332, 7709

Mervyn for reliable Television Components and  
Sound Apparatus

**"Short-Wave Apparatus at Radiolympia"**

(Continued from page 489.)

*A. C. Cossor, Ltd., Highbury Road, N.5.* Stand No. 70.—Pentagrid frequency-changers for battery operation are amongst the most interesting exhibits for short-wave readers on this stand. The Cossor Pentagrid valve oscillates quite freely down to very low wavelengths so that the amateur constructor will have no difficulty in building an efficient short-wave super-het. Special non-microphonic low-capacity and steep-slope triode valves are available for use as detectors, while high-frequency pentodes suitable for frequency-changing, detection, I.F. or R.F. amplification, will also be available.

*Dubilier Condenser Co. (1925), Ltd., Victoria Road, N. Acton, W.3.* Stand No. 67.—In addition to the familiar mica and paper condensers of all types Dubilier will be showing non-inductive condensers with screw caps, multiple capacity dry electrolytics with flexible leads and suitable for 500-volt working, reversible electrolytics for A.C. or D.C. operation, and low-voltage tubular electrolytics.

*J. J. Eastick and Sons, 118 Bunhill Row, E.C.* Stand No. T9.—Ealex short-wave convertors have been very popular for many years. Three models are now available and suitable for use

with all types of receivers. The model BM is a single-valve instrument for use with battery, A.C. or D.C. mains receivers, consisting of a triode oscillator circuit and tuning between 15 and 60 metres with an alternative coil tuning up to 120 metres. Model B2 is for battery receivers only and uses a two-valve circuit. It consists of an untuned high-frequency stage followed with a triode oscillator and the same tuning arrangements as the model BM. Model M2 is a two-valve unit for A.C. mains receivers and is complete with internal power supply.

*Edison Swan Electric Co., Ltd., 155 Charing Cross Road, W.C.2.* Stand No. 79.—Amateurs will find their needs well catered for on this stand. Special valves have been introduced for low-power transmitting work, while triode pentode frequency-changers suitable for ultra-high-frequency operation will also be on show. The ESW/501 is one of the new special valves for low-power transmission. Rated at 65 watts it is suitable for operation on all wavelengths down to 2½ metres. It gives a remarkably high degree of efficiency on ultra-high frequencies. Mercury-arc rectifiers, carbon-anode modulators and pentode valves suitable for electron coupling should interest most amateurs. Complete cathode-ray equipment will also be demonstrated, including the latest television tube.

*Electro Dynamic Construction Co., Ltd., Devonshire Grove, S.E.* Stand No. 112.—Rotary convertors of all kinds suitable for L.T. or mains drive will be a feature of this stand. Those interested in portable transmitters should make a special note of the units supplying D.C. or A.C. from 6 to 12 volt L.T. input.

*Epoch Reproducers, Ltd., Aldwych House, Aldwych, W.C.2.* Stand No. 47.—The moving-coil microphone is perhaps the star feature here as far as the amateur is concerned, for this microphone can be used without any special apparatus and gives quality far in advance of that given by the average cheap unit.

*Ever Ready Co. (G.B.), Ltd., Hercules Place, Holloway, N.7.* Stand No. 71.—For the first time Ever Ready receivers and valves will be shown at Olympia. A complete range of valves for all purposes will be shown both for the home constructor and for the set manufacturer. Accumulators filled with jelly electrolyte with capacity of between 15 and 40 ampere hours will be shown.

*Ferranti, Ltd., Moston, Manchester, 10.* Stand No. 74.—Short-wave listeners should take particular care not to miss the short-wave A.C. kit on this stand. Embodying the latest Ferranti

(Continued on page 492.)

**A General Purpose SHORT-WAVE WAVE METER**

RANGE—9.5-220 METRES

All amateurs will realise the large number of uses to which a wave meter of this type can be put. It is buzzer excited and can be used as a signal generator which will not vary. The circuit design also enables it to be used as an absorption meter with the same calibrations holding good. The meter is built in a diecast metal box of handy size and rigid construction. The wave-range is covered with three coils, a calibrated chart being supplied for each. The buzzer is rubber mounted and though mechanically hardly audible, it gives a clear high pitched note without splutter and is very sharply tuned.

PRICE LIST of EDDYSTONE COMPONENTS for the ALL WAVE SUPER			
			s. d.
1—15 m.f.d. Microdenser No. 900	...	...	3 9
1—.0002 S.M. Condenser No. 957	...	...	6 0
1—2 mfd. Condensers No. 990	...	...	4 0
2—Screened H.F.C. No. 982	...	each	5 0
1—Slow Motion Dial Drives No. 970W.	...	...	10 6
3—I.F. Units 450 Kc/s No. 674	...	each	10 6



PRICE £3 : 3 : 0 Complete

**STRATTON & CO., LTD.**  
Bromsgrove Street, BIRMINGHAM.

London Service Depot:  
WEBB'S RADIO STORES,  
14, Soho Street, Oxford Street, W.1.



**EDDYSTONE**

**HIGH GRADE COMPONENTS**

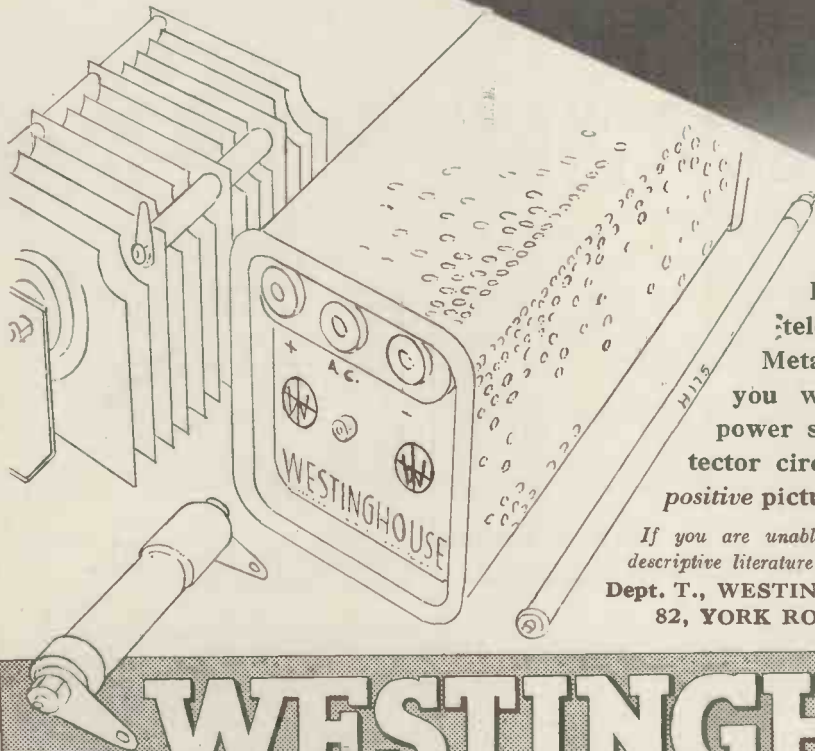

Reliability is the keynote to successful television reception. Use a Westinghouse Metal Rectifier in your power pack, and you will get a constant undeteriorating power supply. Also a Westector in the detector circuit will give you better, clearer and positive pictures.

*If you are unable to visit STAND No. 101 at Olympia write for descriptive literature to:—*

**Dept. T., WESTINGHOUSE BRAKE & SIGNAL CO., LTD.,  
82, YORK ROAD, KING'S CROSS, LONDON, N.1.**

# WESTINGHOUSE

## METAL RECTIFIERS & WESTECTORS

**Short-wave Apparatus at Radiolympia**

(Continued from page 490.)

heptode with single dial control, it is one of the most efficient short-wave sets exhibited. Special transformers and output chokes for matching the modula-



Service men and keen amateurs should make a point of seeing the Ferranti Universal Tester.

tor to P.A. are another special feature instituted by Ferranti. Microphone and matching transformers, a complete range of valves, as well as receivers and inexpensive meters should also be

examined. The Ferranti universal test instruments and universal test meter, have been designed to meet the requirements of the advanced amateur and the service engineer.

General Electric Co., Ltd., Magnet House, Kingsway, W.C. Stand Nos. 35, 44 and 63.—Many amateurs will wish to see the new triode-hexode for A.C. or D.C. operation. This new valve operates as a frequency-changer down to 4 metres and will be used in many television receivers. Special steep-slope output pentodes that will give high wattage when driven by a diode will also be of use to short-wave amateurs building their own A.C.-operated receiver. G.E.C. all-wave receivers will also be shown.

Graham Farish, Ltd., Masons Hill, Bromley, Kent. Stand No. 54.—Constructors who have admired the American type of Aero dial should examine the Graham Farish product. This drive is all steel, has twin ratios of 8/1 and 64/1 with a dial movement of 270 degrees. Calibrated from zero to 100 it is ideal for short-wave work, while the drive only costs 3s. A complete range of short-wave and television apparatus is being designed for the coming season and we advise readers to make careful note of the special components available for the home-constructor.

W. T. Henley's Telegraph Works, Ltd., Holborn Viaduct, E.C.1. Stand

No. 53.—Three electric soldering irons will be shown on this stand varying in size between 65 watts and 240 watts. Resin-cored solder is also a feature on this stand.

High Vacuum Valve Co., Ltd., 113 Farringdon Road, E.C. Stand No. 27.



Hivac midget valves want special bases. Bulgin make this one.

—Constructors interested in five-metre transceivers, deaf aids, or small portable radio sets should make a particular point of visiting the Hivac stand. They will be displaying miniature valves having a high degree of effi-

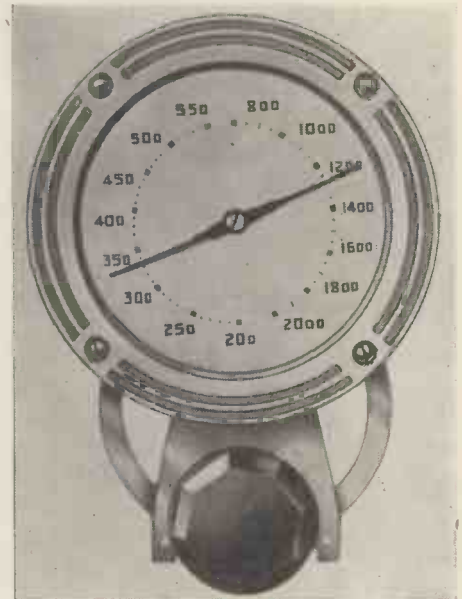

This is the Jackson aeroplane type dial. With a blank scale it will be useful on a short-wave set. Most extension spindles are too heavy. This one is made of paxolin.

ciency which are unique on the English market.

Jackson Brothers (London), Ltd., 72 St. Thomas's Street, S.E. Stand No. 110.—Readers will be glad to know that J.B. have designed a complete new range of short-wave apparatus of the highest quality. An aeroplane-pattern dial and double-ended pointer is excellent for accurate short-wave tuning. One model, fitted with a dual ratio drive of 8/1 and 100/1 is priced at 6s. 6d. Midget condensers for all purposes such as band spreading are available. (Continued on page 494a)

**UNIT**



£6 - 15 - 0

**SHORT-WAVE CONVERTORS**

The Heptode AC/DC Converter will bring the fascination of world-wide short-wave reception to every owner of a mains set.

No alteration to the broadcast receiver is necessary, only aerial and earth connections, and change-over from short-wave to normal reception is effected by a switch on the Converter.

The Heptode Unit is completely self-contained for use on either AC or DC, from 200-250 volts.

Both tuning circuits are ganged and controlled by a 100-1 tuning dial, giving perfect handling.

(See Full "Test" report on page iii.)

**Heptode AC/DC Converter**

Uses Ferranti heptode frequency changer valve, ensuring efficient low-wave mixing and constant oscillation.

Chassis built, non-radiating and free from hand capacity. Incorporates Westinghouse Metal Rectifier.

PRICE, complete with coils and valve,

£6-15-0

**Heptode Battery Converter**

Incorporates all features of mains model, but uses Ferranti Battery Type Heptode Frequency changer valve and operates from batteries of broadcast receiver. No external batteries required. Accurately ganged and tested under working conditions.

PRICE, complete with coils and valve,

£4-5-0

**Universal Short-Wave Unit**

For attachment to any set, Battery, A.C. or D.C. Can be used as either superhet converter for broadcast superhets or sets with H.F. stages or, as plug-in adaptor where no H.F. is available. Price with coils for 13-60 metres, 47/-

With switch for immediate change over 3/- extra.

All Models Cash or C.O.D. Carr. paid.

Descriptive literature and copies of testimonials free on request.

**UNIT RADIO**

SPECIALISTS IN SHORT-WAVE RADIO

347, City Road, London, E.C.1

Telephone: CLErkenwell 5340



# ESSENTIAL FOR THE SHORT WAVE BAND-SPREAD TWO

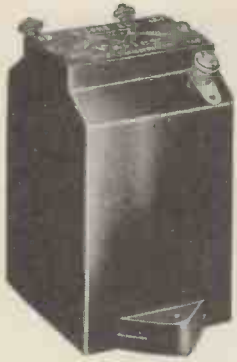

NICLET L.F. TRANSFORMER List No. DP22 PRICE 7/6.

Although Mr. Kenneth Jowers must be well aware of the many existing L.F. Transformers selling at a considerably higher price than the "Niclet," his desire for the greatest possible efficiency has caused him to specify our product for his new set. Experts cannot find a better unit for this particular job, whatever the price, for the most expensive and elaborate means have proved no more effective than this inexpensive nickel-cored component.

COME TO  
STAND

31

RADIOLYMPIA (AUG. 14 - 24)



Write for the new Varley Catalogue.

Oliver Pell Control Ltd., Bloomfield Road, Woolwich, S.E.18  
Telephone: Woolwich 2345.

## ULTRA

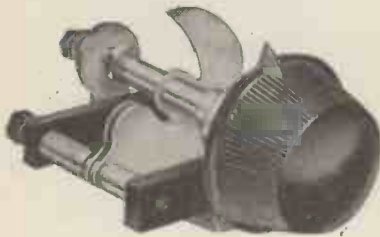

Plain Catalogue No. W.41. Slow Motion  
Catalogue No. W.51.  
15 mmf. 30 mmf.  
.00004. .0001. .00015.

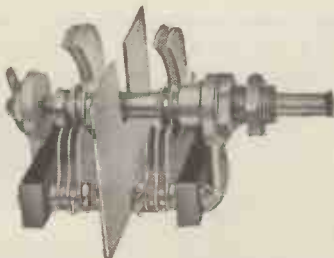

Plain Catalogue No. W.61. Slow Motion  
Catalogue No. W.71.  
15 mmf. 30 mmf. 45 mmf.

## SHORT WAVES

If you are considering condensers for Ultra Short Wave Work, do not fail to see the J. B. Radiolympia range first. These condensers are specially designed for short wave work, not adaptations.

Illustrated are two of this representative range. The larger capacities are suitable for Short Wave tuning, reaction, and

aerial series. The 15 and 30 mmf. types for band spreading and ultra short waves.

The 15, 30 and 40 mmf. twin gang condensers designed for Ultra Short Wave and for trimming the preselectors of broadcast superhet receivers. All types have very low minimum capacity, low losses, and are non-microphonic.

All above types may be supplied with Slow Motion (Ratio 8-1) if required.



JACKSON BROTHERS(LONDON)LTD., 72, St. Thomas Street, S.E.1. Telephone: HOP 1837

There is news in the "Television and Short-wave World" advertisements.

# S27

## ANOTHER NEW VALVE?

No, this is the Hivac Stand number at Radiolympia and a hearty invitation is extended to all readers of "Television and Short-wave World" to visit and inspect the full range of Hivac Standard Battery and Mains Valves. Hivac Midget Valves and Midget Receivers using these highly efficient types will also be exhibited.

Those unable to visit Radiolympia should apply for our latest literature.



BRITISH MADE

Battery Types	Mains Types
from . 3/9	from . 9/6

HIGH VACUUM VALVE CO., LTD.  
113-117 Farringdon Road, London, E.C.1



Really Dead Beat High Accuracy meters. Neat black bakelite case with zero adjuster screw. Sturdy construction and white dial with finely divided clear scale. All ranges from 2 to 500 volts and from 1mA to 10 amps. Type M70, flush fitting, 2", 2½" or 3" dials. Prices from **27/6**

Insist on direct us for delivery returned fully



— order from prompt if not satisfied.

TESTED METERS

THE SIFAM ELECTRICAL CO., LIMITED,  
Hollydale Road, Queens Road, S.E.15.

## Short-wave Apparatus at Radiolympia

(Continued from page 492.)

*Kolster Brandes, Ltd., Cray Works, Sidcup, Kent.* Stand No. 78.—Several K.B. receivers suitable for ultra-short-wave working between 15 and 80 metres are shown, in addition to these receivers the K.B. 432 short-wave converter is being introduced at Olympia.

*Lectrolinx, Ltd., 79a Rochester Row, S.W.1.* Stand No. 115.—A special leg-supported valve holder for short- and ultra-short-wave working should be carefully inspected by constructors. The main plate, made from bakelite sheet, is intersected by four patented air slots and supported by a new fixing process which entirely eliminates metal. The familiar resilient Clix sockets being

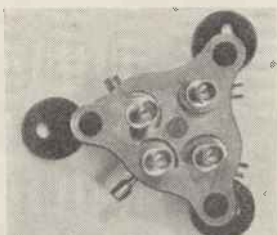

Clix have solved the problem of low capacity valve holders by the introduction of this new leg-type valve holder.

slotted, break up capacity mass, while tags being an integral part of the socket eliminates dry point contact. These holders are available in 4, 5, 7, and 9-pin types with or without terminals. Prices range from 1s. 6d. for the 4-pin without terminals to 3s. 6d. for the 9-pin with terminals. Clix pins, plugs and sockets, insulated plugs and terminals and several useful accessories make this stand well worth a visit.

*Lissen, Ltd., Worple Road, Isleworth.* Stand No. 86.—An entirely new and complete range of short-wave and television apparatus is to be introduced at Olympia. The range is too extensive to deal with at length.

*National Radio Service, Ltd., 15 Alfred Place, W.C.1.* Stand No. 12.—A complete range of all-wave receivers will be on show on this stand. The Mavox D4S is made in two sections and housed in a teak case. It tunes from 13 to 550 metres.

*Radio Society of Great Britain, 53 Victoria Street, S.W.* Stand No. 202.—Amateurs will not need advising that this stand caters for the needs of the radio amateur. On show will be a 100-watt all-band tri-tet transmitter, a special twenty-five-watt transmitter for 7-mc. a two-valve battery short-wave re-

ceiver, a 56-mc. long-line transmitter, two-valve battery short-wave converter, a two-valve mains-operated receiver and several other interesting pieces of apparatus.

*Stratton and Co., Ltd., Bromsgrove Street, Birmingham.* Stand No. 30.—This stand will be a sheer delight to all amateurs. A large number of original and useful components will be shown for the first time. For example, an adjustable insulated bracket for 1s. 6d.,

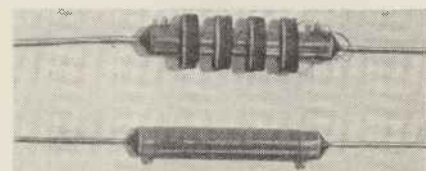

The smaller of these two chokes is suitable for three-metre working while the larger one goes down to 10 metres.

a light extension spindle, a flexible coupler, a new type of 5/90-metre high-frequency choke, an ultra-short-wave H.F. choke for 3/10 metres, a slow motion head, which can be fitted to any condenser, a midget variable with a capacity of between 3 and 65 m/mfd., coils wound on special DL9 former, and an all-wave coil unit tuning between

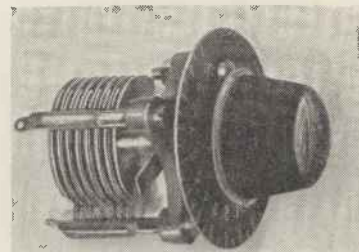

Last year's Eddystone midget preset has now been fitted with a slow motion drive.

13.5 and 91, 260 to 520, and 1,100 to 1,900 metres. Transmitting condensers that can be coupled for split-stator work will also be shown in addition to ultra-short-wave coils, vernier dials, two- and three-gang variable condensers, cross feeder blocks and a wide selection of receivers for amateur-band use and general short-wave reception.

(Continued on page 496.)

## ELECTRADIX BARGAINS

THE FAMOUS EISEL Public Address and Band Mike (Reisz principle), 55/-. Highest quality uniform response. Can be obtained from us only. Worth £5, but Our Price, 55/-. Stand 10/- extra. Screened 55/- imp. matched transformer, 7/6. Stand extra

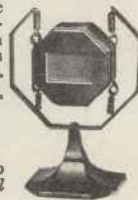

Transmitters, Hand Model, 50/-  
We make 25 types of Microphones to suit all. Prices from 5/6. Special Instructive Leaflet "T.S.W." free.

MORSE KEYS. We have the biggest range of Wireless Keys in the Country. 12 Models from 4/6 to 30/-. Sounder Buzzers 5/-. Bells, best British, 2/-.  
50/-

ELECTRADIX RADIOS,  
218, Upper Thames Street, London, E.C.4.  
Telephone: Central 4611

## TELEVISION AND SHORT-WAVE COMPONENTS

L. LEAMAN, 97 Northfield Ave.  
W. Ealing, W. 13. Phone: Ealing 5394.





**PRICE REDUCTION.**

The large demand and popularity of the famous Ostar Ganz Valves enable us to offer them at a cheaper retail price. The public recognise them as valves of the future—they last longer, consumption is cheaper and they are more efficient. A valve for every purpose—without equal, for short-wave receivers or Television work. In short, the most advanced valve though not shown at Olympia.

**OUR VERSION ON CONVERSION.**

Have a model equal to Olympia's best. Let us convert your present set into a Universal All Mains AC/DC Receiver, at moderate cost. The improved results will astonish you. Technical experts carry out conversion. Send us your set (carriage paid) for free quotation, or write for all particulars from "Conversion Dept."

**FREE TECHNICAL ADVICE.**

We have KITS for every type of set or radio instrument, such as Amplifiers and Transmitters, etc. Prices within the reach of all. Our experts give advice if required. Take advantage of this unique offer (even unskilled enthusiasts) by sending for our interesting Leaflets.

Eugen J. Forbat, 28/29, Southampton Street, Strand, W.C.2. Telephone: TEMple Bar 8608.

**MISSING FROM OLYMPIA—  
Radio's most advanced Set.**

British built HYVOLTSTAR most advanced of all Receivers, incorporates all the refinements of modern radio technique. Our wide range of models each fitted with the famous Ostar Ganz Valves can be had on approval. Why not justify our claim? Remember every model is a Universal All Mains AC/DC Receiver requiring no alteration, even on 100 to 250 volts. These receivers are eminently suited for the present 30 line television system; high definition models are in preparation. Send for descriptive Leaflet "T.T."

**UNIVERSAL HIGH VOLTAGE RADIO LTD.**

28-29, Southampton Street, Strand, W.C.2. Telephone: TEMple Bar 4985.

**SECURITY  
FOR SIXPENCE**

Don't let that next overflow of current cost you shillings or pounds; fit Amplon fuses at all vital points and protect the life of valuable valves, transformers and other expensive components.

**Amplon Cartridge Fuses.**  
from 60 mA to 3 Amp.  
for Battery or Mains sets  
cost only 6d. each.



A reliable and constant form of resistance means consistent radio enjoyment. Amplon wire-wound resistances are "entirely dependable"—that's what "Popular Wireless" said after testing 22 different values.

**Amplon Resistances.**  
50 Ohms to 2 Megohms.  
All colour coded and also have values clearly printed on labels. Price 1/- each (all values).



AMPLION (1932) LTD

82-84, Rosoman St., Rosebery Avenue, London, E.C.1.  
Telephone: Clerkenwell 5440-5441.

Components, Speakers and Sets Literature Free.

**MINIMUM  
"ZERO"**

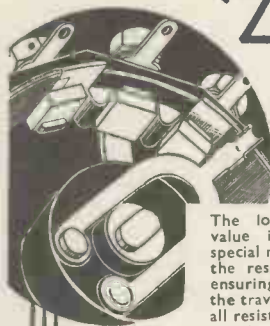

The lowest possible zero value is obtained by the special method of metallising the resistance former, thus ensuring that, at the end of the travel of the moving arm, all resistance is cut out of the circuit. This is just one point of Reliance superiority.

Wire-wound 5 to 100,000 ohms - 4/6

Composition Tracks: .05 ohms to 5 megohms 4/9

Folder "T.S.W." Free.

**RELIANCE**

THE PRODUCT OF SPECIALISED RESEARCH

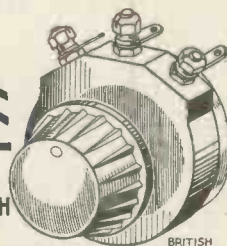

RELIANCE MANUFACTURING CO (SOUTHWARK) LTD  
WESTBURY ROAD, LONDON E17

**STAND 202**

THE HOME OF AMATEUR RADIO

**AT OLYMPIA**

The R.S.G.B. will again be "at home" to Radio Amateurs at the London R.M.A. Exhibition.

Stand 202 will as in former years be the Mecca for all interested in Amateur Radio—the greatest of all scientific hobbies.

Short wave transmitters and receivers, embodying the latest principles, will be displayed together with numerous other components of general interest.

Special features will be the new 5 metre apparatus designed exclusively for display at the Exhibition.

"A Guide to Amateur Radio," the third edition, will be published on August 14th. Completely revised, this handbook will become the standard reference for all interested in Amateur Radio. Although enlarged to 100 pages the price remains at 6d. per copy, or 8d. post free.

Full details regarding R.S.G.B. membership will be available on the Stand, or may be obtained direct from:—

The Secretary (Dept. S.W.7),

**RADIO SOCIETY OF GREAT BRITAIN,  
53 Victoria Street, London, S.W.1.**



**B.T.S.**

The **FOREMOST NAME** in  
**SHORT WAVES and TELEVISION**

**SYMBOL of QUALITY and RELIABILITY,** the B.T.S. trade-mark is recognised by experts and amateurs alike as indicative of the **BEST** that money can buy. **BRITISH TELEVISION SUPPLIES, LTD.,** are everywhere acknowledged as the

**LEADING MANUFACTURERS OF PROVED SHORT WAVE AND TELEVISION APPARATUS.**

Designed and produced by experts, B.T.S. products guarantee you all-round reliability and trouble-free service.

- Receiver Kits
- Kerr Cells
- "Telex" Lamps
- Motors
- Scanning Discs
- Synchronising Gear
- Resistances
- Lenses
- Ultra S.W. Apparatus
- Mains Transformers
- Cathode Ray Apparatus

SEE OUR SPECIAL EXHIBIT OF  
ULTRA S.W. APPARATUS at  
**OLYMPIA**  
STAND No. 14 MAIN HALL

From all Dealers or send Direct



BRITISH TELEVISION SUPPLIES, LTD., Bush House, Dept. "T", LONDON, W.C.2  
Telephone: Temple Bar 0134 Telegrams: Television, Bush, London

**Short-wave Apparatus at Radiolympia**

(Continued from page 494.)

*Radio Resistor Co., Ltd., Carlisle Road, N.W.9.* Stand No. 15.—Potentiometers used on metal chassis must have deal spindles, in the majority of circuits. All Erie units are designed in this way so that constructors need have no fear about bushing or isolating the resistance from the metal panel. Erie fixed resistances of 1, 2 or 3-watt types will also be shown together with a new range of tubular fixed condensers. Erie resistors are absolutely noiseless, a quality essential for any component used in a short-wave receiver.

*Sound Sales, Ltd., Junction Road, N.19.* Stand No. 108.—H.T. transformers giving outputs of 3,000 volts and up to 30,000 volts for cathode-ray operation are to be seen on Stand 108. Over a hundred different types of combined transformers can also be supplied together with smoothing chokes of varying inductances. H. T. equipment for cathode-ray work is being specialised in and power amplifiers with outputs varying between 4 and 20 watts can also be seen.

*Telegraph Condenser Co., Ltd., Wales Farm Road, W.3.* Stand No. 37.—Varied ranges of all types of mica and paper fixed condensers including non-inductive paper tubular, together with special types for use in tropical conditions. Dry and aqueous electro-

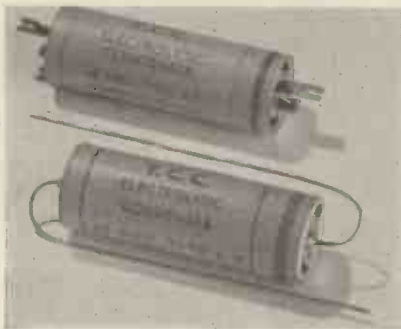

T.C.C. electrolytic low-voltage condensers are intended primarily for by-passing G.B. circuits.

lytic condensers from 12-volt to 550-volt working, the former being contained in waxed cartons, metal boxes and aluminium cans. Low and high voltage electrolytic types. Examples of high-voltage transmitting and receiving condensers up to 80,000 volts test. Condensers and special units including the well-known condenser unit for suppression of interference for radio receivers.

*Telephone Manufacturing Co., Ltd., Martell Road, S.E.* Stand No. 29.—In addition to the series of fixed condensers of all types and capacities a special high-quality microphone is being exhibited for the first time. This microphone embodies certain features,

which permit its response, for a constant sound input, to be uniform and, on account of its variable depth properties, independent of frequency. This microphone responds to frequencies between 20 and 16,000 per second and can be recommended for public address work or transmission.

*(Varley) Oliver Pell Control, Ltd., 103 Kingsway, W.C.2.* Stand No. 31.—Constructors interested in single signal supers should examine the 465 k.c. I.F. transformers with air spaced trimmers, also an I.F. transformer with panel control giving variable selectivity or variable reproduction. Special chokes and transformers for transmitting use will also be shown, in particular input and output transformers for use with PX25A valves in push-pull, an output transformer with a tapped winding for 5,000, 10,000 and 15,000-ohm loads.

*Westinghouse Brake and Signal Co., Ltd., 82 York Road, King's Cross, N.1.* Stand No. 101.—The new H type metal rectifier should be examined. Similar in thickness to a blue pencil they are obtainable to give outputs of between 18 volts 10 milliamps. to 650 volts 10 milliamps. The H10, for example, gives 40 volts at 5 milliamps., and is priced at 4s. 6d. It is suitable for cathode-ray bias. The H75 gives 270 volts at 10 milliamps. or 306 volts 5 milliamps. and is suitable for PA bias. The normal H.T. and meter rectifiers will also be on show.

*Wingrove and Rogers, Ltd., 188/9 Strand, W.C.2.* Stand No. 49.—Single and two-gang brass vanes mounted on steatite, double-spaced receiving type condensers fitted with phosphor-bronze balls and slow motion drives, micro tuning drive, with ratios of 7-1, or 100-1,

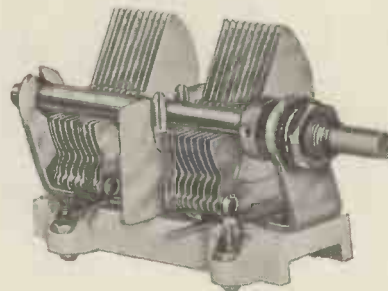

The Polar twin gang condenser is mounted on Steatite. It is suitable for receivers or split stator grid tuning.

midget, 2, 3 or 4-gang tuning condensers, air dielectric reaction condensers, volume-controls, semi-dry electrolytic condensers, tubular condensers and noiseless resistances are some of the excellent components to be seen on this Polar stand.

*Wright and Weaire, Ltd., 740 High Road, Tottenham.* Stand No. 217.—Three coils covering 13-28, 25-50, 48-100 metres with patented construction will be the high light of this stand. The construction of the coil is such that all

metal fixings will be eliminated. A short-wave converter in kit form will also be shown, blueprints being available. The standard HF3 choke, which is effective between 7.5 and 100 metres is still being continued. Mycalex in-

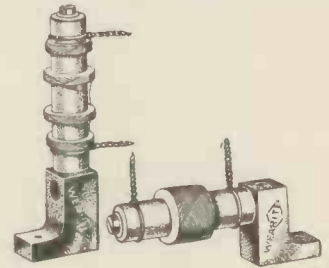

These Wearite H.F. chokes can be mounted vertically or horizontally.

sulation is being used on short-wave valve holders and special H.F. chokes while the cylindrical type of plug-in coil, which is extremely low-loss, should be examined. These are excellent for low power transmitting circuits.

**"There is Something Lacking in Television"**

(Continued from page 471.)

current and the other still nothing. (Of course both meters are passing the A.C. variations due to the light and shade of the subject, but this is not detectable as they read D.C. only.) Increase the brilliancy of the light in the studio and look again. The first meter reads still more current and the second zero.

A little reflection will, I think, make it clear that the D.C. reading on the first meter represents the average illumination of the studio which is lost because the coupling condenser in series with the second meter is naturally a complete bar to any direct current, and passes only the A.C. variations. And if it were not this condenser an ordinary amplifying chain as used for television contains plenty of coupling condensers and transformers, each of which is an insuperable obstacle to direct current.

But it is this direct current, which alone is proportional to the studio lighting and at present is lost almost as soon as it is generated, that in future will have in some way to be made to control the brightness of the receiving screen if television is to compete in range and scope with the film. Fortunately there is reason to believe that the difficulty of transmitting the D.C. is not as great as at first sight it might appear, and that in fact it has already been accomplished, so we may look forward in the future to an added realism in television reproduction.

AUGUST, 1935.

TELEVISION & S.W. COMPONENTS.  
MAKE YOUR PRESENT SET ALL WAVE.  
COMPLETE CONVERTER KITS FROM 17/6.

Send for Television and Short-wave Lists.

"PRACTICAL TELEVISION HANDBOOK" 1/-  
Television explained and Receiver Construction.  
High Definition and Disc Kits Supplied.  
BENNETT TELEVISION CO., REDHILL

## Unit Radio, Heptode Converter

Users of mains-operated broadcast receivers often feel they would like to hear some of the short-wave stations if it could be done without any trouble. Unit Radio, of 347 City Road, E.C. 1, have recently designed an entirely new heptode short-wave converter for A.C. or D.C. operation. This converter will bring in stations between 13 and 100 metres. It is entirely self-contained with its own power supply, making it entirely independent of the existing radio set. Stations are tuned in by merely adjusting the one tuning condenser, which, incidentally, has a slow-motion drive of 100-1.

The converter can be left permanently connected to the radio set, for an internal switch connects the aerial either directly to the radio set or to the



Unit Radio, Heptode Converter.

converter. This means that the movement of one knob enables short-wave stations to be heard. One of the latest heptode valves is used as a combined detector-oscillator. This means maximum sensitivity on short waves.

Six tuning coils are provided, two of which are used at a time. The white spot tunes between 13 and 26 metres, the red spot 23 to 55 metres, and the yellow spot 49 to 100 metres.

It can be taken for granted that any D.C. or A.C. broadcast set can be converted into an all-wave superhet by the use of one of these Unit converters.

The converter is supplied complete with all accessories in a fine walnut cabinet for £6 15s. od., or for battery use at £4 5s. od.

## H. E. SANDERS & Co.

SUPPLY ALL LATEST TELEVISION APPARATUS.  
Construct your own Time Base and Power Unit, ready for High Definition Reception. Kit Prices on request.

A few sets of 30 Matched Lenses for Lens Disc at Reduced Price of 15/- per set.

Synchronising Gear as described in this Journal, Price 25/6. Send or call for illustrated list.

## H. E. SANDERS & CO.

4, GRAY'S INN ROAD, LONDON, W.C.1

Telephone: CHANCERY 8778.

### "TELEVISION COUPON and SHORT-WAVE WORLD." FOR FREE INQUIRY SERVICE

Name \_\_\_\_\_

Address \_\_\_\_\_

August, 1935

## THE CONSTRUCTORS' CIRCLE

### Application for Membership

To be filled in and sent with a stamped envelope for reply to the Editor, "Television and Short-wave World," Chansitor House, Chancery Lane, London, W.C. 2.

(1) I already subscribe to your journal at the address below.

(2) I have placed a regular order for TELEVISION and SHORT WAVE WORLD with my book-sellers, Messrs.....

\* .....  
.....  
.....  
and desire to be enrolled as a member of the TELEVISION and SHORT WAVE WORLD. "Constructors' Circle."

Please send membership badge free of charge to

Name (in block letters) .....

Address .....

\*Strike out lines not applicable.

READ TELEVISION  
& SHORT-WAVE WORLD  
REGULARLY

## MISCELLANEOUS ADVERTISEMENTS

The charge for advertisements in these columns is 12 words or less 2/-, and 2d. for every additional word. All advertisements must be accompanied by remittance. Cheques and Postal Orders should be made payable to Bernard Jones Publications Ltd., and crossed, and should reach this office not later than the 15th of the month previous to date of issue.

COMPLETE DISC RECEIVER, new motor, neon, cost £10 10s. Accept £6 or nearest. Clark, Wolverhampton Road, Bloxwich, Walsall.

GEE & CO., patents and trade marks throughout the world (H. T. P. Gee, Mem. R.S.G.B., A.M.I.R.E., etc.), 51-52, Chancery Lane, London, W.C.2 (2 doors from Government Patent Office). Phone: Holborn 1525. Handbook free.

DOUBLE ENDED MOTORS all voltages 9/6d, AC/DC guaranteed 30/s. type. Synchronisers 8/6d. poles, coils, tooth wheel. Electric drills 14/6d. used reconditioned, fully guaranteed, £2 10s. type. Ance! Cine Television Co., 8, Highbury Terrace Mews.

A. MATHISEN, Chartered Patent Agent, F.Tel.S. Patents, Designs and Trade Marks.—First Avenue House, High Holborn, W.C.1. Holborn 8950. Telegrams: "Patam" Holb., London.

TELEVISION FOR SALE. Patents covering new method mechanised receivers easy and cheap to manufacture high definition. Apply XYZ, office of this paper, Chansitor House, Chancery Lane, W.C.

UNREPEATABLE BARGAINS IN "BRYCE" mains transformers, chokes, and "Peak" condensers. Controlled sale at Works' prices of end of season surplus stocks. Opportunity will not occur again. Transformers from 7/3d., Condensers from 6d. Send at once for bargain lists to:—Associated Mall Supplies, 4, Ashland Place, Paddington Street, London, W.1.

SUMMER CALLBOOKS—many pages of new DX calls, 6/-, handbooks, 4/6, Lightning calculators, 4/6, all post free.—G5KA, 41 Kinfauns Road, Goodmayes, Essex. Seven Kings 2888.

"PAREX" METAL CABINETS and chassis made to order. Supplies to all Leading Amateurs. Let us quote you. E. PAROUSSI, 10, Featherstone Bldgs., W.C.1. Phone—Chancery 7010.

## INDEX TO ADVERTISERS

Amplion (1932), Ltd. ....	495
Automatic Coil Winder & Electrical Equipment Co., Ltd. ....	434
Belling & Lee, Ltd. ....	Cover ii
Bennett Television Co. ....	Cover iii
British Television Supplies, Ltd. ....	495
Bryce, Andrew W., & Co. ....	Cover ii
Bulgin, A. F., & Co., Ltd. ....	433
Edison Swan Electric Co., Ltd. ....	Cover iv
Electradix Radios ....	494
Eugen J. Forbat ....	495
Ferranti, Ltd. ....	487
Fluxite, Ltd. ....	Cover ii
Henley, W. T., Telegraph Works Co., Ltd. ....	487
High Vacuum Valve Co., Ltd. ....	494
Jackson Bros. (London), Ltd. ....	493
Leaman, L. ....	494
Lectro Linx, Ltd. ....	488
Mervyn Sound & Vision Co. ....	489
Radio Resistor Co., Ltd. ....	433
Radio Society of Great Britain ....	495
Reliance Manufacturing Co. ....	495
Sanders, H. E., & Co. ....	Cover iii
Savage, Bryan, Ltd. ....	487
Sound Sales, Ltd. ....	433
Stratton & Co. ....	490
Television Society ....	488
The Sifam Electrical Co., Ltd. ....	494
Unit Radio ....	492
Varley ....	493
Westinghouse Brake & Signal Co., Ltd. ....	491
Wright & Weaire, Ltd. ....	487



Purveyors of  
Electric Lamps  
By Appointment

# EDISWAN



Manufacturers  
and Purveyors  
of Electric Lamps  
By Appointment

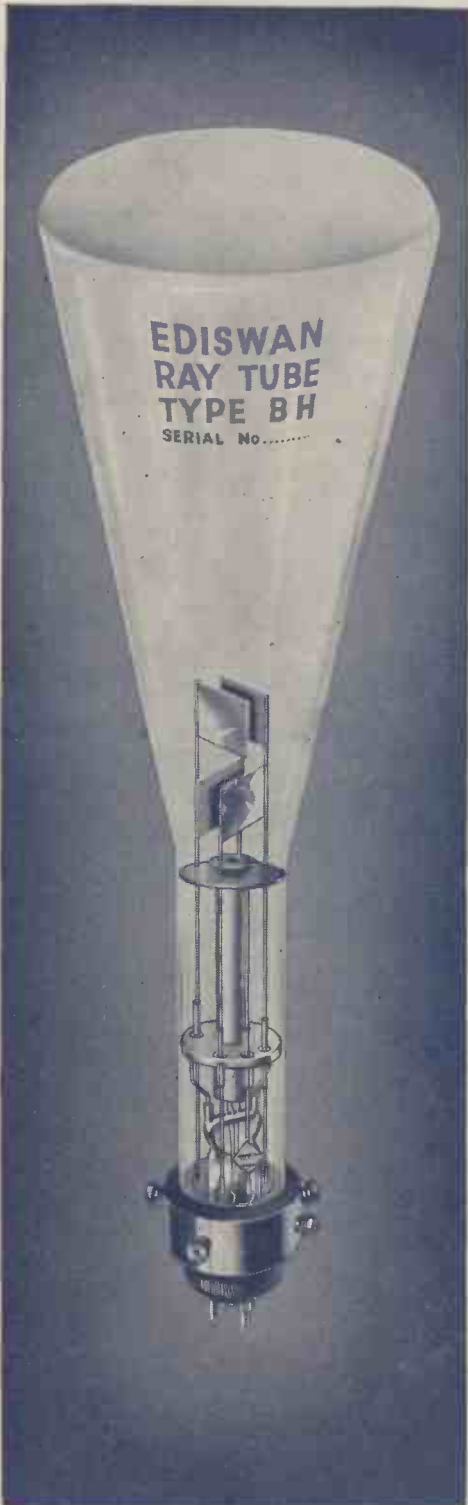

## Television developments

Here is the Cathode Ray Tube specially developed for television reception. Ediswan have been associated with the application of Cathode Ray Tubes to television from the commencement and have kept to the front with the most recent improvements.

Ediswan High Vacuum Cathode Ray Tubes are made in two sizes:

### Prices

Type AH - £10.10.0      Type BH - £8.8.0

All have special screens giving a black-and-white image. Green or Blue screens can be supplied without extra charge.

We also manufacture:

- Mercury Vapour Rectifiers
- High Vacuum Diodes
- Transmitting Valves for ultra-short waves
- Grid controlled discharge tubes for time bases

These have been specially developed for line-scanning circuits.

Full information on the tube and its associated circuits can be obtained on application to the Technical Service Department, at the address below.

ENTIRELY BRITISH MADE

# EDISWAN RADIO VALVES

THE EDISON SWAN ELECTRIC CO. LTD.



155 CHARING CROSS RD., LONDON, W.C.2

## USED BY ALL GOVERNMENT DEPARTMENTS

R.E.245