

# TELEVISION

THE FIRST TELEVISION JOURNAL IN THE WORLD

Special Features in  
This Issue:

**Universal Receiver for  
Mirror Drum or  
Cathode Rays**

• •

**Improving the Quality  
of Pictures**

• •

**The Whole Problem of  
Synchronising**

• •

**Building the Simplest  
Cathode-ray Receiver**

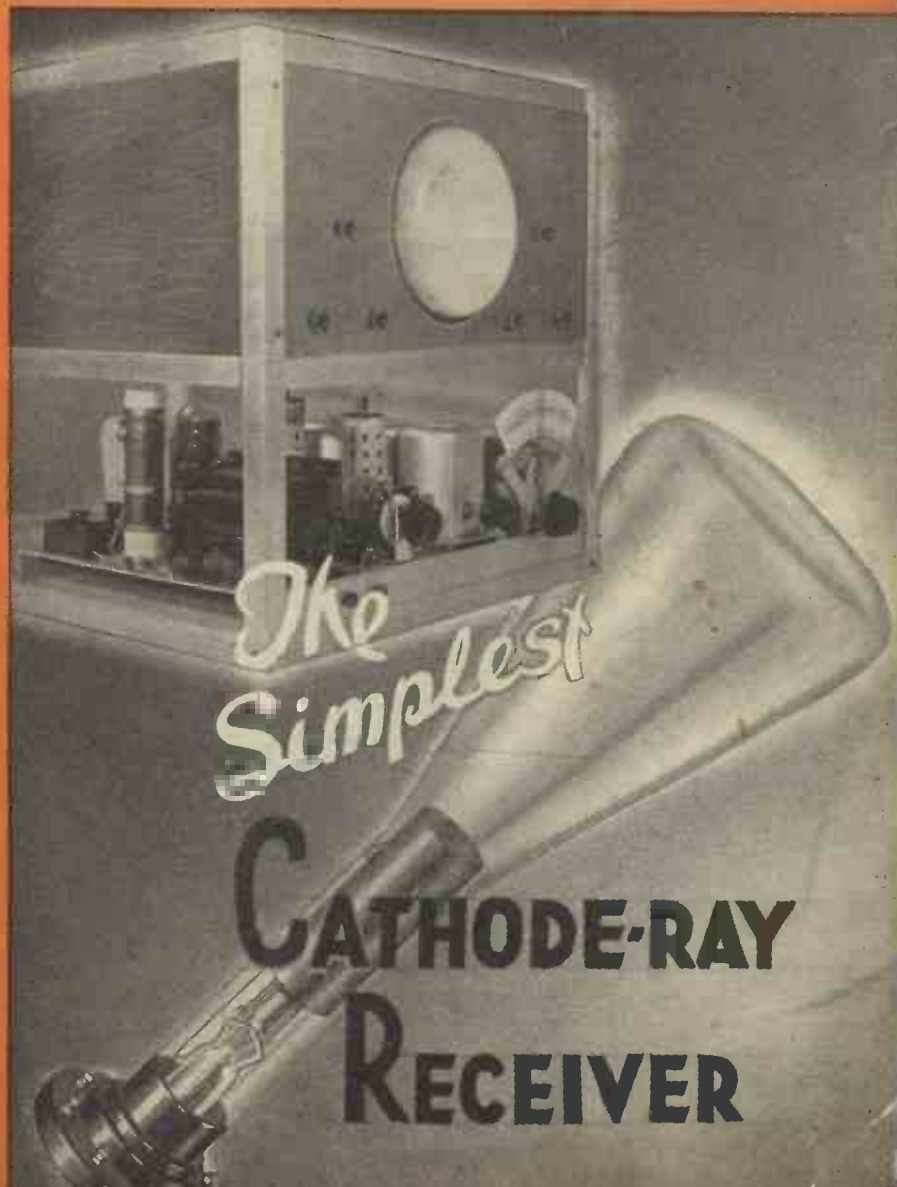

*The  
Simplest*

**CATHODE-RAY  
RECEIVER**

NOVEMBER



1934. No. 81

MONTHLY

Bernard Jones Publications Ltd., 58-61, Fetter Lane, E.C.4



**VARLEY COMPONENTS FOR TELEVISION SETS.**

- EP38. Mains Transformer, suitable for power amplifiers of large output and high quality.
- EP33. Mains Transformer, for medium power amplifier.
- DP43. DP30. DPI0. Heavy Duty Smoothing and output chokes.
- DP16. High Inductive Choke.
- Resistances. All types.
- Power Potentiometers.
- Volume Controls.
- Nicore Flat-Gang units.
- Duo Nicore Coils.
- Junior H.F. Chokes.
- Nicore H.F. Chokes.

**FOR YOUR TELEVISION SET**

Use Varley components for your television set. Remember that thirty-six years' experience in specialised electrical engineering goes into the production of every Varley product!

**NICORE FLAT-GANG UNITS**

One of the many Varley components suitable for television sets—Nicore Flat-Gang Units. Small, neat and compact, they are easily incorporated and prove highly efficient in use.



Advertisement of Varley (Oliver Pell Control, Ltd.) Bloomfield Road, Woolwich, S.E.18. Telephone : Woolwich 2345.



**A.C.-D.C. CIRCUIT TESTER**



**RANGES :**  
A.C. VOLTS : 0-15, 0-150, 0-300, 0-450, 0-600.

A.C. MILLIAMPS : 0-1.

D.C. VOLTS : 0-3, 0-15, 0-150, 0-300, 0-450, 0-600.

D.C. MILLIAMPS : 0-1, 0-7.5, 0-30, 0-150, 0-750.

RESISTANCE : 0-50,000 ohms self-contained and up to 30 megohms with external 600 volt supply.

An 0.5 mfd. plug-in Condenser Unit can be supplied (Price 5/-) to enable the instrument to be used directly to measure output voltages.

Write for Leaflet Wb 529/D.

for the measurement of

**A.C. VOLTAGE D.C. VOLTAGE  
D.C. MILLIAMPS AND RESISTANCE**

Complete with External Resistance to give voltage ranges up to 600 volts.

Price

**FERRANTI LTD., HOLLINWOOD, LANCS. £5-15-0**  
London: Bush House, Aldwych, W.C.2.

**NEW**

**Osram  
Valves**

for

**UNIVERSAL (A.C. or D.C.)  
APPLICATION**

<b>W 30</b>	Variable Mu. H.F. Screen Pentode	<b>17/6</b>
<b>X 30</b>	Heptode Frequency Changer	<b>20/-</b>
<b>H 30</b>	Triode	<b>13/6</b>
<b>DH 30</b>	Double Diode Triode	<b>15/6</b>
<b>N 30</b>	Output Pentode	<b>18/6</b>
<b>U 30</b>	Rectifier.	<b>15/-</b>

Write for Full Particulars

MADE IN ENGLAND

Advt. of The General Electric Co., Ltd., Magnet House, Kingsway, London, W.C.2.

Advertisers like to know you saw it in "Television"

## HOW MANY LINES?

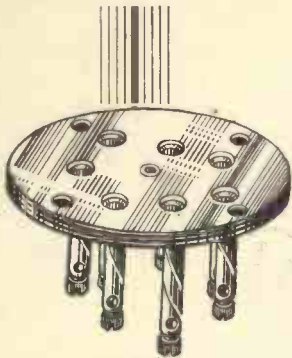

CLIX SPECIFIED  
for the  
A.C.—D.C.  
TELEVISION  
THREE VALVER

Every additional line to the Clix range of perfect contact components has a definite duty to perform. Each is designed to add to simplicity and efficiency in the construction and operation of Television or Radio apparatus.

This month, in addition to specifying Clix Chassis-Mounting Valveholders the designer has chosen Clix Plugs and Sockets and Clix Anode connectors for use in the A.C.—D.C. Television Three Valver.

### DO YOU KNOW HOW MANY CLIX LINES THERE ARE?

It is a simple matter to secure that valuable information. There is a two-colour Folder (Ref. "T") fully illustrated. A copy will be sent you free on request.

**LECTRO LINX LTD.**

79a, Rochester Row, London, S.W.1.

## 500% IMPROVEMENT IN YOUR TELEVISION RECEPTION BY USING THE Dr. LEMON White Modulating Lamp

May be used In place of any existing  
Neon Lamp without alteration

MOUNTED READY FOR USE

For the first time a WHITE Modulating Lamp is available (Continuous Spectrum) ensuring a real photographic picture—hitherto unobtainable. The lamp requires less modulation to secure perfection.

A REALLY WONDERFUL INVENTION

Price **21/-** Nett.

Packing and Postage Free. Cash with Order or C.O.D.  
MONEY REFUNDED IF NOT SATISFIED.

**CHRYSTUBE MANUFACTURING Co. Ltd.**

Dr. C. G. LEMON, F.Ph.Soc., A.M.I.R.E., Director.

No. 7 Factory, Waddon, Croydon, Surrey

## CAN YOU RELY on your H.T. supply?

Are you sure that when you invite your friends in to see your television demonstration you will not experience a "mid-programme fade-out"? Do you know that your favourite broadcast will not be spoilt due to a failure of your high tension supply?



A Westinghouse Metal Rectifier never lets you down. It will deliver a constant undeteriorating high tension supply for as long as the set itself is in use . . . and longer. No more rectifier valve renewals. No replacements of any description.

If you are on A.C. Mains you cannot afford to be without a Westinghouse Metal Rectifier. 3d. in stamps will bring you full details in the form of our attractive booklet "The All Metal Way, 1935."

The Westinghouse Brake & Saxby  
Signal Co., Ltd.,

82, York Road, King's Cross, London, N.1.

## YOU CAN IF YOU USE WESTINGHOUSE METAL RECTIFIERS

When replying to advertisements, please mention "Television"

# MERVYN SPECIAL ANNOUNCEMENT!

## Sensational Advance

in the NEW

# DUPLEX NU-GLO 16

## TELEVISION LAMP!

Provisional Patents

Two lamps in one—can be used in a variety of circuits.

PRICE **12/6** ONLY.  
NO INCREASE.

The new Mervyn Duplex Nu-Glo 16 marks the most important advance yet in Television Lamp production. Available as either Nu-Glo 16 or 20 types, the new Duplex lamps give double the ordinary area of glow. Each glowing area can be used separately; neither obscures the other. Virtually in purchasing the new Duplex you buy two standard Nu-Glo lamps in one bulb. Experimenters can use a variety of circuits with the Duplex lamp. It can be operated as the standard Nu-Glo, and if required will carry twice the current of ordinary Television lamps. All light is scientifically conserved and reflected to the disc.

**THE LAMP THAT ALLOWS YOU TO EXPERIMENT WITH MANY CIRCUITS.**

**TECHNICAL DETAILS:**

Striking Voltage, 180 volts to 200 volts. Current for full coverage of each glowing electrode—6 m.a. Low Self Capacity. Maximum steady current for each glowing electrode 30 m.a. D.C. Maximum double electrode current 55 m.a. Colour of light, Rich Nu-Glo Yellow Orange of high intrinsic brilliance.

**IF YOU WANT BETTER VISION, SEND AT ONCE FOR THE NEW DUPLEX NU-GLO LAMP.**

The **MERVYN**  
**SOUND & VISION Co. Ltd.,**  
4, Holborn Place, LONDON, W.C.1.

Managing Director : W. J. Nobbs.      Phones : Holborn 6332 and 7709.  
French Office : 8, Square Henri-Delormel, Paris, 14e.

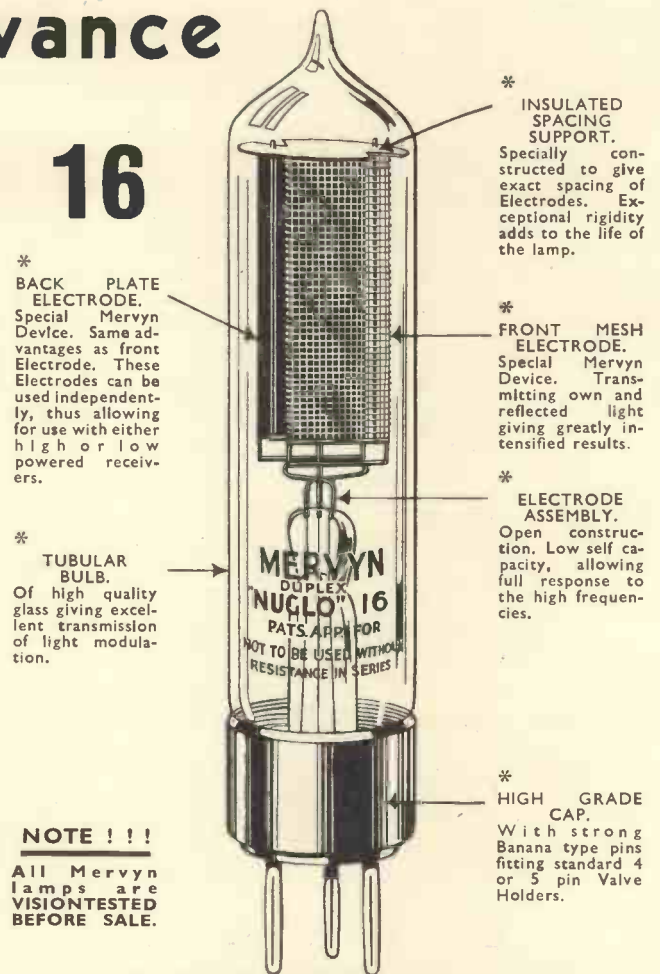

**NOTE!!!**  
All Mervyn lamps are VISIONTESTED BEFORE SALE.

**MERVYN**  
**POPULAR TELEVISION KIT**  
*DEFINITELY brings Pictures into your home.*

Although offered at the low price of £3, the set of parts includes the famous Mervyn Nu-Glo 16 Lamp, which was exclusively specified in the popular *Daily Express* Kit. Here is a great opportunity for the enthusiast to obtain for a small outlay a complete set of tested parts that definitely will bring pictures into the home.

**LIST OF PARTS INCLUDED IN THE MERVYN TELEVISION KIT.**

(1) 1 B.D. 4 disc 15½ in. Diameter	6/-
(2) 1 B.M. 3 universal motor	20/-
(3) 1 pair Motor Brackets	5/6
(4) 1 Variable Resistance	6/6
(5) 1 Fixed Resistance	4/-
(6) 1 Lamp Holder	9d.
(7) 2 Pairs of Terminals and Blocks	2/-
(8) 1 Mervyn Nu-Glo 16 lamp (as used in the <i>Daily Express</i> Kit)	12/6
(9) Base board parts	3/6

**PRICE OF PARTS ... 60/- COMPLETE**  
Write to-day FOR FULL DETAILS.

Advertisers like to know you saw it in "Television"

# TELEVISION

THE FIRST TELEVISION JOURNAL IN THE WORLD

## Special Features in this Issue

	PAGE
A Universal Receiver for Mirror Drum or Cathode Rays ... ..	476
Valves for the Microwaves ... ..	480
Home-made Nicol Prisms ... ..	481
Displaced Multiple Scanning ... ..	483
An Adjustable Lamp Holder for Mirror-drum Projection ... ..	485
Studio and Screen ... ..	487
Television Terms Explained ... ..	489
The Whole Problem of Synchronising Recent Developments ... ..	493
Transmitting and Receiving System Used by Safar ... ..	499
The Simplest Cathode-ray Receiver ...	501
Getting Results with the Disc Screen Projector ... ..	503
Current for the Lab. ... ..	507
The Stroboscope Effect ... ..	511
Hum and the Cathode-ray Tube ...	513
An Experimental Television Camera ...	516
The White Light Lamp ... ..	518

## TELEVISION

Proprietors:

BERNARD JONES PUBLICATIONS, LTD

Editor-in-Chief:

BERNARD E. JONES.

Editor:

H. CORBISHLEY.

Editorial, Advertising and Publishing  
Offices:

58-61, Fetter Lane, London, E.C.4.

Telephone: Central 4341 (four lines).

Telegrams: Beejapee, Fleet, London.

Subscription Rates: Post paid to any  
part of the world—3 months, 3/6;  
6 months, 6/9; 12 months, 13/6.

Published Monthly—1/- net.

(Last Wednesday in every month for  
following month).

Contributions are invited and will be  
promptly considered. Correspondence  
should be addressed according to its  
nature, to the Editor, the Advertisement  
Manager, or the Publisher, "Tele-  
vision," 58-61, Fetter Lane, London,  
E.C.4.

## COMMENT OF THE MONTH

### *Can the 30-line Transmissions be Improved?*

WE understand that in certain official quarters at the B.B.C. the opinion is held that the thirty-line transmissions have now reached a stage when no further improvement is possible; in other words, the entire possibilities of low-definition television have now been explored and fully developed. This is an opinion with which we cannot by any means agree, despite the skill and care which it is evident have been bestowed upon these transmissions both by producer and engineers. It surely cannot be contended that the scanning device which is at present used is the last word in apparatus of this kind. Experience must have shown that in some respects it is not ideal and there is no doubt that were it redesigned a considerable improvement could be effected. Correct focusing with the present system depends almost entirely upon the skill and judgment of the engineer who operates the scanner; it does not require a great deal of imagination to realise that this operation could be made semi-automatic or at all events that the focusing control could be considerably simplified. It is perhaps natural that at this juncture the B.B.C. are not prepared to spend money on new apparatus, but it is certainly a fact that it could be bettered.

Noticeable improvements have been made in studio technique and presentation even during so short a period as the last three months, so who can say that finality has been reached now? Then there is the matter of synchronism which, as explained in an important article in this issue, is so closely bound up with presentation. Trouble in this respect will mar any programme and it is a feature which requires the closest co-operation between producer and engineers. If transmission technique can be developed so that it simplifies reception, and we contend that much still remains to be done in this direction, then the benefit will quickly become apparent.

It is rather remarkable that no attempt has been made to utilise films for the thirty-line transmissions. We are well aware that there are certain reasons for this, but in our opinion they do not seem sufficient to exclude their use; in fact we venture to say that use of the film would provide much useful information which would be of value and in all probability lead to improvements in many directions.

### *The Saturday Afternoon Broadcasts.*

Approval of the Saturday afternoon transmissions is general; trade and public alike have acclaimed this innovation as the most helpful gesture in regard to television which the B.B.C. has made since the inception of the television broadcasts. And may we add a word of commendation of the first few of these matinee programmes which have been of particular excellence. The one fly in the ointment is that some listeners have difficulty in receiving the sound programme from Midland Regional during daylight hours, but this is a trouble which should disappear when the new Midland Regional transmitter is installed.

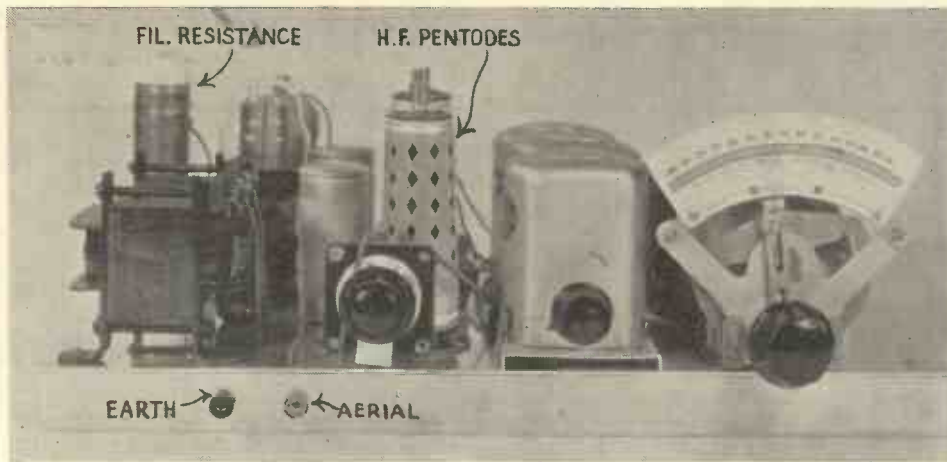

*A front view of the receiver showing the principal components.*

**T**WO high-frequency stages, followed by either a Westector, which can be tapped and fed into a power amplifier for mirror-drum work, or alternatively coupled to a triode amplifier which will give the required 30 volts for a cathode-ray tube. We have therefore a dual-purpose receiver which will answer equally well for either system. But I have gone a step further than that. By using universal mains valves with 13-volt heaters the receiver can be used on A.C. or D.C. mains without alteration. The saving in cost over the standard A.C. set is also very considerable.

### Points in the Circuit

All the frills have been cut out, while the components have been chosen to give the best possible results. In some cases you may think that a component here or there could be cheaper, but unless you do know the whys and wherefores of receiver design you will be well advised to make the receiver using the parts specified.

First of all the coils. These are of the iron-cored type and are mounted on a chassis complete with internal switching. The first coil nearest to the front of the receiver is the aerial coil. You will notice from the circuit that this coil is shunted with a .0003 differential reaction condenser. This condenser acts as a volume control and makes quite sure that the receiver cannot possibly overload. The input to the first valve can be regulated to prevent distortion at the very beginning. So many sets have a post detector volume control and no means of preventing overloading of the high-frequency stages.

The second coil is a high-frequency transformer. I chose this method of coupling for it enables the most to be obtained from the high-frequency pentodes and at the same time does away with the high-frequency chokes and coupling condensers. Incidentally selectivity is better when using Varley high-frequency transformers, for they are switched on both primary and secondary, so optimum results are obtained on both wavebands.

Both of the high-frequency pentodes have a small fixed bias permanently in circuit. This is for two reasons. First, as they are of the variable- $\mu$  type the anode current would be high with zero bias. Second, with a slight bias the grid acceptance is increased,

# A UNIVERSAL MIRROR CATHO Designed by

*The receiver described in this article is universal in every way used on any mains, either alternating or direct current; in tube or by the omission of the last valve it can be used in cathode-ray drum or other mechanical scanner. It thus*

allowing for a greater output and greater freedom from distortion.

As a detector there is the Westector which gives distortionless rectification so necessary with a television receiver. On the low-frequency side of the Westector is the normal coupling circuit, but instead of taking the output straight to the grid of the low-frequency amplifier the circuit is broken and taken to two sockets.

### Alternative Use

If you want to use a mirror-drum receiver the output of the Westector can be taken straight to the grid of the first valve in a power amplifier. On the other hand, should you want to use a cathode-ray tube which only requires 30 volts input for full modulation, then the two sockets can be joined together and the output taken from the two terminals marked A and C.

The output circuit from A and C has been arranged for cathode-ray work which accounts for the massive



*This photograph shows the two output terminals for the cathode-ray tube.*

# RECEIVER

OR

# DRUM

R

# DERAYS

Kenneth Jowers

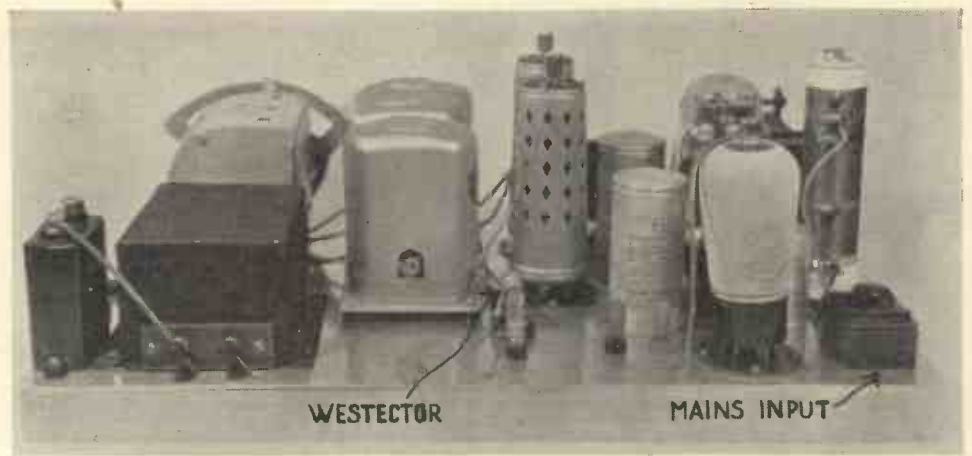

A rear view showing the Westector mounted in clips for ease of reversal of phase.

way. It employs universal valves which allow of its being its complete form it is suitable for reception on a cathode-ray junction with an amplifier for the operation of a mirror-fulfils every requirement for television purposes.

low-frequency choke in the anode circuit of the H30 valve. This choke was made specially for this receiver.

A power pack has been included, so the receiver is entirely separate and independent of the normal sound receiver.

Do not have any qualms on the score of stability. On the high-frequency side the receiver is as stable as a house, both anode circuits have been decoupled as much as is required, so if you follow the layout the receiver is guaranteed to work from the time you first switch on.

On the low-frequency side there is again adequate decoupling and even when the Westector was coupled to an amplifier by means of long leads (provided they were shielded) no trouble was experienced.

## For Use on Any Mains

Remember the receiver is suitable for any mains from 190 to 250 volts A.C. or D.C. with any frequency A.C. There is a condenser in the earth lead so there will not be any trouble on D.C. mains and as there is a double-pole on-off switch there is no leak through the isolating condenser when the receiver is used on A.C.

This is one of the easiest receivers to build I have ever designed, and if you go about it in the right way you will agree with me. First of all cut the holes for the valve holders. Mark out the positions and cut the holes with a centre bit. Cut away until you almost get through the base-plate and then turn it over and go through from the other side. In this way the hole will be cut nice and cleanly. Then fix the electrolytic condensers, fuse holder and voltage dropping resistance and finally the smoothing choke.

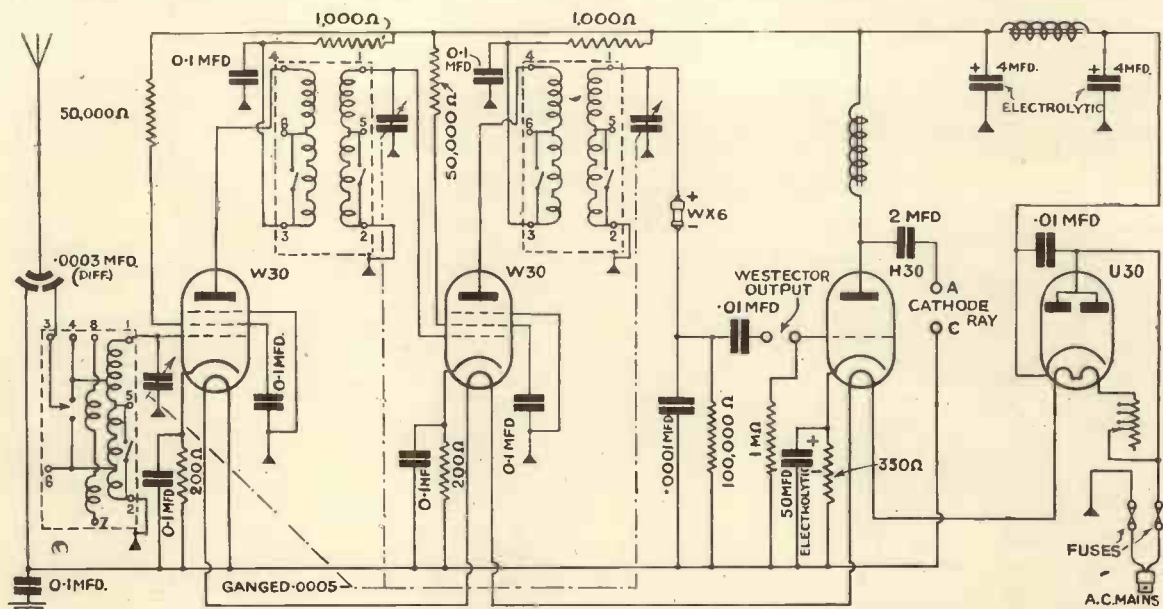

This is the circuit diagram which incorporates two high-frequency pentodes with tuned transformer coupling, Westector for detection enabling a reversal of the image to be made, resistance-capacity coupling on to a triode output for feeding a cathode-ray tube.

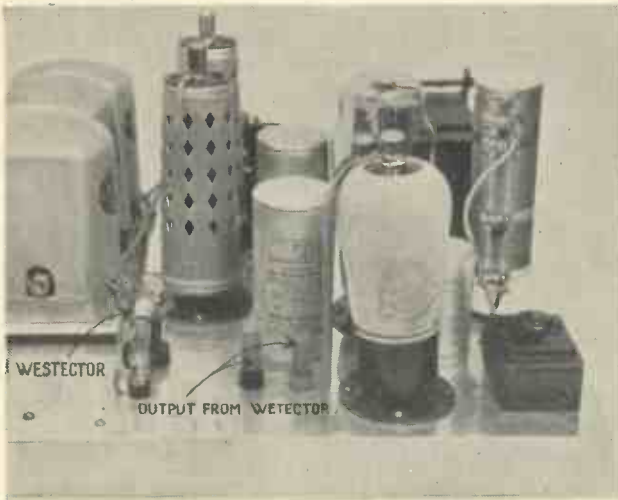

This photograph shows the output terminals from the Westector for use with a mirror-drum; for cathode-ray television these terminals are shorted.

Next turn your attention to the three-gang variable condenser. This is of the midget type and you will find it easy to fix, for the makers supply a template with it.

The coil chassis is fitted by means of four bolts so that will be easy. When you fix the volume control remember that the spindle must be isolated from the bracket otherwise you will not get any signals through to the grid of the first W30. One side of the volume control is connected underneath the bracket. The centre goes to the aerial socket while the remaining side goes to terminal No. 3 on the aerial coil.

All the connections on the top of the base-plate are of a simple nature so that will not cause any trouble. Turn the base-plate over and see how most of the fixed condensers are anchored by means of the connecting wires.

By the way, a good percentage of the components are connected to the metal base-plate. So as to make these connections quite clear they have been indicated by means of a black triangle. Remember that every wire with a black triangle against it must be connected to the chassis.

The Westector, which is of the WX6 type (not a W6) is mounted in a grid leak holder so that it can be changed round if negative images are received.

You will want a quantity of small 6 B.A. nuts and bolts for fixing the components. Get brass ones for they can be used as terminal points as wires can be soldered to them. There is only one connection to the electrolytic condensers, the negative side is automatically earthed to the chassis.

## Wiring

All wires must be covered with sleeving and remember the wires that go through the base-plate must not be pulled too tight or the sleeving may fray against the sharp edges of the hole and so cause a short circuit.

You may remark on the absence of reaction. On test it was found that the receiver gave ample volume without reaction even under very bad conditions. As the reaction control would have been a passenger and as I did not want any spare knobs it is not necessary. By the way, have you noticed the novel chassis? This is made of sheet aluminium 16 in. by 10 in. with some  $\frac{3}{4}$  in. aluminium angle along the back and front edges. In this way anyone can make a simple chassis with the minimum expense and trouble.

The tuning dial is calibrated in wavelengths, so you will have little or no difficulty in finding the stations. It should be possible to receive television broadcasts in any part of the country when used with either cathode-ray or mirror-drum equipment.

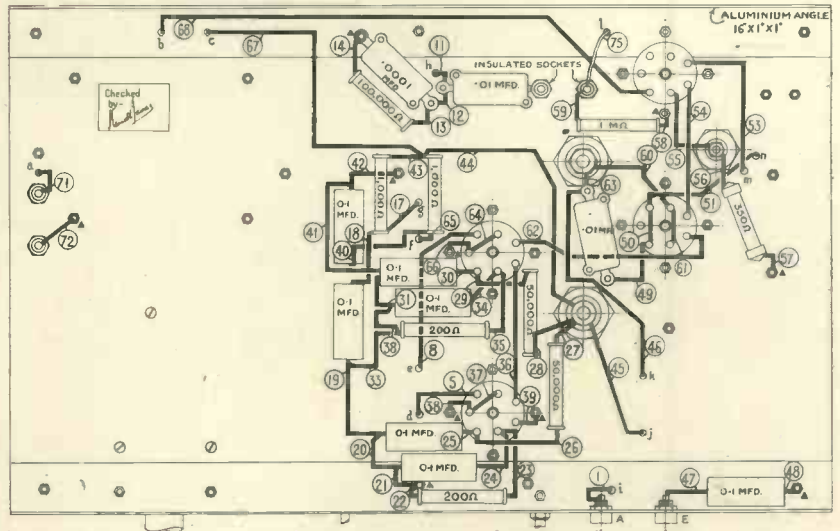
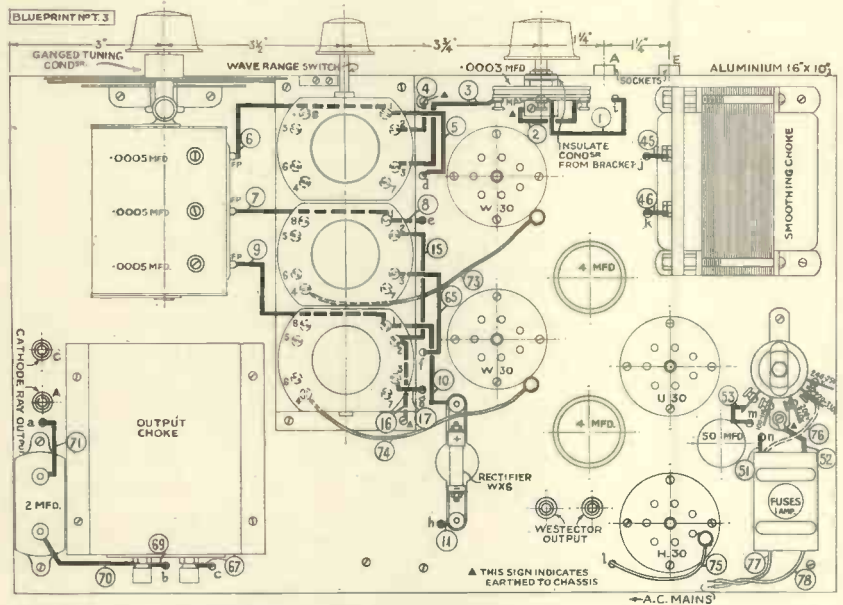

The layout and wiring diagram of the receiver. A full-size blueprint of this can be obtained from TELEVISION offices, price 1s. 6d.



Automatic-volume-control can be fitted very simply, and it may be advisable if the receiver is used at a distance from the transmitters. A simple Westector circuit will do quite well and should be fitted in the usual

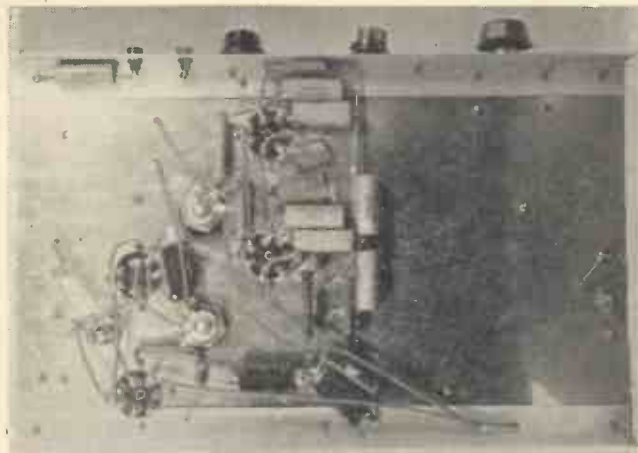

A view of the underside of the chassis of the Universal receiver.

way. Any readers wishing to make this addition can obtain diagrams from the Query Department of this paper.

### Trimming and Operating

Trimming the condensers is usually a troublesome matter if you have not any meters, but in this set, as the coils are so well matched, you will not have any trouble if you go about it in the right way.

Tune in the local station and then adjust the trimmer on the first condenser to give maximum volume. Follow this with the second and then the third, adjusting the main tuning control every time. Finally, go over all the trimmers a second time with the set tuned to a more distant station.

The setting of the trimmers will not alter if you should change your aerial system for the actual aerial load is isolated from the receiver by means of the volume

### PARTS FOR THE UNIVERSAL RECEIVER.

- |  |  |
|--|--|
| <b>BASEBOARD.</b><br>1—Aluminium 16 in. by 10 in. with two aluminium angle strips 16 in. by 1 in. by 1 in.   | <b>HOLDERS, VALVE.</b><br>4—Clix seven-pin, type chassis mounting.   |
| <b>CONDENSERS, FIXED.</b><br>3—Dubilier, type 670, values —.001-, .01-microfarad (2).<br>6—Dubilier, type 4403, value —1-microfarad.<br>1—Dubilier, type BB, value —2-microfarad.<br>2—T.C.C., type electrolytic, value —4-microfarad.<br>1—Franklin, type electrolytic, value —50-microfarad. | <b>PLUGS, TERMINALS, ETC.</b><br>6—Clix plugs and sockets, marked Aerial, Earth, L.S.+, L.S.—, Output+, Output—.<br>3—Clix metal anode connectors.   |
| <b>CONDENSERS, VARIABLE.</b><br>1—J.B., three-gang .0005-microfarad, type Baby Gang with plain type Arcuate drive.<br>1—J.B..0003-microfarad differential.   | <b>RECTIFIER.</b><br>1—Westector, type WX6.  |
| <b>COILS.</b><br>1—Varley three-gang unit, types BP50, BP51 (two).   | <b>RESISTANCES, FIXED.</b><br>9—Erie, type 1-watt, values —200- (2), 350-, 1,000- (2), 100,000-, 50,000 (2), 1-megohm.<br>1—Bulgin, type MR53.   |
| <b>CHOKES, LOW-FREQUENCY.</b><br>1—Savage, type L34.<br>1—National Radio Service, type 63.   | <b>SUNDRIES.</b><br>1—Graham Farish horizontal resistance holder.<br>Connecting wire and sleeving (Gol-tone).<br>1—1½ in. metal mounting bracket.<br>1—Insulating bush with ½ in. hole.<br>4—Doz. ½ in. 6BA round head steel bolts, and nuts (Adams).<br>2—Yd. thin flex (Gol-tone). |
| <b>HOLDER, FUSE.</b><br>1—Bulgin twin, type Fig.   | <b>VALVES.</b><br>2—Marconi W30.<br>1—Marconi H30.<br>1—Marconi U30.   |

control condenser. The tapped resistance is calibrated and this must be adjusted to suit your mains supply voltage, otherwise the valves will either be over or under run. Either way will cause a decrease in the effective life.

Selectivity is approximately 11-kilocycles, more than enough for a television receiver, as it gives good enough separation, with good top note response. Volume from the H30 is small when judged by loud-speaker volume standard as it does not rise above 200 milliwatts, but this is ample for a cathode-ray tube.

If you want to receive radio programmes in the usual way it will be necessary to add another stage of low-frequency amplification or to change to pentode output with a valve such as the Mazda AC/2Pen, which only needs 3 grid volts r.m.s. to give a maximum output of 3,400 milliwatts.

Taking the receiver from every angle it will meet the needs of most television amateurs, irrespective of mains supply. The cost is reasonable, it is easy to build, and the efficiency is above reproach.

### BENNETT ACCESSORIES

The Bennett Television Co., of Station Road, Redhill, have submitted samples of several useful accessories for visors of the disc type. These include a 4-in. diameter biconvex lens in a metal-clip type mount, an apertured mask in dull black metal of 4½ in. centre height, and an aperture 30 scanning holes wide, and also a pair of motor mounts. A test of the lens proved that it was practically non-distorting and the glass is particularly clear. The above accessories are shown in the accompanying photographs, and in each case the finish is excellent.

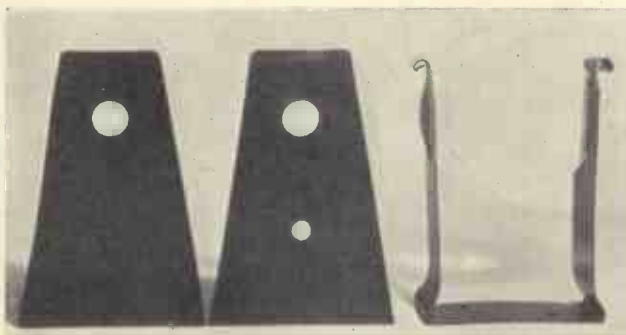

From left to right these photographs show the pair of Bennett motor mounts, the 4½-in. lens and clip type mount and the metal apertured mask for disc machines.

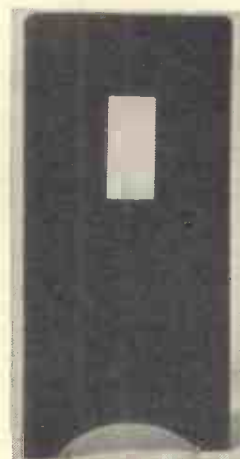

# VALVES FOR THE MICROWAVES

Here are some particulars of a special type of valve that has been developed for use on centimetre wavelengths and which have now passed the laboratory stage. It appears probable that they will be suitable for television purposes.

AS far back as in the early part of 1933 rumours of special midget or acorn valves for the ultra-short waves were prevalent. The Westinghouse Company, at their laboratories in Pittsburg, spent considerable time and money on the de-

The R.C.A. Company, of New Jersey, U.S.A., have just announced first details of some really interesting valves for use on the centimetre waves.

So far these valves are of the general-purpose type, but they can be

$\frac{1}{2}$  in. This will give you some idea of the size of the electrodes and the minute clearances between them. As was to be expected, the first valve to be produced was of the triode type and suitable for mains operation. They have an A.C. resistance of between 10 and 15,000 ohms with a slope of 1.5 milliamperes per volt.

In order to realise the maximum heater power a cylindrical anode has been used. Electrode spacings are approximately .005 in., which has been found to be the smallest value possible, if the manufacturing costs are to be kept to a reasonable level. As you will see from the illustration, the lead-out wires are kept very short, and taken directly from the electrode concerned. In this way the inter-electrode capacity is kept to a very low level.

The construction is more or less conventional for the cathode, grid and anode supports are all anchored to mica bridges, while the circular getter pan is also clipped to this support.

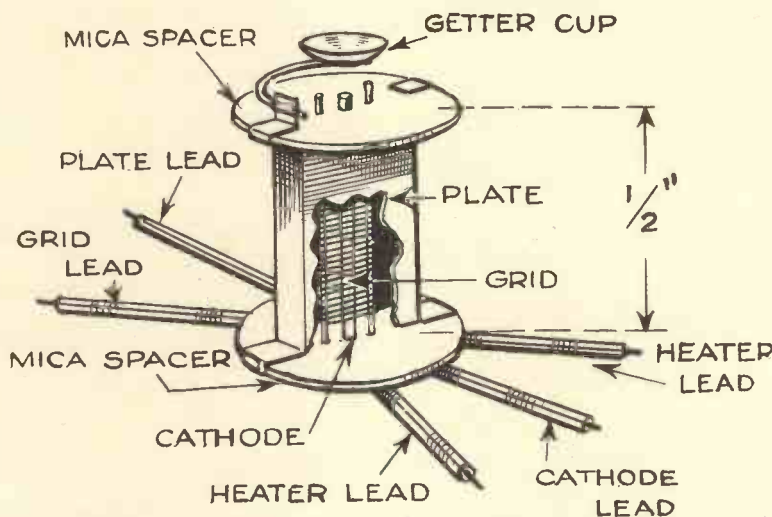

The electrode construction of the new acorn valves. All the electrodes are anchored to a mica bridge at the top and bottom.

## Down to 40 Centimetres

This type of valve will operate quite well down to 40 centimetres when used in conventional circuits, so it opens up a new field of experiment in opposition to the magnetron which has so far held sway. Valves of the screen-grid type are in the course of development, so it does not seem unlikely that television receivers for 1-metre working will be an accomplished fact.

These valves do not, of course, have any type of valve holder, as the connecting wires are of heavy gauge, come through the actual glass bulb and are interconnected with the normal receiver wiring.

At the moment one is restricted to a simple two-valve receiver, for in addition to detecting and oscillating down to the low wavelength of 40 centimetres, these valves are also suitable as low-frequency amplifiers. The output will, of course, be very small, but sufficient for cathode-ray modulation.

velopment of special ultra short-wave valves, while other companies were forging ahead with ideas on similar lines.

Primarily, the scheme behind it all was to obtain some measure of high-frequency amplification, down to wavelengths in the order of 4 to 5 metres.

As is generally known, when screen-grid valves are used below a certain wavelength the inter-electrode capacity effectively stops any possibility of high-frequency gain, while it is well known that beyond certain frequencies the wide electrode gaps, renders it impossible to obtain any degree of amplification.

These troubles were overcome by the design of midget valves with microscopical clearances between electrodes, which gave very good results in the laboratory. Actually, the valves were more or less standard valves with the size of the electrodes and the clearances between them scaled down in proportion.

made commercially, which is saying a great deal.

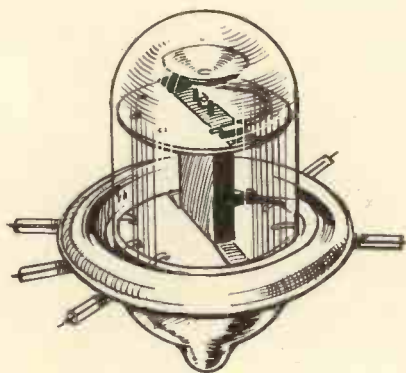

Valve-holders are not necessary with this type of valve as all the wires are brought directly through the glass.

The overall dimensions of the electrode assembly are approximately

# HOME-MADE NICOL PRISMS

By A. H. Berry, M.Sc. (Lond.)

Here are instructions for making a very efficient substitute for the Nicol prism for experimenting in television reception. Even if you do not intend building a television receiver, it will be found that with the simple unit described quite a number of entertaining experiments can be made illustrative of the principles employed in reception.

IN order to obtain a picture on our screen, the light must be modulated by the television signals. The simplest way of doing this is to use the amplified signals to raise or lower the brilliancy of the lamp. This change in brilliancy must, however, take place in a very short time indeed, so

Let us suppose that the line PQ (Fig. 2a) represents the direction of travel of light, i.e., PQ is a ray of light, the direction of disturbance could be as shown by the line AB at right angles to PQ. AB is, however, not the only possible direction of vibration, since there are an infinite

If the two shorter diagonals of the diamonds are parallel, AB and CD of Fig. 3, the light can pass through with but little absorption, but if they are at an angle (AB and EF) less light will pass, and if they are perpendicular (CD and GH) practically no light will pass through at all. In this last case the Nicols are said to be "crossed," and we have the rather curious phenomenon of two transparent objects combining to form an opaque one.

The Nicols of Fig. 1 are crossed, so that in the ordinary way no light gets through to the mirrors and screen, but supposing that after the light has passed through the first Nicol, its direction of vibration is changed by some means, what will happen? To fix our ideas suppose AB (Fig. 4) is the direction of vibration of the polarised light, then CD will be the direction of the shorter diagonal of the second Nicol (the light is supposed to be travelling through the paper). Now if by some means we change the direction of vibration to EF, some of the light will be able to get through the second Nicol, and we shall have the screen illuminated by an amount which will depend upon how much the direction of vibration

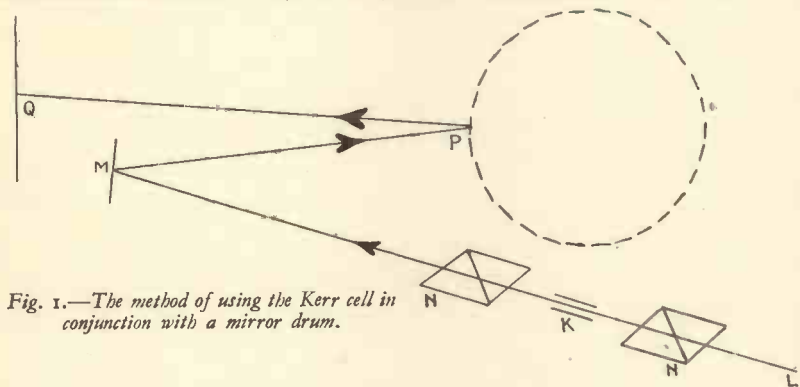

Fig. 1.—The method of using the Kerr cell in conjunction with a mirror drum.

that an ordinary metal filament lamp is quite useless. Neon and similar gas lamps are practically instantaneous in action and can be used, but are open to several objections, the chief one being the amount of light that can be obtained, which is insufficient for large screens.

Fig. 1 shows the method of modulating light by means of a Kerr cell and Nicol prisms. The light from L passes through Nicol prisms N before reaching the mirror m (only one ray of light is shown, and the necessary lenses have been omitted for simplicity). Between the Nicols is placed a Kerr cell κ. This Kerr cell consists of metal plates A and B immersed in a liquid, generally nitrobenzene, and the output terminals from the receiver are connected to these plates.

How does this modulate the light? To see this we must consider the nature of light itself. As is well known, light has the same nature as the waves used in wireless, i.e., light is a wave motion which in general travels in straight lines (the "ray" PQ (Fig. 1), for instance, is merely a line showing the direction of travel from the drum to the screen), but the vibration of the wave is always at right angles to the direction of propagation of the disturbance or wave.

number of lines perpendicular to PQ as shown in Fig. 2b, in which the point Q is the end of the line PQ, i.e., our ray of light is now travelling vertically upwards through the paper, then the direction of vibration may be along any of the lines AB, CD, etc. If the light is passed through a Nicol prism it is found that the emergent

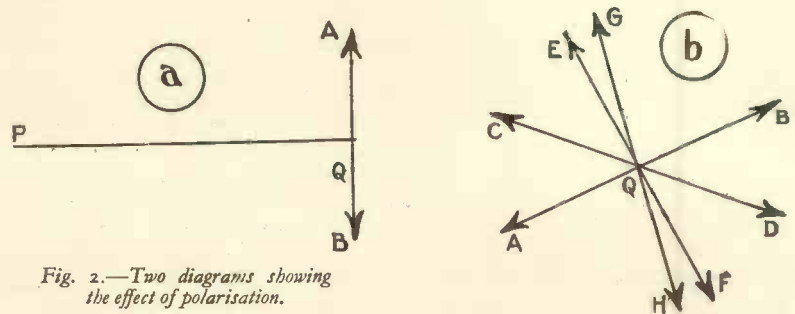

Fig. 2.—Two diagrams showing the effect of polarisation.

light is "plane-polarised," that is, the Nicol only allows light the vibrations of which are in one particular plane to pass through it. The ends of Nicols are roughly diamond-shaped (Fig. 3) and the light which emerges from the Nicol is vibrating in the direction of the shorter diagonal of this diamond (AB or CD of Fig. 3).

Now suppose this plane-polarised light is sent through another Nicol.

has been changed, i.e., full illumination for a twist through a right angle, and lesser amounts for lesser twists.

The liquid nitrobenzene in the Kerr cell has this property; when it is subjected to electric strain, such as it experiences when a potential or voltage difference is applied to the two small plates in the cell; it twists the direction of vibration of polarised light passing through it, and subject

to certain limits we may say that the bigger the voltage difference between the plates the greater will be the amount of twist, and hence the greater the amount of light passing through the second Nicol and reaching the screen. We thus have a

est in the present connection happens to the light while it is actually passing through the glass, so that it is not the thickness of the latter but the number of plates that is important. The thicker the glass is, the more light will it absorb, and hence for the

are perfectly clean; it will generally be found that they are quite clean when obtained from the supplier, and it is best to handle them as little as possible for two reasons; firstly, they are very thin and fragile, and secondly, the grease from human fingers is rather difficult to remove completely from glass. Cleanliness is very important.

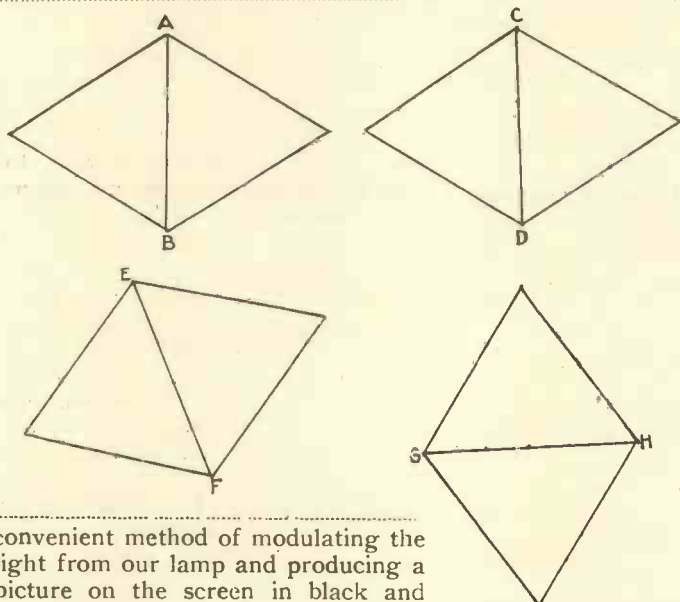

Fig. 3.—The effect of passing plane polarised light through second Nicol prism.

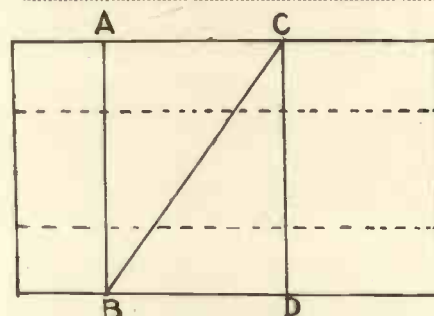

Fig. 5.—Method of cutting the cork to support the glass plates.

convenient method of modulating the light from our lamp and producing a picture on the screen in black and white.

The Nicol prisms used in connection with the Kerr cell are somewhat expensive. They are made of Iceland spar.

There is, however, a very effective substitute for Iceland spar which does not seem to be very well known to experimenters. This is known as

best results a fairly large number of thin plates is required.

Such a pile of plates, if carefully constructed, will then produce practically the same effects as a Nicol; the only difference when used with television apparatus is that the dark parts of the picture are not quite so black as when Nicols are used, since there is always a small amount of ordinary light passing through the Kerr cell. None but a trained eye, on the look-out for the effect, would, however, be able to observe it.

The construction of a prism of this type is a very simple matter and the cost but a few pence. The materials required are: Two good corks 1 in. diameter and about 2 in. long. Ten or twelve microscope cover glasses (obtainable from any microscope dealer),  $\frac{3}{4}$  in. wide rubber tape. Cork borer,  $\frac{1}{2}$  in. (A cork borer consists of a short length of thin-walled brass tube sharpened at one end.) Old razor blade.

First bore a clean hole  $\frac{1}{2}$  in. in diameter through the cork. Then with an indelible pencil draw a ring round the outside of the cork, at a distance of about  $\frac{1}{2}$  in. from one end (AB, Fig. 5);  $1\frac{1}{2}$  in. from this ring draw another (CD). Then make a clean cut through the cork from the top (C) of one ring to the bottom (B) of the other.

Make sure that the cover glasses

Now place five or six of the glasses between the pieces of cork as shown in Fig. 6, and wrap pure rubber tape (not black adhesive tape, as this will become soft and sticky because of the heat from the lamp) round the two parts of the cork, pressing them together firmly during the process. A small vice or clamp is very useful here. Your Nicol substitute is now complete.

After having made the two necessary piles, test them by putting them end to end and looking at the sky through them. It will be found that as one is rotated with respect to the other that in one certain position the sky disappears almost completely,

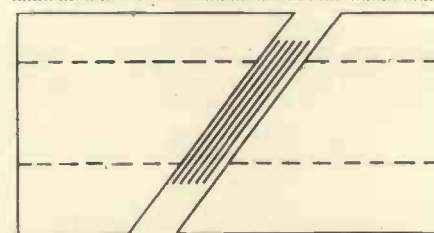

Fig. 6.—Showing the assembly of the home-made Nicol prism.

whilst on turning one of them through a right angle from this position the light coming through is hardly affected at all.

Even those experimenters who already possess a pair of Nicols will find it worth while to make a pair of piles, for use when working with intense sources of light. Nicols are very easily damaged by heat, but the cover glasses used in the pile are so thin that the danger of cracking them is very slight.

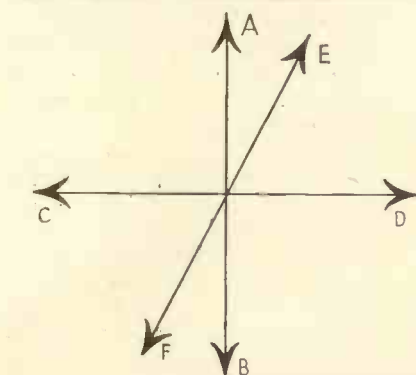

Fig. 4.—Showing how the combination of two Nicols allows a portion of the light to pass.

the "pile of plates," and it can quite easily be constructed at the cost of a few pence by any experimenter with a little patience.

It is found that after the light has passed through six or eight plates in a certain direction that 80 to 90 per cent. of the transmitted light is vibrating in one plane only, and only light vibrating in this direction is transmitted. Notice that nothing of inter-

# DISPLACED MULTIPLE SCANNING

## A Method of Improving the Quality of Pictures

By Robert I. Rosenfelder.

THE quality of cinema pictures of to-day, with normal frame frequency, normal brightness, and normal dimensions for being viewed is entirely satisfactory. To reach that standard of quality is the aim in the development of television.

In the production of a television picture only one method is used to-day. It consists in scanning the screen with a beam of light which is modulated in its intensity according to the corresponding elemental areas of the synchronously scanned picture at the transmitting end. Scanning

*Here is an interesting discussion on the advantages of displaced multiple scanning which the author claims would result in increased brightness and better definition. It is understood that experiments using this method are now being made, so there is the likelihood that more will be heard of this system.*

prove the brightness of the television picture by using more than one source of light, each of which scans a zone or alternate adjacent lines. This arrangement would only be practicable were all the light sources always of the same intensity and modulated equally. If that requirement is not strictly fulfilled, the picture will lose its quality in spite of increased brightness.

Suggestions have been made for making use of several equally modulated sources, which by constant superposition of their spots ("multiple scanning, undisplaced"), would give a picture, the brightness of which is according to the number of light sources used. Practical difficulties, however, are still to be overcome, especially the achieving of constant optical imposition of the spots. For this reason, these systems are not

likely to be of really great practical value.

In spite of the wider frequency range which might be required for reproducing the pictures, the new method about to be described is, the writer contends, more suitable for practical use.

This new method of producing television pictures may be described as "a displaced multiple scanning system." It, therefore, consists in

the production of pictures in a way that before a complete picture is obtained by one source of light by means of its scanning device, the rest of the light sources are producing new complete pictures by means of the same scanner or others. At each instant, therefore, the image is scanned simultaneously by separate light sources, the scanning commencing at different points of the image. Not only all technical and economical drawbacks of the above-mentioned systems are avoided by this method, but the following chief advantages are also secured.

By using several sources of light, the desired increased brightness is obtained, and if the rows are caused to overlap each other there would be more detail, and distortion would be reduced. Animated scenes, especially, would be presented with greater clarity and reduced distortion. Also flicker would be considerably lessened.

### Displaced Scanning Explained

The following explanation will make the matter clear. With the present system of scanning an object of the form of a constantly moving point can only be recognised as moving if its velocity is less than the scanning speed in the direction of the lines or transverse to them. Otherwise nothing at all will be visible of the object, or only a part of the way it actually travelled, or parts of the way with the appearance of beads on a string. The well-known sloping distortion of rod-like objects standing vertically and moving with constant speed in a transverse direction (Fig. 1a and b), cannot be avoided either with present methods. This distortion limits transmission to comparatively slow movement and requires observance of certain rules regarding direction of movement and scanning; also, it is necessary to choose a frame frequency considerably above that which would suffice to produce the stroboscopic phenomenon. If, in

*(Continued at foot of next page.)*

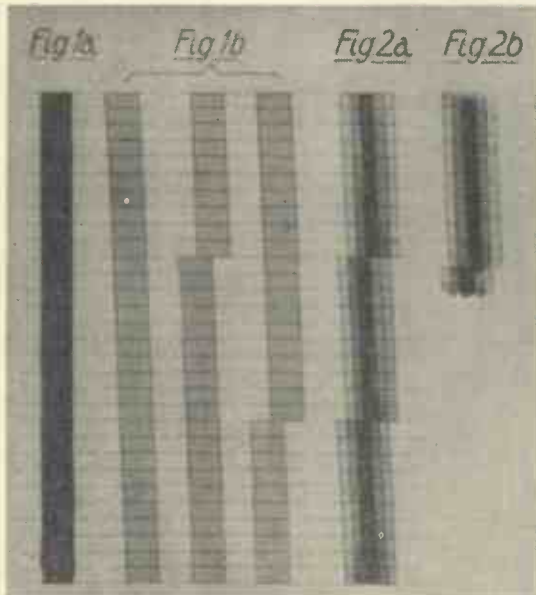

*A perpendicular rod seen in a 30-line low definition. Scanning horizontally.*

- Fig. 1. — The rod not moving.*
- Fig. 1b. — The moving rod being once scanned, its appearance is changing according to phase of the scanning beam.*
- Fig. 2a. — The moving rod scanned simultaneously by three beams, the phases of which are displaced, acc. Fig. 1b—c.*
- Fig. 2b. — Displaced multiple scanning, according Fig. 2a, with overlapping scanning lines.*

in the receiver is accomplished by scanning line after line of a screen, or viewing the modulated source of light by means of a scanning device. The picture obtained by this method is only distinct if one elemental area of the whole picture is viewed under an angle less than 1 to 3 minutes. Diminishing these values will not at all increase the quality of the pictures, especially animated ones.

Theoretically it is possible to im-

spite of all this, flickering is apparent, it is due to the still occurring distortion of the actual path of the movement, the correction of which is left to the eye of the spectator. The eye, already tired by the bridging of the changes of the pictures, does this additional corrective work only with great difficulty and fatigue, so that soon the flickering becomes increasingly noticeable.

Mention must also be made of the

flickering phenomenon that regularly occurs with the spontaneous opening or closing of the eyelid when watching the picture.

### Reduced Flicker

It is the writer's contention that pictures transmitted in the new way are much less subject to these drawbacks, the distorted pictures produced by one light source being corrected

by the pictures of the others while being created (Fig. 2a). In consequence of the overlapping of individual pictures the result is a well corrected, and almost flickerless picture instead of a succession of fleeting distorted pictures, as shown in Fig. 1. Also it is not necessary to use high frame frequency together with all the associated transmitting difficulties connected with it. On the contrary, even a lowering of frequency may be possible (within certain limits, of course) without any essential loss of quality of the picture.

Adopting the new displaced multiple scanning in systems with rotating scanning devices, such as revolving discs or mirror-drums, etc., allows of a reduction of the number of revolutions according to the number of light sources adopted and the disposition of the spots projected by them. If the rows of these out-of-phase spots are partially overlapping each other a still further increase of the quality of the picture is secured, for by filling up the jags of the sloping lines, the impression of high definition is created with comparatively low definition scanning (Fig. 2b).

In this way, the new method of displaced multiple scanning makes possible pictures of standard quality, increased brightness, little flicker and good definition, although cheap and simple television receivers be used.

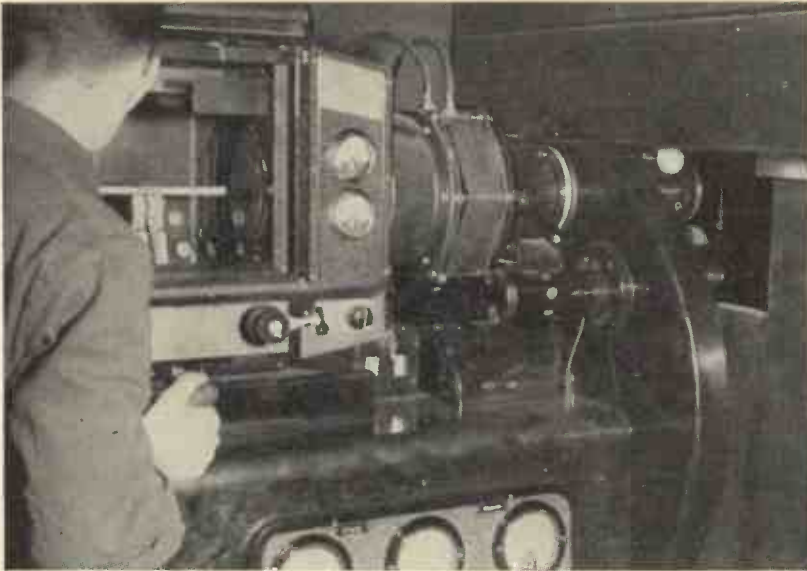

The Fernseh A.G. 180-line scanner for 25 pictures per second. The disc runs in vacuo and the light source is a 150-amp. arc.

## Punching Holes in a Scanning Disc

An alternative method to the direct punching of square holes when making a scanning disc is to first drill a round hole and then square this by inserting a square tapered drift, such as the tang of a small file carefully filed to the correct shape. This procedure will leave a slight burr on the underside, but it is a simple matter to remove this by means of a sharp knife and a final rub with fine emery cloth. On the whole this method is more simple than using a square punch, although the latter will probably give the better results when the work is very carefully carried out.

The North Middlesex Radio Society, which recently held its 400th meeting, has decided to widen its activities to include television research. A number of the members are experienced short-wave enthusiasts and it was felt that the prospect of short-

wave television offered an excellent opportunity for widening the interest of the Society and providing a fresh field for discussion.

It is proposed to commence with the design of a high quality receiver, all the work being done by the members themselves, and it is hoped later to undertake an experimental short-wave transmitter if the necessary permission can be obtained.

The Society, which is one of the oldest in London, would welcome new members to whom this fascinating branch of radio would appeal. The Secretary is Mr. J. G. Turner, of 3 The Ridgeway, Old Southgate, N.4. Tel.: PALmers Green 1100.

It is well known that the image thrown on a screen by a convex lens is inverted. What is not so often realised, however, is that the image thrown on the retina of the eye through the lens of the eye is therefore also inverted!

We therefore view all objects upside-down! The impression received by the brain, owing to the training which our eyes have had from birth, gives the image in its true relation to other objects around us.

Mr. J. Skeel, of 1 Hale Avenue, Cambridge, would be glad to hear from any amateurs in the Cambridge district who would care to co-operate with him in the investigation of television problems, either transmission or reception.

Television pictures are built up by the travel of a light spot in a series of lines. The number of lines used is the scanning frequency and, of course, the number at the receiving end must correspond with the number used during transmission. In the case of the present B.B.C. transmissions the number is thirty, but a hundred-and-eighty and even more have been successfully demonstrated.

# An Adjustable Lamp Holder for Mirror-drum Projection

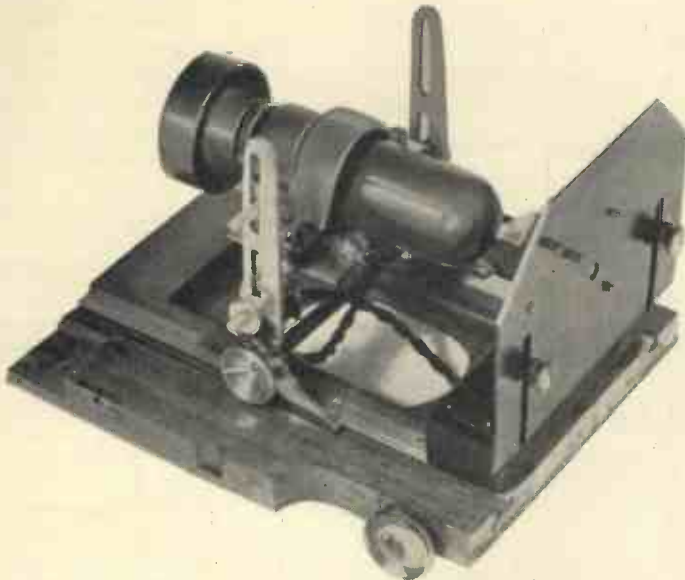

A photograph of the complete holder and aperture mask.

IN designing an experimental mirror-drum projector it is almost essential to make the various parts adjustable. This applies particularly to the lampholder and the

necessary! The basis of the unit is the focusing rack taken from an old wooden studio camera such as can be picked up in most junk shops for an odd shilling or two. The kind in

which the bellows of the camera are supported at the front by two brackets, which slide in grooves on the sliding rack, should be purchased. These two brackets, shown at I in Fig. 1, have a groove cut in them to allow the front of the camera to be moved up or down.

Remove the bellows, etc., retaining only the base with the sliding rack and the two brackets referred to above. To the front end of the sliding rack screw a piece of wood about 1 in. thick and 2 in. wide and the same length as the rack. On this block of wood are mounted two brass brackets, to which the mask is secured. Details of the latter are given in Figs. 4 and 5 and are fairly clear. Note that the under edge of the square hole in the condenser vane

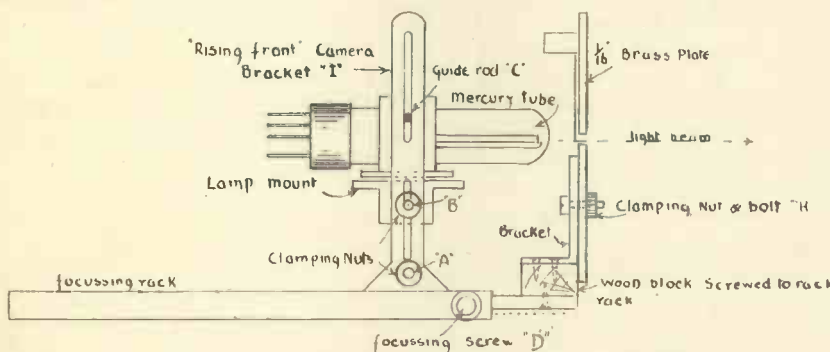

Fig. 1.—A side elevation of the holder and mask showing details of construction.

mask. Where the light source is a crater tube or a mercury discharge tube it is necessary to arrange matters so that the concentrated light beam falls exactly on the hole in the mask. This means that it must be possible to move the lamp sideways, up and down and backwards and forwards.

The mask should be designed so that the size of the aperture can be varied within certain limits and yet always remain square; it should also be possible to vary the height of the mask.

The apparatus about to be described has been designed to fill all these conditions and it is easily constructed with the usual hacksaw, file and drill possessed by most amateurs. A little patience is required but only the minimum of skill is

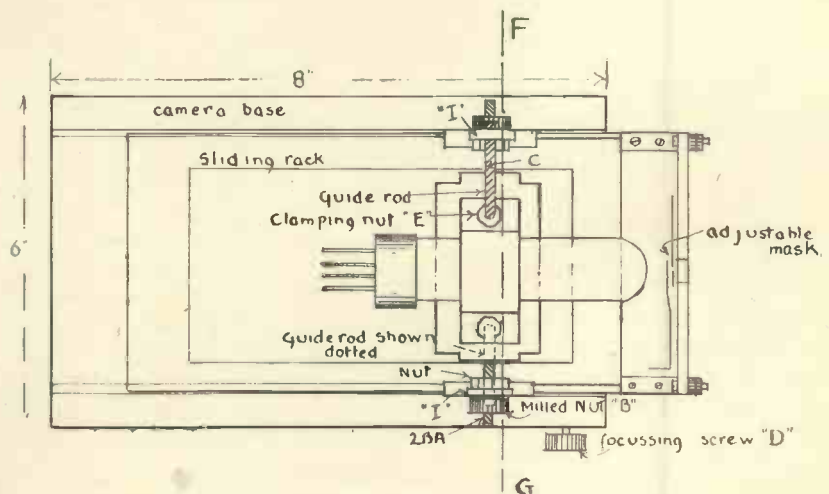

Fig. 2.—This is a plan view which shows how the camera base is utilised for focusing.

is bevelled to a sharp edge, whilst the upper edge of the V-shaped slot in the aluminium strip is treated in the same way. Fig. 5 shows an enlarged sketch of a section through this part of the mask.

Both these two parts of the mask are held in position by 4 BA bolts

will be seen that it consists of two "U" shaped pieces of brass, in which the lamp is held, arranged to slide in grooves in the supporting brackets I.

The guide rods C are necessary to prevent the holder from pivoting on the securing rods at B. The nuts E (Fig. 3) which work on the guide

the sides, so that it can be slipped into position over the guide rods.

Felt pads are inserted between the glass bulb of the lamp and the metal holder to allow the glass to expand as it heats up in use (see Fig. 3).

The position of the lamp in relation to the screen is adjusted by sliding the brass brackets I, in the desired direction, and clamping the brackets on to the sliding rack by tightening up the nuts at A, in the same way that the front of the camera would be adjusted.

In adjusting the apparatus, first set the aperture in the mask to approximately the right size and then adjust the lamp to get the brightest beam of light through the mask. The beam is then projected via any lenses and reflecting mirrors on to the mirror drum and then on to the screen. Focus the square spot of light on the screen as sharply as possible by means of the focusing screw D, in Fig. 2.

If through any slight inaccuracies in constructing the mask the light spot is not square or is tilted slightly, any necessary adjustments can now be made by resetting the adjustable parts of the mask.

To prevent stray light from the lamp being reflected on to the viewing screen, the glass bulb should be painted over with Indian ink or black stain, except for the end of the

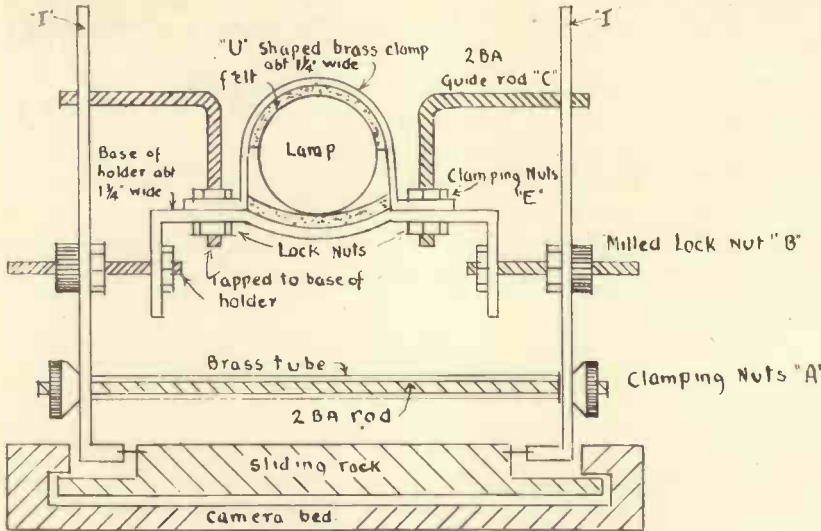

Fig. 3.—A section of the holder through the line FG of Fig. 2.

tapped into the brass screen. The aluminium strip has a slot cut in it which is just 4 BA clearance. It will be seen that by sliding this strip down, the aperture will be reduced in size, and vice versa. At the same time, however, the hole will always remain square. The holes in the condenser vane, through which the 4 BA fixing screws pass, should be about 1/4 in. diameter so that a slight adjustment of this portion can be made if required. In assembling the mask, fix the condenser vane in position so that the bottom left- and top right-hand corners of the square hole in the vane are in line with a diagonal drawn from the left- and top right-hand corners of the screen (see Fig. 4). The bottom left-hand corner of the square hole should just clear the 1/4 in. hole in the brass screen. The screen itself slides up and down in slots and is clamped in position by 4 BA nuts and bolts marked H in Fig. 4. A slight sideways movement of the screen can be obtained by making the slots in the screen a little wider. This is not really essential, as ample sideways movement is provided in the lampholder.

**The Lampholder**

Details of the lampholder are given in Figs. 1, 2 and 3, from which it

rods C, clamp the upper part of the holder down on to the lamp.

Both the guide rods and securing rods should be tapped into the lower half of the holder, and either sweated in or firmly locked in position by nuts

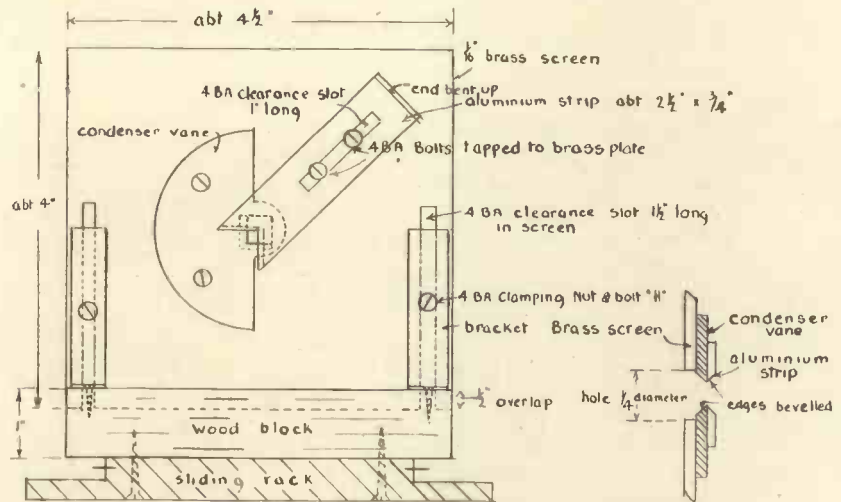

Fig. 4.—Details of mask. Fig. 5 (right).—Detail of aperture.

on the under side. Incidentally, the nuts E should be run on to the guide rods, either before bending the rods or before finally securing them to the lower half of the lampholder.

The upper half of the lampholder has slots cut in the two flanges at

bulb, of course, where the light beam appears. The back of the mask should also be treated in a similar manner. Contact is made to the base of the lamp by insulated sockets and flexible leads carried to a suitable terminal panel.—W.L.P.





REVIEWS OF THE PROGRAMMES AND RECEPTION REPORTS

FURTHER experiments in the propagation of ultra-short waves are to be undertaken by the B.B.C. After months of inactivity the transmitter on the roof at Broadcasting House is to broadcast again on an ultra-short wavelength. A carrier-wave will probably be sufficient for these tests and it is unlikely that television signals will be transmitted. But the development is significant.

For two hours Eustace Robb sat on a silken mattress in a Japanese room in South Kensington, absorbing atmosphere for the programme to be transmitted on October 31. Meanwhile, the professor talked, rising from his haunches at intervals to change the records of geishas' singing and to refill the producer's glass with saké, a Japanese liquor distilled from rice.

The programme will be built around Yeichi Nimura, a Japanese

dancer, now at the Alhambra. For two years the producer has wanted to bring this remarkable artist to the studio; but he has only recently arrived within range. Nimura's grandfather was a Shinto priest and his father held high office in the police of Japan; but such careers were not planned for young Yeichi, who was packed off to Columbia University to absorb a Western culture. After study the lad went to concerts, and one evening watched Ruth St. Denis and Ted Shawn dancing. His ambition was fired, and, despite parental displeasure, he left college and started to study the art. He has danced at the Metropolitan Opera House, New York, and on Wednesday we shall see a Western interpretation of Japanese symbols.

Maria Sandra is to sing songs from the Japanese by Granville Bantock, and translations from Japanese poets

will be heard in the programme.

I should not like to think what would happen if the producer were offered hasheesh.

\* \* \*

November 3 brings a ballet programme, with Sokolova, Idzikowski and Harold Stern in the second edition of "The Gods Go a-Begging." Keith Lester, an addition to the cast, is a young English dancer who was picked to partner Karsavina. It will be his début in the studio.

A popular programme follows on Wednesday, November 7, at night. Valerie Coales, a cabaret dancer, is a newcomer to television, and we shall also see and hear some old favourites. Betty Bolton, Eric Barker and the Three Astons with their cycling rodea, are in the bill. This high-speed cycling act forms a severe test for many visors.

\* \* \*

The producer feared that it might be difficult to secure artists for the programmes on Saturday afternoons, which we all welcome. Eleven o'clock at night is an awkward time for lookers and eleven in the morning is a worse; but it is an advantage that artists are often disengaged at these hours. The producer draws on the stage and cabaret for much of his talent and, as the studio is central, artists are able to appear in the evening after leaving the theatre and before going on to a cabaret. For the morning transmissions there is no difficulty unless an early rehearsal happens to be called in a theatre. On Saturday afternoons there are always matinees at the theatres, and I feared that programmes might suffer in consequence; but they show no signs of doing so.

As Saturday afternoon is a popular time for listening, the producer arranges features which should also appeal to listeners to Midland



Autumn fashions televised; the mannequins who displayed the latest day and evening fashions in a recent broadcast.

Regional who are not equipped with visors.

The first matinee produced a strong programme, whether judged from visual or a purely aural aspect, and I was much amused by the topical patter which Roy Royston and Dimitri Vetter introduced in the old song, "The Optimist and the Pessimist." Roy Royston, like several other stars, has television to thank for his introduction to broadcasting. As a juvenile, he was in the original production of the *Passing Show* at the Palace Theatre, where Arthur

have been notable for the variety and originality of costume and for the exceptional quality of the dancing. Carlotta, a theatrical designer, has been attracted by the peculiar needs of the television studio to devote some study to the costumes. She achieves an artistic effect from extremely simple materials. Some of her work was seen in the programme in which Olga Alexieva appeared as a nun and sang Ave Maria with great purity and spiritual feeling. This simple black and white costume made an excellent picture, and the doll

Of many talented dancers, I most enjoyed the performance of Lydia Sokolova, appearing this time alone, and Lydia Kyasht, who brought some of the glamour of the old Imperial Ballet to the studio. Alicia Markova and Cleo Nordi were both seen to advantage.

After her performance, Lydia Kyasht remarked that the heavy blue and white make-up reminded her of Chaliapin when he was playing Mephistopheles.

\* \* \*

Cleo Nordi helps so much with the arrangement of dances in the studio that she is qualifying for the job of choreographer to the B.B.C. Her programme, in which Leonie Zifado and Frank Sale also appeared, was accompanied by a trio of well-known concert musicians. Sidonie Goossens played the harp, Cyril Smith the piano, and Norman Chapple the violin. I always welcome an orchestral combination in the studio as a relief from the monotony of the piano.

Of the lighter fare, I most enjoyed the programme with Helen Raymond and tiny Georgie Harris, whose face first appeared at the bottom of the picture. The effect was produced by focusing the comedian in a semi-distant position with only his face in the beam. Later, when the announcer declared that a telegram from Bombay complained that he could not be seen, he was raised on a chair, and we got a full figure picture. His abrupt exit is explained by his falling backwards from the chair into the arms of a studio attendant, who was there to catch him.

SPECTATOR.



The entry of the Toreador in the "Carmen" broadcast; the artists are Frank Sale, baritone; Elsa Brunelleschi, gipsy dancer; and Sarah Fischer, as Carmen.

Playfair and Nelson Keys sang this evergreen duet.

During the month, programmes

which the artist carried and put to sleep in a later number also appeared with ample definition in my visor.

## Tuning Superhets

The superheterodyne receiver is often unjustly accused of giving poor quality reproduction when, as a matter of fact, the fault is almost invariably due to lack of skill of the person tuning in. Most superhet receivers are extremely selective and stations should come in and go out on the slightest movement of the tuning dial. It is, therefore, certain that quality will be sacrificed if volume is reduced by de-tuning.

To obtain the best results it is essential that the set be tuned with absolute accuracy and the volume reduced by means of the volume con-

trol. It is, of course, rather difficult to tune a superhet perfectly by ear, and an ingenious device which eliminates this difficulty has been incorporated in the new Cossor superhet. This arrangement takes the form of a small neon tube placed at the side of the tuning scale. When the set is untuned, the indicator glows low down in the tube. When a station is tuned in, the glow rises until, as perfect synchronism is obtained, the glow reaches a maximum height, and the control is tuned up to the required volume.

**Read "Television" Regularly**

## The Constructors' Circle

We shall be glad to hear from members of the Constructors' Circle who are desirous of getting into touch with other amateurs with a view to co-operation or the formation of local clubs. Members are reminded that co-operation of this nature would enable apparatus to be made or purchased which might be beyond the means of the individual.

Television Australia, Ltd., has been founded with a capital of £100,000 for the development of television; it is hoped to carry out regular transmissions in 1935.

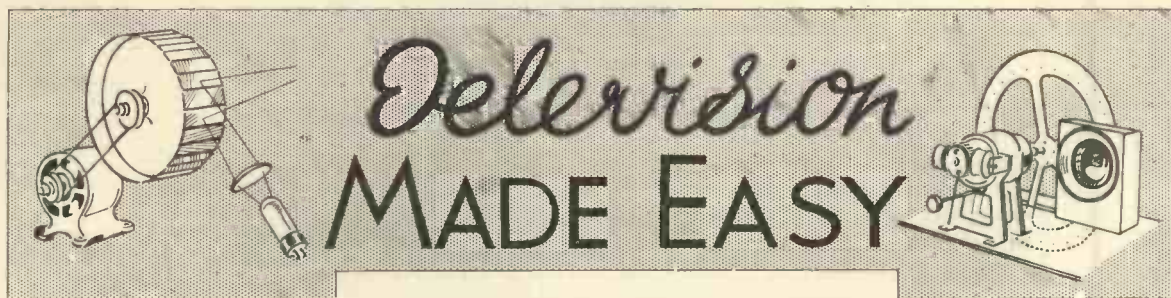

## TELEVISION TERMS EXPLAINED

The following are explanations of the general terms used in television. Intended for the beginner, they are written in simple language so that the veriest novice will have no difficulty in understanding them.

### Cathode Rays

A beam or fine pencil of electrons which are negatively charged. It behaves as a conductor carrying current and can be deflected by external magnetic or electric fields. As the beam is weightless it possesses no inertia and can be moved at any speed.

### Cathode-ray Tube

A special pear-shaped glass vessel provided with a suitable electrode system for the production of cathode rays. The inner side of the large end of the tube is coated with a fluor-



A cathode-ray tube.

escent material against which the electron beam strikes, its presence being revealed by the production of a spot of light. The electrode system consists of a cathode, anode and shield.

### Shield

An electrode in the cathode-ray tube. It is in the form of a cylinder and its purpose is to compress the beam of electrons and cause it to pass through a central hole in the anode on its way to the screen. For this purpose it is given a negative charge.

### Anode or Accelerator

(Cathode-ray tube.) A circular metal plate forming one of the electrodes of the cathode-ray tube. It

has a circular hole in it through which the electrons pass and the intensity of the beam is governed by the potential applied to it. It is sometimes referred to as a gun.

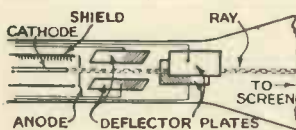

The electrode system of the cathode-ray tube.

### Cathode

(Cathode-ray tube.) The filament or electron producing electrode of the cathode-ray tube.

### Screen

(Cathode-ray tube.) The internal coating on the large end of the cathode-ray tube. This is a fluorescent material, usually zinc silicate, and the beam of electrons is revealed as a spot of light at the point at which it impinges.

### Time Base

An arrangement of components consisting of resistances condenser, diode valve and mercury relay for the purpose of deflecting the electron beam of the cathode-ray tube at the correct intervals of time. Two time bases are employed, one to cause the vertical deflection and the other the horizontal.

### Deflector Plates

Two pairs of flat metal plates which form part of the electrode structure of the cathode-ray tube. The pairs are placed at right angles to each other and when potentials are applied to

them they attract or repel the electron beam according to the value of the potentials and their polarity.

### Exciter Unit

The unit for the provision of high-tension and low-tension supplies to the cathode-ray tube.

### Oscillogram

The term given to the trace produced by the movement of the beam of electrons in a cathode-ray tube over the fluorescent screen. The term "oscillograph" is applied to the complete cathode-ray equipment.

### Fluorescence

(Cathode - ray.) The property some materials have of emitting light on the impact of electrons. The materials generally used are zinc silicate, zinc phosphate, cadmium tungstate and calcium tungstate.

### Scanning

The process of causing a light spot to travel over the image to be televised

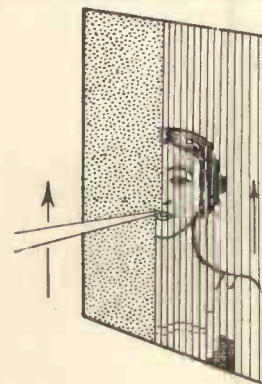

Diagram illustrating the principle of scanning.

at the transmitting end, or over the screen at the receiving end.

## Modulation

In television this term is generally used to indicate the alteration of intensity of the light which is to produce the image. In some instances the light is varied directly, that is upon its production. In other cases the modulation takes place after its production. Lamps with which direct modulation is possible are the neon and mercury and sodium vapour types or combinations of these. It is also possible to modulate the arc directly.

## Persistence of Vision

A phenomenon associated with the human eye by which an impression remains after the cause of the impression has been removed. Its duration is approximately one-tenth of a

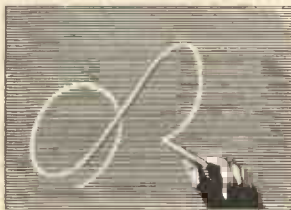

The persistence of vision effect.

second and the principle of persistence of vision makes possible the impression of continuity when an image is built up as a series of units as in television, or a series of pictures as with the cinematograph.

## Synchronism

The conditions that obtain when two mechanisms are running at exactly



Two clocks illustrating synchronism.

the same speed and are in step. An example is two clocks which are keeping exact time and show exactly the same time.

## Isochronism

Isochronism differs from synchronism in that it denotes that two mechanisms are running at the same speed but are out of step, as for example two clocks which though

keeping accurate time do not show the same time, or two men who are moving at the same speed but are out of step.

## Scanning Disc

A circular disc, usually metal, with a series of holes in it arranged in spiral formation. The positions of

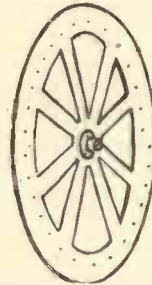

The usual type of scanning disc employed in simple receivers.

the holes are such that when the disc is revolved the holes pass over a predetermined area at every revolution.

## Multi-spiral Scanning Disc

A disc in which there is more than one series of holes. Such discs are

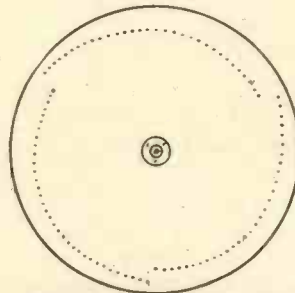

A multi-spiral scanning disc.

used for colour television and usually contain three series of holes.

## Lensed Disc

A disc supporting a series of lenses arranged in spiral formation. Its

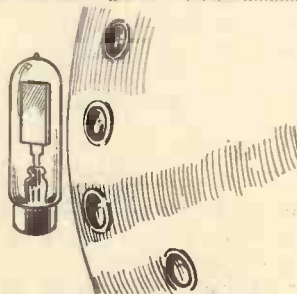

A section of a lensed disc.

purpose is to produce a projected picture with a disc, the light from a lamp placed behind the disc being brought to a focus by means of the lenses on to a screen.

## Mirror Screw

An assembly of flat metal plates silvered on one edge and arranged spirally similar to a spiral staircase.



An example of a mirror screw.

It forms a direct scanning device, the image being produced by direct reflection from the faces of the mirrors.

## Mirror Drum

An assembly of a number of plane mirrors round the periphery of a drum. These are each placed at a certain angle with reference to the preceding mirror, this angle being determined by the number of mirrors.

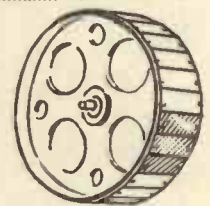

The usual construction of a mirror drum.

The mirror drum is probably the most efficient scanning device for it makes use of practically the whole of the light which is projected upon it. Its chief disadvantage is that when a large number of mirrors are to be used it becomes unwieldy and requires considerable power to drive. Fifty mirrors is the maximum number that can conveniently be used.

## Chopper Disc

A disc containing a number of slots which chop light which is passed through the slots.

## Screen

The general term applied to the surface upon which a picture is projected.

**Kerr Cell**

A type of electrical light valve which has no moving parts. It consists of an assembly of metal plates similar to a miniature condenser immersed in nitro-benzol. When a beam of plane-polarised light is passed between the combination of metal plates in the nitro-benzol and a potential is applied to the metal plates, its plane of polarisation is moved round, the extent of the move-

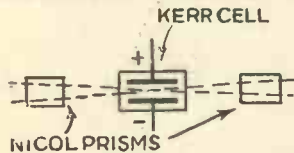
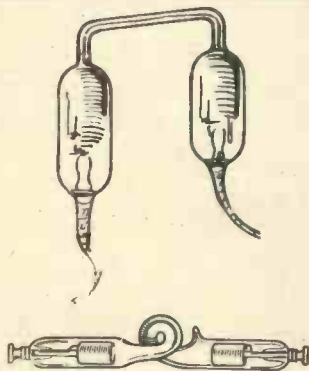

Diagram illustrating the assembly of Kerr cell and Nicol prisms.

ment depending upon the value of the potential. This device placed between two Nicol prisms controls the amount of light that can pass by rotating the plane-polarised light to a greater or lesser extent depending upon the value of the applied potential. The combination of prisms and cell thus acts as a light shutter which has no inertia and operates instantaneously. It has the disadvantage that only a small percentage of the light actually passes through and its efficiency therefore is rather poor.

**Gas-discharge Lamps**

A general term applied to lamps of



Two types of gas-discharge lamps—the mercury vapour and the neon mercury.

the neon mercury vapour and positive column types.

**Neon Lamp**

A lamp of the gas-discharge type which contains a small amount of

neon gas which is caused to glow when a suitable potential is applied. Familiar types are the Osglim and the various kinds used for advertising

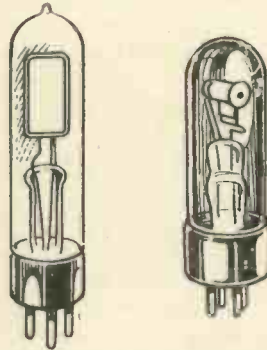

Two neon lamps—the flat plate and the crater point.

signs, etc. A lamp of special construction is used for television purposes, one electrode consisting of a flat metal plate so that an even field of light is produced.

**Crater-point Lamp**

A neon lamp of special construction in which the light produced is concentrated over a very small area and is therefore of greater intensity.

**Recording Lamp**

A special construction of mercury-vapour lamp primarily intended for film recording purposes but which is



A recording tube.

very suitable for use in television. It provides a bluish-white light which can be directly modulated.

**Positive-column Lamps**

Typical examples of these are the neon tubes used for advertising purposes. Special types have been manufactured for television purposes.

**Mercury-vapour Lamp**

A lamp of the gas-discharge type similar to the neon lamp but containing a small amount of mercury vapour instead of neon gas. This type of lamp requires a higher potential than the neon for its operation but it yields a brighter light, the colour of which is a greenish white.

**Phasing**

A picture is out of phase when it appears on the screen in two vertical parts and the condition is due to the

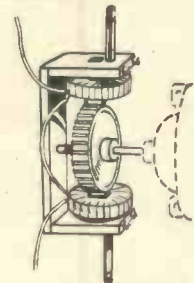

Diagram showing the effect of incorrect phasing.

receiving scanning device running isochronously, but not synchronously, with the transmitting scanner.

**Synchronising Gear**

A device which is used to maintain the speed of the motor of the receiving scanner the same as that of the transmitter. Usually it comprises a toothed wheel which is mounted on the motor



A typical example of simple synchronising gear.

shaft and two electro magnets supported on a frame diametrically opposite each other. The synchronising signal is fed to the coils of the magnets and a pull is exerted on the teeth of the wheel at the correct instants of time.

**Synchronising Valve**

An output valve for the purpose of amplifying the synchronising signal which is then fed to the coils of the synchroniser.

**Synchronising Transformer**

A peaked transformer used in conjunction with the synchronising valve. It is peaked to pass the particular

frequency required and in the case of the thirty-line transmissions it is peaked at 375 cycles.

## Diode

A simple two-electrode rectifying valve. It was the forerunner of the present triode valve. It is used in the time bases for cathode-ray television as a speed regulator for the charging of the condenser which causes the

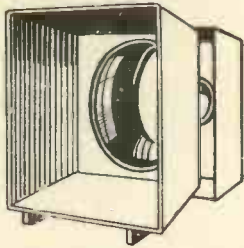

A viewing tunnel for disc visors.

mercury-vapour relay to flash over at the correct periods of time. In this case its action is that of a resistance which remains constant whatever the current flow.

## Mercury-vapour Relay

A special form of soft valve containing a small quantity of mercury vapour. No anode current passes until the anode voltage has reached a definite figure when the valve will blue glow or flash over. It is used in the time bases for cathode-ray television causing the discharge of the condenser.

## Nicol Prisms

A specially cut prism of Iceland spar which has the property of plane polarising light. The effect is that only light in one plane of wave motion passes through and two such prisms suitably placed prevent the passage of any light through the combination. The same effect can be obtained by the use of a number of very thin pieces of glass arranged at a suitable angle.

## Scanning Frequency

Television pictures are built up by the travel of a light spot in a series of lines. The number of lines used is the scanning frequency and, of course,

the number at the receiving end must correspond with the number used during transmission. In the case of the present B.B.C. transmissions the number is thirty, but a hundred and eighty and even more have been successfully demonstrated.

## Picture Frequency

The number of complete pictures that are produced upon the screen in one second. The B.B.C. picture frequency at present is twelve and a half per second but experimental transmissions have been demonstrated with a frequency of twenty-five per second. The higher the frequency the less is the noticeable flicker.



The effect produced when a picture is out of frame.

## Framing

A picture is said to be out of frame when it is divided horizontally so that two half pictures appear on the screen. Its correction is a simple matter by allowing the picture to float slightly

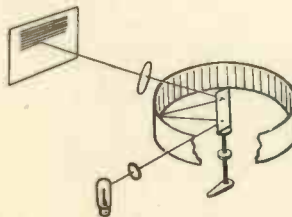

A stationary mirror-drum.

in one direction or the other and is usually accomplished by a small ad-

justment of the synchronising device.

## Viewing Tunnel

A device usually fitted to disc machines which acts as a support for the lens used to magnify the picture and also as a shield to prevent extraneous light interfering with the picture.



A typical example of a photo-electric cell.

## Photo-electric Cell

A light-sensitive device which possesses the property of emitting electrons when light falls upon the specially prepared surface within the glass globe. Actually it provides a means of converting light into electricity and is used in all television transmissions.

## Picture Points

A term used to describe the composition of a picture in units; thus the standard thirty-line picture is assumed to have 2,100 points derived from the fact that the ratio of the picture is 7 by 3 and therefore 30 units are contained in the width and 70 in the depth.

## Photo-conducting Cell

A device of which the electrical resistance varies according to the illumination incident upon the cell.

## Photo-voltaic Cell

A device in which a difference of potential is developed across the rectifying contact between the surfaces of a semi-conductor and a metal under the influence of illumination; this potential gives rise to a current in an external circuit.

# THE WHOLE PROBLEM OF SYNCHRONISING

By T. S. Roberts

IT is definite that television reception is no entertainment unless the synchronism is satisfactory, however perfect the picture may be, whatever the system, or degree of definition.

*Synchronism presents one of the most difficult problems of television reception and it is one that has only partly been solved. There are more considerations than are usually apparent and these are dealt with in detail in this article which will be found particularly helpful in getting the best results with existing systems.*

Before going any further, let us be quite sure what is meant by synchronism in the television sense because it may surprise readers to state that synchronism, in the true meaning of the word, is never obtained in perfect television reception.

As you all know, the television image signal is pro-

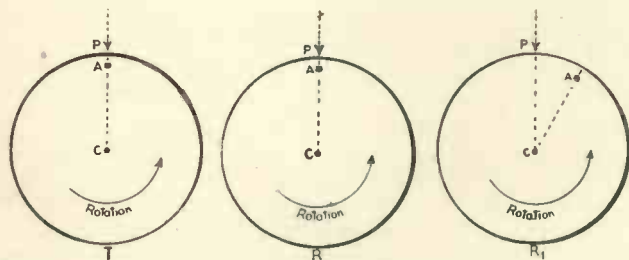

Fig. 1.—The relative positions occupied by a disc aperture when in synchronism and isochronism.

duced by a spot of light travelling over a given area, while at the receiver, another spot of light traverses another area of similar proportions, though the actual measurements may be different.

The movement of this spot of light at the transmitter is produced by a rotating mass—a mirror drum—the resultant signal which is received is either on a system depending on a rotating mass or a cathode-ray tube; the latter we will not consider for the present. Therefore, to produce a picture, the transmitting and receiving rotating mechanisms must rotate speed for speed; that is to say in isochronism.

Turning to Fig. 1, let the circle T represent the disc of a transmitter with, for convenience, one aperture A. Circles R and R<sub>1</sub> are similar discs of receivers. In T the aperture A is cutting the vertical dotted line C P, the same applies in R. If the two discs R and T are rotating at the same speed they are said to be in synchronism, because a definite similar point on each disc will always cut the line P, C, at the same time. In R<sub>1</sub>, however, the aperture A is either lagging 30° or leading 330° on T, and if it revolves at the same speed as T it is said to be in isochronism. In actual television reception when the picture is framed correctly all receiving spots are lagging on those of the transmitter by about two degrees, which in time equals .0004 second. (These figures refer to radio reception of a 30-line picture by the Baird system.)

## Cause of Delay

This delay is nearly all due to the time taken for the signal to travel from the television studio to the radio transmitter at Brookman's Park. The writer was much intrigued some years ago on being shown in the Baird Company's control room during a broadcast transmission both the out-going picture to Brookman's Park and the received radio picture produced on the

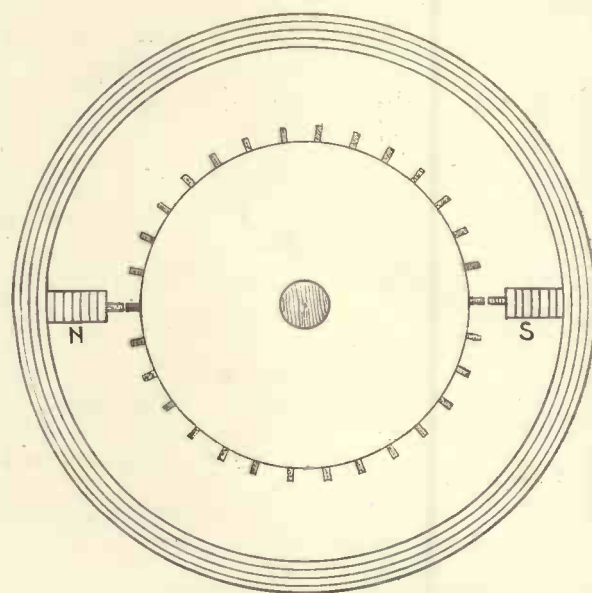

Fig. 2.—Diagram showing the toothed wheel synchronising device.

same screen, the images overlapping to the extent of the mouth of the radio picture appearing across the nose of the line picture, in a "close-up."

In television the term synchronism has come to mean a correctly framed image on the receiving screen and though, as pointed out above, it is not quite accurate, it is good enough not to split hairs over.

Let us see how synchronism is at present obtained, though perhaps at first we should examine what perfection is called for. When looking at a television screen, we must have all seen the phenomenon of the picture either slowly rising or falling one or more pictures. For one picture to fall or rise, the receiving

disc or mirror drum must have retarded or accelerated by twelve degrees on the transmitter (provided the transmitter speed is constant). A picture which rises or falls even once in ten seconds is hardly entertainment, even a slow rise and fall of half a picture is decidedly annoying and for proper entertainment a rise or fall—"hunting" as it is termed—of .75 degrees is about the limit, provided it does not do so more than once per second. Synchronism is obtained by either hand regulation of the motor speed, a semi-automatic device known as a "toothed wheel," or a synchronous motor on frequency controlled mains.

### How Synchronism is Obtained

It is the semi-automatic device which for the moment will interest us most. As most readers know, it consists of a 30-toothed iron wheel, which for best results should be built up of laminations and mounted on the same shaft as the receiving disc or mirror drum. As

degrees which go to make a whole scanning line, for two of those degrees no light spot is on the object. The resultant light falling on the photo-cell is graphically shown in Fig. 3 a, this fluctuating light, which causes a unidirectional flow of current through a resistance produces an equivalent A.C. voltage which is duly amplified.

As there are 375 scanning strips per second, we get an A.C. signal of that frequency (375), which is, of course, far from being of sine wave form. At the receiver this 375-cycle signal is passed through the coils of magnets N and S, Fig. 2, but as these coils are in series with the H.T. battery, and anode of the valve, as in a, Fig. 4, the A.C. signal will be superimposed on a steady D.C. current, and will, if once started, rotate the toothed wheel at 12.5 times per second. If the output circuit was of the type shown in Fig. 4 b, the number of teeth in the wheel would have to be increased to 60, which means that double the impulses are applied to the toothed wheel, and in consequence there is less likelihood of "hunting."

Now we must analyse what happens. Supposing a toothed wheel, of which only two teeth are shown (a, Fig. 5) is rotating in the direction of the arrow, and is running speed for speed with the transmitter motor. A 375-cycle impulse arrives and the effect on the wheel is to pull the tooth opposite the pole piece N, thereby accelerating the rotation. Now if the rotating mass is small compared to the power in the pole piece, the wheel will rapidly accelerate, and when coming opposite N, as in Fig. 2, will be retarded till the impulse has died down, and will in consequence rotate in a series of jerks, which are, however, generally smoothed out owing to the momentum of the moving mass.

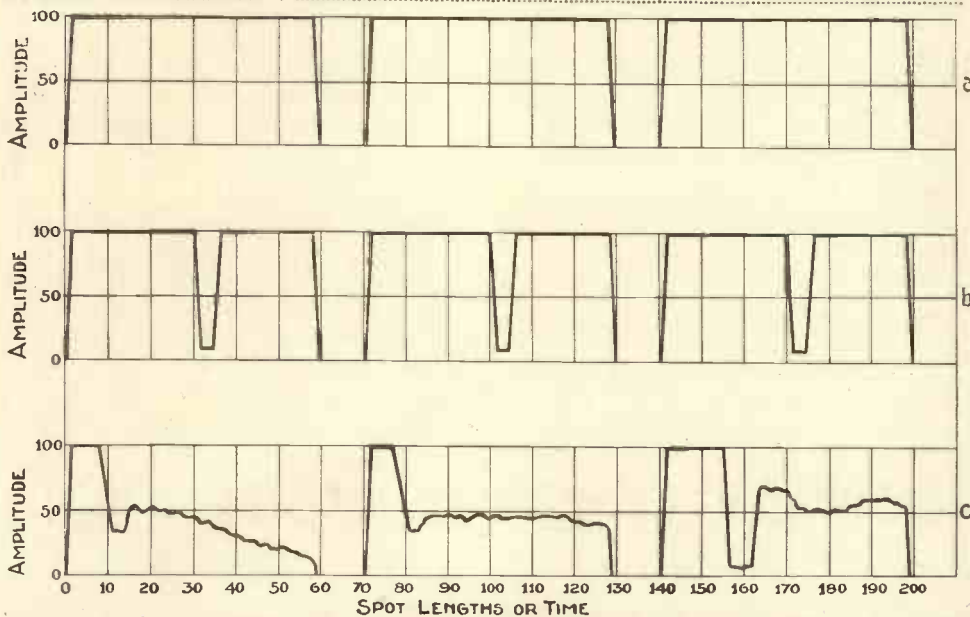

Fig. 3.—0 to 70=1 line : 70 to 140=1 line : 140 to 210=1 line. 70 spot lengths=1 line=.0026 second.  
 Lower line, 0 to 70, dark clothing; 70 to 140, lady with light dress; 140 to 210, lady with hat.

there are thirty teeth, they are divided by twelve degrees, the space between the teeth occupying ten degrees, and the teeth two degrees, the reason for which will be discussed later. This toothed wheel revolves between the poles of a magnet, diagrammatically shown in Fig. 2. The pole pieces N and S are energised by current in the coils (not shown in figure) on the pole pieces. If D.C. current is passed through the coils the magnetism produced will pull the toothed wheel so that a tooth will come opposite each pole piece, while if we superimpose an A.C. current in the coils, say, of 50 cycles and give the wheel a start, it will continue to revolve, in fact becomes a synchronous motor.

Having described the construction of the toothed wheel, let us examine its *modus operandi*. We will start first with the transmission of a plain white object. Now the scanning spot of the transmitter is so arranged that between each scanning line there is a period when no spot is on the object being televised; of the twelve

If, on the other hand, the rotation of the receiver was slightly less than that of the transmitter motor, the impulse will obviously help to speed up the receiver. When the receiver is running slightly faster, the impulse will first tend to further increase the speed till such time as when the teeth are opposite the pole pieces when the impulse arrives and will act as a retarding force. If the synchronising impulse arrives when the pole piece is equi-distant from two teeth as in b, Fig. 5, its effect is practically nil while in c, Fig. 5, it will definitely retard.

When the receiver is running slower than the transmitter this retardation will eventually produce a state of affairs as in a, Fig. 5, when the impulses will begin to produce an acceleration. From the above a little thought will show that this form of synchronising device works best when the receiving motor is just tending to accelerate on that of the transmitter.



### Effect of the Image

So far we have only considered the effect of a 375-cycle signal on a synchroniser, that is to say, the reception of a blank screen—an easy subject to synchronise on, as most of us who have television receivers know. Unfortunately, once we start to receive a scene the synchronising tends to become erratic. Suppose we televise a white screen with a black horizontal bar across it, six spot widths wide. This will produce a current variation in the photo-cell circuit as in b, Fig. 3. One will at once realise that another impulse has been put into the signal similar to that of the synchronising one, except that it is of slightly less amplitude, as all black objects will reflect a small quantity of light. This signal will now have 750 impulses per record, the first commencing at 30, second at 58, third a repetition of the first at 100, and fourth a repetition of the third at 128—that is to say, there are twelve degrees of the rotating scanner between first and third, second and

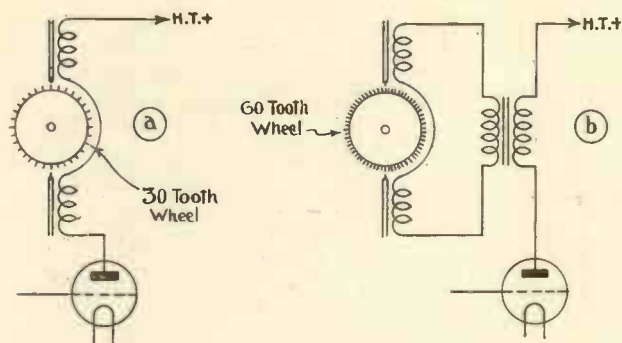

Fig. 4.—Synchronising arrangements using 30 and 60 toothed wheels.

fourth, and so on—impulses, which, of course, means that we have two groups of 375-cycle signals, either of which may synchronise the receiver, or under certain conditions may nullify each other.

One may wonder how such a signal may become ineffective for synchronising. Supposing a blank screen is being televised and the driving motor adjustments are such that the synchronising impulses arrive, say, as in Fig. 5 a, which will help the receiver to keep up to the transmitter's speed of rotation. Now a black bar is placed across the blank screen producing a second series of impulses, as already described, and this second impulse may arrive as a tooth is leaving the pole piece as at c, Fig. 5; its retarding effect will cause the receiver to run slow or out of synchronism.

If the transmitted scene was comprised of a series of black and white lines, say, four spots wide each, the synchronising would be even more confused, and the only chance the receiver would have of remaining synchronised, is that the amplitude of the correct impulse is always a little greater than a black line, and if the receiver is synchronised very (for want of a better word) finely, the toothed wheel may ignore the other impulses owing to the fact that its construction is such that for every 12 degrees of rotation the pole pieces are only really effective for about four degrees.

In practice synchronising of a receiver is best on

full-length figures and the reason is not hard to see. Such subjects rarely produce any signal resembling that of secondary synchronising impulses. This is not the case with a close-up. The line of the shoulders in the case of dark clothing has the effect of increasing the time period of the synchronising impulse as well as reducing its "sharpness" (see c, Fig. 2), and in a usual "close-up," the biggest impulse will probably be the white strip of the background over the head which the receiver will most likely select to synchronise on.

It must here be stated that the toothed wheel is not particular whether it works on a positive or negative picture and in consequence the impulse from the white background is just as effective. This will be gone into more fully later.

As long as the person being televised as a "close-up" remains relatively still the receiver will synchronise, but should the person bob up and down and so decrease or increase the amount of background above, at the same time affecting the space from their shoulders to the bottom of the picture, the synchronising impulse besides varying in amplitude will also be varying along the time base, with generally unsatisfactory results.

There is another effect which unfortunately is only too common; one adjusts one's receiver on a subject, say, a dancer, so that the picture is properly "framed" or "racked." With the next scene, a "close-up" of a lady in a light dress, the picture remains properly framed! the lady exits only to return wearing a large hat which goes right across the picture introducing a secondary synchronising impulse. This impulse takes control, with the result that the picture goes out of frame and appears with a black line in the middle with the picture cut in half, which necessitates re-framing.

Technically the impulse caused by the hat has either advanced or retarded the receivers by about six degrees.

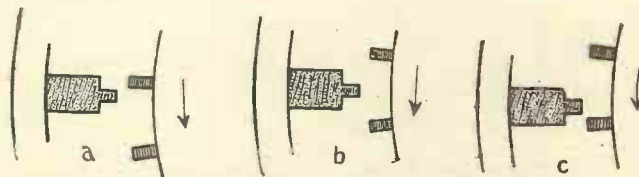

Fig. 5.—Diagrams showing how the magnets control the speed of the scanner

Further, when the lady leaves the picture, the change back to the original impulse, which will be sure to be inoperative for a few lines owing to the spacing of the teeth, may allow the receiver either to gather or loose speed to such an extent as completely to run out of synchronism, which, of course, it may also do when the lady enters the picture with the hat on. Another cause for poor synchronism is the rapid lowering and raising of the view point at the transmitter. This is done by a rising or falling mask,\* which causes the synchronising impulse to be retarded or accelerated along the time base, which, if done at all quickly, is another cause of erratic synchronism.

(To be continued.)

\* For full details of B.B.C. Transmitter see TELEVISION, April, 1934, "How the B.B.C. Transmits Television," by D. C. Birkinshaw, and "Television Transmission Equipment" by J. C. Wilson—*Journal of the Television Society*, September, 1933.

## A NOVEL SCANNER DRIVE

THE desirability of incorporating some sort of mechanical filter device between the actual scanner and the driving motor is, of

Tests have shown that the variable drive shown in the photographs will drive a 6 in. diameter mirror drum,  $2\frac{1}{2}$  lbs. in weight, from 60 r.p.m. to well over 1,000 r.p.m. The speed is very steady, and easy to control by the knob under the motor, as explained below.

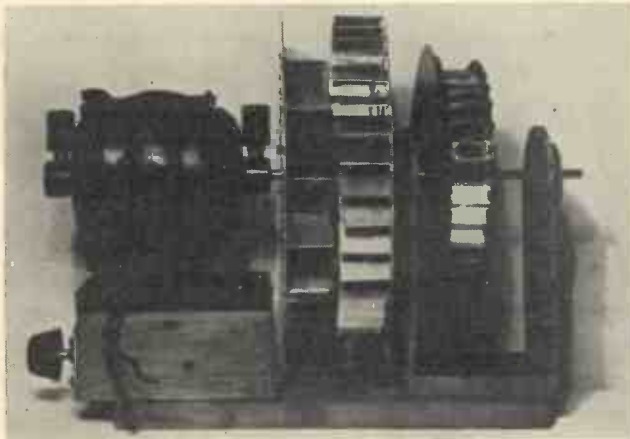

course, well known. Usually this takes the form of a spring or a friction clutch which allows the scanner a certain amount of freedom independently of the motor so that slight irregularities of speed in the latter are not transmitted to the scanner.

The photographs show an ingenious adaptation of this principle in which there is no mechanical connection between the driving motor and the scanner whatever. The only connecting medium, in fact, is air and the principle used has certain similarities to the fluid fly-wheel drive which is now a feature of some motor cars.

*The photograph above shows the novel air-driven scanner with the fan almost withdrawn from the rotor. The lower picture shows the two driving units, the fan and rotor.*

The mirror drum and 6 oz. rotor are mounted on a shaft running in ball-bearings, and lined up with the motor shaft. A centrifugal fan is

One of the photographs shows the rotor and fan and the other the complete assembly with the fan almost entirely withdrawn from the rotor.

The discs supporting the fan and rotor blades are both made from aluminium sheet with the blades riveted on; each disc is 9 ins. diameter and the assembly when the fan is fully in is  $1\frac{1}{4}$  ins. wide.

### Any Motor Speed

It will be appreciated that with this type of drive the speed of the motor is immaterial, providing that it is in excess of the normal scanning speed and it therefore allows the motor to be run at a more efficient speed than is normally the case. The designer

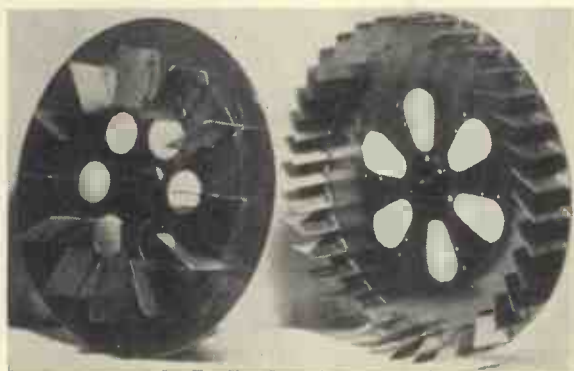

mounted on the motor and by means of a slide the fan can be made to enter the rotor and so vary the speed as required.

of this novel system is F. V. Whitehead, of Bradford, and we understand that the scheme is provisionally protected.

## 10-METRE AMATEUR TRANSMISSIONS

TELEVISION enthusiasts will be interested to learn that transmissions are now being radiated by Mr. J. H. Reyner, a contributor to this journal, on the amateur wavelength of ten metres. The call sign of the station is G6JR, the power being limited for the present to the normal ten watts. Since a special dipole aerial has been installed, however, at a mean height of 35 feet it is hoped that a reasonable range will be obtained.

The Post Office limits the type of transmission to objects of an experimental character with an occasional short length of film. It is possible, however, to obtain a great deal of useful information regarding one's re-

ceiver by such means. The transmission of a simple letter A, for instance, gives a severe test for bass response. If the receiver is correct the background will be a pure black, but if there is a bass cut-off the letter will be fringed with black, but the background will tail off and become rapidly lighter towards the top of the picture.

Similarly, a check pattern of fine squares will give a test for the upper frequency response, the limit with a thirty-line transmission being obtained with a pattern having fifteen black and white squares horizontally and a corresponding number vertically.

Reception on ten metres can be

carried out by using a reacting detector circuit followed by suitable L.F. stages or by using a superhet adapter and linking this up with an ordinary broadcast receiver. Components and information on the subject can be obtained from Messrs. Stratton & Co., makers of the well-known Eddystone kits, while a 10-metre adapter which can be used either as a straight receiver or a superhet adapter is obtainable from British Television Supplies.

Transmissions from G6JR usually take place in the latter part of the evening, but any reader who is interested can obtain information by writing direct to Mr. Reyner, at the Furzehill Laboratories, Boreham Wood, Herts. Mr. Reyner will also be glad to have reports on the reception of his signals.

# RECENT DEVELOPMENTS

## A RECORD OF PATENTS AND PROGRESS Specially Compiled for this Journal

**Variable-velocity Scanning :: Combined Synchronising and Picture Signals :: Mirror Mounting for Mirror Drums :: New Type of Fluorescent Screen :: Stereoscopic Television :: Fluorescent Screens :: Cathode-ray Projection.**

### Scanning Systems (Patent No. 413,401.)

In so-called "variable-velocity" scanning, the picture is formed on the fluorescent screen of a cathode-ray tube by altering the speed of the electron stream in accordance with the varying light-and-shade values of the picture. Theoretically the scanning velocity should be inversely proportional to the actual light intensity of each point on the picture, but in practice it is impossible to cover so wide a range of speeds, so that there is a tendency for the lighter parts of the picture to be reproduced in greater detail than the darker parts. Whilst this is, to some extent, an advantage, there is a tendency for the effect to become unduly exaggerated, causing a definite falling-off in the proper perspective of the picture.

In order to remove this defect, and to restore a more accurate balance, some degree of intensity modulation is introduced at the receiving end without increasing the width of the frequency-band necessary to transmit the signals through the ether. This is accomplished by deriving two voltages from the incoming signals, one being the time-integral of the other. The first is employed for effecting the scanning proper, whilst the second is used to apply the additional intensity-control.—(W. R. Bullimore and L. H. Bedford.)

### Synchronising (Patent No. 413,561.)

One method of synchronising the scanning frequencies used for transmission and reception is to superimpose on the carrier wave a periodic "control" impulse of larger amplitude than the picture signals. However, in order to distinguish and separate the "control" signal at the receiving end, its amplitude should be at least twice as large as any of the picture signals. This means that only one-fourth of the transmitter

output is available to carry the actual picture. An alternative method is to transmit the synchronising and picture signals on different frequencies, but this in turn is inconvenient

separately. It has a cam-shaped end N which is fitted with a pin P coaxial with the spindle. The pin P is inserted into a hole O, formed in the face of the disc close to the spring

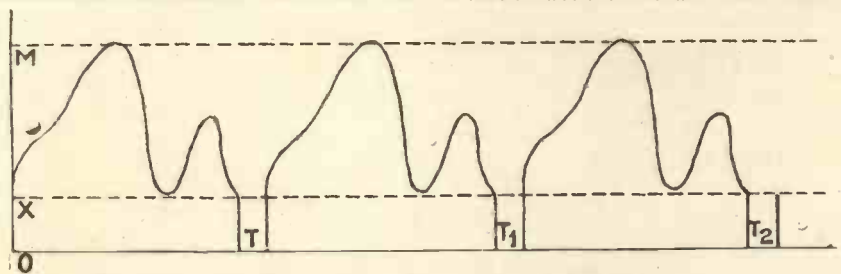

Combined synchronising and picture signals. Patent No. 413,561.

because it necessitates the use of complex circuits at the receiving end.

In order to overcome both these disadvantages it is now proposed to transmit the picture signals on a modulated wave, which, as shown in the figure, varies in amplitude from a comparatively low minimum OX to a maximum OM, and only drops to zero at periodic intervals T, T<sub>1</sub>, T<sub>2</sub>, which determine the synchronising frequency.—(Telefunken Co.)

S, and rotation of the key then slowly forces the spring S to move in the desired direction.—(Marconi Co., Ltd.; H. M. Dowsett; and E. F. Goodenough.)

### Mirror Drums

(Patent No. 413,645.)

The mirrors are mounted so that each can be adjusted, both tangentially and as regards "tilt." As shown in the figure each mirror M is set on a channel-section support C, which is connected both to the face of the scanning disc D and to the flange D<sub>1</sub> by flat leaf-springs S, S<sub>1</sub>. Tangential adjustment is effected by pivoting the springs S, S<sub>1</sub> about the holding-screws T, T<sub>1</sub>, as axes, whilst "tilt" is controlled by flexing the springs radially at right-angles to the former direction. The spring S, which fastens the mirror-unit to the face of the disc, is formed with an end-slot large enough to allow the required amount of play.

The actual adjustment is made with the help of a special key K, shown

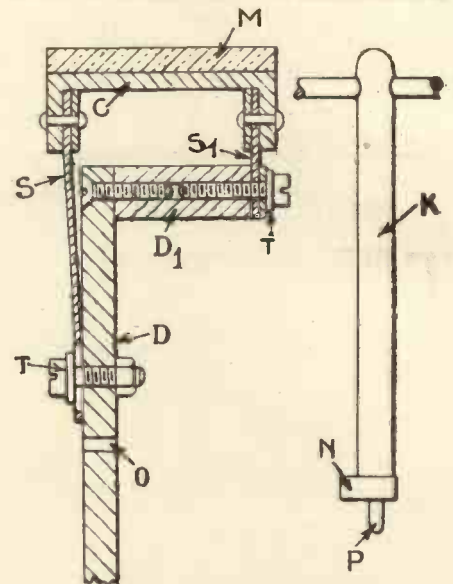

Method of mounting mirrors on mirror drums. Patent No. 413,645.

### Fluorescent Screens

(Patent No. 413,720.)

Some of the light produced by the impact of the electron stream against the fluorescent screen of a cathode-

The information and illustrations on this page are given with permission of the Controller of H.M. Stationery Office.

ray tube is lost, so far as the observer is concerned, because it is dispersed back into the interior of the bulb. In order to avoid this loss, the surface of the screen nearest the cathode is coated with a thin layer of metal, preferably silver. The deposit of metal is so thin that it does not affect the passage of the electron stream through it on its way to the screen proper. At the same time it acts as an efficient reflector to concentrate all the light coming from the fluorescent screen in the forward direction, towards the eyes of the person viewing the picture.—(K. Schlesinger.)

right eye R and the other image by the left L, thus giving the complete picture a "solid" or three-dimensional appearance.—(Marconi Co., Ltd.)

picture is viewed from the opposite side of the fluorescent screen from that on which the electron stream makes impact. If, however, the screen S is inclined to the axis of the

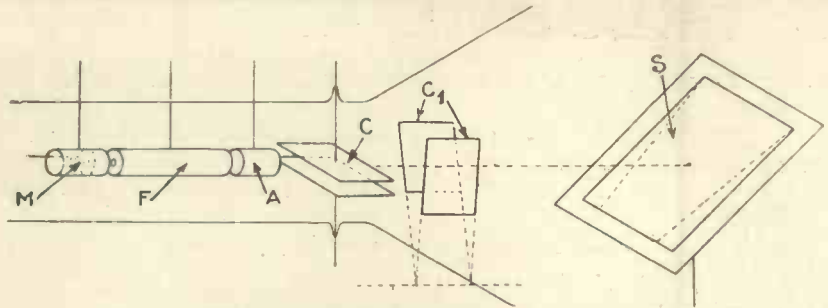

Method of eliminating the "keystone" effect. Patent No. 415,143.

**Stereoscopic Television**

(Patent No. 413,894.)

In order to produce a stereoscopic effect, two separate cathode-ray tubes A, B, Fig. 1, are used for scanning the picture at the transmitting end, the tubes being brought into action

**Preparing Fluorescent Screens**

(Patent No. 414,597.)

The fluorescent screen of a cathode-ray tube is made of zinc sulphide to which minute particles of a metal,

electron stream, as shown in the figure, it is possible to see the picture from the same side of the screen, which naturally gives a brighter image, but in such cases it is necessary to re-arrange the scanning system so that it covers the keystone-shaped area shown in dotted lines, instead of the usual rectangular shape, so as to compensate for foreshortening.

According to the invention this is ensured by setting the second pair of scanning electrodes C<sub>1</sub> at an angle to each other. The electron beam from the cathode passes first through a modulating electrode M and a focusing cylinder F to the anode A. It is then subjected to the picture-frequency control-electrodes C which are set parallel, and finally to the line-frequency control-electrodes C<sub>1</sub> which are inclined, as shown. The same arrangement is applicable to a cathode-ray transmitter of the type in which the picture to be transmitted is first focused on to an inclined "mosaic" of photo-sensitive material before being scanned by the electron stream.—(Electric and Musical Industries, Ltd., and J. D. McGee.)

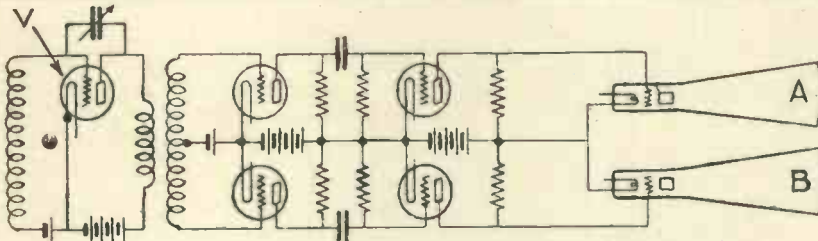

Fig. 1.—Transmitting arrangements for stereoscopic television. Patent No. 413,804.

alternately, and in rapid succession, so that the scanning lines intended for the right eye are separated from those intended for the left eye. This

such as copper, have been added by cathode sputtering. The presence of the metal has the effect of increasing the intensity of the light produced by

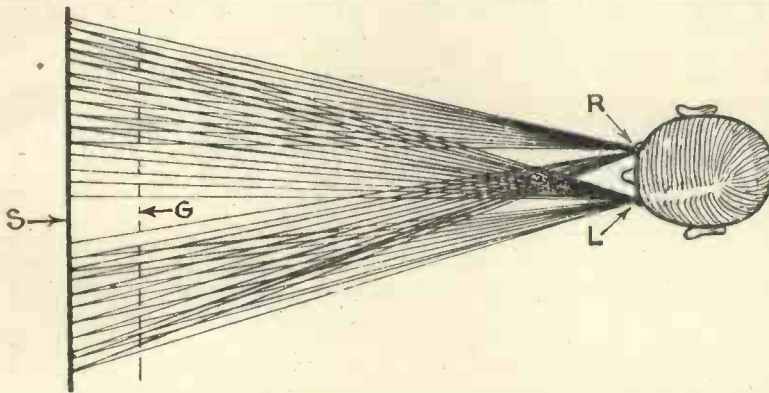

Fig. 1a.—At the receiving end both images are thrown on a single screen. Patent No. 413,894.

effect is obtained by using a valve oscillator V to throw the bias of the control grid of first one tube and then the other above the cut-off point.

In reception both images are thrown on to the viewing-screen S, Fig. 1A, of a single cathode-ray tube, but a ruled grating G is interposed between the observer and the screen, so that one image is seen only by the

the cathode-ray stream as it strikes against the screen. The proportion of the metal particles should not exceed one part in 10,000, otherwise the light response is not improved.—(A. C. Cossor, Ltd.)

**Cathode-ray Tubes**

(Patent No. 415,143.)

In the ordinary way the received

**Summary of Other Television Patents**

(Patent No. 413,757.)

Cathode-ray tube for simultaneously handling a number of different frequencies.—(Marconi Co., Ltd., and A. W. Ladner.)

(Patent No. 413,954.)

Television system in which the picture to be transmitted is first focused on a photo-sensitive surface and the resulting electrostatic image is used to modulate the electron stream from a cathode-ray tube.—(F. C. P. Henroteau.)

(Other patents on page 520.)

# TRANSMITTING AND RECEIVING SYSTEMS

USED BY

## 'SAFAR' S.A. MILAN

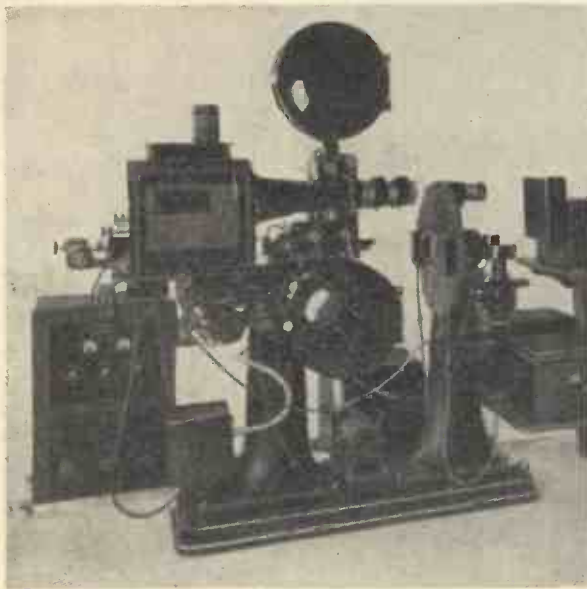

The Safar film transmitter with disc scanner.

The following abstract, taken from the "S.A.F.A.R. Review," a journal of the Italian Radio Manufacturing Company, describes their ultra-short-wave television equipment, and is particularly interesting to the Television Engineer in view of the developments which are taking place in Germany at the present time. It is gratifying to note that the results obtained were on British cathode-ray tubes, supplied by two of the leading manufacturers in this country.

THE theoretical circuit of the transmitter is shown in Fig. 1. There are five stages in all, but the transmitter is designed for the addition of a 3-stage Class B amplifier to increase the aerial power from 40 W. to 1 kW. The driving stage is quartz crystal controlled on a wavelength of 12.44 m. The second stage acts as a frequency multiplier and therefore oscillates on 6.22 m., which is the working wavelength. Then follows a third (1st A.F.) stage, which acts as separator, the second A.F. stage and then the modulator stage which feeds the aerial. The stages are connected by a tuned anode coupling. All the valves, with the exception of the driving valve, are screen-grid valves neutralised for greater stability.

To ensure constant frequency the filaments are battery heated and each stage is separately fed by the H.T. rectifier banks. Due to the use of

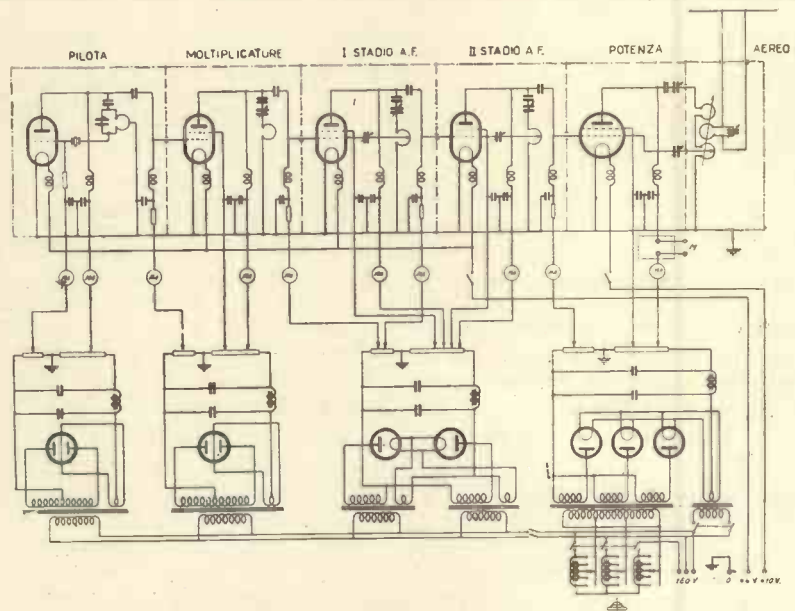
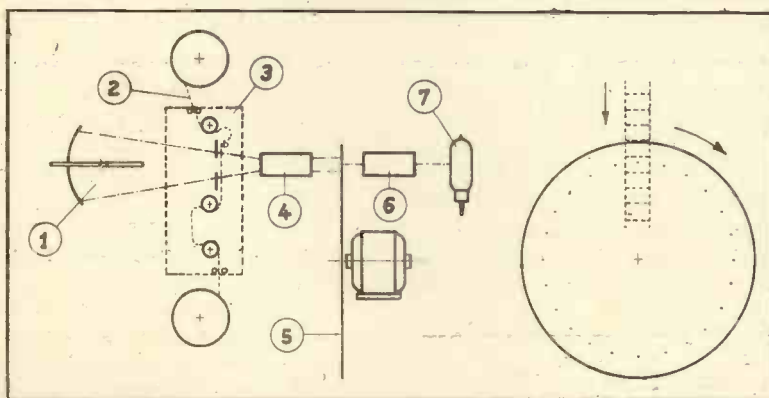

Fig. 1.—The theoretical circuit of the Safar ultra short wave transmitter. Note the separate H.T. supplies to the valves.



Schematic layout of the film transmitter. 1 arc, 2 film, 3 projector, 4 objective, 5 scanning disc, 6 lens, 7 photo cell

filters on H.T. and L.T., and efficient screening, the stability of the A.F. stages is assured.

The anode H.T. supply is derived from: (1) full-wave, gas-filled rectifier for the driving stage, (2) full-wave gas-filled rectifier for the second stage, (3) two half-wave gas-filled rectifiers in full-wave circuit for the third and fourth stages, (4) half-wave three-phase mercury-vapour rectifier for the fifth stage and the modulator. Oscillator harmonics are negligible, as they are too far from the fundamental and so do not affect standard ultra-short wave receivers.

On the other hand, modulation

harmonics are appreciable; and give the effect of striae in the picture. This slight defect, due probably to the synchronising signal, can, however, in practice, be eliminated by reducing the amplitude of the vision signal and increasing the power of the transmitter.

## Receiving Section

The receiver described is the monitoring receiver, used for checking the quality of the transmission, and it is intended that this shall form the

detectors in push-pull. The features of this superhet are the tuned aerial, the separate oscillator, a band width in the I.F. stages of 1,000 kc., push-pull detectors and a low-frequency compensator to cover a frequency range of 25 to 500,000 cycles per second.

In the vision receiver is mounted a separator valve, to separate the synchronising impulse from the picture frequency, a saw-toothed signal generator and the exciter unit for the tube. The separator consists of two valves having their anode circuits tuned to 25 and 4,500 cycles. These drive the two saw-tooth generators, which are connected to the deflector plates through intermediate amplifying stages. The saw-tooth generators are of the standard mercury-vapour relay type. It is claimed

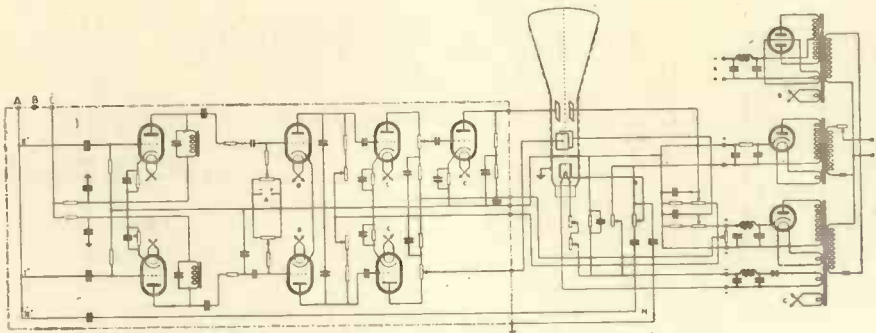
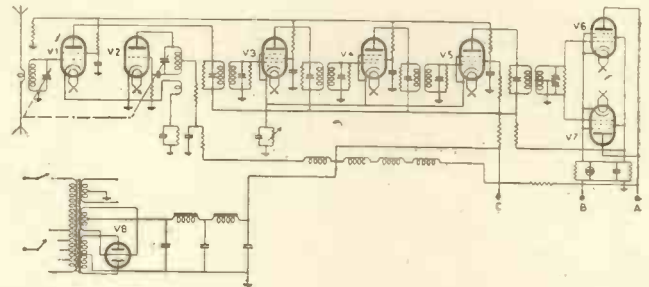

Fig. 3.—Double time base scanning circuit for use with the receiver of Fig. 2.

In regard to the system of modulation used, both variation of the grid potential and variation of the anode potential were tested with equally good results. Such systems were found satisfactory for quality of modulation, but not very stable on the H.F. side during the modulation itself.

A third system was attempted, by introducing the A.F. in an amplifier in Class A to feed the Class B after the modulation, without, however, obtaining better results. Results, satisfactory as to quality and depth of modulation and A.F. stability, have, on the other hand, been obtained by modulating with a simultaneous variation of the anode and screen-grid potential of a screened valve. This system has given the best results for this transmitter, particularly in the decreased attenuation in comparison with previous systems.

Fig. 2. — The theoretical circuit of the cathode-ray receiver.



basis of the standard commercial type of receiver which will be available later.

The radio receiver is a special type of superhet designed for 180-line television reception, while the television viewer is of the cathode-ray type with automatic synchronising. Fig. 2 shows the theoretical circuit of the original radio receiver.  $V_2$  is the oscillator,  $V_1$  the mixer and first detector,  $V_3$ ,  $V_4$ ,  $V_5$  are the I.F. amplifying stages;  $V_6$ ,  $V_7$  the second

that the additional R.C. coupled stage for the 4,500 cycle oscillator allows of a better separation and eliminates mutual interference between the two frequencies.

The 25-cycle synchronising impulses are also applied to the modulating electrode of the tube in order to eliminate the return stroke at the end of every picture. A modulation depth of 50 per cent. was used without appreciable loss of focus or distortion.

## THE TELEVISION SOCIETY

Notice of meeting, on Wednesday, November 14, 1934, at 7 p.m.

"Synthetic Sound," by Capt. A. G. D. West, M.A., B.Sc.

A demonstration of Herr Rudolf Pfenninger's synthetic sound will be given, with explanatory notes. His method of preparing the sound tracks on the drawing board and photographing these tracks, and of combining them to form synthetic sounds

and music will be described and fully illustrated by descriptive films, which will show his efforts at artistic presentation of these sounds, combined with cartoon and marionette subjects.

Herr Pfenninger does not aim at producing imitations of existing sounds but he tries rather to develop

new sounds and a suitable technique for presenting them. This paper will be read and the films demonstrated at the Gaumont-British Theatre, Film House, Wardour Street, London, W.1., by kind permission of the Gaumont-British Picture Corporation.

Cards of invitation for non-members of the Society may be had on written application to the Hon. Business Secretary, J. J. Denton, Esq., 25 Lisburne Road, Hampstead, N.W.3.

**Our Policy**  
"The Development of  
Television."

# THE SIMPLEST CATHODE- RAY RECEIVER

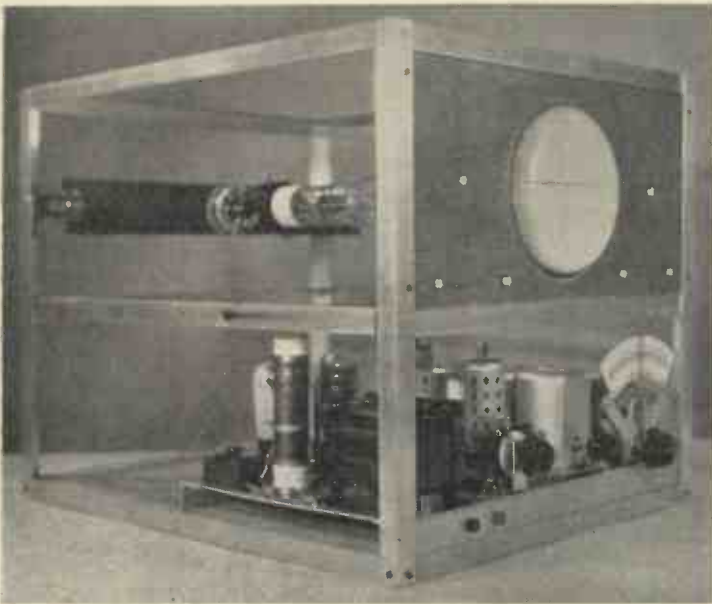

This photograph shows the arrangement of the cathode-ray tube in the chassis with the Universal wireless receiver below.

This article is the first of a short series describing the construction and operation of a practical and simple Cathode-ray Receiver for all-mains operation. We think we can justly claim to be the first journal to issue such a design, and we feel confident that our readers will find the results worthy of the trouble taken in assembling it. The receiver will utilise the new high vacuum tube recently developed by the Edison Swan Electric Co. which was described in a previous issue. The actual wireless receiver incorporated is that described on other pages in this issue which thus can be made to fulfil a dual purpose.

THE improved facilities given by the B.B.C. for testing television transmission at reasonable hours will have induced many readers to consider re-building their sets on more modern lines and to make provision for the future developments in short-wave transmission. While it is not wise to prophesy, it seems fairly certain that the P.M.G.'s Committee on Television will advocate the adoption of short-wave transmission in the near future, and with this in view it is desirable for readers to obtain their experience in the new technique as soon as possible.

For high-definition television the cathode-ray system of reception is essential, owing to the mechanical limitations of the mirror-drum. Further, the cathode-ray tube is adaptable to all forms of transmission and can be used on the existing system with ease. The experimenter can therefore graduate, as it were, and turn to the reception of short-waves later with the knowledge obtained on the standard low-definition practice.

In designing this complete cathode-ray receiver, the following points have been considered:

(1) The cabinet must not be too bulky; in this respect the cabinet is not much larger than that required

for a disc receiver, but the depth is considerable on account of the length of the cathode-ray tube.

(2) The receiver must be capable of giving good signal strength up to a

distance of, say, 300 miles, and must have an output stage sufficient to operate a disc receiver if required for comparison purposes.

(3) The time-base system for the

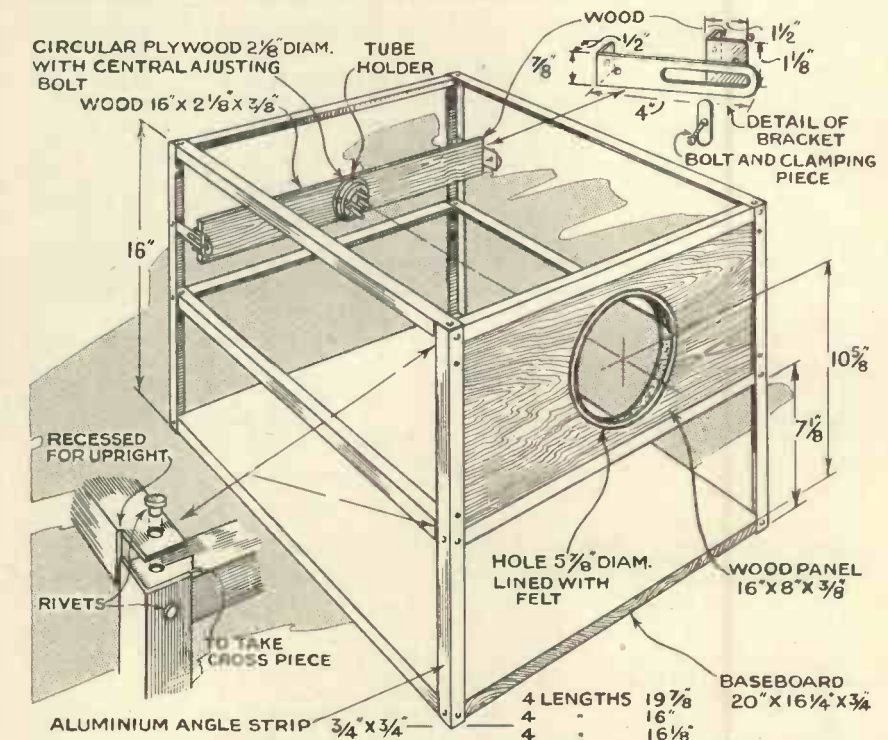

Constructional details of the aluminium angle chassis with the method of making the joints. The arrangements for supporting the rear end of the cathode-ray tube are shown at the top.

cathode-ray tube must be adaptable for 180-line definition as well as for 30-line. This is not always possible if the number of controls is to be kept down to minimum, but the alteration can be carried out with the minimum of extra components and in a few minutes when required.

mensions of which can be obtained from the drawing. At a point half-way up the frame the whole structure is braced by cross pieces which also form a platform for mounting the time-base circuit. The upper portion of the frame is occupied by the cathode-ray tube, the controls being brought to the front panel and projecting each side of the screen of the tube. The use of aluminium for the frame make a solid construction without adding unduly to the weight of the chassis.

### Construction

Commence by cutting lengths of aluminium angle strip to the dimensions given in the drawing. All the holes should be drilled in the strip before it is put into place as it is soft and easily distorted. If the experi-

right, part of the web must be cut away to allow them to fit snugly in line with the outer edge of the upright. This is shown in the sketch. Two further requirements are angle brackets for holding the cathode-ray tube socket, which are of the standard type supplied by Peto Scott.

The baseboard, of  $\frac{3}{4}$ -in. deal, is cut to measure 20 in. by  $16\frac{1}{2}$  in., and the angle strips are screwed to the corners. One of the screws in each corner will be screwed into the end grain of the wood, and should therefore be as long as possible to obtain a firm grip. The holes in the angle must be staggered slightly to prevent one screw fouling the other in the wood.

The front panel for holding the tube is cut from  $\frac{3}{8}$ -in. plywood, measuring 16 in. by 8 in. The central hole for taking the end of the tube is  $5\frac{7}{8}$ -in. diameter, and it is lined with a thin strip of felt. The end of the tube should be an easy fit when the felt is in place, as the main weight of the tube is taken by the socket strip at the back of the chassis. The panel itself is secured to the framework by four screws which can be seen in the photographs.

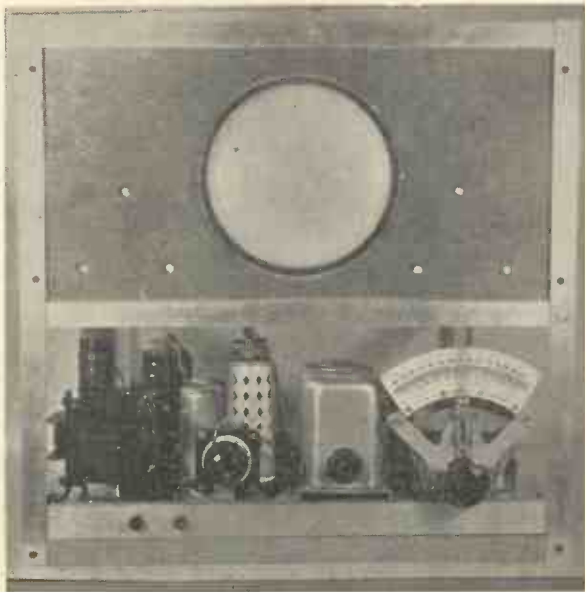

A front view showing the control panel and the Universal wireless receiver in position.

(4) The majority of readers having mains supply, the set has been designed to operate from A.C. mains. This has the advantage that the comparatively high voltage necessary for the cathode-ray tube can be obtained from a rectifier supply. At the same time, for those who have no mains supply, it is possible to operate the set from H.T. batteries, and sufficient space is left at the back of the chassis to enable the batteries to be accommodated inside the cabinet.

(5) The whole receiver is chassis built, with each section removable, so that alterations and adjustments can be done without dismantling.

### The Receiver Chassis

This is mounted on the baseboard of the whole assembly which is made from  $\frac{3}{4}$ -in. deal. The receiving set is described on other pages in this issue and employs universal valves. The space behind the chassis is utilised for the H.T. supply for the cathode-ray tube.

### Framework

The framework is built up from  $\frac{3}{4}$ -in. aluminium angle strip, the di-

menter is used to working in metal the strips can be riveted together with soft aluminium rivets, but 6B.A. bolts and nuts can equally well be used, with the possible advantage that they allow of the chassis being dismantled easily if this is desired for any reason. Where the angles fit together at the centre of each up-



This photograph shows clearly the method of supporting the rear end of the cathode-ray tube.

### Mounting the Tube

To enable the tube to be turned when in position the socket itself is mounted on a circular piece of  $\frac{3}{8}$ -in. plywood which is fastened to the main strip by a single screw through its centre. The connections to the

(Continued on page 520).



# GETTING THE BEST RESULTS WITH THE DISC SCREEN PROJECTOR

*In the October issue a novel system of obtaining screen pictures from a disc machine was described and full constructional details of the accessory apparatus were given. Below are given instructions for the correct adjustment of the unit together with some operating notes.*

**A**S the disc projector system described in the October issue is new and marks a fresh development in simple apparatus, it is natural that it should have created a great deal of interest—and some criticism. Briefly, it is a method which by means

it and failed years ago. An extract from another letter reads—“ . . . it cannot work, if only for the reason that the two large-diameter lenses between the screen and projection-lens are fundamentally redundant in accepted projection practice.”

Were cost of no consequence, Fig. 1 represents the arrangement which would have been adopted and published. Light from the source A is collected by the meniscus-biconvex condenser B, which projects it through the disc C, the image of which is

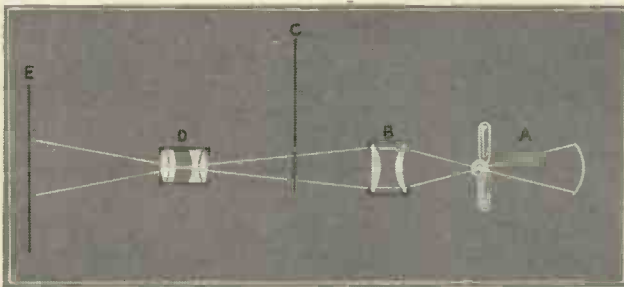

Fig. 1.—A standard type of optical projection system.

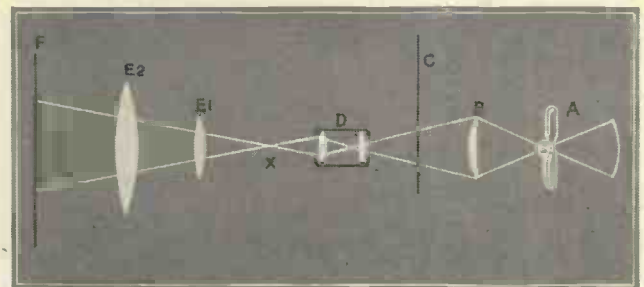

Fig. 2.—The optical arrangements used in the unit described.

of a simple unit allows of screen pictures being obtained (of a size approximately 4 in. by 2½ in.) with a disc machine. The system has been demonstrated to the members' hon. secretary of the Television Society, who expressed the opinion that both as regards brightness and definition the results were very little below the standard obtainable with mirror-drum apparatus.

Many correspondents are frankly incredulous of the results obtained. One states that whatever may be the originator's claims, it cannot be done because he (the correspondent) tried

## The Optical System

Now, regarding this pair of large-diameter lenses. These were included for the purpose of very considerably cutting down the cost of the projection lens. Without them, the projection lens would have to be of extremely short focus, wide angle, and wide aperture. The cost of such a lens was found to run into pounds instead of shillings; therefore its use had to be avoided if the system was to cost but little more than the ordinary disc machine.

picked up by the projection lens D, through which it is enlarged upon the screen E. Nothing could be simpler, and this is accepted projection practice.

Now turn to Fig. 2. Light from source A is collected by a simple plano-convex condenser B, which, as before, projects the rays through disc C. The image of disc C is now picked up by the simple lens-combination D, which cannot give a good brilliant image larger than that set by the boundary at the point x. If no screen be placed at x, we have there a small but brilliant virtual image. E1, E2 now form the final projector system, after picking up this image, and it is interesting to note that in this latter lens-system the rays do not cross, owing to the virtual image being situated inside their principal focus. Though the problem of “how and why” may become a little more complicated, the problem of expense becomes a great deal easier.

## Adjusting the Lenses

Now regarding the matter of getting the best results with this system.

It is suggested that the experimenter should, after having built up the apparatus, proceed to adjust the op-

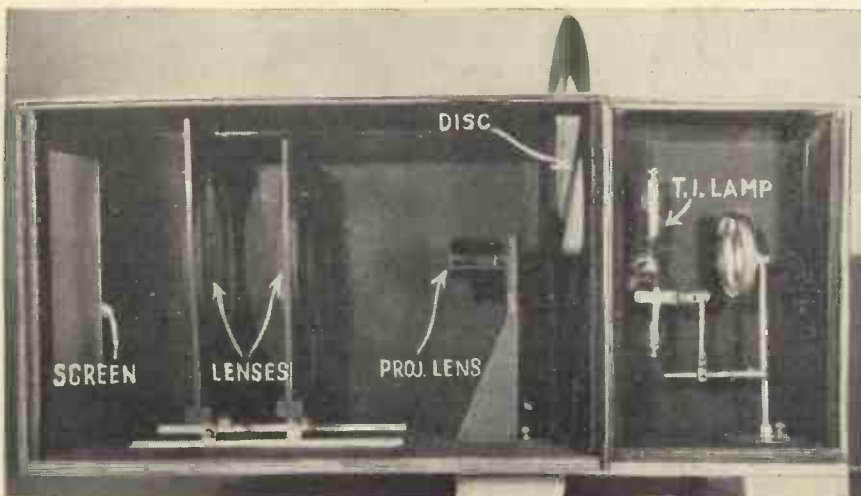

tical system first. If separate lamp excitation is available, this may be done without the aid of the receiver. Otherwise, the receiver must be coupled up to obtain voltage and current for the lamp.

The first requirement is to strike the lamp; and it is presumed the reader needs no instruction in this direction, beyond information already in his possession gathered from the October issue, pages 449-450, in addition to instructions given by the lamp-manufacturers with every lamp. Either of these diagrams, or a simple combination of one with another, should be found to meet the experimenter's conditions. Should any difficulty be experienced in the first striking of the lamp, still further details and methods were given in TELEVISION for March, 1934, page 101, and for June, 1934, page 265.

Readers are reminded that until the lamp has been "aged," or in use for a few hours, it is sometimes difficult to "get going." After ageing, however, it is usually quite lively, and will be found self-striking immediately the signal from the receiver is applied. A useful tip, is to allow the receiver to warm up to its full output before switching the lamp into circuit. The sudden surge is then sufficient; but, in all cases where adequate H.T. supply is available, no difficulty will arise, even when operating with new, un-aged lamps.

Having obtained our light, the reflector should next be adjusted. It should be placed at a distance behind the lamp, so that the cone of light from the reflector comes to an apex within the centre of the light itself. This may be verified by such simple means as the blowing of smoke or a little powdered chalk into the beam, when the rays of light will clearly be distinguishable.

Next, the combined lamp and reflector, as one unit, should be placed at a distance behind the lamp-house condenser glass so that the condenser converges the beam or cone to a circular patch upon the back of the disc. By varying the distance of the lamp, this patch may be expanded or contracted until it just covers an area equal to the distance between two scanning-apertures. Take care that the height of the lamp brings its centre dead central to the lamp-house condenser glass, or you will miss the "flash-point." This also applies to sideways movement.

When satisfied that you have the cleanest and most brilliant patch of

light possible, and in the correct position upon the disc, remove this latter, temporarily.

Now, again with the aid of smoke or chalk, find the position of the apex of the cone of light projected from the lamp-house; and this point should be occupied by approximately the centre of the projection-lens barrel. Fix the projection-lens here, taking care to preserve a straight optical axis throughout.

Next, replace the disc, and turn it so that the fifteenth aperture, counting from either end, is approximately in the optical axis. That is, in the centre of the light-patch cast upon the disc from the lamp-house. Now place your screen a few inches in front of the projection-lens, and draw it back and forth until you focus a sharp image of the disc aperture upon it. At this point (x) in the diagram,

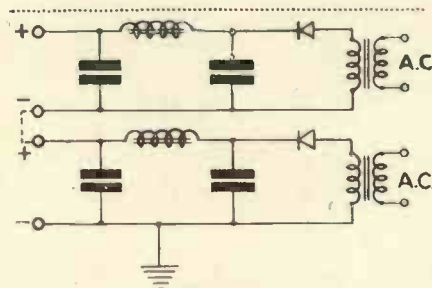

Fig. 3.—Circuit showing the use of two power packs for the purpose of obtaining increased H.T.

Fig. 2, the virtual image is situated.

Having so far proved all in order, the screen may now be mounted in its correct position, and the two large-diameter bi-convex and plano-convex lenses interposed between the screen and the projector-lens.

The positions of these lenses cannot be described as critical. The object should be to get the rear, or smaller, of the pair, as near to the point x as possible without sacrificing picture-size in exchange for too high a brilliance. Work for the best compromise between size and brightness. The nearer the point x, the greater the light, but the smaller the picture. A picture size of  $4\frac{1}{2}$  to 5 inches leaves plenty of brilliance. It should be noted that if the distance between the largest lens nearest the screen, and the screen, be once fixed at, say, 4 inches, it only becomes necessary to make adjustments with the rear one of this pair. Remember, however, that every adjustment for size of picture made with this lens will make it necessary to re-focus for sharpness of image by means of the projector-lens.

If the foregoing has been both understood and adhered to, the claims made for the system will at once be appreciated.

Another tip may be of service. As it appears impossible to purchase ground glass of the correct grade for maximum results, the writer has found it best to procure the cheapest possible quality, and "dope" it. After mounting it in position, with the rough side outwards, or towards you when viewing, smear it with a film of colourless oil. This will render it nearly transparent, closely resembling clear glass. Turn on the light, spin the disc and wipe off the oil gradually with a piece of cambric or other non-fluffy material, until the desired gradation of translucence be obtained. It will last in this condition for many weeks. Waxed paper also makes a quite good screen.

## H.T.

### Supply

The question of H.T. appears to have caused some misgivings to a few workers. It should not, however, as under no circumstances, no matter what light source be used, can really good pictures be obtained with voltages short of those required in the present system. Most of the inquiries in this direction are devoted to ways and means of including the lamp in circuit with existing H.T. feed arrangements.

These inquirers may quite safely be referred to pages 449-450, in the October issue. The arrangement employed by the writer is the 4th circuit on page 450 (October issue).

One high-tension query is, however, sufficiently interesting to be dealt with here, as it may suggest to many others a ready means of saving expense. The correspondent asks for information as to the advisability of connecting two H.T. eliminators or power packs in series. Though possible, unless extreme care be taken, expensive accidents may happen; and for this reason it is generally considered inadvisable. Nevertheless, in view of the fact that the average television worker has already learned the value of caution, and may be relied upon to take care, we give in Fig. 3 the method for A.C.

Care must be taken that both eliminators are fitted with mains-transformers. Take care that only one of the eliminator negatives be earthed, and take care that this negative is the one *not* connected to the other

(Continued in first col. of next page).



# Correspondence

Correspondence is invited. The Editor does not necessarily agree with views expressed by readers which are published on this page.

## Multi-Spiral Scanning :: Optical Efficiency of Lenses

### Multi-Spiral Scanning

SIR,  
Our attention has again been drawn to a statement in your journal (Vol. 7, No. 80, October, 1934, at p. 458) to the effect that the use of multi-spiral scanning discs was due to Walton and Sanabria; this is, of course, not the case, the use of the three spiral disc was first demonstrated by Mr. Baird at the meeting of the British Association at Glasgow in 1928, and the idea was described in British Patent No. 321,389 (J. L. Baird) as we have already pointed out in your issue for August, 1934, at page 361.

BAIRD TELEVISION, LTD.  
\* \* \*

### Optical Efficiency of Lenses

SIR,  
In the article "What is Light Efficiency?" by J. C. Wilson, in TELEVISION, August, 1934, the

### "Getting the best Results with Disc-Screen Projector."

(Continued from preceding page.)

eliminator positive. Also see that the receiver "earth" is not connected to the non-earthed eliminator.

In the circuit shown, the rectifiers are indicated in simple symbols, but these may, of course, be either metal or valve, preferably metal. The series connection is indicated by the dotted line, and the circuit is merely of skeleton form to give the general idea. It has been shorn of voltage-dropping resistances, decoupling-condensers, etc., for the sake of simplicity.

One last hint, regarding the lamp. The electrode connected to the positive line will glow red, and this end of the lamp generates by far the most heat. It is advisable, therefore, to mount the lamp in its holder with this end uppermost, in order to allow the heat to rise straight off the lamp, without engulfing the rest of the tube. The lamp-house roof may also be provided with a few ventilation holes. Cool working, and long lamp-life will result.

incorrect definition of the "optical efficiency" of a simple lens, leads the author to a paradoxical result, giving to the following rule a vague signification. "In a simple lens system, the maximum optical efficiency is obtained, when the image formed is equal in size to the object."

The correct definition of the light efficiency of a lens or of an optical system is: The ratio between the input luminous flow, and the input luminous flux, in lumens, of the lens or of the optical system.

But with this definition it is necessary to give attention to the quality of the image given by the lens.

We know that a simple spherical lens is astigmatic, that is to say, the different luminous rays coming off the same point of the object do not fall on the same point on the image. The theory of spherical dioptries shows that a luminous beam coming off a point of the object and passing through a lens gives, at the way out of the dioptrie, a luminous beam that is concentrated, not into a single point but into two little perpendicular lines situated at some distance one of the other. These two little lines are called "focales." They give a single point on the optical axis if the different rays contained in the luminous beam proceeding from the object point have a small angle with the optical axis, that is to say, if the lens is used with a small aperture.

In consequence, to obtain a correct image with a simple lens, it is necessary to use this lens with a maximum aperture. Then, we are obliged to diaphragm the lens and consequently to reduce the luminous flux passing out of the lens. So, the light efficiency is reduced, because a part of the luminous flux is stopped by the diaphragm.

The rule, given in the beginning of the article, means that when the image has the same dimension of the object, a simple lens can be used with a larger aperture, than in the other cases, so for an equal input luminous flux, the output luminous flux is maximum, and the optical efficiency is a maximum.

For brilliance, or luminous intensity per unit of area, of the object or of the image, it is very simple to prove that these are in the ratio of the luminous flux input and output, and so the brilliancy of the image cannot equal the brilliancy of the object.

Let us suppose a very small luminous source of area  $s_1$ , and of brilliancy  $b_1$ , the luminous intensity of this source in candles is:  $b_1 s_1$  candles.

The luminous flux  $\Phi_1$  falling on a lens of radius  $R$  and situated to a distance  $x$  of the luminous source, is equal to the luminous intensity multiplied by the solid angle under which, from the object, we see the lens:

$$\Phi_1 = \frac{b_1 s_1 \pi R^2}{x^2} \text{ lumens.}$$

Let us call  $\pi$ , the optical efficiency.

The output flux will be:

$$\pi \Phi_1 \text{ lumens.}$$

And the luminous intensity of the image will be equal to this luminous flux divided by the solid angle under which, from the image, we see the lens:

$$\text{We have: } \frac{\pi \Phi_1 y^2}{\pi R^2} \text{ candles.}$$

And the brilliancy of the image is:

$$b_2 = \frac{\pi \Phi_1^2 y^2}{\pi R^2 s_2}, \text{ } s_2 \text{ is the area of the image, and } y \text{ is distance to the lens.}$$

$$\frac{s_1}{s_2} = \frac{x^2}{y^2}$$

The brilliancy of the image is:

$$b_2 = \pi b_1.$$

With these considerations, it is not correct to say that "in the case of simple systems such as those in which a small aperture is to be brightly illuminated (for example, for mirror-drum or lensed-disc scanning) the best condition is obtained when the source itself is brought up directly behind the aperture, and no condensing lens is used."

ROGER TURPIN,

Ingénieur-Conseil E.P.C.I. (Paris).

FOR  
DISC AND MIRROR DRUM SYSTEMS

**"BAIRD" and "MERVYN"**

KITS AND COMPONENTS

L. LEAMAN, 97, Northfield Avenue,  
W. Ealing, W.13.  
Phone—EALING 5394

## MOUNTING THE PHOTO-CELL

If a photo-cell is to be used for experimental work it is essential to screen it from external interference.

If, in addition, the screen is light tight, the cell can be used in all kinds



The photo-cell mounted in its screening can.

of places without the necessity of darkening the room.

The screening can shown in the photograph was made from a coil screening box (actually an "Igranic" coil) whose dimensions were chosen

to take the cell and leave the top terminal and part of the base projecting. A hole is cut in the base of the can of a diameter equal to the base of the cell where it tapers, and a corresponding hole is cut in the top of the can to take the terminal moulding.

The dimensions of the can were such that when the cell was inserted it was jammed between the base and top, leaving room for a Sorbo rubber ring to take up vibration and hold the cell central.

Before finally fixing the cell in place, a slot is cut in the side of the can in the position shown by the dotted lines in the drawing. The height of the slot will depend on the dimensions of the cell, but in the one used (Osram) the centre of the slot was  $1\frac{1}{4}$  in. from the top of the can.

Two holes were drilled with a  $\frac{1}{8}$  in. drill  $\frac{1}{2}$  in. apart and then joined with a fretsaw cut and filed true. When the cell is inserted, care must be taken that the slot is facing the front of the cathode surface.

The cell in its mount can be fitted directly in an amplifier, corresponding to a "first stage" valve, but if it is required to have the cell at a little distance, the base shown in the photograph is a useful adjunct. This is made from a 3 in. by 3 in. wooden switch block, obtainable from electrical suppliers. A baseboard mount-

ing valvholder is let in to the centre of the block and the connections to the sockets are made by means of four Belling-Lee terminals screwed

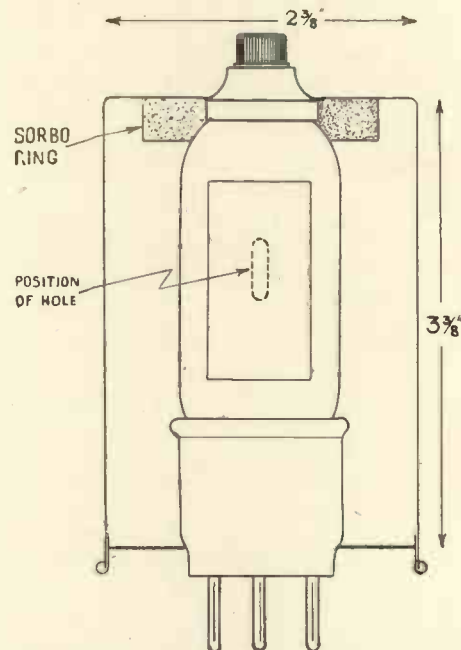

Diagram showing the arrangement of the cell in the can.

through the sides. Actually only one terminal is required for the cell, but if all four sockets are connected the holder can be used for valves as well.

It is important that the can be earthed.



A Television Exhibition in a London Store; this is a photograph of the display of television apparatus made by Holdrons, Ltd., of Peckham. Several types of scanning apparatus were shown under working conditions, each being placed in a semi-darkened cubicle as shown above.

## Television in a London Store

An exhibition of television apparatus was recently staged by Holdrons, Ltd., the well-known London store, of Rye Lane, Peckham. A representative collection of receivers was displayed and although, of course, it was not practicable to show these reproducing pictures, they were shown under working conditions with the motors running. Firms who lent apparatus for the display were British Television Supplies, Ltd., The Edison Swan Electric Co., Ltd., The Mervyn Sound and Vision Co., Ltd., and Television Instruments, Ltd. Included also were the Simplest Mirror-drum receiver and the Disc Screen Projector, both of which were recently described in this journal. The large amount of attention that the display created was proof of the interest of the public in television.

**THE AMATEUR TELEVISION EXPERIMENTER.**

**CURRENT SUPPLY FOR THE LAB.**

*This is the second article of a series dealing with the complete equipment of the amateur television laboratory. The articles are based upon the practical experience of two research engineers over a period of several years and they will provide a reliable guide for the serious experimenter.*

FOR general experimental work nothing can beat an accumulator for a high-tension supply. It is perfectly true that a battery is rather messy, also rather bulky and requires a certain amount of maintenance, but it more than compensates all these drawbacks by its smoothness of volts and good regulation. For the first stages of a transmitting amplifier an accumulator is all but essential, unless extraordinary precautions are taken with regard to smoothing. It is quite a good rule to use battery H.T. for amplifiers whose grid swing is less than .5 volt; while

and a 5,000 milliamper-hour 300 volt battery is better.

Whatever the size and shape of battery it is of the utmost importance to mount it in a place where it can be got at. "Out of sight, out of mind" is never so true as when applied to battery installations! As a result they are given casual treatment, the topping up of the cells is neglected, and in a very short time the outlay on a good set of cells is wasted. Put them on a good shelf where they can be seen without stooping in a dark corner, and make a rule to dismantle the assembly once a month to see that no acid leakage has taken place and that there are no shorted cells. A properly looked after H.T. battery should last for years, and the time spent in keeping it in good order is a direct saving in money.

Regarding charging arrangements, it will be an economy to use the H.T. eliminator for supplying both the amplifiers and for charging in its spare time. The switching is quite simple (Fig. 1), while Fig. 2 is the diagram for use when the battery voltage is higher than that of the H.T. rectifier supply. Experimenters who have d.c. mains should have an accumulator supply of not less than 400 volts, preferably 600.

**The H.T. Eliminator**

Now let us consider the H.T. eliminator for A.C. mains. The first question is—should one use valves or metal rectifiers? In performance they are equal. Valves are cheaper to install, but cost more to run (it takes power to heat the filaments). Metal rectifiers are expensive to install, cheaper to run, and have an almost

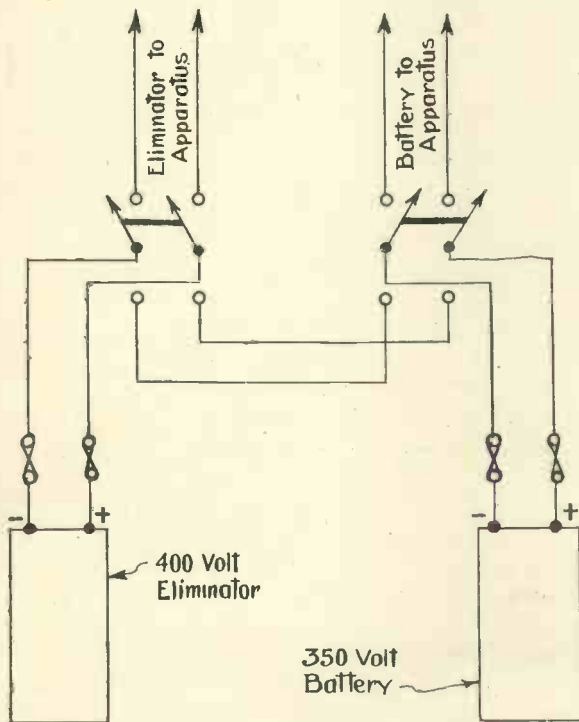

Fig. 1.—Method of using an eliminator for H.T. supply or charging purposes

mains eliminators can be reasonably used for amplifiers whose input voltage is of the order of .5 volt or more.

Choice of H.T. accumulators is the next consideration. Three hundred volts is a useful minimum voltage as all but output power valves rarely require more than 200 volts on the plate, and such a battery will allow a 100-volt drop in the anode and coupling resistance.

When buying a battery, buy as high a voltage as can be afforded, up to about 600, and as large a capacity as possible to save trouble in continual charging. Needless to say, battery charging facilities are almost essential, and if these are available a 2,500 milliamper-hour battery at 500 volts will be found satisfactory for most purposes. If it is impossible to charge one's own batteries, then voltage will be sacrificed to capacity,

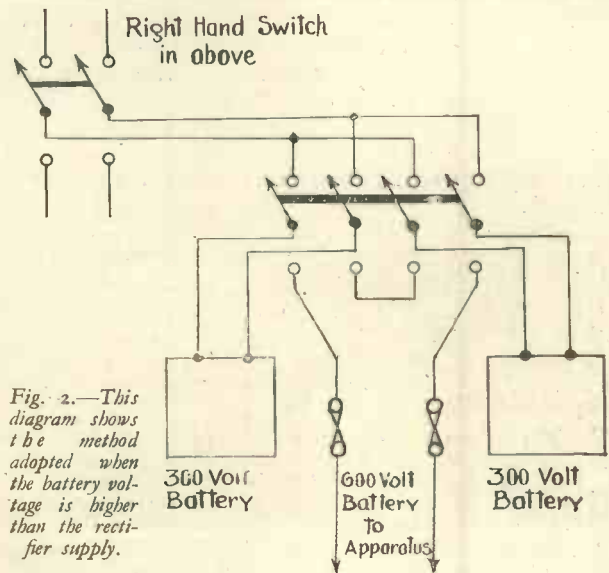

Fig. 2.—This diagram shows the method adopted when the battery voltage is higher than the rectifier supply.

# THE AMATEUR TELEVISION EXPERIMENTER

indefinite life—the writers recommend the metal rectifier. Fig. 3 is the circuit of an ordinary metal rectifier voltage doubler of conventional type, and can be well recommended. To get over 550 volts with a valve is not convenient for most amateurs. No further details of eliminators are given, as they can be so easily found in the Westinghouse handbook—"All Metal Way," or the various valve manufacturers' booklets.

While on the subject of eliminators and charging, one must not forget to make provision for charging L.T. batteries. With A.C. mains and a metal rectifier the

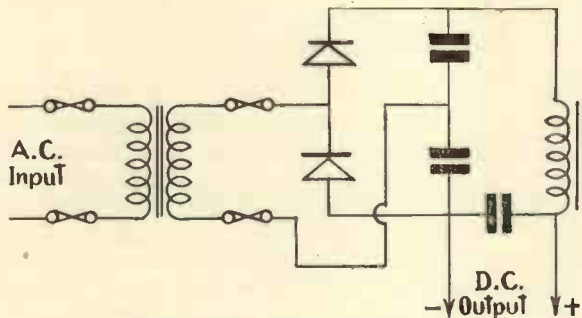

Fig. 3.—Circuit of metal rectifier of the voltage-doubler type.

job is easy, but D.C. mains are rather a problem, as one ampere is generally the lowest charging rate desirable, which means 200 watts, or a unit every five hours on a 200-volt supply, while the most useful type of L.T. is the 30-60 ampere-hour battery, which should be charged at not less than 3-4 amperes. One way to get over the difficulty is to have a large number of low-capacity cells and have a rather complicated series-parallel switching system, which put the cell in parallel for operating and series for charging as in Fig. 4.

One can, of course, also use a motor-generator for either D.C. or A.C. mains, but such an outfit is far from cheap. One of the writers, possessing a motor to turn various workshop tools, found it very satisfactory to run an ex-aeroplane generator rated at 12 volts 250 watts at half load for charging, the generator only cost five shillings in a well-known London disposal stores. While this price is rather exceptional, it is quite easy to obtain these generators for about fifteen shillings.

As to the type of L.T. battery, the small 6 volt car battery is admirable if a charging current of not less than 3 amperes is available, and they are cheap to buy. At least two L.T. batteries are recommended to start with. One of these batteries should be 6 volts and the other 2 or 6, of which the 2-volt will probably be chosen as most of our battery valves are 2 volts.

## Wiring

It will be found very convenient to wire up the L.T. supply permanently to the experimental benches with terminals fixed a few feet apart. The wiring must be carried out in heavy cable to avoid voltage drop—about 7/18 gauge, and the cable should be properly sweated

into thimbles for clamping behind terminals. The terminals themselves should be comparable in thickness with the cable; one often sees a thick wire held by one or two strands to a 6 B.A. screw, and, of course, the voltage drop avoided by the thick cable is wasted at the actual contact with the terminal. For protection, ordinary slip conduit is quite satisfactory, and is the cheapest. When mains leads are run, however, it is as well to consult the local electricity authorities on their requirements.

In outdoor workshops the wiring regulations are more stringent and it is usually necessary to use lead-covered cable, enclosing this in conduit, the whole being earthed at two or three points. Most power companies frown on live terminals connected to the mains supply, even though a switch is installed, but it must be said that a pair of terminals at at least one point on the bench is a very useful change from switch sockets! The diagram, Fig. 5, shows a suggested layout for a small bench equipped with L.T. and mains supply with plug points every two or three feet to suit the length of the bench. The conduit is carried on the front of the batten in the case of the mains supply, while the L.T. is brought to pairs of terminals fixed to the back woodwork of the bench. Above the L.T. terminals is a flat copper strip 3/4 in. wide by 1/16 in. thick for an earth connection. If possible this should be run without a break to the tube or earth plate buried in the ground. The correct methods of ensuring good earth

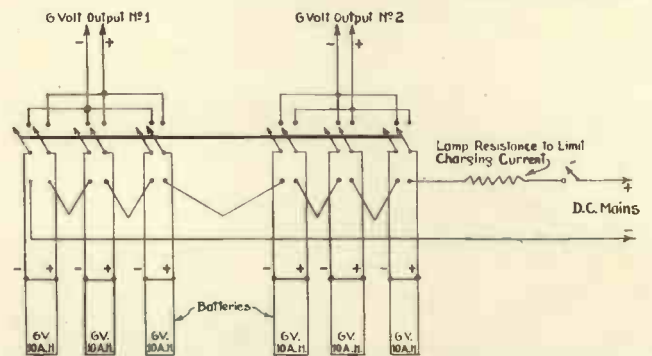

Fig. 4.—Series parallel arrangement for charging low-voltage batteries from a high-voltage source.

have been written about so many times that no excuse is needed for omitting them in this article.

The conduit or lead-covered mains cable can usually be relied on for an earth in most districts, but it is always better to have a separate lead which can be bonded to the supply earth. In experiments with photo-cells and with cathode-ray tubes a great deal of trouble can be avoided by having a satisfactory earth, and the best advice to those who are doubtful about their earth plates is "Dig it up and bury it deeper."

When wiring up mains points it is very important to see that the switch is connected in the "live" lead. Besides conforming with the supply companies' regulations, this ensures that there is no interference from mains when the switch is off. In one case in the

(Continued at foot of next page.)

## SIMPLE LENS MOUNTS

THE cutting of round holes of over one inch diameter is a problem with which the amateur constructor is often faced, and it is sur-

prising how few home mechanics know that a cheap and efficient tool can be obtained from any good tool shop for the purpose. I refer to the washer or fly cutter. The photograph shows such a tool in operation. As can be seen it consists of two cutting blades, which are adjustable about the centre. When holes smaller than about three inches in diameter are required only one blade is used, the other being removed and replaced with blade pointing upwards. The tool is fitted with the usual square taper shank suitable for an ordinary brace. The one illustrated cost 3s. 6d. and will cut holes from 1/2 in. to 3 in. radii. While primarily

intended for wood, it can be used for soft metal, such as aluminium.

When cutting a hole, one first cuts from one side and then the other, for the cleanest results when working in wood, a small hole being drilled through the centre of the required circle to mark the centre on both sides.

Wooden rings or washers can be easily cut with the tool. First, the outside circle is cut the required diameter, the cutter arm is then reduced

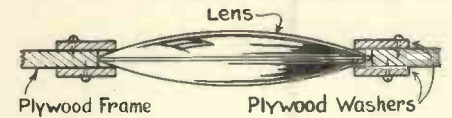

A simple lens mount made from three pieces of plywood.

to the requisite inside diameter of the washer and the second cut made. In television work the cutter is most useful for making simple lens mountings. The drawing shows in section a simple lens mount made of ply-wood by the aid of the cutter illustrated.—T.R.



Photograph showing how the holes are cut.

**READ  
TELEVISION  
REGULARLY**

### "Current Supply for the Lab."

(Continued from preceding page.)

writer's experience a strong 50-cycle hum was found in a photo-cell circuit which was adequately screened. On tracking it down it was found to come from a soldering iron, in which the switch was on the "dead" main, although the iron itself was wired in screened flex and earthed.

By the way, for those who have not met it, there is a type of screened flex available in which the conductors

### Aerial Equipment

The aerial equipment is largely governed by the type of experimental room available, as said before. If an outdoor workshop is available it is easiest to sling a small aerial between upright posts fastened to each end of the shed, giving a length of some 20 feet. The rapidly growing interest in short-wave television makes the provision of a short-wave aerial desirable, and this could be fitted in the same way, great care being taken to make a rigid structure. For 7-metre work a horizontal "doublet" aerial can be used with the incoming leads brought straight through the roof of the shed down to the bench. This type of aerial has directional properties, so look at the compass before erecting it! For further details on short-wave aeri-als, experimenters are advised to consult the Eddystone Short Wave Manual.

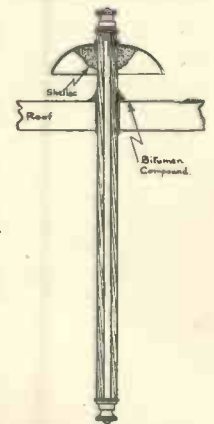

Fig. 6.—An improvised water-tight lead-in.

It is always a difficult matter to make the lead-in of the aerial water-tight, especially when it is taken through the roof of a shed, and Fig. 6 may help those who have trouble in this respect. The lead-in tube is of best quality ebonite, or better still, paxolin, and on the top end is fixed with resin a switch cover of moulded bakelite. This acts as an efficient rain shield and prevents dribbling through the hole in the roof. As an extra precaution the hole through the tube can be filled with bitumen compound, which should also be used to line the hole through which the tube passes.

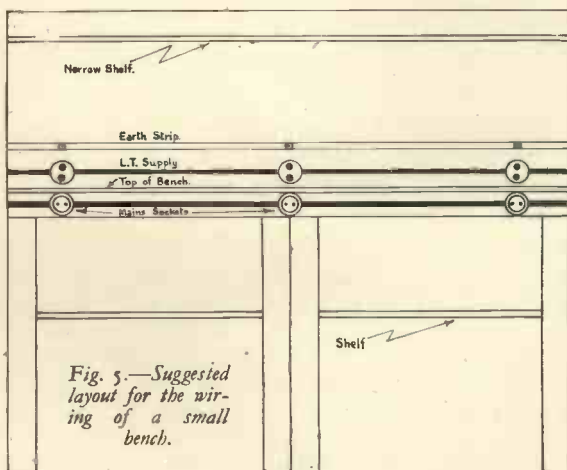

Fig. 5.—Suggested layout for the wiring of a small bench.

are wrapped round with aluminium foil, which in turn is covered with braided cotton. This avoids the trouble sometimes met with in ordinary braided screened flex—the possibility of the covering shorting various live terminals if it comes into contact with them.

# ANSWERS to QUERIES

## Mechanical Drive for Scanning Disc

As I have no mains supply nor facilities for charging an accumulator do you consider it practicable to drive a scanning disc by mechanical means as for instance with a gramophone motor?—B.T. (Horley).

There is no reason why a scanning disc should not be driven by mechanical means, but it is doubtful whether a gramophone motor will be sufficiently powerful to drive it at the correct speed. A gramophone turntable runs at approximately 78 revolutions per minute and as the speed of the scanning disc is nearly ten times this it is doubtful whether the speed could be maintained by means of a motor of this type even though it was geared down; in any case the duration of the run would be only a few minutes. Your best plan would be to use a 6-volt motor and a car battery for current supply. This would only require charging at infrequent intervals, and the nearest garage would do this.

## Cathode-ray Synchronising

I understand in a general way the operation of the cathode-ray tube for television purposes with the exception of the means used to obtain synchronism. Will you briefly explain this?—T.S. (Bexhill).

It is not possible to explain the method of synchronising very briefly and we must refer you to the article on the subject which appeared in the March issue of this year. The system employed is the application of a portion of the signal voltage to the scanning circuit in order to lock it into step with the transmitter. As there are no mechanical moving parts the power required is negligible.

## Multiplicity of Images

Recently in the screen of my visor four pictures appeared in pairs one above the other so that four quarters of the screen were occupied by the same picture. None of the pictures was split

in the way which can be accounted for by incorrect phasing and no alteration had been made in the apparatus. Can you explain the reason for this which lasted for the entire duration of the programme and incidentally has not since been repeated?—A.L. (Bromley).

Four pictures can be produced in the manner described if the scanning device is running at an incorrect speed. Half speed will produce this effect and also double speed will do the same. The latter can be checked by allowing the motor to slow down gradually and noticing whether a phase is passed through when the picture again appears. If this does not occur then it may be taken for granted that the speed at which the scanner is running is half the correct speed. The fact that it has not occurred again indicates that there was some wrong adjustment of the motor controlling resistance, which has since been righted.

## Negative Pictures with a Super-het

I am using a five-valve super-het for receiving the vision programmes and get excellent results except that the pictures are negative. Can you tell me how I can remedy this fault.—D.M. (Hastings).

A super-het receiver presents a rather different problem in this respect to the ordinary straight receiver. The usual procedure with a straight receiver is to alter the form of detec-

tion—leaky-grid to anode-bend or vice-versa—or change over one set of transformer connections. The first, of course, does not apply to a super-het, and if it is of British make it is improbable that a transformer is fitted. With a superhet of this type, therefore, the only method is to add another stage of L.F.

## Motor Speed Control

I find that on many occasions the speed of my motor after running for a time falls below the correct scanning speed and no adjustment of the rheostat will produce the necessary increase. This seems to occur more often after I have given the motor a lengthy run in order to warm it up.—R.F. (Worthing).

It frequently happens that the speed of a motor falls after a lengthy run and provision must be made for this in the amount of resistance that can be cut out. A fair amount of latitude should be allowed on either side, otherwise there is always the possibility of not being able to bring the motor to the correct speed after it has attained its average working temperature. Alternatively, there is always the possibility that the motor is not sufficiently powerful for maintaining the scanner at the correct speed. As the difference in all probability is very small it is usually possible to compensate for this by careful attention to the running of the motor, as for instance, light pressure of the brushes on the commutator, and ensuring that the bearings are quite free. It is also practicable to reduce the size of the disc slightly by cutting a strip off all the way round; this will often just make up for a slight lack of power.

## Screen Pictures with a Disc Receiver

I have built the unit described in last month's issue for obtaining screen pictures with a disc receiver, but have failed to cause the T.I. lamp to strike. Can you give me any further information?—D.M. (Bradford).

This lamp requires a slightly higher voltage than the ordinary neon for its operation and it appears likely, therefore, that the voltage you are using is a little too low. Provided that the voltage is approximately correct the striking may be facilitated by rubbing the tube with a piece of silk.

### ANSWERS TO QUERIES

An expert service is available to assist readers who experience difficulties in the construction, operation and maintenance of television apparatus or associated wireless receivers and amplifiers.

The following rules should be observed:

Please write clearly giving all essential particulars.

A stamped, addressed envelope and also the coupon on the last page must accompany all queries. Not more than two questions should be sent at any time.

Reply will be made by post.

Queries should be addressed to the Query Department, TELEVISION, 58-61, Fetter Lane, London, E.C.4.



# THE STROBOSCOPIC EFFECT

## —AS AN AID TO SPEED DETERMINATION

THE stroboscopic effect has proved an invaluable aid in determining at what speed a scanning device is running. Perhaps its most valuable feature in the case of television is that it imposes no load on the apparatus as would any mechanical device which can be used for the purpose of speed determination. Secondly, it is easy to see at a glance whether the device is running too fast or too slow; and thirdly, the effect can be produced on practically any scale, which makes it very easy to read.

The one requirement to produce the effect is a light which will fluctuate

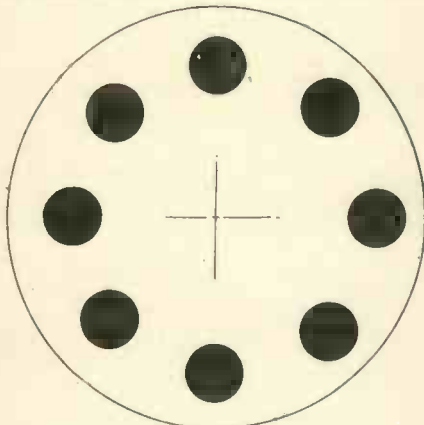

A useful type of stroboscope disc for 50-cycle A.C. mains.

ate at a constant frequency, and the most usual way of obtaining this is by the use of a lamp which is fed from A.C. mains of known frequency, and which, in nine cases out of ten, are available to the television experimenter.

### How the Stroboscopic Works

In order to understand the phenomenon, imagine a disc on which there is a single black spot, and that it is illuminated for a very short period once every second. Each time the illumination appears the spot will be seen, and, of course, with the disc stationary, always in the same position. Now if the disc is caused to rotate, as the speed increases instead of one spot being seen there will a number, the reason being that the illumination occurs with the spot in different positions. The number of

spots will be seen to diminish as the speed of the disc increases, until, when the disc is revolving at a speed of one revolution per second, the spot will appear in one definite position and the disc, so far as the indication that the movement of the spot provides, will appear stationary, and we know that its speed is one revolution per second. The sharpness or clearness of the spot will depend upon the shortness of duration of the flash of light, for obviously it must be viewed in an interval of time during which its movement must be very small.

Now let us increase the speed of the disc beyond that of one revolution per second. It will be obvious that between each flash the spot will not only have travelled round the complete circle, but also that it will have gone a little further, and the impression on the eye will be that of a spot moving slowly round in the direction in which the disc itself is travelling. Alternatively, if the speed be slowly decreased, the spot will appear to travel slowly in the opposite direction.

As the motion is slowed down until the disc is revolving at a steady speed of one complete revolution every two seconds, obviously two spots would appear, one at each end of a diameter of the circle. The stroboscopic speed is that which makes the spots appear stationary, and when the number is the same as the number of spots on the disc this is the fundamental speed. Other speeds which cause a number of stationary spots to appear which are a multiple of the number actually on the disc are sub-multiples of the fundamental.

### Stroboscopic Calculations

We can now consider the case of an actual scanning device such as a mirror drum or disc which is provided with a number of spots or spokes. It will be clear that we can arrange the number of spokes so that in the interval between the flashes a spoke has moved the distance between two spokes, and to the eye it will appear that the spoke has not moved at all. If we cause the lamp to flash  $f$  times a second and the number of spots in the disc is  $n$ , then to maintain the fundamental fre-

quency the disc must take  $\frac{n}{f}$  seconds to make a complete revolution.

The most common source of interrupted light which we can employ for stroboscopic purposes is that from A.C. mains, and as this is usually 50-cycle supply this gives light with 100 interruptions per second, that is, one interruption for each half wave. It is now easy to see how the number of spokes necessary to obtain a fundamental is calculated. The speed of the disc required with the present thirty-line television is 750 revolutions per minute, or  $12\frac{1}{2}$  per second, which equals an angular velocity of  $360 \times 12\frac{1}{2} = 4,500$  degrees per second. If the interrupted light source is from 50-cycle mains, that is with 100 interruptions per second, then if we divide the number of degrees by 100 this will give us the amount of movement in degrees which will take place between each interruption. In other words this is the distance in degrees which the disc must rotate in a hundredth part of a second.

$$\frac{4,500}{100} = 45$$

We now divided this number of degrees into the total number in the circle, and the answer is the number of spots or spokes which must be employed:

$$\frac{360}{45} = 8$$

The neon lamp provides a very convenient source of interrupted light for producing stroboscopic effects, and it is always worth while fitting one of the small indicator type specially for this purpose. A switch should be provided so that the lamp can be switched on or off at will. The effect can also be observed with ordinary filament lamps, but it is not so pronounced. It should not be forgotten that some of the neon lamps produced specially for television purposes give practically no light on one half of the alternating current cycle, and so in this case the angular velocity must be divided by the number of cycles.

Those who have not A.C. mains available are somewhat at a disadvantage

(Continued in 3rd col. of next page.)

# The Television Society

President: Sir Ambrose Fleming, M.A., D.Sc., F.R.S.

Hon. Secretaries: J. J. Denton, 25, Lisburne Road, Hampstead, London, N.W.5.  
W. G. W. Mitchell, B.Sc., "Lynton," Newbury, Berks.

THE opening night of the seventh session of The Television Society was held at University College, London, on October 10, 1934, at 7 p.m.

W. G. Mitchell, Esq., B.Sc., lecture secretary and editor of the *Journal of The Television Society*, who occupied the chair, pointed out that by opening the session with the yearly talks on the Berlin Radio Exhibition, steps of definite achievement in television progress were placed before members.

In 1931, when Mr. Traub made his first report, the outstanding work of Manfred von Ardenne and his improved cathode-ray tube was appar-

The improvements to be noted were mostly improvements in picture quality, but there was an absence of new ideas; so there was little to report along original lines.

Here followed a full description of the exhibits by Fernseh, A.-G., Tekade, Telefunken, R.P.Z., Manfred von Ardenne, and R.R.G.

By aid of many lantern slides, and the fully tabulated form handed to each member of the audience, all present were made to realise the thoroughness and extent of the television section of the exhibition held last August.

In the October issue of TELEVISION a report of the exhibition was made by Mr. Traub. In this lecture, the fullest technical details were given, of which the following can only be a very meagre summary. Fernseh, A.-G., showed their latest film transmitter, which Mr. Traub referred to as the Rolls-Royce of television. The transmitter was a work of precision, having a 3 ft. disc scanner with four sets of spirals of 45 holes, also a shutter to block out the three unused spirals. Speed 6,000 r.p.m. with maintained vacuum for the disc. The spot light resulted from a special high-intensity water-cooled arc lamp consuming 150 amperes. Two large photo-electric caesium cells with sensitivity of 80 microamperes per lumen were used with this transmitter.

The image, 180 lines, was seen on a cathode-ray tube receiver, the length of which was 3 ft. and the image produced was 12 in. by 10 in.

Tekade:—Ninety and one-hundred-and-twenty line mirror-screws were shown working on alternate days. Long Kerr cells with cylindrical lenses mounted on a valve base were here applied. 180-line mirror-screws using neon lamps were also demonstrated.

Here Mr. Traub fully discussed the technique relating to the new models known as spherical mirror-screws, he also gave details relating to the prisms and Kerr cells used.

A new departure of this firm was the exhibit of a small cathode-ray receiver, of which Mr. Traub showed a lantern slide.

Telefunken:—The best pictures in the show, said the lecturer, and in black and white. The contrast range was blacker than the cinema. The pictorial display being very realistic owing to the selection of subjects, but flicker was intense, and much objected to by the public.

The transmitter used disc scanner, and film subjects were transmitted to the cathode-ray receiver.

Telefunken also showed by flood-light transmission a 3 ft. 3 in. picture due to Professor Karolus, which employed a mirror-drum receiver applying the Karolus four-electrode Kerr cell.

Loewe:—One exhibit gave promise of being a commercial proposition, as it was not difficult to tune, but for the most part the exhibits here were improvements on last year's productions. The picture quality of the cathode-ray receivers shown was due to the high vacuum tubes employed.

Referring to experiments with the telephone and television, the lecturer said the German Post Office had ordered 60-line mirror-screws, and intend experimenting with speech and vision communication between the Science Museum and the postal ministry in Berlin.

The new high vacuum cathode-ray tube of Manfred von Ardenne was illustrated and described, the picture size being 13 by 17 cms., the receiver being operated by the signals received from the Berlin radio transmitter.

The German Broadcasting Company created much interest by televising the crowds in the grounds of the exhibition from a movable van, using an intermediate film transmitter, and demonstrating 90 seconds later.

## "The Stroboscopic Effect"

(Continued from preceding page.)

tage in using stroboscopic methods of speed determination. It is, however, quite practicable to rig up devices of various kinds, both electrical and mechanical, which will provide the necessary number of flashes. One such arrangement employs a tuning fork. The vibration frequency of the tuning fork must be known, and one arm of this serves as an armature which makes and breaks contact of the transformer circuit which energises the neon. The prongs of the fork are kept in constant vibration by means of the electro-magnet and separate battery and contact-breaker.



A German short-wave kit that has been put on the market by Tekade to sell at 90 marks.

ent: In the 1932 report we observed the progress of 7-metre transmission, and last year the development of 180-line television. Mr. Mitchell then called upon Ernest H. Traub, Esq. (foreign secretary) to give his paper on "Television at the 1934 Berlin Radio Exhibition."

A whole hall was devoted to television, said the lecturer, and for the first time seats were provided so that a portion of the twelve hundred persons present could watch in comfort large screen television demonstrations, which were given by the intermediate film method. Seats were also provided for the screen demonstrations by Professor Karolus.

# HUM—AND THE CATHODE-RAY TUBE

*When the cathode-ray outfit is first set up one has to keep an eye open for stray interferences which may upset the performance of the tube. One of the most likely causes of trouble is the ripple on the mains and in this article J. H. Reyner, B.Sc., A.M.I.E.E., shows how this may be nullified.*

LET us consider first of all the effect of an insufficiently smoothed supply to the tube. We will assume that this supply is being obtained from A.C. mains through the customary power unit comprising a step-up transformer, rectifier and smoothing circuit. This supply usually provides a voltage for

tor plate produces a large deflection, whereas with a high gun voltage, the electron velocity is faster and more voltage is required on the deflector plate to produce the same deviation. The small variation produced by ripple on the power supply, however, is negligible as regards this particular effect.

cording to whether the  $12\frac{1}{2}$ -cycle base is running slow or fast.

If these bands are really marked then something must be done to smooth out the power supply and an arrangement such as that shown in Fig. 1 may be adopted. Incidentally this particular arrangement operating off a potentiometer across the power supply is to be recommended for cathode-ray television because the voltages on gun and shield are not seriously dependent upon the gun current. The more usual arrangements as employed in oscillograph work where the shield is biased off the gun current itself, rather like self bias in an ordinary A.C. indirectly heated valve, is not satisfactory because the gun current is fluctuating all the time and therefore the shield bias is not steady.

This, however, is by the way. The point is that if any serious black bands are noticed additional smoothing must be added and, in particu-

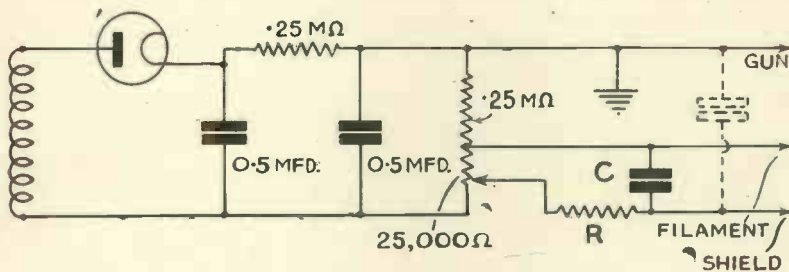

Fig. 1. Typical arrangements for smoothing.

the gun—anything from 600 to 1,500 volts—and also the voltage on the shield or cylinder which is anything up to 80 volts negative under normal conditions.

Neither of these two sources of voltage has to supply any appreciable power. The current taken by the gun under ordinary conditions is something like 50 microamps, so that a large condenser following the rectifier in the power unit will provide practically all the smoothing that is required. Very often a smoothing circuit consisting of a high resistance and another condenser is added as shown in Fig. 1. The very small current taken by the load enables a high resistance to be used as a smoothing choke quite satisfactorily.

Now small variations in the voltage on the gun have practically no effect upon the results. They will not cause the position of the spot to change appreciably since this is controlled by the voltages on the deflector plates. True, if the voltage on the gun varies seriously, then the velocity of the electrons in the beam will also change and this means that the deflection produced by a given voltage on the deflector plate will alter. With a low gun voltage where the electrons are moving slowly a small voltage on the deflec-

The effect of the gun voltage on the brilliance of the spot is also quite negligible from the point of view of ripple and we may therefore say that unless the smoothing on the power supply is hopelessly inadequate no trouble is likely to arise as far as the gun voltage is concerned. The supply to the shield or control electrode is a little more critical because we use this electrode for controlling the brilliance of the spot.

### Effect of Ripple Voltage

Since full modulation is often obtained with as little as 20 or 30 volts it is clear that a ripple voltage of 1 or 2 volts could produce quite an appreciable variation in the brilliance of the spot. Such an effect is shown up by the presence of dark bands alternating with light ones on the screen. If the picture is in perfect synchronism these bands will be four in number and will remain absolutely stationary as shown in Fig. 2. It is more likely, however, that the synchronism will not be perfect, partly because one usually looks for this trouble at a time when there is no transmission taking place, so that there is no synchronising signal, and for this reason the bands will appear to move slowly across the screen ac-

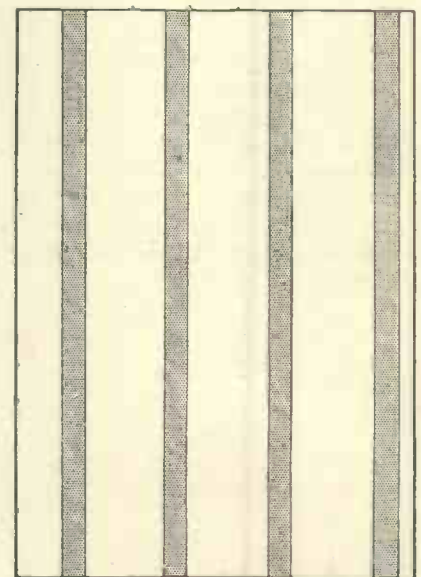

Fig. 2. The effect of a ripple voltage is as shown by this diagram.

lar, care must be taken with the earthing of the power unit. Sometimes also the earthing of the receiver itself requires attention because since the receiver supplies voltage to the shield, any hum in the

output stage of the receiver will produce this same interference effect. Consequently the power unit of the receiver requires careful attention, firstly as regards the smoothing and secondly as regards the earthing.

Indeed this question of hum in the output stage of the receiver is more important than may be imagined. It

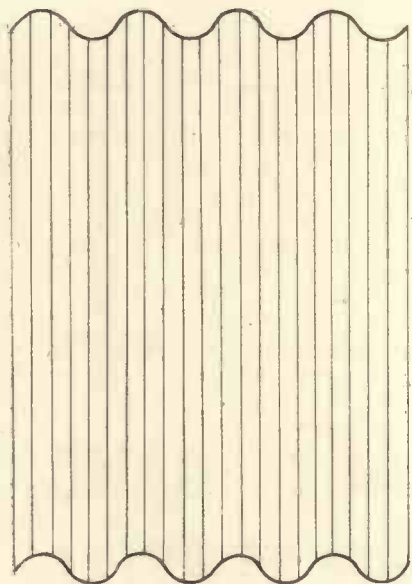

Fig. 3. The effect of stray magnetic fields.

is quite possible to have a ripple of two or three volts in the output of a radio receiver without hearing any serious hum. Yet a hum of this order would be quite sufficient to cause serious interference on a cathode-ray tube set up for receiving television, so that a little attention to this point will often clear up the picture.

It should be pointed out in passing that a faint black band formation is not serious and can be neglected altogether. In fact I sometimes use it myself as a means of checking the correctness of the  $12\frac{1}{2}$ -cycle base. If there are four pairs of bands and these are stationary or nearly so I know that this time base is correct.

### Distortion Due to Hum

We now come to the second form of distortion due to hum and similar effects. This arises not from any ripple on the supplies to the tube itself but to direct action on the beam of electrons by external sources. It must be remembered that the pencil of electrons produced in the tube is

not only affected by the voltages on the deflector plates but can also be deviated by any magnetic field. Some cathode-ray tubes indeed are operated in this way by placing a pair of coils on either side of the neck and passing currents round these coils in order to produce a magnetic field. This deflects the beam instead of using a pair of deflector plates.

It is clear, therefore, that we must take care not to have any fluctuating magnetic fields in the neighbourhood of the tube. You may ask where such fields can come from. The most usual answer is from mains transformers operating in the neighbourhood.

The magnetic flux which we produce in a mains transformer is supposed to reside in the iron of the laminations on which the transformer is constructed. In practice a good deal of it does do so, but there are lines of magnetic field which stray



Fig. 4. The appearance of the trace when there are stray magnetic fields present and the 375-cycle base is cut off.

outside the confines of the iron and wander round the neighbourhood. You would be surprised at the extent of this wandering. I have known a tolerably good transformer exert appreciable influence at a distance of as much as 6 ft. Generally, however, a distance of three feet is sufficient to reduce the effect to small dimensions.

The presence of these stray magnetic fields is shown up by distortion of the picture. The lines do not run parallel with one another but are crowded together at certain parts. In severe cases the top of the frame is not straight but shows a pronounced ripple as shown in Fig. 3. If the 375-cycle base is cut off, leaving what should be a horizontal line on the screen, it will usually be found to show a very lop-sided sort of ripple such as is indicated in Fig. 4

This lop-sidedness is due to the fact that the influence of the magnetic field is not exactly at right angles to the movement produced by the X plates. It is obvious that it would hardly be so except by a pure coincidence and any lop-sided effects of any sort like this is sure indica-

tion of strays picked up by the tube.

The remedy is to keep any mains transformers well away from the tube—at least 3 feet is desirable—and also to enclose any such apparatus in a fairly stout iron box. Twenty gauge sheet iron will be satisfactory and the casing must, of course, be connected to earth. Do not forget that radiation can occur not only from the power unit on the tube but also from the power unit which supplies the receiver. It is possible that the interference is coming from some other power unit not being used on the cathode-ray outfit at all.

### Checking

A very simple method of checking is to remove the mains plugs from any suspected units, one at a time. Even the mains plug of the power supply to the cathode-ray tube may be removed, because there is sufficient energy left in the reservoir condensers of the power unit to keep the tube running for 10 or 15 seconds at least. If the removal of the power unit plug immediately sets matters right so that the wiggleness disappears, then it is the power unit transformer which is causing the trouble. If this action does not have the desired effect, then the source of interference is elsewhere and further tests must be made.

It should be emphasised that in checking for radiation of this sort it is essential to remove the plug from the socket. Switching off is not sufficient because this may still leave one side of the transformer connected to the mains and a small amount of induction can still take place.

Once the apparatus has been set up properly and these various sources of interference located and eliminated, no further trouble is likely to arise in practice. It pays, therefore, to spend a few hours methodically removing any sources of hum or interference so that one is able subsequently to concentrate on the much more important business of obtaining clear and steady pictures.

We have received from Messrs. Ferranti, Ltd., of Hollinwood, Lancs., a copy of a recently issued list of mains components. This includes transformers, chokes, mica paper and electrolytic condensers and resistances. Copies of the list may be had free if mention of this journal is made and a  $1\frac{1}{2}$ d. stamp enclosed for postage.

# SPECIFIED

for the  
**AC - DC TELEVISION  
THREE VALVER**

**Q** The choke specified is the SAVAGE L34 with a resistance of 360 ohms and an inductance of 23 henries at 100 m/A.

Manufacturers type 13/-

PRICES:

Standard type 15/-



**SEND TO-DAY  
FOR PRICE &  
SPECIFICATION  
LIST No. T2.**

The illustration shows a standard type SAVAGE transformer.

*Extra special service on non-standard specifications. Send details for quotation.*

# SAVAGE

W. BRYAN SAVAGE, 56/58, CLERKENWELL ROAD, LONDON, E.C.1.

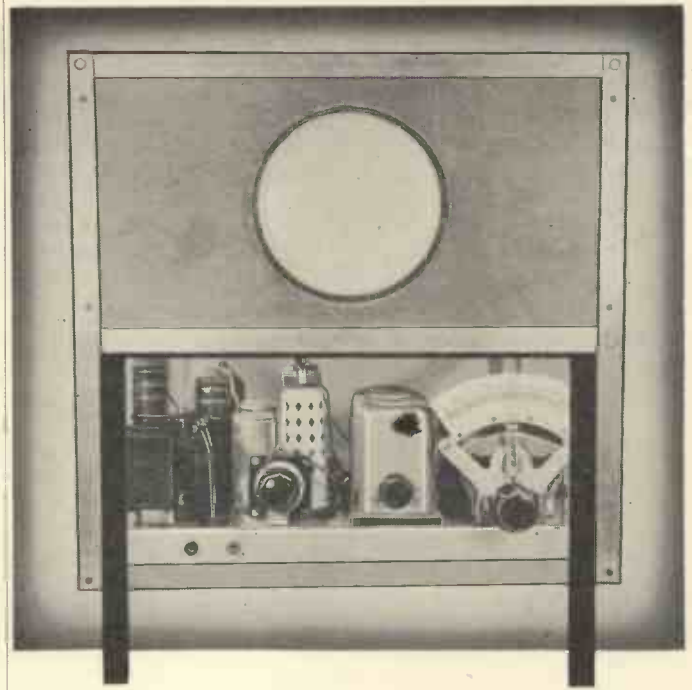

**J.B. BABY GANG  
J.B. DIFFERENTIAL**

# SPECIFIED

FOR THE " TELEVISION "  
**A.C./D.C. 3-VALVE  
TELEVISION SET**

Once again Jackson Bros.' components have been specified ! This time for the " A.C./D.C. 3-VALVE TELEVISION SET." Specified components are reliable components—insist on J.B. and get the best results from this fine television set !



Jackson Bros. (London) Ltd., 72 St. Thomas Street, London, S.E.1. Telephone: Hob, 1929

## The Journal of the Television Society

Principal Contents of Vol. I, Part XI  
(Sept. 1934)

**NOW READY**

**E. H. Traub :**

Television at the 1934 Berlin Radio Exhibition.

**H. R. Ruff :**

Recent Developments in Photo-electric Cells and their Applications.

**E. B. Kurtz.**

Teaching by Television.

Review of current literature and instruments, Notes, etc.

## The Journal of the Television Society

is published three times a year. All members are entitled to a copy ; and it is also sold to Non-Members, at an annual subscription of 15/- post free; single copies 5/-.

Forms of proposal for Membership, and further information regarding the Society, may be obtained on application to the Business Secretary, J. J. Denton, 25, Lisburne Road, Hampstead, London, N.W.3.

Mention of "Television" will ensure prompt attention

# AN EXPERIMENTAL TELEVISION CAMERA

*This article, by H. Montague Smith, F.T.S., contains suggestions for a line of experiment which readers may care to pursue.*

IT is hoped that this article will be found of some help to those who really like experimenting. The apparatus necessary for the experiments described here is cheap, and most readers will have very little to purchase. The ideas given here are simple, and they may lead to something really "worth-while."

Primarily the following apparatus will be used:

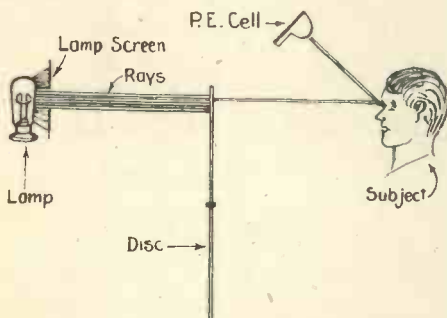

Fig. 1.—The spotlight system of scanning.

A scanning disc—a few blanks will be very useful—but one standard disc will do just as well.

A camera. Either a plate or a film camera may be used. It can be old, or new, with no fear of any damage being done to it.

A photo-electric cell. This can be one of those advertised as "extalkie outfit" cells.

A suitable amplifier for the cell. The other sundries needed may be made for a few pence.

The method usually adopted in transmitting pictures is represented in Fig. 1. The photo-electric cell is actuated by the light reflected from the subject, scanned by a small powerful illuminant. The subject is actually explored by a minute spot of light; the white parts of the subject reflect maximum light, the dark parts practically no light, on to a photo-cell which is placed to catch every reflection. This process has often been described, together with the manner in which the subject is rebuilt, so it is unnecessary to enter into these matters here.

Fig. 2 shows the method adopted

for our experimental apparatus. Here the subject itself is fully illuminated and the scanning disc, instead of cutting up the light falling upon the subject, as in Fig. 1, here cuts up the light from the subject falling upon the cell. It will be apparent that the size of the illuminated subject can be no more than the total scanning area of the disc employed.

Our first problem then is to reduce the size of the subject to conform to this condition, our second is to illuminate that reduced subject in its entirety. Let us take a plate camera and focus it on to a suitable subject. Upon the ground-glass screen, which for the time replaces the sensitised photographic plate, we shall see a reduced and more or less brilliantly lit reproduction of the scene before the lens of the camera. Here then is the solution of our two problems, but it will be realised at this point that another problem has arisen, also connected with size.

It will be appreciated that we are proposing to arrange a disc in close proximity to the ground-glass screen, as in Fig. 2, to explore the illuminated subject. I have already said that it is obvious that the size of this image can be no more than the scanning area of the disc, and it follows, therefore, that the screen itself must be reduced in size. This may be done by making a frame adapter to take a smaller screen, or you will probably prefer to mark out on the

full screen the scanning area, and black the rest in with a light-proof dense black. Incidentally, with a standard 30-hole disc of 16-in. diameter, this scanning area is approximately  $1\frac{9}{16}$  in. by  $\frac{5}{8}$  in.

So now we have our camera focused on to a well-lit scene. On the glass screen at the back we can see the small image (upside down, of course). Fig. 3 will, I think, be

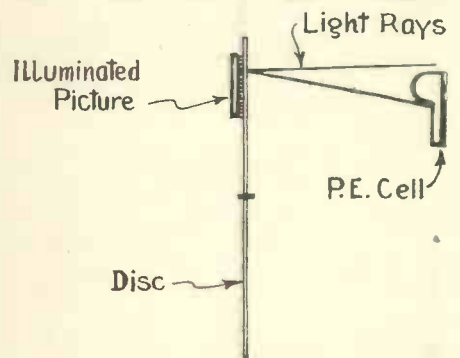

Fig. 2.—The proposed scanning arrangement as suggested in this article.

found self-explanatory and these important points must be observed—(a) the disc must be as close to the screen as possible, and (b) the compartment containing the cell, or cells, must be absolutely light-proof—black velvet will be found useful here. At the

(Continued at foot of page 518.)

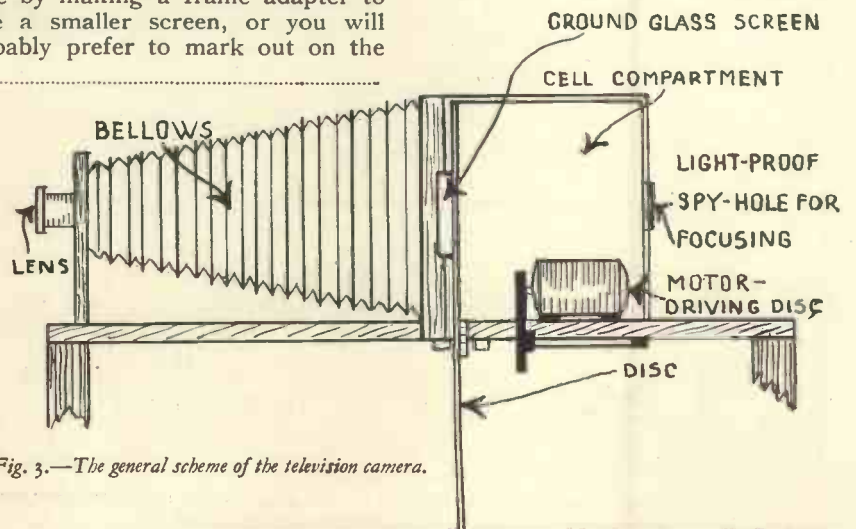

Fig. 3.—The general scheme of the television camera.



## 84 STATIONS ON THE "W.M." STENODE . . . ★

When I tell you that on one Saturday night in October I received and logged 84 stations on the A.C. Stenode, you can take this statement as a general indication of the sensitivity and selectivity of the set. . . .

. . . I was amazed to find that I had starred no less than 32 stations as coming in with good volume and quality, and having a really satisfactory programme value. Quite frankly this seemed an impossible result.

. . . I care only for quality . . . when I say that I could listen with pleasure to at least 30 stations brought in by the Stenode, I am making a statement which amazes me so much that I can still hardly believe it.

A point which struck me very favourably, also in comparison with other super-hets, was the absence of valve noises and other atrocities of a similar kind.

The Stenode is remarkably easy to use, provided one remembers that it is extremely selective and that the tuning must be exactly on the peak.

The extreme selectivity of this set will be a revelation to those who have not previously used a Stenode. The way stations come in and go out as the knob is moved is a revelation.

★ Extracts from a report by Capt. E. H. Robinson on Paul Tyers' A.C. Stenode which appears in "Wireless Magazine" for November.

# WIRELESS MAGAZINE

for November . . . . Price 1/-

# STENODE COUPLERS

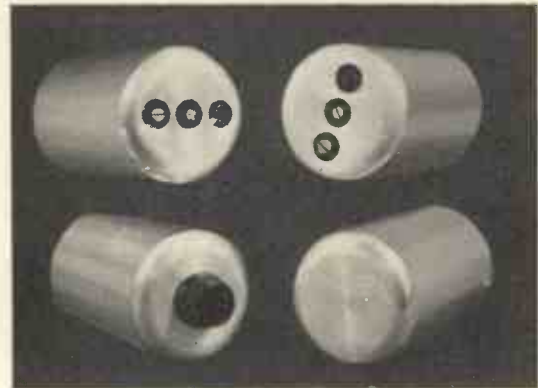

Set of 4 Couplers . . . Price 65/-  
Separate Couplers . . . each 16/6

USUAL Belling-Lee workmanship, quality and finish, has been put into the manufacture of these stenode couplers to the specification of the British Radiostat Corporation.

They comply in every way with the requirements of the inventor Dr. James Robinson, and the designer of the Wireless Magazine Stenode Receivers—Mr. Paul D. Tyers.



## BELLING-LEE

CAMBRIDGE ARTERIAL RD., ENFIELD, MIDDX

Better service results from mentioning "Television" when writing to advertisers

# THE WHITE-LIGHT LAMP

*The following particulars of the White Light lamp have been supplied by Dr. C. G. Lemon, the inventor of the tube.*

The new White Light Television Lamp (Prov. Patent) invented by Dr. C. G. Lemon, which is shown by the accompanying illustration, should be of great interest to all television enthusiasts.



*The Chrystube White-light Lamp.*

The lamp gives a perfectly white light evenly distributed, and tests carried out with a spectroscope show that it has a continuous spectrum, an important feature when viewing coloured scenes in monochrome. The resultant image with a simple disc viewer is just like a photograph in black and white.

A great point of interest about the lamp is its ease of modulation—whereas a neon lamp requires anything from 2 to 4 watts undistorted

output to produce an image, only 1 watt is required for this new lamp. A simple three-valve receiver, for instance, consisting of an H.F. stage, anode-bend detector and triode output, will easily overload the lamp.

From a technical point of view, the lamp may be considered as a non-inductive load of 3,000 ohms, which is suitable for most types of triodes, and is therefore connected directly in the anode circuit of the output valve. The average voltage drop across the lamp is 180 volts and it is capable of being worked from as low as 10 mA to as high as 40 mA. The brilliancy is, of course, greatly increased at high current densities. The striking voltage is in the region of 300 volts, but as most mains-operated receivers deliver a no-load voltage in excess of this figure, no auxiliary voltage supply is required.

Provision should, of course, be made in the output stage of the receiver to allow for the 180 volts drop across the lamp without actually starving the valve. For best results it is usually recommended to use a low impedance output valve, such as the Mullard AC/044 or Osram PX4, which both work admirably at 200 volts and to use an anode supply of from 350 to 400 volts. As only 1 watt is required for modulation, the valve will not require its full input.

It has been found that in some districts where signal strength is insufficient to give a picture with an ordinary neon lamp, perfect pictures are obtainable with Dr. Lemon's white lamp.

The lamp is fitted with a standard 4-pin valve base and the connections are taken to the grid and anode pins. The grid pin is to be connected to the anode of the output valve and the anode pin to H.T. positive.

The price of this lamp is 21s. and supplies are obtainable from the Chrystube Manufacturing Co., Ltd., No. 7 Factory, Waddon, Croydon.

## "An Experimental Television Camera"

*(Continued from page 516.)*

back of this compartment a light-proof "spy-hole" must be made, so that you will be able to focus the scene on to the screen.

In conclusion, a few idle thoughts that might help you. The standard disc speed is at 750 revs. per minute, that is 12½ picture-explorations a second. That speed is sufficient for slowly moving subjects; where, how-

ever, reproduction of greater speeds is required, the disc may be speeded up to, say, 20 pictures per second, i.e., 1,200 r.p.m. Any extra difficulties due to this speed I leave to you: you are the experimenter, not I. The standard 30-hole disc is adequate for ordinary subjects.

There are a great number of interesting variations of the above arrangements that may be tried, some of which are:

- (1) The disc may be in front of the screen—that is, between the lens and screen—thus acting upon the light before it reaches the screen.
- (2) The screen may be omitted, in which case the image may be focused upon the disc itself.
- (3) Try focusing on to the cell.
- (4) A large condenser lens may be placed between the cell and the disc.
- (5) The image, after exploration, may be focused on to a system of mirrors, either to spread or concentrate the light eventually to the cell.
- (6) If the camera is of the long-extension type, and a highly magnified image is procurable of any object placed close to the lens, an interesting object would be an insect, say, contained in a glass vessel and upon which a powerful light is shone.

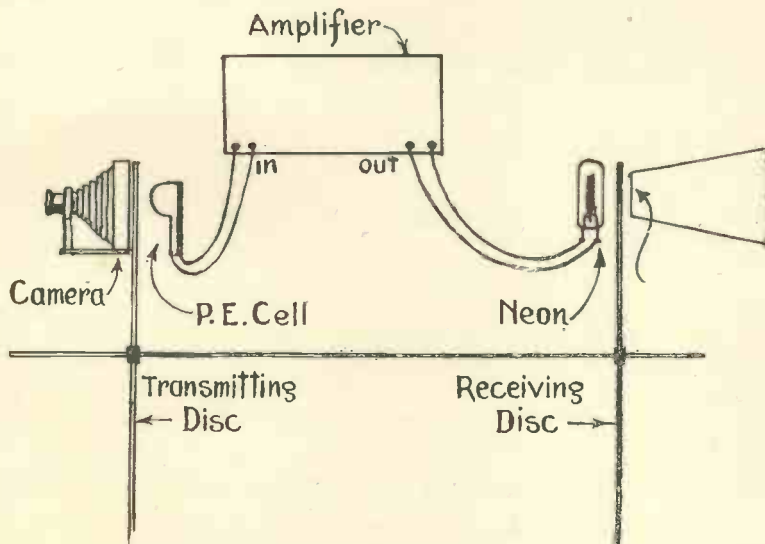
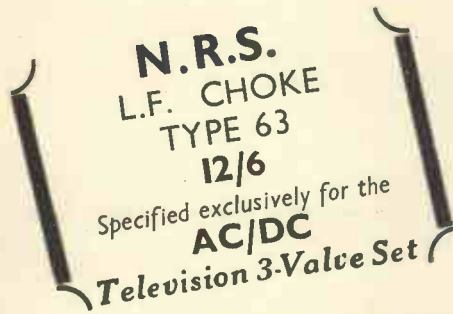

Fig. 4.—Showing the arrangement of the transmitter and receiver.

Fig. 4 will be found to be a suitable arrangement for the whole experiment. Bear in mind that whatever you do at the transmission end must be faithfully copied at the receiving end. Finally, remember that if we knew what results we would get from anything, there would be no need to experiment! I should be pleased to hear what results you get!



# Exclusive Specification



**N.R.S.**  
L.F. CHOKE  
TYPE 63  
12/6  
Specified exclusively for the  
AC/DC  
Television 3-Valve Set

Accuracy with reliability is absolutely necessary in television. N.R.S. components can be relied upon in every way. Television Set constructors know the value of N.R.S. component parts, and their Service. Special components made to any specification.

The **NATIONAL RADIO SERVICE CO.**

Specialists Radio Repairs

Technical Consultant: S. G. BROWN, F.R.S., M.I.E.E.

15/16, Alfred Place, Tottenham Court Road, London, W.C.1

Telephone: MUSEUM 7651

## The highest degree of efficiency!



**TELEVISION DEMANDS** that only components of proved reliability be chosen. **SOUND SALES**

wide range of Television Components are worthy of your consideration. They are used by leading Television companies and are consistently specified by well-known designers of television apparatus.

### TRANSFORMERS AND CHOKES

Cathode-Ray tube excitor transformers. Input 210/230/250. H.T. secondary 1,000 v. at 5 m.a. 1-0-1 at 1.5 amps. .75-0-.75 at 1.25 amps. Type ED/1000. N.B.—No additional 2 v. accumulator is needed for the tube heater. Specially designed for the Edison Swan Cathode-Ray tube—as supplied to Messrs. Edison Swan, Ltd., and recommended by them ... £3-0-0  
Separate H.T. and L.T. excitor transformers, for use with Cossor tubes as described by Mr. Haynes in the "Wireless World" Cathode-Ray Oscillograph. Type HTC/3000. H.T. transformer maximum input 240. H.T. secondary 0-1500-3000 at 50 microamps ... £2-0-0  
L.T. transformer. Input 0-120-220-240 pilot winding 3.5 v. at .5 to 1 amp. Rectifier winding 0-2-4-6 v. ... £1-0-0  
Special Heavy Duty 30 Hy. L.F. Choke (Type S.R.C.1250) as exclusively specified for "The Standard Television Receiver." Also suitable as a speaker replacement choke for the new 6 watt "Wireless World Mondial." D.C. resistance 1,250 ohms, Inductance 30 henrys at 120 m.a. ... £1-5-0

Specified by **SOUND SALES** the Experts

SOUND SALES Ltd. Phone: Archway 1 166-2

Tremlett Grove Highgate, London, N.19

Write for Special Television Components List "V."

# THE LAMP

FOR TELEVISION

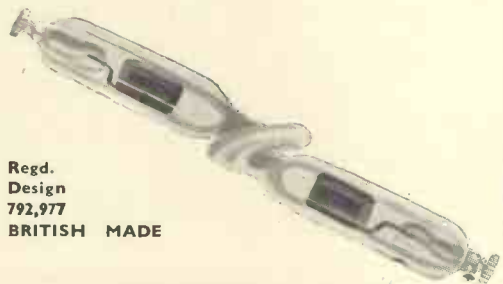

Regd. Design 792,977 BRITISH MADE

25/-

## THE MOST BRILLIANT TELEVISION LAMP YET PRODUCED.

Adaptable to ALL modulated lamp systems. Can be used for direct viewing or projection.

**CAN PROJECT A PICTURE ON A SCREEN THROUGH A DISC.**

Demonstrated before many well-known consultants and experimenters who have, without exception, agreed that the "Ti" lamp is the most powerful light source available and the only lamp that can project a picture through a simple disc with results equal to most expensive systems.

A customer writes:—  
"Your statements are in no way exaggerated, the results are certainly equal, if not superior, to Cathode Ray or the expensive Mirror Drum scanner."

**THE "Ti" POWER PACK INCORPORATING WESTINGHOUSE METAL RECTIFIER** In crystalline louvered metal case providing adequate voltage and current for "Ti" and all other gas discharge lamps. **55/-**

The "Ti" Projection lens ... ..	8/6
The "Ti" Reflector ... ..	4/6
The "Ti" Combined reflector and lamp stand ... ..	5/-

"Ti" lamp ...	} Combined ... ..	32/6
"Ti" reflector ...		
"Ti" stand ...		
4" and 6" lenses for projector receiver	22/6 pair.	

The Revolutionary Screen Projector described in the October issue of this journal may be inspected at any time at the address below. YOU are invited to call.

**TELEVISION INSTRUMENTS LIMITED**  
323, CITY ROAD, LONDON, E.C.1  
Telephone: Clerkenwell 4494.

There is news in the "Television" advertisements

**The Constructors' Circle  
Additional Members**

R. Appleton, 44 Delce Road, Rochester, Kent; A. Mac, 14 Edward Street, Aldershot, Hants; P. R. Coleman, "Wayside," 92 Melton Road, Syston, nr. Leicester; T. H. Seymour, 331 Ashton Old Road, Lr. Openshaw, Manchester; L. V. C. Tarling, 11 Senghenydd Road, Cathays Park, Cardiff; R. Kitchen, 18 Stot Fold Road, King's Heath, Birmingham; W. Murgatroyd, 5 Kenwyn Avenue, Blackpool, Lancs; M. W. Boulton, Birks Hall, Cragg Vale, Mytholmroyd; H. C. Turnham, 48 Edgehill House, Loughborough Road, Brixton, S.W.9; R. Pentecost, 55 Princess Victoria Street, Clifton, Bristol, 8; R. S. Copeland, Elmfield, Harrow, Middlesex; E. W. Tandy, "Homestead," 73 The Drive, Loughton, Essex; I. Waters, Sutton Valence School, Maidstone, Kent; J. R. Ford, 6 Maynard Road, Walthamstow, E.17; D. M. R. Collinson, "Fownhope," Albany Road, Fleet, Hants; A. Whitehead, Flint Hill House, nr. Horncastle, Lincs; T. G. Atkinson, Myrtle House, Roadside, Netherton, nr. Huddersfield, Yorks; B. P. Martin, St. Jude's Vicarage, Mapperly, Nottingham, Notts; C. W. Cannell, 30 Highfield Road, Dartford, Kent; C. Richardson, 27 Melton Road, South Tottenham, N.15; F. E. T. Clarke, "Bonnie Doone," Trent Lock, Sawley, nr. Derby; J. J. Dobson, 24 Rutland Road, Ansdell, Lytham; R. Elias, 86 Queensborough Gardens, Ilford.

**Other Television Patents  
(Patent No. 414,616.)**

Kerr cells having a high "constant" and using substituted derivatives of the benzene ring as the electro-optical liquid.—(*Sueddeutsche Telefon, Kabel and Drahtwerke Akt., "Tekade."*)

(Patent No. 414,905.)

Improvements in the composition and manufacture of fluorescent screens as used in cathode-ray tubes.—(*Marconi's Wireless Telegraph Co., Ltd.*)

(Patent No. 415,036.)

Mirror-drum scanning system in

which the scanning beam is split up into a numbers of different rays.—(*J. L. Baird, and Baird Television, Ltd.*)

(Patent No. 415,071.)

Improvements in cathode-ray tubes of the "hard" type.—(*Electric and Musical Industries, Ltd.; W. F. Tedham; and J. D. McGee.*)

**"Simplest Cathode-ray Receiver"**

(Continued from page 502.)

socket being flexible, the tube can be turned by slight pressure on the front of the bulb and the picture can be "squared up" when it is being received. The socket and the plywood circle can be seen in the photographs. The socket itself is a special insulated one supplied by Messrs. Stratton & Co. for short-wave receivers, and is air-spaced between the contacts. Although the voltage between the pins on the tube is not excessive (it will not exceed 700) it is advisable to guard against leakage wherever possible.

To provide for slight discrepancies in the length of the tube itself the socket board has been made adjustable. On each end is fastened a piece of angle strip, or a component bracket which is bolted to the component bracket attached to the main frame. The socket strip can thus be slid up and down until the tube is fitted in the hole in the panel, when it can be secured in position by tightening the nuts. The angle brackets can be seen in the photographs and the drawing.

**"Television"**  
will keep you abreast of the  
times.

The time-bases and tube controls which will be fully described in next month's issue are mounted on two strips of  $\frac{3}{8}$ -in. plywood measuring 6 in. by  $19\frac{1}{4}$  in., which fit on either side of the tube on the centre platform.

(To be continued.)

**Life of Cathode-ray Tube**

Properly used, a cathode-ray tube should last for from 500 to 600 hours. Its life will, however, be considerably shortened if the filament is overrun or too great a voltage is used on the anode—in other words if the tube is forced. It also may be damaged by allowing the spot to remain on one part of the screen for any length of time. Tubes have been improved very considerably of late in respect of length of life, and the user will only have himself to blame if the useful life falls short of the period mentioned above.

**The Postmaster General's  
Committee**

Visits to U.S.A. and Germany

Some members of the Postmaster-General's Television Committee, which included Lord Selsdon, Col. A. S. Angwin, Mr. Noel Ashbridge, and Mr. F. W. Phillips, sail for America on October 24 in order to study at first hand American television system.

Other members of the Committee are to visit Germany for the same purpose. No exact date has been fixed for their return but it is expected that it will be in the later part of November.

**Controlling Scanner Speed**

The action of a variable resistance in controlling the speed of a scanning motor is somewhat slow, and it frequently happens that once the motor has run away a considerable time elapses before it can be brought back. A useful tip is to set the control so that the tendency, if anything, is for the motor to increase its speed, then, if the scanner gets too fast, to flick the motor switch off momentarily. A little practice will enable this to be done so that the speed returns almost instantly and the control, of course, remains set. Another useful dodge in cases where synchronising gear is fitted is to momentarily short the synchronising coils.

Television has become a subject of world-wide interest, and this journal circulates in all parts of the world. If you are unable to obtain your copy locally, we will dispatch it regularly each month after receipt of this form and remittance.

BERNARD JONES PUBLICATIONS, LTD., 58-61, Fetter Lane, London, E.C.4.

**"TELEVISION" SUBSCRIPTION FORM.**

Starting with the issue dated .....

Period.....months.

Remittance to the value of.....enclosed herewith

Name .....

Address .....

Date .....

"Television" is published on the last Wednesday of each month, bearing date of the month following.

Subscription Rates : Great Britain and Abroad 13/6 for twelve months, post free ; 6/9 for six months, post free ; 3/6 for three months, post free.

# FULL DETAILS of ENGLISH PROGRAMMES from TWELVE CONTINENTAL STATIONS

Every week RADIO PICTORIAL devotes seven pages in giving full details of the English-speaking programmes from Continental stations for the coming week.

These programmes are exclusive to RADIO PICTORIAL.

RADIO PICTORIAL always contains forty pages revealing in pictures and in words the latest news and gossip about radio stars and well-known personalities of the microphone.

RADIO PICTORIAL appears every Friday, and is sold by all newsagents and bookstalls—price 3d.

# RADIO PICTORIAL

★ Listen to the "Radio Pictorial" Concerts from Radio Normandy and Paris (Poste Parisien)

Full details of Programmes etc. in the current issue.

40 pp. Every Friday  
Price - - 3d.

## H. E. SANDERS & Co

### THE NEW LAMP

Development. Let us demonstrate the marvellous new principle—

### THE "MERVYN" DUPLEX NU-GLO 16

"Two Lamps in One."

Striking voltage, 180-200 volts.

Price 12/6. Post 6d.

OUR SUPER LENS 5" DIA. Used in conjunction with the new lamp. PICTURES 4½" in size can be obtained. Price 7/5. Post 6d.

SANDERS SUPER LENS, 4" dia., for larger non-distorted pictures. Price 4/6. Post 6d.

DISC RECEIVER KIT, including Nu-Glo Lamp and Baseboard Fittings. Price £3 Carriage Paid. Handbook, "Easy Lessons In Television." 2/- Post Free.

Send for Illustrated List.

## H. E. SANDERS & Co

4, GRAYS INN ROAD, LONDON, W.C.1

Telephone: Chancery 8778

### THE CONSTRUCTORS' CIRCLE

#### Application for Membership

To be filled in and sent with a stamped envelope for reply to the Editor, "Television," 58-61, Fetter Lane, London, E.C.4.

- (1) I already subscribe to your journal at the address below.
- (2) I have placed a regular order for TELEVISION with my booksellers, Messrs.....

.....  
.....  
and desire to be enrolled as a member of the TELEVISION "Constructors' Circle."

Please send membership badge free of charge to

Name (in block letters) .....

Address .....

\*Strike out lines not applicable.

### "TELEVISION" COUPON

#### FOR FREE INQUIRY SERVICE

Name .....

Address .....

November, 1934.

### MISCELLANEOUS ADVERTISEMENTS

The charge for advertisements in these columns is 12 words or less 2/-, and 2d. for every additional word. All advertisements must be accompanied by remittance. Cheques and Postal Orders should be made payable to Bernard Jones Publications Ltd., and crossed, and should reach this office not later than the 15th of the month previous to date of issue.

A. MATHISEN, CHARTERED PATENT AGENT. Patents, Designs and Trade Marks.—First Avenue House, High Holborn, W.C.1. Holborn 8950. Telegrams: "Patam," Holb., London.

HALF PRICE.—AF5C, valves, etc., callers only.—Davies, 1, Clovelly Avenue, Colindeep Lane, Hendon.

WANTED—Small Television Transmitting Set. Price, particulars.—G., 19, Stockwell Gardens, S.W.9.

TELEVISION and Wireless Parts, cheap. Write list.—Smith, 98, West End Road, Morecambe.

PATENTS—Trade Marks, Advice. Handbook and Consultations Free.—B. T. King, Patent Agent, G.B., U.S.A. and Canada. 146a, Queen Victoria Street, London. 48 years references. Phone: City 6161.

KINGSTONE QUALITY COMPONENTS.—The "NuVu" Television Kit, 42/-. Motors: 1/16 h.p., 19/-; 1/40 h.p., 15/-. Synchronised motor, 30/-. Speed regulator, Type A, 7/6; Type B, 5/-. Complete synchroniser outfit, 14/6. Synchroniser coils, 4/- pair. Toothed wheels, machine cut, 4/8. Kerr cell, 10/-. Scanning discs, 20" diameter, 9/-. Stamp for illustrated list—Kingstone & Co., 372, Essex Road, London, N.1.

\$40.00—Inventions patented—United States.—Samuel Goldstein, Registered Attorney, 275, East Gunhill Road, New York City.

TELEVISION MOTORS and other components, clearing at greatly reduced prices. Illustrated lists free.—Ansel Ciné Television Co., 16, Highbury Terrace, N.5.

### BENNETT TELEVISION KIT 60/- COMPLETE RECEIVER

THIS IS A SPECIAL 7 DAYS OFFER. EVERY PURCHASER WILL RECEIVE THE 67/6 BENNETT RECEIVER, WHICH INCLUDES VIEWING LENS AND USES NU-GLO LAMP. ORDER TO-DAY and "SEE FOR YOURSELF." BICONVEX 4" diam. Non-distorting Lens, 12" f.c., 4/6. BICONVEX PROJECTOR LENS, 2½" f.c., 1½" diam., 4/6. "Ti" LAMP FOR DISC PROJECTION, 25/-. CRATER LAMP Mercury neon (strikes 150v.), 37/6. MIRROR-DRUM READY FOR ASSEMBLY, 55/-. A.C./D.C. MOTOR, 20/-. 6-VOLT MOTOR, 22/6. CATHODE RAY TUBE (Ediswan), 6 guineas. Write for details of apparatus and Free List.

TRADE SUPPLIES Lists now ready.

PRACTICAL TELEVISION HANDBOOK, 1/-

BENNETT TELEVISION Co., REDHILL

### INDEX TO ADVERTISERS

Belling & Lee, Ltd. . . . .	517
Bennett Television, Ltd. . . . .	Cover iii
Chrystube . . . . .	473
Edison Swan Electric Co., Ltd. . . . .	Cover iv
Ferranti, Ltd. . . . .	Cover ii
General Electric Co., Ltd. . . . .	Cover ii
Jackson Bros. . . . .	515
Leaman . . . . .	505
Lectro Linx, Ltd. . . . .	473
Mervyn Sound & Vision Co., Ltd. . . . .	474
National Radio Service, Ltd. . . . .	519
Sanders, H. E., & Co. . . . .	Cover iii
Sound Sales . . . . .	519
Savage, Bryan . . . . .	515
Television Instruments, Ltd. . . . .	519
Television Society . . . . .	515
Varley . . . . .	Cover ii
Wireless Magazine . . . . .	517
Westinghouse Brake & Saxby Signal Co., Ltd. . . . .	473

It helps us if you mention "Television"

PURVEYORS OF  
ELECTRIC LAMPS  
BY APPOINTMENT



# EDISWAN



MANUFACTURERS  
& PURVEYORS OF  
ELECTRIC LAMPS  
BY APPOINTMENT

# CATHODE RAY OSCILLOGRAPH

with the improved  
Fluorescent Screen

for

# TELEVISION AND RADIO RESEARCH



Exciter Unit. Prices on application.

The Ediswan Cathode Ray Oscillograph is of the "sealed off" type and possesses a number of unique refinements. Full particulars of this tube and of suitable circuits for its use as a Television viewer, or in research work, will be supplied on request.

*We invite enquiries for:—*

- ★ Mercury Vapour Rectifiers.
- ★ Grid controlled discharge tubes for time bases.
- ★ High Vacuum Diodes.
- ★ Transmitting Valves, low and medium powers.

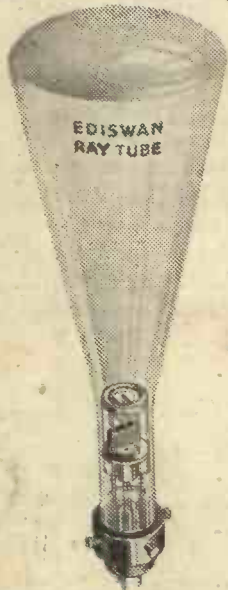

Ediswan Ray Tube  
Price £6. 6. 0.

# EDISWAN

# RADIO VALVES



THE EDISON SWAN ELECTRIC CO.  
LTD., 155, CHARING CROSS ROAD,  
W.C.2  
RE 222

*Used by all Government Departments*